

PRECISIONTM
BY TRANSCAT[®]

User Manual

TCL-SERIES BALANCES

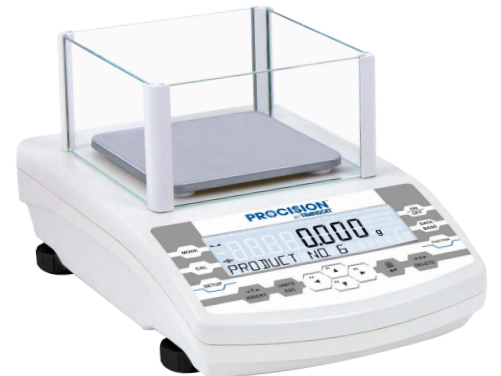

March 2021

TABLE OF CONTENTS

1. GENERAL INFORMATION	1
1.1. INTENDED USE	1
1.2. INAPPROPRIATE USE	1
1.3. WARRANTY	1
2. UNPACKING AND INSTALLATION	1
2.1. STANDARD DELIEVERY COMPONETS LIST	1
2.2. PLACE OF USE AND ASSEMBLY	1
2.3. UNPACKING	2
2.4. BALANCE ASSEMBLY	2
2.5. BALANCE LEVELING	6
2.6. POWERING THE DEVICE	6
2.7. AMBIENT CONDITIONS STATE INDICATION (ANALYTICAL BALANCES)	7
3. BALANCE KEYBOARD	8
3.1. USER MENU	9
3.2. ADMIN LOG-IN	10
4. BALANCE OPERATION- GENERAL INFORMATION	11
4.1. BALANCE ZEROING	11
4.2. BALANCE TARING	11
4.2.1. MANUAL TARE DETERMINATION	11
4.2.2. DELETING TARE	12
4.2.3. TARE DATABASE	12
4.3. UNITS	12
4.4. TEMPORARY MEASURING UNIT	12
4.5. UNITS ACCESSIBILITY	13
4.6. START UNIT SELECTION	13
4.7. CUSTOM UNIT	13
5. WORKING MODES- GENERAL INFORMATION	14
5.1. RUNNING WORKING MODE	15
5.2. WORKING MODE ACCESSIBILITY	15
5.3. WORKING MODE PROFILE	16
5.4. WORKING MODE SETTINGS- READING	16
5.4.1. FILTER LEVEL SETTING	17
5.4.2. VALUE RELEASE	17
5.4.3. AUTOZERO	18
5.4.4. LAST DIGIT DISPLAY	18
5.4.5. BALANCE AMBIENT CONDITIONS	18
5.5. WORKING MODE SETTINGS- AUTOTARE	19
5.6. WORKING MODE SETTINGS- PRINT MODE	20
5.7. WORKING MODE SETTINGS- INFORMATION	21
5.8. WORKING MODE SETTINGS- Non-Standard INFORMATION	22
5.9. WORKING MODE SETTINGS- F shortcut keys	23
6. CALIBRATION	24
6.1. CALIBRATION Menu Settings	24

6.2. MANUAL CALIBRATION	24
6.2.1. EXTERNAL CALIBRATION.....	24
6.2.2. USER CALIBRATION.....	25
6.3. CALIBRATION REPORT PRINTOUT	25
7. WEIGHING	25
7.1. UNDER-PAN WEIGHING	27
8. PARTS COUNTING	27
8.1. SETTING REFERENCE MASS: MASS DETERMINATION FOR THE SAMPLE OF KNOWN QUANTITY	27
8.2. SETTING REFERENCE MASS: ENTERING MASS VALUE.....	28
9. CHECKWEIGHING.....	29
10. DOSING.....	30
11. PERCENT WEIGHING	31
11.1. SETTING THE REFERENCE MASS: WEIGHING REFERENCE SAMPLE	31
11.2. SETTING THE REFERENCE MASS: ENTERING THE MASS VALUE.....	32
12. DENSITY OF SOLIDS.....	32
13. DENSITY OF LIQUIDS.....	34
14. ANIMAL WEIGHING.....	36
14.1. RUNNING THE PROCESS MANUALLY.....	36
14.2. RUNNING THE PROCESS AUTOMATICALLY	37
15. STATISTICS.....	38
15.1. DELETING STATISTICS	39
16. PEAK HOLD.....	40
17. TOTALISING	41
18. PIPETTES CALIBRATION	42
19. ADDING.....	46
20. DATABASES.....	48
20.1. USERS	48
20.2. PRODUCTS	49
20.3. TARES	50
20.4. WEIGHINGS.....	50
20.5. ALIBI MEMORY	52
21. EXPORT AND IMPORT OF DATABASES	53
21.1. DATABASE EXPORT	53
21.2. DATABASE IMPORT	54
21.3. MEASUREMENT DATA PRINTOUT	54
22. MISCELLANEOUS PARAMETERS	55
23. DETERMINING PRINTOUT CONTENT.....	58
23.1. CALIBRATION REPORT	58
23.2. HEADER, FOOTER, GLP PRINTOUTS	58
23.3. NON-STANDARD PRINTOUTS	60
23.3.1. INSERTING TEXT.....	60
23.4. VARIABLES	62

23.5. SEPERATOR	63
24. COMMUNICATION.....	63
24.1. RS 232 PORT SETTINGS (COM)	63
24.2. WIFI PORT SETTINGS.....	64
24.3. PORT USB	65
25. PERIPHERAL DEVICES	66
25.1. COMPUTER	66
25.1.1. COMPUTER CONNECTION PORT.....	66
25.1.2. CONTINOUS TRANSMISSION	67
25.1.3. PRINTOUTS INTERVAL FOR CONTINOUS TRANSMISSION	67
25.2. PRINTER.....	67
25.3. BARCODE READER	69
25.4. EXTERNAL BUTTONS	69
26. COOPERATION WITH PERIPHERALS.....	70
26.1. TRANSFERRED DATA FORMAT	71
26.2. FORMAT OF DATA SENT ON PRESSING PRINT BUTTON	71
26.2.1. RESPONSE FORMAT	72
27. COMMUNICATION PROTOCOLS.....	72
27.1. LIST OF COMMANDS	73
28. APPENDIX	84
28.1. DIMENSIONS	84
28.2. CONNECTORS	85
28.3. Maintenance Activities	85
28.4. Connection Cables - Diagrams	87
29. Error Messages.....	87

1. GENERAL INFORMATION

1.1. INTENDED USE

Transcat TCL-series balances are designed to provide accurate measurement of weighed loads, performed under laboratory conditions. It is intended for application as a non-automatic weighing instrument only, i.e. the material to be weighed is manually and carefully placed in the center of the weighing pan. Weighing result should be read only after stable reading has been obtained.

1.2. INAPPROPRIATE USE

- Prior to first use, it is highly recommended to carefully read this User Manual, and operate the balance as intended.
- Do not use the balance for a dynamic weighing. Even if small quantities of weighed material are added or removed from the weighing pan of the instrument, the reading should be taken only after stabilization of the measurement results.
- Do not place any magnetic materials on the weighing pan, as this can cause damage to the measuring system of the instrument.
- While loading the balance make sure that load is placed in the very center of the weighing pan.
- Make sure the load does not exceed instrument's measuring range (maximum capacity).
- Do not leave heavy loads on the weighing pan for a long period of time.
- In case of failure, immediately unplug the instrument.
- Balances to be decommissioned, should be decommissioned in accordance with valid legal regulations.
- Do not use the balance in areas endangered with explosion. The balance is not designed to operate in EX zones.

1.3. WARRANTY

Warranty is invalid for the following:

- Non-observation of the guidelines of this user manual
- Use of the balance other than specified in this manual
- Alteration to or opening of the device

2. UNPACKING AND INSTALLATION

2.1. STANDARD DELIVERY COMPONENTS LIST

- Balance and components shown in Section 2.4 depending on balance model
- Warranty Card
- User Manual

2.2. PLACE OF USE AND ASSEMBLY

- The balance should be stored and used in locations free of vibrations and shakes, free of air movement and dust.
- Ambient air temperature should not exceed the range of: +10 °C ÷ +40 °C.
- Ambient relative humidity should not exceed 80%.
- During balance operation, ambient temperature in the weighing room should not change rapidly.

- The balance should be located on a stable wall console desk or a stable working table which is not affected by vibrations and distant from heat sources.
- Take special precaution when weighing magnetic objects, as part of the balance is a strong magnet. Should such loads be weighed, use under-pan weighing option, which removes the weighed load from area influenced by the balance's magnet. The hook for under-pan weighing is installed in balance's base.
- Keep all package element should your device be transported in the future. Remember that only original packaging can be used for shipping purposes. Prior to packing, uncouple any cables, remove any separable components (weighing pan, shields, inserts). Pack the device components into an original packaging. The original packaging protects the equipment against potential damage during transportation.

2.3. UNPACKING

To unpack the system, follow the diagram below-

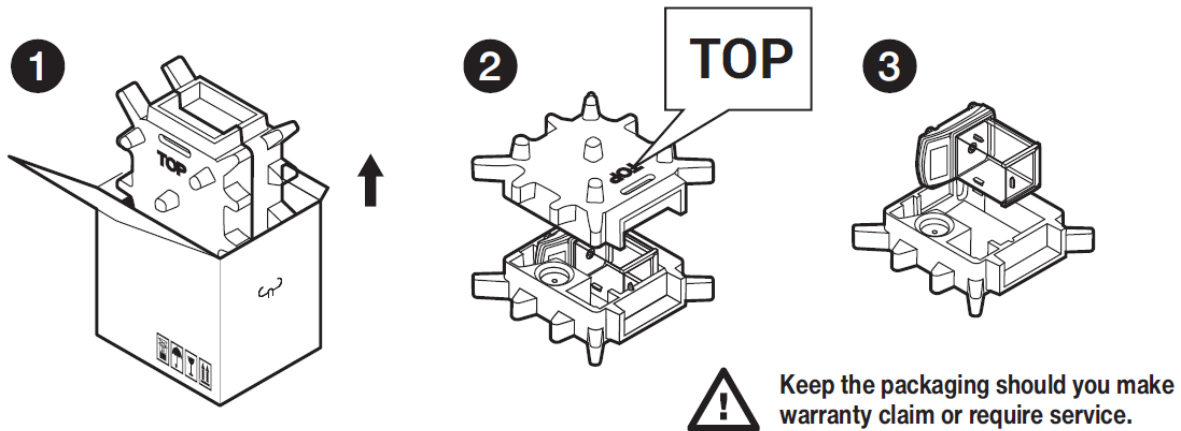

2.4. BALANCE ASSEMBLY

Model: TCL-64, TCL-224, TCL-314
Components-



Balance
x 1



Weighing pan
x 1



Draft shield
x 1



Bottom insert
x 1



Power adapter
x 1

Installation-

1) Remove the transport lock– gently press the transport lock and turn it accordingly to <OPEN>, keep the transport lock should your balance be transported in the future.

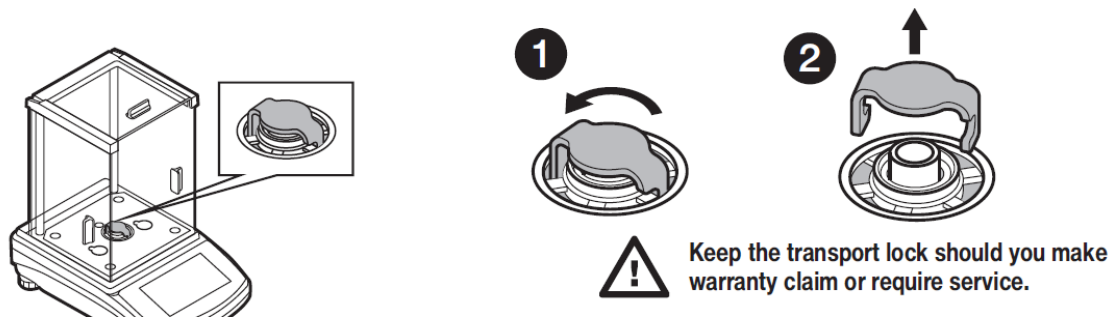

2) Check grounding spring to insure it is in the appropriate location. Make sure that the grounding spring juts slightly out of the hole.

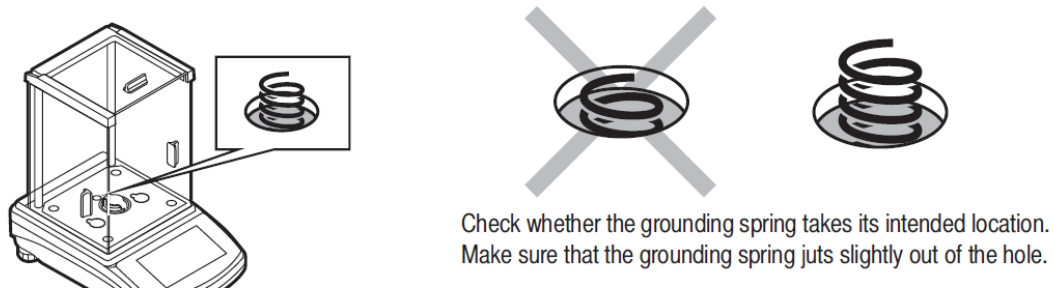

3) Install components following diagram below:
 i. Bottom insert
 ii. Centering ring [embossment side up]
 iii. Weighing pan

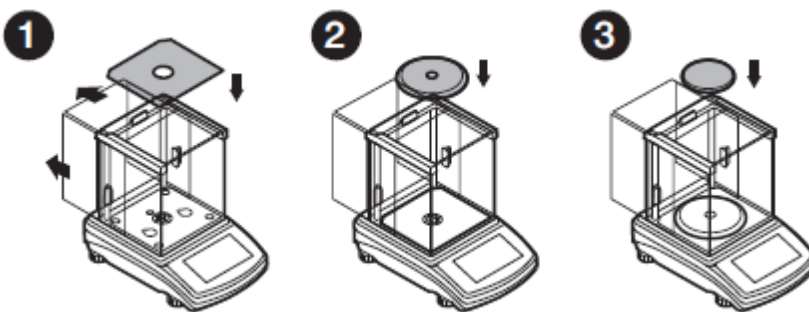

Model: TCL-363, TCL-603, TCL-1003

Components-

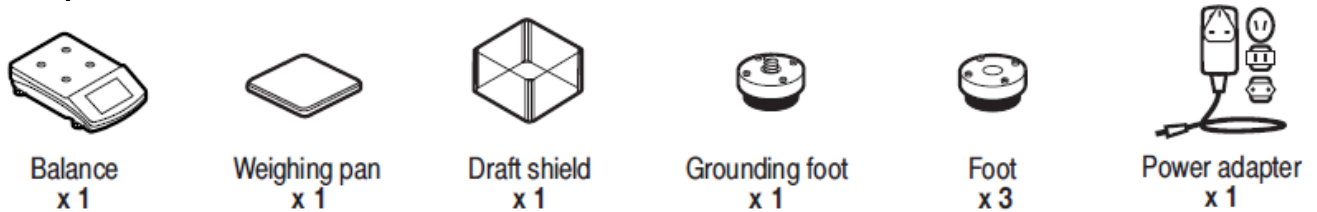

Installation-

1) Remove the transport lock– keep the transport lock should your balance be transported in the future.

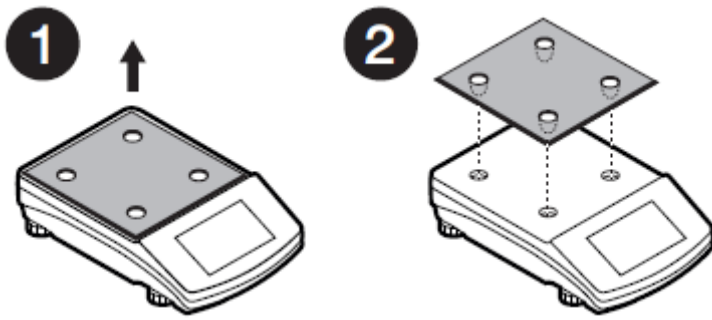

2) Check that the grounding spring is in the correct location, the spring juts slightly out of the hole.

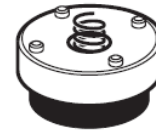
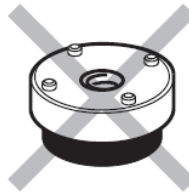

Check whether the grounding spring takes its intended location. Make sure that the grounding spring juts slightly out of the hole.

3) Install components following diagram below:

- i. Grounding foot and feet
- ii. Weigh pan
- iii. Draft shield

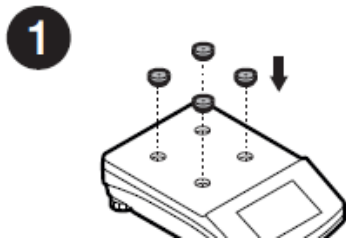

Install the grounding foot in a freely selected opening.

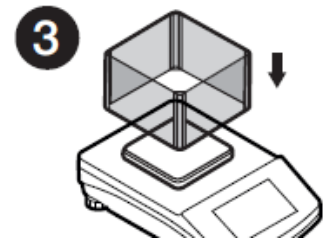
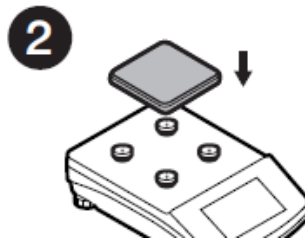

Model: TCL-2102
Components-

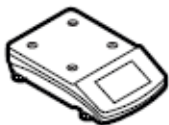

Balance
x 1



Weighing pan
x 1



Grounding foot
x 1



Foot
x 3



Power adapter
x 1

Installation-

1) Remove the transport lock– keep the transport lock should your balance be transported in the future.

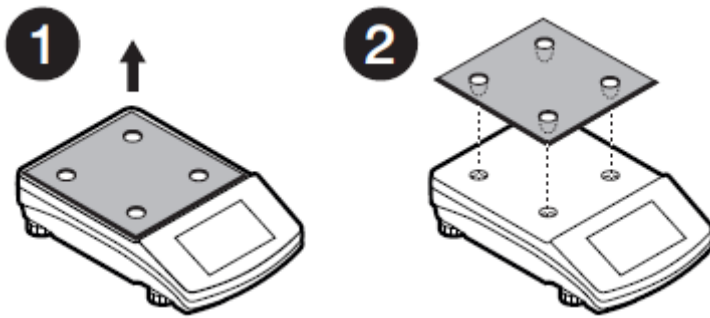

2) Check that the grounding spring is in the correct location, the spring juts slightly out of the hole.

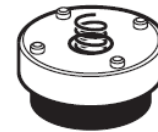
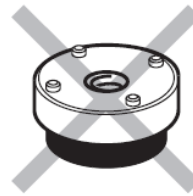

Check whether the grounding spring takes its intended location. Make sure that the grounding spring juts slightly out of the hole.

3) Install components following diagram below:

- i. Grounding foot and feet
- ii. Weighing pan

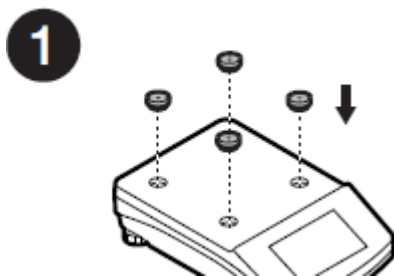

Install the grounding foot in a freely selected opening.

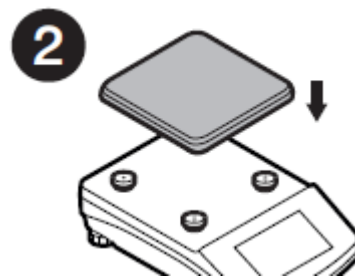

Model: TCL-4502, TCL-6002
Components-



Balance
x1



Weighing pan x1



Draft shield
x1



Power adapter
x 1

Installation-

1) Install components following diagram below:

- i. Draft Shield
- ii. Weighing pan

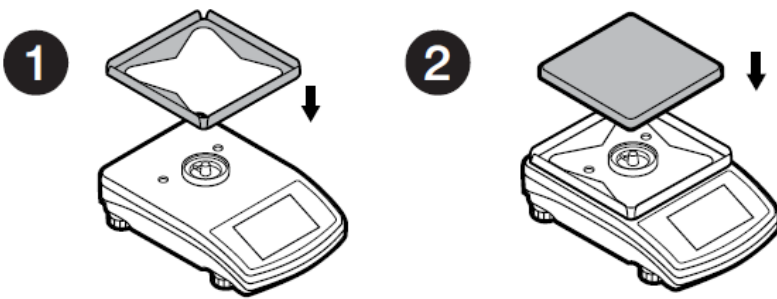

2.5. BALANCE LEVELING

It is necessary to level the balance prior connecting it to the mains. To level the balance, turn its feet until an air bubble takes the central position.

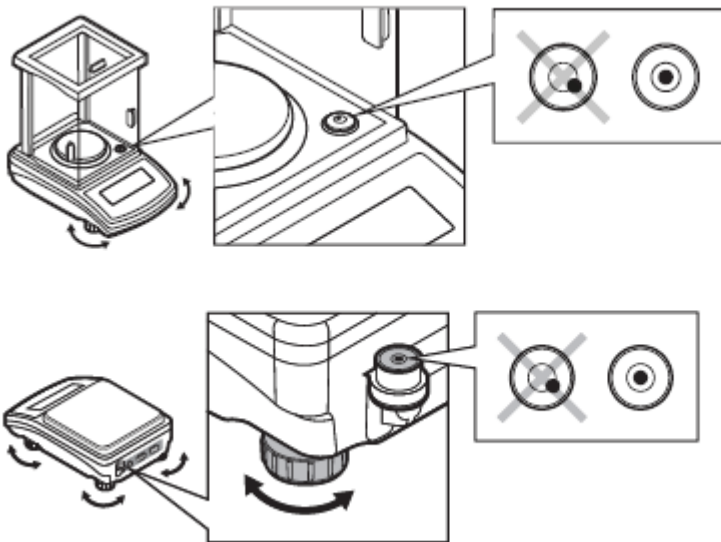

The balance should firmly rest on a surface, each of the feet must be supported.

2.6. POWERING THE DEVICE

Before plugging in your balance, it is imperative to wait until the balance reaches thermal stabilization.

For balances that were stored in much lower temperatures (e.g. during winter period), thermal stabilization period will take at least 4 hours for Precision balances, and 8 hours for Analytical balances.

- Balance should be plugged in only with the power adapter that comes standard with the model. Nominal power supply of the power adapter (specified on the power adapter data plate) should be compatible to the power supply.
- Plug the balance in – connect the power adapter to the socket, next connect its connector to port located at the back of the balance housing.
- Press **ON/OFF** button located in the top right hand corner of the key pad.
- Remember to start the balance with no load on the weighing pan
- Test of the display unit takes place right after connecting the balance to the power, all the elements and pictograms are backlit for a short time.

- Next, the software version appears (please note, software version number may be different than what appears below)



- If the indication gets to ZERO (displayed reading unit depends on the balance). During the balance start, the test of an internal mass calibration mechanism occurs (single location and elevation of the internal mass calibration).

- If the indication is different than zero, please press  button

It is not recommended to run screensaver mode in balances with $d=0.01$ mg, this is due to the fact that switching the backlight on/off causes temperature change which may affect the error of repeatability. In the case of balances with $d=0.01$ mg it is advised to set the backlight parameter to value <None>.

2.7. AMBIENT CONDITIONS STATE INDICATION (ANALYTICAL BALANCES)

The function is intended to inform on unstable ambient conditions for a balance, it is enabled only for Analytical balances (0.01/0.1mg).



The function controls dynamic temperature changes occurring in the balance during its operation. If the variation is greater than set limit values (temperature changes speed), then a blinking thermometer pictogram is displayed on the screen.

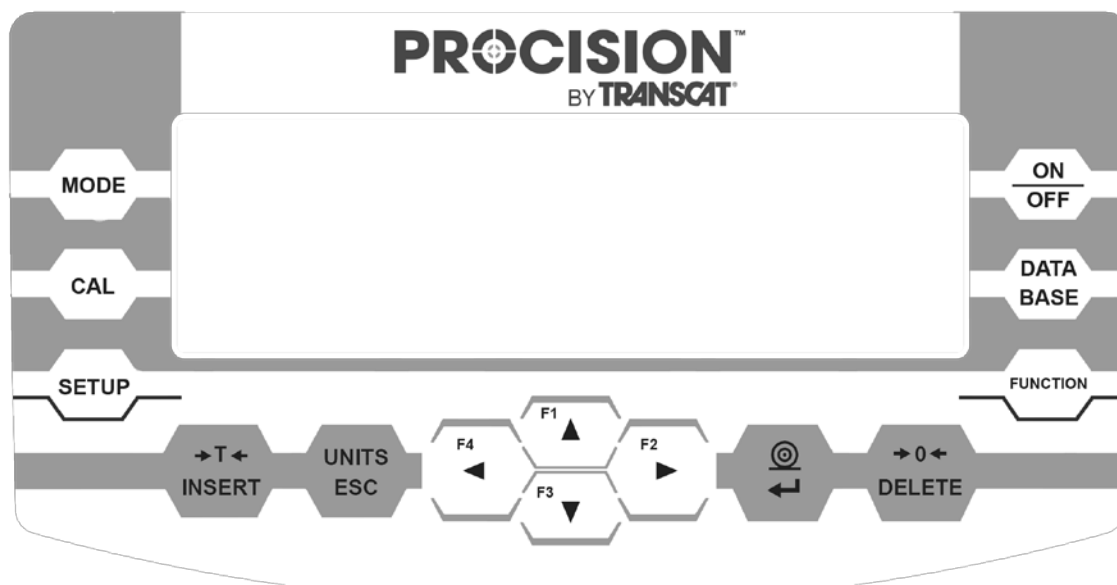

The blinking thermometer pictogram means that temperature inside the balance is not stable, this may result in inaccurate mass measurement. For such a case it is recommended to wait until the temperature stabilizes or to perform balance calibration (blanking of the blinking thermometer pictogram).

3. BALANCE KEYBOARD



ON OFF	Press to switch the balance ON/OFF. If switched off, balance components other than the display are powered, and balance is in stand-by mode. F9 button of the computer keyboard.
DATA BASE	Press to access data stored in a database: user, product, tare. F10 button of the computer keyboard.
FUNCTION	Press to enter directly the active working mode settings. F11 button of the computer keyboard.
MODE	Press to select working mode. F5 button of the computer keyboard.
UNITS ESC	Press to change measuring units.
 	PRINT/ENTER button Press to send measurement to a printer or a computer (PRINT). Press to confirm selected parameter value or function (ENTER).
→0← DELETE	Press to Zero the balance
→T← INSERT	Press to Tare the balance
CAL	Press to start calibration / calibration process immediately. F6 button of the computer keyboard.
SETUP	Press to enter the main menu of a balance. F7 button of the computer keyboard.
	Press to operate balance menu or change parameter value.

3.1. USER MENU

Menu is divided into 9 basic function groups. Each group has an individual name starting with a capital letter, **P**. To enter balance user menu, press 

P1 CALIBRATION

P1.2	EXT. CALIB.		[external calibration]
P1.3	USER CALIBRATION		[user calibration]

P2 WORKING MODES

P2.1	ACCESSIBILITY		[settings for the accessibility of individual modes while working with the balance]
P2.2	WEIGHING		[setting for the function weighing]
P2.3	COUNTING PCS		[settings for the function counting pieces]
P2.4	CHECKWEIGHING		[settings for the function checkweighing]
P2.5	DOSING		[settings for the function dosing]
P2.6	DEVIATIONS		[settings for the function deviations % against the mass of the standard]
P2.7	DENS. OF SOLIDS		[settings for determining density of solids]
P2.8	DENS OF LIQUIDS		[settings for determining density of liquids]
P2.9	ANIMAL WEIGHING		[settings for the function animal weighing]
P2.10	STATISTICS		[settings for the function statistics]
P2.11	TOTALISING		[settings for the function totalising]
P2.12	PEAK HOLD		[settings for the function peak hold]
P2.13	PIPETTES CALIB.		[settings for the function pipettes calibration]
P2.15	ADDING		[settings for the function adding]

P3 COMMUNICATION

P3.1	COM1		[transmission parameters port COM 1]
P3.2	COM2		[transmission parameters port COM 2]

P4 DEVICES

P4.1	COMPUTER		[PC connection port]
P4.2	PRINTER		[printer connection port]
P4.3	BARCODE READER		[barcode connection port]
P4.4	ADD.DISPLAY		[additional display port]
P4.5	EXT.BUTTONS		[external button port]

P5 PRINTOUT

P5.1	CAL. REPORT		[contents of the calibration report]
P5.2	HEADER		[contents of the header printout]
P5.3	GLP PRNT.		[contents of the weighing result prnt.]
P5.4	FOOTER		[contents of the footer printout]
P5.5	NSD.PRN.1		[project of non-standard printout 1]
P5.6	NSD.PRN.2		[project of non-standard printout 2]
P5.7	NSD.PRN.3		[project of non-standard printout 3]
P5.8	NSD.PRN.4		[project of non-standard printout 4]
P5.9	VARIABLE1		[project of variable 1]
P5.10	VARIABLE2		[project of variable 2]
P5.11	SEPERATOR DOT		[define value separator type]

P6 OTHER

P6.1	LANGUAGE		[menu language]
P6.2	ACCESS LEV.		[access levels for editing menu]
P6.3	KEY SOUND		[key sound]
P6.4	BACKLIGHT		[display backlight level]
P6.5	STAND-BY MODE		[backlight turn-off time interval]
P6.6	AUTO OFF		[display turn-off time interval]
P6.7	DATE		[date settings]
P6.8	TIME		[time settings]
P6.9	DATE FORM.		[date format]
P6.10	TIME FORM.		[time format]

P7 INFO

P7.1	BALANCE ID		[balance serial number]
P7.2	SCALE TYPE		[balance model type]
P7.3	SOFT.VER.		[software version]
P7.4	ID. PROD		[product ID]
P7.4	TEMP.		[internal temperature]
P7.5	SETUP PRNT.		[print balance settings]

P8 UNITS

P8.1	ACCESSIBILITY		[declaration of units to be available for balance operation]
P8.2	START UNIT		[selection of a start unit, unit active on balance start-up]
P8.3	USER UNIT U1		[parameter defining user's unit 1]
P8.4	USER UNIT U2		[parameter defining user's unit 2]

P9 IMPORT/EXPORT (ONLY ON CONNECTION OF PENDRIVE)

IE1	EXPORT		[data export]
IE2	IMPORT		[data import]



CAUTION!

*Balance memory modifications will be saved upon abandoning the menu (on return to weighing).
Press ESC button several times.*

3.2. ADMIN LOG-IN

In order to have full access to user parameters and be enabled to edit databases, the balance operator should log in as **<ADMINISTRATOR>** each time running the balance. The software enables the entry of 100 users with various access rights.

First Log In operation - procedure:

Run home screen and press  button, next select **<LOG IN>** option, operators database window opens with list of available users, or press function button with **<LOG IN>** function assigned, or press

 button, enter users database and select **<ADMIN>** user.

Press  button for confirmation, wait to be asked for a password.

Enter the password: "1111", next press  for confirmation.

Home screen of the software is displayed again automatically.

When logged in, add users and set the permissions levels

On future Log-in, select a user from the list and enter the password, the software initiates operation with permissions level set for the selected user.

If any user is logged in, a pictogram  is displayed.

Log out operation – procedure:

- Select <NONE> position out of the list of available users
- Home screen of the software is displayed again, and the display shows no logged-in user. (no logged-in user, no pictogram  on the display).

4. BALANCE OPERATION- GENERAL INFORMATION

4.1. BALANCE ZEROING

Zeroing is a function allowing to zero the mass on the indication. To perform this function, press  button. Mass indication of zero value shall be displayed together with precise zero $\rightarrow 0 \leftarrow$ and stability markers $\blacktriangle \blacktriangleleft$.

The zeroing process is an equivalent for determining new zero point, recognized by the balance as precise zero. Zeroing is possible only for stable status of display indication.

! CAUTION

Zeroing the display indication is possible only within $\pm 2\%$ range of instrument's maximum capacity. If the zeroed value is above $\pm 2\%$ of the maximum capacity, then the balance indicates a respective -Err2- error message.

4.2. BALANCE TARING

Taring is a function allowing to determine net weight of a measured object. To determine the net weight of the object, place object's container (packaging) on the weighing pan, and on stabilization of

measurement result press  key. The display indicates mass equaling zero and symbols: **Net** and $\blacktriangle \blacktriangleleft$. On taking off the weighed load and its packaging from the weighing pan, the display indicates sum of total tared mass with a minus sign.

The balance allows the user tare value to a database-stored product. Using this option, the software automatically uploads data on tare value for a particular product upon its selection from the database.

! CAUTION

Taring negative values is impossible. On taring negative values the balance responds with an error message, - Err3 -. In such case, zero balance indication and repeat taring procedure.

4.2.1. MANUAL TARE DETERMINATION

This option allows for the setting of a tare value through a manual input of the value.

Procedure:

- Press quick access key F2, to which <ENTER TARE> option has been assigned.
- Wait for a respective window to open.

- Use the arrow buttons to enter the tare value and press  button,
- The balance returns to the weighing mode, and the display indicates entered tare value with minus “-” sign.



4.2.2. DELETING TARE

Entered tare value can be deleted by pressing  button on the overlay or by entering tare value of 0.000g (see description above)



4.2.3. TARE DATABASE

Tare values commonly utilized by user can be saved within the Tare Database.

Procedure:

- Press quick access key F4, to which **<SELECT TARE>** option has been assigned or click **<SELECT TARE>** option available upon pressing  button.
- Wait for the first packaging weight, recorded in tare database, to be displayed.
- Use the arrow buttons to select the tare which is to be recalled and press  button,
- The balance returns to the weighing mode, and the display indicates entered tare value with a minus “-” sign.

OR

- While in any working mode, press  button.
- Enter b3 **<TARE>** option.
- Wait for the first packaging weight, recorded in tare database, to be displayed.
- Use the arrow buttons to select the tare which is to be recalled and press  button.
- The balance returns to the weighing mode, and the display indicates entered tare value with a minus “-” sign.

4.3. UNITS

UNITS parameter group enables the user to change availability of mass units (the change can be performed in-course of balance operation), and to define two custom units, thus positively effecting comfort and speed of operation. It is possible to change unit to other than unit [g] during weighing process or during operation of other modes. Working modes *Parts Counting* and *Percent Weighing* are exceptions.

4.4. TEMPORARY MEASURING UNIT

Function enables selecting a measuring unit which is to be indicated next to mass reading during the operation. The set measuring unit will be in use from the moment of its activation until its change or switching the balance off and on.

Each pressing of the  button results with change of the measuring unit.

Options:

- You can select from the following: [g], [mg], [kg], [ct], [lb], [oz], [ozt], [dwt], [tlh], [tls], [tlt], [tlc], [mom], [gr], [ti], [N]

4.5. UNITS ACCESSIBILITY

By pressing button , the user may declare units to be available for selection of temporary unit. Units with parameter value set to <YES> are available for selection in specified operating modes.

Procedure:

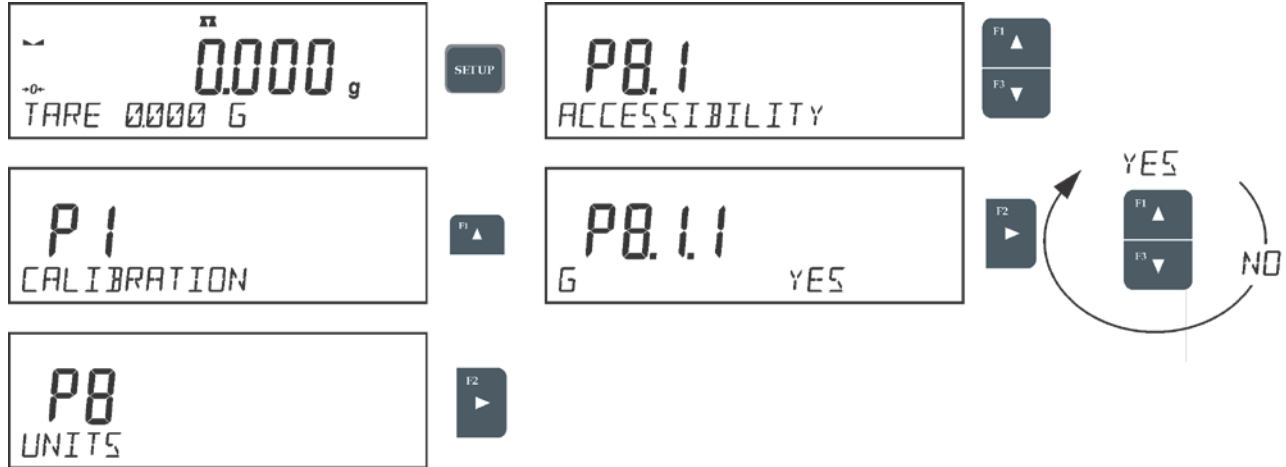

4.6. START UNIT SELECTION

Upon selection of start unit, the balance activates with the specified unit for these modes where change of the unit is possible.

Procedure:

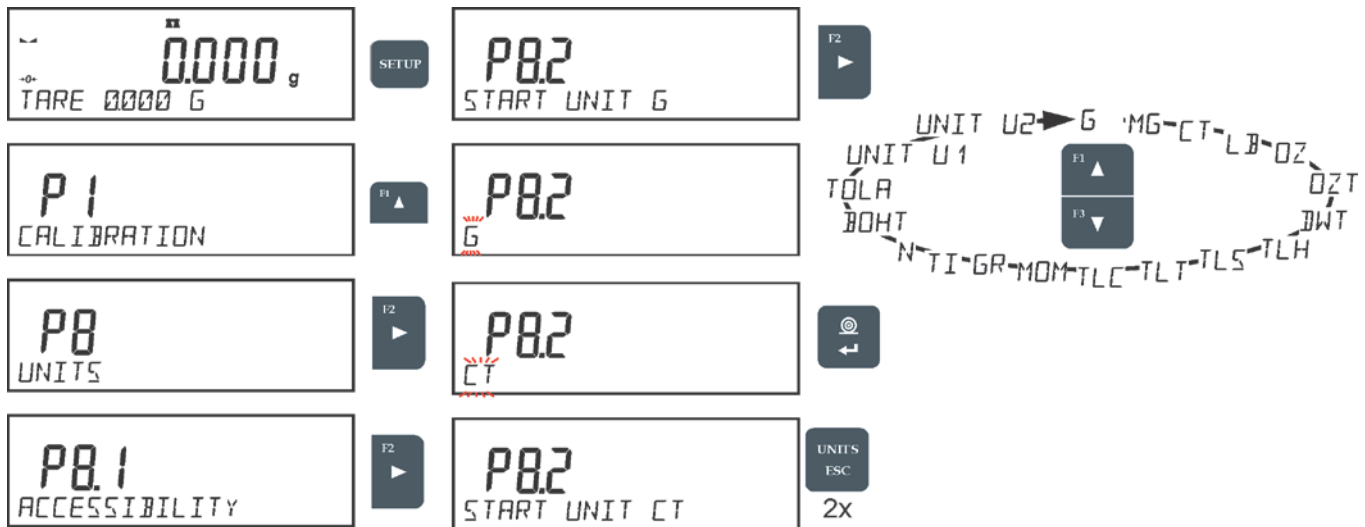

4.7. CUSTOM UNIT

You can declare two custom units. The custom unit is a result of indication multiplied by a specified coefficient.





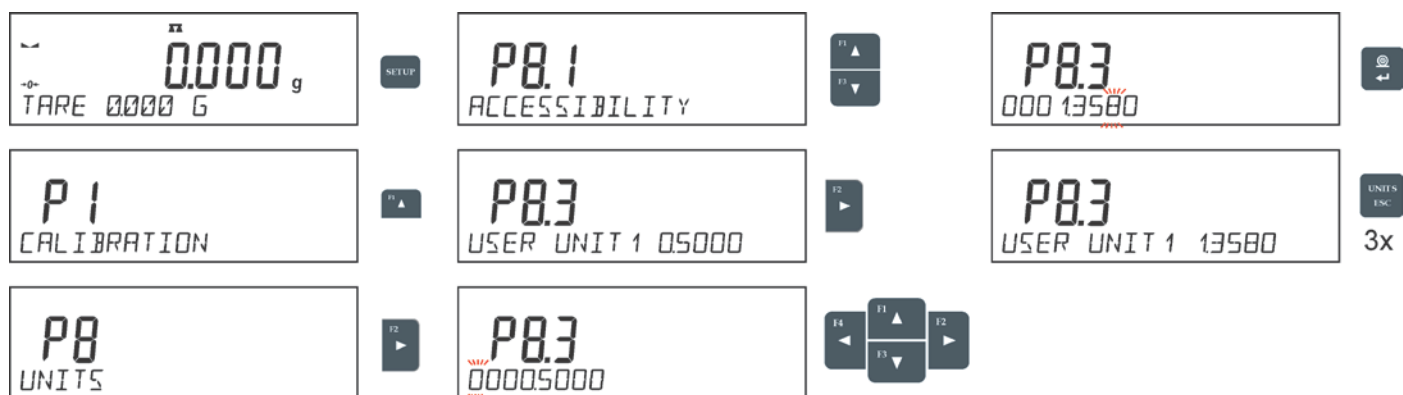





The units are displayed as **[u1]** – user unit 1, and **[u2]** – user unit 2.



Procedure for declaration of coefficient for the custom unit:



5.WORKING MODES- GENERAL INFORMATION

The balance features the following working modes:

	<p>Weighing Means of operation: weight of a load is determined through an indirect measurement. A balance measures gravitational force which attracts the load. An obtained result is processed to a digital format and displayed in a form of measurement result.</p>
	<p>Parts Counting Means of operation: based on a determined mass of a single part it is possible to count another part, if the mass of the single part is determined with sufficient accuracy, and that the following parts are equal in mass.</p>
	<p>Check Weighing Means of operation: control of sample mass with applied thresholds. A user should specify the value of min threshold <LO> and max threshold <HI>.</p>
	<p>Dosing Means of operation: a user should specify sample's target mass to be obtained by pouring.</p>
	<p>Deviations % (Percent Weighing) Means of operation: control of percent ratio of a sample in relation to a standard (reference). Obtained data provides percent ratio on how test sample differs from the accepted standard (reference).</p>
	<p>Density of solids Means of operation: based on Archimedes principle, a balance determines density of solids. The mode requires an optional density determination kit.</p>
	<p>Density of liquids Means of operation: based on Archimedes principle, a balance determines density of liquids. The mode requires an optional density determination kit.</p>
	<p>Animal Weighing Means of operation: mass measurement takes place with application of filters dampening animal moves on a weighing pan, thus enabling obtaining a correct measurement result.</p>
	<p>Statistics Means of operation: carried out measurements are used to calculate statistical data, such as Min, Max, deviation, etc.</p>
	<p>Peak Hold Means of operation: max temporary indication occurring in course of the weighing process is hold on a display.</p>

	<p>Totalizing Means of operation: by mixing specified ingredients you can obtain particular mixture, in order to program given formulation you have to specify weight of particular ingredients.</p>
	<p>Pipettes Calibration Means of operation: applied to fixed volume pipettes and adjustable volume pipettes. Software determines accuracy and repeatability errors.</p>
	<p>Adding Means of operation: allows you to add net masses of weighed samples.</p>

5.1. RUNNING WORKING MODE

In order to run a particular mode press **MODE** button, and select the mode from the list.

Procedure:

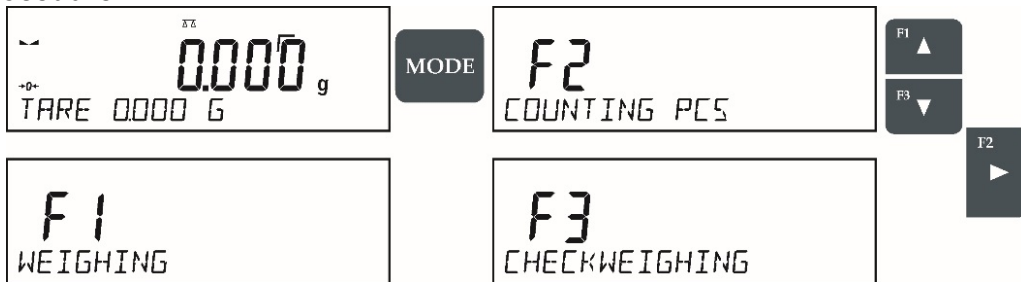

CAUTION!

Upon restart, the balance is launched with the most recently operated working mode. For settings of this function read later sections of this user manual.

5.2. WORKING MODE ACCESSIBILITY

User's have the availability to declare which working modes are to be accessible. You can deactivate working that are not used in course of balance operation, to do it, change the accessibility value to <NO> for a particular parameter.

Procedure:

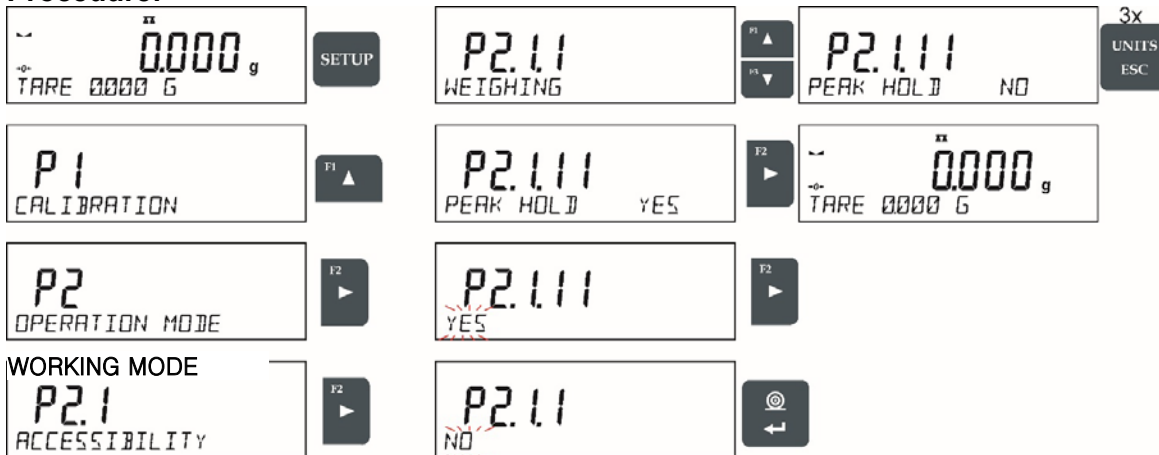

5.3. WORKING MODE PROFILE

To simplify balance operation, there are 4 profiles in the software. The profiles are selected and saved so that the weighings for respective requirements and conditions are optimized. Profile settings apply to settings for specific working mode.



These are the following profiles:

- **User** - the basic profile for which filter settings are selected in a way enabling fast and precise weighing
- **Fast** - profile enabling weighing of any mass regardless of the working mode. When running the balance for the first time, this profile is started automatically. For this profile the parameters are selected in a way enabling obtaining the measurement result as fast as it is possible
- **Fast dosing** – the profile is dedicated for fast dosing.
- **Precision** – the profile is dedicated for precise dosing of any mass regardless of the working mode. For this profile the weighing process takes the most time, but the result is the most accurate and precise

Caution: You can modify all settings of User profile. Settings of other profiles (Fast, Fast dosing and Precision) can be modified only to a limited extend.

Name of currently selected profile is displayed in the bottom line. The profile can be selected individually for working mode. The balance saves the last used profile in each working mode (with your modifications) and starts operation with that profile selected.

Procedure:

- Press  button, utilize navigation keys to reach reach <Profil> and press  button
- Utilize navigation keys to reach proper profile, select profile by pressing  button
- The balance returns to main screen and operates in accordance with set profile.



5.4. WORKING MODE SETTINGS- READING

The software allows setup of operating parameters (filters, value release, and autozero function, last digit, and other setting) separately for each working mode. Only for **User** profile can you modify all settings. For other profiles (**Fast**, **Fast dosing**, **Precision**) filter and value release parameters are default and cannot be modified.

It enables customizing the instrument and utilizing its properties depending on your needs and expectations, or on specific requirements for selected working mode (e/g/ DOSING); as a result the device operation is quick and easy.

5.4.1. FILTER LEVEL SETTING

Filter level setting (function unavailable for the following profiles: Fast, Fast dosing, Precision)

Filter settings calibration depends on the working environment. For the best possible conditions the filter can work in a very fast mode (V.FAST value for Filter parameter); however, if the conditions are poor (shakes, drafts), the filter should be set to slow or very slow option (SLOW or V. SLOW value for Filter parameter). The effectiveness of the filter is different throughout the weighing range. The filter works slower when “approaching” the weighed mass, it works more intensively for weighed mass within the set range of the filter (the parameter for setting filter range is accessible only from the service menu – the user does not have any access to it).

Depending on the filter, the weighing time is shorter (V.FAST and FAST) or longer (SLOW and V. SLOW).

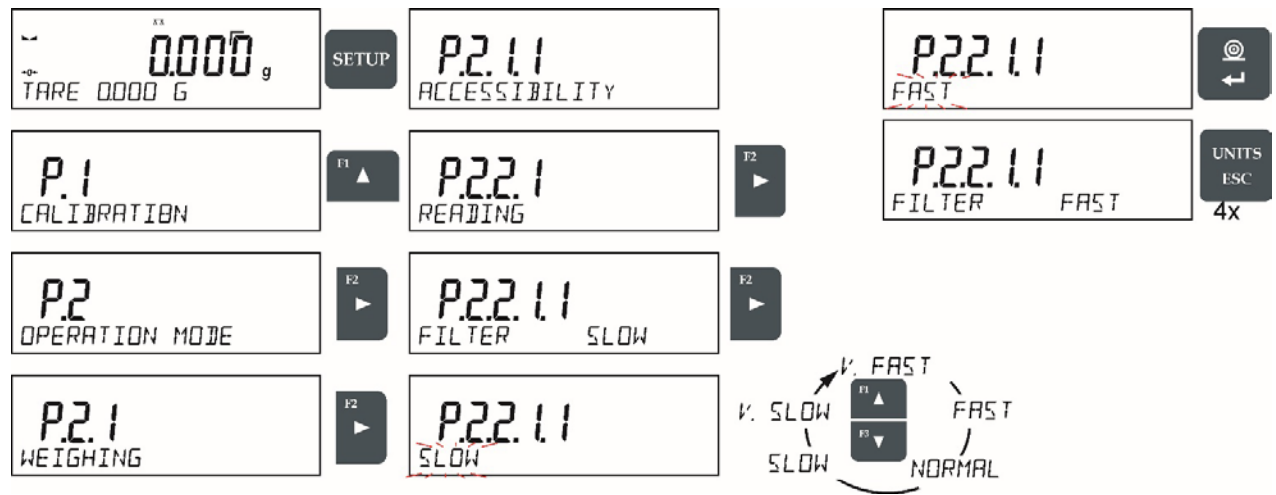

5.4.2. VALUE RELEASE

Value release setting (function unavailable for the following profiles: Fast, Fast dosing, Precision)

Since ambient conditions at a workplace vary, it is necessary to determine the value release parameter that are best for your working environment, parameter options are: <FAST.+REL.>, <FAST> or <RELIABLE>. Depending on the selected option, weighing time is either shorter or longer.

Procedure:

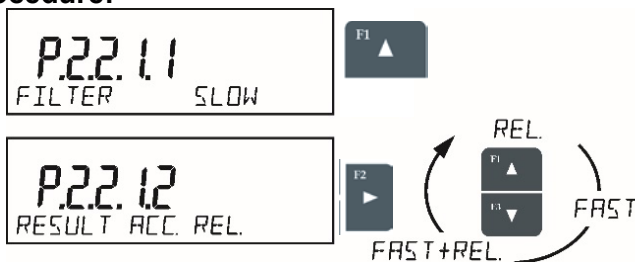

5.4.3. AUTOZERO

The balance features an autozero function (Auto). This function automatically controls and corrects the zero reading. When Autozero is enabled, it compares balance readings at declared time interval e.g. 1s, if weighing pan is unloaded and display indication is close to zero. If results vary less than declared AUTOZERO range e.g. one division, balance zeroes automatically, marker of stable measurement result $\blacktriangle\blacktriangle$, and precise zero marker $\rightarrow 0 \leftarrow$ are displayed.

If AUTOZERO function is enabled, then each weighing process starts from precise zero point. There are, however, some instances when this function can be a disturbing factor for the measuring process; e.g. very slow placing of a load on the weighing pan (load adding). Here, zero reading correction can also correct the actual reading of loaded mass.

Procedure:

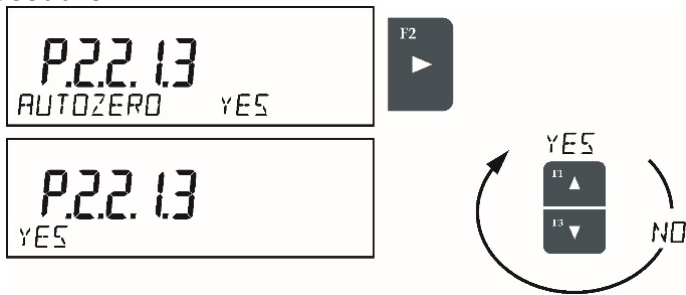

5.4.4. LAST DIGIT DISPLAY

Function enables displaying the last digit of decimal place for a weighing result. There are three available options:

- **<ALWAYS>** all digits visible
- **<NEVER>** last digit is not displayed
- **<WHEN STB>** last digit is displayed only for a stable weighing result

Procedure:

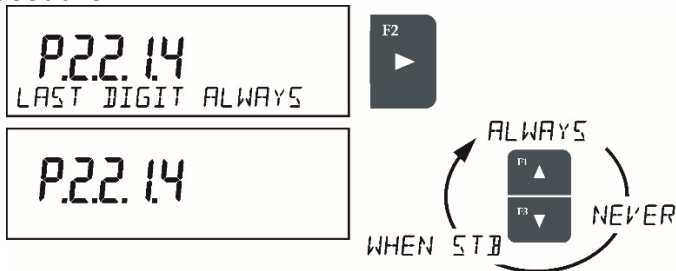

5.4.5. BALANCE AMBIENT CONDITIONS

Parameter relating to ambient and environmental conditions in which the balance operates.

There are two options: **<STABLE>** and **<UNSTABLE>**.

- Selecting **<STABLE>** mode makes the balance work much faster, i.e. weighing takes much less time than for **<UNSTABLE>** mode.
- If the ambient conditions are unstable it is recommended to use UNSTABLE mode. By default, the parameter is set to **<STABLE>** option.

Procedure:

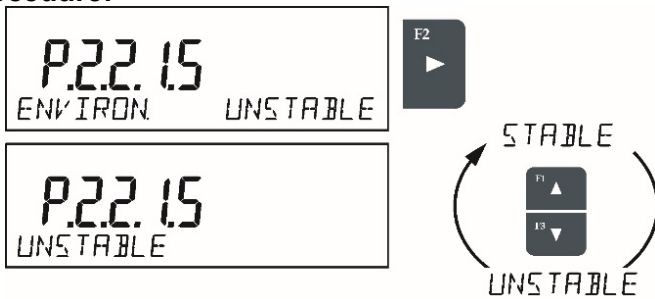

5.5. WORKING MODE SETTINGS- AUTOTARE

Autotare is used for quick determination of net weight for loads with different tare values, wherein they are measured one after another.

When the function is active (<AUTOTARE> parameter set to <YES> option), the operating process takes the following steps.

Procedure:

- Make sure that the weighing pan is empty and press button responsible for zeroing.
- Put product packaging on a weighing pan.
- After measurement stabilization, automatic taring of the packaging mass takes place (Net marker then appears in the upper part of the display).
- Place product to be weighed into the packaging.
- The display shows net weight of the product.
- Remove the product together with the packaging from the weigh pan.
- The balance removes the tare value (packaging weight recorded during the first step of the operating process) after the gross weight value (set in <AUTO THRES> parameter) has been exceeded.
- Place packaging of the next product on the weighing pan, automatic taring of the packaging weight proceeds after measurement stabilization (Net marker appears in the top section of the display);
- Place next product that is to be packed.

For correct operation of the balance with AUTOTARE function, it is necessary to adjust the threshold value.

<AUTO THRES> parameter is connected with the following functions:

- automatic tare
- automatic operation



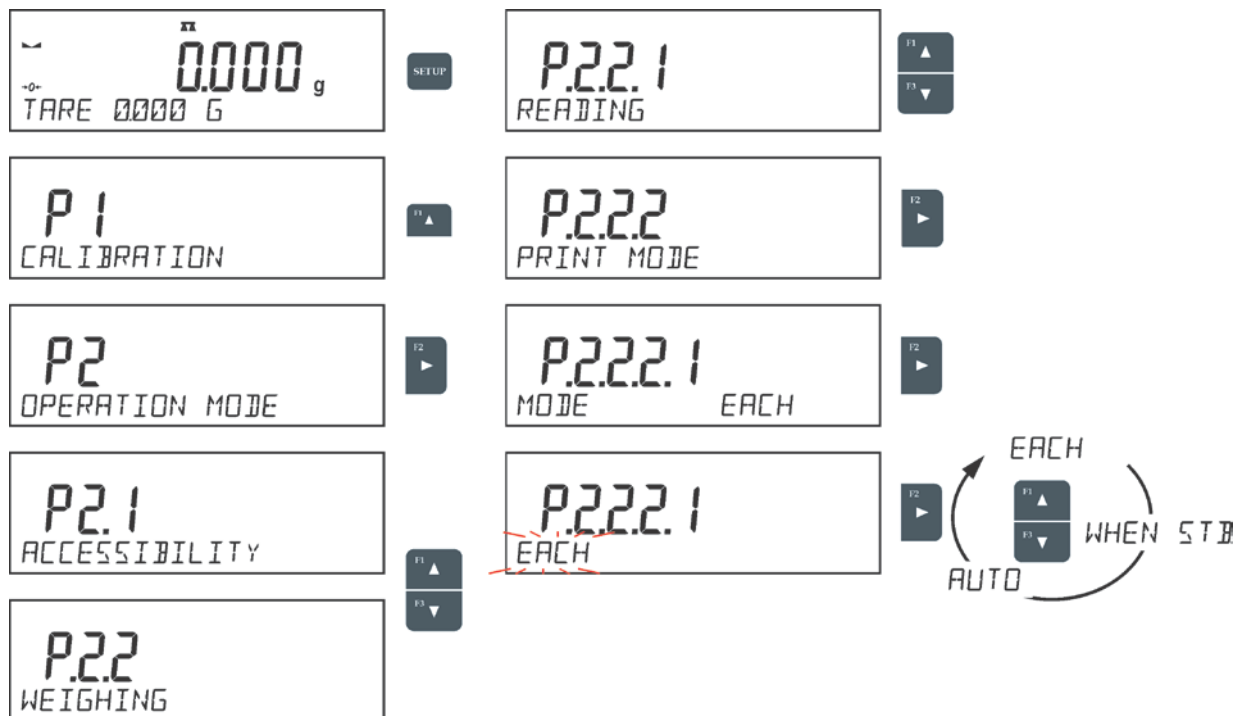

No automatic taring takes place as long as the gross weight value stays within the range set in <AUTO THRES> parameter.



5.6. WORKING MODE SETTINGS- PRINT MODE

Function designed to enable print mode setting, it activates  key.

Print mode options:

- <WHEN STAB>, for this option stable measurement result, along with the settings for parameter  <GLP PRINTOUT>, is sent to the printer port. On pressing  key, when the result is not stable (no  marker on a display), the balance software sends the measurement result to the port after reaching stability for the measurement.
- <EACH>, for this option every single pressing of  button results with sending the measurement indication to the printer port along with the settings for <GLP PRINTOUT> parameter. Every single indication is sent (stable and unstable). For unstable indication <?> character appears at the beginning of the printing frame. **This function applies to non-verified balances exclusively.**
- <AUTO> - select this option to enable automatic printing of measurements. If this option has been selected, remember to set <AUTO THRES> parameter to suit your needs.
- <AUTO+INT.> select this option to start automatic printout and record of indications in Weighings database and Alibi database, carried out in a cyclic manner in a specified time interval. The interval is set in minutes, in parameter P2.2.3.3 <AUTO INT.>. Interval range is 1-9999 min.



For automatic operation with interval it is necessary to specify interval value in [min].

CAUTION!

Each result is printed and recorded (stable and unstable).
Automatic operation with interval starts at the moment of switching the function on and it lasts until it is switched off.
On switching the function of auto print with interval, PRINT button becomes inoperative (no indication is printed when pressed).

Automatic operation procedure:



- Press  button to zero the balance (marker of stable measurement  and zero marker  are shown on a display).
- Deposit load, the balance sends the first stable measurement to the printer port.
- Remove the load from the pan.
- The next measurement is possible when the indication is lower than the set value of <AUTO THRES.> parameter (next measurement does not require zero value).

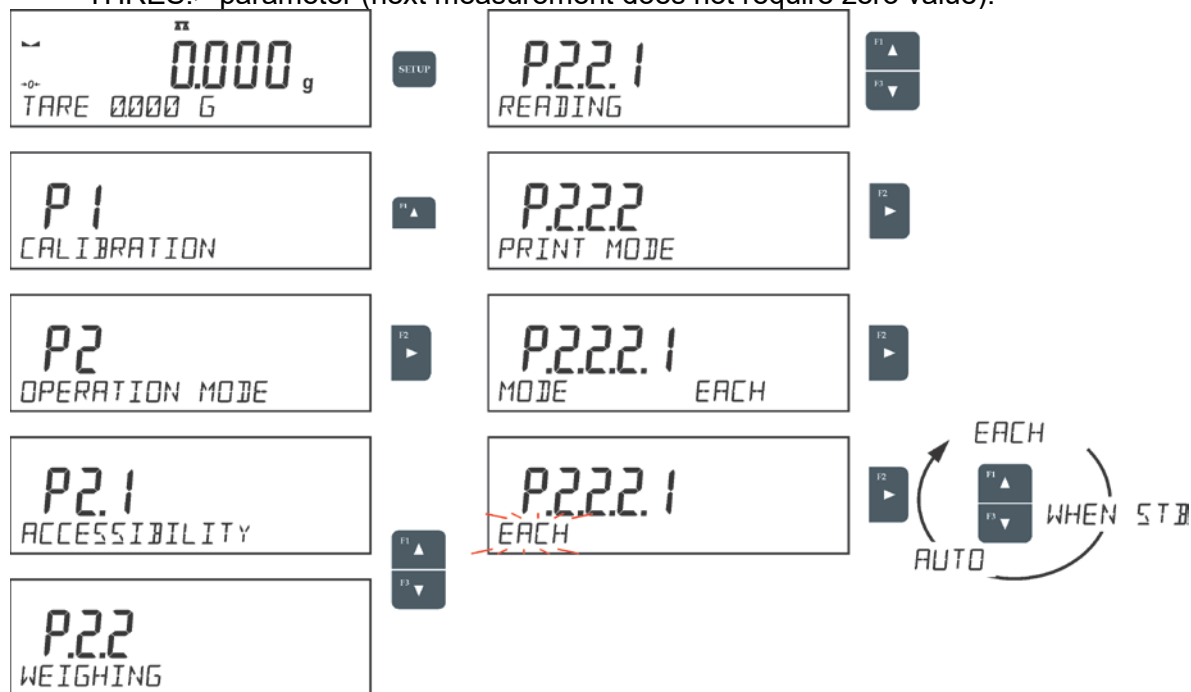

For automatic operation adjust the threshold value.

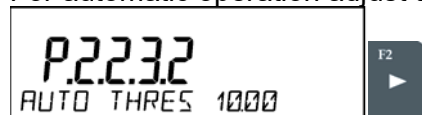

5.7. WORKING MODE SETTINGS- INFORMATION

Function enables displaying additional information in the bottom line. Depending on the needs, you can choose the following options, which are shown while working in <WEIGHING> mode:

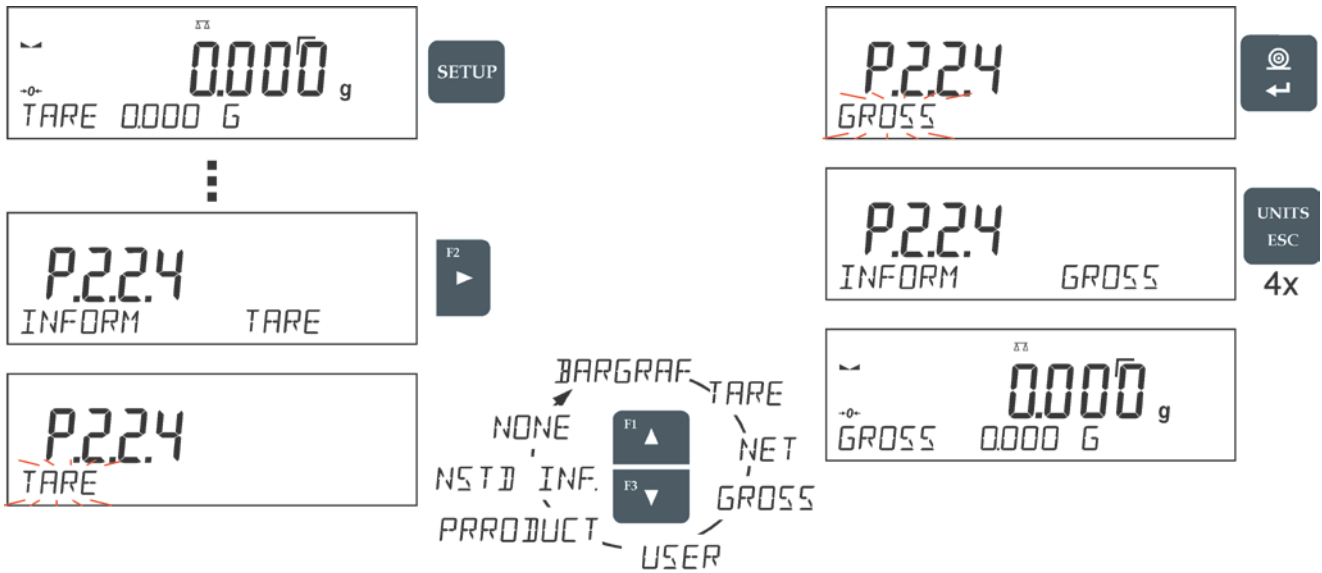

<BARGRAF> option presents amount of used weighing capacity in a graphic form, it covers 0 – MAX range.



Example of a TCL-1003 balance display with bar graph option on: 500 g heavy load placed on a weighing pan means that 50% of max capacity has been used (half-filled bar graph bottom line).

It is possible to enable <BARGRAF> option for the following modes: PARTS COUNTING, DOSING, PERCENT WEIGHING, WEIGHING, ANIMAL WEIGHING, STATISTICS, TOTALIZING, PEAK HOLD.

5.8. WORKING MODE SETTINGS- NON-STANDARD INFORMATION

Function enables declaring non-standard information, which is to be displayed in the bottom line of the display. You can insert any text consisting of 19 characters' maximum.

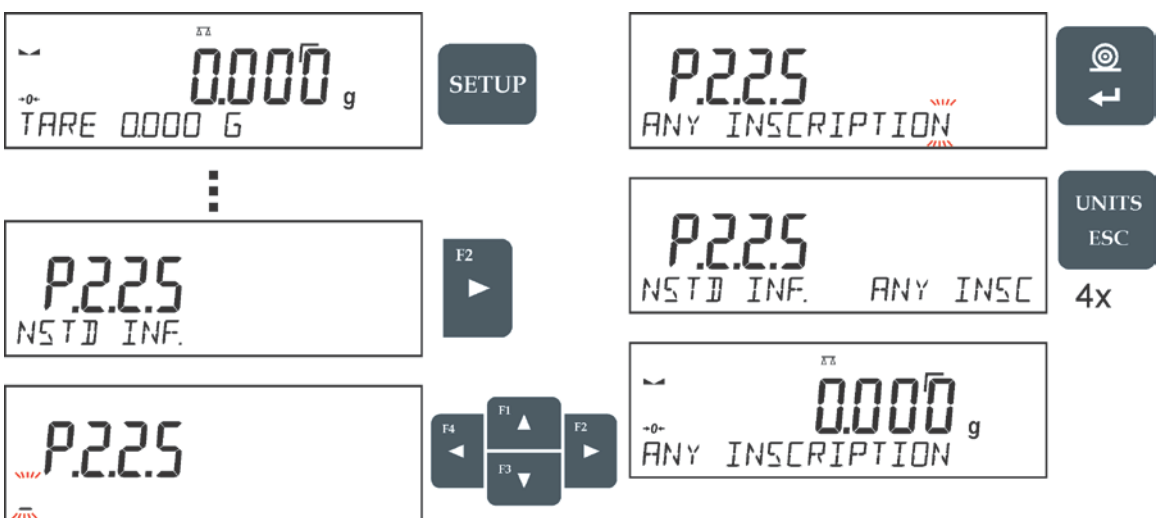

If you want the declared non-standard information is to be visible, set parameter P2.1.2 to < NSTD. INF. > option.

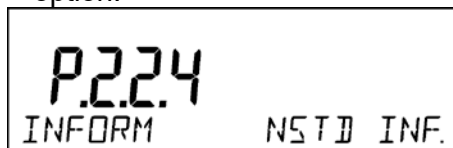

5.9. WORKING MODE SETTINGS- F SHORTCUT KEYS

Function enables assigning quick access for weighing functions which are to be accessible by pressing F1, F2, F3 or F4 keys. You can choose between the following options for <WEIGHING> mode: <NONE / ENTER TARE / PRINT HEADER / PRINT FOOTER / VARIABLE 1 / VARIABLE 2>. These options can be freely assigned to any of the F keys. For other modes there are more available options (see further sections of this manual).

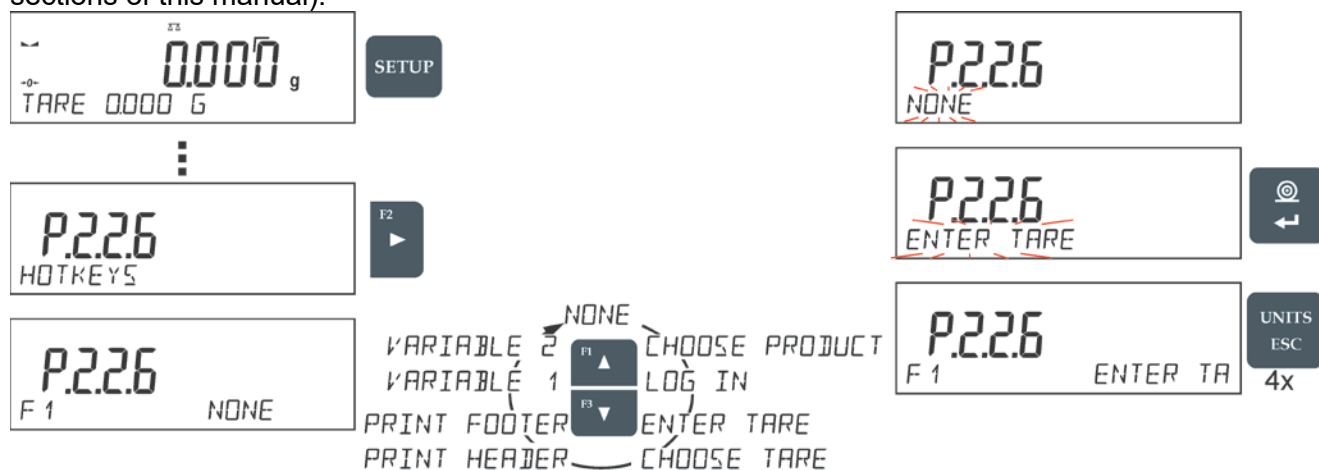

Functions for particular working modes:

Function	Modes featuring the function
SELECT PRODUCT	All modes
LOG IN	All modes
ENTER TARE	All modes
SELECT TARE	All modes
PRINT HEADER	All modes
PRINT FOOTER	All modes
VARIABLE 1	All modes
VARIABLE 2	All modes
ON/OFF LAST DIGIT	All modes
ENTER SAMPLE	Parts Counting, Dosing, Percent Weighing
DETERMINE SAMPLE	Parts Counting, Percent Weighing

SET HI_LO	Checkweighing exclusively
START	Animal Weighing, Solids Density, Liquids Density, Pipettes Calibration
RESULT	Statistics exclusively
END	Statistics, Totalizing
DELETE LAST	Totalizing exclusively

6. CALIBRATION

In order to ensure the highest weighing accuracy, it is recommended to periodically introduce a corrective factor of indications to balance memory, the said factor must be referred to a mass standard. In other words, balance calibration shall be performed from time to time.

Calibration should be carried out:

Before the beginning of weighing procedure,
If long breaks between following measuring series occur.

Types of calibration:

Manual internal calibration

Calibration with an external weight of declared mass which cannot be modified or of any mass, but not lower than 30% of maximum range.



CAUTION!

Remember to carry out the calibration process when there is no load on the pan! When the weighing pan is loaded, command **<RANGE EXCEEDED>** is displayed. In such a case remove the load and restart the the calibration process. Calibration process can be aborted if necessary by pressing **Esc** button at any time during the process.

6.1. CALIBRATION MENU SETTINGS

- EXT. CALIB. – External calibration (with an external weight)
Calibration with an external weight, value of which is saved in factory settings (function unavailable for verified balances).



- USER CALIB. – User calibration (with an external weight)
Calibration with an external weight of any mass within balance range, however not lower than 30% of Max range (function unavailable for verified balances).





6.2. MANUAL CALIBRATION

6.2.1. EXTERNAL CALIBRATION

The external calibration for Transcat TCL-series balances should be carried out with an external mass standard of class F₁.

Run an external calibration process, the balance displays a command ordering to unload the weighing pan, **<REMOVE MASS>** (the weighing pan must be empty). When the weighing pan is

unloaded, press  button. The balance determines mass of an empty pan, message **<CALIBRATION>** is displayed in the bottom line. Next, message **<PLACE MASS>** and mass value to be placed on the weighing pan are displayed, e.g. **200.000g** (depending on the type of balance).

Place an external calibration weight of displayed mass value and press  button. The balance determines the mass, message **<CALIBRATION>** is displayed in the bottom line. On completing calibration process the balance returns to submenu **P1.2 EXT.CALIB.**

6.2.2. USER CALIBRATION

The external calibration for Transcat TCL-series balances should be carried out with an external mass standard of class E₂ for the Semi-Micro and Analytical balances (0.01mg and 0.1mg) and F₁ for the Precision balances (0.001g and 0.01g).

Run an external calibration process, the first step of the process is to declare the mass of a weight that is to be used for calibration. The mass must be $\geq 30\%$ Max capacity.

Once the mass of the weight is entered and confirmed, the message prompting the user to remove the weight from the pan is displayed: **<REMOVE MASS>** (the weighing pan must be empty). Unload

the pan and press  button, the balance determines the weight of an unloaded pan, message **<CALIBRATION>** is shown in the bottom line. Next, message **<PLACE MASS>** and mass value to be placed on the weighing pan are displayed, e.g. **200.000g** (depending on the type of balance).

Place an external calibration weight of displayed mass value and press  button. The balance determines the mass, message **<CALIBRATION>** is displayed in the bottom line. On completing calibration process the balance returns to submenu **P1.2 EXT.CALIB.**

6.3. CALIBRATION REPORT PRINTOUT

At the end of each calibration process or calibration test, a calibration report is generated automatically and sent to the communication port. The content of the report is declared in menu P5.1 CAL REPORT.

The instruction on how to declare settings for this option is described in section about printouts.

The report can be printed out via a printer connected to the balance or it can be sent to the computer and saved as a file for archiving purposes.

7.WEIGHING

Weighing is a working mode which enables the mass determination of an object.

In order to ensure long lasting use of a balance plus correct and reliable measurement of weighed loads, follow below procedures:

- Start the balance with no load on the weighing pan (permissible value of load on the weighing pan on balance start is $\pm 10\%$ of its maximum capacity).
- Load the weighing pan steadily avoiding shocks:

YES

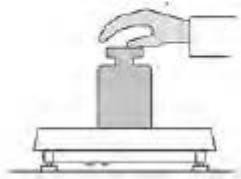

NO

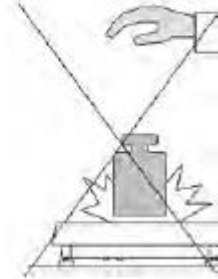

- Place weighed loads centrally on the weighing pan :

YES

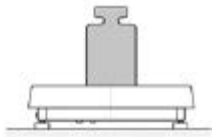

NO

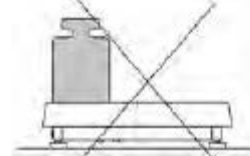

- Avoid side loading, in particular side shocks:

NO





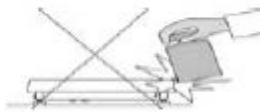

NO





The balance requires calibration before weighing process start or in case of drastic change of ambient conditions at a workstation.

- Prior to the measurement, it is recommended to load the weighing pan, several times, with mass close to the maximum capacity. In the case of dual range balances, the initial load of the weighing pan depends on the reading unit value.
- Before the start of weighing procedure, it is recommended to load the weighing pan a few times with mass close to balance max capacity
- Check if unloaded balance indicates “precise zero” $\rightarrow 0 \leftarrow$ and whether measurement is stable

 , if not, press  button

- Press  button to set a measuring unit
- Place object on the weighing pan and read result only on stabilization 
- Mass indication of a load placed on the weighing pan can be tared multiple times by pressing  (CAUTION: do not exceed maximum capacity during taring procedure)

The balance shall stay plugged into the mains in between measurement series. It is recommended to switch off the balance display by pressing  button. By pressing the  button, the balance is ready for operation and carrying out measurements.

7.1. UNDER-PAN WEIGHING

In standard analytical and precision balances, loads can be weighed under a weighing pan. Such means of operation requires placing a balance in an uplifted position.

For under-pan weighing follow below procedure:

- Remove plastic hole plug located in the balance base,
- Under the plug you can find a special holder with an opening dedicated for suspending the load (fixed permanently)
- The opening is used for fixing a hook intended for either load or a dedicated weighing pan, once depositing a load one can start weighing
- Upon completing under-pan weighing, put the plastic plug back onto its place.

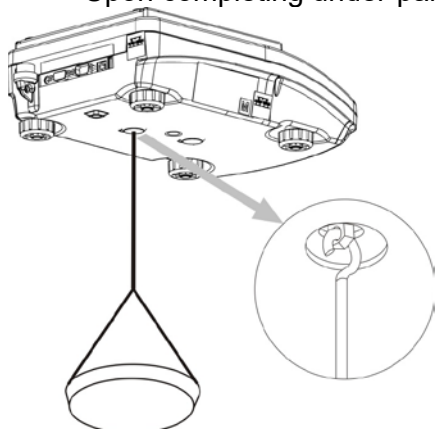

CAUTION!

The suspension for hook must not be turned, twisted or manipulated in any direction. Such actions may cause damage to balance mechanism.

Mass of all additional elements of under pan weighing kit, like the hook, weighing pan, string, etc. should be zeroed

by pressing  or .

8. PARTS COUNTING

Parts counting is a working mode which enables determination of quantity of small parts with equal weight. Determined mass of a single part is used for the counting procedure.

8.1. SETTING REFERENCE MASS: MASS DETERMINATION FOR THE SAMPLE OF KNOWN QUANTITY

While determining the mass of a single piece, **ACAI** function (Automatic Accuracy Correction) is in use.



Means of operation of ACAI function:

- Number of pieces (on adding) on balance's weighing pan must be greater than before
- Number of pieces (on adding) on balance's weighing pan must be less than twice the amount displayed before adding parts
- Current quantity of parts must be within the ± 0.3 tolerance of the total value,
- Measurement result has to be stabilised.

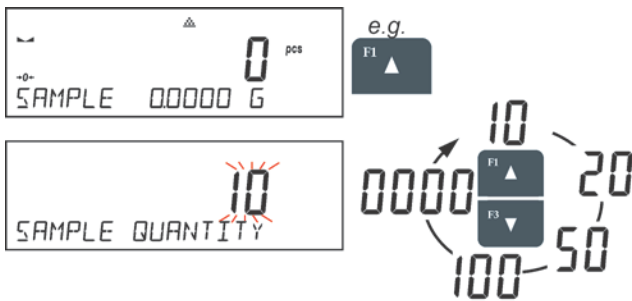

Procedure:

- Place the container on the pan and tare its mass,
- Press F button to which the function **<DETERMINE SAMPLE>** is assigned, wait to see the editing window **<SAMPLE QUANTITY>**



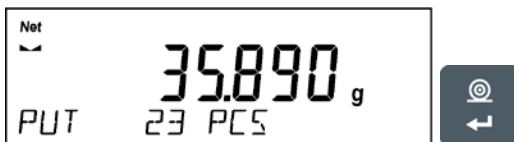

- Use arrow buttons  or  to select the correct sample quantity.
- For optional quantity variable (displayed value <0000>) enter any number using arrow buttons
- Confirm selected sample quantity, confirmation message - <PLACExx PCS> - shall be seen.

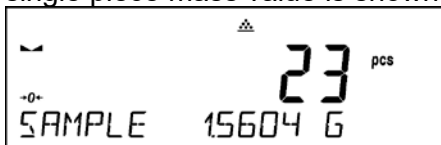

- Place the declared number of pieces in the container and when the result is stable (the symbol  is displayed) confirm the mass by pressing  button,
- The balance software automatically counts a single piece mass and enters the mode <PARTS COUNTING> displaying the number of pieces which are on the pan (pcs). In the bottom line, a single piece mass value is shown (if the option has been selected for <INFORMATION> function).



CAUTION!
Remember that:

- The total mass of all the pieces put on the weighing pan must not be greater than the balance maximum weighing range.
- The mass of a single piece cannot be lower than **0.1 reading unit** of the balance. If this condition is not met, the balance displays message: <Single part mass too low>.
- While determining the number of pieces, wait for the stability pictogram , next confirm the quantity.
- You can confirm the declared quantity by pressing  button only after the stability pictogram is displayed. Otherwise, the balance will not accept the measurement.

8.2. SETTING REFERENCE MASS: ENTERING MASS VALUE

Procedure:

- Press F button to which the function <ENTER SAMPLE> is assigned, wait to see the editing window <ENTER SAMPLE>

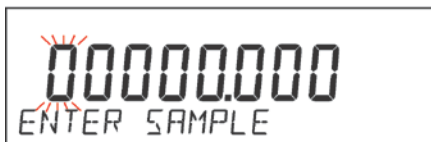

- Use arrow buttons to enter the known weight value of a single piece.



- The balance software automatically enters **<PARTS COUNTING>** mode displaying the number of pieces which are on the pan (**pcs**). In the bottom line, a single piece mass value is shown (if the option has been selected for **<INFORMATION>** function)

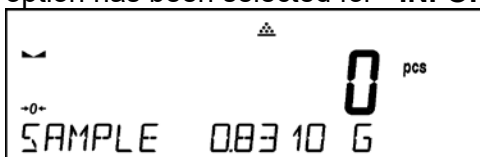

9. CHECKWEIGHING

Checkweighing is a working mode using two thresholds (LOW and HIGH) in order to check mass of the samples. It is generally assumed that the mass is correct if it is contained within the threshold values.

Procedure:

- Press F button to which the function **<ASSIGN THRESHOLDS>** is assigned, the editing window is displayed and the value of MIN low threshold can be ascribed. The ascribed value must be given in a current unit.



- Use arrow buttons to enter low threshold value, press button to confirm.
- The software automatically proceeds to the editing window of MAX high threshold value, which is

to be given in the current unit. Use arrow buttons to enter high threshold value, press button to confirm.

- The balance software proceeds to **<CHECKWEIGHING>** mode, values of declared thresholds are displayed in the bottom line (if such an option has been selected for **<INFORMATION>** function).
- At the top of the display the message **<Min>** is shown, it indicates weight value placed on the weighing pan in relation to low limit weight value. Bottom line of the display, if **<BARGRAPH>** option is enabled, shall demonstrate weight indication, in a graphic form, in relation to set thresholds.

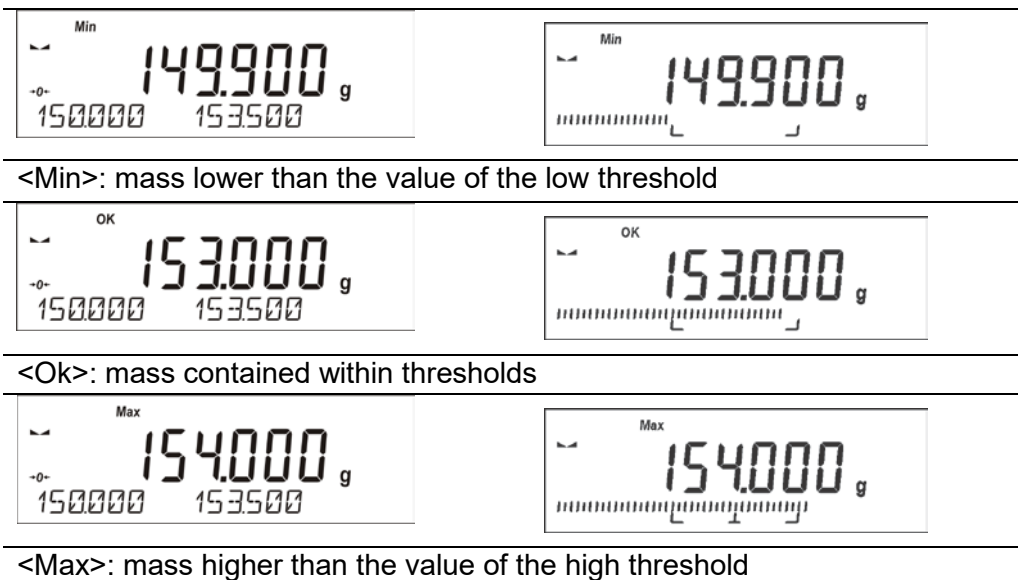

Since LCD display capacity is limited, the threshold markers do not reflect threshold setups and target weight value precisely. They provide rough information and serve as user aid in course of the balance operation.

10. DOSING

Dosing mode comprises process of sample weighing, wherein the said sample weighing is performed until target mass is reached. The target mass is defined along with dosing tolerance value. The tolerance value is set as a percentage of the target mass.

An example:

Target weight = 100.000g



Tolerance = 2.5% (2.5% of 100g, which amounts to 2.5g)

i.e.: the software accepts correctly dosed value within the following thresholds: from 97.500g to 102.500g.

Procedure:

- Press F button to which function **<ENTER SAMPLE>** is assigned, the editing window is displayed. The target weight value must be given in a current unit.



- Use arrow buttons to enter the target weight, press  button to confirm.
- The software automatically sets tolerance of target mass dosing. Use arrow buttons to set the tolerance value, press  button to confirm.
- The balance software automatically enters **<DOSING>** mode and displays the target mass value with a minus sign, and in the bottom line, reference mass value – target mass (if such option has been selected for **<INFORMATION>** function).



- The sign <Min> is shown at the top of the display. It indicates the status of the mass on the pan with relations to the target mass. Bottom line of the display, if <BARGRAPH> option is enabled, shall demonstrate weight indication, in a graphic form, in relation to target weight and set tolerance value

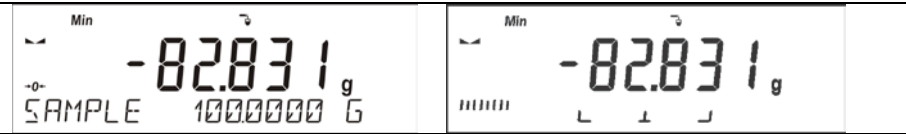

<Min>: mass lower than the Target Value - Tolerance



<Ok>: mass contained within tolerance Target Value +/- Tolerance



<Max>: mass greater than the Target Value + Tolerance

Since LCD display capacity is limited, the threshold markers do not reflect threshold setups and target weight value precisely. They provide rough information and serve as user aid in course of the balance operation.

11. PERCENT WEIGHING

Percent weighing is a working mode for comparison of a measured sample with the reference mass. The result is expressed in [%].

11.1. SETTING THE REFERENCE MASS: WEIGHING REFERENCE SAMPLE

Procedure:

- Press F button to which function <DETERMINE SAMPLE> is assigned, <PUT 100%> editing window is displayed.

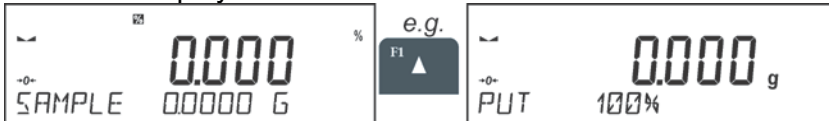

- Place the reference sample (to represent 100%) on the pan, and when the result is stable (▶ symbol is displayed) press ◀ button to confirm.

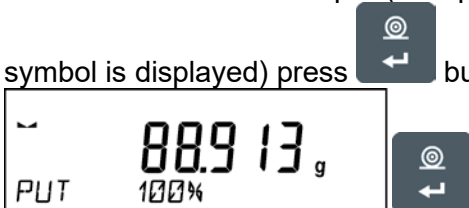

- The software automatically enters the measured load value as a reference sample and enters <PERCENT WEIGHING> mode displaying the value of 100.000%, the bottom line displays reference mass value (if such an option has been selected for <INFORMATION> function).



11.2. SETTING THE REFERENCE MASS: ENTERING THE MASS VALUE

Procedure:

- Press F button to which function <ENTER SAMPLE> is assigned, <ENTER SAMPLE> editing window is displayed.

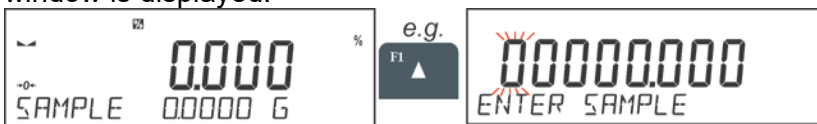

- Use arrow buttons to enter the known reference mass value, press  button to confirm.
- The software automatically enters <PERCENT WEIGHING> mode displaying the value of 0.000%, the bottom line displays entered reference mass value (if such an option has been selected for <INFORMATION> function).



12. DENSITY OF SOLIDS

Solids density is a working mode enabling determination of density of a representative sample material. In order to operate this mode, an optional Density Determination Kit is available for purchase. For the measurement, an appropriate model of the kit is used for the balance depending on pan configuration. Prior to installing the kit, it is necessary to remove the weighing pan and a draft shield.

Density determination of solids can be carried out by means of two pre-defined types of liquids or user-defined liquid of specified density:

- WATER** (distilled water),
- ETHANOL** (spirit 100% +/- 0.1% in temp. 20°C),
- OTHER** (another liquid of specified density).

When determining density in water or alcohol it is necessary to specify their temperature. For liquid of specified density, its value (density) is inserted from balance keyboard. Density determination is carried out by weighing a sample first in the air (top weighing pan of the density kit), and then weighing the same sample in liquid (on the bottom weighing pan of the density kit). As the same sample is weighed in liquid, the result of density determination is automatically indicated on a balance display.

Procedure:

1. Install the density determination kit.
2. Enter <SOLIDS DENSITY> function.
3. Prepare a sample.
4. Initiate the process.



- Set the process following the displayed messages.
- Select liquid in which the determination is to be carried out.

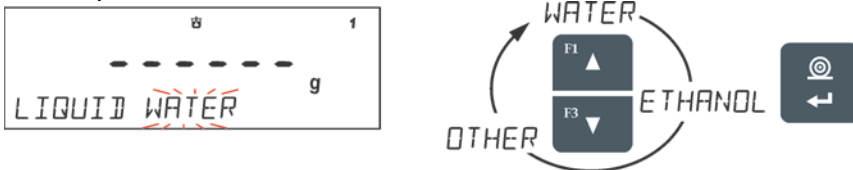

- After selecting and entering a liquid type by pressing <ENTER> button, the software proceeds to setting the liquid temperature.



- If <OTHER> liquid of determined density has been chosen, enter its density.

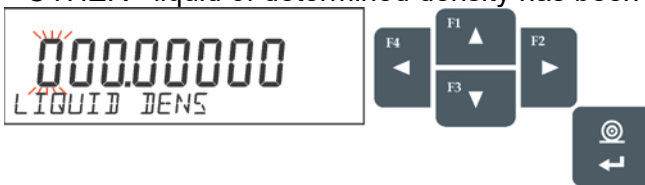

- With this data entered, the program proceeds to weighing.
- First, place a mass sample on the top weighing pan of the kit (weighing in the air), and confirm the indication when stable.

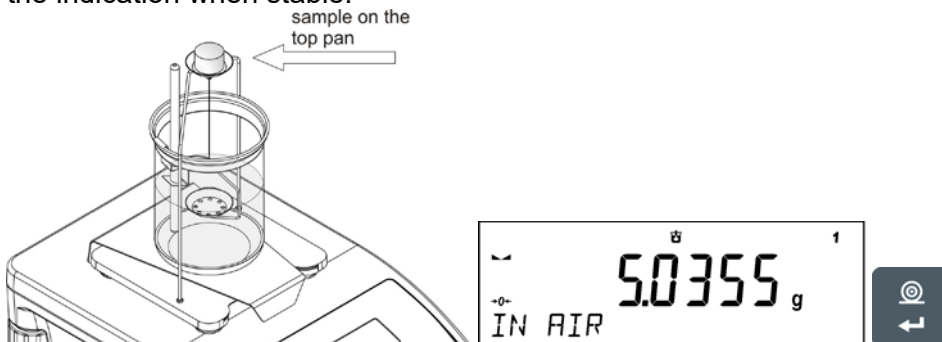

- Next, place a mass sample on the bottom pan of the kit (mass determination in the liquid), and confirm the indication when stable.

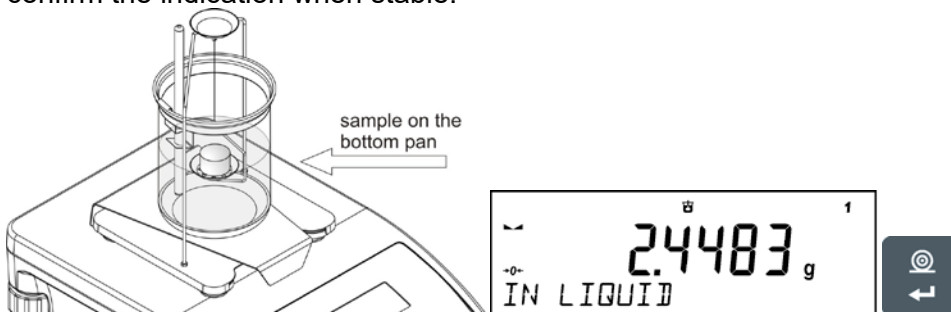

12. On the second confirmation of the indication, the program automatically calculates and displays the tested solid object density. At the same time, a report on the measurement is sent to a selected port of a printer.

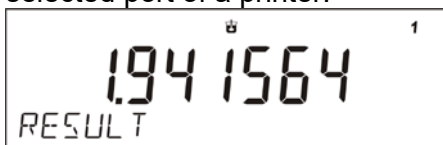



An example report:

-----Solids Dens-----	
Date	27.08.2013
Time	13:34:50
Balance ID	32100000
User	ADMIN
Liquid	Water
Temp.	23.0 °C
Liquid Dens	0.99756 g/cm3
In Air	5.0363 g
In Liquid	2.4489 g
Density	1.941722 g/cm3

Signature	
.....	



The report may be reprinted upon pressing  button. In order to finish, press  button. The software returns to the main window of the mode and a next measurement can be performed. The balance operates with previously set parameter values (liquid, temperature) thus shortening time needed for the exact measurement.

13. DENSITY OF LIQUIDS

Liquids density is a working mode enabling determination of density of liquid with use of representative sample of a given liquid.

To operate this mode, an optional Density Determination Kit is available for purchase. For the measurement, an appropriate model of the kit is used for the balance depending on pan configuration. Prior to installing the kit, it is necessary to remove the weighing pan and a draft shield. Density determination kit is the same for solids and for liquids.

The density of liquids is calculated using the following formula:

$$\rho = \frac{A - B}{V} + d$$

ρ - density of liquid

A - sinker weight measured in the air

B - sinker weight measured in water

V - volume of the sinker

d - air density (max 0.001 g/cm³)

The basic element for measuring liquids density is the sinker. Its volume is precisely determined and given on a sinker's hanger. Before starting liquid density determination, enter sinker's volume value to the balance memory. In order to measure the density of liquid, first determine mass of the sinker in the

air. Then, measure mass of the same sinker in the tested liquid. The result of liquid density determination is automatically indicated on balance display.

Procedure:

The basic element for measuring liquids density is the sinker. Its volume is precisely determined and given on a sinker's hanger. Before starting liquid density determination, enter sinker's volume value to the balance memory. In order to measure the density of liquid, first determine mass of the sinker in the air. Then, measure mass of the same sinker in the tested liquid. The result of liquid density determination is automatically indicated on balance display.

In order to determine the liquid density you need to:

1. Install the density determination kit.
2. Enter <LIQUIDS DENSITY> function.
3. Prepare a sample.
4. Initiate the process.
5. Set the process following the displayed messages.
6. Set volume of the sinker used for measuring.



7. On entering the data, the software proceeds to weighing.
8. First, place the sinker on the hook (a sample mass determination in the air), and confirm the indication when stable.



9. Next, take the sinker out of the hook, put the beaker with liquid on the beaker's basis (the beaker cannot touch the hook), gently hang the sinker on the hook providing that it is totally immersed in the tested liquid (sample mass determination in liquid) – and confirm the indication when stable.



10. On the second confirmation of the indication, the program automatically calculates and displays the tested solid object density. At the same time, a report on the measurement is sent to a selected port of a printer.

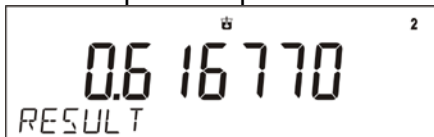



An example report:

-----Liquid Dens-----	
Date	28.08.2013
Time	9:38:39
Balance ID	32100000
User	ADMIN
Sinker vol.	10.0000 cm3
In Air	23.3511 g
In Liquid	17.1834 g
Density	0.616770 g/cm3

Signature	
.....	



The report may be reprinted upon pressing  button. In order to finish, press  button. The software returns to the main window of the mode and a next measurement can be performed. The balance operates with previously set parameter values (liquid, temperature) thus shortening time needed for the exact measurement.

14. ANIMAL WEIGHING

Animal weighing is a working mode allowing reliable determination of mass of weighed objects in motion. In principle, this type of object generates unstable measurement, thus it requires using a different filtering method of measurement signal.

Apart from standard settings for this mode (i.e. weighing mode settings) some additional parameters have been designed to describe operation of the mode.

Additional settings list:

- **AVERAGING TIME** – Amount of time during which recorded measurement results are analyzed. Obtained data is used to determine average measurement result.
- **THRESHOLD** - It is a value expressed in mass measuring units. To start measurement, the indication value has to exceed the set threshold value.
- **AUTOSTART** - Determines start criterion for measurements: whether they are to be initiated manually, on pressing a button or selecting **<START>**, or automatically. When the parameter is set to **<YES>** option, the measurement starts automatically if an indication on a balance display exceeds the set threshold value. The following measurement can start on removing the weighed object from a balance pan (the indication has to return below the value set in the threshold), and on loading the pan with a new object at a moment when the set threshold value indication is exceeded.

Prior to tests it is necessary to adjust settings of the above options so that correct values were provided. The selected options shall be respective to needs and expectations resulting from working environment.

14.1. RUNNING THE PROCESS MANUALLY

To start the process of weighing manually, enter the mode settings, select an **<AUTOSTART>** parameter and set **<NO>** value.

Procedure:

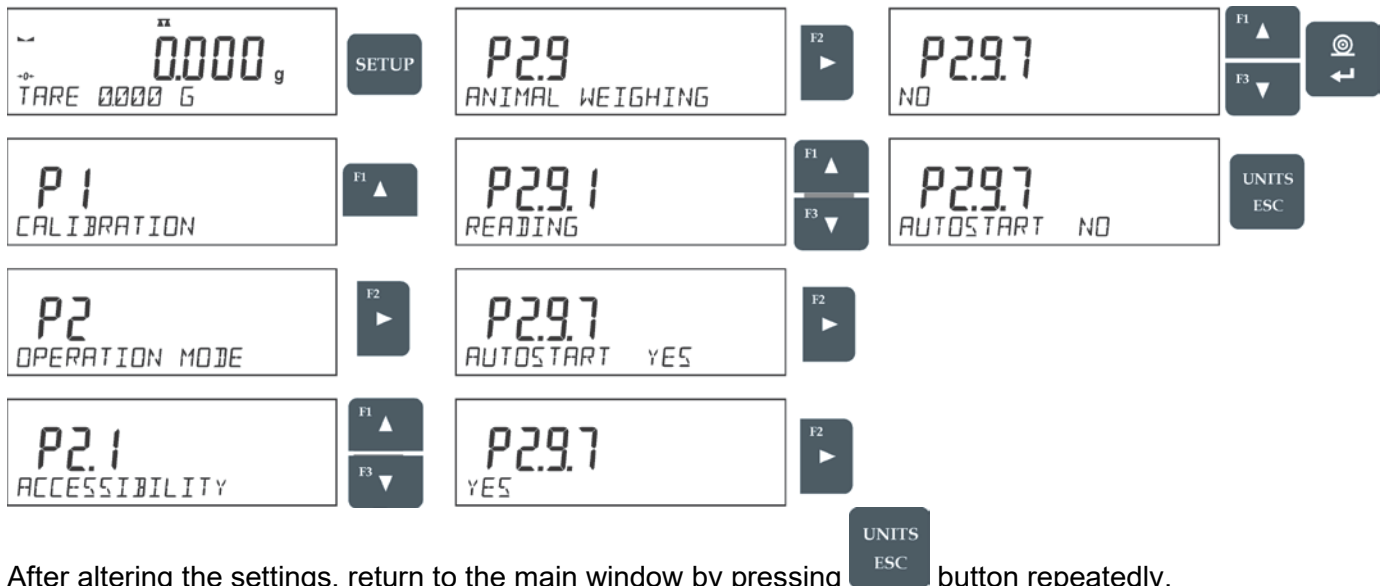

After altering the settings, return to the main window by pressing  button repeatedly. Next, set the averaging time in seconds. It is the time, during which the balance software acquires measurements and based on these measurements the average result is determined.

The <THRESHOLD> parameter is not required for this measurement mode.

Select <ANIMAL WEIGHING> mode.

Place the container in which the measurement is to be carried out on the weighing pan and when the indication is stable carry out taring.

Next, enter the mode options and start the measurement procedure following the instruction below.



After weighing process completion, the measurement result is locked and automatically printed.

14.2. RUNNING THE PROCESS AUTOMATICALLY

To start the process of weighing automatically, enter the mode settings, select an <AUTOSTART> parameter and set <YES> value, follow description from the previous paragraph. Additionally, set parameters <AVERAGING TIME> and <THRESHOLD>.

In order to carry out the measurement in a container (TARE) for this mode, select the option <ENTER TARE>, for the option overview to be found in weighing mode options description.

To start the process (after setting the options), enter the weight of the container, then put the container on the pan and place the object that is being weighed in the container. The balance automatically begins the process of measurement after exceeding the set mass threshold.

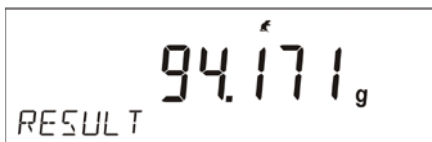

After weighing process completion, the measurement result is locked and automatically printed.

In order to finish the measurement, press  button.

The program automatically returns to the main window of Animal Weighing mode.

15. STATISTICS

Statistics is a working mode allowing to acquire data from series of measurements and to produce statistics using the acquired data. Settings of this function determine which data is displayed.

Info field provides the following information:

- N (number of samples),
- Sum (total weight of samples within a series)
- AVG (average value of the series)
- Min (minimum value in a series)
- Max (maximum values in a series)
- DIF (difference between MAX and MIN within the series)
- SDV (standard deviation)
- RDV (variance coefficient)

Procedure:

- Enter <STATISTICS> mode.
- Place the first load on the weighing pan.

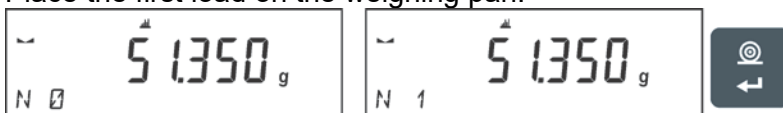

- When the indication is stable, confirm the measurement by pressing  button, the measurement is saved in the balance memory, next it is automatically printed out with the measurement number.
- Remove the load from the weighing pan
- Carry out measurements for other loads within this series



- When all the measurements are saved, it is possible to check the results of statistics by pressing

 button:

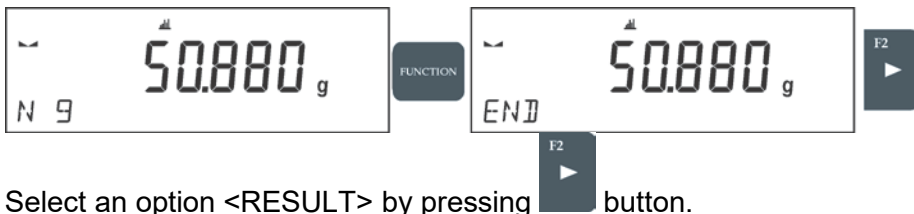

- Select an option <RESULT> by pressing button.

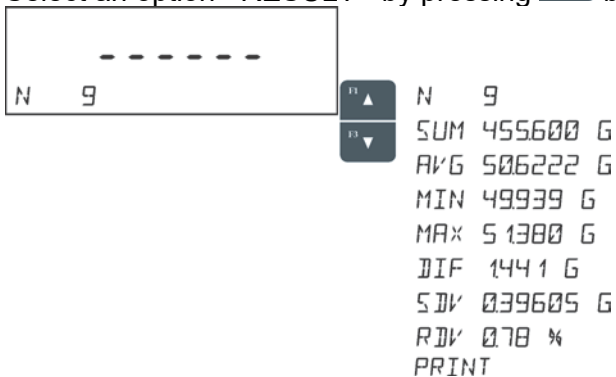

- The information on number of saved measurements is displayed in a bottom line. On pressing or , the type of displayed information changes.
- Selecting an option <PRINT> and pressing button initiates printing out the statistics data in a form of a report.

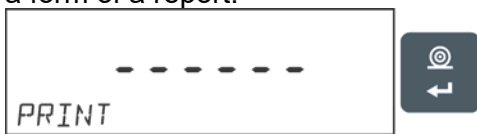

An example report:

----- Statistics -----	
N	9
Sum	455.600 g
Avg	50.6222 g
Min	49.939 g
Max	51.380 g
Dif	1.441 g
Sdv	0.39605 g
Rdv	0.78 %

15.1. DELETING STATISTICS

To delete statistics data carried out for a series of measurements, follow the following step.

Procedure:

To delete statistics data carried out for a series of measurements, follow this procedure:



Activating <FINISH> option results in printing out the statistics data and moving to a <RESULT> window, using this window it is possible to check the data and print it out again, if necessary.



To exit, press  button. This leads to returning to the main window of <STATISTICS> mode and zeroing the data related to carried out measurements.



You can begin another series of measurements or return to the weighing mode.

16. PEAK HOLD

Peak Hold is a function that enables snapping peak hold applied to the weighing pan during a single checkweighing process. Apart from standard settings for this mode (described in the weighing mode), additional setting for threshold values activating function has been introduced.

The option is available in the settings for mode Peak Hold and it is:

- **Threshold** – this function specifies starting point for control of maximum pressure applied onto the weighing pan, wherein the said control is performed by the balance software. The threshold must be set in accordance with the needs prior to the measuring process.

Procedure:

- Enter <PEAK HOLD> mode
Once you select the mode, the function is active and information about the net mass is displayed in a bottom line (only if a different information has not been selected by a user).
In order to provide proper operation, set the threshold in grams determining point beyond which the function starts to register maximum force applied.
- From now on the balance registers and holds every single weighing which is above the threshold, and which is higher than the result of the previous peak hold. If the software detects mass above the threshold, the highest detected indication is held on the main display and the pictogram <Max> is shown at the top of the display.

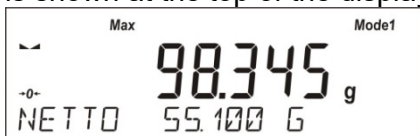

You can print the result out by pressing  button.

The start of the next process of peak hold measurement is possible only after removing the load



from the weighing pan and pressing  button. This causes returning to the main window of <PEAK HOLD> mode, pictogram <Max> is automatically deleted.



CAUTION!

Current unit may be selected only if the weighing result is not snapped. In order to select the unit, Units/Esc button is used. If any result has already been snapped than Esc button deletes the last snapped Max result.

17. TOTALISING

The Totalising function allows you to weigh individual ingredients of a mixture and totalize its total mass. The software enables adding up approximately 30 ingredients for one mixture.

Apart from standard settings for this mode (i.e. weighing mode settings) additional parameter has been designed to describe operation of the mode:

- **<REP. PRNT. T.>** – allows to turn off printing the tare value on a report.

Procedure:

- Enter **<TOTALISING>** mode
The bottom line shows total sum and data relating to the number of ingredients which are added to the total sum (if such information is selected in the settings for totalising mode).
- On the weighing pan place a container in which the ingredients are to be weighed, tare its mass. Next, place the first ingredient in the container and confirm its mass when stable by pressing



button

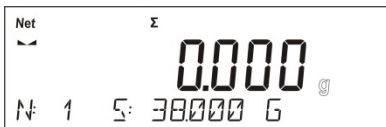

The software adds mass of the ingredient to the total mass, next automatic taring of the indication proceeds (zero indication is shown on the main display). In the bottom, line modified data relating to the number of ingredients and total sum is presented.

- Next, place other ingredients in the container and when the indication is stable confirm their mass by pressing  button.

- If a mistake has occurred concerning the mass of the last added ingredient, you can return to the previous step of the procedure. After changing the mass value, it is possible for the user to add this mass to the total sum. In such a case, follow this procedure:

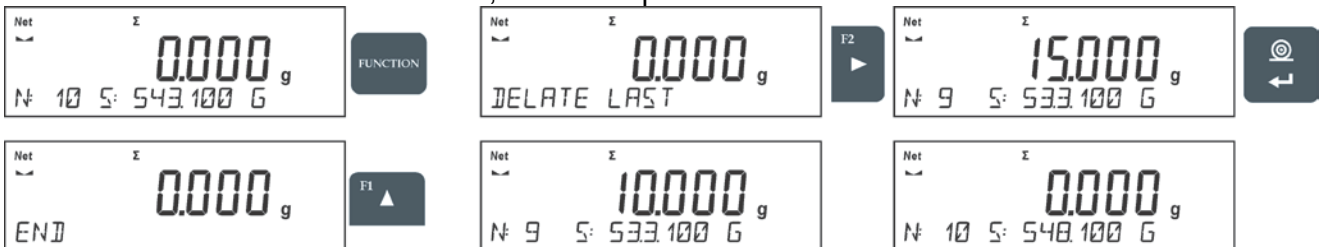

- When all the ingredients have been weighed finish the procedure of totalising.

Procedure:



- The message **<RESULT>** is displayed in a bottom line, this means that the total result of all the ingredients that have been weighed is shown on the main display. Additionally, the final report, containing information on mass of individual ingredients, total sum and mass of the applied tare, is printed out.

An example report:

----- Totalising -----	
1.	38.000 g
2.	100.000 g
3.	50.000 g
4.	10.000 g
5.	125.000 g
6.	15.100 g
7.	148.000 g
8.	6.000 g
9.	41.000 g
10.	15.000 g

Total	548.100 g
Tare	100.000 g

It is possible to print out the report again by pressing  button.

To exit this window, press  button. The main window for <TOTALISING> mode is displayed, data related to carried out measurements is automatically zeroed.

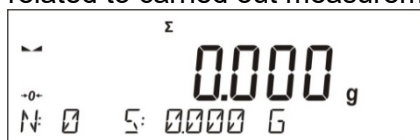

18. PIPETTES CALIBRATION

Caution! Function valid for Transcat TCL-Series Analytical (0.01 and 0.1mg) series balances exclusively.

Pipettes calibration function applies to fixed volume pipettes and adjustable volume pipettes. During volume testing procedure, the software determines accuracy and repeatability errors. In case of pipettes with adjustable volume, errors for Max, Min and ½ Max volume are estimated.

All pipettes are tested for adherence to requirements of PN-EN ISO 8655:2003. During the tests dosing repeatability and accuracy are monitored.

In order to ensure the highest accuracy of pipettes calibration process, maintain the following ambient conditions at a workstation:

- Ambient temperature of a pipette, tips and liquid should be kept between 20°C - 25°C with change rate during testing within $\pm 0.5^{\circ}\text{C}$,
- Relative humidity 50 - 75%; and
- Use distilled water for pipettes calibration processes,
- Make sure that a pipette, tips and distilled water are thermally stabilized in the room intended for weighing operation performance. The reference standard advises that minimum acclimatization time for above mentioned is 2 hours.

Prior pipettes calibration start, it is necessary to install a dedicated set inside the draft shield. The set is not a standard balance equipment. The picture below presents set installation. Evaporation ring minimizes measurement errors being a result of evaporation of liquid occurring in course of the weighing process.

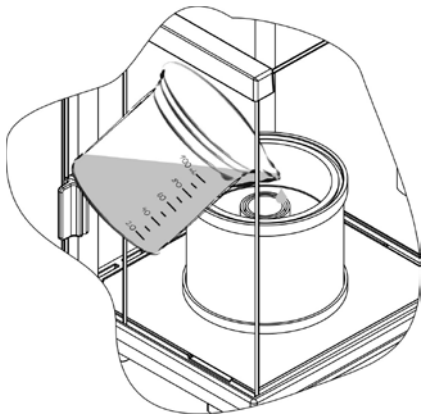

Prior to pipettes calibration pour 2/3 of the evaporation ring with distilled water. The set is ready to be used after about 1 hour – it takes this long for humidity to stabilize. Excess water can be removed using automatic pump or an external pipette.

To minimize any humidity changes inside the chamber and to avoid air draft influence while opening the door, dose the liquid from a pipette to an evaporation ring via an opening of a weighing chamber lid.

With thus prepared balance you can start pipettes calibration procedure.

Apart from standard settings for this mode (i.e. weighing mode settings) some additional parameters have been designed to describe operation of the mode.

Additional settings list:

- **VOLUME DETERMINATION** – allows to predefine number of tested volumes for a particular pipette. For pipettes with fixed volume please set parameter <1>, for pipettes with adjustable volume set parameter <2> and <3>.
- **MEASUR. NO** – allows to predefine number of measurements for each tested volume. Number of measurements ranges from 6 to 20.
- **AUTOMATIC TARING** - allows to turn on function of automatic taring of dosed portion of water after confirmation of measurement (value set to <YES>)

Remember to select correct values of the above options before pipettes calibration procedure is performed. The settings should reflect expectations and needs being a result of working environment.

Procedure:

- Enter <PIPETTES CALIBRATION.> mode.
- Start the process.



- Follow the prompts to set the correct options.
- Enter the ambient temperature, next press ENTER for confirmation. The computer software proceeds to the next step, i.e. ambient humidity settings.

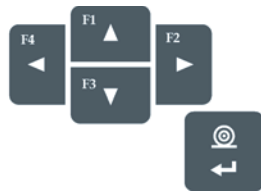

- Set the ambient humidity, next press ENTER for confirmation. The computer software proceeds to the next step, i.e. air pressure settings.

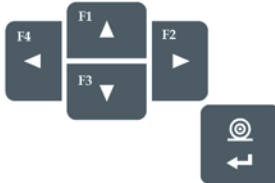

- Set the air pressure, next press ENTER for confirmation. The computer software proceeds to the next step, i.e. entering the first control volume (V1) for a tested pipette.

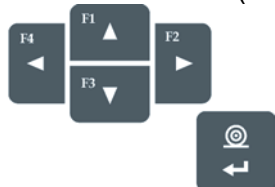

- Enter (V1) control volume. For fixed volume pipettes (P2.13.5 VOLUME DETERMINATION parameter set to value <1>) this is the one and only value to be entered. The computer software proceeds to the next step, i.e. entering the second control volume (V2) for a tested pipette.

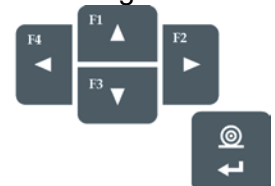

- Enter (V2) control volume. The computer software proceeds to the next step, i.e. entering the third control volume (V3) for a tested pipette.

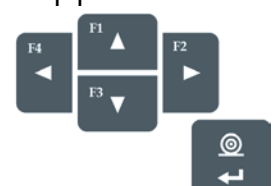

- Enter (V3) control volume.

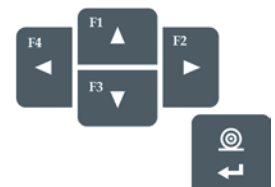
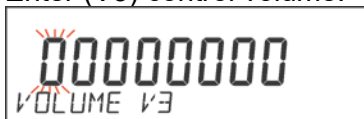

- Upon entering the data the computer software proceeds to pipettes calibration.



- Follow the displayed description and complete the procedure.
- By means of a pipette, dose the first portion of water, wait until the measurement is stable and press ENTER to confirm.



- The computer software records the measurement. If P2.3.7 **AUTOMATING TARING** parameter is set to value <YES> than the indication is automatically tared. If P2.3.7 **AUTOMATIC TARING** parameter is set to value <NO> than the user must press TARE button in order to tare the indication before (s)he doses another portion of water.
- Upon completion of series of measurements, summary is displayed.

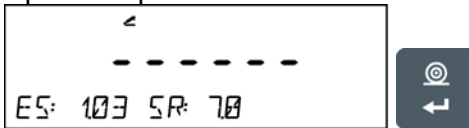

- Press ENTER to continue measuring process, press Esc. to stop it. Upon pressing Esc. button the computer software returns to the main window.
- Upon pressing ENTER, while displaying the summary result for the last adjustable pipette volume, a report is generated. The report is printed on a printer connected to the balance (ambient conditions visible on a report are those that user entered at the beginning of the calibration procedure). For fixed volume pipette the situation is similar if the user presses ENTER while displaying summary for volume V1.

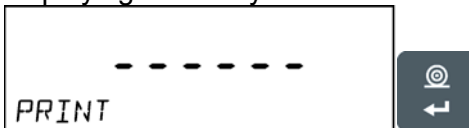

- The computer software returns to the main window.
- Now the user may either start new procedure for the same pipette or enter new data for a different pipette.

An example report: adjustable volume pipette, 3 volumes tested:

-----Pipettes calibration-----	
Measur. No.	10
Date	24.04.2014
Time	11:31:27
Temp.	22.0 °C
Humidity	50 %
Pressure	1013 hPa
-----Tested volume: 1000 µl-----	
1	1003 µl
2	993 µl
3	1013 µl
4	1023 µl
5	1003 µl
6	993 µl
7	1003 µl
8	1013 µl
9	1053 µl
10	1003 µl
Average volume [Va]	1010 µl
Systematic error [Es]	1.03 %
Random error [Sr]	17.7 µl

-----Tested volume: 5000 µl-----	
1	4966 µl
2	4966 µl
3	4966 µl
4	4986 µl
5	4976 µl
6	4966 µl
7	4966 µl
8	4976 µl
9	4976 µl
10	4976 µl
Average volume [Va]	4972 µl
Systematic error [Es]	0.56 %
Random error [Sr]	7.0 µl

-----Tested volume: 10000 µl-----	
1	10033 µl
2	10033 µl
3	10033 µl
4	10033 µl
5	10043 µl
6	10043 µl
7	10043 µl
8	10043 µl
9	10043 µl
10	10043 µl
Average volume [Va]	10039 µl
Systematic error [Es]	0.39 %
Random error [Sr]	5.2 µl

Signature	
.....	

19. ADDING

Adding function allows you to add net masses of weighed samples.

This function enables adding maximum 9999 ingredients in one cycle or such quantity of samples which value of totalized masses is possible to be displayed on 8-section display.

Procedure:

- Enter <ADDING> mode.
- The bottom line shows total sum and data relating to the number of ingredients which are added to the total sum and the total mass (if such information is selected in the settings for totalising mode).
- Load the weighing pan with the first sample. Confirm its mass when stable by pressing  button

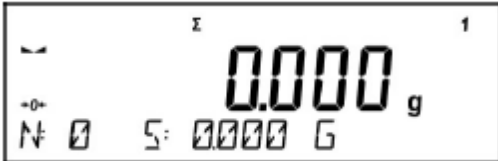

- Sample mass is saved to the sum. In the bottom line, data on ingredients quantity and total sum is changed and data on saved measurement is printed.



1. Net	38.00 g
Tare	0.000 g
Gross	38.00 g

- Next, take off the first sample and load the weighing pan with the second. Confirm its mass when stable by pressing  button
- Carry out adding rest of the samples left in a measurement series.
- If mass of the last added sample is incorrect, you can return to the previous step and on changing the sample, add it again. In such case, follow the steps:

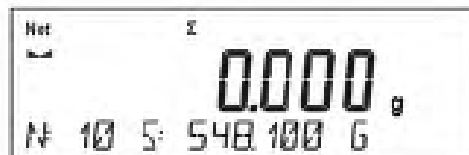
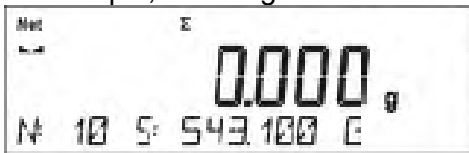

- On adding all samples, end adding procedure by following the steps:

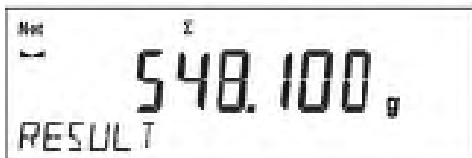

- In the bottom line message <RESULT> is displayed. It means that the total result of all measured samples masses is displayed and the sum is automatically printed.

An example printout:

1. Net	38.000 g
Tare	0.000 g
Gross	38.000 g
.	
.	
.	
10. Net	15.000 g
Tare	0.000 g
Gross	15.000 g
-----Adding-----	
Sum	0.00 g

CAUTION: On adding process completion, only a summary is printed. Masses of particular samples are printed on confirmation.

You can print the sum once again. To do that, press  button. Press  button to exit the window. You return to <ADDING> mode home screen and the data on carried out measurements is automatically zeroed.

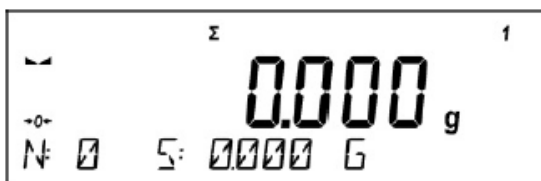

You can print an intermediate sum of saved samples. In such case, follow the steps presented below.

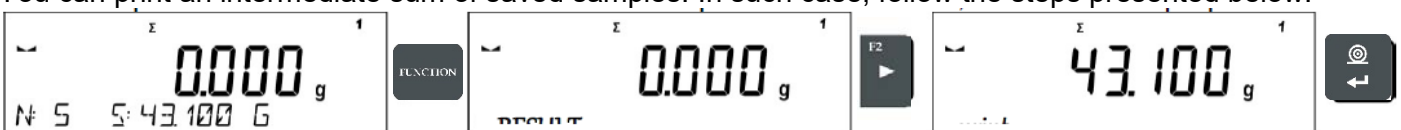

1. Net	38.000g
Tare	0.000g
Gross	38.000g
.	
.	
.	
5. Net	5.000g
Tare	0.000g
Gross	5.000g

Sum	43.100g

In order to continue adding process, press  button on printing out the sum. Home screen of the main mode is displayed.

If samples are measured with packagings, load the weighing pan with the packaging, wait for stabilization and press  button.

20. DATABASES

The balance software has 3 databases that can be edited (USERS, PRODUCTS, TARES) as well as 2 databases (WEIGHINGS AND ALIBI), to which all the measurements, carried out by means of the balance, are saved.

Data saved within particular databases:

USERS – 100 different users.

PRODUCTS – 1000 different products.

TARES – 10 different masses of the packaging.

WEIGHINGS – 5 000 consecutive measurements

ALIBI – 100 000 consecutive measurements

20.1. USERS

Each user is characterized by the following data:

NAME (30 characters), **CODE** (6 characters),

PASSWORD (8 characters, digits only),

ACCESS (USER, ADVANCED, ADMIN),

LANGUAGE (any of the available).

Access levels

The balance software has three access levels: USER, ADVANCED, ADMINISTRATOR.

Once the balance is switched on, the display stays active all the time, this enables carrying out mass measurements even when no user is logged-in.

User parameters, databases and software functions may be edited depending on the access level granted to a particular user. Access levels are presented in the table below.

Access levels	Permissions
USER	Access to parameters of the submenu <Reading>, permission to change settings for parameter group <Other> except for <Date and Time>. Permission to start and carry out all the weighing processes. You can preview information in <Databases> and define universal variables.
ADV	Access to editing parameters of the submenu: <Reading>; <Working modes>; <Communication>; <Devices>; <Other> except for <Date and Time>. Permission to start and carry out all the weighing processes.
ADMIN	Access to all user parameters and functions, permission to edit databases.

In order to add a user, follow the scheme shown below, add a user and assign a name to him/her.





Once the user name is added, enter the following:

- User code – Max 6 characters,
- User password – Max 8 numbers.

Next select:

- Access level (USER, ADV, ADMIN)
- Language

In order to remove a user you should follow this procedure:

- Enter the user database
- Select the user that is to be removed from the list
- Press  button
- The software shows <DELETE?> message in the bottom line
- Confirm by pressing  button
- When confirmed, the software removes the selected user from the list

20.2. PRODUCTS

PRODUCTS – 1000 different products. The following data can be inserted for each product:

- **NAME** (30 characters)
- **CODE** (6 characters)
- **EAN** (16 characters)
- **MASS** (with the accuracy of a reading unit)

- **TARE** (mass of the packaging relating to a particular product with the accuracy of a reading unit),
- **MIN** (low limit for the <CHECKWEIGHING> mode, to be inserted with the accuracy of a reading unit), **MAX** (high limit for the <CHECKWEIGHING> mode, to be inserted with the accuracy of a reading unit),
- **TOLERANCE** (tolerance limits to $[\pm]$ for <DOSING> mode, entered as a % of the target mass).

In order to add a product, enter products database and add name of the product along with respective data (follow the procedure as in the section above).

20.3. TARES

TARES – 100 different weights of the packaging. The following data can be inserted for each packaging:

- **NAME** (30 characters),
- **TARE** (packaging weight, enter a value with the accuracy of a reading unit).

In order to add tare – packaging weight, enter tare database and add name of the tare along with respective data (follow the procedure as in Users section).

20.4. WEIGHINGS

Weighings database is non-editable i.e. the data relating to the weighings is saved automatically. A user has a possibility of viewing this data and printing it out or exporting it to a PENDRIVE (if such a need occurs go to later sections for more information on export).

The balance software allows you to save and store up to 5,000 measurements carried out on the balance. This occurs automatically, after pressing the <PRINT> button, no additional actions or settings change is needed.

Additional data is saved along with the measurement.

- Date of the measurement
- Time of the measurement
- Measurement result (mass)
- Tare value
- Name of the product that has been weighed
- Person carrying out the measurement (logged-in user)
- Working mode for which the measurement has been carried out
- Value of variable 1 and 2

The software saves the measurements in a so called loop, i.e. when the measurement 5 001 is saved, the measurement 1 is automatically deleted from the balance’s memory.



The measurements saved in the balance’s memory cannot be deleted.

It is possible for a user to view and print out the data saved in the memory.

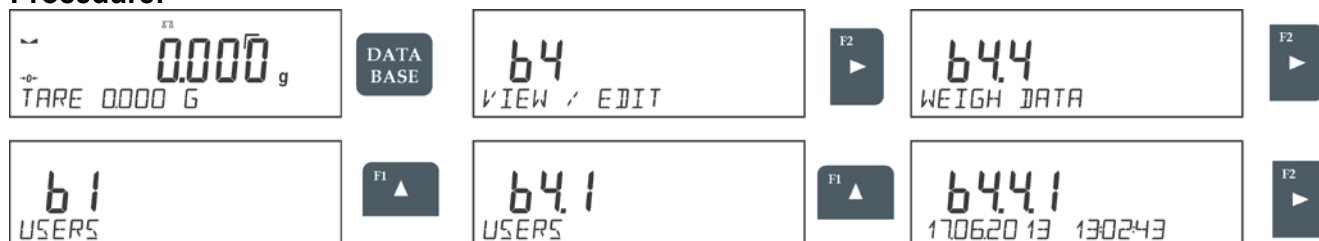
Procedure:



Each measurement is saved with its individual number. The format is: b4.4.n, where <n> is the consecutive number of the saved measurement. In the bottom line the date and time are displayed for every single measurement.

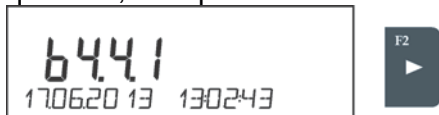

To swap between measurements recorded in database, use the arrow buttons,  or . Pressing one of these buttons lets the user move to the next measurement either up or down the list. To view the remaining data relating to a respective measurement, first select the measurement in

question, next press  button:

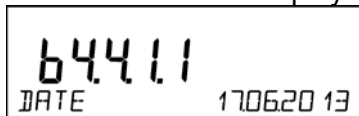

The software automatically shows the data relating to the measurement, data is presented in the bottom line of the balance display.



To swap between data relating to the measurement, press  or . The data relating to the measurement can be printed out by selecting the option <PRINT> and pressing  button.

An example printout:

```

Date 21.06.2013
Time                13:05:02
User
Product

Tare                0.000 g
Gross               0.000 g
0.000 g
-----Cal. report.-----
Cal. Type           Internal
User
Project            1234567890123459
Date               16.07.2013
Time              13:27:09
Balance ID         10353870
Cal. diff.         -0.004 g
-----
Signature
.....
    
```

The data that is to be printed out, depends on the settings of parameter P5.3 GLP PRINTOUT. Parameters selected for the printout (<YES> option), are printed out also on measurement result printout for WEIGHINGS database.

20.5. ALIBI MEMORY

The balance is equipped with “ALIBI”, a type of memory that allows you to save and store up to 100 000 measurements carried out on the balance.

If the “ALIBI” memory is installed in the balance, the saving of the measurements occurs automatically, by pressing <PRINT> button, without a need of additional actions or settings change.

The additional data is saved along with the measurement.

- Date of the measurement
- Time of the measurement
- Measurement result (mass)
- Tare value
- Person carrying out the measurement (logged-in user)
- The name of the product that has been weighed

The software saves the measurements in a so called loop, i.e. when the measurement 100 001 is saved, the measurement 1 is automatically deleted from the balance’s memory.

The measurements saved in the balance’s memory cannot be deleted.

It is possible for a user to view and print out the data saved in the “ALIBI” memory.

Procedure:

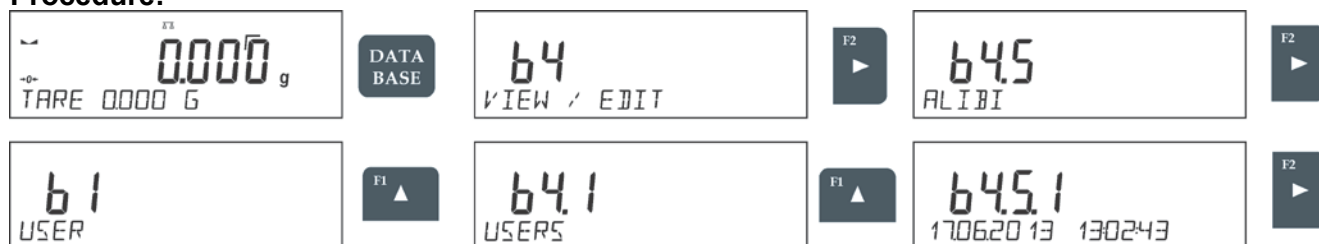

Each measurement is saved with its individual number. The format is: b4.5.n, where <n> is the consecutive number of the saved measurement. In the bottom line the date and time are displayed for every single measurement.

Operations for ALIBI database and WEIGHINGS database are likewise, for detailed information read the previous section.

An example printout:

Date	19.06.2013
Time	6:48:41
Result	199.90 g
Tare	0.000 g
User	SMITH
Product	PILL



To return to the weighing mode press **UNITS ESC** button repeatedly.

21. EXPORT AND IMPORT OF DATABASES

This option allows the user to:

- Archive data relating to the carried out weighings – WEIGHINGS database and ALIBI database.
- Copy the products, tares and users databases between balances of this series.

This can be performed by using external USB flash drive, which shall feature **<FAT files system>**
Plug the flash drive into USB 1 Type A port.

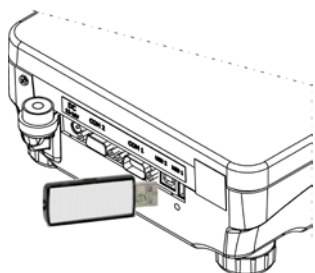

The balance automatically detects the flash drive, the message enabling operations relating to the export or import of the database is displayed.



The following options are available when entering this parameter:

- Database EXPORT
- Database IMPORT

21.1. DATABASE EXPORT

To export the database, select an option EXPORT.

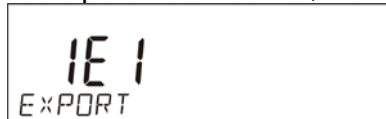

The following functions are available:

- Export of all the databases
- Export of users databases
- Export of product databases
- Export of tares databases
- Export of weighings
- Export of weighings saved in ALIBI memory
- Export of user parameters

After selecting **<ALL DATABASES>** option, the balance software creates files on the flash drive. The files are of relevant names, data from individual databases is recorded in them. The files are characterized by special extensions, saved data is encoded in a way that the files cannot be read or viewed by standard computer programs.

Special computer software manufactured by our company is used to read data from database files: ALIBI and WEIGHINGS. The data from files storing information from PRODUCTS, USERS, and TARES databases is read automatically by the balance software when option **<IMPORT>** is enabled.

21.2. DATABASE IMPORT

<IMPORT> function allows transfer of data, recorded in balance databases, from one balance to another. This is a quick and reliable way for entering the data without any mistakes.

To import the database, plug a flash drive to USB port, next select IMPORT option and choose one of the following:

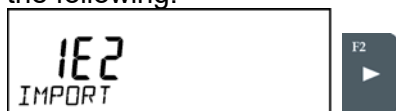

The following options are available:



- Import of all databases
- Import of users databases
- Import of products databases
- Import of tares databases
- Import of user parameters

The data from ALIBI and WEIGHINGS databases cannot be imported.

21.3. MEASUREMENT DATA PRINTOUT

Balance software allows the user to save data, relating to a measurement, on an external USB flash drive.

The operation can be performed as follows:

- Plug a flash drive into USB port.
- Press  button to abandon automatically started <IMPORT/EXPORT> option.
- Set parameter P4.2.1 <DEVICES/PRINTER/PORT> to <PENDRIVE> option.
- Return to the weighing mode.
- From this moment on, every single pressing of the button  results with record of measurement data (compatible with the settings for GLP0 PRINTOUT) in a text file, the text file is automatically created by the balance software. The file name is: *printout.txt*.
- Press  button to switch the balance off, next remove the pendrive from the port and read the data on a computer. Keeping to this sequence of actions you are guaranteed that the data is saved.

More data can be recorded in the same file. The balance software will add the data to the file that has already been created on a flash drive. Consequently, you can continue saving measurements in the same file once created.

CAUTION:

USB flash drive shall feature <**FAT file system**>.

22. MISCELLANEOUS PARAMETERS

You can set up parameters which influence balance operation. These parameters are to be found in parameters group **P6 OTHER**.

Settings modification for particular parameters of this parameter group proceeds likewise as described in the previous section.

Menu language

Language parameter enables selecting the language of the balance menu descriptions.

Available languages: POLISH, ENGLISH, GERMAN, SPANISH, FRENCH, TURKISH, CZECH, ITALIAN, HUNGARIAN.

Permissions

Permissions parameter enables choosing access level for a particular user, one that is not logged in.

Available access levels: ADMIN. / USER. / ADV.

Depending on selected permissions level, you can enter balance parameters and modify the settings, as far as possible for a particular level.

“Beep” sound – reaction to operation of pressing a key

Sound parameter enables switching on/off a ‘beep’ sound responsible for informing a user about pressing any key of balance overlay.

NO - ‘beep’ sound off

YES - ‘beep’ sound on.

Backlight, and display brightness calibration

The parameter enables setting the brightness of the backlight or switching off the display brightness completely.

100 - maximum brightness of the backlight

10 - minimum brightness of the backlight

NONE - display brightness switched off

Backlight turn-off time

Parameter <P6.5 STAND-BY MODE> enables use of function responsible for activation of the display stand-by mode when weighing process is not being performed (stable indication is a necessary condition for activation of the stand-by mode).

NONE – backlit turn-off time not activated

0.5; 1; 2; 3; 5 – time given in minutes

If the software registers stable indication for a specified time interval, set in parameter <P6.5 STAND-BY MODE>, then the display goes out immediately.

The backlight activates upon change of indication (no stability pictogram on the display) or pressing any key on the balance keypad. Blanking works also when balance menu is entered.

Auto switch-off

Parameter <P6.6 AUTO OFF> enables use of function responsible for automatic display deactivation

(functions as  button). Upon display deactivation the other subassemblies are powered and the balance turns to stand-by mode.

NONE – auto switch-off not activated

0.5; 1; 2; 3; 5 – time given in minutes

If the software registers stable indication for a specified time interval, set in parameter <P6.6 AUTO OFF> settings, then the display is turned-off immediately (inactive backlight function, no indication on the display, clock displayed).

To start-up the balance it is necessary to press  button located on the balance keypad. The balance will automatically return to weighing.

The balance cannot be turned off if any process is started or if balance menu is entered.

Date

Date parameter enables setting the current date.

Procedure:



Time

Date parameter enables setting the current time.

Procedure:



Date format

Date form. parameter enables altering the date format on the printout [YYYY.MM.DD / YYYY.DD.MM / DD.MM.YYYY / MM.DD.YYYY], where: YYYY – year; MM – month; DD – day.

Time format

Time form. parameter enables specifying time format for a printout [12h / 24h].

For [12h] option selected, <A> or <P> letter is displayed next to presented time value, where: **A** stands for hours before noon; **P** stands for hours after noon.

GLP autotest

AUTOTEST function is designed to aid a user in assessing balance's operation and diagnosing the reasons for occurrence of errors in weighing which exceed the maximum permissible values for a given balance model.

By means of a simple, repeatable and fully documented way, the function enables optimizing balance's settings to maintain the best possible repeatability and weighing time at workstation. The main purpose of the function is the possibility of monitoring the above-mentioned parameters at optional moment and saving records from the carried out tests in the form of printed reports of the tests that are automatically generated at the end of examination.

The test controls repeatability of placing the interval weight and determining error of indication with reference to balance's maximum capacity.

Testing procedure:

- deposit internal weight twice
- deposit internal weight ten times
- perform balance calibration
- calculate the value of standard deviation
- print a report.

Test results provide balance data, calculated error for Max capacity and value of repeatability of indication expressed as standard deviation.

An example report:



```
.....
----- Autotest GLP: Report -----
Balance type      TCL-4502
Balance ID       400010
User             Admin
Software rev.    v.0.4.9
Date            2013.07.16
Time            09:17:16
-----
Number of measurements  10
Reading unit           0.001/0.01 g
Internal weight mass  1402.094 g
Filter                Average
Value release         Fast &Reliable
-----
Deviation for Max.     -0.118 g
Repeatability         0.0088 g
Signature
.....
```

Procedure:

To initiate parameter <P6.11 GLP AUTOTEST > press  button. The balance software launches the GLP autotest procedure and it is carried out automatically from now on to the end.

You can stop the procedure at any time by pressing  button of the GLP process window. Once the procedure is finished, the value of standard deviation of all measurements is shown in the main display, and message <RESULT> in the bottom line, the final report is printed out automatically (as

shown above). It is possible to print out the report again by pressing  button. Report is not saved, therefore when abandoning this level, it is deleted from the balance volatile memory.

To abandon the window press  button and the program returns to the main menu. To return to weighing, press  button repeatedly.

23. DETERMINING PRINTOUT CONTENT

23.1. CALIBRATION REPORT

CAL. REPORT, is a group of parameters enabling user to declare data that is to be printed on an calibration printout.

Variable	Overview
PROJECT	Option enables naming the project (name associated with a particular type of weighing). The name may consist of 16 characters maximum.
CALIB TYPE	Option enables printing out the type of the calibration being carried out.
USER	Option enables printing out the name of a logged-in user.
PROJECT	Option enables printing out the name of the project (see parameter Project).
DATE	Option enables printing out the date of the carried out calibration.
TIME	Option enables printing out the time of the carried out calibration.
BALANCE ID	Option enables printing out the balance ID number.
CAL. DIFFER	Option enables printing out the difference between mass of an calibration weight measured during the last calibration and the current measured mass of this weight.
DASHES	Option enables printing out dashes that separate the date of a printout from a signature.
SIGNATURE	Option enables providing an area for the signature of a user performing the calibration.

For the parameters described above, one of these values must be selected:

NO - do not print

YES - print

An example report:

-----Cal. Report-----	
Calib. type	Internal
User	Admin
Project	Project name-1
Date	04.06.2013
Time	10:54:27 AM
Balance ID	353870
Cal. differ.	0.045 g

Signature:	
.....	

23.2. HEADER, FOOTER, GLP PRINTOUTS

HEADER	group of parameters enabling to declare data that is to be printed on a header printout.
GLP PRINTOUT	group of parameters enabling to declare data that is to be printed on a measurement result printout
FOOTER	group of parameters enabling to declare data that is to be printed on a footer printout

Printout variables list:

Variable	Overview	Active for
WORKING MODE	Option enables printing out the name of a working mode.	Header Footer
BALANCE TYPE	Option enables printing out the balance type.	Header Footer
BALANCE ID	Option enables printing out the balance ID number.	Header Footer
USER	Option enables printing out the name of a logged-in user.	Header GLP printout Footer
PRODUCT	Option enables printing out the name of a currently selected product.	Header GLP printout Footer
DATE	Option enables printing out the date of the carried out calibration.	Header GLP printout Footer
TIME	Option enables printing out the time of the carried out calibration.	Header GLP printout Footer
VARIABLE 1	Option enables printing out the value of VARIABLE 1.	Header GLP printout Footer
VARIABLE 2	Option enables printing out the value of VARIABLE 2.	Header GLP printout Footer
NET	Option enables printing out net weight value in a basic unit (calibration unit).	GLP printout
TARE	Option enables printing out the tare value in the current unit.	GLP printout
GROSS	Option enables printing out the gross mass value in the current unit.	GLP printout
CURR.RES	Option enables printing out the current measurement result (NET weight) in a current unit .	GLP printout
CAL.REPORT	Option enables printing out a report from the last calibration, according to the settings declared for the calibration report printout (see sec. 14.1 of this user manual).	Header GLP printout Footer
DASHES	Option enables printing out separating dashes.	Header Footer
EMPTY LINE	Option enables printing out an empty separating line.	Header Footer
SIGNATURE	Option enables providing an area for the signature of a user performing the calibration.	Footer
NSTD. PRNT.	Option enables printing out one of 100 non-standard printouts on the footer printout. The way of entering non-standard printouts is described further down this user manual.	Header GLP printout Footer

For the parameters described above, one of these values must be selected:

NO - do not print; **YES** - print

Example reports:

Header

```

-----
Working modes      Weighing
Date              24.07.2013
Time              7:37:30
ScaleType         AS
Balance ID        10353870
User              ADMIN ENG
Product           Tablet
    
```

GLP printout

```

Date              04.06.2013
Time              11:11:24 AM
Product           NAZWA
0.000 g
    
```

Footer

```

-----
Date              24.07.2013
Time              7:41:10
User              ADMIN ENG

Signature

.....
    
```

23.3. NON-STANDARD PRINTOUTS

The balance software enables entering 4 non-standard printouts. Each of them can consist of approximately 160 characters.

Non-standard printout may include:

variables dependent on the working mode and other needs (mass, date etc.)

permanent text from the user menu, remember to use capital letters exclusively, no polish signs allowed

Non-standard printout can consist of 160-character long string.

23.3.1. INSERTING TEXT

List of variables mutual for all working modes, having the same values:

%%	Printout of a “%” character
%V	Current net mass in the current unit
%N	Current net mass in the basic unit
%G	Current gross mass in the basic unit
%T	Current tare mass in the basic unit
%D	Current date
%M	Current time
%I	Balance number
%R	Program number
%P	Project number
%U	User number
%F	Name of a current function – working mode
%C	Date and time of the last calibration
%K	Type of the last calibration
%S	Currently weighed product
%Y	Deviation for the last calibration
%1	Variable 1
%2	Variable 2

Variables depending on the currently used working mode

Variable	Description	Mode for which the variable is active
%W	Standard mass 1 pcs	PARTS COUNTING
%H	High threshold	CHECKWEIGHING
%L	Low threshold	
%A	Target mass	DOSING
%B	Reference mass	PERCENT WEIGHING

Non-standard characters used in designing non-standard printouts

\\	a single „\” character
\C	CRLF
\R	CR
\N	LF
\T	Tabulator
\F	Form feed (for PCL printers)
%E	Crop the paper for EPSON printers

Every single printout can contain max 160 characters (letters, numerals, non-standard characters, spaces). You can apply non-standard characters depending on type of data that is to be printed out.

Example 1:

“AAAAAA”

DATE: <current measurement date>

TIME: <current measurement time>

PRODUCT MASS: <current mass indication>

*****SIGNATURE:.....

<current working mode>

Enter printout content settings and design the printout using respective data variables and characters for text format.

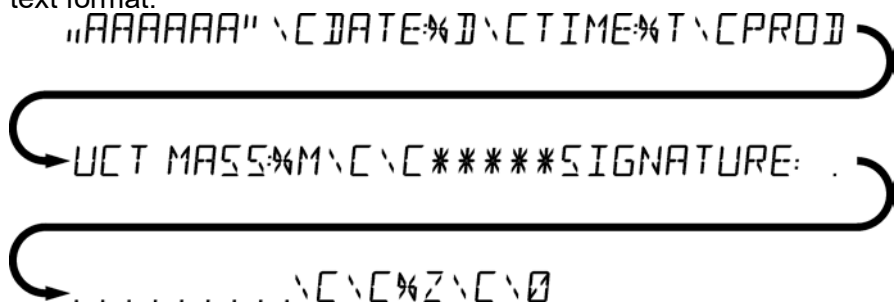

Example 2:

To crop the paper after the printout had been carried out by EPSON printer (if the printer is equipped with an autocutter blade) the user must select (for a given printout: HEADER, GLP PRINTOUT or FOOTER) an option of non-standard printout 1,2,3 or 4 with <%E> value available and select this printout for a given printout setting.

In such case <SUFFIX> command should stay empty.

Paper must be cropped underneath the FOOTER.







Example settings:

P5.4.14 STANDARD PRINTOUT | NSD. PRN. 1

P5.5 NSD. PRN. 1 | %E

The way of inserting texts:

- By means of balance keyboard

	Selecting a character to be replaced. Moving a cursor or an active (blinking) character to the right.
	Selecting a character to be replaced. Moving a cursor or an active (blinking) character to the left.
	Change of the character by one value down
	Change of the character by one value up
	Deleting a character
	Inserting a character

- By the means of computer keyboard of the USB type
A computer keyboard of USB type can be connected to a balance, this enables easier and quicker editing of the printouts.
Willing to insert any text, it is necessary to select a respective menu option and, using the keyboard, type the text. Next the text must be confirmed by means of Enter button.

CAUTION: It is important to type variables, used for non-standard printouts, in capital letters.

23.4. VARIABLES

Variable is defined as alphanumeric data which can be linked to printouts, products or other information related to weighing. Every variable is characterized by its content; the content must be given. Variables are used for entering various data during the weighing process, e.g. serial number or batch number. The program allows to enter two variables. Each can consist of max 32 characters.

In order to input a variable content, the user needs to enter variable settings (parameter P5.9 – VARIABLE 1 or P5.10 – VARIABLE 2) and enter the respective values using direction keys (arrows) on the balance keypad or a computer keyboard. Procedure for entering texts is the same as for non-standard printouts. Working Modes

- Weighings
- Parts Counting
- Checkweighing
- Dosing
- Deviations % in reference to mass of the standard
- Animal Weighing
- Density Determination of Solids
- Density Determination of Liquids
- Statistics
- Totalising
- Peak Hold
- Pipettes Calibration
- Adding

In order to run a particular mode press  button, and select the mode from the list.

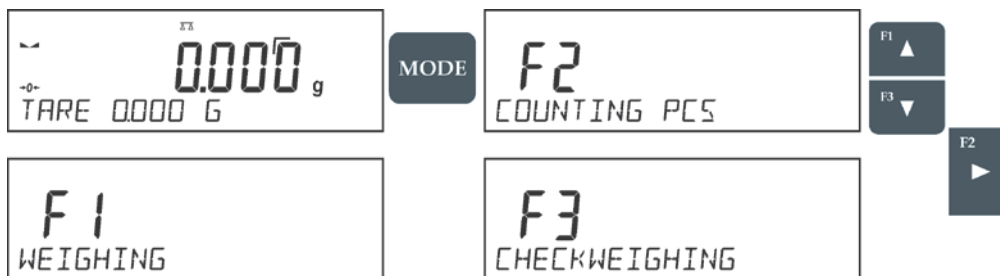

Once the button **MODE** has been pressed, the name of the first available function is shown.

F1 **F3** - press to select working mode

F2 - press to enter the selected working mode

CAUTION!

Upon restart, the balance is launched with the most recently operated working mode!!! For settings of this function read later sections of this user manual.

23.5. SEPERATOR

Balance program enables selecting separator type for mass indication that is printed out.

Options:

DOT --. --

COMMA --,--

By default the separator value is <DOT>. The mass value is printed with a dot as a decimal point (e.g. 5.45 g). If the separator value is set to <COMMA>, the mass value is printed with a comma as a decimal point (e.g. 5.45 g).

24. COMMUNICATION

Communication menu enables configuration of port settings. The settings are accessed upon pressing **SETUP** button.

Communication with peripheral devices is established via the following ports:

- COM 1 (RS232)
- COM 2 (RS232)
- USB type A
- USB type B
- WIFI

Parameters of USB ports are not configurable. The port type B is designed to connect a printer or a computer, and the port type A is designed to connect a computer keyboard, a bar code reader or the flash drive.

24.1. RS 232 PORT SETTINGS (COM)

Procedure:

- Select communication port <COM 1> or <COM 2>,

- Set respective values

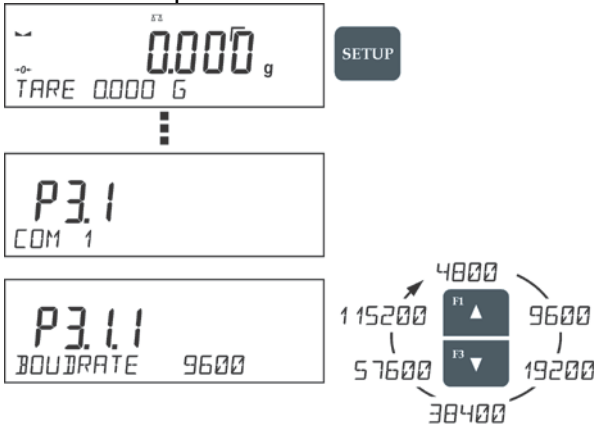

The RS 232 ports enable the following setting of transmission parameters:

- Baud rate – 2400, 4800, 9600, 19200, 38400, 57600, 115200 bit/s
- Parity – NONE, ODD, EVEN

24.2. WIFI PORT SETTINGS

CAUTION!

- The transmission parameters must be matched to the customer’s local network.
- To ensure proper communication with a computer via Wi-Fi port, set the computer port parameter on your balance to <WIFI>: P4.1.1 <DEVICES/COMPUTER/PORT/WIFI>.

Parameters for Wi-Fi connection:

P3.3.1 – STATUS

P3.3.2 – WIFI

P3.3.3 – CHOOSE NETWORK

P3.3.4 – NETWORK SETTING

P3.3.3.1 – DHCP

P3.3.3.2 – NAME (the name of the network that has been selected)

P3.3.3.3 – PASSWORD (password – ‘stars’ are displayed)

P3.3.3.4 – IP (balance ID number, make sure that the number is not engaged by a different device using this network)

P3.3.3.5 – MASK (default 255.255.000.000)

P3.3.3.6 – GATE (default 10.10.8.244)

P3.3.3.7 – MAC ADRES (0008DC...)

After entering the parameter, message <STATUS> and value describing the connection status for Wi-Fi network appear in the bottom line.

- **CONNECT** – the balance is connected to one of the available Wi-Fi networks, additionally, at the top  pictogram turns up and stays visible as long as network connection is active.
- **CONNECTIVITY** – the balance is trying to re-establish connection with the previously connected network, suitable for previously entered settings (network, IP, etc.)
- **NONE** – Wi-Fi module is not installed in the balance.



Procedure:

- Switch <WIFI> module on – parameter P3.3.2 <COMMUNICATION/WIFI – YES>.
- Set respective value for DHCP parameter P3.3.4.1 <COMMUNICATION/WIFI/NETWORK SETTINGS/DHCP>:
NO - manual entering of data such as: <IP; MASK, DEFAULT GATE>,

YES - the balance software automatically reads and displays data assigned by Wi-Fi Router, the one to which the balance is to be connected.

- Now enter parameter <P3.3.3 – SELECT NETWORK> and start the procedure of searching for

available networks by pressing  button. Search procedure starts and after its completion the first network detected by the balance appears in the bottom line.

- Use  or  buttons to select the demanded network and press  button.
- Message <PASSWORD*****> appears in the bottom line. Use a computer keyboard connected to USB port to easily enter the case-sensitive password (using balance keyboard you can enter

only upper-case letters and digits). Enter the network password and confirm it by pressing  button.

- Upon entering a respective password, the balance automatically connects to the selected network.
- Go to the parameter <P3.3.1 – STATUS>, message <CONNECTIVITY> is displayed meaning that the balance is trying to connect to the network using the settings.
- When the balance connects to Wi-Fi network, the status changes to <CONNECT>,  pictogram is displayed.
- If the balance cannot connect to the network for a long time (<CONNECTIVITY> status displayed), it is likely that network parameters have been incorrectly entered.
- Ensure that the settings are correctly entered and repeat the connecting process.

Selected network and parameters settings are stored by the balance memory, each time when the balance is launched the software connects to the network referring to the set parameters.

To disconnect the network, switch the communication off:
COMMUNICATION/WIFI/WIFI – NO

24.3. PORT USB

USB1 port of type A is intended for:

- Connecting a flash drive storing <FAT files system>
- Connecting balance to PCL printer
- Connecting EPSON TM-T20 printer to USB port

Flash drive may be used for export/import of data stored in balances, or for carrying out measurement data printout (set parameter P4.2.1 <DEVICES/PRINTER/PORT> to <PENDRIVE> value).

Please remember that for PCL printer the drivers print completely filled page, i.e. the page will be printed only upon pressing PRINT button, located on a balance, for several times (it depends on a printout size how many times the PRINT button shall be pressed prior printout).

It is possible to obtain printout upon pressing PRINT button once only, supposing that control code <0C> has been set as SUFIX.

USB port of type B is intended for:

- Connecting balance to a PC computer

For free software to connect the Transcat TCT-Series balance to your computer, please contact support@schulerci.com

25. PERIPHERAL DEVICES

SETUP

PERIPHERAL DEVICES menu is comprised within Parameters menu. It is accessed by pressing key. The menu features list of devices that can cooperate with the balance.

25.1. COMPUTER

<COMPUTER> submenu allows the user to select a port for connection of a computer running software which enables:

- communication with a balance,
- switching the continuous transmission on and off, and

25.1.1. COMPUTER CONNECTION PORT

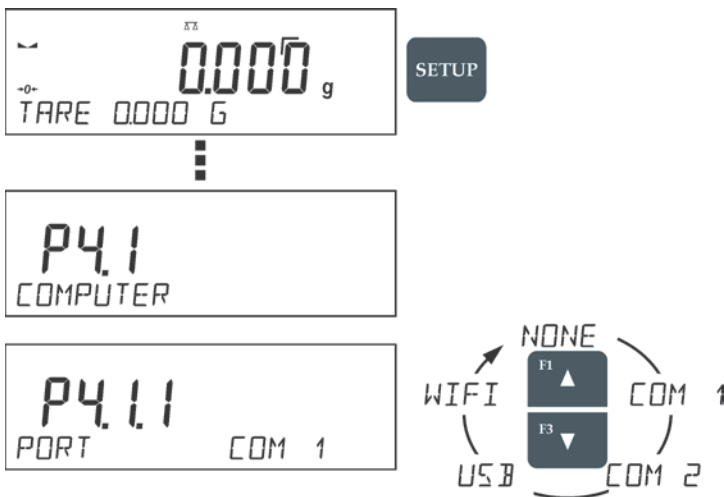

Procedure:

- press **SETUP** button
- enter <P4 DEVICES> menu
- enter menu group: <P4.1 COMPUTER>
- select port to which a computer is to be connected,

COM 1 or **COM 2** – RS 232 port, to which the computer is connected

USB 2 type B – USB port, to which the computer is connected

WIFI – WIFI port

USB FREE LINK – USB port, type B, for connecting a computer. Tool for entering data, it functions as a keyboard. Upon proper modification of the printout and pressing declared balance button (e.g. F1 header, F3 footer, ENTER printout), the data is directly entered to computer programs, e.g. Excel, Word, Notepad etc. Select port and configure its settings in order to enable correct cooperation of the balance with computer programs:

SPREADSHEET

- value 'YES --,--' – cooperation with Excel type program, transferred decimal values are separated by dot (.)
- value 'YES --,--' – cooperation with Excel type program, transferred decimal values are separated by coma (,)
- value 'NO' – cooperation with other programs (mass value transferred in a form of text),

DELAY - if the transferred information is incomplete, i.e. part of it gets lost (due to autoentering or auto-formatting of data by computer program) during cooperation with Excel

type program, set the parameter value to . If the transferred information is still incomplete, the parameter value must be higher. The value ranges between 0 (quick data transfer) and 9 (slow data transfer – around 10 characters per second).

25.1.2. CONTINUOUS TRANSMISSION

Continuous transmission parameter enables turning on/off continuous transmission of a measurement result.

Available options:

- Continuous transmission in a calibration unit <CAL. UNIT>, independently from currently chosen weight unit, measurements are transmitted in unit set on a main measuring device (calibration unit)
- Continuous transmission in a current unit <CURRENT UNIT> measurements are transmitted in a current unit; the unit changes dynamically whenever the user presses Units button in order to modify the unit on a display.
- Continuous transmission off <NONE>

Procedure:

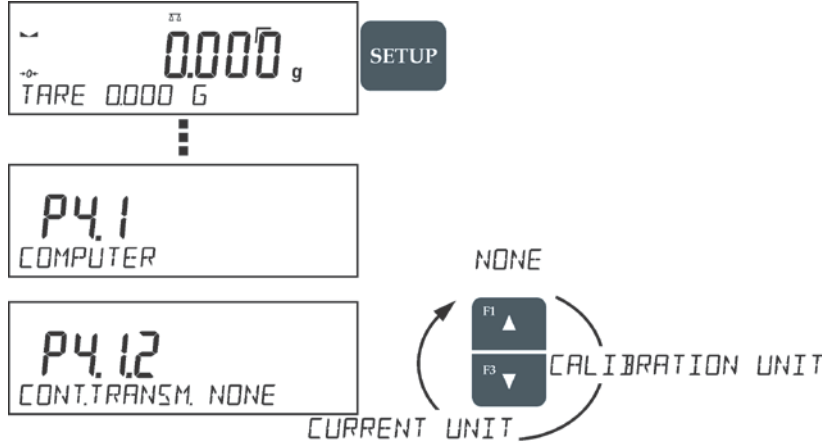

CAUTION!

Continuous transmission may be turned on/off by means of a command sent from a computer (go to COMMUNICATION PROTOCOL section)

25.1.3. PRINTOUTS INTERVAL FOR CONTINUOUS TRANSMISSION

Parameter <P4.1.3. INTERVAL> enables setting frequency of printouts for continuous transmission.

Frequency of printouts is set in seconds, wherein the accuracy is 0.1s.

The user may set any time value ranging from 1000 to 0.1 s.

The setting is valid for continuous transmission in calibration unit and in current unit activated by means of the balance (see parameter P4.2.1.2), it is also valid for continuous transmission activated by command sent from a computer.

25.2. PRINTER

Submenu <PRINTER> allows the user to choose a port and a device, to which the data is to be sent

upon pressing  button on a balance. Content of data being transferred is set in parameter <PRINTOUTS/PRINTOUT GLP>.

Procedure:

- press  button
- enter <P4 DEVICES> menu
- enter menu group: <P4.2 PRINTER>
- select port to which the printer is to be connected:
 - COM 1** or **COM 2** – RS 232 port, to which the printer is connected

USB 1 type A – USB port, to which PCL printer or EPSON printer is connected

WIFI – WIFI port, which can send data to special PC software. For this software please contact support@schulersci.com.

PENDRIVE – USB 1 port, type A, for connecting USB flash drive. PENDRIVE option requires setting format of saved file. You can save the data in the following formats:

- *.txt format (text file that can be opened on the computer using Notepad),
- *.csv (.) format (file that can be opened using Excel, the transferred decimal value is separated using dot character), or
- *.csv (,) format (file that can be opened using Excel, the transferred decimal value is separated using comma character)

USB PC –USB port type B, to which the computer with the special PC Software. For this software please contact support@schulersci.com

USB FREE LINK – USB port, type B, for connecting a computer. Tool for entering data, it functions as a keyboard. Upon proper modification of the printout and pressing declared balance button (e.g. F1 header, F3 footer, ENTER printout), the data is directly entered to computer programs, e.g. Excel, Word, Notepad etc. Select port and configure its settings in order to enable correct cooperation of the balance with computer programs:

SPREADSHEET

- value 'YES --,--' – cooperation with Excel type program, transferred decimal values are separated by dot (.)
- value 'YES --,--' – cooperation with Excel type program, transferred decimal values are separated by comma (,)
- value 'NO' – cooperation with other programs (mass value transferred in a form of text),

DELAY - if the transferred information is incomplete, i.e. part of it gets lost (due to autoentering or auto-formatting of data by computer program) during cooperation with Excel type program, set the parameter value to . If the transferred information is still incomplete, the parameter value must be higher. The value ranges between 0 (quick data transfer) and 9 (slow data transfer – around 10 characters per second).

Additionally, you can enter a controlling code (of a hexadecimal form) to a printer either at the beginning of the printout - <P4.2.2 PREFIX> or at the end of it - <P4.2.3 SUFFIX>. Sending these codes allows to control globally both, information and actions carried out at the beginning and/or at the end of each printout sent from a balance to a printer.

This function is most frequently used to send an information about the code page of a printout sent by a balance, at the beginning, and to send a command enabling the crop of a paper in EPSON printers (if the printer is equipped with an autocutter blade), at the end.

<PREFIX> and <SUFFIX> parameters settings are available for all the printouts sent from balance, e.g. calibration reports, density, statistics etc., and for the header, footer and GLP printouts.

CAUTION:

It must be remembered that inserting paper crop command to <SUFFIX> parameter (control code) results in sending the code after each printout. If the user wishes for one whole printout to consist of: HEADER, GLP PRINTOUT and FOOTER and to be cropped underneath the FOOTER, then the paper crop command should be inserted only for FOOTER settings as a non-standard printout with <%E> value (paper crop for EPSON printer). In such a case <SUFFIX> command must remain empty.

To ensure correct cooperation of the balance with the printer (correct printout of diacritical signs of a given language), respective baud rate obligatory for a given printer must be chosen (see the printer settings). Additionally, code page of a sent printout must be accordant with a code page of a printer.

Accordance of a code page may be obtained in two ways:

- setting the right code page in the settings of a printer (see a user manual of the printer) – it must be accordant with the printout code page of a balance (**1250** code page for POLISH, CZECH, HUNGARIAN; **1252** for ENGLISH, GERMAN, SPANISH, FRENCH, ITALIAN; **1254** for TURKISH),
- sending the control code from the balance, which automatically sets the right code page of the printer (code page accordant with the one of a balance) prior to printout of data taken from the balance (this possibility is available only for printers with such option – see a user manual of the printer).

CAUTION! CODES MUST BE ENTERED IN A HEXADECIMAL FORM!

Example balance settings for correct cooperation with **Epson TM-U220D** connected to RS232 port:

Communication parameters for port to which the printer is connected:

- BAUD RATE - 9600 bit-s
- PARITY – none

Printer parameters for a PERIPHERALS group:

- PORT – COM1 or COM2 (the one to which the printer is connected)

25.3. BARCODE READER

Submenu <BARCODE READER> comprises settings for cooperation with a barcode reader.

Procedure:

- press  button
- enter <P4 DEVICES> menu
- enter menu group <P4.3 BAR CODE READER>
- select port to which the barcode reader is to be connected: NONE, COM 1, COM 2

25.4. EXTERNAL BUTTONS

Submenu <EXTERNAL BUTTONS> comprises settings that enable the balance to cooperate with external buttons: TARE and PRINT.

Procedure:

- press 
- enter <P4 DEVICES> menu
- enter menu group <P4.5 EXTERNAL BUTTONS>
- run the buttons
 - <P4.5.1. TARE> set to <YES> value
 - <P4.5.2. PRINT> set to <YES> value
- exit the balance menu

CAUTION:

The balance program enables cooperation with one or both buttons. If you need to connect both external buttons, first connect a several electrical outlet to COM 2 port, next connect buttons TARE and PRINT to the electrical outlet. Connect the printer or terminal to COM 1 or to the electrical outlet (determine the PRINTER-BALANCE transfer parameters). Every time the user presses TARE and PRINT external button, the balance reacts as if TARE and PRINT buttons of the balance keyboard were pressed.

If you need to use only one button, connect it directly to COM 2 port or use the electrical outlet.

In order to ensure the proper cooperation, you need to remember:

- to connect additional buttons to COM 2 port,
- to connect the buttons to appropriate sockets of the electrical outlet if in use (see descriptions above),
- to activate the buttons in the balance parameters (see description above),
- to disconnect other external devices (additional display or barcode reader) on COM2 port (for these devices it should be <NONE>),
- to set the port for <PRINTER> to <COM 2> value if the printer is connected to the electrical outlet (CPU socket).

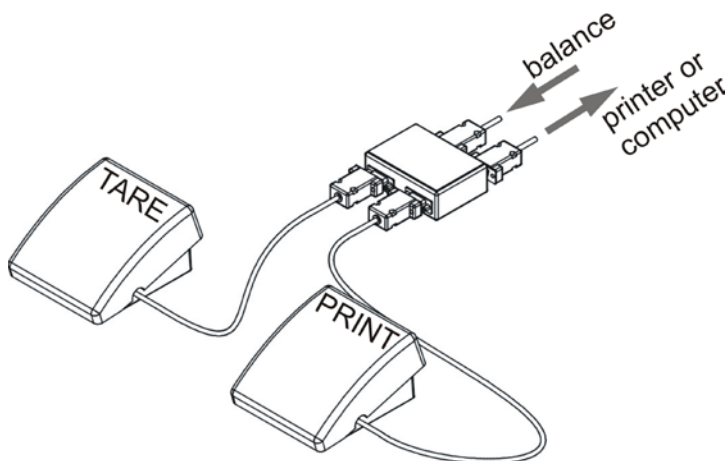

Set of external buttons TARE and PRINT.

Standard balance equipment does not include the set of external buttons.

26. COOPERATION WITH PERIPHERALS



CAUTION!

A peripheral device that is connected to RS 232 or USB port of a balance, has to be powered from the common low voltage grid equipped with common anti-shock protection in order to provide that possible occurrence of different potentials in zero cables of the peripheral device and the balance is precluded.

Balance transmission parameters must correspond to the parameters of a device that is connected to the balance.



- Baud rate - 4800 ÷ 115200 bit / s

- Parity control - NONE, ODD, EVEN

Value indicated on a display can be sent via RS232 or USB port to a peripheral device in one of four accessible ways:

- manually - on pressing  button
- automatically - on stabilisation of a weighing result
- continuously - on activation of a function or sending a command
- on command sent from a peripheral device (see additional functions).

Value indicated on a display can be sent via COM port or USB port in the following form:

- stable – data is sent immediately on stabilisation of weighing result (button )
- unstable – on pressing  button, display status is sent immediately to a peripheral device (on a printout such status is marked with <?> symbol located in front of the weighing result). This option is only available for non-verified balances.

26.1. TRANSFERRED DATA FORMAT

The measurement result can be transferred from a balance to an external device by pressing  button, located on the balance, or by sending a control command from a computer.

26.2. FORMAT OF DATA SENT ON PRESSING PRINT BUTTON



CAUTION!
Unstable measurement printout is disabled for a verified balance.

Printout format:

1	2	3	4 - 12	13	14 - 16	17	18
stability marker	space	character	mass	space	unit	CR	LF

- Stability marker [space] if stable
[?] if unstable
[^] if high limit is out of range
[v] if low limit is out of range
- Character [space] for positive values
[-] for negative values
- Mass 9 characters with decimal point and right justification
- Unit 3 characters with left justification

26.2.1. RESPONSE FORMAT

On receipt of a command, the balance responds as follows.

first:

XX_A CR LF	command understood and in progress
XX_I CR LF	command understood but not accessible at this moment
XX_^ CR LF	command understood but max threshold is exceeded
XX_v CR LF	command understood but min threshold is exceeded
XX_E CR LF	time limit exceeded while waiting for stable measurement result (time limit is balance characteristic parameter)

Where XX stands for command name.

next:

1 - 3	4	5	6	7	8 - 16	17	18 - 20	21	22
command	space	stability marker	space	character	mass	space	unit	CR	LF

Command	1-3 characters
Stability marker	[space] if stable [?] if unstable [^] if high limit is out of range [v] if low limit is out of range
Character	[space] for positive values [-] for negative values
Mass	9 characters with decimal point and right justification
Unit	3 characters with left justification

27. COMMUNICATION PROTOCOLS

General information

- A. A character based communication protocol balance-terminal is designed for establishing communication between a balance and a peripheral device via RS-232C or Ethernet serial interface.
- B. It consists of commands sent from a peripheral device to the balance and responses from the balance.
- C. Responses are sent from the balance on each receipt of a command as a reaction to a specific command.
- D. Commands, forming the communication protocol, enable both, obtaining data on balance status and influencing balance operation, e.g.: acquiring measurement results from the balance, zeroing, etc.

27.1. LIST OF COMMANDS

Command	Command overview
Z	Zero balance
T	Tare balance
OT	Give tare value
UT	Set tare
S	Send stable measurement result in basic measuring unit
SI	Immediately send measurement result in basic measuring unit
SU	Send stable measurement result in current measuring unit
SUI	Immediately send measurement result in current measuring unit
C1	Switch on continuous transmission in basic measuring unit
C0	Switch off continuous transmission in basic measuring unit
CU1	Switch on continuous transmission in current measuring unit
CU0	Switch off continuous transmission in current measuring unit
DH	Set min checkweighing threshold
UH	Set max checkweighing threshold
ODH	Give value of min checkweighing threshold
OUH	Give value of max checkweighing threshold
SM	Set mass value of a single item
TV	Set target mass value
RM	Set reference mass value
NB	Give balance serial number
SS	Value release
IC	Internal calibration performance
IC1	Disable automatic internal calibration of the balance
IC0	Enable automatic internal calibration of the balance
K1	Lock balance keypad
K0	Unlock balance keypad
OMI	Give available working modes
OMS	Set working mode
OMG	Give current working mode
UI	Give accessible units
US	Set unit
UG	Give current unit
BP	Activate sound signal
PC	Send all implemented commands
BN	Give balance type
FS	Give Max capacity
RV	Give program version
A	Set autozero function
EV	Set ambient conditions state
FIS	Set filter
ARS	Set value release
LDS	Set last digit

CAUTION!

Each command must end with CR LF characters;

On receipt of a command, the terminal responds as follows:

XX_A CR LF	command understood and in progress
XX_D CR LF	command carried out (appears only after the command XX_A)
XX_I CR LF	command understood but not accessible at this moment
XX_^ CR LF	command understood but max threshold is exceeded
XX_v CR LF	command understood but min threshold is exceeded
XX_OK CR LF	command carried out
ES_CR LF	command not recognised
XX_E CR LF	time limit exceeded while waiting for stable measurement result (time limit is balance characteristic parameter)

Where:

XX - name of a sent command
 _ - spaces

Commands Overview

Zero balance

Format: **Z CR LF**

Response options:

Z_A CR LF	- command understood and in progress
Z_D CR LF	- command carried out
Z_A CR LF	- command understood and in progress
Z_^ CR LF	- command understood but zeroing range is exceeded
Z_A CR LF	- command understood and in progress
Z_E CR LF	- time limit exceeded while waiting for a stable measurement result
Z_I CR LF	- command understood but not accessible at this moment

Tare balance

Format: **T CR LF**

Response options:

T_A CR LF	- command understood and in progress
T_D CR LF	- command carried out
T_A CR LF	- command understood and in progress
T_v CR LF	- command understood but taring range exceeded
T_A CR LF	- command understood and in progress
T_E CR LF	- time limit exceeded while waiting for stable measurement result
T_I CR LF	- command understood but not accessible at this moment

Give tare value

Format: **OT CR LF**

Response: **OT_TARE CR LF** - command carried out

Response format:

1	2	3	4-12	13	14	15	16	17	18	19
O	T	space	tare	space	unit			space	CR	LF

Tare - 9 characters with right justification

Unit - 3 characters with left justification

CAUTION!

Tare value is always given in calibration unit.

Set tare

Format: **UT_TARE CR LF**, where **TARE** – tare value

Response options:

UT_OK CR LF	- command carried out
UT_I CR LF	- command understood but not accessible at this moment
ES CR LF	- command not recognised (tare format incorrect)

CAUTION! Use dot in tare format as decimal point.

Send stable measurement result in a basic measuring unit

Format: **S CR LF**

Response options:

- S_A CR LF - command understood and in progress
- S_E CR LF - time limit exceeded while waiting for stable measurement result
- S_I CR LF - command understood but not accessible at this moment
- MASS FRAME - response: mass value in a basic measuring unit

Response format:

1	2-3	4	5	6	7-15	16	17	18	19	20	21
S	space	stability marker	space	character	mass	space	unit			CR	LF

An example:

- S CR LF - command send form a computer
- S_A CR LF - command understood and in progress
- S _ _ _ _ _ - _ _ _ _ _ 8 . 5 _ g _ _ CR - command carried out, response: mass value in a basic measuring unit.

where: _ - space

Immediately send measurement result in a basic measuring unit

Format: **SI CR LF**

Response options:

- SI_I CR LF - command understood but not accessible at this moment
- MASS FRAME - immediate response: mass value in a basic measuring unit

Response format:

1	2	3	4	5	6	7-15	16	17	18	19	20	21
S	I	space	stability marker	space	character	mass	space	unit			CR	LF

An example:

- S I CR LF - command sent from a computer
- S I _ ? _ _ _ _ _ 1 8 . 5 _ k g _ CR LF - command carried out, immediate response: mass value in a basic measuring unit

where: _ - space

Send stable measurement result in a current measuring unit

Format: **SU CR LF**

Response options:

- SU_A CR LF - command understood and in progress
- SU_E CR LF - time limit exceeded while waiting for a stable measurement result
- SU_I CR LF - command understood but not accessible at this moment
- MASS FRAME - response: mass value in a current measuring unit

Response format:

1	2	3	4	5	6	7-15	16	17	18	19	20	21
S	U	space	stability marker	space	character	mass	space	unit			CR	LF

An example:

- S U CR LF - command send form a computer
- S U_A CR LF - command understood and in progress
- S U _ _ _ - _ _ 1 7 2 . 1 3 5 _ N _ _ CR - command carried out, response: mass value in a current measuring unit

where: _ - space

Immediately send measurement result in a current measuring unitFormat: **SUI CR LF**

Response options:

SUI_I CR LF - command understood but not accessible at this moment

MASS FRAME - immediate response: mass value in a current measuring unit

Response format:

1	2	3	4	5	6	7-15	16	17	18	19	20	21
S	U	I	stability marker	space	character	mass	space	unit			CR	LF

An example:

S U I CR LF - command sent from a computer

S U I ? _ - _ _ _ 5 8 . 2 3 7 _ k g _ CR LF - command carried out, immediate response: mass value in a current measuring unit

where: _ - space

Switch on continuous transmission in a basic measuring unitFormat: **C1 CR LF**

Response options:

C1_I CR LF - command understood but not accessible at this moment

C1_A CR LF - command understood and in progress

MASS FRAME - response: mass value in a basic measuring unit

Response format:

1	2	3	4	5	6	7-15	16	17	18	19	20	21
S	I	space	stability marker	space	character	mass	space	unit			CR	LF

Switch off continuous transmission in a basic measuring unitFormat: **C0 CR LF**

Response options:

C0_I CR LF - command understood but not accessible at this moment

C0_A CR LF - command understood and carried out

Switch on continuous transmission in a current measuring unitFormat: **CU1 CR LF**

Response options:

CU1_I CR LF - command understood but not accessible at this moment

CU1_A CR LF - command understood and in progress

MASS FRAME - response: mass value in a current measuring unit

Response format:

1	2	3	4	5	6	7-15	16	17	18	19	20	21
S	U	I	stability marker	space	character	mass	space	unit			CR	LF

Switch off continuous transmission in a current measuring unitFormat: **CU0 CR LF**

Response options:

CU0_I CR LF - command understood but not accessible at this moment

CU0_A CR LF - command understood and carried out

Set min checkweighing thresholdFormat: **DH_XXXXX CR LF**, where: _ - space, **XXXXX** – mass format

Response options:

DH_OK CR LF - command carried out

ES CR LF - command not recognised (mass format incorrect)

Set max checkweighing threshold

Format: **UH_XXXXX CR LF**, where: _ - space, **XXXXX** - mass format

Response options:

UH_OK CR LF - command carried out

ES CR LF - command not recognised (mass format incorrect)

Give value of min checkweighing threshold

Format: **ODH CR LF**

Response: **DH_MASA CR LF** - command carried out

Response format:

1	2	3	4-12	13	14	15	16	17	18	19
D	H	space	mass	space	unit			space	CR	LF

Mass - 9 characters with right justification

Unit - 3 characters with left justification

Give value of max checkweighing threshold

Format: **OUH CR LF**

Response: **UH_MASA CR LF** - command carried out

Response format:

1	2	3	4-12	13	14	15	16	17	18	19
U	H	space	mass	space	unit			space	CR	LF

Mass - 9 characters with right justification

Unit - 3 characters with left justification

Set mass value of a single item (only for PARTS COUNTING)

Format: **SM_XXXXX CR LF**, where: _ - space, **XXXXX** – mass format

Response options:

SM_OK CR LF - command carried out

SM_I CR LF - command understood but not accessible at this moment (e.g. mode other than PARTS COUNTING)

ES CR LF - command not recognised (mass format incorrect)

Set target mass value (e.g. for DOSING)

Format: **TV_XXXXX CR LF**, where: _ - space, **XXXXX** - mass format

Response options:

TV_OK CR LF - command carried out

TV_I CR LF - command understood but not accessible at this moment (e.g. mode other than DOSING)

ES CR LF - command not recognised (mass format incorrect)

Set reference mass value (e.g. for DEVIATIONS)

Format: **RM_XXXXX CR LF**, where: _ - space, **XXXXX** – mass format

Response options:

RM_OK CR LF - command carried out

RM_I CR LF - command understood but not accessible at this moment (e.g. mode other than DEVIATIONS)

ES CR LF - command not recognised (mass format incorrect)

Value release

Format: **SS CR LF**

Response options:

SS_OK CR LF - command understood and in progress

Command's function is similar to function of PRINT button located on an overlay,

Internal calibration

Format: IC CR LF

Response options:

IC_A CR LF - command understood and in progress

IC_D CR LF - calibration completed

IC_A CR LF - command understood and in progress

IC_E CR LF - time limit exceeded while waiting for a stable measurement result

IC_I CR LF - command understood but not accessible at this moment

Disable automatic internal calibration of the balance

Format: IC1 CR LF

Response options:

IC1_I CR LF - command understood but not accessible at this moment

IC1_E CR LF - operation disabled, e.g. for verified balance

IC1_OK CR LF - command carried out

Operation is disabled for verified balances.

For non-verified balances the command inhibits internal calibration until it is enabled via IC0 command or until the balance is turned off. The command does not modify settings specifying calibration start.

Enable automatic internal calibration of the balance

Format: IC0 CR LF

Response options:

IC0_I CR LF - command understood but not accessible at this moment

IC0_OK CR LF - command carried out

Operation is disabled for verified balances.

Give balance serial number

Format: NB CR LF

Response options:

NB_A "x" CR LF - command understood, response: serial number

NB_I CR LF - command understood but not accessible at this moment

x – serial number of the device (inserted in between inverted commas)

An example:

Command: NB CR LF – return serial number

Response: NB_A "1234567" – serial number of the device – "1234567"

Lock balance keypad

Format: K1 CR LF

Response options:

K1_I CR LF - command understood but not accessible at this moment

K1_OK CR LF - command carried out

Command locks the balance keypad (proximity sensors, touch panel) until the moment of turning the balance off or until sending K0 command

Unlock balance keypad

Format: K0 CR LF

Response options:

K0_I CR LF - command understood but not accessible at this moment

K0_OK CR LF - command carried out

Give available working modes

Command overview: Command returns accessible working modes.

Format: OMI <CR><LF>

Response options:

OMI <CR><LF>

n_ "Nazwa modu" <CR><LF>: – command carried out, response: accessible working modes

n_ "Nazwa modu" <CR><LF>

OK <CR><LF>

OMI_I <CR><LF> – command understood but not accessible at this moment

Mode name – parameter, working mode name, inserted in between inverted comas. The name takes form given on a particular balance display, it is provided in a currently selected language.

n – parameter, decimal value determining working mode number.

n →

- 1 – Weighing
- 2 – Parts Counting
- 3 – Deviations
- 4 – Dosing
- 5 – Formulas
- 6 – Animal Weighing
- 8 – Solids Density
- 9 – Liquids Density
- 10 – Peak Hold
- 11 – Totalizing
- 12 – Checkweighing
- 13 – Statistics

CAUTION! Working modes numbering is identical for each kind of balance. The numbers are assigned to working modes names. Some balances give only the number as a response.

An example 1:

Command: OMI <CR><LF> – return accessible working modes
Response: OMI <CR><LF>
2_ " Parts counting" <CR><LF> – accessible working modes are given in
4_ " Dosing" <CR><LF> return:
12_ "Checkweighing" <CR><LF> mode number + name
OK <CR><LF> – command carried out

An example 2:

Command: OMI <CR><LF> – return accessible working modes
Response: OMI <CR><LF>
2 <CR><LF> – accessible working modes are given in
4 <CR><LF> return:
12 <CR><LF> mode number
OK <CR><LF> – command carried out

Set working mode

Command overview: Command sets particular working mode.

Format: OMS_n <CR><LF>

Response options:

OMS_OK <CR><LF> – command carried out

OMS_E <CR><LF> – error in-course of command execution, no parameter or incorrect format

OMS_I <CR><LF> – command understood but not accessible at this moment

n – parameter, decimal value determining working mode number. To see detailed description go to OMI command

An example:

Command: OMS_13<CR><LF> – set Statistics mode

Response: OMS_OK<CR><LF> – Statistics mode set

Give current working mode

Command overview: Command returns currently set working mode.

Format: OMG <CR><LF>

Response options:

OMG_n_OK <CR><LF> – command carried out, response: current working mode
 OMG_I <CR><LF> – command understood but not accessible at this moment
 n – parameter, decimal value determining working mode number. To see detailed description go to OMI command.

An example:

Command: OMG<CR><LF> – return current working mode
 Response: OMG_13_OK<CR><LF> – balance operates in Statistics working mode

Give accessible units

Command overview: Command returns units available for a particular device and for a current working mode.

Format: UI <CR><LF>

Response options:

UI_x1,x2, ... xn_OK<CR><LF> – command carried out, returns accessible units
 UI_I <CR><LF> – command understood but not accessible at this moment

x – unit symbols, separated by means of commas

x → g, mg, ct, lb, oz, ozt, dwt, tlh, tls, tlt, tlc, mom, gr, ti, N, baht, tola, u1, u2

An example:

Command: UI <CR><LF> – return available units
 Response: UI_g, mg, ct_OK<CR><LF> – response: available units

Set current unit

Command overview: Command sets current unit for a particular device.

Format: US_x <CR><LF>

Response options:

US_x_OK <CR><LF> – command carried out, response: current unit
 US_E <CR><LF> – error in-course of command execution, no parameter or incorrect format

US_I <CR><LF> – command understood but not accessible at this moment

x – parameter, units symbols: g, mg, ct, lb, oz, ozt, dwt, tlh, tls, tlt, tlc, mom, gr, ti, N, baht, tola, msg, u1, u2, next



CAUTION! if x=next, the command swaps to another available unit on the list (it simulates „UNITS ESC” button pressing).

An example:

Command: US_mg<CR><LF> – set „mg” unit
 Response: US_mg_OK<CR><LF> – „mg” set as a current unit

Give current unit

Command overview: command returns current unit.

Format: UG <CR><LF>

Response options:

UG_x_OK<CR><LF> – command carried out, response: current unit
 UG_I <CR><LF> – command understood but not accessible at this moment

x – parameter, unit symbol

An example:

Command: UG<CR><LF> – return current unit
 Response: UG_ct_OK<CR><LF> – currently set unit is „ct”

Activate sound signal

Command overview: command activates BEEP sound signal for a specified amount of time

Format: BP_CZAS <CR><LF>

Response options:

BP_OK <CR><LF> – command carried out, BEEP sound signal activated
 BP_E <CR><LF> – no parameter or incorrect format

BP_I <CR><LF> – command understood but not accessible at this moment

TIME – parameter, decimal value specifying how long shall the sound last, parameter given in [ms].
Recommended range <50 - 5000>.

If value greater than the permissible high limit is given, than BEEP sound is operated for the maximum permissible amount of time.

An example:

Command: BP_350<CR><LF> – activate BEEP for 350 ms

Response: BP_OK<CR><LF> – BEEP activated

CAUTION!

BEEP sound activated via BP command is inhibited if in-course of its activation the sound is activated by means of other device: keypad, touch panel, proximity sensors.

Send all implemented commands

Format: PC CR LF

Command: PC CR LF – send all implemented commands

Response: PC_A_”Z,T,S,SI...” – command carried out, the terminal displays all implemented commands.

Give balance type

Format: BN <CR><LF>

Response options:

BN_A_”x” <CR><LF> – command understood, response: balance type

BN_I <CR><LF> – command understood but not accessible at this moment

x – series of types for a particular balance (in between inverted commas), with general balance type in front

An example:

Command: BN <CR><LF> – return balance type

Response: BN_A_”AS R” – balance type: ”AS R”

Give max capacity

Format: FS <CR><LF>

Response options:

FS_A_”x” <CR><LF> – command understood, response: Max capacity

FS_I <CR><LF> – command understood but not accessible at this moment

x – Max value of reading units (in between inverted commas)

An example:

Command: FS <CR><LF> – return Max capacity

Response: FS_A_”220.0000” – Max capacity: ”220 g”

Give program version

Format: RV <CR><LF>

Response options:

RV_A_”x” <CR><LF> – command understood, response: program version

RV_I <CR><LF> – command understood but not accessible at this moment

x – program version (in between inverted commas)

An example:

Command: RV <CR><LF> – return program version

Response: RV_A_” 1.1.1” – program version: ”1.1.1”

Set AUTOZERO function

Format: A_n <CR><LF>

Response options:

A_OK <CR><LF> – command carried out

A_E <CR><LF> – error in-course of command execution, no parameter or incorrect format
A_I <CR><LF> – command understood but not accessible at this moment
n – parameter, decimal value determining autozero settings
n → 0 – autozero off
1 – autozero on

CAUTION!

Command changes settings for a current working mode.

An example:

Command: A_1<CR><LF> – turn autozero function on
Response: A_OK<CR><LF> – autozero function is on
AUTOZERO function operates until it is turned off by A 0 command.

Set ambient conditions state

Format: EV_n <CR><LF>

Response options:

EV_OK <CR><LF> – command carried out
EV_E <CR><LF> – error in-course of command execution, no parameter or incorrect format
EV_I <CR><LF> – command understood but not accessible at this moment
n – parameter, decimal value determining ambient conditions state
n → 0 – unstable ambient conditions
1 – stable ambient conditions

CAUTION!

Command changes settings for a current working mode.

An example:

Command: EV_1<CR><LF> – set value 'stable' for ambient conditions option
Response: EV_OK<CR><LF> – ambient conditions option set to value 'stable'
<AMBIENT CONDITIONS> parameter is set to value <STABLE> until command EV 0 swaps it to value <UNSTABLE>.

Set filter

Format: FIS_n <CR><LF>

Response options:

FIS_OK <CR><LF> – command carried out
FIS_E <CR><LF> – error in-course of command execution, no parameter or incorrect format
FIS_I <CR><LF> – command understood but not accessible at this moment
n – parameter, decimal value determining filter number
n → 1 – very fast
2 – fast
3 – average
4 – slow
5 – very slow

CAUTION!

The numbering is assigned to a particular filter name and it is identical for all balance types.

The command changes settings for a current working mode if, for a particular balance type, filter settings are assigned to the working mode.

An example:

Command: FIS_3<CR><LF> – set average filter
Response: FIS_OK<CR><LF> – average filter set

Set Value release

Format: ARS_n <CR><LF>

Response options:

ARS_OK <CR><LF> – command carried out
ARS_E <CR><LF> – error in-course of command execution, no parameter or incorrect format
ARS_I <CR><LF> – command understood but not accessible at this moment
n – parameter, decimal value determining value release options

- n → 1 – fast
- 2 – fast+reliable
- 3 – reliable

CAUTION!

The numbering is assigned to a particular value release option and it is identical for all balance types. The command changes settings for a current working mode if, for a particular balance type, value release settings are assigned to the working mode

An example:

Command: ARS_2<CR><LF> – set value release parameter to fast+reliable option
Response: ARS_OK<CR><LF> – fast+reliable option set

Set last digit

Format: LDS_n <CR><LF>

Response options:

LDS_OK <CR><LF> – command carried out
LDS_E <CR><LF> – error in-course of command execution, no parameter or incorrect format
LDS_I <CR><LF> – command understood but not accessible at this moment

n – parameter, decimal value determining last digit settings

- n → 1 – always
- 2 – never
- 3 – when stable

CAUTION!

The numbering is assigned to a particular last digit option and it is identical for all balance types. The command changes settings for a current working mode if, for a particular balance type, last digit settings are assigned to the working mode.

An example:

Command: LDS_1<CR><LF> – set last digit option to value 'always'
Response: LDS_OK<CR><LF> – 'always' value set

28. APPENDIX

28.1. DIMENSIONS

Transcat TCL-series with d=0.01/0.1mg and d=0.1mg:

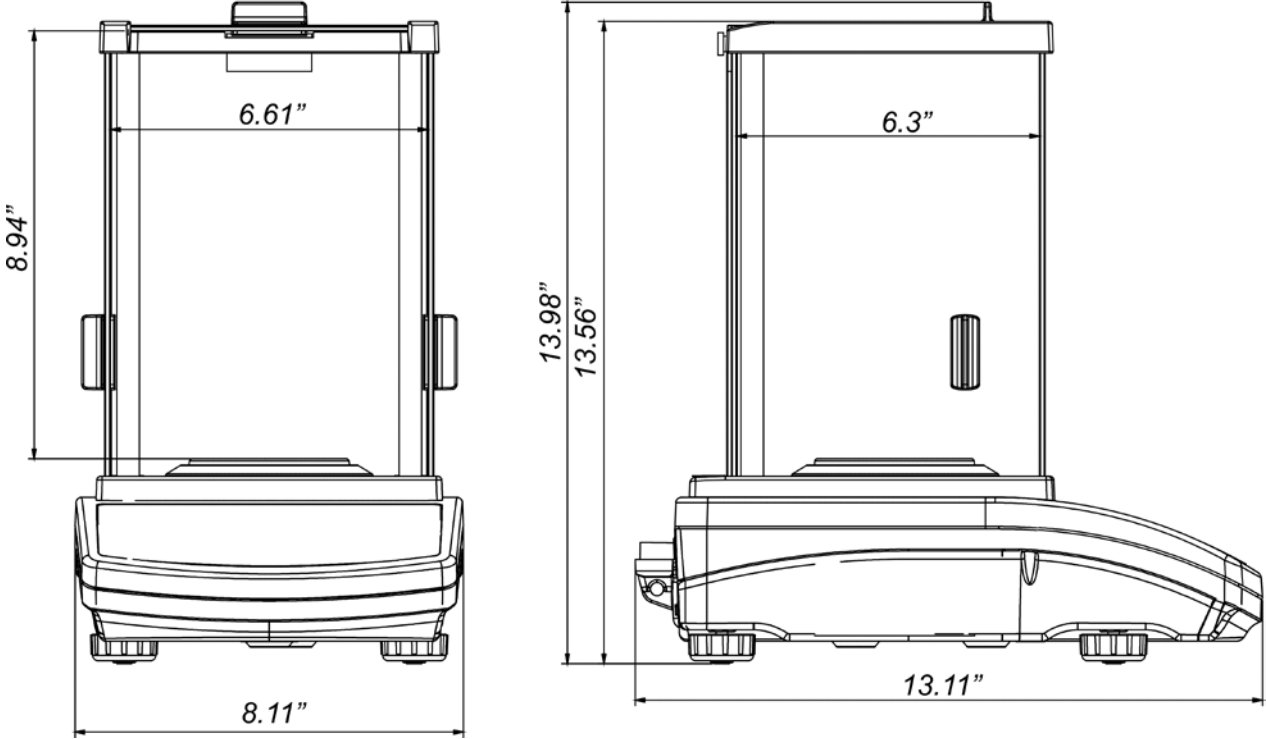

Transcat TCL-series with pan 128 x 128 mm:

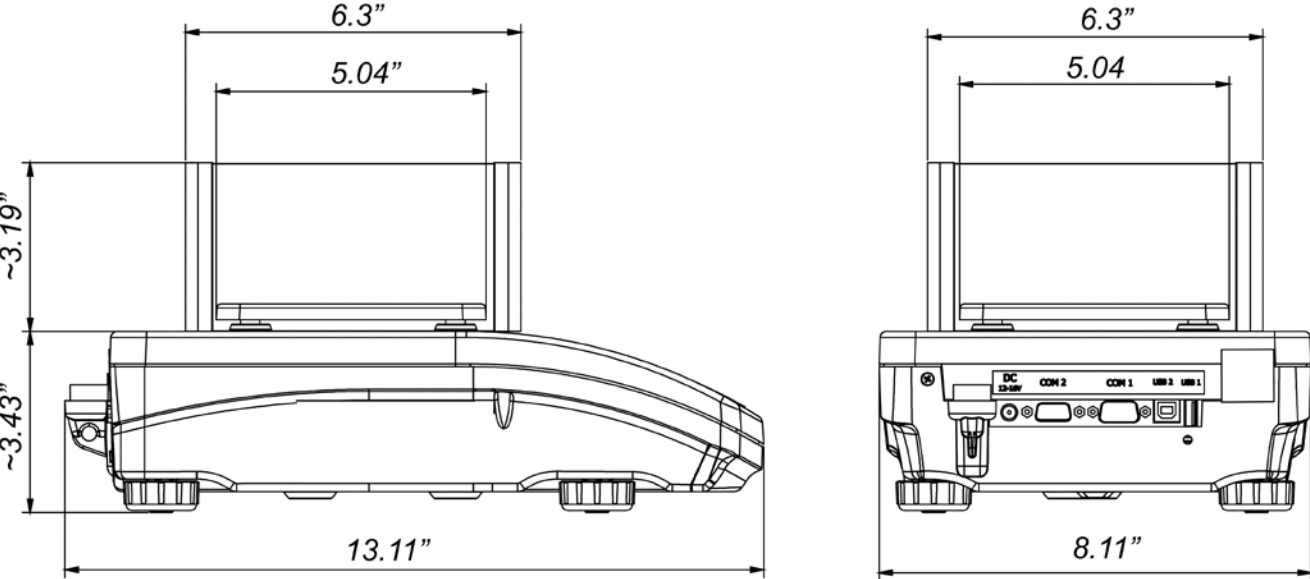

Transcat TCL-series with pan 195 x 195 mm:

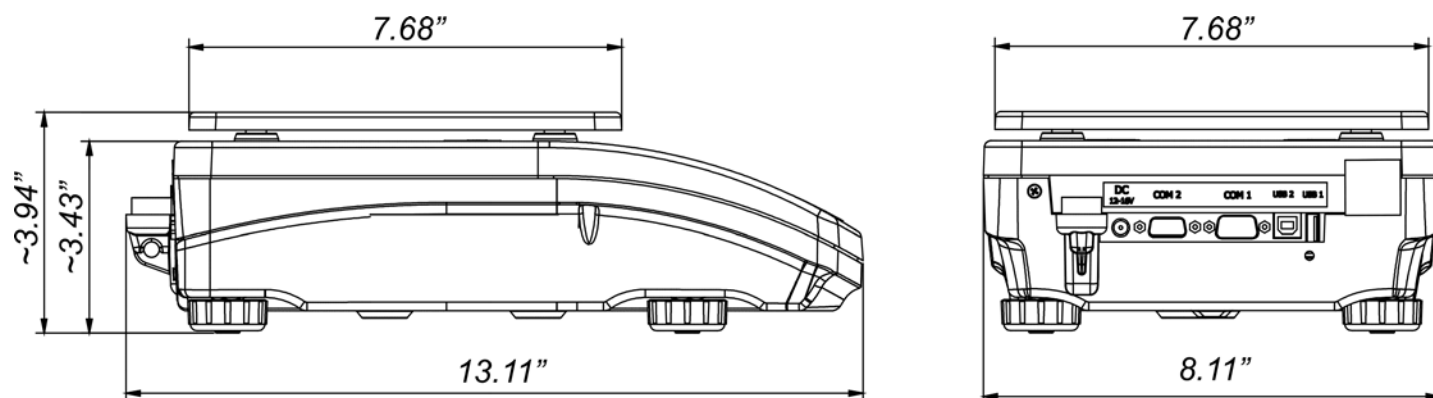

28.2. CONNECTORS

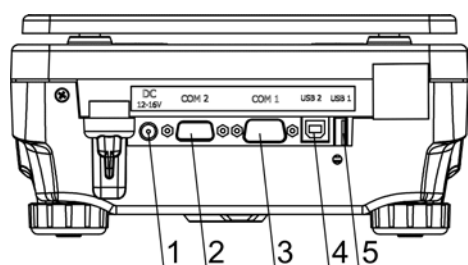

- 1 Power supply socket
- 2 COM 2 connector (additional display or external buttons)
- 3 COM 1 connector (printer)
- 4 USB 2, type B (computer)
- 5 USB 1, type A (keyboard)

28.3. MAINTENANCE ACTIVITIES

1. Disassemble the weighing pan and other detachable components (the components differ depending on a balance type – see *Unpacking* section). Be careful while detaching the components so as not to cause any damages to the balance mechanism.
2. Using a dry flannel cloth clean glass parts (mild cleanser may be applied if it does not contain any abrasive substances) – draft shield disassembly instruction is to be found further down this section.
3. Using a dry flannel cloth clean disassembled components (mild cleanser may be applied if it does not contain any abrasive substances).

CAUTION!

Cleaning draft shield while still installed may cause damage of the measuring system.

In order to ease cleaning of glass draft shield panes, it is permissible to remove them following the below instruction.

Transcat TCL-series w/attached draft shield – sequence of actions :

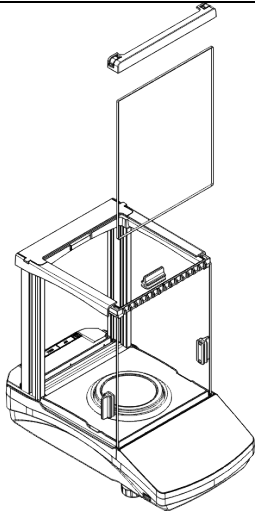
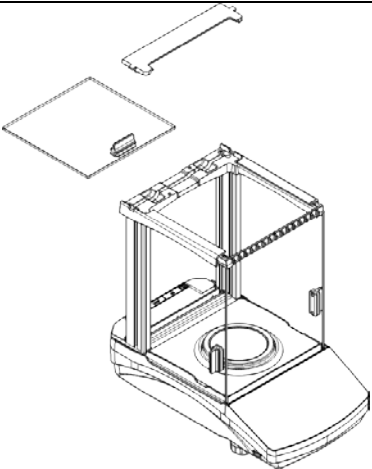
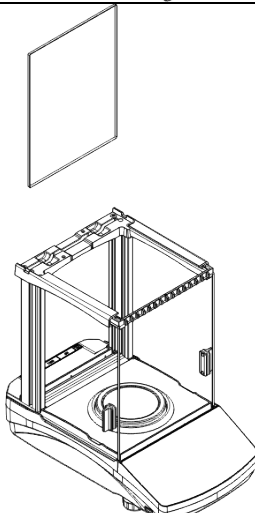
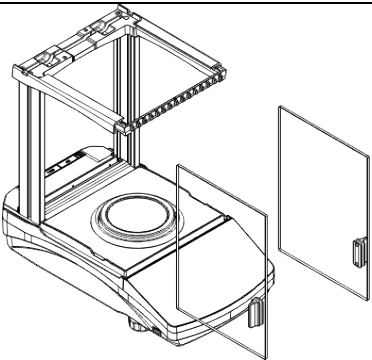
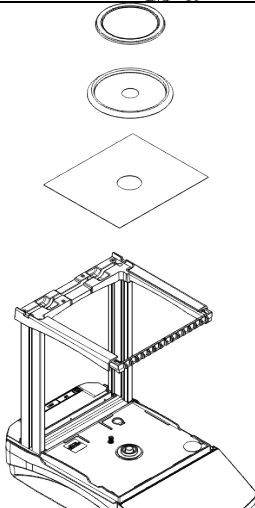
	<p>Detach the front part of the frame and take out the front pane.</p>		<p>Detach the back part of the frame and take out the top pane.</p>
	<p>Remove the back pane of the chamber.</p>		<p>Remove the left and the right side pane.</p>
	<p>Carefully disassemble the weighing pan, the draft shield and the bottom insert.</p>		

Clean the weighing chamber and the panes. All the operations have to be done carefully. Pay special attention to the spot where the weighing pan is installed; dirt and other small elements might enter the balance construction through this opening. This may cause incorrect operation of the instrument. Upon maintenance completion carry out the same set of actions in a reverse order. Pay a special attention to the left and the right side panes, assembly them on the correct side of the balance.

Thus prepared draft shield and panes can be properly cleaned. All the operations should be done carefully. Pay special CAUTION to the spot where the weighing pan was installed: dirt and other small elements might enter the balance construction through this opening, which might negatively influence the balance parameters.

28.4. CONNECTION CABLES - DIAGRAMS

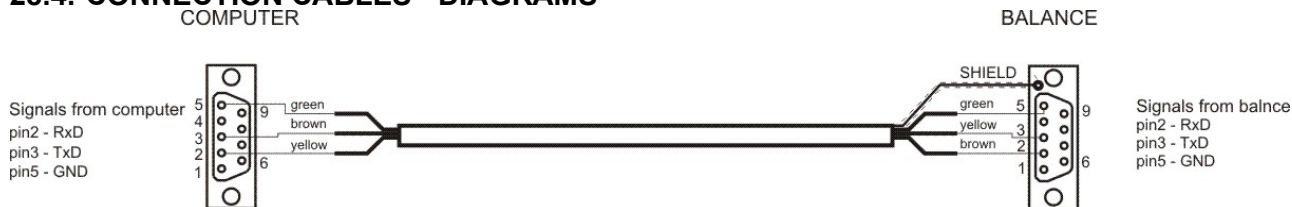

Scale – computer cable (RS232)



Scale – printer cable (CITIZEN, EPSON)

29. ERROR MESSAGES

Error Message	Cause	Solution
-Err2-	Value beyond zero range	*Only Zero balance with weighing pan empty *Wait until stability marker appears to press the Zero button
-Err3-	Value beyond tare range	*Only Tare balance with load on the weighing pan *Wait until stability marker appears to press the Tare button
-Err8-	Taring / Zeroing operation time exceeded	*Move balance to stable location free of vibrations or air drafts
-NULL-	Zero value from converter	*Check the weighing pan is installed properly *If unit was started without the pan in place, turn off unit, install pan and turn back on the unit.
-FULL-	Measurement range exceeded	*Unload the weighing pan, ensure only loads are placed on the pan reaching the max capacity of unit
-LH-	Start mass error	*Turn off unit, disassemble and reassemble all components. Once reassembled, turn on unit. *For milligram (0.001g readability) and toploaders (0.01g readability) ensure all 4 rubber mandrels are located under the weighing pan *Make sure no load is on the pan while unit is starting up

If additional support is required, please contact support@schulerci.com or 800-539-1886.