

■ 3-PHASE POWER QUALITY ANALYZER

8336

PowerPad® III



IMPORTANT WARRANTY NOTE:

By registering online within 30 days from the date of purchase, your warranty will be extended to 3 years

Copyright © Chauvin Arnoux®, Inc. d.b.a. AEMC® Instruments. All rights reserved.

No part of this documentation may be reproduced in any form or by any means (including electronic storage and retrieval or translation into any other language) without prior agreement and written consent from Chauvin Arnoux®, Inc., as governed by United States and International copyright laws.













Chauvin Arnoux®, Inc. d.b.a. AEMC® Instruments
15 Faraday Drive • Dover, NH 03820 USA
Tel: (800) 945-2362 or (603) 749-6434 • Fax: (603) 742-2346

This documentation is provided “as is,” without warranty of any kind, express, implied, or otherwise. Chauvin Arnoux®, Inc. has made every reasonable effort to ensure that this documentation is accurate; but does not warrant the accuracy or completeness of the text, graphics, or other information contained in this documentation. Chauvin Arnoux®, Inc. shall not be liable for any damages, special, indirect, incidental, or inconsequential; including (but not limited to) physical, emotional or monetary damages due to lost revenues or lost profits that may result from the use of this documentation, whether or not the user of the documentation has been advised of the possibility of such damages.

Chauvin Arnoux®, Inc, AEMC®, DataView®, AmpFlex®, MiniFlex® and PowerPad® are registered trademarks of AEMC® Instruments.

Thank you for purchasing a **PowerPad® III Model 8336**

For best results from your instrument and for your safety, read the enclosed operating instructions carefully and comply with the precautions for use. These products must be only used by qualified and trained users.

	WARNING, risk of DANGER! The operator must refer to these instructions whenever this danger symbol appears.		Useful information or hint to read.
	CAUTION! Risk of electric shock. The voltage at the parts marked with this symbol may be dangerous.		Important instructions to read and to fully understand.
	Equipment is protected by double insulation.		Kensington anti-theft system.
	USB socket.		The product has been declared recyclable after analysis of its life cycle in accordance with the ISO14040 standard.
	Ground/Earth.		The CE marking guarantees conformity with European directives and with regulations covering EMC.
	Must not be applied to or removed from bare conductors carrying dangerous voltages. Type B current sensor as per EN 61010-2-032.		The trash can with a line through it means that in the European Union, the product must undergo selective disposal for the recycling of electric and electronic material, in compliance with Directive WEEE 2002/96/EC.
	Application or withdrawal authorized on conductors carrying dangerous voltages. Type A current sensor per IEC 61010-2-032.		

Definition of Measurement Categories (CAT)

- **CAT IV** Measurement category IV corresponds to measurements taken at the source of low-voltage installations.
Example: power feeders, counters and protection devices.
- **CAT III** Measurement category III corresponds to measurements on building installations.
Example: distribution panel, circuit-breakers, machines or fixed industrial devices.
- **CAT II** Measurement category II corresponds to measurements taken on circuits directly connected to low-voltage installations.
Example: power supply to domestic electrical appliances and portable tools.

PRECAUTIONS FOR USE

This instrument is compliant with safety standard IEC 61010-2-030, the leads are compliant with IEC 61010-031, and the current sensors are compliant with IEC 61010-2-032, for voltages up to 600V in category IV or 1000V in category III. Failure to observe the safety instructions may result in electric shock, fire, explosion, and destruction of the instrument and/or other equipment.

- The operator and/or the responsible authority must carefully read and clearly understand the various precautions for use of the instrument. Sound knowledge and a keen awareness of electrical hazards are essential when using this instrument.
- If you use this instrument other than as specified, the protection it provides may be compromised, thereby endangering you.
- Do not use the instrument on networks which the voltage or category exceeds those mentioned.
- Do not use the instrument if it appears damaged or otherwise compromised.
- Before each use, check the condition of the insulation on the leads, housing, and accessories. Any item on which the insulation is deteriorated (even partially) must be set aside for repair or scrapping.
- Before using your instrument, check that it is perfectly dry. If it is wet, it must be thoroughly dried before being connected or being operated in any way. This includes the terminals and keypad.
- Use only the leads and accessories supplied. Using leads (or accessories) of a lower voltage or category reduces the voltage or category of the combined instrument and leads (or accessories) to that of the leads (or accessories).
- Always use personal protection equipment.
- Keep your hands away from the terminals of the instrument.
- When handling the leads, test probes, and alligator clips, keep your fingers behind the physical guard.
- Use only the AC power cord and battery pack supplied by the manufacturer. They include specific safety features.
- Some current sensors must not be placed on or removed from bare conductors at hazardous voltages: refer to the manual and comply with the handling instructions.

Your instrument is equipped with a NiMH battery. This technology offers several advantages:

- Long battery charge life for a limited volume and weight.
- Possibility of quickly recharging your battery.
- Significantly reduced memory effect: you can recharge your battery even if it is not fully discharged.
- Respect for the environment: no pollutant materials such as lead or cadmium, in compliance with the applicable regulations.

After prolonged storage, the battery may be completely discharged. If so, it must be completely recharged. Your instrument may not function during part of this recharging operation. Full recharging of a completely discharged battery may take several hours.

 **NOTE:** In this case, at least 5 charge/discharge cycles will be necessary for your battery to recover 95% of its capacity.

To make the best possible use of your battery and extend its effective service life:

- Only use the charger supplied with your instrument. Use of another charger may be dangerous.
- Only charge your instrument at temperatures between 32° and 104°F (0° and 40°C).
- Comply with the conditions of use defined in the operating manual.
- Comply with the storage conditions specified in the operating manual.

NiMH technology allows a limited number of charge/discharge cycles depending significantly on:

- The conditions of use.
- The charging conditions.











 Do not dispose of the battery pack with other solid waste. Used batteries must be entrusted to a qualified recycling company or to a company specialized in processing hazardous materials.





TABLE OF CONTENTS

1. BEFORE YOU BEGIN.....	6
1.1 RECEIVING YOUR SHIPMENT	6
1.2 ORDERING INFORMATION	6
1.2.1 ACCESSORIES	6
1.2.2 REPLACEMENT PARTS.....	6
1.3 INSTALLING THE BATTERY	7
1.4 CHARGING THE BATTERY.....	7
1.5 SETTING THE LANGUAGE.....	7
2. INTRODUCTION	8
2.1 DESCRIPTION.....	8
2.2 MEASUREMENTS.....	8
2.3 DISPLAY	9
2.4 CONFIGURATION	9
2.5 OVERALL VIEW.....	10
2.6 ON/OFF BUTTON.....	11
2.7 DISPLAY	11
2.8 CONNECTION TERMINALS.....	12
2.9 POWER SUPPLY.....	13
2.10 STAND	13
3. USE.....	14
3.1 START-UP	14
3.2 CONFIGURATION (SET-UP MODE).....	14
3.3 INSTALLATION OF THE LEADS AND CURRENT SENSORS	14
3.3.1 CONNECTION PROCEDURE.....	15
3.3.2 DISCONNECTION PROCEDURE.....	15
3.4 FUNCTIONS.....	16
4. CONFIGURATION	17
4.1 CONFIGURATION (SET-UP MENU).....	17
4.1.1 DATE/TIME.....	18
4.1.2 DISPLAY.....	19
4.1.2.1 BRIGHTNESS	19
4.1.2.2 COLORS.....	19
4.1.2.3 DISPLAY SHUTDOWN.....	20
4.1.2.4 BACKGROUND COLOR (NIGHT MODE).....	20
4.1.3 CALCULATION METHODS	21
4.1.3.1 NON-ACTIVE QUANTITIES.....	21
4.1.3.2 UNIT OF ENERGY.....	22
4.1.3.3 K FACTOR.....	22
4.1.3.4 PHASE HARMONIC RATIOS.....	23
4.1.3.5 LONG-TERM FLICKER.....	23
4.1.4 ELECTRICAL HOOK-UP.....	24
4.1.5 PROBES AND RATIOS	28

4.1.5.1	CURRENT PROBES	28
4.1.5.2	VOLTAGE RATIOS	29
4.1.6	CAPTURE MODE	30
4.1.6.1	TRANSIENT VOLTAGE THRESHOLDS	30
4.1.6.2	TRANSIENT CURRENT THRESHOLDS	31
4.1.6.3	INRUSH CURRENT THRESHOLDS	32
4.1.7	TREND MODE	33
4.1.8	ALARM MODE CONFIGURATION	36
4.1.9	ERASING MEMORY	37
4.1.10	ABOUT	38

5. DISPLAY MODES..... 39

5.1	WAVEFORM CAPTURE MODE 	39
5.1.1	TRANSIENT MODE 	40
5.1.1.1	PROGRAMMING AND STARTING A SEARCH	40
5.1.1.2	DISPLAYING A TRANSIENT	41
5.1.1.3	DELETING A TRANSIENTS SEARCH	43
5.1.1.4	DELETING A TRANSIENT	43
5.1.2	INRUSH CURRENT MODE 	43
5.1.2.1	PROGRAMMING A CAPTURE	44
5.1.2.2	DISPLAYING CAPTURE PARAMETERS	45
5.1.3	TRUE RMS CURRENT AND VOLTAGE	46
5.1.4	INSTANTANEOUS INRUSH CURRENT	48
5.2	HARMONICS MODE 	50
5.2.1	PHASE-TO-NEUTRAL VOLTAGE HARMONICS	50
5.2.2	CURRENT	52
5.2.3	APPARENT POWER	53
5.2.4	PHASE-TO-PHASE VOLTAGE	55
5.2.5	EXPERT MODE	56
5.3	WAVEFORM MODE 	58
5.3.1	RMS MEASUREMENTS	58
5.3.1.1	RMS (3U)	59
5.3.1.2	RMS (4V)	59
5.3.1.3	RMS (4A)	60
5.3.1.4	RMS (NEUTRAL)	61
5.3.2	MEASUREMENT OF TOTAL HARMONIC DISTORTION (THD)	61
5.3.2.1	THD (3U)	61
5.3.2.2	THD (4V)	62
5.3.2.3	THD (4A)	62
5.3.3	MEASUREMENT OF THE PEAK FACTOR (CF)	63
5.3.3.1	CF (3U)	63
5.3.3.2	CF (4V)	64
5.3.3.3	CF (4A)	64
5.3.4	MEASUREMENT OF EXTREME AND MEAN VOLTAGE AND CURRENT VALUES 	65
5.3.5	SIMULTANEOUS DISPLAY 	66
5.3.6	PHASOR DIAGRAM DISPLAY 	67
5.4	ALARM MODE 	68
5.4.1	ALARM MODE CONFIGURATION	69

5.4.2	PROGRAMMING AN ALARM CAMPAIGN	69
5.4.3	STARTING AN ALARM CAMPAIGN	69
5.4.4	MANUALLY STOPPING AN ALARM CAMPAIGN	70
5.4.5	DISPLAYING A LIST OF ALARM CAMPAIGNS	70
5.4.6	LIST OF ALARMS	70
5.4.7	DELETING ALARM CAMPAIGNS	71
5.4.7.1	DELETING A SINGLE ALARM CAMPAIGN	71
5.4.7.2	DELETING ALL ALARM CAMPAIGNS	72
5.5	TREND MODE 	72
5.5.1	PROGRAMMING AND STARTING A RECORDING	72
5.5.2	VIEWING THE RECORDING LIST	73
5.5.3	DELETING RECORDINGS	73
5.5.4	VIEWING RECORDS	74
5.5.5	TREND GRAPHS	74
5.6	POWER AND ENERGY MODE 	82
5.6.1	3L FILTER	82
5.6.1.1	POWER	82
5.6.1.2	QUANTITIES ASSOCIATED WITH POWER	83
5.6.1.3	ENERGY CONSUMED	83
5.6.1.4	ENERGY GENERATED	84
5.6.2	L1, L2, AND L3 FILTERS	84
5.6.2.1	POWERS AND ASSOCIATED QUANTITIES	84
5.6.2.2	ENERGY METERS	86
5.6.3	Σ FILTER	86
5.6.3.1	TOTAL POWERS AND ASSOCIATED QUANTITIES	86
5.6.4	TOTAL ENERGY METERS	87
5.6.5	STARTING AND STOPPING ENERGY MEASUREMENTS	88
5.6.6	RESETTING THE ENERGY MEASUREMENT	88
5.7	SCREEN SNAPSHOTS 	88
5.7.1	VIEWING A SNAPSHOT	89
5.7.2	DELETING A SNAPSHOT	89
5.8	HELP 	89
6.	DATAVIEW SOFTWARE	90
6.1	INSTALLING DATAVIEW	90
6.2	POWERPAD III CONTROL PANEL	92
7.	MAINTENANCE	93
7.1	CLEANING	93
7.2	REPLACING THE BATTERY	93
7.3	UPDATING SOFTWARE & FIRMWARE	94
8.	ICONS, BUTTON & SYMBOLS	95
8.1	FUNCTION BUTTON ICONS	95
8.2	KEYPAD BUTTONS	96
8.2.1	FUNCTION BUTTONS (YELLOW BUTTONS)	96
8.2.2	NAVIGATION BUTTONS	96
8.2.3	MODE BUTTONS (VIOLET BUTTONS)	96

8.2.4 OTHER BUTTONS	97
8.3 ABBREVIATIONS.....	97
9. SPECIFICATIONS.....	99
9.1 REFERENCE CONDITIONS.....	99
9.2 ELECTRICAL SPECIFICATIONS.....	100
9.2.1 VOLTAGE INPUTS	100
9.2.2 CURRENT INPUTS	100
9.2.3 BANDWIDTH.....	100
9.2.4 POWER SUPPLY.....	100
9.2.5 ACCURACY SPECIFICATIONS (EXCLUDING CURRENT PROBES)	101
9.2.6 CURRENT PROBE ACCURACY (TO BE ADDED TO THE MODEL 8336'S ACCURACY).....	109
9.2.7 CURRENT PROBES AND SENSORS	110
9.3 CLASS B UNDER STANDARD IEC 61000-4-30	112
9.3.1 CONFORMITY OF THE DEVICE	112
9.3.2 ACCURACY AND MEASUREMENT RANGES.....	112
9.3.3 REAL-TIME CLOCK ACCURACY	113
9.4 MECHANICAL SPECIFICATIONS.....	113
9.5 ENVIRONMENTAL SPECIFICATIONS	113
9.6 SAFETY SPECIFICATIONS.....	114
APPENDIX.....	115
A.1 HYSTERESIS	115
A.1.1 SURGE DETECTION.....	115
A.1.2 UNDERVOLTAGE OR BLACKOUT DETECTION	115
A.1.3 MINIMUM SCALE VALUES FOR WAVEFORMS AND MINIMUM RMS VALUES	116
A.1.4 FOUR-QUADRANT DIAGRAM	116
A.1.5 MECHANISM FOR TRIGGERING TRANSIENT SENSORS	117
A.1.6 CAPTURE CONDITIONS IN INRUSH CURRENT MODE.....	117
GLOSSARY OF TERMS	117
REPAIR AND CALIBRATION	121
TECHNICAL AND SALES ASSISTANCE.....	121
LIMITED WARRANTY.....	122
WARRANTY REPAIRS	122

1. BEFORE YOU BEGIN

1.1 RECEIVING YOUR SHIPMENT

Make sure the contents shipped are consistent with the packing list. Notify your distributor of any missing items. If the equipment appears damaged, file a claim immediately with the carrier and notify your distributor at once. Save the damaged packing container to substantiate your claim. Do not use equipment which is damaged or appears to be damaged.

1.2 ORDERING INFORMATION

PowerPad® III Model 8336 (No Probes)..... Cat. #2136.30

PowerPad® III Model 8336 (w/4 A193-24-BK Sensors)..... Cat. #2136.31

PowerPad® III Model 8336 (w/4 MN193-BK Probes) Cat. #2136.32

Includes extra large tool bag, soft carrying pouch, 5 ft USB cable, five 10 ft black voltage leads with alligator clips, twelve color-coded input ID markers, power adapter 110/230V with US power cord, 9.6V NiMH battery, SD-Card, quick start guide, and a USB stick containing DataView® software and user manual.

 Only the AmpFlex® sensors are rated 600V CAT IV and IP67. The MN probes are rated 300V CAT IV, 600V CAT III.

1.2.1 ACCESSORIES

10 ft USB Cable..... **Cat. #2136.80**

AC/DC Current Probe Model SL261* **Cat. #1201.51**

* Adapter - BNC Adapter (mandatory if using an SL261 w/ the 8336)..... **Cat. #2140.40**

AC Current Probe Model MR193-BK..... **Cat. #2140.28**

AC Current Probe Model MN93-BK..... **Cat. #2140.32**

AC Current Probe Model SR193-BK **Cat. #2140.33**

AmpFlex® Sensor 24" Model 193-24-BK **Cat. #2140.34**

AmpFlex® Sensor 36" Model 193-36-BK **Cat. #2140.35**

AC Current Probe Model MN193-BK **Cat. #2140.36**

MiniFlex® Sensor 10" Model MA193-10-BK **Cat. #2140.48**

MiniFlex® Sensor 14" Model MA193-14-BK..... **Cat. #2140.50**

AC/DC Current Probe Model J93-BK **Cat. #2140.49**

1.2.2 REPLACEMENT PARTS

Extra Large Classic Tool Bag **Cat. #2133.73**

Soft Carrying Pouch **Cat. #2140.15**

Battery 9.6V NiMH..... **Cat. #2140.19**

(5) Black 10 ft (3M) Leads with (5) Black Alligator Clips..... **Cat. #2140.43**

(1) Black 10 ft (3M) Lead with (1) Black Alligator Clip **Cat. #2140.44**

(Leads are rated 100V CAT IV 10A, Clips rated 1000V CAT IV 15A, UL)

Set of 12, Color-coded Input ID Markers **Cat. #2140.45**

5 ft USB Cable..... **Cat. #2140.46**

Power Adapter 110/230V with US Power Cord **Cat. #5000.19**

1.3 INSTALLING THE BATTERY

⚠ WARNING:

- For safety reasons, replace the battery only with the original replacement model (see § 1.2.2).
- Do not expose the battery to heat exceeding 212°F (100°C).
- Do not short-circuit the battery terminals.
- To eliminate all risk of electric shock, disconnect the power supply cord and measurement leads of the instrument.

1. Turn the instrument over, raise the stand, and prop it up.
2. Use a coin to unscrew the two quarter-turn screws on the back of the housing.
3. Using a flat screwdriver, remove the cover from the compartment.
4. Turn the instrument over and hold the battery as it slides out of its compartment.
5. Disconnect the battery connector without pulling on the wires.
6. Connect the new battery. The connector is error-proofed to prevent reversals of polarity.
7. Place the battery in its compartment and arrange the wires so that they do not protrude.
8. Put the battery compartment cover back in place and screw the two screws back in.

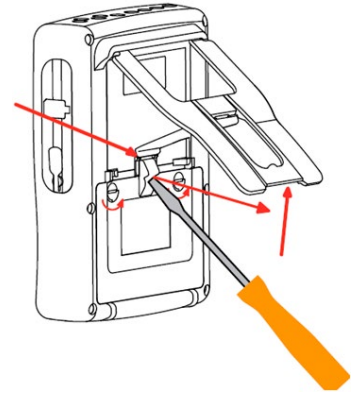

1.4 CHARGING THE BATTERY

Fully charge the battery before the first use.

i NOTE: A full recharge of a completely discharged battery takes approximately 5 hrs.

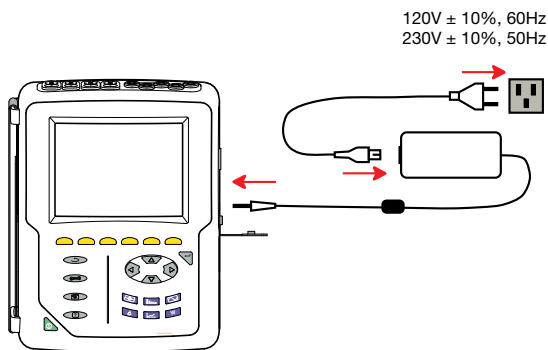

To recharge the battery:

- Remove the cover of the battery charging connector.
- Connect the supplied power cord to the instrument and AC power.
- The  button lights and will go out when the power cord is disconnected.

1.5 SETTING THE LANGUAGE

- Before using the instrument, first choose the language in which you want the instrument to display data and information.
- Press the green button to turn the instrument ON.
- Press the Configuration  button.
- Press the yellow function button corresponding to the desired language.

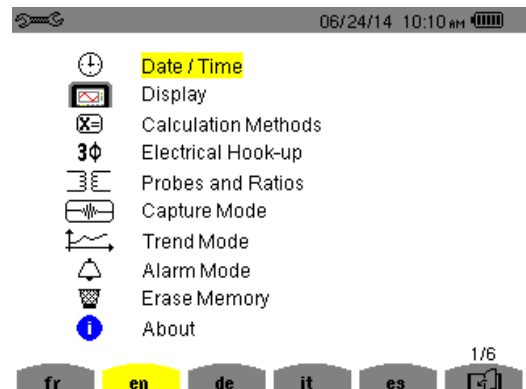

2. INTRODUCTION

2.1 DESCRIPTION

The PowerPad® III Model 8336 is a 3-phase network analyzer with a color graphic display and built-in rechargeable battery. This instrument can be used to:

- Measure the RMS values, powers, and perturbations on electric distribution networks
- Deliver a snapshot of the principal characteristics of a 3-phase network
- Track the variations of various parameters over time

The measurement accuracy of the instrument is better than 1% (excluding uncertainties due to connected sensors). The instrument is also very flexible, with a choice of sensors allowing measurements ranging from a few milliamperes (MN193) to several kiloamperes (AmpFlex®). The Model 8336 is compact and impact resistant; its ergonomics and simple interface make it easy to use. The instrument is intended for technicians and engineers responsible for electrical installation and network inspection and maintenance.

2.2 MEASUREMENTS

The Model 8336 measures:

- RMS values of AC voltages up to 1000V between terminals. By using ratios, the instrument can measure voltages up to hundreds of gigavolts.
- RMS values of AC currents up to 10,000 amperes (neutral included). By using ratios, the instrument can measure currents up to hundreds of kiloamperes.
- DC components of voltages and currents (neutral included).
- Minimum and maximum half-cycle RMS voltage and current values (excluding neutral).
- Peak voltage and current values (neutral included).
- Frequency of 50Hz and 60Hz networks.
- Current and voltage peak factors (neutral included).
- Calculation of the harmonic loss factor (FHL), application to transformers in the presence of harmonic currents.
- Calculation of the K factor (KF), application to transformers in the presence of harmonic currents.
- Measurement of total harmonic distortion with respect to the fundamental (THD in %f) of the current and of the voltages (excluding neutral).
- Measurement of the total harmonic distortion with respect to the RMS AC value (THD in %r) for the current and the voltages (neutral included)
- Active, reactive (capacitive and inductive), non-active, distortion, and apparent power, by phase and cumulative (excluding neutral).
- Power factor (PF) and displacement factor (DPF or $\cos \Phi$) (excluding neutral).
- Measurement of the RMS distortion value (d) for the current and the voltages (excluding neutral).
- Short-term voltage flicker (PST) (excluding neutral).
- Measurement of the long-term flicker of the voltages (PLT) (excluding neutral).
- Active, reactive (capacitive and inductive), non-active, distortion, and apparent energy (excluding neutral).
- Current and voltage harmonics (excluding neutral) up to order 50: RMS value, percentage referred to the fundamental, (%f) (excluding neutral), or the total RMS value (%r), minimum and maximum and sequence harmonics.
- Apparent harmonic power up to order 50 (excluding neutral): percentages referred to the fundamental apparent power (%f) or the total apparent power (%r), minimum and maximum of a rank.
- Inrush currents, starting of motors.

2.3 DISPLAY

- **Waveforms** (voltages and currents)
- **Frequency Bar Chart** (voltages and currents)
- **Inrush Current Function:** displays parameters useful for study of the starting of a motor
 - Instantaneous current and voltage at the instant designated by the cursor
 - Maximum instantaneous absolute value of the current and of the voltage (over the entire starting time)
 - RMS value of the half-cycle (or lobe) of the current and voltage (excluding neutral) on which the cursor is positioned
 - Maximum half-cycle RMS current (over the entire starting time)
 - Instantaneous network frequency at the instant designated by the cursor
 - Maximum, mean, and minimum network frequencies (over the entire starting time)
 - Time at which starting of motor commenced
- **Screen Captures** (50 maximum)
- **Transients Function:** Detection and recording of transients (up to 210) between user-defined start and stop dates and times. Recording of four complete cycles (one before the triggering event and three after) on the eight acquisition channels.
- **Trend Recording (data logging) Function:** 2GB memory with date-stamping and user-defined start and stop dates for recording, with a maximum of 100 recording sessions. Display, in bar chart or graph form, of the means of many parameters vs. time, with or without minima and maxima.
- **Alarm Function:** List recorded alarms (up to 16,000) exceeding thresholds defined in the configuration menu. User-defined alarm monitoring start and stop times.

2.4 CONFIGURATION

- Date and time setting
- Screen brightness setting
- Graph colors
- Display management
- Night mode
- Calculation methods (non-active quantities broken down or not, choice of the unit of energy, choice of the coefficients of calculation of the K factor, choice of reference for the level of harmonics, PLT calculation (sliding or not))
- Distribution system (single-phase, 2-phase, 3-phase with or without neutral) and of the connection method (standard, 2-element method or 2½-element method)
- Configure recording, alarms, inrush currents, and transients
- Delete data (total or partial)
- Display software and hardware version numbers
- Language
- Current sensors detected, not detected, not managed, simulated, or impossible to simulate (2-element connection method). Set voltage and current ratio, transduction ratios, and sensitivity

2.5 OVERALL VIEW

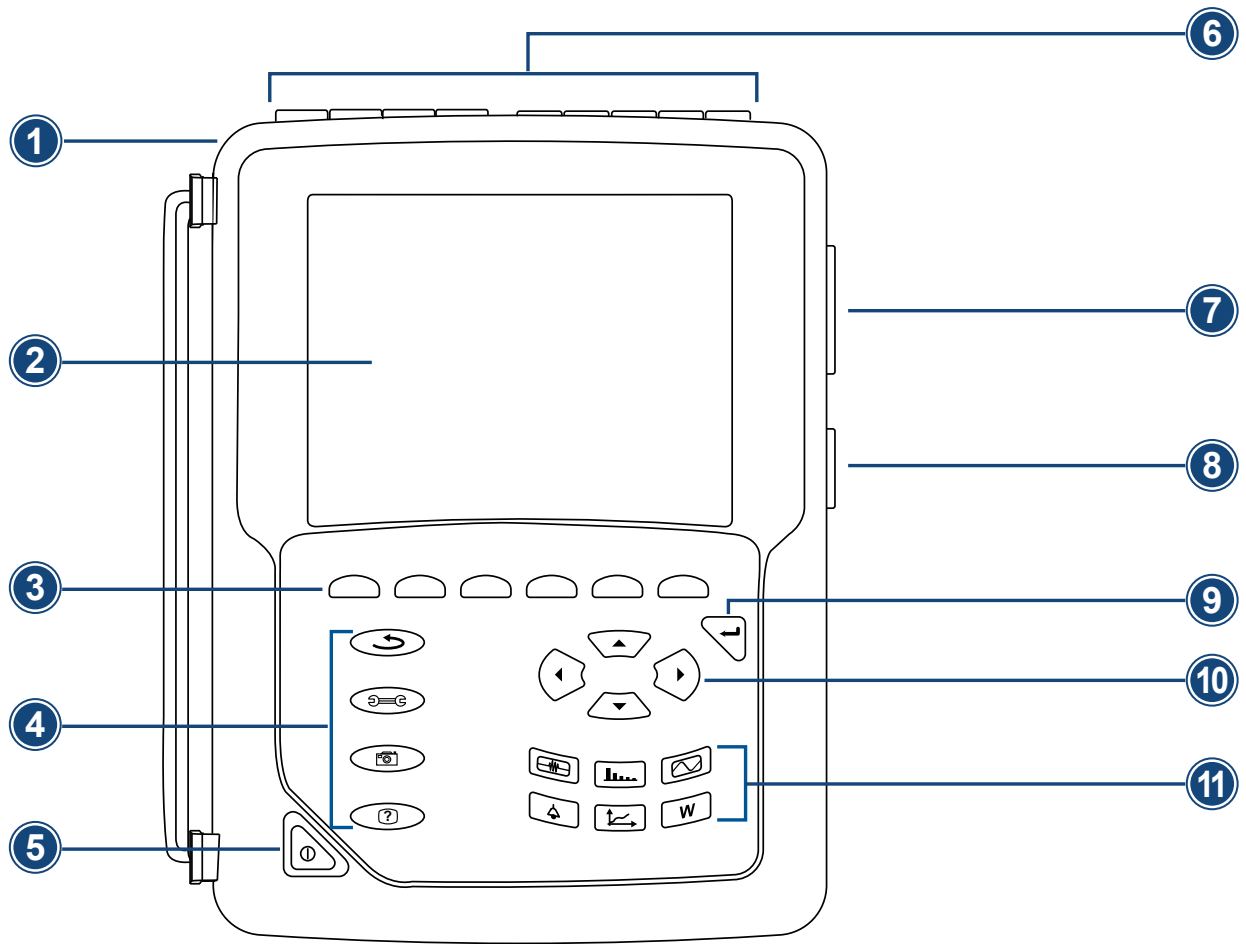



Figure 2-1

1. Over molded protective case.
2. Color TFT 320 X 240 (1/4 VGA) display with graphic representation of system parameters and measurements.
3. Six (6) function buttons used to modify the display mode.
4. Four (4) function buttons.
5. ON / OFF button.
6. Four (4) current input terminals on the top of the instrument to enable the use of current sensors (MN, SR, AmpFlex®, MiniFlex®, MR, SL and J93 probes). It is possible to use different current probes per input voltage ratio selectable. Five (5) voltage input terminals (voltage ratio can be set before recording).
7. USB optically isolated output for configuring, running tests and transferring data to a PC.
8. Input for external power supply and battery charging.
9. Enter button.
10. Four (4) buttons that enable movement of the cursor, browsing or the selection of data.
11. Buttons for directly accessing the 6 display modes.



NOTE: Refer to § 8 for function button descriptions.

2.6 ON/OFF BUTTON

The Model 8336 can operate on either battery or on AC power. Pressing the  button powers up the instrument. If the instrument is shut OFF suddenly (line power outage in the absence of the battery) or automatically (battery low), an information message is displayed when it is next started up.

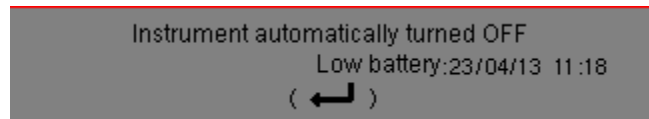
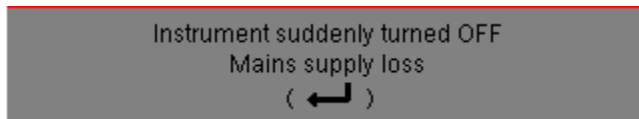

Pressing the  button again turns the instrument OFF. If the instrument is recording, metering energy, or searching for transients, alarms, and/or inrush current acquisition, it requests confirmation.

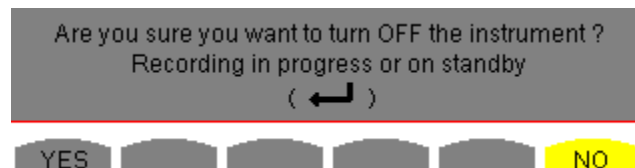

Select **YES** or **NO** on the corresponding yellow buttons, then press the  button to confirm.

- If **NO** is selected, recording will continue.
- If **YES** is selected, the data recorded until that point are finalized and the instrument is turned OFF.

2.7 DISPLAY

The backlit 320x240-pixel (1/4 VGA) graphic TFT screen displays all measurements with their graphs, the parameters of the unit, the graphs selected, the instantaneous values of the signals, and the type of measurement selected. When the instrument is powered up, it automatically displays the Waveform screen.

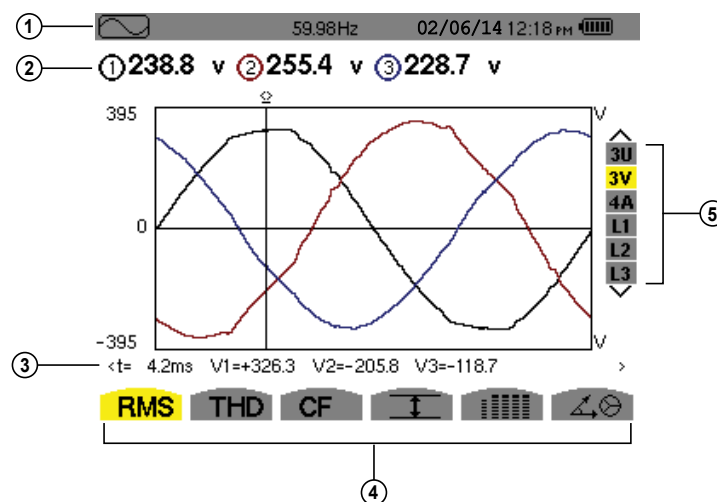



Figure 2-2

1. Top bar on the display, including:
 - Mode indicator (, etc.)
 - Frequency of measured signal
 - Memory capacity status bar (only available in certain modes)
 - Current date and time
 - Battery charge status (see § 2.9)
2. Measured RMS values associated with waveforms.

3. Values of signals at an instant “t” at the intersection of cursor and the waveforms. The cursor can be moved along the time scale by pressing the ◀ and ▶ buttons.

4. Measurement selection (refer to § 8).

i Calculation of DPF, Tan, KF, Φ , UNB, Min, Max, VAR, Harmonics, PST, and DF parameters and the frequency measurement can only be performed if voltage or current with a frequency of 40 to 70Hz is applied to the Ch1 voltage input or the A1 current input.

5. Selection of waveforms to be displayed (use the ▲ and ▼ buttons to select):

U: Signifies phase-to-phase voltage

V: Signifies phase-to-neutral voltage

A: Displays current for each phase

L1, L2, L3: Refer to the phases (A,B,C)

The Auto Power Off function can be turned ON and OFF during instrument configuration (see § 4.1.2.3).

2.8 CONNECTION TERMINALS

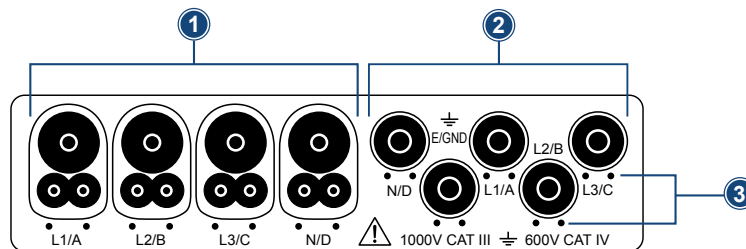

Figure 2-3

1. Four (4) current input terminals on the top of the instrument to enable the use of current sensors (MN, SR, AmpFlex®, MiniFlex®, MR, SL & J93 probes).
2. Five (5) voltage input terminals (measures four voltages).
3. Insertion locations for the current and voltage color-coded ID markers.

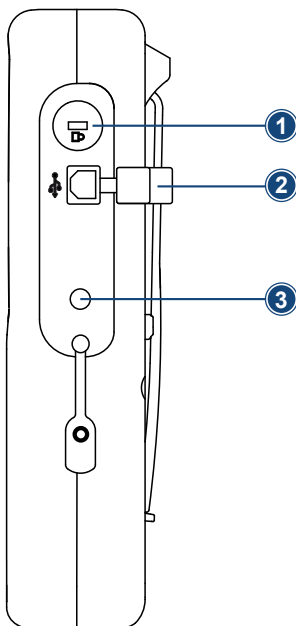







Figure 2-4

1. Theft-prevention access port, used to secure the instrument with padlock.
2. USB connector for connection to a PC.
3. Input for external AC power supply and battery charging.

2.9 POWER SUPPLY

The battery icon in the top right corner of the screen shows the battery level. The number of bars is proportional to the charge level.

Icon	Battery Charge Status
	Battery charged
	Low battery
	Battery charging
	Red bar: Condition of the battery is unknown because it had never been fully charged.
	The instrument is connected to AC power using the power cord.

When the capacity of the battery is too low, the following message is displayed:

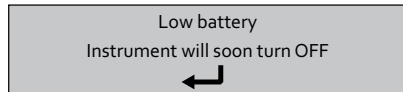

Press  to confirm. The instrument will turn OFF if you do not connect the PowerPad® to AC power (using the power cord) within one minute of this message appearing.

2.10 STAND

A retractable stand on the back of the Model 8336 can be used to hold the instrument in a tilted position.



1. Retractable stand.
2. Battery compartment.

NOTE: The SD card is located under the battery.

Figure 2-5

3. USE

3.1 START-UP

To turn the Model 8336 ON, press the  button. The button lights up when initially pressed; it then goes OFF if the power cord is not connected to AC power. During startup, several informational screens appear, displaying data such as the firmware version and serial number of the instrument. When startup is complete, the Waveform screen is displayed.

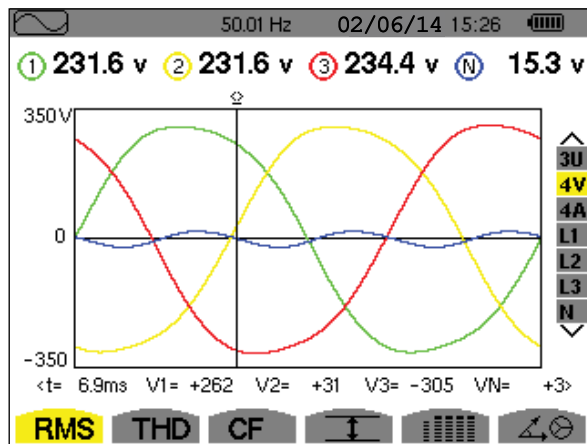



Figure 3-1

3.2 CONFIGURATION (SET-UP MODE)

 **NOTE:** The instrument must be configured before each use. The configuration is saved in memory when the instrument is turned OFF.

To display the Configuration screen, press the  button and follow the instructions in the Configuration chapter (see § 4).

NOTE: All configurations can also be modified through DataView® software.

3.3 INSTALLATION OF THE LEADS AND CURRENT SENSORS

Color-coded ID markers are supplied with the PowerPad® to identify the leads and input terminals.

- Detach the appropriate inserts from the color-coded marker and place them in the holes provided under the terminals (larger inserts for current terminals, smaller inserts for voltage terminals).
- Clip the rings of the same color to the ends of the lead that will connect to the terminal.

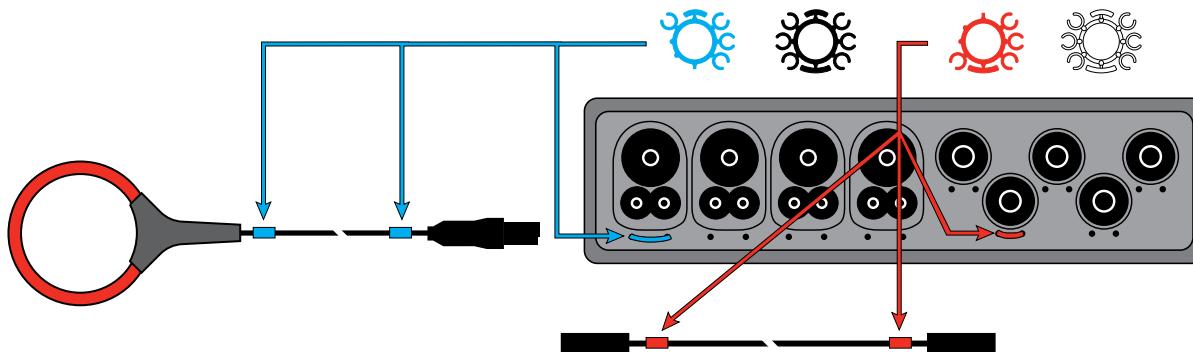

Figure 3-2

- Connect the measurement leads to the terminals of the instrument (see § 2.8).

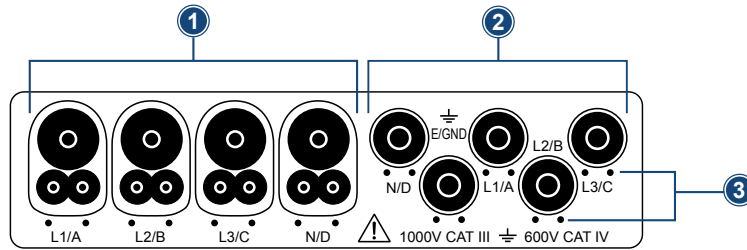

Figure 3-3

1. Four (4) current input terminals on the top of the instrument to enable the use of current sensors (MN, SR, AmpFlex®, MiniFlex®, MR, SL & J93 probes).
2. Five (5) voltage input terminals (measures four voltages).
3. Insertion locations for the current and voltage color-coded ID markers.

i **NOTE:** Remember to define the transformation ratios of the current sensors and of the voltage inputs (see § 4.1.5).

To make a measurement, the following must be configured and programmed:

- Calculation method (see § 4.1.3)
- Electrical hook-up (see § 4.1.4)
- Ratios of the sensors (see § 4.1.5)

3.3.1 CONNECTION PROCEDURE



1. Turn the instrument ON.
2. Configure the instrument for the measurement to be made and the type of network concerned (see § 4).
3. Connect the leads and current sensors to the unit.
4. Connect the ground and/or neutral lead to the network ground and/or neutral (when it is distributed) and connect the corresponding current sensor.
5. Connect the L1 phase lead to the network L1 phase and connect the corresponding current sensor.
6. If applicable, repeat the procedure for phases L2 and L3 and for N.

i **NOTE:** Complying with this procedure minimizes connection errors and saves time.

3.3.2 DISCONNECTION PROCEDURE

1. Proceed in the reverse of the order of connection, always finishing by disconnecting the neutral (when distributed).
2. Disconnect the leads and turn the instrument OFF.

3.4 FUNCTIONS

Any screen can be saved (screen snapshot) by pressing the  button for three seconds (see § 5.7). You can press the Help button  at any time. The Help screen will inform you about the functions and the symbols used for the current display mode.

Refer to § 5 for detailed information on the available display modes:



- Waveform Capture



- Harmonics



- Waveform Measurements



- Alarm Recording



- Recording (Trend Mode)



- Power and Energy Measurements



- Screen Snapshot

4. CONFIGURATION

4.1 CONFIGURATION (SET-UP MENU)

The Configuration button  displays the Configuration menu. This menu enables you to configure the instrument. This must be done before each new type of measurement. The configuration settings remain in memory, even after the instrument is turned OFF.

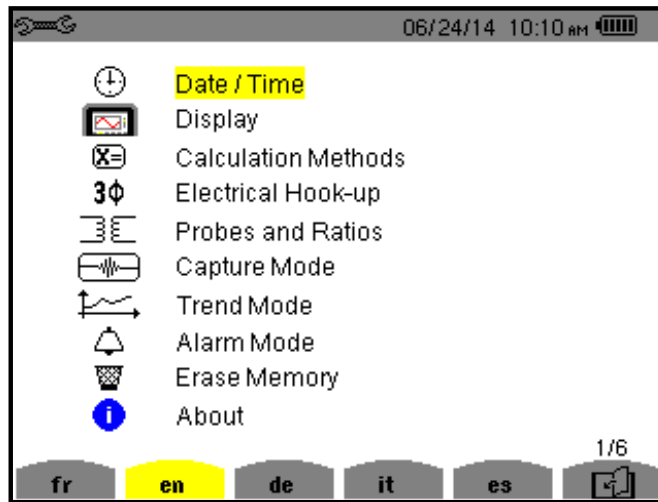



Figure 4-1

When working with the Configuration menu, use the arrow buttons (\blacktriangle or \blacktriangledown or \blacktriangleleft or \blacktriangleright) to navigate through the menus and options, then use the  button to select and validate your choices.

The Configuration menu allows you to define the following parameters:

PARAMETER	FUNCTION
Date / Time	Sets the date and time format (see § 4.1.1)
Display	Adjusts the contrast and brightness of the display (see § 4.1.2.1) Defines the color of the voltage and current curves (see § 4.1.2.2) Defines the settings for Auto Power Off (see § 4.1.2.3) Enables/Disables Night mode settings (see § 4.1.2.4)
Calculation Methods	Determines if harmonics are used or not used in calculations of reactive quantities (power and energy) - (see § 4.1.3) <ul style="list-style-type: none"> • With harmonics: Harmonics are taken into account when calculating reactive parameters • Without harmonics: Only the fundamental part is used for the calculation of reactive parameters
Electrical Hook-Up	Determines the type of connection to the network (see § 4.1.4) <ul style="list-style-type: none"> • 1-Phase 2-Wire • 1-Phase 3-Wire • 2-Phase 2-Wire • 2-Phase 3-Wire • 2-Phase 4-Wire • 3-Phase 3-Wire • 3-Phase 4-Wire • 3-Phase 5-Wire

Probes and Ratios	Defines the type of current probe to connect (see § 4.1.5) <ul style="list-style-type: none"> • MN93: 200A • MN193: 100A or 5A (with variable ratio) • SR193: 1000A • SL261: 10A and 100A range • AmpFlex® Sensors: 100A, 6500A and 10,000A (measures up to 10kA) • MiniFlex® Sensors: 100A, 6500A and 10,000A • MR193: 1000AAC/1200ADC • J93: 3500AAC/5000ADC • 5A 3-phase adapter (3-channel only)
Capture Mode	Configures the voltage and current thresholds (see § 4.1.6)
Trend Mode	Selects the parameters to record (see § 4.1.7) (Up to four configurations)
Alarm Mode	Defines the parameters of an alarm (see § 4.1.8)
Erase Memory	Deletes configurations, alarm settings, snapshots, and recordings (see § 4.1.9)
About	Displays the serial number, software and hardware version (see § 4.1.10)

4.1.1 DATE/TIME

The Date/Time menu  defines the system date and time. The display is as follows:

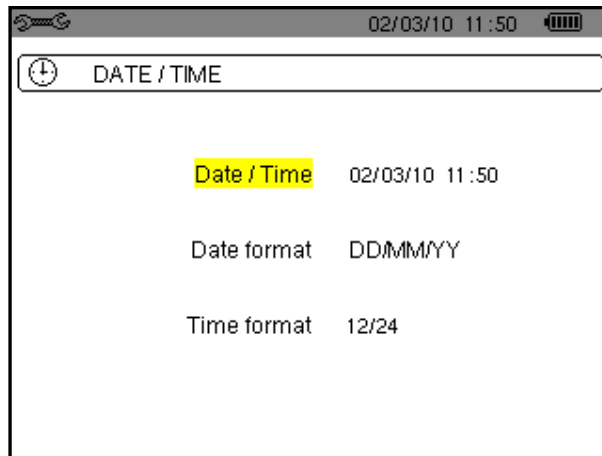









Figure 4-2

With the Date/Time field highlighted in yellow, press . To change a value, press  or . To move from one field to another, press  or . To confirm, press .

Proceed in the same way for selecting data format (DD/MM/YY or MM/DD/YY) and time format (12/24 or AM/PM). Changes take effect immediately in the data display. To return to the Configuration menu, press .

 **NOTE:** The date and time parameters cannot be configured while the instrument is recording, metering energy, or searching for transients, alarms, and/or inrush current acquisition.

4.1.2 DISPLAY

4.1.2.1 BRIGHTNESS

The Brightness button  initiates a menu that sets the brightness of the display.

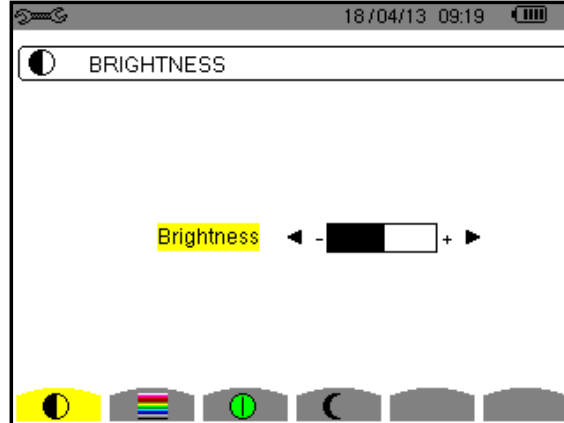



Figure 4-3

Use the ◀ or ▶ buttons to change the brightness. To return to the Configuration menu, press ↶.

4.1.2.2 COLORS

The Colors menu  is used to define the colors of the voltage and current traces on the graph. There are 15 colors available: green, dark green, yellow, orange, pink, red, brown, blue, turquoise blue, dark blue, light grey, grey, dark grey, and black.

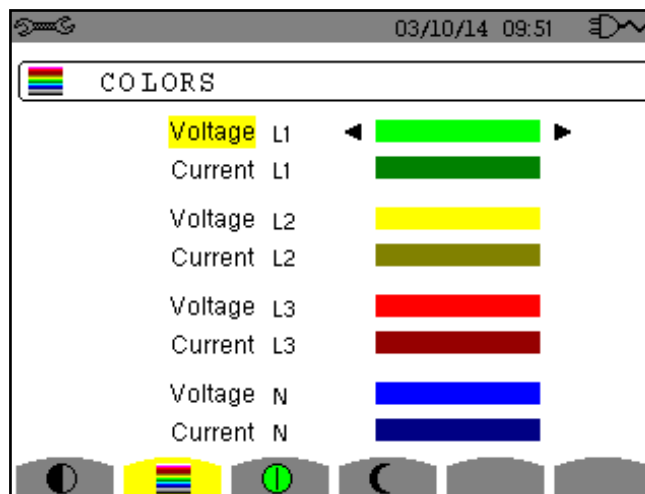



Figure 4-4

Use the arrow buttons to change colors. To return to the Configuration menu, press ↶.

4.1.2.3 DISPLAY SHUTDOWN

The Display Status button  displays a menu that defines the display shutdown process.

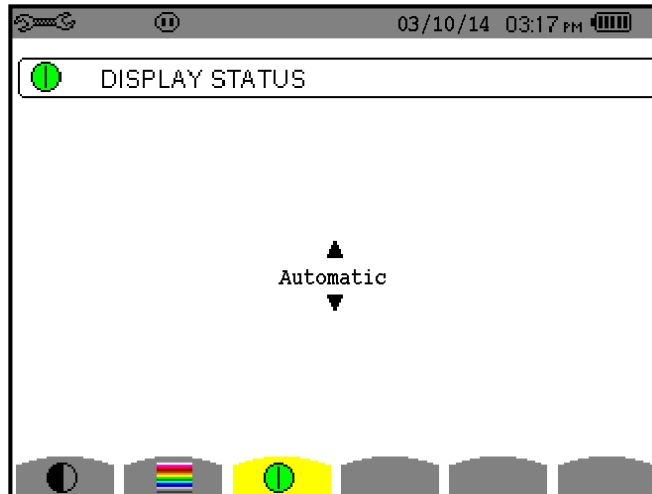





Figure 4-5

Use the ▲ and ▼ buttons to choose Automatic or Never.

- In Automatic mode the display turns OFF automatically after:
 - 5 minutes of inactivity when the instrument is powered by the battery and a recording is in progress.
 - 10 minutes if no recording is in progress.
- The ON/OFF button  blinks to indicate that the instrument is still in operation. Press any button to relight the display. To return to the Configuration menu, press .

4.1.2.4 BACKGROUND COLOR (NIGHT MODE)

The Night mode button  displays a menu that initiates night mode on the display.

In night mode, the screen displays “reverse” video and all colors are changed.

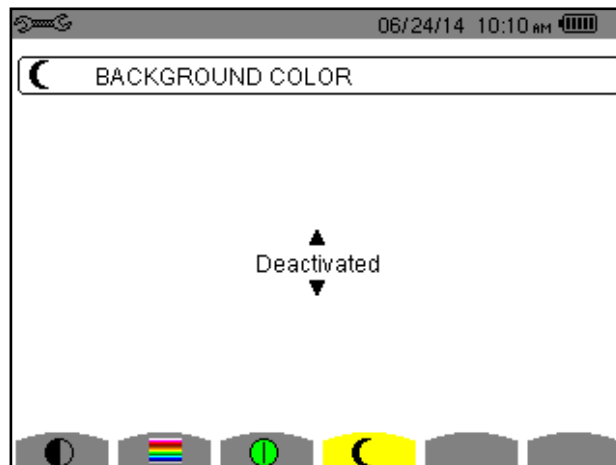

Figure 4-6

Use the ▲ and ▼ buttons to activate or deactivate night mode.

4.1.3 CALCULATION METHODS

The Calculation Methods menu  defines:

- Breakdown or no breakdown of the non-active quantities
- Unit of energy
- Reference for the level of harmonics of the phases
- Coefficients of calculation for the K factor
- Method of calculation of the long-term flicker

4.1.3.1 NON-ACTIVE QUANTITIES

The **var** menu is used to choose whether to separate or combine the non-active quantities (power and energy).

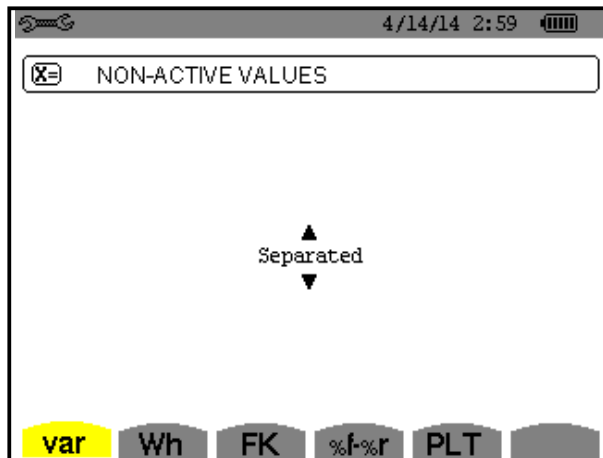



Figure 4-7

Use the ▲ and ▼ buttons to select Separated or Combined.

- **Separated:** Non-active power N is separated into reactive power (fundamental) Q1 and distorting power D. Non-active energy Nh is separated into Q1h and Dh.
- **Combined:** Non-active power N and non-active energy Nh are displayed.

Press  to confirm the selection and return to the Configuration menu.

 **NOTE:** This setting cannot be modified when the instrument is recording, metering energy, and/or searching for alarms.

4.1.3.2 UNIT OF ENERGY

The **Wh** menu defines the unit of energy for displayed data.

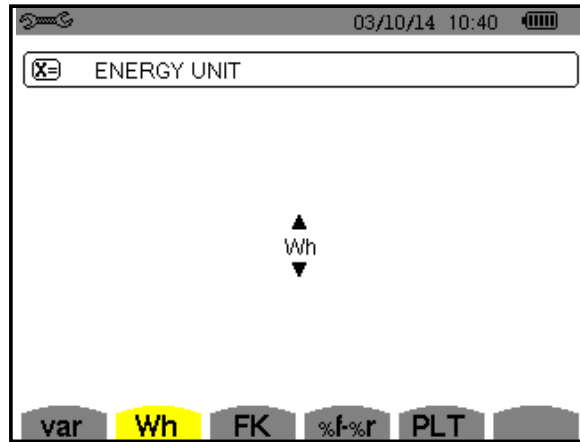



Figure 4-8

Use the up and down arrow buttons to select the unit:

- **Wh:** watt-hour
- **J:** joule
- **toe (nuclear):** nuclear tonne oil equivalent
- **toe (non-nuclear):** non-nuclear tonne oil equivalent
- **BTU:** British Thermal Unit

Press  to confirm the selection and return to the Configuration menu.

4.1.3.3 K FACTOR

The **FK** menu defines the coefficients used for the calculation of the K factor (Factor K). This value is used for weighting the harmonic load currents in accordance with their effects on transformer heating. A higher K factor indicates larger harmonic heating effects.

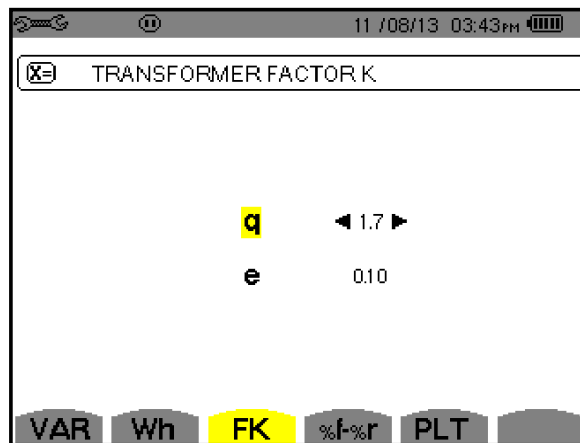



Figure 4-9

Use the arrow buttons to set the value of coefficients q and e:

- **q:** exponential constant that depends on the type of winding and the frequency. The value of q can range from 1.5 to 1.7. The value of 1.7 is suitable for transformers having round or square conductors, in all types of winding. The value of 1.5 is suitable for those in which the low-voltage windings are in tape form.
- **e:** ratio between the losses linked to eddy currents (at the fundamental frequency) and resistive losses (both evaluated at the reference temperature). The value of e can range from 0.05 to 0.1.

The default values ($q = 1.7$ and $e = 0.10$) are suitable for most applications.

Press  to confirm the selection and return to the Configuration menu.

 **NOTE:** This setting cannot be modified when the instrument is recording, and/or searching for alarms.

4.1.3.4 PHASE HARMONIC RATIOS

The %f-%r Phase Harmonics menu defines the reference for the level of harmonics of the phases.

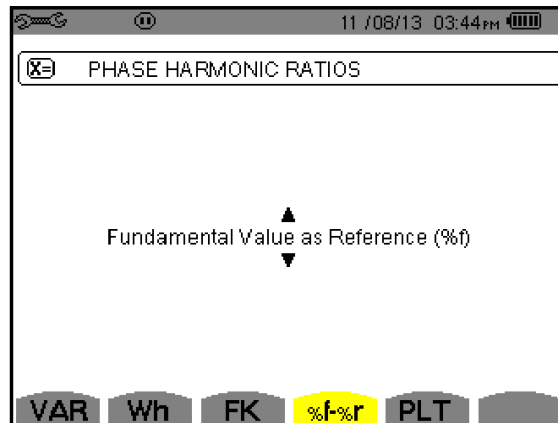



Figure 4-10

Use the ▲ and ▼ buttons to select the reference for the level of harmonics:

- %f: the reference is the value of the fundamental
- %r: the reference is the total value

For harmonics of the V-h, A-h, and U-h phases, the fundamental and total values are RMS values. For harmonics of the S-h phases, the fundamental and total values are apparent power values.

Press  to confirm the selection and return to the Configuration menu.

 **NOTE:** This setting cannot be modified when the instrument is recording, and/or searching for alarms.

4.1.3.5 LONG-TERM FLICKER

The PLT menu defines the method used to calculate long-term flicker. This screen defines whether a fixed or sliding window is used to calculate long-term flicker (rapid fluctuations in the power supply).

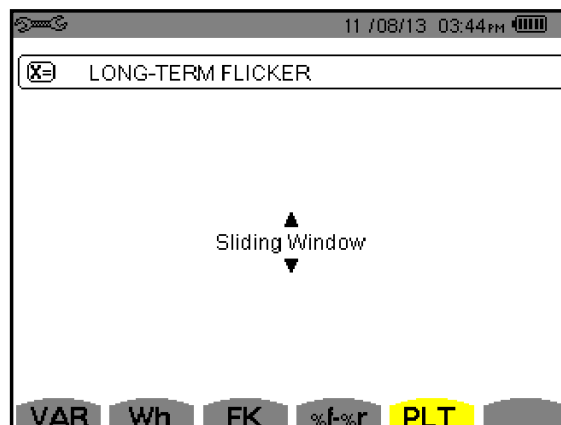



Figure 4-11

Use the ▲ and ▼ buttons to choose sliding or non-sliding.

- **Sliding:** The PLT is calculated every 10 minutes. The first value is available 2 hours after the instrument is switched on because it takes 12 values of PST to calculate the PLT.
- **Non-sliding:** The PLT is calculated every 2 hours.

Press  to confirm the selection and return to the Configuration menu.

 **NOTE:** This setting cannot be modified when the instrument is recording, and/or searching for alarms.

4.1.4 ELECTRICAL HOOK-UP

The 3Φ menu is used to define how the Model 8336 is connected, according to the type of network.

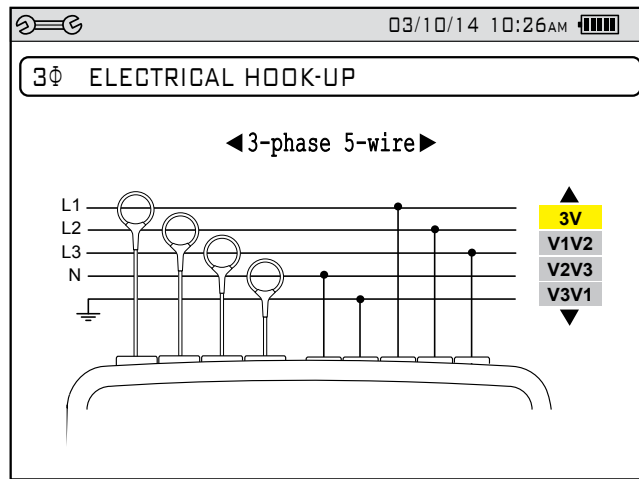



Figure 4-12

Several electrical diagrams can be selected. Use the arrow buttons to choose a connection. One or more types of network correspond to each distribution system.

These connection choices allow you to connect the instrument to all existing networks.

Press  to confirm the selection and return to the Configuration menu.

 **NOTE:** This setting cannot be modified when the instrument is recording, and/or searching for alarms.

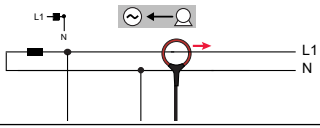
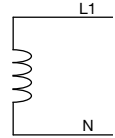
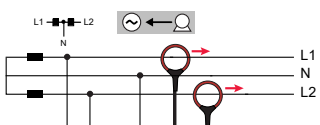
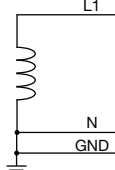
Distribution System	Source	
Single-phase 2-wire (L1 and N) 	Single-phase 2-wire non-grounded neutral	
Single-phase 3-wire (L1, N and ground) 	Single-phase 3-wire grounded neutral	

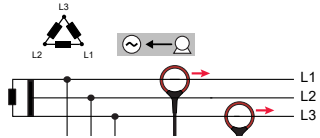
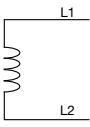
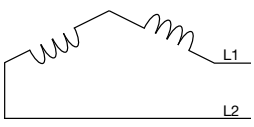
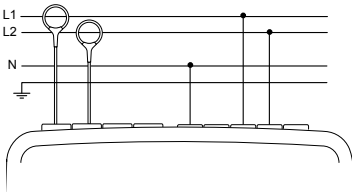
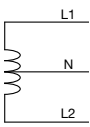
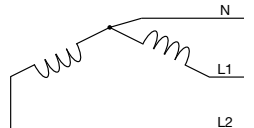
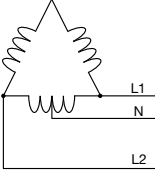
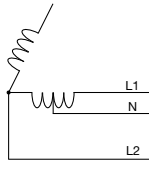
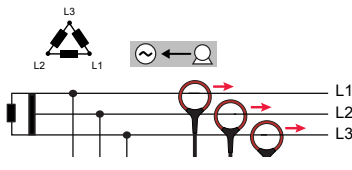
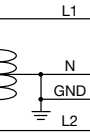
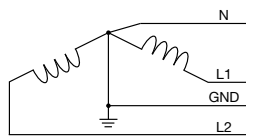
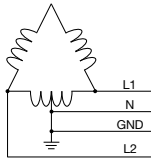
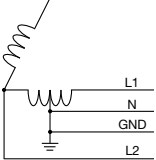
Distribution System	Source	
<p>Split-phase 2-wire (L1 and L2)</p> 	Split-phase 2-wire	
	3-phase open star 2-wire	
<p>Split-phase 3-wire (L1, L2 and N)</p> 	Split-phase 3-wire non-grounded neutral	
	3-phase open star 3-wire non-grounded neutral	
	3-phase high leg delta 3-wire non-grounded neutral	
	3-phase open high leg delta 3-wire non-grounded neutral	
<p>Split-phase 4-wire (L1, L2, N and ground)</p> 	Split-phase 4-wire grounded neutral	
	3-phase open star 4-wire grounded neutral	
	3-phase high leg delta 4-wire grounded neutral	
	3-phase open high leg delta 4-wire grounded neutral	

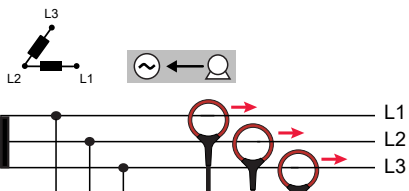
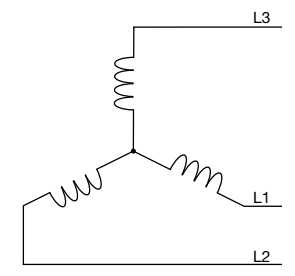
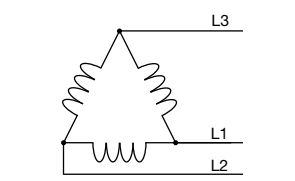
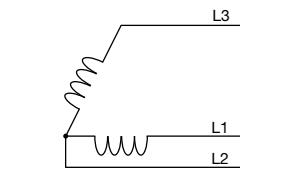
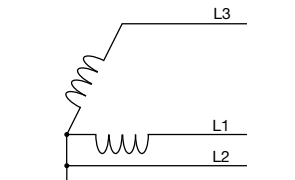
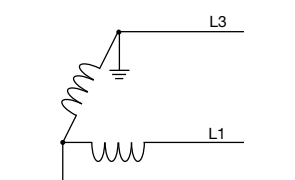
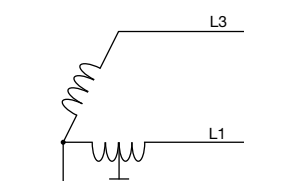
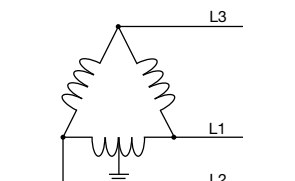
Distribution System	Source	
<p>3-phase 3-wire (L1, L2 and L3)</p>  <p>Indicates which 2 current sensors will be connected: A1 and A2, or A2 and A3, or A3 and A1.</p> <p>Two-wattmeter method or two-element method or Aron method.</p> <p>The third sensor is not necessary if the other two are of the same type, same range, and same ratio. Otherwise, the third sensor must be connected to make current measurements.</p>	3-phase star 3-wire	
	3-phase delta 3-wire	
	3-phase open delta 3-wire	
	3-phase open delta 3-wire grounded junction of phases	
	3-phase open delta 3-wire grounded corner of phase	
	3-phase high leg delta 3-wire	
	3-phase open high leg delta 3-wire	

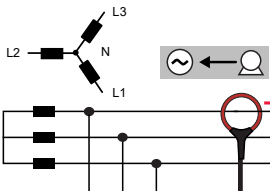
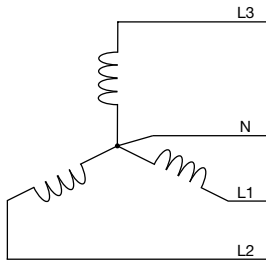
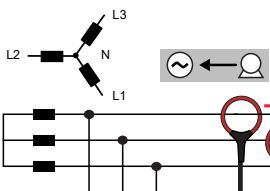
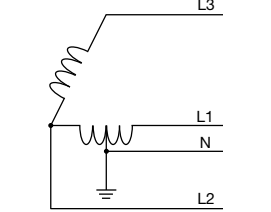
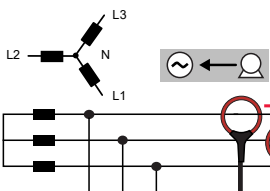
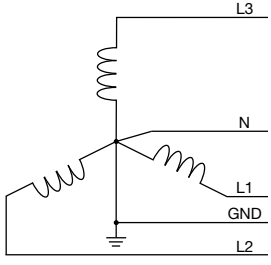
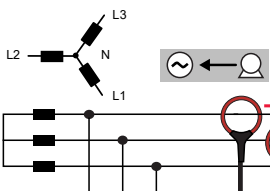
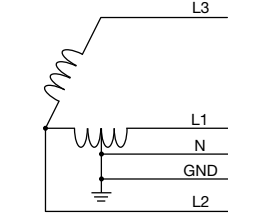
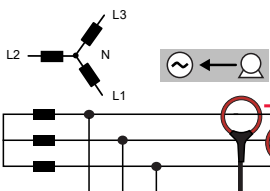
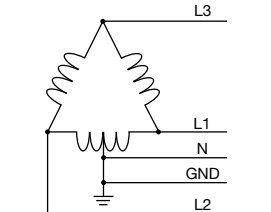
Distribution System	Source	
<p>3-phase 4-wire (L1, L2, L3 and N)</p>  <p>Indicates which voltages will be connected: all 3 (3V) or only 2 (V1 and V2, or V2 and V3, or V3 and V1).</p> <p>If only two of the three voltages are connected, the three phase voltages must be balanced (2½-element method)</p>	<p>3-phase star 4-wire non-grounded neutral</p>	
<p>3-phase 5-wire (L1, L2, L3, N and ground)</p>  <p>Indicates which voltages will be connected: all 3 (3V) or only 2 (V1 and V2, or V2 and V3, or V3 and V1).</p> <p>If only two of the three voltages are connected, the three phase voltages must be balanced (2½-element method)</p>	<p>3-phase open high leg delta 4-wire non-grounded neutral</p>	
<p>3-phase 5-wire (L1, L2, L3, N and ground)</p>  <p>Indicates which voltages will be connected: all 3 (3V) or only 2 (V1 and V2, or V2 and V3, or V3 and V1).</p> <p>If only two of the three voltages are connected, the three phase voltages must be balanced (2½-element method)</p>	<p>3-phase star 5-wire grounded neutral</p>	
<p>3-phase 5-wire (L1, L2, L3, N and ground)</p>  <p>Indicates which voltages will be connected: all 3 (3V) or only 2 (V1 and V2, or V2 and V3, or V3 and V1).</p> <p>If only two of the three voltages are connected, the three phase voltages must be balanced (2½-element method)</p>	<p>3-phase open high leg delta 5-wire grounded neutral</p>	
<p>3-phase 5-wire (L1, L2, L3, N and ground)</p>  <p>Indicates which voltages will be connected: all 3 (3V) or only 2 (V1 and V2, or V2 and V3, or V3 and V1).</p> <p>If only two of the three voltages are connected, the three phase voltages must be balanced (2½-element method)</p>	<p>3-phase high leg delta 5-wire grounded neutral</p>	

4.1.5 PROBES AND RATIOS

4.1.5.1 CURRENT PROBES

The  screen defines the current probes and ratios.

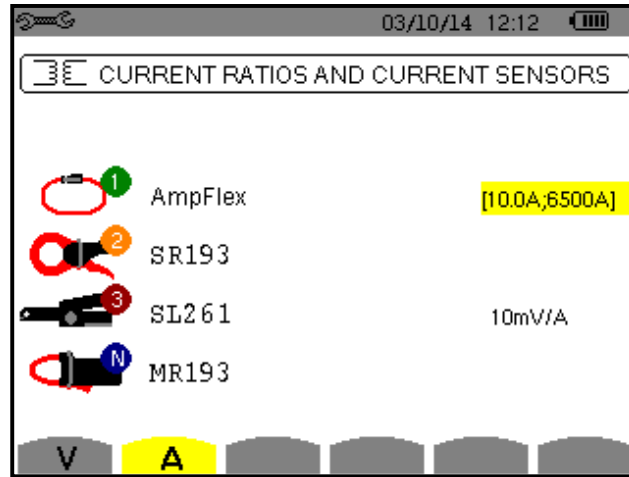

Figure 4-13







This menu enables you to define

- Current probes (press **A**)
- Current ratios (press **V** or **U**, depending on set-up)

Press **A** to define the current probes and ratios. This displays the current probe models detected by the instrument. If a probe is detected but not managed, an error message is displayed.

For a 3-wire 3-phase set-up where only two of the three current sensors required are connected, if these two sensors are of the same type and have the same ratio, the instrument simulates the third sensor by assuming the same characteristics as for the two others. The third sensor will be shown in the list as either being simulated, or impossible to simulate.

The current probe choices that are available are:

	MN93 clamp: 200Aac
	MN193 clamp: 100 or 5Aac
	SR193 clamp: 1000Aac
	J93 clamp: 3500Aac/5000Adc
	AmpFlex® A193: 100A/6500A/10,000Aac
	MiniFlex® MA193: 100A/6500Ac
	MR193 clamp: 1000A/1200Aac/dc
	SL261 clamp: 100A (sensitivity 10mV/Aac/dc)
	SL261 clamp: 10A (sensitivity 100mV/Aac/dc)

If an MN193 clamp (5A range) or an adapter is used, the current ratio setting is proposed automatically. If an MN193 clamp (5A range), an Adapter, an AmpFlex®, a MiniFlex®, J93 or an SL261 clamp is used; adjustment of the ratio, range, or sensitivity is proposed automatically.

Use the arrow buttons to define the ratios between the primary current (1A to 60,000A) and the secondary current (1A, 2A or 5A), then confirm the selections with the  button. Note that the primary current cannot be less than the secondary current.

4.1.5.2 VOLTAGE RATIOS

A second screen, **V** or **U** (depending on set-up), defines the voltage ratios. Ratios can be different for each channel, or the same for all or some channels. These are phase-to-neutral voltage ratios when there is a neutral (indicated by **V**)...

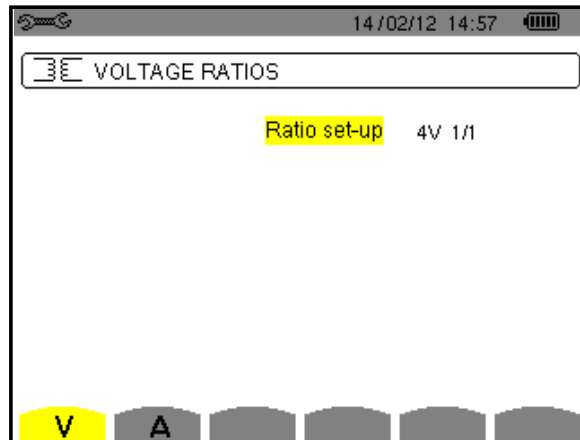

Figure 4-14

...and phase-to-phase voltage ratios when there is not (indicated by **U**).

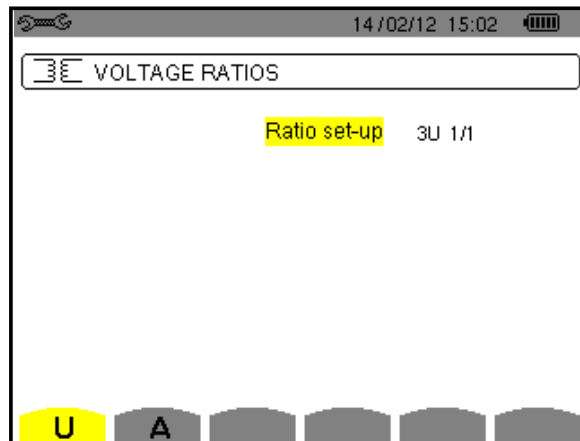







Figure 4-15

Use the ▲ and ▼ buttons to choose the configuration of the ratios.

- **3U 1/1 or 4V 1/1**: all channels have the same 1/1 ratio.
- **3U or 4V**: all channels have the same ratio, to be programmed.
 - Press  then use the ▲ and ▼ buttons to highlight the ratio in yellow.
 - Press  then use the arrow buttons to change the ratio. The primary voltage is in kV and the secondary voltage is in V.
- **3V + VN**: all channels have the same ratio and the neutral has a different ratio. The process is similar to when there is only one ratio, but you must perform the operation twice.
- **U1+U2+U3 or V1+V2+V3+VN**: each channel has a different ratio, to be programmed. The process is similar to when there is only one ratio, but you must perform the operation several times.

Confirm your selections by pressing . To return to the Configuration menu, press .

 **NOTE:** The primary and secondary voltages can each be configured with a multiplier factor of $1/\sqrt{3}$. Note also that you cannot modify ratios if the instrument is recording, metering energy, or searching for transients, alarms, and/or inrush current acquisitions.

4.1.6 CAPTURE MODE

The  Capture mode is used to configure the voltage thresholds, the current thresholds of the transient mode, and the current thresholds of the inrush current mode.

4.1.6.1 TRANSIENT VOLTAGE THRESHOLDS

The first  Thresholds screen, displayed by pressing the **V** icon (or **U**, for set-ups without a neutral), configures the voltage thresholds. These thresholds can be the same for all channels or different for some or each of them.

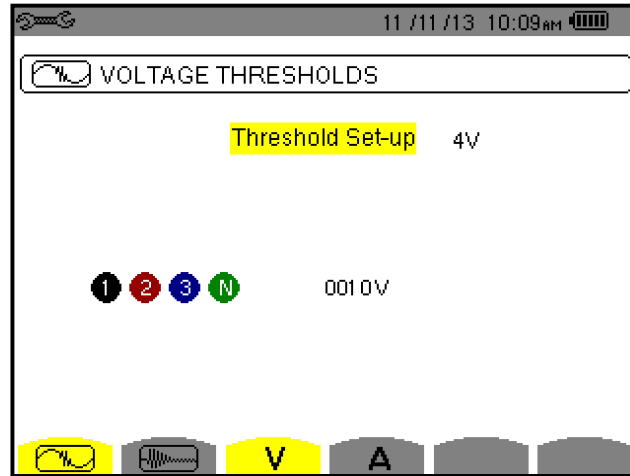









Figure 4-16

To change the voltage thresholds, press .

Use the  and  buttons to choose configuration of the thresholds.

- **4V or 3U:** all channels have the same threshold.
 - Press the  button, then use the  and  buttons to highlight the value of the threshold in yellow.
 - Press the  button, then use the arrow buttons to change the threshold. The unit can be **V** or **kV**.
- **3V + VN:** all channels have the same ratio and the neutral has a different ratio. Proceed as when there is only one ratio, but perform the operation twice.
- **V1+V2+V3+VN or U1+U2+U3:** each channel has a different ratio, to be programmed. Proceed as when there is only one ratio, but perform the operation several times.

Confirm your selections by pressing . To return to the Configuration menu, press .



NOTE: You cannot modify thresholds in the transient mode if the instrument is searching for transients.

4.1.6.2 TRANSIENT CURRENT THRESHOLDS

A second  Thresholds screen, displayed by pressing the **A** icon, configure the current thresholds (independently of the current sensors detected by the instrument). The thresholds programmed can be the same for all channels or different for some or all of them.

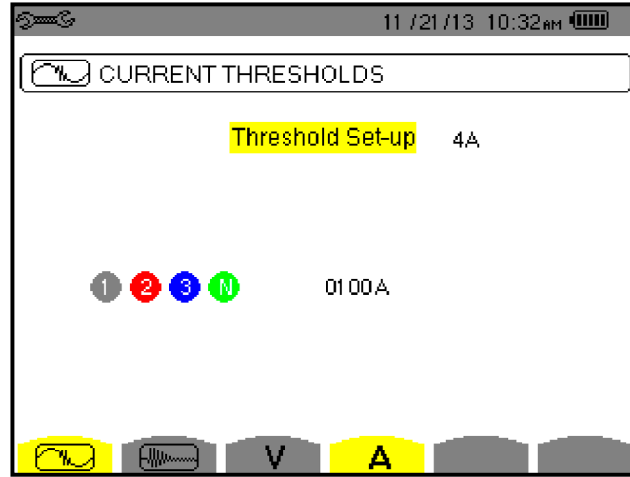











Figure 4-17

To change the current thresholds, press . Use the  and  buttons to choose configuration of the thresholds.

- **4A:** all current sensors have the same threshold.
 - Press the  button, then use the  and  buttons to highlight the value of the threshold in yellow.
 - Press the  button, then use the arrow buttons to change the threshold. The unit can be **A**, **kA**, or **mA**.
- **3A + AN:** all current sensors have the same threshold and the one connected to the neutral has a different threshold. Proceed as when there is only one ratio, but perform the operation twice.
- **A1+A2+A3+AN:** each current sensor has a different threshold, to be programmed. Proceed as when there is only one ratio, but perform the operation several times

Confirm your selections by pressing . To return to the Configuration menu, press .

 **NOTE:** You cannot modify thresholds in the transient mode if the instrument is searching for transients.

4.1.6.3 INRUSH CURRENT THRESHOLDS

A third Thresholds screen, displayed by pressing the  button, defines the inrush current thresholds. This involves setting the triggering threshold and the inrush current capture stopping threshold (the stopping threshold being the triggering threshold less the hysteresis).

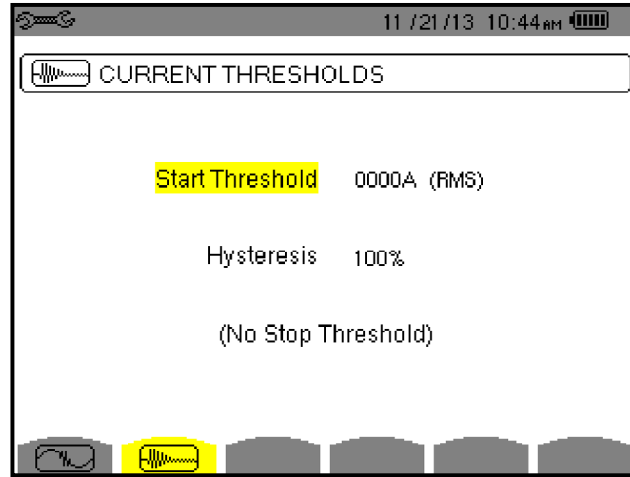









Figure 4-18

To change the inrush current triggering threshold:



- Press the  button.
- Use the arrow buttons to change the triggering threshold. The unit can be **A**, **kA**, or **mA**.
- Press , then use the  and  arrows to highlight the hysteresis in yellow.
- Use the navigation buttons to change the hysteresis.

For more information on the hysteresis, refer to § A.1. Configuring hysteresis at 100% is equivalent to not having a stop threshold (see § A.1.6)

Confirm your selections by pressing . To return to the Configuration menu, press .

 **NOTE:** You cannot modify thresholds in the transient mode if the instrument is searching for transients.

4.1.7 TREND MODE

The instrument has a recording function (activated by the  button, see § 5.5), used to record measured and calculated values (Urms, Vrms, Arms, and so on). To display the Trend Mode menu, press  to display the Configuration menu, and then select .

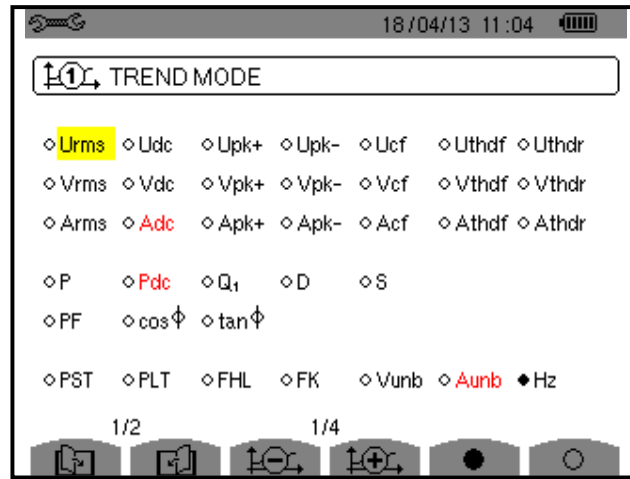



Figure 4-19

The Trend Mode menu consists of two pages. The first page is illustrated in Figure 4-19. To display the next page, press the  button.

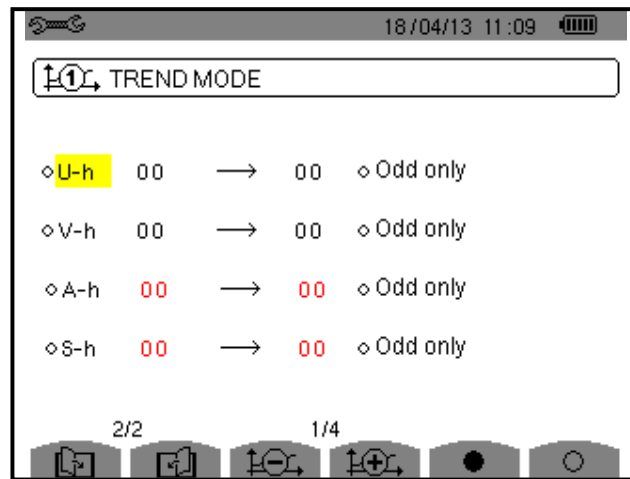













Figure 4-20

There are four possible programmable configurations: , , , . To navigate through these configurations, press the  or  button.

To select a parameter to be recorded, move the yellow cursor to the parameter using the navigation arrow buttons, then press . Selected parameters are identified by a red spot. The frequency (Hz) is always selected (black spot).

i NOTE: If a quantity is displayed in red, it is incompatible with the configuration chosen (connection selected, sensors connected, ratios programmed, reference of the level of harmonics of the phases, breakdown of the non-active quantities). For example, if no current sensor is connected, all current quantities appear in red.

To select all of the parameters of a page, press the  button. To deselect all of the parameters of a page, press the  button.

To change configuration pages, press the  or  button.





The recordable values are:

Unit	Designation
Urms	RMS phase-to-phase voltage
Udc	DC phase-to-phase voltage
Upk+	Maximum peak value of phase-to-phase voltage
Upk-	Minimum peak value of phase-to-phase voltage
Ucf	Crest (peak) factor of phase-to-phase voltage
Uthdf	Harmonic distortion of the phase-to-phase voltage with the RMS value of the fundamental as reference
Uthdr	Harmonic distortion of the phase-to-phase voltage with the total RMS value without DC as reference
Vrms	RMS phase-to-neutral voltage
Vdc	DC phase-to-neutral voltage
Vpk+	Maximum peak value of the phase-to-neutral voltage
Vpk-	Minimum peak value of the phase-to-neutral voltage
Vcf	Crest factor of phase-to-neutral voltage
Vthdf	Harmonic distortion of the phase-to-neutral voltage with the RMS value of the fundamental as reference
Vthdr	Harmonic distortion of the phase-to-neutral voltage with the total RMS value without DC as reference
Arms	RMS current
Adc	DC current
Apk+	Maximum peak value of the current
Apk-	Minimum peak value of the current
Acf	Crest factor of current
Athdf	Harmonic distortion of the current with the RMS value of the fundamental as reference
Athdr	Harmonic distortion of the current with the total RMS value without DC as reference
P	Active power
Pdc	DC power
Q1	Reactive power (fundamental)
N	Non-active power
D	Distortion power
S	Apparent power
PF	Power factor
cos Φ	Cosine of the phase shift of the voltage with respect to the current (displacement factor or fundamental power factor – DPF)
tan Φ	Tangent of the phase shift of the voltage with respect to the current
PST	Short-term flicker
PLT	Long-term flicker
FHL	Harmonic loss factor
FK	K factor
Vunb or Uunb	Phase-to-neutral voltage unbalance (set-up with neutral). Phase-to-phase voltage unbalance (set-up without neutral)
Aunb	Current unbalance
Hz	Network frequency
U-h	Harmonics in phase-to-phase voltage
V-h	Harmonics in phase-to-neutral voltage
A-h	Harmonics in current
S-h	Harmonics in power

The last four entries in the preceding table (U-h, V-h, A-h, and S-h) involve the recording of the harmonics of U, V, A, and S. You can select a range of orders of the harmonics to be recorded (between 0 and 50) for each of these quantities; and within this range (if desired) only odd harmonics.

i **NOTE:** The level of harmonics of order 01 will be displayed only if they concern values expressed in % r.

To change an order of harmonic:

1. Select the parameter to be recorded (identified by a red spot).
2. Move the yellow cursor to the parameter using the navigation arrow buttons.
3. Confirm the selection by pressing .
4. Change the value using the  and  arrow buttons, then confirm by pressing .

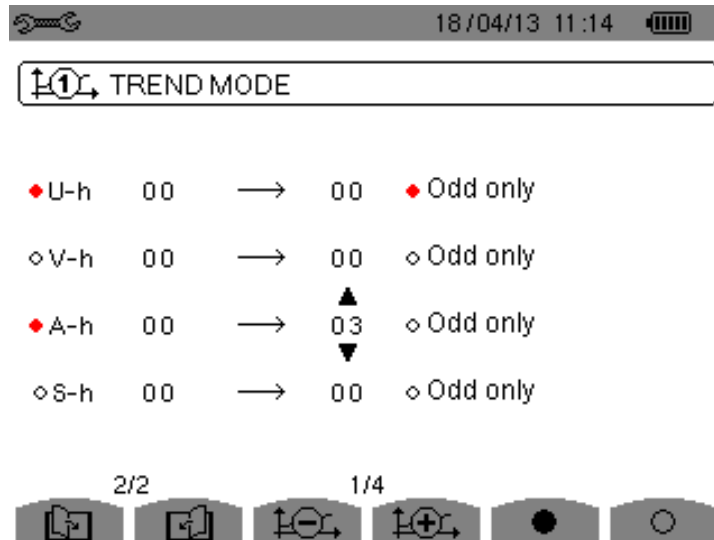





Figure 4-21

i **NOTE:** If a recording is in progress, the associated configuration cannot be modified and the selected values are identified by black spots.

To return to the Configuration menu, press .

4.1.8 ALARM MODE CONFIGURATION

The  Alarm mode menu defines the alarms used by the Alarm mode function (see § 5.4 for a complete list of alarms). To activate an alarm, highlight it using the up and down arrow buttons, then confirm the selection by pressing . The active alarm is identified by a red spot. An alarm that is not programmed (identified by a question mark "?") cannot be activated. To program the alarm, select the parameter, then enter a new value. Confirm the change by pressing .

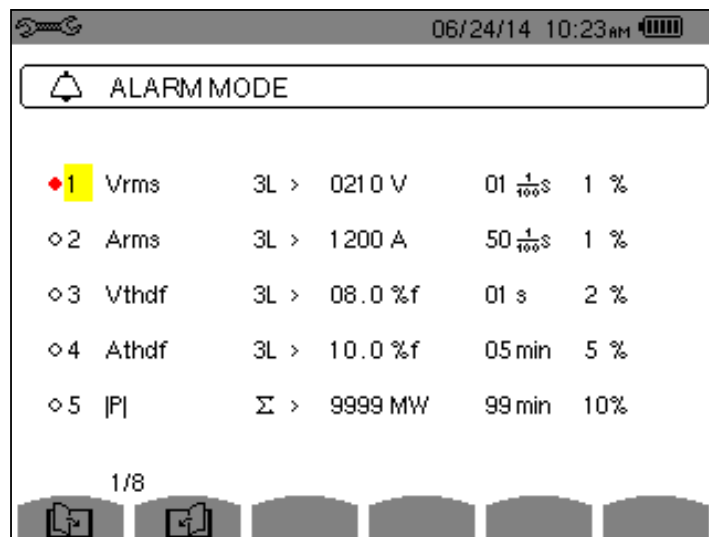



Figure 4-22

The Alarm mode menu defines:

- Type of alarm
- Order of the harmonic (between 0 and 50), for |S-h|, A-h, U-h and V-h only
- Target of the alarm:
 - 3L: 3 phases monitored individually
 - N: monitoring of neutral
 - 4L: 3 phases and neutral monitored individually
 - Σ: surveillance of the value of the complete system
- Direction of the alarm (> or <) in the case of Hz, Urms, Vrms, Arms, |Udc|, |Vdc|, |Adc|, |Upk+|, |Vpk+|, |Apk+|, |Upk-|, |Vpk-| and |Apk-|.
- Triggering threshold of the alarm (value and unit for Urms, Vrms, Arms, |Udc|, |Vdc|, |Adc|, |Upk+|, |Vpk+|, |Apk+|, |Upk-|, |Vpk-|, |Apk-|, |P|, |Pdc|, |Q1| or N, D and S).
- Triggering delay, or minimum duration above or below the alarm threshold: in minutes or seconds or, in the case of Vrms, Urms and Arms (excluding the neutral), in hundredths of a second.
- Hysteresis: 1%, 2%, 5% or 10% (see § A.1).

To go from one page to the other, press the  or  button. Each overshoot of an alarm will be recorded in a campaign of alarms.

 **NOTE:** A red alarm indicates the programmed quantity and/or target is incompatible with the configuration chosen (connection selected, sensors connected, ratios programmed, calculation methods chosen).

The alarms on the level of harmonics of order 01 concern only the values expressed in % r.

If a search for alarms is in progress, the activated alarms cannot be modified and are identified by black dots. However, new alarms (not yet programmed or not activated) can be activated.

To return to the Configuration menu, press .

4.1.9 ERASING MEMORY

The  Erase Memory menu partially or totally deletes data recorded in the instrument.

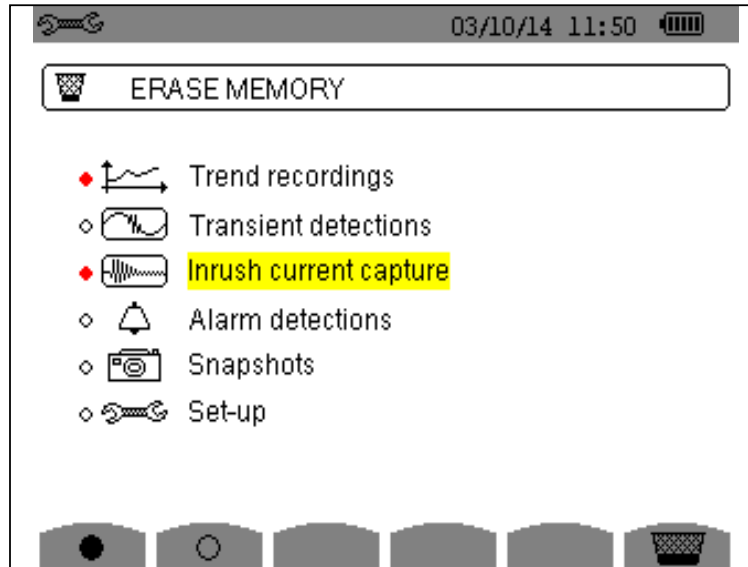









Figure 4-23

- To select an item to be deleted, highlight it using the arrow buttons, then confirm the selection by pressing .
A red dot appears identifying the item to be deleted. To select all items, press . To deselect all items, press .
- To proceed with the deletion, press the  button, then confirm by pressing .
- To return to the Configuration menu, press .

 **WARNING:** Which deletions are possible depends on the recordings in progress (recording, metering of energy, search for transients, alarms, and/or inrush current acquisition).

4.1.10 ABOUT

The  About menu displays information concerning the instrument.

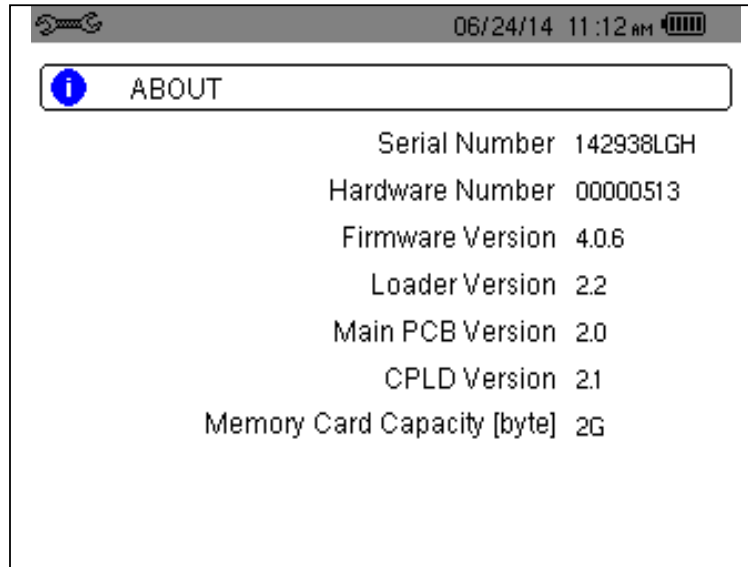

Figure 4-24

5. DISPLAY MODES

To select parameters in all modes, use the ◀ ▶ ▲ ▼ buttons to move to the desired parameter and use the ↵ button to confirm selections.

5.1 WAVEFORM CAPTURE MODE

The Waveform capture menu enables you to display and to capture transients and inrush currents. It contains two sub-modes:

- Transient mode (see § 5.1.1)
- Inrush current mode (see § 5.1.2)

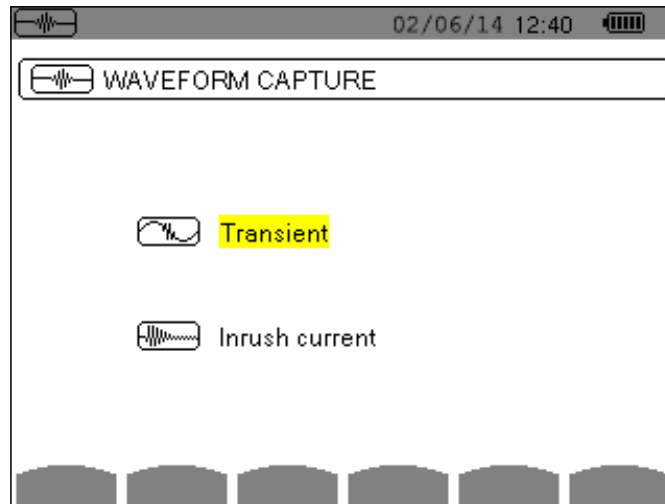

Figure 5-1

To select the sub-mode, highlight either Transient or Inrush current using the ▲ and ▼ buttons, then press ↵.

To return to the Waveform Capture screen, press ↶.

5.1.1 TRANSIENT MODE

The Transient menu is used to record transients, look up the list of recorded searches and the list of transients they contain, or erase them. You can record up to 7 detections and 210 transients.

When the Transient mode is selected, the display screen will depend on the following conditions:

if ...	then ...
no record has been made	the <i>Detection Schedule</i> screen is displayed
transients have been recorded	the <i>List of Seaches for Transients</i> screen is displayed

5.1.1.1 PROGRAMMING AND STARTING A SEARCH

To program the search for a transient, select **Transient** by pressing the  button in the Waveform Capture screen (see Figure 5-1). The Detection Schedule screen is displayed.

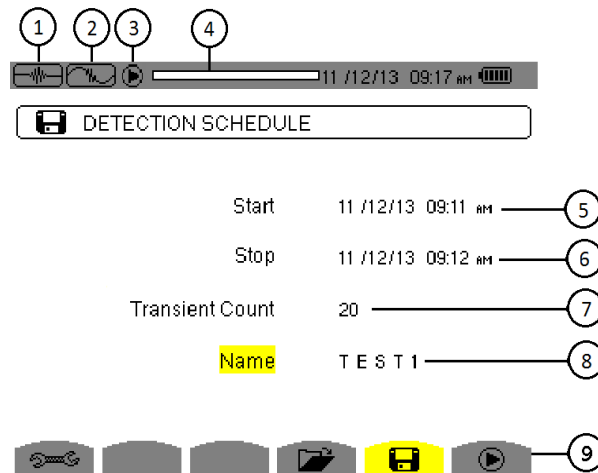















Figure 5-2

Item	Function
1	Reminder of the mode used
2	Display of sub-mode used
3	Flashing  icon: indicates that the search has been started
4	Memory indicator. Black area = used memory; White area = available memory
5	Transients search start time
6	Transients search end time
7	Number of transients
8	Name of transient
9	Display a list of searches; Program a search; Start a search

To program a search for a transient, enter the start date and time, the stop date and time, the number of transients to search for, and the name of the search.

To change an item, move the yellow cursor to it using the  and  buttons, then confirm the selection with the  button. Change the value using the , , , and  arrow buttons, then press . The name can be up to eight characters long. Several searches can bear the same name. The available alphanumeric characters are uppercase letters from A through Z and the digits 0 through 9. The last five names assigned (in the transient, trend, and alarm modes) are stored in memory. When a name is entered, it may then be completed automatically.

 **NOTE:** The start date and time must be later than the current date and time. The stop date and time must be later than the start date and time.

After you program the search, start it by pressing the  button. The  icon on the status bar blinks to indicate that the search is underway. While the search is active, the  button replaces the  button and can be used to stop the search before it is finished.

The message “*Detection on standby*” is displayed until the start time of the search is reached. When the search starts, this message is replaced by the message “*Detection in progress.*” When the stop time is reached, the Detection schedule menu returns with the  button displayed. You can now program another search. During a search for transients, only the stop date field can be modified. It is automatically highlighted in yellow.

To return to the Waveform capture screen, press .

5.1.1.2 DISPLAYING A TRANSIENT

To display the recorded transient, proceed as follows:

To display the recorded transients, press  button. The Detection List screen is displayed.

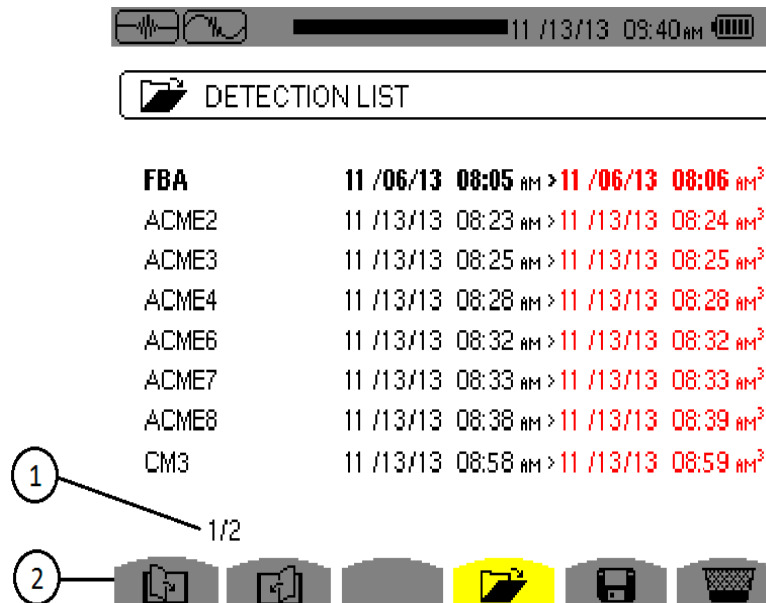





Figure 5-3

Item	Function
1	The displayed value indicates the page number and the number of pages.
2	These icons let you browse through the previous and next screens. Press the yellow buttons corresponding to these icons to display the pages.

If the stop date is in red, it means that it does not match the stop date initially programmed, because either:

- There is a power supply problem (battery low or disconnection from AC power)
- The number of transients has been reached, thereby ending the search

To select a search for transients, move the cursor to it using the  and  buttons. The selected search is bolded. Confirm by pressing . The screen then displays a list of transients.

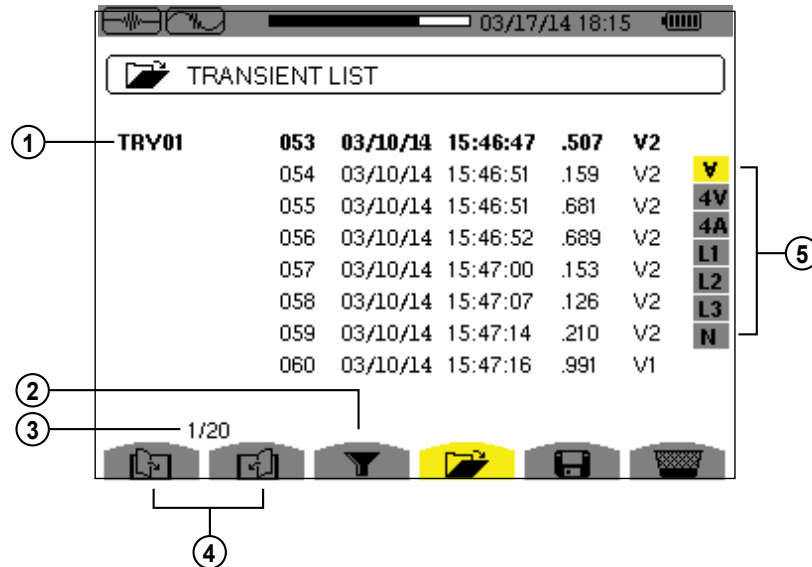

Figure 5-4

Item	Function
1	Transient name, number, date, time and triggering channel of transient.
2	Activates/deactivates the choice of a transient list display filter.
3	The displayed value indicates the page number and the number of pages.
4	These icons let you browse through the previous and next screens. Press the yellow buttons corresponding to these icons to display the pages.
5	Transient display filter: - V : displays the 4 single voltages during the transient (here in a 5-wire 3-phase connection) - 4V : displays the 4 single voltages during the transient (here in a 5-wire 3-phase connection) - 4A : displays the 3 currents and the neutral current during the transient - L1, L2 or L3 : displays the current and the single voltage successively in relation to phases 1, 2 and 3 - N : displays neutral

To select a transient, move the cursor to it using the ▲ and ▼ buttons. The selected field is bolded. Validate with the button. The screen then displays the transients in graph form.

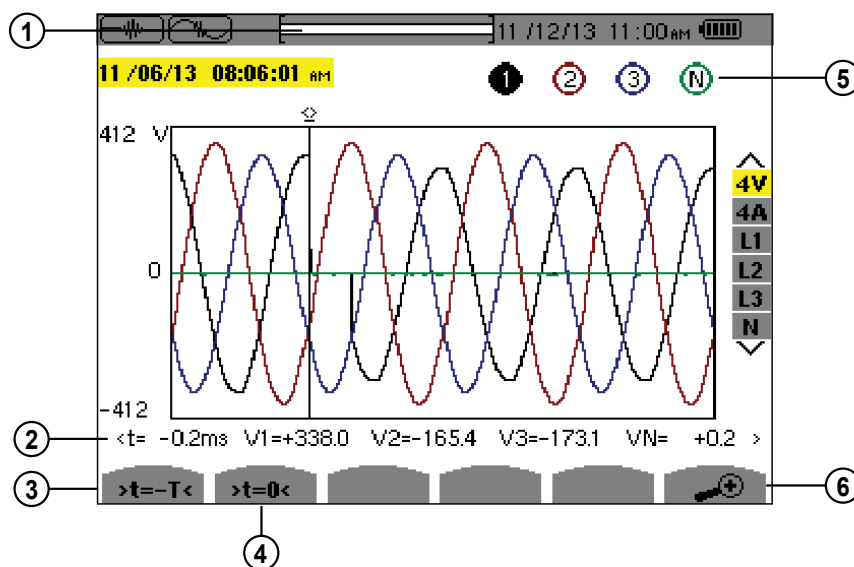





Figure 5-5



Item	Function
1	Location in the record of the zone displayed.
2	Instantaneous value of the signals according to the position of the cursor on the scale. To move the cursor use the ◀ and ▶ buttons.
3	Move cursor to one period of the signal before transient triggering time.
4	Move cursor to transient triggering time.
5	Number assigned to displayed graph (e.g. 1 is highlighted indicating channel V1 triggered capture of the transient)
6	 : Zoom In - Press this button to zoom in.  : Zoom Out - Press this button to zoom out.

 **NOTE:** The selection filter is dynamic and depends on the connection chosen. For example, the selection filter lists (3U, 3A) for a 3-wire 3-phase set-up.



To return to the Transient List screen, press .

5.1.1.3 DELETING A TRANSIENTS SEARCH



You can remove a stored search for transients from memory.

To do this, when the Detection List screen is displayed (see Figure 5-3), select the search to be deleted. Then press the  button, and press  to confirm the deletion. Note that you can delete a transient search only if it is not actively in progress. To return to the Waveform capture screen, press .

5.1.1.4 DELETING A TRANSIENT

When the Transient List screen is displayed (see Figure 5-3), select the transient to be deleted. The selected transient is bolded. Next, press the  button, and then press  to confirm the deletion. To return to the Waveform capture screen, press .

5.1.2 INRUSH CURRENT MODE

While in Waveform  mode, the Inrush current  sub-mode is used to capture (record) Inrush currents (voltage and current waveforms, network frequency, half-cycle RMS voltages and currents except for the neutral) and to view and delete the recordings.

When Inrush Current mode is selected, the screen displayed will depend on the following conditions:

if ...	then ...
no capture has been made	the <i>Capture Schedule</i> screen is displayed
captures have been made	the <i>Capture Parameters</i> screen is displayed

5.1.2.1 PROGRAMMING A CAPTURE

To program the capture of an Inrush current, proceed as follows:

- At the Waveform Capture screen (Figure 5-1), select Inrush Current. The Capture Schedule screen is displayed.

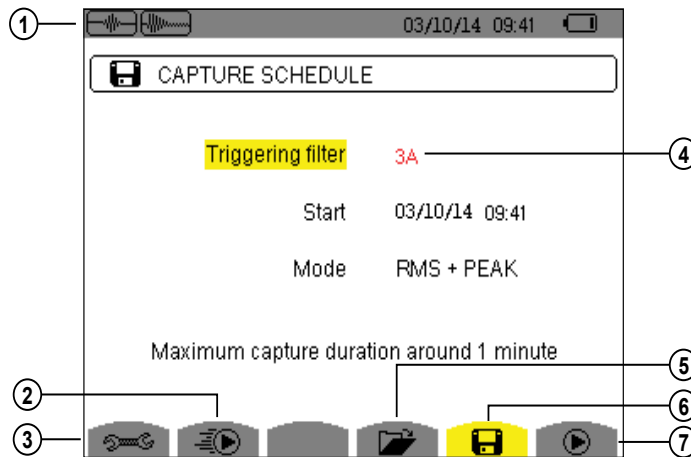

Figure 5-6

Item	Function
1	Icons for the mode and sub-mode.
2	Rapid programming and start of capture.
3	Shortcut to the Configuration menu to set triggering thresholds.
4	When triggering filter appears in red it is not available due to incompatibility with the configuration (connection, type of sensors, or current ratio).
5	Displays the parameters of the capture.
6	Programs the capture.
7	<ul style="list-style-type: none"> : confirms programming of a capture. : deletes a capture (this icon is displayed if a capture has been made).

To quickly start recording, press the button. Recording starts immediately with a current threshold of 0A and a hysteresis of 100%. Note that the rapid starting of an inrush current modifies the configuration of the current threshold.

To program a capture, enter the triggering filter (3A, A1, A2, or A3), the start date and time, and the recording mode (RMS + PEAK or RMS only).

- The **RMS + PEAK** recording mode is used to produce a trend recording of the half-period RMS values and a trend recording of the samples (envelopes and waveforms). The maximum duration of such a recording depends on the network frequency; on average the duration is approximately one minute.
- In the **RMS** only recording mode, the recording of the samples is eliminated in favor of a longer maximum capture duration. This mode records only the half-period RMS values and its maximum duration is about ten minutes.

To modify an item, move the yellow cursor to it using the and buttons, then confirm the selection with the button. Change the value using the arrow buttons, then confirm again.

NOTE: For more information on the triggering filter, refer to § A.1.6. You cannot program an alarm campaign if an inrush current capture is in progress.

After you program the capture, start it by pressing the button. The icon on the status bar blinks to indicate that the capture is underway. While the capture is active, the button replaces the button and can be used to stop the capture before it is finished.

NOTE: The voltage must be present before the inrush current for a stable and correct frequency lock.

The message “*Capture pending*” is displayed until the start time is reached and the triggering conditions are satisfied. It is then replaced by the message “*Capture in progress*”. The memory status indicator appears at the top of the screen. The indicator disappears when the capture is completed.



Figure 5-7

If the capture is terminated with a stop event (see conditions in § A.1.6) or if the recording memory of the instrument is full, the capture stops automatically.

NOTE: The instrument can keep in memory only a single inrush current capture. If you wish to make another capture, you must delete the previous one.

To return to the Waveform Capture screen, press .

5.1.2.2 DISPLAYING CAPTURE PARAMETERS

To display the characteristics of the capture, press . The Capture parameters screen appears.

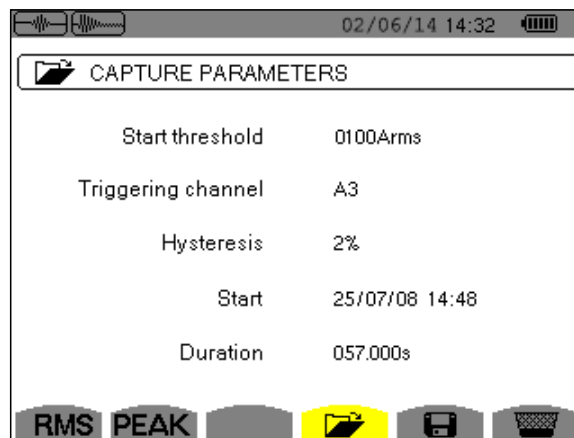

Figure 5-8

When a capture duration is displayed in red, it has been cut short for one of the following reasons:

- power supply problem (battery low)
- memory full
- measurement error
- incompatibility between the quantity monitored and the configuration of the instrument (e.g. withdrawal of a current sensor)

Choose the type of display, **RMS** or **PEAK**, by pressing the yellow button corresponding to the icon. The instrument then displays the graphs.

NOTE: The PEAK button is not displayed when the inrush current capture recording mode is RMS only.

In the PEAK display, the available information is:

- The instantaneous current and voltage at the time indicated by the cursor (in a “waveform” representation).
- The maximum instantaneous current and voltage in the half-cycle indicated by the cursor (in an “envelope” representation).
- The maximum instantaneous absolute value of the current and voltage (over the entire capture).

In the RMS display, the available information is:

- The instantaneous frequency at the time indicated by the cursor.
- The minimum, mean, and maximum instantaneous values of the frequency over the entire capture.
- The RMS current and voltage in the half-cycle (or lobe) on which the cursor is positioned.
- The maximum half-cycle RMS current and voltage (over the entire capture).



A voltage must be present on the phase before the motor start-up for a stable and correct frequency control.

5.1.3 TRUE RMS CURRENT AND VOLTAGE

RMS mode displays the record of the trend of the true half-cycle RMS current and voltage, and the frequency trend graph. The display depends on the type of selection filter:

- **3V:** displays the three voltages during the inrush current capture for set-ups with neutral
- **3U:** displays the three voltages during the inrush current capture for set-ups without neutral
- **3A:** displays the three currents during the inrush current capture
- **L1, L2, L3:** display the current and voltage in phases 1, 2, and 3 respectively (for set-ups with neutral only)
- **Hz:** displays the evolution of the network frequency vs. time

The following section show four display examples.

3A RMS DISPLAY SCREEN FOR A 3-PHASE CONNECTION WITH NEUTRAL

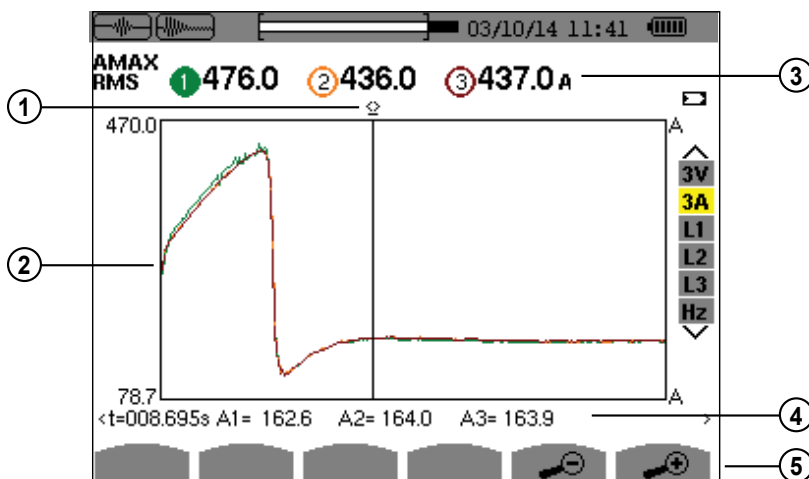

Figure 5-9

Item	Function
1	Instantaneous value cursor; change values with the cursor using the ◀ and ▶ buttons
2	Scale of values
3	- Maximum half-period RMS value of the Inrush current capture - Indicator of number attributed to the displayed curve - Value of the measured current
4	- t: relative time position of the cursor (t = 0 corresponds to the start of the Inrush capture) - Values at the position of the cursor. In the example shown in Figure 5-9, A1 , A2 , and A3 are the RMS values of currents 1, 2, and 3.
5	⊖ : Zoom Out - Zooms out on the graph at the current cursor position ⊕ : Zoom In - Zooms in on the graph at the current cursor position

3A RMS DISPLAY SCREEN (3-PHASE CONNECTION WITHOUT NEUTRAL)

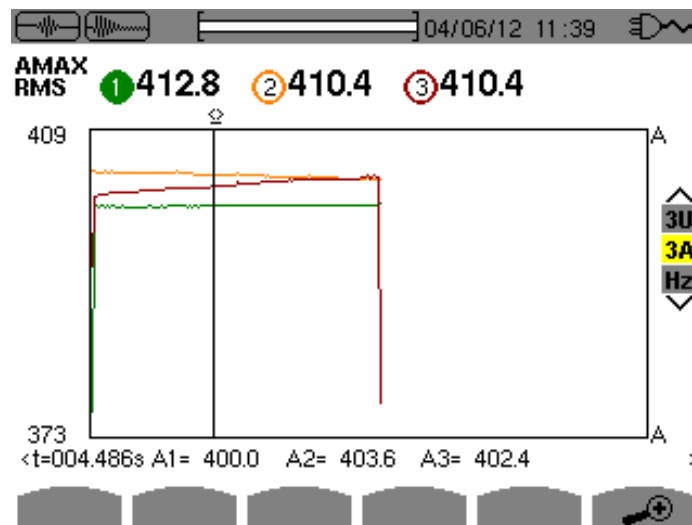

Figure 5-10

L1 RMS DISPLAY SCREEN FOR A 3-PHASE CONNECTION WITH NEUTRAL

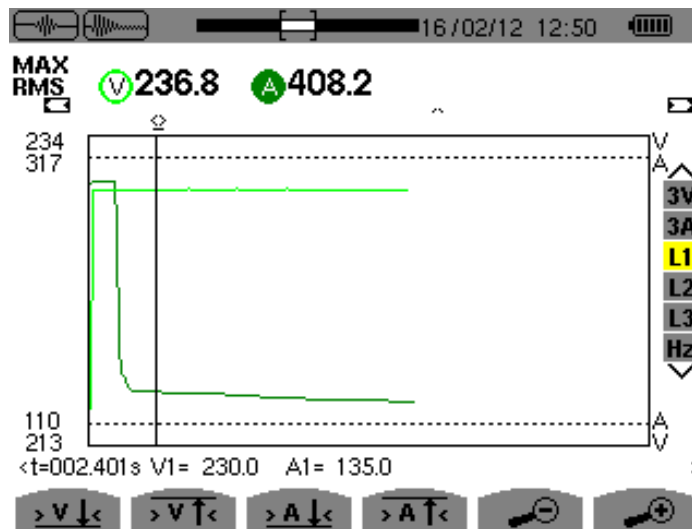

Figure 5-11

NOTE: Filters L2 and L3 are used to display the recording of the true half-cycle RMS current and voltage of phases 2 and 3. The screen is identical to the one displayed for filter L1.

The $\overline{>V\downarrow<}$, $\overline{>V\uparrow<}$, $\overline{>A\downarrow<}$, and $\overline{>A\uparrow<}$ buttons are used to go to the first occurrence of a minimum or maximum voltage or current value.

RMS DISPLAY SCREEN IN HZ FOR A THREE-PHASE CONNECTION WITHOUT NEUTRAL

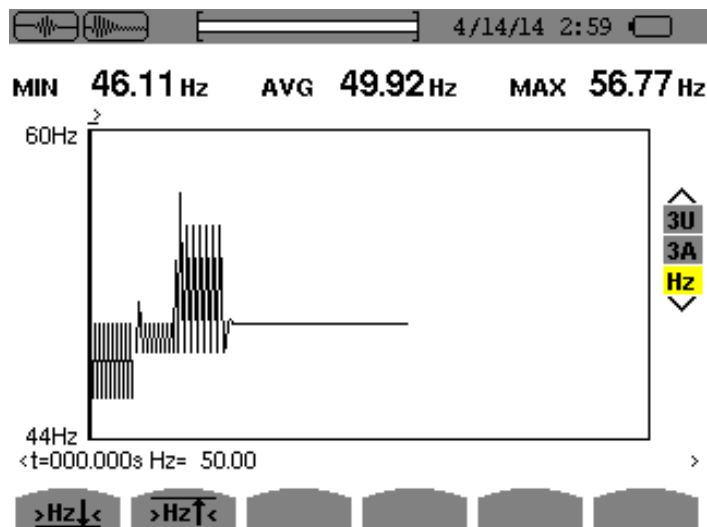

Figure 5-12

The **>Hz↓<** and **>Hz↑<** buttons allow you to go to the first occurrence of a minimum or maximum frequency value.

5.1.4 INSTANTANEOUS INRUSH CURRENT

PEAK mode is used to display the envelopes and waveforms of the inrush current capture. The PEAK display of an inrush current capture provides two possible representations:

- envelope
- waveform

The change from one of these representations to the other is automatic, as a function of the zoom level. If zoom in is high enough, the representation is of the “waveform” type. The display depends on the type of display filter:

- **4V**: displays the four voltages during the inrush current capture for set-ups with neutral (for a waveform type display only).
- **3U**: displays the three voltages during the inrush current capture for set-ups without neutral (for a waveform type display only).
- **4A**: displays the four currents during the inrush current capture (for a waveform type display only).
- **L1, L2 or L3**: display the voltage and current of phases 1, 2, and 3, respectively (only for set-ups with neutral and for a waveform type display).
- **N**: displays the neutral current and neutral voltage during the inrush current capture (for a waveform type display only).
- **V1, V2, V3**: displays the three voltages during the inrush current capture for set-ups with neutral (for an envelope type display only).
- **U1, U2, U3**: displays the three voltages during the inrush current capture for set-ups without neutral (for an envelope type display only).
- **A1, A2, A3**: displays the three currents during the inrush current capture (for an envelope type display only).

The following section shows two display examples.

4A PEAK DISPLAY SCREEN FOR A 5-WIRE 3-PHASE CONNECTION

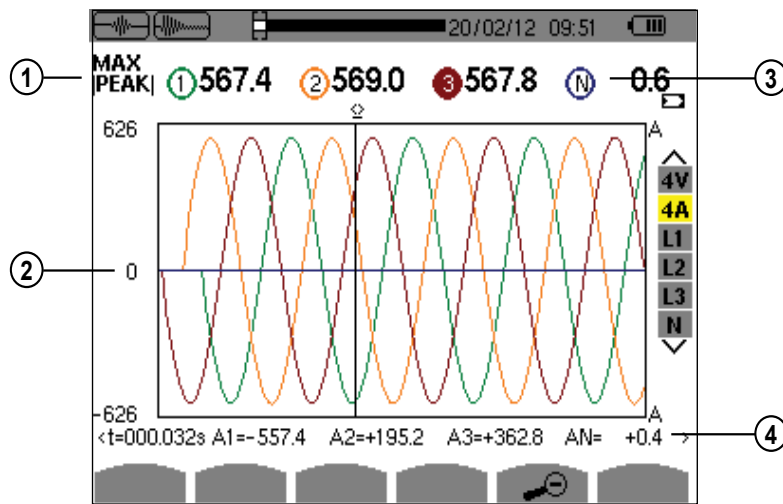

Figure 5-13

Item	Function
1	- MAX IPEAKI : maximum instantaneous absolute value of inrush current capture
2	- Scale of values in amperes
3	- Number assigned to the displayed graph. In this example circle 3 is filled indicating that channel A3 triggered capture of the inrush current.
4	- t : relative time position of the cursor (t = 0 corresponds to the start of the Inrush capture) - Values at the position of the cursor. In this example, A1, A2, A3: instantaneous values of currents 1, 2, and 3 at the position of the cursor

A1 PEAK display screen for a 3-phase connection without neutral

In the case shown below, there is enough zoom out to force the envelope type of representation.

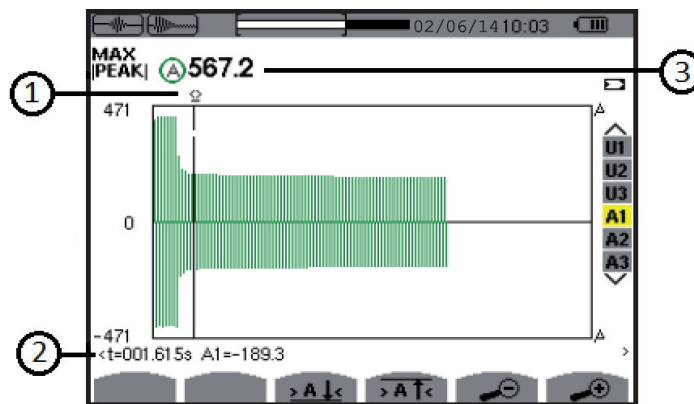

Figure 5-14

Item	Function
1	Instantaneous value cursor; change values with the cursor using the ◀ and ▶ buttons
2	- t : relative time position of the cursor (t = 0 corresponds to the start of the Inrush capture) - Values at the position of the cursor. In the example shown in Figure 5-14, A1 : maximum instantaneous current of the half-cycle identified by the cursor
3	- MAX : maximum instantaneous absolute value of the Inrush current capture

NOTE: Filters A2 and A3 display the record of the current envelope of phases 2 and 3. The screen is identical to the one displayed for filter A1.

5.2 HARMONICS MODE

The Harmonics mode displays a representation of the harmonic levels of the voltage, current, and apparent power, order by order. It can be used to determine the harmonic currents produced by nonlinear loads, and analyze problems caused by harmonics according to their order (overheating of neutrals, conductors, motors, and so on).

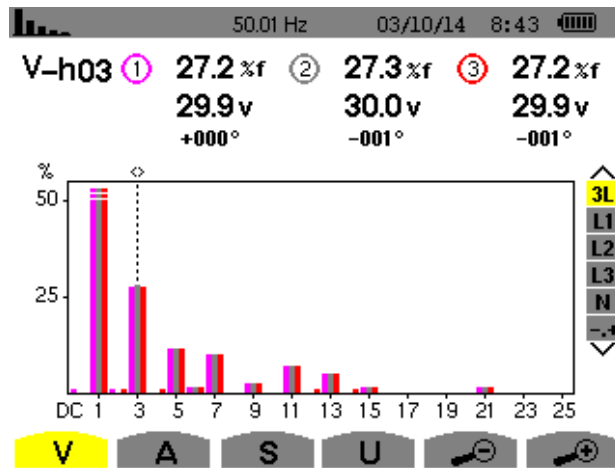



Figure 5-15

- **V** - Phase-to-neutral voltage
- **A** - Harmonics of the current
- **S** - Apparent power of the harmonics
- **U** - Phase-to-phase voltage harmonics
- The  and  buttons allow the user to zoom in or out, in increments of 2%, 5%, 10%, 20%, 50% and 100%.

5.2.1 PHASE-TO-NEUTRAL VOLTAGE HARMONICS

The **V** sub-menu displays the harmonics of the phase-to-neutral voltage only for sources having a neutral.

NOTE: The choice of curves to be displayed depends on the type of connection (see § 4.1.4):

- **Single-phase, 2-wire:** no choice (L1)
- **Single-phase, 3-wire:** L1, N
- **Split-phase, 3-wire:** 2L, L1, L2
- **Split-phase, 4-wire:** 2L, L1, L2, N
- **3-phase, 4-wire:** 3L, L1, L2, L3, -,+
- **3-phase, 5-wire:** 3L, L1, L2, L3, N, -,+

The examples shown in the following sections were obtained with a 5-wire 3-phase connection.

3L PHASE-TO-NEUTRAL VOLTAGE HARMONICS

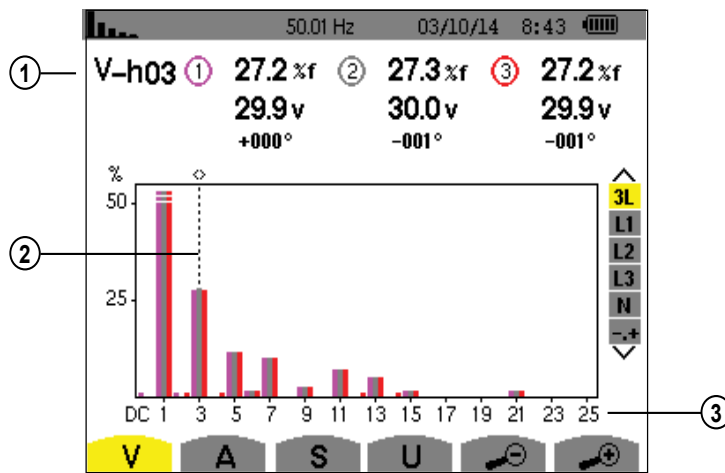

Figure 5-16

Item	Function
1	Data about harmonic indicated by cursor: V-h03 : harmonic number %: level of harmonics with fundamental RMS value as reference (%f) or (total) RMS value as reference (%r). V : RMS voltage of harmonic +000° : phase shift with respect to fundamental (order 1).
2	Harmonic selection cursor; change values with the cursor using the ◀ and ▶ buttons
3	Horizontal axis indicates orders of harmonics. Level of harmonic is given as a percentage with respect to fundamental or total RMS value. DC: DC component. 1 to 25: harmonics of order 1 to 25. When cursor exceeds order 25, order 26 to 50 appears.

Display in expert mode **-.+** (on the right-hand side) is available for 3-phase hookups by pressing the ▲ and ▼ buttons.

L1 PHASE VOLTAGE HARMONICS

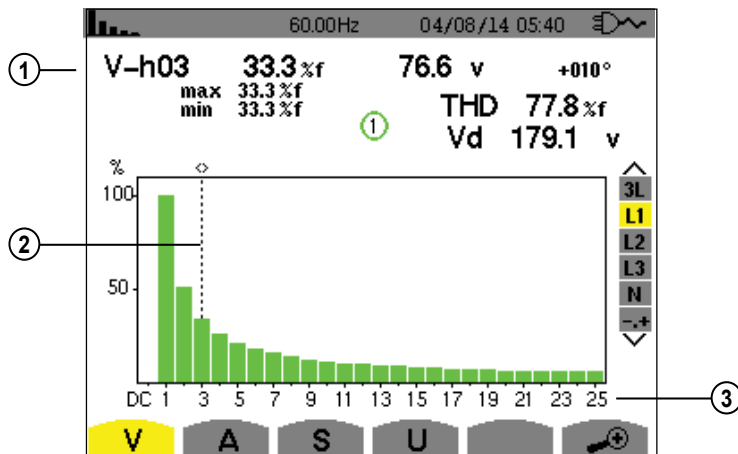

Figure 5-17

Item	Function
1	Data about harmonic indicated by cursor: V-h03 : harmonic number %: level of harmonics with fundamental RMS value (%f) or (total) RMS value (%r) as reference V : RMS voltage of harmonic -143° : phase shift with respect to fundamental (order 1) max – min : maximum and minimum levels of harmonic. Reset when harmonic number is changed or ◀ is pressed THD : total harmonic distortion Vd : RMS distortion voltage

2	Harmonic selection cursor; change values with the cursor using the ◀ and ▶ buttons
3	Horizontal axis indicates orders of harmonics Level of harmonic is given as a percentage with respect to fundamental or to total RMS value DC: DC component 1 to 25: harmonics of order 1 to 25. When the cursor exceeds order 25, order 26 to 50 appears

NOTE: Filters L2 and L3 display the harmonics of the phase-to-neutral voltage for phases 2 and 3, respectively. The screen is identical to the one displayed for filter L1.

There is no phase shift or distortion value for the neutral channel.

5.2.2 CURRENT

The **A** sub-menu displays the harmonics of the current.

3L CURRENT HARMONICS

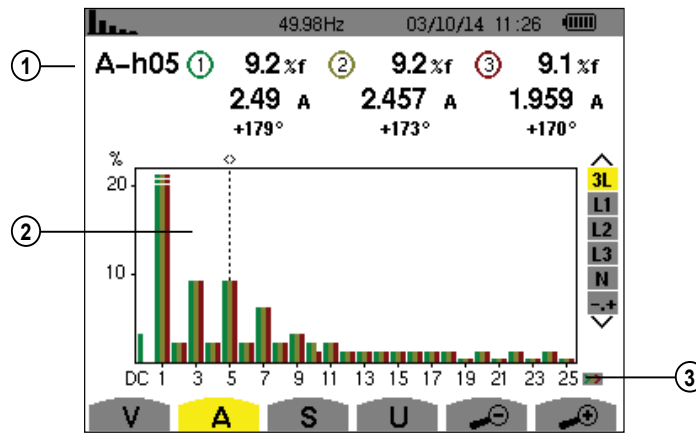

Figure 5-18

Item	Function
1	Data about harmonic indicated by cursor: A-h05: harmonic number %: level of harmonics with fundamental RMS value (%) or (total) RMS value (%) as reference A: RMS current of harmonic +179°: phase shift with respect to fundamental (order 1)
2	Harmonic selection cursor; change values with the cursor using the ◀ and ▶ buttons
3	Horizontal axis indicates orders of harmonics Level of harmonic is given as a percentage with respect to the fundamental or to the total RMS value Range DC: DC component 1 to 25: harmonics of order 1 to 25. When the cursor exceeds order 25, order 26 to 50 appears

L1 CURRENT HARMONICS

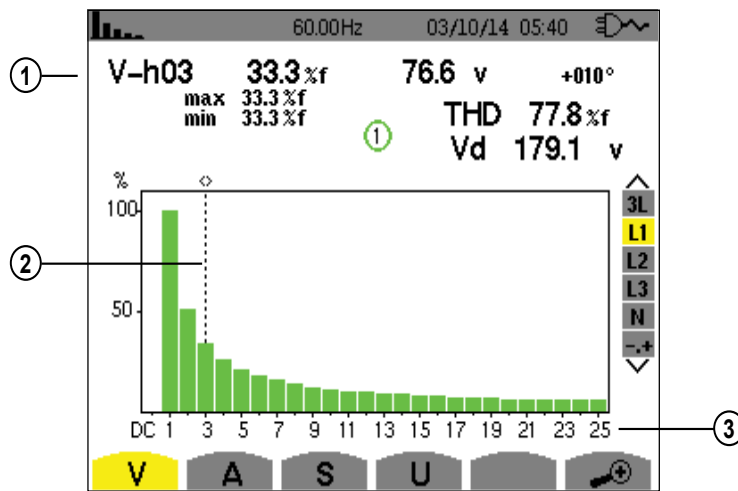

Figure 5-19

Item	Function
1	Data about harmonic indicated by cursor: A-h05 : harmonic number %: level of harmonics with fundamental RMS value (%f) or (total) RMS value (%r) as reference A : RMS current of harmonic +178° : phase shift with respect to fundamental (order 1) max – min : maximum and minimum levels of harmonic. Reset when harmonic number is changed or pressed THD : total harmonic distortion Ad : RMS distortion current
2	Harmonic selection cursor; change values with the cursor using the ◀ and ▶ buttons
3	Horizontal axis indicates orders of harmonics Level of harmonic is given as a percentage with respect to the fundamental or to the total RMS value Range DC : DC component 1 to 25 : harmonics of order 1 to 25. When the cursor exceeds order 25, order 26 to 50 appears

NOTE: Filters L2 and L3 display the current harmonics of phases 2 and 3, respectively. The screen is identical to the one displayed for filter L1.

There is no phase shift or distortion value for the neutral channel.

5.2.3 APPARENT POWER

The **S** sub-menu displays the harmonics of the apparent power, for all connections except 3-wire 3-phase. The horizontal axis indicates the orders of the harmonics. The bars of the bar chart above the horizontal center line signify harmonic power consumed, those below it harmonic power generated.

3L APPARENT POWER HARMONICS

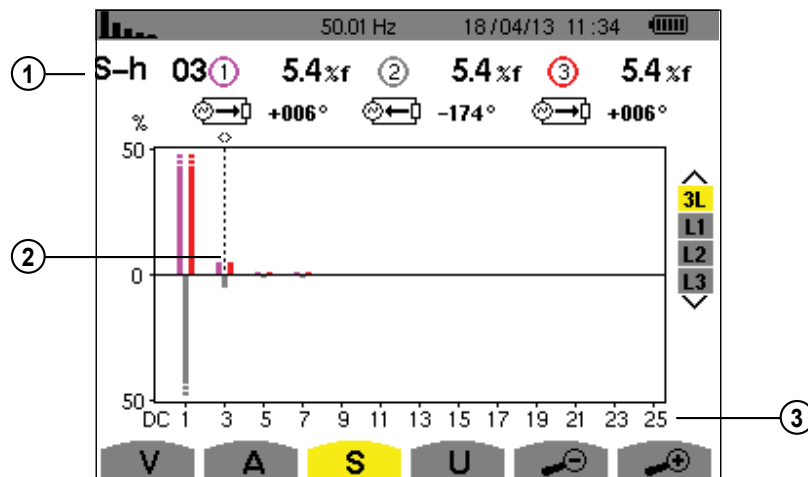

Figure 5-20

Item	Function
1	<p>S-h03: harmonic number</p> <p>%: level of harmonics with fundamental apparent power (%f) or (total) apparent power (%r) as reference</p> <p>+006°: phase shift of voltage harmonic with respect to current harmonic</p> <p>↻←: energy generated for this harmonic</p> <p>↻→: energy consumed for this harmonic</p>
2	Harmonic selection cursor; change values with the cursor using the ◀ and ▶ buttons
3	<p>Horizontal axis indicates orders of harmonics.</p> <p>Harmonic level is percentage of fundamental apparent or (total) apparent power</p> <p>Range DC: DC component</p> <p>1 to 25: harmonics of order 1 to 25. When cursor exceeds order 25, order 26 to 50 appears</p>

L1 APPARENT POWER HARMONICS

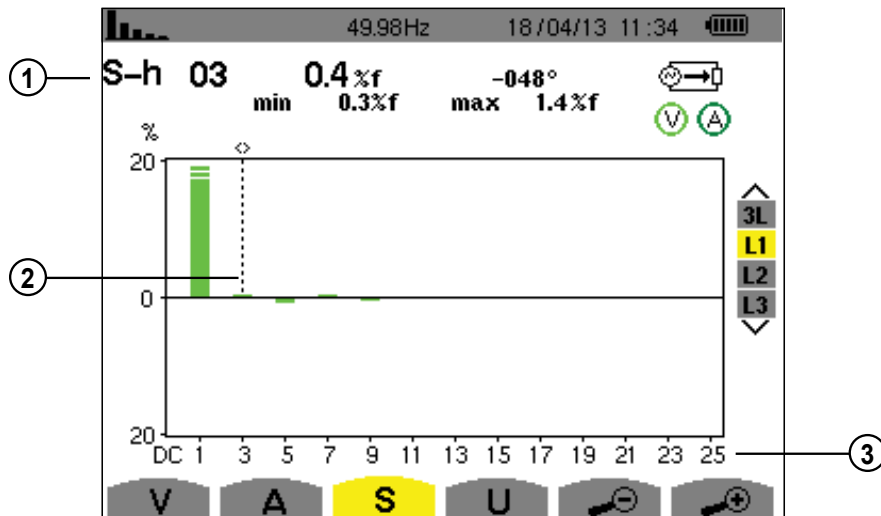

Figure 5-21

Item	Function
1	<p>Data about harmonic indicated by cursor:</p> <p>S-h03: harmonic number</p> <p>%: level of harmonics with fundamental RMS value (%f) or (total) RMS value (%r) as reference</p> <p>A: RMS current of harmonic</p> <p>+45°: phase shift of the voltage harmonic with respect to the current harmonic</p> <p>max – min: maximum and minimum levels of harmonic. Reset when harmonic number is changed or ↵ pressed</p>

2	Harmonic selection cursor; change values with the cursor using the ◀ and ▶ buttons
3	Horizontal axis indicates orders of harmonics. Level of harmonic is given as a percentage with respect to the fundamental or to the total RMS value. Range DC: DC component 1 to 25: harmonics of order 1 to 25. When the cursor exceeds order 25, order 26 to 50 appears ⊞→0: energy consumed for this harmonic

NOTE: Filters L2 and L3 display the apparent power of the harmonics for phases 2 and 3, respectively. The screen is identical to the one displayed for filter L1.

5.2.4 PHASE-TO-PHASE VOLTAGE

The **U** sub-menu is available for all connections except 2- or 3-wire single-phase. This sub-menu displays the harmonics of the phase-to-phase voltage.

3L PHASE-TO-PHASE VOLTAGE HARMONICS

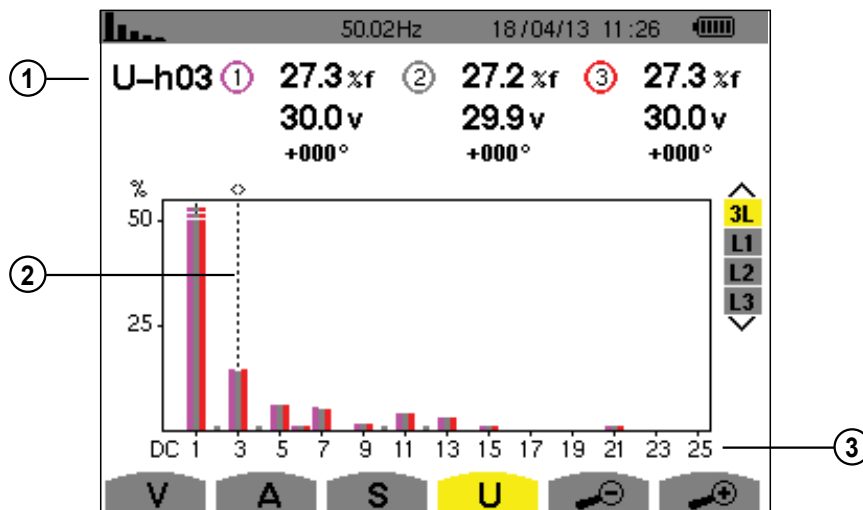

Figure 5-22

Item	Function
1	U-h03: harmonic number %: level of harmonics with fundamental apparent power (%f) or (total) apparent power (%r) as reference V: RMS voltage of harmonic +000°: phase shift with respect to fundamental (order 1)
2	Harmonic selection cursor; change values with the cursor using the ◀ and ▶ buttons
3	Horizontal axis indicates orders of harmonics. Harmonic level is percentage of fundamental apparent or (total) apparent power Range DC: DC component 1 to 25: harmonics of order 1 to 25. When cursor exceeds order 25, order 26 to 50 appears

L1 PHASE-TO-PHASE VOLTAGE HARMONICS

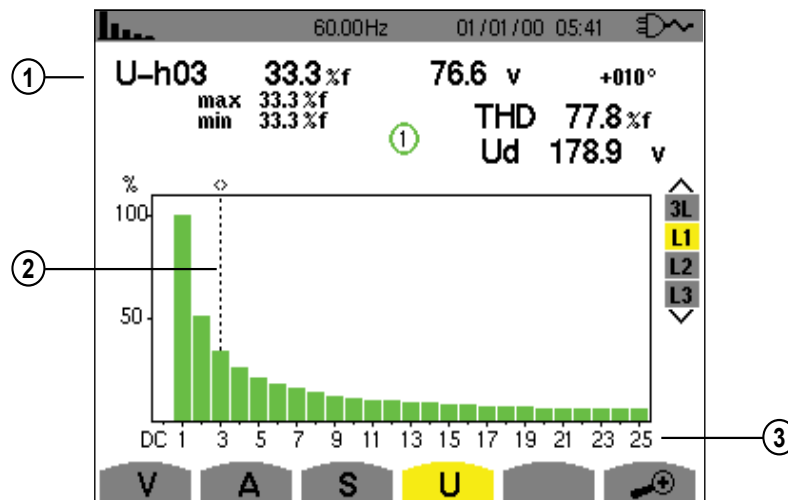



Figure 5-23

Item	Function
1	Data about harmonic indicated by cursor: U-h03 : harmonic number %: level of harmonics with fundamental RMS value (%f) or (total) RMS value (%r) as reference V : RMS voltage of harmonic +000°: phase shift with respect to fundamental (order 1) max – min: maximum and minimum levels of harmonic. Reset when harmonic number is changed or by pressing  THD : total harmonic distortion Ud : phase-to-phase RMS distortion voltage
2	Harmonic selection cursor; change values with the cursor using the ◀ and ▶ buttons
3	Horizontal axis indicates orders of harmonics. Level of harmonic is given as a percentage with respect to the fundamental or to the total RMS value. Range DC : DC component 1 to 25 : harmonics of order 1 to 25. When the cursor exceeds order 25, order 26 to 50 appears

NOTE: Filters L2 and L3 display the harmonics of the phase-to-neutral voltage for phases 2 and 3, respectively. The screen is identical to the one displayed for filter L1.

5.2.5 EXPERT MODE

The  Expert mode is available with a 3-phase connection only. It displays the influence of the harmonics on heating the neutral and on rotating machines. To display the expert mode press the ▲ or ▼ button. The selection is highlighted in yellow and the screen simultaneously displays the expert mode.

From this screen, two sub-menus are available:

- **V** for 3-phase set-ups with neutral or **U** for the 3-phase set-up without neutral
- **A** for the expert mode in current

NOTE: The breakdown into sequences shown in the following figure is valid only in the case of a balanced load.

PHASE-TO-NEUTRAL VOLTAGE EXPERT MODE

For 3-phase set-ups with neutral, the **V** sub-menu displays the influence of the harmonics of the phase-to-neutral voltage on the heating of the neutral and on rotating machines.

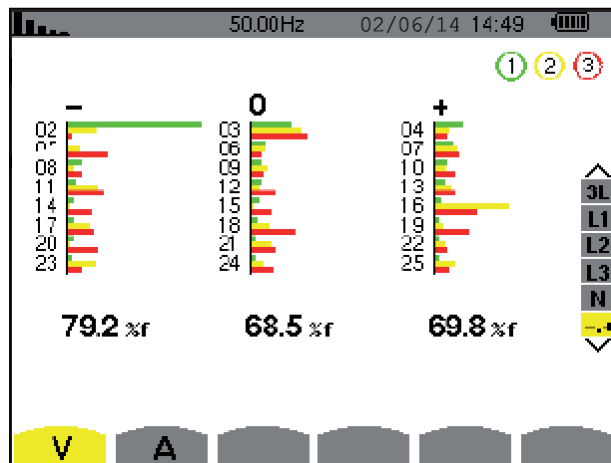

Figure 5-24

- **Column One:** The harmonics inducing a negative sequence.
- **Column Two:** Those inducing a zero sequence.
- **Column Three:** Those inducing a positive sequence.
- **%:** Level of harmonics with fundamental RMS value as reference (%f) or the (total) RMS value as reference (%r)

For 3-phase set-ups without neutral, the **U** sub-menu displays the influence of the harmonics of the phase-to-phase voltage on the heating of revolving machines.

CURRENT EXPERT MODE

The **A** sub-menu displays the influence of current harmonics on heating the neutral and on rotating machines.

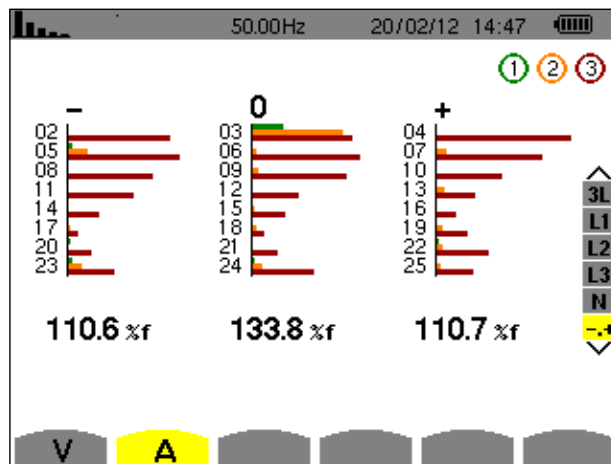

Figure 5-25

- **Column One:** The harmonics inducing a negative sequence.
- **Column Two:** Those inducing a zero sequence.
- **Column Three:** Those inducing a positive sequence.
- **%:** Level of harmonics with fundamental RMS value as reference (%f) or the (total) RMS value as reference (%r)

5.3 WAVEFORM MODE

The Waveform mode displays the current and voltage graphs, along with the values measured and those calculated from the voltages and currents (except for power, energy, and harmonics). This is the screen that appears when the instrument is powered up.

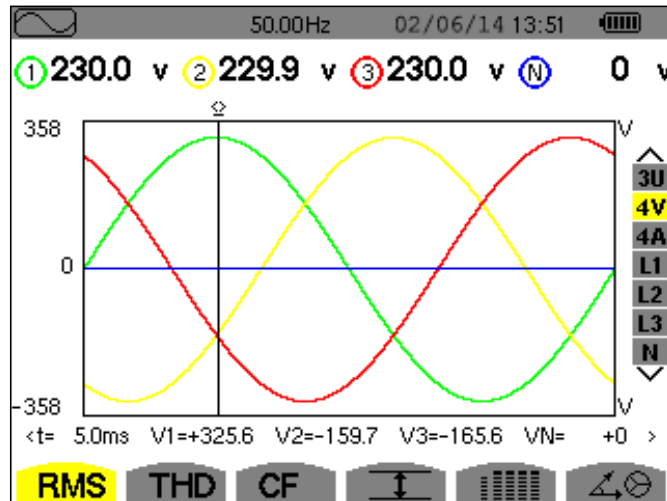

















Figure 5-26

Item	Function
RMS	Measurement of the true RMS value
THD	Measurement of total harmonic distortion
CF	Measurement of the peak factor
	Display of Min/Max, RMS and peak values (see § 5.3.4)
	Simultaneous display of the following measurements: RMS, DC, THD, CF, PST, PLT, FHL and FK (see § 5.3.5)
	Display of phasor (Fresnel) diagram of signals (see § 5.3.6)

5.3.1 RMS MEASUREMENTS

This sub-menu displays the waveforms over a period of the measured signals and the true effective values of the voltage and the current.

 The choice of graphs to be displayed depends on the type of electrical connection that was set up during the configuration (see § 4.1.4).

- Single-phase, 2-wire or Split-phase, 2-wire: no choice (L1)
- Single-phase, 3-wire:
 - For RMS, THD, CF,  and : 2V, 2A, L1, N
 - For : no choice (L1)
- Split-phase, 3-wire:
 - For RMS, THD, CF,  and : U, 2V, 2A, L1, L2
 - For : 2V, 2A, L1, L2
- Split-phase, 4-wire:
 - For RMS, THD, CF,  and : U, 3V, 3A, L1, L2, N
 - For : 2V, 2A, L1, L2
- 3-phase, 3-wire: 3U, 3A
- 3-phase, 4-wire: 3U, 3V, 3A, L1, L2, L3
- 3-phase, 5-wire:
 - For RMS, THD, CF,  and : 3U, 4V, 4A, L1, L2, L3, N
 - For : 3U, 3V, 3A, L1, L2 and L3

5.3.1.1 RMS (3U)

This screen displays the three phase-to-phase voltages of a 3-phase system.

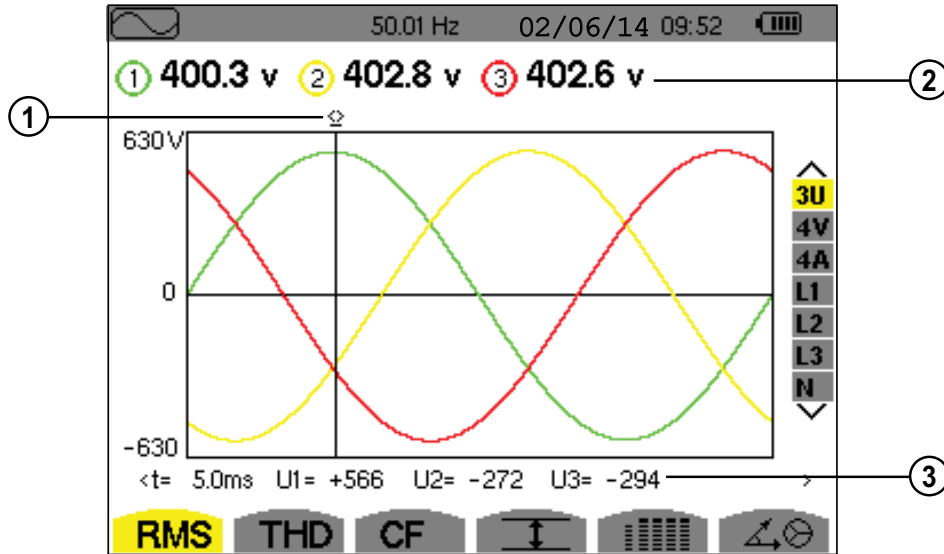

Figure 5-27

Item	Function
1	Instantaneous value cursor; change values with the cursor using the ◀ and ▶ buttons
2	RMS phase-to-phase voltages
3	Instantaneous value of the signals at the intersection of the cursor and the curves t : time relative to the start of the period (expressed in milliseconds) U1 : instantaneous phase-to-phase voltage between phases 1 and 2 (U_{12}) U2 : instantaneous phase-to-phase voltage between phases 2 and 3 (U_{23}) U3 : instantaneous phase-to-phase voltage between phases 3 and 1 (U_{31})

5.3.1.2 RMS (4V)

This screen displays the three phase-to-neutral voltages and the neutral-to-ground voltage of a 3-phase system.

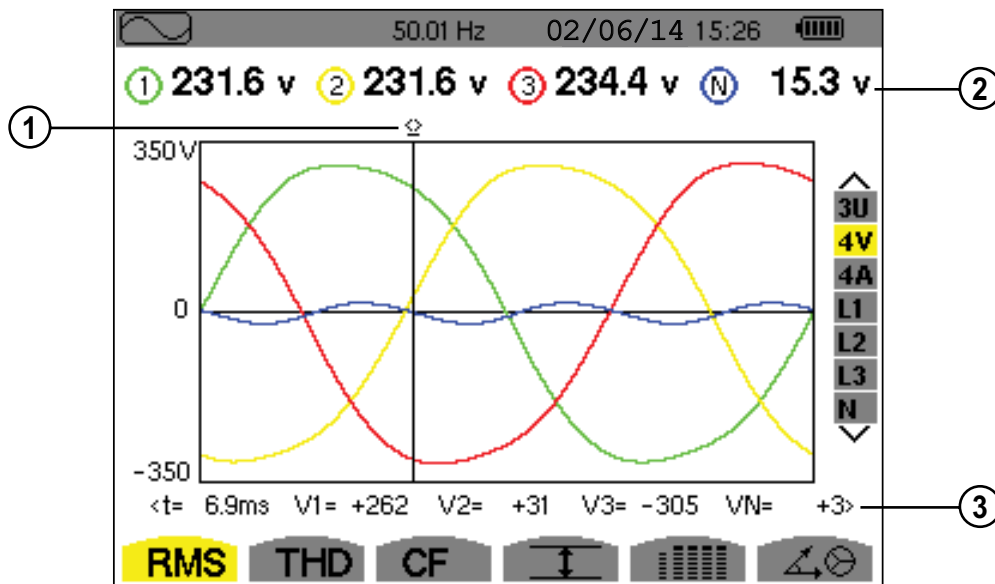

Figure 5-28

Item	Function
1	Instantaneous value cursor; change values with the cursor using the ◀ and ▶ buttons
2	Effective phase-to-neutral voltages
3	Instantaneous value of the signals at the intersection of the cursor and the curves t : time relative to the start of the period (expressed in milliseconds) V1 : instantaneous phase-to-neutral voltage of curve 1 V2 : instantaneous phase-to-neutral voltage of curve 2 V3 : instantaneous phase-to-neutral voltage of curve 3 VN : instantaneous neutral voltage

5.3.1.3 RMS (4A)

This screen displays the three phase currents and the neutral current of a 3-phase system.

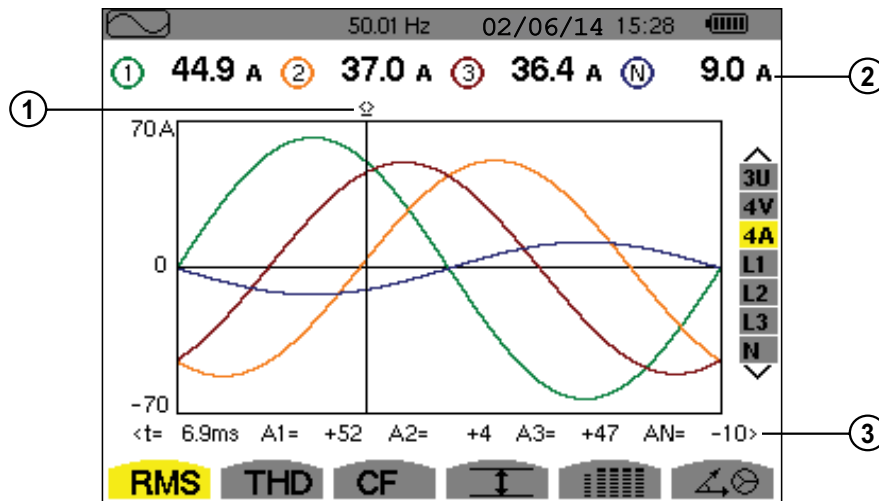

Figure 5-29

Item	Function
1	Instantaneous value cursor; change values with the cursor using the ◀ and ▶ buttons
2	RMS currents
3	Instantaneous value of the signals at the intersection of the cursor and the curves t : time relative to the start of the period (expressed in milliseconds) A1 : instantaneous current of phase 1 A2 : instantaneous current of phase 2 A3 : instantaneous current of phase 3 AN : instantaneous neutral voltage

5.3.1.4 RMS (NEUTRAL)

This screen displays the neutral voltage relative to ground and the neutral current.

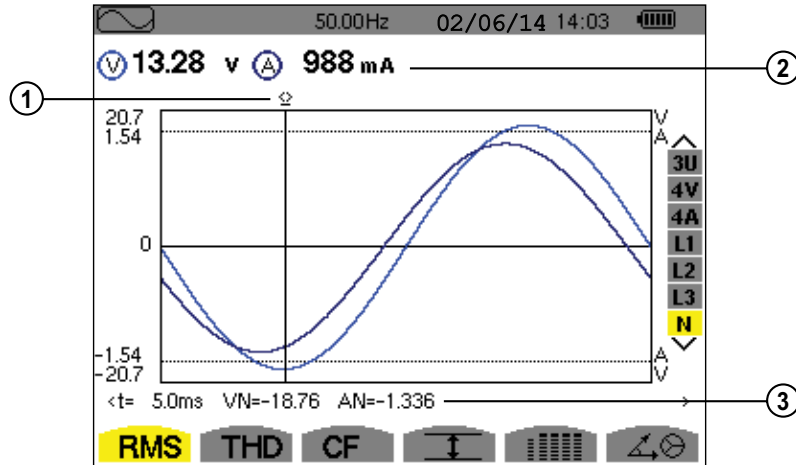

Figure 5-30

Item	Function
1	Instantaneous value cursor; change values with the cursor using the ◀ and ▶ buttons
2	Effective values of RMS voltage and current
3	Instantaneous value of the signals at the intersection of the cursor and the graphs t : time relative to the start of the period (expressed in milliseconds) VN : instantaneous neutral voltage AN : instantaneous neutral current

NOTE: Filters L1, L2, and L3 display the current and voltage in phases 1, 2, and 3, respectively. The screen is identical to the one displayed for the neutral.

5.3.2 MEASUREMENT OF TOTAL HARMONIC DISTORTION (THD)

The **THD** sub-menu displays the waveforms of the signals measured over one full cycle and the total voltage and current harmonic distortion. The levels are displayed either with the fundamental RMS value as reference (%f) or with the RMS value without DC as reference (%r), depending on which reference is chosen in the Configuration menu.

5.3.2.1 THD (3U)

This screen displays the phase-to-phase voltage waveforms for one period and the total harmonic distortion values.

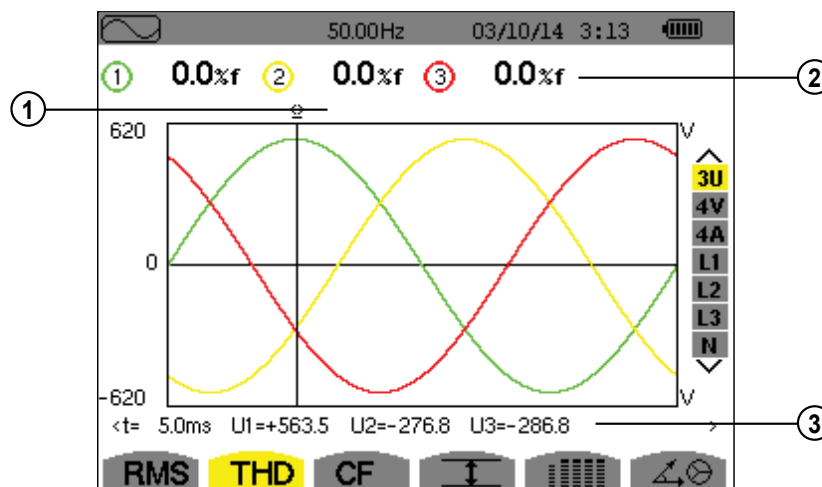

Figure 5-31

Item	Function
1	Instantaneous value cursor; change values with the cursor using the ◀ and ▶ buttons
2	Harmonic distortion rate for each curve
3	Instantaneous value of the signals at the intersection of the cursor and the curves t : time relative to the start of the period (expressed in milliseconds) U1 : instantaneous phase-to-phase voltage between phases 1 and 2 (U_{12}) U2 : instantaneous phase-to-phase voltage between phases 2 and 3 (U_{23}) U3 : instantaneous phase-to-phase voltage between phases 3 and 1 (U_{31})

5.3.2.2 THD (4V)

This screen displays the phase-to-neutral voltage waveforms for one period and the total harmonic distortion values.

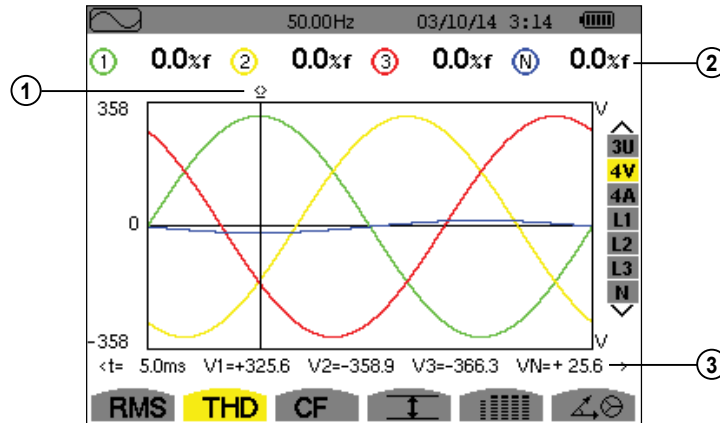

Figure 5-32

Item	Function
1	Instantaneous value cursor; change values with the cursor using the ◀ and ▶ buttons
2	Harmonic distortion rate for each curve
3	Instantaneous value of the signals at the intersection of the cursor and the curves t : time relative to the start of the period (expressed in milliseconds) V1 : instantaneous phase-to-neutral voltage of curve 1 V2 : instantaneous phase-to-neutral voltage of curve 2 V3 : instantaneous phase-to-neutral voltage of curve 3 VN : instantaneous value of the neutral voltage

5.3.2.3 THD (4A)

This screen displays the phase current waveforms for one period and the total harmonic distortion values.

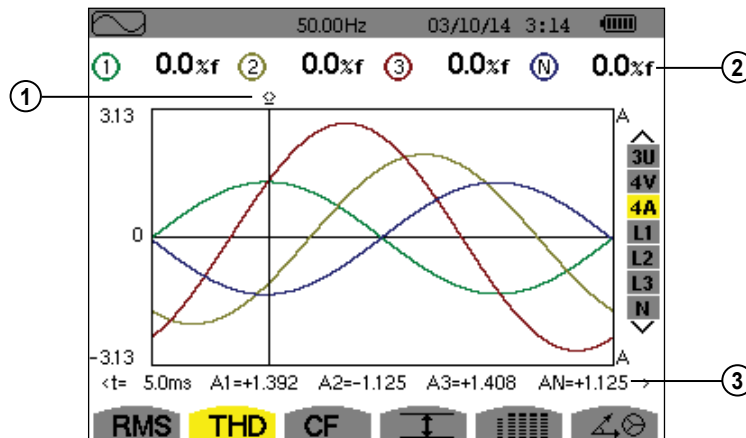

Figure 5-33

Item	Function
1	Instantaneous value cursor; change values with the cursor using the ◀ and ▶ buttons
2	Harmonic distortion rate for each curve
3	Instantaneous value of the signals at the intersection of the cursor and the curves t : time relative to the start of the period (expressed in milliseconds) A1 : instantaneous current of phase 1 A2 : instantaneous current of phase 2 A3 : instantaneous current of phase 3 AN : instantaneous value of the neutral current

Note: Filters L1, L2, L3 and N display the total current and voltage harmonic distortion for phases 1, 2, and 3, and the neutral channel respectively.

5.3.3 MEASUREMENT OF THE PEAK FACTOR (CF)

The CF sub-menu displays the waveforms of the signals measured over one period and the voltage and current peak factors.

5.3.3.1 CF (3U)

This screen displays the phase-to-phase voltage waveforms of one period and the peak factors.

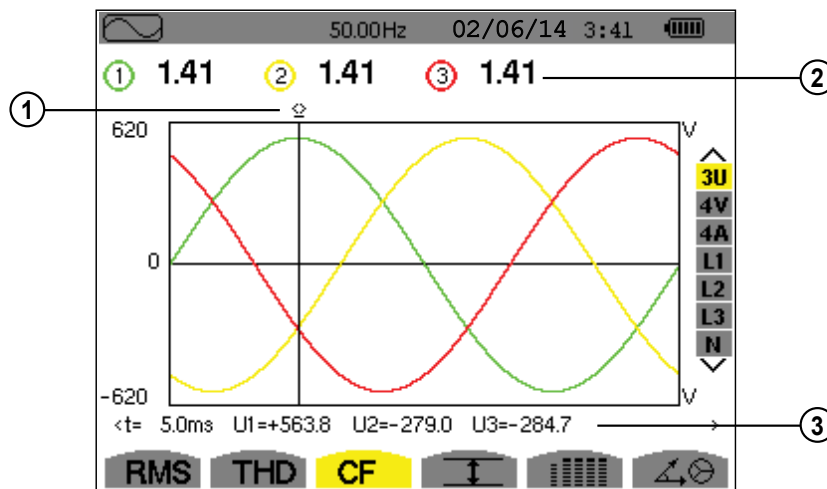

Figure 5-34

Item	Function
1	Instantaneous value cursor; change values with the cursor using the ◀ and ▶ buttons
2	Peak factor for each curve
3	Instantaneous value of the signals at the intersection of the cursor and the graphs t : time relative to the start of the period (expressed in milliseconds) U1 : instantaneous voltage peak factor between phases 1 and 2 (U_{12}) U2 : instantaneous voltage peak factor between phases 2 and 3 (U_{23}) U3 : instantaneous voltage peak factor between phases 3 and 1 (U_{31})

5.3.3.2 CF (4V)

This screen displays the phase-to-neutral voltage waveforms of one period and the peak factors.

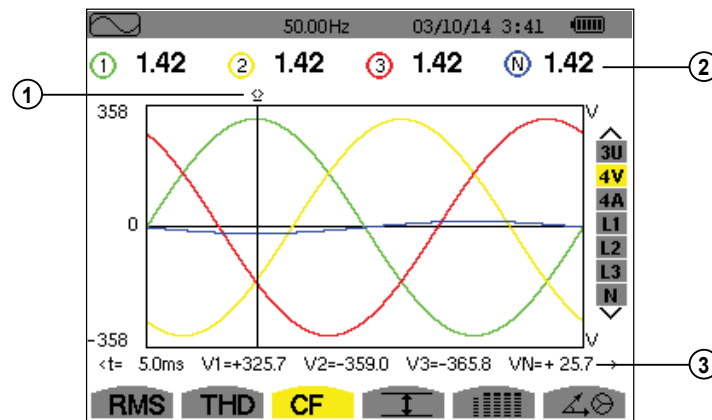

Figure 5-35

Item	Function
1	Instantaneous value cursor; change values with the cursor using the ◀ and ▶ buttons
2	Peak factor for each curve
3	Instantaneous value of the signals at the intersection of the cursor and the curves t : time relative to the start of the period (expressed in milliseconds) V1 : instantaneous phase-to-neutral voltage of phase 1 V2 : instantaneous phase-to-neutral voltage of phase 2 V3 : instantaneous phase-to-neutral voltage of phase 3 VN : instantaneous phase-to-neutral voltage of the neutral

5.3.3.3 CF (4A)

This screen displays the current waveforms of one period and the peak factors.

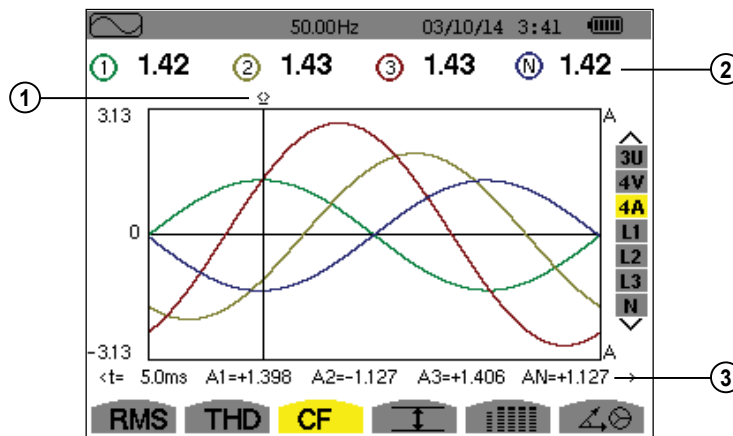



Figure 5-36

Item	Function
1	Instantaneous value cursor; change values with the cursor using the ◀ and ▶ buttons
2	Peak factor for each curve
3	Instantaneous value of the signals at the intersection of the cursor and the graphs t : time relative to the start of the period (expressed in milliseconds) A1 : instantaneous current of phase 1 A2 : instantaneous current of phase 2 A3 : instantaneous current of phase 3 AN : instantaneous value of the neutral current

NOTE: Filters L1, L2, L3 and N display the total current and voltage harmonic distortion for phases 1, 2, and 3, and the neutral channel respectively.

5.3.4 MEASUREMENT OF EXTREME AND MEAN VOLTAGE AND CURRENT VALUES

The  sub-menu displays the RMS, maximum, minimum and average values for voltage and current, as well as the instantaneous positive and negative voltage and current peaks.

 **NOTE:** The display screen varies depending on which value is selected.

- **3U:** Displays the one-second mean and half-cycle maximum and minimum RMS values and the instantaneous positive and negative phase-to-phase voltage peaks.
- **4V:** Displays the one-second mean and half-cycle maximum and minimum RMS values and the instantaneous positive and negative peaks of the phase-to-neutral voltages and of the neutral.
- **4A:** Displays the one-second mean and half-cycle maximum and minimum RMS values and the positive and negative instantaneous peak values of the phase and neutral currents.
- **L1/L2/L3:** Displays the one-second mean and half-cycle maximum and minimum RMS values and the instantaneous positive and negative peaks of the phase-to-neutral voltage and of the current of phase 1.
- **N:** Displays the RMS values and the positive and negative instantaneous peaks of the neutral relative to ground.

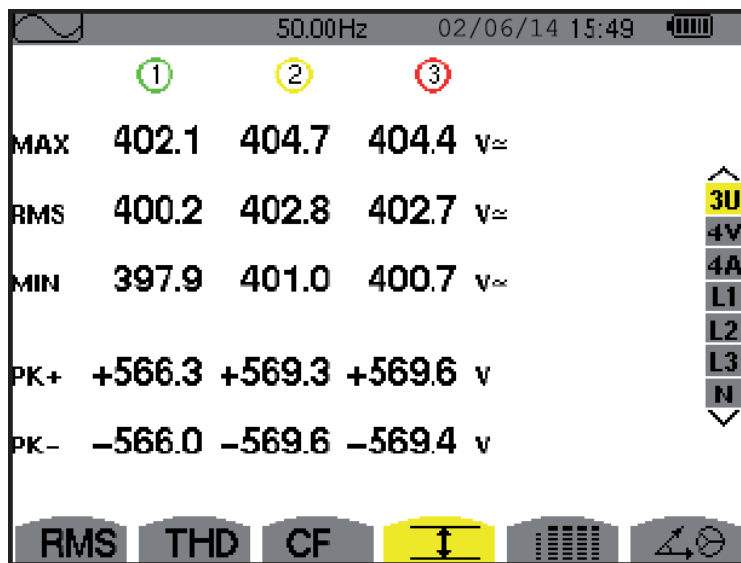







Figure 5-37

The columns display the values relative to each voltage, current or neutral graph.

Item	Function
MAX	Maximum RMS phase-to-phase voltage since the instrument was turned ON or the last time  button is pressed.
RMS	True RMS phase-to-phase voltage
MIN	Minimum RMS phase-to-phase voltage since the instrument was turned ON or the last time  button is pressed.
PK+	Maximum (positive) peak phase-to-phase voltage since instrument was turned ON or the last time  button is pressed.
PK-	Minimum (negative) peak phase-to-phase voltage since instrument was turned ON or the last time  button is pressed.

NOTE: The MAX and MIN RMS measurements are calculated every half-period (e.g. every 10ms for a signal at 50Hz). The measurements are refreshed every 250ms.

To reset the MIN and MAX on the display, press the  button.

5.3.5 SIMULTANEOUS DISPLAY

The  sub-menu displays all the voltage and current measurements (RMS, DC, THD, CF, PST, PLT, FHL and FK).

 **NOTE:** The display screen varies depending on which value is selected.

- **3U:** Displays the RMS, DC, THD and CF values of the phase-to-phase voltages.
- **4V:** Displays the RMS, DC, THD, CF, PST and PLT values of the phase-to-neutral voltages and of the neutral.
- **4A:** Displays the RMS, DC, THD, CF, FHL and FK values of the phase and neutral currents.
- **L1/L2/L3:** Displays the RMS, DC, THD, CF, PST and PLT values of the phase-to-neutral voltage and of the current, the DC and PST parameters of the phase-to-neutral voltage, and the DC value (if the current sensor allows) and FK of the current for phase 1.
- **N:** This screen displays the RMS, THD and CF voltage and current of the neutral, the DC component of the neutral voltage, and (if the current sensor allows) the DC component of the neutral current.

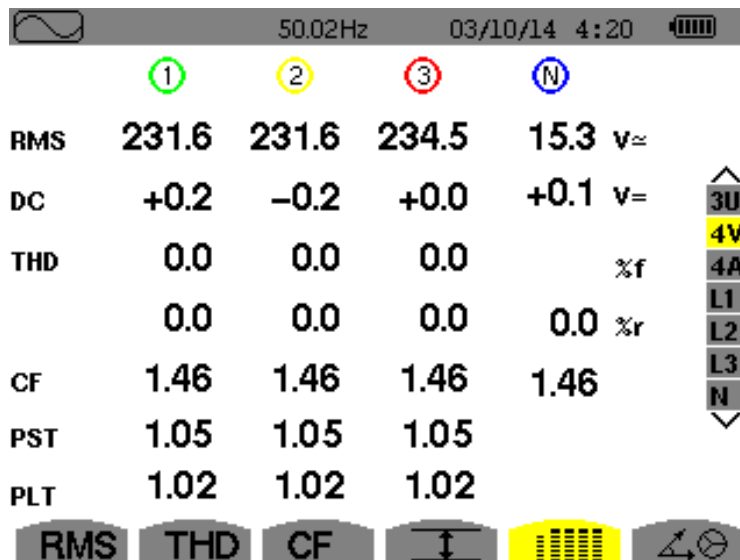



Figure 5-38

Item	Function
RMS	True effective value of voltage or current
DC	Direct component
THD	Total harmonic distortion rate
CF	Peak factor calculated in relation to the displayed waveform
PST	Short-term flicker calculated over 10 minutes
PLT	Long-term flicker calculated over 2 hours
FHL	Harmonic loss factor for oversizing of transformers relative to harmonics
FK	K factor - Oversizing of transformers relative to harmonics

NOTE: The DC value of the current of phase 1 is displayed only if the associated current sensor can measure direct current. L2 and L3 provide the simultaneous display of the current and voltage for phases 2 and 3, respectively.

5.3.6 PHASOR DIAGRAM DISPLAY

The  sub-menu displays a vector representation of the fundamentals of the voltages and currents. It indicates their associated quantities (modulus and phase of the vectors) and the unbalances of the voltages and currents.

 **NOTE:** The display screen varies depending on which value is selected.

- **3U:** Displays a vector representation of the fundamentals of the phase-to-phase voltages and of the currents. It indicates their associated quantities (modulus and phase of the phase-to-phase voltage vectors) and the voltage unbalance. The reference vector of the representation (at 3 o'clock) is U1.
- **3V:** Displays a vector representation of the fundamentals of the phase-to-neutral voltages and of the currents. It indicates their associated quantities (modulus and phase of the phase-to-neutral voltage vectors) and the voltage unbalance. The reference vector of the representation (at 3 o'clock) is V1.
- **3A:** Displays a vector representation of the fundamentals of the phase-to-neutral voltages and of the currents. It indicates their associated quantities (modulus and phase of the current vectors) and the current unbalance. The reference vector of the representation (at 3 o'clock) is A1.
- **L1/L2/L3:** Displays a vector representation of the fundamentals of the phase-to-neutral voltages and the currents of one phase. It indicates their associated quantities (modulus and phase of the current and phase-to-neutral voltage vectors). The reference vector of the representation (at 3 o'clock) is the current vector.

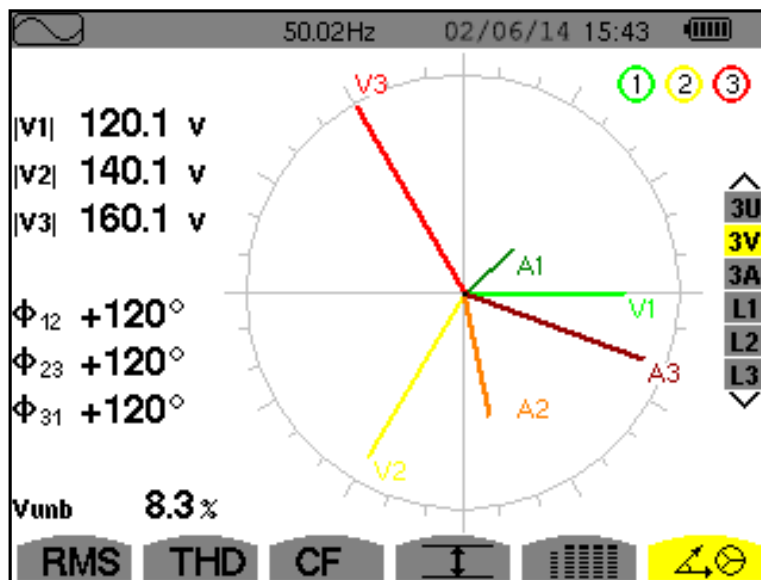



Figure 5-39

Item	Function
U1, U2, U3	Absolute values of the voltages at fundamental frequency
V1, V2, V3	Absolute values of the voltages at fundamental frequency
A1, A2, A3	Absolute values of the current at fundamental frequency
ϕ_{12}	Phase displacement of phase 1 relative to phase 2
ϕ_{23}	Phase displacement of phase 2 relative to phase 3
ϕ_{31}	Phase displacement of phase 3 relative to phase 1
ϕ_{VA}	Phase displacement of voltage (V) relative to current (A)
Unb	Unbalance of line voltages

NOTE: L2 and L3 display vector representations of the fundamentals of the phase-to-neutral voltages and the currents of phases 2 and 3, respectively. They indicate their associated quantities (modulus and phase of the current and phase-to-neutral voltage vectors of phases 2 and 3, respectively). The reference vector of the representation (at 3 o'clock) is the current vector (A2 and A3, respectively).

5.4 ALARM MODE

The Alarm  mode detects overshoots of thresholds on each of the following parameters:

Hz	Upk-	Vthdr	PST
Urms	Vpk-	Athdr	PLT
Vrms	Apk-	P	FHL
Arms	Ucf	Pdc	FK
Udc	Vcf	Q1 or N	Vunb (or Uunb for a 3-phase source without neutral)
Vdc	Acf	D	Aunb
Adc	Uthdf	S	U-h
Upk+	Vthdf	PF	V-h
Vpk+	Athdf	cos Φ	A-h
Apk+ ,	Uthdr	tan Φ	S-h

(See also the table of abbreviations in § 8.3)

The alarm thresholds must:

- have been programmed in the Configuration / Alarm mode screen (see § 4.1.8)
- be active (marked with a red spot on that same screen)

 **NOTE:** Stored alarms can subsequently be transferred to a PC via the DataView data analysis program. You can capture over 16,000 alarms.

When the Alarm mode button  is pressed, the Detection Schedule screen will appear:

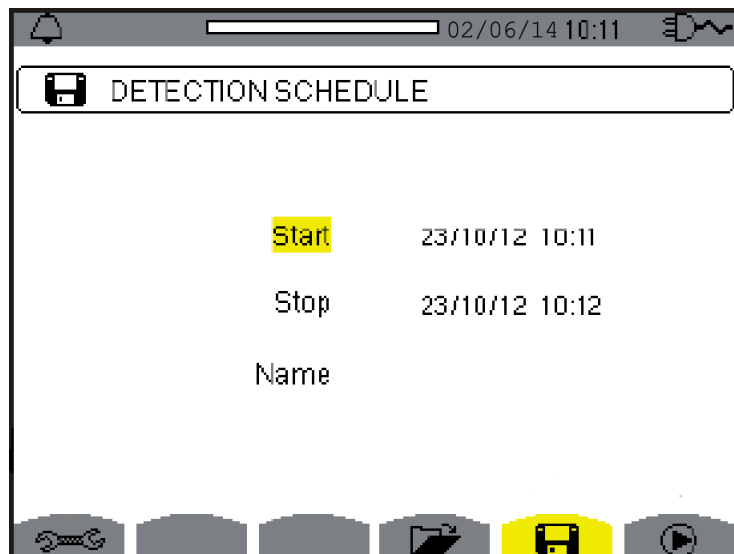











Figure 5-40

Item	Measurement Type
	Displays the Alarm mode configuration sub-menu
	Displays alarm campaigns
	Programs an alarm
	Validates the programming of an alarm (after  is selected, the  icon appears)
	Manually stops an alarm that is in progress

5.4.1 ALARM MODE CONFIGURATION

 To program/display alarms, they must first be configured (see § 4.1.8).

The  Alarm Mode configuration submenu displays the list of alarms configured (see § 4.1.8). This shortcut button lets you define or change alarm configurations. Press  to return to the Detection Schedule (Programming a Campaign) screen.

5.4.2 PROGRAMMING AN ALARM CAMPAIGN



The  Detection Schedule screen specifies the start and stop times for an alarm campaign.







Figure 5-41

To program an alarm campaign, enter the start date and time, the stop date and time, and the name of the campaign. To modify an item, move the yellow cursor to it using the up and down arrow buttons, then validate with the  button. Change the value using the arrow buttons, then validate again.

The name can be up to eight characters long. Several campaigns can have the same name. Allowable characters are uppercase letters A through Z and digits 0 through 9. The last five names assigned (in the transient, trend, and alarm modes) are kept in memory. When a name is entered, it can then be completed automatically.

 **NOTE:** The start date and time must be later than the current date and time. The stop date and time must be later than the start date and time. You cannot program an alarm campaign if an inrush current capture is in progress.

5.4.3 STARTING AN ALARM CAMPAIGN

After the settings are entered, the campaign can be started by pressing the  button. The  icon on the status bar blinks to indicate that the campaign has been started. The  button replaces the  button and can be used to stop the campaign before it is finished.

Alarms in progress (not yet ended) are recorded in the campaign if their duration is equal to or greater than their programmed minimum duration. The message “Campaign on standby” is displayed until the start time is reached. It is then replaced by the message “Campaign running.”

When the stop time is reached, the Detection Schedule screen returns with the  button. You can then program another campaign.

 **NOTE:** During an alarm campaign, only the stop date field can be modified. It is automatically highlighted in yellow.

5.4.4 MANUALLY STOPPING AN ALARM CAMPAIGN

An alarm can be manually stopped before the stop date and time by pressing the  icon's yellow button. The **OK** icon will reappear in the same location.

5.4.5 DISPLAYING A LIST OF ALARM CAMPAIGNS

To display the list of campaigns performed, press the  button. The Detection List screen is displayed.

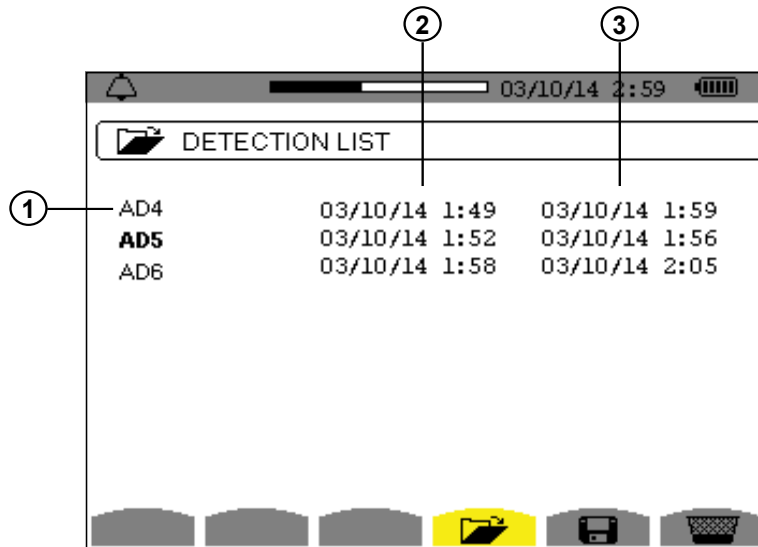





Figure 5-42

Item	Function
1	Name of the campaign
2	Start date and time of the campaign
3	Stop date and time of the campaign

If the stop date of the campaign is in red, it does not match the stop date initially programmed for one of the following reasons:

- Power supply problem (battery low or disconnection of the instrument supplied by AC power only).
- Memory is full.

5.4.6 LIST OF ALARMS

To select a campaign, move the cursor to it using the  and  arrow buttons. The selected field is bolded. Then validate with the  button. The instrument then displays the alarms in list form.

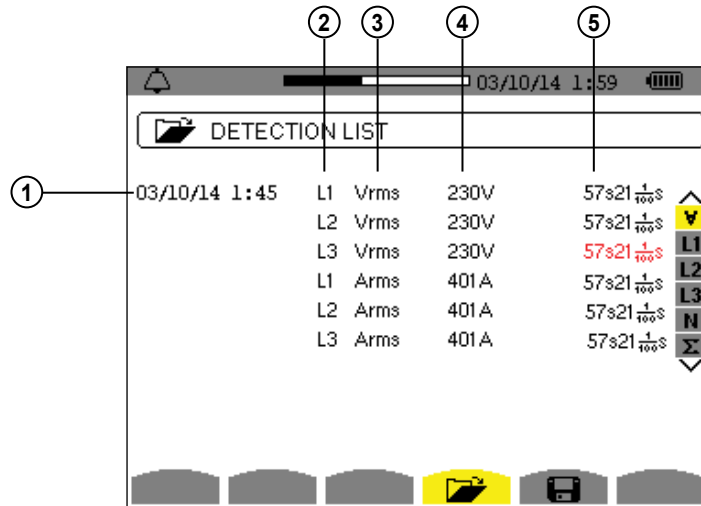



Figure 5-43

Item	Function
1	Alarm date and time
2	Target of alarm detected
3	Type of alarm detected
4	Minimum or maximum (configuration dependent) of alarm detected
5	Dynamic filter (connection type dependent)



If an alarm duration is displayed in red, it was cut short for one of the following reasons:

- Power supply problem (battery low)
- Manual stoppage of the campaign by pressing  or by turning the instrument OFF
- Memory is full
- Measurement error
- Incompatibility between the quantity monitored and the configuration of the instrument (for example withdrawal of a current sensor)

In the last two cases, the minimum or maximum (whichever is applicable) s also displayed in red. To return to the Detection List screen, press .

5.4.7 DELETING ALARM CAMPAIGNS

5.4.7.1 DELETING A SINGLE ALARM CAMPAIGN

When the list of campaigns performed is displayed (see Figure 5-42), select the campaign to be deleted by moving the cursor to it using the up and down arrow buttons. The selected campaign is bolded. Then press the  button. Press  to confirm the deletion or  to cancel.

 **NOTE:** You cannot delete an alarm campaign in progress.

5.4.7.2 DELETING ALL ALARM CAMPAIGNS

Erasing all alarm campaigns from memory is performed via the Configuration menu, in the Erase Memory sub-menu (see § 4.1.9).

5.5 TREND MODE

5.5.1 PROGRAMMING AND STARTING A RECORDING

The  Trend mode records changes to parameters previously specified in Trend mode configuration screen (see § 4.1.7). Pressing this button displays the Recording Schedule screen.

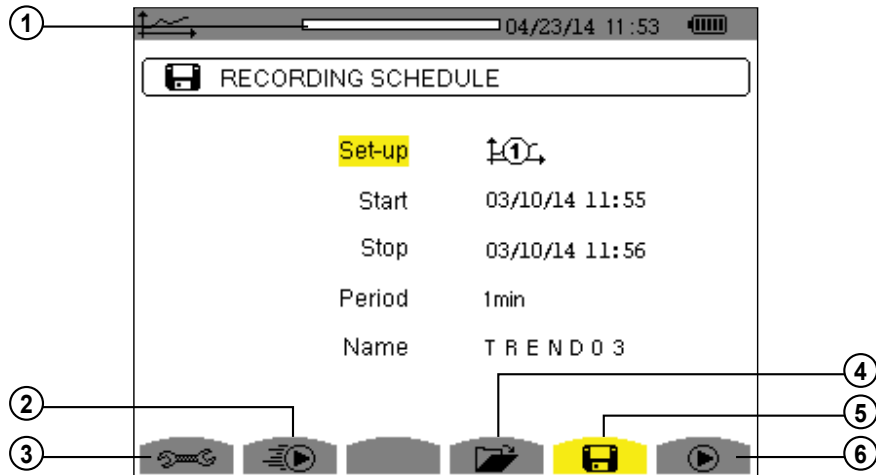







Figure 5-44



Item	Function
1	Memory card usage
2	Rapid programming and starts a recording
3	Shortcut to the Trend Mode configuration screen
4	Displays a list of recordings
5	Programs a recording
6	Starts a recording



The  screen specifies the characteristics of a recording (see Figure 5-44). To quickly start a recording, press the  button. Recording starts immediately; all measurements are recorded every second until the memory is completely full.



The configuration displayed is .

To program a recording, set the parameters listed in the Recording Schedule screen:

- **Set-up** identifies the configuration  through .
- **Start** defines the time and date when the recording starts. The start date and time must be later than the current date and time.
- **Stop** specifies when the recording ends. This must be later than the start date and time.
- **Period** is the time over which the measurements of each recorded value are averaged (arithmetic mean). Allowable values are 1s, 5s, 20s, 1min, 2min, 5min, 10min, and 15min.
- **Name** can be up to eight characters long. Several recordings can have the same name. Allowable characters are uppercase A through Z and the numbers 0 through 9. The last five names assigned (in the transient, trend, and alarm modes) are kept in memory. When a name is entered, it can then be completed automatically.

To modify an item, move the yellow cursor to it using the up and down arrow buttons, then press the  button. Change the value using the arrow buttons, then press  again to confirm.

After you finish setting the parameters, start the recording by pressing the  button. If not enough memory is available, an error message appears informing you of this. The  icon in the status bar blinks to indicate that recording has begun.

NOTE: The  button replaces the  button and can be used to stop the recording before it is finished.

The “Recording on standby” message is displayed until the start time is reached. It is then replaced by the message “Recording running.” When the stop time is reached, the Recording Schedule screen returns with the  button displayed. You can then program a new recording. During the recording of a trend, only the stop date field can be modified. It is automatically highlighted in yellow.

5.5.2 VIEWING THE RECORDING LIST

The Recording List  submenu displays the recording list already made..

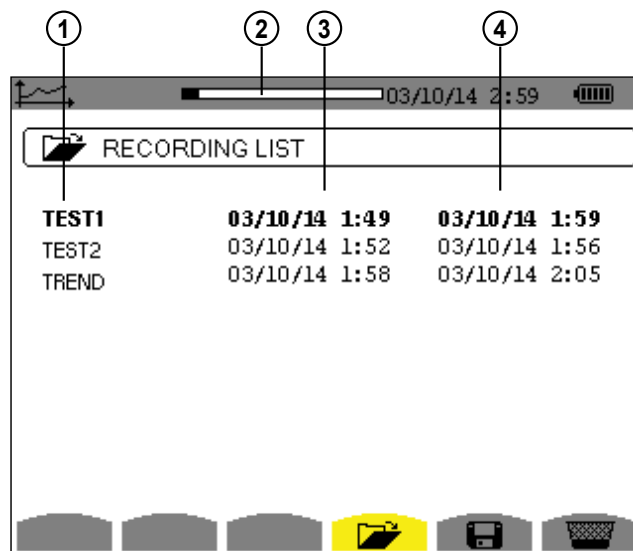







Figure 5-45

Item	Function
1	Recording name
2	Memory usage (black indicates % of memory used)
3	Recording start time
4	Recording end time

If the stop date is in red, it does not match the stop date initially programmed because of a power supply problem (battery low or disconnection of the instrument from AC power).

5.5.3 DELETING RECORDINGS

When the list of records is displayed (see Figure 5-45), select the recording to be deleted using the  or  button. The selected recording is bolded. Press the  button. Press the  button to confirm deletion, or the  button to cancel.

5.5.4 VIEWING RECORDS

When the list of records is displayed (see Figure 5-45), use the up and down arrow buttons to select the record to be displayed. The selected recording is bolded. Press \checkmark to validate.

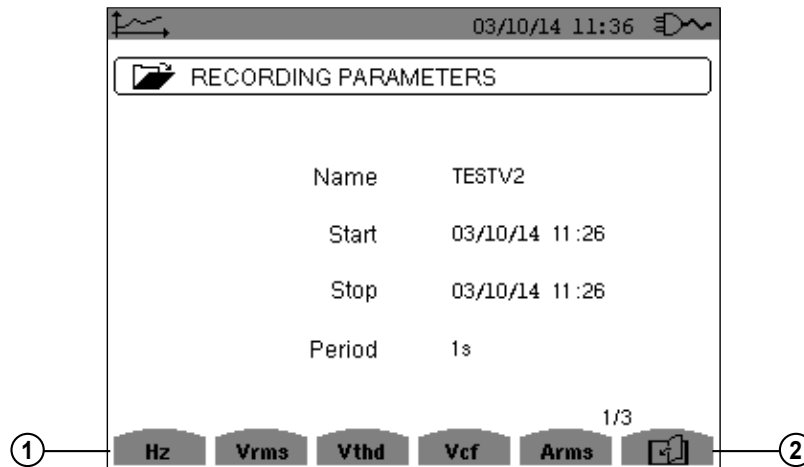

Figure 5-46

Item	Function
1	Types of measurement chosen upon configuration
2	Displays additional pages of parameters

If a measurement does not appear in the tabs, it was incompatible with the configuration chosen (connection, types of sensors, ratios programmed). For example, if the calculation mode chosen during the programming is “Non-active Quantities not separated” (see § 4.1.3), the D tab does not appear. Press the appropriate yellow button to display a specific graph.

5.5.5 TREND GRAPHS

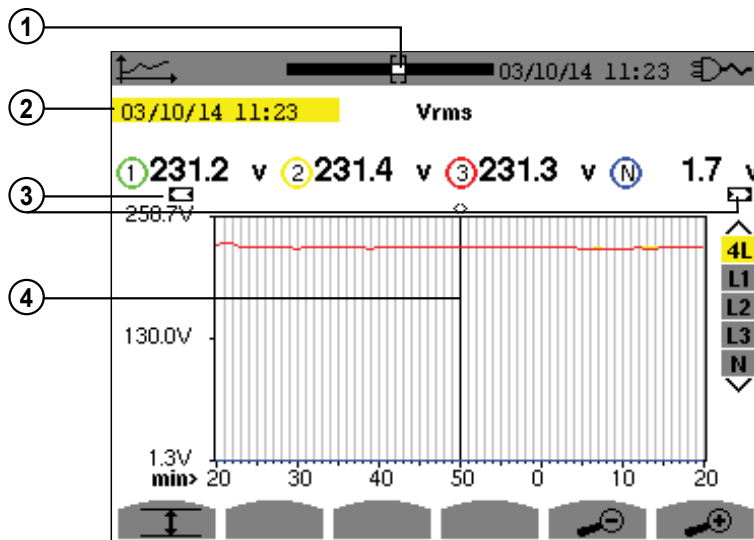



Figure 5-47

Item	Function
1	Position of viewing window in the record
2	Date indicated by the cursor position
3	Indicates that this screen is a partial view of the trend graph. There are other screens before and after this screen.
4	Use the \blacktriangle and \blacktriangledown arrow buttons to move the cursor.

The display period of this graph is one minute. Since the period of the record is one second, each point on the graph corresponds to a value recorded in a one-second window once per minute. There is therefore a substantial loss of information (59 values out of 60), but the display is rapid.

NOTE: Values of the cursor in red indicate saturated values. Black dashes indicate erroneous values. Red dashes indicate values that are not calculated (following the end of calculation of the MIN-MAX-AVG mode when  is pressed).

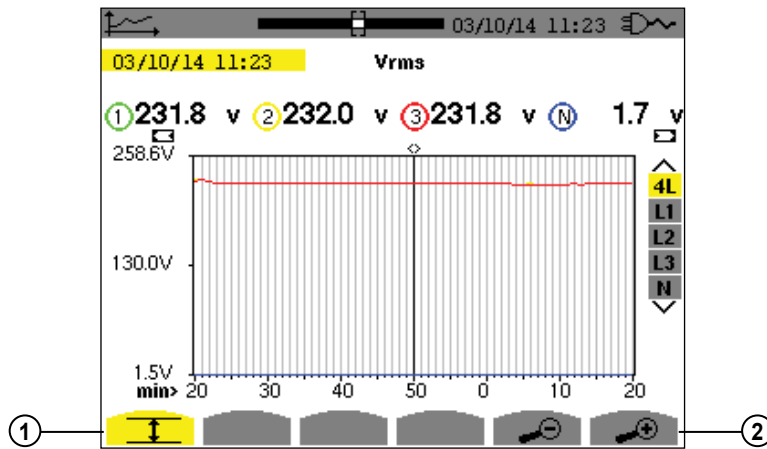

Figure 5-48

Item	Function
1	Indicates that the MIN-AVG-MAX mode is active
2	Changes the scale of the display between 1 minute and 5 days

The display period of the graph shown in Figure 5-48 is one minute. With the MIN-AVG-MAX mode activated, each point of this graph represents the arithmetic mean of 60 values recorded every second. This graph is therefore more precise than the graph shown in Figure 5-47, since there is no loss of information. It is slower, however.

To stop the calculation of the MIN-AVG-MAX mode, press .

NOTE: While MIN-AVG-MAX mode is being calculated, a progress bar is displayed for this calculation in the status strip instead of the recording display window positioning bar. The MIN-AVG-MAX mode is not available while a trend is being recorded.

To return to the Recording Parameters screen, press .

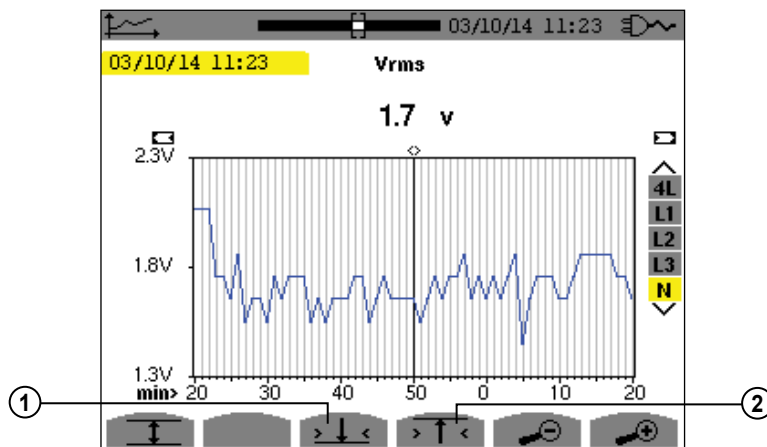

Figure 5-49

Item	Function
1	Places cursor on first occurrence of minimum value
2	Places cursor on first occurrence of maximum value

Pressing the $\leftarrow \uparrow \rightarrow$ or $\leftarrow \downarrow \rightarrow$ button automatically sets “zoom in” to the highest level (the display period is identical to the recording period) and deactivates the MIN-AVG-MAX mode if previously activated.

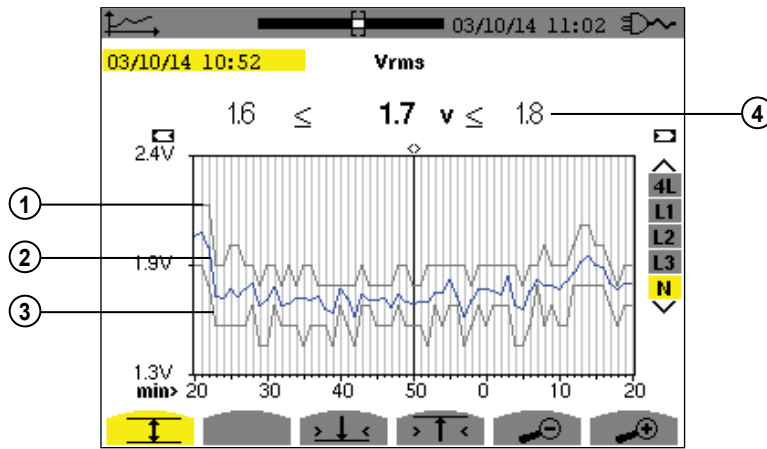

Figure 5-50

Item	Function
1	Graph of MAX
2	Graph of AVG
3	Graph of MIN
4	Values at cursor position (MIN-AVG-MAX)

The display period of the graph shown in Figure 5-50 is one minute. Each point of the AVG graph represents the arithmetic mean of 60 values recorded every second. Each point of the graph of the MAX represents the maximum of the 60 values recorded every second. Each point of the graph of the MIN corresponds to the minimum of the 60 values recorded every second. This display is therefore more precise than the one illustrated in Figure 5-49.

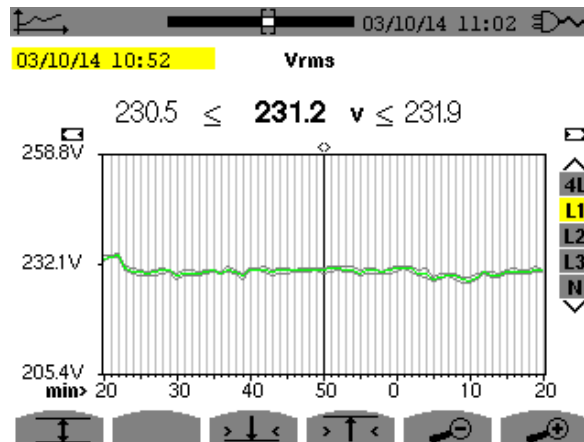

Figure 5-51

For each of the phases (L1, L2, and L3), at each recording of a value over one second (recording period), the instrument also records the minimum half-cycle RMS value over one second and the maximum half-cycle RMS value over one second. These are the three graphs shown in Figure 5-51.

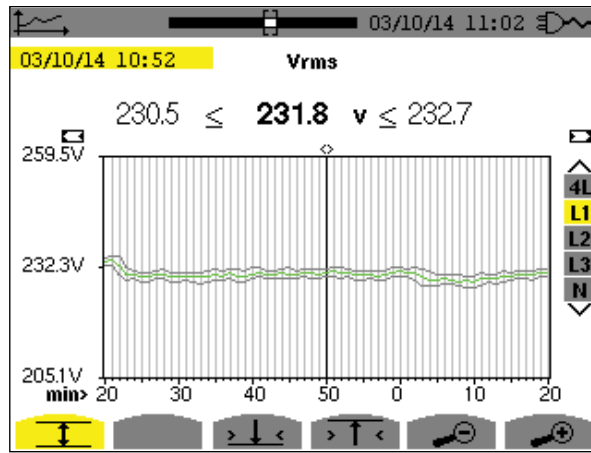

Figure 5-52

This graph differs slightly from the one shown in Figure 5-51 because, with the MIN-AVG-MAX mode, there is no loss of information.

NOTE: For the quantities (P, Pdc, VAR, S, D, PF, $\cos \Phi$ and $\tan \Phi$) and for a 3-phase source without neutral, only the total quantities are represented.

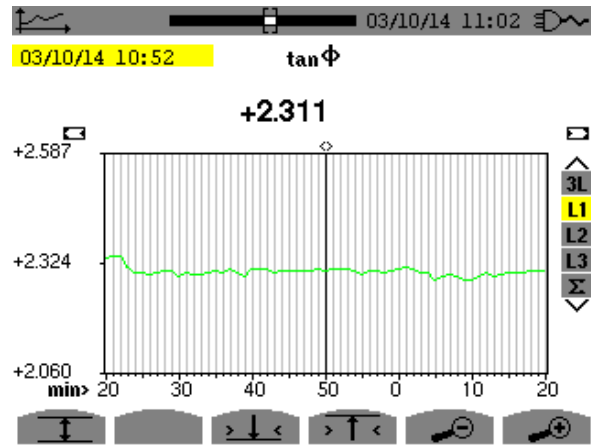

Figure 5-53

This graph is an example of $\tan \Phi$ (L1) without MIN-AVG-MAX for a 3-phase connection with neutral.

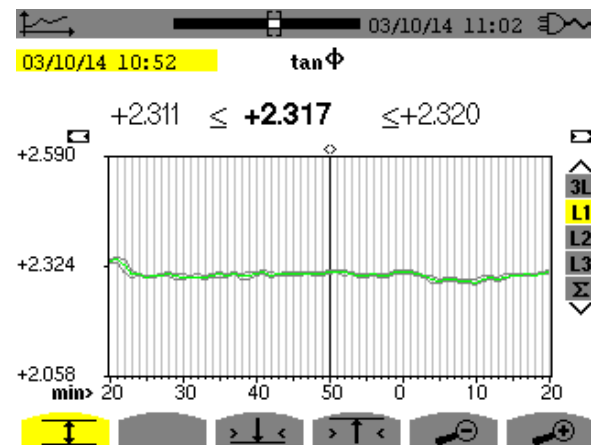

Figure 5-54

This graph is an example of $\tan \Phi$ (L1) with MIN-AVG-MAX.

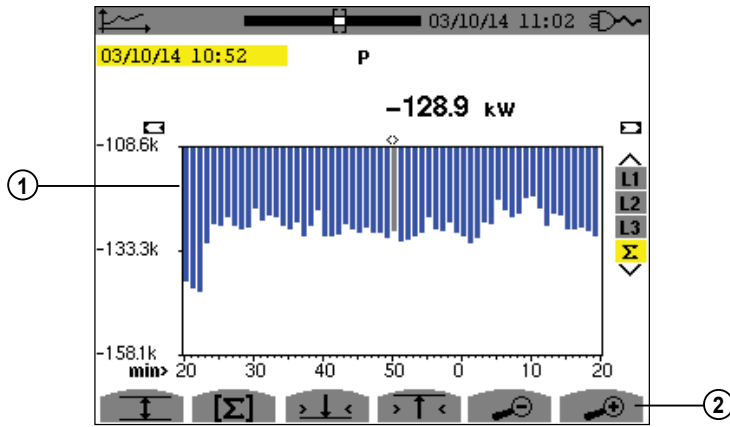

Figure 5-55

Item	Function
1	Sum of powers of the three phases is presented in bar graph form.
2	Changes the scale of display between 1 minute and 5 days.

For the energy graphs, the quantities are expressed in Wh, J, toe, or BTU, depending on the unit chosen in the configuration of the instrument (see § 4.1.3.2).

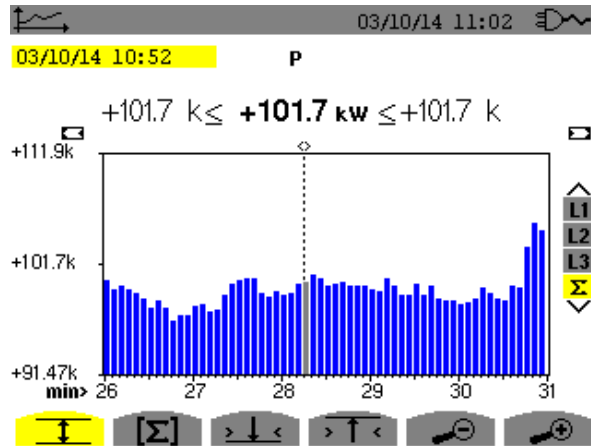

Figure 5-56

This graph (Figure 5-56) differs slightly from the previous one because, with the MIN-AVG-MAX mode, there is no loss of information.

The MIN-AVG-MAX mode can be activated for the powers to be displayed (above the graph) the mean power value at the cursor date along with the maximum and minimum power values. Note that, in contrast with the other quantities, only the bar chart of mean values is represented.

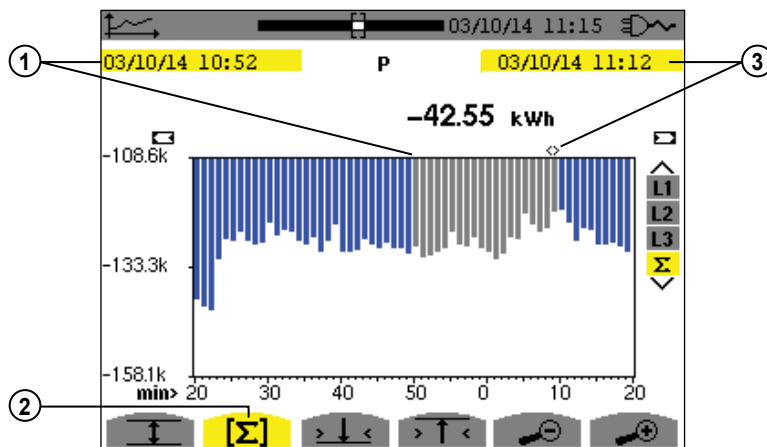

Figure 5-57

Item	Function
1	Start date of selected period
2	Energy calculation mode. Pressing this button lets you define the start of the selection.
3	Date indicated by cursor (defines end date of selected period). Use the ◀ and ▶ buttons to move the cursor.

The display period of this bar chart is one minute. Since the recording period is one second, each bar of this bar chart represents a value recorded in a one-second window once a minute. The energy calculation mode determines the sum of the powers on the selected bars.

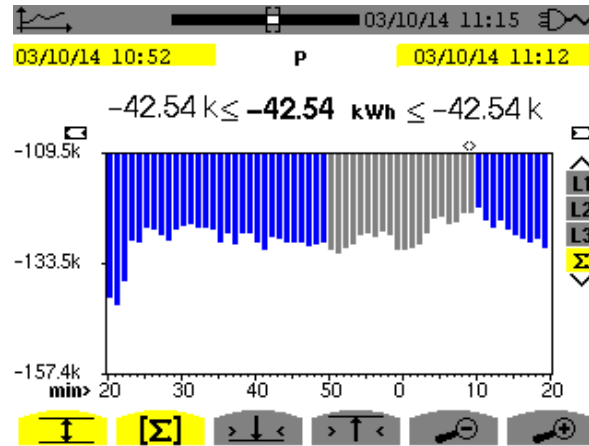

Figure 5-58

With the MIN-AVG-MAX mode activated, the display differs slightly from the previous one because there is no loss of information.

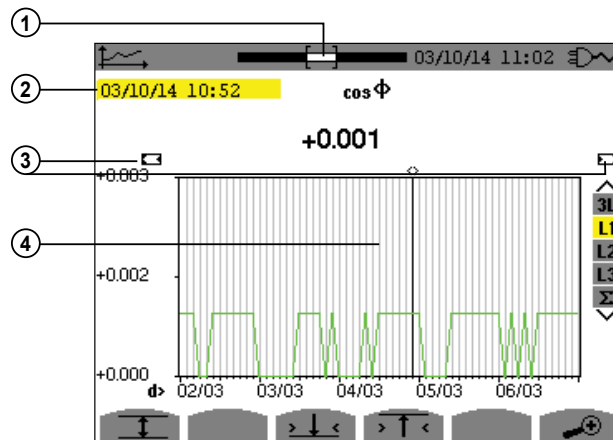

Figure 5-59

Item	Function
1	Position of viewing window in record.
2	Date defined by cursor position.
3	Indicates that this screen is a partial view of the trend graph. There are other screens before and after this visible screen.
4	Use the ◀ and ▶ buttons to move the cursor.

The period of display of this graph is two hours. Since the recording period is one second, each point of this graph represents a value recorded every second taken every two hours. There is therefore a substantial loss of information (7199 out of 7200), but the display is rapid.

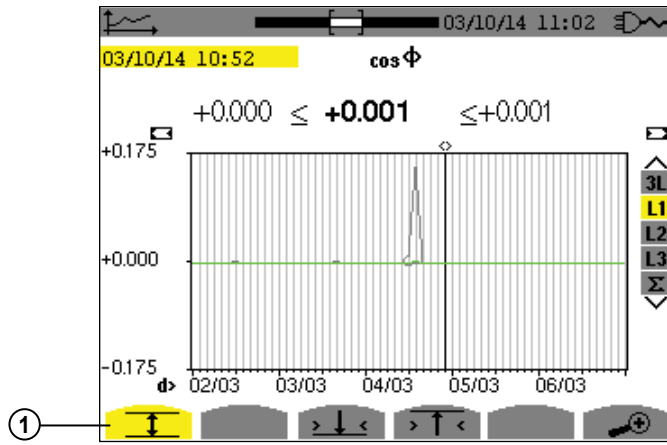

Figure 5-60

Item	Function
1	Indicates MIN-AVG-MAX mode has been activated.

This graph differs considerably from the one illustrated by Figure 5-59 in that MIN-AVG-MAX mode is activated. Each point of the AVG curve represents the arithmetic mean of 7,200 values recorded every second. Each point of the graph of the MAX represents the maximum of the 7,200 values recorded every second. Each point of the graph of the MIN corresponds to the minimum of the 7,200 values recorded every second. This display is therefore more precise, because there is no loss of information, but it is slower.

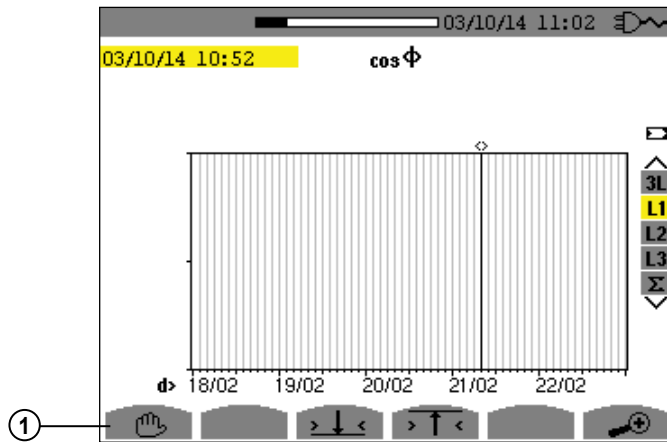

Figure 5-61

Item	Function
1	You can stop the loading of recorded values and calculation of the values displayed at any time by pressing this button.

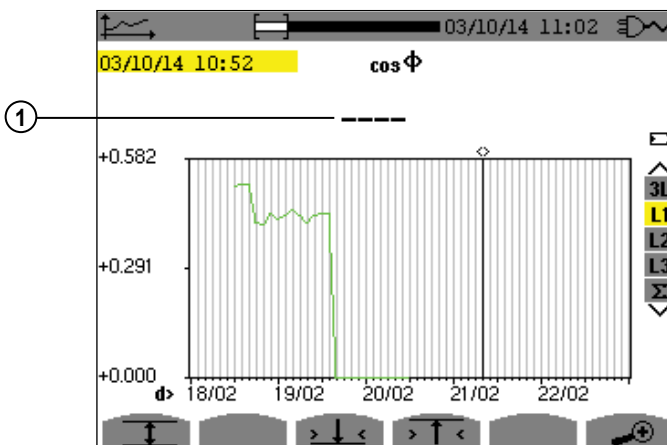

Figure 5-62

Item	Function
1	Dashes indicate that the value is not available at the cursor position because it was not calculated.

Display of the record is not complete because construction was stopped before the end.

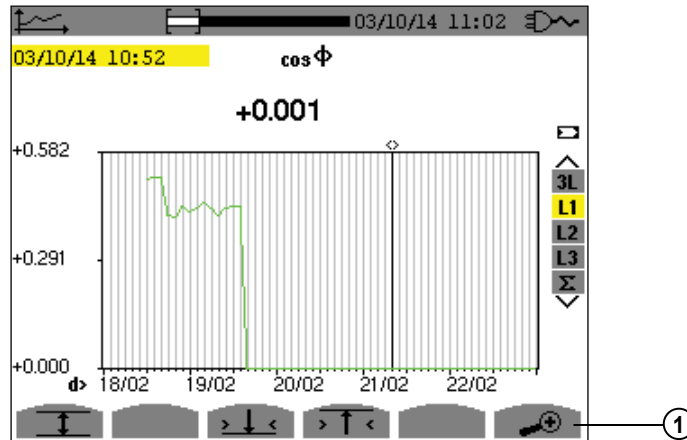



Figure 5-63

Item	Function
1	Changes the scale of the display between 1 minute and 5 days.







The display has not been stopped and is therefore complete.

The following table indicates the time needed to display the graph on screen as a function of the width of the display window for a recording period of one second:

Width of display window (60 points or increments)	Grid increment	Typical waiting time for display with the MIN-AVG-MAX mode deactivated	Typical waiting time for display with the MIN-AVG-MAX mode activated
5 days	2 hours	11 seconds	10 minutes
2.5 days	1 hour	6 seconds	5 minutes
15 hours	15 minutes	2 seconds	1 minute 15 seconds
10 hours	10 minutes	2 seconds	50 seconds
5 hours	5 minutes	1 second	25 seconds
1 hour	1 minute	1 second	8 seconds
20 minutes	10 seconds	1 second	2 seconds
5 minutes	5 seconds	1 second	1 second
1 minute	1 second	1 second	1 second

These times can be long; you can stop the display at any time by pressing .

You can also, at any time, press:

-  or  to change the scale of the display
-  or  to move the cursor
-  or  to change the display filter

 **NOTE:** Pressing these buttons may restart the loading and/or calculation of the values from the beginning.

5.6 POWER AND ENERGY MODE \mathbb{W}

The \mathbb{W} Power and Energy button displays power and energy measurements. The sub-menus available depend on which filter is selected:

- For 2- and 3-wire single-phase connections and for the 2-wire 2-phase connection, only L1 is available. The filter is therefore not displayed; but the display is the same as for L1.
- For the 3-wire 3-phase connection, only the Σ filter selection is available. The filter is therefore not displayed, but the display is the same as for Σ .

5.6.1 3L FILTER

5.6.1.1 POWER

The \mathbb{W} ... sub-menu is used to display power.

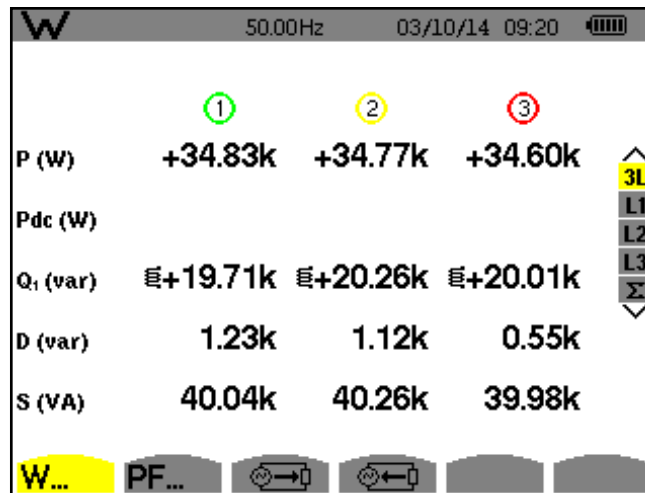

Figure 5-64

Item	Function
P (W)	Active power
Pdc (W)	DC power (only if a DC current sensor is connected)
Q ₁ (var)	Reactive power
D (var)	Distortion power
S (VA)	Apparent power
\mathbb{W} ...	Power
PF...	Power Factor (this button is only available for the 3L filter)
Wh...	Energy Meters (this button is not available for the 3L filter)
$\odot \rightarrow \square$	Energy consumed (active, reactive, and apparent power) (this button is only available for the 3L filter)
$\odot \leftarrow \square$	Energy generated (active, reactive, and apparent power) (this button is only available for the 3L filter)

On the right side of the screen are a set of filters: 3L, L1, L2, L3, and Σ . Use the \blacktriangle and \blacktriangledown buttons to choose the filter. The values displayed on the Power and Energy screens are dependent on which of these filters is selected; different data will appear for different filters. The following sections describe how these screens appear for the 3L, L1/L2/L3 (all three display the same fields), and Σ filters.

NOTE: This screen corresponds to the choice “non-active quantities separated” in the AR tab of the Calculation Methods menu in Configuration mode. If the choice is “non-active quantities combined” the D label (distortion power) does not appear, and Q₁ is replaced by N. This non-active power is unsigned and has no inductive or capacitive effect.

5.6.1.2 QUANTITIES ASSOCIATED WITH POWER

The PF... sub-menu displays the quantities associated with power.

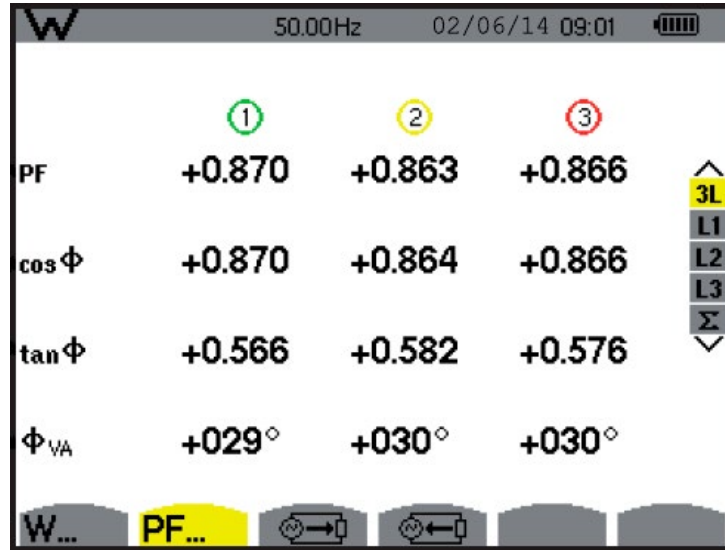

Figure 5-65

The values in this screen are as follows:

Item	Function
PF	Power factor
cos Φ	Fundamental power factor (also called DPF - displacement factor)
tan Φ	Tangent of phase shift
Φ_{VA}	Phase shift of voltage with respect to current

5.6.1.3 ENERGY CONSUMED

The Energy Consumed sub-menu displays the meters of energy consumed by the load.

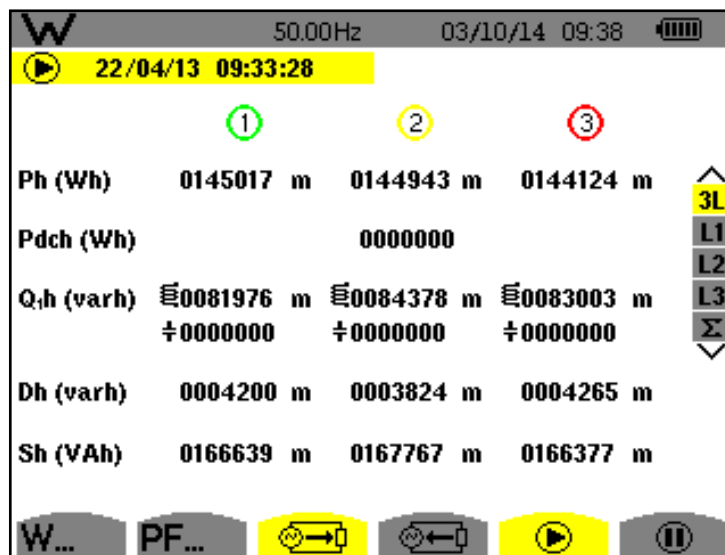





Figure 5-66

NOTE: This screen corresponds to the choice “non-active quantities separated” in the VAR tab of the Calculation Methods menu in Configuration mode. If the choice is “non-active quantities combined” Dh does not appear and Q_ih is replaced by Nh. This non-active energy has no inductive or capacitive effect.

Item	Function
Ph (Wh)	Active energy consumed
Pdch (Wh)	DC energy (only if a DC current sensor is connected)
Q _i h (varh)	Reactive energy consumed
Dh (varh)	Distortion energy.
Sh (VAh)	Apparent energy consumed
	Inductive reactive effect
	Capacitive reactive effect

5.6.1.4 ENERGY GENERATED

The  Energy Generated screen displays the meters of the energy generated by the load.

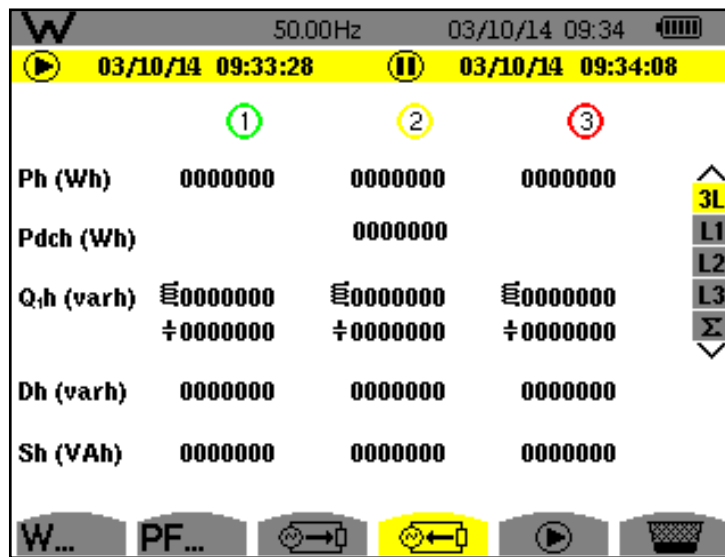

Figure 5-67

i **NOTE:** This screen corresponds to the choice “non-active quantities separated” in the VAR tab of the Calculation Methods menu in Configuration mode. If the choice is “non-active quantities not separated” Dh does not appear and Q_ih is replaced by Nh. This non-active energy has no inductive or capacitive effect.

5.6.2 L1, L2, AND L3 FILTERS

5.6.2.1 POWERS AND ASSOCIATED QUANTITIES

The **W...** sub-menu displays the power and associated quantities.

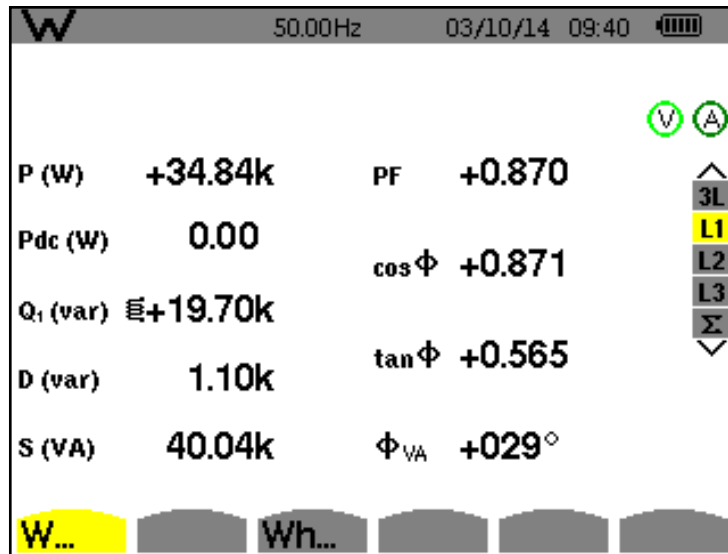

Figure 5-68

The values in this screen are as follows:

Item	Function
P (W)	Active power
Pdc (W)	DC power
Q₁ (var)	Reactive power
D (var)	Distortion power
S (VA)	Apparent power
PF	Power factor
cos Φ	Fundamental power factor (also called DPF - displacement factor)
tan Φ	Tangent of the phase shift
Φ_{VA}	Phase shift of voltage with respect to current (Φ is displayed for the 2-wire 2-phase set-up).

i **NOTE:** This screen corresponds to the choice “non-active quantities separated” in the VAR tab of the Calculation Methods menu in Configuration mode. If the choice is “non-active quantities combined” D (distortion power) does not appear and Q₁ is replaced by N. This non-active energy has no inductive or capacitive effect.

Filters L2 and L3 display the same information for phases 2 and 3.

Φ_{VA} is displayed for the 2-wire 2-phase set-up.

5.6.2.2 ENERGY METERS

The **Wh...** sub-menu displays the energy meters.

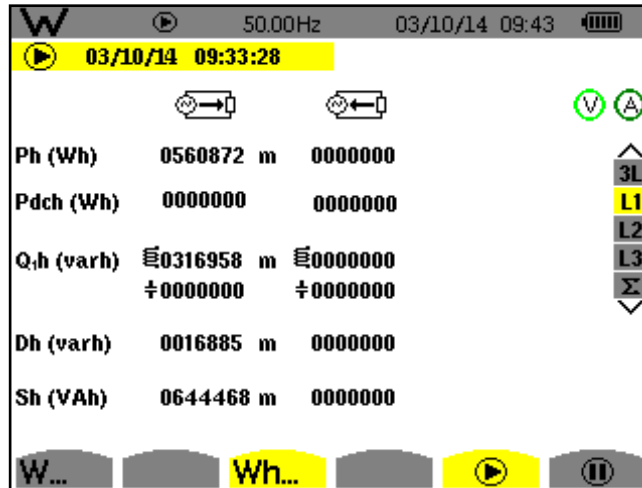

Figure 4-69

The values in this screen are as follows:

Item	Function
	Meters of the energy consumed by the load
	Meters of the energy generated by the load

Filters L2 and L3 display the same information for phases 2 and 3.

5.6.3 Σ FILTER

5.6.3.1 TOTAL POWERS AND ASSOCIATED QUANTITIES

When the Σ filter is selected, the **W...** sub-menu displays the powers and associated quantities.

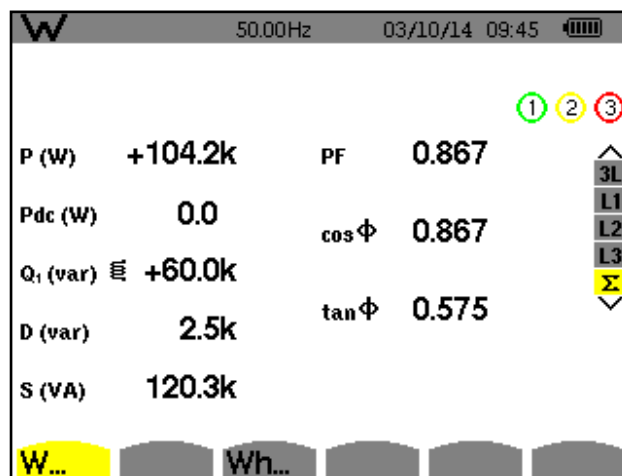

Figure 4-70

NOTE: This screen corresponds to the choice “non-active quantities separated” in the VAR tab of the Calculation Methods menu in Configuration mode. If the choice is “non-active quantities combined” D does not appear and Q₁ is replaced by N. This non-active energy has no inductive or capacitive effect.

Filters L2 and L3 display the same information for phases 2 and 3.

Item	Function
P (W)	Total active power
Pdc (W)	Total DC power
Q₁ (var)	Total reactive power
D (var)	Total distortion power
S (VA)	Total apparent power
PF	Total power factor
cos Φ	Total fundamental power factor (also called DPF - displacement factor)
tan Φ	Total tangent
Φ VA	Phase shift of voltage with respect to current (Φ is displayed for the 2-wire 2-phase set-up).

5.6.4 TOTAL ENERGY METERS

The **Wh...** sub-menu displays the energy meters.

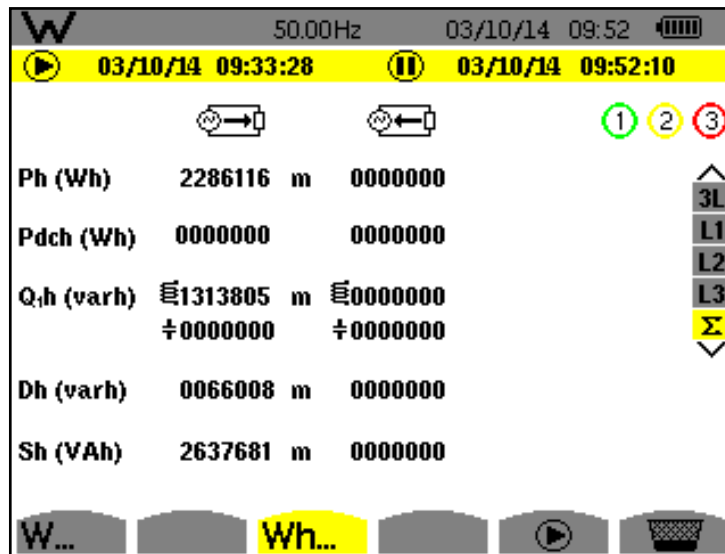

Figure 4-71









Item	Function
	Meters of the energy consumed by the load
	Meters of the energy generated by the load
Ph (Wh)	Total active energy consumed
Pdch (Wh)	Total DC energy (only if a DC current sensor is connected)
Q₁h (varh)	Total reactive energy consumed
Dh (varh)	Total distortion energy.
Sh (VAh)	Total apparent energy consumed
	Total inductive reactive effect
	Total capacitive reactive effect



NOTE: This screen corresponds to the choice “non-active quantities separated” in the VAR tab of the Calculation Methods menu in Configuration mode. If the choice is “non-active quantities combined” Dh does not appear and Q₁h is replaced by Nh. This non-active energy has no inductive or capacitive effect.

For the 3-wire 3-phase set-up, only the display of total quantities is available; the method of calculation of the powers used is the two-wattmeter method.



5.6.5 STARTING AND STOPPING ENERGY MEASUREMENTS

To start a measurement:

1. Press the  button while in an energy display (, , or **Wh...**). The date and time at which the measuring starts will appear in the upper left corner of the screen, and the  icon on the screen blinks to indicate that energy metering is in progress.
2. To stop the measurement, press the  button. The date and time at which the measuring stops will appear in the upper right corner of the screen. The  icon is also replaced by the  icon.
3. To resume metering, press the  button again.













 **NOTE:** If no recording is in progress, disconnecting the energy metering results in the appearance of the blinking  icon in the status bar (in place of the  icon).

5.6.6 RESETTING THE ENERGY MEASUREMENT

To reset the measurement, press the  button to stop metering. Then press the  button, and then  to confirm. All energy values (consumed and generated) are reset.

5.7 SCREEN SNAPSHOTS

The  button enables you to take up to 50 screen snapshots and display the recorded snapshots. Saved screens can then be downloaded to a PC using DataView.

Press the  button for approximately three seconds to shoot any screen displayed on the instrument. When a screen snapshot is taken, the icon of the active mode (, , , , , , , **W**) in the top strip of the display unit is replaced by the  icon. You can then release the  button. The instrument can record only 50 screen snapshots. If you want to record a 51st screen, the instrument informs you that snapshots must be deleted by displaying the  icon in place of .

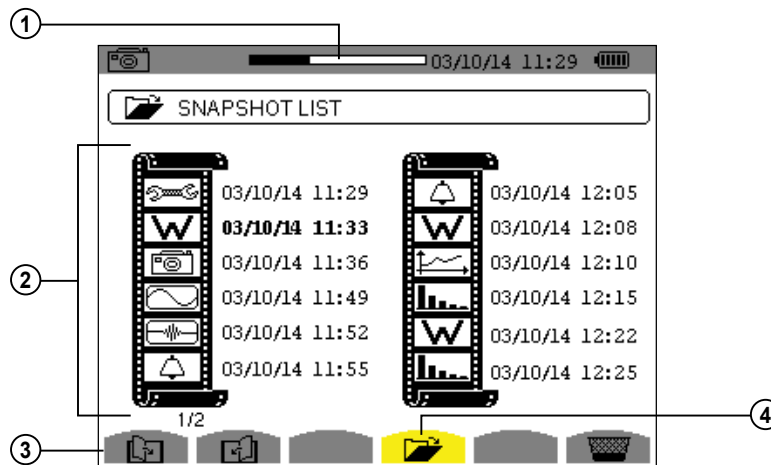





Figure 5-72



Item	Function
1	Available image memory. Black represents memory used.
2	List of saved snapshots. Each icon represents the type of screen recorded. It is followed by the date and time of the screen snapshot.
3	Icons for browsing through the screen pages.
4	Displays a list of snapshots.

 **NOTE:** These screens can be downloaded to a computer using DataView®

5.7.1 VIEWING A SNAPSHOT

- A **short press** (about 1s) on the  button gives access to the menu of snapshots that have been saved.
- Use the arrow buttons to select the snapshot.
- The date and time of the selected snapshot are bolded. Press  to display the selected snapshot.
- Press  to return to the list of screen snapshots.

5.7.2 DELETING A SNAPSHOT

- Select the snapshot that you want to delete using the arrow buttons.
- Press the  button and confirm the deletion by pressing .

To leave the screen without deleting any alarm, press the  button.

5.8 HELP

Press this button to obtain help for the currently displayed mode.

To exit the Help mode, press the  button once again.

6. DATAVIEW SOFTWARE

DataView is a software program that enables a PC to connect to and interact with a variety of AEMC instruments, including the Model 8336. As its name implies, a primary purpose of DataView is to view data that has been recorded by the instrument and displayed on the PC. With DataView you can:

- Connect PC to the instrument
- Download data
- Display and analyse data
- Generate reports
- Export to a spreadsheet
- Configure the instrument from the PC

6.1 INSTALLING DATAVIEW

i **DO NOT CONNECT THE INSTRUMENT TO THE PC BEFORE INSTALLING THE SOFTWARE AND DRIVERS.**

When you purchase an AEMC instrument supported by DataView, the software is included as part of the product package. DataView program files are stored on a USB stick.

i **NOTE:** When installing, the user must have Administrative access rights during the installation. The users access rights can be changed after the installation is complete. DataView must be reinstalled for each user in a multi-user system.

1. Insert the DataView thumb drive into an available USB port on your computer. If Autorun is enabled, an AutoPlay window appears on your screen. Click “Open folder to view files” to display the DataView folder. If Autorun is not enabled or allowed, use Windows Explorer to locate and open the USB drive labeled “DataView.”
2. When the DataView folder is open, find the file Setup.exe located in the root directory of the USB drive, and double-click it to run the installation program.
3. The DataView setup screen appears.

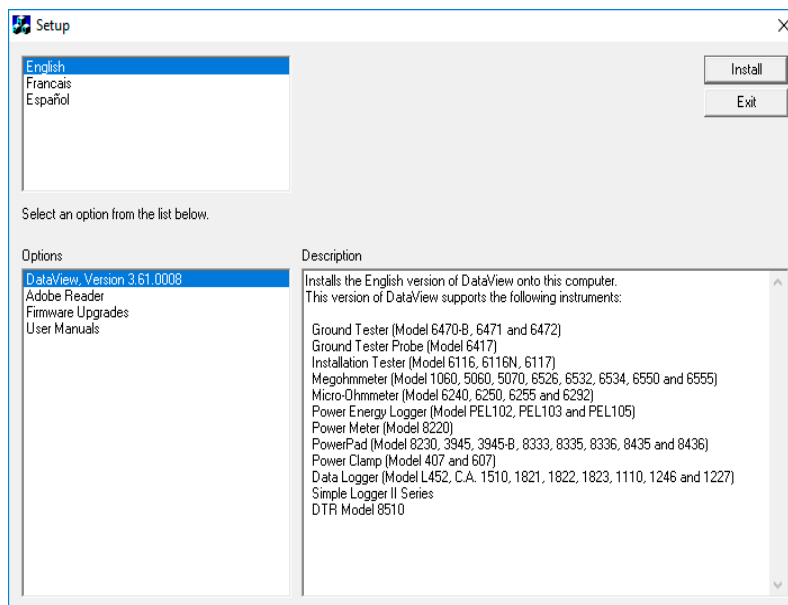

Figure 6-73

In the upper left corner of the screen, choose the language version of the Setup interface. (All Setup screens and dialogs will immediately appear in the selected language.)

In the lower left corner are the available installation options. In addition to the DataView software, you can select "Adobe Reader." This links to the Adobe web site where you can download the latest version of Reader. This program is required to view DataView .pdf documents. The option Firmware Upgrades links to the website where you can check for new firmware updates for the instrument. Finally, User Manuals displays a list of .pdf files contained in the USB drive that accompanies DataView. (DataView also comes with a Help system that is installed with the program files.)

To install DataView, select DataView in the Options list and click Install.

4. Select the language version of DataView you want to install (English, French, or Spanish) then click Next. (By default, the language selected in step 3 is highlighted.)

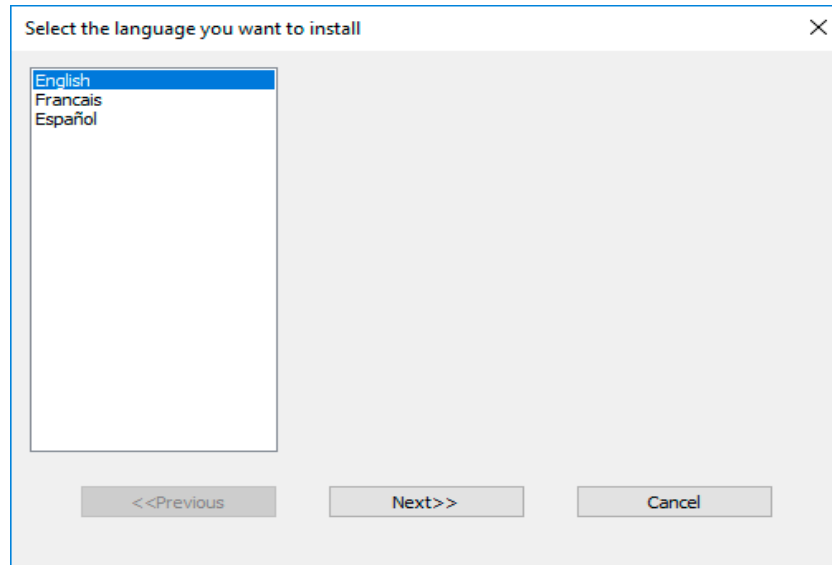

Figure 6-74

5. You are now prompted to select the software you want to install. Each AEMC product family has its own specially designed Control Panel. If you are performing a Complete install, by default all available Control Panels are selected (a check mark next to the Control Panel indicates it is selected). Control Panels take up disk space on the computer; so unless you have other types of AEMC instruments, we recommend that you select PowerPad III and deselect the rest. You should also check the option DataView Core, which is a requirement if you plan to create DataView reports.

After you finish selecting and deselecting Control Panels and/or DataView Core, click Next.

6. The Setup program now informs you that it is ready to install DataView. If you want to review any of your previous selections, click the Previous button to return to earlier screens. Otherwise, click Install to begin installation.
7. The InstallShield program installs the selected software. If an earlier version of the software is already installed on your computer, for each selected program the InstallShield program will:
 - (a) Ask you to confirm the installation of the program. Click Next.
 - (b) Display a status bar indicating the progress of the installation.
 - (c) Inform you when the program is installed. Click Finish to install the next selected program.

If the software is not installed (or if the installed software is the same version as the selected software), the software is installed without requesting confirmation.

When all programs are installed, a message appears informing you of this. Click Finish to return to the Setup screen

8. You can now select additional Setup options to install (see step 3 above). When finished, click Exit.
9. The DataView folder now appears on your computer desktop, within which is the PowerPad III  icon and the icon(s) for any other Control Panel(s) you have installed.

6.2 POWERPAD III CONTROL PANEL

Clicking the DataView icon in the DataView folder on your desktop opens the core DataView program. Clicking the PowerPad III Control Panel icon opens the PowerPad III Control Panel:

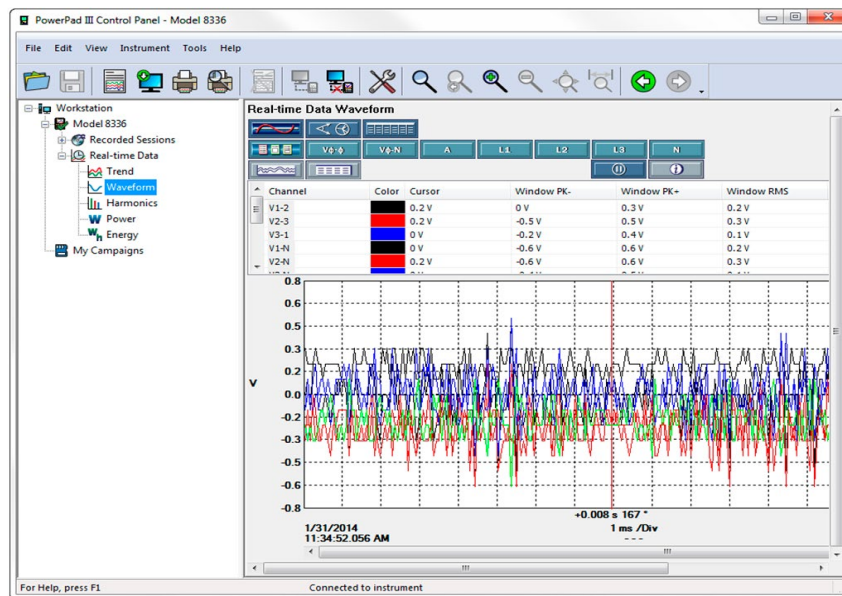

Figure 6-75

In general, core DataView features are for creating, viewing, editing, and storing DataView reports; while the Control Panel is for connecting to, configuring, viewing measurements on, and downloading data from the instrument. You can access all DataView features through either the DataView icon or the Control Panel icon. For users who interact with PowerPad III series instruments, we recommend primarily using the Control Panel. However, there are situations where using the core DataView icon may be more convenient for some users, such as when viewing multiple archived reports from different AEMC product families.

For further information about using the PowerPad III Control Panel, consult the Help system that comes with the product. Access this Help by clicking the option Help in the Control Panel's menu bar at the top of the screen.

7. MAINTENANCE

Use only factory specified replacement parts. AEMC® will not be held responsible for any accident, incident, or malfunction following a repair done other than by its service center or by an approved repair center.

7.1 CLEANING

! Disconnect the instrument from any source of electricity.

- Use a soft cloth, lightly dampened with soapy water
- Wipe with a damp cloth and then dry with a dry cloth
- Do not splash water directly on the instrument
- Do not use alcohol, solvents or hydrocarbons

For the current probes and sensors: Keep the air gaps of the clamps perfectly clean using a cloth. Lightly oil visible metal parts to avoid rust.

7.2 REPLACING THE BATTERY

! **WARNING:**

- For safety reasons, replace the battery only with the original replacement model (see § 1.2.2).
- Do not expose the battery to heat exceeding 212°F (100°C).
- Do not short-circuit the battery terminals.
- To eliminate all risk of electric shock, disconnect the power supply cord and measurement leads of the instrument.

1. Turn the instrument over, raise the stand, and prop it up.
2. Use a coin to unscrew the two quarter-turn screws on the back of the housing.
3. Using a flat screwdriver, remove the cover from the compartment.
4. Turn the instrument over and hold the battery as it slides out of its compartment.
5. Disconnect the battery connector without pulling on the wires.
6. Connect the new battery. The connector is error-proofed to prevent reversals of polarity.
7. Place the battery in its compartment and arrange the wires so that they do not protrude.
8. Put the battery compartment cover back in place and screw the two screws back in.

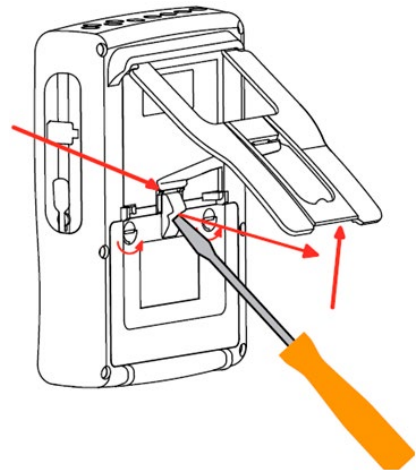

i **NOTE:** If the battery is disconnected, it must then be fully recharged, even if it is not replaced, so that the instrument will know the battery charge condition (this information is lost when the battery is disconnected).

7.3 UPDATING SOFTWARE & FIRMWARE

To provide our customers the best possible service in terms of performance and technical upgrades, AEMC® offers free software and firmware updates on our website.

- Visit us at: www.aemc.com
- Click on the **TECH INFO** tab, then click on the **Software & Firmware Updates** button.

You can also update the software by selecting “Update” from the Help menu within the DataView® software.

 **NOTE:** Updating embedded software or firmware resents the configuration and erases all data stored on the instrument. As a precaution, you should always save stored data to a PC before performing any software or firmware updates.

8. ICONS, BUTTON & SYMBOLS

8.1 FUNCTION BUTTON ICONS

The Model 8336 display includes the following icons for the yellow function buttons:

Icon	Function	Icon	Function
V	Phase-to-neutral voltage mode		Energy calculation
A	Phase-to-neutral current mode		Zoom in
S	Power mode		Zoom out
U	Phase-to-phase voltage mode		Contrast
var	Non-active quantities		Colors of the measurement channels
Wh	Unit of energy		Screen shutdown
FK	Coefficients of K factor		Night mode
%f-%r	Reference for level of harmonics of phases		Recording programming mode.
PLT	Long-term flicker calculation		Recording look-up mode.
CF	Peak factors		Start of recording.
RMS	RMS values		Rapid programming and start of recording
PEAK	Peak values		Disconnect recording
THD	Harmonic distortion		Stop function in progress
PF...	PF, cos Φ (DPF), tan Φ , and Φ		Wastebasket for deleted items
W...	Power & associated quantities (PF, cos Φ , DPF, tan Φ & Φ_{VA})		Configuration
Wh...	Energy meters		Activate/deactivate transients filter
	Mean and min/max values		Inrush current mode
	Move cursor to first occurrence of maximum phase-to-neutral voltage		Phasor diagram
	Move cursor to first occurrence of minimum phase-to-neutral voltage		$>t=0<$ Move cursor to transient triggering time
	Move cursor to first occurrence of maximum phase-to-phase voltage		$>t=-T<$ Move cursor one signal period before triggering date of transient
	Move cursor to first occurrence of minimum phase-to-phase voltage		Energy consumed by the load
	Move cursor to first occurrence of maximum current		Energy generated by the load
	Move cursor to first occurrence of minimum current		First page of Help
	Move cursor to first occurrence of maximum instantaneous frequency		Second page of Help
	Move cursor to first occurrence of minimum instantaneous frequency		Third page of Help
	Move cursor to first occurrence of maximum of measurement displayed		Fourth page of Help
	Move cursor to first occurrence of minimum of measurement displayed		Previous configuration
	Simultaneous display of all voltage and current measurements (RMS, DC, THD, CF, PST, PLT, FHL, FK)		Next configuration
	Select all items		Previous page screen
	De-select all items		Next page screen
	Transient mode		







8.2 KEYPAD BUTTONS

8.2.1 FUNCTION BUTTONS (YELLOW BUTTONS)

These six buttons activate the function or tool represented by the corresponding icon on the screen.





8.2.2 NAVIGATION BUTTONS



A block of four arrow buttons, a select button and a return button are available for navigating menus.

Button	Function
	Up direction or navigation button.
	Down direction or navigation button.
	Right direction or navigation button.
	Left direction or navigation button.
	Confirms the selection.
	Return button.

8.2.3 MODE BUTTONS (VIOLET BUTTONS)

These buttons provide access to specific modes:



Button	Function	See
	Waveform acquisition mode, with two sub-modes: transients mode (blackouts, interference, etc.) and inrush current mode (starting of motor).	§ 5.1
	Harmonic display mode: displays voltage, current, and power harmonics, order by order; determination of harmonic currents produced by nonlinear loads, analysis of problems caused by harmonics according to their order (overheating of neutrals, conductors, motors, etc.).	§ 5.2
	Voltage and current waveforms mode, display of minima and maxima of summary tables, determine phase rotation.	§ 5.3
	Alarm mode: list recorded alarms exceeding the thresholds programmed in the configuration; record network blackouts with half-cycle resolution (Vrms, Arms, Urms), determine energy consumption overshoots, monitor compliance with a power supply quality contract.	§ 5.4
	Trend mode: record parameters selected in the Configuration menu.	§ 5.5
W	Power and energy measurements	§ 5.6

Three of these buttons are real-time mode buttons: **W**, , and . In each of these modes, the colored circles on a white ground (for example ①) in which the channel numbers or types appear indicate saturation: the ground of the circle is colored when the channel measured is potentially full (for instance ①).

When a numbered circle corresponds to a simulated channel (for example in 4-wire 3-phase with selection V1V2, 2½-element method, or in 3-wire 3-phase with selection A1A2, 2-element method) this channel is potentially full if at least one channel used in calculating it is potentially full. Similarly, if the circle corresponds to a phase-to-phase voltage channel, it is potentially full if at least one of the phase-to-neutral voltage channels used in calculating it is potentially full.

8.2.4 OTHER BUTTONS

The other buttons have the following functions:

Button	Function	See
	Configuration button	§ 4.1
	Snapshot of current screen and retrieval of screens already stored	§ 5.7
	Help information about functions and the symbols used for current display mode.	§ 5.8

8.3 ABBREVIATIONS

Prefixes of International System (SI) units:

Prefix	Symbol	Multiplies by
milli	m	10^{-3}
kilo	k	10^3
Mega	M	10^6
Giga	G	10^9
Tera	T	10^{12}
Peta	P	10^{15}
Exa	E	10^{18}

Meanings of the symbols and abbreviations used:

\approx	AC and DC components	P	Active power
\sim	AC component only	Pdc	DC power
$=$	DC component only	Pdch	DC energy
	Inductive phase shift	PEAK or PK	Maximum (+) or minimum (-) peak instantaneous value of the signal
\mp	Capacitive phase shift	PF	Power factor
$^{\circ}$	Degree	PLT	Long-term flicker
-.+	Expert mode	PST	Short-term flicker
$ $	Absolute value	Q₁	Reactive power (fundamental)
Σ	Sum of values	Q_{1h}	Reactive energy (fundamental)
%	Percentage	RMS	True RMS value (current or voltage).
%f	Fundamental value as reference	S	Apparent power
%r	Total value as reference	S-h	Apparent harmonic power
$\Phi\Phi_{VA}$ or $\Phi\Phi_{UA}$	Phase shift of voltage with respect to current	Sh	Apparent energy.
A	Current; also Ampere (unit)	t	Relative date of time cursor.
A-h	Current harmonic	tan Φ	Tangent of the phase shift of voltage with respect to current.
Acf	Crest (peak) factor of current	THD	Total harmonic distortion (in %f or in %r).
Ad	RMS distortion current	U	Phase-to-Phase voltage.
Adc	DC current	U-h	Phase-to-phase voltage harmonic.
Apk+	Maximum peak value of the current	Ucf	Phase-to-Phase voltage crest factor.
Apk-	Minimum peak value of the current	Ud	Phase-to-phase RMS distortion voltage.
Athdf	Total harmonic distortion of current in % f	Udc	Phase-to-phase DC voltage.

Athdr	Total harmonic distortion of current in % r	Upk+	Maximum peak value of the phase-to-phase voltage.
Aunb	Current unbalance	Upk-	Minimum peak value of the phase-to-phase voltage.
AVG	Mean value (arithmetic mean)	Urms	True RMS phase-to-phase voltage.
CF	Peak factor (current or voltage)	Uthdf	Total phase-to-phase voltage harmonic distortion in %f.
cos Φ	Cosine of the phase shift of voltage with respect to current (DPF – fundamental power factor or displacement factor)	Uthdr	Total phase-to-phase voltage harmonic distortion in %r.
D	Distortion power	Uunb	Phase-to-phase voltage unbalance.
DC	DC component (current or voltage)	V	Phase-to-neutral voltage; also Volt (unit)
DPF	Displacement factor (cos F)	V-h	Phase-to-neutral voltage harmonic
Dh	Distortion energy.	Vcf	Voltage crest (peak) factor.
FHL	Harmonic loss factor	Vd	Phase-to-neutral RMS distortion voltage.
FK	K factor	Vdc	Phase-to-neutral DC voltage.
Hz	Frequency of network studied	Vpk+	Maximum peak value of the phase-to-neutral voltage.
L	Channel (Line)	Vpk-	Minimum peak value of the phase-to-neutral voltage.
MAX	Maximum value	Vrms	True RMS phase-to-neutral voltage.
MIN	Minimum value	Vthdf	Total harmonic distortion of phase-to-neutral voltage in %f.
ms	Millisecond	Vthdr	Total harmonic distortion of phase-to-neutral voltage in %r.
N	Non-active power	Vunb	Phase-to-neutral voltage unbalance
Nh	Non-active energy.	Vdc	Phase-to-neutral DC voltage.

9. SPECIFICATIONS

9.1 REFERENCE CONDITIONS

Parameter	Reference Conditions
Ambient temperature	73°F ± 5°F (23°C ± 3°C)
Humidity (relative humidity)	[45%; 75%]
Atmospheric pressure	[860 hPa; 1060 hPa]
Phase-to-neutral voltage	[50Vrms; 1000Vrms] without DC (< 0.5%)
Standard current circuit input voltage (except AmpFlex® & MiniFlex®)	[30mVrms; 1Vrms] without DC (< 0.5%) *A _{nom} ↔ 1Vrms 3 × *A _{nom} ÷ 100 ↔ 30mVrms
Unamplified Rogowski current circuit input voltage (Only AmpFlex® & MiniFlex®)	[11.73mVrms; 391mVrms] without DC (< 0.5%) 10kArms ↔ 391mVrms to 50Hz 300Arms ↔ 11.73mVrms to 50Hz
Amplified Rogowski current circuit input voltage (Only AmpFlex® & MiniFlex®)	[117.3μVrms; 3.91mVrms] without DC (< 0.5%) 100Arms ↔ 3.91mVrms to 50Hz 3Arms ↔ 117.3μVrms to 50Hz
Frequency of electrical network	50/60Hz ± 0.1Hz
Phase shift	0° (active power and energy) 90° (reactive power and energy)
Harmonics	< 0.1%
Voltage unbalance	< 10%
Voltage ratio	1 (unity)
Current ratio	1 (unity)
Voltages	Measured (not calculated)
Current sensors	Actual (not simulated)
Power supply	Battery only
Electric field	< 1 V.m ⁻¹ for [80 MHz ; 1 GHz] ≤ 0,3 V.m ⁻¹ for [1 GHz ; 2 GHz] ≤ 0,1 V.m ⁻¹ for [2 GHz ; 2,7 GHz]
Magnetic field	< 40 A.m ⁻¹ DC (earth's magnetic field)

 **NOTE:** The symbol “U” may be used throughout this manual and in the instrument to refer to phase-to-phase voltage measurement. The symbol “V” will be used for phase-to-neutral voltage measurement.

The values of A_{nom} are provided in the table below.

Current Sensor (Excluding AmpFlex® & MiniFlex®)	Nominal RMS current (A _{nom}) [A]	Lower limit of the reference range (3 × A _{nom} ÷ 100) [A]
SR193 clamp	1000	30
MR193 clamp	1000	30
MN93 clamp	200	6
MN193 clamp (100A)	100	3
MN193 clamp (5A)	5	0.15
SL261 clamp (10mV/A)	100	3
SL261 clamp (100mV/A)	10	0.15
5A adapter	5	0.15
J93	3500	105

9.2 ELECTRICAL SPECIFICATIONS

9.2.1 VOLTAGE INPUTS

Range for use: 0 to 1000Vrms AC+DC phase-to-neutral and neutral-to-ground
0 to 2000Vrms AC+DC phase-to-phase

(on condition of compliance with 1000Vrms with respect to ground in CAT III)

Input Impedance: 1195k Ω (between phase and neutral and between neutral and ground)

Admissible Overload: 1200Vrms constant
2000Vrms for one second

9.2.2 CURRENT INPUTS

Operating Range: 0 to 1V

Input Impedance: 1M Ω for current probe circuit
12.4k Ω for AmpFlex[®] and MiniFlex[®] circuit

Overload: 1.7Vrms constant

9.2.3 BANDWIDTH

Measurement channels: 256 points per period, e.g.:

- At 50 Hz: 6.4 kHz ($256 \times 50 \div 2$)
- At 60 Hz: 7.68 kHz ($256 \times 60 \div 2$)

The analogue 3-dB bandwidth: 76 kHz.

9.2.4 POWER SUPPLY

AC Power (external power supply) - 600V CAT IV; 1000V CAT III

Operating Range: 230V_{AC} \pm 10% @ 50Hz and 120V_{AC} \pm 10% @ 60Hz

Max Power: 65VA

Battery Power (allows use in the event of an interruption)

Type: 8 NiMH 4000mAh min

Rated Voltage: 9.6V

Charge Time: 5 hrs approx

Battery Life: 10 hrs (completely charged) approx
>15 hrs (recording in progress) approx

Operating Temperature: 32° to 122°F (0° to 50°C)

Recharging Temperature: 50° to 104°F (10° to 40°C)

Storage Temperature: -4 to +122°F (-20 to +50°C) for \leq 30 days

Typical current when meter is powered	Battery Charging	Battery Charged
Active power (W)	17	6
Apparent power (VA)	30	14
RMS current (mA)	130	60

9.2.5 ACCURACY SPECIFICATIONS (EXCLUDING CURRENT PROBES)

Quantities concerning currents and voltages

Measurement		Measurement range without ratio (with unity ratio)		Display resolution (with unity ratio)	Accuracy
		Minimum	Maximum		
Frequency		40Hz	70Hz	10mHz	±10mHz
RMS voltage ⁽⁵⁾	simple	2V	1000V ⁽¹⁾	100mV V < 1000V	±(0.5% + 200mV)
				1V V ≥ 1000V	±(0.5% + 1V)
	compound	2V	2000V ⁽²⁾	100mV U < 1000V	±(0.5% + 200mV)
				1V U ≥ 1000V	±(0.5% + 1V)
Direct voltage (DC) ⁽⁶⁾	simple	2V	1200V ⁽³⁾	100mV V < 1000V	±(1% + 500mV)
				1V V ≥ 1000V	±(1% + 1V)
	compound	2V	2400V ⁽³⁾	100mV U < 1000V	±(1% + 500mV)
				1V U ≥ 1000V	±(1% + 1V)
RMS ½ voltage	simple	2V	1000V ⁽¹⁾	100mV V < 1000V	±(0.8% + 1V)
				1V V ≥ 1000V	
	compound	2V	2000V ⁽²⁾	100mV U < 1000V	±(0.8% + 1V)
				1V U ≥ 1000V	
Peak voltage	simple	2V	1414V ⁽⁴⁾	100mV V < 1000V	±(3% + 2V)
				1V V ≥ 1000V	
	compound	2V	2828V ⁽⁴⁾	100mV U < 1000V	±(3% + 2V)
				1V U ≥ 1000V	
Severity of short-term flicker (PST)		0	12	0.01	See the corresponding table
Severity of long-term flicker (PLT)		0	12	0.01	Accuracy of PST
Peak factor (PF) (voltage and current)		1	9.99	0.01	±(1% + 5cts) CF < 4
					±(5% + 2cts) CF ≥ 4

Measurement		Measurement range without ratio (with unity ratio)		Display resolution (with unity ratio)	Accuracy
		Minimum	Maximum		
RMS current ⁽⁵⁾	J93 clamp	3A	3500A	1A	±(0.5% + 1A)
	SR193 clamp MR193 clamp	1A	1000A	100mA A < 1000A	±(0.5% + 200mA)
				1A A ≥ 1000A	±(0.5% + 1A)
	MN93 clamp	200mA	200A	100mA	±(0.5% + 200mA)
	SL261 clamp (10mV/A) MN193 clamp (100A)	100mA	100A	10mA A < 100A	±(0.5% + 20mA)
				100mA A ≥ 100A	±(0.5% + 100mA)
	SL261 clamp (100mV/A)	10mA	10A	1mA A < 10A	±(0.5% + 2mA)
				10mA A ≥ 10A	±(0.5% + 10mA)
	MN193 clamp (5A) 5A adapter	5mA	5A	1mA	±(0.5% + 2mA)
	AmpFlex MiniFlex (10kA)	10A	10kA	1A A < 10kA	±(0.5% + 3A)
10A A ≥ 10kA					
AmpFlex MiniFlex (6500A)	10A	6500A	100mA A < 1000A	±(0.5% + 3A)	
			1A A ≥ 1000A		
AmpFlex MiniFlex (100A)	100mA	100A	10mA A < 100A	±(0.5% + 30mA)	
			100mA A ≥ 100A		
Direct current (DC) ⁽⁶⁾	J93 clamp	3A	5000A	1A	±(1% + 1A)
	MR193 clamp	1A	1300A ⁽⁷⁾	100mA A < 1000A	±(1% + 1A)
				1A A ≥ 1000A	
	SL261 clamp (10mV/A)	100mA	100A ⁽⁷⁾	10mA A < 100A	±(1% + 100mA)
				100mA A ≥ 100A	
SL261 clamp (100mV/A)	10mA	10A ⁽⁷⁾	1mA A < 10A	±(1% + 10mA)	
			10mA A ≥ 10A		

(1) In 1000V_{RMS}, category III, provided that the voltage between each of the terminals and earth does not exceed 1000V_{RMS}.

(2) Two-phase (opposite phases) – same note as (1).

(3) Limitation of the voltage inputs.

(4) $1000 \times \sqrt{2} \approx 1414$; $2000 \times \sqrt{2} \approx 2828$;

(5) Total RMS value and RMS value of the fundamental

(6) DC harmonic component (n= 0)

(7) Limitation of the MR193 and SL261 clamps

Measurement		Measurement range without ratio (with unity ratio)		Display resolution (with unity ratio)	Maximum intrinsic accuracy
		Minimum	Maximum		
RMS ½ current	J93 clamp	1A	3500A	1A	±(1% + 1A)
	SR193 clamp MR193 clamp	1 A	1200A	100mA A < 1000A	±(1% + 1A)
				1A A ≥ 1,000A	
	MN93 clamp	200mA	240A	100mA	±(1% + 1A)
	SL261 clamp (10mV/A) MN193 clamp (100A)	0.1A	120A	10mA A < 100A	±(1% + 100mA)
				100mA A ≥ 100A	
	SL261clamp (100mV/A)	10mA	12A	1mA A < 10A	±(1% + 10mA)
				10mA A ≥ 10A	
	MN193 clamp (5A) 5A adapter	5mA	6A	1mA	±(1% + 10mA)
AmpFlex MiniFlex (10kA)	10A	10kA	1A A < 10kA	±(2.5% + 5A)	
			10A A ≥ 10kA		
AmpFlex MiniFlex (6500A)	10A	6500A	100mA A < 1000A	±(2.5% + 5A)	
			1A A ≥ 1000A		
AmpFlex MiniFlex (100A)	100mA	100A	10mA A < 100A	±(2.5% + 200mA)	
			100mA A ≥ 100A		
Peak current (PK)	J93 clamp	1A	4950A ⁽¹⁾	1A	±(1% + 2A)
	SR193 clamp MR193 clamp	1A	1,414A ⁽¹⁾	1A A < 1,000A	±(1% + 2A)
				1A A ≥ 1000A	
	MN93 clamp	200mA	282.8A ⁽¹⁾	100mA	±(1% + 2A)
	SL261 clamp (10mV/A) MN193 clamp (100A)	100mA	141.4A ⁽¹⁾	10mA A < 100A	±(1% + 200mA)
				100mA A ≥ 100A	
	SL261 clamp (100mV/A)	10mA	14.14A ⁽¹⁾	1mA A < 10A	±(1% + 20mA)
				10mA A ≥ 10A	
	MN93A clamp (5A) 5A adapter	5mA	7.071A ⁽¹⁾	1mA	±(1% + 20mA)
AmpFlex MiniFlex (10kA)	10A	14.14kA ⁽¹⁾	1A A < 10kA	±(3% + 5A)	
			10A A ≥ 10kA		
AmpFlex MiniFlex (6500A)	10A	9,192kA ⁽¹⁾	100mA A < 1000A	±(3% + 5A)	
			1A A ≥ 1000A		
AmpFlex MiniFlex (100A)	100mA	141.4A ⁽¹⁾	10mA A < 100A	±(3% + 600mA)	
			100mA A ≥ 100A		

(1) $3500 \times \sqrt{2} \approx 4,950$; $1000 \times \sqrt{2} \approx 1414$; $200 \times \sqrt{2} \approx 282.8$; $100 \times \sqrt{2} \approx 141.4$; $10 \times \sqrt{2} \approx 14.14$; $10,000 \times \sqrt{2} \approx 14,140$;
 $6500 \times \sqrt{2} \approx 9192$;

Quantities concerning powers and energies

Measurement		Measurement range without ratio (with unity ratio)		Display resolution (with unity ratio)	Maximum intrinsic accuracy
		Minimum	Maximum		
Active power (P) ⁽¹⁾	Excluding AmpFlex MiniFlex	10mW ⁽³⁾	10MW ⁽⁴⁾	4 digits at most ⁽⁵⁾	$\pm(1\%)$ $\cos \Phi \geq 0.8$
	AmpFlex MiniFlex				$\pm(1.5\% + 10\text{cts})$ $0.2 \leq \cos \Phi < 0.8$
					$\pm(1\%)$ $\cos \Phi \geq 0.8$
					$\pm(1.5\% + 10\text{cts})$ $0.5 \leq \cos \Phi < 0.8$
Reactive power (Q _r) ⁽²⁾ and non-active (N)	Excluding AmpFlex MiniFlex	10mvar ⁽³⁾	10Mvar ⁽⁴⁾	4 digits at most ⁽⁵⁾	$\pm(1\%)$ $\sin \Phi \geq 0.5$
	AmpFlex MiniFlex				$\pm(1.5\% + 10\text{cts})$ $0.2 \leq \sin \Phi < 0.5$
					$\pm(1.5\%)$ $\sin \Phi \geq 0.5$
					$\pm(2.5\% + 20\text{cts})$ $0.2 \leq \sin \Phi < 0.5$
Distortion power (D) ⁽⁷⁾		10mvar ⁽³⁾	10Mvar ⁽⁴⁾	4 digits at most ⁽⁵⁾	$\pm(4\% + 20\text{cts})$ if $\forall n \geq 1, \tau_n \leq (100 \div n) [\%]$
					or
					$\pm(2\% + (n_{\text{max}} \times 0.5\%) + 100\text{cts})$ $\text{THD}_A \leq 20\%f$
Apparent power (S)		10mVA ⁽³⁾	10MVA ⁽⁴⁾	4 digits at most ⁽⁵⁾	$\pm(1\%)$
DC power (P _{dc})		20mVA ⁽⁸⁾	6MVA ⁽⁹⁾	4 digits at most ⁽⁵⁾	
Power factor (PF)		-1	1	0.001	$\pm(1.5\%)$ $\cos \Phi \geq 0.5$
Active energy (Ph) ⁽¹⁾	Excluding AmpFlex MiniFlex	1mWh	9,999,999MWh ⁽⁶⁾	7 digits at most ⁽⁵⁾	$\pm(1\%)$ $\cos \Phi \geq 0.8$
	AmpFlex MiniFlex				$\pm(1.5\%)$ $0.2 \leq \cos \Phi < 0.8$
					$\pm(1\%)$ $\cos \Phi \geq 0.8$
					$\pm(1.5\%)$ $0.5 \leq \cos \Phi < 0.8$
Reactive energy (Q _r h) ⁽²⁾ and non-active energy (N) ⁽²⁾	Excluding AmpFlex MiniFlex	1mvarh	9,999,999Mvarh ⁽⁶⁾	7 digits at most ⁽⁵⁾	$\pm(1\%)$ $\sin \Phi \geq 0.5$
	AmpFlex MiniFlex				$\pm(1.5\%)$ $0.2 \leq \sin \Phi < 0.5$
					$\pm(1.5\%)$ $\sin \Phi \geq 0.5$
					$\pm(2.5\%)$ $0.2 \leq \sin \Phi < 0.5$
Distortion energy (Dh)		1mvarh	9,999,999Mvarh ⁽⁶⁾	7 digits at most ⁽⁵⁾	$\pm(5.5\%)$ $\text{THD}_A \leq 20\%f$
Apparent energy (Sh)		1mVAh	9,999,999MVAh ⁽⁶⁾	7 digits at most ⁽⁵⁾	$\pm(1\%)$
DC energy (Pdch)		1mWh	9,999,999MWh ⁽¹⁰⁾	7 digits at most ⁽⁵⁾	

(1) The stated accuracy on the active power and energy measurements are maximum for $|\cos \Phi| = 1$ and typical for the other phase differences.

(2) The stated accuracy on the reactive power and energy measurements are maximum for $|\sin \Phi| = 1$ and typical for the other phase shifts.

(3) With MN193 clamp (5A) or 5A adapter.

- (4) With AmpFlex or MiniFlex for a 2-wire single-phase connection (phase-to-ground voltage).
 (5) The resolution depends on the current sensor used and on the value to be displayed.
 (6) The energy is equivalent to more than 114 years of the associated maximum power (unity ratios).
 (7) n_{max} is the highest order for which the harmonic ratio is non-zero.
 (8) With SL261 clamp (100mV/A)
 (9) With J93 clamp, for a 2-wire single-phase connection (phase-to-ground voltage).
 (10) The energy corresponds to more than 190 years at maximum power P_{dc} (unit ratios).

Quantities associated with power

Measurement	Measurement range		Display resolution	Maximum intrinsic accuracy
	Minimum	Maximum		
Phase differences of fundamentals	-179°	180°	1°	±2°
cos Φ (DPF)	-1	1	0.001	±1° for Φ ±5cts for cos Φ
tan Φ	-32.77 ⁽¹⁾	32.77 ⁽¹⁾	0.001 tan Φ < 10	±1° for Φ
			0.01 tan Φ ≥ 10	
Voltage unbalance (UNB)	0%	100%	0.1%	±3cts UNB ≤ 10%
				±10cts UNB > 10%
Current unbalance (UNB)	0%	100%	0.1%	±10cts

(1) $|\tan \Phi| = 32,767$ corresponds to $\Phi = \pm 88.25^\circ + k \times 180^\circ$ (k being a natural number)

Quantities concerning the spectral composition of the signals

Measurement	Measurement range		Display resolution	Maximum intrinsic accuracy
	Minimum	Maximum		
Voltage harmonic ratio (τ_n)	0%	1500%f 100%r	0.1% $\tau_n < 1000\%$	±(2.5% + 5cts)
			1% $\tau_n \geq 1000\%$	
Current harmonic ratio (τ_n) (excluding AmpFlex & MiniFlex)	0%	1500%f 100%r	0.1% $\tau_n < 1000\%$	±(2% + (n × 0.2%) + 10cts) n ≤ 25
			1% $\tau_n \geq 1000\%$	±(2% + (n × 0.6%) + 5cts) n > 25
Current harmonic ratio (τ_n) (AmpFlex & MiniFlex)	0%	1500%f 100%r	0.1% $\tau_n < 1000\%$	±(2% + (n × 0.3%) + 5cts) n ≤ 25
			1% $\tau_n \geq 1000\%$	±(2% + (n × 0.6%) + 5cts) n > 25
Total voltage harmonic distortion (THD) (referred to the fundamental) of voltage	0%	999.9%	0.1%	±(2.5% + 5cts)
Total current harmonic distortion (THD) (referred to the fundamental) of current (excluding AmpFlex & MiniFlex)	0%	999.9%	0.1%	±(2.5% + 5cts) si $\forall n \geq 1. \tau_n \leq (100 \div n)$ [%]
				or
				±(2% + ($n_{max} \times 0.2\%$) + 5cts) $n_{max} \leq 25$
Total current harmonic distortion (THD) (referred to the fundamental) of current (AmpFlex & MiniFlex)	0%	999.9%	0.1%	±(2% + ($n_{max} \times 0.5\%$) + 5cts) $n_{max} > 25$
				or
				±(2.5% + 5cts) si $\forall n \geq 1. \tau_n \leq (100 \div n^2)$ [%]
Total voltage harmonic distortion (THD) (referred to the signal without DC) of voltage	0%	100%	0.1%	±(2% + ($n_{max} \times 0.3\%$) + 5cts) $n_{max} \leq 25$
				or
				±(2% + ($n_{max} \times 0.6\%$) + 5cts) $n_{max} > 25$
Total voltage harmonic distortion (THD) (referred to the signal without DC) of voltage	0%	100%	0.1%	±(2.5% + 5cts)

Total current harmonic distortion (THD) (referred to the signal without DC) of current (excluding AmpFlex & MiniFlex)	0%	100%	0.1%	$\pm(2.5\% + 5\text{cts})$ si $\forall n \geq 1. \tau_n \leq (100 \div n)$ [%]
				or
				$\pm(2\% + (n_{\text{max}} \times 0.2\%) + 5\text{cts})$ $n_{\text{max}} \leq 25$
Total current harmonic distortion (THD) (referred to the signal without DC) of current (AmpFlex & MiniFlex)	0%	100%	0.1%	$\pm(2.5\% + 5\text{cts})$ si $\forall n \geq 1. \tau_n \leq (100 \div n^2)$ [%]
				or
				$\pm(2\% + (n_{\text{max}} \times 0.3\%) + 5\text{cts})$ $n_{\text{max}} \leq 25$
Harmonic loss factor (FHL)	1	99.99	0.01	$\pm(5\% + (n_{\text{max}} \times 0.4\%) + 5\text{cts})$ $n_{\text{max}} \leq 25$
				$\pm(10\% + (n_{\text{max}} \times 0.7\%) + 5\text{cts})$ $n_{\text{max}} > 25$
K factor (FK)	1	99.99	0.01	$\pm(5\% + (n_{\text{max}} \times 0.4\%) + 5\text{cts})$ $n_{\text{max}} \leq 25$
				$\pm(10\% + (n_{\text{max}} \times 0.7\%) + 5\text{cts})$ $n_{\text{max}} > 25$
Phase shifts of harmonics (order ≥ 2)	-179°	180°	1°	$\pm(1.5^\circ + 1^\circ \times (n \div 12.5))$

Note : n_{max} is the highest order for which the harmonic ratio is non-zero.

Measurement		Measurement range (with unity ratio)		Display resolution (with unity ratio)	Maximum intrinsic accuracy
		Minimum	Maximum		
RMS harmonic voltage (order $n \geq 2$)	simple	2V	1000V ⁽¹⁾	100 mV $V < 1000V$	$\pm(2.5\% + 1V)$
				1V $V \geq 1000V$	
	compound	2V	2000V ⁽²⁾	100 mV $U < 1000V$	$\pm(2.5\% + 1V)$
				1V $U \geq 1000V$	
RMS distortion voltage	simple (Vd)	2V	1000V ⁽¹⁾	100 mV $V < 1000V$	$\pm(2.5\% + 1V)$
				1V $V \geq 1000V$	
	compound (Ud)	2V	2000V ⁽²⁾	100 mV $U < 1000V$	$\pm(2.5\% + 1V)$
				1V $U \geq 1000V$	

Measurement		Measurement range (with unity ratio)		Display resolution (with unity ratio)	Maximum intrinsic accuracy
		Minimum	Maximum		
RMS harmonic current (order $n \geq 2$)	J93 clamp	1A	3500A	1A	$\pm(2\% + (n \times 0.2\%) + 1A)$ $n \leq 25$
	SR193 clamp MR193 clamp	1A	1000A	100mA $A < 1000A$	$\pm(2\% + (n \times 0.2\%) + 1A)$ $n \leq 25$
				1A $A \geq 1000A$	$\pm(2\% + (n \times 0.5\%) + 1A)$ $n > 25$
	MN93 clamp	200mA	200A	100mA	$\pm(2\% + (n \times 0.2\%) + 1A)$ $n \leq 25$
					$\pm(2\% + (n \times 0.5\%) + 1A)$ $n > 25$
	SL261 clamp (10mV/A) MN93A clamp (100A)	100mA	100A	10mA $A < 100A$	$\pm(2\% + (n \times 0.2\%) + 100mA)$ $n \leq 25$
				100mA $A \geq 100A$	$\pm(2\% + (n \times 0.5\%) + 100mA)$ $n > 25$
	SL261 clamp (100mV/A)	10mA	10A	1mA $A < 10A$	$\pm(2\% + (n \times 0.2\%) + 10mA)$ $n \leq 25$
				10mA $A \geq 10A$	$\pm(2\% + (n \times 0.5\%) + 10mA)$ $n > 25$
	MN193 clamp (5A) 5A adapter	5mA	5A	1mA	$\pm(2\% + (n \times 0.2\%) + 10mA)$ $n \leq 25$
					$\pm(2\% + (n \times 0.5\%) + 10mA)$ $n > 25$
	AmpFlex MiniFlex (10kA)	10A	10kA	1A $A < 10kA$	$\pm(2\% + (n \times 0.3\%) + 1A + (A_{FRMS}^{(R)} \times 0.1\%))$ $n \leq 25$
				10A $A \geq 10kA^*$	$\pm(2\% + (n \times 0.6\%) + 1A + (A_{FRMS}^{(R)} \times 0.1\%))$ $n > 25$
	AmpFlex MiniFlex (6500A)	10A	6500A	100mA $A < 1000A$	$\pm(2\% + (n \times 0.3\%) + 1A + (A_{FRMS}^{(R)} \times 0.1\%))$ $n \leq 25$
1A $A \geq 1000A$				$\pm(2\% + (n \times 0.6\%) + 1A + (A_{FRMS}^{(R)} \times 0.1\%))$ $n > 25$	
AmpFlex MiniFlex (100A)	100mA	100A	10mA $A < 100A$	$\pm(2\% + (n \times 0.2\%) + 30cts)$ $n \leq 25$	
			100mA $A \geq 100A$	$\pm(2\% + (n \times 0.5\%) + 30cts)$ $n > 25$	

* **NOTE:** Peak Measurement is 14.1kA

Measurement		Measurement range (with unity ratio)		Display resolution (with unity ratio)	Maximum intrinsic accuracy
		Minimum	Maximum		
RMS distortion current (Ad) ⁽⁴⁾	J93 clamp	1A	3500A	1A	$\pm((n_{max} \times 0.4\%) + 1A)$
	SR193 clamp MR193 clamp	1 A	1000A	100 mA A < 1000A 1A A ≥ 1000A	$\pm((n_{max} \times 0.4\%) + 1A)$
	MN93 clamp	200mA	200A	100 mA	$\pm((n_{max} \times 0.4\%) + 1A)$
	SL261 clamp (10mV/A) MN93A clamp (100A)	0.1A	100A	10mA A < 100A 100mA A ≥ 100A	$\pm((n_{max} \times 0.4\%) + 100 \text{ mA})$
	SL261 clamp (100mV/A)	10mA	10A	1mA A < 10A 10mA A ≥ 10A	$\pm((n_{max} \times 0.4\%) + 10 \text{ mA})$
	MN193 clamp (5A) 5A adapter	5mA	5A	1mA	$\pm((n_{max} \times 0.4\%) + 10 \text{ mA})$
	AmpFlex MiniFlex (10kA)	10A	10 kA	1A A < 10 kA 10A A ≥ 10 kA	$\pm((n_{max} \times 0.4\%) + 1A)$
	AmpFlex MiniFlex (6500A)	10A	6500A	100mA A < 1000A 1A A ≥ 1000A	$\pm((n_{max} \times 0.4\%) + 1A)$
	AmpFlex MiniFlex (100A)	100mA	100A	10mA A < 100A 100mA A ≥ 100A	$\pm(n_{max} \times 0.5\%) + 30\text{cts}$

(1) In 1000 V_{RMS}, category III, provided that the voltage between each of the terminals and ground/earth does not exceed 1000 V_{RMS}.

(2) Two-phase (opposite phases) – same note as (1).

(3) RMS value of the fundamental.

(4) n_{max} is the highest order for which the harmonic ratio is non-zero.

Severity of short-term flicker

Rectangular variations per minute (50% duty cycle)	Maximum intrinsic error of the short-term flicker severity measurement (PST)			
	120 V lamp 60 Hz network		230 V lamp 50 Hz network	
1	PST ∈ [0.5 ; 4]	± 5%	PST ∈ [0.5 ; 4]	± 5%
2	PST ∈ [0.5 ; 5]	± 5%	PST ∈ [0.5 ; 5]	± 5%
7	PST ∈ [0.5 ; 7]	± 5%	PST ∈ [0.5 ; 8]	± 5%
39	PST ∈ [0.5 ; 12]	± 5%	PST ∈ [0.5 ; 10]	± 5%
110	PST ∈ [0.5 ; 12]	± 5%	PST ∈ [0.5 ; 10]	± 5%
1620	PST ∈ [0.25 ; 12]	± 15%	PST ∈ [0.25 ; 10]	± 15%

Range of current and voltage ratios

Ratio	Minimum	Maximum
Voltage	100 1000 x $\sqrt{3}$	9,999,900 x $\sqrt{3}$ 0.1
Current ⁽¹⁾	1	60,000 / 1

(1) Only for the MN193 clamp (5A) and the 5A adapter.

Measurement ranges after application of the ratios

Measurement		Measurement range	
		Minimum with minimum ratio(s)	Maximum with maximum ratio(s)
RMS & RMS ½ voltage	simple	120mV	170GV
	compound	120mV	340GV
Direct voltage (DC)	simple	120mV	200GV
	compound	120mV	400GV
Peak voltage (PK)	simple	160mV	240GV
	compound	320mV	480GV
RMS & RMS ½ current		5mA	300kA
Direct current (DC)		10mA	5kA
Peak current (PK)		7mA	420kA
Active power (P)		600µW	51PW ⁽³⁾
DC power (Pdc)		1.2mW	1PW ⁽³⁾
Reactive power (Q _r) non-active (N) and distortion power (D)		600µvar	51Pvar ⁽³⁾
Apparent power (S)		600µVA	51PVA ⁽³⁾
Active energy (Ph)		1mWh	9,999,999EWh ⁽¹⁾
DC energy (Pdch)		1mWh	9,999,999EWh ⁽²⁾
Reactive energy (Q _r ,h) non-active (Nh) and distortion energy (Dh)		1mvarh	9,999,999Evarh ⁽¹⁾
Apparent energy (Sh)		1mVAh	9,999,999EVAh ⁽¹⁾

(1) The energy corresponds to more than 22,000 years of the associated maximum power (maximum ratios).

(2) The energy Pdch corresponds to more than 1 million years at maximum power Pdc (maximum ratios).

(3) Maximum value calculated for a 2-wire single-phase connection (phase-to-ground voltage).

9.2.6 CURRENT PROBE ACCURACY (TO BE ADDED TO THE MODEL 8336'S ACCURACY)

Sensor errors are offset by a typical correction inside the device. This typical correction, applied to the phase and amplitude, depends on the type of sensor connected (detected automatically) and the gain in the current acquisition channel used.

The RMS current measurement error and phase error are additional errors (which must therefore be added to the device errors), indicated as influences on the calculations carried out by the analyzer (powers, energies, power factors, tangents, etc.).

Type of sensor	RMS current (A _{RMS})	Maximum error for A _{RMS}	Maximum error for Φ
AmpFlex 6500A / 10kA	10A to 100A	±3%	±1°
	100A to 10 kA	±2%	±0.5°
MiniFlex 6500A / 10kA	10A to 100A	±3%	±1°
	100A to 10kA	±2%	±0.5°
AmpFlex 100A	100mA to 100A	±3%	±1°
MiniFlex 100A	100mA to 100A	±3%	±1°
J93 clamp 3500A	3A to 50A	-	-
	50A to 100A	±(2% + 2.5A)	±4°
	100A to 500A	±(1.5% + 2.5A)	±2°
	500A to 2000A	±1%	±1°
	2000A to 3500A	±1%	±1.5°
	3500A to 5000A _{DC}	±1%	-

SR193 clamp 1000A	1A to 10A	±0.8%	±1°
	10A to 100A	±0.3%	±0.5°
	100A to 1000A	±0.2%	±0.3°
MR193 clamp 1000A	1A to 10A	±(1.5% + 1A)	-
	10A to 100A	±(1.5% + 1A)	±2°
	100A to 200A	±3%	±1.5°
	200A to 800A	±3%	±1.5°
	800A to 1000A	±5%	±1.5°
	1000A to 1300ADc	±5%	-
MN93 clamp 200A	200mA to 500mA	-	-
	500mA to 10A	±(3% + 1A)	-
	10A to 40A	±(2.5% + 1A)	±3°
	40A to 100A	±(2.5% + 1A)	±3°
	100A to 200A	±(1% + 1A)	±2°
MN193 clamp 100A	100mA to 1A	±(0.7% + 2mA)	±1.5°
	1A to 100A	±0.7%	±0.7°
SL261 clamp (10mV/A) 100A	100mA to 40A	±(2% + 50mA)	±0.5°
	40A to 100A	±7.5%	±0.5°
SL261 clamp (100mV/A) 10A	10mA to 10A	±(1.5% + 50mA)	±1°
Clamp MN193 5A	5mA to 50mA	±(1% + 100µA)	±1.7°
	50mA to 500mA	±1%	±1°
	500mA to 5A	±0.7%	±1°
5A adapter	5mA to 50mA	±(1% + 1.5mA)	±1°
	50mA to 1A	±(0.5% + 1mA)	±0°
	1A to 5A	± 0.5%	±0°

Note: This table does not take into account possible distortion of the measured signal (THD) because of the physical limitations of the current sensor (saturation of the magnetic circuit or of the Hall-effect cell). Class B under standard IEC61000-4-30.

9.2.7 CURRENT PROBES AND SENSORS

When installing probes, face the arrow on the probe in the direction of the load. Note that only AmpFlex® sensors are watertight; all other probes and sensors are non-watertight.

Model SR193	
Nominal Range	1000A _{AC} for f ≤ 1kHz
Measurement Range	1A to 1200A _{AC} max (I > 1000A not continuously)
Probe Output Signal	1mV _{AC} /A _{AC}
Maximum Clamping Ø	2" (52mm)
Safety	EN 61010-2-032, Pollution Degree 2, 600V CAT IV, 1000V CAT III

NOTE: Currents <0.5A will be displayed as zero. Neutral current measures down to 0A.

Model MN93	
Nominal Range	200A _{AC} for f ≤ 1kHz
Measurement Range	2A to 240A _{AC} max (I > 200A not permanent)
Probe Output Signal	5mV _{AC} /A _{AC}
Maximum Clamping Ø	0.8" (20mm)
Safety	EN 61010-2-032, Pollution Degree 2, 300V CAT IV, 600V CAT III

NOTE: Currents <0.5A will be displayed as zero. Neutral current measures down to 0A.

Model MR193	
Nominal Range	1000A _{AC} , 1400A _{DC} max
Measurement Range	10A to 1000A _{AC} , 10A to 1300A _{PEAK AC+DC}
Probe Output Signal	1mV/A
Maximum Clamping Ø	One 1.6" (42mm) or two 0.98" (25.4mm) or two bus bars 1.96 x 0.19" (50 x 5mm)
Safety	EN 61010-2-032, Pollution Degree 2, 300V CAT IV, 600V CAT III

NOTE: Currents <1A_{AC/DC} will be displayed as zero. Neutral current measures down to 0A.

Model MN193	
Nominal Range	5A and 100A _{AC}
Measurement Range	5A: 0.005A to 6A _{AC} max (1A to 1200A with ratio 1000/5 selected) 100A: 0.1A to 120A _{AC} max
Probe Output Signal	5A: 200mV/A _{AC} ; 100A: 10mV/A _{AC}
Maximum Clamping Ø	0.8" (20mm)
Safety	EN 61010-2-032, Pollution Degree 2, 300V CAT IV, 600V CAT III

The 5A range of the MN193 is designed to work with secondary current transformers.

Best accuracy is available when entering the transformer ratio (e.g. 1000/5A). When used to measure 5A direct, the resolution will be limited to 0.1A max.

NOTE: Currents < (Primary x 5) ÷ (Secondary x 1000) or <250mA on the 5A range and <0.2A on the 100A range will be displayed as zero with this probe. Power calculations will also be zeroed when the current is zeroed.

AmpFlex® Sensors	
Nominal Range	3000A _{AC}
Measurement Range	100mA to 10kA
Probe Output Signal*	140mV _{AC} /3000A _{AC} at 60Hz (117.3mV _{AC} /3000A _{AC} at 50Hz)
Sensor	Length = 24" (610mm); Ø = 7.64" (190mm) Length = 36" (910mm); Ø = 11.46" (290mm)
Safety	EN 61010-2-032, Pollution Degree 2, 600V CAT IV, 1000V CAT III

*Output is proportional to the amplitude and frequency of the measured current.

NOTE: Currents <10A will be displayed as zero. Neutral current measures down to 0A (if 6500A or 10kA is selected)
Currents <100mA will be displayed as zero. Neutral current measures down to 0A (if 100A is selected)

MiniFlex® Sensors	
Nominal Range	3000A _{AC}
Measurement Range	100mA to 3000A _{AC}
Probe Output Signal*	47mV _{AC} /1000A _{AC} at 60Hz (39.1 at 1000A _{AC} 50Hz)
Sensor	Length = 10" (250mm); Ø = 2.75" (70mm)
Safety	EN 61010-2-032, Pollution Degree 2, 600V CAT IV, 1000V CAT III

*Output is proportional to the amplitude and frequency of the measured current.

NOTE: Currents <10A will be displayed as zero. Neutral current measures down to 0A. (if 6500A or 10kA is selected)
Currents <100mA will be displayed as zero. Neutral current measures down to 0A. (if 100A is selected)

Limitations of the AmpFlex® and MiniFlex®

Like all Rogowski sensors, the AmpFlex® and MiniFlex® have output voltage that is proportional to the frequency. A high current at high frequency can saturate the instrument's current input.

Model SL261	
Nominal Range	10A to 100A _{AC}
Measurement Range	100mV/A: 100mA to 10A peak 10mV/A: 1 to 100A peak
Probe Output Signal	1000mV peak max
Maximum Clamping Ø	0.46" (11.8mm)
Safety	EN 61010-2-032, Pollution Degree 2, 600V CAT III

NOTE: Currents <0.5A will be displayed as zero. Neutral current measures down to 0A.

Model J93	
Nominal Range	3500A _{AC} and 5000A _{DC}
Measurement Range	50 to 3500A _{AC} 50 to 5000A _{DC}
Maximum Clamping Ø	2.83" (72mm)
Variation of the position of the conductor in the sensor	< ± 2%
Adjacent conductor carrying alternating current	> 35 dB typical, DC to 2kHz
Safety	IEC 61010-2-032, pollution degree 2, 600V CAT IV, 1000V CAT III

9.3 CLASS B UNDER STANDARD IEC 61000-4-30

9.3.1 CONFORMITY OF THE DEVICE

The Model 8336 and its DataView Control Panel software are compliant with class B of standard IEC61000-4-30 for the following parameters:

- Industrial frequency
- Supply voltage amplitude
- Flicker
- Supply voltage brownouts
- Temporary overvoltages at industrial frequency
- Supply voltage blackouts
- Voltage transients
- Supply voltage unbalance
- Voltage harmonics

NOTE: To ensure this compliance, trend recordings (Trend mode) must be made with:

- A recording period of one second
- The quantities V_{rms} and U_{rms} selected
- The quantities V-h01 and U-h01 selected

9.3.2 ACCURACY AND MEASUREMENT RANGES

Parameter		Range	Accuracy	U _{din}
Industrial frequency		[42.5Hz ; 69Hz]	±10mHz	[50V ; 1000V]
Supply voltage amplitude		[50V ; 1000V]	±1% of U _{din}	[50V ; 1000V]
Flicker		[0.25 ; 12]	See the corresponding tables	V ∈ {120V ; 230V} U ∈ {207V ; 400V}
Supply voltage brownouts	Residual voltage	[5% of U _{din} ; U _{din}]	±2% of U _{din}	[50V ; 1000V]
	Duration	[10 ms ; 65,535 days]	80 ppm ±10 ms (maximum) 30 ppm ±10 ms (typical)	
Temporary overvoltages at industrial frequency	Maximum amplitude	[U _{din} ; 150% of U _{din}]	±2% of U _{din}	[50V ; 1000V]
	Duration	[10ms ; 65,535 days]	80 ppm ±10 ms (maximum) 30 ppm ±10 ms (typical)	
Supply voltage blackouts	Duration	[10ms ; 65,535 days]	80 ppm ±10 ms (maximum) 30 ppm ±10 ms (typical)	[50V ; 1000V]
Supply voltage unbalance		[0% ; 10%]	±(0.3% ±3cts)	[50V ; 1000V]
Voltage harmonics	Rate	[0% ; 1500%]	±(2.5% + 5cts)	[50V ; 1000V]
	Voltage	[2V ; 1000V]	±(2.5% + 1V)	

9.3.3 REAL-TIME CLOCK ACCURACY

The accuracy of the real-time clock is 80 ppm at most (device 3 years old used at an ambient temperature of 50°C). With a new device used at 25°C, this accuracy is only 30 ppm.

9.4 MECHANICAL SPECIFICATIONS

Dimensions: 7.9 x 9.8 x 2.6" (200 x 250 x 67mm)

Weight: 5.36 lb (2kg) approx.

Shock and Vibration: per IEC 61010-1

Tightness:

- IP53 per EN 60529 when the instrument is on its stand, with no lead connected, with the jack cover and the cap on the USB connector in the closed position
- IP20 at the level of the measurement terminals
- IK08 per EN 62262
- Drop Test - 1m per IEC 61010-1

9.5 ENVIRONMENTAL SPECIFICATIONS

Reference Temperature: 20 to 26°C (68 to 78.8°F) from 45 to 75% RH

Operating Temperature: 0 to 42.5°C (32 to 108.5°F) from 10 to 85% RH
0 to 50°C (32 to 122°F) from 45 to 75% RH

Storage Temperature:

With batteries: -20 to 35°C (-4 to 95°F) from 0 to 95% RH
-20 to 50°C (-4 to 122°F) from 0 to 75% RH

Without batteries: -20 to 70°C (-4 to 158°F) from 0 to 75% RH

Recharging Temperature: 0 to 40°C (32 to 104°F) max

Altitude

Operating: 0 to 2000 meters (6560 ft)

Non-Operating: 0 to 10,000 meters (32800 ft)

Pollution degree 2

Indoor Use

 **WARNING:** Above 104°F (40°C) the instrument must be powered by the battery alone **OR** from AC power with the battery removed. Use of the instrument with both the battery **AND** AC power is **prohibited**.

9.6 SAFETY SPECIFICATIONS

Electrical Safety



IEC 61010-1; 600V CAT IV or 1000V CAT III

- The use of the AmpFlex®, MiniFlex® and SR probes rate the “device + probe” at **600V CAT IV** or **1000V CAT III**.
- The use of the MR193, MN93, MN193, J93 and SL261 probes rate the “device + current probe” at **300V CAT IV** or **600V CAT III**.
- The use of the 5A adapter rates the “device + current probe” at **150V CAT IV** or **300V CAT III**.

Electromagnetic Compatibility

Emissions and immunity in an industrial setting compliant with IEC 61326-1. For electromagnetic emissions, the instrument belongs to group 1, class A, under standard EN55011. Class A devices are intended for use in industrial environments. There may be difficulties ensuring electromagnetic compatibility in other environments, due to conducted and radiated disturbance.

For immunity to radio frequency fields, the instrument is intended for use at industrial sites under standard IEC61326-1. For the AmpFlex® and MiniFlex® sensors:

- An (absolute) influence of 2% may be observed on the current THD measurement in the presence of a radiated electric field.
- An influence of 0.5A may be observed on the RMS current measurement in the presence of conducted radio frequencies.
- An influence of 1A may be observed on the RMS current measurement in the presence of a magnetic field.

Specifications are subject to change without notice.

APPENDIX

A.1 HYSTERESIS

A.1.1 Surge detection

With a hysteresis of 2%, for example, the return level for surge detection is equal to $(100\% - 2\%)$ or 98% of the reference voltage threshold.

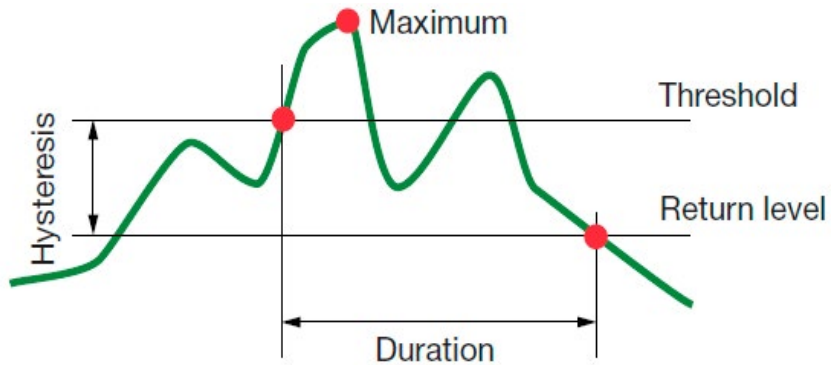

A.1.2 Undervoltage or blackout detection

With a hysteresis of 2%, for example, the return level for undervoltage detection is equal to $(100\% + 2\%)$ or 102% of the U_{ref} voltage threshold.

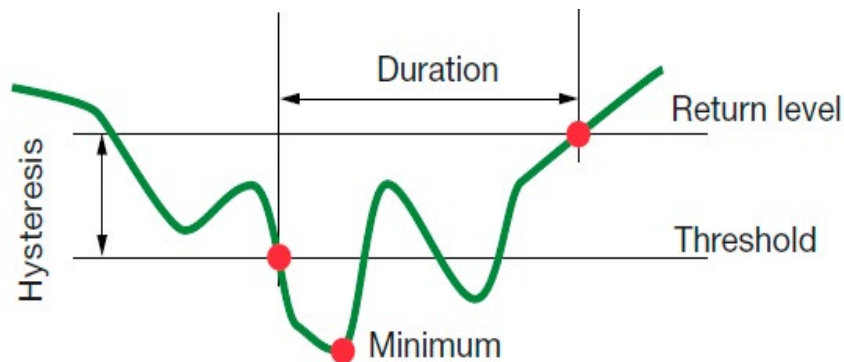

A.1.3 Minimum scale values for waveforms and minimum RMS values

Type	Minimum scale value [waveform mode]	Min RMS values
Phase-to-neutral and phase-to-phase voltages	8V ⁽¹⁾	5V ⁽¹⁾
AmpFlex® & MiniFlex®	90A	10A
SR193	8A	1A
MR193	8A	1A
MN93	2A	0.2A
MN193 (100A)	0.8A	0.1A
SL261 (10mV/A)	0.8A	0.1A
SL261 (100mV/A)	0.08A	0.01A
MN193 (5A)	0.04A ⁽¹⁾	0.005A ⁽¹⁾
5A Adaptor	0.04A ⁽¹⁾	0.005A ⁽¹⁾

⁽¹⁾ Value to be multiplied by the ratio in effect (if not unity).

A.1.4 Four-Quadrant Diagram

This diagram is used for **W** power and energy measurements (see § 5.6).

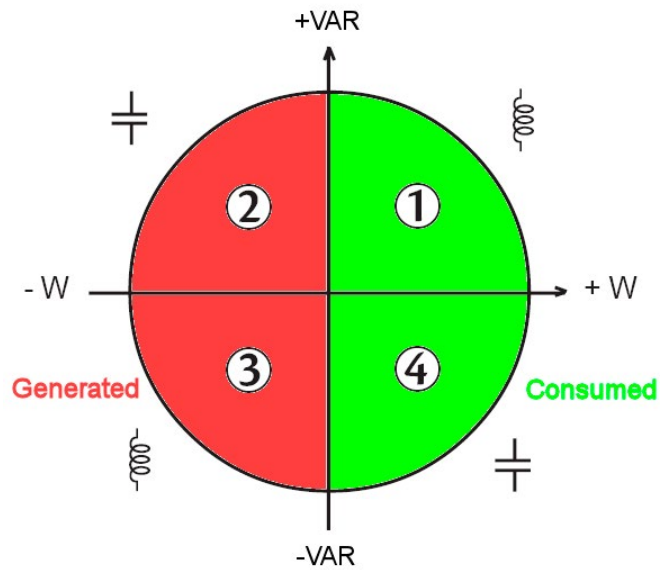

Here VAR is the fundamental reactive power (and not the non-active power).

A.1.5 Mechanism for triggering transient sensors

The sampling rate is a constant 256 samples per cycle. When a transient capture is started, each sample is compared to the sample from the preceding cycle. The preceding cycle defines the mid-point of the trigger envelope and is used as reference. As soon as a sample is outside the envelope, the triggering event occurs; the representation of the transient is then captured by the instrument. The cycle preceding the event and the three following cycles are saved to memory.

The following is a graphical representation of the transient capture trigger mechanism:

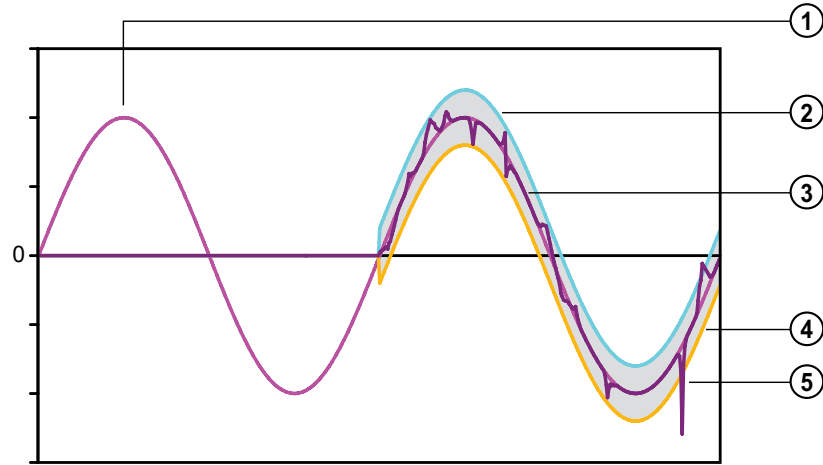

Item	Function
1	Reference period
2	Top of envelope
3	Cycle monitored
4	Bottom of envelope
5	Triggering event

A.1.6 Capture Conditions in Inrush Current Mode

Captures depend on the trigger event and a stop event. If the capture ends with a stop event or if the recording memory of the Model 8336 is full, the capture stops automatically.

The stop threshold for capture is calculated as follows:

$$[\text{Stop threshold [A]}] = [\text{Start threshold [A]}] \times (100 - [\text{Stop hysteresis [\%]}]) \div 100$$

The following table shows the conditions for triggering and stopping capture:

Triggering filter type	Triggering and stop conditions
A1	Triggering condition \Leftrightarrow [A1 half-cycle RMS value] > [Triggering threshold] Stop condition \Leftrightarrow [A1 half-cycle RMS value] < [Stop threshold]
A2	Triggering condition \Leftrightarrow [A2 half-cycle RMS value] > [Triggering threshold] Stop condition \Leftrightarrow [A2 half-cycle RMS value] < [Stop threshold]
A3	Triggering condition \Leftrightarrow [A3 half-cycle RMS value] > [Triggering threshold] Stop condition \Leftrightarrow [A3 half-cycle RMS value] < [Stop threshold]
3A	Triggering condition \Leftrightarrow [the half-cycle RMS value of one current channel] > [Triggering threshold] Stop condition \Leftrightarrow [the half-cycle RMS values of all current channels] < [Stop threshold]

GLOSSARY OF TERMS

\sphericalangle	AC and DC components
\equiv	AC component only
\equiv	DC component only
$\text{—} $	Inductive phase shift
$\text{—} $	Capacitive phase shift
°	Degree
-.+	Expert mode
	Absolute value
Σ	Values of the system
%	Percentage
%f	Fundamental value as reference
%r	Total value as reference
Φ_{VA}	Phase shift of the voltage with respect to the current
A	Current or the unit “ampere”
A-h	Harmonics in current
Acf	Peak factor of the current
Ad	RMS distortion current
Adc	DC current
Ah	Current harmonic
Apk+	Maximum peak value of the current
Apk-	Minimum peak value of the current
Arms	RMS current
Athd	Total harmonic distortion of the current
Athdf	Harmonic distortion of the current with the RMS value of the fundamental as reference
Athdr	Harmonic distortion of the current with the total RMS value without DC as reference
Aunb	Unbalance in current
AVG	Mean value (arithmetic mean)
Blackout	Fall of voltage, at some point in the power network, to below a specified threshold
BTU	British Thermal Unit
CF	Peak factor (Crest Factor) in current or voltage: ratio of the peak value of a signal to the RMS value
Channel and phase	A measurement channel corresponds to a difference in potential between two conductors. A phase is a single conductor. In polyphased systems, a measurement channel may be between two phases, or between a phase and neutral, or between a phase and earth, or between neutral and earth.
cos Φ	Cosine of the phase shift of the voltage with respect to the current (displacement factor – DPF)
D	Distortion power
Dip threshold	Specific voltage used to define the beginning and end of a voltage dip
DC	DC component (current or voltage)
Dh	Distortion energy
DPF	Displacement factor (cos Φ)
E	Exa (10^{18})
FK	K factor. Used to quantify the effect of a load on a transformer
FHL	Harmonic loss factor
Flicker	A visual effect of voltage variations
Frequency	Number of full voltage or current cycles in one second
Fundamental component	Component at the fundamental frequency
G	Giga (10^9)
Harmonics	In electrical systems, voltages and currents at frequencies that are multiples of the fundamental frequency

Hysteresis	Difference between thresholds for reciprocal changes of state
Hz	Frequency of the network
J	Joule
k	kilo (10 ³)
L	Channel (Line)
m	milli (10 ⁻³)
ms	millisecond
M	Mega (10 ⁶)
MAX	Maximum value
MIN	Minimum value
N	Non-active power
Nh	Non-active energy
Nominal voltage	Reference voltage of a network
non-nuclear toe	Non-nuclear tonne oil equivalent
nuclear toe	Nuclear tonne oil equivalent
Order of a harmonic	Ratio of the frequency of the harmonic to the fundamental frequency; a whole number
P	Peta (10 ¹⁵)
P	Active power
Passband	Range of frequencies in which the response of an instrument exceeds some specified minimum
Pdc	DC power
Pdch	DC energy
PF	Power Factor -- ratio of active power to apparent power
Ph	Active energy
Phase	Temporal relationship between current and voltage in alternating current circuits
PK or Peak	Maximum (+) or minimum (-) peak value of the signal
PLT	Long-term severity. The instrument calculates its PLT over 2 hours
PST	Short-term severity. The instrument calculates its PST over 10 minutes
Q₁	Reactive power
Q₁h	Reactive energy
RMS	RMS (Root Mean Square) value of current or voltage. Square root of the mean of the squares of the instantaneous values of a quantity during a specified interval
S	Apparent power
S-h	Power harmonics
Sh	Apparent energy
Temporary surge at industrial frequency	Temporary increase in voltage at some point in the power network, to above a specified threshold
t	Relative date of the Time cursor
T	Tera (10 ¹²)
tan Φ	Tangent of the phase shift of the voltage with respect to the current
THD	Total Harmonic Distortion. The total harmonic distortion describes the proportion of the harmonics of a signal with respect to the fundamental RMS value (%f) or with respect to the total RMS value without DC (%r)
U	Phase-to-phase voltage
U-h	Phase-to-phase voltage harmonics
Ucf	Peak factor of the phase-to-phase voltage
Ud	Phase-to-phase RMS distortion voltage
Udc	Phase-to-phase DC voltage
Uh	Harmonic of the phase-to-phase voltage
Unb	Unbalanced
Upk+	Maximum peak value of phase-to-phase voltage

Upk-	Minimum peak value of phase-to-phase voltage
Urms	Phase-to-phase RMS voltage
Uthd	Total harmonic distortion of the phase-to-phase voltage
Uthdf	Harmonic distortion of the phase-to-phase voltage with the RMS value of the fundamental as reference
Uthdr	Harmonic distortion of the phase-to-phase voltage with the total RMS value without DC as reference
Uunb	Unbalance in phase-to-phase voltage
V	Phase-to-neutral voltage or the unit "volt"
V-h	Harmonics in phase-to-neutral voltage
Vcf	Peak factor of the voltage
Vd	Phase-to-neutral RMS distortion voltage
Vdc	Phase-to-neutral DC voltage
Vpk+	Maximum peak value of the phase-to-neutral voltage
Vpk-	Minimum peak value of the phase-to-neutral voltage
Vh	Harmonic of the phase-to-neutral voltage
Voltage dip	Temporary fall of voltage, at some point in the power network, to below a specified threshold
Voltage unbalance in a polyphased electric power network	State in which the RMS voltages between conductors (fundamental component) and/or the phase differences between successive conductors are not all equal
Vrms	RMS phase-to-neutral voltage
Vthd	Total harmonic distortion of phase-to-neutral voltage
Vthdf	Total harmonic distortion of phase-to-neutral voltage with the fundamental RMS value as reference
Vthdr	Total harmonic distortion of phase-to-neutral voltage with the total RMS value without DC as reference
Vunb	Phase-to-neutral voltage unbalance
Wh	Watt-hour

REPAIR AND CALIBRATION

To ensure that your instrument meets factory specifications, we recommend that it be scheduled back to our factory Service Center at one-year intervals for recalibration, or as required by other standards or internal procedures.

For instrument repair and calibration:

You must contact our Service Center for a Customer Service Authorization Number (CSA#). This will ensure that when your instrument arrives, it will be tracked and processed promptly. Please write the CSA# on the outside of the shipping container. If the instrument is returned for calibration, we need to know if you want a standard calibration, or a calibration traceable to N.I.S.T. (Includes calibration certificate plus recorded calibration data).

Ship To: Chauvin Arnoux®, Inc. d.b.a. AEMC® Instruments

15 Faraday Drive • Dover, NH 03820 USA

Phone: (800) 945-2362 (Ext. 360)

(603) 749-6434 (Ext. 360)

Fax: (603) 742-2346 or (603) 749-6309

E-mail: repair@aemc.com

(Or contact your authorized distributor)

Costs for repair, standard calibration, and calibration traceable to N.I.S.T. are available.

NOTE: You must obtain a CSA# before returning any instrument.

TECHNICAL AND SALES ASSISTANCE

If you are experiencing any technical problems, or require any assistance with the proper operation or application of your instrument, please call, fax or e-mail our technical support team:

Chauvin Arnoux®, Inc. d.b.a. AEMC® Instruments

Phone: (800) 343-1391 • (508) 698-2115

Fax: (508) 698-2118

E-mail: techsupport@aemc.com

LIMITED WARRANTY

The Model 8336 is warranted to the owner for a period of two years from the date of original purchase against defects in manufacture. This limited warranty is given by AEMC® Instruments, not by the distributor from whom it was purchased. This warranty is void if the unit has been tampered with, abused or if the defect is related to service not performed by AEMC® Instruments.

Full warranty coverage and product registration is available on our website at: www.aemc.com/warranty.html.

Please print the online Warranty Coverage Information for your records.

What AEMC® Instruments will do:

If a malfunction occurs within the warranty period, you may return the instrument to us for repair, provided we have your warranty registration information on file or a proof of purchase. AEMC® Instruments will, at its option, repair or replace the faulty material.

IMPORTANT WARRANTY NOTE:

By registering online within 30 days from the date of purchase, your warranty will be extended to 3 years

WARRANTY REPAIRS

What you must do to return an Instrument for Warranty Repair:

First, request a Customer Service Authorization Number (CSA#) by phone or by fax from our Service Department (see address below), then return the instrument along with the signed CSA Form. Please write the CSA# on the outside of the shipping container. Return the instrument, postage or shipment pre-paid to:

Ship To: Chauvin Arnoux®, Inc. d.b.a. AEMC® Instruments

15 Faraday Drive • Dover, NH 03820 USA

Phone: (800) 945-2362 (Ext. 360)

(603) 749-6434 (Ext. 360)

Fax: (603) 742-2346 or (603) 749-6309

E-mail: repair@aemc.com

Caution: To protect yourself against in-transit loss, we recommend you insure your returned material.

NOTE: You must obtain a CSA# before returning any instrument.



08/24

99-MAN 100405 v13