

6050H

Calibration Bath

User's Guide

LIMITED WARRANTY AND LIMITATION OF LIABILITY

Each Fluke product is warranted to be free from defects in material and workmanship under normal use and service. The warranty period is one year and begins on the date of shipment. Parts, product repairs, and services are warranted for 90 days. This warranty extends only to the original buyer or end-user customer of a Fluke authorized reseller, and does not apply to fuses, disposable batteries, or to any product which, in Fluke's opinion, has been misused, altered, neglected, contaminated, or damaged by accident or abnormal conditions of operation or handling. Fluke warrants that software will operate substantially in accordance with its functional specifications for 90 days and that it has been properly recorded on non-defective media. Fluke does not warrant that software will be error free or operate without interruption.

Fluke authorized resellers shall extend this warranty on new and unused products to end-user customers only but have no authority to extend a greater or different warranty on behalf of Fluke. Warranty support is available only if product is purchased through a Fluke authorized sales outlet or Buyer has paid the applicable international price. Fluke reserves the right to invoice Buyer for importation costs of repair/replacement parts when product purchased in one country is submitted for repair in another country.

Fluke's warranty obligation is limited, at Fluke's option, to refund of the purchase price, free of charge repair, or replacement of a defective product which is returned to a Fluke authorized service center within the warranty period.

To obtain warranty service, contact your nearest Fluke authorized service center to obtain return authorization information, then send the product to that service center, with a description of the difficulty, postage and insurance prepaid (FOB Destination). Fluke assumes no risk for damage in transit. Following warranty repair, the product will be returned to Buyer, transportation prepaid (FOB Destination). If Fluke determines that failure was caused by neglect, misuse, contamination, alteration, accident, or abnormal condition of operation or handling, including overvoltage failures caused by use outside the product's specified rating, or normal wear and tear of mechanical components, Fluke will provide an estimate of repair costs and obtain authorization before commencing the work. Following repair, the product will be returned to the Buyer transportation prepaid and the Buyer will be billed for the repair and return transportation charges (FOB Shipping Point).

THIS WARRANTY IS BUYER'S SOLE AND EXCLUSIVE REMEDY AND IS IN LIEU OF ALL OTHER WARRANTIES, EXPRESS OR IMPLIED, INCLUDING BUT NOT LIMITED TO ANY IMPLIED WARRANTY OF MERCHANTABILITY OR FITNESS FOR A PARTICULAR PURPOSE. FLUKE SHALL NOT BE LIABLE FOR ANY SPECIAL, INDIRECT, INCIDENTAL, OR CONSEQUENTIAL DAMAGES OR LOSSES, INCLUDING LOSS OF DATA, ARISING FROM ANY CAUSE OR THEORY.

Since some countries or states do not allow limitation of the term of an implied warranty, or exclusion or limitation of incidental or consequential damages, the limitations and exclusions of this warranty may not apply to every buyer. If any provision of this Warranty is held invalid or unenforceable by a court or other decision-maker of competent jurisdiction, such holding will not affect the validity or enforceability of any other provision.

Fluke Corporation
P.O. Box 9090
Everett, WA 98206-9090
U.S.A.

Fluke Europe B.V.
P.O. Box 1186
5602 BD Eindhoven
The Netherlands

Table of Contents

Title	Page
Before You Start	1
Symbols Used	1
Safety Information	2
Cautions	6
How to Contact Fluke Calibration	7
Product Introduction	8
Specifications and Environmental Conditions	9
Specifications	9
Environmental Conditions	10
Quick Start	10
Unpacking	10
Set Up	11
Power	11
Set the Temperature	11
Installation	13
Bath Environment	13
“Dry-out” Period	14
Bath Preparation and Filling	14
Probe	14
Power	15
Tipping Prevention Brackets Installation	15
Installation on a Concrete Floor	15
Bath Use	16
General	17
Comparison Calibration	17
Calibration of Multiple Probes	18
Parts and Controls	18
Front Panel	18
Bath Tank and Lid	20
Back Panel	22
General Operation	24
Bath Fluid	24
Safety	24
Heat Transfer Salt	24
Stirring	25
Power	25
Heater	26
Fluid Drain	26

Temperature Controller	26
Controller Operation	27
Bath Temperature.....	27
Reset Cutout.....	27
Temperature Set-point.....	29
Programmable Set-points.....	29
Set-point Value	30
Set-point Vernier.....	30
Temperature Scale Units.....	31
Secondary Menu	32
Heater Power.....	32
Proportional Band.....	33
Cutout.....	35
Controller Configuration.....	36
Probe Parameters	36
R0.....	36
ALPHA.....	36
Operating Parameters	36
Cutout Reset Mode.....	37
Stir Mode Select	37
Stir Set-point.....	38
Heat Up Power	38
Serial Interface Parameters.....	39
BAUD Rate	39
Sample Period	40
Duplex Mode	40
Linefeed.....	41
IEEE-488 Parameters.....	41
IEEE-488 Address	41
Calibration Parameters.....	42
CTO.....	42
CO and CG.....	42
H and L.....	43
Digital Communication Interface.....	44
Serial Communications.....	44
Wiring	44
Setup	45
Serial Operation.....	46
IEEE-488 Communication (optional).....	46
Setup	46
IEEE-488 Operation	46
Interface Commands	47
Power Control Functions	50
Calibration Procedure.....	51
Calibration Points	51
Measuring the Set-point Error	51
Computing R0 and ALPHA.....	52
Calibration Example	52
Maintenance.....	54
Troubleshooting.....	55
Troubleshooting Table.....	55
Comments	59
EMC Directive.....	59
Low Voltage Directive (Safety).....	59

List of Tables

Table	Title	Page
1.	Symbols.....	1
2.	Interface Command Summary	47
3.	Power Control Commands	50

List of Figures













Figure	Title	Page
1.	6050H Bath Cross Section (Optional Cart Shown)	8
2.	Tipping Prevention Bracket Installation	16
3.	Front Panel.....	18
4.	Bath and Lid Components.....	20
5.	Back Panel Features	23
6.	Controller Operation Flow Chart.....	28
7.	Bath Temperature Fluctuation at Various Proportional Band Settings	33
8.	Serial Communication Cable Wiring.....	44
9.	Calibration Example	53





Before You Start

Symbols Used

Table 1 lists the International Electrical Symbols. Some or all of these symbols may be used on the instrument or in this manual.

Table 1. Symbols

Symbol	Description
	WARNING. HAZARDOUS VOLTAGE. Risk of electric shock.
	WARNING - RISK OF DANGER. Consult user documentation.
	AC (Alternating Current)
	AC-DC
	DC
	Double Insulated
	PE Ground
	Battery
	Hot surface
	Off
	On
	Certified by CSA Group to North American safety standards.
CAT II	Measurement Category II is applicable to test and measuring circuits connected directly to utilization points (socket outlets and similar points) of the low-voltage MAINS installation.

	Conforms to European Union directives.
	Conforms to relevant Australian EMC standards.
	Fuse
	This product complies with the WEEE Directive marking requirements. The affixed label indicates that you must not discard this electrical/electronic product in domestic household waste. Product Category: With reference to the equipment types in the WEEE Directive Annex I, this product is classed as category 9 "Monitoring and Control Instrumentation" product. Do not dispose of this product as unsorted municipal waste.

Safety Information

DISCLAIMER: Fluke Calibration manufactures baths for the purpose of temperature calibration. Baths used for applications other than calibration are used at the discretion and sole responsibility of the customer. Hart Scientific cannot accept any responsibility for the use of baths for any application other than temperature calibration.

Use this instrument only as specified in this manual. Otherwise, the protection provided by the instrument may be impaired.

The following definitions apply to the terms "Warning" and "Caution".

"WARNING" identifies conditions and actions that may pose hazards to the user.

"CAUTION" identifies conditions and actions that may damage the instrument being used.

WARNING

To avoid personal injury, follow these guidelines.

GENERAL

- **Appropriate personal safety protection should be worn by the operator at all times while using the bath.**
- **Fluke Calibration does not recommend that user's drain the salt from the bath. Fluke Calibration provides the service of draining salt from the bath. If draining the bath salt is necessary, contact an Authorized Service Center (see the How to Contact Fluke Calibration section) for an RMA and instructions on returning the bath. Insure that the control probe is removed from the bath before the salt solidifies. If the control probe is not removed before shipping the bath, the control probe may be damaged during shipping and the Service Centers assume no liability for damage incurred during shipping.**
- **DO NOT use the instrument for any application other than calibration work. The instrument was designed for temperature calibration. Any other use of the unit may cause unknown hazards to the user.**
- **DO NOT use the unit in environments other than those listed in the user's guide.**

- **DO NOT** overfill the bath. Overflowing extremely hot fluid may be harmful to the operator. See the *Bath Preparation and Filling* section for specific instructions.
- Follow all safety guidelines listed in the user's manual.
- Calibration Equipment should only be used by Trained Personnel.
- If this equipment is used in a manner not specified by the manufacturer, the protection provided by the equipment may be impaired.
- Before initial use, or after transport, or after storage in humid or semi-humid environments, or anytime the instrument has not been energized for more than 10 days, the instrument needs to be energized for a "dry-out" period of 2 hours before it can be assumed to meet all of the safety requirements of the IEC 1010-1. If the product is wet or has been in a wet environment, take necessary measures to remove moisture prior to applying power such as storage in a low humidity temperature chamber operating at 50 °C for 4 hours or more.
- **DO NOT** operate high temperature baths (500 °C) near flammable materials. Extreme temperatures could ignite the flammable material.
- Overhead clearance is required. Do not place the instrument under a cabinet or other structure. Always leave enough clearance to allow for safe and easy insertion and removal of probes.
- The instrument is intended for indoor use only.
- Ensure that you check the appropriate OSHA and local fire code regulations for proper equipment required to suppress a fire for the Salt utilized in the bath.

BURN HAZARD

- High temperatures may be present in this equipment. Fires and severe burns may result if personnel fail to observe safety precautions.
- Ensure the bath **DOES NOT** contain any water and has been completely dried prior to filling with salt. Any trapped water can cause a steam explosion resulting in personal injury. If the bath has recently been filled with water, ensure the inside of the drain tube is dry prior to filling the bath with salt.

- When immersing any object in the bath, ensure that you are not introducing anything into the bath that will react with the bath salt. Ensure that probes are DRY and free of contaminants. Read the MSDS (Material Safety Data Sheet) for the salt used. If you are still unsure if the material you are going to introduce into the bath will react with the salt, refer to the individual MSDS sheets for the three components that make up the salt.
- The bath is provided with an access cover. The access cover can be modified to allow the probes being calibrated to be inserted through the access cover. The bath should be operated with the access cover on at all times. Operating the bath without the access cover reduces stability, increases out gassing of fluids, and increases the possibility of personal injury or fire hazard.
- When removing probes from the bath DO NOT wipe probes down with a paper towel. If the bath setpoint is high, the salt can cause the paper towel to ignite in your hand. Provide a safe surface and situation for the probes to cool prior to cleaning the salt from the probes.
- The bath generates extreme temperatures. Precautions must be taken to prevent personal injury or damage to objects. Probes may be extremely hot when removed from the bath. Cautiously handle probes to prevent personal injury. Carefully place probes on a heat resistant surface or rack until they are at room temperature.
- Be extremely careful when filling the bath with salt and bringing it up to temperature. Salt expands with temperature. It is easy to add salt, but extremely dangerous to remove hot molten salt because the bath is over filled. DO NOT fill the bath above the indicated fill line when the stirring is on. It will overflow.

ELECTRICAL HAZARD

- These guidelines must be followed to ensure that the safety mechanisms in this instrument will operate properly. This instrument must be plugged into an outlet as listed in the *Specifications* section. The power cord of the instrument is equipped with a three-pronged grounding plug for your protection against electrical shock hazards. It must be plugged directly into a properly grounded three-prong receptacle. The receptacle must be installed in accordance with local codes and ordinances. Additionally, the instrument has a Permanent Earth Ground that must be connected during use. Consult a qualified electrician. DO NOT use an extension cord or adapter plug.

- **DO use a 30 mA ground fault interrupt device. This unit contains a liquid. A ground fault device is advised in case liquid is present in the electrical system and could cause an electrical shock.**
- **Always replace the power cord with an approved cord of the correct rating and type. If you have questions, contact an Authorized Service Center (see the *How to Contact Fluke Calibration* section).**
- **High voltage is used in the operation of this equipment. Severe injury or death may result if personnel fail to observe the safety precautions. Before working inside the equipment, turn off the power and disconnect the power cord.**
- **Keep all combustible materials away from the bath when using salt. Operate the bath on a heatproof surface such as concrete. Provide a means of safety for containing any spill, which may occur.**

BATH SALT

- **Salt used in this unit may produce noxious or toxic fumes under certain circumstances. Consult the fluid manufacturer's MSDS (Material Safety Data Sheet). Proper ventilation and safety precautions must be observed.**
- **The unit is equipped with a soft cutout (user settable firmware) and a hard cutout (set at the factory). Check the flash point, boiling point, or other fluid characteristic applicable to the circumstances of the unit operation. Ensure that the soft cutout is adjusted to the fluid characteristics of the application. Failing to set the cutout to the limits of the bath fluid can result in fire hazards and personal injury.**

Cautions

⚠ Caution

- Always operate the instrument in room temperatures listed in the *Environmental Conditions* section. Allow sufficient air circulation by leaving at least 15 cm (6 inches) of clearance around the instrument.
- DO NOT overfill the bath. Overflowing liquid may damage the electrical system. Be sure to allow for thermal expansion of the fluid as the bath temperature increases. See the *Bath Preparation and Filling* section, for specific instructions.
- Read the *Bath Use* section, before placing the bath into service.
- DO NOT change the values of the bath calibration constants from the factory set values. The correct setting of these parameters is important to the safety and proper operation of the unit.
- Only authorized personnel should perform the Factory Reset Sequence if no other action is successful in correcting a malfunction. You must have a copy of the most recent Report of Test to restore the test parameters.
- DO NOT operate this instrument in an excessively wet, oily, dusty, or dirty environment.
- The bath is a precision instrument. Although it has been designed for optimum durability and trouble free operation, it must be handled with care. Position the bath before the tank is filled with salt.
- Most probes have handle temperature limits. Be sure that the probe handle temperature limit is not exceeded in the air above the instrument.
- The instrument and any thermometer probes used with it are sensitive instruments that can be easily damaged. Always handle these devices with care. Do not allow them to be dropped, struck, stressed, or overheated.
- DO ensure the salt is cleaned from the probes prior to immersing the probe in the next bath. Clean your probe between each bath to avoid contamination between bath fluids.
- Under filling the bath may reduce the bath performance and may possibly damage the bath.
- When calibrating PRTs always follow correct calibration procedure and calibrate from high temperatures to low temperatures with the appropriate triple point of water checks. Never immerse a wet or cold PRT into a bath filled with hot fluid. Severe damage to the PRT may result as well as personal injury to the calibration technician.

- **This bath is not designed to be portable. Therefore, moving the bath once it has been installed should be kept to a minimum. NEVER MOVE A BATH THAT IS FULL OF “HOT” FLUID. This action could be extremely dangerous and could result in personal injury to the person moving the bath. If the bath is going to be placed in an area where it may need to be moved frequently, Fluke Calibration sells a special cart designed to accommodate the bath. However, even with a cart the bath should not be moved full of “hot” fluid. The fluid can splash causing injury or if the bath and cart tip, the “hot” fluid could cause damage to the surrounding area and personnel.**
- **If the bath must be moved, allow the salt to solidify and cool. Care must be used when moving the bath with the fluid solidified in the bath. The control probe can easily be damaged. Two people are required to safely move the bath. One person should lift the bath by the tower, while the second person lifts from underneath the bath tank.**
- **The control probe must be inserted through the lid into the bath fluid and plugged into the socket at the back of the bath. DO NOT operate the bath without the control probe properly inserted and attached. The bath will not operate correctly without the control probe. Injury to operating personnel and permanent damage to the bath could occur.**

How to Contact Fluke Calibration

To contact Fluke Calibration, call one of the following telephone numbers:

- Technical Support USA: 1-877-355-3225
- Calibration/Repair USA: 1-877-355-3225
- Canada: 1-800-36-FLUKE (1-800-363-5853)
- Europe: +31-40-2675-200
- Japan: +81-3-6714-3114
- Singapore: +65-6799-5566
- China: +86-400-810-3435
- Brazil: +55-11-3759-7600
- Anywhere in the world: +1-425-446-6110

To see product information and download the latest manual supplements, visit Fluke Calibration's website at www.flukecal.com.

To register your product, visit <http://flukecal.com/register-product>.

When contacting Fluke Calibration, please have the following information:

- Model Number
- Serial Number
- Voltage
- Complete description of the problem

Product Introduction

The Fluke Calibration 6050H is a constant temperature bath intended mainly for the application of temperature calibration. However, its high stability and the availability of factory modifications make it suitable for other uses as well.

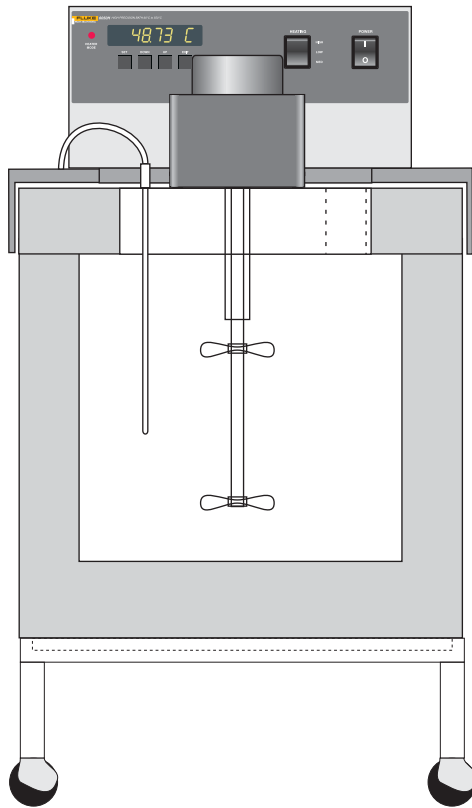

Figure 1. 6050H Bath Cross Section (Optional Cart Shown)

6050 cross section.eps

Specifications and Environmental Conditions

Specifications

6050H	
Range	180 °C to 550 °C †
Stability	±0.002 °C at 200 °C (salt) ±0.004 °C at 300 °C (salt) ±0.008 °C at 550 °C (salt)
Uniformity	±0.005 °C at 200 °C (salt) ±0.020 °C at 550 °C (salt)
Temperature Setting	Digital display with push-button data entry
Set-Point Resolution	0.01 °C; high-resolution mode, 0.00018 °C
Display Temperature Resolution	0.01 °C
Digital Setting Accuracy	±1 °C
Digital Setting Repeatability	±0.02 °C
Heaters	400/1200/2000 Watts
Access Opening	5" x 10" (127 x 254 mm)
Depth	12" (305 mm)
Wetted Parts	304 stainless steel
Power	230 VAC (±10 %), 50/60 Hz, 10 A, 2200 W
Volume	7.1 gallons (27 liters), requires 112 lb. of bath salt
Weight	180 lb. (82 kg)
Size	28.5" H x 20.4" W x 24.5" D (724 x 518 x 622 mm)
Automation Package	Interface-it software and RS-232 computer interface are available for setting bath temperature via remote computer. For IEEE-488, add the 2001-IEEE to the automation package.
Safety	OVERVOLTAGE (Installation) CATEGORY II, Pollution Degree 2 per IEC61010-1

Environmental Conditions

Although the instrument has been designed for optimum durability and trouble-free operation, it must be handled with care. The instrument should not be operated in an excessively dusty or dirty environment. Maintenance and cleaning recommendations can be found in the Maintenance Section of this manual.

The instrument operates safely under the following conditions:

- ambient temperature range: 5 50 °C (41 122 °F)
- ambient relative humidity: maximum 80% for temperature <31 °C, decreasing linearly to 50 % at 40 °C
- mains voltage within ± 10 % of nominal
- vibrations in the calibration environment should be minimized
- altitude less than 2,000 meters
- indoor use only

Quick Start

⚠ Caution

READ the *Bath Use* section before placing the bath in service. Incorrect handling can damage the bath and void the warranty.

This section gives a brief summary of the steps required to set up and operate the 6050H bath. This should be used as a general overview and reference and not as a substitute for the remainder of the manual. Please read *Installation* through *General Operation* carefully before operating the bath.

Unpacking

Unpack the bath carefully and inspect it for any damage that may have occurred during shipment. If there is shipping damage, notify the carrier immediately.

Verify that all components are present:

- Bath
- Access Hole Cover
- Controller Probe
- Manual
- Report of Test

If you are missing any item, please contact Fluke Calibration.

Set Up

Set up of the bath requires careful unpacking and placement of the bath, filling the bath with fluid, installing the probe and connecting power. Consult the *Installation* section for detailed instructions for proper installation of the bath. Be sure to place the bath in a safe, clean and level location. Remember that the bath operates at very high temperatures.

Fill the bath tank with salt. (See the *Heat Transfer Salt* section.) Refer to sections *Bath Use* through *Parts and Controls* for more information on bath setup and use.

The control probe **must** be inserted through the lid into the bath and plugged into the socket at the back of the bath. DO NOT operate the bath without the control probe properly installed.

Power

Plug the bath power cord into a mains outlet of the proper voltage, frequency, and current capability. See the Specifications section for power details. Additionally, a separate ground connection is provided and required to permanently connect the instrument to earth ground for added operator safety.

Set the Temperature

In the following discussion a solid box around the word SET, UP, EXIT or DOWN indicates the panel button while the dotted box indicates the display reading. Explanation of the button or display reading are to the right of each button or display value.

To view or set the bath temperature set-point proceed as follows. The front panel LED display normally shows the actual bath temperature.



Bath temperature display

When "SET" is pressed the display shows the set-point memory that is currently being used and its value. Eight set-point memories are available.



Access set-point selection

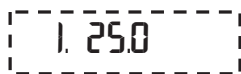

Set-point 1, 25.0 °C currently used

Press "SET" to select this memory and access the set-point value.



Access set-point value



Current value of set-point 1, 25.00 °C

Press "UP" or "DOWN" to change the set-point value.



Increment display



New set-point value

Press "SET" to accept the new value and display the vernier value. The bath begins heating or cooling to the new set-point.



Store new set-point, access vernier



Current vernier value

Press "EXIT" and the bath temperature will be displayed again.



Return to the temperature display

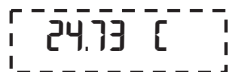

Bath temperature display

The bath heats or cools until it reaches the new set-point temperature. Set the heater switch to position "MED" or "HIGH" to allow the bath to more quickly reach a higher temperature. The higher heater settings may be necessary to reach higher temperatures and control at high temperatures.

When setting the set-point temperature be careful not to exceed the temperature limit of the bath fluid. The over-temperature cutout should be correctly set to prevent this from happening. See the *Cutout* section.

If operating the bath below 45 °C set the COOLING power switch to ON. The cooling temperature may require adjustment to provide the proper amount of cooling. See the *Cooling* section.

To obtain optimum control stability adjust the proportional band as discussed in the *Proportional Band* section.

Installation

⚠ Caution

Read the *Bath Use* section before placing the bath in service. Incorrect handling can damage the bath and void the warranty.

This bath is not designed to be portable. Therefore, moving the bath once it has been installed should be kept to a minimum.

⚠ Warning

Never move a bath that is full of fluid. This action could be extremely dangerous and could result in personal injury to the person moving the bath.

If the bath is going to be placed in an area where it will need to be moved frequently, Fluke Calibration sells a special cart designed to accommodate the bath. Thus making the bath much more portable. However, even with a cart the bath should not be moved full of “hot” fluid. The fluid can splash causing injury or if the bath and cart tip, the “hot” fluid could cause damage to the surrounding area and personal injury to personnel.

⚠ Caution

Care must be used when moving the bath with the fluid solidified in the bath. The control probe can easily be damaged.

If the bath must be moved, all the salt to solidify and cool. To safely move the bath, two people are required. One person should lift the bath by the tower, while the second person slides their hands underneath the bath tank and lifts the bath.

Bath Environment

⚠ Caution

DO NOT place under a cabinet or other structure. Allow for overhead clearance.

The 6050H bath is a precision instrument which should be located in an appropriate environment. The location should be free of drafts, extreme temperatures and temperature changes, dirt, etc. The surface where the bath is placed must be level.

Because the bath is designed for operation at high temperatures, keep all flammable and meltable materials away from the bath. Although the bath is well insulated, top surfaces do become hot. Beware of the danger of accidental fluid spills. We recommend placing the bath on a heat-proof surface such as concrete with plenty of clear space around the bath.

If the bath is operated at high temperatures, a fume hood should be used to remove any vapors given off by hot bath fluid.

“Dry-out” Period

⚠ Warning

Before initial use, after transport, and any time the instrument has not been energized for more than 10 days, the bath will need to be energized for a “dry-out” period of 1-2 hours before it can be assumed to meet all of the safety requirements of the IEC 1010-1. If the product is wet or has been in a wet environment, take necessary measures to remove moisture prior to applying power such as storage in a low humidity temperature chamber operating at 50 °C for 4 hours or more.

Bath Preparation and Filling

The Model 6050H Bath is only intended to be used with salt. Bath salt is available from Hart Scientific and other sources.

Bath salt is discussed in detail in the *Bath Fluid* section.

Remove any access hole cover from the bath and check the tank for foreign matter (dirt, remnant packing material, etc.).

Before filling the bath make sure the drain is well plugged (see Figure 4 and Figure 5). When using heat transfer salt you must follow a special procedure in filling and heating the bath because the salt is solid at lower temperatures. See the *Heat Transfer Salt* section.

Disconnect power to the stirrer if at any time the material in the bath is solid and prevents the stirrer from turning. Fill the bath with clean unpolluted salt. Fill the bath carefully through the large square access hole to a level that will allow for stirring and thermal expansion. Under-filling may reduce bath performance and may possibly damage the bath heater. The salt should never exceed a height of 1/2” below the top of the tank. See Figure 4 for reference to the fluid level with regards to the top of the tank and the lid of the bath. Carefully monitor the bath fluid level as the bath temperature rises to prevent overflow or splashing. Use caution to prevent bath fluid from spilling on the stir motor while filling.

⚠ Caution

Underfilling may reduce bath performance and may possibly damage the bath.

Probe

Inspect the bath controller probe (see Figure 4). It should not be bent or damaged in any way. Reasonable caution should be used in handling this probe as it contains a precision platinum sensor and is mechanically shock sensitive. Dropping, striking, or other physical shock may cause a shift in resistance in the probe resulting in diminished bath accuracy. If damaged, the probe can be replaced. Contact the factory.

Insert the probe into the 1/4 inch probe hole at the top left side of the bath lid. The tip of the probe must be well immersed in the fluid. The probe connector is plugged into the rear of the bath into the socket labeled “PROBE”.

Power

With the bath power switch off (see Figure 3), plug the bath into an AC mains outlet of the appropriate voltage, frequency, and current capacity (see the Specifications section for power details). A separate ground connection is provided and required to permanently connect the instrument to earth ground for added operator safety.

Be sure the stirring motor power cord is plugged into the “STIRRER” socket at the back of the bath (see Figure 5).

Tipping Prevention Brackets Installation

Warning

Fluke Calibration recommends installing the bath on a heat-resistant non-flammable surface.

In order to create the safest possible conditions under use, your bath comes equipped with Tipping Prevention Brackets. The installation of the brackets is required for compliance with the International Safety Standard IEC 61010-1, Section 7.3, Stability, which applies to the stability of the bath under normal operating conditions.

Installation on a Concrete Floor

Using a concrete drill and concrete drill bit, drill three 1/4 inch x 1 1/4 inch deep (approximately 6.5 mm x 32 mm) holes in the concrete floor using the bracket to mark the hole placement. Drop the flare anchor bolt into the hole. Tightening the screw expands the anchor in the drilled hole and secures the bracket. Ensure that the bracket is installed in such a way as to ensure the bath will have a minimum of 6 inches of clearance for air circulation (see Figure 2). Screw the brackets securely to the floor.

Installation of The Bath

Slide the back casters of the bath completely into the bracket caster slots (see Figure 2). Lock the front casters of the bath. Check that the bath is securely locked into the brackets by gently pushing on the bath. Proceed to fill the bath with the applicable bath fluid after reading the entire User's Guide. If you have any questions concerning installation of the tipping prevention brackets, please contact an Authorized Service Center (see the *How to Contact Fluke Calibration* section).

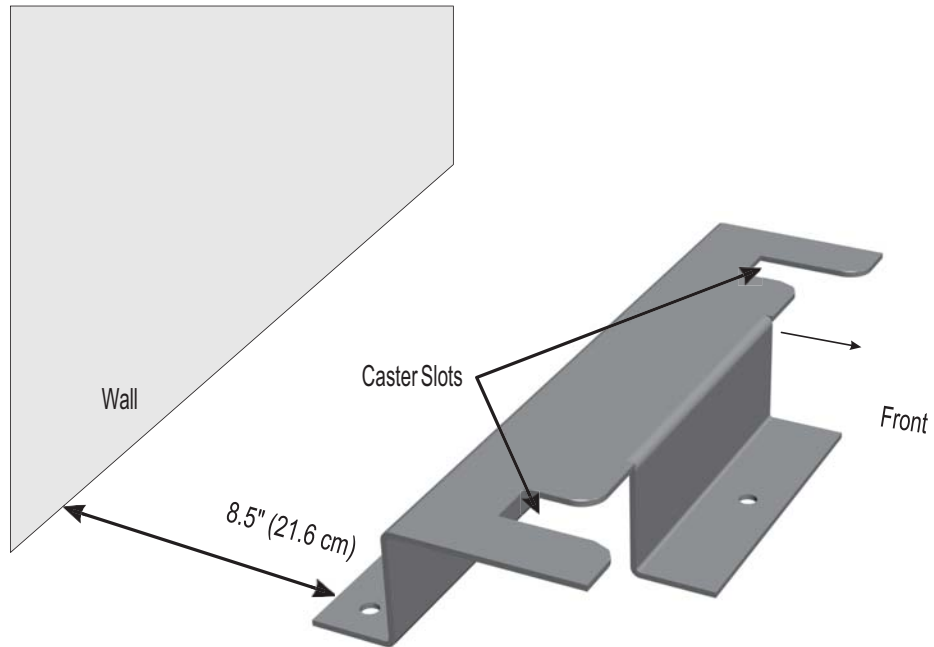

tip.eps

Figure 2. Tipping Prevention Bracket Installation

Bath Use

⚠ Caution

Read before placing bath in service.

The information in this section is for general information only. It is not designed to be the basis for calibration laboratory procedures. Each laboratory will need to write their own specific procedures.

General

The 6050H bath is intended to be used with heat transfer salt only. Refer to the MSDS (Material Safety Data Sheet) for information specific to the salt selected. Generally, baths are set to one temperature and used to calibrate probes only at that single temperature. This means that the type of bath fluid does not have to change. Additionally, the bath can be left energized reducing the stress on the system.

The bath generates extreme temperatures. Precautions must be taken to prevent personal injury or damage to objects. Probes may be extremely hot or cold when removed from the bath. Cautiously handle probes to prevent personal injury. Carefully place probes on a heat/cold resistant surface or rack until they are at room temperature. It is advisable to remove the salt from the probe before inserting it into another bath. This prevents the mixing of fluids from one bath to another. If the probe has been calibrated in liquid salt, carefully wash the probe in warm water and dry completely before transferring it to another fluid. Always be sure that the probe is completely dry before inserting it into a hot fluid. Some of the high temperature fluids react violently to water or other liquid mediums. Be aware that cleaning the probe can be dangerous if the probe has not cooled to room temperature. Additionally, high temperature fluids may ignite the paper towels if the probe has not been cooled.

For optimum accuracy and stability, allow the bath adequate stabilization time after reaching the set-point temperature. Modify the access cover to accept probes for calibration. The bath should be covered at all times. Allowing the access cover to be open during the calibration process reduces the stability and accuracy of the test and increases the outgassing of the fluid which can cause safety concerns for attending personnel.

Comparison Calibration

Comparison calibration involves testing a probe (unit under test, UUT) against a reference probe. After inserting the probes to be calibrated into the bath, allow sufficient time for the probes to settle and the temperature of the bath to stabilize.

One of the significant dividends of using a bath rather than a dry-well to calibrate multiple probes is that the probes do not need to be identical in construction. The fluid in the bath allows different types of probes to be calibrated at the same time. However, stem effect from different types of probes is not totally eliminated. Even though all baths have horizontal and vertical gradients, these gradients are minimized inside the bath work area. Nevertheless, probes should be inserted to the same depth in the bath liquid. Be sure that all probes are inserted deep enough to prevent stem effect. From research at Fluke Calibration, we suggest a general rule-of-thumb for immersion depth to reduce the stem effect to a minimum: $15 \times \text{the diameter of the UUT} + \text{the sensor length}$. **Do not submerge the probe handles.** If the probe handles get too warm during calibration at high temperatures, a heat shield could be used just below the probe handle. This heat shield could be as simple as aluminum foil slid over the probe before inserting it in the bath or as complicated as a specially designed reflective metal apparatus.

When calibrating over a wide temperature range, better results can generally be achieved by starting at the highest temperature and progressing down to the lowest temperature.

Probes can be held in place in the bath by using probe clamps or drilling holes in the access cover. Other fixtures to hold the probes can be designed by the metrologist. The object is to keep the reference probe and the probe(s) to be calibrated as closely grouped as possible in the working area of the bath. Bath stability is maximized when the bath working area is kept covered.

In preparing to use the bath for calibration start by:

- Placing the reference probe in the bath working area.
- Placing the probe to be calibrated, the UUT, in the bath working area as close as feasibly possible to the reference probe.

Calibration of Multiple Probes

Fully loading the bath with probes increases the time required for the temperature to stabilize after inserting the probes. Using the reference probe as the guide, be sure that the temperature has stabilized before starting the calibration.

Parts and Controls

Front Panel

The following controls and indicators are present on the controller front panel (see Figure 2 below):

- ① the digital LED display
- ② the control buttons
- ③ the bath on/off power switch
- ④ the control indicator light
- ⑤ the heater power switch
- ⑥ the cooling power switch.

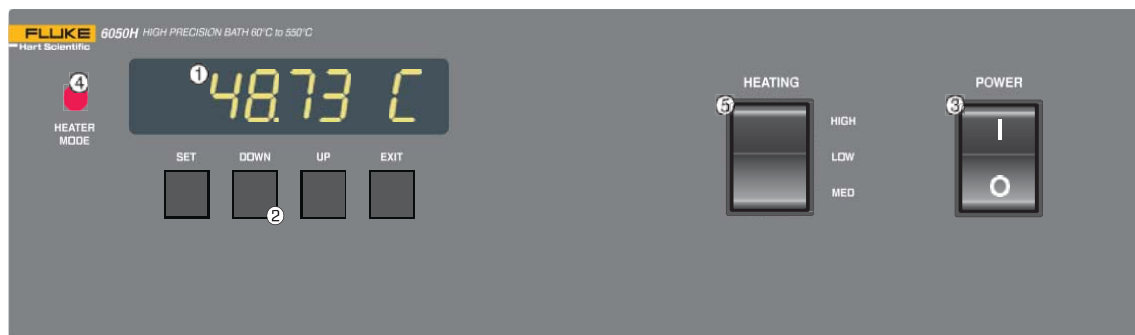

Figure 3. Front Panel

figure 2.eps

1. The digital display is an important part of the temperature controller. It displays the set-point temperature and bath temperature as well as the various other bath functions, settings, and constants. The display shows temperatures in values according to the selected scale units °C or °F.
2. The control buttons (SET, DOWN, UP, and EXIT) are used to set the bath temperature set-point, access and set other operating parameters, and access and set bath calibration parameters.

A brief description of the functions of the buttons follows:

SET – Used to display the next parameter in a menu and to set parameters to the displayed value.

DOWN – Used to decrement the displayed value of parameters.

UP – Used to increment the displayed value.

EXIT – Used to exit from a menu. When EXIT is pressed any changes made to the displayed value will be ignored.

3. The on/off switch controls power to the entire bath including the stirring motor.
4. The control indicator is a two color light emitting diode (LED). This indicator lets the user visually see the ratio of heating to cooling. When the indicator is red the heater is on and when the indicator is green the heater is off and the bath is cooling.
5. The heater power switch is used to select the appropriate heater power levels for heating and controlling temperatures.

Bath Tank and Lid

The bath tank and lid assembly includes (see Figure 4):

- ① the tank
- ② the control probe
- ③ the stirring motor
- ④ the access holes
- ⑤ the access hole cover
- ⑥ the drain tube

⚠ Warning

The drain is for factory use only.

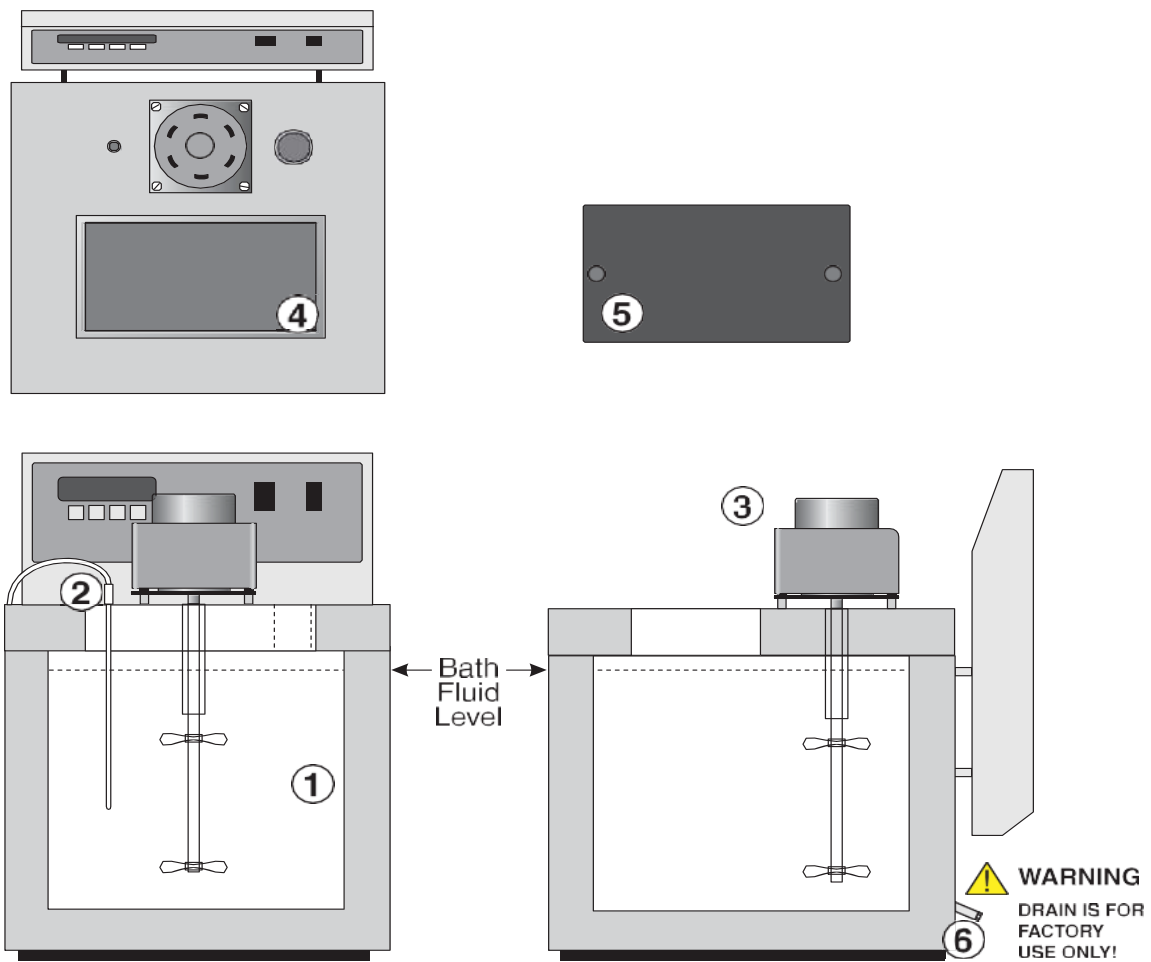

Figure 4. Bath and Lid Components

bathlid.eps

1. The bath tank is constructed of stainless steel. It is very resistant to oxidation in the presence of most chemicals and over a wide range of temperatures.
2. The control probe provides the temperature feedback signal to the controller allowing the controller to maintain a constant temperature. The control probe is a precision platinum resistance thermometer (PRT). The control probe is delicate and must be handled carefully. The probe is placed in the small hole in the top of the bath so that the probe tip is fully immersed in the bath fluid. The probe cable connects to the bath at the probe connector on the back panel.
3. The stirring motor is mounted on the bath tank lid. It drives the stirring propeller to provide mixing of the bath fluid. Proper mixing of the fluid is important for good constant temperature stability. The stirring motor power cord plugs into the back of the bath at the power socket labelled "STIRRER".
4. On the bath lid is a large rectangular access hole and a small circular access hole. These holes are used for placement of thermometers and devices into the bath. When possible the access holes should be covered.
5. An access hole cover is recommended to cover the large square access opening in the top of the bath. This improves bath temperature stability, prevents excess fluid evaporation or fumes and increases safety with hot fluid. The user may drill or cut holes in the cover to accommodate the instruments to be calibrated or immersed in the bath. Spare covers are available from Hart Scientific.
6. The drain tube, located at the lower left corner of the bath, is for factory use only.

Back Panel

The back panel has six standard features and two optional features (see Figure 4):

The back panel of the bath contains the following features (see Figure 5):

- ① the bath power cord
- ② the stirring motor power socket
- ③ the internal fuses
- ④ the probe socket
- ⑤ the RS-232 interface connector (optional)
- ⑥ the IEEE-488 interface connector (optional)
- ⑦ the drain tube

⚠ Warning

The drain tube is for factory use only.

1. The bath power cord extends from the back of the bath. It provides power for the bath temperature controller, the heaters, and the stirring motor. The cord is plugged into an AC mains socket of 230 VAC ($\pm 10\%$), 10 A, 50/60 Hz.
2. The stirring motor power cord plugs into the socket labelled "STIRRER". Power to the stirring motor is switched on by the POWER switch on the control panel.
3. The system and heater fuses are internal. Never replace a fuse with one of a rating greater than that specified. The heater fuses protect against shorted heaters.
4. The control probe plugs into the bath at the socket on the back of the bath labelled "PROBE".
5. If the bath is supplied with a serial RS-232 interface, the interface cable is attached to the back of the bath at the connector labelled "RS-232".
6. If the bath is supplied with a GPIB IEEE-488 interface, the interface cable is attached to the back of the bath at the connector labelled "IEEE-488".
7. The drain is for factory use only, but must be tightly sealed when the bath is in use.

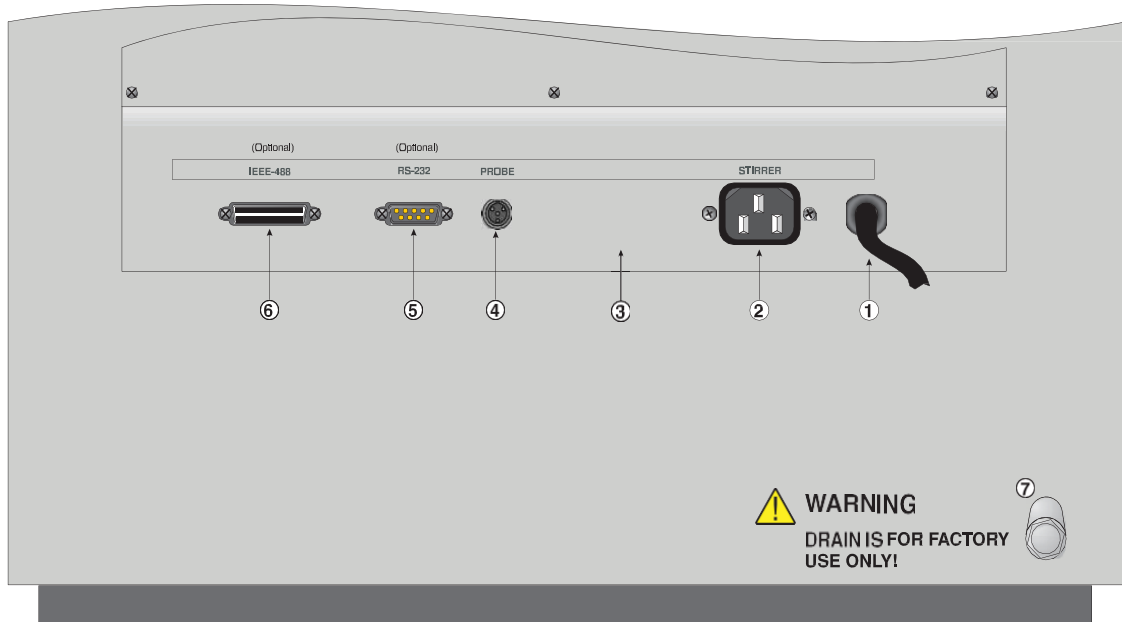

Figure 5. Back Panel Features

back_panel.eps

1. The probe connector in the back panel is used for the temperature controller probe.
2. The stirrer power is provided for the stirring motor.
3. The power cord
4. A drain valve is provided for ease of removing the fluid media from the bath. Always use a container of adequate size to hold the FULL LOAD of fluid. Some oils are more easily drained at higher temperatures. (See caution note in next section.)
5. The serial number is located on the upper right corner of the back panel. The series is also stamped on this panel. When consulting with an Authorized Service Center, use the model number and the serial number.
6. If the bath is supplied with a serial RS-232 interface, the interface cable is attached to the back of the bath at the connector labeled "Serial Port".
7. If the bath is supplied with a GPIB IEEE-488 interface, the interface cable is attached to the back of the bath at the connector labeled "IEEE".
8. The mains out of range indicator is on (red) when the line voltage is low. See the Warnings in the *Safety Information* section for details.

General Operation

Bath Fluid

Heat transfer salt is intended to be used with the 6050H bath. Other fluids should not be used.

Safety

Always consider the safety issues associated with using salt in the Warnings and Cautions sections of the Safety Information section (see the *Safety Information* section of this manual). Obviously where there are extreme temperatures there can be danger to personnel and equipment. Salt may also be hazardous for other reasons. Some salt may be considered toxic. Contact with eyes, skin, or inhalation of vapors may cause injury. A proper fume hood must be used if hazardous or bothersome vapors are produced.

⚠ Warning

Fluids at high temperatures may pose danger from BURNS, FIRE, and TOXIC FUMES. Use appropriate caution and safety equipment.

Salt may be flammable or pose a fire hazard and require special fire safety equipment and procedures.

Environmentally hazardous salts require special disposal according to applicable federal or local laws after use.

Heat Transfer Salt

Heat transfer salt is often used at high bath temperatures. Salt has a very high upper temperature limit and a wide useful temperature range. New bath salt melts around 145 °C however its viscosity is such that its functional range is from around 180 °C up to the upper limit of the bath. The melting temperature will change as the salt ages or becomes contaminated. When the bath is not in use we recommend keeping the temperature above 230 °C to prevent excessive amounts of salt from freezing on the stir shaft and other cooler parts of the tank. Viscosity is low, especially at higher temperatures. Salt when melted has very low electrical resistivity. Salt may be corrosive to some materials. Salt will quickly oxidize the coating on galvanized metal. Carbon steel may be used with salt up to 450 °C. Beyond this temperature stainless steel is recommended.

⚠ Caution

Keep all combustible materials away from the bath when using salt. Operate the bath on a heat-proof surface such as concrete. Provide a means of safely containing any spills which may occur.

The greatest safety concern with liquid salt is with its high temperature. The fluid provides a source of heat which can ignite or destruct materials. Especially dangerous are spills since the hot fluid is difficult to contain. Salt may also cause steam explosions if it comes into contact with water or other volatile fluids. Using salt requires special caution. Read carefully the information and safety data sheets provided with the salt. Use of a fume hood is recommended to remove any products of decomposition or oxidation.

Because salt is solid at room temperature special procedures are required in using the bath with salt. Before filling the bath with solid salt disconnect the stirring motor to prevent it from being damaged. (See the *Stir Mode Select* section.)

⚠ Caution

Never allow the stir motor to run with solid material in the bath. Restraining the motor from turning may over-heat and damage the motor. Use HIGH heat (Heater Switch) and “LO” Heat Up Power with solid salt. A Fast Start Heater Model 2024 may be used to aid in the melting of solid salt. See the *Stir Mode Select* section.

Solid salt has poor thermal conductivity. The 6050H bath uses a special "soft start" program to prevent the heaters from being overheated until the salt is completely molten. This program controls the heater duty cycle at 25 % until the bath temperature reaches 200 °C. To allow the bath to control below 200 °C the soft start feature must be deactivated (see the *Stir Mode Select* section, *Stir Set-point* section, and *Heat Up Power* section.)

Salt is supplied in a pink granular form. Fill the bath gradually as the salt heats and melts. Because of the heat required to melt the salt this is a slow process and may take 10 hours or more. Fill the bath until the liquid is a few inches below the lid. The level will rise as much as two inches as it is heated to the upper temperature limit.

Stirring

Stirring of the bath fluid is very important for stable temperature control. The fluid must be mixed well for good temperature uniformity and fast controller response. The stirrer is precisely adjusted for optimum performance. When the salt in the bath is solid, it is very important that the stirrer power be disconnected until the salt melts. Otherwise, the stirrer will likely over-heat and be damaged.

Power

Power to the bath is provided by an AC mains supply. See the *Specifications* section for power details. See Figure 5. Power to the bath passes through a filter to prevent switching spikes from being transmitted to other equipment

To turn on the bath switch the control panel power switch to the ON position. The stirring motor will turn on, the LED display will begin to show the bath temperature, and the heater will turn on or off until the bath temperature reaches the programmed set-point.

When powered on the control panel display briefly shows a four digit number. This number indicates the number of times power has been applied to the bath. Also briefly displayed is data which indicates the controller hardware configuration. This data is used in some circumstances for diagnostic purposes.

Heater

The power to the bath heater is precisely controlled by the temperature controller to maintain a constant bath temperature. Power is controlled by periodically switching the heater on for a certain amount of time using a solid-state relay.

The front panel red/green control indicator (see Figure 3) shows the state of the heater. The control indicator glows red when the heater is on and glows green when the heater is off. The indicator will pulse constantly when the bath is maintaining a stable temperature.

The heater has two power level settings. The "MED" and "HIGH" heater power settings are used to more quickly heat the bath fluid up to the desired operating temperature. These heater power settings may also be required for control at higher temperatures. The "HIGH" setting is used to heat solid salt. The "LOW" setting is used when controlling at lower temperatures, and for scanning at slower rates. When controlling at the "MED" or "HIGH" heater power settings instead of "LOW" the proportional band may need to be increased (typically two or four times) to compensate for the increase in power gain. Otherwise the temperature may oscillate.

Fluid Drain

The drain at the back of the bath (see Figure 5) is for factory use only. During operation of the bath the drain plug must be screwed on tightly.

Temperature Controller

The bath temperature is controlled by Fluke Calibration's unique hybrid digital/analog temperature controller (see Figure 3). The controller offers the tight control stability of an analog temperature controller as well as the flexibility and programmability of a digital controller.

The bath temperature is monitored with a platinum resistance sensor in the control probe. The signal is electronically compared with the programmable reference signal, amplified, and then fed to a pulse-width modulator circuit which controls the amount of power applied to the bath heater.

The bath is operable within the temperature range given in the specifications. For protection against solid-state relay failure or other circuit failure, the microcontroller automatically turns off the heater with a second mechanical relay anytime the bath temperature is more than a certain amount above the set-point temperature. As a second protection device, the controller is also equipped with a separate thermocouple temperature monitoring circuit which shuts off the heater if the temperature exceeds the cut-out set-point.

The controller allows the operator to set the bath temperature with high resolution, set the cut-out, adjust the proportional band, monitor the heater output power, and program the controller configuration and calibration parameters.

The controller may be operated in temperature units of degrees Celsius or Fahrenheit. The controller is operated and programmed from the front control panel using the four key switches and digital LED display. The controller may also be optionally equipped with a serial RS-232 or IEEE-488 GPIB digital interface for remote operation. Operation of the controller using the front control panel is discussed following in the *Controller Operation* section. Operation using the digital interfaces is discussed in the *Digital Communications Interface* section.

When the controller is set to a new set-point the bath heats or cools to the new temperature. Once the new temperature is reached the bath usually takes 10–15 minutes for the temperature to settle and stabilize. There may be a small overshoot or undershoot of about 0.5 °C.

Controller Operation

This section discusses in detail how to operate the bath temperature controller using the front control panel. Using the front panel key switches and LED display the user may monitor the bath temperature, set the temperature set-point in degrees C or F, monitor the heater output power, adjust the controller proportional band, set the cut-out set-point, and program the probe calibration parameters, operating parameters, serial and IEEE-488 interface configuration, and controller calibration parameters. Controller operations are summarized in the flow chart in Figure 6.

Bath Temperature

The digital LED display on the front panel allows direct viewing of the actual bath temperature. This temperature value is what is normally shown on the display. The units, C or F, of the temperature value are displayed at the right. For example,

 Bath temperature in degrees Celsius

The temperature display function may be accessed from any other function by pressing the “EXIT” button.

Reset Cutout

If the over-temperature cutout has been triggered, then the temperature display alternately flashes,

 Indicates cutout condition

The message continues to flash until the temperature is reduced and the cutout is reset.

The cutout has two modes — automatic reset and manual reset. The mode determines how the cutout is reset which allows the bath to heat up again. When in automatic mode, the cutout resets itself as soon as the temperature is lowered below the cutout set-point. With manual reset mode the cutout must be reset by the operator after the temperature falls below the set-point.

When the cutout is active and the cutout mode is set to manual ("reset"), the display flashes "cutout" until the user resets the cutout. To access the reset cutout function press the "SET" button.



Access cutout reset function

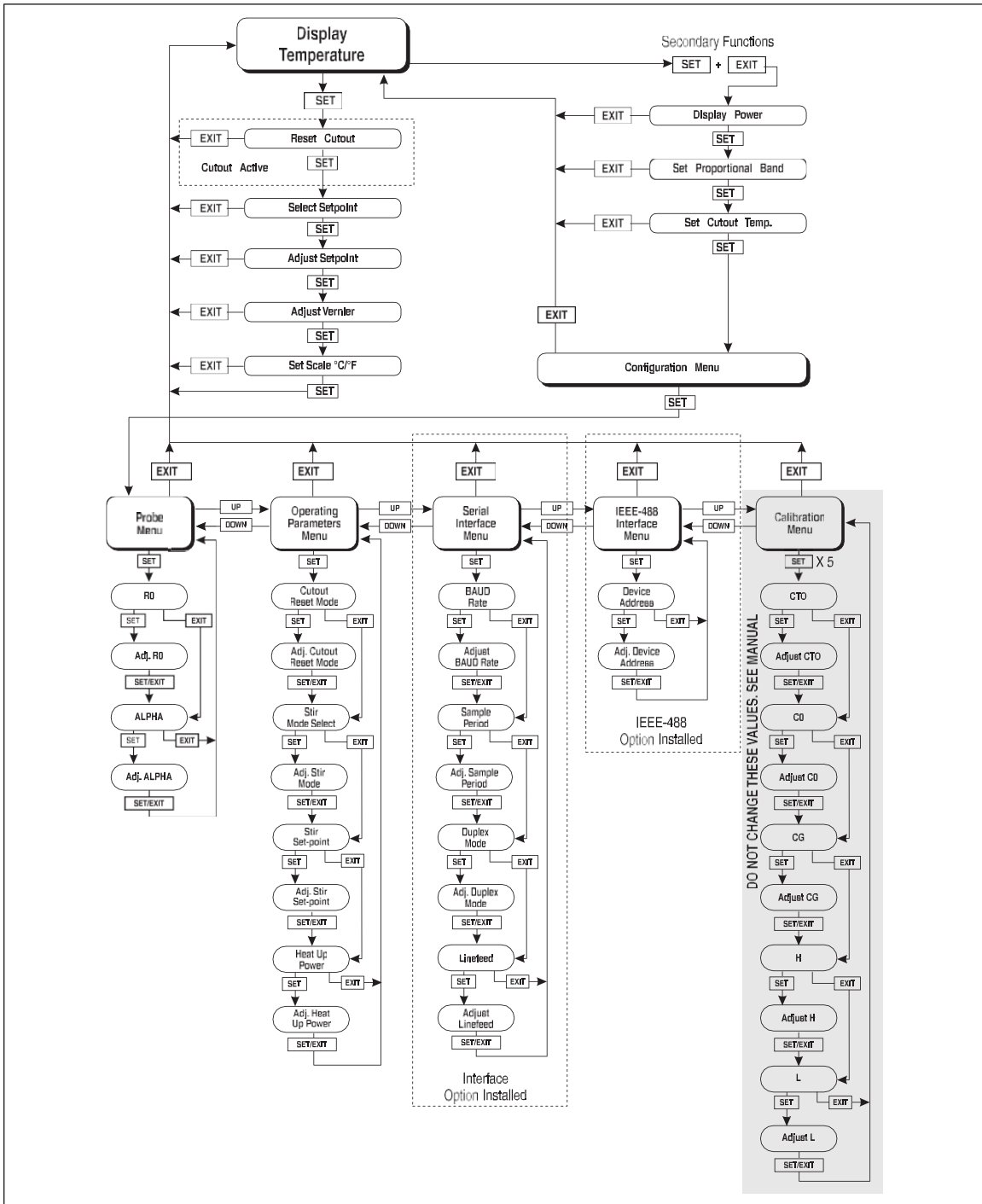
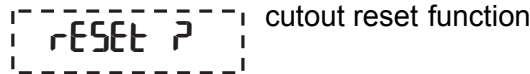

Figure 6. Controller Operation Flow Chart

figure 7.eps

The display will indicate the reset function.



cutout reset function

Press “SET” once more to reset the cutout.



Reset cutout

This action also switches the display to the set temperature function. To return to displaying the temperature press the “EXIT” button. If the cutout is still in the over-temperature fault condition the display continues to flash “cutout”. The bath temperature must drop a few degrees below the cutout set-point before the cutout can be reset.

Temperature Set-point

The bath temperature can be set to any value within the range and with resolution as given in the specifications. The temperature range of the particular fluid used in the bath must be known by the operator and the bath should only be operated well below the upper temperature limit of the liquid. In addition, the cutout temperature should also be set below the upper limit of the fluid.

Setting the bath temperature involves three steps:

1. select the set-point memory
2. adjust the set-point value
3. adjust the vernier if desired.

Programmable Set-points

The controller stores 8 set-point temperatures in memory. The set-points can be quickly recalled to conveniently set the bath to a previously programmed temperature set-point.

To set the bath temperature one must first select the set-point memory. This function is accessed from the temperature display function by pressing “SET”. The number of the set-point memory currently being used is shown at the left on the display followed by the current set-point value.



Bath temperature in degrees Celsius



Access set-point memory

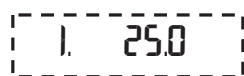

Set-point memory 1, 25.0°C currently used

To change the set-point memory press “UP” or “DOWN”.



Increment memory



New set-point memory 4, 40.0°C

Press "SET" to accept the new selection and access the set-point value.



Accept selected set-point memory

Set-point Value

The set-point value can be set with a resolution of 0.01 °C. The user may want to adjust the set-point slightly to achieve a more precise bath temperature. The set-point vernier allows the temperature to be adjusted below or above the

set-point by a small amount with very high resolution. Each of the 8 stored set-points has an associated vernier setting. The vernier is accessed from the set-point by pressing "SET". The vernier setting is displayed as a 6 digit number with five digits after the decimal point. This is a temperature offset in degrees of the selected units, C or F.



Set-point 4 value in °C

If the set-point value need not be changed then press "EXIT" to resume displaying the bath temperature. Press "UP" or "DOWN" to adjust the set-point value.



Increment memory

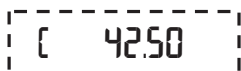

New set-point value

When the desired set-point value is reached press "SET" to accept the new value and access the set-point vernier. If "EXIT" is pressed instead then any changes made to the set-point will be ignored.



Accept new set-point value

Set-point Vernier

The set-point value can only be set with a resolution of 0.01 °C. The user may want to adjust the set-point slightly to achieve a precise bath temperature. The set-point vernier allows one to adjust the temperature below or above the set-point by a small amount with very high resolution. Each of the 8 stored set-points has an associated vernier setting. The vernier is accessed from the set-point by pressing "SET". The vernier setting is displayed as a 6 digit number with five digits after the decimal point. This is a temperature offset in degrees of the selected units, C or F.



Current vernier value in °C

To adjust the vernier press "UP" or "DOWN". Unlike most functions the vernier setting has immediate effect as the vernier is adjusted. "SET" need not be pressed. This allows one to continually adjust the bath temperature with the vernier as it is displayed.

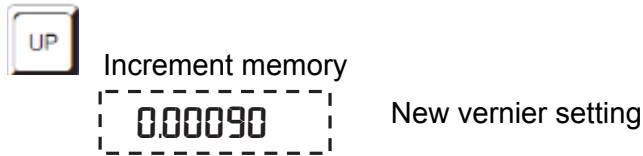

Next press “EXIT” to return to the temperature display or “SET” to access the temperature scale units selection.

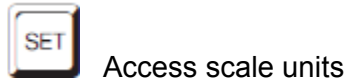

Temperature Scale Units

The temperature scale units of the controller may be set by the user to degrees Celsius (°C) or Fahrenheit (°F). These units are used in displaying the bath temperature, set-point, vernier, proportional band, and cutout set-point.

The temperature scale units selection is accessed after the vernier adjustment function by pressing “SET”. From the temperature display function access the units selection by pressing “SET” 4 times.

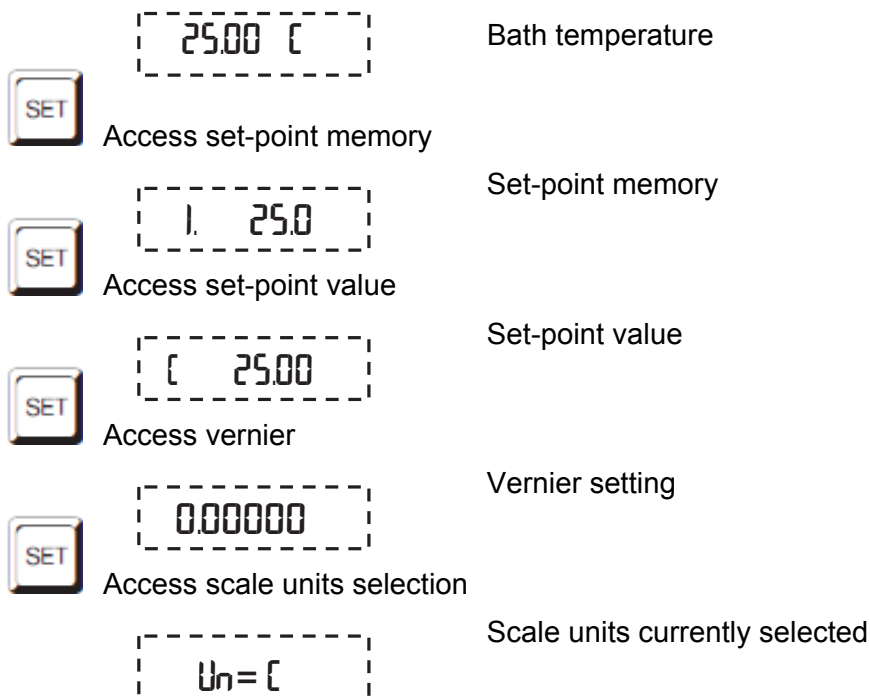

Press “UP” or “DOWN” to change the units.



Press "SET" to accept the new selection and resume displaying the bath temperature.



Set the new units and resume temperature display

Secondary Menu

Functions which are used less often are accessed within the secondary menu. The secondary menu is accessed by pressing "SET" and "EXIT" simultaneously and then releasing. The first function in the secondary menu is the heater power display (see Figure 6).

Heater Power

The temperature controller controls the temperature of the bath by pulsing the heater on and off. The total power being applied to the heater is determined by the duty cycle or the ratio of heater on time to the pulse cycle time. This value may be estimated by watching the red/green control indicator light or read directly from the digital display. By knowing the amount of heating to the bath the user can tell if the bath is heating up to the set-point, cooling down, or controlling at a constant temperature. Monitoring the percent heater power lets the user know how stable the bath temperature is. With good control stability the percent heating power should not fluctuate more than $\pm 1\%$ within one minute.

The heater power display is accessed in the secondary menu. Press "SET" and "EXIT" simultaneously and release. The heater power will be displayed as a percentage of full power.



Access heater power in secondary menu

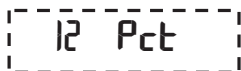

Heater power in percent

To exit out of the secondary menu press "EXIT". To continue on to the proportional band setting function press "SET".

Proportional Band

In a proportional controller such as this the heater output power is proportional to the bath temperature over a limited range of temperatures around the set-point. This range of temperature is called the proportional band. At the bottom of the proportional band the heater output is 100 %. At the top of the proportional band the heater output is 0. Thus as the bath temperature rises the heater power is reduced, which consequently tends to lower the temperature back down. In this way the temperature is maintained at a fairly constant temperature.

The temperature stability of the bath depends on the width of the proportional band. See Figure 7. If the band is too wide the bath temperature will deviate excessively from the set-point due to varying external conditions. This is because the power output changes very little with temperature and the controller cannot respond very well to changing conditions or noise in the system. If the proportional band is too narrow the bath temperature may swing back and forth because the controller overreacts to temperature variations. For best control stability the proportional band must be set for the optimum width.

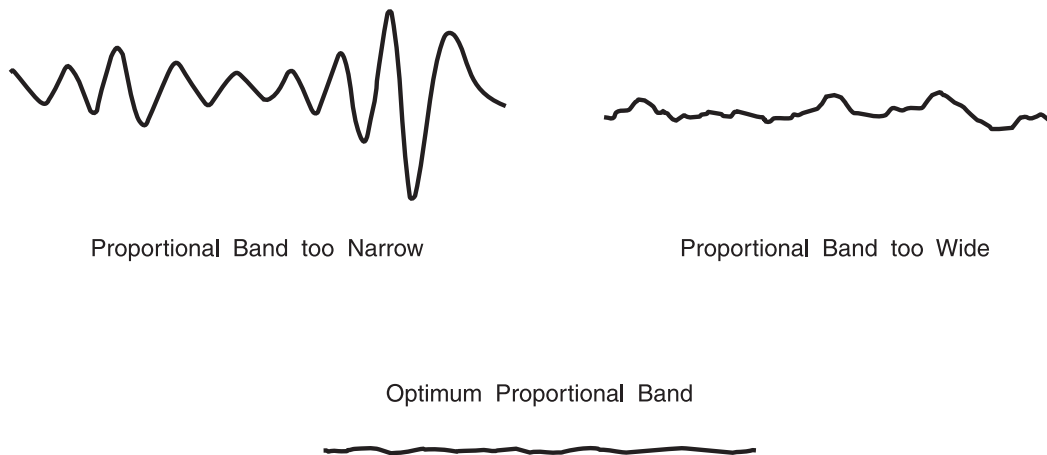

Figure 7. Bath Temperature Fluctuation at Various Proportional Band Settings

figure 8.eps

The optimum proportional band width depends on several factors among which are fluid volume, fluid characteristics (viscosity, specific heat, thermal conductivity), heater power setting, operating temperature, and stirring. Thus the proportional band width may require adjustment for best bath stability when any of these conditions change. Of these, the most significant factors affecting the optimum proportional band width are heater power setting and fluid viscosity.

The proportional band should be wider when the higher power setting is used so that the change in output power per change in temperature remains the same. The proportional band should also be wider when the fluid viscosity is higher because of the increased response time.

The proportional band width is easily adjusted from the bath front panel. The width may be set to discrete values in degrees C or F depending on the selected units. The optimum proportional band width setting may be determined by monitoring the stability with a high resolution thermometer or with the controller percent output power display. Narrow the proportional band width to the point at which the bath temperature begins to oscillate and then increase the band width from this point to 3 or 4 times wider.

The proportional band adjustment may be accessed within the secondary menu. Press "SET" and "EXIT" to enter the secondary menu and show the heater power. Then press "SET" to access the proportional band.

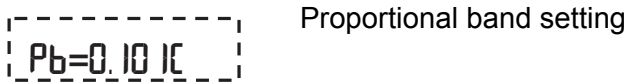
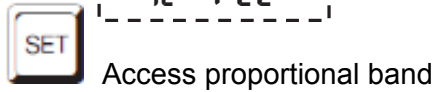
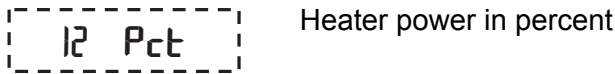
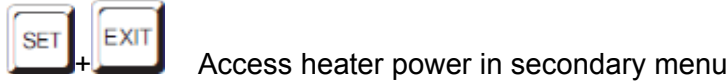

To change the proportional band press "UP" or "DOWN".

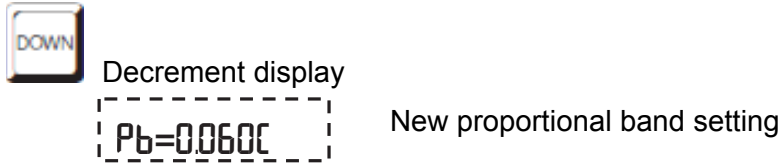

To accept the new setting and access the cutout set-point press "SET". Pressing "EXIT" exits the secondary menu ignoring any changes just made to the proportional band value.



Cutout

As a protection against software or hardware fault, shorted heater triac, or user error, the bath is equipped with an adjustable heater cutout device that shuts off power to the heater if the bath temperature exceeds a set value. This protects the heater and bath materials from excessive temperatures and, most importantly, protects the bath fluids from being heated beyond the safe operating temperature preventing hazardous vaporization, breakdown, or ignition of the liquid. The cutout temperature is programmable by the operator from the front panel of the controller. It must always be set below the upper temperature limit of the fluid and no more than 10 degrees above the upper temperature limit of the bath.

If the cutout is activated because of excessive bath temperature then power to the heater shuts off and the bath cools. The bath cools until it reaches a few degrees below the cutout set-point temperature. At this point the action of the cutout is determined by the setting of the cutout mode parameter. The cutout has two selectable modes — automatic reset or manual reset. If the mode is set to automatic, the cutout automatically resets itself when the bath temperature falls below the reset temperature allowing the bath to heat up again. If the mode is set to manual, the heater remains disabled until the user manually resets the cutout.

The cutout set-point may be accessed within the secondary menu. Press “SET” and “EXIT” to enter the secondary menu and show the heater power. Then press “SET” twice to access the cutout set-point.



Access heater power in secondary menu

12 Pct

Heater power in percent



Access proportional band

Pb=0.10 1C

Proportional band setting



Access cutout set-point

CO= 2 10C

Cutout set-point

To change the cutout set-point press “UP” or “DOWN”.



Decrement display

CO= 95C

New cutout set-point

To accept the new cutout set-point press “SET”.



Accept cutout set-point

The next function is the configuration menu. Press “EXIT” to resume displaying the bath temperature.

Controller Configuration

The controller has a number of configuration and operating options and calibration parameters which are programmable via the front panel. These are accessed from the secondary menu after the cutout set-point function by pressing “SET.” There are 5 sets of configuration parameters — probe parameters, operating parameters, serial interface parameters, IEEE-488 interface parameters, and controller calibration parameters. The menus are selected using the “UP” and “DOWN” keys and then pressing “SET”.

Probe Parameters

The probe parameter menu is indicated by,

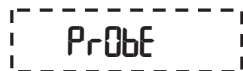

Probe parameters menu

Press “SET” to enter the menu. The probe parameters menu contains the parameters, R0 and ALPHA, which characterize the resistance-temperature relationship of the platinum control probe. These parameters may be adjusted to improve the accuracy of the bath. This procedure is explained in detail in the *Calibration Procedure* section.

The probe parameters are accessed by pressing “SET” after the name of the parameter is displayed. The value of the parameter may be changed using the “UP” and “DOWN” buttons. After the desired value is reached press “SET” to set the parameter to the new value. Pressing “EXIT” causes the parameter to be skipped ignoring any changes that may have been made.

R0

This probe parameter refers to the resistance of the control probe at 0 °C. Normally this is set for 100.000 ohms.

ALPHA

This probe parameter refers to the average sensitivity of the probe between 0 and 100 °C. Normally this is set for 0.00385 °C⁻¹.

Operating Parameters

The operating parameters menu is indicated by,

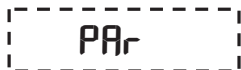

Operating parameters menu

Press “UP” to enter the menu. The operating parameters menu contains the cutout reset mode parameter, the stirrer mode select, and stirrer set-point.

Cutout Reset Mode

The cutout reset mode determines whether the cutout resets automatically when the bath temperature drops to a safe value or must be manually reset by the operator.

The parameter is indicated by,

`[CtorSt]` cutout reset mode parameter

Press “SET” to access the parameter setting. Normally the cutout is set for manual mode.

`[Cto=Auto]` cutout set for automatic reset

To change to manual reset mode press “UP” and then “SET”.

`[Cto=rSt]` cutout set for manual reset

Stir Mode Select

This parameter along with the Stir set-point allows the user to set the temperature at which the stir motor is activated. This setting is generally used when salt is used for the bath medium. For example, you can set the mode to “auto” and the temperature to 200 °C. This allows the stir motor to shut off and turn on only when the salt is a liquid (>200 °C) preventing the stir motor from overheating and or being damaged.

`[Str Act]` The parameter is indicated by, Stir mode selection parameter

Press “SET” to access the parameter setting.

`[Str=Auto]` Stir motor is set for automatic activation at the stir set-point temperature.

To change the setting to **always** on press the “UP” or “DOWN” buttons and then “SET”. When set to “Str=ON” the stir motor comes on regardless of the temperature set in the stir set-point parameter.

Note

Stir Mode Select defaults to “Auto” each time the power of the bath is cycled off and back on. Therefore, this parameter has to be set each time the bath is powered on if “Str-ON” is the desired mode of operation.

Stir Set-point

The stir set-point allows setting of the temperature above which the stir motor activates when the stir activation is set to automatic.

To access the parameter press "SET" from the stir activation parameter. Set-point mode selection parameter is indicated by,

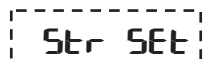
 Stir motor activation set-point parameter

Press "SET" to access the parameter value.

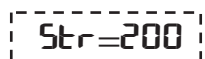
 Stir motor activation set-point

Press "UP" or "DOWN" to change the value and then "SET" to enter the new value.

Heat Up Power

Note

This section applies to controller parameters, not to High/Low setting of the front panel heater switch.

The Heat Up Power or "soft start" feature allows heat transfer salt to be melted in the bath without overheating the heaters. When salt solidifies it shrinks leaving gaps between the solid salt and the sides of the bath. Applying full power to the heaters while the salt is solid can cause the heaters to overheat since there is poor heat conduction between the walls of the bath and the solid salt. The Heat Up Power feature prevents the heaters from overheating by limiting the power. When the Heat Up Power is set to 'Low', the heaters operate at 25% power until the temperature reaches 200°C and is completely melted. While the solid salt is being heated the control LED flashes. The heater switch setting should be set to HIGH enabling all the heaters to provide adequate power to melt the salt and to melt it as quickly as possible. Once the temperature exceeds 200°C, the heaters operate at full power again and the control LED glows red constantly until the set-point temperature is reached. The Heat Up Power always defaults to 'Low' when the bath is switched on.

The heat up power option is indicated by,

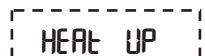
 Heat up power option

Press "SET" to access the parameter value.

 Low power heat up mode for heat transfer salt

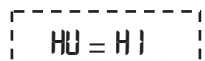
 High power heat up mode

Press “UP” or “DOWN” to change the option and then press “SET” to store the setting.

Note

When using salt as the fluid be sure to always set this option to LO to maximize the lifetime of the heaters.

Serial Interface Parameters

The serial RS-232 interface parameters menu is indicated by,



Serial RS-232 interface parameters menu

The serial interface parameters menu contains parameters which determine the operation of the serial interface. These controls only apply to baths fitted with the serial interface. The parameters in the menu are — BAUD rate, sample period, duplex mode, and linefeed.

BAUD Rate

The BAUD rate is the first parameter in the menu. The BAUD rate setting determines the serial communications transmission rate.

The BAUD rate parameter is indicated by,



Serial BAUD rate parameter

Press “SET” to choose to set the BAUD rate. The current baud rate value will then be displayed.



Current BAUD rate

The BAUD rate of the bath serial communications may be programmed to 300,600,1200, or 2400 BAUD. Use “UP” or “DOWN” to change the BAUD rate value.



New BAUD rate

Press “SET” to set the BAUD rate to the new value or “EXIT” to abort the operation and skip to the next parameter in the menu.

Sample Period

The sample period is the next parameter in the serial interface parameter menu. The sample period is the time period in seconds between temperature measurements transmitted from the serial interface. If the sample rate is set to 5, the bath transmits the current measurement over the serial interface approximately every five seconds. The automatic sampling is disabled with a sample period of 0. The sample period is indicated by,

SAmPLe

Serial sample period parameter

Press "SET" to choose to set the sample period. The current sample period value will be displayed.

SA= 1

Current sample period (seconds)

Adjust the value with "UP" or "DOWN" and then use "SET" to set the sample rate to the displayed value.

SA= 60

New sample period

Duplex Mode

The next parameter is the duplex mode. The duplex mode may be set to full duplex or half duplex. With full duplex any commands received by the bath via the serial interface are immediately echoed or transmitted back to the device of origin. With half duplex the commands are executed but not echoed. The duplex mode parameter is indicated by,

dUPL

Serial duplex mode parameter

Press "SET" to access the mode setting.

dUP=FULL

Current duplex mode setting

The mode may be changed using "UP" or "DOWN" and pressing "SET".

dUP=HALF

New duplex mode setting

Linefeed

The final parameter in the serial interface menu is the linefeed mode. This parameter enables (on) or disables (off) transmission of a linefeed character (LF, ASCII 10) after transmission of any carriage-return. The linefeed parameter is indicated by,

 Serial linefeed parameter

Press "SET" to access the linefeed parameter.

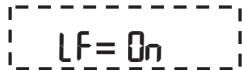
 Current linefeed setting

The mode may be changed using "UP" or "DOWN" and pressing "SET".

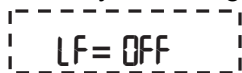
 New linefeed setting

IEEE-488 Parameters

Baths may optionally be fitted with an IEEE-488 GPIB interface. In this case the user may set the interface address within the IEEE-488 parameter menu. This menu does not appear on baths not fitted with the interface. The menu is indicated by,

 IEEE-488 parameters menu

Press "SET" to enter the menu.

IEEE-488 Address

The IEEE-488 interface must be configured to use the same address as the external communicating device. The address is indicated by,

 IEEE-488 interface address

Press "SET" to access the address setting.

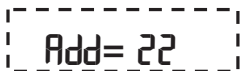
 Current IEEE-488 interface address

Adjust the value with "UP" or "DOWN" and then use "SET" to set the address to the displayed value.

 New IEEE-488 interface address

Calibration Parameters

The operator of the bath controller has access to a number of the bath calibration constants namely CTO, C0, CG, H, and L. These values are set at the factory and must not be altered. The correct values are important to the accuracy and proper and safe operation of the bath. Access to these parameters is available to the user only so that in the event that the controller's memory fails the user may restore these values to the factory settings. The user should have a list of these constants and their settings with the manual.

Caution

DO NOT change the values of the bath calibration constants from the factory set values. The correct setting of these parameters is important to the safety and proper operation of the bath.

The calibration parameters menu is indicated by,

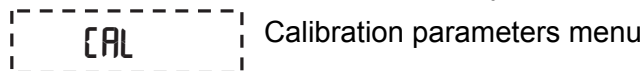

Press "SET" five times to enter the menu. The display now shows:



CTO

Parameter CTO sets the calibration of the over-temperature cutout. This parameter is not adjusted through software. It is adjusted with an internal potentiometer. The following values are set by the factory: 565 °C ±5 °C.

CO and CG

These parameters calibrate the accuracy of the bath set-point. They are programmed at the factory when the bath is calibrated and the values are entered onto the Report of Test.

Note

Do not alter the value of these parameters. If improved bath accuracy is needed, calibrate R0 and ALPHA according to the procedure given in the Calibration section.

To restore these values, press "SET" to display,



Press "SET" to show the current value of C0.

Use the "UP" and "DOWN" keys until the value displayed matches the C0 value on the Report of Calibration. Press "SET" to store the value.

The display now shows,

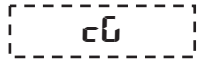

Press "SET" to show the current value of Cg. Use the "UP" and "DOWN" keys until the value displayed matches the Cg value on the Report of Calibration. Press "SET" to store the value. The display now shows,

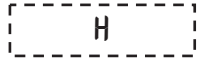

H and L

These parameters set the high and low set-point limits of the bath. These parameters are factory set to the following: High 550 °C ±0 °C, Low 0 °C ±0 °C.

Note

DO NOT change the values of these parameters from the factory set values. To do so may present danger of the bath overheating and causing damage or fire.

To adjust, press "SET" to show the current value of H. Use the "UP" and "DOWN" keys until the value matches the factory settings listed above. Press "SET" to store the value.

The display now shows,



Press "SET" to show the current value of L. Use the "UP" and "DOWN" keys until the value matches the factory settings listed above. Press "SET" to store the value.

The display now shows,



Press "EXIT" to return to displaying the temperature.

Digital Communication Interface

If supplied with the option, the 6050H bath is capable of communicating with and being controlled by other equipment through the digital interface. Two types of digital interface are available the RS-232 serial interface and the IEEE-488 GPIB interface.

With a digital interface the bath may be connected to a computer or other equipment. This allows the user to set the bath temperature, monitor the temperature, and access any of the other controller functions, all using remote communications equipment. In addition the heater power may be controlled. To enable the digital interface to control the heater the "HEATER" switch must be set to the "LOW" position.

Serial Communications

The bath may be installed with an RS-232 serial interface that allows serial digital communications over fairly long distances. With the serial interface the user may access any of the functions, parameters and settings discussed in the *Controller Operation* section with the exception of the BAUD rate setting.

Wiring

The serial communications cable attaches to the bath through the DB-9 connector at the back of the instrument. Figure 8 shows the pin-out of this connector and suggested cable wiring. To eliminate noise, the serial cable should be shielded with low resistance between the connector (DB-9) and the shield.

RS-232 Cable Wiring for IBM PC and Compatibles

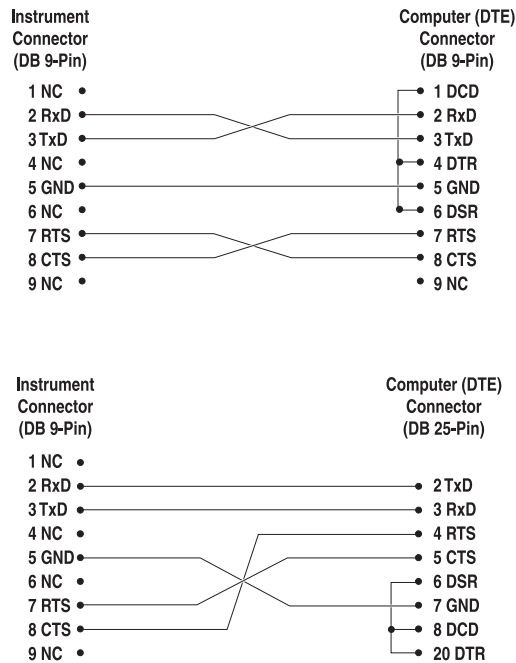

Figure 8. Serial Communication Cable Wiring

figure 9.eps

Setup

Before operation the serial interface of the bath must first be set up by programming the BAUD rate and other configuration parameters. These parameters are programmed within the serial interface menu.

The serial interface parameters menu is outlined in Figure 6. To enter the serial parameter "EXIT" while pressing "SET" and release to enter the secondary menu. Press "SET" repeatedly until the display reads "ProbE". This is the menu selection. Press "UP" repeatedly until the serial interface menu is indicated with "SErIAL". Finally press "SET" to enter the serial parameter menu. In the serial interface parameters menu are the baud rate, the sample rate, the duplex mode, and the linefeed parameter.

Baud Rate

The baud rate is the first parameter in the menu. The display will prompt with the baud rate parameter by showing "BAUd". Press "SET" to choose to set the baud rate. The current baud rate value will then be displayed. The baud rate of the serial communications may be programmed to 300,600,1200, or 2400 baud. The baud rate is pre-programmed to 1200 baud. Use "UP" or "DOWN" to change the baud rate value. Press "SET" to set the baud rate to the new value or "EXIT" to abort the operation and skip to the next parameter in the menu.

Sample Period

The sample period is the next parameter in the menu and prompted with "SAmPLE". The sample period is the time period in seconds between temperature measurements transmitted from the serial interface. If the sample rate is set to 5, the bath transmits the current measurement over the serial interface approximately every five seconds. The automatic sampling is disabled with a sample period of 0. Press "SET" to choose to set the sample period. Adjust the period with "UP" or "DOWN" and then use "SET" to set the sample rate to the displayed value.

Duplex Mode

The next parameter is the duplex mode indicated with "dUPL". The duplex mode may be set to half duplex ("HALF") or full duplex ("FULL"). With full duplex any commands received by the bath via the serial interface are immediately echoed or transmitted back to the device of origin. With half duplex the commands are executed but not echoed. The default setting is full duplex. The mode may be changed using "UP" or "DOWN" and pressing "SET".

Linefeed

The final parameter in the serial interface menu is the linefeed mode. This parameter enables ("On") or disables ("OFF") transmission of a linefeed character (LF, ASCII 10) after transmission of any carriage-return. The default setting is with linefeed on. The mode may be changed using "UP" or "DOWN" and pressing "SET".

Serial Operation

Once the cable has been attached and the interface set up properly the controller immediately begins transmitting temperature readings at the programmed rate. The set-point and other commands may be sent to the bath via the serial interface to set the bath and view or program the various parameters. The interface commands are discussed in the *Interface Commands* section. All commands are ASCII character strings terminated with a carriage-return character (CR, ASCII 13).

IEEE-488 Communication (optional)

The IEEE-488 interface is available as an option. Baths supplied with this option may be connected to a GPIB type communication bus which allows many instruments to be connected and controlled simultaneously. To eliminate noise, the GPIB cable should be shielded.

Setup

To use the IEEE-488 interface first connect an IEEE-488 standard cable to the back of the bath. Next set the device address. This parameter is programmed within the IEEE-488 interface menu.

To enter the IEEE-488 parameter programming menu first press "EXIT" while pressing "SET" and release to enter the secondary menu. Press "SET" repeatedly until the display reaches "PrObE". This is the menu selection. Press "UP" repeatedly until the IEEE-488 interface menu is indicated with "IEEE". Press "SET" to enter the IEEE-488 parameter menu. The IEEE-488 menu contains the IEEE-488 address parameter.

IEEE-488 Interface Address

The IEEE-488 address is prompted with "AddrESS". Press "SET" to program the address. The default address is 22. Change the device address of the bath if necessary to match the address used by the communication equipment by pressing "UP" or "DOWN" and then "SET".

IEEE-488 Operation

Commands may now be sent via the IEEE-488 interface to read or set the temperature or access other controller functions. All commands are ASCII character strings and are terminated with a carriage-return (CR, ASCII 13). Interface commands are listed below.

Interface Commands

The various commands for accessing the bath controller functions via the digital interfaces are listed in this section (see Table 2). These commands are used with both the RS-232 serial interface and the IEEE-488 GPIB interface. In either case the commands are terminated with a carriage-return character. The interface makes no distinction between upper and lower case letters, hence either may be used. Commands may be abbreviated to the minimum number of letters which determines a unique command. A command may be used to either set a parameter or display a parameter depending on whether or not a value is sent with the command following a “=” character. For example “s”<CR> will return the current set-point and “s=50.00”<CR> will set the set-point to 50.00 degrees.

In the table of commands, characters or data within brackets, “[” and “]”, are optional for the command. A slash, “/”, denotes alternate characters or data. Numeric data, denoted by “n”, may be entered in decimal or exponential notation. Characters are shown in lower case although upper case may be used.

Spaces may be added within command strings and are ignored. Backspace (BS, ASCII 8) may be used to erase the previous character. A terminating CR is implied with all commands.

Table 2. Interface Command Summary

Command Description	Command Format	Command Example	Returned	Returned Example	Acceptable Values
Display Temperature					
Read current set-point	s[etpoint]	s	set: 9999.99 {C or F}	set: 150.00 C	
Set current set-point to n	s[etpoint]=n	s=450			Instrument Range
Read vernier	v[ernier]	v	v: 9.99999	v: 0.00000	
Set vernier to n	v[ernier]=n	v=.00001			Depends on Con-figuration
Read temperature	t[emperature]	t	t: 9999.99 {C or F}	t: 55.69 C	
Read temperature units	u[nits]	u	u: x	u: C	
Set temperature units:	u[nits]=c/f				C or F
Set temperature units to Celsius	u[nits]=c	u=c			
Set temperature units to Fahrenheit	u[nits]=f	u=f			
Secondary Menu					
Read proportional band setting	pr[op-band]	pr	pb: 999.9	pb: 15.9	
Set proportional band to n	pr[op-band]=n	pr=8.83			Depends on Con-figuration
Read cutout setting	c[utout]	c	c: 9999 {x},{xxx}	c: 620 C, in	
Set cutout setting:	c[utout]=n/r[eset]				

Command Description	Command Format	Command Example	Returned	Returned Example	Acceptable Values
Set cutout to n degrees	c[utout]=n	c=500			Temperature Range
Reset cutout now	c[utout]=r[eset]	c=r			
Read heater power (duty cycle)	po[wer]	po	po: 9999	po: 1	
Configuration Menu					
Probe Menu					
Read R0 calibration parameter	r[0]	r	r0: 999.999	r0: 100.578	
Set R0 calibration parameter to n	r[0]=n	r=100.324			98.0 to 104.9
Read ALPHA calibration parameter	al[pha]	al	al: 9.9999999	al: 0.0038573	
Set ALPHA calibration parameter to n	al[pha]=n	al=0.0038433			.00370 to .00399
Operating Parameters Menu					
Read cutout mode	cm[ode]	cm	cm: {xxxx}	cm: AUTO	
Set cutout mode:	cm[ode]=r[eset]/a[uto]				RESET or AUTO
Set cutout to be reset manually	cm[ode]=r[eset]	cm=r			
Command Description	Command Format	Command Example	Returned	Returned Example	Acceptable Values
Set cutout to be reset automatically	cm[ode]=a[uto]	cm=a			
Read stirrer mode	smod	smod	smod:{xxxx}	smod:AUTO	
Set stirrer mode:	smod=o[n]/a[uto]				ON or AUTO
Set stirrer to on	smod=o[n]	smod=o			
Set stirrer to automatic	smod=a[uto]	smod=a			
Read stirrer set-point	sset	sset	sset:999.99 {C or F}	set:150.0C	
Set stirrer set-point	sset=n	sset=450			instrument range
Serial Interface Menu					
Read serial sample setting	sa[mple]	sa	sa: 9	sa: 1	
Set serial sampling setting to n seconds	sa[mple]=n	sa=0			0 to 4000

Command Description	Command Format	Command Example	Returned	Returned Example	Acceptable Values
Set serial duplex mode:	du[plex]=f[ull]/h[alf]				FULL or HALF
Set serial duplex mode to full	du[plex]=f[ull]	du=f			
Set serial duplex mode to half	du[plex]=h[alf]	du=h			
Set serial linefeed mode:	lf[eed]=on/off[f]				ON or OFF
Set serial linefeed mode to on	lf[eed]=on	lf=on			
Set serial linefeed mode to off	lf[eed]=off[f]	lf=of			
Calibration Menu					
Read C0 calibration parameter	*c0	*c0	b0: 9	b0: 0	
Set C0 calibration parameter to n	*c0=n	*c0=0			-999.9 to 999.9
Read CG calibration parameter	*cg	*cg	bg: 999.99	bg: 156.25	
Set CG calibration parameter to n	*cg=n	*cg=156.25			-999.9 to 999.9
Read low set-point limit value	*tl[ow]	*tl	tl: 999	tl: -80	
Set low set-point limit to n	*tl[ow]=n	*tl=-80			-999.9 to 999.9
Read high set-point limit value	*th[igh]	*th	th: 999	th: 205	
Set high set-point limit to n	*th[igh]=n	*th=205			-999.9 to 999.9
Miscellaneous (not on menus)					
Read firmware version number	*ver[sion]	*ver	ver.9999,9.99	ver.2100,3.56	
Read structure of all commands	h[elp]	h	list of commands		
Read heater	fn	f1	f1:9	f1:1	

Command Description	Command Format	Command Example	Returned	Returned Example	Acceptable Values
Set heater	fn=1/0 (1=on, 0=off) (n=1 or 2)				0 or 1
Set heater to off	fn=0	f1=0			
Set heater to on	fn=1	f1=1			
<p>Legend:</p> <ul style="list-style-type: none"> [] Optional Command data { } Returns either information n Numeric data supplied by user 9 Numeric data returned to user x Character data returned to user <p>Note:</p> <p>When DUPLEX is set to FULL and a command is sent to READ, the command is returned followed by a carriage return and linefeed. Then the value is returned as indicated in the RETURNED column.</p>					

Power Control Functions

The digital interface is capable of controlling the heating functions so that the bath can be remotely operated at any temperature within the range of the bath. To allow the interface to control the heating, the front panel controls are disabled by switching the heater switch to "LOW". Otherwise, the interface would not be able to switch the heater functions off. The 6050H bath has two control functions with the digital interface. These control functions are for heaters settings Med and High.

To control the heaters with the digital interface the front panel heater switch must be set to "LOW". The heater function is controlled with the "F1" and "F2" commands. These commands are either set to "0" or "1" according to Table 4. The default settings are "F1=0" and "F2=0" which is "LOW". Sending a command without a parameter returns the state, "1" for on or "0" for off.

Table 3. Power Control Commands

Power	F1	F2
400 W	0	0
1200 W	1	0
2000 W	x	1

Calibration Procedure

Note

This procedure is to be considered a general guideline. Each laboratory should write their own procedure based on their equipment and their quality program. Each procedure should be accompanied by an uncertainty analysis also based on the laboratory's equipment and environment.

In some instances the user may want to calibrate the bath to improve the temperature set-point accuracy. Calibration is done by adjusting the controller probe calibration constants R0 and ALPHA so that the temperature of the bath as measured with a standard thermometer agrees more closely with the bath set-point. The thermometer used must be able to measure the bath fluid temperature with higher accuracy than the desired accuracy of the bath. By using a good thermometer and carefully following procedure the bath can be calibrated to an accuracy of better than 0.02 °C over a range of 100 degrees.

Calibration Points

In calibrating the bath R0 and ALPHA are adjusted to minimize the set-point error at each of two different bath temperatures. Any two reasonably separated bath temperatures may be used for the calibration, however, best results are obtained when using bath temperatures which are just within the most useful operating range of the bath. The farther apart the calibration temperatures the larger the calibrated temperature range, but the calibration error is also greater over the range. For instance, if 50 °C and 150 °C are chosen as the calibration temperatures, then the bath may achieve an accuracy of ± 0.03 °C over the range 40 to 160 °C. Choosing 80 °C and 120 °C may allow the bath to have a better accuracy of maybe ± 0.01 °C over the range 75 to 125 °C but outside that range the accuracy may be only ± 0.05 °C.

Measuring the Set-point Error

The first step in the calibration procedure is to measure the temperature errors (including sign) at the two calibration temperatures. First set the bath to the lower set-point, t_L . Wait for the bath to reach the set-point and allow 15 minutes to stabilize at that temperature. Check the bath stability with the thermometer. When both the bath and the thermometer have stabilized, measure the bath temperature with the thermometer and compute the temperature error, err_L , which is the actual bath temperature minus the set-point temperature. For example, if the bath is set for a lower set-point of $t_L=50$ °C and the bath reaches a measured temperature of 49.7 °C then the error is -0.3 °C.

Next, set the bath for the upper set-point, t_H , and, after stabilizing, measure the bath temperature and compute the error, err_H . For example, suppose the bath was set for 150 °C and the thermometer measured 150.1 °C giving an error of $+0.1$ °C.

Computing R0 and ALPHA

Before computing the new values for R0 and ALPHA the current values must be known. The values may be found by either accessing the probe calibration menu from the controller panel or by inquiring through the digital interface. The user should keep a record of these values in case they may need to be restored in the future. The new values R0' and ALPHA' are computed by entering the old values for R0 and ALPHA, the calibration temperature set-points t_L and t_H , and the temperature errors err_L and err_H into the following equations:

$$R_0' = \left[\frac{err_H t_L - err_L t_H}{t_H - t_L} ALPHA + 1 \right] R_0$$

$$ALPHA' = \left[\frac{(1 + ALPHA t_H)err_L - (1 + ALPHA t_L)err_H}{t_H - t_L} + 1 \right] ALPHA$$

For example, if R0 and ALPHA were previously set for 100.000 and 0.0038500 respectively and the data for t_L , t_H , err_L , and err_H were as given above, the new values R0' and ALPHA' would be computed as 100.193 and 0.0038272 respectively. Program the new values R0 and ALPHA into the controller. Check the calibration by setting the temperature to t_L and t_H and measuring the errors again. If desired the calibration procedure may be repeated again to further improve the accuracy.

Calibration Example

The bath is to be used between 75 and 125 °C and it is desired to calibrate the bath as accurately as possible for operation within this range. The current values for R0 and ALPHA are 100.000 and 0.0038500 respectively. The calibration points are chosen to be 80.00 and 120.00 °C. The measured bath temperatures are 79.843 and 119.914 °C respectively. Refer to Figure 9 for applying equations to the example data and computing the new probe constants.

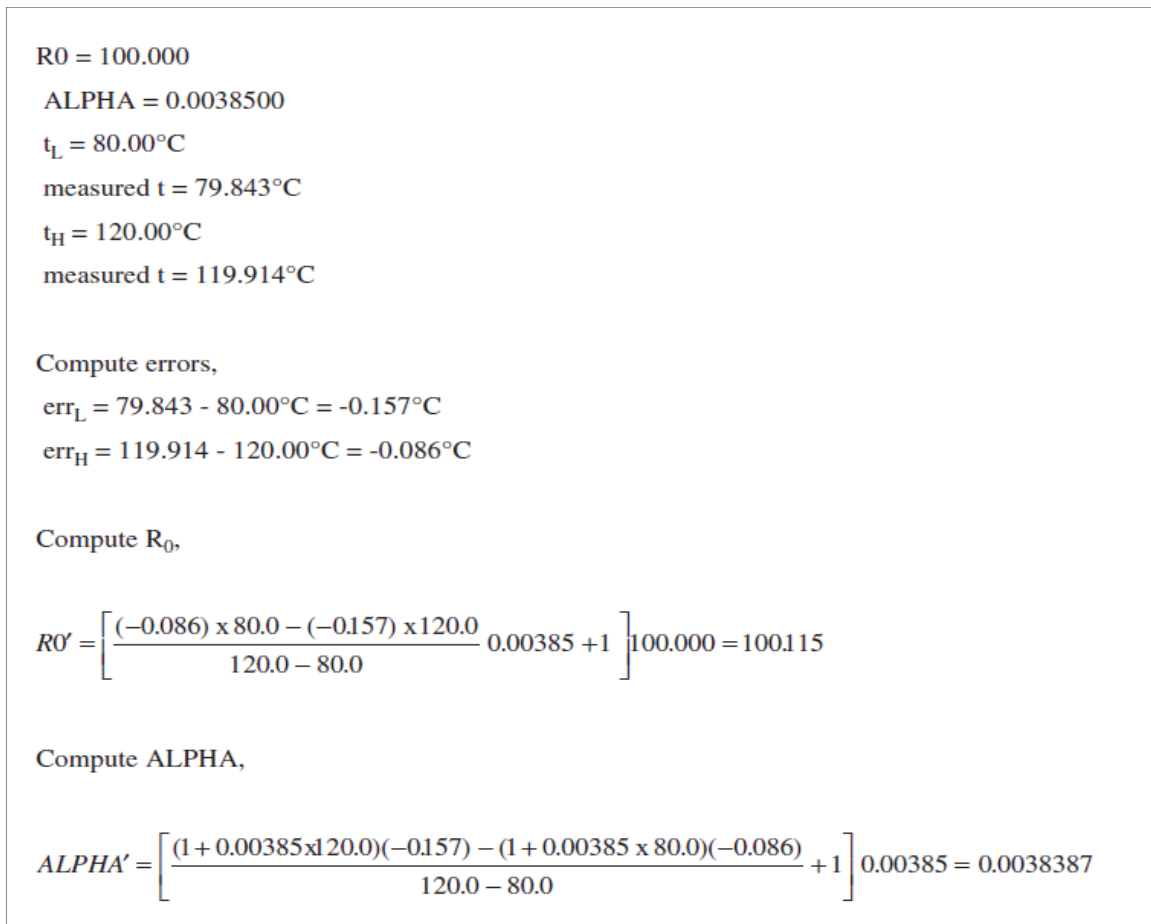

figure 10.eps

Figure 9. Calibration Example

Maintenance

The calibration instrument has been designed with the utmost care. Ease of operation and simplicity of maintenance have been a central theme in the product development. Therefore, with proper care the instrument should require very little maintenance. Avoid operating the instrument in dirty or dusty environments.

- A battery is used to maintain operating parameters in the unit. All operating parameters, including calibration parameters should be checked on a regular basis to insure accuracy and proper operation of the instrument. See the troubleshooting section for the procedure on checking the status of the battery.
- The bath should be cleaned regularly to prevent a buildup of oil, salt, or dust. Use a paint safe cleaning agent on all painted surfaces. Solvents such as Trichloroethylene or Acetone may dull or dissolve the paint. The stainless steel surfaces may be cleaned with solvents as necessary to remove salt.
- The stirring motor should be clean to allow proper cooling. Normally only the outside surfaces will require any attention. If the inside of the motor has become heavily loaded with salt or dust, blow it out with compressed air. Follow normal safety procedures when using pressurized gasses.
- Periodically check the fluid level in the bath to ensure that the level has not dropped. A drop in the fluid level affects the stability of the bath. Changes in fluid level are dependent upon several factors specific to the environment in which the equipment is used. A schedule cannot be outlined to meet each environmental setting. Therefore, the first year the bath should be checked weekly with notes kept as to changes in bath fluid. After the first year, the user can set up a maintenance schedule based on the data specific to the application.
- Salt requires little maintenance. There is very little evaporation with salt. Periodic fluid level checks are sufficient.
- If a hazardous material is spilled on or inside the equipment, the user is responsible for taking the appropriate decontamination steps as outlined by the national safety council with respect to the material. MSDS sheets applicable to all salt used in the bath should be kept in close proximity to the instrument.
- If the mains supply cord becomes damaged, replace it with a cord with the appropriate gauge wire for the current of the bath. If there are any questions, contact an Authorized Service Center for more information.
- Before using any cleaning or decontamination method except those recommended by Hart, users should check with an Authorized Service Center to be sure that the proposed method will not damage the equipment.
- If the instrument is used in a manner not in accordance with the equipment design, the operation of the bath may be impaired or safety hazards may arise.

⚠ Warning

When checking the over-temperature cutout, be sure that the temperature limits of the bath fluid are not exceeded. Exceeding the temperature limits of the bath fluid could cause harm to the operator, lab, and instrument.

- The over-temperature cutout should be checked every 6 months to see that it is working properly. In order to check the user selected cutout, follow the controller directions for setting the cutout. Both the manual and the auto reset option of the cutout should be checked. Set the bath temperature higher than the cutout. Check to see if the display flashes cutout and the temperature is decreasing.

Troubleshooting

In the event the bath appears to function abnormally this section may help to find and solve the problem. Several possible problem conditions are described along with likely causes and solutions. If a problem arises please read this section carefully and attempt to understand and solve the problem. If the bath seems faulty or the problem cannot otherwise be solved, then contact an Authorized Service Center for assistance. Opening the unit without contacting an Authorized Service Center may void the warranty.

Troubleshooting Table

Problem	Causes and Solutions
<p>The heater indicator LED stays red but the temperature does not increase</p>	<p>If the display does not show "cutout" and shows the correct bath temperature, consider the following possibilities:</p> <p>Insufficient heating. Insufficient heating may be caused by the heater power setting being too low, especially at higher operating temperatures. Switching to the higher heater power switch setting, if available, may solve the problem.</p> <p>No heating. This is caused by blown heater fuses and/or burned out heaters. Check the heater fuses to make sure that they are still good. Access the heater fuses by removing the L-shaped panel covering the display electronics. If they are blown, and continue to blow when replaced, the heaters may be shorted. If you suspect that the heaters are shorted or burned out, contact an Authorized Service Center for assistance.</p>
<p>The controller display flashes "CUToUT" and the heater does not operate</p>	<p>If the display flashes "CUToUT" alternately with the correct process temperature, check the following:</p> <p>Wrong cutout setting. The cutout disconnects power to the heaters when the bath temperature exceeds the cutout set-point. This causes the bath temperature to drop back down to a safe value. If the cutout mode is set to "AUTO", the heater switches back on when the temperature drops. If the mode is set to "RESET", the heater only comes on again when the temperature is reduced and the operator manually resets the cutout.</p> <p>Check that the cutout set-point is adjusted to 10 or</p>

Problem	Causes and Solutions
	<p>20°C above the desired maximum bath operating temperature and that the cutout mode is set as desired.</p> <p>Continuous cutout. If the cutout activates when the bath temperature is well below the cutout set-point or the cutout does not reset when the bath temperature drops and it is manually reset, the cutout circuitry may be faulty. Try performing the Factory Reset Sequence explained below.</p> <p>Factory Reset Sequence Hold the “SET” and “EXIT” keys down at the same time while powering up the unit. The display shows “-init”, the model number, and the firmware version. Each of the controller parameters and calibration constants must be re-programmed. The values can be found on the Report of Calibration that was shipped with the instrument.</p>
<p>The display flashes “CUToUT” alternately with an incorrect process temperature</p>	<p>Low battery. A problem could exist with the memory back-up battery. If the battery voltage is insufficient to maintain the memory, data may become scrambled causing problems. A nearby large static discharge may also affect data in memory. Access the battery by removing the L-shaped panel covering the display electronics.</p> <p>Corrupt controller memory. If the problem reoccurs after the battery is replaced, initialize the memory by performing a Factory Reset Sequence (described in a previous solution).</p>
<p>The controller displays the wrong temperature and the bath continually heats or cools regardless of the set-point value</p>	<p>Defective control probe. The bath control probe may be disconnected, burned out, or shorted. Check first that the probe is connected properly to the socket in the rear of the bath labeled “PROBE”.</p> <p>The probe may be checked with an ohmmeter to see if it is open or shorted. The probe is a platinum 4-wire Din 43760 type. The resistance should read 0.2 to 2.0 ohms between pins 1 and 2 on the probe connector and 0.2 to 2.0 ohms between pins 3 and 4. The resistance should read from 100 to 300 ohms between pins 1 and 4 depending on its current temperature.</p> <p>Corrupt controller memory. Initialize the memory by performing a Factory Reset Sequence (described in a previous solution).</p>

Problem	Causes and Solutions
<p>The controller controls or attempts to control at an inaccurate temperature</p>	<p>If the controller appears to operate normally except that the bath's temperature does not agree with the temperature measured by the user's reference thermometer to within the specified accuracy, consider the following:</p> <p>Erroneous parameters. Check that the calibration parameters are all correct according to the Report of Calibration. If not, reprogram the constants. If the controller does not keep the correct parameters, the memory backup battery may be weak causing errors in data. See "Low Battery" in a previous solution.</p> <p>Poor uniformity. There may be an actual difference between the bath's control probe and the reference thermometer due to excess gradients in the bath.</p> <p>Check that the bath has an adequate amount of fluid in the tank and that the stirrer is operating properly. Also check that the reference thermometer and control probe are both fully inserted into the bath to minimize temperature gradient errors.</p> <p>Defective control probe. Check that the control probe has not been struck, bent, or damaged. Refer to the previous solution for how to check the probe's resistance.</p>
<p>The controller shows that it is controlling at the proper temperature, but the bath temperature is unstable</p>	<p>If the bath does not achieve the expected degree of temperature stability when measured using a thermometer, consider the following:</p> <p>Wrong proportional band setting. If the proportional band is set too narrow, the bath will oscillate causing poor stability. In this case, increase the width of the proportional band.</p> <p>If the proportional band setting is too wide, the long-term stability of the bath is affected. In this case decrease the width of the band.</p> <p>Bath salt is too thick. Make sure that the bath salt used is less than 50 centistokes (10 is ideal) at the temperature at which the bath is controlling. Check the salt manufacturer's specifications.</p> <p>Defective control probe. Check that the control probe has not been struck, bent, or damaged. Refer to the previous solution for how to check the probe's resistance.</p>
<p>The controller alternately heats for a while then cools</p>	<p>Wrong proportional band setting. If the proportional band is set too narrow, the bath will oscillate between too much heating and too much cooling causing instability. Increase the width of the proportional band until the temperature stabilizes.</p>
<p>Stir motor does not function</p>	<p>Improper setting or normal operation. See Section 9.11.2, Stir Mode Select, for proper stir mode settings.</p>

Problem	Causes and Solutions
	<p style="text-align: center;"><i>Note</i></p> <p><i>Stir Mode Select defaults to "Auto" each time the power of the bath is cycled off and back on. Therefore, this parameter has to be set each time the bath is powered on if "Str-ON" is the desired mode of operation.</i></p> <p><i>If stir motor still does not function, contact an Authorized Service Center for assistance.</i></p>
<p>The controller does not maintain controller parameters or parameters are reset each time the power to the unit is removed.</p>	<p style="text-align: center;"><i>Note</i></p> <p><i>Before performing the memory check, you need to record the controller calibration parameters (found in the CAL menu of the instrument) and any user-adjusted parameters that you have changed (such as the programmable set points and proportional band).</i></p> <p>Memory Check</p> <p><i>Doing a memory check is the easiest way to verify the ability of the battery to maintain controller parameters.</i></p> <ol style="list-style-type: none"> <i>1. Power off the instrument.</i> <i>2. Disconnect the instrument from AC power for 10 seconds.</i> <i>3. Reconnect the AC power and power on the instrument.</i> <i>4. If the display shows "InIT" and/or the cycle count shows a low number such as 0002, the battery is spent and should be replaced. Contact an Authorized Service Center for assistance.</i> <i>5. After replacing the battery, you must reprogram the calibration and user-adjustable parameters into the controller.</i>

Comments

EMC Directive

Fluke Calibration's equipment has been tested to meet the European Electromagnetic Compatibility Directive (EMC Directive, 89/336/EEC). The Declaration of Conformity for your instrument lists the specific standards to which the unit was tested.

Low Voltage Directive (Safety)

In order to comply with the European Low Voltage Directive (73/23/EEC), Hart Scientific equipment has been designed to meet the EN 61010-1 and EN 61010-2-010 standards.

