

InfiniiVision 3000G X-Series Oscilloscopes

Product Overview

The InfiniiVision 3000G X-Series oscilloscopes with bandwidth models ranging from 100 MHz up to 1 GHz offer high-end technology in a small form factor. With an intuitive touch user-interface, industry-leading waveform update rate, zone trigger, and 8 new standard features, you can capture and isolate elusive glitches and anomalies not possible on other oscilloscopes.



Table of Contents

InfiniiVision 3000G X-Series: The best in usability deserves the best features.....	Error! Bookmark not defined.
Touch: Designed-for-touch operation to simplify use	4
Discover: Fast update rate and zone triggering uncover hidden signal problems.....	8
Solve: Analyze waveform data quickly with advanced features	17
7-in-1 instrument integration provides synergistic measurements.....	27
Other advanced measurements and features.....	32
Configuring Your Oscilloscope.....	39
Choose your bandwidth and number of channels.....	39
Select hardware upgrades	39
Select software upgrades.....	39
Performance Characteristics.....	42
Related Literature.....	58
After-purchase license-only upgrades	58

InfiniiVision 3000G X-Series: The Best in Usability Deserves the Best Features

Meet the new generation of Keysight's industry leading InfiniiVision X-Series oscilloscopes. With the best in usability, a comprehensive front panel with quick access buttons, easy-to-use touch operation or mouse-based control through direct connection or web-based UI, the InfiniiVision 3000G X-Series oscilloscope enables you to work in whatever way is best for you.

Keysight's InfiniiVision 3000G X-Series oscilloscope come in 2-channel models, 4-channel models, and mixed signal oscilloscope (MSO) models with bandwidths ranging from 100 MHz up to 1 GHz.

All models are enhanced with **standard features** that you would typically expect to pay extra for including:

- Powerful triggering and decoding serial buses including I²C, SPI, UART/RS232/RS485, I²S, and USB-PD
- High performance mask and measurement limit testing enabled in hardware
- Frequency response analysis (Bode plots)
- Waveform & measurement histograms
- Built-in function/arbitrary waveform generator
- HDTV video analysis
- LAN/VGA I/O communication
- PathWave BenchVue Oscilloscope software for control, automation, and offline analysis



Figure 1. InfiniiVision 3000G X-Series with MegaZoom IV smart memory technology

Touch, Discover, Solve

The InfiniiVision 3000G X-Series oscilloscopes have a capacitive touch screen user-interface that was designed for touch operation. Also included is hardware-based zone triggering combined with an industry-leading uncompromised update rate of 1 million waveform/sec to give you the confidence that you're seeing all of your signal detail and the ability to discover any issues.

The InfiniiVision 3000G X-Series redefines what you can expect in a general-purpose oscilloscope by providing all the performance and capability you need to get to measurement insights faster:

Touch:

- 8.5-inch capacitive touch screen
- Designed-for-touch interface

Discover:

- Industry's fastest uncompromised waveform update rate
- Zone trigger

Solve:

- Wide range of serial decodes
- 7-in-1 instrument integration
- Time/frequency domain correlation

Touch: Designed-for-touch operation to simplify use

From the start of product development, we designed every aspect of this oscilloscope to be seamlessly driven by a touch interface. Large, easy-to-touch targets, a graphical user interface that adapts to show you more and be easier to touch, and a large, sensitive, capacitive touch screen all combine to make operation quick and natural, just like your favorite tablet devices.



Figure 2. An 8.5" capacitive touch display with large, touchable targets.

Capacitive touch screen technology enables productivity

The user interface allows you to use the alphanumeric pad for quick annotation, place waveforms or cursors in exact positions and drag docking panels across the screen to see more measurement information.

The InfiniiVision 3000G X-Series offers three ways to access key menus and features: touch GUI for those that prefer tablet or smart phone touch interfaces, front panel buttons and knobs for the traditional oscilloscope users, and Keysight Insight pull down menu for users who prefer Windows-like operations. The 3000G X-Series also offers a “touch off” button as well as USB mouse and keyboard support.

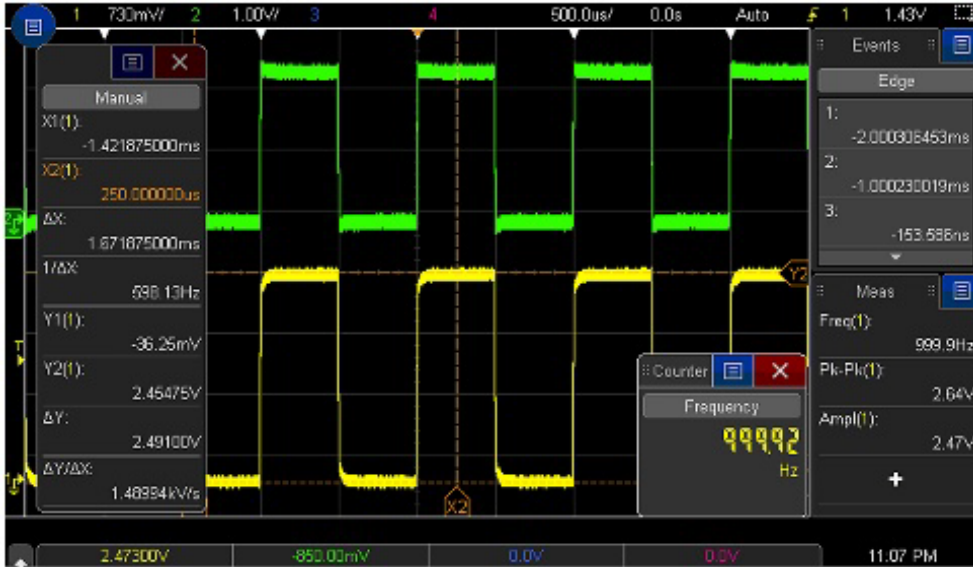

Figure 3. Side bar with movable docks allows information to be placed on the screen precisely where you want it for documentation.

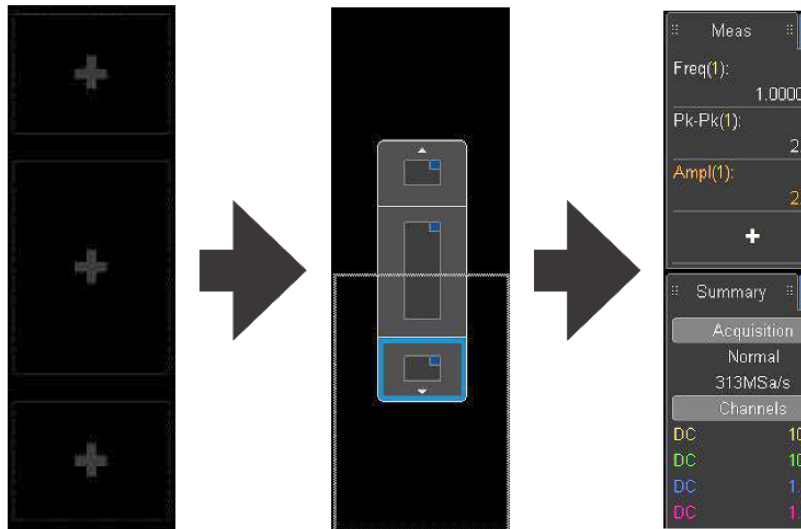

Figure 4. A dockable sidebar allows you to customize how you view your measurements.

Touch interface simplifies documentation

The availability of up to 10 annotations on screen makes it easy to highlight key items on screen shots. Streamline documentation with the ability to input information via a pop-up soft keyboard on the touch screen or a USB keyboard. A sidebar displays additional information without covering the waveform graticule and allows you to dock and scroll through multiple measurement values. Touch gestures (like flicking) make navigating lists or moving between segment waveforms easy.

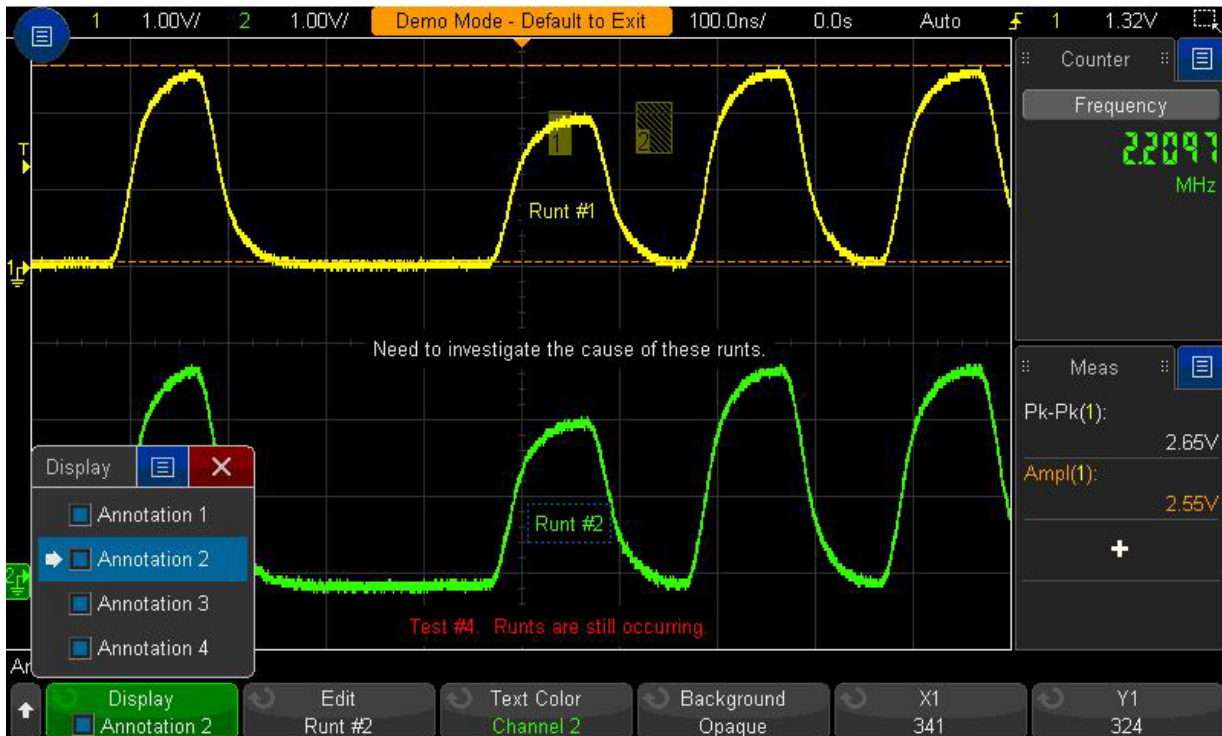

Figure 5. See up to ten annotations on screen at once for documentation. The standard touch screen makes inputting notes simple.

In addition to the benefits of touch, built-in USB host and USB device ports, as well as a LAN port, make PC connectivity easy. The BV0004B oscilloscope control and PC-based software (standard with the purchase of each InfiniiVision X-Series oscilloscope) lets you control and visualize the InfiniiVision 3000G X-Series and multiple measurements simultaneously. It lets you build automated test sequences just as easily as you can with the front panel. Save time with the ability to export measurement data to Excel, Word and MATLAB in three clicks. Monitor and control your 3000G X-Series oscilloscope with a mobile device from anywhere. Simplify your testing with BenchVue software.

Learn more at www.keysight.com/find/BenchVue



Figure 5. Use BenchVue for remotely logging and plotting measurement data.

The screenshot shows an email setup dialog box with the following fields and options:

- To:** john@yourcompany.com
- From:** john@yourcompany.com
- Server:** smtp.yourcompany.com
- Subject:** Scope Picture
- Format:** 24-bit Bitmap image (*.bmp)
- Invert Grayscale:** Off
- Palette:** Color
- Setup Info:** Off

The dialog box has a 'Setup' button at the top left and a close button (X) at the top right.

Figure 6. With the standard LAN/VGA module you can email yourself setups, data, and screenshots.

Redefine your remote web control oscilloscope experience

The InfiniiVision 3000G X-Series oscilloscope offers traditional control via a PC Web browser, but also supports remote control through popular tablet devices when using the standard LAN/VGA interface.



Figure 7. Remotely control the InfiniiVision 3000G X-Series oscilloscope via tablet device.

Discover: Fast Update Rate and Zone Triggering Uncover Hidden Signal Problems

Industry-leading uncompromised update rate

If you can't see the problem, you can't fix the problem. With an industry-leading update rate of over one million waveforms per second, the InfiniiVision 3000G X-Series oscilloscope gives you the highest probability of capturing random and infrequent events that you would miss on an oscilloscope with a lower waveform update rate.

Powered by MegaZoom IV smart memory technology, the InfiniiVision 3000G X-Series not only lets you see more waveforms, but it has the uncompromised ability to find the most difficult problems in your design under any conditions. Unlike other oscilloscopes, uncompromised ability means:

- Always-fast, responsive operation
- No slowdown with logic channels on
- No slowdown with protocol decoding on
- No slowdown with math functions on
- No slowdown with measurements on
- No slowdown with vectors on
- No slowdown with sinx/x interpolation on

What is waveform update rate?

As oscilloscopes acquire data, process it, and plot it to the screen, there is inevitable “dead time,” or the time oscilloscopes miss signals completely while processing waveform data from the previous acquisition. In general, the faster the waveform update rate, the shorter the dead time. The shorter the dead time, the more likely an oscilloscope is to capture anomalies and infrequent events. This is why it is important to select an oscilloscope with a fast waveform update rate. Figures 9 and 10 demonstrate the difference between a slower update rate and a faster update rate.

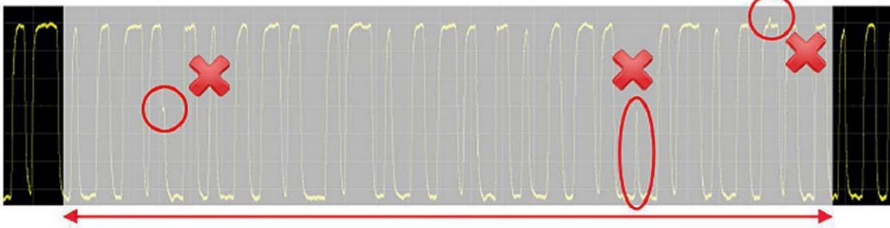

Figure 9. Another vendor's oscilloscope with 50,000 waveforms/second. A long dead time decreases your chances of capturing infrequent events.

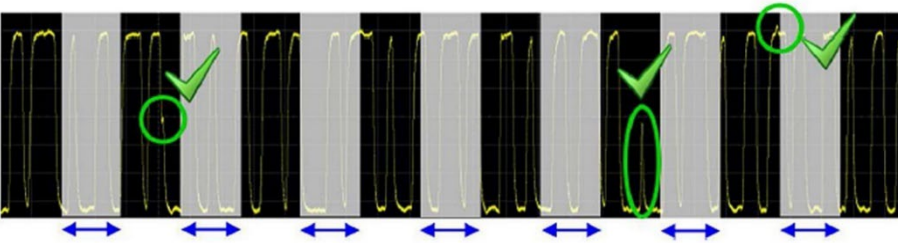

Figure 10. InfiniiVision 30000G X-Series with 1,000,000 waveforms/second. A short dead time increases the probability of capturing infrequent events.

But all specs aren't equal. Many vendors may claim a fast update rate specification, but that is only in a special mode, or without any features turned on. Table 1 shows the 3000G X-Series' update rate versus a competing oscilloscope.

While all scopes update rate will vary to some degree by the timebase setting, it is critical that the update rate remain constant regardless of the functionality you are using within the oscilloscope.

Table 1. Measured update rate between the 3000G X-Series and the Danaher Tektronix MDO3000. Note how the update rate fluctuates wildly on the MDO3000 based on different settings/features.

	10 ns/div			
	Keysight 3000G X-Series		Tektronix MDO3000 Series	
	Update rate	Probability	Update rate	Probability
Max with no features on				
Max with digital ch on	1,114,000	94%	281,000	50%
Max with measurements on	1,101,000	94%	132	0.03%
Max with FFT on	1,114,000	94%	2,200	0.55%
Max with serial on	1,114,000	94%	2,200	0.55%
Max with search on	1,100,000	94%	1,800	0.45%
Max with ref wfms on	1,113,000	94%	2,200	0.55%

Why is an uncompromised update rate important?

When debugging or troubleshooting a project, it is important that you see as much signal detail as possible. A fast update rate is just part of the overall equation to determine the likelihood of seeing an anomaly. The frequency of the anomaly, the timebase setting of the oscilloscope and the amount of time you allow the oscilloscope to see the anomaly all come in to play:

$$P_t = 100 \times (1 - [1 - RW]^{(U \times t)})$$

Where:

P_t = Probability of capturing anomaly in “t” seconds

t = Observation time

U = Scope’s measured waveform update rate

R = Anomalous event occurrence rate

W = Display acquisition window = Timebase setting x 10

Therefore, it is important to select an oscilloscope with the fastest uncompromised update rate to allow enough time to increase your chances of seeing the glitch. In Table 1, in addition to the measured update rate, we show the probability of seeing a glitch that happens 5 times a second while allowing the oscilloscope to acquire for 5 seconds. With the 3000G X-Series you maximize your chances of seeing the infrequent glitch. With the competing scope, if you are using any of the other features like measurements, or search or digital channels, the update rate slows considerably. The only option you have in this case is to allow the oscilloscope to run longer. For example, if you are using digital channels, you’ll have to let the scope run over 8,000 times longer to get a similar probability to the uncompromised update rate of the 3000G X-Series. That’s almost 12 hours of time versus 5 seconds!

MegaZoom IV smart memory technology enables uncompromised update rate

Traditionally, CPU processing was the major bottleneck for oscilloscope waveform update rate and responsiveness. Typically, the CPU handles interpolations, logic channel plotting, serial bus decoding, measurements and more, and the waveform update rate drops dramatically as these features are turned on.

The InfiniiVision 3000G X-Series requires minimum support from a CPU, as most core operations are handled by Keysight proprietary technology, the MegaZoom IV smart memory ASIC. MegaZoom includes hardware serial decoders and hardware mask limit testing capability, plots analog and digital data directly to the display, supports GUI operation, and integrates additional instruments like the WaveGen function/arbitrary waveform generator.

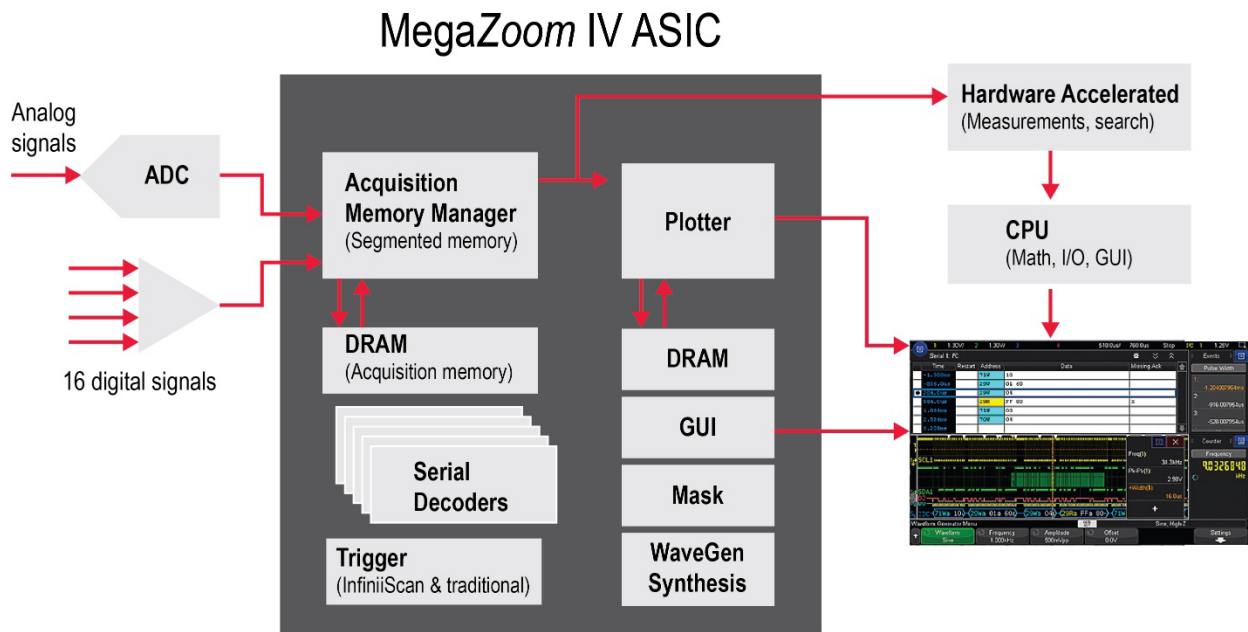

Figure 11. The 3000G X-Series oscilloscopes' uncompromised responsiveness, speed and waveform update rate are enabled by the MegaZoom IV, smart memory ASIC. The CPU is not used for core waveform operations.

Excellent signal integrity allows you to see more signal detail

The 3000G X-Series has excellent signal integrity, including full bandwidth to 1 mV/div and the ability to obtain up to 12-bits of resolution using the high-resolution acquisition mode.

Some oscilloscopes in this class limit their bandwidth at lower volt-per-division settings without on-display user notifications. This is likely to keep the noise acceptable at lower volt-per-division settings.

Table 2 shows a comparison of the typical noise floor at 20 $\mu\text{s}/\text{div}$ between the normal and high-resolution mode. You will notice that the noise floor performance improves as much as five times.

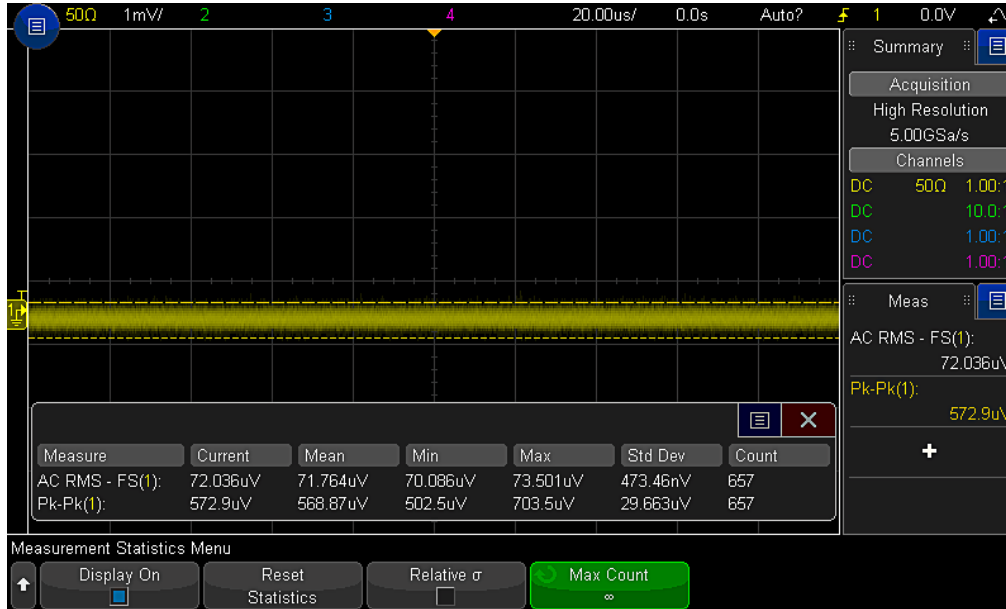

Figure 12. High resolution mode allows you to lower your noise and increase your resolution up to 12-bits.

Table 2. Noise comparison between the normal and high-resolution mode at 20 $\mu\text{s}/\text{div}$.

50 Ω 1 GHz bandwidth V_{rms} measurement (units = mV)			
Vertical setting	Normal mode	High resolution mode	Notes
1 mV	0.277	0.072	Some other manufacturers will limit their bandwidth significantly at these vertical settings, but the Keysight 3000G X-Series provides full bandwidth at all settings.
2 mV	0.277	0.072	
5 mV	0.297	0.081	
10 mV	0.352	0.081	
20 mV	0.597	0.102	
50 mV	1.500	0.340	
100 mV	2.560	0.480	
200 mV	5.500	1.050	
500 mV	15.200	3.630	
1 V	26.000	4.830	

Zone trigger makes triggering on complex signals simple

An uncompromised update rate allows you to see an anomaly, but to continue the debug process you must isolate it. Setting up advanced trigger conditions has been a challenge since oscilloscopes introduced triggered waveforms. While oscilloscopes have added more and more triggering capability over the years, setting up specialized trigger conditions has remained complex at best and impossible at worst.

Zone trigger eliminates the complexity of setting up advanced triggers. Now, if you can see an infrequent event on the display of the oscilloscope, you can trigger on it by simply drawing a box that intersects a portion waveform you want to isolate.

See how easy Zone touch triggering can be with these examples:

Steps to isolate a non-monotonic edge: 3000G X-Series:

- Draw box on the infrequent non-monotonic edge
- Select “must intersect”

In some cases, you may have to select the appropriate source/channel if it wasn't already selected.

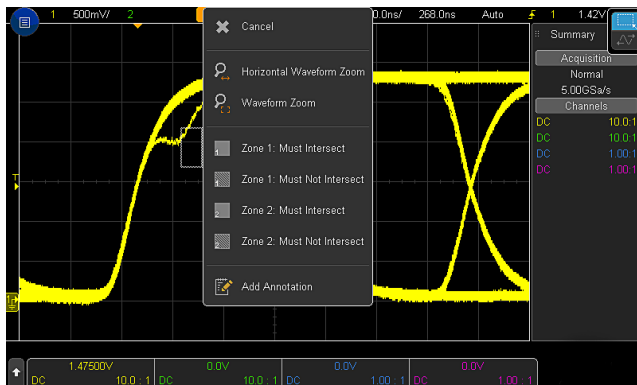

Traditional scopes with advanced triggers

(assuming the update rate is fast enough to see what you want to trigger on):

1. Determine what trigger makes the most sense for the signal you are trying to isolate. In this case, we'll try a rise-time trigger first.
2. Select cursors
3. Move cursor a to 10% level
4. Move cursor b to 90% level on the non-monotonic edge
5. Obtain the delta time (rise time) between the cursors
6. Select trigger menu
7. Press trigger type
8. Select Rise/Fall time Trigger
9. Select your source
10. Select your slope
11. Select when you want it to trigger – is it less than, greater than, equal to, not equal to. We'll select greater than.
12. Dial in the “greater than” setting to the measured rise time
13. Adjust your low threshold to the 10% level
14. Adjust your high threshold to the 90% level

Steps to trigger on a runt signal: 3000G X-Series

1. Draw box on the infrequent runt pulse
2. Select “must intersect”
3. Draw a second box if needed to further isolate the runt from other runs
4. Select “must intersect” or “must not intersect”

In some cases, you may have to select the appropriate source/channel if it wasn't already selected.

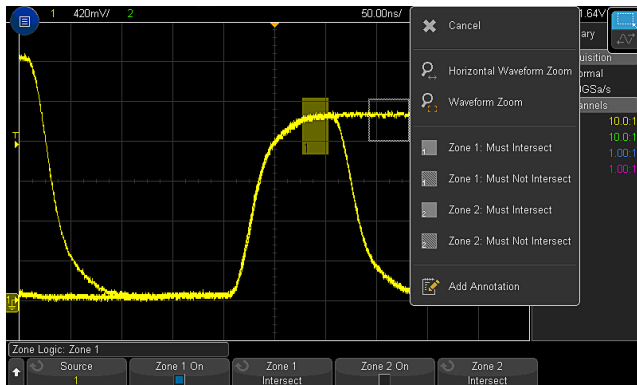

Traditional scopes with advanced triggers

(Assuming the update rate is fast enough to see what you want to trigger on).

Determine what trigger makes the most sense for the signal you are trying to isolate. In this case, we'll use a runt trigger first.

1. Select trigger menu
2. Press trigger type
3. Select runt Trigger
4. Select your source
5. Select the runt's polarity
6. Adjust your low threshold to below the runt
7. Adjust your high threshold to above the runt
8. Select when you'll trigger – in this case, we want to trigger on the exact pulse width of the runt
9. Select cursors
10. Move cursor a to the rising edge of the pulse at the 50% mark
11. Move cursor b to the falling edge of the pulse at the 50% mark
12. Obtain the delta time (pulse width) between the cursors
13. Adjust the runt width to be equal to the pulse width that was measure

Standard segmented smart memory allows you to capture longer periods of time at higher sample rates

Acquisition memory size is an essential oscilloscope specification because it determines sustainable sample rate and the amount of time you can capture in a single acquisition. In general, longer memory is better. However, no memory will always be long enough to capture all the signals you need, especially when capturing infrequent anomalies, data bursts, or multiple serial bus packets. Segmented memory acquisition lets you selectively capture and store important signal activity without capturing unimportant signal idle time. In addition, it provides a time stamp of each segment relative to the first trigger event to enable analysis of the frequency of the event. Segmented memory comes standard on the InfiniiVision 3000G X-Series oscilloscope.

Figure 13 shows segmented memory successfully capturing 100 small and large glitch events at 5 GSa/s in 47 seconds. Traditional memory architecture would require almost 203G points of memory to accomplish the same result! This memory is not available on any scope in the market.

Furthermore, segmented memory discovered that the worst offender glitch happened 40 seconds from the first trigger event, or at the 95th glitch. It also found out a unique glitch took place 13 seconds after the first glitch. As shown in figure 14, you can overlay all segments to have a comprehensive view as well.



Figure 13. Segmented memory reveals different types of glitches are taking place.



Figure 14. Screen showing an overlay of all 100 segments for worst case waveform analysis.

Dedicated search & navigation helps you navigate deep memory

Parametric and serial bus search and navigation comes standard on the InfiniiVision 3000G X-Series oscilloscopes. When you are capturing long, complex waveforms using an oscilloscope’s acquisition memory, manually scrolling through stored waveform data to find specific events of interest can be slow and cumbersome. With automatic search and navigation capability, you can easily set up specific search criteria and then quickly navigate to “found and marked” events. Available search criteria include edges, pulse width (time-qualified), rise/fall times (time-qualified), runt pulses (time-and level-qualified), frequency peaks (FFT function, threshold and excursion qualified), and serial bus frames, packets, and errors.

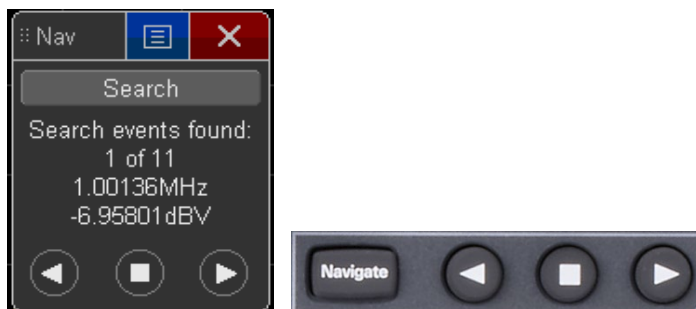

Close-up on buttons on the front panel of the scope. Alternatively, you also can use the touch navigation control.

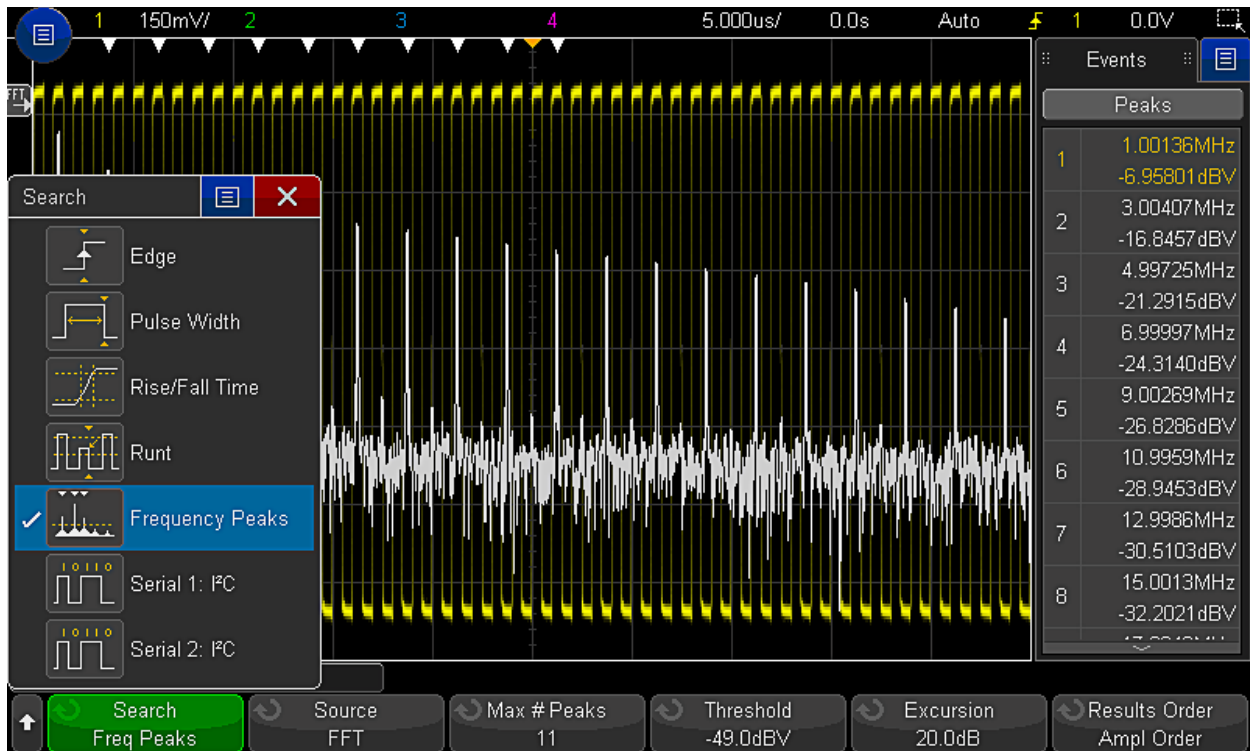

Figure 15. The InfiniiVision 3000G X-Series was set up to capture clock signals for FFT analysis. Using the search and navigation capability, the scope was able to find, mark (white triangles) and quickly navigate to the first 11 frequency peak occurrences. You can select to sort the search results in the order of frequency or amplitude.

Solve: Analyze waveform data quickly with advanced features

Hardware-based serial decode & triggering makes easy work of low-speed serial buses

Keysight InfiniiVision oscilloscopes, including the new 3000G X-Series, use hardware-based serial protocol decoding. Most other vendors use software post-processing techniques to decode serial packets/frames, and therefore have slow waveform and decode capture rates and could miss critical events and errors due to a long dead-time. Faster decoding with hardware-based technology enhances the probability of capturing infrequent serial communication errors.

After capturing serial bus communication, you can easily perform a search operation based on specific criteria and then quickly navigate to bytes/frames of serial data that satisfy that search criteria. The 3000G X-Series can decode two serial buses simultaneously using hardware-based decoding and display the captured data in a time-interleaved “lister” display.

Serial protocol decoding can be used simultaneously with segmented memory and Zone triggering. The 3000G X-Series has the most decode/trigger capabilities in this class of instrument including I²C, SPI, RS232/422/485/UART, I²S, CAN, CAN FD, LIN, SENT, CXPI, FlexRay, MIL-STD 1553, ARINC 429, USB PD, and USB 2.0 low- & full-speed.

Optional and standard supported serial bus protocols

The InfiniiVision 3000G X-Series supports a range of different serial decode and trigger options including:

- I²C (standard)
- SPI (2/3/4 wire, standard)
- RS232/422/485/UART (standard)
- USB 2.0 low- and full-speed
- CAN (symbolic with .dbc file)
- CAN FD (symbolic with .dbc file)
- LIN (symbolic with .ldf file)
- SENT
- CXPI
- FlexRay
- MIL-STD 1553
- ARINC 429
- USB PD (standard)
- I²S (standard)
- User-definable Manchester
- User-definable NRZ

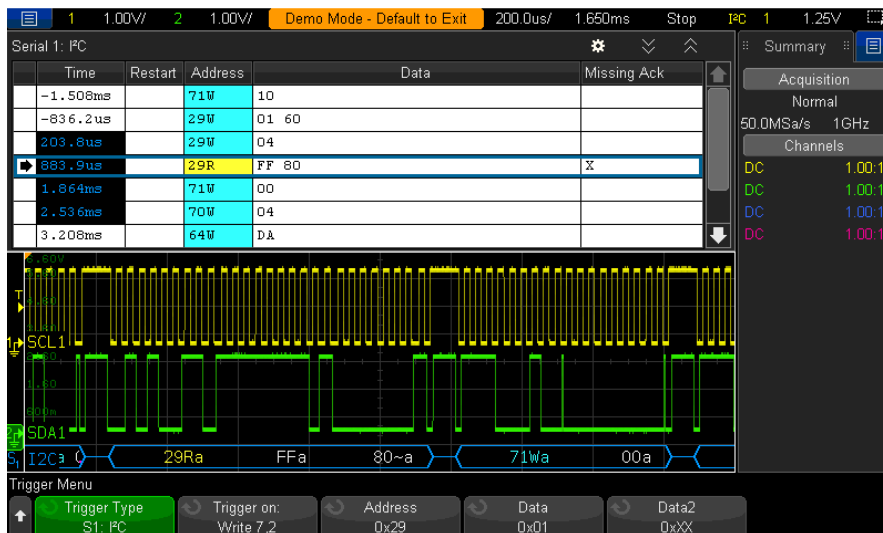

Figure 16. I²C decode and trigger.

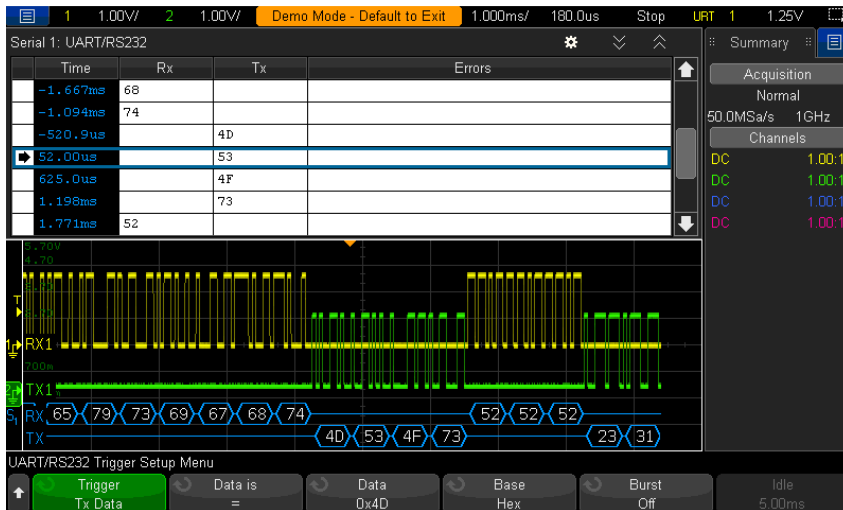

Figure 17: UART/RS232/RS485 trigger and decode.

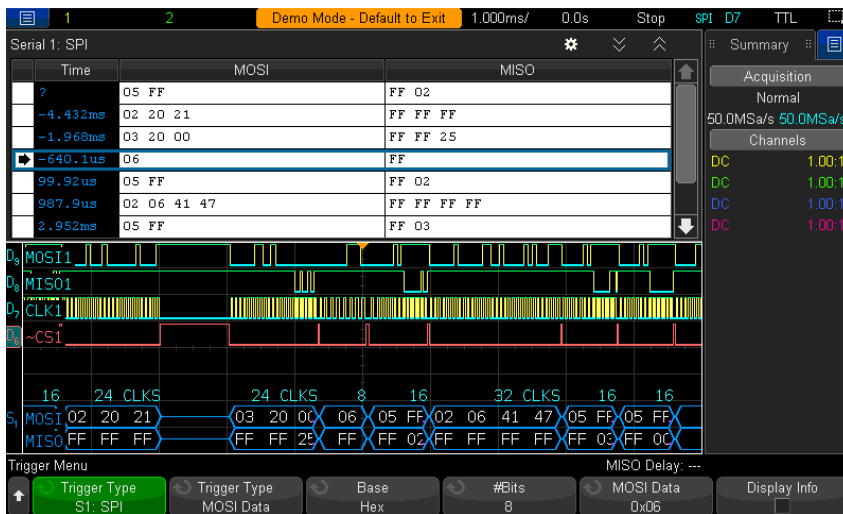

Figure 18: SPI trigger and decode.

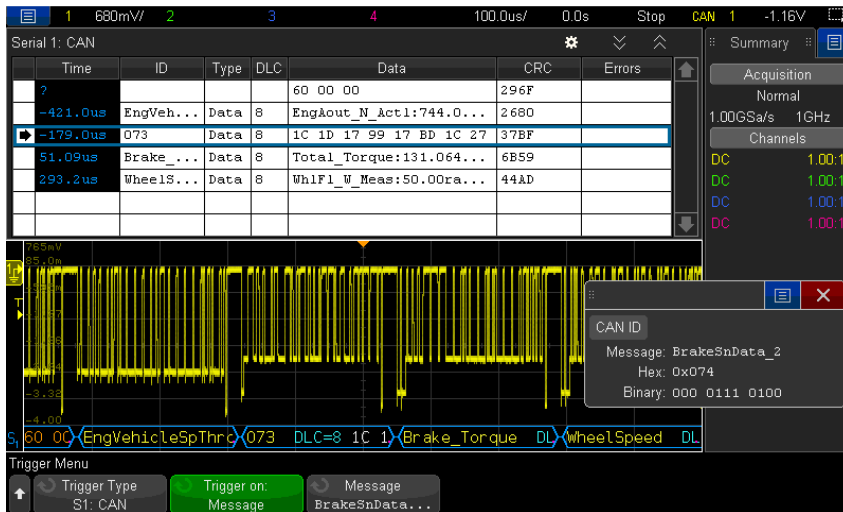

Figure 19: CAN trigger and decode with symbolic .dbc file.

Segmented memory combined with protocol analysis enables insights over long periods of time

Segmented memory works in conjunction with any of the optional serial protocol decodes. For example, by setting the trigger condition to “SENT serial bus error,” segmented memory captures and stores only SENT pulse period error packets and stitches together each segment for easy viewing of the decoded data in the lister. You can quickly compare time tags to discover time intervals between errors.

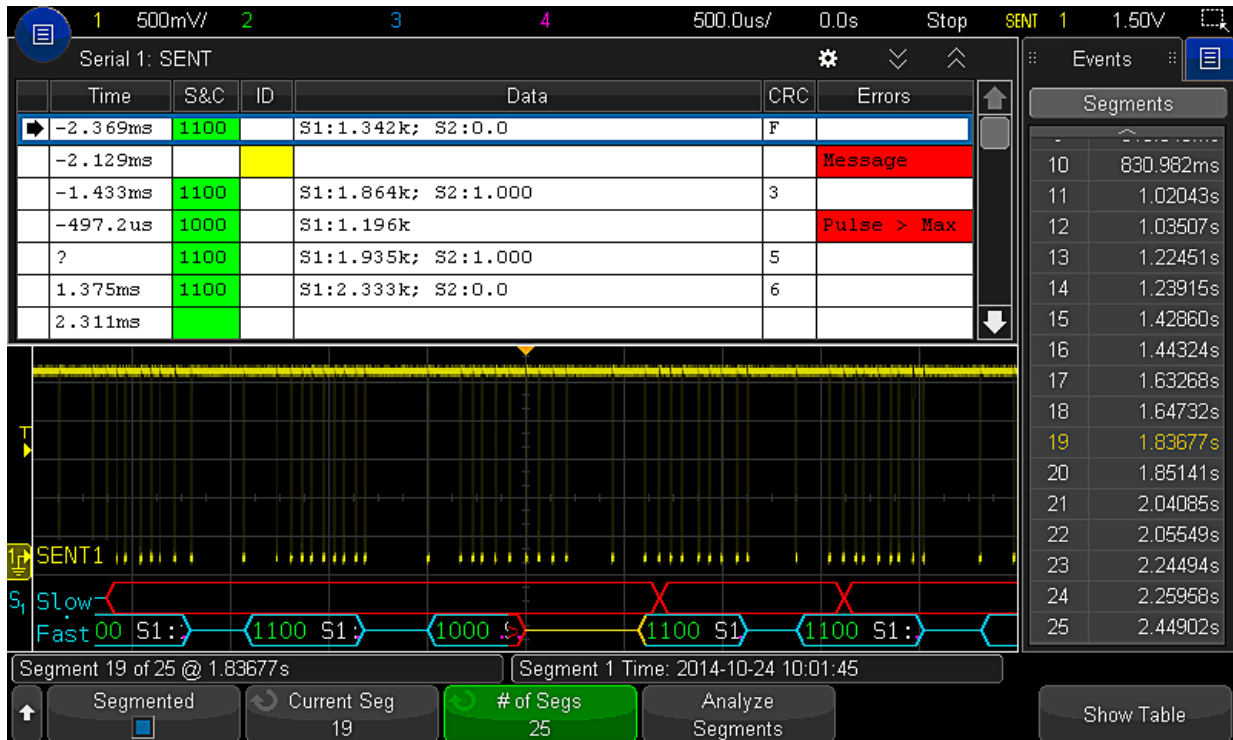

Figure 20. Segmented memory being used in conjunction with SENT bus serial decode resulting in maximum insight to the serial bus.

Dedicated frequency/spectrum analysis allows you to time-correlate analog, digital, and frequency-domain waveforms in a single instrument

Viewing the frequency content of waveforms is greatly simplified by a dedicated FFT button and level adjustment knobs. Pop up keypads make inputting start, stop, span and center frequency easy. And the new problem-solving feature called “gated FFT”, unique in this class of instrument, lets you time correlate the analog, digital, and frequency domain to aid in analysis and debug. In addition, there are new capabilities for peak searching, max and min hold and averaging of FFTs to increase dynamic range.

When gated FFT is on, the oscilloscope goes into zoom mode. The FFT analysis shown in the zoomed (bottom) window is taken from the period of time indicated by the zoom box in the main (top) window. In the gated FFT mode, touch and flick the zoom box through the acquisition to investigate how the FFT analysis changes over time, correlating the RF phenomenon with the analog and digital phenomenon.

Figure 21 through 25 show a simple gated FFT example observing a RF signal frequency transition from 400 MHz to 200 MHz, time correlated to both the SPI controlling signal (digital) and a VCO enable signal (analog). Note, you can also visualize the RF signal itself in the time-domain to gain additional insight such as a gap in the RF time domain waveform.

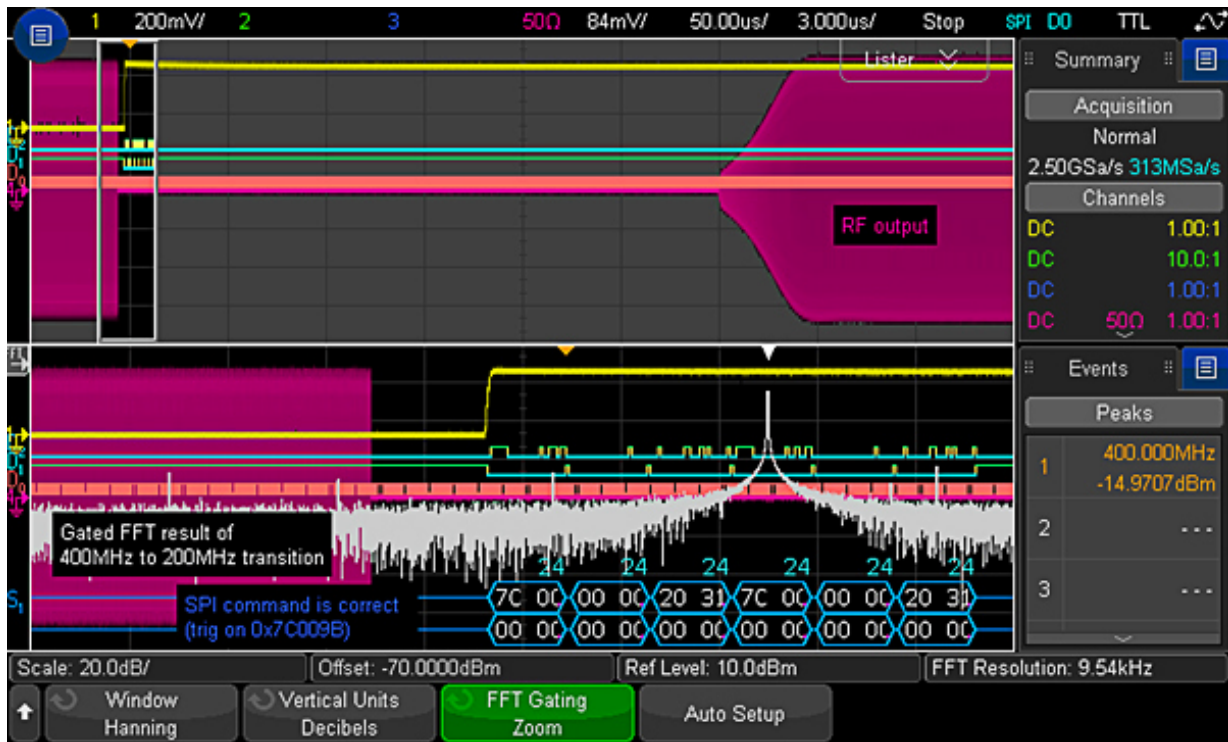

Figure 21. Triggered on a SPI command, the RF signal is still at 400 MHz as indicated in the frequency peak search result lister.

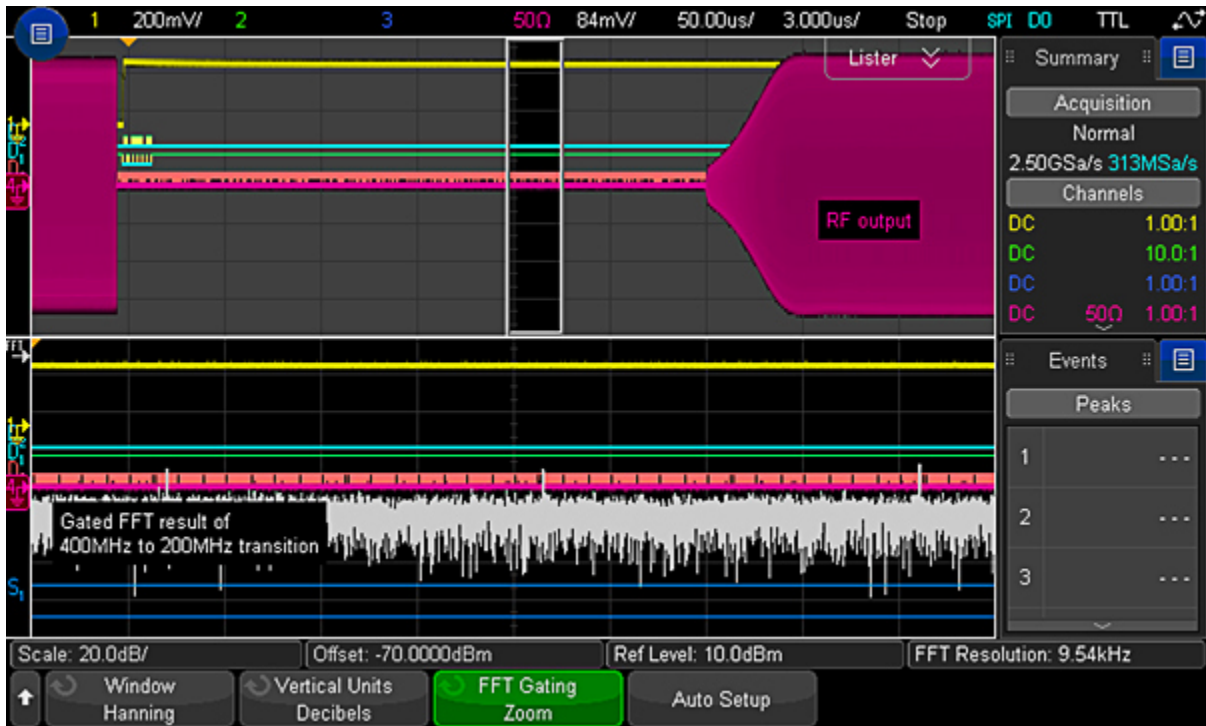

Figure 22. No RF activities in this zoomed time.

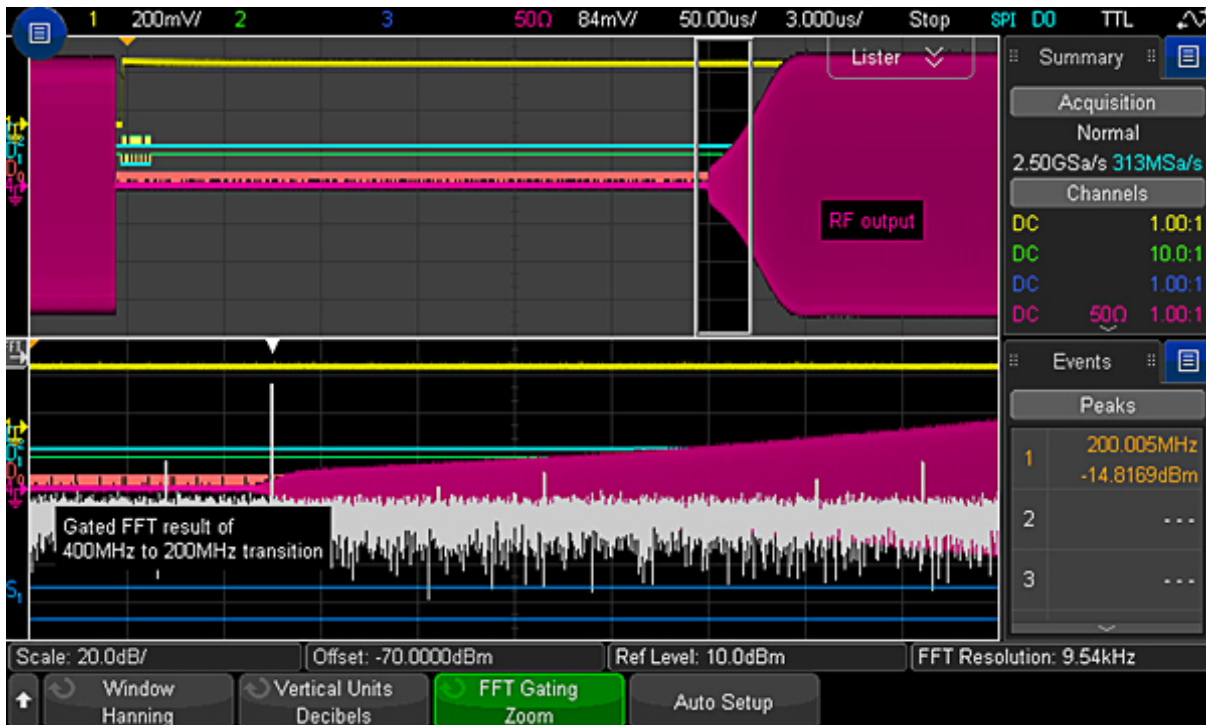

Figure 23. Start observing the RF signal at 200 MHz. You can validate this from the RF analog waveform as well.

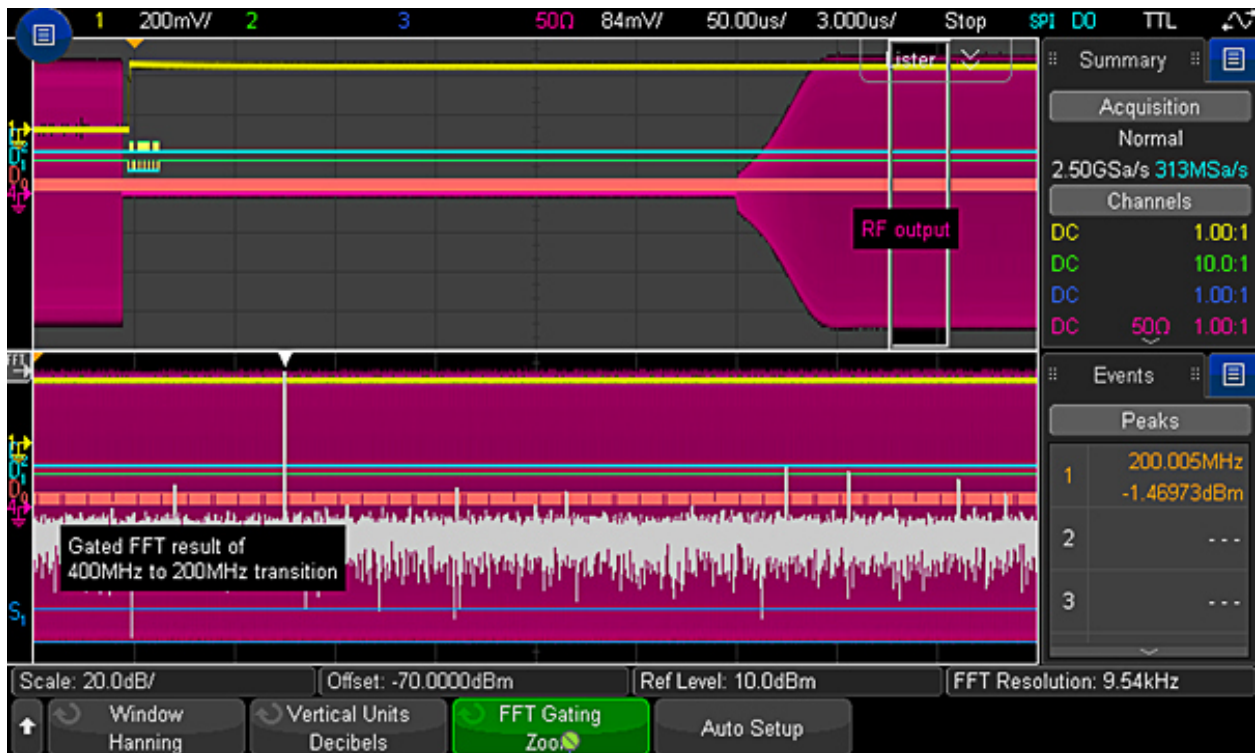

Figure 24. RF signal settled down at 200 MHz as indicated in the search lister.

Analyze statistical distribution of jitter and noise with waveform and measurement histograms

Using the oscilloscope's touch screen, you can draw a rectangular "slice" across a horizontal or vertical segment of a repetitively captured and updated waveform to view a static histogram of timing jitter or vertical noise along with statistical results as shown in Figures 25 and 26.

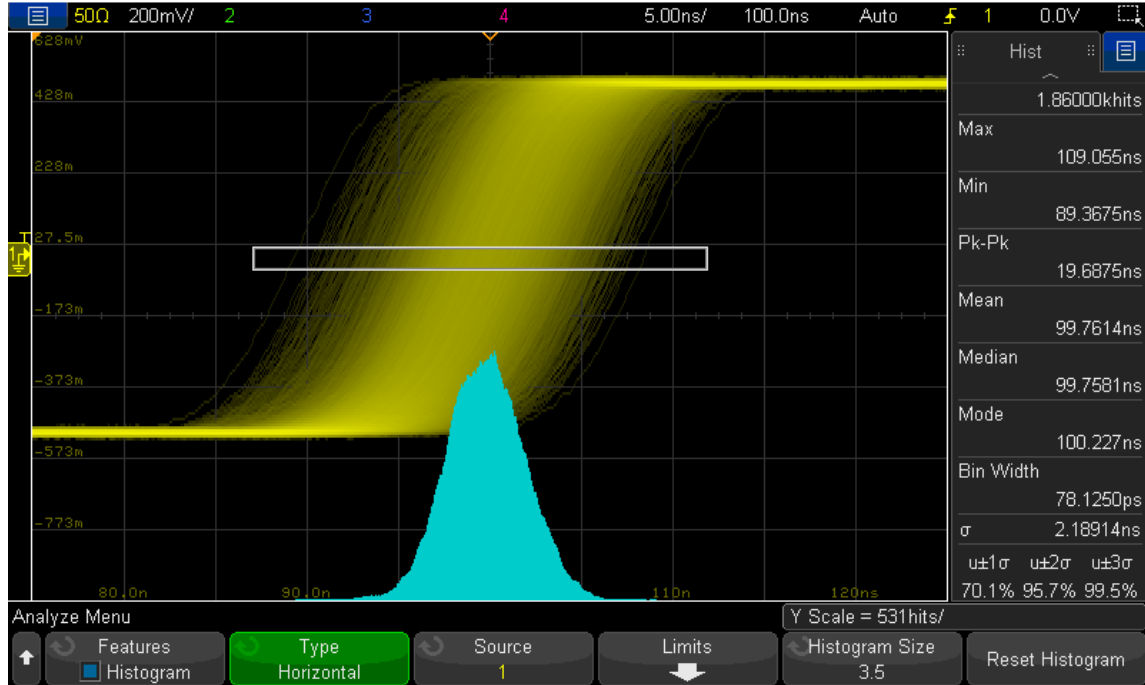

Figure 25. Horizontal waveform histogram reveals Gaussian jitter with standard deviation of 2.2 ns.

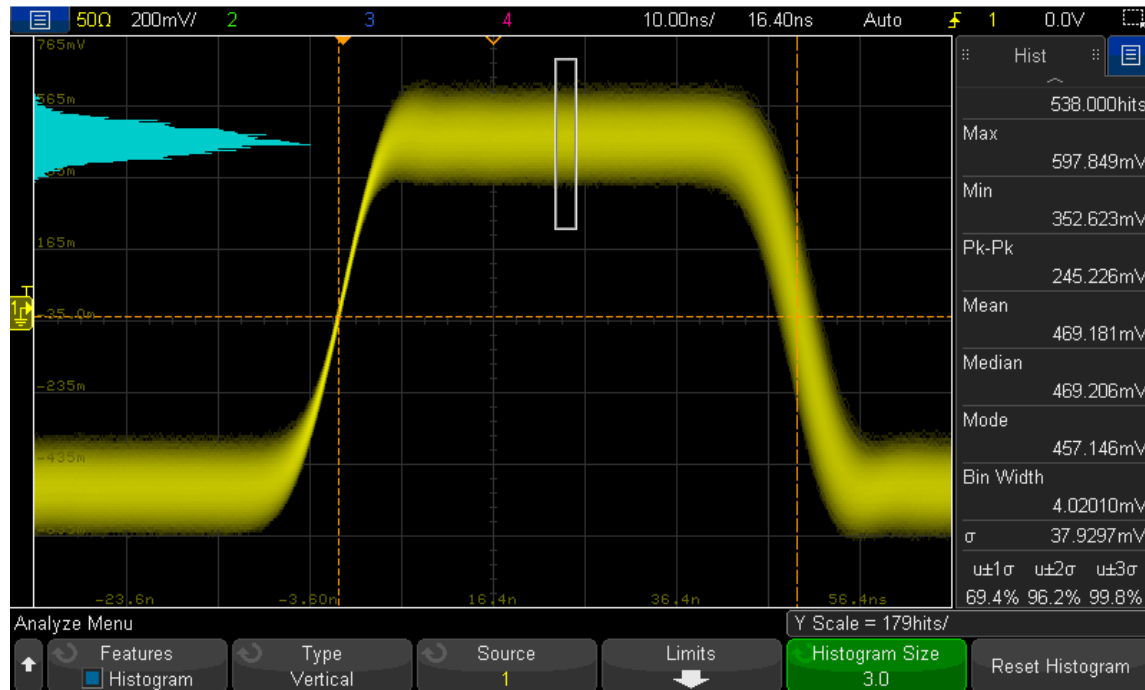

Figure 26. Vertical waveform histogram reveals Gaussian noise with standard deviation of 38 ns.

Advanced waveform math functions

Advanced math analysis provides a variety of additional math functions and comes standard on the 3000G X-Series. Additionally, math functions can be nested to provide additional insight into your designs. You can create up to two math functions, with one math function and FFT displayed at a time.

The InfiniiVision 3000G X-Series supports up to two cascaded math functions with an assortment of operators, transforms, filters, and visualization functions:

Operators

- Add, subtract, multiply, divide

Transforms

- Differentiate, integrate
- FFT (magnitude and phase)
- $Ax + B$
- Squared, square root
- Absolute value
- Common logarithm, natural logarithm
- Exponential, base 10 exponential

Filters

- Low-pass filter, high-pass filter, band-pass filter
- Averaged value
- Smoothing
- Envelope

Visualizations

- Magnify
- Max and min hold
- Measurement trend
- Chart logic bus timing, chart logic bus state
- Chart serial signal (CAN, CAN FD, LIN, and SENT)
- Maximum and minimum
- Peak-Peak

Automatic parametric measurements provide quick answers

Automatic measurements are the essential tool of an oscilloscope. To make quick and efficient measurements, the InfiniiVision 3000G X-Series provides 44 powerful automatic measurements and can display up to 8 at a time. Measurements can be gated by auto select, main window, zoom window, or cursors, and include full statistics.

Vertical

- Peak-to-peak, maximum, minimum, Y at X, amplitude, top, base, overshoot, pre-shoot, average N-cycles, average full-screen, DC RMS-N cycles, DC RMS-full screen, AC RMS-N cycles, AC RMS full-screen (standard deviation), ratio N-cycles, ratio full-screen

Time

- Period, frequency, counter, + width, - width, burst width, + duty cycle, - duty cycle, bit rate, rise time, fall time, time at edge, delay, phase, X at min Y, X at max Y

Count

- Positive pulse count, negative pulse count, rising edge count, falling edge count

Mixed

- Area N-cycles, area full-screen, slew rate

Power

- Channel power, occupied power, adjacent power ratio, total harmonic distortion

7-in-1 instrument integration provides synergistic measurements

In addition to the class leading oscilloscope and powerful serial protocol analysis capabilities, the InfiniiVision 3000G X-Series offers five additional integrated instrument capabilities not always found in this class of oscilloscope.

Integrated mixed signal oscilloscope (MSO – optional)

The InfiniiVision 3000G X-Series offers 16 optional, integrated, and upgradable digital channels. Digital content is everywhere in today's designs and traditional 2 and 4 channel oscilloscopes do not always provide enough channels for the job at hand.

With an additional 16 integrated digital channels, you now have up to 20 channels of time-correlated acquisition and viewing on the same instrument. In addition to offering powerful triggering across the analog and digital channels, this also gives you additional channels to use for serial decode and triggering. You can either purchase an MSO model that comes standard with the 16 additional digital/logic channel and a logic probe or purchase a DSO model and then upgrade it at any time to an MSO with a software license (DSOXG3MSO) that ships with the 16-channel logic probe.

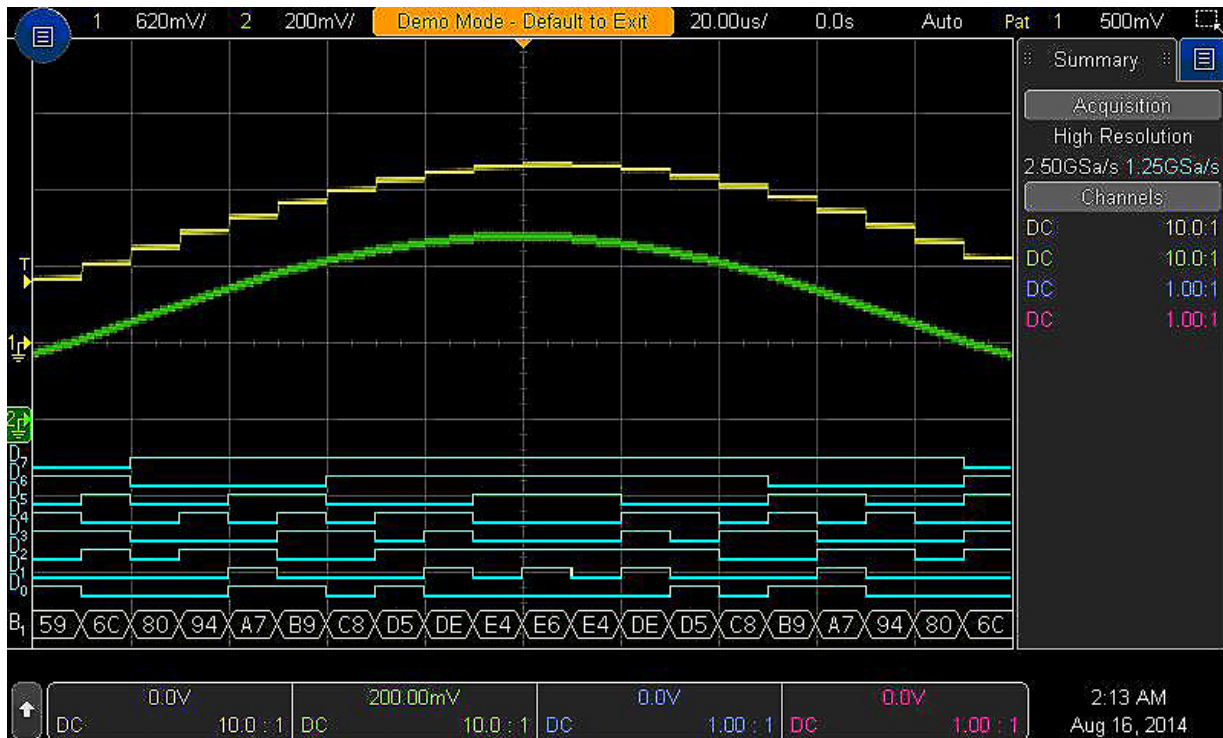

Figure 27. Optional digital channels allow a timing view of up to 16 channels. Tightly integrated, they work with the analog triggers and serial triggers/decoding.

Frequency response analysis (Bode plots, standard)

Frequency Response Analysis (FRA) is an often-critical measurement used to characterize the frequency response (gain and phase versus frequency) of a variety of today's electronic designs, including passive filters, amplifier circuits, and negative feedback networks of switch mode power supplies (loop response). InfiniiVision 3000G X-Series oscilloscopes use the oscilloscope's built-in waveform generator (WaveGen) to stimulate the circuit under test at various frequency settings and capture the input and output signals using two oscilloscope channels. At each test frequency, the oscilloscope measures, computes, and plots gain ($20\log V_{out}/V_{in}$) and phase logarithmically.



Figure 28. Frequency response analysis plot (Bode gain & phase) of a bandpass filter.

DSOXBODE Bode plot training kit (optional)

The [DSOXBODE](#) Bode plot training kit consists of a series R-L-C circuit board with a BNC input that attaches directly to the output of the oscilloscope's WaveGen function generator. There are clearly labeled test points for probing VIN and BPFOUT (bandpass filter output) or LPFOUT (low-pass filter output). Also included with this training kit is a comprehensive [tutorial and lab guide](#) that engineering students and professors can download. The DSOXBODE Bode plot training kit is compatible with all InfiniiVision 3000G X-Series oscilloscopes.

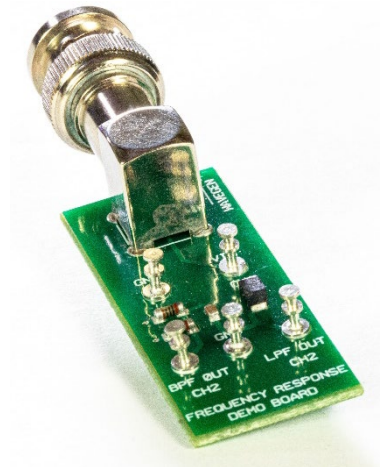

Integrated WaveGen: Built-in 20 MHz function/arbitrary waveform generator

The InfiniiVision 3000G X-Series comes standard with an integrated 20 MHz function/arbitrary waveform generator (WaveGen) that also support modulation. The function generator provides stimulus output of sine, square, ramp, pulse, DC, Sinc (x), exponential rise/fall, cardiac, Gaussian Pulse and noise waveforms to your device under test. The modulation feature supports AM, FM, and FSK modulations with modulation shapes of sine, square, and ramp. The generator can output a continuous or a single-shot waveform. With AWG functionality, you can store waveforms from analog channels or reference memory to the arbitrary memory and output from WaveGen. Then easily create or edit the waveform using the built-in editor via touch and the large screen or by using Keysight's BenchLink Waveform Builder software: www.keysight.com/find/33503



Figure 29. Standard arbitrary waveform generator provides easy access to stimulus. The integrated arbitrary waveform generator makes capturing, modifying, and replaying signals simple.

Integrated DVM: Standard 3-digit digital voltmeter

An integrated 3-digit voltmeter is included standard on your InfiniiVision 3000G X-Series oscilloscope. The voltmeter operates through the same probes as the oscilloscope channels. However, the DVM measurements are made independently from the oscilloscope acquisition and triggering system so you can make both the DVM and triggered oscilloscope waveform captures with the same connection. The voltmeter results are always displayed, keeping these quick characterization measurements at your fingertips.



Figure 30. DVM and counter takes advantage of separate signal paths to provide measurements without a trigger, while still using the scope probes.

Integrated frequency measurements: Standard 8-digit counter and totalizer

Traditional oscilloscope counter measurements offer only five or six digits of resolution, which may not be enough for the most critical frequency measurements are being made.

With the InfiniiVision 3000G X-Series' standard 8-digit counter, you can see your measurements with the precision you would normally expect only from a standalone counter. Because the integrated counter measures frequencies up to a wide bandwidth of 1.0 GHz, you can use it for many high-frequency applications as well.

The counter's totalizer feature adds another valuable capability to the oscilloscope. It can count the number of events (totalize), and it also can monitor the number of trigger-condition-qualified events. The trigger-qualified events totalizer does not require an actual trigger to occur. It only requires a trigger-satisfying event to take place. In other words, the totalizer can monitor events faster than the trigger rate of a scope, as fast as 25 million events per second (a function of the oscilloscope's holdoff time, which has the minimum of 40 ns). Figure 31 shows example of a totalizer counting the number of CAN FD CRC delimiter bit error packets that took place in a design.

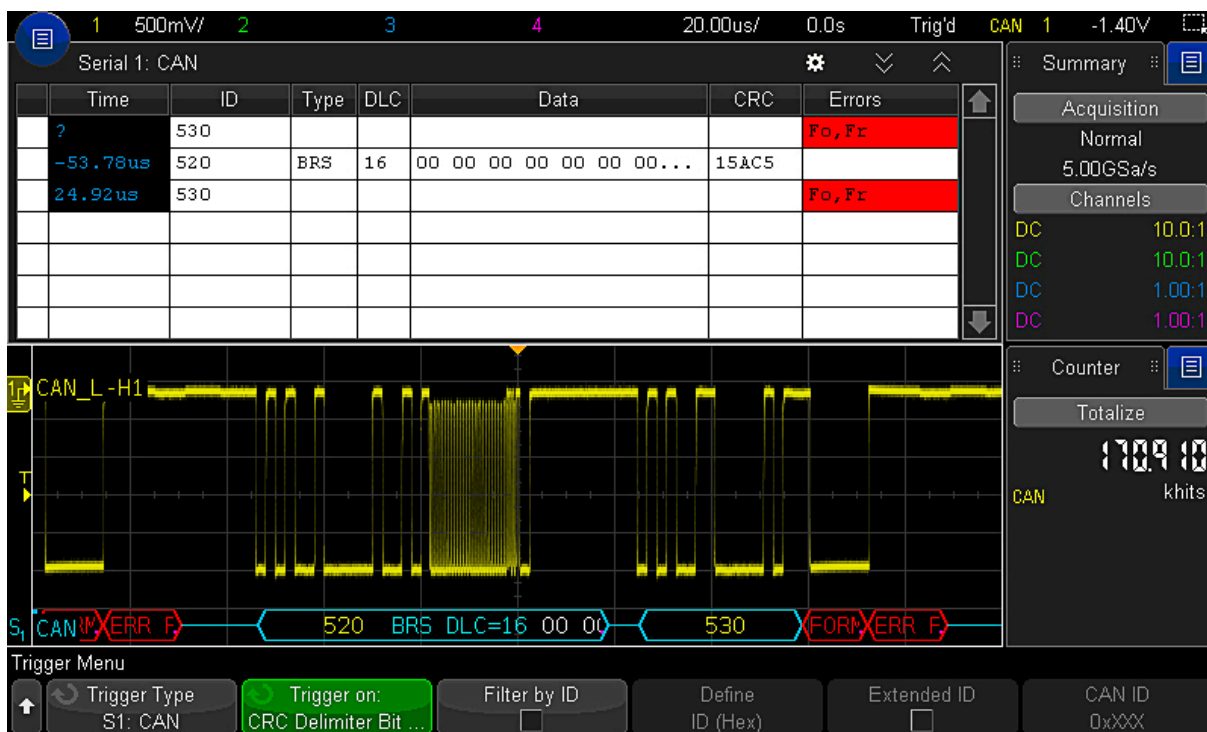

Figure 31. Totalizer counts the number of events. In addition, it can count the number of trigger-condition-qualified events as fast as 25 million events a second.

Other Advanced Measurements and Features

Hardware-based mask limit & measurement limit testing (standard) for quick pass/fail testing

Whether you are performing pass/fail tests to specified standards in manufacturing or testing for infrequent signal anomalies, mask limit and measurement limit testing can be a valuable productivity tool. The InfiniiVision 3000G X-Series features powerful hardware-based mask testing that can perform up to 270,000 tests per second. You can select multiple test criteria, including the ability to run tests for a specific number of acquisitions, a specified time, or until detection of a failure.

With the standard measurement limit testing capability, you can perform pass/fail testing based on user-defined maximum and minimum limits on any parametric measurement that has been selected and turned on. Stop-on-failure is also available.

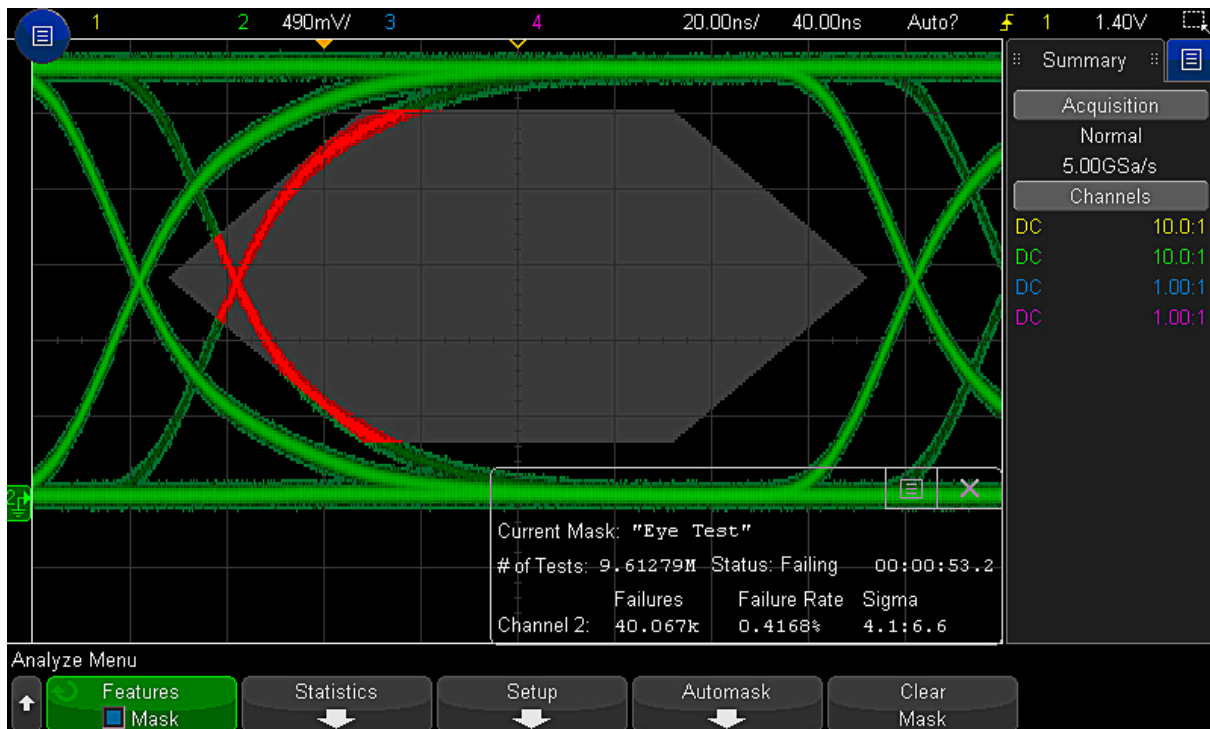

Figure 32. Hardware accelerated mask testing allows testing against a golden waveform or user created mask to find violations. In this example we captured over 5M tests in only 30 seconds.

Integrated advanced power supply measurements and analysis (optional)

When you are working with switching power supplies and power devices, the power measurements software package (D3000PWRB) provides a full suite of power measurements and analysis in the oscilloscope.

Click [here](#) to learn more about the D3000PWRB optional software package.

In addition, there are several power specific probes that make analysis of your power supplies (e.g., switch mode power supplies) and power consuming devices (e.g., batteries) easy.

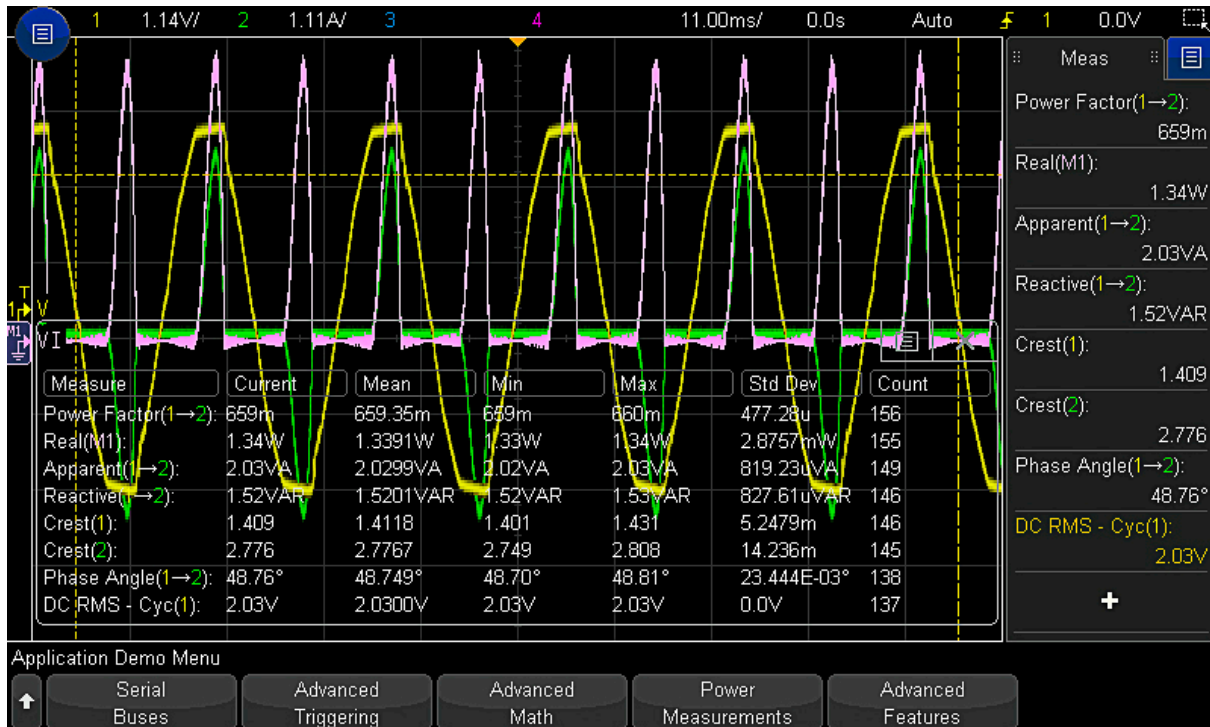

Figure 33. Integrated power measurements make quick work of analyzing power producing and power consuming devices.

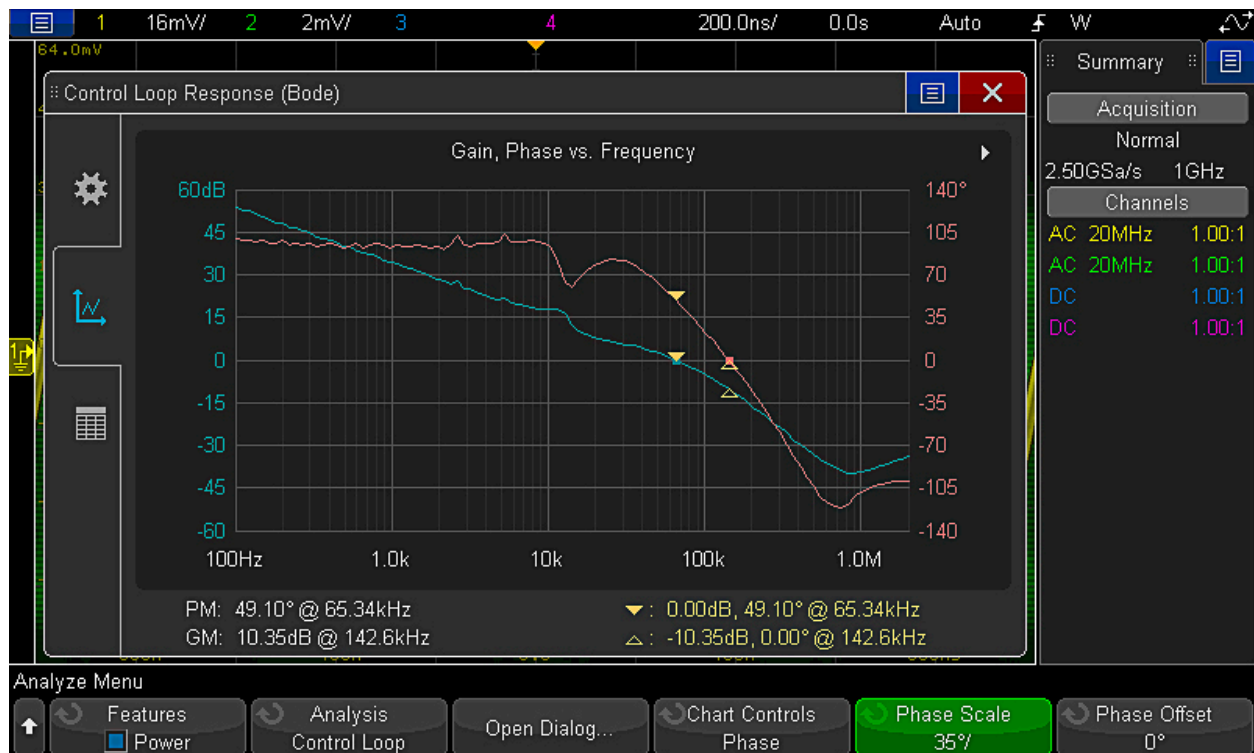

Figure 34. Control loop response analysis (bode plot) shows the gain/phase plot over frequency sweep range up to 20 MHz with automatic determination of phase margin (PM) and gain margin (GM).

Innovative power rail probe (option) provides insights for DC output integrity

The power rail noise, ripple, and transient measurements can be challenging due to required offset range and mV sensitivity. With its ± 24 V offset range, ultra-low noise 1:1 attenuation ratio, and 2-GHz bandwidth, the N7020A power rail probe is for users making critical power integrity measurements that need mV sensitivity on their DC power rails.

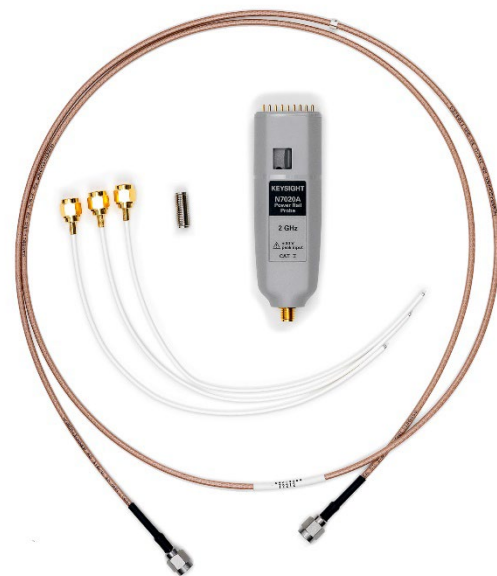

Figure 35. N7020A Power Rail Probe.

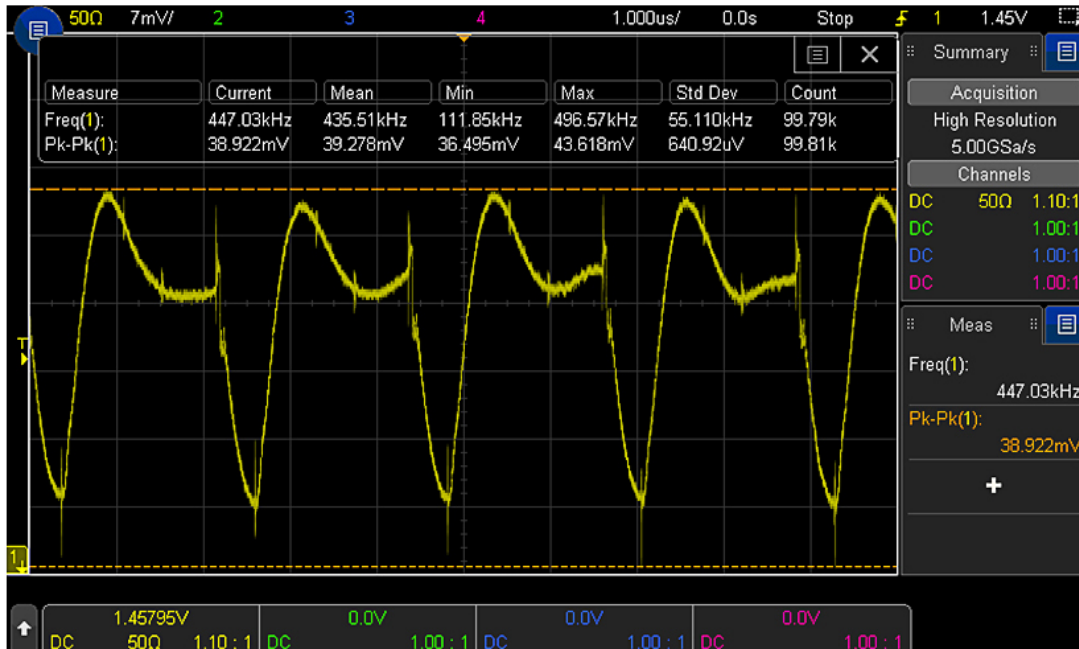

Figure 36. 3000G X-Series and N7020A acquire not only the power rail ripples but the high frequency transients as well.

Enhanced HDTV video analysis (standard)

Whether you are debugging consumer electronics with HDTV or characterizing a design, Enhanced Video Analysis (optional) provides support for a variety of HDTV standards for triggering and analysis.

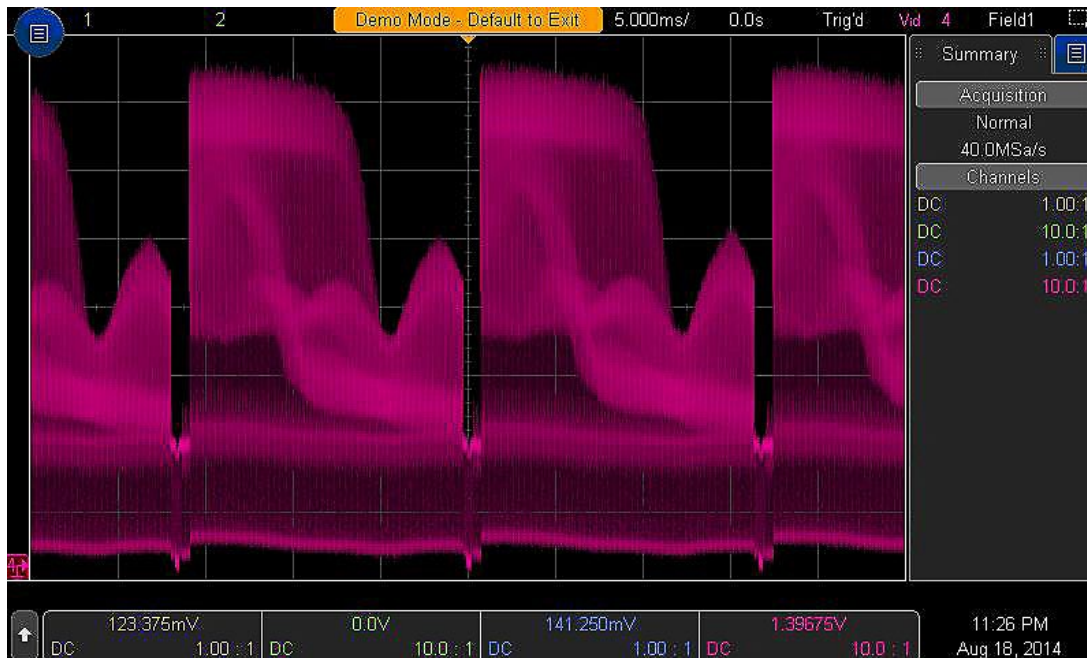

Figure 37. Trigger on and display HDTV signals with enhanced HDTV video analysis (standard).

While the “Touch, Discover, & Solve” elements of the scope highlight the key features that will make it easy to debug and troubleshoot your device, there are other features that you may also want to consider when choosing your next oscilloscope.

Total Cost of Ownership

The InfiniiVision 3000G X-Series offers an extremely low cost of ownership. Between an industry leading mean time between failure (MTBF) of over 250,000 hours and a market-leading calibration period of 3 years, you can rest assured that your investment in a 3000G X-Series will be protected for years to come. In addition, because needs change over time, you can purchase just what you need today and then upgrade the scope’s bandwidth or application-specific software packages easily over time as your projects evolve.

Educator’s Training Kit

Have new hires that need to quickly become familiar with the scope? Or are you a professor that wants to teach your students what an oscilloscope is and how to perform basic measurements? The Educator’s Oscilloscope Training Kit (standard) makes that easy. It includes training tools created specifically for electrical engineering and physics undergraduate students and professors. It contains an array of built-in training signals (built into the scope), a comprehensive oscilloscope lab guide and tutorial written specifically for the undergraduate student and an oscilloscope fundamentals PowerPoint slide set for professors and lab assistants. The built-in training signals are included standard in the oscilloscope, while the lab guide, slide set, as well as other valuable technical resources for students and professors are available to download at www.keysight.com/find/edk.

Built-in Features to Help the Infrequent User

In addition to the educator’s training kit, the oscilloscope includes a localized front panel and GUI available in 15 languages, along with an integrated (and localized) help system. Just press & hold down any front panel key or soft panel button and a brief overview will appear that explains how to use that feature.

30-day Trial License

The InfiniiVision 3000G X-Series comes with a one-time 30-day, all optional-features trial license. You can choose to start the 30-day trial at any time. In addition, you can redeem individual optional feature 30-day trial licenses at any time by visiting www.keysight.com/find/30daytrial. This enables you to receive in effect 60 days of trial license of each optional feature.

Localized GUI and Front Panel Overlays

The InfiniiVision 3000G X-Series oscilloscope supports 15 different languages:

- English
- Japanese
- Simplified Chinese
- Traditional Chinese
- Thai
- Korean
- German
- French
- Spanish
- Russian
- Portuguese
- Italian
- Polish
- Czech
- Turkish

“Designed for Touch”. **8.5-inch capacitive touch screen with gesture support.**

7-in-1 instruments helps you solve your problems: oscilloscope channels digital channels, frequency response analysis, serial protocol analysis, WaveGen, DVM, and 8-digit counter-totalizer. **Fully upgradeable** including bandwidth.

Reconfigurable Docking panels with the capacitive touch screen adds a new dimension to the usability.

Zone touch trigger, if you can see it, you can trigger on it by drawing a box.

Standard **Gated FFT** for your time correlated analog, digital, and frequency domain signal

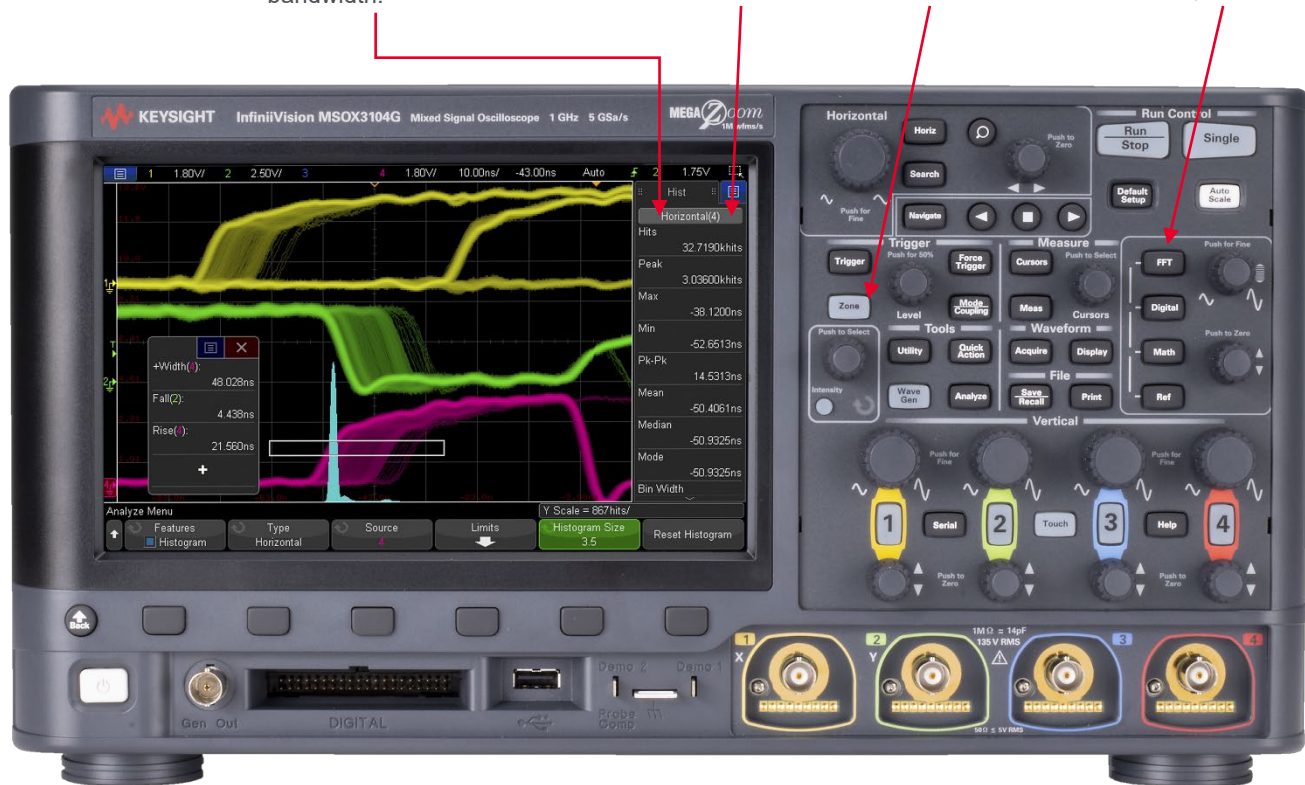

Uncompromised 1,000,000 waveform per second update rate minimize the dead-time for maximum probability of capturing infrequent events and anomalies.

Built-in features to help the infrequent user - **GUI available in 15 languages.**

Display up to **8 measurements** simultaneously, without compromising other key info. 44 automatic measurements. **Gated by cursors** supported.

Integrated DVM and 8-digit counter with totalizer. Wide coverage of application and serial protocol solutions including **CAN-FD and SENT trigger and decode.**

Both **USB keyboard and mouse** are supported in 3000G X-Series for additional ease of use.

Standard segment memory with event lister powered by **MegaZoom IV** smart memory technology intelligent capture of just the signals of interest.

Configuring Your Oscilloscope

Step 1

Choose your bandwidth and number of channels

3000 X-Series Specification Overview											
		3012G	3014G	3022G	3024G	3032G	3034G	3052G	3054G	3102G	3104G
Bandwidth (–3 dB)		100 MHz		200 MHz		350 MHz		500 MHz		1 GHz	
Calculated rise time (10 to 90%)		≤ 3.5 ns		≤ 1.75 ns		≤ 1 ns		≤ 700 ps		≤ 450 ps	
Input channels	DSOX	2	4	2	4	2	4	2	4	2	4
	MSOX	2 + 16	4 + 16	2 + 16	4 + 16	2 + 16	4 + 16	2 + 16	4 + 16	2 + 16	4 + 16

For example, if you chose 1 GHz, 4+16 channels, the model number will be MSOX3104G

Step 2

Select hardware upgrades

Hardware Upgrade	Description	Model Number to Order
Enhanced Security Option	Disable non-volatile memory, USB, LAN, and firmware upgrades	DSOXG3SECA
GP-IB module	Plug-in module to support GP-IB connectivity	DSOXGPIB

Step 3

Select software upgrades

License Upgrade	Description	Model Number to Order
Embedded software package	I ² C, SPI, UART (RS232/422/485), I ² S, and USB PD serial trigger and decode, plus Measurement Limit Testing, Mask Limit Testing, Frequency Response Analysis (Bode plots), and Enhanced HDTV Video Analysis	Standard
Automotive software package	CAN (symbolic with .dbc file), CAN FD (symbolic with .dbc file), LIN (symbolic with .ldf file), FlexRay, SENT, CXPI, PSI5 (user-definable Manchester), and User-definable NRZ serial trigger & decode (CAN/CAN FD mask files available to download)	D3000AUTB
Aero software package	MIL-STD 1553 and ARINC 429 serial trigger & decode (standard mask files available to download)	D3000AERB

USB software package	USB 2.0 Low- & Full-speed	D3000USBB
Power software package	Power quality, current harmonics, switching loss, transient response, turn-on/off time, output ripple, efficiency, control loop response, PSRR, etc.	D3000PWRB
Ultimate bundle software package	CAN, CAN FD, LIN, FlexRay, CXPI, PSI5 (User-definable Manchester), User-definable NRZ, MIL-STD 1553, and ARINC 429 serial trigger & decode, and Power Analysis	D3000BDLB

Step 4

Choose your probes

For a complete list of compatible probes, visit http://www.keysight.com/find/scope_probes. In general, the InfiniiVision 3000G X-Series supports up to two active probes simultaneously with some exceptions. Contact Keysight for more detail.

Probes		
N2843A	Passive probe 500 MHz, 10:1, 1 M Ω , 11 pF	Standard (1 per channel)
N2756A	16 digital channel MSO cable	Standard on MSOX models and with DSOXG3MSO MSO upgrade
N2870A	Passive probe 35 MHz, 1:1, 1 M Ω	Optional
10076C	Passive probe 500 MHz 100:1 attenuation (4 kV)	Optional
N2795A	1.0 GHz 10:1 single-ended active probe, 1 M Ω / 1 pF, \pm 8 V	Optional
N2797A	1.5 GHz 10:1 single-ended active probe, 1 M Ω / 1 pF, \pm 8 V, extreme temperature	Optional
N2791A	25 MHz 10:1/100:1 HV differential active probe, 8 M Ω / 8 pF, \pm 700 V	Optional
N2790A	100 MHz 50:1/500:1 HV differential probe, 8 M Ω /3.5 pF, \pm 1,400 V	Optional
N2805A	200 MHz 50:1 HV differential active probe, 4 M Ω / 4 pF, \pm 100 V	Optional
N2804A	300 MHz 100:1 HV differential active probe, 8 M Ω / 10 pF, \pm 300 V	Optional
DP0010A	250 MHz 17:1/85:1 differential probe, 1.7 M Ω / 1.5 pF, \pm 42 V	Optional
DP0011A	500 MHz 17:1/85:1 differential probe, 1.7 M Ω / 1.5 pF, \pm 42 V	Optional
DP0012A	1.0 GHz 17:1/85:1 differential probe, 1.7 M Ω / 1.5 pF, \pm 42 V	Optional
DP0013A	1.8 GHz 17:1/85:1 differential probe, 1.7 M Ω / 1.5 pF, \pm 42 V	Optional
DP0021A-009	Automotive sub-DB9 accessory for DP001xA differential active probes	Optional
N2750A	1.5 GHz 2:1/10:1 differential active probe, 200 k Ω / 0.7 pF, \pm 5 V	Optional

N7020A	2 GHz 1:1 power rail probe, ± 24 V offset range, 50 k Ω , ± 850 mV ripple range	Optional
1147B	50 MHz, 15 Amp AC/DC current probe	Optional
N2893A	100 MHz, 15 Amp AC/DC current probe	Optional
N7026A	150 MHz, 40 Amp AC/DC high-sensitivity current probe	Optional
N2820A	2-channel high-sensitivity current probe 50 μ A to 5 A	Optional
N2821A	1-channel high-sensitivity current probe 50 μ A to 5 A	Optional
N7040A	23 MHz, 3 kA, Rogowski coil AC current probe	Optional
N7041A	30 MHz, 600 A, Rogowski coil AC current probe	Optional
N7042A	30 MHz, 300 A, Rogowski coil AC current probe	Optional

Step 5

Choose your accessories and additional productivity software

Recommended Accessories and PC Software		
DSOXBODE	Bode plot training kit	Optional
N2167A	Front panel cover	Optional
N2168A	Front panel cover and soft carrying case	Optional
N2169A	Rack mount kit	Optional
Hard transit case	CaseCruzer 3F1112-1510J (available from http://www.casecruzer.com/)	Optional
BV0004B	BenchVue Oscilloscope Application PC software	Standard
33503A	BenchLink Waveform Builder Pro and Basic PC Software	Optional
D9010BSEO	Infiniium Offline Oscilloscope Analysis PC Software	Optional
D9010UDAA	User-definable Application (UDA) software	Optional
89601B (version 2020 and higher)	Vector Signal Analyzer (VSA) software	Optional

Step 6

Calibration plans¹

Calibration		
DSOX3000G-1A7	Calibration + uncertainties + guardbanding certificate (not accredited)	Optional
DSOX3000G-AMG	Calibration + uncertainties + guardbanding certificate (accredited)	Optional

1. The InfiniiVision 3000G X-Series oscilloscope come from the factory calibrated with a standard calibration certificate. Additional calibration testing with uncertainties and guardbanding can be purchased as an option.

Performance Characteristics

3000G X-Series Specification Overview											
		3012G	3014G	3022G	3024G	3032G	3034G	3052G	3054G	3102G	3104G
Bandwidth 1 (-3 dB)		100 MHz		200 MHz		350 MHz		500 MHz		1 GHz	
Calculated rise time (10 to 90%)		≤ 3.5 ns		≤ 1.75 ns		≤ 1 ns		≤ 700 ps		≤ 450 ps	
Input channels	DSOX	2	4	2	4	2	4	2	4	2	4
	MSOX	2 + 16	4 + 16	2 + 16	4 + 16	2 + 16	4 + 16	2 + 16	4 + 16	2 + 16	4 + 16
Maximum sample rate		5 GSa/s half channels, 2.5 GSa/s all channels									
Maximum memory depth		4 Mpts half channels, 2 Mpts all channels									
Display size and type		8.5-inch capacitive touch gesture-enabled display									
Waveform update rate		> 1,000,000 waveforms per second									
Vertical System Analog Channels											
Hardware bandwidth limits		Approximately 20 MHz (selectable)									
Input coupling		AC, DC									
Input impedance		Selectable: 1 MΩ ± 1% (14 pF), 50 Ω ± 1.5%									
Input sensitivity range		100 MHz ~ 500 MHz models: 1 mV/div to 5 V/div 2 (1 MΩ and 50 Ω)									
		1 GHz models: 1 mV/div to 5 V/div 2 (1 MΩ), 1 mV/div to 1 V/div (50 Ω)									
Vertical resolution		8 bits (measurement resolution is 12 bits with averaging)									

Maximum input voltage	125 Vrms; 190 Vpk
	Probing technology allows testing of higher voltages. For example, the included N2843A 10:1 probe supports testing up to 300 Vrms
	Use this instrument only for measurements within its specified measurement category (not rated for CAT II, III, IV). No transient overvoltage allowed
DC vertical accuracy	\pm [DC vertical gain accuracy + DC vertical offset accuracy + 0.25% full scale] ²
DC vertical gain accuracy ¹	\pm 2.0% full scale ²
DC vertical offset accuracy	\pm 0.1 div \pm 2 mV \pm 1% of offset setting
Channel-to-channel isolation	> 100:1 from DC to maximum specified bandwidth of each model (measured with same V/div and coupling on channels)
Offset range	\pm 2 V (1 mV/div to 200 mV/div)
	\pm 50 V (> 200 mV/div to 5 V/div)
Vertical System Digital Channels	
Digital input channels	16 digital (D0 to D15. pod 1: D7 ~ D0, Pod 2: D15 ~ D8)
Thresholds	Threshold per pod
Threshold selections	TTL (+1.4 V), 5 V CMOS (+2.5 V), ECL (-1.3 V), user-defined (selectable by pod)
User-defined threshold range	\pm 8.0 V in 10 mV steps
Maximum input voltage	\pm 40 V peak
Threshold accuracy ¹	\pm (100 mV + 3% of threshold setting)
Maximum input dynamic range	\pm 10 V about threshold
Minimum voltage swing	500 mVpp
Input impedance	100 k Ω \pm 2% at probe tip
Input capacitance	~8 pF
Vertical resolution	1 bit

1. Denotes warranted specifications, all others are typical.

2. Specifications are valid after a 30-minute warm-up period and \pm 10 °C from firmware calibration temperature. 1 mV/div and 2 mV/div are a magnification of 4 mV/div setting. For vertical accuracy calculations, use full scale of 32 mV for 1 mV div and 2 mV/div sensitivity setting.

Horizontal System Analog Channels										
	3012G	3014G	3022G	3024G	3032G	3034G	3052G	3054G	3102G	3104G
Time base range	5 ns/div to 50 s/div		2 ns/div to 50 s/div				1 ns/div to 50 s/div		500 ps/div to 50 s/div	
Time base accuracy ¹	± 1.6 ppm + aging factor (1st year: ± 0.5 ppm, 2nd year: ± 0.7 ppm, 5 years: ± 1.5 ppm, 10 years: ± 2.0 ppm)									
Time base delay time range	Pre-trigger	Greater of 1 screen width or 250 µs								
	Post-trigger	1 s to 500 s								
Channel-to-channel deskew range	± 100 ns									
Δ Time accuracy (using cursors)	± (time base acc. x reading) ± (0.0016 x screen width) ± 100 ps									
Modes	Main, zoom, roll, XY									
XY	On channels 1 and 2 only. Z Blanking on Ext Trigger Input, 1.4 V threshold									
	Bandwidth: Maximum bandwidth. Phase error at 1 MHz: < 0.5 degree									
Horizontal System Digital Channels										
Minimum detectable pulse width	5 ns									
Channel-to-channel skew	2 ns (typical); 3 ns (maximum)									
Maximum analog channels sample rate	5 GSa/s half channel interleaved, 2.5 GSa/s all channel									
Maximum analog channels record length	4 Mpts half channel interleaved, 2 Mpts all channel									
Maximum digital channels sample rate	1.25 GSa/s all pods									
Maximum digital channels record length	2 Mpts (with digital channels only)									
Acquisition mode	Normal	Default mode								
	Peak detect	Capture glitches as narrow as 250 ps at all time base settings								
	Averaging	Selectable from 2, 4, 8, 16, 64, ... to 65,536								

	High resolution	Real time boxcar averaging reduces random noise and effectively increases vertical resolution 12 bits of resolution when $\geq 10 \mu\text{s}/\text{div}$ at 5 GSa/s or $\geq 20\text{-}\mu\text{s}/\text{div}$ at 2.5 GSa/s
	Segmented	Segmented memory optimizes available memory for data streams that have long dead times between activity. Maximum segments = 1000. Re-arm time = 1 μs (minimum time between trigger events)
	Digitizer	Allows independent selection of sample rate and memory depth
Time mode	Normal	Default mode
	Roll	Displays the waveform moving across the screen from right to left. Available at the time base 50 ms/div or slower
	XY	Displays the volts-versus-volts display. Time base can be set from 200 ns/div to 50 ms/div

Trigger System	
Trigger sources	Analog channel (1 ~ 4), digital channel (D0 ~ D15), line, external, WaveGen (1 or mod) (FM/FSK)
Trigger modes	Normal (triggered): Requires trigger event for scope to trigger
	Auto: Triggers automatically in absence of trigger event
	Single: Triggers only once on a trigger event, press [Single] again for scope to find another trigger event, or press [Run] to trigger continuously in either Auto or Normal mode
	Force: front panel button that forces a trigger
Trigger coupling	DC: DC coupled trigger
	AC: AC coupled trigger, cutoff frequency: < 10 Hz (internal); <50 Hz (external)
	HF reject: High frequency reject, cutoff frequency ~ 50 kHz
	LF reject: Low frequency reject, cutoff frequency ~ 50 kHz
	Noise reject: Selectable OFF or ON, decreases sensitivity 2x
Trigger holdoff range	40 ns to 10.00 s
Trigger Sensitivity	
Internal ¹	< 10 mV/div: Greater of 1 div or 5 mV; ≥ 10 mV/div: 0.6 div
External ¹	200 mVpp from DC to 100 MHz
	350 mVpp 100 MHz to 200 MHz
Trigger Level Range	
Any channel	± 6 div from center screen
External ²	± 8 V
Trigger Type Selections	
Zone (HW zone qualifier)	Trigger on user-defined zones drawn on the display. Applies to one analog channel at a time. Specify zones as either "must intersect" or "must not intersect." Up to two zones. > 200,000 scans/sec update rate
	Supported modes: normal, peak detect, high resolution
	Also works simultaneously with the serial trigger and mask limit test
Edge	Trigger on a rising, falling, alternating or either edge of any source
Edge then edge (B trigger)	Arm on a selected edge, wait a specified time, then trigger on a specified count of another selected edge
Pulse width	Trigger on a pulse on a selected channel, whose time duration is less than a value, greater than a value, or inside a time range
	Minimum duration setting: 2 ns (500 MHz, 1 GHz), 4 ns (350 MHz), 6 ns (200 MHz), 10 ns (100 MHz)
	Maximum duration setting: 10 s
	Range minimum: 10 ns
Runt	Trigger on a position runt pulse that fails to exceed a high-level threshold. Trigger on a negative runt pulse that fails to exceed a low-level threshold. Trigger on either polarity runt pulse based on two threshold settings. Runt triggering can also be time-qualified (< or >) with a minimum time setting of 2 ~ 10 ns and maximum time setting of 10 s

	Minimum time setting: 2 ns (500 MHz, 1 GHz), 4 ns (350 MHz), 6 ns (200 MHz)
	10 ns (100 MHz)
Setup and hold	Trigger and clock/data setup and/or hold time violation. Setup time can be set from -7 to 10 s. Hold time can be set from 0 s to 10 ns
Rise/fall time	Trigger on rise-time or fall-time edge speed violations (< or >) based on user-selectable threshold
	Select from (< or >) and time settings range between
	Minimum: 1 ns (500 MHz, 1 GHz), 2 ns (350 MHz), 3 ns (200 MHz), 5 ns (100 MHz)
	Maximum: 10 s

1. Denotes warranted specifications, all others are typical. Specifications are valid after a 30-minute warm-up period and ± 10 °C from firmware calibration temperature.
2. 1 mV/div and 2 mV/div is a magnification of 4 mV/div setting. For vertical accuracy calculations, use full scale of 32 mV for 1 mV/div and 2 mV/div sensitivity setting.

Trigger Type Selections	
N th edge burst	Trigger on the Nth (1 to 65535) edge of a pulse burst. Specify idle time (10 ns to 10 s) for framing
Pattern	Trigger when a specified pattern of high, low, and don't care levels on any combination of analog, digital, or trigger channels is [entered exited]. Pattern must have stabilized for a minimum of 2 ns to qualify as a valid trigger condition
	Minimum duration setting: 2 ns (500 MHz, 1 GHz), 4 ns (350 MHz), 6 ns (200 MHz), 10 ns (100 MHz)
	Maximum duration setting: 10 s
	Range minimum: 10 ns
Or	Trigger on any selected edge across multiple analog or digital channels
Video	Trigger on all lines or individual lines, odd/even or all fields from composite video, or broadcast standards (NTSC, PAL, SECAM, PAM-M)
Enhanced Video (standard)	Trigger on lines and fields of enhanced and HDTV standards (480p/60, 567p/50, 720p/50, 720p/60, 1080p/24, 1080p/25, 1080p/30, 1080p/50, 1080p/60, 1080i/50, 1080i/60)
USB	Trigger on start of packet, end of packet, reset complete, enter suspend, or exit suspend. Support USB low-speed and full-speed
I ² C (standard)	Trigger at a start/stop condition or user defined frame with address and/or data values. Also trigger on missing acknowledge, address with no ack, restart, EEPROM read, and 10-bit write
SPI (standard)	Trigger on SPI (Serial Peripheral Interface) data pattern during a specific framing period. Supports positive and negative Chip Select framing as well as clock Idle framing and user-specified number of bits per frame. Supports MOSI and MISO data
RS-232/422/485/UART (standard)	Trigger on Rx or Tx start bit, stop bit or data content or parity error
I ² S (standard)	Trigger on 2's complement data of audio left channel or right channel (=, ≠, <, >, > <, < >, increasing value, or decreasing value)
CAN (optional)	Trigger on CAN (controller area network) version 2.0A, 2.0B, and CAN-FD (Flexible Data-rate) signals. Trigger on the start of frame (SOF), the end of frame (EOF), data frame ID, data frame ID and data (non-FD), data frame ID and data (FD), remote frame ID, remote or data frame ID, error frame, acknowledge error, from error, stuff error, CRC error, spec error (ack or form or stuff or CRC), all errors, BRS Bit (FD), CRC delimiter bit (FD), ESI bit active (FD), ESI bit passive (FD), overload frame., message, message and signal (non-FD), message and signal (FD, first

	8 bytes only)
LIN (optional)	Trigger on LIN (Local Interconnect Network) sync break, sync frame ID, or frame ID and data, parity error, checksum error, frame (symbolic), frame and signal (symbolic)
CXPI (optional)	Trigger on the start of frame (SOF), the end of frame (EOF), PTYPE, frame ID, data and info frame ID, data and info frame ID (long frame), CRC field error, parity error, inter-byte space error, inter-frame space error, framing error, data length error, sample error, all errors, sleep frame, wakeup pulse
FlexRay (optional)	Trigger on frame ID, frame type (sync, start-up, null, normal), cycle-repetitive, cycle-base, and errors.
MIL-STD 1553 (optional)	Trigger on MIL-STD 1553 signals based on word type (Data or Command/Status), Remote Terminal Address, data, and errors (parity, sync, Manchester encoding)
ARINC 429 (optional)	Trigger on ARINC429 data. Trigger on word start/stop, label, label + bits, label range, error conditions (parity, word, gap, word or gap, all), all bits (eye), all 0 bits, all 1 bits
SENT (optional)	Trigger on SENT bus. start of fast channel message, start of slow channel message, fast channel SC and data, slow channel message ID, slow channel message ID and data, tolerance violation, fast channel CRC error, slow channel CRC error, all CRC errors, pulse period error, successive sync pulses error (1/64)
User-definable Manchester/NRZ (optional)	Trigger on start-of-frame (SOF), bus value, and Manchester errors
USB PD (standard)	Trigger on preamble, EDP, ordered sets, preamble errors, CRC errors, header content (control messages, data messages, extended messages, and value in HEX)
NFC (standard)	NFC-A: SENS_REQ, ALL_REQ, or Either NFC-B: SENSB_REQ, ALLB_REQ, or Either NFC-F (212 kbps): SENSF_REQ or ATR_REQ NFC-F (242 kbps): SENSF_REQ or ATR_REQ

Waveform Measurements		
Cursors ²	Single cursor accuracy: \pm [DC vertical gain accuracy + DC vertical offset accuracy + 0.25% full scale]	
	Dual cursor accuracy: \pm [DC vertical gain accuracy + 0.5% full scale] ¹	
	Units: Seconds(s), Hz (1/s), phase (degrees), ratio (%)	
Automatic measurements	<p>Measurements continuously updated with statistics. Cursors track last selected measurement. Select up to eight measurements from the list below:</p> <p>Snapshot All: Measure all single waveform measurements (31)</p> <p><u>Vertical</u>: Peak-to-peak, maximum, minimum, amplitude, top, base, overshoot, pre-shoot, average- N cycles, average- full screen, DC RMS- N cycles, DC RMS- full screen, AC RMS- N cycles, AC RMS- full screen (std deviation), ratio- N cycle, ratio- full screen, Y at X</p> <p><u>Time</u>: Period, frequency, counter, T at edge, + width, - width, burst width, +duty cycle, -duty cycle, bit rate, rise time, fall time, delay, phase, X at min Y, X at max Y,</p> <p><u>Count</u>: Positive pulse count, negative pulse count, rising edge count, falling edge count</p> <p><u>Mixed</u>: Area- N cycles, area- full screen, slew rate</p> <p><u>Power</u>: Channel power, occupied bandwidth, adjacent power ratio, total harmonic distortion</p>	
Automatic measurement logging	Available via BenchVue	
Counter	Built-in frequency counter	
	Source: On any analog or digital channel	
	Resolution: 5 digits	
	Maximum frequency: Bandwidth of scope	
Waveform Math		
Number of math functions	Two, displays FFT and one math simultaneously. Can be cascaded	
Arithmetic	Add, subtract, multiply, divide, differentiate, integrate, FFT, Ax + B, squared, square root, absolute value, common logarithm, natural logarithm, exponential, base 10 exponential, low pass filter, high pass filter, averaged value, smoothing, envelope, magnify, max hold, min hold, measurement trend, chart logic bus (Timing or State), chart serial signal (CAN, CAN FD, LIN, and SENT)	
Enhanced FFT	Record size	Up to 64 kpts resolution
	Window types	Hanning, Flat Top, Rectangular, Blackman-Harris, Bartlett
	Time gated FFT	Gate the time range of data for FFT analysis in the zoom view. For time and frequency domain correlated analysis.

Waveform Measurements		
	Waveforms	FFT, max hold, min hold, average
	Peak search	Max 11 peaks, threshold and excursion control
Search, Navigate, and Lister		
Type	Edge, pulse width, rise/fall, runt, frequency peak, serial bus 1, serial bus 2	
Copy	Copy to trigger, copy from trigger	
Frequency peak	Source	Math functions
	Max # of peaks	11
	Control	Results order in frequency or amplitude
Result display	Event lister or navigation. Manual or auto scroll via navigation or touch event lister entry to jump to a specific event	
Display Characteristics		
Display	8.5-inch capacitive touch/gesture enabled TFT LCD	
Resolution	800 (H) x 480 (V) pixel format (screen area)	
Graticules	8 vertical divisions by 10 horizontal divisions with intensity controls	
Format	YT, XY, and Roll	
Maximum waveform update rate	> 1,000,000 waveforms/sec	
Persistence	Off, infinite, variable persistence (100 ms to 60 s)	
Intensity gradation	64 intensity levels	

1. Denotes warranted specifications, all others are typical.
Specifications are valid after a 30-minute warm-up period and ± 10 °C from firmware calibration temperature.
2. 1 mV/div and 2 mV/div is a magnification of 4 mV/div setting. For vertical accuracy calculations, use full scale of 32 mV for 1 mV/div and 2 mV/div sensitivity setting.

WaveGen – Built-in Function/Arbitrary Waveform Generator (specifications are typical)	
WaveGen out	Front-panel BNC connector
Waveforms	Sine, Square, Ramp, Pulse, DC, Noise, Sine Cardinal (Sinc), Exponential Rise, Exponential Fall, Cardiac, Gaussian Pulse, and Arbitrary
Modulation	Modulation types: AM, FM, FSK Carrier waveforms: sine, ramp, sine cardinal, exponential rise, exponential fall, and cardiac Modulation source: internal (no external modulation capability)
	AM: Modulation: sine, square, ramp Modulation frequency: 1 Hz to 20 kHz Depth: 0% to 100%
	FM: Modulation: sine, square, ramp Modulation frequency: 1 Hz to 20 kHz Minimum carrier frequency: 10 Hz Deviation: 1 Hz to carrier frequency or $(2e12 / \text{carrier frequency})$, whichever is smaller
	FSK: Modulation: 50% duty cycle square wave FSK rate: 1 Hz to 20 kHz Hop frequency: 2 x FSK rate to 10 MHz
Sine	Frequency range: 0.1 Hz to 20 MHz
	Amplitude flatness: ± 0.5 dB (relative to 1 kHz)
	Harmonic distortion: -40 dBc
	Spurious (non-harmonics): -40 dBc
	Total harmonic distortion: 1%
	SNR (50 Ω load, 500 MHz BW): 40 dB ($V_{pp} \geq 0.1$ V); 30 dB ($V_{pp} < 0.1$ V)
Square wave /pulse	Frequency range: 0.1 Hz to 10 MHz
	Duty cycle: 20 to 80%
	Duty cycle resolution: Larger of 1% or 10 ns
	Pulse width: 20 ns minimum
	Rise/fall time: 18 ns (10 to 90%)
	Pulse width resolution: 10 ns or 5 digits, whichever is larger
	Overshoot: $< 2\%$
	Asymmetry (at 50% DC): $\pm 1\% \pm 5$ ns
	Jitter (TIE RMS): 500 ps
Ramp/triangle wave	Frequency range: 0.1 Hz to 200 kHz

WaveGen – Built-in Function/Arbitrary Waveform Generator (specifications are typical)	
	Linearity: 1%
	Variable symmetry: 0 to 100%
	Symmetry resolution: 1%
Noise	Bandwidth: 20 MHz typical
Sine Cardinal (Sinc)	Frequency range: 0.1 Hz to 1.0 MHz
Exponential Rise/Fall	Frequency range: 0.1 Hz to 5.0 MHz
Cardiac	Frequency range: 0.1 Hz to 200.0 kHz
Gaussian Pulse	Frequency range: 0.1 Hz to 5.0 MHz
Arbitrary	Waveform length: 1 to 8k points
	Amplitude resolution: 10 bits (including sign bit) ¹
	Repetition rate: 0.1 Hz to 12 MHz
	Sample rate: 100 MSa/s
	Filter bandwidth: 20 MHz

1. Full resolution is not available at output due to internal attenuator stepping.

WaveGen – Built-in Function/Arbitrary Waveform Generator (specifications are typical) (continued)	
Frequency	Sine wave and ramp accuracy:
	130 ppm (frequency < 10 kHz)
	50 ppm (frequency > 10 kHz)
	Square wave and pulse accuracy:
	[50+frequency/200] ppm (frequency < 25 kHz)
	50 ppm (frequency ≥ 25 kHz)
	Resolution: 0.1 Hz or 4 digits, whichever is larger
Amplitude	Range:
	20 mVpp to 5 Vpp into Hi-Z ¹
	10 mVpp to 2.5 Vpp into 50 Ω ¹
	Resolution: 100 μV or 3 digits, whichever is higher
	Accuracy: 2% (frequency = 1 kHz)
DC offset	Range:
	± 2.5 V into Hi-Z ¹
	± 1.25 V into 50 Ω ¹
	Resolution: 100 μV or 3 digits, whichever is higher
	Accuracy (waveform modes): ± 1.5% of offset setting ± 1% of amplitude ± 1 mV
	Accuracy (DC mode): ± 1.5% of offset setting ± 3 mV
Trigger output	Trigger output available on Trig out BNC
Main output	Impedance: 50 Ω typical
	Isolation: Not available, main output BNC is grounded
	Protection: Overload automatically disables output
Output mode	Normal
	Single-shot (arbitrary, sine, ramp, sine cardinal, exp rise/fall, cardiac, Gaussian pulse)
Digital Voltmeter (specifications are typical)	
Functions	ACrms, DC, DCrms
Resolution	ACV/DCV: 3 digits
Measuring rate	100 times/second
Autoranging	Automatic adjustment of vertical amplification to maximize the dynamic range of measurements

WaveGen – Built-in Function/Arbitrary Waveform Generator (specifications are typical) (continued)		
Range meter		Graphical display of most recent measurement, plus extrema over the previous 3 seconds
Precision Counter/Totalizer (specification are typical)		
Counter	Source	Any analog channel or trigger qualified event
	Resolution	8 digits (8 digits for trigger qualified event)
	Max frequency	1 GHz
	Trig qual events	1/(trigger hold off time) for trigger qualified events (max 25 MHz, minimum dead time of 40 ns)
Measurement		Frequency, period, totalize
Totalizer	Counter size	64-bit totalizing counter
	Edge	Rise or fall
	Gating	Positive or negative level. Select from analog channels except the source

1. Gaussian Pulse: 4 Vpp maximum into Hi-Z; 2 Vpp maximum into 50 Ω.

Connectivity	
Standard ports	One USB 2.0 hi-speed device port on rear panel. Supports USBTMC protocol
	Two USB 2.0 hi-speed host ports, front and rear panel. Support memory devices, printers, and keyboards
	LAN (10/100Base-T)
	WVGA video out
Optional ports	GPIB
Trigger out	BNC connector on the rear panel. Supported modes: triggers, mask, and waveform generator sync pulse
General and Environmental Characteristics	
Power line consumption	Max 100 W
Power voltage range	100 to 120 V, 50/60/400 Hz; 100 to 240 V, 50/60 Hz
Environmental rating	0 to 50 °C with 4000m max Maximum Relative Humidity: 95%RH up to 40 °C From 40°C to 50°C, the maximum % Relative Humidity follows the line of constant dew point
Electromagnetic compatibility	Meets EMC directive (2004/108/EC), meets or exceeds IEC 61326-1:2005/EN 61326-1:2006 Group 1 Class A requirement CISPR 11/EN 55011 IEC 61000-4-2/EN 61000-4-2 IEC 61000-4-3/EN 61000-4-3 IEC 61000-4-4/EN 61000-4-4 IEC 61000-4-5/EN 61000-4-5 IEC 61000-4-6/EN 61000-4-6 IEC 61000-4-11/EN 61000-4-11 Canada: ICES-001:2004 Australia/New Zealand: AS/NZS
Safety	ANSI/UL Std. No. 61010-1:2012; CAN/CSA-C22.2 No. 61010-1-12
	ANSI/UL Std. No. 61010-2-030:2012; CAN/CSA-C22.2 No. 61010-2-030-12
Vibration	Meets IEC60068-2-6 and MIL-PRF-28800; class 3 random
Shock	Meets IEC 60068-2-27 and MIL-PRF-28800; class 3 random; (Operating 30 g, ½ sine. 11 ms duration, 3 shocks/axis along major axis, total of 18 shocks
Dimensions (W x H x D)	381 mm (15 in) x 204 mm (8 in) x 142 mm (5.6 in)
Weight	Net: 4.2 kg (9.3 lbs.), shipping: 4.4 kg (9.5 lbs.)

Nonvolatile Storage		
Reference waveform display	Two internal waveforms or USB thumb drive. Displays 1 reference waveform at a time	
Data/file save	Setup/image	Setup (*.scp), 8 or 24-bit Bitmap image (*.bmp), PNG 24-bit image (*.png)
	Waveform data	CSV data (*.csv), ASCII XY data (*.csv), Binary data (*.bin), Lister data (*.csv), Reference waveform data (*.h5), multi-channel waveform data (*.h5), Arbitrary Waveform data (*.csv)
	Application data	Mask (*.msk), Power harmonics data (*.csv), USB signal quality (*.html & *.bmp)
	Analysis results (*.csv)	Cursor data, measurement results, mask test statistics, search, segmented timestamps
Max USB flash drive size	Supports industry standard flash drives	
Set ups without USB flash drive	10 internal setups	
Set ups with USB flash drive	Limited by size of USB drive	
Included Standard with Oscilloscope		
Calibration	Soft copy of Certificate of Calibration (CoC) with measurement results downloadable from https://service.keysight.com/infoline/public/details.aspx?i=DOC , 3-year calibration interval	
Mean time before failure (MTBF)	> 250,000 hours	
Standard secure erase		
Probes		
N2843A Passive probe 500 MHz 10:1 attenuation	1 per channel	
N2756A 16 digital channel MSO cable	1 per scope included on all MSO models and DSOXT3MSO	
Interface and built-in help language support	English, Chinese (simplified), Chinese (traditional), Czech, French, German, Italian, Japanese, Korean, Portuguese, Russian, Spanish, Polish, Thai, Turkish	
Localized power cord and overlay		

For MET/CAL procedures, click on the Cal Labs solutions link <https://www.callabsolutions.com/procedures/>. These procedures are FREE to customers

Related Literature

Publication Title	Publication Number
Triggering on Infrequent Anomalies and Complex Signals using Zone Trigger - Application Note	5991-1107EN
InfiniiVision 3000G X-Series Oscilloscopes - Product Fact Sheet	3122-1256EN
Time Gated Fast Fourier Transforms for Time Correlated Mixed Domain Analysis - Application Note	5992-0244EN
Embedded Software Package - Data Sheet	5992-3924EN
Automotive Software Package - Data Sheet	5992-3912EN
Aero Software Package - Data Sheet	5992-3910EN
Power Software Package - Data Sheet	5992-3925EN
USB Software Package - Data Sheet	5992-3920EN
Ultimate Bundle Software Package - Data Sheet	5992-3918EN

After-purchase license-only upgrades

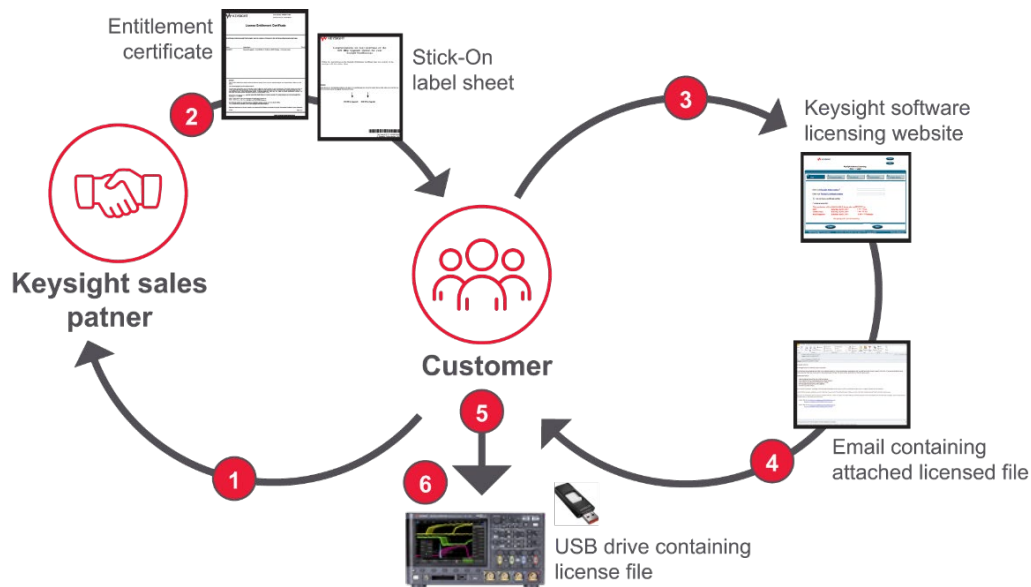

1. Place order for a license-only upgrade to a Keysight sales partner.
2. You will receive a paper or electronic .pdf Entitlement Certificate.
3. Use Entitlement Certificate containing instructions and certificate number needed to generate a license file for a particular 3000G X-Series oscilloscope model number and serial number unit.
4. Receive the licensed file and installation instructions via email.
5. Copy license file (.lic extension) from email to a USB drive and follow instructions in email to install the purchased bandwidth upgrade or measurement application on the oscilloscope.

Software Upgrades

Model Number	Description
D3000AUTB	Automotive Software Package: CAN, CAN FD, LIN, FlexRay, SENT, CXPI, PSI5 (User-definable Manchester), and User-definable NRZ serial trigger & decode
D3000AERB	Aero Software Package: MIL-STD 1553 and ARINC 429 serial trigger and decode
D3000PWRB	Power Software Package: Power quality, current harmonics, switching loss, turn-on/off time, transient response, loop response, PSRR, & more
D3000BDLB	Ultimate Bundle Software Package: CAN, CAN FD LIN, FlexRay, CXPI, PSI5 (User-definable Manchester), User-definable NRZ, MIL-STD 1553, and ARINC 429

Hardware Upgrades

Model Number	Description
DSOXG3MSO	MSO upgrade: Add 16 digital timing channels (N2756A MSO cable delivered separately)
DSOXG3SECA	Enhanced security option

Download Your Next Insight

Keysight software is downloadable expertise. From first simulation through first customer shipment, we deliver the tools your team needs to accelerate from data to information to actionable insight.

- Electronic design automation (EDA) software
- Application software
- Programming environments
- Productivity software

Learn more at www.keysight.com/find/software

Start with a 30-day free trial. www.keysight.com/find/free_trials

Keysight Oscilloscopes

Multiple form factors from 50 MHz to 110 GHz | Industry leading specs | Powerful applications

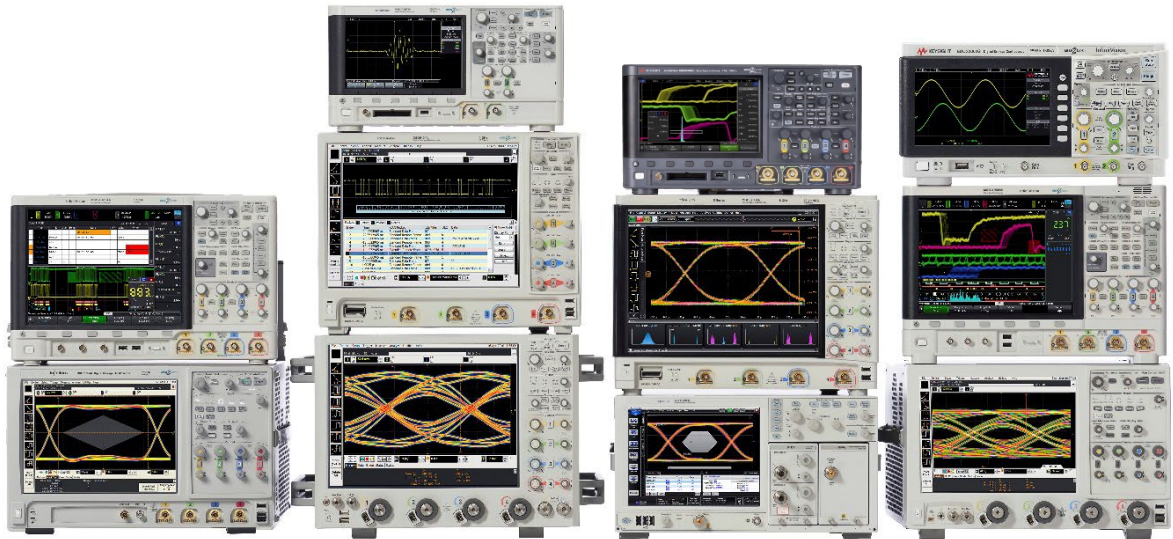

Learn more at: www.keysight.com

For more information on Keysight Technologies' products, applications or services, please contact your local Keysight office. The complete list is available at: www.keysight.com/find/contactus



Find us at www.keysight.com

This information is subject to change without notice. © Keysight Technologies, 2022. Published in USA, January 26, 2022, 3121-1451.EN

Page 60