

Keysight InfiniiVision 6000 X-Series Oscilloscopes

Service Guide

Notices

© Keysight Technologies, Inc. 2008-2021

No part of this manual may be reproduced in any form or by any means (including electronic storage and retrieval or translation into a foreign language) without prior agreement and written consent from Keysight Technologies, Inc. as governed by United States and international copyright laws.

Manual Part Number

54609-97083

Edition

November 2021

Available in electronic format only

Published by:

Keysight Technologies, Inc.
1900 Garden of the Gods Road
Colorado Springs, CO 80907 USA

Warranty

The material contained in this document is provided “as is,” and is subject to being changed, without notice, in future editions. Further, to the maximum extent permitted by applicable law, Keysight disclaims all warranties, either express or implied, with regard to this manual and any information contained herein, including but not limited to the implied warranties of merchantability and fitness for a particular purpose. Keysight shall not be liable for errors or for incidental or consequential damages in connection with the furnishing, use, or performance of this document or of any information contained herein. Should Keysight and the user have a separate written agreement with warranty terms covering the material in this document that conflict with these terms, the warranty terms in the separate agreement shall control.

Technology Licenses

The hardware and/or software described in this document are furnished under a license

and may be used or copied only in accordance with the terms of such license.

U.S. Government Rights

The Software is "commercial computer software," as defined by Federal Acquisition Regulation ("FAR") 2.101. Pursuant to FAR 12.212 and 27.405-3 and Department of Defense FAR Supplement ("DFARS") 227.7202, the U.S. government acquires commercial computer software under the same terms by which the software is customarily provided to the public. Accordingly, Keysight provides the Software to U.S. government customers under its standard commercial license, which is embodied in its End User License Agreement (EULA), a copy of which can be found at www.keysight.com/find/sweula. The license set forth in the EULA represents the exclusive authority by which the U.S. government may use, modify, distribute, or disclose the Software. The EULA and the license set forth therein, does not require or permit, among other things, that Keysight: (1) Furnish technical information related to commercial computer software or commercial computer software documentation that is not customarily provided to the public; or (2) Relinquish to, or otherwise provide, the government rights in excess of these rights customarily provided to the public to use, modify, reproduce, release, perform, display, or disclose commercial computer software or commercial computer software documentation. No additional government requirements beyond those set forth in the EULA shall apply, except to the extent that those terms, rights, or licenses are explicitly required from all providers of commercial computer software pursuant to the FAR and the DFARS and are set forth specifically in writing elsewhere in the EULA. Keysight shall be under no obligation to update, revise or otherwise modify the Software. With respect to any technical data as defined by FAR 2.101, pursuant to FAR 12.211 and 27.404.2 and DFARS 227.7102, the U.S. government

acquires no greater than Limited Rights as defined in FAR 27.401 or DFAR 227.7103-5 (c), as applicable in any technical data.

Safety Notices

This product has been designed and tested in accordance with accepted industry standards, and has been supplied in a safe condition. The documentation contains information and warnings that must be followed by the user to ensure safe operation and to maintain the product in a safe condition.

CAUTION

A **CAUTION** notice denotes a hazard. It calls attention to an operating procedure, practice, or the like that, if not correctly performed or adhered to, could result in damage to the product or loss of important data. Do not proceed beyond a **CAUTION** notice until the indicated conditions are fully understood and met.

WARNING

A **WARNING** notice denotes a hazard. It calls attention to an operating procedure, practice, or the like that, if not correctly performed or adhered to, could result in personal injury or death. Do not proceed beyond a **WARNING** notice until the indicated conditions are fully understood and met.

In This Service Guide

This book provides the service information for the Keysight 6000 X-Series oscilloscopes. This manual is divided into these chapters:

1 Characteristics and Specifications

This chapter contains a partial list of characteristics and specifications for the Keysight InfiniiVision 6000 X-Series oscilloscopes.

2 Testing Performance

This chapter explains how to verify correct oscilloscope operation and perform tests to ensure that the oscilloscope meets the performance specifications.

3 Calibrating and Adjusting

This chapter explains how to adjust the oscilloscope for optimum operating performance.

4 Troubleshooting

This chapter begins with suggestions for solving general problems that you may encounter with the oscilloscope. Procedures for troubleshooting the oscilloscope follow the problem solving suggestions.

5 Replacing Assemblies

This chapter describes how to remove assemblies from the 6000 X-Series oscilloscope.

6 Replaceable Parts

This chapter describes how to order replaceable assemblies and parts for the Keysight 6000 X-Series oscilloscopes. It includes diagrams and parts lists for hardware that you can order.

7 Safety Information

At the front of the book you will find safety notice descriptions and document warranties.

Digital Channels

Because all of the oscilloscopes in the Keysight 6000 X-Series have analog channels, the analog channel topics in this book apply to all instruments. Whenever a topic discusses the digital channels, that information applies only to Mixed-Signal Oscilloscope (MSO) models or DSO models that have been upgraded to an MSO.

Abbreviated instructions for pressing a series of keys

Instructions for pressing a series of keys are written in an abbreviated manner. Instructions for pressing Key1, then pressing Softkey2, then pressing Softkey3 are abbreviated as follows:

Press **[Key1] & Softkey2 & Softkey3**.

The keys may be front panel keys, or softkeys, which are located directly below the oscilloscope display.

Contents

In This Service Guide / 3

Figures / 9

Tables / 11

1 Characteristics and Specifications

Power Requirements / 13

Measurement Category / 14

Measurement Category / 14

Measurement Category Definitions / 14

Maximum Input Voltages / 15

Environmental Conditions / 16

Specifications / 16

Contact us / 16

2 Testing Performance

Overview / 18

List of Test Equipment / 19

Conventions / 20

To construct the test connector (for use with MSO models only) / 21

To test digital channels (MSO models only) / 23

To verify digital channel threshold accuracy (MSO models only) / 24

When to Test / 24

- What to Test / 24
- Verifying Test Results / 24
 - To verify DC vertical gain accuracy / 29
 - To verify dual cursor accuracy / 34
 - To verify bandwidth (-3 dB) / 38
 - To verify time base accuracy / 43
 - To verify trigger sensitivity / 45
 - Test Internal Trigger Sensitivity / 46
 - Test External Trigger Sensitivity (all models) / 49
- Keysight 6000 X-Series Oscilloscopes Performance Test Record / 52
- 3 Calibrating and Adjusting**
 - User Calibration / 57
 - To perform User Calibration / 57
 - User Calibration Status / 57
- 4 Troubleshooting**
 - Solving General Problems with the Oscilloscope / 60
 - If there is no display / 60
 - If there is no trace display / 60
 - If the trace display is unusual or unexpected / 61
 - If you cannot see a channel / 61
 - Verifying Basic Operation / 63
 - To power-on the oscilloscope / 63
 - To perform hardware self test / 64
 - To perform front panel self test / 64
 - To verify default setup / 64
 - To perform an Auto Scale on the Probe Comp signal / 66
 - To compensate passive probes / 67

Troubleshooting Internal Assemblies /	69
Equipment Required for Troubleshooting Internal Assemblies /	69
To prepare for internal assembly troubleshooting /	69
Flowchart for Internal Assembly Power Troubleshooting /	71
To check the line filter AC output /	72
To check the power supply DC output /	73
To check the fan power supply /	75
To check power to the acquisition board /	77
To check power to the front panel (AutoProbe) interfaces /	80

5 Replacing Assemblies

To remove the cabinet /	85
To remove the rear deck assembly /	86
To remove the power supply shield /	91
To remove the probe power shield /	92
To remove the AC input shield /	93
To replace the battery /	94
To remove the acquisition board /	95
To remove the front panel knobs /	100
To remove the front bezel assembly /	101
To remove the display assembly /	103
To remove the keyboard and keypad /	105
To remove the fan assembly /	109
To remove the power supply /	111
To remove the power board /	113

6 Replaceable Parts

Ordering Replaceable Parts / 118

Listed Parts / 118

Unlisted Parts / 118

Direct Mail Order System / 118

Exchange Assemblies / 119

Exploded Views / 120

Replaceable Parts List / 122

7 Safety Information

Index

Figures

- Figure 1. Constructing the 8-by-2 Connector / 22
- Figure 2. Setting Up Equipment for Digital Channel Threshold Accuracy Test / 26
- Figure 3. Setting up Equipment for DC Vertical Gain Accuracy Test / 32
- Figure 4. Using a Blocking Capacitor to Reduce Noise / 33
- Figure 5. Setting up Equipment for Dual Cursor Accuracy Test / 36
- Figure 6. Using a Blocking Capacitor to Reduce Noise / 37
- Figure 7. Setting Up Equipment for Bandwidth (-3 dB) Verification Test / 39
- Figure 8. Setting Up Equipment for Internal Trigger Sensitivity Test / 47
- Figure 9. Setting Up Equipment for 4-Channel External Trigger Sensitivity Test / 50
- Figure 10. Default setup screen / 66
- Figure 11. Example pulses / 68
- Figure 12. Verify line filter AC output / 72
- Figure 13. Verify power supply DC output / 74
- Figure 14. Location of the J104 fan connector / 75
- Figure 15. Location of the J105 acquisition board power connector / 77
- Figure 16. J105 connector pinout / 78
- Figure 17. Location of the J106 probe power connector / 80
- Figure 18. Removing the cabinet / 85
- Figure 19. Removing the BNC securing nuts and washers / 86
- Figure 20. Removing perimeter screws securing rear deck / 87
- Figure 21. Removing rear-facing screws securing rear deck / 88
- Figure 22. Removing cables from power board to other boards / 89
- Figure 23. Separating front and rear deck assemblies / 90
- Figure 24. Removing the power supply shield / 91
- Figure 25. Removing the probe power shield / 92
- Figure 26. Removing the AC input shield / 93
- Figure 27. Battery location / 94

Figures

- Figure 28. Removing the analog channel BNC securing T6 screws / 95
- Figure 29. Removing the display backlight power cable (54609-61605) from the acquisition board / 96
- Figure 30. Removing the LVDS display cable (54609-61610) from the acquisition board / 96
- Figure 31. Removing the keyboard cable (54709-61610) from the acquisition board / 97
- Figure 32. Acquisition board TORX T10 mounting screw locations / 98
- Figure 33. Lifting acquisition board off the front deck / 99
- Figure 34. Removing the front panel knobs / 100
- Figure 35. Removing the bezel / 101
- Figure 36. Disconnecting the keyboard cable / 102
- Figure 37. Removing the display assembly / 103
- Figure 38. Display assembly removed / 104
- Figure 39. Disconnecting the softkey board cable / 105
- Figure 40. Disconnecting the speaker/microphone cable / 106
- Figure 41. Removing the keyboard / 107
- Figure 42. Keyboard and keypad removed / 107
- Figure 43. Unclip the softkey board from the bezel / 108
- Figure 44. Softkey board and keypad removed / 108
- Figure 45. Disconnecting the fan cable / 109
- Figure 46. Removing fan assembly / 110
- Figure 47. Removing cables to/from power supply / 111
- Figure 48. Removing the power supply / 112
- Figure 49. Disconnecting the ground wire / 113
- Figure 50. Removing the power board / 114
- Figure 51. Removing power switch extender / 115
- Figure 52. Exploded View 1 of 2 / 120
- Figure 53. Exploded View 2 of 2 / 121

Tables

Table 1. List of test equipment	/ 19
Table 2. Conventions	/ 20
Table 3. Materials required to construct the test connectors	/ 21
Table 4. Equipment Required to Test Digital Channel Threshold Accuracy	/ 25
Table 5. Threshold Accuracy Voltage Test Settings	/ 27
Table 6. DC Vertical Gain Accuracy Test Limits	/ 29
Table 7. Equipment Required to Verify DC Vertical Gain Accuracy	/ 29
Table 8. Settings Used to Verify DC Vertical Gain Accuracy	/ 30
Table 9. Equipment Required to Verify Dual Cursor Accuracy	/ 34
Table 10. Settings Used to Verify Dual Cursor Accuracy	/ 35
Table 11. Bandwidth (-3 dB) Test Limits	/ 38
Table 12. Equipment Required to Verify Bandwidth (-3 dB)	/ 38
Table 13. Equipment Required to Verify Time Base Accuracy	/ 43
Table 14. Internal Trigger Sensitivity Test Limits	/ 45
Table 15. External Trigger Sensitivity Test Limits, All Models	/ 45
Table 16. Equipment Required to Verify Trigger Sensitivity	/ 46
Table 17. External Trigger Sensitivity Test Settings	/ 49
Table 18. Equipment Required to Troubleshoot the Oscilloscope	/ 69
Table 19. DC output from power supply	/ 74
Table 20. Fan power	/ 76
Table 21. Power supplies to acquisition board (from power board J105)	/ 78
Table 22. Power supplies to front panel board (AutoProbe power, from power board J106)	/ 81
Table 23. Replaceable Parts	/ 122
Table 24. Description of Safety related symbols that may appear on a product	/ 128

1 Characteristics and Specifications

Power Requirements / 13
Measurement Category / 14
Environmental Conditions / 16
Specifications / 16
Contact us / 16

This chapter contains a partial list of characteristics and specifications for the Keysight InfiniiVision 6000 X-Series oscilloscopes.

For a full list of Keysight InfiniiVision 6000 X-Series oscilloscopes characteristics and specifications see the data sheets.

The data sheets are available at www.keysight.com/find/6000X-Series.

Power Requirements

Line voltage, frequency, and power:

- ~Line 100-120 Vac, 50/60/400 Hz
- 100-240 Vac, 50/60 Hz
- 200 W max

Measurement Category

Measurement Category

The InfiniiVision 6000 X-Series oscilloscopes are not intended to be used for measurements in Measurement Category II, III, or IV.

WARNING

Use this instrument only for measurements within its specified measurement category (not rated for CAT II, III, IV). No transient overvoltages allowed.

Measurement Category Definitions

The "Not rated for CAT II, III, IV" measurement category is for measurements performed on circuits not directly connected to MAINS. Examples are measurements on circuits not derived from MAINS, and specially protected (internal) MAINS derived circuits. In the latter case, transient stresses are variable; for that reason, the transient withstand capability of the equipment is made known to the user.

Measurement category II is for measurements performed on circuits directly connected to the low voltage installation. Examples are measurements on household appliances, portable tools and similar equipment.

Measurement category III is for measurements performed in the building installation. Examples are measurements on distribution boards, circuit-breakers, wiring, including cables, bus-bars, junction boxes, switches, socket-outlets in the fixed installation, and equipment for industrial use and some other equipment, for example, stationary motors with permanent connection to the fixed installation.

Measurement category IV is for measurements performed at the source of the low-voltage installation. Examples are electricity meters and measurements on primary overcurrent protection devices and ripple control units.

Maximum Input Voltages

CAUTION

Maximum input voltage at analog inputs

Do not exceed the maximum input voltage rating.

The maximum input voltage for the 50 Ω input impedance setting is ± 5 V.

Input protection is enabled in 50 Ω mode and the 50 Ω load will disconnect if greater than 5 V_{rms} is detected. However the inputs could still be damaged, depending on the time constant of the signal. The 50 Ω input protection functions only when the oscilloscope is powered on.

The maximum input voltage for the 1 M Ω input impedance setting is 30 V_{rms} or ± 40 V_{max} (DC+V_{peak})

Probing technology allows for testing of higher voltages; the included N2894A 10:1 probe supports 300 V_{rms} or ± 400 V_{max} (DC+V_{peak}). No transient overvoltage allowed.

CAUTION

When measuring voltages over 30 V, use a 10:1 probe.

CAUTION

Maximum input voltage for digital channels:

± 40 V peak

Environmental Conditions

Environment	Indoor use only.
Ambient temperature	Operating 0 °C to +50 °C; non-operating –30 °C to +70 °C
Humidity	Maximum Relative Humidity (non-condensing): 80% RH up to 40 °C, decreases linearly to 50% at 50 °C. From 40 °C to 50 °C, the maximum % Relative Humidity follows a line of constant dew point.
Altitude	Maximum operating altitude: 3,962 m (13,000 ft)
Overvoltage Category	This product is intended to be powered by MAINS that comply to Overvoltage Category II, which is typical of cord-and-plug connected equipment.
Pollution Degree	The InfiniiVision 6000 X-Series oscilloscopes may be operated in environments of Pollution Degree 2 (or Pollution Degree 1).
Pollution Degree Definitions	<p>Pollution Degree 1: No pollution or only dry, non-conductive pollution occurs. The pollution has no influence. Example: A clean room or climate controlled office environment.</p> <p>Pollution Degree 2. Normally only dry non-conductive pollution occurs. Occasionally a temporary conductivity caused by condensation may occur. Example: General indoor environment.</p> <p>Pollution Degree 3: Conductive pollution occurs, or dry, non-conductive pollution occurs which becomes conductive due to condensation which is expected. Example: Sheltered outdoor environment.</p>

Specifications

Please see the *InfiniiVision 6000 X-Series Oscilloscopes Data Sheet* for complete, up-to-date specifications and characteristics.

To download a copy of the data sheet please visit:
www.keysight.com/find/6000X-Series.

Contact us

To contact Keysight, see: www.keysight.com/find/contactus

2 Testing Performance

Overview / 18
List of Test Equipment / 19
To construct the test connector (for use with MSO models only) / 21
To test digital channels (MSO models only) / 23
To verify digital channel threshold accuracy (MSO models only) / 24
To verify DC vertical gain accuracy / 29
To verify dual cursor accuracy / 34
To verify bandwidth (-3 dB) / 38
To verify time base accuracy / 43
To verify trigger sensitivity / 45
Keysight 6000 X-Series Oscilloscopes Performance Test Record / 52

This chapter explains how to verify correct oscilloscope operation and perform tests to ensure that the oscilloscope meets the performance specifications.

Overview

To completely test and troubleshoot MSO models, create and use the test connector accessory as described in this chapter.

- The test connector is only required for oscilloscopes that have the MSO option licensed (enabled).
- The connector is used in the digital channel threshold accuracy test.
- The test connector keeps electrical distortion to a minimum and makes it easy for you to connect the oscilloscope probes to function generators and measurement equipment.

Let the Equipment Warm Up Before Testing

For accurate test results, let the test equipment and the oscilloscope warm up 30 minutes before testing.

Verifying Test Results

During the tests, record the readings in the Performance Test Record on [page 52](#). To verify whether a test passes, verify that the reading is within the limits in the Performance Test Record.

If a performance test fails

If a performance test fails, first perform the User Calibration procedure. Press the following keys to access User Calibration: [Utility]→Service→Start User Calibration.

List of Test Equipment

Below is a list of test equipment and accessories required to perform the performance test verification procedures.

Table 1 List of test equipment

Equipment	Critical Specifications	Recommended Model/ Part Number
Test connector, 8-by-2*	See page 21 for instructions on building test connector.	n/a
Digital Multimeter	0.1 mV resolution, 0.005% accuracy	Keysight 34401A/34461A
Power Splitter	Outputs differ by 0.20 dB	Keysight 11667A
Precision Source	DC voltage of -5.5 V to 35.5 V, 0.1 mV resolution	Keysight B2912A/B2962A
Signal Generator	100 kHz to 6 GHz sine waves	Keysight N5171B with 6 GHz option
Power Meter	6 GHz $\pm 3\%$ accuracy	Keysight N1914A
Power Sensor	6 GHz $\pm 3\%$ accuracy	Keysight E9304A or N8482A
50 Ω BNC Cable (qty 3)	BNC - BNC, 48" length	Keysight 8120-1840 [†]
Cable	Type N (m) 609.6 mm (24 in.)	Keysight 11500B
Probe cable*	No substitute	16-channel: Keysight N6450-60001 or N2756-60001 8-channel: Keysight N6459-60001 or N2755-60001 [†]
Adapter (qty 2)	BNC (f) to banana (m)	Keysight 1251-2277 [†]
BNC Tee	BNC Tee (m) (f) (f)	Keysight 1250-0781 [†] or Pomona 3285
Adapter	Type N (m) to BNC (m)	Keysight 1250-0082 or Pomona 3288 with Pomona 3533
Shorting cap	BNC	Keysight 1250-0774
Blocking capacitor	Note: if a BNC blocking capacitor is not available use an SMA blocking capacitor.	Keysight 11742A + Pomona 4289 + Pomona 5088
50 Ohm Feedthrough Termination	50 Ω BNC (f) to BNC (m)	Keysight 0960-0301

* Required only for testing digital channels of oscilloscopes that have the MSO option.

Most parts and equipment are available at www.keysight.com. See respective manufacturer's websites for their equipment.

[†] These parts available at www.parts.keysight.com at the time this manual was published.

Conventions

The following conventions will be used when referring to oscilloscope models throughout this chapter.

Table 2 Conventions

DSO-X 6002A, DSO-X 6004A, MSO-X 6002A, MSO-X 6004A Bandwidth Option	Referred to as:
(none)	1 GHz Models
BW250	2.5 GHz Models
BW400	4 GHz Models
BW600	6 GHz Models

To construct the test connector (for use with MSO models only)

Keysight 6000 X-Series oscilloscopes that have digital channels enabled require the test connector described below. Follow the steps to build the test connector.

Table 3 Materials required to construct the test connectors

Description	Recommended Part	Qty
BNC (f) Connector	Keysight 1250-1032 or Pomona 4578	1
Berg Strip, 8-by-2	3M .100" x .100" Pin Strip Header or similar	1 strip, cut to length (8x2)
Jumper wire		

- 1 Obtain a BNC connector and an 8-by-2 section of Berg strip. A longer strip can be cut to length using wire cutters.
- 2 On one side of the Berg strip, solder a jumper wire to all of the pins (shown in [Figure 1](#) on page 22).
- 3 On the other side of the Berg strip, solder another jumper wire to all of the pins.
- 4 Solder the center of the BNC connector to a center pin on one of the rows on the Berg strip.
- 5 Solder the ground tab of the BNC connector to a center pin on the other row on the Berg strip.

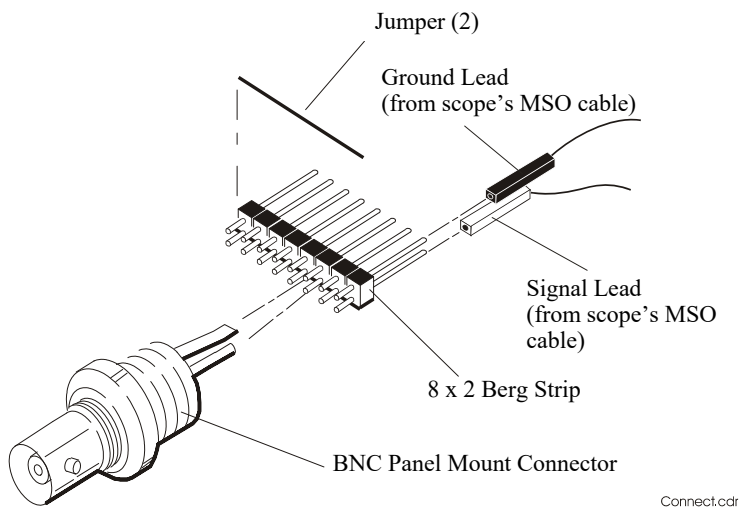

Figure 1 Constructing the 8-by-2 Connector

To test digital channels (MSO models only)

The acquisition system testing provides confidence that the acquisition system is functioning correctly. It does not, however, check a particular specification.

- 1** Disconnect all probes from the circuit under test and from any other input source.
- 2** Using probe leads and grabbers, connect digital channels D0, D1, D2, and D3 to the Probe Comp signal on the center of the front panel.
- 3** Press the **[AutoScale]** key.

If four square waves appear, the acquisition system is functioning correctly.

If the square waves do not appear, go to the “Troubleshooting” chapter. Then return here to finish testing the digital channels.

- 4** Disconnect the digital channels from the calibration point.
- 5** Use steps 2 and 3 to test the following sets of digital channels. After you test one set of digital channels, remove them before connecting the next set.
 - D4, D5, D6, D7
 - D8, D9, D10, D11
 - D12, D13, D14, D15

To verify digital channel threshold accuracy (MSO models only)

This test verifies the digital channel threshold accuracy specification of the Keysight 6000 X-Series oscilloscopes.

Threshold accuracy test limits: $\pm(100 \text{ mV} + 3\% \text{ of threshold setting})$

When to Test

You should perform this test every two years or after 4000 hours of operation, whichever comes first.

What to Test

Use these instructions to test the threshold settings of digital channels D7-D0. Then, use the same instructions to test digital channels D15-D8.

Verifying Test Results

After each threshold test, record the voltage reading in the Performance Test Record on [page 52](#). To verify whether a test passes, verify that the voltage reading is within the limits in the Performance Test Record.

Table 4 Equipment Required to Test Digital Channel Threshold Accuracy

Equipment	Critical Specifications	Recommended Model/Part
Digital Multimeter	0.1 mV resolution, 0.005% accuracy	Keysight 34401A/34461A
Precision Source	DC voltage of -5.5 V to 35.5 V, 0.1 mV resolution	Keysight B2912A/B2962A
Adapter (qty 2)	BNC(f) to banana (m)	Keysight 1251-2277
BNC Tee	BNC Tee (m) (f) (f)	Keysight 1250-0781 or Pomona 3285
50 Ω BNC Cable	BNC - BNC, 48" length	Keysight 8120-1840
BNC Test Connector, 8-by-2		User-built (See page 21)
Probe Cable	No substitute	16-channel: Keysight N6450-60001 or N2756-60001 8-channel: Keysight N6459-60001 or N2755-60001

- 1 Turn on the test equipment and the oscilloscope. Let them warm up for 30 minutes before starting the test.
- 2 Set up the precision source.
 - a Set the precision source to provide a DC offset voltage at the Channel 1 output.

Note: Set the Low Force terminal of the Precision Source to its "Floating" state to prevent offset error caused by ground loop current from the Precision Source ground to the DUT ground.
 - b Use the multimeter to monitor the precision source DC output voltage.
- 3 Use the 8-by-2 test connector and the BNC cable assembly to connect digital channels D0-D7 to one side of the BNC Tee. Then connect the D0-D7 ground lead to the ground side of the 8-by-2 connector. See [Figure 2](#).

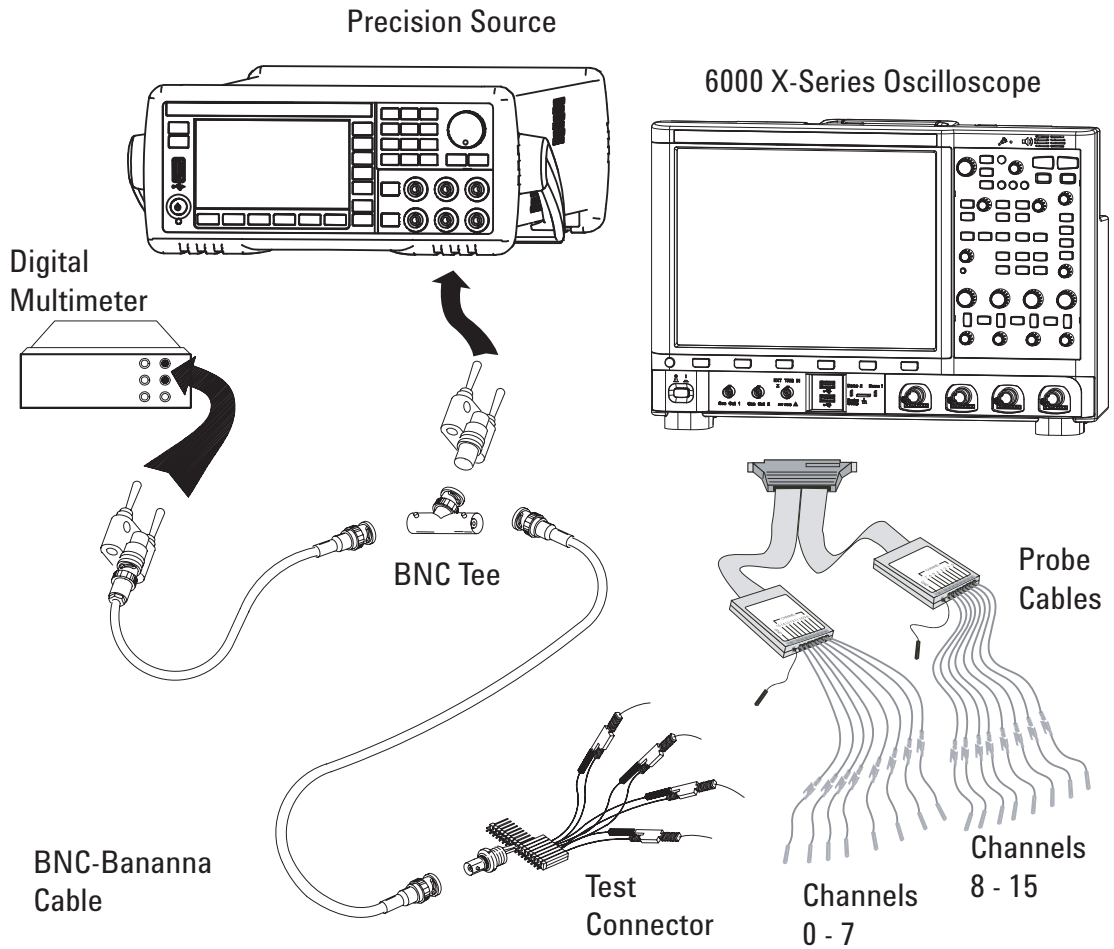

Figure 2 Setting Up Equipment for Digital Channel Threshold Accuracy Test

- 4 Use a BNC-bananna cable to connect the multimeter to the other side of the BNC Tee.
- 5 Connect the BNC Tee to the Channel 1 output of the precision source as shown in **Figure 2**.
- 6 On the oscilloscope, press the **[Digital]** key, then press the **Thresholds** softkey, then press the **D7 - D0** softkey repeatedly until the check mark is next to **User**.

- 7 Press the **User** softkey to the right of the **D7 - D0** softkey, then turn the Entry knob (↻) on the front panel of the oscilloscope to set the threshold test settings as shown in [Table 5](#).

Table 5 Threshold Accuracy Voltage Test Settings

Threshold voltage setting (in oscilloscope User softkey)	DC offset voltage setting (on precision source)	Limits
+5.00 V	+5.250 V ±1 mV dc	Lower limit = +4.750 V Upper limit = +5.250 V
-5.00 V	-4.750 V ±1 mV dc	Lower limit = -5.250 V Upper limit = -4.750 V
0.00 V	+100m V ±1 mV dc	Upper limit = +100 mV Lower limit = -100 mV

- 8 Do the following steps for each of the threshold voltage levels shown in [Table 5](#).

- a Set the threshold voltage shown in the **User** softkey using the Entry knob on the oscilloscope.
- b Enter the corresponding DC offset voltage on the precision source front panel. Then use the multimeter to verify the voltage.

Digital channel activity indicators are displayed on the status line at the top of the oscilloscope display. The activity indicators for D7-D0 should show all of the channels at digital high levels.

- c Use the knob on the precision source to decrease the offset voltage, in increments of 10 mV, until the activity indicators for digital channels D7-D0 are all at digital low levels. Record the precision source voltage in the Performance Test Record (see [page 52](#)).
- d Use the knob on the precision source to increase the offset voltage, in increments of 10 mV, until the activity indicators for digital channels D7-D0 are all at digital high levels. Record the precision source voltage in the Performance Test Record (see [page 52](#)).

Before proceeding to the next step, make sure that you have recorded the precision source voltage levels for each of the threshold settings shown in [Table 5](#).

- 9** When testing 6000 X-Series MSOs, use the 8-by-2 test connector to connect digital channels D15-D8 to the output of the precision source. Then connect the D15-D8 ground lead to the ground side of the 8-by-2 connector.
- 10** Repeat this procedure (steps 6 through 8) for digital channels D15-D8 to verify threshold accuracy and record the threshold levels in the Performance Test Record (see [page 52](#)). Be sure to set the thresholds with the **User** softkey for the appropriate set of channels.

To verify DC vertical gain accuracy

This test verifies the accuracy of the analog channel DC vertical gain for each channel.

In this test, you will measure the dc voltage output of a precision source using the oscilloscope's **Average - Full Screen** voltage measurement and compare the results with the multimeter reading.

Table 6 DC Vertical Gain Accuracy Test Limits

Models	Test Limits	Notes
6000 X-Series	±2.5% of full scale	<ul style="list-style-type: none"> Full scale is defined as 16 mV on the 1 mV/div range. Full scale on all other ranges is defined as 8 divisions times the V/div setting.

Table 7 Equipment Required to Verify DC Vertical Gain Accuracy

Equipment	Critical Specifications	Recommended Model/Part
Precision Source	DC voltage of -5.5 V to 35.5 V, 0.1 mV resolution	Keysight B2912A/B2962A
Digital multimeter	Better than 0.01% accuracy	Keysight 34401A/34461A
50 Ω BNC Cable (qty 2)	BNC - BNC, 48" length	Keysight 8120-1840
Adapter (qty 2)	BNC (f) to banana (m)	Keysight 1251-2277
BNC Tee	BNC tee (m) (f) (f)	Keysight 1250-0781 or Pomona 3285
Shorting cap	BNC	Keysight 1250-0774
Blocking capacitor	Note: if a BNC blocking capacitor is not available use an SMA blocking capacitor.	Keysight 11742A + Pomona 4289 + Pomona 5088

- 1 Press **[Save/Recall] > Default/Erase > Factory Default** to recall the factory default setup.

- 2 Set up the oscilloscope.
 - a Adjust the horizontal scale to **200.0 us/div**.
 - b Set the Volts/Div setting to the value in the first line in **Table 8** (depending on the oscilloscope model).
 - c Adjust the channel's vertical position knob to place the baseline (reference level) at 0.5 major division from the bottom of the display.

Table 8 Settings Used to Verify DC Vertical Gain Accuracy

Volts/Div Setting	Precision Source Setting	Test Limits		
5 V/Div	35 V	34 V	to	36 V
2 V/Div	14 V	13.6 V	to	14.4 V
1 V/Div	7 V	6.8 V	to	7.2 V
500 mV/Div	3.5 V	3.4 V	to	3.6 V
200 mV/Div	1.4 V	1.36 V	to	1.44 V
100 mV/Div	700 mV	680 mV	to	720 mV
50 mV/Div	350 mV	340 mV	to	360 mV
20 mV/Div	140 mV	136 mV	to	144 mV
10 mV/Div	70 mV	68 mV	to	72 mV
5 mV/Div ¹	35 mV	34 mV	to	36 mV
2 mV/Div ^{1,2}	14 mV	13.6 mV	to	14.4 mV
1 mV/Div ^{1,2}	7 mV	6.6 mV	to	7.4 mV

¹ A blocking capacitor is required at this range to reduce noise. See **"Use a Blocking Capacitor to Reduce Noise"** on page 33.

² Full scale is defined as 16 mV on the 1 mV/div range. Full scale on all other ranges is defined as 8 divisions times the V/div setting.

- d Press the **[Acquire]** key.
- e Then press the **Acq Mode** softkey and select **Averaging**.
- f Then press the **#Avgs** softkey and set it to 64.

Wait a few seconds for the measurement to settle.

- 3 Add a measurement for the average voltage:
 - a Press the **[Meas]** key.
 - b Press **Source**; then, turn the Entry knob (labeled  on the front panel) to select the channel you are testing.
 - c Press **Type**; then, turn the Entry knob to select **Average - Full Screen**, and press **Add Measurement**.
- 4 Read the “current” average voltage value as V1.
- 5 Use the BNC tee and cables to connect the precision source / power supply to both the oscilloscope and the multimeter (see [Figure 3](#)).

Note: Set the Low Force terminal of the Precision Source to its "Floating" state to prevent offset error caused by ground loop current from the Precision Source ground to the DUT ground.

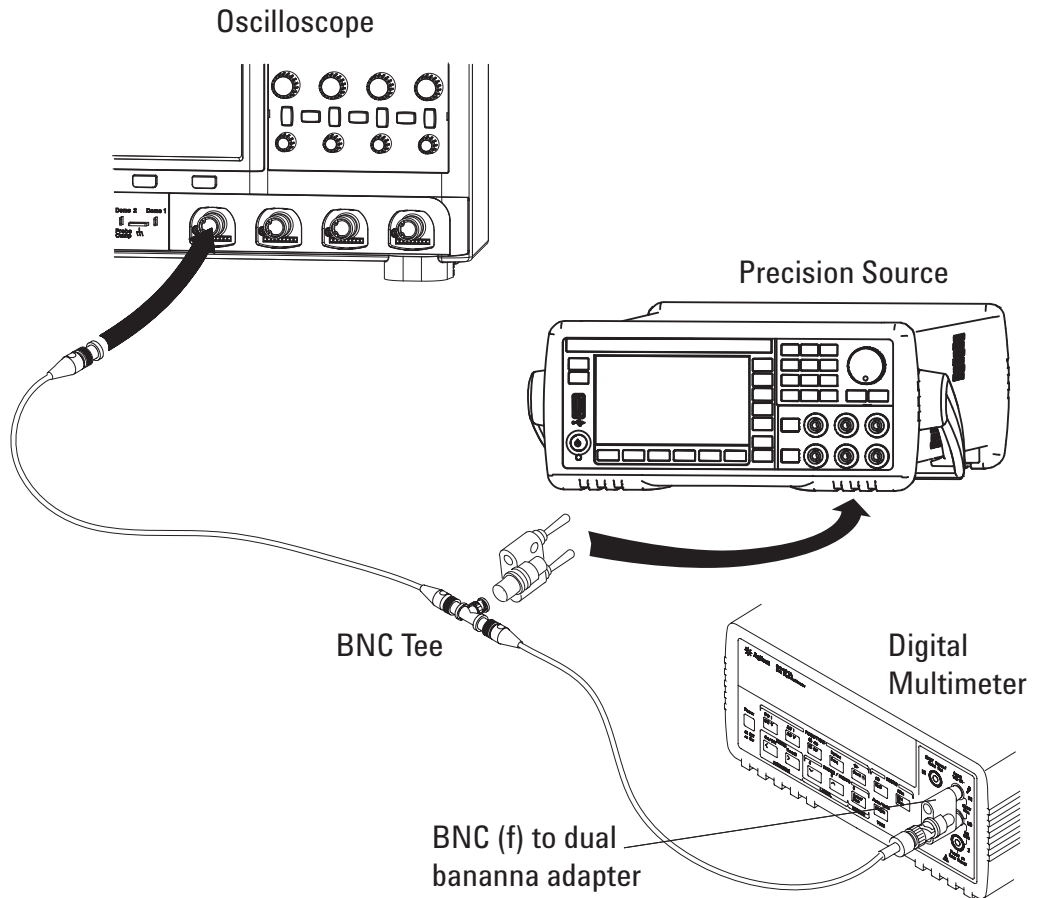

Figure 3 Setting up Equipment for DC Vertical Gain Accuracy Test

- 6 Adjust the output so that the multimeter reading displays the first Volts/div precision source setting value in [Table 8](#) (depending on the oscilloscope model).
- 7 Disconnect the multimeter.
- 8 Wait until the measurement settles.
- 9 Read the “current” average voltage value again as V2.
- 10 Calculate the difference $V2 - V1$.

The difference in average voltage readings should be within the test limits of **Table 8** (depending on the oscilloscope model).

If a result is not within the test limits, go to the “Troubleshooting” chapter. Then return here.

- 11 Disconnect the precision source from the oscilloscope.
- 12 Repeat this procedure to check the DC vertical gain accuracy with the remaining Volts/div setting values in **Table 8** (depending on the oscilloscope model).
- 13 Finally, repeat this procedure for the remaining channels to be tested.

Use a Blocking Capacitor to Reduce Noise

On the more sensitive ranges, such as 1 mV/div, 2 mV/div, and 5 mV/div, noise may be a factor. To eliminate the noise, add a BNC Tee, blocking capacitor, and shorting cap at the oscilloscope channel input to shunt the noise to ground. See **Figure 4**. If a BNC capacitor is not available, use an SMA blocking capacitor, adapter, and cap. See “**Blocking capacitor**” in the equipment list on **page 19** for details.

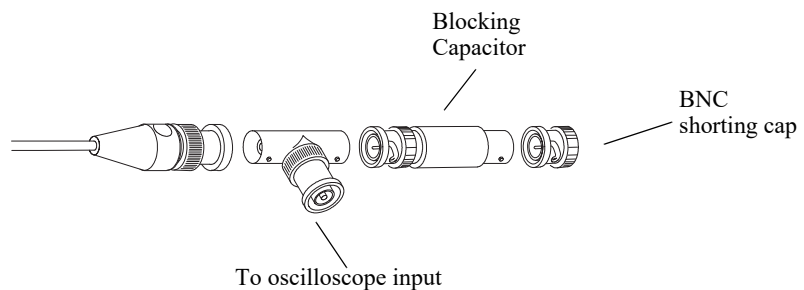

Figure 4 Using a Blocking Capacitor to Reduce Noise

To verify dual cursor accuracy

This test verifies the dual cursor accuracy for each analog channel.

This test is similar to the test for verifying the DC vertical gain, except you will measure the dc voltage output of an precision source using dual cursors on the oscilloscope and compare the results with the multimeter reading.

Dual cursor accuracy test limits: \pm [DC vertical gain accuracy + 0.42% full scale]

For the DC vertical gain accuracy test limits, see [Table 6](#) on page 29.

Table 9 Equipment Required to Verify Dual Cursor Accuracy

Equipment	Critical Specifications	Recommended Model/Part
Precision Source	DC voltage of -5.5 V to 35.5 V, 0.1 mV resolution	Keysight B2912A/B2962A
Digital multimeter	Better than 0.01% accuracy	Keysight 34401A/34461A
50 Ω BNC Cable (qty 2)	BNC - BNC, 48" length	Keysight 8120-1840
Adapter (qty 2)	BNC (f) to banana (m)	Keysight 1251-2277
BNC Tee	BNC tee (m) (f) (f)	Keysight 1250-0781 or Pomona 3285
Shorting cap	BNC	Keysight 1250-0774
Blocking capacitor	Note: if a BNC blocking capacitor is not available use an SMA blocking capacitor.	Keysight 11742A + Pomona 4289 + Pomona 5088

- 1 Press [**Save/Recall**] > **Default/Erase** > **Factory Default** to recall the factory default setup.
- 2 Set up the oscilloscope.
 - a Set the Volts/Div setting to the value in the first line in [Table 10](#) (depending on the oscilloscope model).
 - b Adjust the channel 1 position knob to place the baseline at 0.5 major division from the bottom of the display.

Table 10 Settings Used to Verify Dual Cursor Accuracy

Volts/Div Setting	Precision Source Setting	Test Limits		
5 V/Div	35 V	33.832 V	to	36.168 V
2 V/Div	14 V	13.533 V	to	14.467 V
1 V/Div	7 V	6.766 V	to	7.234 V
500 mV/Div	3.5 V	3.383 V	to	3.617 V
200 mV/Div	1.4 V	1.353 V	to	1.447 V
100 mV/Div	700 mV	676.64 mV	to	723.36 mV
50 mV/Div	350 mV	338.32 mV	to	361.68 mV
20 mV/Div	140 mV	135.33 mV	to	144.67 mV
10 mV/Div	70 mV	67.66 mV	to	72.34 mV
5 mV/Div ¹	35 mV	33.83 mV	to	36.17 mV
2 mV/Div ^{1,2}	14 mV	13.53 mV	to	14.47 mV
1 mV/Div ^{1,2}	7 mV	6.533 mV	to	7.467 mV

¹ A blocking capacitor is required at this range to reduce noise. See **"Use a Blocking Capacitor to Reduce Noise"** on page 37.

² Full scale is defined as 16 mV on the 1 mV/div range. Full scale on all other ranges is defined as 8 divisions times the V/div setting.

- c Press the **[Acquire]** key.
 - d Then press the **Acq Mode** softkey and select **Averaging**.
 - e Then press the **#Avgs** softkey and set it to 64.
- Wait a few seconds for the measurement to settle.
- 3 Press the **[Cursors]** key, set the **Mode** softkey to **Normal**, then press the **X Y** softkey and select **Y**. Press the **Y1** softkey, then use the Entry knob (labeled  on the front panel) to set the Y1 cursor on the baseline of the signal.
 - 4 Use the BNC tee and cables to connect the precision source / power supply to both the oscilloscope and the multimeter (see **Figure 5**).

Note: Set the Low Force terminal of the Precision Source to its "Floating" state to prevent offset error caused by ground loop current from the Precision Source ground to the DUT ground.

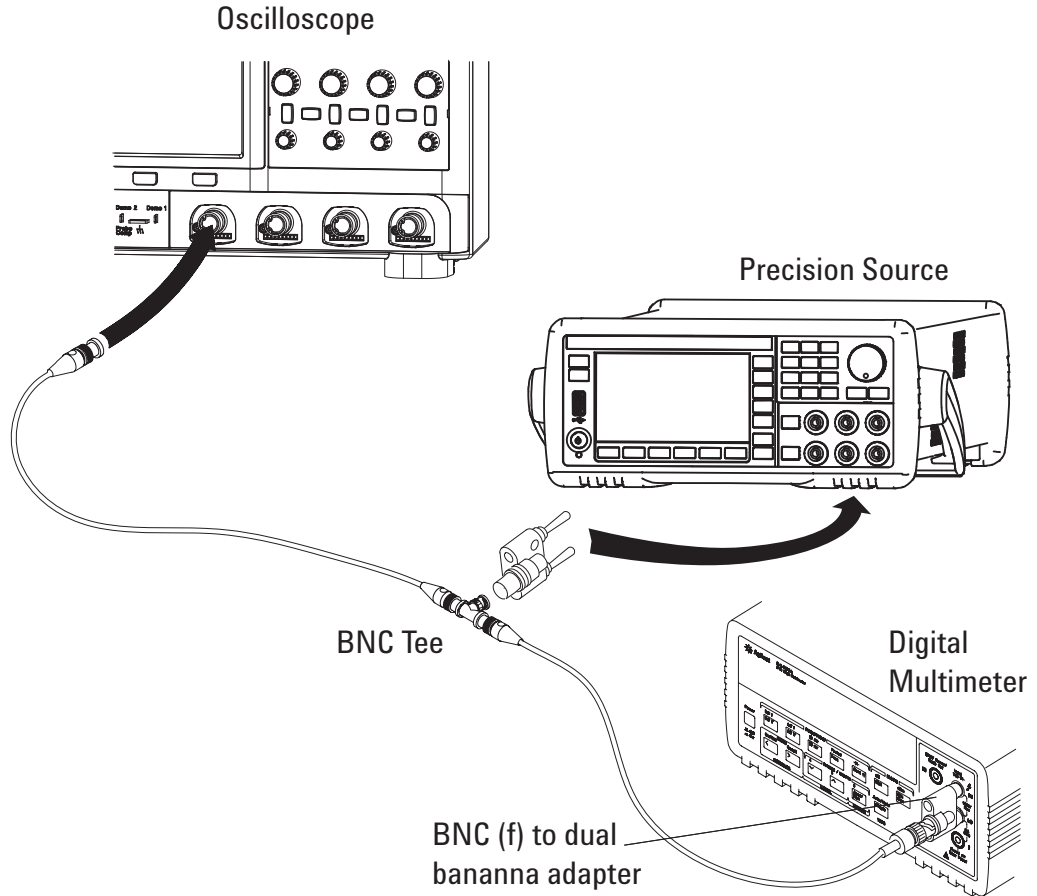

Figure 5 Setting up Equipment for Dual Cursor Accuracy Test

- 5 Adjust the output so that the multimeter reading displays the first Volts/div precision source setting value in [Table 10](#).
- 6 Disconnect the multimeter.
- 7 Wait until the measurement settles.

- 8 Press the **Y2** softkey, then position the Y2 cursor to the center of the voltage trace using the Entry knob.

The ΔY value on the lower line of the display should be within the test limits of **Table 10**.

If a result is not within the test limits, go to the “Troubleshooting” chapter. Then return here.

- 9 Disconnect the precision source from the oscilloscope.
- 10 Repeat this procedure to check the dual cursor accuracy with the remaining Volts/div setting values in **Table 10**.
- 11 Finally, repeat this procedure for the remaining channels to be tested.

Use a Blocking Capacitor to Reduce Noise

On the more sensitive ranges, such as 1 mV/div, 2 mV/div, and 5 mV/div, noise may be a factor. To eliminate the noise, add a BNC Tee, blocking capacitor, and shorting cap at the oscilloscope channel input to shunt the noise to ground. See **Figure 6**. If a BNC capacitor is not available, use an SMA blocking capacitor, adapter, and cap. See “**Blocking capacitor**” in the equipment list on **page 19** for details.

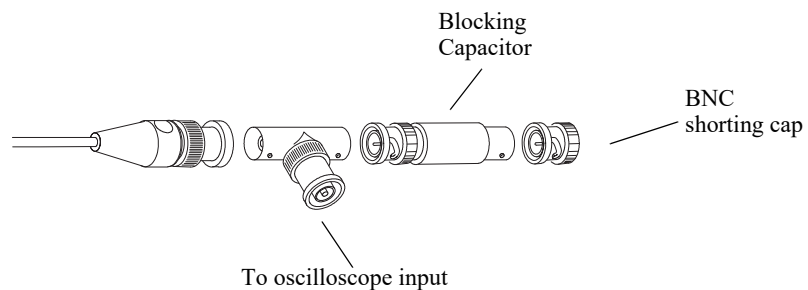

Figure 6 Using a Blocking Capacitor to Reduce Noise

To verify bandwidth (-3 dB)

This test checks the bandwidth (-3 dB) of the oscilloscope. In this test you will use a signal generator and a power meter.

Table 11 Bandwidth (-3 dB) Test Limits

Models	Test Limits
6 GHz Models	All channels (-3 dB), dc to 6 GHz
4 GHz Models	All channels (-3 dB), dc to 4 GHz
2.5 GHz Models	All channels (-3 dB), dc to 2.5 GHz
1 GHz Models	All channels (-3 dB), dc to 1 GHz

Table 12 Equipment Required to Verify Bandwidth (-3 dB)

Equipment	Critical Specifications	Recommended Model/Part
Signal Generator	100 kHz - 6 GHz at 200 mVrms	Keysight N5171B with 6 GHz option
Power Meter	1 MHz - 6 GHz $\pm 3\%$ accuracy	Keysight N1914A
Power Sensor	1 MHz - 6 GHz $\pm 3\%$ accuracy	Keysight E9304A or N8482A
Power Splitter	outputs differ by < 0.20 dB	Keysight 11667A
Cable	Type N (m) 24 inch	Keysight 11500B
Adapter	Type N (m) to BNC (m)	Keysight 1250-0082 or Pomona 3288 with Pomona 3533

- 1 Connect the equipment (see [Figure 7](#)).
 - a Use the N cable to connect the signal generator to the input of the power splitter input.
 - b Connect the power sensor to one output of the power splitter.
 - c Use an N-to-BNC adapter to connect the other splitter output to the channel 1 input.

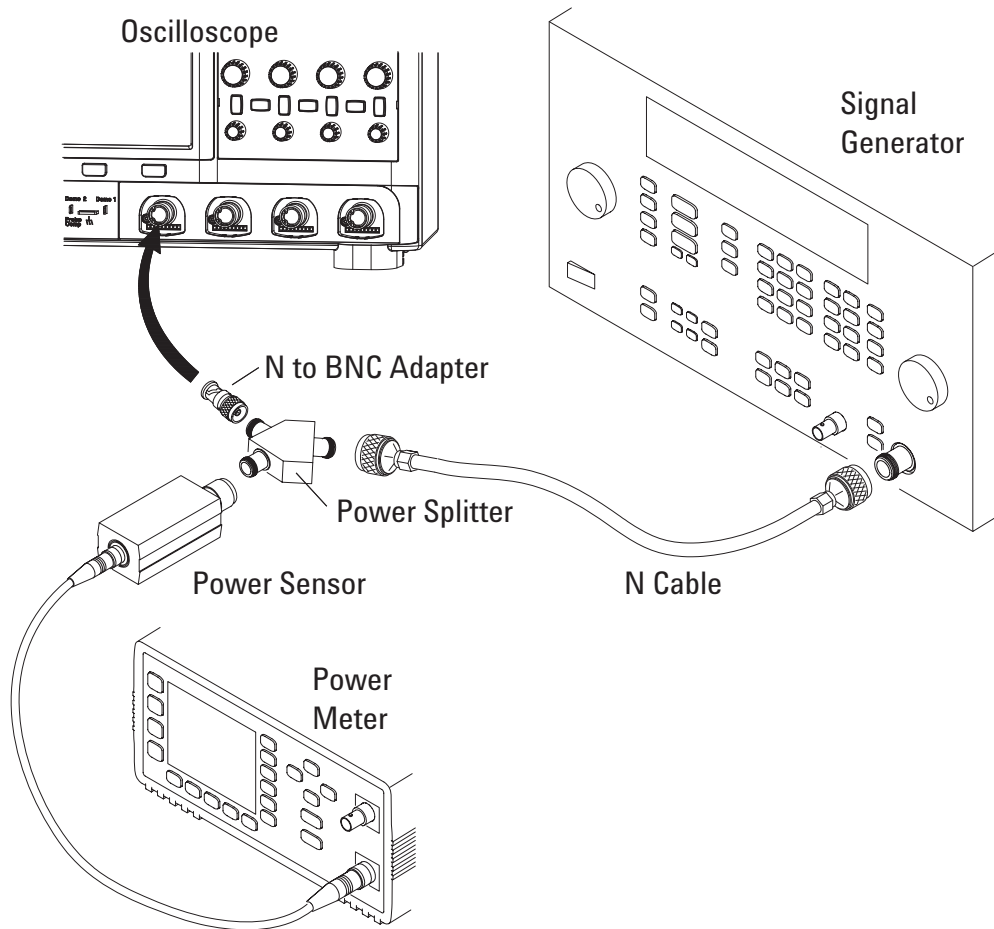

Figure 7 Setting Up Equipment for Bandwidth (-3 dB) Verification Test

2 Set up the power meter.

Set the power meter to display measurements in units of watts.

- 3 Set up the oscilloscope.
 - a Press the **[Default Setup]** key.
 - b Set channel 1 **Coupling** to **DC**.
 - c Set channel 1 **Imped** to **50 Ohm**.
 - d Set the time base to 500 ns/div.
 - e Set the Volts/Div for channel 1 to 100 mV/div.
 - f Press the **[Trigger]** key, then press the **Source** softkey.
 - g Turn the Entry knob to select **External**.

NOTE

This will measure the AC RMS of the input signal without having the oscilloscope trigger.

- 4 Set the signal generator for 1 MHz and six divisions of amplitude.
The signal on the oscilloscope screen should be about five cycles at six divisions amplitude.
- 5 Set up the Amplitude measurement
 - a Press the **[Meas]** key.
 - b Press the **Clear Meas** softkey and then the **Clear All** softkey.
 - c Press the **Type:** softkey and use the Entry knob to select **AC RMS - Full Screen (Std Deviation)** within the select menu.
 - d Press the **Add Measurement** softkey.
- 6 Note the oscilloscope AC RMS - FS(1) reading at the bottom of the screen. (This is the RMS value with any dc offset removed.)
- 7 Set the power meter Cal Factor % to the 1 MHz value on the calibration chart on the power sensor.
- 8 Note the reading on the power meter and covert to Vrms using the expression:

$$V_{in\ 1MHz} = \sqrt{P_{meas\ 1MHz} \times 50\Omega}$$

For example, if the power meter reading is 892 uW, then $V_{in\ 1MHz} = (892 \times 10^{-6} * 50\Omega)^{1/2} = 211.2\ mV_{rms}$.

- 9** Change the signal generator output frequency according to the maximum frequency for the oscilloscope using the following:
- 6 GHz Models: 6 GHz
 - 4 GHz Models: 4 GHz
 - 2.5 GHz Models: 2.5 GHz
 - 1 GHz Models: 1 GHz
- 10** Referencing the frequency from step 9, set the power meter Cal Factor % to the frequency value on the calibration chart on the power sensor.
- 11** Set the oscilloscope sweep speed according to the following:
- 6 GHz Models: 100 ps/div
 - 4 GHz Models: 100 ps/div
 - 2.5 GHz Models: 100 ps/div
 - 1 GHz Models: 500 ps/div
- 12** Note the oscilloscope AC RMS - FS(1) reading at the bottom of the screen.
- 13** Note the reading on the power meter and convert to V_{rms} using the expression:

$$V_{in_{maxfreq}} = \sqrt{P_{meas_{maxfreq}} \times 50\Omega}$$

- 14** Calculate the response using the expression:

$$\text{response(dB)} = 20 \log_{10} \left[\frac{V_{out_{min\ freq}}/V_{in_{min\ freq}}}{V_{out_{1MHz}}/V_{in_{1MHz}}} \right]$$

Example

If:

$$P_{meas_{1\ MHz}} = 892 \text{ uW}$$

$$\text{AC RMS - FS}(n)_{1\ MHz} = 210.4 \text{ mV}$$

$$P_{meas_{max\ freq}} = 687 \text{ uW}$$

$$\text{AC RMS - FS}(n)_{max\ freq} = 161.6 \text{ mV}$$

Then after converting the values from the power meter to V_{rms} :

$$\text{response(dB)} = 20 \log_{10} \left[\frac{161.6 \text{ mV}/185.3 \text{ mV}}{210.4 \text{ mV}/211.2 \text{ mV}} \right] = -1.16 \text{ dB}$$

- 15** The result from step 14 should be within -3.0 dB. Record the result in the Performance Test Record (see [page 52](#)).

2 Testing Performance

- 16** Move the power splitter from the channel 1 to the channel 2 input.
- 17** Turn off the current channel and turn on the next channel using the channel keys.
- 18** Repeat steps 3 through 17 for the remaining channels, setting the parameters of the channel being tested where appropriate.

To verify time base accuracy

This test verifies the accuracy of the time base. In this test you will measure the absolute error of the time base oscillator and compare the results to the specification.

Table 13 Equipment Required to Verify Time Base Accuracy

Equipment	Critical Specifications	Recommended Model/Part
Signal Generator	100 kHz - 6 GHz, 0.01 Hz frequency resolution, jitter: < 2ps	Keysight N5171B with 6 GHz option
50 Ω BNC Cable	BNC - BNC, 48" length	Keysight 8120-1840

- 1 Set up the signal generator.
 - a Set the output to 10 MHz, approximately 1 V_{pp} sine wave.
- 2 Connect the output of the signal generator to oscilloscope channel 1 using the BNC cable.
- 3 Set up the oscilloscope:
 - a Press **[Auto Scale]**.
 - b Set the oscilloscope Channel 1 vertical sensitivity to 200 mv/div.
 - c Set the oscilloscope horizontal sweep speed control to 5 ns/div.
 - d Adjust the intensity to get a sharp, clear trace.
 - e Turn off Jitter-Free Trigger: press **[Utility] > Options > Preferences > Jitter-Free Trigger**.
 - f Adjust the oscilloscope's trigger level so that the rising edge of the waveform at the center of the screen is located where the center horizontal and vertical grid lines cross (center screen).
 - g Ensure the horizontal position control is set to 0.0 seconds.

- 4 Make the measurement.
 - a Set oscilloscope horizontal sweep speed control to 2 ms/div.
 - b Set horizontal position control to +10 ms.
 - c Set the oscilloscope horizontal sweep speed control to 5 ns/div or 10 ns/div.
 - d Measure the number of nanoseconds from where the rising edge crosses the center horizontal grid line to the center vertical grid line. Each ns equals 0.1 ppm of time base error.

Time base accuracy limit: ± 1.6 ppm + aging

Aging factors:

- 1 year: ± 0.5 ppm
- 2 years: ± 0.7 ppm
- 5 years: ± 1.5 ppm
- 10 years: ± 2.0 ppm

Use the date code on the oscilloscope's serial tag to calculate the number of years since manufacture.

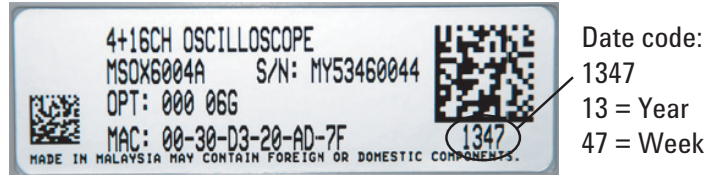

- e In the Performance Test Record (see [page 52](#)), record the time base error in ppm and whether it is within the specified limit.

To verify trigger sensitivity

This test verifies the trigger sensitivity. In this test, you will apply a sine wave to the oscilloscope at the upper bandwidth limit. You will then decrease the amplitude of the signal to the specified levels, and check to see if the oscilloscope is still triggered.

Table 14 Internal Trigger Sensitivity Test Limits

BW Models	V/div	Frequency	Sensitivity
1 GHz	< 10 mV/div	All	greater of 1 div or 5 mV _{pp}
	>= 10 mV/div	All	0.6 div
2.5 GHz, 4 GHz, and 6 GHz	< 10 mV/div	DC to 2 GHz	greater of 1 div or 5 mV _{pp}
		2 GHz to 3.5 GHz	greater of 1.5 div or 5 mV _{pp}
	>= 10 mV/div	DC to 2 GHz	0.6 div
		2 GHz to 3.5 GHz	1.0 div

Table 15 External Trigger Sensitivity Test Limits, All Models

Input Range	Frequency	Sensitivity
1.6 V	DC to 100 MHz	40 mV _{pp}
	100 MHz to 200 MHz	70 mV _{pp}
8 V	DC to 100 MHz	200 mV _{pp}
	100 MHz to 200 MHz	350 mV _{pp}

Table 16 Equipment Required to Verify Trigger Sensitivity

Equipment	Critical Specifications	Recommended Model/Part
Signal Generator	100 kHz to 6 GHz sine waves	Keysight N5171B with 6 GHz option
Power splitter	Outputs differ < 0.20 dB	Keysight 11667A
Power Meter	6 GHz \pm 3% accuracy	Keysight N1914A
Power Sensor	6 GHz \pm 3% accuracy	Keysight E9304A or N8482A
Cable	Type N (m) 24 inch	Keysight 11500B
Adapter	Type N (m) to BNC (m)	Keysight 1250-0082 or Pomona 3288 with Pomona 3533
50 Ohm Feedthrough Termination	50 Ω BNC (f) to BNC (m)	Keysight 0960-0301

Test Internal Trigger Sensitivity

- 1 On the oscilloscope, press the **[Default Setup]** key.
- 2 Press the **[Mode/Coupling]** key; then, press the **Mode** softkey to select **Normal**.

- 3 Connect the equipment (see **Figure 8**).
 - a Connect the signal generator output to the oscilloscope channel 1 input.

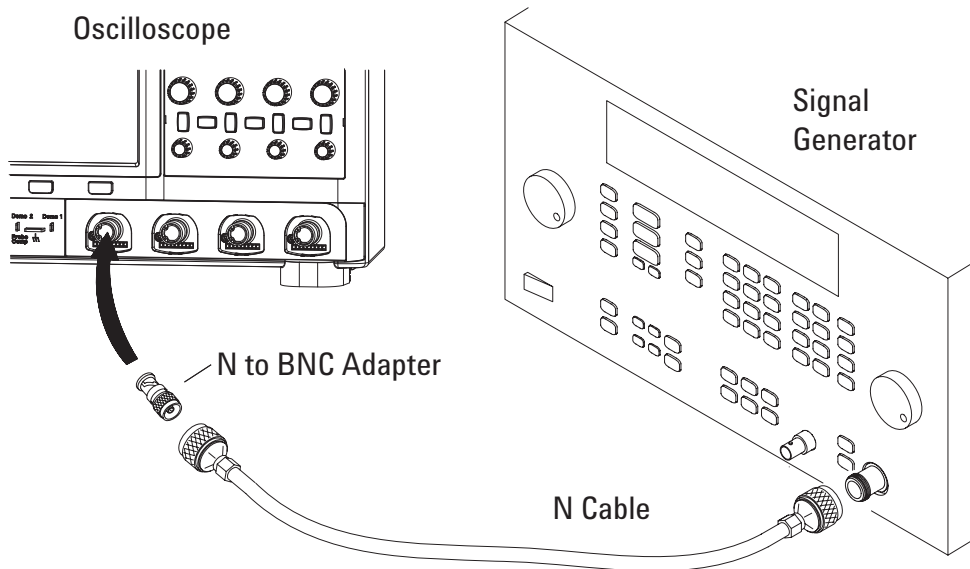

Figure 8 Setting Up Equipment for Internal Trigger Sensitivity Test

- b Set channel 1 **Impedance** to **50 Ohm**.

- 4 To verify the trigger sensitivity, for each of the settings listed in the following table for your oscilloscope model, follow these steps:

Oscilloscope BW Model	Signal Generator Frequency	Signal Generator Amplitude	Oscilloscope V/div	Vertical Division of Signal
1 GHz	1 GHz	10 mV _{pp}	5 mV/div	1 vertical division (about 5 mV _{pp})
	1 GHz	20 mV _{pp}	10 mV/div	0.6 vertical division (about 6 mV _{pp})
2.5 GHz, 4 GHz, and 6 GHz	2 GHz	10 mV _{pp}	5 mV/div	1 vertical division (about 5 mV _{pp})
	2 GHz	20 mV _{pp}	10 mV/div	0.6 vertical divisions (about 6 mV _{pp})
	3.5 GHz	10 mV _{pp}	5 mV/div	1.5 vertical division (about 7.5 mV _{pp})
	3.5 GHz	20 mV _{pp}	10 mV/div	1 vertical division (about 10 mV _{pp})

- a Set the **Signal Generator Frequency**.
- b Set the **Signal Generator Amplitude**.
- c Press the **[Auto Scale]** key.
- d Press **[Acquire] > Acq Mode** and select **Averaging**. Press **# Avgs** and set the value to **64**.
- e Set the time base to 10 ns/div.
- f Set channel 1 to **Oscilloscope V/div**.
- g Decrease the amplitude from the signal generator until **Vertical Division of Signal** is displayed.

The trigger is stable when the displayed waveform is stable. If the trigger is not stable, try adjusting the trigger level. If adjusting the trigger level makes the trigger stable, the test still passes. If adjusting the trigger does not help, change the trigger edge to trigger on falling edge, try adjusting the trigger level again. If trigger on falling edge makes the trigger stable, the test still passes. If changing to falling edge trigger does not help, see the “Troubleshooting” chapter. Then return here.

- h Record the result as Pass or Fail in the Performance Test Record (see [page 52](#)).
- i Repeat this step for the remaining oscilloscope channels.

Test External Trigger Sensitivity (all models)

This test applies to all models.

Verify the external trigger sensitivity at these settings:

Table 17 External Trigger Sensitivity Test Settings

Input Range	100 MHz	200 Mhz
1.6 V	40 mV _{pp}	70 mV _{pp}
8 V	200 mV _{pp}	350 mV _{pp}

- 1 Connect the equipment (see **Figure 9**).
 - a Use the N cable to connect the signal generator to the power splitter input.
 - b Connect one output of the power splitter to the Aux Trig input through a 50Ω feedthrough termination.
 - c Connect the power sensor to the other output of the power splitter.

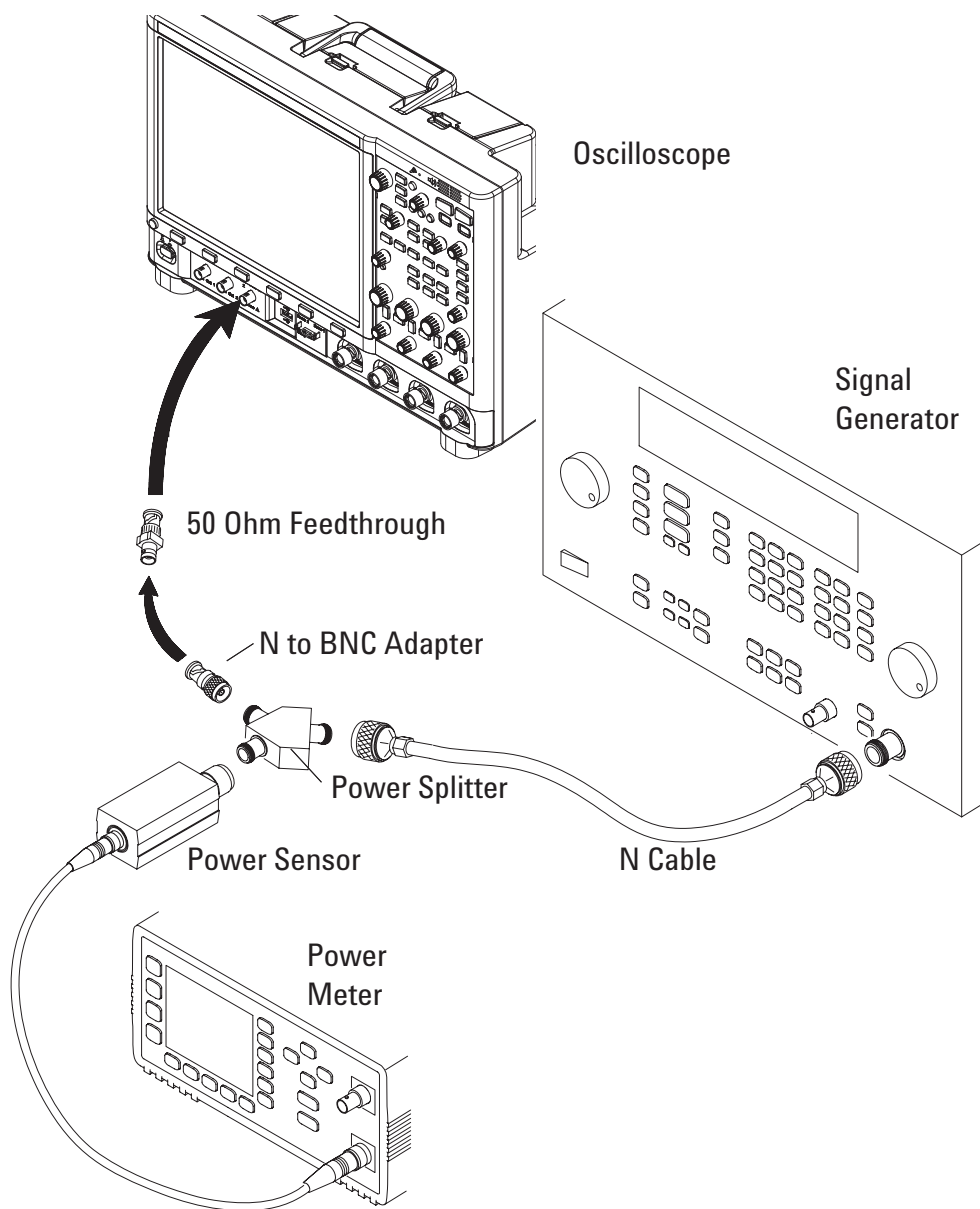

Figure 9 Setting Up Equipment for 4-Channel External Trigger Sensitivity Test

- 2 Set up the oscilloscope.
 - a Press the **[Default Setup]** key.
 - b Press the **[Mode/Coupling]** key; then, press the **Mode** softkey to select **Normal**.
- 3 Change the signal generator output frequency to 100 MHz or 200 MHz.
- 4 Set the power meter Cal Factor % to the appropriate value (100 MHz or 200 MHz) on the calibration chart on the power sensor. If necessary, do a linear interpolation if a 100 MHz or 200 MHz factor is not included in the power meter's calibration chart.
- 5 Adjust the signal generator output for reading on the power meter of:

Signal Generator Frequency	Calculation	Power Meter Reading
100 MHz	$40 \text{ mV}_{pp} = 14.14 \text{ mV rms}$, Power = $V_{in}^2/50\Omega = 14.14 \text{ mV}^2/50\Omega$	4 μW
200 MHz	$70 \text{ mV}_{pp} = 24.75 \text{ mV rms}$, Power = $V_{in}^2/50\Omega = 24.75 \text{ mV}^2/50\Omega$	12.25 μW
100 MHz	$200 \text{ mV}_{pp} = 70.71 \text{ mV rms}$, Power = $V_{in}^2/50\Omega = 70.71 \text{ mV}^2/50\Omega$	100 μW
200 MHz	$350 \text{ mV}_{pp} = 123.74 \text{ mV rms}$, Power = $V_{in}^2/50\Omega = 123.74 \text{ mV}^2/50\Omega$	306 μW

- 6 Press the **[Trigger]** key, then press the **Source** softkey to set the trigger source to **External**.
- 7 Check for stable triggering and adjust the trigger level if necessary. Triggering is indicated by the **Trig'd** indicator at the top of the display. When **Trig'd?** is displayed, the oscilloscope is not triggered. When **Trig'd** is displayed (no question mark), the oscilloscope is triggered.
- 8 Record the results as Pass or Fail in the Performance Test Record (see [page 52](#)).

If the test fails, see the “Troubleshooting” chapter. Then return here.

Keysight 6000 X-Series Oscilloscopes Performance Test Record

Serial No. _____		Test by _____	
Test Interval _____		Work Order No. _____	
Recommended Next Testing _____		Temperature _____	

Threshold	Specification	Limits	Ch D7-D0	Ch D15-D8
Accuracy Test	5 V - 250 mV	4.750 V	_____	_____
(100 mV + 3% of threshold setting)	5 V + 250 mV	5.250 V	_____	_____
	-5 V - 250 mV	-5.250 V	_____	_____
	-5 V + 250 mV	-4.750 V	_____	_____
	0 V - 100 mV	-100 mV	_____	_____
	0 V + 100 mV	100 mV	_____	_____

DC Vertical Gain Accuracy			Channel 1	Channel 2	Channel 3*	Channel 4*
Range	Power Supply Setting	Test Limits				
5 V/Div	35 V	34 V to 36 V	_____	_____	_____	_____
2 V/Div	14 V	13.6 V to 14.4 V	_____	_____	_____	_____
1 V/Div	7 V	6.8 V to 7.2 V	_____	_____	_____	_____
500 mV/Div	3.5 V	3.4 V to 3.6 V	_____	_____	_____	_____
200 mV/Div	1.4 V	1.36 V to 1.44 V	_____	_____	_____	_____
100 mV/Div	700 mV	680 mV to 720 mV	_____	_____	_____	_____
50 mV/Div	350 mV	340 mV to 360 mV	_____	_____	_____	_____
20 mV/Div	140 mV	136 mV to 144 mV	_____	_____	_____	_____
10 mV/Div	70 mV	68 mV to 72 mV	_____	_____	_____	_____
5 mV/Div	35 mV	34 mV to 36 mV	_____	_____	_____	_____
2 mV/Div	14 mV	13.6 mV to 14.4 mV	_____	_____	_____	_____
1 mV/Div	7 mV	6.6 mV to 7.4 mV	_____	_____	_____	_____

Continued on next page.

Dual Cursor Accuracy						
Range	Power Supply Setting	Test Limits	Channel 1	Channel 2	Channel 3*	Channel 4*
5 V/Div	35 V	33.832 V to 36.168 V	_____	_____	_____	_____
2 V/Div	14 V	13.533 V to 14.467 V	_____	_____	_____	_____
1 V/Div	7 V	6.766 V to 7.234 V	_____	_____	_____	_____
500 mV/Div	3.5 V	3.383 V to 3.617 V	_____	_____	_____	_____
200 mV/Div	1.4 V	1.353 V to 1.447 V	_____	_____	_____	_____
100 mV/Div	700 mV	676.64 mV to 723.36 mV	_____	_____	_____	_____
50 mV/Div	350 mV	338.32 mV to 361.68 mV	_____	_____	_____	_____
20 mV/Div	140 mV	135.33 mV to 144.67 mV	_____	_____	_____	_____
10 mV/Div	70 mV	67.66 mV to 72.34 mV	_____	_____	_____	_____
5 mV/Div	35 mV	33.83 mV to 36.17 mV	_____	_____	_____	_____
2 mV/Div	14 mV	13.53 mV to 14.47 mV	_____	_____	_____	_____
1 mV/Div	7 mV	6.533 mV to 7.467 mV	_____	_____	_____	_____
Bandwidth (-3 dB)	Model BW Option	Test Limits	Channel 1	Channel 2	Channel 3*	Channel 4*
	BW600	-3 dB at 6 GHz	_____	_____	_____	_____
	BW400	-3 dB at 4 GHz	_____	_____	_____	_____
	BW250	-3 dB at 2.5 GHz	_____	_____	_____	_____
	(none)	-3 dB at 1 GHz	_____	_____	_____	_____
Time Base Accuracy	Limits		Measured time base error (ppm)	Pass/Fail		
	Time Base Accuracy Limit: ± 1.6 ppm + aging		_____	_____		

Continued on next page.

Internal Trigger Sensitivity						
	Generator Setting	Test Limits	Channel 1	Channel 2	Channel 3*	Channel 4*
6 GHz models, 4 GHz models, 2.5 GHz models:	3.5 GHz	< 10 mV/div: greater of 1.5 div or 5 mVpp >= 10 mV/div: 1 div	_____	_____	_____	_____
	2 GHz	< 10 mV/div: greater of 1 div or 5 mVpp >= 10 mV/div: 0.6 div	_____	_____	_____	_____
1 GHz models:	1 GHz	< 10 mV/div: greater of 1 div or 5 mVpp >= 10 mV/div: 0.6 div	_____	_____	_____	_____
External Trigger Sensitivity						
Input Range: 8 V	Generator Setting	Test Limits	Ext Trig In			
	200 MHz	350 mV	_____			
	100 MHz	200 mV	_____			
Input Range: 1.6 V	Generator Setting	Test Limits	Ext Trig In			
	200 MHz	70 mV	_____			
	100 MHz	40 mV	_____			
* Where applicable						

3 Calibrating and Adjusting

This chapter explains how to adjust the oscilloscope for optimum operating performance. You should perform self-calibration according to the following recommendations:

- Every two years or after 4000 hours of operation
- If the ambient temperature is >10 °C from the calibration temperature
- If you want to maximize the measurement accuracy

The amount of use, environmental conditions, and experience with other instruments help determine if you need shorter adjustment intervals.

Let the Equipment Warm Up Before Adjusting

Before you start the adjustments, let the oscilloscope and test equipment warm up for at least 30 minutes.

Read All Cautions and Warnings

Read the following cautions and warning before making adjustments or performing self-calibration.

WARNING

HAZARDOUS VOLTAGES!

Read the safety notice at the front of this book before proceeding.

Maintenance is performed with power supplied to the oscilloscope and with the protective covers removed. Only trained service personnel who are aware of the hazards involved should perform the maintenance. Whenever possible, perform the procedures with the power cord removed from the oscilloscope.

CAUTION

REMOVE POWER TO AVOID DAMAGE!

Do not disconnect any cables or remove any assemblies with power applied to the oscilloscope. Otherwise, damage to the oscilloscope can occur.

CAUTION

USE EXTERNAL FAN TO REDUCE TEMPERATURE!

When you must operate the oscilloscope with its cover and main shield removed, use an external fan to provide continuous air flow over the samplers (the ICs with heat sinks on them). Air flow over the samplers is reduced when the cover and main shield is removed, which leads to higher than normal operating temperatures. Have the fan blow air across the acquisition board where the heat sinks are located. If the cover is removed but the main shield remains installed and the bottom holes are not blocked, the instrument will cool properly.

CAUTION

AVOID DAMAGE TO ELECTRONIC COMPONENTS!

Electrostatic discharge (ESD) can damage electronic components. When you use any of the procedures in this chapter, use proper ESD precautions. As a minimum, place the oscilloscope on a properly grounded ESD mat and wear a properly grounded ESD strap.

User Calibration

Perform user-calibration:

- Every two years or after 4000 hours of operation.
- If the ambient temperature is $>10^{\circ}\text{C}$ from the calibration temperature.
- If you want to maximize the measurement accuracy.

The amount of use, environmental conditions, and experience with other instruments help determine if you need shorter User Calibration intervals.

User Calibration performs an internal self-alignment routine to optimize the signal path in the oscilloscope. The routine uses internally generated signals to optimize circuits that affect channel sensitivity, offset, and trigger parameters. Disconnect all inputs and allow the oscilloscope to warm up before performing this procedure.

Performing User Calibration will invalidate your Certificate of Calibration. If NIST (National Institute of Standards and Technology) traceability is required perform the procedures in **Chapter 2** in this book using traceable sources.

To perform User Calibration

The user calibration procedure requires the included calibration BNC cable (54609-61609).

To perform user calibration:

- 1** Disconnect all inputs from the front and rear panels, including the digital channels cable on an MSO, and allow the oscilloscope to warm up 30 minutes before performing this procedure.
- 2** Press the rear-panel CAL button to disable calibration protection.
- 3** Press the **[Utility]** key; then, press the **Service** softkey.
- 4** Press the **Start User Calibration** softkey.

User Calibration Status

Pressing the **User Calibration Status** softkey displays the following summary results of the previous User Calibration, and the status of probe calibrations for probes that can be calibrated. Note that AutoProbes do not need to be calibrated, but InfiniiMax probes can be calibrated.

3 Calibrating and Adjusting

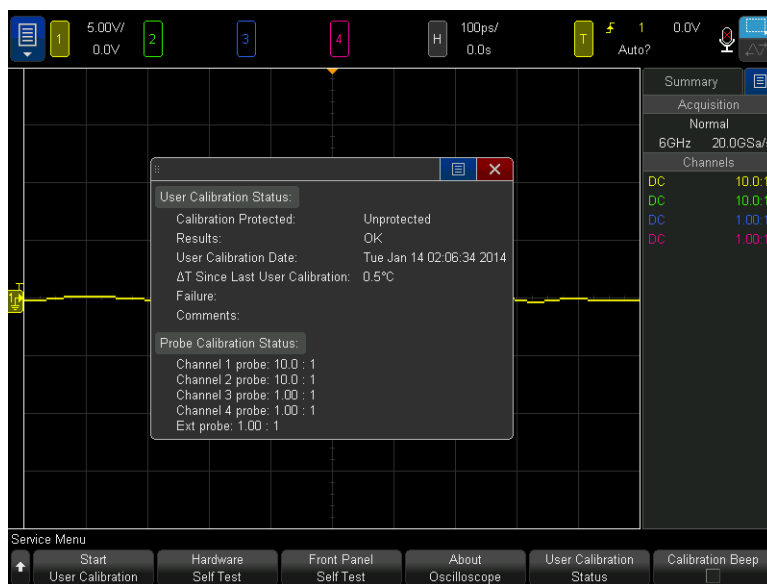

4 Troubleshooting

Solving General Problems with the Oscilloscope / 60

Verifying Basic Operation / 63

Troubleshooting Internal Assemblies / 69

Read All Cautions and Warnings

Before you begin any troubleshooting, read all Warning and Cautions in the “Troubleshooting” section.

This chapter begins with **“Solving General Problems with the Oscilloscope”**. It tells you what to do in these cases:

- **If there is no display.**
- **If there is no trace display.**
- **If the trace display is unusual or unexpected.**
- **If you cannot see a channel.**

Next, this chapter describes procedures for **“Verifying Basic Operation”** of the oscilloscope:

- **To power-on the oscilloscope.**
- **To perform hardware self test.**
- **To perform front panel self test.**
- **To verify default setup.**
- **To perform an Auto Scale on the Probe Comp signal.**
- **To compensate passive probes.**

Finally, this chapter describes procedures for **“Troubleshooting Internal Assemblies”** when performing assembly-level repair:

- **To prepare for internal assembly troubleshooting.**

- To check the line filter AC output.
- To check the power supply DC output.
- To check the fan power supply.
- To check power to the acquisition board.
- To check power to the front panel (AutoProbe) interfaces.

Solving General Problems with the Oscilloscope

This section describes how to solve general problems that you may encounter while using the Keysight 6000 X-Series oscilloscopes.

After troubleshooting the oscilloscope, if you need to replace parts, refer to **Chapter 6**, “Replaceable Parts,” starting on page 117.

If there is no display

- ✓ Check that the power cord is firmly seated in the oscilloscope power receptacle.
- ✓ Check that the power source is live.
- ✓ Check that the front-panel power switch is on.
- ✓ If there is still no display, go to the troubleshooting procedures in this chapter.

If there is no trace display

- ✓ Check that the Intensity (on the front panel) is adjusted correctly.
- ✓ Recall the default setup by pressing **[Default Setup]**. This will ensure that the trigger mode is Auto.
- ✓ Check that the probe clips are securely connected to points in the circuit under test, and that the ground is connected.
- ✓ Check that the circuit under test is powered on.
- ✓ Press the **[Auto Scale]** key.
- ✓ Obtain service from Keysight Technologies, if necessary.

If the trace display is unusual or unexpected

- ✓ Check that the Horizontal time/division setting is correct for the expected frequency range of the input signals.
- ✓ The sampling speed of the oscilloscope depends on the time/division setting. It may be that when time/division is set to slower speeds, the oscilloscope is sampling too slowly to capture all of the transitions on the waveform. Use peak detect mode.
- ✓ Check that all oscilloscope probes are connected to the correct signals in the circuit under test.
- ✓ Ensure that the probe's ground lead is securely connected to a ground point in the circuit under test. For high-speed measurements, each probe's individual ground lead should also be connected to a ground point closest to the signal point in the circuit under test.
- ✓ Check that the trigger setup is correct.
- ✓ A correct trigger setup is the most important factor in helping you capture the data you desire. See the *User's Guide* for information about triggering.
- ✓ Check that persistence in the Display menu is turned off, then press the **Clear Display** softkey.
- ✓ Press the **[Auto Scale]** key.

If you cannot see a channel

- ✓ Recall the default setup by pressing **[Default Setup]**. This will ensure that the trigger mode is Auto.
- ✓ Check that the oscilloscope probe's BNC connector is securely attached to the oscilloscope's input connector.
- ✓ Check that the probe clips are securely connected to points in the circuit under test.
- ✓ Check that the circuit under test is powered on.

You may have pressed the **[Auto Scale]** key before an input signal was available.

Performing the checks listed here ensures that the signals from the circuit under test will be seen by the oscilloscope. Perform the remaining checks in this topic to make sure the oscilloscope channels are on, and to obtain an automatic setup.

- ✓ Check that the desired oscilloscope channels are turned on.
 - a** Press the analog channel key until it is illuminated.
 - b** On models with the MSO option, press the digital channels **[Digital]** key until it is illuminated.
- ✓ Press the **[Auto Scale]** key to automatically set up all channels.

Verifying Basic Operation

To power-on the oscilloscope

- 1 Connect the power cord to the rear of the oscilloscope, then to a suitable ac voltage source.

The oscilloscope power supply automatically adjusts for input line voltages in the range of 100 to 240 VAC. Ensure that you have the correct line cord (see [page 117](#)). The power cord provided is matched to the country of origin.

WARNING

AVOID INJURY.

Always operate the oscilloscope with an approved three conductor power cable. Do not negate the protective action of the three conductor power cable.

- Press the power switch.
 - When the oscilloscope is turned on, the front panel LEDs will briefly light up in groups from bottom to top.
 - Next the Keysight logo appears on the display.
 - It will take a minute for the oscilloscope to go through its basic self test and power-up routine.
- 2 Proceed to **"To perform hardware self test"** on page 64.

To perform hardware self test

Pressing **[Utility] > Service > Hardware Self Test** performs a series of internal procedures to verify that the oscilloscope is operating properly.

It is recommended you run Hardware Self Test:

- After experiencing abnormal operation.
- For additional information to better describe an oscilloscope failure.
- To verify proper operation after the oscilloscope has been repaired.

Successfully passing Hardware Self Test does not guarantee 100% of the oscilloscope's functionality. Hardware Self Test is designed to provide an 80% confidence level that the oscilloscope is operating properly.

To perform front panel self test

Pressing **[Utility] > Service > Front Panel Self Test** lets you test the front panel keys and knobs as well as the oscilloscope display.

Follow the on-screen instructions.

Failures in the front panel self test indicate problems with the keyboard, LEDs, display, touchscreen, speaker, or microphone.

To verify default setup

The oscilloscope is designed to turn on with the setup from the last turn on or previous setup.

To recall the default setup:

- 1 Press the **[Default Setup]** key.

This returns the oscilloscope to its default settings and places the oscilloscope in a known operating condition. The major default settings are:

- **Horizontal:**
 - main mode.
 - 100 us/div scale.
 - 0 s delay.
 - center time reference.
- **Vertical:**

- Channel 1 on.
- 5 V/div scale.
- dc coupling.
- 0 V position.
- probe factor to 1.0 if an AutoProbe probe is not connected to the channel.
- **Trigger:**
 - Edge trigger.
 - Auto sweep mode.
 - 0 V level.
 - channel 1 source.
 - dc coupling.
 - rising edge slope.
 - 40 ns holdoff time.
- **Display:**
 - 20% grid intensity.
 - persistence off.
- **Other:**
 - Acquire mode normal.
 - Run/Stop to Run.
 - cursor measurements off.

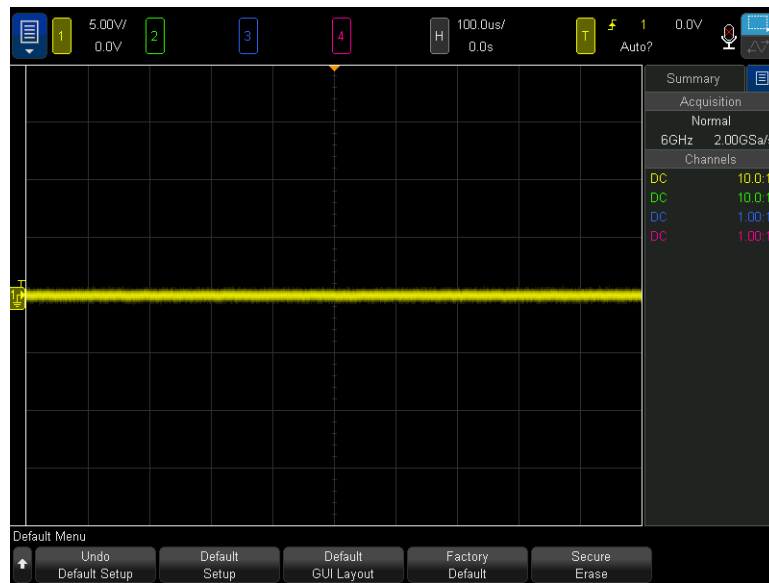

Figure 10 Default setup screen

- 2 If your screen looks substantially different, replace the acquisition board.

To perform an Auto Scale on the Probe Comp signal

- 1 Press the **[Default Setup]** key. The oscilloscope is now configured to its default settings.
- 2 Connect an oscilloscope probe from channel 1 to the **Probe Comp** signal terminal on the front panel.
- 3 Connect the probe's ground lead to the ground terminal that is next to the **Demo 2** (Probe Comp) terminal.
- 4 Press **[Auto Scale]**.

5 You should see a waveform on the oscilloscope's display similar to this:

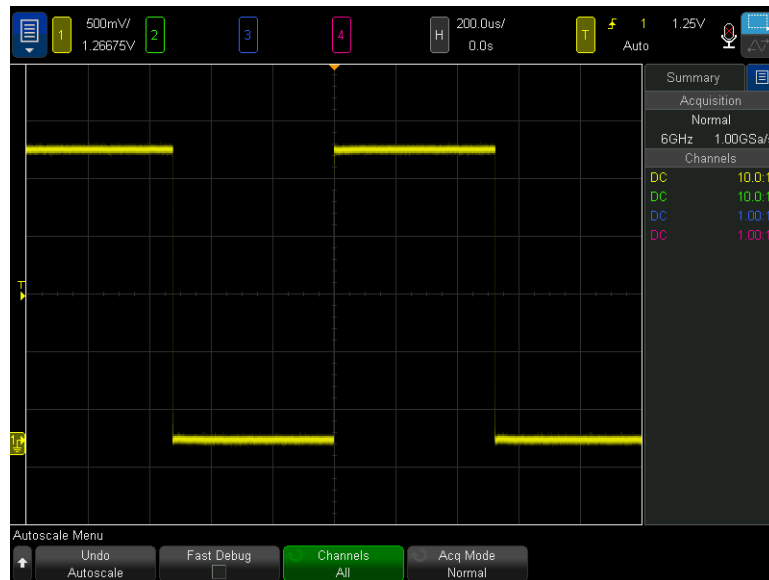

If you see the waveform, but the square wave is not shaped correctly as shown above, perform the procedure **“To compensate passive probes”** on page 67.

If you do not see the waveform, ensure your power source is adequate, the oscilloscope is properly powered-on, and the probe is connected securely to the front-panel analog channel input BNC and to the Demo 2 (Probe Comp) terminal.

6 If you still do not see the waveform, use the troubleshooting flowchart in this chapter to isolate the problem.

To compensate passive probes

You should compensate your passive probes to match their characteristics to the oscilloscope's channels. A poorly compensated probe can introduce measurement errors.

- 1 Perform the procedure **“To perform an Auto Scale on the Probe Comp signal”** on page 66
- 2 Press the channel key to which the probe is connected ([1], [2], etc.).

- 3 In the Channel Menu, press **Probe**.
- 4 In the Channel Probe Menu, press **Probe Check**; then, follow the instructions on-screen.

If necessary, use a nonmetallic tool (supplied with the probe) to adjust the trimmer capacitor on the probe for the flattest pulse possible.

On the N2862/63/90 probes, the trimmer capacitor is the yellow adjustment on the probe tip. On other probes, the trimmer capacitor is located on the probe BNC connector.

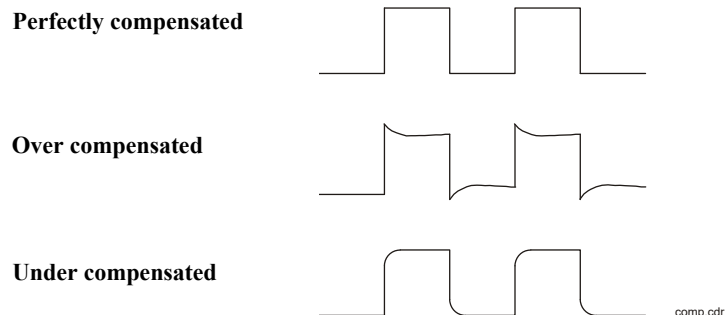

Figure 11 Example pulses

- 5 Connect probes to all other oscilloscope channels (channel 2 of a 2-channel oscilloscope, or channels 2, 3, and 4 of a 4-channel oscilloscope).
- 6 Repeat the procedure for each channel.

The process of compensating the probes serves as a basic test to verify that the oscilloscope is functional.

Troubleshooting Internal Assemblies

The service policy for all bandwidth model oscilloscopes is assembly level replacement. You can use the procedures described in this section to help identify assemblies that need replacement.

Generally, you want to make sure cables to the assembly are good and properly seated. Then, you check that the assembly is supplied with the proper power. If cables are good and the power is good, but the assembly still does not function properly, it must be replaced.

If you need parts or assistance from Keysight Technologies to repair your instrument, go to www.keysight.com and locate the service facility for your area.

Equipment Required for Troubleshooting Internal Assemblies

The equipment listed in this table is required to troubleshoot the oscilloscope.

Table 18 Equipment Required to Troubleshoot the Oscilloscope

Equipment	Critical Specifications	Recommended Model/Part
Digital multimeter	Accuracy $\pm 0.05\%$, 1 mV resolution	Keysight 34401A/34461A
Oscilloscope	Capable of measuring ≥ 500 MHz signal. 1 M Ω input impedance.	Keysight DSO6102A, MSO6102A, DSO7104A/B, or MSO7104A/B

To prepare for internal assembly troubleshooting

WARNING

HAZARDOUS VOLTAGES EXIST – REMOVE POWER FIRST !

The procedures described in this section are performed with power supplied to the oscilloscope and with the protective covers removed. Only trained service personnel who are aware of the hazards involved should perform the procedures. Whenever possible, perform the procedures with the power cord removed from the oscilloscope. Read the safety notice at the back of this book before proceeding.

WARNING



HAZARDOUS VOLTAGES EXIST – HIGH VOLTAGE IS PRESENT ON POWER SUPPLY HEAT SINKS !

The power supply heat sinks of the 6000 X-Series oscilloscopes are at a high potential. This presents an electric shock hazard. Protect yourself from electric shock by keeping this area covered or by not coming in contact with the heat sinks when the power cord is attached to the oscilloscope!

CAUTION

REMOVE POWER TO AVOID DAMAGE !

Do not disconnect any cables or remove any assemblies while power is applied to the oscilloscope, or damage to the oscilloscope can occur.

CAUTION

AVOID ESD DAMAGE TO COMPONENTS !

ELECTROSTATIC DISCHARGE (ESD) can damage electronic components. Use proper ESD precautions when doing any of the procedures in this chapter. As a minimum, place the oscilloscope on a properly grounded ESD mat and wear a properly grounded ESD strap.

- 1 Disconnect any external cables from the front panel.
- 2 Disconnect the power cord.
- 3 Remove the cabinet following the instructions on [page 85](#).
- 4 Remove the power supply shield, the AC input shield, and the probe power shield following the instructions starting on [page 91](#).

CAUTION

MAKE SURE EARTH GROUND IS MAINTAINED FOR THE FRONT DECK !

If separating the front and rear decks (for example, to check the display power supply), connect a cable with alligator clips between the rear deck chassis and the front deck chassis, or connect a BNC cable from one of the BNCs on the acquisition board to a known grounded BNC on your workbench.

Other advice:

- Place the front deck in a cover or rest it on a cloth to prevent scuffing the front panel knobs.
- 5 Make sure all cables are properly connected.

CAUTION

USE AN EXTERNAL FAN TO AVOID OVERHEATING COMPONENTS !

When you remove the oscilloscope cover and main shield, use an external fan to provide continuous air flow over the heat sinks. Air flow over the heat sinks is reduced when the cover and main shield are removed, which leads to higher than normal operating temperatures. Have the fan blow air across the acquisition board where the heat sinks are located. Otherwise, damage to the components can occur. If the cabinet of a 6000 X-Series oscilloscope is removed but the main power supply shield remains installed and the bottom holes are not blocked, the instrument will cool properly.

Flowchart for Internal Assembly Power Troubleshooting

The following flowchart is a simplified overview of troubleshooting power to the oscilloscope's internal assemblies.

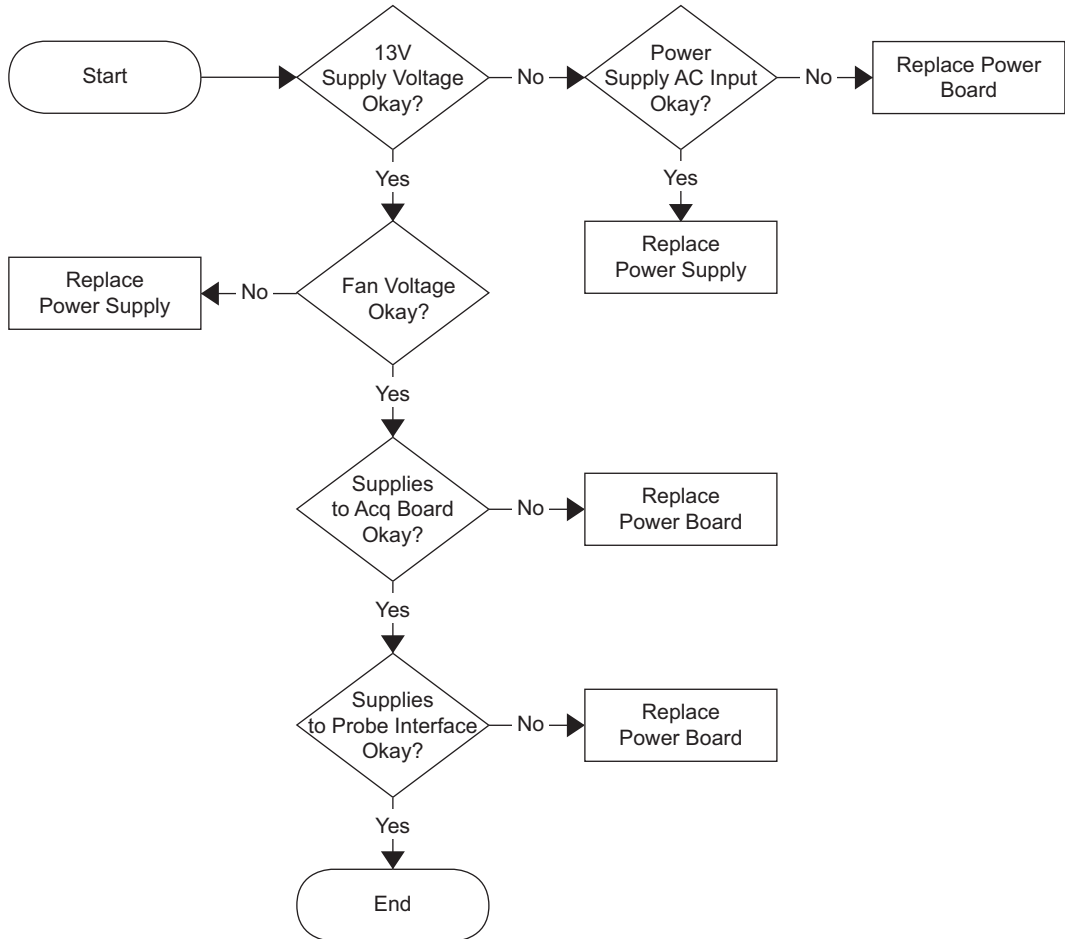

To check the line filter AC output

When the 13 V bulk power is not being properly supplied, this procedure tests the AC input to the power supply to determine whether there is a problem with the line filter.

- 1 Follow the instructions in **“To prepare for internal assembly troubleshooting”** on page 69.
- 2 Connect the power cord, and turn on the oscilloscope.
- 3 Verify that AC power is present on LINE (brown wire) and NEUTRAL (blue wire) at SK1 on the power supply using a DVM and probes as shown in the following picture (remember this is an AC voltage measurement!).



Verify AC potential between these two points

Figure 12 Verify line filter AC output

- If you have AC power equal to what is being applied to J100 (power cord socket) on the line filter, the AC mains portion of the line filter is probably okay.

- If there is no AC power at SK1 of the power supply, there is something wrong with the power switch or AC mains section of the line filter, and you need to *replace the power board*.
- If there is AC power at SK1 of the power supply, but the instrument still will not power ON when the power switch (S100) is in the ON position, go to **"To check the power supply DC output"** on page 73.

To check the power supply DC output

This procedure checks the power supply DC output after verifying the AC input is good.

- 1** Follow the instructions in **"To prepare for internal assembly troubleshooting"** on page 69.
- 2** Connect the negative lead of the multimeter to a ground point on the oscilloscope.
- 3** Connect the power cord, and turn on the oscilloscope.
- 4** Verify there is +13V on power board between power board connector J102 pins 3, 4, or 5 (GND, black wires) and pins 8, 9, or 10 (+13V, red wires).

If +13V is not present:

- a** Turn off the oscilloscope.
- b** Disconnect the power cord.
- c** Verify the continuity of the wires on the cable from the power supply to connector J102.
 - If the cable is good, *replace the power supply*.
 - If the cable is bad, *replace the cable*.

If the voltage measured is out-of-range, *replace the power supply*.

If +13V is present, the power supply is good.



Figure 13 Verify power supply DC output

Table 19 DC output from power supply

Supply	Test Point	Expected Value	If Good	If Bad
VP13V	Connector J102: pins 8, 9, 10 = +13V pins 3, 4, 5 = GND	+13 V \pm 0.2V	Indicates power supply is good.	Indicates power supply is bad or cable from power supply to power board connector J102 is bad.

To check the fan power supply

The +12 V fan power comes from the power supply.

The fan speed is controlled by a circuit on the acquisition board. Signal FAN_PWM_DRIVE comes from the acquisition board and the FAN_TACH signal returns to the acquisition board.

If the fan is not running, it may be defective. First verify the fan power using these steps:

- 1 Follow the instructions in **"To prepare for internal assembly troubleshooting"** on page 69.
- 2 Connect the power cord, and turn on the oscilloscope.
- 3 Measure the fan voltage at the J104 connector on the power board between pin 1 (red wire, VP12V_FAN, also J102 pin 1) and pin 4 (black wire, VP12V_FAN_RTN or fan ground, also J102 pin 2).

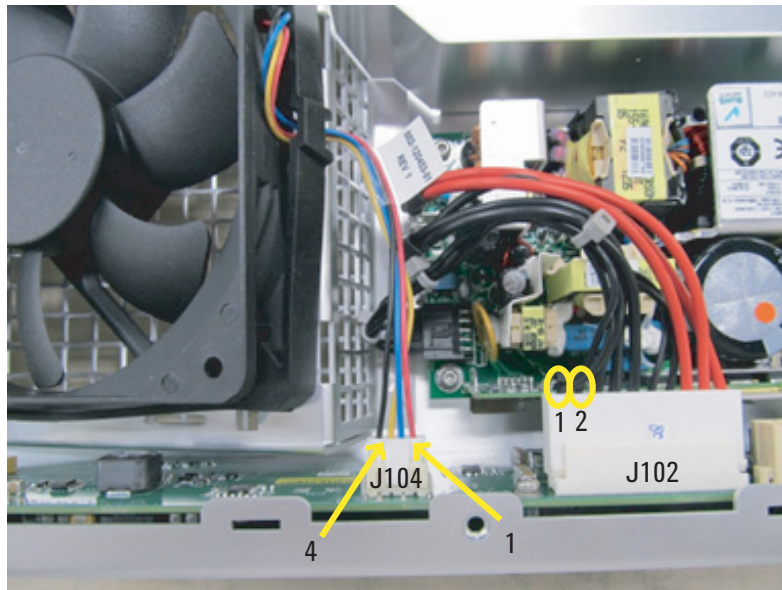

Figure 14 Location of the J104 fan connector

Table 20 Fan power

Supply	Test Point	Expected Value	If Good	If Bad
VP12V_FAN	Connector J104, pin 1 Connector J102, pin 1	+12 V	Indicates power supply is good.	Indicates power supply is bad or cable from power supply to power board connector J102 is bad.
VP12V_FAN_RTN	Connector J104, pin 4 Connector J102, pin 2	0 V		

If +12V is not present:

- a** Turn off the oscilloscope.
- b** Disconnect the power cord.
- c** Verify the continuity of the wires on the cable from the power supply to connector J102.
 - If the cable is good, *replace the power supply*.
 - If the cable is bad, *replace the cable*.

If the voltage measured is out-of-range, *replace the power supply*.

If +12V is present but the fan is not spinning, the problem is either the fan or the FAN_PWM_DRIVE control from the acquisition board.

To check power to the acquisition board

This procedure checks the power supplies from the power board to the acquisition board. Values outside the expected range help identify bad assemblies.

- 1 Follow the instructions in **"To prepare for internal assembly troubleshooting"** on page 69.
- 2 Connect the negative lead of the multimeter to a ground point on the oscilloscope.
- 3 Connect the power cord, and turn on the oscilloscope.
- 4 First check the bulk power supply voltage: **"To check the power supply DC output"** on page 73
- 5 Next, check the supplies from the power board to the acquisition board:

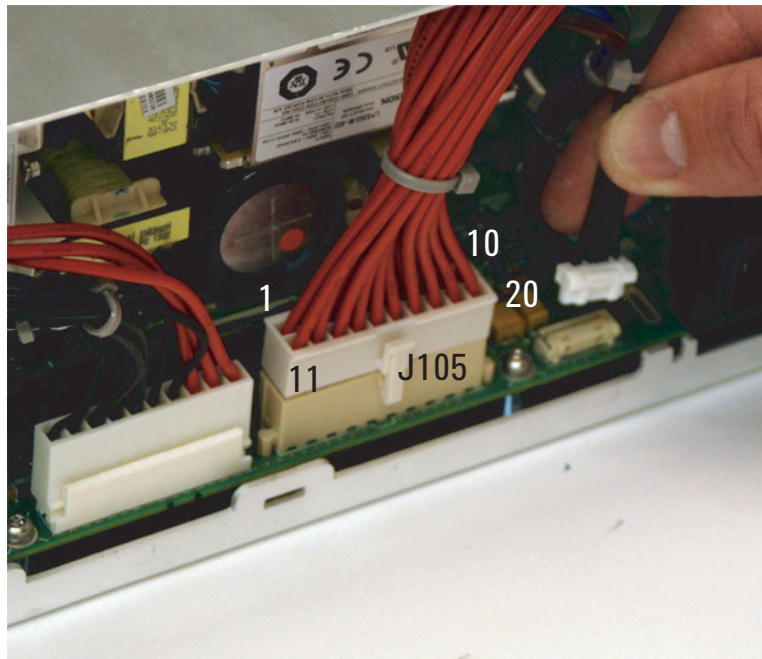

Figure 15 Location of the J105 acquisition board power connector

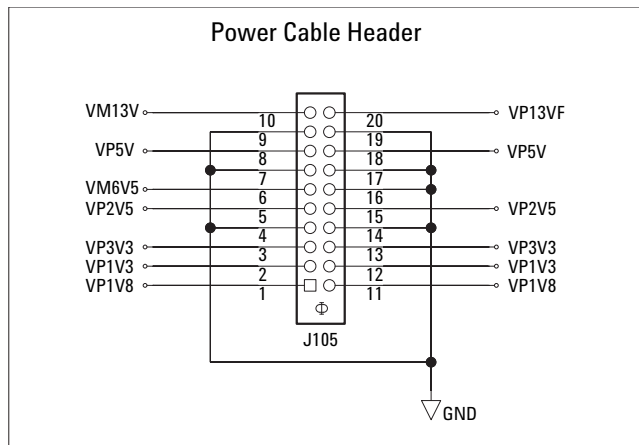

Figure 16 J105 connector pinout

Table 21 Power supplies to acquisition board (from power board J105)

Supply	Test Point	Expected Value	If Good	If Bad
VP13VF	J105, pin 20	+12.9V to +13V, >+12.8 V when loaded by acquisition board, see also "VP13VF" on page 79	Supply is good.	Replace the power board.
VP5V	J105, pin 8 J105, pin 18	+5.051 V \pm 3%	Supply is good.	Replace the power board.
VP3V3	J105, pin 3 J105, pin 13	+3.353 V \pm 3%	Supply is good.	Replace the power board.
VP2V5	J105, pin 5 J105, pin 15	+2.508 V \pm 1.6%	Supply is good.	Replace the power board.
VP1V8	J105, pin 1 J105, pin 11	+1.825 V \pm 2.6%	Supply is good.	Replace the power board.
VP1V3	J105, pin 2 J105, pin 12	+1.3 V \pm 3%	Supply is good.	Replace the power board.
VM13V	J105, pin 10	-13 V \pm 2%	Supply is good.	Replace the power board.
VM6V5	J105, pin 6	-6.5 V \pm 2.2%	Supply is good.	Replace the power board.

VP13VF

VP13VF is a filtered +13V supply that is the source for other supplies on the acquisition board.

When connected to an acquisition board, VP13VF should measure $>+12.8$ V using a DMM.

If VP13VF is less than $<+12$ V, it indicates that there may be abnormal current draw on acquisition board. The suggested troubleshooting steps:

- 1** Turn off the oscilloscope.
- 2** Disconnect the power cord.
- 3** Disconnect cable assembly from the power board's J105 connector.
- 4** Connect the power cord, and turn on the oscilloscope.
- 5** Using a DMM in DC volts mode, measure VP13VF (J105 pin 20).

The DMM should show DC voltage close to 12.9 V to 13 V.

If a significant voltage drop is observed without J105 connected, *replace the power board*.

If the voltage is in the proper range when the cable assembly is disconnected:

- a** Turn off the oscilloscope.
- b** Disconnect the power cord.
- c** Reconnect cable assembly J105.
- d** Check the various supplies on acquisition board that are derived from VP13VF.

To check power to the front panel (AutoProbe) interfaces

This procedure checks the power supplies from the power board to the front panel keyboard (for the AutoProbe interface). Values outside the expected range help identify bad assemblies.

- 1 Follow the instructions in **"To prepare for internal assembly troubleshooting"** on page 69.
- 2 Connect the negative lead of the multimeter to a ground point on the oscilloscope.
- 3 Connect the power cord, and turn on the oscilloscope.
- 4 First check the bulk power supply voltage: **"To check the power supply DC output"** on page 73
- 5 Next, check the supplies from the power board to the front panel AutoProbe interfaces:

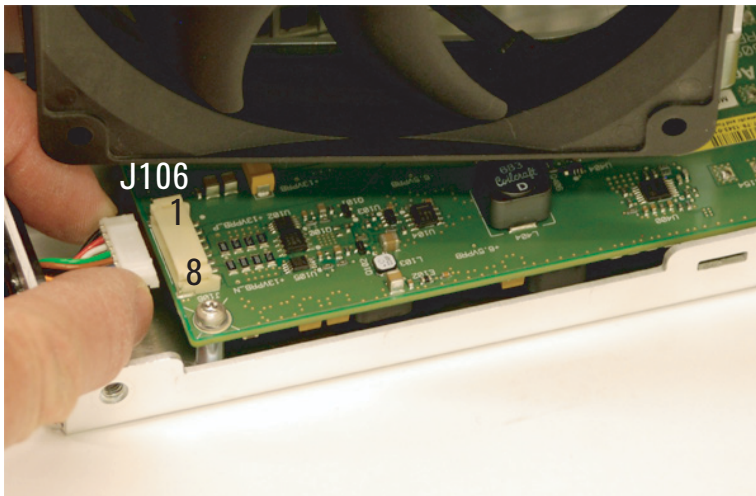

Figure 17 Location of the J106 probe power connector

Table 22 Power supplies to front panel board (AutoProbe power, from power board J106)

Supply	Test Point	Expected Value	If Good	If Bad
VP13VF_PRB	J106, pin 1	+13 V \pm 2%	Supply is good.	Replace the power board.
VM13VF_PRB	J106, pin 2	-13 V \pm 2%	Supply is good.	Replace the power board.
VM6V5_PRB	J106, pin 3	-6.512 \pm 3%	Supply is good.	Replace the power board.
VP6V5_PRB	J106, pin 4	+6.512 \pm 3%	Supply is good.	Replace the power board.

5 Replacing Assemblies

This chapter describes how to remove assemblies from an oscilloscope. To install a replacement assembly after you have removed an old one, follow the instructions in reverse order.

The parts shown in the following figures are representative and may look different from what you have in your oscilloscope.

Instructions for removable assemblies include:

- To remove the cabinet / 85
- To remove the rear deck assembly / 86
- To replace the battery / 94
- To remove the acquisition board / 95
- To remove the front panel knobs / 100
- To remove the front bezel assembly / 101
- To remove the display assembly / 103
- To remove the keyboard and keypad / 105
- To remove the fan assembly / 109
- To remove the power supply shield / 91
- To remove the probe power shield / 92
- To remove the AC input shield / 93
- To remove the probe power shield / 92
- To remove the power supply / 111

Tools Used for Disassembly

Use these tools to remove and replace the oscilloscope assemblies:

- TORX T6, T10, and T20 drivers.
- 5/8-inch socket driver or adjustable wrench (for BNC nuts).

- Flat head screwdriver.

See how the Oscilloscope Parts Fit Together

An exploded view of the oscilloscope is included in the “Replaceable Parts” chapter. It shows the individual part numbers used in the assemblies, and shows you how the parts fit together.

Read All Warnings and Cautions

Read the following warnings and cautions before removing and replacing any assemblies in the oscilloscope.

WARNING

HAZARDOUS VOLTAGES!

Read the safety summary at the back of this book before proceeding. Maintenance is performed with power supplied to the oscilloscope and with the protective covers removed. Only trained service personnel who are aware of the hazards involved should perform the maintenance. Whenever possible, perform the procedures with the power cord removed from the oscilloscope.

WARNING



AVOID ELECTRICAL SHOCK!

Hazardous voltages exist on the LCD assembly and power supply. To avoid electrical shock:

- 1 Disconnect the power cord from the oscilloscope.
- 2 Wait at least three minutes for the capacitors in the oscilloscope to discharge before you begin disassembly.

Read the Safety Summary at the back of this manual before you begin.

CAUTION

REMOVE POWER TO AVOID DAMAGE!

Remove power before you begin to remove and replace assemblies. Do not remove or replace assemblies while the oscilloscope is turned on, or damage to the components can occur.

CAUTION

AVOID DAMAGE TO ELECTRONIC COMPONENTS!

ELECTROSTATIC DISCHARGE (ESD) can damage electronic components. When doing any of the procedures in this chapter, use proper ESD precautions. As a minimum, you should place the instrument on a properly grounded ESD mat and wear a properly grounded ESD strap.

To remove the cabinet

Removing the cabinet allows access to the rear deck, fan assembly, power supply cover, power supply assembly, and power switch assembly.

- 1 Using a TORX T20 driver, remove the five screws securing the cabinet to the rear deck assembly.
- 2 Carefully slide cabinet back away from rear deck assembly.



Figure 18 Removing the cabinet

To remove the rear deck assembly

Removing the rear deck allows access to the front deck and acquisition board.

- 1 Remove the BNC securing nuts and washers.



Figure 19 Removing the BNC securing nuts and washers

- 2 Using a TORX T10 driver, locate and remove all the perimeter screws securing rear deck to front deck.

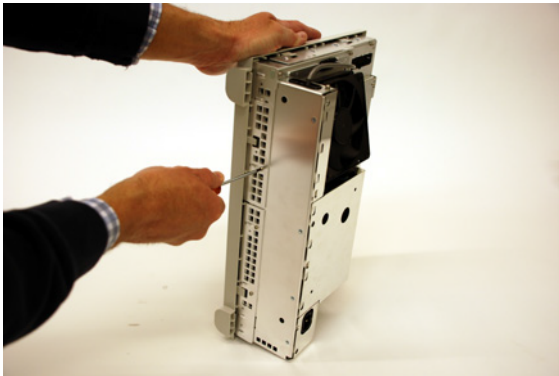

Figure 20 Removing perimeter screws securing rear deck

- 3 Locate and remove all rear-facing screws securing rear deck to front deck.

You need to remove the AC input shield (see **"To remove the AC input shield"** on page 93) before you can remove the screw on the lower right.

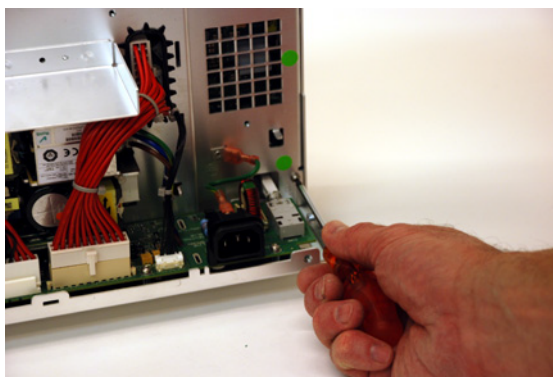

Figure 21 Removing rear-facing screws securing rear deck

- 4 Disconnect the acquisition board control cable, the acquisition board power cable, and the probe power cable. Note cable locations for re-assembly.

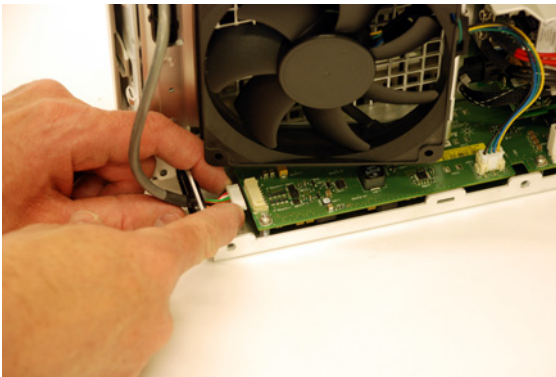

Figure 22 Removing cables from power board to other boards

- 5 Carefully separate rear deck from front deck. Take care not damage extender switch.

WARNING

Sheet metal parts may have sharp edges. Handle with care to avoid injury.

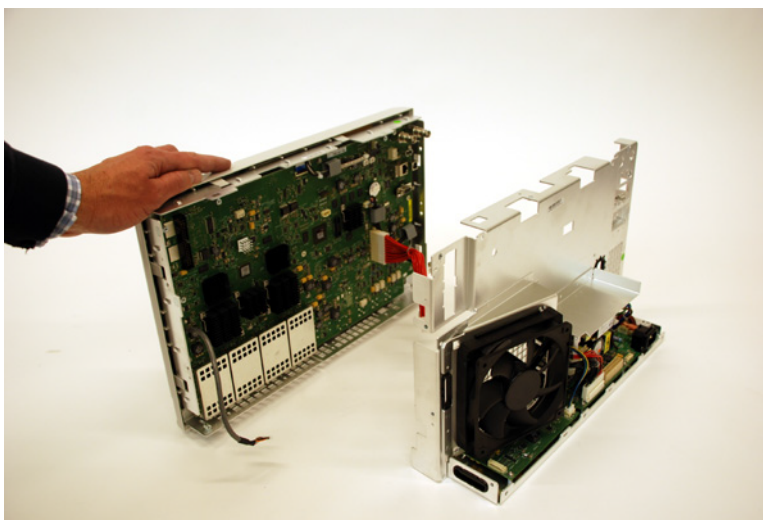

Figure 23 Separating front and rear deck assemblies

To remove the power supply shield

- 1 To remove the power supply shield, locate and remove using a TORX T10 driver the two screws securing the shield to the rear deck.

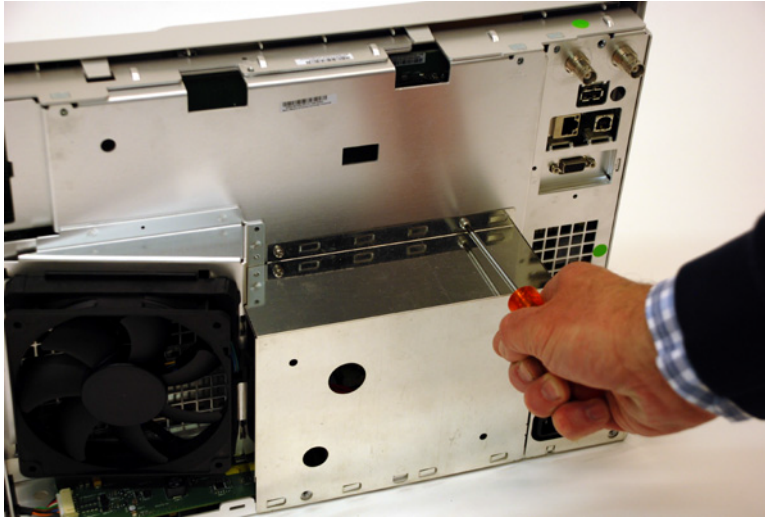

Figure 24 Removing the power supply shield

WARNING

Thin sheet metal parts may have sharp edges. Handle with care to avoid injury.

- 2 Once the screws have been removed, carefully remove the power supply cover by lifting the cover up and off retaining tabs on rear deck.

To remove the probe power shield

- 1 To remove the probe power shield, locate and remove using a TORX T10 driver the one screw securing the shield to the rear deck.



Figure 25 Removing the probe power shield

WARNING

Thin sheet metal parts may have sharp edges. Handle with care to avoid injury.

- 2 Once the screw has been removed, carefully remove the probe power shield by lifting the cover up and off retaining tabs on rear deck.

To remove the AC input shield

- 1 To remove AC input shield, locate and remove using a TORX T10 driver the two screws securing the shield to the rear deck.



Figure 26 Removing the AC input shield

WARNING

Thin sheet metal parts may have sharp edges. Handle with care to avoid injury.

- 2 Once the screws have been removed, carefully remove the shield by lifting it up and off retaining tabs on rear deck.

To replace the battery

If the battery needs to be replaced, use a CR2032/1HG or CR2032/HGN 3V manganese dioxide lithium battery.

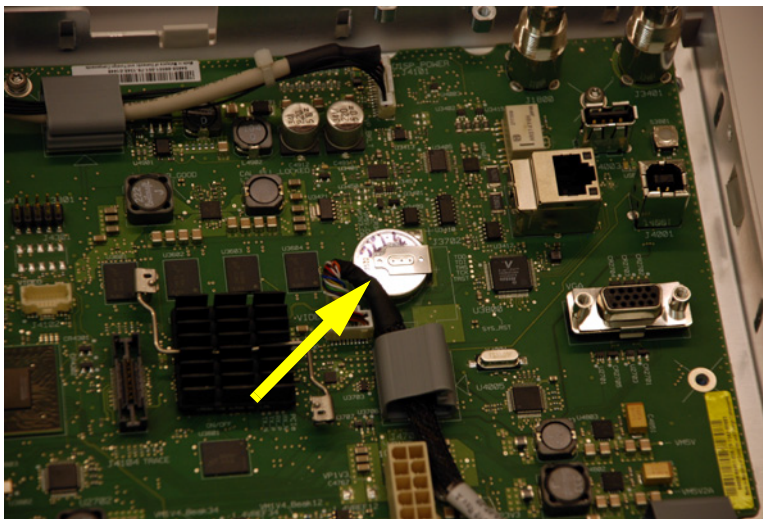

Figure 27 Battery location

To remove the acquisition board

These steps show how to remove the acquisition board.

- 1 Using a TORX T6 driver locate and remove the 4 screws on the front of the instrument (4 Channel version).



Figure 28 Removing the analog channel BNC securing T6 screws

- 2 Disconnect display power, display video, and keyboard cables. Note locations for re-connection.

The keyboard cable connector has a latch that must be flipped up before you can disconnect the cable.

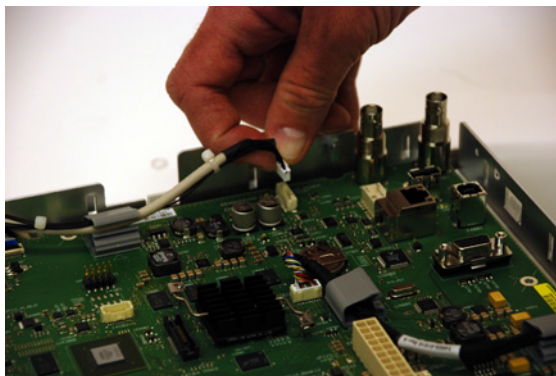

Figure 29 Removing the display backlight power cable (54609-61605) from the acquisition board

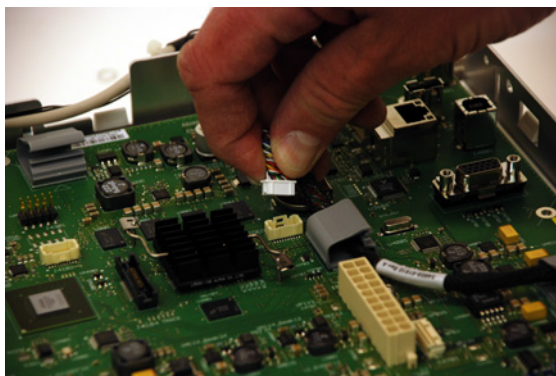

Figure 30 Removing the LVDS display cable (54609-61610) from the acquisition board

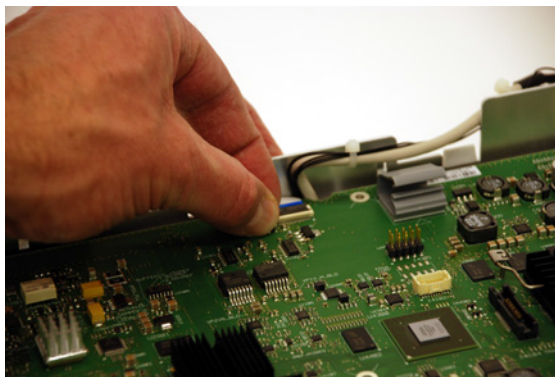

Figure 31 Removing the keyboard cable (54709-61610) from the acquisition board

- 3 Using a TORX T10 driver locate and remove 12 mounting screws.

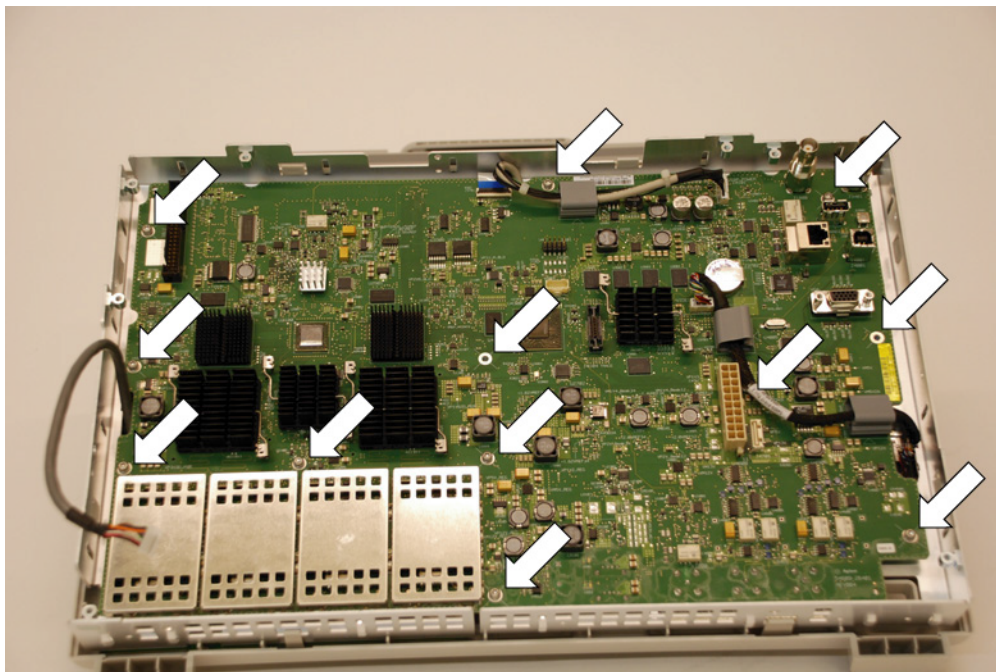

Figure 32 Acquisition board TORX T10 mounting screw locations

- 4 Carefully lift acquisition board off front deck.

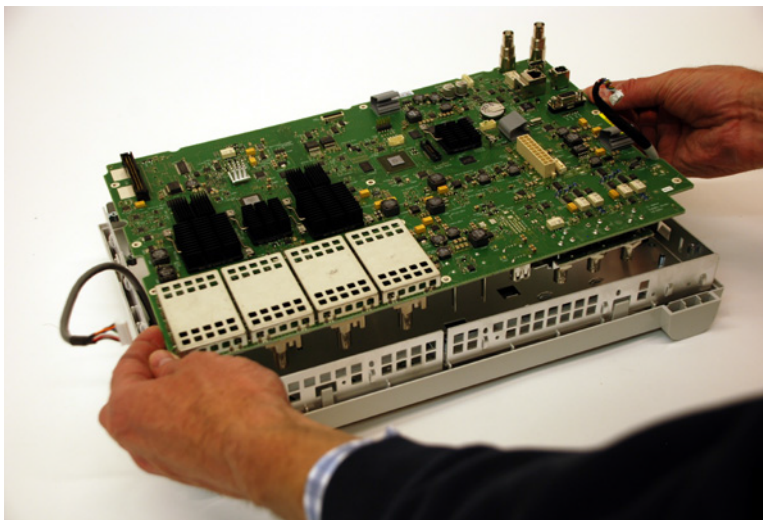

Figure 33 Lifting acquisition board off the front deck

To remove the front panel knobs

The front panel knobs must be removed prior to localized front panel overlay installation or front panel disassembly.

- 1 Gently pull on the front panel knobs to remove them.



Figure 34 Removing the front panel knobs

To remove the front bezel assembly

- 1 Remove the bezel from the front deck.

The bezel is secured to front deck by molded-in retaining clips located around the perimeter of the bezel. Gently pry these outward (either by hand or using a flat head screwdriver). Working your way around the bezel releasing the clips gently.

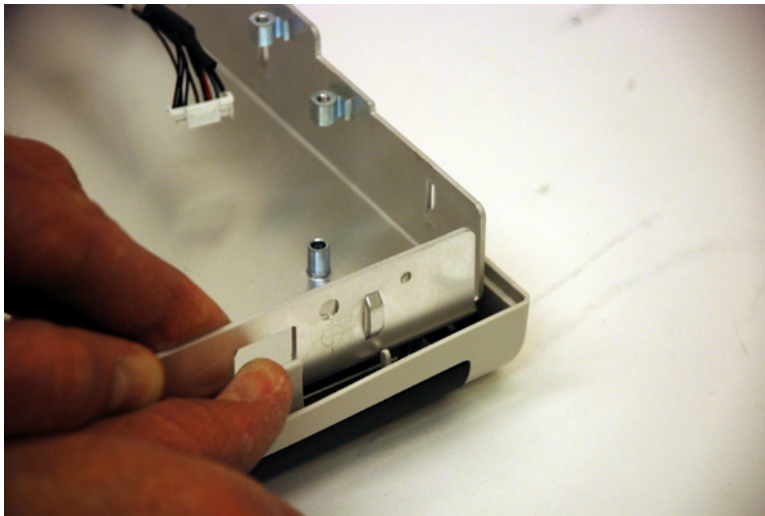

Figure 35 Removing the bezel

- 2 Before separating the bezel from the front deck, unlatch and disconnect the keyboard cable.

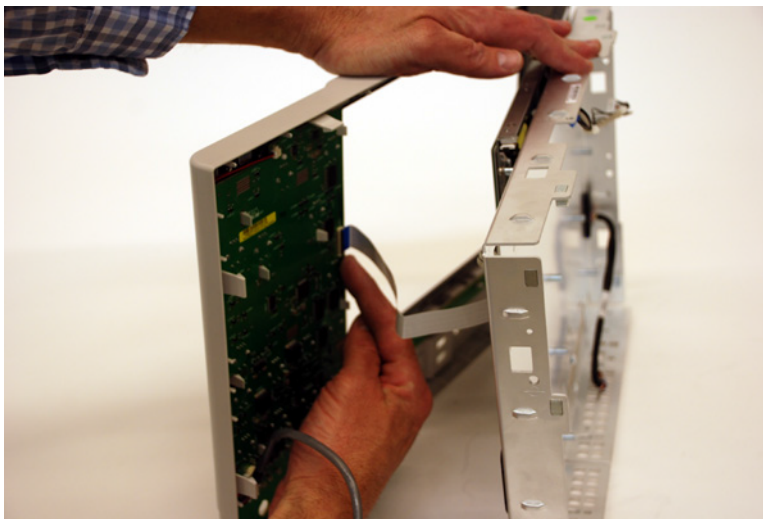

Figure 36 Disconnecting the keyboard cable

To remove the display assembly

- 1 Using a TORX T10 driver, remove the two screws that secure the display assembly to the front deck.

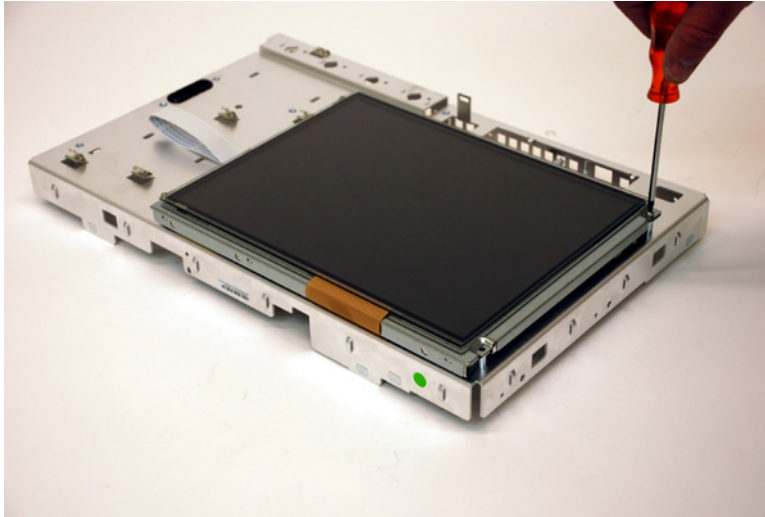

Figure 37 Removing the display assembly

- 2 Take care while guiding display cables through front deck sheet metal openings.

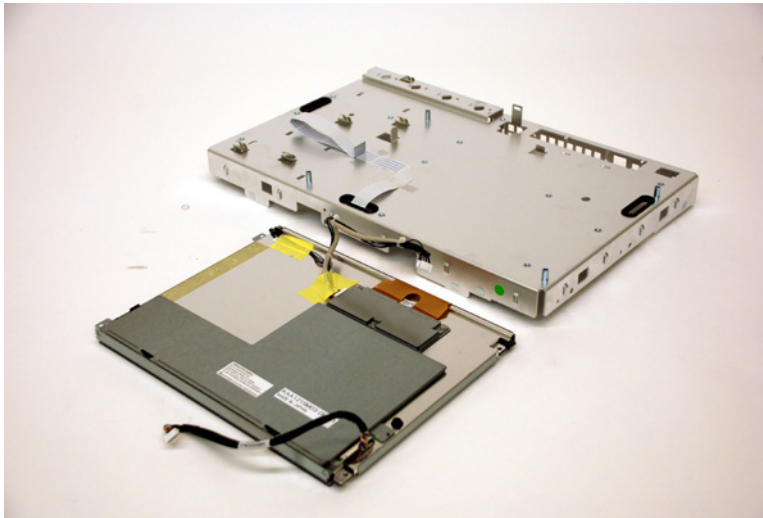

Figure 38 Display assembly removed

To remove the keyboard and keypad

- 1 Remove the softkey board cable from the keyboard board.

Slide the connector clamp toward the softkey board; then, slide the ribbon cable out.

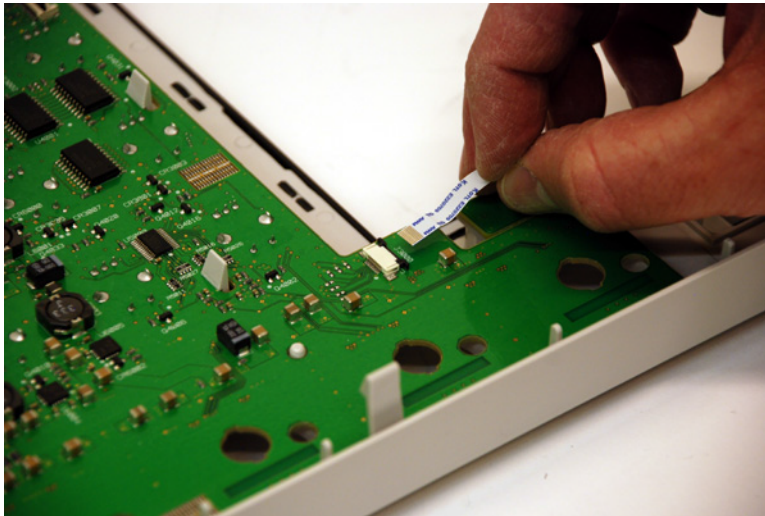

Figure 39 Disconnecting the softkey board cable

- 2 Remove the speaker/microphone cable from the keyboard board.



Figure 40 Disconnecting the speaker/microphone cable

- 3 To separate the keyboard board from the bezel, carefully pull back locking tabs that secure it.

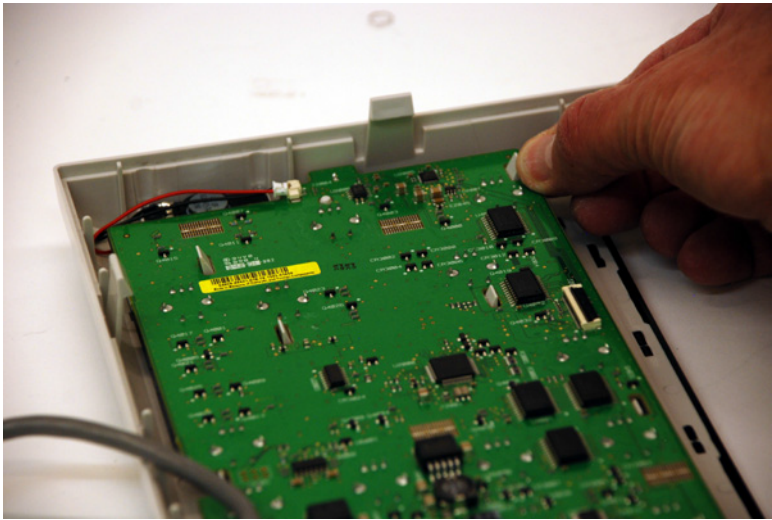

Figure 41 Removing the keyboard

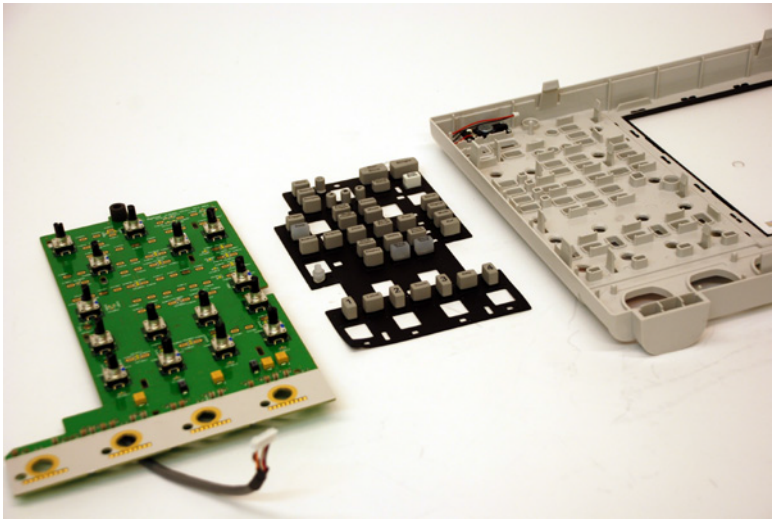

Figure 42 Keyboard and keypad removed

- 4 To separate the softkey board from the bezel, carefully pull back locking tabs that secure it.

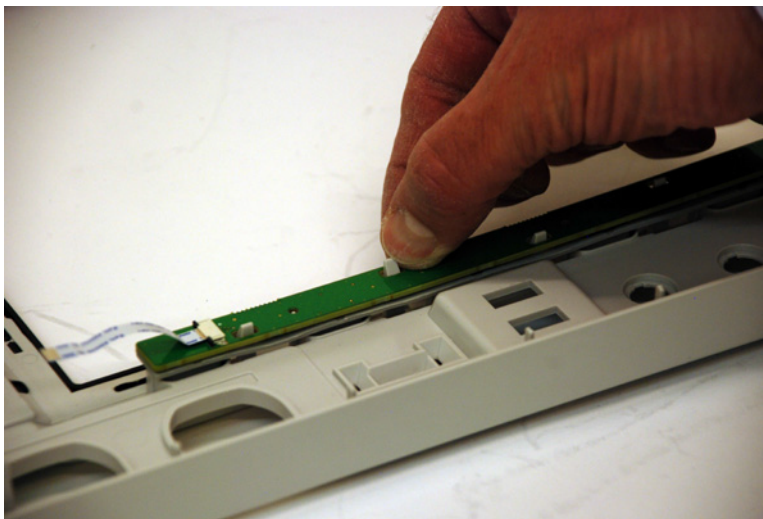

Figure 43 Unclip the softkey board from the bezel

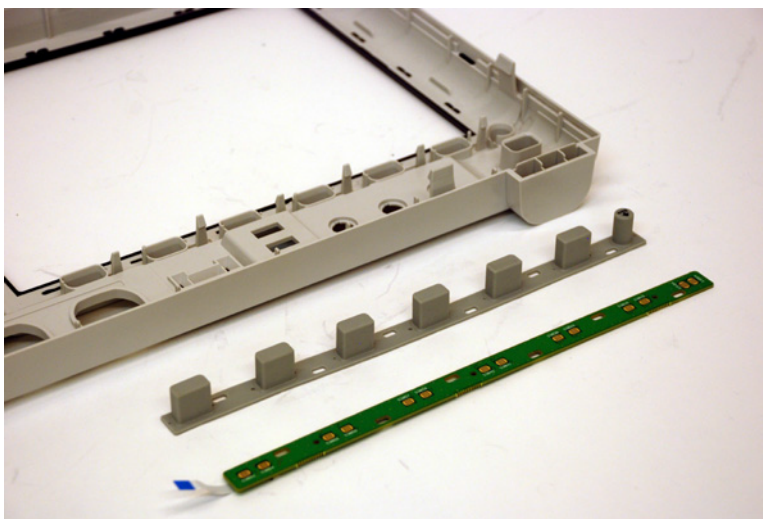

Figure 44 Softkey board and keypad removed

To remove the fan assembly

- 1 Ensure that the fan power cable has been disconnected from the power board.

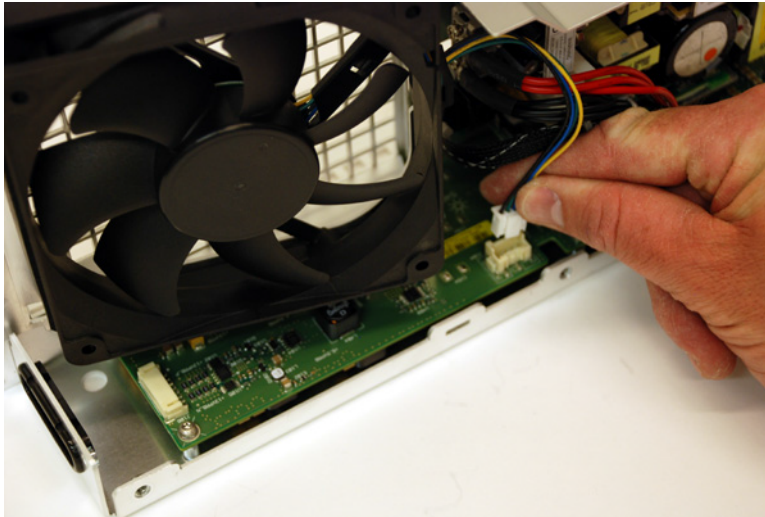

Figure 45 Disconnecting the fan cable

- 2 Carefully slide fan assembly (fan and fan mount) to the right, then lift away from rear deck.

Note, fan mount is soft and can be damaged by sharp sheet metal edges. Take care that the fan power cable is not damaged when pulling across sheet metal edges.

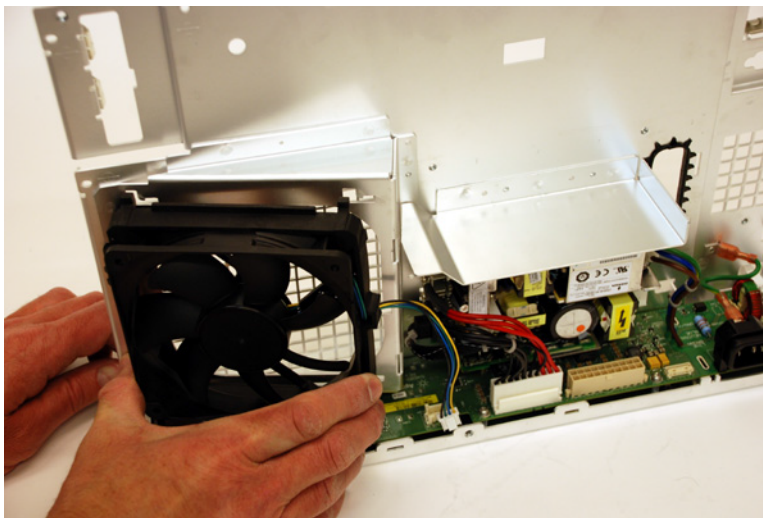

Figure 46 Removing fan assembly

To remove the power supply

- 1 Disconnect all cables between the power supply and the power board.

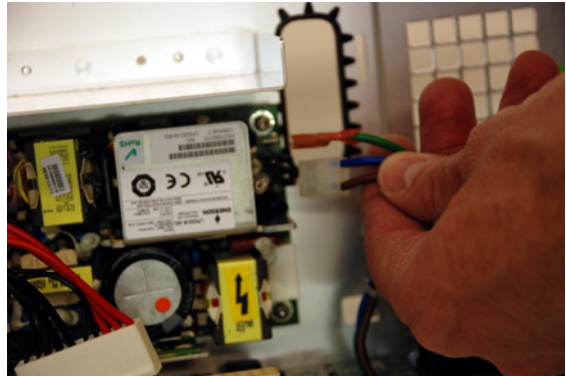

Figure 47 Removing cables to/from power supply

- 2 Locate and remove using a TORX T10 driver the four screws securing the power supply assembly to the rear deck.



Figure 48 Removing the power supply

To remove the power board

- 1 Disconnect the ground wire from its chassis terminal.

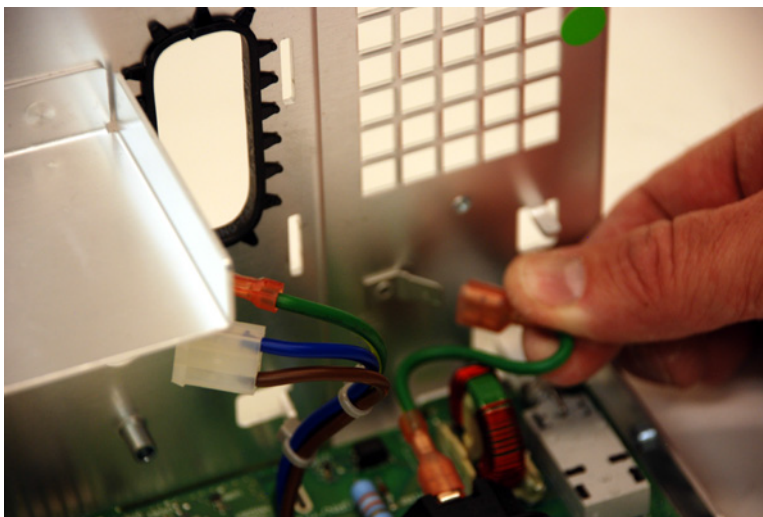

Figure 49 Disconnecting the ground wire

- 2 Locate and remove using a TORX T10 driver the four screws securing the power board to the rear deck.

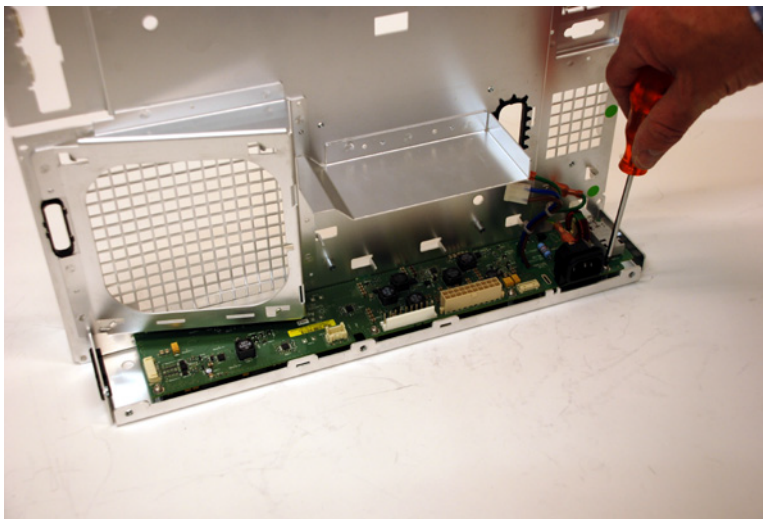

Figure 50 Removing the power board

- 3 Slide assembly back and lift out of rear deck.
- 4 Take care that you do not damage the switch extender during removal.

- 5 To remove the switch extender, gently pry open the extender using a flat head screwdriver.

CAUTION

Twisting the latch too much could cause it to break!

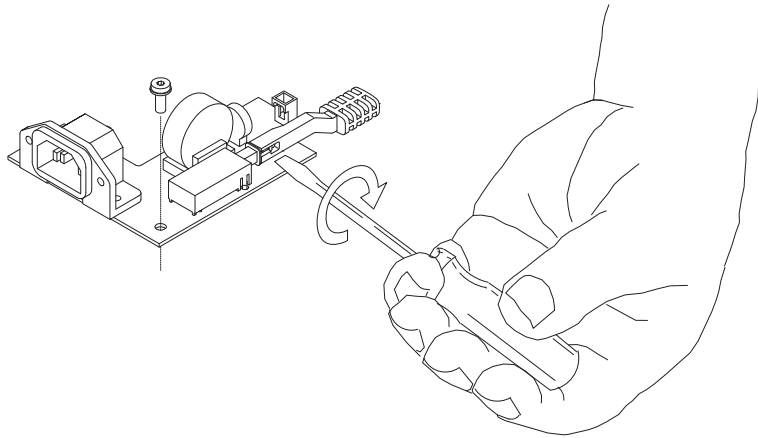

Figure 51 Removing power switch extender

6 Replaceable Parts

This chapter describes how to order replaceable assemblies and parts for the Keysight 6000 X-Series oscilloscopes.

Diagrams and parts lists are included for assemblies and hardware that you can order.

Before working on the oscilloscope, read the safety summary at the back of this book.

Ordering Replaceable Parts

Listed Parts

To order a part in the parts list, quote the Keysight Technologies part number, indicate the quantity desired, and address the order to the nearest Keysight Technologies Sales Office. To find your nearest sales office go to www.keysight.com.

Unlisted Parts

To order a part not listed in the parts list, include the instrument part number, instrument serial number, a description of the part (including its function), and the number of parts required. Address the order to the nearest Keysight Technologies Sales Office.

Direct Mail Order System

Within the USA, Keysight Technologies can supply parts through a direct mail order system. There are several advantages to this system:

- Direct ordering and shipping from the Keysight Technologies parts center in California, USA.
- No maximum or minimum on any mail order. (There is a minimum amount for parts ordered through a local Keysight Technologies Sales Office when the orders require billing and invoicing.)
- Prepaid transportation. (There is a small handling charge for each order.)
- No invoices.

In order for Keysight Technologies to provide these advantages, please send a check or money order with each order.

Mail order forms and specific ordering information are available through your local Keysight Technologies Sales Office. Addresses and telephone numbers are located in a separate document shipped with the manuals.

Exchange Assemblies

Some parts used in this instrument have been set up for an exchange program. This program allows the customer to exchange a faulty assembly with one that has been repaired, calibrated, and performance-verified by the factory. The cost is significantly less than that of a new part. The exchange parts have a part number in the form XXXXX-695XX.

After receiving the repaired exchange part from Keysight Technologies, a United States customer has 30 days to return the faulty assembly. For orders not originating in the United States, contact the local Keysight Technologies service organization. If the faulty assembly is not returned within 30 days, the customer will be charged an additional amount. The additional amount will be the difference in price between a new assembly and that of an exchange assembly.

Exploded Views

The following exploded views provide a graphical representation of the oscilloscope at the time this manual was released. Not all parts are shown. Your parts may be slightly different than those shown. These views provide reference designator numbers that map to those used in the parts list table in this chapter.

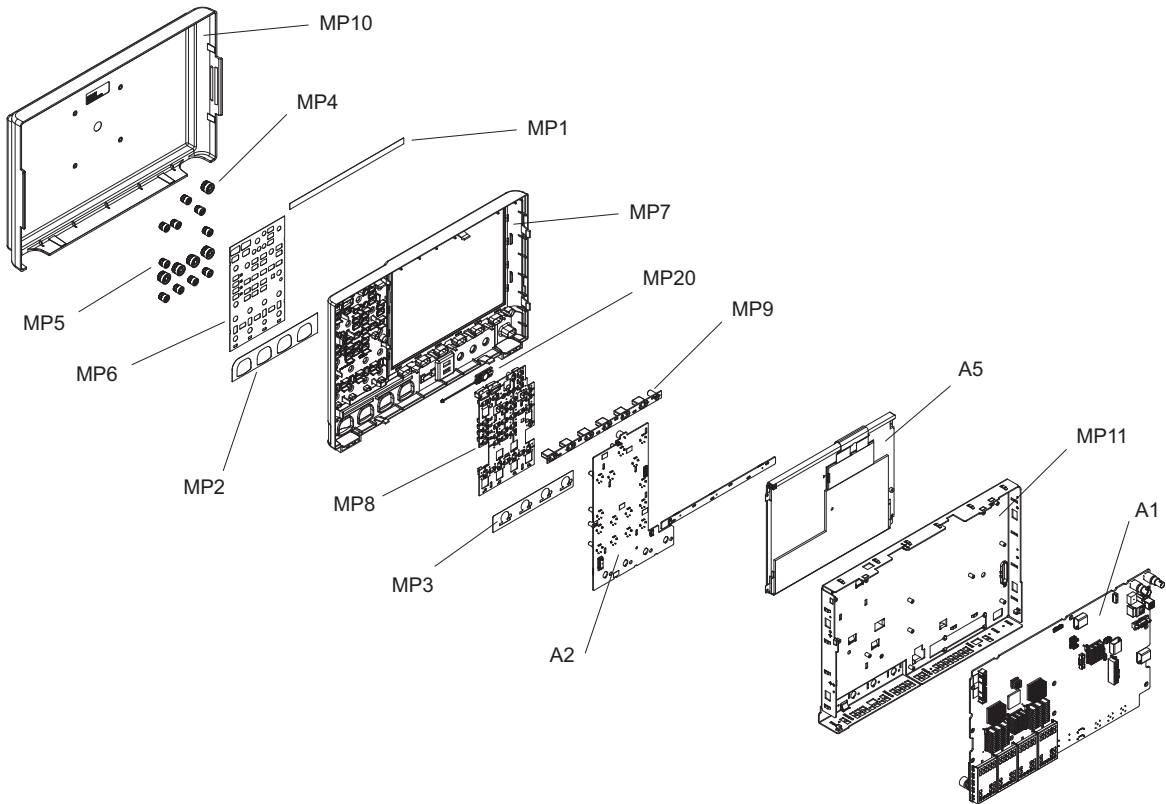

Figure 52 Exploded View 1 of 2

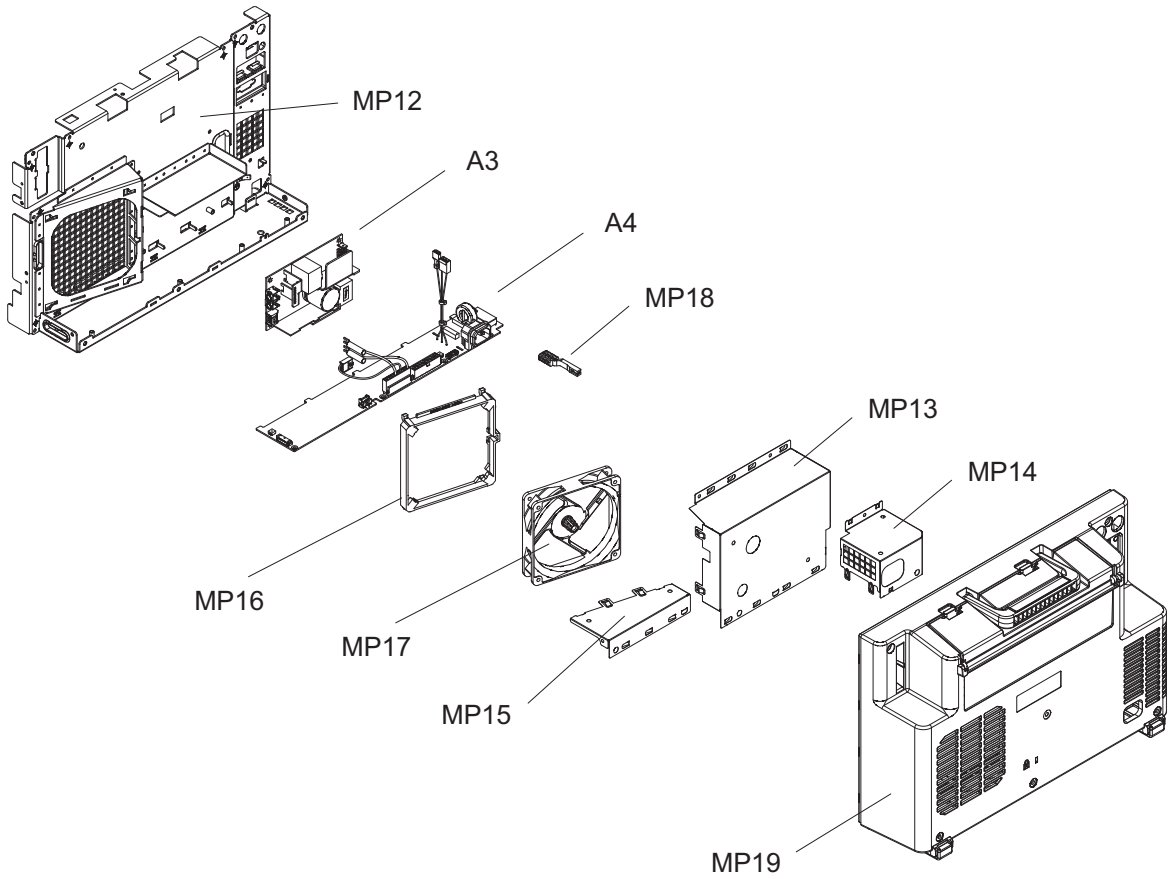

Figure 53 Exploded View 2 of 2

Replaceable Parts List

The information given for each part consists of the following:

- Reference designation.
- Keysight Technologies part number.
- Total quantity (Qty) in the instrument or on assembly.
- Description of the part.

Table 23 Replaceable Parts

Ref Des	Keysight Part Number	Qty	Description
A1	54608-66601	1	Acquisition board 6000 X-Series 2-Ch
A1	54608-69501	1	Acquisition board 6000 X-Series 2-Ch (exchange)
A1	54608-69501-DEF	1	Acquisition board 6000 X-Series 2-Ch (return)
A1	54609-66601	1	Acquisition board 6000 X-Series 4-Ch
A1	54609-69501	1	Acquisition board 6000 X-Series 4-Ch - (exchange)
A1	54609-69501-DEF	1	Acquisition board 6000 X-Series 4-Ch - (return)
A2	54608-66421	1	PCA - 2 Channel Keyboard 6000 X-Series
A2	54609-66421	1	PCA - 4 Channel Keyboard 6000 X-Series
A3	0950-5492	1	Power Supply AC-DC 250W 1-Output
A4	54609-66422	1	PCA - Line Input, Power Conversion Board
A5	2090-1069	1	Display LCD 12.1-in TFT SVGA with P-CAP touch Panel
Not shown	54684-42202	2	Hole plug front panel (2 Channel only)
Not shown	2950-0054	2	Nut, 1/2-28 THD (secures BNCs)
Not shown	2190-0068	2	Washer-LK Intl T 1/2 In. .505 IN-ID (for BNCs)
Not shown	0515-0374	36	Screw-Machine with Crest-Cup-Con-Washer Pan-HD Torx-T10 M3X0.5 10mm-LG SST-300 passivated finish

Table 23 Replaceable Parts (continued)

Ref Des	Keysight Part Number	Qty	Description
Not shown	0515-0380	5	Screw-Machine W/Crest-Cup-Con-Washer Pan-HD Torx-T20 M4X0.7 12mm-LG SST-300 Passivated
Not shown	0515-0659	2, 4	Screw-Machine with CrestCup-Washer Pan-HD Torx-T6 M2X0.4 8mm-LG SST-300 passivated (qty=2 for 2 Ch, qty=4 for 4 Ch)
Not shown	0515-1753	9	Screw-Machine with Patch-Lock Pan-HD Torx-T10 M3X0.5 8mm-LG SST-300 Passivated
Not shown	3030-1637	4	Screw-tapping Pan-HD 1-32-THD 0.25-in-LG Carbon Steel Zn-clear Chromate
MP1	54608-94303	1	ID Label MSO-X 6002A
MP1	54609-94303	1	ID Label MSO-X 6004A
MP1	54608-94305	1	ID Label DSO-X 6002A
MP1	54609-94305	1	ID Label DSO-X 6004A
MP2	54608-94306	1	2 Channel BNC Label (not shown)
MP2	54609-94306	1	4 Channel BNC Label
MP3	54608-94304	1	2 Channel AutoProbe Label (not shown)
MP3	54609-94304	1	4 Channel AutoProbe Label
MP4	75019-47401	5	Large Rotary Knob
MP5	75019-47402	10	Small Rotary Knob
MP6	54608-94301	1	2 Channel Control Panel Label (not shown)
MP6	54609-94301	1	4 Channel Control Panel Label
MP7	54609-60201	1	Plastic Bezel Assembly

Table 23 Replaceable Parts (continued)

Ref Des	Keysight Part Number	Qty	Description
MP8	54609-41901	1	Keyboard Keypad
MP9	54709-41903	1	Softkey Keypad
MP10	54609-44102	1	Cover Protective Front
MP11	54609-00101	1	Front Deck
MP12	54609-00102	1	Rear Deck
MP13	54609-00602	1	Shield Power Supply
MP14	54609-00604	1	Shield AC Input
MP15	54609-00606	1	Shield Probe Power
MP16	54609-44701	1	Fan Mount
MP17	3160-4377	1	Fan
MP18	54695-43901	1	Extender, Power Switch
MP19	54609-64401	1	Cabinet Assembly
Not shown	54609-87101	1	Chassis to Fan Seal
MP20	54609-61606	1	Speaker Assembly

Table 23 Replaceable Parts (continued)

Ref Des	Keysight Part Number	Qty	Description
Not shown	54609-61601	1	Cable Line to Power Supply
Not shown	54609-61602	1	Cable Power Supply Control and DC Out
Not shown	54609-61603	1	Cable Acquisition Power
Not shown	54609-61604	1	Cable Probe Power
Not shown	54609-61605	1	Cable Display Backlight - Touch
Not shown	54609-61607	1	Cable Power Supply Sense
Not shown	54609-61610	1	LVDS Display Cable
Not shown	54709-61610	1	Soft Keyboard Cable
Not shown	75019-61604	1	Cable - Ground Wire
Not shown	54609-61609	1	Calibration Cable 50 Ohm BNC to BNC
Not shown	Power cord	0-1	Part number varies by country. Contact your local Keysight sales office for replacement.
Not shown	N2894A	*	Passive Probe 10:1, 700 MHz

Table 23 Replaceable Parts (continued)

Ref Des	Keysight Part Number	Qty	Description
Not shown	54609-94311	*	Overlay - Traditional Chinese, 4 channel
Not shown	54608-94311	*	Overlay - Traditional Chinese, 2 channel
Not shown	54609-94317	*	Overlay - Japanese, 4 channel
Not shown	54608-94317	*	Overlay - Japanese, 2 channel
Not shown	54609-94319	*	Overlay - Russian, 4 channel
Not shown	54608-94319	*	Overlay - Russian, 2 channel
Not shown	54609-94314	*	Overlay - French, 4 channel
Not shown	54608-94314	*	Overlay - French, 2 channel
Not shown	54609-94316	*	Overlay - Spanish, 4 channel
Not shown	54608-94316	*	Overlay - Spanish, 2 channel
Not shown	54609-94313	*	Overlay - German, 4 channel
Not shown	54608-94313	*	Overlay - German, 2 channel
Not shown	54609-94318	*	Overlay - Portuguese, 4 channel
Not shown	54608-94318	*	Overlay - Portuguese, 2 channel
Not shown	54609-94310	*	Overlay - Simplified Chinese, 4 channel
Not shown	54608-94310	*	Overlay - Simplified Chinese, 2 channel
Not shown	54609-94312	*	Overlay - Korean, 4 channel
Not shown	54608-94312	*	Overlay - Korean, 2 channel
Not shown	54609-94315	*	Overlay - Italian, 4 channel
Not shown	54608-94315	*	Overlay - Italian, 2 channel
Not shown	N2111-60001	*	Rack Mount Kit for 6000 X-Series Oscilloscope

*Optional item.

7 Safety Information

The following general safety precautions must be observed during all phases of operation of this instrument. Failure to comply with these precautions or with specific warnings or operating instructions in the product manuals violates safety standards of design, manufacture, and intended use of the instrument. Keysight Technologies assumes no liability for the customer's failure to comply with these requirements. Product manuals are provided with your instrument on CD-ROM and/or in printed form. Printed manuals are an option for many products. Manuals may also be available on the Web. Go to www.keysight.com and type in your product number in the Search field at the top of the page.

General Do not use this product in any manner not specified by the manufacturer. The protective features of this product may be impaired if it is used in a manner not specified in the operation instructions.

Before Applying Power Verify that all safety precautions are taken. Make all connections to the unit before applying power. Note the instrument's external markings described in "**Safety Symbols**" on page 128.

Ground the Instrument If your product is provided with a grounding type power plug, the instrument chassis and cover must be connected to an electrical ground to minimize shock hazard. The ground pin must be firmly connected to an electrical ground (safety ground) terminal at the power outlet. Any interruption of the protective (grounding) conductor or disconnection of the protective earth terminal will cause a potential shock hazard that could result in personal injury.

Fuses See the user's guide or operator's manual for information about line-fuse replacement. Some instruments contain an internal fuse, which is not user accessible.

- Do Not Operate in an Explosive Atmosphere** Do not operate the instrument in the presence of flammable gases or fumes.
- Do Not Remove the Instrument Cover** Only qualified, service-trained personnel who are aware of the hazards involved should remove instrument covers. Always disconnect the power cable and any external circuits before removing the instrument cover.
- Cleaning** Clean the outside of the instrument with a soft, lint-free, slightly dampened cloth. Do not use detergent or chemical solvents.
- Do Not Modify the Instrument** Do not install substitute parts or perform any unauthorized modification to the product. Return the product to an Keysight Sales and Service Office for service and repair to ensure that safety features are maintained.
- In Case of Damage** Instruments that appear damaged or defective should be made inoperative and secured against unintended operation until they can be repaired by qualified service personnel.

CAUTION

A CAUTION notice denotes a hazard. It calls attention to an operating procedure, practice, or the like that, if not correctly performed or adhered to, could result in damage to the product or loss of important data. Do not proceed beyond a CAUTION notice until the indicated conditions are fully understood and met.

WARNING

A WARNING notice denotes a hazard. It calls attention to an operating procedure, practice, or the like that, if not correctly performed or adhered to, could result in personal injury or death. Do not proceed beyond a WARNING notice until the indicated conditions are fully understood and met.

Safety Symbols

Table 24 Description of Safety related symbols that may appear on a product



Symbol	Description
	Direct current
	Alternating current
	Both direct and alternating current

Table 24 Description of Safety related symbols that may appear on a product (continued)



















Symbol	Description
	Three phase alternating current
	Earth ground terminal
	Protective earth ground terminal
	Frame or chassis ground terminal
	Terminal is at earth potential
	Equipotentiality
N	Neutral conductor on permanently installed equipment
L	Line conductor on permanently installed equipment
	On (mains supply)
	Off (mains supply)
	Standby (mains supply). The instrument is not completely disconnected from the mains supply when the power switch is in the standby position
	In position of a bi-stable push switch
	Out position of a bi-stable push switch

Table 24 Description of Safety related symbols that may appear on a product (continued)

Symbol	Description
	Equipment protected throughout by DOUBLE INSULATION or REINFORCED INSULATION
	Caution, refer to accompanying documentation
	Caution, risk of electric shock
	Do not apply around or remove from HAZARDOUS LIVE conductors
	Application around and removal from HAZARDOUS LIVE conductors is permitted
	Caution, hot surface
	Ionizing radiation
CAT II	Measurement Category II
CAT III	Measurement Category III
CAT IV	Measurement Category IV

Index

A

accuracy, DC vertical gain, 29
accuracy, dual cursor, 34
assemblies
 exchange, 119
 replacing, 83

B

bandwidth
 verification, 38

C

cabinet, removing, 100
calibration, 57
cautions, 70, 71, 77, 80, 84
certificate of calibration, 57
channels
 problem solving, 61
compensating your probe, 67
connecting for threshold test, 26
contact Keysight, 16

D

DC vertical gain accuracy, 29
digital channel
 testing, 23
 verification, 24
digital channels, 4
display
 assembly removal, 101
 problem solving, 60
dual cursor accuracy, 34

E

equipment, test, 19
exchange assemblies, 119
exploded view

front panel, 120
instrument, 121

F

fan assembly removal, 109
front panel
 exploded view, 120
 removal, 86
front panel self test, 64

H

hardware self test, 64

I

internal self-tests, 64

K

keyboard, removal, 95
Keysight
 contact information, 16

L

LED, startup sequence, 63
lid, removal, 85
line filter board removal, 113

M

making test connector, 21
measurement category, 14
 definitions, 14

N

NIST, 57

O

ordering parts, 118
overvoltage category, 16

P

parts
 list, 122
 ordering, 118
passive probe, 125
perform user calibration, 57
performance
 test record, 52
pollution degree, 16
pollution degree, definitions, 16
power
 cord list, 125
 supply removal, 111
 supply shield, removal, 91, 92, 93
power requirements, 13
probe
 N2894A, 125
probes
 compensating, 67
problem solving, 59

R

record tests, 52
remove, 113
 cabinet, 100
 display assembly, 101
 fan assembly, 109
 front panel, 86
 keyboard, 95
 power supply, 111
 power supply shield, 91, 92, 93
 storage lid, 85
replaceable parts list, 122
replacing assemblies, 83
run self-tests, 64

S

- safety information, 127
- safety notice, 56, 69
- safety symbols, 128
- self test, front panel, 64
- self test, hardware, 64
- self-alignment, user calibration, 57
- self-tests, 64
- specifications, 16
- startup sequence, 63
- status, User Calibration, 57
- status, user calibration, 57
- storage lid, removal, 85

T

test

- connector, constructing, 21
- digital channels, 23
- equipment, 19
- record, 52

threshold

- accuracy, digital channel, 24
- test diagram, 26

trace display

- problem solving, 60, 61

transient withstand capability, 15

trigger

- sensitivity, 45
- sensitivity, external, 49
- sensitivity, internal, 46

troubleshooting, 59

- equipment required, 69
- fan, 75
- flowchart, 71
- power supply, 77, 80

U

user calibration, 57

V

verify

- bandwidth, 38
- digital channel, 24
- trigger, 45

W

- warnings, 84, 91, 92, 93
- warranted specifications, 16