X-Series Signal Analyzers

Vector Modulation Analyzer Mode

E6680A E6680E E7515B
M9410A M9411A M9415A M9416A
M9410E M9411E M9415E M9416E
M8920A M8920B
N9000B N9010B N9020B N9021B N9030B N9040B N9041B N9042B
S9100A S9101A S9110A



Notices

Copyright Notice

© Keysight Technologies 2024

No part of this manual may be reproduced in any form or by any means (including electronic storage and retrieval or translation into a foreign language) without prior agreement and written consent from Keysight Technologies, Inc. as governed by United States and international copyright laws.

Trademarks

WiMAX and Mobile WiMAX are US trademarks of the WiMAX Forum.

Manual Part Number

N9054-90001

Edition

Edition: 6, April 2024
Published in USA

Published by:

Keysight Technologies, Inc.
1400 Fountaingrove Parkway
Santa Rosa, CA 95403

Technology Licenses

The hardware and/or software described in this document are furnished under a license and may be used or copied only in accordance with the terms of such license.

U.S. Government Rights

The Software is "commercial computer software," as defined by Federal Acquisition Regulation ("FAR") 2.101. Pursuant to FAR 12.212 and 27.405-3 and Department of Defense FAR Supplement ("DFARS") 227.7202, the US government acquires commercial computer software under the same terms by which the software is customarily provided to the public. Accordingly, Keysight provides the Software to US government customers under its standard commercial license, which is embodied in its End User License Agreement (EULA), a copy of which can be found at

<http://www.keysight.com/find/sweula>. The license set forth in the EULA represents the exclusive authority by which the US government may use, modify, distribute, or disclose the Software. The EULA and the license set forth therein, does not require or permit, among other things, that Keysight: (1) Furnish technical information related to commercial computer software or commercial computer software documentation that is not customarily provided to the public; or (2) Relinquish to, or otherwise provide, the government rights in excess of these rights customarily provided to the public to use, modify, reproduce, release, perform, display, or disclose commercial computer software or commercial computer software documentation. No additional government requirements beyond those set forth in the EULA shall apply, except to the extent that those terms, rights, or licenses are explicitly required from all providers of commercial computer software pursuant to the FAR and the DFARS and are set forth specifically in writing elsewhere in the EULA. Keysight shall be under no obligation to update, revise or otherwise modify the Software. With respect to any technical data as defined by FAR 2.101, pursuant to FAR 12.211 and 27.404.2 and DFARS 227.7102, the US government acquires no greater than Limited Rights as defined in FAR 27.401 or DFAR 227.7103-5 (c), as applicable in any technical data.

Warranty

THE MATERIAL CONTAINED IN THIS DOCUMENT IS PROVIDED "AS IS," AND IS SUBJECT TO BEING CHANGED, WITHOUT NOTICE, IN FUTURE EDITIONS. FURTHER, TO THE MAXIMUM EXTENT PERMITTED BY APPLICABLE LAW, KEYSIGHT DISCLAIMS ALL WARRANTIES, EITHER EXPRESS OR IMPLIED, WITH REGARD TO THIS MANUAL AND ANY INFORMATION CONTAINED HEREIN, INCLUDING BUT NOT LIMITED TO THE IMPLIED WARRANTIES OF MERCHANTABILITY AND FITNESS FOR A PARTICULAR PURPOSE. KEYSIGHT SHALL NOT BE LIABLE FOR ERRORS OR FOR INCIDENTAL OR CONSEQUENTIAL DAMAGES IN CONNECTION WITH THE FURNISHING, USE, OR PERFORMANCE OF THIS DOCUMENT OR OF ANY INFORMATION CONTAINED HEREIN. SHOULD KEYSIGHT AND THE USER HAVE A SEPARATE WRITTEN AGREEMENT WITH WARRANTY TERMS COVERING THE MATERIAL IN THIS DOCUMENT THAT CONFLICT WITH THESE TERMS, THE WARRANTY TERMS IN THE SEPARATE AGREEMENT SHALL CONTROL.

Safety Information

CAUTION

A CAUTION notice denotes a hazard. It calls attention to an operating procedure, practice, or the like that, if not correctly performed or adhered to, could result in damage to the product or loss of important data. Do not proceed beyond a CAUTION notice until the indicated conditions are fully understood and met.

WARNING

A WARNING notice denotes a hazard. It calls attention to an operating procedure, practice, or the like that, if not correctly performed or adhered to, could result in personal injury or death. Do not proceed beyond a WARNING notice until the indicated conditions are fully understood and met.

Table Of Contents

Vector Modulation Analyzer Mode User's & Programmer's Reference	1
Table Of Contents	3
1 Documentation Roadmap	84
1.1 Products Covered by this Document	85
1.2 Additional Documentation	86
2 User Interface	88
2.1 Screen Tabs	89
2.1.1 Mode/Meas/View Dialog	90
2.1.1.1 Mode	91
2.1.1.2 Application Mode Remote Commands	94
Application Mode Catalog Query (Remote Command Only)	94
Current Application Model (Remote Command Only)	95
Current Application Revision (Remote Command Only)	95
Current Application Options (Remote Command Only)	96
Application Catalog Number of Entries (Remote Command Only)	96
Application Catalog Model Numbers (Remote Command Only)	96
Application Catalog Revision (Remote Command Only)	97
Application Catalog Options (Remote Command Only)	97
ESA SA compatibility command (Remote Command only)	97
GSM Mode compatibility command (Remote Command only)	98
SA compatibility command for EMC (Remote Command only)	98
Receiver compatibility command for EMC (Remote Command only)	98
APD compatibility command for EMC (Remote Command only)	98
IF Mode compatibility command for EMC (Remote Command only)	99
2.1.1.3 Measurement	99
2.1.1.4 View	99
2.1.1.5 Sequencer	101
2.1.1.6 Screen Name	104
2.1.1.7 Delete This Screen	105
2.1.1.8 Delete All But This Screen	105
2.1.1.9 89600 VSA	106
2.1.2 Add Screen	107
2.2 Meas Bar	109
2.3 Measurement Display	113

Table Of Contents

2.3.1 Window Title	113
2.3.2 Measurement Data	117
2.3.3 Annotation Hotspot	120
2.4 Menu Panel	122
2.4.1 Right-Click Menu	132
2.4.1.1 Add to User Menu	132
2.4.1.2 Help on this setting	132
2.4.2 User Menu	132
2.5 Cancel key	133
2.6 Onscreen Keyboard key	134
2.7 Touch On/Off Key	135
2.8 Tab key	136
2.9 Local Button	137
2.10 Control Bar	138
2.11 Windows	139
2.12 Undo/Redo	140
2.13 File Functions	144
2.13.1 File Explorer	144
2.14 Help	145
2.15 Status Bar	146
2.16 Block Diagram	154
2.17 View Editor	156
2.17.1 To Create a User View	160
2.17.2 To Resize or Rearrange Windows in a View	165
2.17.3 To Delete a Window from a View	168
2.17.4 To Save a User View	170
2.17.5 To Rename a User View	175
2.17.6 To Delete a User View	175
2.17.7 To Delete All User Views	175
2.17.8 Use Case: Displaying Marker and Peak Tables	175
2.17.9 View Editor Remote Commands	176
2.18 Multiscreen	177
2.18.1 Select Screen	179

2.18.2	Screen List (Remote only command)	180
2.19	Fullscreen	181
3	VMA Mode	182
3.1	Digital Demod Measurement	183
3.1.1	Index Sub-Fields	184
3.1.1.1	Summary of Result Types	185
3.1.1.2	Measurement Results for RI = 01 or Not Specified	186
3.1.1.3	Measurement Results for RI = 02	201
3.1.1.4	Measurement Results for RI = 06	203
3.1.1.5	Measurement Results for RI = 07	204
3.1.1.6	Measurement Results for RI = 08	205
3.1.1.7	Measurement Results for RI = 09	205
3.1.1.8	Measurement Results for RI = 10	206
3.1.1.9	Measurement Results for RI = 11	206
3.1.1.10	Measurement Results for RI = 12	207
3.1.1.11	Measurement Results for RI = 13	207
3.1.1.12	Measurement Results for RI = 14	207
3.1.1.13	Measurement Results for RI = 15	208
3.1.1.14	Measurement Results for RI = 16	208
3.1.1.15	Measurement Results for RI = 17	208
3.1.1.16	Measurement Results for RI = 20	209
3.1.1.17	Measurement Results for RI = 21	209
3.1.2	Views	209
3.1.2.1	Normal	210
3.1.2.2	Demod Traces	210
3.1.2.3	Demod Error	211
3.1.2.4	Result Summary	211
3.1.2.5	Eye Diagram	211
3.1.3	Windows	211
3.1.3.1	Data	212
Pre Demod		214
Raw Main Time		214
Search Time		214
Time		215

Table Of Contents

Spectrum	215
Demod	215
IQ Meas Time	215
IQ Ref Time	216
IQ Meas Spectrum	216
IQ Ref Spectrum	217
FSK Meas Time	217
FSK Ref Time	217
FSK Meas Spectrum	218
FSK Ref Spectrum	218
ASK Meas Time	218
ASK Ref Time	219
ASK Meas Spectrum	220
ASK Ref Spectrum	220
Demod Error	220
Error Vector Time	220
Error Vector Spectrum	220
Mag Error	221
Phase Error	221
FSK Error Time	221
FSK Error Spectrum	221
Mag Error (Carrier)	222
ASK Error Time	222
ASK Error Spectrum	222
Response	222
CH Freq Response	223
EQ Impulse Response	223
Tables	223
Metrics	223
Eye Diagram Metrics	223
Demod Bits	226
Frame Summary	226
Demod Traces	226
3.1.3.2 Selected Segment / Format	227
3.1.4 Amplitude	228
3.1.4.1 Y Scale	229
Auto Scale	229
Auto Scale at Restart	229
Ref Value	229
Scale/Div	230
Ref Position	230
3.1.4.2 Attenuation	231
Full Range Atten	233
Mech Atten	234
Elec Atten	236
Adjust Atten for Min Clipping	240
Adjust Atten	240

Pre-Adjust for Min Clipping	241
Mech Atten Step	245
3.1.4.3 Range (Non-attenuator models)	246
Range	246
Adjust Range for Min Clipping	247
Pre-Adjust for Min Clipping	247
Peak-to-Average Ratio	248
Mixer Lvl Offset	249
3.1.4.4 Range (Baseband Input models)	249
Range Auto/Man	250
I Range	251
Q Range	252
Q Same as I	253
3.1.4.5 Signal Path	254
Presel Center	254
Preselector Adjust	255
Internal Preamp	256
LNA	258
μ W Path Control	259
Allow Full Bypass in Auto	268
Software Preselection	269
SW Preselection Type	271
SW Preselection BW	271
High Freq Prefilter	272
3.1.5 BW	273
3.1.5.1 Settings	274
Info BW	274
3.1.6 Display	274
3.1.6.1 Meas Display	274
Demod Bits Format	275
Tx Pattern Display	275
Ideal State Shape	275
Ideal State Size	276
3.1.6.2 View	276
Views	276
User View	277
Restore Layout to Default	278
Save Layout as New View	278
Re-Save User View	278
Rename User View	279
Delete User View	279
Delete All User Views	279
View Editor Remote Commands	280
View Listing Query	280
User View Listing Query	280

Table Of Contents

3.1.6.3 Annotation	281
Graticule	281
Screen Annotation	281
Trace Annotation	282
Control Annotation	282
Meas Bar	282
Display Enable (Remote Command Only)	283
3.1.7 Frequency	284
3.1.7.1 Settings	284
Center Frequency	284
CF Step	287
3.1.8 Marker	288
3.1.8.1 Select Marker	288
3.1.8.2 Settings	289
Marker X	289
Marker Y	290
Marker Y Imag	290
Marker Mode	291
Delta Marker (Reset Delta)	292
Marker Settings Diagram	292
All Markers Off	292
Couple Markers	292
3.1.8.3 Peak Search	293
Marker X	293
Peak Search	293
Next Peak	293
Next Higher Amplitude	294
Next Pk Right	294
Next Pk Left	294
Minimum Peak	295
Pk-Pk Search	295
Marker Delta	295
3.1.8.4 Properties	296
Marker X	296
Relative To	296
Marker Window	297
Marker Settings Diagram	297
3.1.8.5 Marker Function	297
Marker X	297
Band Function	297
Band Span	298
Band Left	298
Band Right	299
3.1.8.6 Marker To	299

Marker X	299
Mkr -> CF	299
3.1.9 Meas Setup	300
3.1.9.1 Selected Segment	300
3.1.9.2 Settings	300
Avg Hold Number	300
Averaging On/Off	301
Averaging Mode	301
Spur Avoidance	301
Optimize EVM	303
EVM Optimization Method	303
Iterative EVM Optimization Target	304
Auto Couple	304
Meas Preset	306
3.1.9.3 Meas Standard	306
Preset to Std	306
3.1.9.4 Frame	322
Search Length	322
Segment Number	323
Capture Time Diagram (Segment Number = 1)	323
Symbol Rate	323
Burst Search	324
Search Length	324
Meas Interval	325
Segment Config Diagram (Segment Number >1)	326
Seg Name	326
Modulation Format	326
Symbol Rate	327
Meas Offset	328
Meas Interval	328
Meas Offset Reference	329
Equalizer	329
Sync Search	330
EQ Source	331
Burst Search	331
Burst Search Threshold	331
Sync Search	332
Sync Offset	332
Sync Pattern	333
3.1.9.5 Meas Time	333
Meas Interval	334
Meas Offset	334
Meas Offset Reference	334
3.1.9.6 Demod	335
Modulation Format	335
Symbol Rate	336

Table Of Contents

Points / Symbol	337
Meas Filter	337
Ref Filter	340
Alpha	340
BT	341
Advanced Setup	341
General	341
Equalizer	341
Filter Length	342
Convergence	343
Equalizer Hold	344
Equalizer Reset	344
FFT Window	345
Spectrum	345
Gain Imb/Quad Skew Coupling	346
Clock Adjust	346
IQ Rotation	347
IQ Normalize	347
Low SNR Enhancement	348
EVM Normalization Reference	348
IQ Offset Compensation	349
Report EVM in DB	350
Multi-Carrier Filter	350
FSK	351
Tx Frequency Offset	351
FSK Deviation Ref	351
APSK	352
APSK R2 / R1	352
APSK R3 / R1	353
CPM	354
CPM Auto	354
CPM Index	354
MSK	355
Differential Decoder Anchor State	355
OQPSK	355
OQPSK Align I & Q	355
Custom IQ	355
Sync Persistence Target	356
Phase Rotation	356
Shift	356
Differential	357
Offset	357
Insert Pilot	357
Pilot Repeat Cycle	358
Pilot Start Symbol	358
Pilot Active Symbols	358
Pilot Modulation	359
Constellation Settings (Except Custom IQ)	359
Constellation Settings (Custom IQ)	359

Preset To Standard Constellation	359
Axis Type	359
Go to Row	360
Insert Row Below	360
Delete Row	360
Clear Table	360
Phase Rotation	360
Apply Phase Rotation	360
Normalize RMS	361
Validate	361
User-Defined Filter Coefficient	361
User-Defined Meas Filter Coefficient List Data (Remote Command Only)	361
User-Defined Ref Filter Coefficient List Data (Remote Command Only)	361
3.1.9.7 Advanced	362
IF Gain	362
Other IF Gain	363
Spur Avoidance	363
LO Dither	364
PhNoise Opt	365
Mixing Mode	370
Spectrum Stitching	371
Cross-Correlated EVM	371
Multi Channel Config	371
Multi Channel Config	372
Input Channel IP address	372
Input Channel Instrument port	372
Lock	372
Channel Configuration Information (Remote Query only)	373
3.1.9.8 BER	373
BER	373
Total Bit Num	374
3.1.9.9 Limits	374
Limit Test	374
Edit Scalar Limits	375
Tx Power	375
RMS EVM	376
Frequency Error	376
Clock Error	377
RMS Offset EVM	377
Deviation Accuracy	378
Select Limit	378
Limit On/Off	378
Edit Trace Limit	379
Select Limit	379
Go to Row	379
Insert Row Below	379
X Axis Unit	380
Y Axis Unit	380

Table Of Contents

X Offset	381
Y Offset	381
Apply Offset to Limit Table	381
Delete Row	382
Delete Limit	382
Edit Trace Limit Settings	382
Select Limit	382
X Reference	383
Copy from Limit	383
Copy	384
Description	384
Comment	384
Apply to Window	384
Margin	385
Type	386
Delete All Limits	386
Limit Line Fail? (Remote Command Only)	386
Limit Line X List Data (Remote Command Only)	387
Number of Limit X List Points Query (Remote Query Only)	387
Limit Line Y List Data (Remote Command Only)	388
Number of Limit Y List Points Query (Remote Query Only)	388
Trace Fail (Remote Query Only)	389
3.1.9.10 Global	389
Global Center Freq	389
Restore Defaults	390
3.1.10 Sweep	390
3.1.10.1 Sweep/Control	390
Sweep/Measure	390
Restart	392
Pause/Resume	395
Abort (Remote Command Only)	395
3.1.10.2 X Scale	396
X Width	396
Ref Value	396
Ref Position	397
Auto Scaling	397
Symbol Interval	398
Time Unit	398
3.1.10.3 Recording	398
3.1.10.4 Playback	399
Playback Mode	400
Playback Start	401
Playback Stop	402
Step Forward	403
Sample Rate	403
3.1.11 Trace	403

3.1.11.1 Trace Align	404
Reference	404
Offset	405
Interval	406
3.2 Custom OFDM Measurement	408
3.2.1 Views	412
3.2.2 Windows	413
3.2.2.1 Data	413
Pre Demod	414
Raw Main Time	415
Spectrum	415
Demod	415
IQ Meas Time	415
IQ Ref Time	415
Demod Error	416
Error Vector Time	416
Error Vector Spectrum	416
RMS Error Vector Time	416
RMS Error Vector Spectrum	416
Common Pilot Error	417
Error Vector 3D	417
ccEVM vs Symbol	417
Response	417
CH Freq Response	417
EQ Impulse Response	417
Tables	418
Demod Results	418
Burst Info	418
3.2.2.2 Format	418
3.2.2.3 Component Carrier	419
3.2.3 Amplitude	419
3.2.3.1 Y Scale	419
Auto Scale	419
Auto Scale at Restart	420
Ref Value	420
Scale/Div	421
Ref Position	421
3.2.3.2 Attenuation	421
Full Range Atten	423
Mech Atten	424
Elec Atten	427
Adjust Atten for Min Clipping	431
Adjust Atten	431
Pre-Adjust for Min Clipping	432

Table Of Contents

Mech Atten Step	436
3.2.3.3 Range (Baseband Input models)	437
Range Auto/Man	437
I Range	438
Q Range	440
Q Same as I	441
3.2.3.4 Range (Non-attenuator models)	441
Range	442
Adjust Range for Min Clipping	442
Pre-Adjust for Min Clipping	442
Peak-to-Average Ratio	443
Mixer Lvl Offset	444
3.2.3.5 Signal Path	444
Presel Center	445
Preselector Adjust	446
Internal Preamp	447
LNA	449
μ W Path Control	450
Allow Full Bypass in Auto	459
Software Preselection	460
SW Preselection Type	462
SW Preselection BW	462
High Freq Prefilter	463
3.2.4 BW	464
3.2.5 Display	465
3.2.5.1 Meas Display	465
Display Null Subcarriers	465
Display Data Subcarriers	465
Display Pilot Subcarriers	465
Display Preamble Subcarriers	466
Display Sync Correlation in Percent	466
Display EVM in Percent (SCPI only)	466
3.2.5.2 View	467
View	467
User View	467
Restore Layout to Default	468
Save Layout as New View	468
Re-Save User View	468
Rename User View	469
Delete User View	469
Delete All User Views	469
View Editor Remote Commands	470
View Listing Query	470
User View Listing Query	470
3.2.5.3 Annotation	471

Graticule	471
Screen Annotation	471
Trace Annotation	472
Control Annotation	472
Meas Bar	472
Display Enable (Remote Command Only)	473
3.2.6 Frequency	474
3.2.6.1 Settings	474
Carrier Reference Frequency	474
3.2.7 Marker	475
3.2.7.1 Select Marker	475
3.2.7.2 Settings	475
Marker X	476
Marker Z	476
Marker Y	477
Marker Y Imag	478
Marker Mode	478
Delta Marker (Reset Delta)	479
Marker Settings Diagram	479
All Markers Off	479
Couple Markers	479
3.2.7.3 Peak Search	480
Marker X	480
Marker Z	480
Peak Search	480
Next Peak	481
Next Higher Amplitude	481
Next Pk Right	481
Next Pk Left	482
Minimum Peak	482
Pk-Pk Search	482
Marker Delta	483
3.2.7.4 Properties	483
Marker X	483
Relative To	483
Marker Window	484
Marker Settings Diagram	485
3.2.7.5 Marker Function	485
Marker X	485
Marker Function/Interval Function	485
Band Span/Interval Span	485
Band Left/Interval Left	486
Band Right/Interval Right	487
3.2.7.6 Marker To	488

Table Of Contents

Marker X	488
Mkr -> CF	488
3.2.8 Meas Setup	489
3.2.8.1 Component Carrier	489
3.2.8.2 Settings	489
Avg Hold Number	489
Averaging On/Off	489
Average Mode	490
Copy CC To	490
Spur Avoidance	491
Optimize EVM	492
EVM Optimization Method	492
Iterative EVM Optimization Target	493
Auto Couple	493
Meas Preset	495
3.2.8.3 Meas Standard	495
Preset to Std	495
3.2.8.4 Component Carrier	496
Measure Carrier	497
Frequency Offset	497
Bandwidth	497
Spectrum	498
Configure Comp Carriers	498
Configure CCs	498
Advanced Acquisition	498
Input Channel (GUI only)	499
Use Advanced Acquisition Table	499
IF Path Auto	499
Mechanical Attenuation	499
Elec Attenuation	500
LNA	500
Internal Preamp	500
uW Path Control	501
IF Gain	501
IF Path	502
3.2.8.5 Meas Time	502
Search Length	503
Result Length	503
Meas Interval	504
Meas Offset	504
Capture Time Diagram	504
Burst Search	504
Burst Search Threshold	505
3.2.8.6 Demod	505
Demod Settings	505

Format	506
Edit Guard Interval per Symbol	508
Edit Time Gaps	510
Edit Pilot IQ Values	512
Edit Preamble IQ Values	513
Resource Mapping	514
Equalizer & Tracking	517
Filter	521
Filter Type	521
Arbitrary	522
Remez	523
Windowed Sinc	523
Remez & Windowed Sinc	524
Advanced	525
Symbol Time Adjustment	525
Synchronization Mode	526
Synchronization Region Selection	526
Synchronization Reference Interval	526
Synchronization Reference Offset	527
Synchronization Search Interval	527
Synchronization Search Offset	528
Compensate Symbol Clock Error	528
EVM Normalized by Reference	528
Report EVM in DB	529
Extended Frequency Lock Range	529
Extended Frequency Lock Range Width	529
Phase Compensation Mode	530
Phase Compensation Frequency	530
Pilot in Time Domain	531
MIMO On/Off	531
MIMO Transmitter Antennas	531
MIMO Scheme	532
MIMO Type	532
Subcarrier Count Per Channel Estimation Unit	535
Symbol Count Per Channel Estimation Unit	535
3.2.8.7 Advanced	535
IF Gain	535
Other IF Gain	536
Adjust IF Gain For	537
Spur Avoidance	537
LO Dither	538
Phase Noise Optimization	539
Mixing Mode	544
Spectrum Stitching	545
Cross-Correlated EVM	545
Multi Channel Config	546
Multi Channel Config	546
Input Channel IP address	546
Input Channel Instrument port	546

Table Of Contents

Lock	546
Channel Configuration Information (Remote Query only)	547
3.2.9 Sweep	547
3.2.9.1 Sweep/Control	547
Sweep/Measure	547
Restart	549
Pause/Resume	552
Abort (Remote Command Only)	552
3.2.9.2 X Scale	553
X Width	553
Ref Value	554
Ref Position	554
Auto Scaling	554
3.2.9.3 Recording	555
3.2.9.4 Playback	556
Playback Mode	557
Playback Start	558
Playback Stop	559
Step Forward	559
Sample Rate	560
3.2.10 Trace	560
3.3 Monitor Spectrum Measurement	561
3.3.1 Views	561
3.3.1.1 Normal	561
3.3.2 Windows	562
3.3.2.1 Spectrum	562
3.3.3 Amplitude	564
3.3.3.1 Y Scale	564
Ref Value	564
Scale/Div	564
Scale Range	565
Ref Position	566
Auto Scaling	566
3.3.3.2 Attenuation	567
Full Range Atten	569
Mech Atten	570
Elec Atten	572
Adjust Atten for Min Clipping	576
Adjust Atten	576
Pre-Adjust for Min Clipping	577
Mech Atten Step	581

3.3.3.3 Range (Non-attenuator models)	582
Range	582
Adjust Range for Min Clipping	583
Pre-Adjust for Min Clipping	583
Peak-to-Average Ratio	584
Mixer Lvl Offset	585
3.3.3.4 Signal Path	585
Presel Center	585
Preselector Adjust	587
Internal Preamp	588
LNA	589
μ W Path Control	591
Allow Full Bypass in Auto	600
Software Preselection	601
SW Preselection Type	602
SW Preselection BW	603
High Freq Prefilter	604
3.3.4 BW	605
3.3.4.1 Settings	605
Res BW	605
Video BW	607
VBW:3dB RBW	608
Span:3dB RBW	610
3.3.5 Display	611
3.3.5.1 Meas Display	611
3.3.5.2 View	611
View	611
User View	612
Restore Layout to Default	612
Save Layout as New View	613
Re-Save User View	613
Rename User View	613
Delete User View	614
Delete All User Views	614
View Editor Remote Commands	614
View Listing Query	614
User View Listing Query	615
3.3.5.3 Annotation	615
Graticule	615
Screen Annotation	616
Trace Annotation	616
Control Annotation	617
Meas Bar	617
Display Enable (Remote Command Only)	617
3.3.6 Frequency	619

Table Of Contents

3.3.6.1 Settings	619
Center Frequency	619
Span	626
CF Step	628
3.3.7 Marker	629
3.3.7.1 Select Marker	629
3.3.7.2 Settings	630
Marker Frequency	630
Marker Mode	631
Delta Marker (Reset Delta)	632
Marker Settings Diagram	632
All Markers Off	632
Couple Markers	633
3.3.7.3 Peak Search	633
Marker Frequency	633
Peak Search	633
Next Peak	634
Marker Delta	634
3.3.7.4 Properties	635
Marker Frequency	635
Relative To	635
Marker Trace	636
Marker Settings Diagram	636
3.3.7.5 Marker Function	636
Marker Frequency	637
Marker Function	637
Band Span	637
Band Left	638
Band Right	638
3.3.8 Meas Setup	639
3.3.8.1 Settings	639
Avg Hold Num	639
Averaging On/Off	639
Average Mode	640
Spur Avoidance	640
Meas Setup Summary Table	641
Auto Couple	641
Meas Preset	643
3.3.8.2 Advanced	643
Noise Floor Extension	643
Conversion	645
Phase Noise Optimization	646
3.3.8.3 Global	646
Global Center Freq	647

Global EMC Std	647
Restore Defaults	648
3.3.9 Sweep	648
3.3.9.1 Sweep/Control	648
Sweep Time	648
Minimum Acquisition Time	650
Sweep/Measure	651
Restart	653
Pause/Resume	656
Abort (Remote Command Only)	656
Sweep Time Annotation (Remote Query Only)	657
3.3.9.2 Sweep Config	657
Points	657
Auto Sweep Points	659
3.3.10 Trace	659
3.3.10.1 Select Trace	659
3.3.10.2 Trace Control	660
Trace Type	660
Clear and Write Restart Averaging Restart Max/Min Hold	666
View/Blank	666
Trace Settings Table	669
Clear All Traces	669
3.3.10.3 Detector	669
Detector	669
Detector Select Auto/Man	670
3.4 IQ Waveform Measurement	672
3.4.1 Views	674
3.4.1.1 RF Envelope	674
3.4.1.2 I/Q Waveform	675
3.4.2 Windows	675
3.4.2.1 RF Envelope	675
3.4.2.2 Metrics	676
3.4.2.3 I/Q Waveform	676
3.4.3 Amplitude	677
3.4.3.1 Y Scale	677
Ref Value	677
Scale/Div	678
Scale Range	679
Ref Position	680
Auto Scaling	681

Table Of Contents

3.4.3.2 Attenuation	682
Full Range Atten	684
Mech Atten	685
Elec Atten	688
Adjust Atten for Min Clipping	691
Adjust Atten	692
Pre-Adjust for Min Clipping	692
Mech Atten Step	696
3.4.3.3 Range (Baseband Input models)	697
Range Auto/Man	697
I Range	698
Q Range	700
Q Same as I	701
3.4.3.4 Range (Non-attenuator models)	701
Range	702
Adjust Range for Min Clipping	702
Pre-Adjust for Min Clipping	702
Peak-to-Average Ratio	703
Mixer Lvl Offset	704
3.4.3.5 Signal Path	704
Presel Center	705
Preselector Adjust	706
Internal Preamp	707
LNA	709
μ W Path Control	710
Allow Full Bypass in Auto	719
Software Preselection	720
SW Preselection Type	722
SW Preselection BW	722
High Freq Prefilter	723
3.4.4 BW	724
3.4.4.1 Settings	725
Digital IF BW	725
Filter Type	727
Filter BW	729
Filter Alpha	729
Channel Filter Bandwidth (Backwards Compatibility Remote Command Only)	730
3.4.5 Display	730
3.4.5.1 View	730
View	730
User View	730
Restore Layout to Default	731
Save Layout as New View	731
Re-Save User View	732
Rename User View	732

Delete User View	732
Delete All User Views	733
View Editor Remote Commands	733
View Listing Query	733
User View Listing Query	734
3.4.5.2 Annotation	734
Graticule	734
Screen Annotation	735
Trace Annotation	735
Control Annotation	736
Meas Bar	736
Display Enable (Remote Command Only)	736
3.4.6 Frequency	738
3.4.6.1 Settings	738
Center Frequency	738
CF Step	744
3.4.7 Marker	744
3.4.7.1 Select Marker	745
3.4.7.2 Settings	745
Marker Time	745
Marker Mode	747
Delta Marker (Reset Delta)	748
Marker Settings Diagram	748
All Markers Off	749
Couple Markers	749
3.4.7.3 Peak Search	749
Marker Time	750
Peak Search	750
Next Peak	750
Minimum Peak	750
Marker Delta	751
3.4.7.4 Pk Search Config	751
Peak Search Range	751
Peak Search Range Start	752
Peak Search Range Stop	752
3.4.7.5 Marker Function	752
Marker Time	753
Interval Function	753
Interval Span	754
Interval Left	754
Interval Right	754
3.4.7.6 Properties	755
Marker Time	755
Relative To	755

Table Of Contents

Marker Trace	756
Marker Settings Diagram	756
3.4.8 Meas Setup	756
3.4.8.1 Settings	756
Avg/Hold Number (Averaging On/Off)	757
Average Mode	757
Average Type	758
Time Avg Num	759
Meas Time	760
Sample Rate	760
Meas Setup Summary Table	761
Spur Avoidance	762
Auto Couple	765
Meas Preset	767
3.4.8.2 Advanced	767
Phase Noise Optimization	767
ADC Dither	773
LO Dither	774
IF Gain	774
IF Gain Offset	776
Other IF Gain	776
Mixing Mode	777
Invert Spectrum	779
Power Reference Plane	779
Mixing Mode State (Remote Command Only)	780
IF Frequency (Remote Command Only)	781
3.4.8.3 Global	781
Global Center Freq	781
Global EMC Std	782
Restore Defaults	783
3.4.8.4 Sample Period (Aperture) Setting (Remote Query Only)	783
3.4.9 Sweep	783
3.4.9.1 Sweep/Control	783
Restart	783
Pause/Resume	786
Sweep/Measure	786
Abort (Remote Command Only)	788
3.4.9.2 X Scale	789
Ref Value	789
Scale/Div	789
Ref Position	790
Auto Scaling	790
3.4.10 Trace	791
3.5 Channel Power Measurement	792

3.5.1 Views	798
3.5.1.1 Normal	798
3.5.1.2 Carrier Info	799
3.5.2 Windows	799
3.5.2.1 Graph	799
3.5.2.2 Metrics	800
3.5.2.3 Gate	804
3.5.2.4 Marker Table	804
3.5.3 Amplitude	804
3.5.3.1 Y Scale	804
Ref Value	804
Scale/Div	805
Scale Range	806
Ref Position	806
Auto Scaling	806
3.5.3.2 Attenuation	807
Full Range Atten	809
Mech Atten	810
Elec Atten	813
Adjust Atten for Min Clipping	817
Adjust Atten	817
Pre-Adjust for Min Clipping	818
Mech Atten Step	822
3.5.3.3 Range (Non-attenuator models)	823
Range	823
Adjust Range for Min Clipping	824
Pre-Adjust for Min Clipping	824
Peak-to-Average Ratio	825
Mixer Lvl Offset	826
3.5.3.4 Signal Path	826
Presel Center	826
Preselector Adjust	828
Internal Preamp	829
LNA	830
μ W Path Control	832
Allow Full Bypass in Auto	841
Software Preselection	842
SW Preselection Type	843
SW Preselection BW	844
High Freq Prefilter	845
3.5.4 BW	846
3.5.4.1 Settings	846

Table Of Contents

Res BW	847
Video BW	849
RBW Filter Type	851
3.5.5 Display	852
3.5.5.1 Meas Display	852
Bar Graph On/Off	852
3.5.5.2 Annotation	852
Graticule	852
Screen Annotation	853
Trace Annotation	853
Control Annotation	854
Meas Bar	854
Display Enable (Remote Command Only)	854
3.5.5.3 View	856
View	856
User View	856
Restore Layout to Default	857
Save Layout as New View	857
Re-Save User View	857
Rename User View	857
Delete User View	858
Delete All User Views	858
View Editor Remote Commands	858
View Listing Query	859
User View Listing Query	859
3.5.6 Frequency	859
3.5.6.1 Settings	860
Center Frequency	860
Span	865
CF Step	869
Full Span (Remote Command Only)	869
3.5.7 Marker	870
3.5.7.1 Select Marker	870
3.5.7.2 Settings	870
Marker Frequency	870
Marker Mode	872
Delta Marker (Reset Delta)	873
Marker Settings Diagram	873
All Markers Off	873
3.5.7.3 Peak Search	873
Marker Frequency	874
Peak Search	874
Marker Delta	874

3.5.7.4 Properties	874
Marker Frequency	875
Relative To	875
Marker Trace	875
Marker Settings Diagram	876
3.5.8 Meas Setup	876
3.5.8.1 Settings	876
Avg/Hold Number	876
Averaging On/Off	877
Avg Mode	877
Integ BW	878
PSD Unit	879
IF Gain	879
Spur Avoidance	880
Meas Setup Summary Table	880
Auto Couple	881
Meas Preset	882
3.5.8.2 Meas Method	883
Meas Method	883
RRC Filter Alpha	883
RRC Filter BW	884
3.5.8.3 Limits	884
Power Limit	884
PSD Limit	885
Power Limit Fail (Remote Query Only)	886
PSD Limit Fail (Remote Query only)	887
3.5.8.4 Advanced	887
Phase Noise Optimization	887
Noise Floor Extension	893
3.5.8.5 Global	897
Global Center Freq	897
Global EMC Std	898
Restore Defaults	898
3.5.9 Sweep	899
3.5.9.1 Sweep/Control	899
Sweep Time	899
Minimum Acquisition Time	901
Sweep/Measure	902
Restart	904
Pause/Resume	907
Abort (Remote Command Only)	907
Sweep Time Annotation (Remote Query Only)	908
3.5.9.2 Sweep Config	908
Sweep Time Rules	908

Table Of Contents

Points	909
IF Dithering	910
Image Protection	910
3.5.10 Trace	911
3.5.10.1 Select Trace	911
3.5.10.2 Trace Control	911
Trace Type	912
Clear and Write Restart Averaging Restart Max/Min Hold	917
View/Blank	917
3.5.10.3 Math	920
Math Function	920
Operand 1 / Operand 2	926
Offset	927
Reference	927
3.5.10.4 Detector	927
Detector	927
Detector Select Auto/Man	929
3.5.10.5 Trace Function	929
From Trace	930
To Trace	930
Copy	930
Exchange	931
Preset All Traces	931
Clear All Traces	931
3.5.10.6 Advanced	932
Measure Trace	932
3.6 Occupied BW Measurement	933
3.6.1 Views	935
3.6.1.1 OBW Results	936
3.6.1.2 OBW Boundaries	937
3.6.1.3 Gate	937
3.6.2 Windows	937
3.6.2.1 Graph	937
3.6.2.2 Metrics - OBW Results	938
3.6.2.3 Metrics - OBW Boundaries	940
3.6.2.4 Gate	941
3.6.3 Amplitude	942
3.6.3.1 Y Scale	942
Ref Value	942

Scale/Div	942
Scale Range	943
Ref Level Offset	944
Ref Position	944
Auto Scaling	945
3.6.3.2 Attenuation	945
Full Range Atten	947
Mech Atten	948
Elec Atten	951
Adjust Atten for Min Clipping	955
Adjust Atten	955
Pre-Adjust for Min Clipping	956
Mech Atten Step	960
3.6.3.3 Range (Non-attenuator models)	961
Range	961
Adjust Range for Min Clipping	962
Pre-Adjust for Min Clipping	962
Peak-to-Average Ratio	963
Mixer Lvl Offset	964
3.6.3.4 Signal Path	964
Presel Center	964
Preselector Adjust	966
Internal Preamp	967
LNA	968
μ W Path Control	970
Allow Full Bypass in Auto	979
Software Preselection	980
SW Preselection Type	981
SW Preselection BW	982
High Freq Prefilter	983
3.6.4 BW	984
3.6.4.1 Settings	984
Res BW	985
Video BW	986
RBW Filter Type	987
3.6.5 Display	988
3.6.5.1 Meas Display	988
x dB BW Boundaries On/Off	988
Boundary Frequency	989
3.6.5.2 Annotation	989
Graticule	989
Screen Annotation	990
Trace Annotation	990
Control Annotation	991
Meas Bar	991

Table Of Contents

Display Enable (Remote Command Only)	991
3.6.5.3 View	993
View	993
User View	993
Restore Layout to Default	994
Save Layout as New View	994
Re-Save User View	994
Rename User View	995
Delete User View	995
Delete All User Views	995
View Editor Remote Commands	996
View Listing Query	996
User View Listing Query	996
3.6.6 Frequency	997
3.6.6.1 Settings	997
Center Frequency	997
Span	1003
CF Step	1004
Full Span (Remote Command Only)	1005
3.6.7 Marker	1005
3.6.7.1 Select Marker	1005
3.6.7.2 Settings	1006
Marker Frequency	1006
Marker Mode	1007
Delta Marker (Reset Delta)	1008
Marker Settings Diagram	1008
All Markers Off	1008
3.6.7.3 Peak Search	1009
Marker Frequency	1009
Peak Search	1009
Marker Delta	1010
3.6.7.4 Properties	1010
Marker Frequency	1010
Relative To	1010
Marker Trace	1011
Marker Settings Diagram	1011
3.6.8 Meas Setup	1012
3.6.8.1 Settings	1012
Avg/Hold Num	1012
Averaging On/Off	1012
Average Mode	1013
% of OBW Power	1013
Power Ref	1014
x dB	1014

Power Integration Method	1015
Spur Avoidance	1015
Meas Setup Summary Table	1016
Auto Couple	1016
Meas Preset	1018
Max Hold (Remote Command Only)	1018
3.6.8.2 Limits	1019
Limit	1019
Limit Test	1020
Bandwidth	1020
3.6.8.3 Advanced	1021
Noise Floor Extension	1021
IF Gain	1026
3.6.8.4 Global	1027
Global Center Freq	1027
Global EMC Std	1028
Restore Defaults	1028
3.6.9 Sweep	1029
3.6.9.1 Sweep/Control	1029
Sweep Time	1029
Minimum Acquisition Time	1031
Sweep/Measure	1032
Restart	1034
Pause/Resume	1037
Abort (Remote Command Only)	1037
Sweep Time Annotation (Remote Query Only)	1038
3.6.9.2 Sweep Config	1038
Sweep Time Rules	1038
Points	1039
IF Dithering	1040
Image Protection	1040
3.6.10 Trace	1041
3.6.10.1 Select Trace	1047
3.6.10.2 Trace Control	1047
Trace Type	1048
Clear and Write Restart Averaging Restart Max/Min Hold	1053
View/Blank	1053
3.6.10.3 Math	1056
Math Function	1056
Operand 1 / Operand 2	1062
Offset	1063
Reference	1063
3.6.10.4 Detector	1063

Table Of Contents

Detector	1063
Detector Select Auto/Man	1065
3.6.10.5 Trace Function	1065
From Trace	1066
To Trace	1066
Copy	1066
Exchange	1067
Preset All Traces	1067
Clear All Traces	1067
3.6.10.6 Advanced	1068
Measure Trace	1068
3.7 Power Stat CCDF Measurement	1069
3.7.1 Views	1071
3.7.1.1 Normal	1072
3.7.2 Windows	1072
3.7.2.1 Graph	1072
3.7.2.2 Metrics	1073
3.7.3 Amplitude	1075
3.7.3.1 Y Scale	1075
Minimum Probability	1075
3.7.3.2 Attenuation	1076
Full Range Atten	1078
Mech Atten	1079
Elec Atten	1082
Adjust Atten for Min Clipping	1086
Adjust Atten	1086
Pre-Adjust for Min Clipping	1086
Mech Atten Step	1090
3.7.3.3 Range (Baseband Input models)	1091
Range Auto/Man	1091
I Range	1092
Q Range	1094
Q Same as I	1095
3.7.3.4 Range (Non-attenuator models)	1095
Range	1096
Adjust Range for Min Clipping	1096
Pre-Adjust for Min Clipping	1096
Peak-to-Average Ratio	1097
Mixer Lvl Offset	1098
3.7.3.5 Signal Path	1098
Presel Center	1099
Preselector Adjust	1100

Internal Preamp	1101
LNA	1103
μ W Path Control	1104
Allow Full Bypass in Auto	1113
Software Preselection	1114
SW Preselection Type	1116
SW Preselection BW	1116
High Freq Prefilter	1117
3.7.4 BW	1118
3.7.4.1 Settings	1118
Info BW	1119
3.7.5 Display	1120
3.7.5.1 View	1120
View	1120
User View	1120
Restore Layout to Default	1121
Save Layout as New View	1121
Re-Save User View	1122
Rename User View	1122
Delete User View	1122
Delete All User Views	1123
View Editor Remote Commands	1123
View Listing Query	1123
User View Listing Query	1124
3.7.5.2 Annotation	1124
Graticule	1124
Screen Annotation	1125
Trace Annotation	1125
Control Annotation	1126
Meas Bar	1126
Display Enable (Remote Command Only)	1126
3.7.6 Frequency	1128
3.7.6.1 Settings	1128
Center Frequency	1128
CF Step	1134
Adjust Center Frequency to Carrier Config	1135
3.7.7 Marker	1135
3.7.7.1 Select Marker	1135
3.7.7.2 Settings	1136
Marker X-Axis Value	1136
Marker Mode	1137
Delta Marker (Reset Delta)	1138
Marker Settings Diagram	1138
All Markers Off	1138

Table Of Contents

Couple Markers	1138
3.7.7.3 Properties	1138
Marker X-Axis Value	1139
Relative To	1139
Marker Trace	1139
Marker Settings Diagram	1140
3.7.8 Meas Setup	1140
3.7.8.1 Settings	1140
Counts	1140
Meas Cycles	1141
Meas Interval	1141
Meas Setup Summary Table	1141
Auto Couple	1142
Meas Preset	1143
3.7.8.2 Advanced	1144
IF Gain	1144
IF Upsampling Ratio	1145
3.7.8.3 Global	1145
Global Center Freq	1145
Global EMC Std	1146
Restore Defaults	1147
3.7.9 Sweep	1147
3.7.9.1 Sweep/Control	1147
Sweep/Measure	1147
Restart	1149
Pause/Resume	1152
Abort (Remote Command Only)	1152
3.7.9.2 X Scale	1153
Scale/Div	1153
3.7.10 Trace	1153
3.7.10.1 Trace Control	1153
Store Ref Trace	1153
Ref Trace	1154
Gaussian Line	1154
3.8 ACP Measurement	1155
3.8.1 Measurement Results for n = 1, or no Index Specified	1158
3.8.2 Measurement Results for n = 2	1161
3.8.3 Measurement Results for n = 3	1162
3.8.4 Measurement Results for n = 7	1163
3.8.5 Measurement Results for n = 8	1164

3.8.6 Views	1166
3.8.6.1 Normal	1167
3.8.6.2 Carrier Info	1167
3.8.7 Windows	1167
3.8.7.1 Graph	1167
3.8.7.2 Metrics	1168
3.8.7.3 Gate	1171
3.8.7.4 Marker Table	1171
3.8.8 Amplitude	1171
3.8.8.1 Y Scale	1172
Ref Value	1172
Scale/Div	1172
Scale Range	1173
Ref Position	1173
Auto Scaling	1174
3.8.8.2 Attenuation	1174
Full Range Atten	1176
Mech Atten	1177
Elec Atten	1180
Adjust Atten for Min Clipping	1184
Adjust Atten	1184
Pre-Adjust for Min Clipping	1185
Mech Atten Step	1189
3.8.8.3 Range (Non-attenuator models)	1190
Range	1190
Adjust Range for Min Clipping	1191
Pre-Adjust for Min Clipping	1191
Peak-to-Average Ratio	1192
Mixer Lvl Offset	1193
3.8.8.4 Signal Path	1193
Presel Center	1193
Preselector Adjust	1195
Internal Preamp	1196
LNA	1197
μ W Path Control	1199
Allow Full Bypass in Auto	1208
Software Preselection	1209
SW Preselection Type	1210
SW Preselection BW	1211
High Freq Prefilter	1212
3.8.9 BW	1213
3.8.9.1 Settings	1213

Table Of Contents

Res BW	1214
Video BW	1216
RBW Filter Type	1217
RBW Filter BW	1218
3.8.10 Display	1219
3.8.10.1 Meas Display	1219
Bar Graph On/Off	1219
3.8.10.2 Annotation	1219
Graticule	1219
Screen Annotation	1220
Trace Annotation	1220
Control Annotation	1221
Meas Bar	1221
Display Enable (Remote Command Only)	1221
3.8.10.3 View	1223
View	1223
User View	1223
Restore Layout to Default	1224
Save Layout as New View	1224
Re-Save User View	1224
Rename User View	1225
Delete User View	1225
Delete All User Views	1225
View Editor Remote Commands	1226
View Listing Query	1226
User View Listing Query	1226
3.8.11 Frequency	1227
3.8.11.1 Settings	1227
Center Frequency	1227
Span	1232
CF Step	1235
3.8.12 Marker	1236
3.8.12.1 Select Marker	1236
3.8.12.2 Settings	1236
Marker Frequency	1236
Marker Mode	1238
Delta Marker (Reset Delta)	1239
Marker Settings Diagram	1239
All Markers Off	1239
Couple Markers	1239
3.8.12.3 Peak Search	1240
Marker Frequency	1240
Peak Search	1240
Next Peak	1241

Next Pk Right	1241
Next Pk Left	1241
Minimum Peak	1241
Pk-Pk Search	1242
Marker Delta	1242
3.8.12.4 Properties	1242
Marker Frequency	1243
Relative To	1243
Marker Trace	1243
Marker Settings Diagram	1244
3.8.13 Meas Setup	1244
3.8.13.1 Settings	1244
Avg Hold Number	1245
Averaging On/Off	1245
Avg Mode	1246
Meas Method	1246
Carrier/Offset/Limits Config	1248
Carrier	1248
Number of Carriers	1248
Couple to #1	1248
Carrier Pwr Present	1249
Carrier Spacing	1250
Measurement Noise Bandwidth	1251
Method for Carrier	1252
Filter Alpha for Carrier	1252
Offset	1253
Offset Frequency Define	1253
Offset Freq	1256
Integ BW	1258
Offset Side	1259
Method	1260
Filter Alpha	1261
Advanced (Offset)	1261
Offset Freq	1261
Res BW	1262
Video BW	1263
Filter Type	1264
Filter BW	1264
Limits	1265
Limit Test	1265
Offset Freq	1265
Abs Limit	1265
Rel Limit (Car)	1266
Positive Offset Limit (Remote Command only)	1267
Negative Offset Limit (Remote Command only)	1268
Rel Limit (PSD)	1269
Fail Mask	1270
Offset Frequency Define	1271

Table Of Contents

Offset Freq	1273
Integ BW	1275
Offset Side	1275
Method	1276
Filter Alpha	1277
Offset Freq	1277
Res BW	1277
Video BW	1278
Filter Type	1279
Filter BW	1279
Power Ref Type	1280
Limit Test	1281
Offset Freq	1282
Abs Limit	1282
Rel Limit (Car)	1282
Rel Limit (PSD)	1283
Fail Mask	1284
Max Num of Offsets	1285
Limit Test	1285
Spur Avoidance	1286
Meas Setup Summary Table	1286
Auto Couple	1287
Meas Preset	1288
3.8.13.2 Reference	1289
Number of Carriers	1289
Carrier/Offset/Limits Config	1289
Carrier	1290
Number of Carriers	1290
Couple to #1	1290
Carrier Pwr Present	1291
Carrier Spacing	1292
Measurement Noise Bandwidth	1292
Method for Carrier	1293
Filter Alpha for Carrier	1294
Offset	1295
Offset Frequency Define	1295
Offset Freq	1298
Integ BW	1300
Offset Side	1301
Method	1302
Filter Alpha	1303
Advanced (Offset)	1303
Offset Freq	1303
Res BW	1304
Video BW	1305
Filter Type	1306
Filter BW	1306
Limits	1307
Limit Test	1307

Offset Freq	1307
Abs Limit	1307
Rel Limit (Car)	1308
Positive Offset Limit (Remote Command only)	1309
Negative Offset Limit(Remote Command only)	1310
Rel Limit (PSD)	1311
Fail Mask	1312
Offset Frequency Define	1313
Offset Freq	1315
Integ BW	1317
Offset Side	1317
Method	1318
Filter Alpha	1319
Offset Freq	1319
Res BW	1319
Video BW	1320
Filter Type	1321
Filter BW	1321
Power Ref Type	1322
Limit Test	1323
Offset Freq	1324
Abs Limit	1324
Rel Limit (Car)	1324
Rel Limit (PSD)	1325
Fail Mask	1326
Reference Carrier (Carrier Index)	1327
Ref Carrier Freq	1329
Measurement Type	1330
Power Ref	1331
Total Power Ref	1335
PSD Ref	1336
PSD Unit	1338
3.8.13.3 Advanced	1339
Phase Noise Opt	1339
Noise Correction	1345
Noise Floor Extension	1346
Fast Power RBW Mode	1351
Fast Power IF Gain Offset	1351
Integration BW	1351
3.8.13.4 Global	1352
Global Center Freq	1352
Global EMC Std	1353
Restore Defaults	1353
3.8.13.5 Offset RRC Weighting (Backwards Compatibility SCPI)	1354
3.8.13.6 Offset Filter Alpha (Backward Compatibility SCPI)	1354
3.8.13.7 Method for Carrier (Backward Compatibility SCPI)	1354

Table Of Contents

3.8.14 Sweep	1355
3.8.14.1 Sweep/Control	1355
Sweep Time	1355
Minimum Acquisition Time	1357
Sweep/Measure	1358
Restart	1360
Pause/Resume	1363
Abort (Remote Command Only)	1363
Sweep Time Annotation (Remote Query Only)	1364
3.8.14.2 Sweep Config	1364
Sweep Time Rules	1364
Points	1365
3.8.14.3 X Scale	1366
Auto Scaling	1367
3.8.15 Trace	1367
3.8.15.1 Select Trace	1367
3.8.15.2 Trace Control	1368
Trace Type	1368
Clear and Write Restart Averaging Restart Max/Min Hold	1373
View/Blank	1374
3.8.15.3 Math	1376
Math Function	1377
Operand 1 / Operand 2	1383
Offset	1384
Reference	1384
3.8.15.4 Detector	1384
Detector	1384
Detector Select Auto/Man	1386
3.8.15.5 Trace Function	1387
From Trace	1387
To Trace	1387
Copy	1387
Exchange	1388
Preset All Traces	1388
Clear All Traces	1388
3.8.15.6 Advanced	1389
Measure Trace	1389
3.9 SEM Measurement	1390
3.9.1 Results for n = 1	1392
3.9.2 Results for n = 2-4	1393
3.9.3 Results for n = 5	1393

3.9.4 Results for n = 6	1394
3.9.5 Results for n = 7-11	1395
3.9.6 Results for n = 12	1397
3.9.7 Results for n = 14	1397
3.9.8 Results for n = 15	1398
3.9.9 Results for n = 18-20	1399
3.9.10 Number of Offsets	1399
3.9.11 Views	1399
3.9.11.1 Abs Pwr Freq	1401
3.9.11.2 Rel Pwr Freq	1401
3.9.11.3 Integrated Power	1401
3.9.12 Windows	1401
3.9.12.1 Graph	1402
Graph Window in Abs Pwr Freq View	1402
Graph Window in Rel Pwr Freq View	1403
Graph Window in Integrated Power View	1404
Graph Window in Carrier Info View	1405
3.9.12.2 Table	1407
Table Window in Abs Pwr Freq View	1407
Table Window in Rel Pwr Freq View	1410
Table Window in Integrated Power View	1413
Table Window in Carrier Info View	1416
3.9.12.3 Gate	1417
3.9.13 Amplitude	1417
3.9.13.1 Y Scale	1418
Ref Value	1418
Scale/Div	1418
Scale Range	1419
Ref Position	1419
Auto Scaling	1420
3.9.13.2 Attenuation	1420
Full Range Atten	1422
Mech Atten	1423
Elec Atten	1426
Adjust Atten for Min Clipping	1430
Adjust Atten	1430
Pre-Adjust for Min Clipping	1431
Mech Atten Step	1435
3.9.13.3 Range (Non-attenuator models)	1436
Range	1436

Table Of Contents

Adjust Range for Min Clipping	1437
Pre-Adjust for Min Clipping	1437
Peak-to-Average Ratio	1438
Mixer Lvl Offset	1439
3.9.13.4 Signal Path	1439
Presel Center	1439
Preselector Adjust	1441
Internal Preamp	1442
LNA	1443
μ W Path Control	1445
Allow Full Bypass in Auto	1454
Software Preselection	1455
SW Preselection Type	1456
SW Preselection BW	1457
High Freq Prefilter	1458
3.9.14 BW	1459
3.9.14.1 Settings	1459
RBW Filter Type	1459
3.9.15 Display	1460
3.9.15.1 Meas Display	1460
Limit Lines	1460
3.9.15.2 Annotation	1461
Graticule	1461
Screen Annotation	1461
Trace Annotation	1462
Control Annotation	1462
Meas Bar	1463
Display Enable (Remote Command Only)	1463
3.9.15.3 View	1464
3.9.16 Frequency	1464
3.9.16.1 Settings	1465
Center Frequency	1465
CF Step	1470
3.9.17 Marker	1471
3.9.17.1 Select Marker	1471
3.9.17.2 Settings	1472
Marker Frequency	1472
Marker Mode	1473
All Markers Off	1474
Couple Markers	1474
3.9.17.3 Properties	1474
Marker Frequency	1474

Marker Trace	1475
3.9.18 Meas Setup	1475
3.9.18.1 Settings	1475
Avg/Hold Num	1475
Continue Averaging	1476
SEM Terminal Count (Remote Query Only)	1476
Averaging On/Off	1477
Meas Method	1477
RRC Filter Alpha	1478
Non-Contiguous Meas Region	1478
Sweep Type Rules	1478
Mask State	1479
Mask Standard	1480
Spur Avoidance	1481
Offset/Limits Config Table	1481
Offset (Bandwidth)	1482
Offset Freq Define	1483
Offset Detector	1487
Offset Average Type (Remote Command Only)	1488
Start Freq	1489
Stop Freq	1493
Res BW	1495
Meas BW	1497
Video BW	1498
VBW/RBW	1499
Offset (Sweep)	1500
Offset Freq Define	1500
Offset Detector	1501
Start Freq	1501
Stop Freq	1501
Sweep Time	1501
Minimum Acquisition Time	1502
Sweep Time Annotation (Remote Query Only)	1503
Sweep Type	1504
Offset Side	1505
Limits	1506
Start Freq	1506
Stop Freq	1507
Abs Start	1507
Abs Stop	1509
Rel Start	1513
Rel Stop	1515
Fail Mask	1517
Show Abs2 Limit	1519
Abs2 Start	1519
Abs2 Stop	1520
Fail Mask2	1521
Inner Offset (BW)	1522

Table Of Contents

Offset Freq Define	1522
Offset Detector	1525
Cumulate Mask	1525
Cumulate Mask Stop Frequency	1526
Start Freq	1526
Stop Freq	1527
Res BW	1528
Meas BW	1529
Video BW	1530
VBW/RBW	1531
Inner Offset (Sweep)	1532
Offset Freq Define	1532
Offset Detector	1532
Cumulate Mask	1532
Cumulate Mask Stop Frequency	1532
Start Freq	1532
Stop Freq	1532
Sweep Time	1532
Minimum Acquisition Time	1534
Sweep Time Annotation (Remote Query Only)	1535
Sweep Type	1535
Offset Side	1536
Inner Offset (Limits)	1537
Start Freq	1537
Stop Freq	1537
Abs Start	1538
Abs Stop	1539
Rel Start	1540
Rel Stop	1541
Fail Mask	1541
Show Abs2 Limit	1542
Abs2 Start	1542
Abs2 Stop	1543
Fail Mask2	1544
Meas Setup Summary Table	1545
Auto Couple	1545
Meas Preset	1547
3.9.18.2 Carrier	1547
Integ BW	1547
Span	1548
Sweep Time	1550
Minimum Acquisition Time	1552
Sweep Time Annotation (Remote Query Only)	1553
Sweep Type	1553
Res BW	1554
Video BW	1556
VBW/RBW	1557
Channel Detector	1558
Reference Carrier Average Type (Remote Command Only)	1559

Offset/Limits Config Table	1559
3.9.18.3 Reference	1559
Measurement Type	1559
Reference Power	1560
Power Ref	1560
Carrier Index	1566
Total Power Ref	1566
PSD Ref	1567
Spectrum Pk Ref	1567
Measure All Ref Carriers	1568
Offset/Limits Config Table	1568
3.9.18.4 Advanced	1568
Noise Floor Extension	1569
Enable Wideband IF for FFT	1572
3.9.18.5 Global	1573
Global Center Freq	1573
Global EMC Std	1574
Restore Defaults	1575
3.9.19 Sweep	1575
3.9.19.1 Sweep/Control	1575
Sweep/Measure	1575
Restart	1577
Pause/Resume	1580
Abort (Remote Command Only)	1580
3.9.19.2 X Scale	1581
Ref Value	1581
Scale/Div	1581
Ref Position	1582
Auto Scaling	1582
3.9.19.3 Sweep Config	1582
Points	1583
IF Dithering	1583
Image Protection	1583
3.9.20 Trace	1584
3.9.20.1 Select Trace	1584
3.9.20.2 Trace Control	1584
Trace Type	1585
Clear and Write Restart Averaging Restart Max/Min Hold	1590
View/Blank	1590
3.9.20.3 Math	1593
Math Function	1593
Operand 1 / Operand 2	1599
Offset	1600

Table Of Contents

Reference	1600
3.9.20.4 Trace Function	1600
From Trace	1601
To Trace	1601
Copy	1601
Exchange	1602
Preset All Traces	1602
Clear All Traces	1602
3.9.20.5 Advanced	1603
Measure Trace	1603
3.10 Spurious Emissions Measurement	1604
3.10.1 Views	1606
3.10.1.1 Graph + Metrics	1606
3.10.1.2 All Ranges	1606
3.10.2 Windows	1607
3.10.2.1 Graph	1607
3.10.2.2 Table	1608
3.10.2.3 All Range Table	1609
3.10.2.4 Gate	1610
3.10.2.5 Marker Table	1610
3.10.3 Amplitude	1610
3.10.3.1 Y Scale	1610
Ref Value	1611
Scale/Div	1611
Scale Range	1612
Ref Position	1612
Auto Scaling	1612
3.10.3.2 Attenuation	1613
Full Range Atten	1615
Mech Atten	1616
Elec Atten	1619
Adjust Atten for Min Clipping	1623
Adjust Atten	1623
Pre-Adjust for Min Clipping	1624
Mech Atten Step	1628
3.10.3.3 Range (Non-attenuator models)	1629
Range	1629
Adjust Range for Min Clipping	1630
Pre-Adjust for Min Clipping	1630
Peak-to-Average Ratio	1631
Mixer Lvl Offset	1632

3.10.3.4 Signal Path	1632
Presel Center	1632
Preselector Adjust	1634
Internal Preamp	1635
LNA	1636
μ W Path Control	1638
Allow Full Bypass in Auto	1647
Software Preselection	1648
SW Preselection Type	1649
SW Preselection BW	1650
High Freq Prefilter	1651
3.10.4 BW	1652
3.10.5 Display	1652
3.10.5.1 Meas Display	1652
Center Frequency On/Off	1652
3.10.5.2 Annotation	1653
Graticule	1653
Screen Annotation	1653
Trace Annotation	1654
Control Annotation	1654
Meas Bar	1655
Display Enable (Remote Command Only)	1655
3.10.5.3 View	1656
Views	1656
Graph + Metrics	1657
All Ranges	1657
User View	1657
Restore Layout to Default	1658
Save Layout as New View	1658
Re-Save User View	1659
Rename User View	1659
Delete User View	1659
Delete All User Views	1660
View Editor Remote Commands	1660
View Listing Query	1660
User View Listing Query	1661
3.10.6 Frequency	1661
3.10.6.1 Settings	1661
Center Frequency	1661
CF Step	1666
3.10.7 Marker	1667
3.10.7.1 Select Marker	1667
3.10.7.2 Settings	1668
Marker Frequency	1668

Table Of Contents

Marker Mode	1670
Delta Marker (Reset Delta)	1671
Marker Settings Diagram	1671
All Markers Off	1671
Couple Markers	1671
3.10.7.3 Peak Search	1672
Marker Frequency	1672
Peak Search	1672
Next Peak	1672
Next Pk Right	1673
Next Pk Left	1673
Minimum Peak	1673
Pk-Pk Search	1674
Marker Delta	1674
3.10.7.4 Properties	1674
Marker Frequency	1674
Relative To	1675
Marker Trace	1675
Marker Settings Diagram	1676
3.10.8 Meas Setup	1676
3.10.8.1 Settings	1676
Avg/Hold Num	1676
Averaging On/Off	1677
Average Mode	1677
Average Type	1678
Meas Type	1678
Spur	1680
Range	1680
Spur Report Mode	1681
Range Settings	1681
Bandwidth	1682
Frequency Range	1682
Enabled	1682
Start Freq	1683
Stop Freq	1684
Center Frequency	1685
Span	1690
Res BW	1690
Meas BW	1692
Video BW	1693
Filter Type	1694
Enabled	1695
Frequency Type	1695
Abs Start Freq	1696
Abs Stop Freq	1696
Offset Start Freq	1697
Offset Stop Freq	1698

Offset Side	1699
Filter/Atten	1699
Frequency Range	1699
Enabled	1700
Start Freq	1700
Stop Freq	1700
Center Frequency	1700
Span	1701
Attenuation	1701
IF Gain	1702
Enabled	1703
Res BW	1703
Meas BW	1703
Video BW	1703
Filter Type	1704
Attenuation	1704
IF Gain	1705
Detector/Sweep	1705
Frequency Range	1705
Enabled	1706
Start Freq	1706
Stop Freq	1706
Center Frequency	1706
Span	1706
Sweep Time	1706
Points	1707
Detector 1	1708
Detector 2	1709
Limits	1710
Frequency Range	1710
Enabled	1710
Start Freq	1710
Stop Freq	1710
Center Frequency	1710
Span	1711
Abs Start Limit	1711
Abs Stop Limit	1712
Peak Excursion	1713
Pk Threshold	1714
Meas Setup Summary Table	1714
Auto Couple	1714
Meas Preset	1716
Fast Spurious Meas (Remote Command only)	1716
3.10.8.2 Advanced	1717
Noise Floor Extension	1717
3.10.8.3 Global	1721
Global Center Freq	1721
Global EMC Std	1722

Table Of Contents

Restore Defaults	1722
3.10.9 Sweep	1723
3.10.9.1 Sweep/Control	1723
Sweep/Measure	1723
Restart	1725
Pause/Resume	1727
Abort (Remote Command Only)	1728
3.10.9.2 Sweep Config	1728
Sweep Type	1728
Sweep Time Rules	1729
3.10.10 Trace	1730
3.10.10.1 Select Trace	1736
3.10.10.2 Trace Control	1736
Trace Type	1737
Clear and Write Restart Averaging Restart Max/Min Hold	1742
View/Blank	1742
3.10.10.3 Math	1745
Math Function	1745
Operand 1 / Operand 2	1751
Offset	1752
Reference	1752
3.10.10.4 Trace Function	1752
From Trace	1753
To Trace	1753
Copy	1753
Exchange	1754
Preset All Traces	1754
Clear All Traces	1754
3.10.10.5 Advanced	1755
Measure Trace	1755
3.11 Phase and Amplitude vs Time Measurement	1756
3.11.1 Views	1758
3.11.1.1 Normal	1758
3.11.2 Windows	1759
3.11.2.1 Graph	1759
3.11.2.2 Results	1759
3.11.3 Amplitude	1759
3.11.3.1 Y Scale	1760
Scale	1760
Ref Value	1760

Scale/Div	1761
Ref Position	1762
3.11.3.2 Attenuation	1763
Full Range Atten	1765
Mech Atten	1766
Elec Atten	1769
Adjust Atten for Min Clipping	1772
Adjust Atten	1773
Pre-Adjust for Min Clipping	1773
Mech Atten Step	1777
3.11.3.3 Range (Baseband Input models)	1778
Range Auto/Man	1778
I Range	1779
Q Range	1781
Q Same as I	1782
3.11.3.4 Range (Non-attenuator models)	1782
Range	1783
Adjust Range for Min Clipping	1783
Pre-Adjust for Min Clipping	1783
Peak-to-Average Ratio	1784
Mixer Lvl Offset	1785
3.11.3.5 Signal Path	1785
Presel Center	1786
Preselector Adjust	1787
Internal Preamp	1788
LNA	1790
μ W Path Control	1791
Allow Full Bypass in Auto	1800
Software Preselection	1801
SW Preselection Type	1803
SW Preselection BW	1803
High Freq Prefilter	1804
3.11.4 BW	1805
3.11.5 Display	1806
3.11.5.1 Meas Display	1806
Display Type	1806
3.11.5.2 View	1806
Views	1806
Normal	1807
User View	1807
Restore Layout to Default	1807
Save Layout as New View	1808
Re-Save User View	1808
Rename User View	1808
Delete User View	1809

Table Of Contents

Delete All User Views	1809
View Editor Remote Commands	1809
View Listing Query	1810
User View Listing Query	1810
3.11.5.3 Annotation	1810
Graticule	1810
Screen Annotation	1811
Trace Annotation	1811
Control Annotation	1812
Meas Bar	1812
Display Enable (Remote Command Only)	1812
3.11.6 Frequency	1814
3.11.6.1 Settings	1814
Center Frequency	1814
CF Step	1819
Freq Offset	1820
3.11.7 Marker	1821
3.11.8 Meas Setup	1821
3.11.8.1 Settings	1821
Segments	1821
Total Meas Time	1822
Meas Interval	1822
Meas Offset	1822
Meas Transient	1823
Measure Frequency Error	1823
Frequency Error	1823
Frequency Error Measurement Time	1824
Segment Frequency Error Correction	1824
Sync Type (Models with Multiple Receivers only)	1825
Auto Couple	1825
Meas Preset	1827
3.11.8.2 Advanced	1827
IF Gain	1827
3.11.8.3 Global	1828
Global Center Freq	1828
Global EMC Std	1829
Restore Defaults	1829
3.11.9 Sweep	1830
3.11.9.1 Sweep/Control	1830
Sweep/Measure	1830
Restart	1832
Pause/Resume	1834
Abort (Remote Command Only)	1835

3.11.10 Trace	1835
4 System	1836
4.1 System	1837
4.1.1 Show System	1837
4.1.1.1 Show System contents (Remote Query Only)	1838
4.1.1.2 Computer System description (Remote Query Only)	1838
4.1.2 Show Hardware	1838
4.1.3 Show LXI	1838
4.1.4 Show Support Subscriptions	1839
4.1.5 Show Support ID	1839
4.1.6 Control Panel...	1840
4.1.7 Web Browser	1841
4.1.8 Application Controls	1841
4.1.9 Sounds	1841
4.2 I/O Config	1843
4.2.1 GPIB	1843
4.2.1.1 GPIB Address	1843
4.2.1.2 GPIB Controller	1843
4.2.2 SCPI LAN	1844
4.2.2.1 SCPI Telnet	1845
4.2.2.2 SCPI Socket	1845
4.2.2.3 SICL Server	1846
4.2.2.4 HiSLIP Server	1847
4.2.2.5 Verbose SCPI On/Off	1847
4.2.2.6 Device Clear on Disconnect	1848
4.2.2.7 SCPI Socket Control Port (Remote Query Only)	1849
4.2.2.8 SCPI Instrument Port (Remote Query Only)	1849
4.2.3 Web Password Reset	1849
4.2.4 System IDN Response	1850
4.2.4.1 System IDN Response	1850
4.2.4.2 User IDN	1851
4.2.4.3 SYSTem:PERSONa (Remote Commands Only)	1852
SYSTem:PERSONa:DEFault	1852

Table Of Contents

SYSTem:PERSONa:MANUFACTURer	1853
SYSTem:PERSONa:MANUFACTURer:DEFault	1853
SYSTem:PERSONa:MODEl	1853
SYSTem:PERSONa:MODEl:DEFault	1854
4.2.5 LXI	1854
4.2.5.1 LAN Reset	1854
4.2.5.2 Device Identification (Remote Command Only)	1854
4.2.6 Restore I/O Config Defaults	1855
4.2.7 Query USB Connection (Remote Query Only)	1855
4.2.8 USB Connection Status (Remote Query Only)	1856
4.2.9 USB Packet Count (Remote Query Only)	1856
4.2.10 Lock Remote I/O Session (Remote Command only)	1857
4.2.10.1 Lock Remote I/O Request (Remote Query only)	1858
4.2.10.2 Unlock Remote I/O Session (Remote Command only)	1859
4.2.10.3 Remote I/O Session Lock Name (Remote Query only)	1860
4.2.10.4 Remote I/O Session Lock Owner (Remote Query only)	1860
4.2.11 Multiple Network Interface Card Configuration (Remote Commands Only)	1861
4.2.11.1 Multiple Network Adapters Enabled (Remote Query Only)	1861
4.2.11.2 Config IPV4 Address (Remote Command Only)	1862
4.2.11.3 Config IPV6 Address (Remote Command Only)	1862
4.2.11.4 List All Physical Network Adapter IP Addresses (Remote Query Only)	1862
4.3 Preload / Unload Modes	1864
4.3.1 Power-On Mode	1864
4.3.2 Table of Modes	1865
4.3.3 Preload: Select All, Preload: Deselect All	1865
4.3.4 Move Up, Move Down	1865
4.3.5 Unload	1865
4.3.6 Loaded Modes (Remote Query Only)	1866
4.3.7 User Interface	1866
4.3.7.1 Menu Panel Position	1866
4.3.7.2 Menu Panel Tabs	1867
4.3.7.3 Annotations Local Settings/All Off	1867

4.3.7.4	Display Theme	1867
4.3.7.5	Backlight	1868
4.3.7.6	Backlight Intensity	1869
4.3.7.7	Hints	1869
4.3.7.8	Numeric Entry Auto Open	1869
4.3.7.9	Touch On/Off	1870
4.3.7.10	Control Size	1870
4.3.7.11	Quick Save Mode	1870
4.3.7.12	Screen Tabs Left/Right	1871
4.3.7.13	Hide Screen Tabs in Full Screen	1872
4.3.7.14	2-Screen Orientation	1873
4.3.7.15	Clock Format	1874
4.3.7.16	Language	1875
4.3.7.17	Restore User Interface Defaults	1875
4.3.7.18	User Interface Type (Remote Query Only)	1876
4.4	Power On	1877
4.4.1	Power On State	1877
4.4.2	Power On Application	1879
4.4.3	FPGA Configuration	1879
4.4.3.1	FPGA Load Preference	1882
4.4.3.2	Load FPGA	1883
4.4.4	Restore Power On Defaults	1884
4.4.5	Configure Applications – Desktop application	1884
4.4.6	Configure Applications - Instrument boot-up	1887
4.4.7	Configure Applications - Remote Commands	1887
4.4.7.1	Configuration list (Remote Command Only)	1888
4.4.7.2	Configuration Memory Available (Remote Query Only)	1888
4.4.7.3	Configuration Memory Total (Remote Query Only)	1888
4.4.7.4	Configuration Memory Used (Remote Query Only)	1889
4.4.7.5	Configuration Application Memory (Remote Query Only)	1889
4.5	Restore Defaults	1890
4.5.1	Input/Output	1890
4.5.2	I/O Config	1891

Table Of Contents

4.5.3 User Interface	1891
4.5.4 Power On	1891
4.5.5 Alignments	1892
4.5.6 Misc	1892
4.5.7 All	1893
4.6 Alignments	1895
4.6.1 Auto Align	1895
4.6.1.1 Auto Align	1895
4.6.1.2 All but RF	1898
4.6.1.3 Alert	1898
4.6.2 Align Now	1900
4.6.2.1 Align Now All	1902
4.6.2.2 Align Now All but RF	1904
4.6.2.3 Align Now RF	1906
4.6.2.4 Align Now Expired	1907
4.6.2.5 Align Now Preselector	1908
4.6.2.6 Align Now All but RF Preselector	1909
4.6.2.7 Align Now RF Presel Only (20 Hz to 3.6 GHz)	1909
4.6.2.8 Align Now External Mixer	1910
4.6.2.9 Align Source	1911
4.6.2.10 Align Receiver	1912
4.6.2.11 Align Fast	1912
4.6.2.12 Align LO Leakage	1913
4.6.2.13 Align IF Cable	1913
4.6.2.14 Align RRH Amplitude	1913
4.6.2.15 Align Fast RRH Amplitude	1914
4.6.2.16 Align RRH LO Power	1914
4.6.2.17 Align LO Clock	1914
4.6.2.18 Align VXT Transceiver	1915
4.6.2.19 Align up down converter	1915
4.6.2.20 Align Selected Freq Ranges	1916
Enable Extended Freq Range	1917
Frequency Range	1917
Enable	1919

4.6.2.21	Align External Mixer Path	1919
4.6.2.22	Align Low Band	1920
4.6.2.23	Align High Band	1920
4.6.3	Path Delay Calibration	1921
4.6.3.1	Source Path Delay Calibration	1921
4.6.3.2	Path Delay Correction On/Off(Remote Command only)	1923
4.6.4	Show Alignment Statistics	1923
4.6.5	Timebase DAC	1935
4.6.5.1	Timebase DAC	1935
4.6.5.2	User Value	1936
4.6.6	Advanced	1937
4.6.6.1	Characterize Preselector	1937
4.6.6.2	Characterize Reference Clock	1939
4.6.6.3	Characterize Noise Floor	1941
4.6.6.4	Calibration Temperature History	1943
4.6.6.5	TDS Alignment	1944
4.6.6.6	Backup or Restore Align Data...	1945
	Alignment Data Wizard (without Flash)	1946
	Perform Backup (without Flash) (Remote Command Only)	1955
	Perform Restore (without Flash) (Remote Command Only)	1955
	Alignment Data Wizard (with Flash)	1956
	Perform Backup (with Flash) (Remote Command Only)	1961
	Perform Restore (With Flash) (Remote Command Only)	1961
	Restore Alignment Defaults	1961
4.6.6.7	oGRF Preselector	1962
	Align Now, 20 Hz to 30 MHz	1962
	Align Now, 30 MHz to 3.6 GHz	1963
	Align Now, 20 Hz to 3.6 GHz	1964
	Alert	1965
4.6.6.8	Scheduler	1966
	Schedule Setup	1966
	Task	1966
	Date/Time	1967
	Hour	1968
	Minute	1968
	Recurrence	1968
	Number of Weeks	1968
	Day	1969
4.7	Licensing	1970

Table Of Contents

4.7.1 License Manager	1970
4.7.2 System Software Version Date	1970
4.7.3 Software Support Expiration Date	1971
4.7.4 Network Licenses	1971
4.7.4.1 Application Licenses	1972
4.7.4.2 Instrument Software Options	1972
4.7.4.3 License Checked Out Query (Remote Query Only)	1972
4.7.4.4 List Licenses Checked Out (Remote Query Only)	1973
4.7.4.5 Borrowed Network Licenses	1973
4.7.4.6 Borrow a License	1974
4.7.4.7 Listing Borrowed Licenses and Return a Borrowed License	1975
List Borrowed Licenses (Remote Query Only)	1975
Return a Borrowed License (Remote Command Only)	1976
4.7.4.8 Enabling Network Checkouts While Borrowed	1976
4.7.5 USB Portable Licenses	1977
4.7.6 Configuring Network and USB Portable Licenses	1977
4.7.7 Floating License Manager	1977
4.7.8 Install License (Remote Command Only)	1978
4.7.9 Remove License (Remote Command Only)	1978
4.7.10 List Licenses (Remote Query Only)	1979
4.7.11 Validate License (Remote Query Only)	1980
4.7.12 Host ID Query (Remote Query Only)	1980
4.8 Security	1981
4.8.1 USB Write Protect	1981
4.8.2 Restore Security Defaults	1981
4.9 Diagnostics	1982
4.9.1 Show Hardware Statistics	1982
4.9.2 Pathwave Calibration Advisor...	1982
4.9.3 Query the Mechanical Relay Cycle Count (Remote Query Only)	1982
4.9.4 Query the Operating Temperature Extremes (Remote Query Only)	1983
4.9.5 Query the Elapsed Time since 1st power on (Remote Query Only)	1983
4.10 Service	1984
4.11 System Remote Commands (Remote Commands Only)	1985

4.11.1 List installed Options (Remote Query Only)	1985
4.11.2 Lock the Front-panel keys (Remote Command Only)	1986
4.11.3 Lock Workstation (Remote Command Only)	1986
4.11.4 List SCPI Commands (Remote Query Only)	1988
4.11.5 Front Panel activity history (Remote Query only)	1988
4.11.6 SCPI activity history (Remote Query only)	1989
4.11.7 Instrument start time (Remote Query only)	1989
4.11.8 SCPI Version Query (Remote Query Only)	1990
4.11.9 Date (Remote Command Only)	1990
4.11.10 Time (Remote Command Only)	1990
4.11.11 Input Overload Enable (Remote Command Only)	1991
4.11.12 Power Up (Remote Query Only)	1991
5 Preset	1992
5.1 Preset Dropdown	1995
5.2 Mode Preset	1996
5.3 Restore Mode Defaults	1998
5.4 Input/Output Preset	1999
5.5 Full Mode Preset	2000
5.6 User Preset	2001
5.7 Save User Preset	2003
5.8 User Preset All Modes	2004
5.9 Restore Defaults All Modes	2005
5.10 User Preset All Screens	2006
5.11 Save User Preset All Screens	2007
5.12 Restore Screen Defaults	2008
5.13 Preset Type (Remote Command Only)	2009
5.14 Restart Instrument (Shutdown)	2010
5.15 Restart Application (Application Shutdown)	2011
5.16 System Log Off (Remote Command Only)	2012
5.17 Power Standby (Instrument Shutdown)	2013
6 Input/Output	2014
6.1 RF Source	2015
6.1.1 RF Output	2015

Table Of Contents

6.1.2 RF Output Port	2015
6.1.3 Half Duplex Output Port	2017
6.1.4 RF Power	2018
6.1.5 T/R Port High Power Attenuator	2018
6.1.6 Amplitude Setup	2018
6.1.6.1 RF Power	2018
6.1.6.2 Set Reference Power	2022
6.1.6.3 Power Ref	2023
6.1.6.4 Power Unit	2023
6.1.6.5 Amptd Offset	2024
6.1.6.6 Amplitude Increment	2025
6.1.7 Frequency	2025
6.1.8 List Sequencer	2025
6.1.8.1 Sequencer	2026
6.1.8.2 Initiate Sequence	2026
6.1.8.3 Repetition	2027
6.1.8.4 Trig Out Type	2027
6.1.8.5 Select Data Marker	2027
6.1.8.6 Manual Trigger Now	2028
6.1.8.7 List Sequencer Setup	2028
Number of Steps	2028
Go To Step	2028
Insert Step Before	2029
Delete Step	2029
Clear List	2029
Step Trigger	2029
Transition Time	2030
Band	2031
Device	2035
Freq/Chan	2036
Power	2037
Waveform	2037
Waveform File	2038
Step Duration	2038
Duration Time	2039
Play Count	2040
Trig Out	2041
Step Configuration (Remote Command Only)	2041
Step Configuration of Step Trigger parameter list (Remote Command Only)	2043

Step Configuration of Transition Time parameter list (Remote Command Only)	2044
Step Configuration of Radio Band parameter list (Remote Command Only)	2044
Step Configuration of Radio Band Link parameter list (Remote Command Only)	2045
Step Configuration of Frequency/Channel Number parameter list (Remote Command Only)	2046
Step Configuration of Power parameter list (Remote Command Only)	2046
Step Configuration of Waveform parameter list (Remote Command Only)	2047
Step Configuration of Step Duration parameter list (Remote Command Only)	2048
Step Configuration of Duration Time or Play Count parameter list (Remote Command Only)	2048
Step Configuration of Output Trigger parameter list (Remote Command Only)	2049
Clear List (Remote Command Only)	2049
6.1.8.8 Remote Software Trigger (Remote command Only)	2050
6.1.8.9 Query List Sequence Initiation Armed Status (Remote Query Only)	2050
6.1.9 Frequency Setup	2050
6.1.9.1 Frequency	2050
6.1.9.2 Channel	2053
6.1.9.3 Radio Setup	2057
Radio Standard/Radio Band	2058
Radio Band Link	2062
6.1.9.4 Set Reference Frequency	2062
6.1.9.5 Freq Reference	2063
6.1.9.6 Freq Offset	2064
6.1.9.7 Freq Increment	2065
6.1.9.8 Rx/Tx Coupling	2066
6.1.9.9 Rx/Tx Offset	2067
6.1.10 Modulation	2067
6.1.11 Modulation Setup	2068
6.1.11.1 AM	2068
6.1.11.2 AM Mod Depth	2068
6.1.11.3 AM Rate	2068
6.1.11.4 AM Rate Increment	2069
6.1.11.5 FM	2069
6.1.11.6 FM Deviation	2070
6.1.11.7 FM Rate	2070
6.1.11.8 FM Rate Increment	2070
6.1.11.9 PM	2071

Table Of Contents

6.1.11.10 PM Deviation	2071
6.1.11.11 PM Rate	2071
6.1.11.12 PM Rate Increment	2072
6.1.11.13 ARB Setup	2072
Basic Control	2072
ARB State	2072
Sample Rate	2073
Run-Time Scaling	2077
Baseband Freq Offs	2077
Baseband Power	2078
Mkr 1-4 Polarity	2078
Pulse/RF Blank	2078
ALC Hold	2079
Trigger Type	2080
Continuous trigger	2080
Single trigger	2081
Segment Advance trigger	2082
Trigger Source	2082
Bus Trigger Command (Remote Command Only)	2083
Sync to Trigger Source	2083
External Trigger Delay	2084
External Trigger Polarity	2086
Select PXI Line	2087
PXI Trigger Delay	2087
PXI Trigger Polarity	2088
I/Q Adjustments	2088
I/Q Gain	2089
I/Q Delay	2089
RMS	2090
RMS Calculation Mode	2090
Calculate	2091
Use Header RMS	2091
Real-Time 5G NR Compensation	2092
SCS	2093
Filter	2093
Filter Bandwidth	2093
Select Waveform	2094
Segments in ARB Memory	2095
Recall Waveform	2095
Delete Segment From ARB Mem	2095
Delete All From ARB Memory	2095
Query ARB Memory File List (Remote Query Only)	2095
Query ARB Memory Full File List (Remote Query Only)	2096
Waveform Sequences	2096
Build New Sequence	2096
Segment	2097
Waveform	2097

Repetitions	2097
Marker 1 – Marker 4	2097
Sync Seq File	2097
Insert Waveform	2098
Segments in ARB Memory	2098
Delete Segment From ARB Mem	2099
Delete All From ARB Memory	2099
Delete Segment	2099
Save Sequence	2099
Build New Sequence (Remote Command Only)	2099
Edit Selected Sequence	2102
Segment	2102
Waveform	2102
Repetitions	2102
Marker 1 – Marker 4	2102
Sync Seq File	2103
Insert Waveform	2103
Segments in ARB Memory	2104
Delete Segment From ARB Mem	2104
Delete All From ARB Memory	2104
Delete Segment	2104
Waveform Utilities	2104
Add Waveform	2104
Replace Selected Waveform	2105
Clear Waveform from Slot	2106
Lock Waveform in Slot	2106
Slot Status Query (Remote Command Only)	2107
Slots Free Query (Remote Query Only)	2107
Slots Used Query (Remote Query Only)	2107
Slot Waveform Name Query (Remote Command Only)	2108
Slot Waveform Unique ID Query (Remote Command Only)	2108
Locked Waveform Name List Query (Remote Query Only)	2109
Locked Waveform Unique ID List Query (Remote Query Only)	2109
Multi-Pack License multi-module control state (Remote Command Only)	2109
Header Utilities	2110
Clear Header	2110
Save Header	2110
Query Waveform Unique ID (Remote Query Only)	2110
Query Selected Waveform Header info (Remote Query Only)	2111
6.1.12 Trigger Initiate	2112
6.1.13 Source Sync	2112
6.1.13.1 Sync Config	2112
6.1.13.2 Sync Type	2113
6.1.13.3 Sync Settings	2114
Secondary Module List	2114
Sync Settings	2115
Sync Segment 2	2116

Table Of Contents

Segment 2 Frequency	2116
IP Address	2117
SCPI Socket Port	2117
Add Secondary Module	2117
Delete Secondary Module	2117
Sync Runtime Settings (Remote Command Only)	2118
6.1.13.4 Sync Start	2118
6.1.13.5 Sync Stop	2118
6.1.13.6 Sync Connected (Remote Query Only)	2119
6.1.14 Source Preset	2119
6.2 Input	2120
6.2.1 Select Input	2120
6.2.2 RF Input Port	2129
6.2.3 SA Frequency Extender Firmware Update (Front Panel Only)	2139
6.2.4 SA Frequency Extender Cable Correction	2140
6.2.5 Half Duplex Input Port	2140
6.2.6 Port Information (Remote Command Only)	2141
6.2.7 RF Preselector	2141
6.2.8 Notch Filter	2143
6.2.9 RF Calibrator	2143
6.2.10 RF Coupling	2144
6.2.11 Input Z Correction	2146
6.2.12 All Screens Use Same Input	2147
6.2.13 External Mixer Setup	2147
6.2.13.1 Mixer Presets	2151
6.2.13.2 Mixer Bias	2156
6.2.13.3 Table Type	2157
6.2.13.4 Select VDI CCD Correction	2158
6.2.13.5 Delete All VDI CCD Corrections	2159
6.2.13.6 Harmonic	2159
6.2.13.7 LO Doubler	2160
6.2.13.8 Refresh USB Mixer Connection	2160
6.2.14 Mixer Path	2161
6.2.15 User IF Freq	2162
6.2.16 Signal ID On/Off	2162

6.2.17	Signal ID Mode	2163
6.2.18	Cable IF Loss	2164
6.2.19	I/Q Path	2165
6.2.20	Reference Z	2167
6.2.21	I/Q Setup	2167
6.2.21.1	I Setup	2167
	Differential	2167
	Input Z	2168
	Skew	2169
	Combined Differential/Input Z (Remote Command Only)	2170
6.2.21.2	I Probe	2170
	Attenuation	2171
	Offset	2172
	Coupling	2172
	Clear Calibration	2173
6.2.21.3	Calibrate	2173
	I/Q Isolation Calibration	2174
	I/Q Isolation Calibration Time (Remote Query Only)	2175
	I Port	2175
	I Port Probe Calibration Time (Remote Query Only)	2175
	I-bar Port	2176
	I-bar Port Probe Calibration Time (Remote Query Only)	2176
6.2.21.4	Q Setup	2176
	Q Same as I	2176
	Differential	2177
	Input Z	2178
	Skew	2179
6.2.21.5	Q Probe	2179
	Attenuation	2179
	Offset	2180
	Coupling	2180
	Clear Calibration	2181
6.2.21.6	Calibrate	2181
	Q Port	2182
	Q Port Probe Calibration Time (Remote Query Only)	2182
	Q-bar Port	2182
	Q-bar Probe Calibration Time (Remote Query Only)	2183
6.2.22	I/Q Cable Calibrate	2183
6.2.22.1	I Port	2184
6.2.22.2	I-bar Port	2184
6.2.22.3	Q Port	2185

Table Of Contents

6.2.22.4 Q-bar Port	2185
6.2.22.5 I/Q Cable Calibration Time (Remote Query Only)	2186
6.2.23 Audio Input Channel	2186
6.2.24 Audio Calibrator	2186
6.2.25 Audio Coupling	2186
6.2.26 Audio Input Ground	2187
6.2.27 Audio In Impedance	2187
6.2.28 Input/Output Preset	2187
6.3 External Gain	2189
6.3.1 External Preamp	2189
6.3.2 External Gain - MS	2191
6.3.3 External Gain - BTS	2192
6.3.4 I Ext Gain	2193
6.3.5 Q Ext Gain	2194
6.3.6 Q Gain in I+jQ	2194
6.4 Data Source	2195
6.4.1 Data Source	2205
6.4.2 Current Meas -> Capture Buffer	2206
6.5 Corrections	2207
6.5.1 Select Correction	2208
6.5.2 Correction On/Off	2209
6.5.3 Correction Port	2209
6.5.4 Correction Direction	2211
6.5.5 Edit Correction	2212
6.5.5.1 Select Correction	2213
6.5.5.2 Frequency	2213
6.5.5.3 Amplitude	2214
6.5.5.4 Go to Row	2214
6.5.5.5 Insert Row Below	2214
6.5.5.6 Delete Row	2214
6.5.5.7 Scale X Axis	2214
6.5.5.8 Delete Correction	2215
6.5.5.9 Correction Graph	2215

6.5.6 Edit Correction Settings	2216
6.5.6.1 Select Correction	2216
6.5.6.2 Freq Interpolation	2216
6.5.6.3 Transducer Unit	2218
6.5.6.4 Description	2219
6.5.6.5 Comment	2219
6.5.7 Complex Corrections	2220
6.5.7.1 Go To Row (Select Correction)	2221
6.5.7.2 Delete Row	2221
6.5.7.3 Delete All	2221
6.5.7.4 Correction On	2222
6.5.7.5 Correction Port	2222
6.5.7.6 Direction	2223
6.5.7.7 Description	2224
6.5.7.8 Comment	2224
6.5.7.9 File	2225
6.5.7.10 Freq Interpolation (Remote Command Only)	2225
6.5.7.11 Set Data (Remote Command Only)	2226
6.5.8 Apply Corrections	2226
6.5.9 Delete All Corrections	2227
6.5.10 Correction Group On/Off	2228
6.5.11 Break	2228
6.5.12 Reload Corrections From Files	2231
6.5.13 Edit Correction Group	2231
6.5.13.1 Go to Row	2231
6.5.13.2 Insert Row Below	2231
6.5.13.3 Delete Row	2232
6.5.13.4 Select File	2232
6.5.13.5 Specify File	2232
6.5.13.6 Remove File	2232
6.5.13.7 Correction Trace Display	2232
6.5.13.8 Description	2233
6.5.13.9 Comment	2233

Table Of Contents

6.5.13.10 Start Frequency	2233
6.5.13.11 Stop Frequency	2234
6.5.14 Merge Correction Data (Remote Command Only)	2234
6.5.15 Set (Replace) Data (Remote Command Only)	2235
6.5.16 Correction Group Range Data (Remote Command Only)	2235
6.5.17 Delete Correction Group Range (Remote Command Only)	2236
6.6 Freq Ref Input	2237
6.6.1 Freq Ref Input	2237
6.6.2 Ext Ref Freq	2242
6.6.3 Default External Ref Freq	2243
6.6.4 LO Ref Input	2243
6.6.5 Ref Lock BW	2244
6.6.6 Reference Oscillator On/Off (Remote Command Only)	2245
6.6.6.1 Select Ref	2245
6.6.6.2 Freq Ref In	2246
6.6.6.3 External Freq Ref	2246
6.6.6.4 Ext Ref Locked (Remote Query Only)	2246
6.7 Output	2248
6.7.1 Analog Out	2248
6.7.2 Screen Video Level	2252
6.7.3 Digital Bus Out	2253
6.7.4 Wideband Digital Bus	2253
6.7.5 Data Stream	2256
6.7.6 I/Q Cal Out	2256
6.7.7 Aux IF Out	2257
6.7.8 Arbitrary IF Freq	2259
6.7.9 Ext/Wide IF Out	2259
6.7.10 IF2 Out	2260
6.7.11 REF Out	2261
6.7.12 LO Ref Out	2261
6.8 Trigger Output	2263
6.8.1 Trig 1 – 4 Out	2263
6.8.2 Trig 1 – 4 Out Polarity	2265

6.8.3 Trig 1 – 4 Out Device	2266
6.8.4 Src PXI Trig Out	2266
6.8.5 Src Trig Out Polarity	2267
6.8.6 Select Src PXI Line	2267
6.8.7 Analyzer PXI Trig Out	2268
6.8.8 Analyzer Trig Out Polarity	2269
6.8.9 Select Analyzer PXI Line	2269
6.8.10 Source Internal Trig Out	2269
6.8.11 Source Internal Trig Out Polarity	2270
6.9 Calibration	2272
6.9.1 Configuration	2272
6.9.1.1 Cal Group	2274
6.9.1.2 Calibrate Checked Rows	2274
6.9.1.3 Apply Cal Group	2275
6.9.1.4 Abort Calibration	2275
6.9.1.5 Copy From Cal Group	2276
6.9.1.6 Copy	2276
6.9.1.7 Cal Input	2277
6.9.1.8 Freq Offset	2277
6.9.1.9 Select Calibrator	2278
6.9.1.10 Identify RCal Module	2278
6.9.1.11 RCal Module Serial Number (Remote Query Only)	2278
6.9.1.12 RCal Reference	2278
6.9.1.13 RCal Status	2279
RCal Status (Remote Query Only)	2280
All RCal Status (Remote Query Only)	2280
6.9.1.14 Go to Row	2280
6.9.1.15 Insert Row Below	2281
6.9.1.16 Description	2281
6.9.1.17 Use Current Meas	2281
6.9.1.18 Duplicate Row	2282
6.9.1.19 Delete Row	2282
6.9.1.20 Delete All	2282
6.9.1.21 Calibrate	2282

Table Of Contents

6.9.1.22	Apply	2283
6.9.1.23	Name	2283
6.9.1.24	Last Cal	2284
6.9.1.25	Cal Applied	2284
6.9.1.26	Cal Type	2285
6.9.1.27	Start Freq	2285
6.9.1.28	Stop Freq	2286
6.9.1.29	Freq Step	2287
6.9.1.30	Freq Points	2287
6.9.1.31	Mech Atten Type	2288
6.9.1.32	Mech Atten Start	2288
6.9.1.33	Mech Atten Stop	2289
6.9.1.34	Mech Atten Step	2290
6.9.1.35	Elec Atten Type	2290
6.9.1.36	Elec Atten Start	2290
6.9.1.37	Elec Atten Stop	2291
6.9.1.38	Elec Atten Step	2292
6.9.1.39	Full Range Atten Type	2292
6.9.1.40	Full Range Atten Start	2293
6.9.1.41	Full Range Atten Stop	2293
6.9.1.42	Frequency Extender Attenuation Type	2294
6.9.1.43	Frequency Extender Attenuation Start	2295
6.9.1.44	Frequency Extender Attenuation Stop	2295
6.9.1.45	Frequency Extender Atten Step	2296
6.9.1.46	IF Path	2296
6.9.1.47	IF Gain	2297
6.9.1.48	Preamp	2298
6.9.1.49	Low Noise Amplifier (LNA)	2298
6.9.1.50	μ W Path Control	2299
6.9.1.51	Coupling	2299
6.9.1.52	Phase Noise Optimization	2300
6.9.1.53	Phase Noise Optimization All Option	2305
6.9.1.54	Mixing Mode	2306

6.9.1.55 Match State	2306
6.9.2 Cal Group	2307
6.9.3 Apply Cal Group	2307
6.9.4 All Apply Cal Group Off	2307
6.9.5 Connection	2308
6.10 Calibrator Control	2309
6.10.1 Select Cal Source	2309
6.10.2 Cal Output	2309
6.10.3 Cal Frequency	2310
6.10.4 Cal Signal Type	2310
6.10.5 Cal Comb Spacing	2310
6.10.6 Calibrator Reference	2311
6.11 Advanced	2312
6.11.1 T/R Port High Power Attenuator	2312
6.12 Aux I/O Control	2314
6.12.1 Data 0 – Data 7	2314
6.12.2 Aux IO Control (Remote Command Only)	2314
7 Save/Recall/Print	2315
7.1 Quick Save	2316
7.2 Recall	2319
7.2.1 Recall From File / Open	2320
7.2.2 State	2321
7.2.3 Recall Type	2322
7.2.4 Register 1 thru Register 16	2323
7.2.5 Edit Register Names	2324
7.2.6 Trace+State	2324
7.2.7 Recall To Trace	2325
7.2.8 Register 1 thru Register 16	2325
7.2.9 Edit Register Names	2326
7.2.10 Screen Config + State	2326
7.2.11 Measurement Data	2327
7.2.12 Data Type	2327
7.2.13 Trace	2327

Table Of Contents

7.2.14	Limit	2328
7.2.15	Select Limit	2329
7.2.16	Correction	2329
7.2.17	Select Correction	2330
7.2.18	Complex Correction	2330
7.2.19	Select Complex Correction	2331
7.2.20	Recall VDI CCD Correction	2331
7.2.21	Mask	2332
7.2.22	Sequence	2332
7.2.23	Waveform	2332
7.2.24	Load Segment to ARB Memory	2334
7.2.25	Delete Segment From ARB Mem	2335
7.2.26	Delete All From ARB Memory	2336
7.2.27	Set Default Directory (Remote Command Only)	2336
7.2.28	Query ARB Memory File List (Remote Query Only)	2336
7.2.29	Query ARB Memory Full File List (Remote Query Only)	2337
7.2.30	Demod Info	2337
7.2.31	Data Type	2338
7.2.32	Select Segment	2338
7.2.33	Constellation State	2338
7.2.34	Sync Pattern	2339
7.2.35	Filter Coefficients	2339
7.2.36	Equalizer Coefficients	2340
7.2.37	Tx Pattern	2341
7.2.38	Carrier Setting	2341
7.2.39	Data Segment Index	2342
7.2.40	Data Type	2342
7.2.41	CC Setup	2342
7.2.42	Pilot IQ Values	2343
7.2.43	Preamble IQ Values	2343
7.2.44	Resource Map	2344
7.2.45	Resource Modulation	2344
7.2.46	Filter Coefficients	2344

7.2.47	Power Sensor Cal Factor	2345
7.2.48	Recording	2345
7.2.49	Data Type	2346
7.2.50	Channel	2347
7.2.51	Reset	2347
7.2.52	Recalled data channel table (Display only)	2348
7.2.53	Recording + State	2348
7.2.54	CC Setup	2348
7.2.55	Frame Index (.scp and .pwsq only)	2349
7.2.56	Close VSA after recall (.setx only)	2349
7.2.57	Custom IQ Constellation State	2349
7.2.58	Memory Polynomial and Volterra Coefficients Files	2350
7.2.59	Sample file	2350
7.2.60	Coefficient Lengths	2352
7.2.61	How to apply the coefficients to signal	2353
7.2.62	Loss Comp	2354
7.2.63	Data Pattern	2355
7.3	Save	2356
7.3.1	Save to File / Save As	2357
7.3.2	State	2359
7.3.3	Register 1 thru Register 16	2360
7.3.4	Edit Register Names	2360
7.3.5	Trace+State	2361
7.3.6	Save From Trace	2363
7.3.7	Register 1 thru Register 16	2364
7.3.8	Edit Register Names	2364
7.3.9	Screen Config + State	2365
7.3.10	Measurement Data	2365
7.3.11	Save From	2366
7.3.12	Data Type	2366
7.3.13	Meas Results	2367
7.3.14	CHP Meas Results File Contents	2368
7.3.15	OBW Meas Results File Contents	2371

Table Of Contents

7.3.16 ACP Meas Results File Contents	2374
7.3.17 SPUR Meas Results File Contents	2381
7.3.18 SEM Meas Results File Contents	2384
7.3.19 CCDF Meas Results File Contents	2390
7.3.20 TXP Meas Results File Contents	2394
7.3.21 IQ Waveform Meas Results File Contents	2395
7.3.22 Frequency Scan	2396
7.3.23 Header On/Off	2396
7.3.24 Title	2396
7.3.25 Client	2397
7.3.26 Operator	2397
7.3.27 Product Description	2397
7.3.28 Logo	2397
7.3.29 Browse	2397
7.3.30 Setting On/Off	2397
7.3.31 Trace Data On/Off	2397
7.3.32 Amplitude Correction Display	2397
7.3.33 Limits Display State	2398
7.3.34 Screen State	2398
7.3.35 Scan Table On/Off	2398
7.3.36 Signal List On/Off	2398
7.3.37 Output Format	2398
7.3.38 Disturbance Analyzer	2398
7.3.39 Title	2398
7.3.40 Client	2398
7.3.41 Operator	2398
7.3.42 Product Description	2399
7.3.43 Comment	2399
7.3.44 Meas Setup On/Off	2399
7.3.45 Disturbance List On/Off	2399
7.3.46 Trace (All Traces) On/Off	2399
7.3.47 Channel On/Off	2399
7.3.48 Limit	2399

7.3.49 Select Limit	2403
7.3.50 Correction	2403
7.3.51 Select Correction	2407
7.3.52 Saving a SCPI Recording as a Python Script	2407
7.3.53 Mask	2409
7.3.54 Waveform Sequence	2409
7.3.55 Demod Info	2409
7.3.56 Data Type (Digital Demod Measurement)	2409
7.3.57 Select Segment	2409
7.3.58 Constellation States	2409
7.3.59 Sync Pattern	2411
7.3.60 Filter Coefficients	2412
7.3.61 Equalizer Coefficients	2413
7.3.62 Tx Pattern	2415
7.3.63 Data Type (Custom OFDM Measurement)	2416
7.3.64 Filter Coefficients	2416
7.3.65 Pilot IQ Values	2417
7.3.66 Preamble IQ Values	2417
7.3.67 Screen Image	2417
7.3.68 Theme	2419
7.3.69 Power Sensor Cal Factor	2420
7.3.70 Recording	2420
7.3.71 Data Type	2421
7.3.72 Channel	2422
7.3.73 Recording + State	2423
7.3.74 Remote Only Commands	2423
7.3.75 Mass Storage Catalog (Remote Command Only)	2423
7.3.76 Mass Storage Change Directory (Remote Command Only)	2423
7.3.77 Mass Storage Copy (Remote Command Only)	2424
7.3.78 Mass Storage Device Copy (Remote Command Only)	2424
7.3.79 Mass Storage Delete (Remote Command Only)	2424
7.3.80 Mass Storage Data (Remote Command Only)	2425
7.3.81 Mass Storage Make Directory (Remote Command Only)	2425

Table Of Contents

7.3.82 Mass Storage Move (Remote Command Only)	2425
7.3.83 Mass Storage Remove Directory (Remote Command Only)	2426
7.3.84 Mass Storage Determine Removable Media (Remote Query Only)	2426
7.3.85 Mass Storage Determine Removable Media Label (Remote Command Only)	2426
7.3.86 Mass Storage Determine Removable Media Write-protect status (Remote Query Only)	2427
7.3.87 Mass Storage Determine Removable Media size (Remote Query Only)	2427
7.3.88 :SYSTem:SET (Remote Command Only)	2427
7.4 Print	2429
7.5 Page Setup	2430
8 Trigger	2432
8.1 Trigger	2433
8.1.1 Select Trig Source	2433
8.1.1.1 Free Run	2446
8.1.1.2 Video/ADC	2446
8.1.1.3 ADC Trigger	2447
8.1.1.4 Line	2448
8.1.1.5 External 1	2448
8.1.1.6 External 2	2449
8.1.1.7 External 3	2450
8.1.1.8 Audio External	2451
8.1.1.9 RF Burst	2451
8.1.1.10 Periodic	2452
8.1.1.11 I/Q Mag	2454
8.1.1.12 Input I	2454
8.1.1.13 Input Q	2455
8.1.1.14 I (Demodulated)	2455
8.1.1.15 Q (Demodulated)	2456
8.1.1.16 Aux I/Q Mag	2456
8.1.1.17 PXI	2457
8.1.1.18 Internal	2457

8.1.1.19 Prot Channel Detection	2458
8.1.1.20 Prot Frame Aligned	2458
8.1.1.21 Prot Event	2459
8.1.2 Trigger Level	2459
8.1.3 Trigger Delay	2461
8.1.4 Trigger Slope	2465
8.1.5 Trigger Level Absolute/Relative	2466
8.1.6 Absolute Trigger Level	2467
8.1.7 Relative Trigger Level	2467
8.1.8 Period	2469
8.1.9 Offset	2470
8.1.10 Reset Offset Display	2471
8.1.11 Offset Adjust (Remote Command Only)	2471
8.1.12 Sync Source	2472
8.1.13 TV Line	2472
8.1.14 Field	2473
8.1.15 Standard	2474
8.1.16 Trigger Center Frequency	2475
8.1.17 Trigger BW	2475
8.1.18 Zero Span Delay Compensation On/Off	2476
8.1.19 Select PXI Line	2476
8.1.20 Reset Sync Monitor	2477
8.1.21 Trigger Optimization	2478
8.1.22 Trigger Settings Diagram	2479
8.2 Gate Source	2480
8.2.1 Select Gate Source	2480
8.2.2 Sync Holdoff	2481
8.3 Gate Settings	2483
8.3.1 Gate On/Off	2483
8.3.2 Gate View On/Off	2484
8.3.3 Gate Delay	2486
8.3.4 Gate Length	2487
8.3.5 Gate Method	2488

Table Of Contents

8.3.6 Control Edge/Level	2489
8.3.7 Gate Holdoff	2490
8.3.8 Gate View Sweep Time	2491
8.3.9 Gate View Start Time	2492
8.3.10 Gate Delay Compensation	2493
8.3.11 Min Fast Position Query (Remote Query Only)	2494
8.3.12 Gate Preset (Remote Command Only)	2495
8.3.13 Gate Level (Remote Command Only)	2495
8.3.14 Gate Polarity (Remote Command Only)	2495
8.4 Enables the hardware accelerated stepped FFT gating feature (Display only)	2497
8.5 Periodic Sync Src	2498
8.5.1 Select Periodic Timer Sync Source	2498
8.6 Auto/Holdoff	2499
8.6.1 Trig Holdoff	2499
8.6.2 Auto Trig	2499
8.6.3 Holdoff Type	2500
9 Programming the Instrument	2502
9.1 List of Supported SCPI Commands	2503
*	2503
A	2503
C	2503
D	2511
F	2514
H	2514
I	2514
L	2516
M	2516
O	2517
R	2518
S	2518
T	2540
U	2541

9.2 IEEE 488.2 Common Commands	2542
9.2.1 *CAL? - Calibration Query	2542
9.2.2 *CLS - Clear Status	2543
9.2.3 *ESE - Standard Event Status Enable	2543
9.2.4 *ESR? - Standard Event Status Register Query	2544
9.2.5 *IDN? - Identification Query	2544
9.2.6 *OPC? - Operation Complete	2545
9.2.7 *OPT? - Query Instrument Options	2546
9.2.8 *RCL - Recall Instrument State	2546
9.2.9 *RST - Reset	2546
9.2.10 *SAV - Save Instrument State	2547
9.2.11 *SRE - Service Request Enable	2547
9.2.12 *STB? - Status Byte Query	2548
9.2.13 *TRG - Trigger	2548
9.2.14 *TST? - Self Test Query	2548
9.2.15 *WAI - Wait-to-Continue	2549
9.3 SCPI Operation and Results Query	2550
9.3.1 Mode Control	2550
9.3.2 Measurement Control	2550
9.3.2.1 CONFigure	2551
9.3.2.2 INITiate	2552
9.3.2.3 FETCh	2552
9.3.2.4 READ	2553
9.3.2.5 MEASure	2554
9.3.3 Trace Formatting Commands	2555
9.3.3.1 Clear Trace (Remote Command Only)	2555
9.3.3.2 Send/Query Trace Data (Remote Command Only)	2556
9.3.3.3 Format Data: Numeric Data (Remote Command Only)	2558
9.3.3.4 Format Data: Byte Order (Remote Command Only)	2559
9.3.3.5 Calculate/Compress Trace Data Query (Remote Command Only)	2559
9.3.3.6 Calculate Peaks of Trace Data (Remote Command Only)	2565
9.3.3.7 Smooth Trace Data (Remote Command Only)	2567

Table Of Contents

9.3.3.8	Number of Points for Smoothing (Remote Command Only)	2568
9.3.3.9	Mean Trace Data (Remote Command Only)	2569
9.4	Status Register System & STATus Subsystem	2570
9.4.1	Status Register System Diagram	2570
9.4.2	Status Register Hierarchy	2572
9.4.3	Status Register SCPI Commands	2574
9.4.4	How to Use Status Registers	2575
9.4.4.1	Polling Method	2575
Monitoring Options		2576
9.4.4.2	Service Request (SRQ) Method	2576
Using the Service Request (SRQ) Method		2576
9.4.5	Status Register Bit Parameters	2578
9.4.6	Status Subsystem Registers and Commands	2579
9.4.6.1	Status Byte Register	2579
Service Request Enable Register		2582
Preset the Status Byte		2582
9.4.6.2	Standard Event Status Register	2583
Standard Event Status Enable Register		2584
9.4.6.3	Operation Register	2585
Operation Condition Query		2586
Operation Enable		2587
Operation Event Query		2587
Operation Negative Transition		2588
Operation Positive Transition		2588
9.4.6.4	Operation Instrument Register	2589
Operation Instrument Condition		2589
Operation Instrument Enable		2590
Operation Instrument Event Query		2590
Operation Instrument Negative Transition		2591
Operation Instrument Positive Transition		2591
9.4.6.5	Questionable Register	2592
Questionable Condition		2593
Questionable Enable		2593
Questionable Event Query		2594
Questionable Negative Transition		2594
Questionable Positive Transition		2594
9.4.6.6	Questionable Power Register	2595
Questionable Power Condition		2596
Questionable Power Enable		2596
Questionable Power Event Query		2597
Questionable Power Negative Transition		2597

Questionable Power Positive Transition	2597
9.4.6.7 Questionable Temperature Register	2598
Questionable Temperature Condition	2599
Questionable Temperature Enable	2599
Questionable Temperature Event Query	2600
Questionable Temperature Negative Transition	2600
Questionable Temperature Positive Transition	2600
9.4.6.8 Questionable Frequency Register	2601
Questionable Frequency Condition	2602
Questionable Frequency Enable	2602
Questionable Frequency Event Query	2603
Questionable Frequency Negative Transition	2603
Questionable Frequency Positive Transition	2604
9.4.6.9 Questionable Calibration Register	2604
Questionable Calibration Condition	2605
Questionable Calibration Enable	2606
Questionable Calibration Event Query	2606
Questionable Calibration Negative Transition	2607
Questionable Calibration Positive Transition	2607
9.4.6.10 Questionable Calibration Extended Needed Register	2608
Questionable Calibration Extended Needed Condition	2609
Questionable Calibration Extended Needed Enable	2609
Questionable Calibration Extended Needed Event Query	2610
Questionable Calibration Extended Needed Negative Transition	2610
Questionable Calibration Extended Needed Positive Transition	2610
9.4.6.11 Questionable Calibration Extended Failure Register	2611
Questionable Calibration Extended Failure Condition	2612
Questionable Calibration Extended Failure Enable	2612
Questionable Calibration Extended Failure Event Query	2613
Questionable Calibration Extended Failure Negative Transition	2613
Questionable Calibration Extended Failure Positive Transition	2614
9.4.6.12 Questionable Calibration Skipped Register	2614
Questionable Calibration Skipped Condition	2615
Questionable Calibration Skipped Enable	2616
Questionable Calibration Skipped Event Query	2616
Questionable Calibration Skipped Negative Transition	2616
Questionable Calibration Skipped Positive Transition	2617
9.4.6.13 Questionable Integrity Register	2617
Questionable Integrity Condition	2619
Questionable Integrity Enable	2619
Questionable Integrity Event Query	2620
Questionable Integrity Negative Transition	2620
Questionable Integrity Positive Transition	2620
9.4.6.14 Questionable Integrity Signal Register	2621
Questionable Integrity Signal Condition	2622

Table Of Contents

Questionable Integrity Signal Enable	2622
Questionable Integrity Signal Event Query	2623
Questionable Integrity Signal Negative Transition	2623
Questionable Integrity Signal Positive Transition	2624
9.4.6.15 Questionable Integrity Output Register	2624
Questionable Integrity Output Condition	2625
Questionable Integrity Output Enable	2625
Questionable Integrity Output Event Query	2626
Questionable Integrity Output Negative Transition	2626
Questionable Integrity Output Positive Transition	2627
9.4.6.16 Questionable Integrity Uncalibrated Register	2627
Questionable Integrity Uncalibrated Condition	2628
Questionable Integrity Uncalibrated Enable	2629
Questionable Integrity Uncalibrated Event Query	2629
Questionable Integrity Uncalibrated Negative Transition	2629
Questionable Integrity Uncalibrated Positive Transition	2630
10 Hardware-Accelerated Fast Power Measurement (Remote Command Only)	2631
10.1 Reset Fast Power Measurement (Remote Command Only)	2632
10.2 Reset Fast Power Measurement (Remote Command Only)	2633
10.2.1 Acquisition Time	2633
10.2.2 Center Frequency	2633
10.2.3 DC Coupled	2633
10.2.4 Detector Type	2634
10.2.5 Do Noise Correction	2634
10.2.6 Do Spur Suppression	2634
10.2.7 Electronic Attenuator Bypass	2635
10.2.8 Electronic Attenuation	2635
10.2.9 External Reference Frequency	2635
10.2.10 Frequency Reference Source	2636
10.2.11 IF Gain	2636
10.2.12 IF Type	2636
10.2.13 Include Power Spectrum	2636
10.2.14 Mechanical Attenuation	2637
10.2.15 Preamp Mode	2637
10.2.16 Resolution Bandwidth Mode	2637
10.2.17 Resolution Bandwidth	2638

10.2.18 Trigger Delay	2638
10.2.19 Trigger Level	2638
10.2.20 Trigger Slope	2638
10.2.21 Trigger Source	2638
10.2.22 Trigger Timeout	2639
10.2.23 Signal Input	2639
10.2.24 Use Preselector	2639
10.2.25 Channel Bandwidth Array	2639
10.2.26 Channel Filter Type Array	2640
10.2.27 Channel Filter Alpha Array	2640
10.2.28 Channel Measurement Function Array	2640
10.2.29 Channel Offset Frequency Array	2641
10.2.30 Channel Occupied Bandwidth Percent Array	2641
10.2.31 Channel x-dB Bandwidth Array	2642
10.3 Define Fast Power Measurement Query (Remote Command Only)	2643
10.4 Configure Fast Power Measurement (Remote Command Only)	2644
10.5 Initiate Fast Power Measurement (Remote Command Only)	2645
10.6 Fetch Fast Power Measurement (Remote Command Only)	2646
10.7 Execute Fast Power Measurement (Remote Command Only)	2647
10.8 Binary Read Fast Power Measurement (Remote Command Only)	2648
10.9 Diagnostic Binary Read Fast Power Measurement (Remote Command Only)	2649

1 Documentation Roadmap

This section describes the Keysight products covered by this document, and provides links to related documentation.

- ["Products Covered by this Document" on page 85](#)
- ["Additional Documentation" on page 86](#)

- 1 Documentation Roadmap
- 1.1 Products Covered by this Document

1.1 Products Covered by this Document

For the full list of instrument models covered by this documentation, see the title page: "[Vector Modulation Analyzer Mode User's & Programmer's Reference](#)" on page [1](#).

1.2 Additional Documentation

If your instrument or computer has an internet connection, then you can access the latest editions of all relevant X-Series documentation via the links below.

This document is available in 3 formats:

- **Embedded Help**, in the instrument
- **Online Help**, at Keysight's web site

For information on this Mode, browse to:

<http://rfmw.em.keysight.com/wireless/helpfiles/VMAMode/FlexUI.htm>

- **Users & Programmers Reference**, in downloadable PDF format

For information on this Mode, download from:

<http://literature.cdn.keysight.com/litweb/pdf/N9054-90001.pdf>

The following documents are available online at keysight.com:

[X-Series Messages Guide](#)

The following documents are in downloadable PDF format:

Getting Started Guides & Security

- [N90x0B Getting Started & Troubleshooting Guide](#)
- [N9041B Getting Started & Troubleshooting Guide](#)
- [X-Series Status Register System Diagram](#)
- [Security Features & Statement of Volatility](#)

Specifications Guides

- [N9000B CXA Specifications Guide](#)
- [N9010B EXA Specifications Guide](#)
- [N9020B MXA Specifications Guide](#)
- [N9030B PXA Specifications Guide](#)
- [N9040B UXA Specifications Guide](#)

- 1 Documentation Roadmap
- 1.2 Additional Documentation

- [N9041B UXA Specifications Guide](#)

Measurement Guides

- [Spectrum Analyzer Mode Measurement Guide](#)
- [Real-Time Spectrum Analyzer Measurement Guide](#)
- [Noise Figure Measurement Guide](#)
- [Analog Demod Measurement Application Measurement Guide](#)
- [Phase Noise Measurement Application Measurement Guide](#)
- [EMI Measurement Application Measurement Guide](#)
- [M9484C VXG Signal Generator and X-Series Signal Analyzers Measurement Guide](#)

Service Guides

- [N9010B EXA Service Guide](#)
- [N9020B MXA Service Guide](#)
- [N9030B PXA Service Guide](#)
- [N9040B UXA Service Guide](#)

2 User Interface

Here are the basic elements of the Multitouch User Interface. For more information, tap a topic.

Included in this section are also topics for several front panel keys not described in other topics. Tap one of these topics for more information.



"Cancel key" on
page 133



"Onscreen Keyboard key" on
page 134



"Touch On/Off Key" on
page 135



"Tab key" on
page 136

2.1 Screen Tabs

In the X-Series Multitouch User Interface (or Multitouch UI), you can run many different Measurement Applications, or “Modes”. Examples are Spectrum Analyzer Mode, LTE-A FDD Mode, IQ Analyzer Mode, and Real Time Spectrum Analyzer Mode. Each Mode has its own set of controls, windows and SCPI commands.

Each Mode runs within a “Screen”. The Multitouch UI supports multiple “Screens” (see ["Multiscreen" on page 177](#) for more information). Each screen displays one Measurement in one Mode. The set of configured screens is shown across the top of the display as a set of Screen Tabs, with a + tab at the right for adding new Screens:



You can see up to six tabs at a time on the UXA, and 4 at a time on the CXA, EXA, MXA and PXA. If there are more Screens configured than this, arrows appear to the left and right of the Screen Tabs; pressing the arrows scrolls the Screen Tabs to the left or right. A scroll bar also appears at the bottom of the Screen Tabs, indicating that you can scroll the tabs by dragging them with your finger; you can also scroll them by dragging the scroll bar.

Pressing a Screen Tab selects that screen for operation. Pressing the blue (selected) Screen Tab is the same as pressing the Mode/Meas front panel key.



Both actions open the ["Mode/Meas/View Dialog" on page 90](#). In addition, if you have a PC keyboard plugged in, the sequence CTL-SHIFT-M will open up this dialog.

The + tab at the right of the Screen Tabs bar adds a new Screen by cloning the current screen. The new Screen has the identical setup and settings as the current Screen. You can then change the Mode, Measurement and/or settings of the new Screen.

You can define up to 16 screens at once.

Example Multiscreen View

The example below shows a four-screen display in Multiscreen view.

The Screen called “Real-Time SA 2” is selected, as indicated by its blue tab. Touching any other screen or tab selects the screen for that tab and brings it to the foreground.



The following topics provide more information:

- "Mode/Meas/View Dialog" on page 90
- "Add Screen" on page 107
- "Multiscreen" on page 177

2.1.1 Mode/Meas/View Dialog

The Mode/Meas/View dialog opens when you press the selected (blue) Screen tab (see "Screen Tabs" on page 89) or the **Mode/Meas** front panel key.

This dialog displays lists of available Modes, Measurements and Views, as well as the "Sequencer" on page 101 control for configuring Screens.

2 User Interface

2.1 Screen Tabs

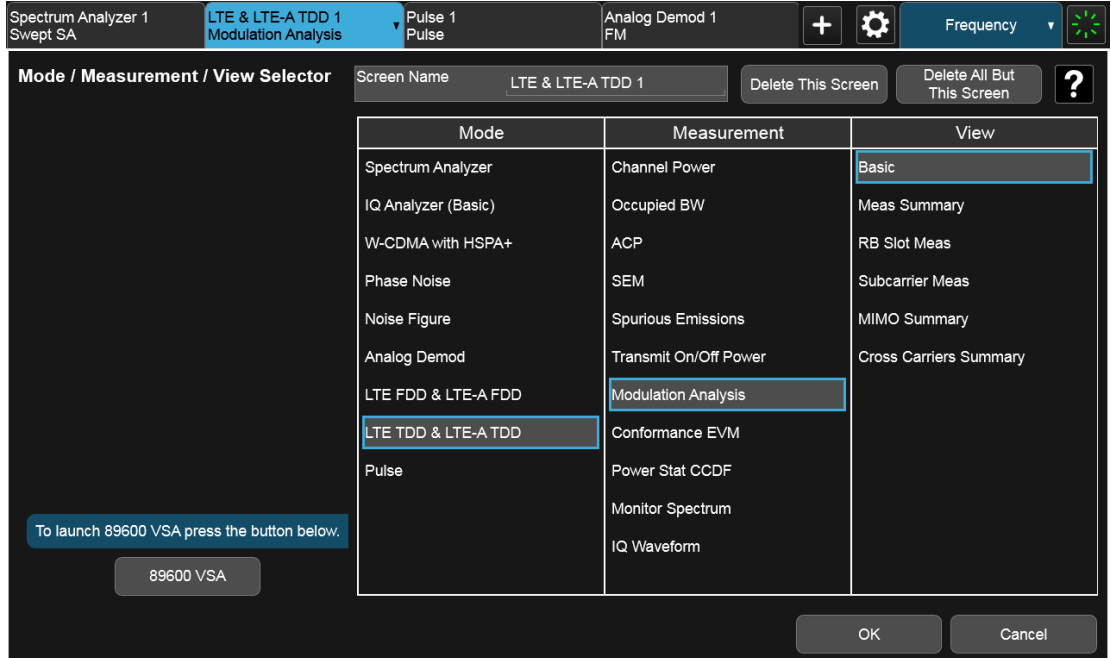

2.1.1.1 Mode

The first column in the Mode/Meas/View dialog allows you to select the desired Mode from those currently licensed in your instrument.

Modes, also known as “measurement applications”, are collections of measurement capabilities packaged together to provide you with an instrument personality specific to your measurement needs. Each Mode is ordered separately by Model Number and must be licensed in order for it to be available in the instrument.

You select the Mode you want to run using the Mode/Meas/View dialog. Once a Mode is selected, only the commands that are valid for that mode can be executed

For more information on Modes, preloading Modes, and memory requirements for Modes, see ["More Information" on page 94](#)

The `:INSTRUMENT[:SElect]` command is used to remotely select a Mode by sending the instrument a parameter which represents the name of the desired Mode. The Mode Names may be found in the table under ["Index to Modes" on page 93](#).

The `:INSTRUMENT:NSElect` command is used to remotely select a Mode by sending the Mode Number of the desired Mode. See ["Instrument Number Select" on page 92](#). The Mode Numbers may be found in the table under ["Index to Modes" on page 93](#).

The `:INSTRUMENT:CONFigure` command causes a Mode and Measurement switch at the same time. This generally results in faster overall switching than sending the

`:INSTRument:SElect` and `CONFigure` commands separately. See "Mode and Measurement Select" on page 92.

Remote Command	<code>:INSTRument[:SElect] <mode_id></code> where <code><mode_id></code> is one of the values listed in "Index to Modes" on page 93 below <code>:INSTRument[:SElect]?</code>
Example	<code>:INST SA</code>
Notes	A list of the valid mode choices is returned by the <code>:INST:CAT?</code> query
Preset	The default Mode is set to <code>SA</code> on Restore System Defaults->All , unless noted below: For N8973B, N8974B, N8975B, or N8976B: <code>NFIG</code>
State Saved	Saved in instrument state
Annunciation	Application Title is in the Screen Tab

Instrument Number Select

Remote Command	<code>:INSTRument:NSElect <integer></code> <code>:INSTRument:NSElect?</code>
Example	<code>:INST:NSEL 1</code>
Notes	The Mode Numbers may be found in the table under "Index to Modes" on page 93 SA mode is number 1 The command is sequential: that is, continued parsing of commands cannot proceed until the instrument select is complete and the resultant SCPI trees are available
Preset	The default Mode is set to <code>1</code> by Restore System Defaults->All , unless noted in the table above
State Saved	Saved in instrument state

Mode and Measurement Select

Remote Command	<code>:INSTRument:CONFigure:<mode_id>:<meas></code> where <code><mode_id></code> is a valid parameter for the <code>:INST:SEL</code> command and <code><meas></code> is a valid parameter for the <code>:CONF</code> command in the Mode specified by <code><mode></code>
Example	<code>:INST:CONF:SA:SAN</code> selects the Spectrum Analyzer mode and the Swept SA measurement <code>:INST:CONF:WCDMA:RHO</code> selects the WCDMA mode and the Mod Accuracy measurement
Notes	The available parameters for <code><mode_id></code> are dependent upon installed and licensed applications resident in the instrument. The available parameters for <code><meas></code> are dependent on the <code><mode_id></code> parameter and the valid measurements available for that mode, which can depend on model numbers and installed options In general this command will execute more quickly than sending the equivalent separate <code>:INST:SEL</code>

and **:CONF** commands

Index to Modes

The Mode Number in the table below is the parameter for use with the **:INSTrument:NSElect** command. The Mode Parameter is the parameter for use with the **:INSTrument[:SElect]** command. Your actual choices will depend upon which applications are installed in your instrument.

Mode	Mode Number	Mode Parameter <mode_id>
5G NR	109	NR5G
89601 VSA	101	VSA89601
Analog Demod	234	ADEM0D
Avionics	232	AVIONIC
Bluetooth	228	BT00th
Channel Quality / Group Delay	161	CQM
EMI Receiver	141	EMI
GSM/EDGE/EDGE Evo	13	EDGE GSM
I/Q Analyzer (Basic)	8	BASIC
LTE FDD & LTE-A FDD	107	LTEAFDD
LTE TDD & LTE-A TDD	108	LTEATDD
Measuring Receiver	233	MRECEIVE
MSR	106	MSR
Noise Figure	219	NFIGure
Phase Noise	14	PNOISE
Power Amplifier	81	PA
Pulse	151	PULSEX
Radio Test	300	RTS
Real Time Spectrum Analyzer	2	RTSA
Remote Language Compatibility	266	RLC
SCPI Language Compatibility	270	SCPILC
Sequence Analyzer	123	SEQAN
Short Range Comms	218	SRCOMMS
Spectrum Analyzer	1	SA
Vector Modulation Analyzer	200	VMA
WCDMA with HSPA+	9	WCDMA
WLAN	217	WLAN

More Information

The Mode name appears on the Screen Tab, followed by a number identifying which instance of the Mode appears on that screen. Each Screen contains one Mode. For example, in the image below, there is one Real-Time Spectrum Analyzer screen, and two Spectrum Analyzer screens. The current Screen contains **Real-Time SA 1**.

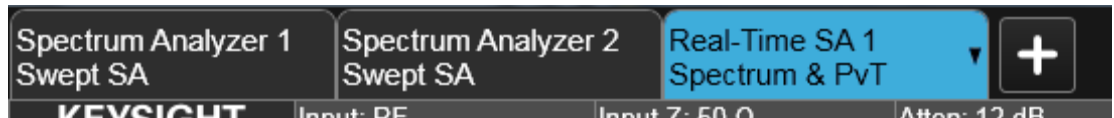

It is possible to specify the order in which the Modes appear in the Mode menu, using the **Configure Applications** utility on the Desktop. Using the same utility, it is also possible to specify a subset of the available applications to load into memory at startup time, which can decrease the startup time of the instrument and the amount of memory consumed.

Each application (Mode) that runs in an X-Series instrument consumes virtual memory. The various applications consume varying amounts of virtual memory, and as more applications run, the memory consumption increases. Keysight characterizes each Mode and assigns a memory usage quantity based on a conservative estimate. The **Configure Applications** utility shows an estimate for how much memory each Mode will consume.

You can still run a Mode even if it is not preloaded into memory – during runtime, the first time an application that is not loaded into memory is selected (either by pressing that application's **Mode** key or by sending that application's **:INST:SEL** command), the Application will be loaded, but this takes a few seconds. The instrument will pause while loading the application while displaying a message box that says “Loading application, please wait...” Preloading the application eliminates this wait time *but* consumes additional memory.

2.1.1.2 Application Mode Remote Commands

This section contains a number of remote commands that are provided for programming convenience and remote compatibility.

Application Mode Catalog Query (Remote Command Only)

Returns a string containing a comma-separated list of names of all the installed and licensed measurement modes (applications). These names can only be used with **:INSTrument[:SElect]**.

Remote Command	:INSTrument:CATalog?
----------------	-----------------------------

Example	<code>:INST:CAT?</code>
Notes	Query returns a quoted string of the installed and licensed modes separated with a comma. Example: <code>"SA,PNOISE,WCDMA"</code>
Backwards Compatibility Notes	VSA (E4406A): <code>:INSTrument:CATalog?</code> returned a list of installed <code>INSTrument:SELECT</code> items as a comma separated list of string values, for example: <code>"BASIC", "GSM", "EDGEgSM", "CDMA", "SERVICE"</code> X-Series uses the ESA/PSA compatible query of a string contain comma separated values: <code>"SA,PNOISE,NFIG,BASIC"</code>

Current Application Model (Remote Command Only)

Returns a string that is the Model Number of the currently selected application (mode). This information is also displayed in the **Show System** screen.

Remote Command	<code>:SYSTem:APPLication[:CURRent][:NAME]?</code>
Example	<code>:SYST:APPL?</code>
Notes	Query returns a quoted string that is the Model Number of the currently selected application (Mode). Example: <code>"N9060A"</code> String length between 6 to 9 characters.
Preset	Not affected by Preset
State Saved	Not saved in state, the value will be the selected application when a Save is done.

Current Application Revision (Remote Command Only)

Returns a string that is the Revision of the currently selected application (mode). This information is also displayed in the Show System screen

Remote Command	<code>:SYSTem:APPLication[:CURREnt]:REVIision?</code>
Example	<code>:SYST:APPL:REV?</code>
Notes	Query returns a quoted string that is the Revision of the currently selected application (Mode). Example: <code>"1.0.0.0"</code> String length is a maximum of 23 characters. (each numeral can be an integer + 3 decimal points) The format is Major.Minor.Build.Compile, where Major must correspond to the Integer portion of the Version in the license file for the application.
Preset	Not affected by a Preset
State Saved	Not saved in state, the value will be the selected application when a Save is done.

Current Application Options (Remote Command Only)

Returns a string that is the Options list of the currently selected application (Mode). This information is also displayed in the Show System screen

Remote Command	<code>:SYSTem:APPLication[:CURRent]:OPTion?</code>
Example	<code>:SYST:APPL:OPT?</code>
Notes	Query returns a quoted string that is the Option list of the currently selected application (Mode). The format is the name as the *OPT? or SYSTem:OPTion command: a comma separated list of option identifiers. Example: "1FP,2FP" String length is a maximum of 255 characters.
Preset	Not affected by a Preset
State Saved	Not saved in state per se, the value will be the selected application when a Save is invoked.

Application Catalog Number of Entries (Remote Command Only)

Returns the number of installed and licensed applications (Modes).

Remote Command	<code>:SYSTem:APPLication:CATalog[:NAME]:COUNT?</code>
Example	<code>:SYST:APPL:CAT:COUN?</code>
Preset	Not affected by Preset
State Saved	Not saved in instrument state.

Application Catalog Model Numbers (Remote Command Only)

Returns a list of Model Numbers for the installed and licensed applications (Modes).

Remote Command	<code>:SYSTem:APPLication:CATalog[:NAME]?</code>
Example	<code>:SYST:APPL:CAT?</code>
Notes	Returned value is a quoted string of a comma separated list of Model Numbers. Example, if SAMS and Phase Noise are installed and licensed: "N9060A,N9068A" String length varies based on licenses. Licenses are between 6 and 9 characters. So the string length will be between $COUNT * 7 - 1$ and $COUNT * 10 - 1$. (7 & 10 = Model Number length + 1 for comma. -1 = no comma for the 1st entry.)
Preset	Not affected by a Preset
State Saved	Not saved in instrument state.

Application Catalog Revision (Remote Command Only)

Returns the Revision of the provided Model Number.

Remote Command	<code>:SYSTem:APPLication:CATalog:REVision? <model></code>
Example	<code>:SYST:APPL:CAT:REV? 'N9060A'</code>
Notes	Returned value is a quoted string of revision for the provided Model Number. The revision will be a null-string ("") if the provided Model Number is not installed, licensed, and loaded. Example, if SAMS is installed and licensed: "1.0.0.0" String length is a maximum of 23 characters. (each numeral can be an integer + 3 decimal points)
Preset	Not affected by a Preset.
State Saved	Not saved in instrument state.

Application Catalog Options (Remote Command Only)

Returns a list of Options for the provided Model Number

Remote Command	<code>:SYSTem:APPLication:CATalog:OPTion? <model></code>
Example	<code>:SYST:APPL:CAT:OPT? 'N9060A'</code>
Notes	Returned value is a quoted string of a comma separated list of Options, in the same format as *OPT? or :SYSTem:OPTion?. If the provided Model Number is not installed and licensed a null-string ("") will be returned. Example, if SAMS is installed and licensed: "2FP" String length is a maximum of 255 characters.
Preset	Not affected by a Preset
State Saved	Not saved in instrument state.

ESA SA compatibility command (Remote Command only)

Provided for backwards compatibility with ESA. When this command is received, the analyzer aliases it to the appropriate Mode.

Remote Command	<code>:INSTrument[:SElect] 'SA' 'PNOISE' 'EDGE' 'GSM' 'BASIC'</code>
Example	<code>:INST 'SA'</code>
Notes	The query is not a quoted string. It is an enumeration as indicated in the Instrument Select table above

GSM Mode compatibility command (Remote Command only)

Provided for backwards compatibility. When this command is received, the analyzer aliases it to the following:

```
:INST:SEL EDGE GSM
```

Remote Command :INSTrument[:SElect] GSM

Example :INST GSM

SA compatibility command for EMC (Remote Command only)

Provided for ESU compatibility. When this command is received, the analyzer aliases it to the following:

```
:INST:SEL SCPI LC
```

This results in the analyzer being placed in SCPI Language Compatibility Mode, in order to emulate the ESU Spectrum Analyzer Mode.

Remote Command :INSTrument[:SElect] SANalyzer

Example :INST SAN

Receiver compatibility command for EMC (Remote Command only)

Provided for ESU compatibility. When this command is received, the instrument aliases it to the following:

```
:INST:SEL EMI
```

```
:CONF FSC
```

This results in the instrument being placed in the EMI Receiver Mode, running the Frequency Scan measurement, in order to emulate the ESU Receiver Mode.

Remote Command :INSTrument[:SElect] REceiver

Example :INST REC

APD compatibility command for EMC (Remote Command only)

Provided for ESU compatibility. When this command is received, the analyzer aliases it to the following:

```
:INST:SEL EMI
```

```
:CONF APD
```

2 User Interface
2.1 Screen Tabs

This results in the analyzer being placed in the EMI Receiver Mode, running the APD measurement, in order to emulate the ESU APD Mode.

Remote Command	<code>:INSTrument[:SElect] APDistribution</code>
----------------	--

Example	<code>:INST APD</code>
---------	------------------------

IF Mode compatibility command for EMC (Remote Command only)

Provided for ESU compatibility. When this command is received, the analyzer aliases it to the following:

`:INST:SEL EMI`

`:CONF MON`

This results in the analyzer being placed in the EMI Receiver Mode, running the Monitor Spectrum measurement, in order to emulate the ESU IF Mode.

Remote Command	<code>:INSTrument[:SElect] IFANalyzer</code>
----------------	--

Example	<code>:INST IFAN</code>
---------	-------------------------

2.1.1.3 Measurement

The Measurement column of the Mode/Meas/View dialog shows all the Measurements available for the Mode which is selected in the first column. Select a Measurement in the second column and the View column will show all the Views available for that measurement. Once you have the Mode, Measurement and View selected, press OK to change the current Screen to that Mode, Measurement and View.

2.1.1.4 View

A View is a collection of Result Windows. The View column of the "Mode/Meas/View Dialog" on page 90 shows all the Views available for the Measurement which is selected in the second column. Once you have the Mode, Measurement and View selected, press OK to change the current Screen to that Mode, Measurement and View.

The View may also be set by using the View tab on the Display menu. The View tab is the last tab on the Display menu for every measurement. The Views are the same as those listed in the "Mode/Meas/View Dialog" on page 90.

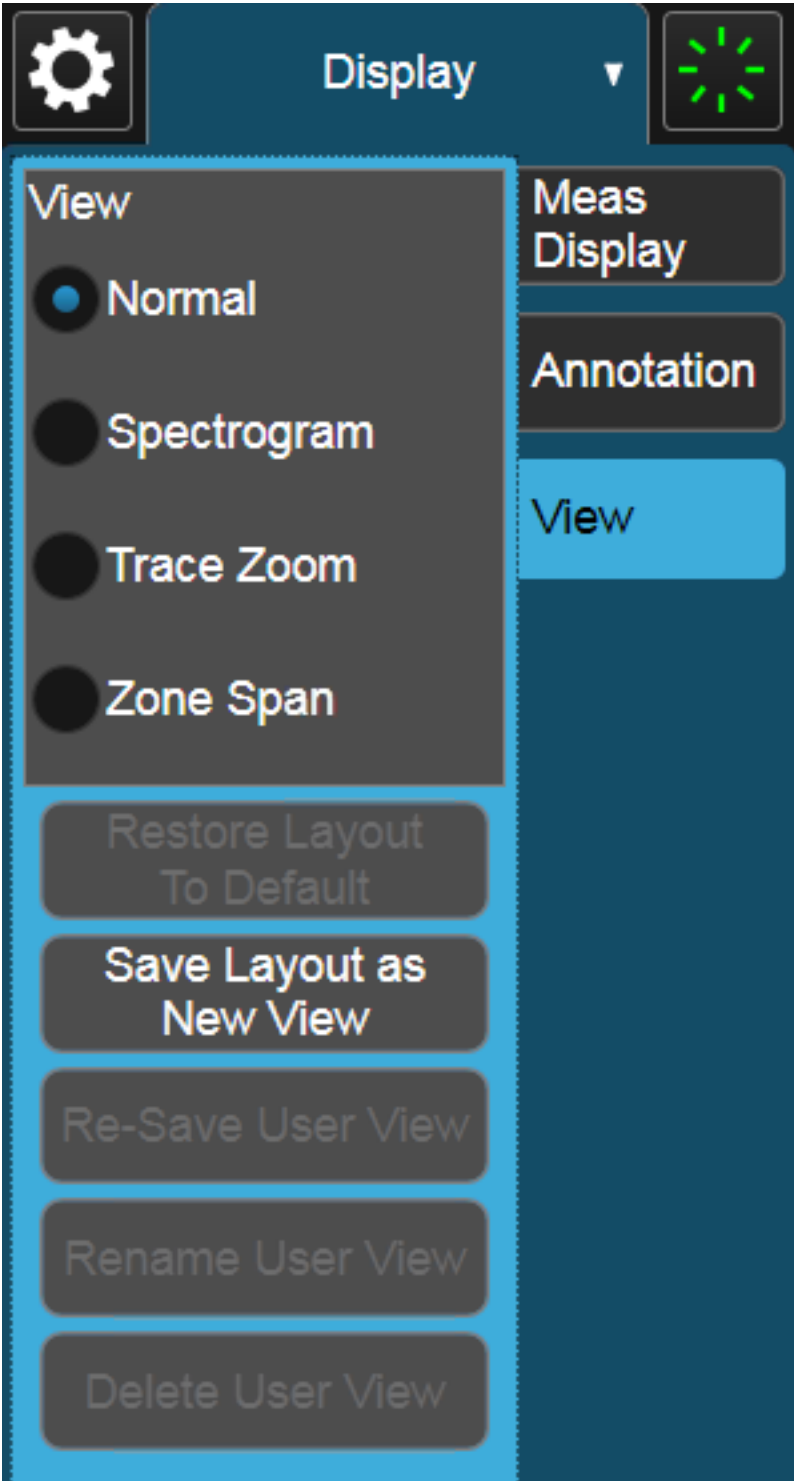

2.1.1.5 Sequencer

Allows multiple Screens to update sequentially while in "Multiscreen" on page 177 display mode. Each Screen updates in sequence, and when all have updated, the sequence will start again.

To start the Sequencer, you must have more than one Screen defined, and you must have Multiscreen selected (see "Screen Tabs" on page 89).

If you want each Screen to use a different input, you must turn off **All Screens Use Same Input** under **Input/Output**, **Input**.

CAUTION

Differences in hardware settings between the Screens may cause switches and/or attenuators to cycle as you go from one Screen to another. This could potentially reduce the life of these components. To avoid this, make sure **Attenuation**, **µW Path Control** and other switch settings are the same in each Screen.

NOTE

When the Sequencer is running, the destination of remote commands is unpredictable, so you should stop the Sequencer before sending any measurement-related commands. Once the Sequencer has stopped, select a specific Screen using `:INSTrument:SCREen:SElect`, before sending any further commands. See "Select Screen" on page 179

NOTE

When the Sequencer is running, Auto alignment is temporarily disabled. A pending auto alignment might be executed when the sequencer is stopped.

See "More Information" on page 101

Remote Command	<code>:SYSTem:SEQuencer ON OFF 1 0</code> <code>:SYSTem:SEQuencer?</code>
Example	<code>:SYST:SEQ ON</code>
Notes	If the display is disabled (via <code>:DISP:ENAB OFF</code>) then the error message "-221, Settings conflict; Screen SCPI cannot be used when Display is disabled" is generated
Dependencies	To start the Sequencer, you must have more than one Screen defined and you must have Multiscreen selected
Preset	<code>OFF</code>

More Information

To start the Sequencer, tap the current (blue) Screen tab to go into the Mode/Meas/View Dialog:

2 User Interface
2.1 Screen Tabs

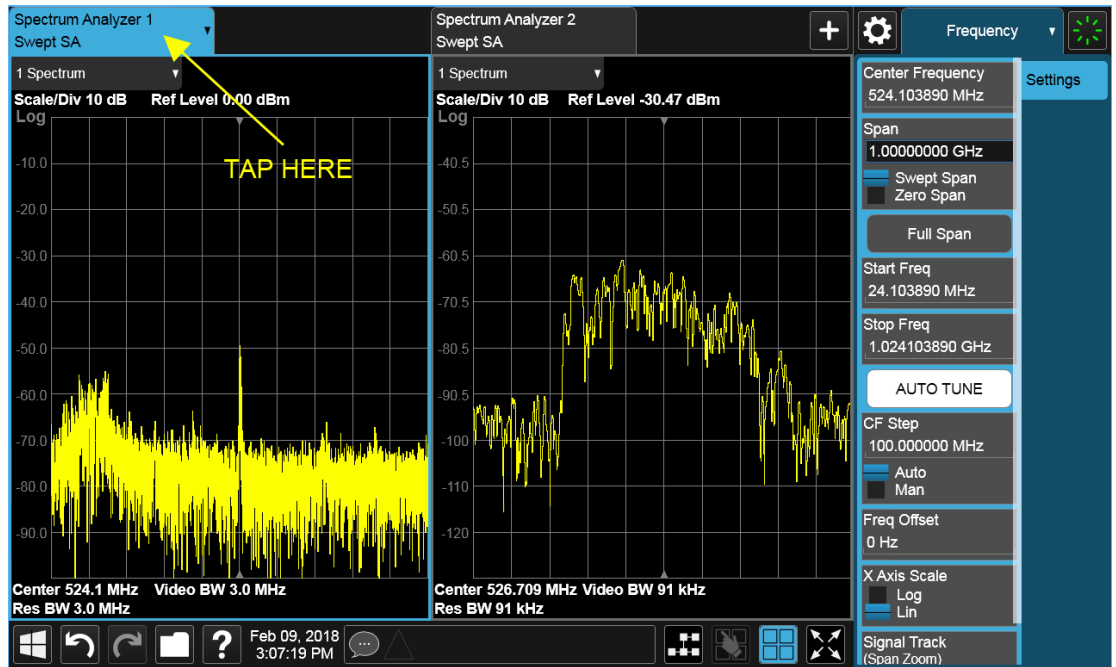

In the Sequencer block in the upper left hand corner, tap the Sequencing switch to turn it On:

The screenshot shows the 'Mode / Measurement / View Selector' dialog box. In the top left corner, there is a 'Sequencer' section with a 'Sequencing' switch. The switch is currently set to 'Off'. A yellow arrow points to the switch with the text 'TAP HERE'. A text box next to the switch explains: 'When Sequencing is On and there are multiple Screens, all Screens update in sequence. When Sequencing is Off, only the selected Screen updates.' Below this, there is a 'Launch VSA' button. The main part of the dialog is a table with three columns: Mode, Measurement, and View.

Mode	Measurement	View
Spectrum Analyzer	Swept SA	Normal
EMI Receiver	Channel Power	Spectrogram
IQ Analyzer (Basic)	Occupied BW	Trace Zoom
W-CDMA with HSPA+	ACP	Zone Span
GSM/EDGE /EDGE Evo	Power Stat CCDF	User View
Phase Noise	Burst Power	Normal 1
Noise Figure	Spurious Emissions	Normal 2
Analog Demod	SEM	
Bluetooth	TOI	
LTE FDD & LTE-A FDD	Harmonics	
LTE TDD & LTE-A TDD	List Sweep	
WLAN		

2 User Interface
2.1 Screen Tabs

The instrument will immediately exit the Mode/Meas/View Dialog and begin making measurements in each of the screens, one after the other. When a measurement is being made in a particular Screen, that Screen's tab will be blue.

Measurement being made in Screen 1:

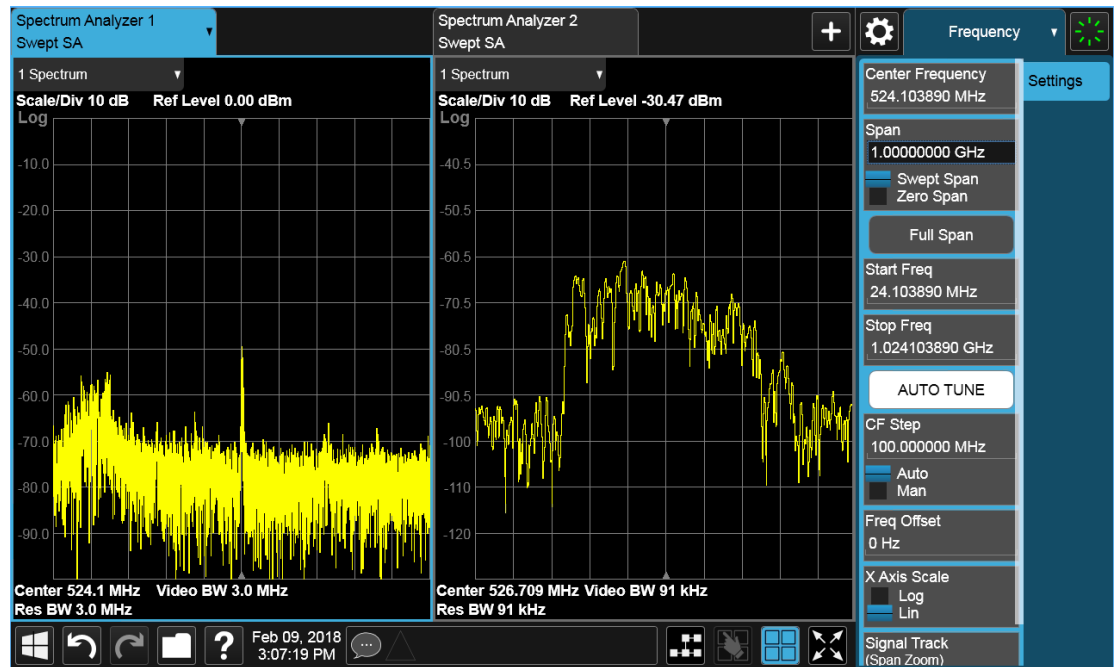

Measurement being made in Screen 2:

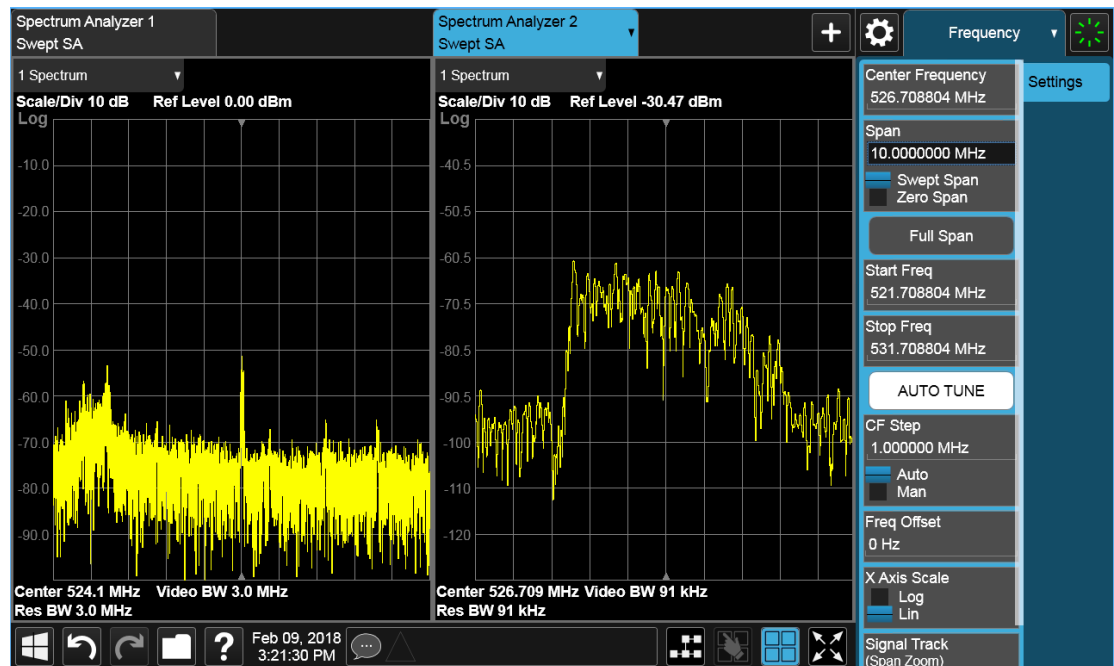

Touching any key or control on the display will cause the Sequencer to stop, so that you can make desired changes. When this happens, the message “Sequencer stopped” is displayed.

When the Sequencer is running, the screens update in the order in which they were created.

Each Screen takes one measurement then passes control to the next Screen. Each Screen updates as though it were in Single Sweep or Single Measurement mode. Thus, if Averaging is on, a Screen may take multiple sweeps before moving on to the next Screen.

2.1.1.6 Screen Name

By default, the screen name is the Mode (Application) name followed by a number indicating the instance of the application.

You may change the name displayed on the Screen Tab of any screen. The control to do this appears in the ["Mode/Meas/View Dialog" on page 90](#):

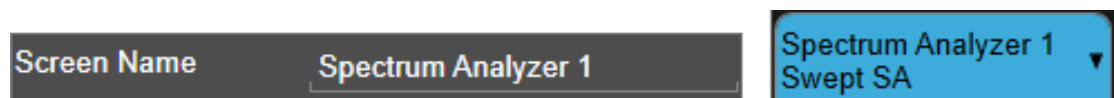

When you touch this control an onscreen keyboard appears, allowing you to change the name. Whatever you change it to appears on the Tab, even if you subsequently change the screen to a different Mode.



To reset the name, delete the screen name entirely.

Each Screen Name must be unique; you cannot give the same name to more than one screen.

Remote Command	<code>:INSTrument:SCReen:REName <alphanumeric></code>
Example	<code>:INST:SCR:REN "Baseband"</code>
Notes	<p>The currently active screen is renamed.</p> <p>If the <code><alphanumeric></code> specifying the new name is already present in the list of screen names, the error message “-224, Illegal parameter value; New name <name> already exists” appears</p> <p>If the display is disabled (via <code>:DISP:ENAB OFF</code>) then the error message “-221, Settings conflict; Screen SCPI cannot be used when Display is disabled” appears</p>

2.1.1.7 Delete This Screen

Pressing this button deletes the current Screen (the one with the blue tab). Deleting a screen removes it from view and selects the next lower screen in the list of screens. If only one screen is configured, it cannot be deleted.

If you press the **Delete This Screen** button, a prompt appears:

“This function will delete the current screen and its settings. This action cannot be undone. Do you want to proceed?”

Pressing **OK** or Enter deletes the screen, pressing **Cancel** or **ESC** does not.

Remote Command	<code>:INSTrument:SCReen:DELeTe</code>
Example	<code>:INST:SCR:DEL</code>
Notes	<p>The currently active screen is deleted</p> <p>If the screen you are attempting to delete is the only configured screen, the error message “-221, Settings conflict; Last screen cannot be deleted” is displayed</p> <p>If the display is disabled (via <code>:DISP:ENAB OFF</code>) then the error message “-221, Settings conflict; Screen SCPI cannot be used when Display is disabled” is generated</p>

2.1.1.8 Delete All But This Screen

Pressing this control deletes all the Screens except the current Screen (the one with the blue tab).

If you press the **Delete All But This Screen** button, a prompt appears:

“This function will delete all defined screens and their settings, except for the current screen. This action cannot be undone. Do you want to proceed?”

Pressing **OK** or Enter deletes the screen, pressing **Cancel** or ESC does not.

Remote Command	<code>:INSTrument:SCReen:DELeTe:ALL</code>
Example	<code>:INST:SCR:DEL:ALL</code>
Notes	<p>You can reset the instrument to the power-on configuration by invoking <code>:INST:SCR:DEL:ALL</code> followed by <code>:SYSTem:DEFault ALL</code></p> <p>If the display is disabled (via <code>:DISP:ENAB OFF</code>) then the error message “-221, Settings conflict; Screen SCPI cannot be used when Display is disabled” appears</p>

2.1.1.9 89600 VSA

Pressing this button launches the 89600 VSA software. The 89600 VSA software is powerful, PC-based software, offering the industry's most sophisticated general purpose and standards specific signal evaluation and troubleshooting tools for R&D engineers. Even for proprietary and non-standard signals in SATCOM or MILCOM applications, you can make signal quality measurements with customized IQ constellation.

The 89600 VSA software offers the following features:

- Over 35 general-purpose analog and digital demodulators ranging from 2FSK to 4096QAM
- Flexible and custom IQ and OFDM signal analysis for single carrier
- Standards specific modulation analysis including:
 - Cellular: GSM/EDGE, cdma2000, W-CDMA, TD-SCDMA, LTE(FDD/TDD),
 - LTE-Advanced and more
 - Wireless networking: 802.11a/b/g, 802.11n, 802.ac, 802.16 WiMAX (fixed/mobile), WiSUN (MR-FSK PHY)
 - RFID
 - Digital satellite video and other satellite signals, radar, LMDS
- Up to 400K bin FFT, for the highest resolution spectrum analysis
- A full suite of time domain analysis tools, including signal capture and playback, time gating, and CCDF measurements
- 20 simultaneous trace displays and the industry's most complete set of marker

functions

- Easy-to-use Microsoft Windows graphical user interface

For more information see the Keysight 89600 Series VSA web site at www.keysight.com/find/89600vsa

To learn more about how to use the 89600 VSA in the instrument, start the 89600 VSA software, then open the 89600 VSA Help and navigate to the topic "About Keysight X-Series Signal Analyzer with 89600 VSA Software".

Example `:INST:SEL VSA89601`
 `:INST:NSEL 101`

2.1.2 Add Screen

On X-Series analyzers you can configure up to 16 different Screens at one time. Each Screen contains one Mode, each Mode contains one Measurement, and each Measurement contains a number of Windows.

You can add screens by pressing the “+” icon in the "Screen Tabs" on page 89 panel. The icon is shown below:



Every time you add a Screen, the instrument “clones” or “copies” the current Screen into the new Screen. If desired, you can then use the "Mode/Meas/View Dialog" on page 90 to change the Mode, Measurement and/or View of the new Screen, or simply operate a second copy of your previous Screen, thus preserving the settings of your previous Screen.

When you have defined the maximum number of Screens (16), the “+” icon disappears.

For more information about operating the instrument with multiple screens configured, see "Multiscreen" on page 177.

Remote Command `:INSTrument:SCReen:CREate`

Example `:INST:SCR:CRE`

Notes The maximum number of screens is 16. If an attempt to add a screen occurs when the maximum have been defined, the error message “-221, Settings conflict; Screen limit reached” appears
When you create a new screen the Screen Name is the current Mode name followed by a number indicating the instance of the Mode.

If the display is disabled (via `:DISP:ENAB OFF`) then the error message “-221, Settings conflict; Screen SCPI cannot be used when Display is disabled” appears

2.2 Meas Bar

The Meas Bar is used to display annotation for the current measurement. There are three primary uses for the Meas Bar:

1. To show annotation for the most important parameters in the measurement so you can see them at a glance
2. To show the annotation that you will most want to have recorded in a screen dump
3. To give you quick access to settings.

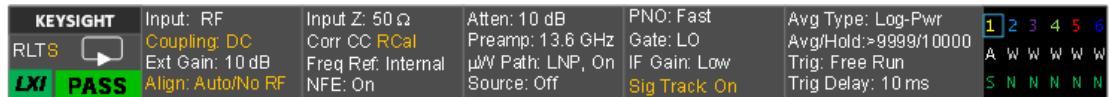

The Meas Bar is made up of a number of annotation panels, each of which, when pressed, opens up a dialog below it which contains controls for those settings.

For example, here is what the display looks like when you touch one of the regions of the Meas Bar:

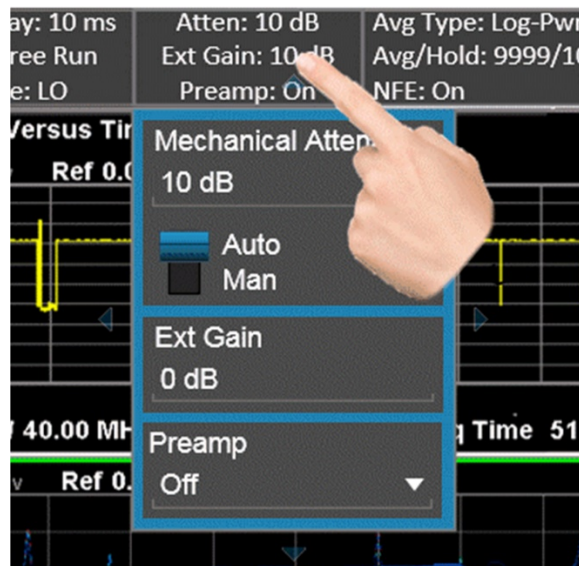

Touching anywhere off the hotspot panel or pressing any hardkey except **Save** or **Quick Save** closes the hotspot panel.

In a hotspot panel, the control in black with the blue border is the active function. Each panel may have its own default active function.

Settings that are colored amber are those that you need to be particularly aware of; for example, if Alignments are off, this is shown in amber, so you will know that you may not be meeting spec. Similarly, if DC coupling is on, this is shown amber, to alert you to be careful what voltage you put on the input.

You can turn the Meas Bar on and off with a switch on the Annotation tab of the Display menu.

System Control Panel

The leftmost panel holds the GPIB/Remote annunciators, the Single/Continuous symbol/control, the LXI indicator and the PASS/FAIL indicator. Tapping this panel drops down controls for Single/Continuous, Pause/Resume and restart.



GPIB/Remote annunciators

The GPIB/Remote annunciators are shown as the letters **KRLTS**. Each letter is shown if the state is true and is not shown if the state is false, as follows:

K	Keylock indicator	This is shown when the instrument is in the Keylock state (turned on and off by the SYST:KLOCK command)
R	Remote annunciator	Shown when the instrument is in the remote state, as when being controlled via the IEEE-488 bus (GPIB) or TCP/IP connections
L	GPIB Listen annunciator	Shown when addressed to listen via GPIB or TCP/IP
T	GPIB Talk annunciator	Shown when addressed to talk via GPIB or TCP/IP
S	GPIB SRQ annunciator	Shown when the instrument is asserting SRQ on GPIB. This annunciator is an amber color

Single/Continuous symbol/control

This annunciator shows as an arrow on an oval line when in Continuous, or an arrow on a straight line when in Single.

LXI indicator

This indicator displays in green when LAN is connected, in white when LAN is not connected, and in red when LAN is connected but has a connection problem.

PASS/FAIL indicator

This annunciator displays when Limits are turned on. It is green if all Limits are passing, and a red FAIL if any limit is not passing.

The following command queries the status of the current measurement limit testing. It returns a 0 if the measured results pass when compared with the current limits. It returns a 1 if the measured results fail any limit tests.

Remote Command `:CALCulate:CLIMits:FAIL?`

Example `:CALC:CLIM:FAIL?`

queries the current measurement to see if it fails the defined limits
Returns a 0 or 1: 0 it passes, 1 it fails

Trace Detector Settings Panel

In the Swept SA and some other measurements, there is a special panel summarizing the settings for the traces in the measurement:



There is one column for each trace. The rows are as follows:

- The top row shows the Trace Number, in the trace color.
- The second row shows the Trace Type for each trace (W=Clear/Write, A=Trace Average, M=Max Hold, m=Min Hold); this letter is in white if the trace is Active, in gray if the trace is inactive; there is a bar through the letter if the trace is not being displayed
- The third row shows the detector for each trace (N=Normal, S=Sample, A=Average, P=peak, p=negative peak, Q=Quasi Peak, E=EMI Average, R=RMS Average, f=math function)

In the example above, trace 1 is active, visible, and in Average using the Sample detector, the other traces are inactive, blanked and in Clear/Write using the Normal detector.

Tapping this panel drops down controls for the Traces.

2.3 Measurement Display

The Measurement Display contains one or more data windows displaying the result of the current measurement. These may be graphical or textual windows.

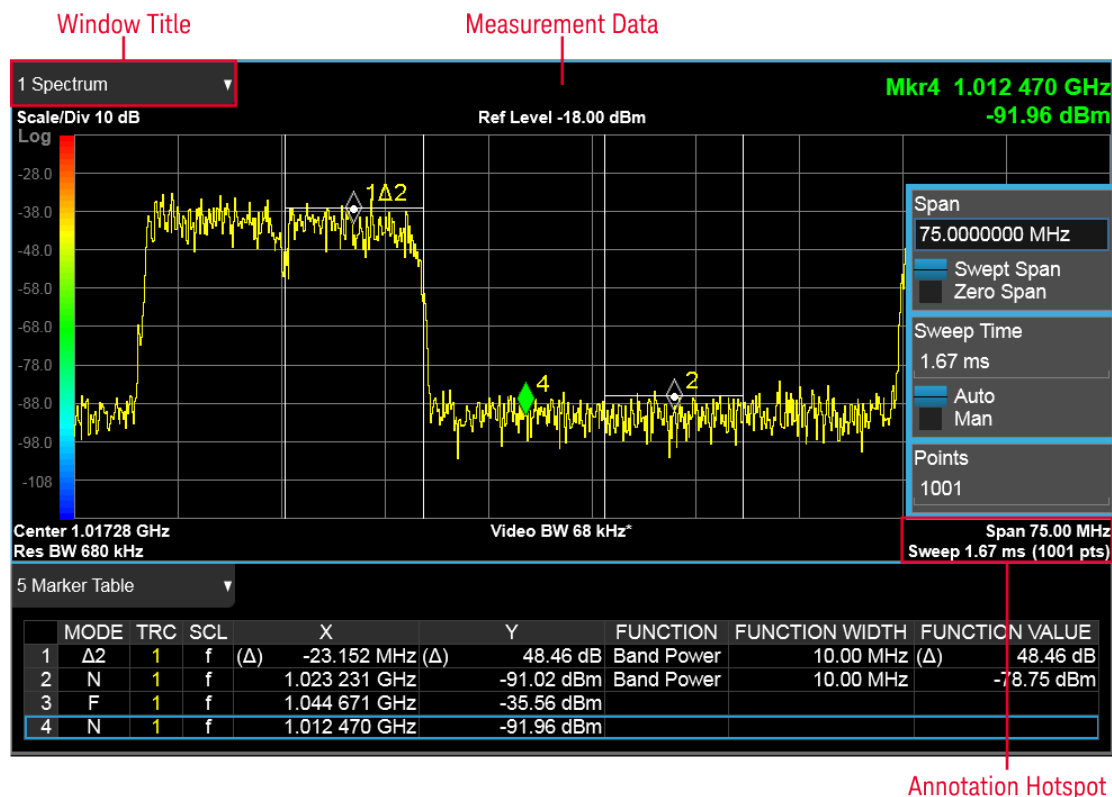

Annotation Hotspot

Each window in the Measurement display contains a "Window Title" on page 113, "Measurement Data" on page 117, and graphical windows also may contain "Annotation Hotspot" on page 120.

The selected window in the Measurement Display is indicated by a blue border. Window-dependent controls in the menu panel always refer to the selected window.

2.3.1 Window Title

The Window Title appears in the upper left hand corner of the window, and includes a title describing the measurement data currently being displayed in the window. The title may also contain additional information about the data in the window, for example in the LTE measurement supplication, the component carrier being displayed in the window will be indicated (e.g., "CC0").

Measurements that support User Views (see "View Editor" on page 156) also display the Window Number in the Window Title, to enable window addressing from SCPI. The number is the number that will be used in the SCPI command to address that window, for example, in the WCDMA Mod Accuracy measurement, Code Domain Power is assigned window number 6, so you address it with the following SCPI command:

```
:DISP:RHO:WIND6:TRAC:Y:RLEV 0.0
```

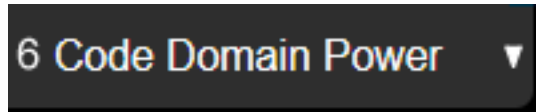

Note the arrow pointing down on the right side of the Window Title. This indicates that touching the Window Title will display a dropdown, which enables you to select the Measurement Data to be displayed in the window.

For example, if we wish to assign the results of the upper window in the display below to the Marker Table, we would touch the window title and then the "Data" control that is revealed, as shown:



And then select Marker Table, yielding the result below:

2 User Interface
 2.3 Measurement Display

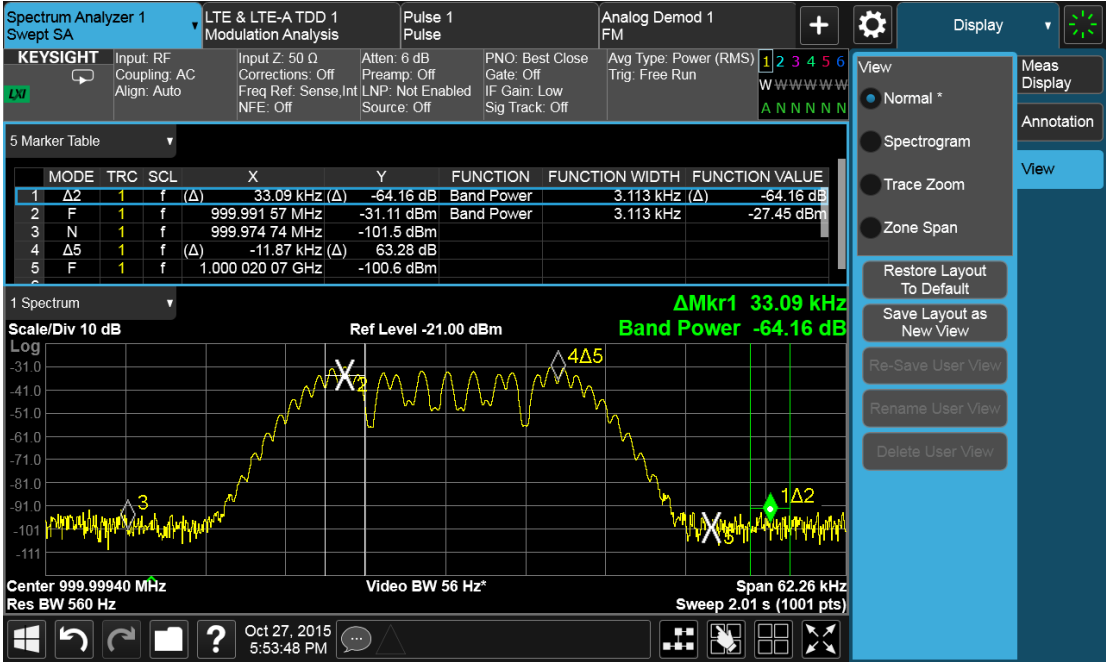

Note also that the Window Data dropdown can be a cascaded list, if the number of available results requires categorization to hold them all:

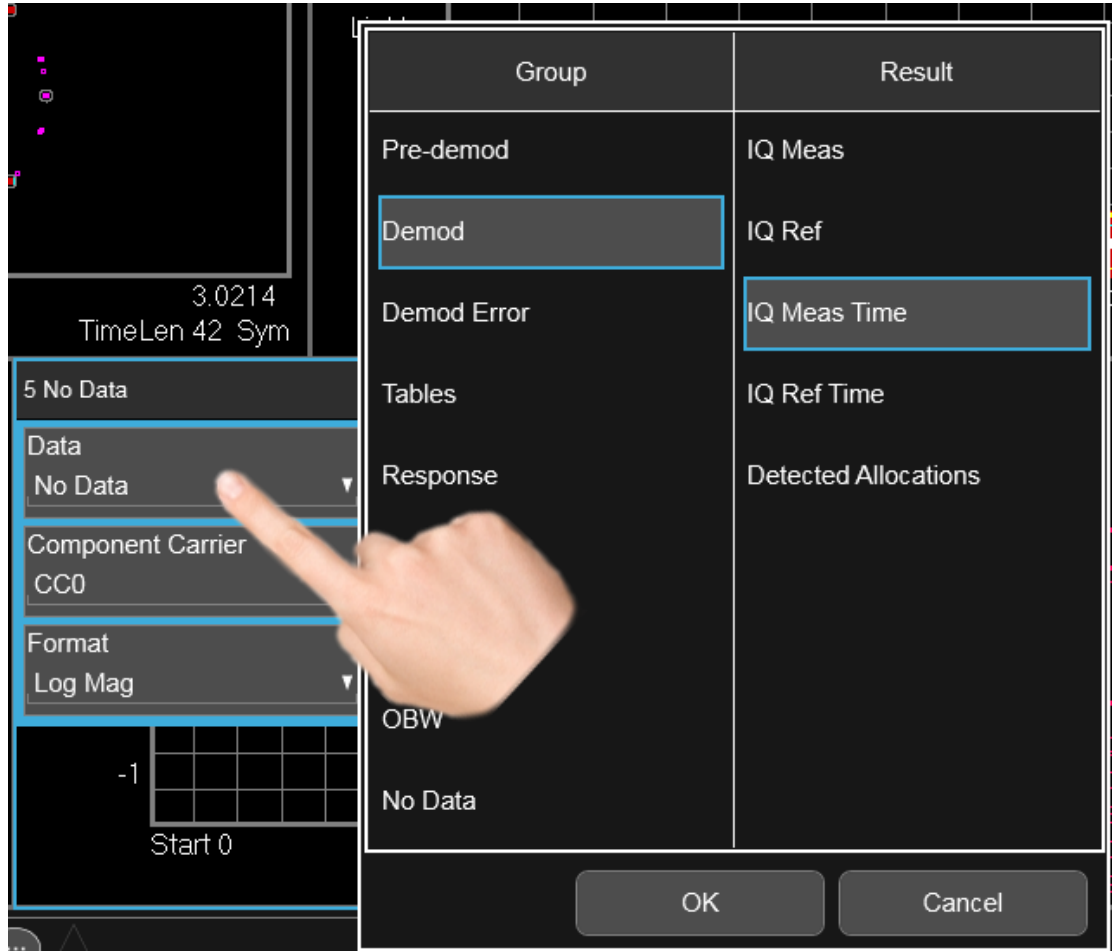

Note also that the Window Data dropdown sometimes includes controls for further configuring the window, for example, in LTE choosing the desired Component Carrier and Data format.

2 User Interface
 2.3 Measurement Display

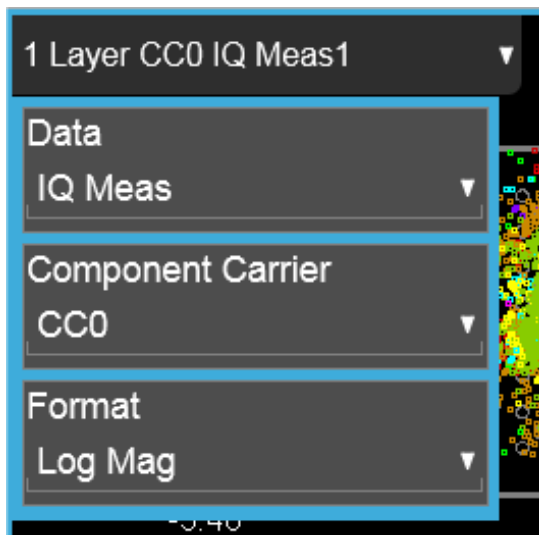

Touching a window's title dropdown also selects the window.

2.3.2 Measurement Data

The Measurement Data region shows graphical or textual data for the Data selected in the Window Title Data control. Below you can see examples of both graphical and textual windows in a four-window display.



There are many gestures which you can use to interact with a measurement display window. They are detailed below.

Swipe

There are several swipe actions, as listed below. One of the most important actions is swiping a spectrum window to the left or right, or up or down, to adjust the frequency and level of the spectrum, as shown below.



Swipe actions are summarized in the table below. Not all of these may be available, depending on the measurement.

Object	Action
Spectrum Trace Left/Right	Drag trace (change Center Frequency)
Spectrum Trace up/down	Drag trace (change Ref Level)
Marker Left/Right	Drag marker along trace
Fixed Marker Left/Right/Up/Down	Drag marker in space
Scrollable area	Scroll vertically or horizontally. Scrollable areas include the Menu Panel (if overfull), tables and lists. A scrollable area is indicated by a vertical or horizontal translucent white bar which can also be dragged by a mouse When scrolling a table: <ul style="list-style-type: none"> – Row headers remain in place when the table is scrolled horizontally, and scroll with the table when the table is scrolled vertically – Column headers remain in place when the table is scrolled vertically, and scroll with the table when the table is scrolled horizontally

2 User Interface
 2.3 Measurement Display

Object	Action
Toggle control	Toggle in that direction

Pinch

You can also pinch in or out either horizontally or vertically to zoom in the x-axis or y-axis dimension. For example, a pinch horizontally lets you adjust the Span of the Spectrum window. Also, pinching on the wings of a Band Power or other Band Function allows you to widen or narrow that Band Function.

Pinching may sometimes be easier if you use the index finger of each hand, rather than pinching with one hand.

Touch-and-Hold

You can also touch-and-hold the display, that is, touch it and hold your finger on the display. A circle is drawn, and when the drawing completes, a right-click gesture is performed that depends on the screen feature touched, as listed in the table below.

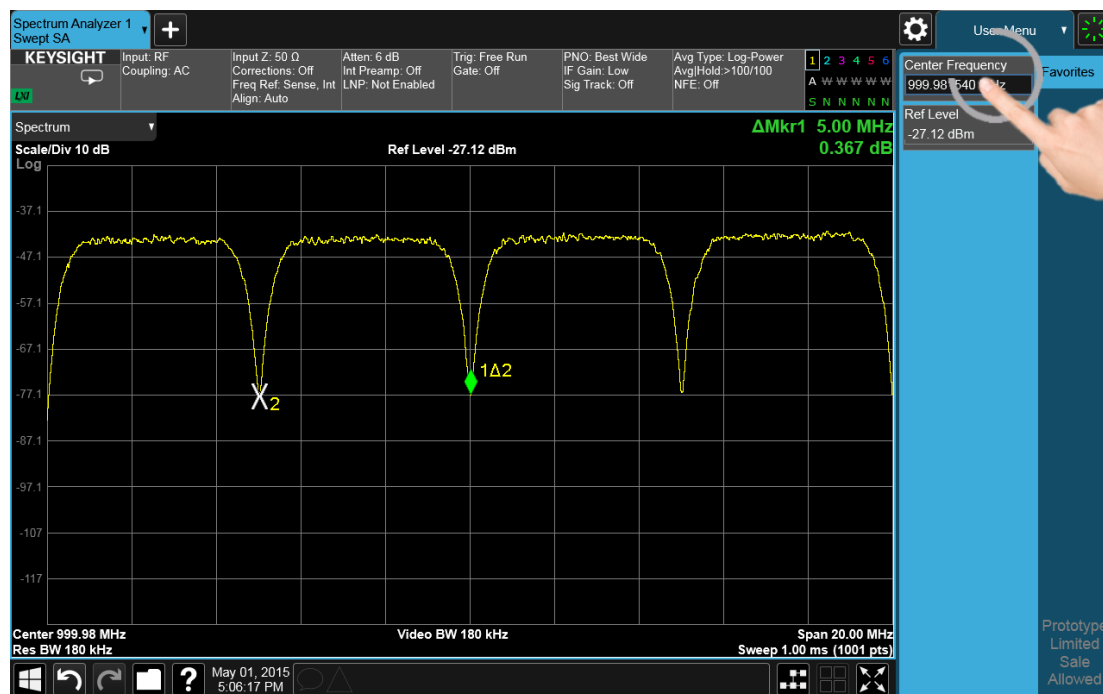

Right Click on the Background	Lets you select Help
Right Click on a Menu Panel control	Lets you add or remove that control from the User Menu or get Help on that control

Tap

Tapping an object causes the actions defined in the table below:

Object	Action
Marker	Select
Marker (repeated taps on stacked)	Cycle through stacked markers
Trace	Select. In addition if Marker is the active function, move the selected marker to the point where you tapped
Trace (repeated taps on stacked)	Cycle through stacked traces
Window	Select if unselected
Screen	Select if unselected

Double Tap

Double-tapping an object causes the actions defined in the table below:

Object	Action
Window	Zoom/Unzoom

2.3.3 Annotation Hotspot

You can tap on a graticule annotation to modify one of the fields in that annotation. For example if you tap on the region with Center Freq and Res BW in it, a menu panel pops up with just those settings on it.

2 User Interface
2.3 Measurement Display

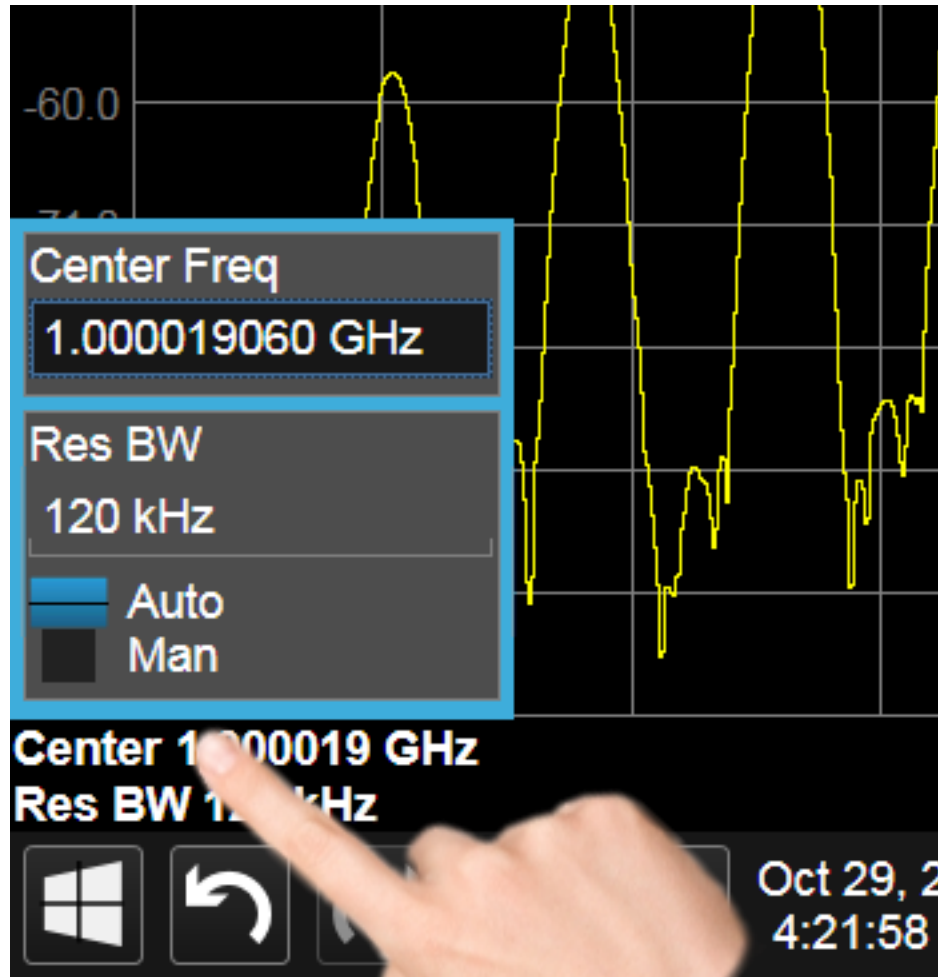

Touching anywhere off the hotspot panel or pressing any hardkey except **Save** or **Quick Save** closes the hotspot panel.

Annotation which is not currently able to be adjusted is not grayed out on the display, but the control in the hotspot that drops down or pops up is grayed out.

In a hotspot panel, the control in black with the blue border is the active function. Each panel may have its own default active function

2.4 Menu Panel

The menu panel is the main focus of the X-Series Multitouch user interface. The controls include active functions, dropdowns, action buttons, radio buttons and toggles.

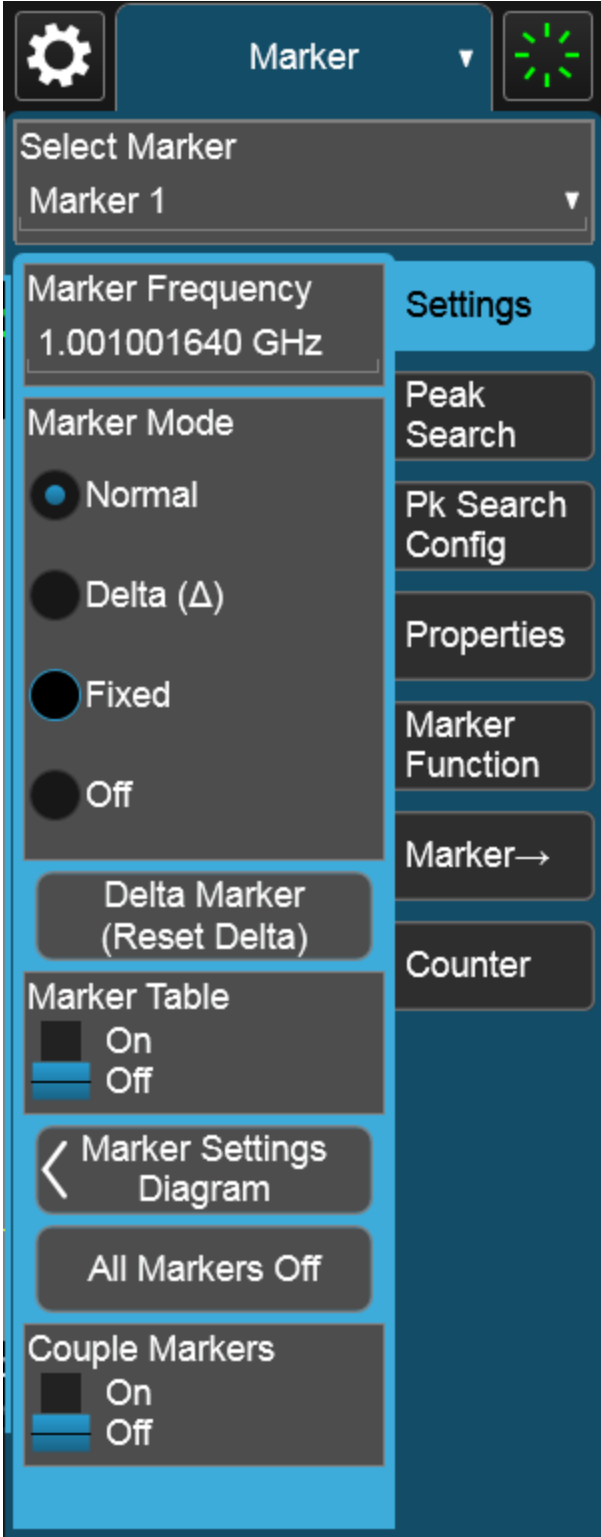

The menu panel normally appears on the right side of the display and consists of a rectangular panel with multiple “sub-panels” lying on top of each other, each sub-panel being accessed by a tab on the right.

You press a front panel key (or “hardkey”) to access a particular menu. On the front panel there are twelve “measurement hardkeys” (the ones in the shaded region in the figures below) – these are the hardkeys that open up menus in the menu panel.

With a menu open, tap a tab to access the controls on its sub-panel. Whenever you press the front panel key associated with a menu, the default (top) tab is selected.

If the number of controls on a panel exceeds the height of the panel, scrolling is enabled, which is indicated by a white bar on the left that fades away after a few seconds. You swipe up or down with your finger to scroll the panel, or you can grab the white bar with a mouse.

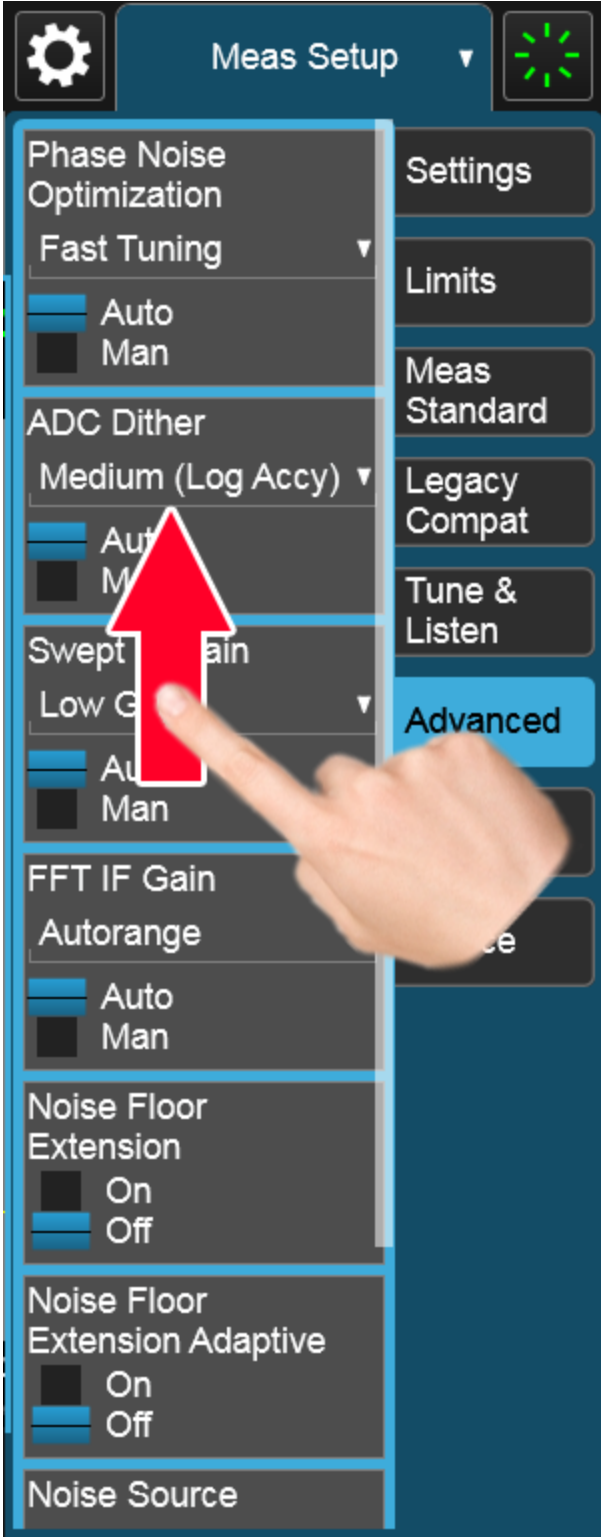

If you move to a different menu panel or sub-panel and then come back to a previous panel, the previous panel is always reset to be scrolled all the way back to the top.

Accessing Menus Without Using Front-Panel Keys

You can access the menu panels without using the front panel keys, as you would need to do if you were operating the instrument using Remote Desktop. Touch or click on the menu title, as shown below. A dropdown containing the twelve measurement hardkeys appears. Selecting a hardkey from the dropdown displays the corresponding menu, and the dropdown disappears.



Entering Numeric Values

Many controls on the menu panel allow you to enter numeric values. These are called “active functions.” An active function control displays a number and a suffix,

2 User Interface

2.4 Menu Panel

for example 13.255 GHz, as in the example below:

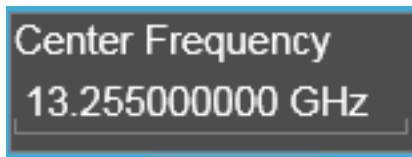

An active function is “active” if the numeric value is surrounded by a black background with a blue border, as below. In this state, it is ready to receive numeric input from the number pad on the front panel, the knob, or the step keys.

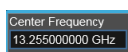

When an active function is in the active state, you can start typing or pressing the number keys on the front panel, which causes the Numeric Entry Panel to appear, as shown below. The Numeric Entry Panel displays the typed value, and the terminators to complete the entry.

Here we see a UXA with an active function control in the active state. Although no Numeric Entry Panel is displayed, you can just touch the “2” key:



This causes the Numeric Entry Panel to pop up to receive the numbers you are typing:



Type in as many digits as required, then touch one of the unit terminator buttons in the Numeric Entry Panel to complete the entry. In this case, 2 GHz was the desired entry, so you just touch the “GHz” terminator:

2 User Interface
2.4 Menu Panel



The Numeric Entry Panel disappears and, in the example, the active function value becomes 2 GHz.



It is important to note that you can always pop up the Numeric Entry Panel by touching an active function control while it is active; for example, if you were to touch it in the figure above, the Numeric Entry Panel would pop up right next to the control:

2 User Interface
2.4 Menu Panel



You can display the Numeric Entry Panel by touching any active function control while it is active, but you don't have to pop up the Numeric Entry Panel first, you can just start typing and it will pop up on its own, thus saving you a keystroke.

You can also adjust a value without displaying the Numeric Entry panel by turning the knob or using the step keys while an active function is active. If you turn the knob or use the step keys while the Numeric Entry Panel is displayed, it disappears, allowing you to see the entire screen while you are making the adjustment.

You can also drag the Numeric Entry Panel to another part of the display if it is covering something that you wish to see while it is on the screen.

2.4.1 Right-Click Menu

If you click with the right mouse button on any of the menus in measurements, a popup menu appears, which includes:

The items in this menu are:

- ["Add to User Menu" on page 132](#)
- ["Help on this setting" on page 132](#)

2.4.1.1 Add to User Menu

For details, see ["User Menu" on page 132](#).

2.4.1.2 Help on this setting

For details, see ["Help" on page 145](#).

2.4.2 User Menu

Lets you create your own menu, to include controls that you frequently use. You can have one **User Menu** for each measurement, and all User Menus survive a power cycle.

You add a control to the User Menu for the current measurement by right-clicking on the control, then selecting ["Add to User Menu" on page 132](#). You can also remove the control from the User Menu using the same right-click menu item.

User Menu appears at the bottom of the menu drop-down panel.

2.5 Cancel key



This front-panel key has the same functions as the Windows **Esc** (Escape) key. It does the following:

- Cancels dialogs
- Cancels active functions (unless there is an entry in progress, in which case it cancels that, and reverts to the previous value)
- Resets input overloads
- Aborts print operations
- Cancels certain other operations (such as alignments)
- Returns you to Local Control (if in Remote)
- If the backlight is off, turns on the backlight, and does nothing else

Most of this functionality is the same as earlier X-Series models and similar to ESA and PSA operation.

When the instrument is in Remote, any hardkey that is pressed on the front panel displays this message:

Analyzer is in Remote. Press ESC to return to Local

The exception is the **Cancel (ESC)** key, which takes the instrument out of Remote.

When the instrument is also in the LLO (local lockout state), the **Local** key is locked out as well. When this is the case, and the **Local** key is pressed, this message is displayed:

Local key is locked out by remote computer. Cancel Local Lockout on computer or release remote control

When you see this message, you should disconnect the remote computer, or use it to take the instrument out of the Local Lockout state.

2.6 Onscreen Keyboard key



This key turns the onscreen alpha keyboard (OSK) on and off.

There are two onscreen keyboards:

- The Multitouch OSK, which pops up automatically if, while using the analyzer application, a text field becomes the active function
- The Windows OSK, which you must open manually when a text field must be entered while interacting with Windows or other apps

2.7 Touch On/Off Key



This front-panel key turns the display touch functionality on and off. If off, you can turn it back on using the front panel **Touch On/Off** key. When the touch functionality is off, you can still use a mouse as a pointer.

When toggled, a dialog box appears midscreen that confirms “Touchscreen On” or “Touchscreen Off”.

This function remains in effect until it is turned off or until the app shuts down. The app always starts up with Touch enabled.

2.8 Tab key



This key has the same function as the **Tab** key on a PC keyboard. You can use this key to display the Windows Taskbar, as follows.

- Alt-Tab to the Desktop
- Touch the desktop
- Touch **TAB**
- The Taskbar appears

2.9 Local Button

Appears in the Menu Panel when the instrument is in remote, and can be brought back to local via the **Local (ESC)** Key. See also "[Cancel key](#)" on page 133.

2.10 Control Bar

The Control Bar contains controls and readouts that let you control instrument functions independent of the current measurement.

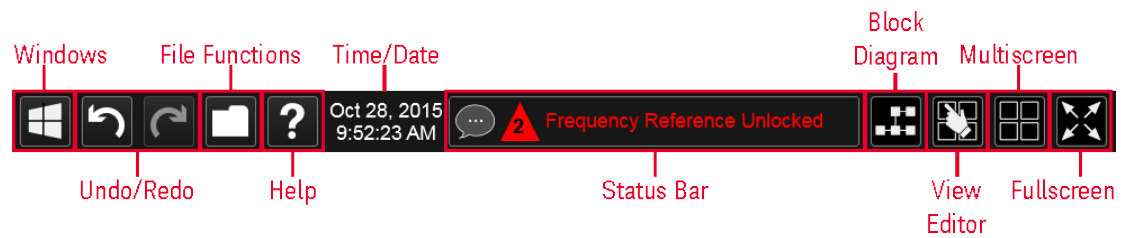

2.11 Windows

Pressing the Windows icon on the "Control Bar" on page 138 has the same effect as pressing the Windows icon on the Windows taskbar. It displays the Windows taskbar and Start Menu, which allows you to launch Windows programs and access features such as the Control Panel.

2.12 Undo/Redo

The Undo button in the "Control Bar" on page 138,



and the Undo front panel key,

Ctrl=Redo



are used to undo the most recently executed function.

If you Undo a function, and then decide you should not have done so, you can use the **Redo** button in the "Control Bar" on page 138 to put it back the way it was. The Redo function may also be executed by pressing **Ctrl+Undo** (holding the **Ctrl** key down while pressing the **Undo** front panel key).



Undo allows you to restore a setting, which you had previously set, back to its value before you changed it. When you press the Undo button or front panel key, the last setting you changed is "undone", that is, its previous setting is restored. You are notified of this fact with an advisory pop up message; for example, if the Center Frequency had been 300 MHz, and you changed it to 1 GHz and then pressed **Undo**, the message would show:

UNDO: Center Freq 1 GHz -> 300 MHz

The instrument can store 5 levels of action for Undo.

To truly understand Undo and Redo, it helps to think of two "stacks", an Undo stack and a Redo stack,

UNDO stack

REDO stack

Whenever you perform an action, it is placed on the Undo stack. So for example, if you set the Center Frequency to 1 GHz, then set the RBW to 1 MHz, then set the Detector to Peak, each of these actions gets "pushed" onto the Undo stack:

2 User Interface
2.12 Undo/Redo

UNDO stack	REDO stack
Det = Peak RBW = 1MHz CF = 1 GHz	

When you press **Undo**, the top item on the Undo stack is removed, the action represented by that item is undone, and the item is placed on the Redo stack. So pressing **Undo** once in the above case would undo the setting of the peak detector, and the stacks would look like this:

UNDO stack	REDO stack
RBW = 1MHz CF = 1 GHz	Det = Peak

Now pressing **Undo** again would undo the RBW = 1 MHz action, and the stacks would look like this:

UNDO stack	REDO stack
CF = 1 GHz	RBW = 1MHz Det = Peak

Now pressing Redo would Redo the RBW = 1 MHz action, and the stacks would again look like this:

UNDO stack	REDO stack
RBW = 1MHz CF = 1 GHz	Det = Peak

Also, whenever you set a value, the Redo stack is cleared; you can't redo an action once you have interrupted the original flow of actions. Think of the Undo stack as the past, and the Redo stack as the future; if you have items in both stacks it means you have gone back to a time in the past; if you then *do* something you have changed the future, so the old future (the Redo stack) gets cleared.

For example, in the example above, if you now were to change another setting, such as VBW = 1 kHz, the Redo stack gets cleared, and the stacks would look like this:

UNDO stack	REDO stack
VBW = 1 kHz	
RBW = 1MHz	
CF = 1 GHz	

Undo can undo changes you make with the knob or step keys, however all contiguous events that affect the same parameter are aggregated into one event for the sake of Undo. For example, if CF is the active function and is 1 GHz, and you turn the knob back and forth, then enter a value, then use the step keys, when you press **Undo**, the instrument returns to CF = 1 GHz.

Actions that Cannot be Undone

There are some actions that cannot be undone, because these clear the Undo/Redo stack:

- Restore Mode Defaults clears the stack for that Mode in that Screen
- Sending SCPI commands clears the stack for that Mode in that Screen
- Loading a state file (including User Preset) clears the stack for that Mode in that Screen
- Deleting a Screen clears all the stacks in that screen
- Changing Views

Undo/Redo works within the context of a Mode. Each Mode in each Screen keeps its own record. Settings in the Control Panel or System Settings menus are not undoable.

There are several actions that may change many parameters. Among these are Auto Tune, and Adjust Atten for Min Clipping. After executing such a function, Undo sets all parameters back to their value before the function was selected. Auto Tune appears to be a single action, even though the instrument executes it in several steps.

Redo reverses the effect of the last Undo action, assuming that no other settings have been changed since the last Undo. Changing a setting after an Undo clears memory of all settings after that Undo, that is, it clears the Redo stack, as explained above.

2 User Interface

2.12 Undo/Redo

When you press the **Redo** icon or **Ctl** and the **Undo** hardkey, you are notified with an advisory popup message; for example, if the Center Frequency had been 300 MHz, and you changed it to 1 GHz and then pressed **Undo**, the message would say:

UNDO: Center Freq 1 GHz -> 300 MHz

If you then press **Redo**, the message will say:

REDO: Center Freq 300 MHz -> 1 GHz

Neither **Undo** nor **Redo** perform any navigation, and have no effect on which menu panel is displayed nor which function is active.

2.13 File Functions

The File Functions popup contains controls for executing Save, Recall, File and Print operations. You display the File Functions popup by tapping the File Functions icon in the "Control Bar" on page 138.

For more information on a control, tap an icon in the image below.

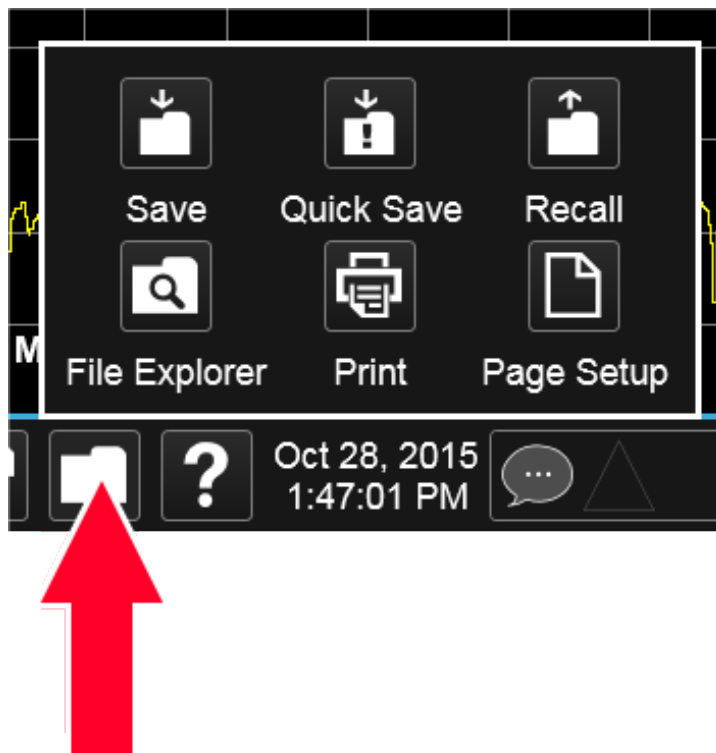

Tapping this folder icon displays the File Functions popup

2.13.1 File Explorer

Pressing the File Explorer button in the "File Functions" on page 144 dialog opens the Windows File Explorer, which allows you to perform operating system file functions such as Move, Copy and Delete.

File Explorer also allows you to map network drives to drive letters on your PC or intranet, in order to more easily save screen images, states and other data, and load them back into the instrument.

2.14 Help



Pressing the **Help** button in the "[Control Bar](#)" on page 138, the **Help** front panel key, or the **F1** key if you have a PC keyboard connected, opens the context-sensitive help system. The **Help** button appears in the "[Control Bar](#)" on page 138 and in the banner of full-screen dialogs

You can also use the Help window's Contents pane to navigate to Help for any function in the instrument

You can also touch-and-hold a specific control to display a "right-click" menu, in which one of the choices is **Help on this setting**

2.15 Status Bar

The Status Panel (or Status Bar) appears at the bottom of the display and contains three fields:



The Message Balloon appears on the left side of the Status Panel and lets you know when there is an unread message in the queue.



No unread messages

Unread messages

The Message Balloon has a gray outline and no fill if there are no unread messages; it has a gray fill and a white outline and displays a white ellipsis in the middle if there are unread messages.

The Condition Indicator appears to the right of the Message Balloon and shows the current number of open conditions. Below are some examples of what the Condition Indicator can look like:



The triangle is unfilled if there are no open conditions, filled with yellow if all open conditions are warnings, and filled with red if at least one open condition is an error. The number displayed is the total number of open conditions.

Touching the Condition Indicator opens up the Show Status dialog (see below) with the Current Conditions tab selected. Touching anywhere else on the Status Bar opens up the Show Status dialog with the History tab selected.

The Condition Message appears to the right of the Condition Indicator. In the example below, the Condition Message is “Align All, Now required”:

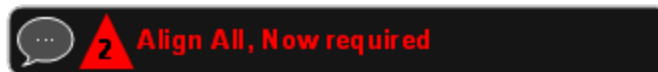

Warning condition messages display in yellow, error condition messages display in red.

If there is more than 1 open condition, the Condition Message cycles through the display of all of the open conditions, one at a time. Each message is displayed for 2 seconds, then the next for 2 seconds, and so on.

Show Status Dialog

The Show Status dialog appears if you tap anywhere in the Status Bar. Touching the Condition Indicator (the triangle in the Status Bar) opens up the Show Status dialog with the Current Conditions tab selected. Touching anywhere else on the Status Bar opens up the Show Status dialog with the History tab selected.

Status	History					
	Type	ID	Message	Repeats	Time	
History		1064	Align Now All required - CLEARED		6:37:49 PM 2/24/2015	
Current Conditions		1301	Meas Uncal - CLEARED		6:37:37 PM 2/24/2015	
Settings		64	Align Now All required - DETECTED		6:36:59 PM 2/24/2015	
		301	Meas Uncal - DETECTED		6:33:27 PM 2/24/2015	
		1301	Meas Uncal - CLEARED		6:31:27 PM 2/24/2015	
		301	Meas Uncal - DETECTED		6:33:27 PM 2/24/2015	
		1141	Input Overload - CLEARED,ADC over range	47	1:07:56 PM 2/24/2015	
		141	Input Overload - DETECTED,ADC over range	47	1:07:56 PM 2/24/2015	
		780	No Peak Found		1:03:55 PM 2/24/2015	
			Informational		Warning	

Press any row for more info about that Message

Clear Message Queue

If the display fills up, scrolling is enabled just as in other X-Series Multi-touch UI displays.

The Status dialog automatically refreshes as new messages and conditions occur.

At the bottom of the screen is a Clear Message Queue button. This button clears all errors in all error queues.

Note the following:

- Clear Message Queue does not affect the current status conditions
- Mode Preset does not clear the message queue
- Restore System Defaults (Super Preset) will clear all message queues
- *CLS only clears the queue if it is sent remotely and *RST does not affect any error queue
- Switching Modes does not affect any error queues

See ["More Information" on page 149](#)

Remote Command `:SYSTem:ERRor[:NEXT]?`

Example `:SYST:ERR?`

Notes The return string has the format:

<Error Number>, <Error>

Where <Error Number> and <Error> are those shown on the Show Errors screen

Backwards
Compatibility
Notes

In some legacy analyzers, the Repeat field shows the number of times the message has repeated since the last time the error queue was cleared. In the X-Series, the Repeat field shows the number of times the error has repeated since the last intervening error. So the count may very well be different than in the past even for identical signal conditions

Unlike previous analyzers, in the X-Series all errors are reported through the Message or Status lines and are logged to the event queue. They never appear as text in the graticule area (as they sometimes do in previous analyzers) and they are never displayed in the settings panel at the top of the screen (as they sometimes do, by changing color, in previous analyzers)

As a consequence of the above, the user can only see one status condition (the most recently generated) without looking at the queue. In the past, at least in the Spectrum Analyzer, multiple status conditions might display on the right side of the graticule

In general, there is no backwards compatibility specified or guaranteed between the error numbers in the X-Series and those of earlier products. Error, event, and status processing code in customers' software will probably need to be rewritten to work with X-Series





In the legacy analyzers, some conditions report as errors and others simply turn on status bits. Conditions that report as errors often report over and over as long as the condition exists. In the X-series, all conditions report as start and stop events. Consequently, software that repeatedly queries for a condition error until it stops reporting will have to be rewritten for the X-series



More Information

The Status Dialog has two screens, selectable by the tabs on the right: **History** and **Current Conditions**:

History

History brings up a screen displaying the front panel message queue in chronological order, with the newest event at the top. Remember that the front panel queue contains all of the events generated by front panel actions as well as error events from all of the SCPI queues. A typical History display appears below:

Status	History				
History	Type	ID	Message	Repeats	Time
Current Conditions		301	Meas Uncal - DETECTED		5:36:35 PM 2/24/2015
Settings		1141	Input Overload - CLEARED;ADC over range	49	1:07:56 PM 2/24/2015
		141	Input Overload - DETECTED;ADC over range	49	1:07:56 PM 2/24/2015
		1141	Input Overload - CLEARED;ADC over range		1:07:53 PM 2/24/2015

 Informational
  Warning
  Error

Press any row for more info about that Message

Clear Message Queue

The fields on the History display are:

Type	Displays the icon identifying the event or condition as an error or warning
ID	Displays the error number
Message	Displays the message text
Repeat (RPT)	<p>This field shows the number of consecutive instances of the event, uninterrupted by other events. In other words, if an event occurs 5 times with no other intervening event, the value of repeat will be 5</p> <p>If the value of Repeat is 1 the field does not display. If the value of Repeat is >1, the time and date shown are those of the most recent occurrence. If the value of repeat reaches 999,999 it stops there. The Repeat field can run into some pretty large numbers when apps (like the GSM app) report things like “GSM sync burst not found” as events rather than conditions, which is actually fairly common</p> <p>Note that the repeat count is unavailable over SCPI</p>
Time	Shows the most recent time (including the date) at which the event occurred. Time is displayed to the second

To understand the History dialog, and to properly program the instrument's messaging system, remember that there are two types of occurrences, events and conditions:

- An event is an occurrence of zero duration. Events generate messages which are displayed in the center of the display for a period of time and then fade away. These may be of an advisory nature or may represent errors, for example “No

peak found”

- A condition is an occurrence of finite duration, that is, it has a start and an end. Conditions are states of the analyzer characterized by some combination of settings or some kind of failure that the user needs to be told about while it is happening, but then can stop being told once it goes away; for example “Input overload; ADC over range”

The error queue contains error events as well as the DETECTED and CLEARED events for condition errors, as seen in the figure above.

DETECTED events have numbers less than 1000 and CLEARED events have the same number plus 1000. For example,

301, Meas Uncal – DETECTED

and later

1301, Meas Uncal – CLEARED

To detect a condition error over SCPI, you should read the error queue and note any DETECTED error which is not followed eventually by an associated CLEARED error. This means the condition is still in effect. It is not sufficient to simply read the error queue until you get “No Errors” back. You may still have the condition error; the condition may still be in effect, and if that is the case, all you have done by clearing the error queue is to remove the first event (the DETECTED event) from the queue. For a condition error, you have to read the error queue until you see the CLEARED event for that condition. THEN you know that the condition is gone.

Current Conditions

The **Current Conditions** display shows all of the open conditions in the instrument. An open condition is a condition error or warning for which a start (detected) event has occurred but for which no corresponding stop (cleared) event has occurred.

An example of the Current Conditions screen appears below:

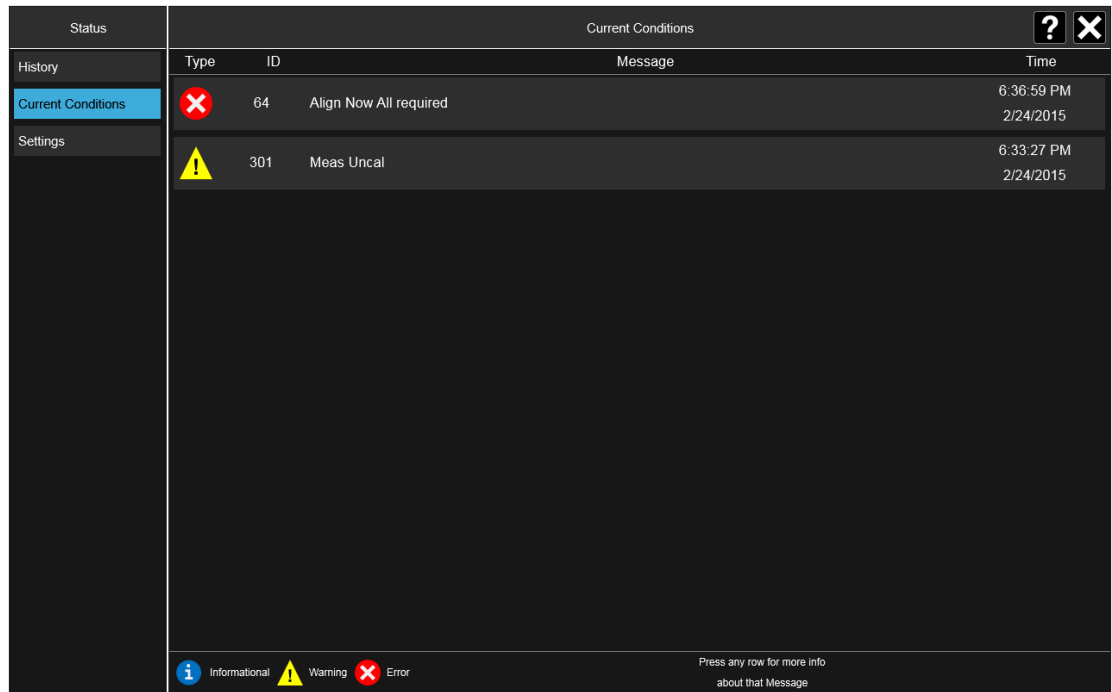

The fields on the Current Conditions display are:

- Type** Displays the icon identifying the event or condition as an error or warning or informational
- ID** Displays the error number
- Message** Displays the message text
- Time** Shows the most recent time (including the date) at which the event occurred. Time is displayed to the second

Touching a condition message expands the display of that message. Touching again collapses it. The description is the same as the one that appears on the message dialog. An example of this is shown in the History section, below.

When there are no open conditions, the display is as shown below:

2 User Interface
2.15 Status Bar

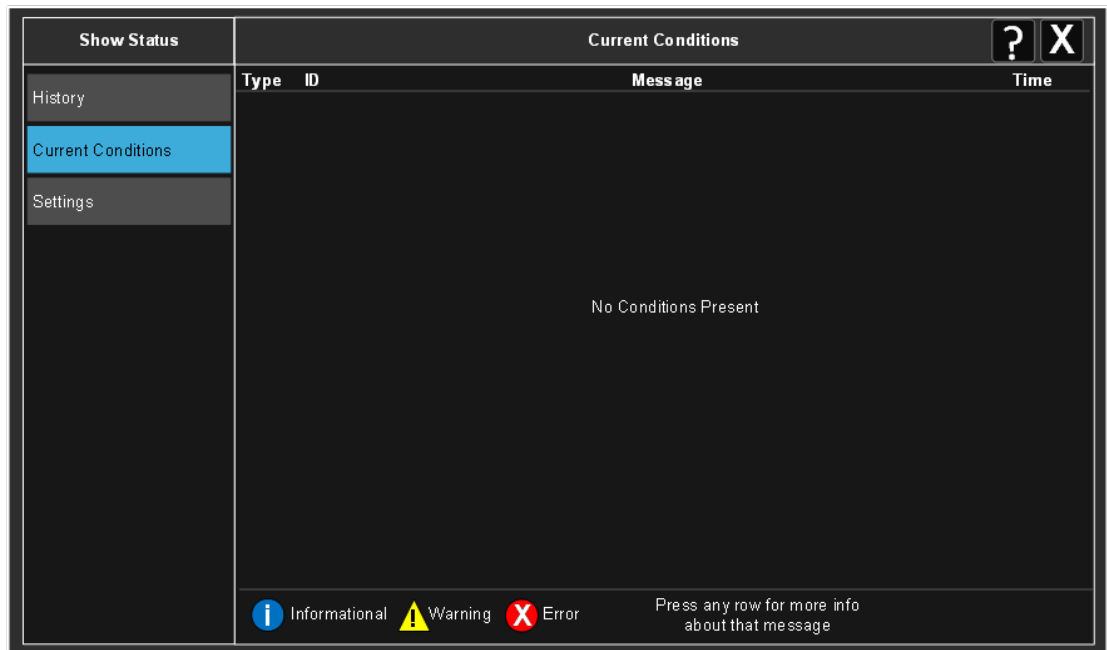

2.16 Block Diagram

When you press the Block Diagram button in the "Control Bar" on page 138, the display changes to a stylized pictorial representation of the current internal hardware setup and signal processing path. When you touch one of the blocks on the Block Diagram, the corresponding menu panel opens.



When you press the Block Diagram button, the display changes to a stylized pictorial representation of the current internal hardware setup and signal processing path. When you touch one of the blocks on the Block Diagram, the corresponding menu panel opens.

While in the Block Diagram display, the button is blue colored, as:



To exit the Block Diagram display, tap the button again.

The Block Diagram display is not meant to be a completely accurate representation, but one which can show differences as you change the hardware setup. For example, here is the basic RF Block Diagram:

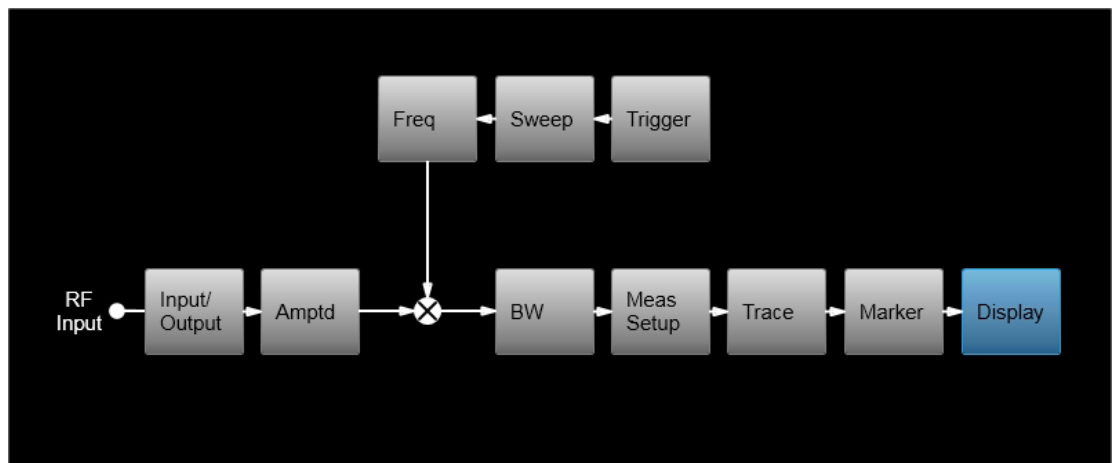

And here is the Block Diagram when External Mixing is selected:

2 User Interface
2.16 Block Diagram

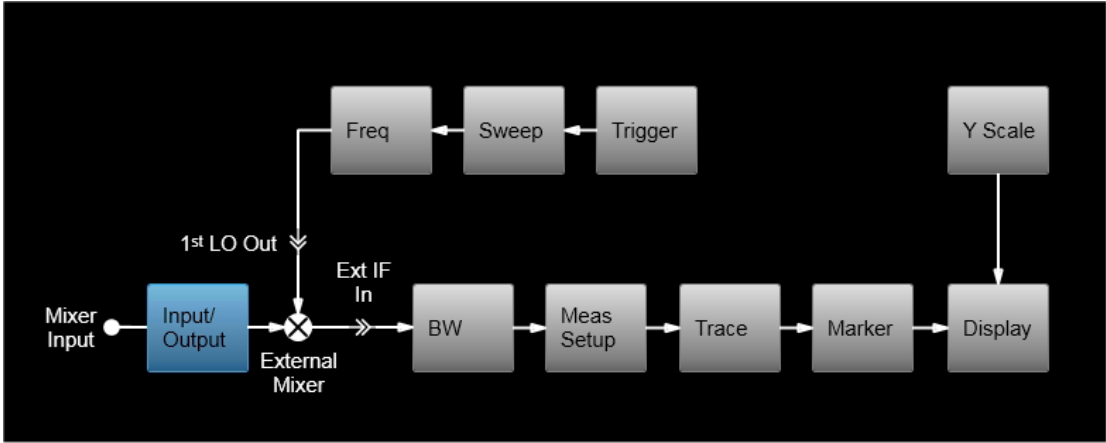

And here is the Block Diagram when the I/Q inputs are selected:

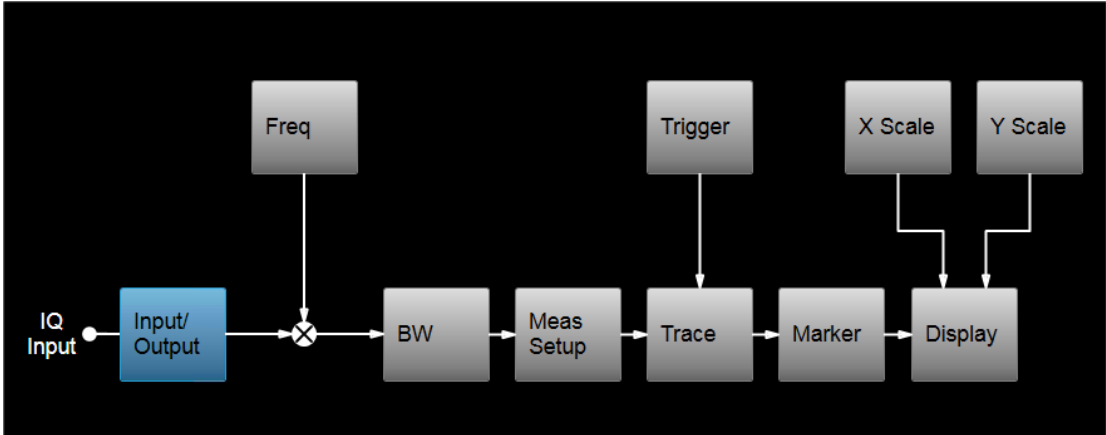

2.17 View Editor

This section describes the use of the View Editor, which allows you to:

- Add windows to and delete windows from the current measurement
- Resize and rearrange windows
- Create User Views

User Views are custom Views that you create by adding, deleting, rearranging, resizing, or changing the contents of the windows in an existing View, and then saving the edited View as a new View. The instrument lists the current User Views for a measurement after the Predefined Views, in the Mode/Meas dialog and on the View menu panel under Display:

ent	View
	Basic Meas Summary RB Slot Meas Subcarrier Meas MIMO Summary Cross Carriers Summary
	User View
	My New View

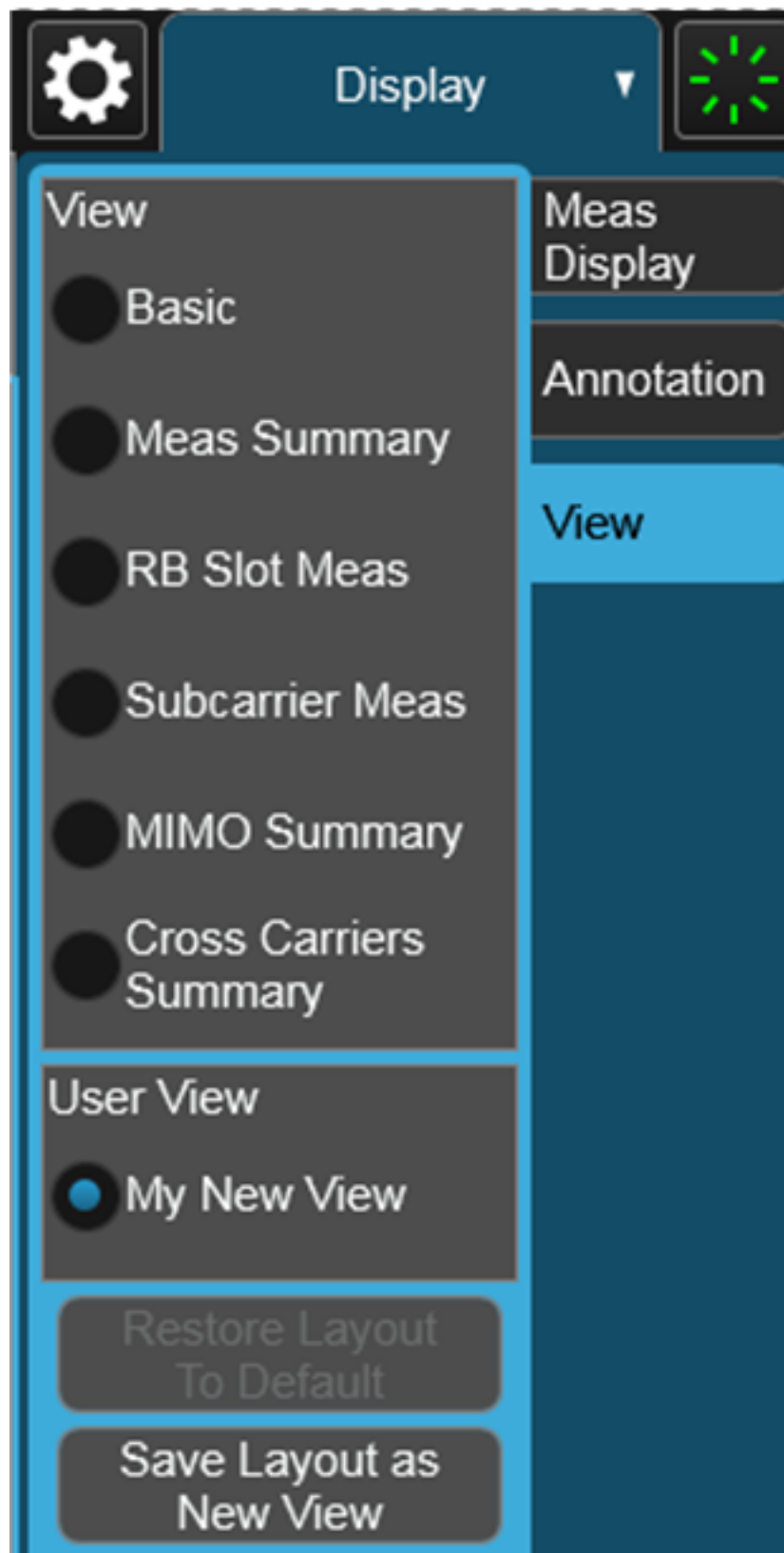

You can save an edited View using the **Save Layout as New View** control in the View menu (see ["To Save a User View" on page 170](#)).

On occasion, the instrument may automatically save an edited View for you. If you have edited a View, so that the * is displaying next to the View name, you must save that View as a User View before you save State or switch measurements. If you forget that you have made changes to a View, then to keep from losing your edited View when you switch measurements, the instrument will save it for you. If you have an edited View that has not been saved and you try to do any of the following:

- Enter the "Save" menu
- Switch Measurements
- Switch Modes
- Switch Screens

the edited view will be saved for you with the name "Autosaved". When this happens, you will receive the following message:

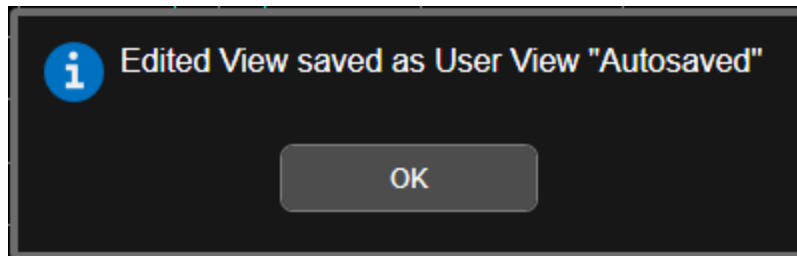

If an Autosaved User View already exists, the User View called "Autosaved" will be overwritten with the currently edited view. If you have multiple edited views, the selected edited view will be Autosaved. If there is not an edited view selected the last selected edited view will be Autosaved.

To Open the View Editor



Pressing the View Editor button (shown above) in the ["Control Bar" on page 138](#), at the bottom right of the screen, opens the View Editor.

While in the View Editor, the icon is blue colored, as:



Pressing the View Editor button again exits the View Editor.

To Close the View Editor

Tap the View Editor button again.

The user chooses the desired View through the use of the Mode/Meas/View dialog (see ["Mode/Meas/View Dialog" on page 90](#)) or the View menu (a tab under the **Display** key). The View menu allows the user to browse the views in the current measurement. The View menu contains a list of Predefined Views for you to use. If you wish to modify a Predefined View or create your own, new View, you use the View Editor.

User Views & Predefined Views

A User View is any View that is not in the list of predefined Views for the current measurement. For example, the Swept SA measurement has four predefined Views: Normal, Spectrogram, Zone Span, and Trace Zoom.

User Views allow you to add, delete, change and rearrange the windows of a predefined View, creating a new custom view.

2.17.1 To Create a User View

Whenever you add or delete a window to/from a predefined View, or change what is being displayed in a Predefined View's window, the Predefined View is marked with an asterisk (*), to show that it has been modified.

For example, to edit the View shown below, you press the Edit View icon.

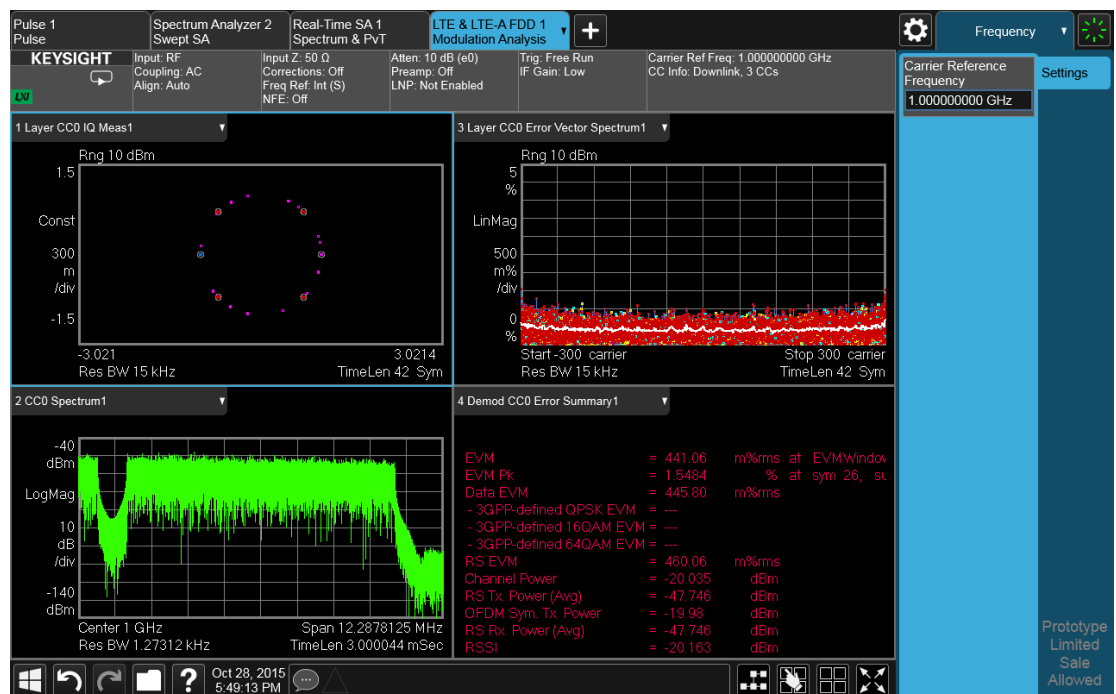

2 User Interface

2.17 View Editor

When you do this, you get the View Editor screen, which appears as below. The menu panel switches to the View menu. Here we see that we are in the Predefined View called “Basic”.

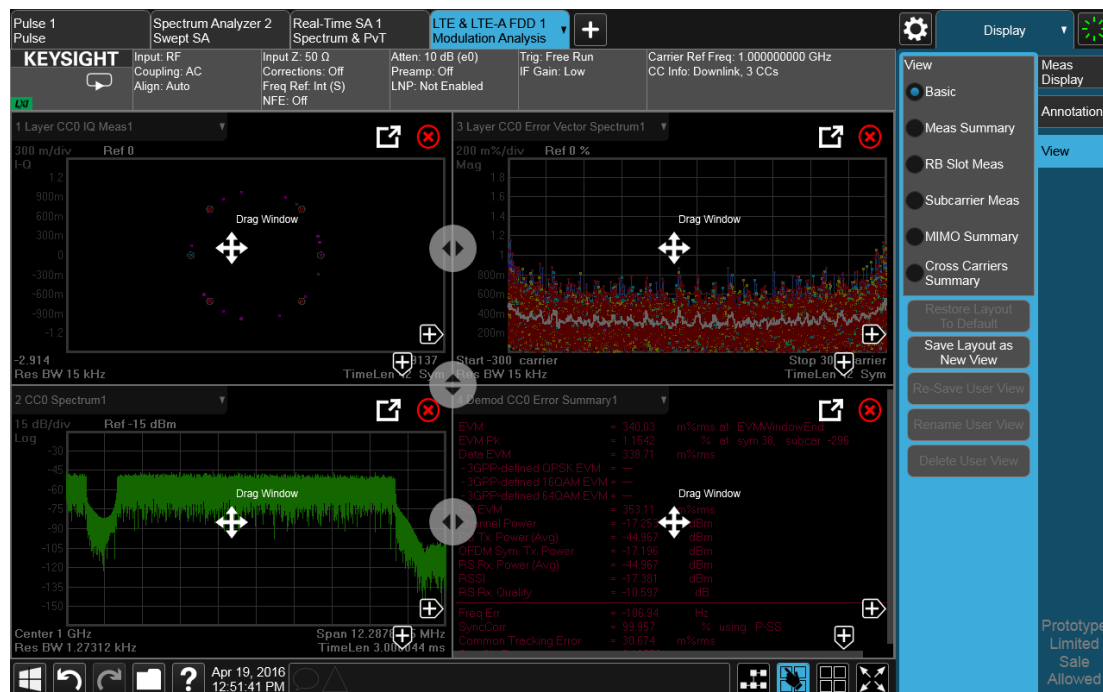

Each window has two arrows containing + signs. Pressing either of the “+” symbols adds a new window on that side. For example, let’s say you press the + symbol on the right of the lower left window:

You would then see this:

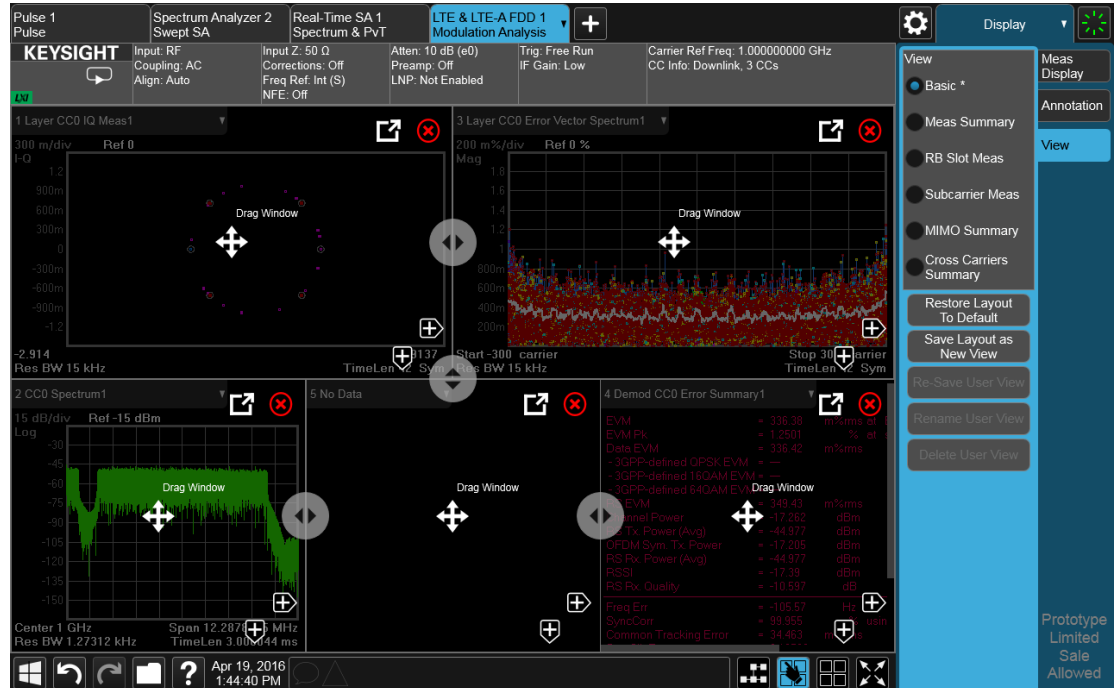

A fifth window has been added, and is automatically assigned the number 5. (The window number, which is displayed in the Window Title region, is used when sending SCPI commands to that window).

Note the * that now appears next to Basic in the View menu, indicating that you are now in the **modified** Basic View. You see the * if you add, delete or rearrange windows, but simply resizing windows does not display the *. The * means you are in a modified View, which must be saved as a User View before you leave the measurement (if you don't save it, the instrument will save it for you).

Note also that the Restore Layout to Default control is no longer grayed out. If you press this control it restores the Basic View to its default state. Restore Layout to Default becomes available when you add, delete or rearrange windows **and** when you resize them; otherwise it is grayed out.

You can add more windows with the “+” arrow symbols. Note that the “+” arrow symbols only appear if the current measurement has more windows available to display. If you are already displaying all the measurement's windows, the “+” symbols disappear.

You can exit the View Editor by again tapping the Edit View icon.

You can specify which result you want to see in the new window by tapping its title region.

2 User Interface

2.17 View Editor

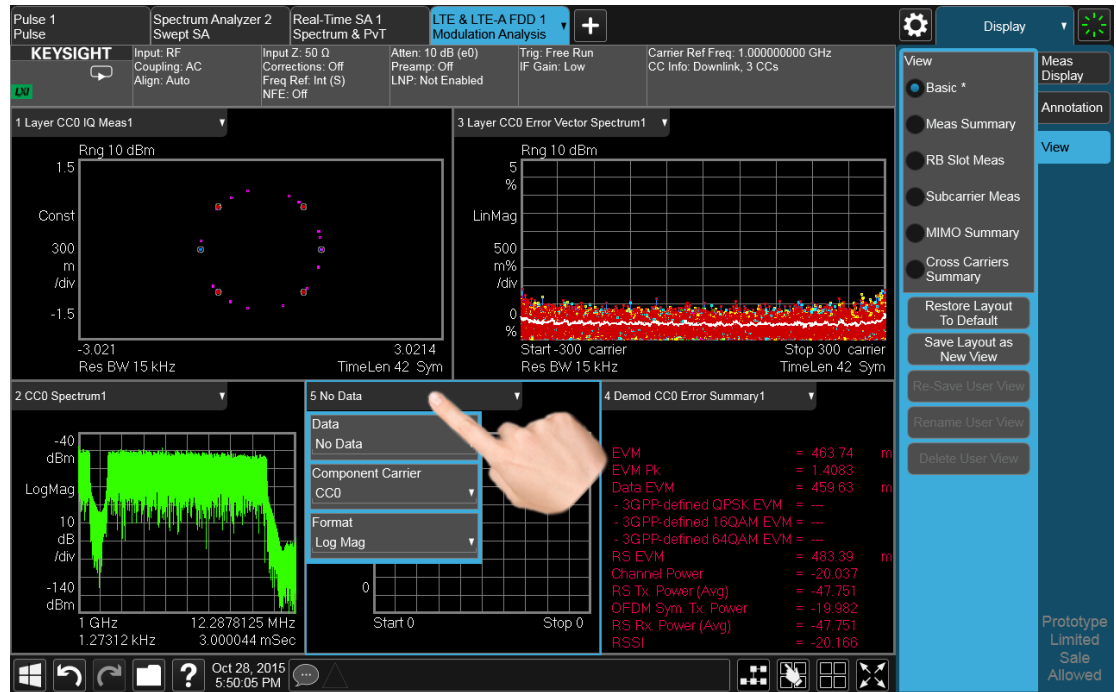

A panel drops down, containing a Data control for specifying window results. Some measurements, such as LTE-A in this example, also provide controls on this dropdown for specifying other window parameters, such as the Component Carrier and Data Format, Tap the Data control and you will see a list of available results for the window. In some cases, as in LTE-A, this will be a cascading list, due to the number of results available:

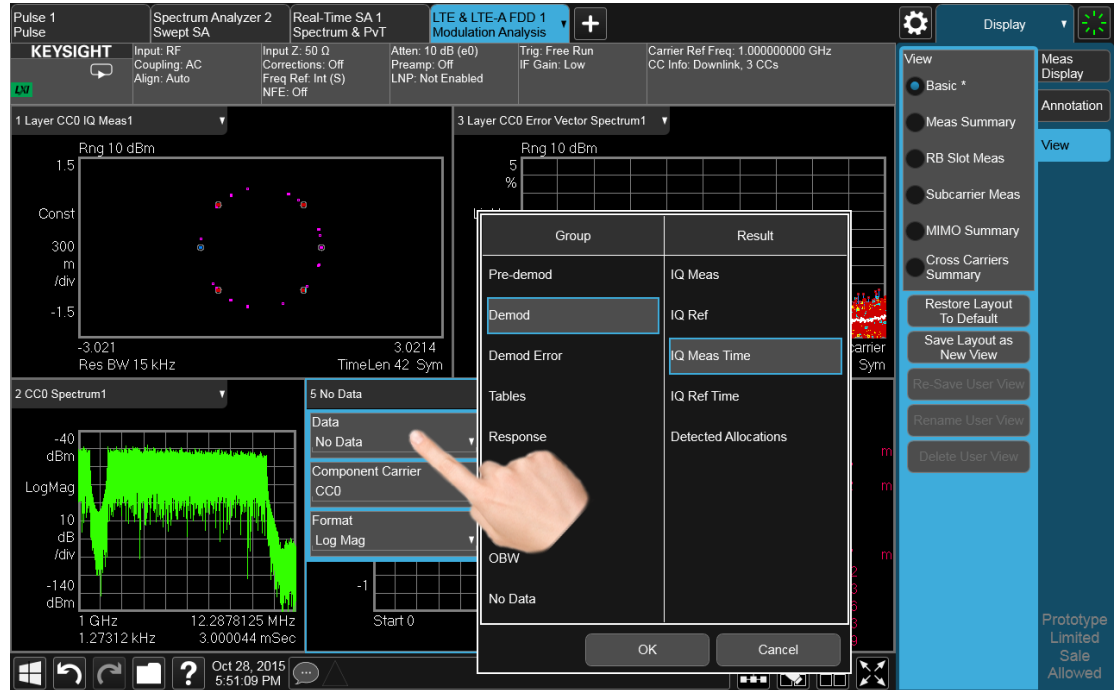

Choose the result you want and tap OK. Here we have chosen IQ Meas Time from the Demod group:

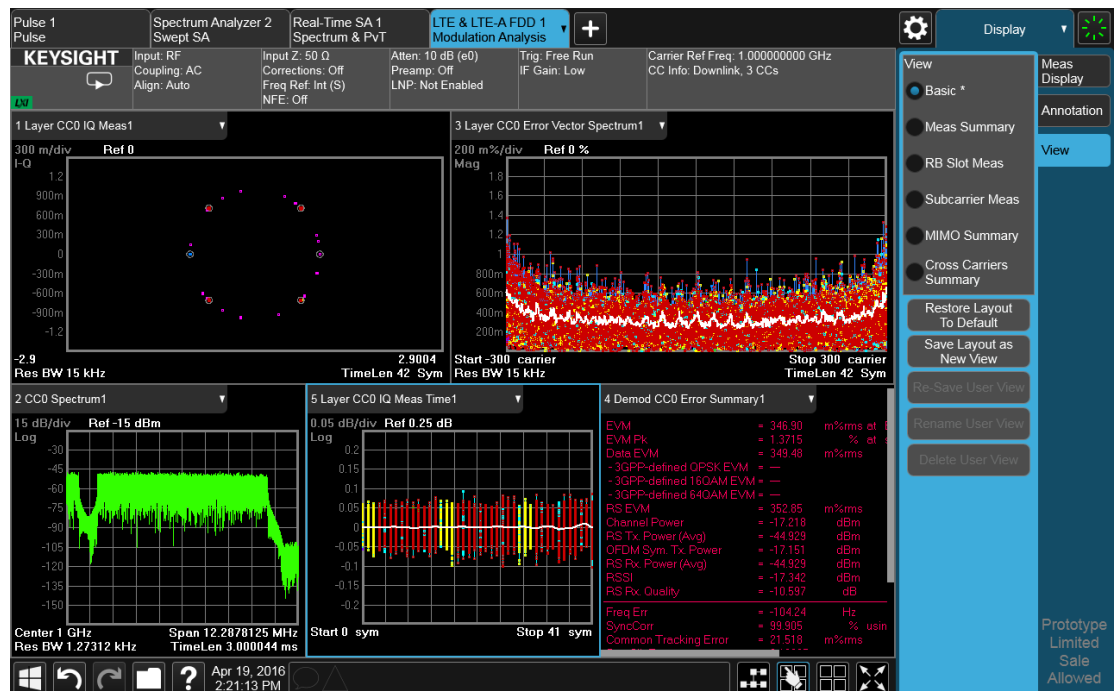

Your new, edited User View is now ready to use.

2.17.2 To Resize or Rearrange Windows in a View

Sometimes you may wish to resize a window. To do this go back into the View Editor and note the large, translucent white circles along the edges of the draggable borders. These are the “resize handles”. You can resize the windows by dragging these handles. Note that in their quiescent state they are slightly translucent; when you touch one it turns solid white, indicating that it is draggable. If you touch and drag one of them it moves the axis to which it is attached.

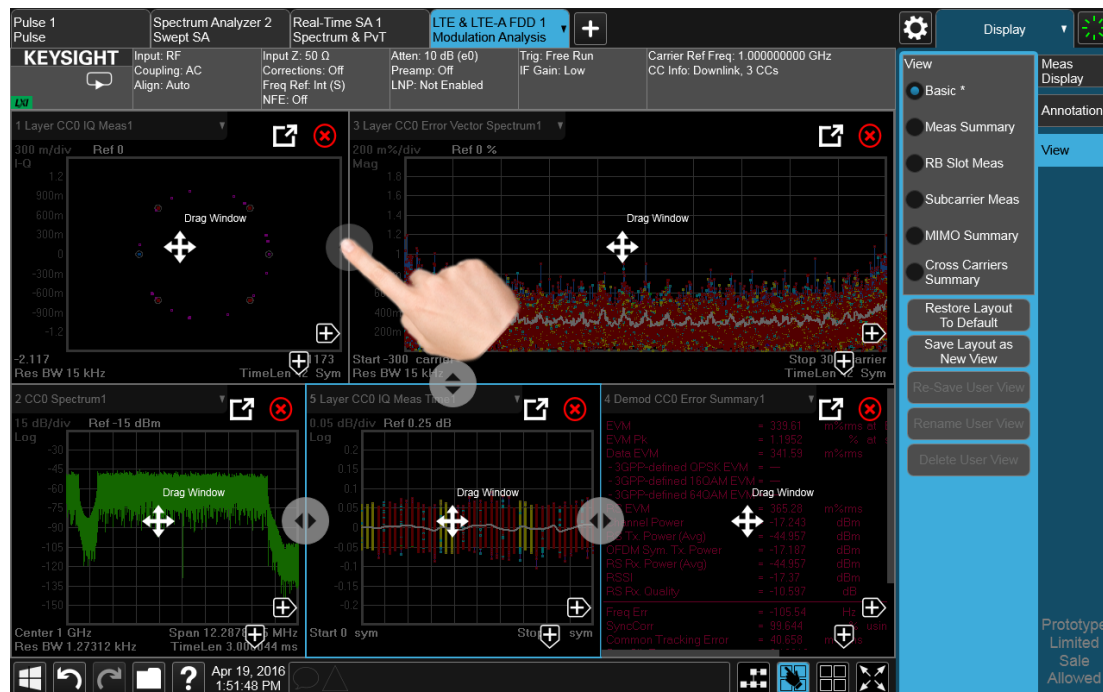

Another feature that comes with the View Editor is the ability to move windows around. You do this by dragging the four-arrow objects in the center of the window; the whole window goes along. Actually you can touch and drag anywhere in the window (except on one of the arrows or the delete circle) and it will drag, but the four-arrow objects give you an indication and a convenient finger target.



The outline of the window appears as it is being dragged. When you start to drag a window, target symbols appear in the other windows:



If you drop a window on one of the targets, it swaps positions with the target window. If you drag a window's center into another window, green stripes appear on the edges to show you where the window will go when you release it:

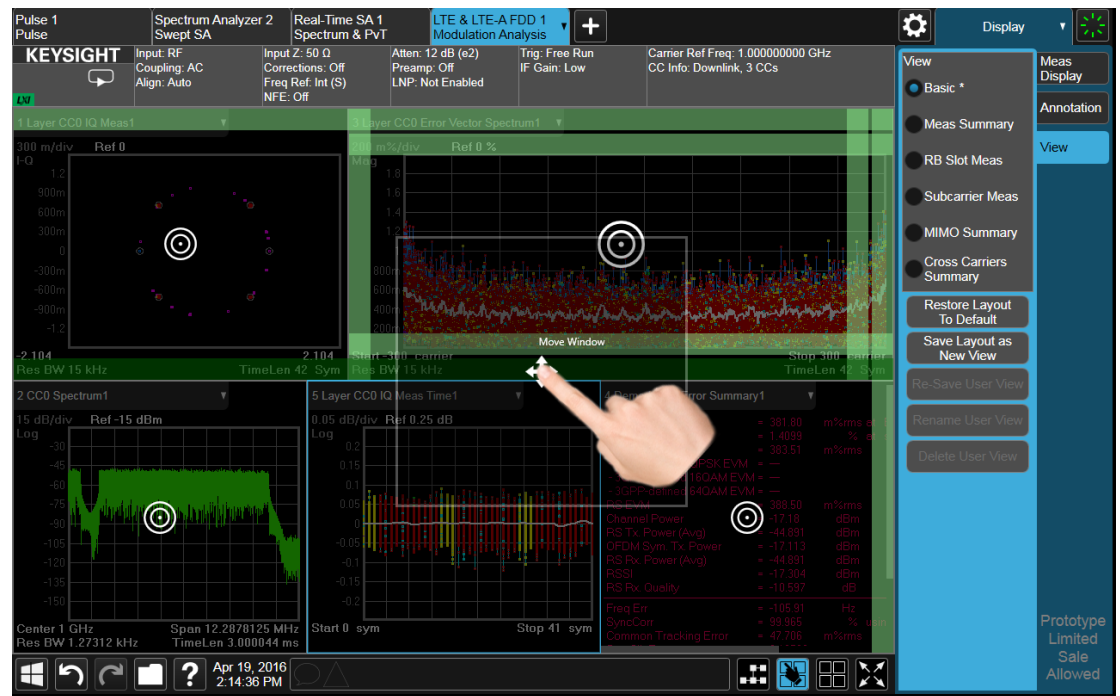

2 User Interface

2.17 View Editor

When you hover over one of the stripes it gets dimmer, to show the position the window being dragged will take on. If you release a window over an inner stripe, the window you are dragging and the window over which you were hovering resize to share the space the target window originally occupied. If you release a window over an outer stripe, as shown below, the window you are dragging takes on a new position outside the array of other windows:

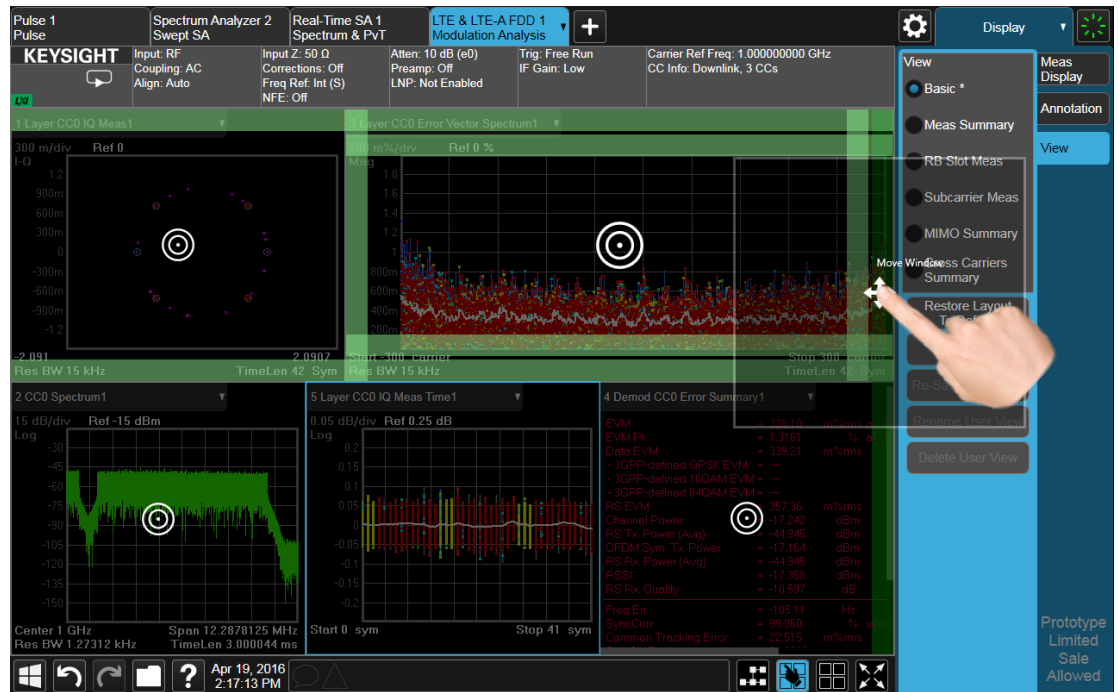

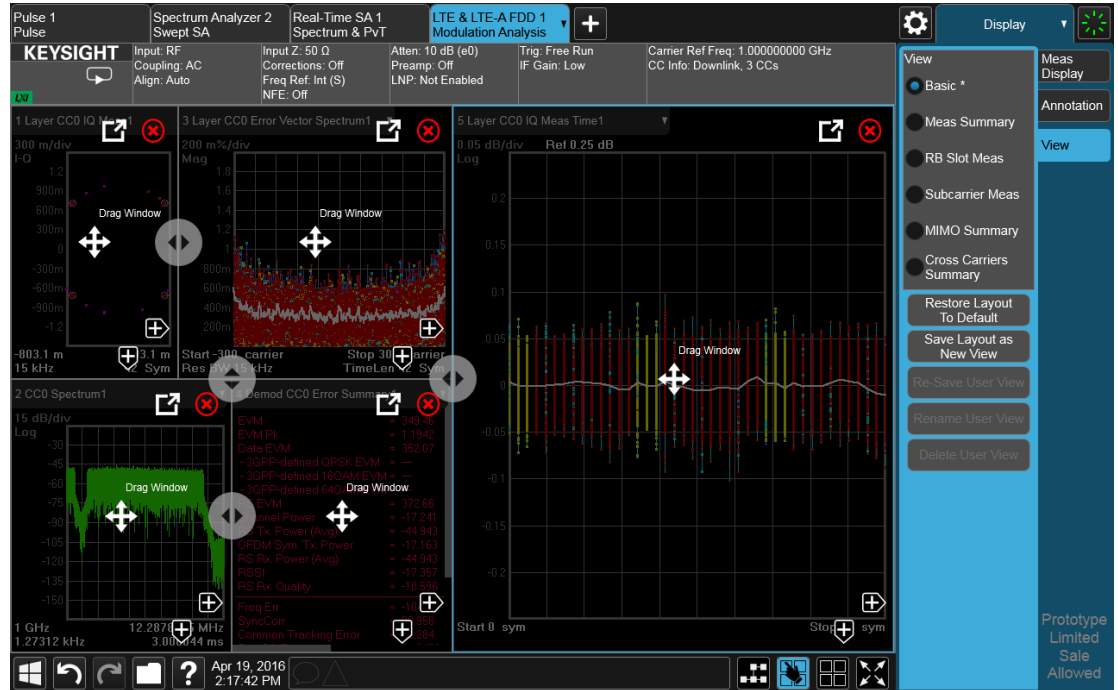

In either case, one or more of the remaining windows resize to occupy the space formerly occupied by the window you were dragging.

2.17.3 To Delete a Window from a View

The View Editor also lets you delete a window. To do this, tap one of the circled red X's, as shown below.

There has to be more than one window for you to see the circled red Xs.

2 User Interface

2.17 View Editor

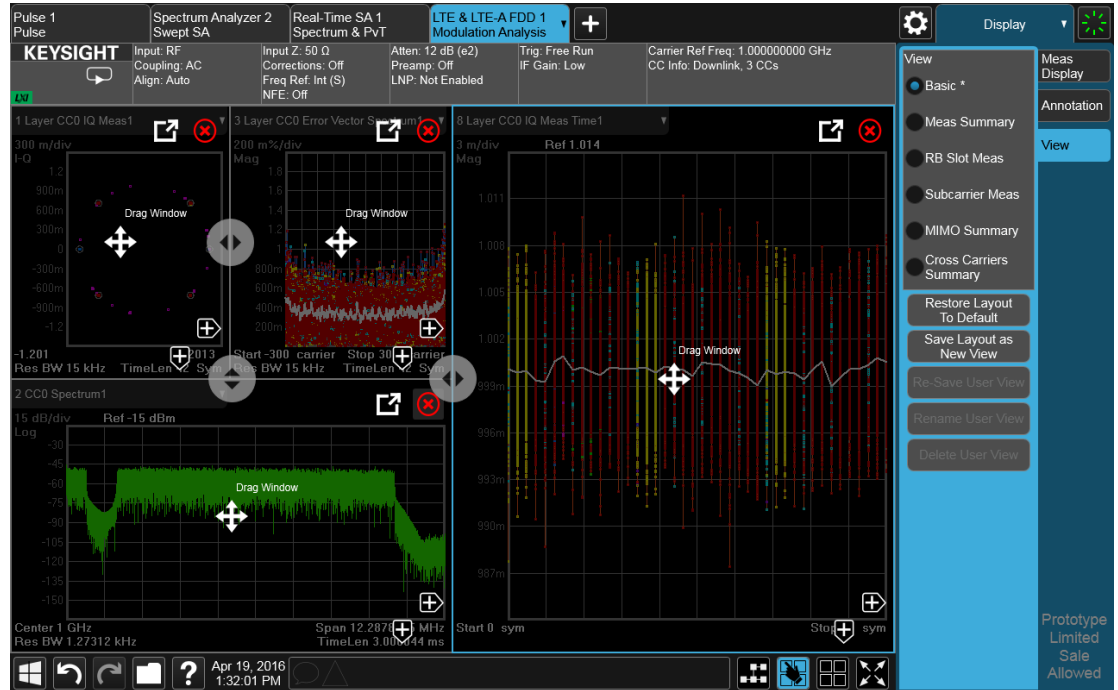

Now press the View Editor button (the blue hand) to exit the View Editor. At this point, you have an edited Predefined View, as shown by the * next to Basic:

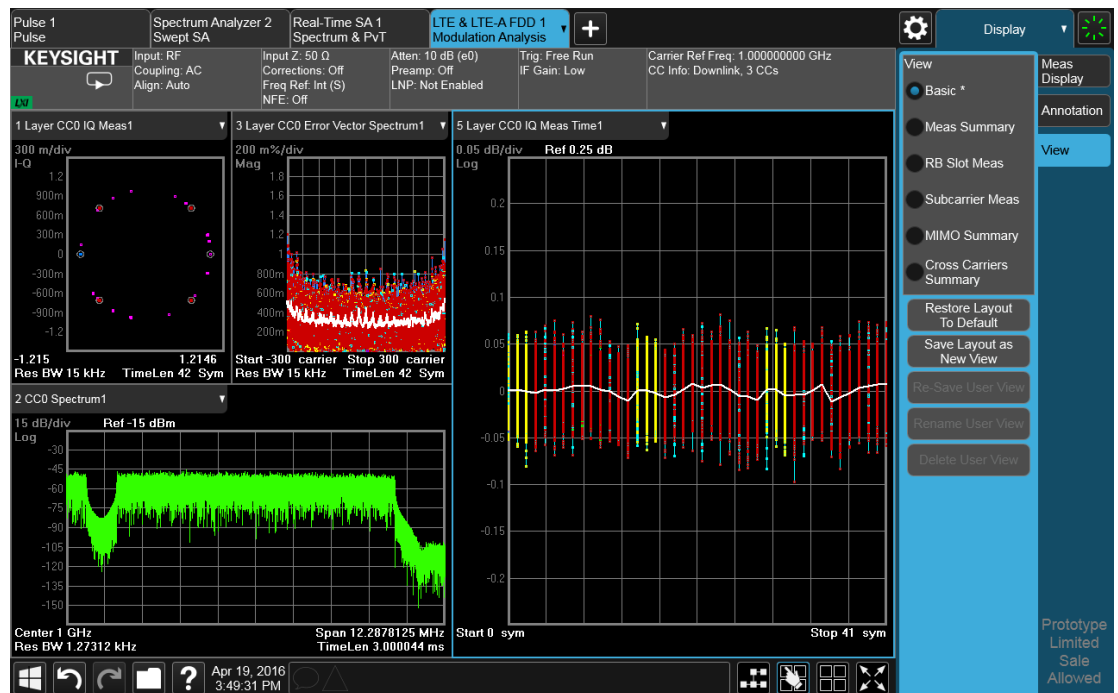

When you are finished with it, you can restore the Layout to the default for Basic by pressing “Restore Layout to Default”. Or you can save your edited View as a “User

View” (if you exit the measurement without saving the edited View, the instrument will save it for you as a User View called “Autosaved”).

If you clone the current Screen by pressing the “+” tab, the modified Predefined View will be saved as a User View called “Autosaved”, and it will be available in the new Screen.

2.17.4 To Save a User View

See also "[Transferring User Views Between Instruments](#)" on page 172

To save your new View as a User View, tap the “Save Layout as New View” control. You will get an alpha keyboard that lets you name your new View; the default is the old View name with a number. Below, we have typed in “My New View”:

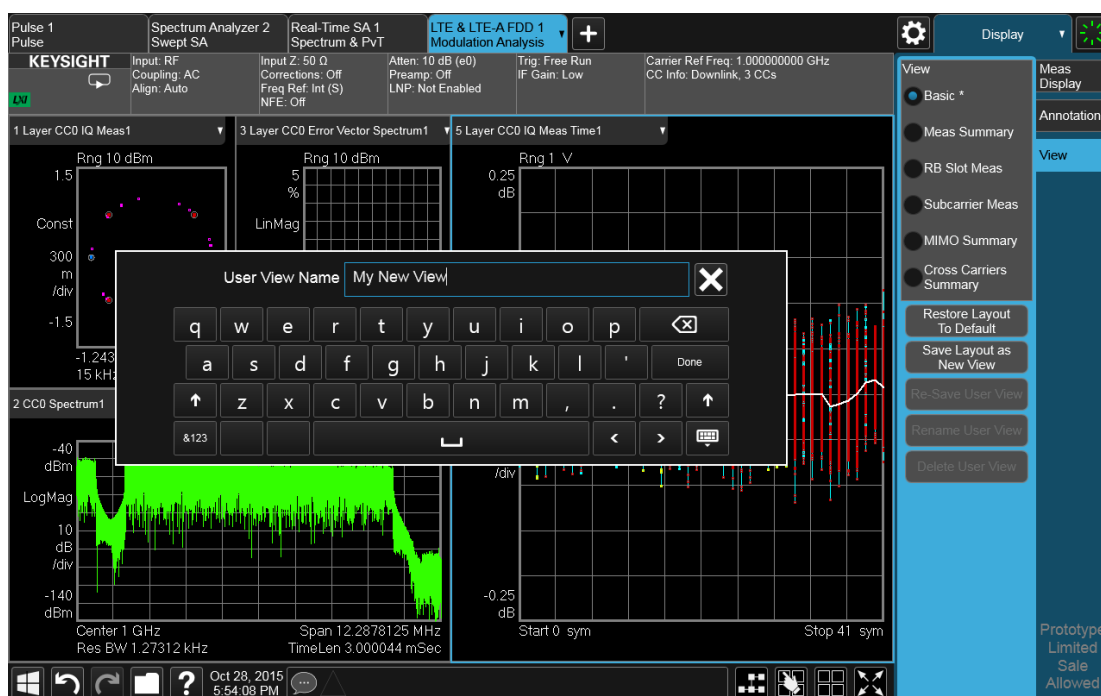

When you tap “Done”, the View is saved:

2 User Interface

2.17 View Editor

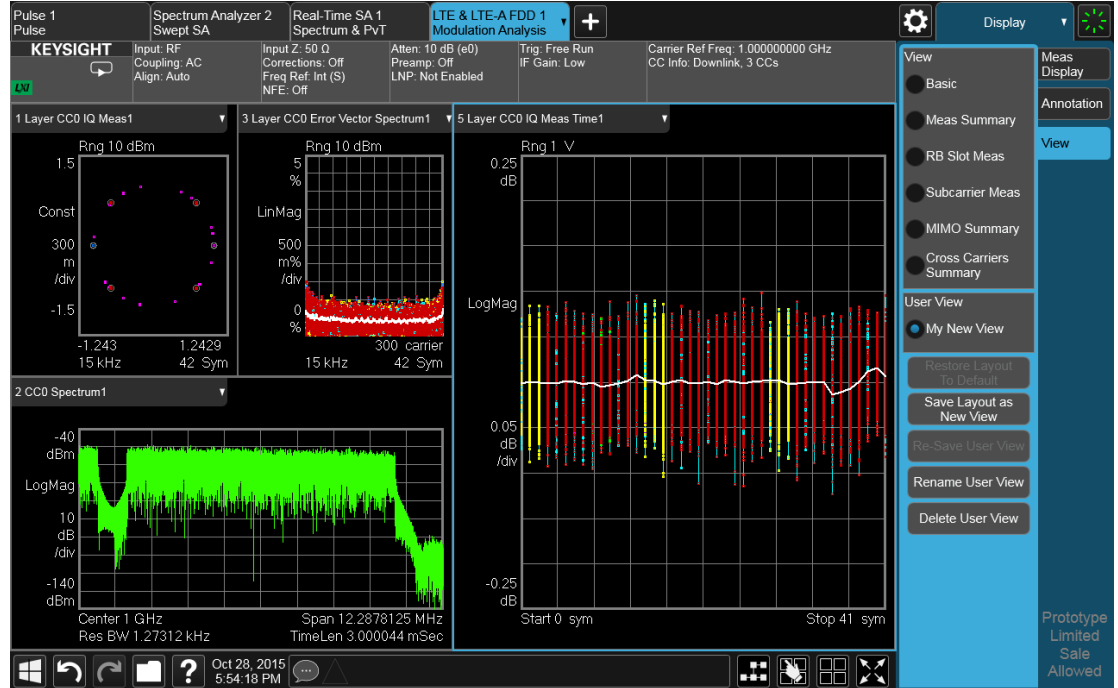

Notice the User View region which has appeared on the menu panel above, with the new User View called “My New View. Notice also that “Basic” has returned to its original, unedited state and the * is gone from its name. Note also that “Restore Layout to Default” is grayed out. Note also that if you go to the Mode/Meas dialog, you will see the User View there as well:

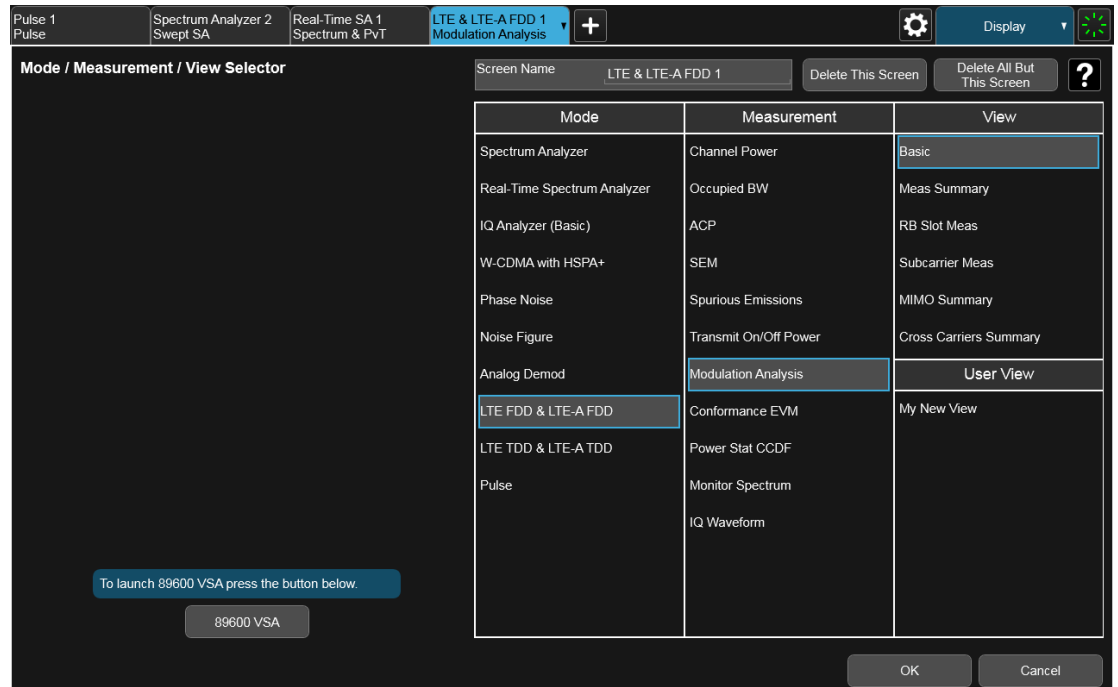

When naming a new View, you must choose a name that is not already in use for any User View in any measurement; this is because User Views get written to permanent memory and are available to all instances of the Measurement in any screen. They survive a Mode Preset and also survive shutdown and restart of the application.

Transferring User Views Between Instruments

To transfer a User View to another instrument, you must copy the desired file to a portable drive or to your network and then copy it to the target instrument.

When you save a User View, a file is created (or updated if it already exists) containing all the User Views for the current measurement. All of these files are saved on the D: drive in the instrument, in the folder:

`D:\Users\Instrument\My Documents\UserViews`

(assuming you are logged in as Instrument, which is the default).

Look for the file for your measurement. The file naming convention is:

`ModeName.MeasName.layout`

Where **ModeName** is the long-form SCPI parameter for the `:INST:SEL` command for your Mode, and **MeasName** is the long-form SCPI parameter for the `:CONF` command for your Measurement.

For a full list of all **ModeName** parameters, see **Index to Modes** in "Mode" on page 91.

The following is a full list of all **MeasName** parameters.

Measurement Name	SCPI ID
ACP, Adjacent Channel Power	<code>ACPower</code>
AM	<code>AM</code>
AM Depth	<code>AMD</code>
Amplitude Probability Distribution	<code>APD</code>
Audio Distortion	<code>AUDDist</code>
Audio Frequency	<code>AUDFreq</code>
Audio Level	<code>AUDLevel</code>
Audio SINAD	<code>AUDSinad</code>
Automatic Direction Finder	<code>ADF</code>
Channel Power	<code>CHPower</code>
Code Domain	<code>CDPower</code>
Combined GSM	<code>CGSM</code>
Combined WCDMA	<code>CWCDma</code>
Complex Spectrum	<code>SPECTrum</code>
Conformance EVM	<code>CEVM</code>
Custom OFDM	<code>OFDM</code>

2 User Interface
2.17 View Editor

Measurement Name	SCPI ID
Digital Demod	DDEMod
Disturbance Analyzer	DANalyzer
EDR In-band Spurious Emissions	IBSPurious
EVM	EEVM
Fast Capture	FCAPture
Fast Spectrum	FSPectrum
FM	FM
FM Deviation	FMDeviation
FM Stereo	FMStereo
Frequency Counter	FCOunter
Frequency Scan	FSCan
GMSK Phase & Freq Error	PFERror
Group Delay	GDELay
Harmonics	HARMonics
HRP UWB Demodulation	HUWB
Instrument Landing System	ILS
IQ Waveform	WAVEform
LE In-band Emissions	IBEMissions
List Power Step	LPSTep
List Sequencer	LSEQuencer
List Sweep	LIST
Log Plot	LPLot
LoRa (CSS) Demodulation	LORA
Marker Beacon	MBE
Mod Accuracy	RHO
Modulation Analysis	EVM
Modulation Distortion	MODDist
Modulation Rate	MODRate
Modulation SINAD	MODSinad
Monitor Spectrum	MONitor
Noise Figure	NFIGure
Occupied BW /	OBWidth
Output Spectrum BW	
Output RF Spectrum	EORFspectr
Phase and Amplitude vs Time	PAVTime

Measurement Name	SCPI ID
PM	PM
PM Deviation	PMDeviation
Power Amplifier	PAMplifier
Power Control	PCONtrol
Power Stat CCDF	PStatistic
Power vs Time	EPVTime
Pulse	PULSe
QPSK EVM	EVMQpsk
Real Time Scan	RTSC
RF Power	RFPower
SEM	SEMask
Spectral Flatness	FLATness
Spectrum & PVT	RTSA
Spot Frequency	SFRequency
Spurious Emissions	SPURious
Streaming	STReaming
Strip Chart	SCHart
Swept SA	SANalyzer
TOI	TOI
Transmit Analysis	TX
Transmit On/Off Power	PVTime
Transmit Power (Burst Power)	TXPower
Tuned RF Level	TRFLevel
Tuned RF Level with Tracking	TTRF
Tx Band Spur	ETSPur
VHF Omni-Directional Range	VOR

Examples:

- The User View file for the Swept SA measurement is [SA.SANalyzer.layout](#)
- The User View file for the ACP measurement in the WCDMA mode is [WCDMA.ACPower.layout](#)

Copy the desired file to a thumb drive or to your network. Then go to the target instrument and copy the file into the [D:\Users\Instrument\My Documents\UserViews](#) directory on that instrument (again, assuming you are logged in as Instrument).

Note that copying this file to another instrument will overwrite the file already in that instrument, if any, and will destroy any User Views that might have been created on that instrument.

Note that when you delete the last User View for a measurement, the file is removed.

2.17.5 To Rename a User View

You can rename a User View by selecting that View and tapping “Rename User View.” You can also re-edit a User View; if you do this, an asterisk will appear next to the User View’s name. You can then tap “Re-Save User View to save it back to its existing name, or “Save Layout as New View” to add another, new User View.

2.17.6 To Delete a User View

You can delete a User View by doing the following:

1. From the **"Mode/Meas/View Dialog"** on page 90, or from the **View** menu, select the User View that you want to delete
2. Switch to the **Display** menu
3. Select the **View** tab
4. Tap **Delete User View**

2.17.7 To Delete All User Views

You can delete all User Views by tapping “Delete All User Views.” The default view becomes the current view for the Measurement if a User View was the current view when this control was pressed.

2.17.8 Use Case: Displaying Marker and Peak Tables

One common application for User Views is to create a View that allows the Spectrum Analyzer to display both a Marker Table and a Peak Table at the same time. To do this, simply add a Marker Table Window and a Peak Table window to the Spectrum window of the Swept SA measurement. The result is shown below; note that the new View has been named “Marker Table & Peak Table”:

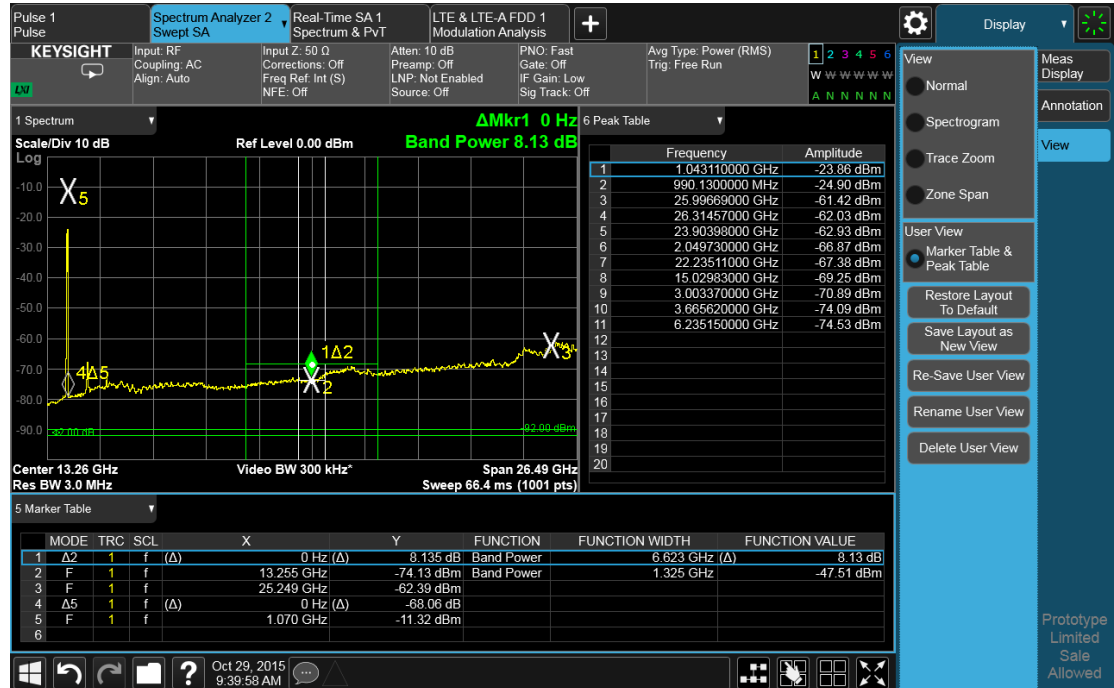

NOTE: There are legacy displays like Marker Table, Peak Table, Measure at Marker and Gate View, which are not Views but special display modes. These are retained for backwards compatibility, however they are turned on and off with switches and do not use the View system. Turning on one of these switches does not create a modified View, it merely adds the specified window to the current View; turning the switch back off removes the window. While the switch is on, NO View shows as selected in the View menu. These switches are grayed out if you are in a modified View or a User View. Since only one of these switches can be on at a time, and because these switches turn off on a Preset, User Views offer a superior way of adding windows than using the switches.

Some measurements do not support User Views; these do not allow adding, deleting or rearranging windows, however they do allow resizing windows. In these measurements you can get into the View Editor but the Add icons, Delete icons and Move icons will not appear. You can still resize the windows and in some cases (e.g. Noise Figure) you can still change window contents.

2.17.9 View Editor Remote Commands

Remote Commands for User Views can be found in the documentation for the Display, View tab.

2.18 Multiscreen

You can configure up to 16 different Screens at a time. Normally, you only see one Screen, and the set of configured screens is shown across the top of the display in a series of "Screen Tabs" on page 89. Touching any screen's tab brings it to the foreground, makes it the current Screen and starts it updating.

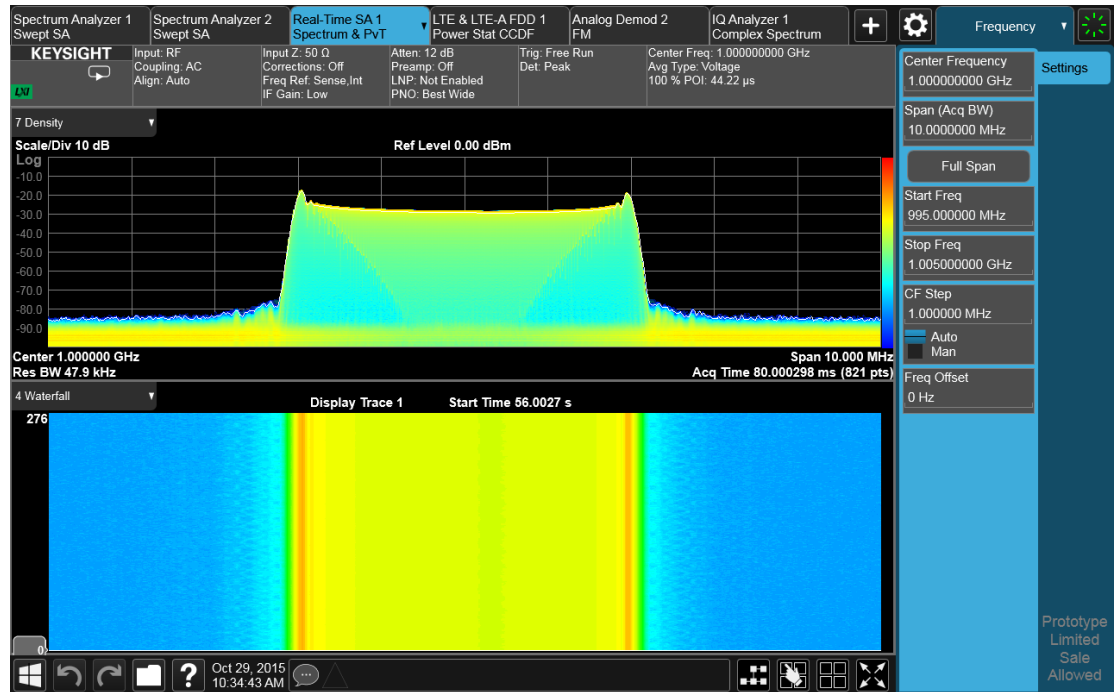

Multiscreen view lets you display all of the configured Screens at once.

You can switch to Multiscreen View by pressing this button in the "Control Bar" on page 138 at the bottom right of the screen:



Multiscreen View looks like this:

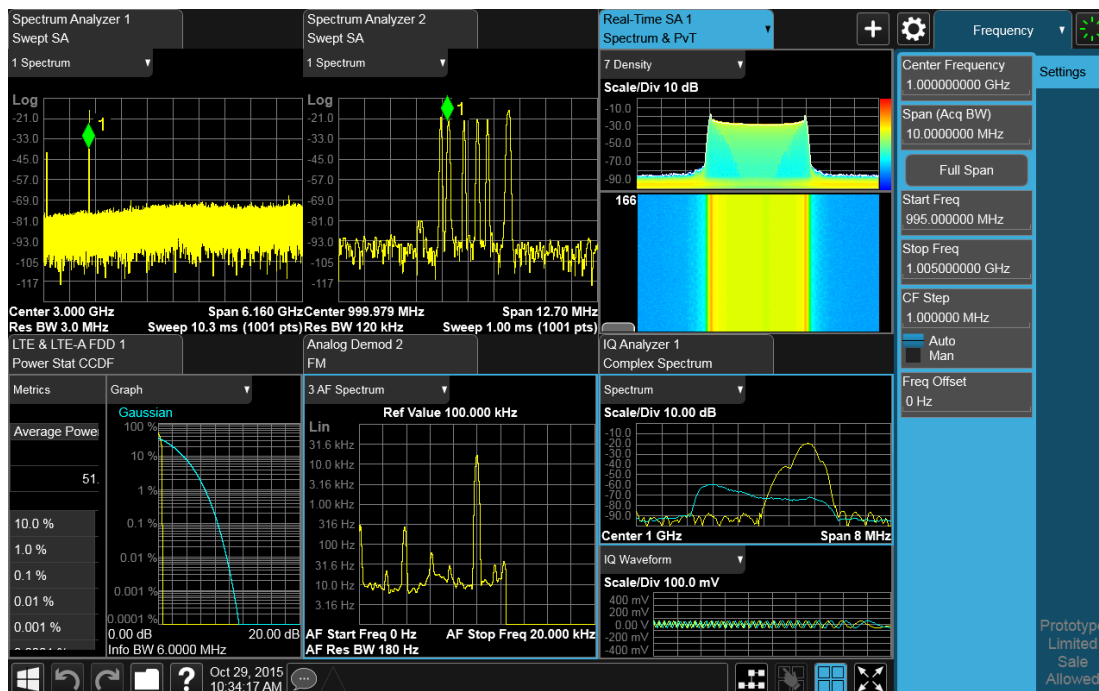

While in Multiscreen View, the button changes from a black background to a blue background:



To exit Multiscreen view, tap the button again.

Multiscreen View cannot be activated if only one screen is configured.

Each Screen contains one Mode, each Mode contains one Measurement, and each Measurement contains a number of Windows arranged in Views. You can configure multiple instances of the same Mode along with any combination of other Modes.

In Multiscreen View, just as in Single Screen View, only one screen is active.

You switch Screens by tapping the Screen Tab you want, or when in Multiscreen View, you can tap the Screen itself. When you switch Screens, the current Screen's state and measurement results are preserved, the new Screen's previous state and data are loaded, and the new Screen starts running its Mode.

In Multiscreen View:

- The Meas Bar does not display
- The Screens are presented in an array of equal size boxes, except where the number of Screens means some have to be different sizes (as when you have 3 Screens, 5 Screens, etc.).

- Each Screen has a tab that contains the name of the Mode and Measurement in the box and a number associated with the instance of that Mode. You can enter a custom Screen name that replaces the Mode name, by going into the Mode/Meas dialog
- There is always one and only one selected Screen. It is indicated by a blue tab. Only the selected Screen is actually running a measurement and updating its display
- The selected window in the selected screen is the context for the current menus. It is the only window on the display with a blue border
- As you go from screen to screen, each screen remembers the last menu that was active in that screen and restores it as the active menu

In Multiscreen View, as in Single Screen View, tapping the blue tab or pressing the Mode/Meas front panel key opens the ["Mode/Meas/View Dialog" on page 90](#) which allows you to change the Mode (or Measurement or View) being displayed in that Screen.

Remote Command	<code>:INSTRument:SCReen:MULTiple[:STATe] OFF ON 0 1</code> <code>:INSTRument:SCReen:MULTiple?</code>
Example	<code>:INST:SCR:MULT ON</code>
Notes	If only one screen is configured, attempting to set Multi-Screen ON generates the error “-221, Settings conflict; Multi-Screen requires >1 screen”
Preset	OFF
	For more information, see the following: <ul style="list-style-type: none"> – "Select Screen" on page 179 – "Screen List (Remote only command)" on page 180

2.18.1 Select Screen

You can select a screen by touching its tab or, in ["Multiscreen" on page 177](#) mode, touching the screen itself. Selecting the Screen activates the screen and suspends the previously selected screen (if any).

Remote Command	<code>:INSTRument:SCReen:SElect <screen name></code> <code>:INSTRument:SCReen:SElect?</code>
Example	<code>:INST:SCR:SEL "Baseband"</code>
Notes	If the <screen name> is specified but not found in the list of Screens, the error message “-224, Illegal parameter value; Screen Name not found” is generated If the display is disabled (via <code>:DISP:ENAB OFF</code>) then the error message “-221, Settings conflict; Screen SCPI cannot be used when Display is disabled” is generated

Preset	Returns the name of the active screen
--------	---------------------------------------

2.18.2 Screen List (Remote only command)

You can obtain a list of currently configured Screens. This permits your remote program to manage screens for selection, renaming, or deletion.

Remote Command	<code>:INSTrument:SCReen:CATalog?</code>
----------------	--

Example	<code>:INST:SCR:CAT?</code>
---------	-----------------------------

Notes	<p>The query response is a comma separated list of Screen Names. If only 1 Screen is configured, there is no trailing comma</p> <p>For R&S compatibility, the following query is also available:</p> <p><code>:INSTrument:SCReen:LIST?</code></p>
-------	---

Preset	Returns list of currently configured Screens
--------	--

2.19 Fullscreen

The Fullscreen button is in the "Control Bar" on page 138, at the lower right corner of the display.



When **Full Screen** is pressed the measurement window expands horizontally over the entire instrument display. The screen graticule area expands to fill the available display area.

It turns off the display of the menu panel, however the controls that drop down from the Meas Bar and on-screen annotation are still available, and you can still drag the trace and markers and perform a pinch zoom, so you can still operate the instrument.

Pressing **Full Screen** again while Full Screen is in effect cancels Full Screen.

You can get even more screen area for your data display by turning off the Meas Bar using the Annotation tab of the Display menu)

Full Screen is canceled by the **Preset** key.

Remote Command	<code>:DISPlay:FSCReen[:STATe] OFF ON 0 1</code> <code>:DISPlay:FSCReen[:STATe]?</code>
Notes	This was set to Off by :SYST:DEF MISC in MXA1, but not by Preset. It is no longer set Off by :SYST:DEF MISC, since it is now meas global instead of mode global
Preset	Unaffected by Preset but set to Off by Restore Misc Defaults or shutdown and restart
State Saved	Not saved in instrument state
Backwards Compatibility SCPI	<code>:DISPlay:MENU[:STATe] OFF ON 0 1</code> This emulates ESA full screen functionality, which is the same as the FSCReen command in PSA except that the sense of on/off is reversed (that is, OFF means the menus are OFF, so Fullscreen is ON) and the default is ON (meaning Fullscreen is OFF)
Backwards Compatibility Notes	In ESA/PSA, Full Screen was turned on with a softkey, so pressing any other key turned Full Screen off. In the X-Series, because a hardkey is provided to turn this function on and off, pressing any other key no longer turns off Full Screen

3 VMA Mode

Vector Modulation Analyzer Mode provides flexible modulation analysis capabilities on a broad variety of digital signal formats and standards. These capabilities are primarily accessed through the Digital Demod measurement and Custom OFDM measurement. It provides various analysis techniques for several standard and non-standard digital modulation formats. The Power Suite measurements (Channel Power, Occupied BW, Adjacent Channel Power, CCDF, Monitor Spectrum, IQ Waveform, Spurious Emissions, and Spectrum Emissions Mask, Phase and Amplitude vs Time) are used in this mode to make specific power measurements.

To view this help, VMA must be the current active Mode. If not, exit Help (**Esc** key), select this Mode, and re-open Help.

Example	<code>:INST:SEL VMA</code> <code>:INST:NSEL 200</code>
---------	---

Dependencies	The mode must be installed and licensed in your instrument before it is available for use
--------------	---

Status Bits/OPC dependencies	Changing modes resets all SCPI status registers and mask registers to their power-on defaults. Therefore, event or condition register masks must be re-established after a mode change
------------------------------	--

This mode requires N9054EM0E-1FP and/or N9054EM1E-1FP licenses:

- N9054EM0E-1FP enables the Digital Demod measurement and Power Suite measurements
- N9054EM1E-1FP enables the Custom OFDM measurement and Power Suite measurements
- N9054EM0E-1FP and N9054EM1E-1FP enable all measurements in VMA Mode

3.1 Digital Demod Measurement

This measurement provides flexible modulation analysis capabilities in the N9054C Vector Modulation Analyzer (VMA) Mode. The measurement is based on the acquisition of IQ Pairs from the instrument. It includes flexible demodulation of a wide variety of standard and custom single-carrier modulation formats. You can simultaneously view pre-demod time and spectrum displays, demodulated signal, reconstructed reference signal, recovered symbols and various error traces and summaries.

Measurement Commands

The following measurement commands and queries are used to configure the measurement:

<code>:INITiate:DDEMod</code>	Initiates a trigger cycle for the DDEMod measurement, but does not return any data. You must then use <code>:FETC:DDEM[n]?</code> to retrieve data
<code>:CONFigure?</code>	Does not change any measurement settings Returns the long form name of current measurement, in this case, DDEMod
<code>:CONFigure:DDEMod</code>	Selects DDEMod measurement with Meas Setup settings in preset state – same as " Meas Preset " on page 306
<code>:CONFigure:DDEMod:NDEFault</code>	Selects DDEMod measurement <i>without</i> affecting settings

The following queries are used to retrieve the results:

<code>:FETCh:DDEMod?</code>	Retrieves the data specified by n
<code>:MEASure:DDEMod [n]?</code>	Switches to DDEMod measurement, restores default values, starts the measurement, then retrieves the data specified by n
<code>:READ:DDEMod[n]?</code>	Starts the measurement, then retrieves the data specified by n

The general functionality of "**CONFigure**" on page 2551, "**INITiate**" on page 2552, "**FETCh**" on page 2552, "**MEASure**" on page 2554, and "**READ**" on page 2553 are described in the section **SCPI Operation and Results Query** in the topic **Programming the Instrument**.

Remote Command Results

For the **FETCh**, **MEASure**, and **READ** queries listed above, the results returned depend on the value of **n**. In many cases, the results returned also depend on the selected "**Modulation Format**" on page 335

For this measurement, the value of **n** is derived by concatenating two 2-digit sub-fields: Segment Index (**SI**) and Result Index (**RI**).

For details, see ["Index Sub-Fields" on page 184](#).

For an overview of all available results, see ["Summary of Result Types" on page 185](#). In cases where results depend on **Modulation Format**, details have been moved to separate tables for clarity.

3.1.1 Index Sub-Fields

The general formula for calculating the desired value of **n** is:

$$n = 100 * SI + RI$$

Sub-field	Variable	Definition	
Most Significant 2 Digits	SI	Segment Index	
		00	Segment1 General results not specific to a segment
		01	Segment2
		02	Segment3
		03	Segment4
		04	Segment5
		05	Segment6
Least Significant 2 Digits	RI	Result Index	
		The information returned is for the specified SI :	
		00	Captured IQ data
		01	Metrics
		02	Limit test results
		03	IQ data for Search Time
		04	IQ data for Time (Meas Interval)
		05	Spectrum Trace
		06	IQ Meas Time
		07	IQ Ref Time
		08	IQ Meas Spectrum
		09	IQ Ref Spectrum
		10	Error Vector Time
11	EVM Spectrum		
12	Magnitude Error		

3 VMA Mode
3.1 Digital Demod Measurement

Sub-field	Variable	Definition
		13 Phase Error
		14 Channel Frequency Response (Amplitude)
		15 Channel Frequency Response (Phase)
		16 Channel Frequency Response (Group Delay)
		17 EQ impulse response
		18 Demod Bits
		19 BER Results
		20 IQ Meas Time (Group Delay)
		21 IQ Ref Time (Group Delay)
		22 ccEVM
		23 Frame Summary
		24 ccEVM vs Symbol magnitude

3.1.1.1 Summary of Result Types

RI	Return Value
00	Returns unprocessed I/Q captured trace data, as a series of trace point values. The I values are listed first in each pair, using 0 through even-indexed values. The Q values are the odd-indexed values
01	See "Measurement Results for RI = 01 or Not Specified" on page 186
or no n value	
02	PASS/FAIL results of Segment SI See "Measurement Results for RI = 02" on page 201
03	Search Time Returns I/Q trace data which is used to burst search, as a series of trace point values. The I values are listed first in each pair, using the 0 through even-indexed values. The Q values are the odd-indexed values The length is determined by "Search Length" on page 324
04	Time of Segment SI Returns pre-demodulated I/Q trace data which is used to demodulation, as a series of trace point values. The I values are listed first in each pair, using the 0 through even-indexed values. The Q values are the odd-indexed values The length is determined by "Meas Interval" on page 334
05	Spectrum Returns the spectrum of the pre-demodulated I/Q trace data
06	Meas Time of Segment SI Dependent on Modulation Format. See "Measurement Results for RI = 06" on page 203
07	Dependent on Modulation Format. See "Measurement Results for RI = 07" on page 204
08	Dependent on Modulation Format. See "Measurement Results for RI = 08" on page 205

RI	Return Value
09	Dependent on Modulation Format. See " Measurement Results for RI = 09 " on page 205
10	Dependent on Modulation Format. See " Measurement Results for RI = 10 " on page 206
11	Dependent on Modulation Format. See " Measurement Results for RI = 11 " on page 206
12	Dependent on Modulation Format. See " Measurement Results for RI = 12 " on page 207
13	Dependent on Modulation Format. See " Measurement Results for RI = 13 " on page 207
14	Dependent on Modulation Format. See " Measurement Results for RI = 14 " on page 207
15	Dependent on Modulation Format. See " Measurement Results for RI = 15 " on page 208
16	Dependent on Modulation Format. See " Measurement Results for RI = 16 " on page 208
17	Dependent on Modulation Format. See " Measurement Results for RI = 17 " on page 208
18	Demod bits Returns the demodulation bits
19	BER Results <ul style="list-style-type: none"> - Tx BER (exponential) - Error Bits Number (exponential) - Total Bits Number (exponential)
20	Dependent on Modulation Format. See " Measurement Results for RI = 20 " on page 209
21	Dependent on Modulation Format. See " Measurement Results for RI = 21 " on page 209
22	<ul style="list-style-type: none"> - ccEVM results of segment1 - ccEVM (%) - Valid Points - Total Points - Improvement Factor (dB) <p>Note: The EVM result will be in "dB" if "Report EVM in dB" is set to true</p>
23	Frame Summary Results for each segment <ul style="list-style-type: none"> - Data EVM (%) - Pilot EVM (%) <p>Note: These results are only available for complicated segment including both data and pilot</p>
24	Returns ccEVM per symbol magnitude results

3.1.1.2 Measurement Results for RI = 01 or Not Specified

In the tables below, the value in the A/P column is one of:

3 VMA Mode
3.1 Digital Demod Measurement

A	Average	Averaged value in average cycle
P	Peak Hold	Detected Peak/Maximum value in average cycle
-	n/a	

The [FETCH](#), [MEASure](#), or [READ](#) queries return the following comma-separated scalar results for Segment [SI](#). For values of [SI](#), see "[Index Sub-Fields](#)" on page 184.

For details of available formats, see "[Modulation Format](#)" on page 335.

Modulation Format: QPSK

#	Name	A/P	Description	Unit, if any
1	Transmit Power	A	Transmit power Floating point number	dBm
2	RMS EVM	A	EVM over the entire measurement area Floating point number	%
3	Peak EVM	P	Peak EVM in the measurement area Floating point number	%
4	Peak EVM Index	P	Location of the symbol that has the largest EVM	
5	RMS Magnitude Error	A	Average magnitude error over the entire measurement area Floating point number	%
6	Peak Magnitude Error	P	Peak magnitude error in the measurement area Floating point number	%
7	Peak Magnitude Error Index	P	Location of the symbol that has the largest magnitude error	
8	RMS Phase Error	A	Average phase error over the entire measurement area Floating point number	°
9	Peak Phase Error	P	Peak phase error in the measurement area Floating point number	°
10	Peak Phase Error Index	P	Location of the symbol that has the largest phase error	
11	Frequency Error	A	Frequency error in the measured signal Floating point number	Hz
12	Clock Error	A	Symbol clock error Floating point number	Hz
13	I/Q Offset	A	I and Q error (magnitude squared) offset from the origin Floating point number	dB

#	Name	A/P	Description	Unit, if any
14	Rho	A	Rho Floating point number	
15	Quad Error	A	Orthogonal error between the I and Q signals Floating point number	°
16	Gain Imbalance	A	Gain ratio between the I and Q signals Floating point number	dB
17	SNR	A	Signal to noise ratio Floating point number	dB
18	Amplitude Ratio of I Eye	A	Free decision distance in height of I Eye Diagram and calculated as percentage of $2B_I/(A_I+B_I)$. A_I and B_I are the maximum and minimum amplitude difference at the decision point of I Eye Diagram. An ideal signal has a decision height of 100%	%
19	Amplitude Ratio of Q Eye	A	Free decision distance in height of Q Eye Diagram and calculated as percentage of $2B_Q/(A_Q+B_Q)$. A_Q and B_Q are the maximum and minimum amplitude difference at the decision point of Q Eye Diagram. An ideal signal has a decision height of 100%	%
20	Time Ratio of I Eye	A	Free decision distance in width of I Eye Diagram and calculated as percentage of $2B'_I/(A'_I+B'_I)$. A'_I and B'_I is the maximum and minimum zero-cross time width in I Eye Diagram. An ideal signal has a decision width of 100%	%
21	Time Ratio of Q Eye	A	Free decision distance in width of Q Eye Diagram and calculated as percentage of $2B'_Q/(A'_Q+B'_Q)$. A'_Q and B'_Q is the maximum and minimum zero-cross time width in Q Eye Diagram. An ideal signal has a decision width of 100%	%

Modulation Formats: Offset QPSK, Shaped Offset QPSK

#	Name	A/P	Description	Unit, if any
1	Transmit Power	A	Transmit power Floating point number	dBm
2	RMS EVM	A	A floating point number of EVM over the entire measurement area	%
3	Peak EVM	P	A floating point number of the peak EVM in the measurement area	%
4	Peak EVM Index	P	Location of the symbol that has the largest EVM	
5	RMS Magnitude Error	A	A floating point number of the average magnitude error over the entire measurement area	%
6	Peak Magnitude Error	P	A floating point number of the peak magnitude error in the measurement area	%

3 VMA Mode
3.1 Digital Demod Measurement

#	Name	A/P	Description	Unit, if any
7	Peak Magnitude Error Index	P	Location of the symbol that has the largest magnitude error	
8	RMS Phase Error	A	A floating point number of the average phase error over the entire measurement area	°
9	Peak Phase Error	P	A floating point number of the peak phase error in the measurement area	°
10	Peak Phase Error Index	P	Location of the symbol that has the largest phase error	
11	Frequency Error	A	A floating point number of the frequency error in the measured signal	ppm
12	I/Q Offset	A	A floating point number of the I and Q error (magnitude squared) offset from the origin	dB
13	RMS Offset EVM	A	A floating point number of Offset EVM over the entire measurement area	%
14	Peak Offset EVM	P	A floating point number of the peak Offset EVM in the measurement area	%
15	Peak Offset EVM Index	P	Location of the symbol that has the largest Offset EVM	
16	Rho	A	A floating point number of Rho	
17	Quad Error	A	A floating point number of orthogonal error between the I and Q signals	°
18	Gain Imbalance	A	A floating point number of the gain ratio between the I and Q signals	dB
19	Clock Error	A	A floating point number of symbol clock error	Hz

Modulation Format: 8-PSK

#	Name	A/P	Description	Unit, if any
1	Transmit Power	A	A floating point number of transmit power	dBm
2	RMS EVM	A	A floating point number of EVM over the entire measurement area	%
3	Peak EVM	P	A floating point number of the peak EVM in the measurement area	%
4	Peak EVM Index	P	Location of the symbol that has the largest EVM	
5	RMS Magnitude Error	A	A floating point number of the average magnitude error over the entire measurement area	%
6	Peak Magnitude Error	P	A floating point number of the peak magnitude error in the measurement area	%
7	Peak Magnitude Error Index	P	Location of the symbol that has the largest magnitude error	

#	Name	A/P	Description	Unit, if any
8	RMS Phase Error	A	A floating point number of the average phase error over the entire measurement area	°
9	Peak Phase Error	P	A floating point number of the peak phase error in the measurement area	°
10	Peak Phase Error Index	P	Location of the symbol that has the largest phase error	
11	Frequency Error	A	A floating point number of the frequency error in the measured signal	Hz
12	Clock Error	A	A floating point number of symbol clock error	Hz
13	I/Q Offset	A	A floating point number of the I and Q error (magnitude squared) offset from the origin	dB
14	Quad Error	A	A floating point number of orthogonal error between the I and Q signals	°
15	Gain Imbalance	A	A floating point number of the gain ratio between the I and Q signals	dB
16	SNR	A	A floating point number of signal to noise ratio	dB
17	Amplitude Droop	A	A floating point number of the change in the magnitude of the signal over the entire measurement	dB/sym

Modulation Formats: DQPSK, $\pi/4$ DQPSK, D8PSK, $\pi/8$ D8PSK

#	Name	A/P	Description	Unit, if any
1	Transmit Power	A	A floating point number of transmit power	dBm
2	RMS EVM	A	A floating point number of EVM over the entire measurement area	%
3	Peak EVM	P	A floating point number of the peak EVM in the measurement area	%
4	Peak EVM Index	P	Location of the symbol that has the largest EVM	
5	RMS Magnitude Error	A	A floating point number of the average magnitude error over the entire measurement area	%
6	Peak Magnitude Error	P	A floating point number of the peak magnitude error in the measurement area	%
7	Peak Magnitude Error Index	P	Location of the symbol that has the largest magnitude error	
8	RMS Phase Error	A	A floating point number of the average phase error over the entire measurement area	°
9	Peak Phase Error	P	A floating point number of the peak phase error in the measurement area	°
10	Peak Phase Error Index	P	Location of the symbol that has the largest phase error	

3 VMA Mode
3.1 Digital Demod Measurement

#	Name	A/P	Description	Unit, if any
11	Frequency Error	A	A floating point number of the frequency error in the measured signal	Hz
12	Clock Error	A	A floating point number of symbol clock error	Hz
13	I/Q Offset	A	A floating point number of the I and Q error (magnitude squared) offset from the origin	dB
14	Quad Error	A	A floating point number of orthogonal error between the I and Q signals	°
15	Gain Imbalance	A	A floating point number of the gain ratio between the I and Q signals	dB
16	Amplitude Droop	A	A floating point number of the change in the magnitude of the signal over the entire measurement	dB/sym

Modulation Formats: BPSK, DBPSK

#	Name	A/P	Description	Unit, if any
1	Transmit Power	A	A floating point number of transmit power	dBm
2	RMS EVM	A	A floating point number of EVM over the entire measurement area	%
3	Peak EVM	P	A floating point number of the peak EVM in the measurement area	%
4	Peak EVM Index	P	Location of the symbol that has the largest EVM	
5	RMS Magnitude Error	A	A floating point number of the average magnitude error over the entire measurement area	%
6	Peak Magnitude Error	P	A floating point number of the peak magnitude error in the measurement area	%
7	Peak Magnitude Error Index	P	Location of the symbol that has the largest magnitude error	
8	RMS Phase Error	A	A floating point number of the average phase error over the entire measurement area	°
9	Peak Phase Error	P	A floating point number of the peak phase error in the measurement area	°
10	Peak Phase Error Index	P	Location of the symbol that has the largest phase error	
11	Frequency Error	A	A floating point number of the frequency error in the measured signal	Hz
12	I/Q Offset	A	A floating point number of the I and Q error (magnitude squared) offset from the origin	dB
13	Amplitude Droop	A	A floating point number of the change in the magnitude of the signal over the entire measurement	dB/sym
14	Clock Error	A	A floating point number of symbol clock error	Hz

Modulation Formats: 16-QAM, 32-QAM, 64-QAM, 128-QAM, 256-QAM, 512-QAM, 1024-QAM, DVB 16-QAM, DVB 32-QAM, DVB 64-QAM, DVB 128-QAM, DVB 256-QAM

#	Name	A/P	Description	Unit, if any
1	Transmit Power	A	A floating point number of transmit power	dBm
2	RMS EVM	A	A floating point number of EVM over the entire measurement area	%
3	Peak EVM	P	A floating point number of the peak EVM in the measurement area	%
4	Peak EVM Index	P	Location of the symbol that has the largest EVM	
5	RMS Magnitude Error	A	A floating point number of the average magnitude error over the entire measurement area	%
6	Peak Magnitude Error	P	A floating point number of the peak magnitude error in the measurement area	%
7	Peak Magnitude Error Index	P	Location of the symbol that has the largest magnitude error	
8	RMS Phase Error	A	A floating point number of the average phase error over the entire measurement area	°
9	Peak Phase Error	P	A floating point number of the peak phase error in the measurement area	°
10	Peak Phase Error Index	P	Location of the symbol that has the largest phase error	
11	Frequency Error	A	A floating point number of the frequency error in the measured signal	Hz
12	I/Q Offset	A	A floating point number of the I and Q error (magnitude squared) offset from the origin	dB
13	Quad Error	A	A floating point number of orthogonal error between the I and Q signals	°
14	Gain Imbalance	A	A floating point number of the gain ratio between the I and Q signals	dB
15	SNR	A	A floating point number of signal to noise ratio	dB

Modulation Format: 2-FSK

#	Name	A/P	Description	Unit, if any
1	Transmit Power	A	A floating point number of transmit power	dBm
2	RMS FSK Error	A	A floating point number of the RMS average of the FSK error at all symbol locations	%
3	Peak FSK	P	A floating point number of the largest FSK error at all symbol	%

3 VMA Mode
3.1 Digital Demod Measurement

#	Name	A/P	Description	Unit, if any
	Error		locations	
4	Peak FSK Error Index	P	Location of the symbol that has the largest FSK error	
5	RMS FSK Mag Error	A	A floating point number of the carrier magnitude error over all symbols	%
6	Peak FSK Mag Error	P	A floating point number of the peak carrier magnitude error in all symbols	%
7	Peak FSK Mag Error Index	P	Location of the symbol that has the largest carrier magnitude error	
8	Carrier Offset	A	A floating point number (in ppm) of the carrier frequency error relative to the instrument's center frequency	ppm
9	Deviation	A	A floating point number of the average deviation of all symbols in the measurement area	Hz
10	Deviation Accuracy	-	A floating point number of the measured deviation accuracy, compared to its reference	%
11	Clock Error	A	A floating point number of symbol clock error	Hz
12	RMS Deviation Offset	-	A floating point number of the average deviation of all symbols in the FSK Meas Time trace	%
13	Peak Deviation Offset	-	A floating point number of the peak deviation of all symbols in the FSK Meas Time trace	%
14	RMS Zero Crossing Error	-	A floating point number of the average zero crossing error of all symbols in the FSK Meas Time trace	%
15	Peak Zero Crossing Error	-	A floating point number of the peak zero crossing error of all symbols in the FSK Meas Time trace	%
16	Deviation (Positive)	-	A floating point number of the positive deviation	Hz
17	Deviation (Negative)	-	A floating point number of the negative deviation	Hz
18	Outer Max Peak	-	A floating point number of the maximum peak of outer deviation in eye diagram used for Deviation Tolerance measurement.	%
19	Outer Min Peak	-	A floating point number of the minimum peak of outer deviation in eye diagram used for Deviation Tolerance measurement.	%
20	Inner Max Peak	-	A floating point number of the maximum peak of inner deviation in eye diagram used for Deviation Tolerance measurement.	%
21	Inner Min Peak	-	A floating point number of the minimum peak of inner deviation in eye diagram used for Deviation Tolerance measurement.	%
22	Zero Crossing Offset (Max)	-	A floating point number of the maximum zero crossing offset in eye diagram used for Zero Crossing Offset measurement.	%
23	Zero Crossing Offset (Min)	-	A floating point number of the minimum zero crossing offset in eye diagram used for Zero Crossing Offset measurement.	%

Modulation Formats: 4-FSK, 8-FSK, 16-FSK

#	Name	A/P	Description	Unit, if any
1	Transmit Power	A	A floating point number of transmit power	dBm
2	RMS FSK Error	A	A floating point number of the RMS average of the FSK error at all symbol locations	%
3	Peak FSK Error	P	A floating point number of the largest FSK error at all symbol locations	%
4	Peak FSK Error Index	P	Location of the symbol that has the largest FSK error	
5	RMS FSK Mag Error	A	A floating point number of the carrier magnitude error over all symbols	%
6	Peak FSK Mag Error	P	A floating point number of the peak carrier magnitude error in all symbols	%
7	Peak FSK Mag Error Index	P	Location of the symbol that has the largest carrier magnitude error	
8	Carrier Offset	A	A floating point number in ppm) of the carrier frequency error relative to the instrument's center frequency	ppm
9	Deviation	A	A floating point number of the average deviation of all symbols in the measurement area	Hz
10	Deviation Accuracy	A	A floating point number of the measured deviation accuracy, compared to its reference	%
11	Clock Error	A	A floating point number of symbol clock error	Hz

Modulation Formats: VSB 8, VSB 16

#	Name	A/P	Description	Unit, if any
1	Transmit Power	A	A floating point number of transmit power	dBm
2	RMS EVM	A	A floating point number of EVM over the entire measurement area	%
3	Peak EVM	P	A floating point number of the peak EVM in the measurement area	%
4	Peak EVM Index	P	Location of the symbol that has the largest EVM	
5	RMS Magnitude Error	A	A floating point number of the average magnitude error over the entire measurement area	%
6	Peak Magnitude Error	P	A floating point number of the peak magnitude error in the measurement area	%
7	Peak Magnitude Error Index	P	Location of the symbol that has the largest magnitude error	
8	RMS Phase Error	A	A floating point number of the average phase error over the entire measurement area	°

3 VMA Mode
3.1 Digital Demod Measurement

#	Name	A/P	Description	Unit, if any
9	Peak Phase Error	P	A floating point number of the peak phase error in the measurement area	°
10	Peak Phase Error Index	P	Location of the symbol that has the largest phase error	
11	Frequency Error	A	A floating point number of the frequency error in the measured signal	Hz
12	SNR	A	A floating point number of signal to noise ratio	dB
13	Pilot Level	A	A floating point number of pilot level	dB

Modulation Format: MSK type 1

#	Name	A/P	Description	Unit, if any
1	Transmit Power	A	A floating point number of transmit power	dBm
2	RMS EVM	A	A floating point number of EVM over the entire measurement area	%
3	Peak EVM	P	A floating point number of the peak EVM in the measurement area	%
4	Peak EVM Index	P	Location of the symbol that has the largest EVM	
5	RMS Magnitude Error	A	A floating point number of the average magnitude error over the entire measurement area	%
6	Peak Magnitude Error	P	A floating point number of the peak magnitude error in the measurement area	%
7	Peak Magnitude Error Index	P	Location of the symbol that has the largest magnitude error	
8	RMS Phase Error	A	A floating point number of the average phase error over the entire measurement area	°
9	Peak Phase Error	P	A floating point number of the peak phase error in the measurement area	°
10	Peak Phase Error Index	P	Location of the symbol that has the largest phase error	
11	Frequency Error	A	A floating point number of the frequency error in the measured signal	Hz
12	I/Q Offset	A	A floating point number of the I and Q error (magnitude squared) offset from the origin	dB
13	Quad Error	A	A floating point number of orthogonal error between the I and Q signals	°
14	Gain Imbalance	A	A floating point number of the gain ratio between the I and Q signals	dB

Modulation Format: MSK type 2

#	Name	A/P	Description	Unit, if any
1	Transmit Power	A	A floating point number of transmit power	dBm
2	RMS EVM	A	A floating point number of EVM over the entire measurement area	%
3	Peak EVM	P	A floating point number of the peak EVM in the measurement area	%
4	Peak EVM Index	P	Location of the symbol that has the largest EVM	
5	RMS Magnitude Error	A	A floating point number of the average magnitude error over the entire measurement area	%
6	Peak Magnitude Error	P	A floating point number of the peak magnitude error in the measurement area	%
7	Peak Magnitude Error Index	P	Location of the symbol that has the largest magnitude error	
8	RMS Phase Error	A	A floating point number of the average phase error over the entire measurement area	°
9	Peak Phase Error	P	A floating point number of the peak phase error in the measurement area	°
10	Peak Phase Error Index	P	Location of the symbol that has the largest phase error	
11	Frequency Error	A	A floating point number of the frequency error in the measured signal	Hz
12	I/Q Offset	A	A floating point number of the I and Q error (magnitude squared) offset from the origin	dB
13	Quad Error	A	A floating point number of orthogonal error between the I and Q signals	°
14	Gain Imbalance	A	A floating point number of the gain ratio between the I and Q signals	dB
15	Amplitude Droop	A	A floating point number of the change in the magnitude of the signal over the entire measurement	dB/sym

Modulation Format: 16-APSK

#	Name	A/P	Description	Unit, if any
1	Transmit Power	A	A floating point number of transmit power	dBm
2	RMS EVM	A	A floating point number of EVM over the entire measurement area	%
3	Peak EVM	P	A floating point number of the peak EVM in the measurement area	%
4	Peak EVM Index	P	Location of the symbol that has the largest EVM	
5	RMS Magnitude	A	A floating point number of the average magnitude error	%

3 VMA Mode
3.1 Digital Demod Measurement

#	Name	A/P	Description	Unit, if any
	Error		over the entire measurement area	
6	Peak Magnitude Error	P	A floating point number of the peak magnitude error in the measurement area	%
7	Peak Magnitude Error Index	P	Location of the symbol that has the largest magnitude error	
8	RMS Phase Error	A	A floating point number of the average phase error over the entire measurement area	°
9	Peak Phase Error	P	A floating point number of the peak phase error in the measurement area	°
10	Peak Phase Error Index	P	Location of the symbol that has the largest phase error	
11	Frequency Error	A	A floating point number of the frequency error in the measured signal	Hz
12	I/Q Offset	A	A floating point number of the I and Q error (magnitude squared) offset from the origin	dB
13	Quad Error	A	A floating point number of orthogonal error between the I and Q signals	°
14	Gain Imbalance	A	A floating point number of the gain ratio between the I and Q signals	dB
15	SNR	A	A floating point number of signal to noise ratio	dB
16	Reserved			

Modulation Format: 32-APSK

#	Name	A/P	Description	Unit, if any
1	Transmit Power	A	A floating point number of transmit power	dBm
2	RMS EVM	A	A floating point number of EVM over the entire measurement area	%
3	Peak EVM	P	A floating point number of the peak EVM in the measurement area	%
4	Peak EVM Index	P	Location of the symbol that has the largest EVM	
5	RMS Magnitude Error	A	A floating point number of the average magnitude error over the entire measurement area	%
6	Peak Magnitude Error	P	A floating point number of the peak magnitude error in the measurement area	%
7	Peak Magnitude Error Index	P	Location of the symbol that has the largest magnitude error	
8	RMS Phase Error	A	A floating point number of the average phase error over the entire measurement area	°
9	Peak Phase Error	P	A floating point number of the peak phase error in the	°

#	Name	A/P	Description	Unit, if any
			measurement area	
10	Peak Phase Error Index	P	Location of the symbol that has the largest phase error	
11	Frequency Error	A	A floating point number of the frequency error in the measured signal	Hz
12	I/Q Offset	A	A floating point number of the I and Q error (magnitude squared) offset from the origin	dB
13	Quad Error	A	A floating point number of orthogonal error between the I and Q signals	°
14	Gain Imbalance	A	A floating point number of the gain ratio between the I and Q signals	dB
15	SNR	A	A floating point number of signal to noise ratio	dB
16	Reserved			
17	Reserved			

Modulation Formats: EDGE

#	Name	A/P	Description	Unit, if any
1	Transmit Power	A	A floating point number of transmit power	dBm
2	RMS EVM	A	A floating point number of EVM over the entire measurement area	%
3	Peak EVM	P	A floating point number of the peak EVM in the measurement area	%
4	Peak EVM Index	P	Location of the symbol that has the largest EVM	
5	RMS Magnitude Error	A	A floating point number of the average magnitude error over the entire measurement area	%
6	Peak Magnitude Error	P	A floating point number of the peak magnitude error in the measurement area	%
7	Peak Magnitude Error Index	P	Location of the symbol that has the largest magnitude error	
8	RMS Phase Error	A	A floating point number of the average phase error over the entire measurement area	°
9	Peak Phase Error	P	A floating point number of the peak phase error in the measurement area	°
10	Peak Phase Error Index	P	Location of the symbol that has the largest phase error	
11	Frequency Error	A	A floating point number of the frequency error in the measured signal	Hz
12	I/Q Offset	A	A floating point number of the I and Q error (magnitude squared) offset from the origin	dB

3 VMA Mode
3.1 Digital Demod Measurement

#	Name	A/P	Description	Unit, if any
13	Quad Error	A	A floating point number of orthogonal error between the I and Q signals	°
14	Gain Imbalance	A	A floating point number of the gain ratio between the I and Q signals	dB
15	Amplitude Droop	A	A floating point number of the change in the magnitude of the signal over the entire measurement	dB/sym
16	95% EVM	A	A floating point number of the EVM below which 95% of the individual symbol EVM occurs	%

Modulation Format: CPM (FM)

#	Name	A/P	Description	Unit, if any
1	Transmit Power	A	A floating point number of transmit power	dBm
2	RMS FSK Error	A	A floating point number of the RMS average of the FSK error at all symbol locations	%
3	Peak FSK Error	P	A floating point number of the largest FSK error at all symbol locations	%
4	Peak FSK Error Index	P	Location of the symbol that has the largest FSK error	
5	RMS FSK Mag Error	A	A floating point number of the carrier magnitude error over all symbols	%
6	Peak FSK Mag Error	P	A floating point number of the peak carrier magnitude error in all symbols	%
7	Peak FSK Mag Error Index	P	Location of the symbol that has the largest carrier magnitude error	
8	Carrier Frequency Offset	A	A floating point number of the carrier frequency error relative to the instrument's center frequency	Hz
9	Deviation	A	A floating point number of the average deviation of all symbols in the measurement area	Hz
10	Deviation Offset	-	a floating point number of the deviation offset	%
11	H1	-	a floating point number of the CPM modulation index H1	
12	H2	-	a floating point number of the CPM modulation index H2	

Modulation Formats: 2-ASK

#	Name	A/P	Description	Unit (if any)
1	Transmit Power	A	Transmit power Floating point number	dBm

#	Name	A/P	Description	Unit (if any)
2	RMS ASK Error	A	RMS average of the ASK error at all symbol locations Floating point number	%
3	Peak ASK Error	P	Largest ASK error at all symbol locations Floating point number	%
4	Peak ASK Error Index	P	Location of the symbol that has the largest ASK error	
5	Carrier Frequency Offset	A	Carrier frequency error relative to the instrument's center frequency Floating point number	Hz
6	Modulation Depth	A	Modulation depth over the entire measurement area Floating point number	%
7	Estimated Carrier Amplitude	A	Estimated carrier amplitude over the entire measurement area Floating point number	V
8	Amplitude Ratio	A	free decision distance in height of I Eye Diagram and calculated as percentage of $2B/(A+B)$ A and B are the maximum and minimum amplitude difference at the decision point of I Eye Diagram. An ideal signal has a decision height of 100%	%
9	Time Ratio	A	free decision distance in width of I Eye Diagram and calculated as percentage of $2B'(A'+B')$ A' and B' are the maximum and minimum zero-cross time width in I Eye Diagram. An ideal signal has a decision width of 100%	%
10	Modulation Index Outer	A	Defined as the measure of extent of outer amplitude variation about an un-modulated carrier Calculated as $(V_{Amax} - V_{Amin}) / (V_{Amax} + V_{Amin})$ V _{Amax} is the largest amplitude at crest. V _{Amin} is the smallest amplitude at bottom. Maximum amplitude difference A is equal to V _{Amax} - V _{Amin}	%
11	Modulation Index Inner	A	Defined as the measure of extent of inner amplitude variation about an un-modulated carrier Calculated as $(V_{Bmax} - V_{Bmin}) / (V_{Bmax} + V_{Bmin})$ V _{Bmax} is the smallest amplitude at crest. V _{Bmin} is the largest amplitude at bottom. Minimum amplitude difference B is equal to V _{Bmax} - V _{Bmin}	%
12	Modulation On/Off Ratio	A	Defined as the ratio of $20\log_{10}(V_{Amax} + V_{Bmax}) / (V_{Amin} + V_{Bmin})$ in dB	

3 VMA Mode
3.1 Digital Demod Measurement

Modulation Format: Custom IQ

#	Name	A/P	Description	Unit (if any)
1	Transmit Power	A	Transmit power Floating point number	dBm
2	RMS EVM	A	A floating point number of EVM over the entire measurement area	%
3	Peak EVM	P	A floating point number of the peak EVM in the measurement area	%
4	Peak EVM Index	P	Peak Hold) is the location of the symbol that has the largest EVM	
5	RMS Magnitude Error	A	A floating point number of the average magnitude error over the entire measurement area	%
6	Peak Magnitude Error	P	A floating point number of the peak magnitude error in the measurement area	%
7	Peak Magnitude Error Index	P	Location of the symbol that has the largest magnitude error	
8	RMS Phase Error	A	A floating point number of the average phase error over the entire measurement area	°
9	Peak Phase Error	P	A floating point number of the peak phase error in the measurement area	°
10	Peak Phase Error Index	P	Location of the symbol that has the largest phase error	
11	Frequency Error	A	A floating point number of the frequency error in the measured signal	Hz
12	SNR	A	A floating point number of signal to noise ratio	dB
13	I/Q Offset	A	A floating point number of the I and Q error (magnitude squared) offset from the origin	dB
14	Quad Error	A	A floating point number of orthogonal error between the I and Q signals	°
15	Gain Imbalance	A	A floating point number of the gain ratio between the I and Q signals	dB
16	Amplitude Droop	A	a floating point number of the change in the magnitude of the signal over the entire measurement	dB/sym
17	Rho	A	a floating point number of Rho	
18	Clock Error	A	a floating point number of symbol clock error	Hz

3.1.1.3 Measurement Results for RI = 02

The **FETCH**, **MEASure**, or **READ** queries return the following comma-separated scalar results for Segment **SI**. For values of **SI**, see ["Index Sub-Fields" on page 184](#).

For details of available formats, see ["Modulation Format" on page 335](#).

Modulation Formats	Results
Offset QPSK Shaped Offset QPSK	Returns 5 comma-separated scalar values of the pass/fail (0.0 = passed, or 1.0 = failed) results determined by testing the following items: <ol style="list-style-type: none"> 1. Pass/Fail result of Tx Power 2. Pass/Fail result of RMS EVM 3. Pass/Fail result of Frequency Error 4. Pass/Fail result of Clock Error 5. Pass/Fail result of RMS Offset EVM
2-FSK, 4-FSK, 8-FSK, 16-FSK	Returns 5 comma-separated scalar values of the pass/fail (0.0 = passed, or 1.0 = failed) results determined by testing the following items: <ol style="list-style-type: none"> 1. Pass/Fail result of Tx Power 2. Pass/Fail result of RMS FSK Error 3. Pass/Fail result of Frequency Error 4. Pass/Fail result of Deviation Offset 5. Pass/Fail result of Clock Error
BPSK, DBPSK 16-QAM, 32-QAM, 64-QAM, 128-QAM, 256-QAM, 512-QAM, 1024-QAM, 2048-QAM, 4096-QAM VSB 8, VSB 16 MSK type 1, MSK type 2 16-APSK, 32-APSK EDGE DVB 16-QAM, DVB 32-QAM, DVB 64-QAM, DVB 128-QAM, DVB 256-QAM Custom IQ	Returns 3 comma-separated scalar values of the pass/fail (0.0 = passed, or 1.0 = failed) results determined by testing the following items: <ol style="list-style-type: none"> 1. Pass/Fail result of Tx Power 2. Pass/Fail result of RMS EVM 3. Pass/Fail result of Frequency Error
QPSK, DQPSK, $\pi/4$ DQPSK 8PSK, D8PSK, $\pi/8$ D8PSK	Returns 4 comma-separated scalar values of the pass/fail (0.0 = passed, or 1.0 = failed) results determined by testing the following items: <ol style="list-style-type: none"> 1. Pass/Fail result of Tx Power 2. Pass/Fail result of RMS EVM 3. Pass/Fail result of Frequency Error 4. Pass/Fail result of Clock Error

3 VMA Mode
3.1 Digital Demod Measurement

Modulation Formats	Results
CPM (FM)	Returns 4 comma-separated scalar values of the pass/fail (0.0 = passed, or 1.0 = failed) results determined by testing the following items: <ol style="list-style-type: none"> 1. Pass/Fail result of Tx Power 2. Pass/Fail result of RMS FSK Error 3. Pass/Fail result of Frequency Error 4. Pass/Fail result of Deviation Offset
2-ASK	Returns 3 comma-separated scalar values of the pass/fail (0.0 = passed, or 1.0 = failed) results determined by testing the following items: <ol style="list-style-type: none"> 1. Pass/Fail result of Tx Power 2. Pass/Fail result of RMS ASK Error 3. Pass/Fail result of Frequency Error

3.1.1.4 Measurement Results for RI = 06

The **FETCh**, **MEASure**, or **READ** queries return the following comma-separated scalar results for Segment **SI**. For values of **SI**, see "[Index Sub-Fields](#)" on page 184.

For details of available formats, see "[Modulation Format](#)" on page 335.

Modulation Formats	Results
2-FSK, 4-FSK, 8-FSK, 16-FSK	FSK Meas Time of Segment SI Returns a series of floating point numbers that represent the data of the corrected measured trace
CPM (FM)	When " IQ Normalize " on page 347 is ON , the magnitude of the trace points are normalized to 1.0
2-ASK	ASK Meas Time of Segment SI Returns a series of floating point numbers that represent the data of the corrected measured trace When " IQ Normalize " on page 347 is ON , the magnitude of the trace points are normalized to 1.0
All others	IQ Meas Time of Segment SI Returns a series of floating point numbers that alternately represent I and Q pairs of the corrected measured trace When " IQ Normalize " on page 347 is ON , the magnitude of the trace points are normalized to 1.0 The first number is the I sample of symbol 0 decision point and the second number is the Q sample of symbol 0 decision point. There are X points per symbol (X = points/symbol). Therefore, the series of numbers is: <ul style="list-style-type: none"> - 1st number = I of the symbol 0 decision point

Modulation Formats	Results
	<ul style="list-style-type: none"> - 2nd number = Q of the symbol 0 decision point - ... - $(2 * X) + 1$ number = I of the symbol 1 decision point - $(2 * X) + 2$ number = Q of the symbol 1 decision point - ... - $(2 * X) * N + 1$ th number = I of the symbol N decision point - $(2 * X) * N + 2$ th number = Q of the symbol N decision point

3.1.1.5 Measurement Results for RI = 07

The **FETCH**, **MEASure**, or **READ** queries return the following comma-separated scalar results for Segment **SI**. For values of **SI**, see ["Index Sub-Fields" on page 184](#).

For details of available formats, see ["Modulation Format" on page 335](#).

Modulation Formats	Results
2-FSK, 4-FSK, 8-FSK, 16-FSK	<p>FSK Ref Time of Segment SI</p> <p>Returns a series of floating point numbers that represent the data of the reconstructed reference trace</p> <p>When "IQ Normalize" on page 347 is ON, the magnitude of the trace points are normalized to 1.0</p>
CPM (FM)	<p>ASK Ref Time of Segment SI</p> <p>Returns a series of floating point numbers that represent the data of the reconstructed reference trace</p> <p>When "IQ Normalize" on page 347 is ON, the magnitude of the trace points are normalized to 1.0</p>
2-ASK	<p>IQ Ref Time of Segment SI</p> <p>Returns a series of floating point numbers that alternately represent I and Q pairs of the reconstructed reference trace</p> <p>When "IQ Normalize" on page 347 is ON, the magnitude of the trace points are normalized to 1.0</p> <p>The first number is the I sample of symbol 0 decision point and the second number is the Q sample of symbol 0 decision point. There are X points per symbol (X = points/symbol). Therefore, the series of numbers is:</p> <ul style="list-style-type: none"> - 1st number = I of the symbol 0 decision point - 2nd number = Q of the symbol 0 decision point - ... - $(2 * X) + 1$ number = I of the symbol 1 decision point - $(2 * X) + 2$ number = Q of the symbol 1 decision point
All others	

Modulation Formats	Results
	<ul style="list-style-type: none"> - ... - $(2 * X) * N + 1$ th number = I of the symbol N decision point - $(2 * X) * N + 2$ th number = Q of the symbol N decision point

3.1.1.6 Measurement Results for RI = 08

The **FETCH**, **MEASURE**, or **READ** queries return the following comma-separated scalar results for Segment **SI**. For values of **SI**, see ["Index Sub-Fields" on page 184](#).

For details of available formats, see ["Modulation Format" on page 335](#).

Modulation Formats	Result
2-FSK, 4-FSK, 8-FSK, 16-FSK CPM (FM)	FSK Meas Spectrum of Segment SI Returns the spectrum of the corrected measured time trace When "IQ Normalize" on page 347 is ON , the trace points are normalized
2-ASK	ASK Meas Spectrum of Segment SI Returns the spectrum of the corrected measured time trace When "IQ Normalize" on page 347 is ON , the trace points are normalized
All others	IQ Meas Spectrum of Segment SI Returns the spectrum of the IQ corrected measured time trace When "IQ Normalize" on page 347 is ON , the trace points are normalized

3.1.1.7 Measurement Results for RI = 09

The **FETCH**, **MEASURE**, or **READ** queries return the following comma-separated scalar results for Segment **SI**. For values of **SI**, see ["Index Sub-Fields" on page 184](#).

For details of available formats, see ["Modulation Format" on page 335](#).

Modulation Formats	Result
2-FSK, 4-FSK, 8-FSK, 16-FSK CPM (FM)	FSK Ref Spectrum of Segment SI Returns the spectrum of the reference time trace When "IQ Normalize" on page 347 is ON , the trace points are normalized
2-ASK	ASK Ref Spectrum of Segment SI Returns the spectrum of the reference time trace When "IQ Normalize" on page 347 is ON , the trace points are normalized
All others	IQ Ref Spectrum of Segment SI Returns the spectrum of the IQ reference time trace When "IQ Normalize" on page 347 is ON , the trace points are normalized

3.1.1.8 Measurement Results for RI = 10

The **FETCh**, **MEASure**, or **READ** queries return the following comma-separated scalar results for Segment **SI**. For values of **SI**, see ["Index Sub-Fields" on page 184](#).

For details of available formats, see ["Modulation Format" on page 335](#).

Modulation Formats	Result
2-FSK, 4-FSK, 8-FSK, 16-FSK CPM (FM)	FSK Error Time of Segment SI Returns a series of floating point numbers (in percent) that represent each sample in the FSK Error Time trace When "IQ Normalize" on page 347 is ON , the trace points are normalized
2-ASK	ASK Error Time of Segment SI Returns a series of floating point numbers (in percent) that represent each sample in the ASK Error Time trace When "IQ Normalize" on page 347 is ON , the trace points are normalized
All others	Error Vector Time of Segment SI Returns a series of floating point numbers (in percent) that represent each sample in the EVM trace. The first number is the symbol 0 decision point. There are X points per symbol (X = points/symbol). Therefore, the decision points are at 0, 1*X, 2*X, ... and so on When "IQ Normalize" on page 347 is ON , the trace points are normalized

3.1.1.9 Measurement Results for RI = 11

The **FETCh**, **MEASure**, or **READ** queries return the following comma-separated scalar results for Segment **SI**. For values of **SI**, see ["Index Sub-Fields" on page 184](#).

For details of available formats, see ["Modulation Format" on page 335](#).

Modulation Formats	Result
2-FSK, 4-FSK, 8-FSK, 16-FSK CPM (FM)	FSK Error Spectrum of Segment SI Returns the spectrum of the FSK Error Time trace When "IQ Normalize" on page 347 is ON , the trace points are normalized
2-ASK	ASK Error Spectrum of Segment SI Returns the spectrum of the ASK Error Time trace When "IQ Normalize" on page 347 is ON , the trace points are normalized
All others	EVM Spectrum of Segment SI Returns the spectrum of the error vector time trace When "IQ Normalize" on page 347 is ON , the trace points are normalized

3.1.1.10 Measurement Results for RI = 12

The **FETCh**, **MEASure**, or **READ** queries return the following comma-separated scalar results for Segment **SI**. For values of **SI**, see ["Index Sub-Fields" on page 184](#).

For details of available formats, see ["Modulation Format" on page 335](#).

Modulation Formats	Result
2-FSK, 4-FSK, 8-FSK, 16-FSK CPM (FM)	Carrier Mag Error of Segment SI Returns a series of floating point numbers (in percent) that represent each sample in the Carrier Magnitude Error trace When "IQ Normalize" on page 347 is ON , the trace points are normalized
2-ASK	Reserved
All others	Magnitude Error of Segment SI Returns a series of floating point numbers (in percent) that represent each sample in the magnitude error trace. The first number is the symbol 0 decision point. There are X points per symbol (X = points/symbol). Therefore, the decision points are at 0, 1*X, 2*X, ... When "IQ Normalize" on page 347 is ON , the trace points are normalized

3.1.1.11 Measurement Results for RI = 13

The **FETCh**, **MEASure**, or **READ** queries return the following comma-separated scalar results for Segment **SI**. For values of **SI**, see ["Index Sub-Fields" on page 184](#).

For details of available formats, see ["Modulation Format" on page 335](#).

Modulation Formats	Result
2-ASK	Reserved
2-FSK, 4-FSK, 8-FSK, 16-FSK CPM (FM)	
All others	Phase Error of Segment SI Returns a series of floating point numbers (in percent) that represent each sample in the phase error trace. The first number is the symbol 0 decision point. There are X points per symbol (X = points/symbol). Therefore, the decision points are at 0, 1*X, 2*X, ...

3.1.1.12 Measurement Results for RI = 14

The **FETCh**, **MEASure**, or **READ** queries return the following comma-separated scalar results for Segment **SI**. For values of **SI**, see ["Index Sub-Fields" on page 184](#).

For details of available formats, see ["Modulation Format" on page 335](#).

Modulation Formats	Result
2-ASK	Reserved
2-FSK, 4-FSK, 8-FSK, 16-FSK	
CPM (FM)	
All others	CH Freq Response (Amptd) of Segment SI Returns the amplitude trace of the channel frequency response trace

3.1.1.13 Measurement Results for RI = 15

The **FETCH**, **MEASure**, or **READ** queries return the following comma-separated scalar results for Segment **SI**. For values of **SI**, see "[Index Sub-Fields](#)" on page 184.

For details of available formats, see "[Modulation Format](#)" on page 335.

Modulation Formats	Result
2-ASK	Reserved
2-FSK, 4-FSK, 8-FSK, 16-FSK	
CPM (FM)	
All others	CH Freq Response (Phase) of Segment SI Returns the phase trace of the channel frequency response trace

3.1.1.14 Measurement Results for RI = 16

The **FETCH**, **MEASure**, or **READ** queries return the following comma-separated scalar results for Segment **SI**. For values of **SI**, see "[Index Sub-Fields](#)" on page 184.

For details of available formats, see "[Modulation Format](#)" on page 335.

Modulation Formats	Result
2-ASK	Reserved
2-FSK, 4-FSK, 8-FSK, 16-FSK	
CPM (FM)	
All others	CH Freq Response (Group Delay) of Segment SI Returns the group delay trace of the channel frequency response trace

3.1.1.15 Measurement Results for RI = 17

The **FETCH**, **MEASure**, or **READ** queries return the following comma-separated scalar results for Segment **SI**. For values of **SI**, see "[Index Sub-Fields](#)" on page 184.

For details of available formats, see "[Modulation Format](#)" on page 335.

3 VMA Mode
3.1 Digital Demod Measurement

Modulation Formats	Result
2-ASK	Reserved
2-FSK, 4-FSK, 8-FSK, 16-FSK	
CPM (FM)	
All others	Equalizer impulse response trace of Segment SI Returns a series of floating point numbers (in dB) that represent each sample in the equalizer's impulse response trace

3.1.1.16 Measurement Results for RI = 20

The [FETCh](#), [MEASure](#), or [READ](#) queries return the following comma-separated scalar results for Segment [SI](#). For values of [SI](#), see "[Index Sub-Fields](#)" on page 184.

For details of available formats, see "[Modulation Format](#)" on page 335.

Modulation Formats	Result
2-FSK, 4-FSK, 8-FSK, 16-FSK	FSK Meas Time (Group Delay) of Segment SI
CPM (FM)	Returns the group delay trace of the FSK IQ Meas Time trace
2-ASK	ASK Meas Time (Group Delay) of Segment SI Returns the group delay trace of the ASK IQ Meas Time trace
All others	IQ Meas Time (Group Delay) of Segment SI Returns the group delay trace of the IQ Meas Time trace

3.1.1.17 Measurement Results for RI = 21

The [FETCh](#), [MEASure](#), or [READ](#) queries return the following comma-separated scalar results for Segment [SI](#). For values of [SI](#), see "[Index Sub-Fields](#)" on page 184.

For details of available formats, see "[Modulation Format](#)" on page 335.

Modulation Formats	Result
2-FSK, 4-FSK, 8-FSK, 16-FSK	FSK Ref Time (Group Delay) of Segment SI
CPM (FM)	Returns the group delay trace of the FSK IQ Ref Time trace
2-ASK	ASK Ref Time (Group Delay) of Segment SI Returns the group delay trace of the ASK IQ Ref Time trace
All others	IQ Ref Time (Group Delay) of Segment SI Returns the group delay trace of the IQ Ref Time trace

3.1.2 Views

There are 5 pre-defined views:

1. "Normal" on page 210
2. "Demod Traces" on page 226
3. "Demod Error" on page 211
4. "Result Summary" on page 211
5. "Eye Diagram" on page 211

Some of these are multiple-window Views. When in a multiple-window View, you select a window by touching it. The menu controls may sometimes change depending on which window is selected.

Whenever the View changes, the default menu is **Frequency**, unless otherwise specified in the View description.

View - Selection by Enum

Remote Command	<code>:DISPlay:DDEMod:VIEW[:SElect] NORMal DTRace DERRor NRESults EDIagram DSEGment FRESults</code> <code>:DISPlay:DDEMod:VIEW[:SElect]?</code>
Example	Set Normal view: <code>:DISP:DDEM:VIEW NORM</code>
Preset	<code>NORM</code>
State Saved	Saved in instrument state

3.1.2.1 Normal

Windows:

- | | |
|--|---|
| <ul style="list-style-type: none"> "IQ Meas Time" on page 215 "Raw Main Time" on page 214 "Spectrum" on page 215 "Metrics" on page 223 | <ul style="list-style-type: none"> "FSK Meas Time" on page 217 "Raw Main Time" on page 214 "Spectrum" on page 215 "Metrics" on page 223 |
|--|---|

Multiple-window view consists of the above four windows.

Example	<code>:DISP:DDEM:VIEW NORM</code>
---------	-----------------------------------

3.1.2.2 Demod Traces

Windows:

3 VMA Mode

3.1 Digital Demod Measurement

"IQ Meas Spectrum" on page 216

"FSK Meas Spectrum" on page 218

"IQ Meas Time" on page 215

"FSK Meas Time" on page 217

Dual-window view consists of the above two windows.

Example `:DISP:DDEM:VIEW DTR`

3.1.2.3 Demod Error

Windows:

"Mag Error" on page 221

"Mag Error (Carrier)" on page 222

"Phase Error" on page 221

"FSK Error Spectrum" on page 221

"Error Vector Time" on page 220

"FSK Error Time" on page 221

"Metrics" on page 223

"Metrics" on page 223

Multiple-window view consists of the above four windows.

Example `:DISP:DDEM:VIEW DERR`

3.1.2.4 Result Summary

Windows: "Metrics" on page 223

Single-window view consists of the above window.

Example `:DISP:DDEM:VIEW NRES`

3.1.2.5 Eye Diagram

Windows: "Eye Diagram Metrics" on page 223

Single-window view consists of the above windows.

Example `:DISP:DDEM:VIEW EDI`

3.1.3 Windows

There are at most 6 windows available. Each window has two properties that you can use to select the trace data and trace display format: Data and Format. The **Format** key is hidden if the selected Data does not support any format.

Use the SCPI command:

```
:DISPlay:DDEMod:WINDow[1]|2|...|6:DATA <enum>
```

to configure the trace data. For example, the following command sets the first window data to **Spectrum**.

```
:DISP:DDEM:WIND1:DATA SPEC
```

Use the SCPI command:

```
:DISPlay:DDEMod:WINDow[1]|2|...|6:FORMat <enum>
```

to configure the trace display format. For example, the following command sets the first window trace display format to Constellation.

```
:DISP:DDEM:WIND1:FORM CONS
```

Use the SCPI command:

```
:DISPlay:DDEMod:WINDow[1]|2|...|6:SEGment <enum>
```

to configure the trace data of which segment to be displayed. For example, the following command sets the segment1 trace data to be displayed.

```
:DISP:DDEM:WIND1:SEGM SEGM1
```

3.1.3.1 Data

Provides a menu of trace data choices for the selected window.

Remote Command	<pre>:DISPlay:DDEMod:WINDow[1] 2 ... 6[:TRACe]:DATA RMTIME STIME TIME SPECTrum MTIME RTIME MSPECTrum RSPECTrum EVTime EVSPECTrum MERRor PERRor CHFResponse EQIResponse DRESuLts DBITs ERESuLts FRSummary CESymbol NONE</pre> <pre>:DISPlay:DDEMod:WINDow[1] 2 ... 6[:TRACe]:DATA?</pre>										
Example	<p>Set the second window data to SPECTrum:</p> <pre>:DISP:DDEM:WIND2:DATA SPEC</pre> <pre>:DISP:DDEM:WIND2:DATA?</pre>										
Notes	<p>The following aliases are supported:</p> <table border="1"> <thead> <tr> <th>Option</th> <th>Alias</th> </tr> </thead> <tbody> <tr> <td>MSPECTrum</td> <td>MSPEctrum</td> </tr> <tr> <td>RSPECTrum</td> <td>RSPEctrum</td> </tr> <tr> <td>DRESuLts</td> <td>DEMResults</td> </tr> <tr> <td>DBITs</td> <td>DEMBits</td> </tr> </tbody> </table>	Option	Alias	MSPECTrum	MSPEctrum	RSPECTrum	RSPEctrum	DRESuLts	DEMResults	DBITs	DEMBits
Option	Alias										
MSPECTrum	MSPEctrum										
RSPECTrum	RSPEctrum										
DRESuLts	DEMResults										
DBITs	DEMBits										
Couplings	Depends on window and modulation format										
Preset	Depends on window and modulation format										
State Saved	Yes										
Range	Raw Main Time Search Time Time Spectrum IQ Meas Time IQ Ref Time IQ Meas Spectrum IQ Ref Spectrum Error Vector Time Error Vector Spectrum Mag Error Phase Error CH Freq Response EQ Impulse Response Metrics Demod Bits EYE Diagram Metrics Frame Summary ccEVM vs Symbol No Data										

Trace data results

Modulation Format FSK

Trace Data	SCPI	Description
FSK Meas Time	MTIME	Demodulated Time Trace
FSK Meas Spectrum	MSpectrum	FFT of FSK Meas Time
FSK Ref Time	RTIME	Reconstructed ideal time waveform to compare FSK Meas Time against
FSK Ref Spectrum	RSpectrum	FFT of FSK Ref Time
FSK Error Time	EVTime	Difference between FSK Meas Time and FSK Ref Time at each point in time
FSK Error Spectrum	EVSpectrum	FFT of FSK Error Spectrum
Mag Error (Carrier)	MERRor	Amplitude error of carrier, relative to average amplitude

Modulation Format ASK

Trace Data	SCPI	Description
ASK Meas Time	MTIME	Demodulated Time Trace
ASK Meas Spectrum	MSpectrum	FFT of ASK Meas Time
ASK Ref Time	RTIME	Reconstructed ideal time waveform to compare ASK Meas Time against
ASK Ref Spectrum	RSpectrum	FFT of ASK Ref Time
ASK Error Time	EVTime	Difference between ASK Meas Time and ASK Ref Time at each point in time
ASK Error Spectrum	EVSpectrum	FFT of ASK Error Spectrum

All Others

Trace Data	SCPI	Description
Raw Main Time	RMTIME	The envelope of the captured data record
Search Time	STIME	The envelope of the captured data used for burst search
Time	TIME	The envelope of the data used for demodulation, it's 20 % longer than the Meas Interval, 10 % of the Meas Interval before the demodulated segment and 10 % after
Spectrum	SPECTrum	Spectrum is the FFT of the Raw Main Time waveform
IQ Meas Time	MTIME	Demodulated Time Trace
IQ Meas Spectrum	MSpectrum	FFT of IQ Meas Time
IQ Ref Time	RTIME	Reconstructed ideal time waveform to compare IQ Meas Time against
IQ Ref Spectrum	RSpectrum	FFT of IQ Ref Time

Trace Data	SCPI	Description
Error Vector Time	EVTime	Vector difference between IQ Meas Time and IQ Ref Time at each point in time
Error Vector Spectrum	EVSpectrum	FFT of Error Vector Time
Mag Error	MERRor	Difference in length of the IQ Meas Time vector and IQ Ref Time vector at each point in time
Phase Error	PERRor	Difference in phase of the IQ Meas Time vector and IQ Ref Time vector at each point in time
EQ Impulse Response	EQIResponse	Impulse response of the adaptive equalizer (no data is available if equalizer is off)
CH Freq Response	CHFResponse	FFT of Equalizer Frequency Response
Metrics	DRESults	Demodulation metrics results
Demod Bits	DBITs	Demodulation bits
Eye Diagram Metrics	ERESults	Eye Diagram metrics results
ccEVM vs Symbol	CESymbol	ccEVM per symbol trace
No Data	NONE	Blank Trace

Pre Demod

Displays the trace data choices that show pre-demodulation results.

Raw Main Time

Raw Main Time is the envelope of the captured raw data. This data is unprocessed and includes additional points acquired for settling of the filters involved in subsequent processing, such as the demodulation filtering.

Example [:DISP:DDEM:WIND2:DATA RMT](#)
Sets the second window data to Raw Main Time

Search Time

Search Time is the envelope of the data which is used to search for the burst or sync pattern. It's generated from the captured raw data according to the Trace Align settings.

Example [:DISP:DDEM:WIND2:DATA STIM](#)

Sets the second window data to Search Time

Time

Time is the envelope of the data which is used to demodulation. It's 20 % longer than the Meas Interval, 10 % of the Meas Interval before the demodulated segment and 10 % after.

Example `:DISP:DDEM:WIND2:DATA TIME`
Sets the second window data to Time

Spectrum

Spectrum shows the FFT of the Raw Main Time waveform.

Example `:DISP:DDEM:WIND3:DATA SPEC`
Sets the third window data to Spectrum

Demod

Displays the general demodulation results.

IQ Meas Time

Available for all modulation formats *except* 2-FSK.

IQ Meas Time is the measured time data results for the input signal. There are 6 available formats for this trace data: I-Q, Constellation, Real, Imaginary, I-Eye, Q-Eye and Group Delay. Normally this trace data is displayed with I-Q format.

Format name	Description
I-Q	Real part of data is shown on horizontal axis, imaginary part is shown on vertical axis, Independent variable (X axis) is normal to display
Constellation	Same as I-Q, but for data with symbols defined, only the symbol points are shown as dots with no connecting lines
Real (I)	Real part of data is shown on a linear Y axis
Imaginary (Q)	Imaginary part of data is shown on linear Y axis
I-Eye	Real part of data is shown with X axis segmented (generally into 2 symbol segments) and each segment is overlaid to show signal crossings at symbol boundaries
Q-Eye	Same as I-eye but imaginary part of data is shown
Group Delay	Shows the derivative of phase response with respect to time

Example : `:DISP:DDEM:WIND:DATA MTIM`
 Sets the first window data to IQ Meas Time
 : `:DISP:DDEM:WIND:FORM CONS`
 Selects Constellation as the first window data format

IQ Ref Time

Available for all modulation formats *except* 2-FSK.

IQ Ref Time is the reconstructed ideal time waveform to compare IQ Meas Time against. There are 6 available formats for this trace data: I-Q, Constellation, Real, Imaginary, I-Eye Q-Eye and Group Delay. Normally this trace data is displayed with I-Q format.

Format name	Description
I-Q	Real part of data is shown on horizontal axis, imaginary part is shown on vertical axis, Independent variable (X axis) is normal to display
Constellation	Same as I-Q, but for data with symbols defined, only the symbol points are shown as dots with no connecting lines
Real (I)	Real part of data is shown on a linear Y axis
Imaginary (Q)	Imaginary part of data is shown on linear Y axis
I-Eye	Real part of data is shown with X axis segmented (generally into 2 symbol segments) and each segment is overlaid to show signal crossings at symbol boundaries
Q-Eye	Same as I-eye but imaginary part of data is shown
Group Delay	Shows the derivative of phase response with respect to time

Example : `:DISP:DDEM:WIND:DATA RTIM`
 Sets the first window data to IQ Ref Time
 : `:DISP:DDEM:WIND:FORM CONS`
 Selects Constellation as the first window data format

IQ Meas Spectrum

Available for all modulation formats *except* any FSK type.

IQ Meas Spectrum is the frequency spectrum of the IQ Meas Time trace data. The demodulator produces the spectrum by windowing and FFT the IQ measured data. If the measured filter is selected, the spectrum represents the signal after filtering.

Example : `:DISP:DDEM:WIND:DATA MSP`
 Sets the first window data to IQ Meas Spectrum

IQ Ref Spectrum

Available for all modulation formats *except* any FSK type.

IQ Ref Spectrum is the frequency spectrum of the IQ Ref Time trace data. The demodulator produces the spectrum by windowing and FFT the IQ reference data. If the reference filter is selected, the spectrum represents the signal after filtering.

Example **:DISP:DDEM:WIND:DATA RSP**
Sets the first window data to IQ Ref Spectrum

FSK Meas Time

Available only when the demodulation format is any FSK type.

FSK Meas Time is the measured time data results for the input signal. There are 6 available formats for this trace data: I-Q, Constellation, Real, Imaginary, I-Eye and Q-Eye. Normally this trace data is displayed with I-Q format.

Format name	Description
I-Q	Real part of data is shown on horizontal axis, imaginary part is shown on vertical axis, Independent variable (X axis) is normal to display
Constellation	Same as I-Q, but for data with symbols defined, only the symbol points are shown as dots with no connecting lines
Real (I)	Real part of data is shown on a linear Y axis
Imaginary (Q)	Imaginary part of data is shown on linear Y axis
I-Eye	Real part of data is shown with X axis segmented (generally into 2 symbol segments) and each segment is overlaid to show signal crossings at symbol boundaries
Q-Eye	Same as I-eye but imaginary part of data is shown

Example **:DISP:DDEM:WIND:DATA MTIM**
Sets the first window data to FSK Meas Time
:DISP:DDEM:WIND:FORM CONS
Selects Constellation as the first window data format

FSK Ref Time

Available only when the demodulation format is any FSK type.

FSK Ref Time is the reconstructed ideal time waveform to compare FSK Meas Time against. There are 6 available formats for this trace data: I-Q, Constellation, Real, Imaginary, I-Eye and Q-Eye. Normally this trace data is displayed with I-Q format.

Format name	Description
I-Q	Real part of data is shown on horizontal axis, imaginary part is shown on vertical axis, Independent variable (X axis) is normal to display
Constellation	Same as I-Q, but for data with symbols defined, only the symbol points are shown as dots with no connecting lines
Real (I)	Real part of data is shown on a linear Y axis
Imaginary (Q)	Imaginary part of data is shown on linear Y axis
I-Eye	Real part of data is shown with X axis segmented (generally into 2 symbol segments) and each segment is overlaid to show signal crossings at symbol boundaries
Q-Eye	Same as I-eye but imaginary part of data is shown
Example	<p><code>:DISP:DDEM:WIND:DATA RTIM</code></p> <p>Sets the first window data to FSK Ref Time</p> <p><code>:DISP:DDEM:WIND:FORM CONS</code></p> <p>Selects Constellation as the first window data format</p>

FSK Meas Spectrum

Available only when the demodulation format is any FSK type.

FSK Meas Spectrum is the frequency spectrum of the FSK Meas Time trace data. The demodulator produces the spectrum by windowing and FFT the FSK measured data. If the measured filter is selected, the spectrum represents the signal after filtering.

Example	<code>:DISP:DDEM:WIND:DATA MSP</code>
	Sets the first window data to FSK Meas Spectrum

FSK Ref Spectrum

Available only when the demodulation format is any FSK type.

FSK Ref Spectrum is the frequency spectrum of the FSK Ref Time trace data. The demodulator produces the spectrum by windowing and FFT the FSK reference data. If the reference filter is selected, the spectrum represents the signal after filtering.

Example	<code>:DISP:DDEM:WIND:DATA RSP</code>
	Sets the first window data to FSK Ref Spectrum

ASK Meas Time

Available only when the demodulation format is any ASK type.

3 VMA Mode

3.1 Digital Demod Measurement

ASK Meas Time is the measured time data results for the input signal. There are 6 available formats for this trace data: I-Q, Constellation, Real, Imaginary, I-Eye and Q-Eye. Normally this trace data is displayed with I-Q format.

Format name	Description
I-Q	Real part of data is shown on horizontal axis, imaginary part is shown on vertical axis, Independent variable (X axis) is normal to display
Constellation	Same as I-Q, but for data with symbols defined, only the symbol points are shown as dots with no connecting lines
Real (I)	Real part of data is shown on a linear Y axis
Imaginary (Q)	Imaginary part of data is shown on linear Y axis
I-Eye	Real part of data is shown with X axis segmented (generally into 2 symbol segments) and each segment is overlaid to show signal crossings at symbol boundaries
Q-Eye	Same as I-eye but imaginary part of data is shown
Example	<pre>:DISP:DDEM:WIND:DATA MTIM</pre> Sets the first window data to ASK Meas Time <pre>:DISP:DDEM:WIND:FORM CONS</pre> Selects Constellation as the first window data format

ASK Ref Time

Available only when the demodulation format is any ASK type.

ASK Ref Time is the reconstructed ideal time waveform to compare ASK Meas Time against. There are 6 available formats for this trace data: I-Q, Constellation, Real, Imaginary, I-Eye and Q-Eye. Normally this trace data is displayed with I-Q format.

Format name	Description
I-Q	Real part of data is shown on horizontal axis, imaginary part is shown on vertical axis, Independent variable (X axis) is normal to display
Constellation	Same as I-Q, but for data with symbols defined, only the symbol points are shown as dots with no connecting lines
Real (I)	Real part of data is shown on a linear Y axis
Imaginary (Q)	Imaginary part of data is shown on linear Y axis
I-Eye	Real part of data is shown with X axis segmented (generally into 2 symbol segments) and each segment is overlaid to show signal crossings at symbol boundaries
Q-Eye	Same as I-eye but imaginary part of data is shown
Example	<pre>:DISP:DDEM:WIND:DATA RTIM</pre> Sets the first window data to ASK Ref Time <pre>:DISP:DDEM:WIND:FORM CONS</pre> Selects Constellation as the first window data format

ASK Meas Spectrum

Available only when the demodulation format is any ASK type.

ASK Meas Spectrum is the frequency spectrum of the ASK Meas Time trace data. The demodulator produces the spectrum by windowing and FFT the ASK measured data. If the measured filter is selected, the spectrum represents the signal after filtering.

Example `:DISP:DDEM:WIND:DATA MSP`
Sets the first window data to ASK Meas Spectrum

ASK Ref Spectrum

Available only when the demodulation format is any ASK type.

ASK Ref Spectrum is the frequency spectrum of the ASK Ref Time trace data. The demodulator produces the spectrum by windowing and FFT the ASK reference data. If the reference filter is selected, the spectrum represents the signal after filtering.

Example `:DISP:DDEM:WIND:DATA RSP`
Sets the first window data to ASK Ref Spectrum

Demod Error

Displays the general demodulation error results.

Error Vector Time

Available for all modulation formats *except* any FSK type.

This trace shows the time domain error vector trace data results. The trace contains the computed error vectors between IQ Meas Time and IQ Ref Time at each point in time. The values of the error vectors are usually plotted as a magnitude.

Example `:DISP:DDEM:WIND2:DATA EVT`
Sets the second window data to Error Vector Time

Error Vector Spectrum

Available for all modulation formats *except* any FSK type.

3 VMA Mode

3.1 Digital Demod Measurement

Error Vector Spectrum is the frequency spectrum of the Error Vector Time trace data. The demodulator produces the spectrum by windowing and FFT the Error Vector Time data. On this trace, the individual error vectors are plotted vs frequency.

Example `:DISP:DDEM:WIND2:DATA EVSP`
Sets the second window data to Error Vector Spectrum

Mag Error

Available for all modulation formats *except* any FSK type.

This trace shows the magnitude error trace in time domain. This trace is computed by comparing the magnitude, point by points, of the IQ measured signal with the magnitude of the IQ reference signal.

Example `:DISP:DDEM:WIND:DATA MERR`
Sets the first window data to Mag Error

Phase Error

Available for all modulation formats *except* any FSK type.

This trace shows the phase error trace in time domain. This trace is computed by comparing the unwrapped phase, point by points, of the IQ measured signal with the unwrapped phase of the IQ reference signal.

Example `:DISP:DDEM:WIND:DATA PERR`
Sets the first window data to Phase Error

FSK Error Time

Available only when the demodulation format is any FSK type.

This trace shows the time domain error vector trace data results. The trace contains the computed error vectors between FSK Meas Time and FSK Ref Time at each point in time. The values of the error vectors are usually plotted as a magnitude.

Example `:DISP:DDEM:WIND2:DATA EVT`
Sets the second window data to FSK Error Time

FSK Error Spectrum

Available only when the demodulation format is any FSK type.

This trace is the frequency spectrum of the FSK Vector Time trace data. The demodulator produces the spectrum by windowing and FFT the FSK Error Time data. On this trace, the individual error vectors are plotted vs frequency.

Example `:DISP:DDEM:WIND2:DATA EVSP`
Sets the second window data to FSK Error Spectrum

Mag Error (Carrier)

Available only when the demodulation format is any FSK type.

This trace shows the carrier magnitude error trace in time domain. This trace is computed by comparing the magnitude, point by points, of the FSK measured signal with the averaged magnitude.

Example `:DISP:DDEM:WIND:DATA MERR`
Sets the first window data to Carrier Mag Error

ASK Error Time

Available only when the demodulation format is any ASK type.

This trace shows the time domain error vector trace data results. The trace contains the computed error vectors between ASK Meas Time and ASK Ref Time at each point in time. The values of the error vectors are usually plotted as a magnitude.

Example `:DISP:DDEM:WIND2:DATA EVT`
Sets the second window data to ASK Error Time

ASK Error Spectrum

Available only when the demodulation format is any ASK type.

This trace is the frequency spectrum of the ASK Vector Time trace data. The demodulator produces the spectrum by windowing and FFT the ASK Error Time data. On this trace, the individual error vectors are plotted vs frequency.

Example `:DISP:DDEM:WIND2:DATA EVSP`
Sets the second window data to ASK Error Spectrum

Response

Displays the trace data choices that show equalizer response results.

CH Freq Response

Displays the channel frequency response for which the equalizer is correcting. It is computed as the inverse of the equalization filter's frequency response.

Example `:DISP:DDEM:WIND2:DATA CHFR`
Sets the second window data to CH Freq Response

EQ Impulse Response

Displays the impulse response of the equalization filter.

Example `:DISP:DDEM:WIND2:DATA EQIR`
Sets the second window data to EQ Impulse Response

Tables

Displays the trace data choices that are in tabular form, including Metrics, Eye Diagram Metrics, and Demod Bits.

Metrics

Displays the measurement numeric results. The available tabular data changes depending on the modulation format chosen.

Example `:DISP:DDEM:WIND4:DATA DRES`
Sets the fourth window data to Metrics

Eye Diagram Metrics

Displays the numeric results calculated from Eye Diagram. The available tabular data changes depending on the modulation format chosen.

Example `:DISP:DDEM:WIND4:DATA ERES`
Sets the fourth window data to Metrics.

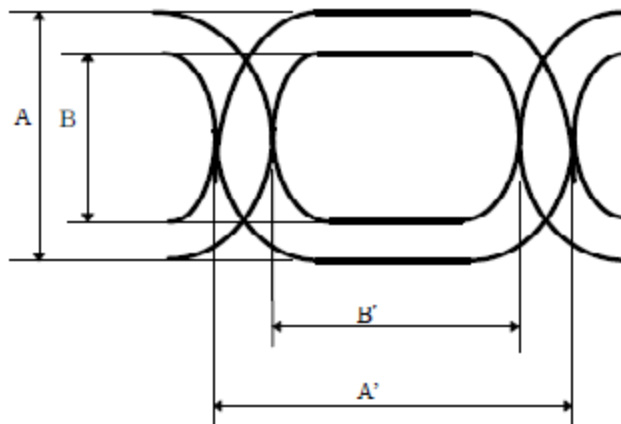

- Amplitude Ratio is the free decision distance in height of a digital signal and is calculated as $2B/(A+B)$. A and B are the maximum and minimum amplitude difference at the decision point. An ideal signal has a decision height of 100%.
- Time Ratio is the free decision distance in width of a digital signal and is calculated as $2B'/(A'+B')$. A' and B' are the maximum and minimum zero-cross time width. An ideal signal has a decision width of 100%.
- Modulation Index Outer (SCPI only) is defined as the measure of extent of outer amplitude variation about an un-modulated carrier. It is calculated as $(V_{Amax} - V_{Amin}) / (V_{Amax} + V_{Amin})$. V_{Amax} is the largest amplitude at crest. V_{Amin} is the smallest amplitude at bottom. Maximum amplitude difference A is equal to $V_{Amax} - V_{Amin}$.
- Modulation Index Inner (SCPI only) is defined as the measure of extent of inner amplitude variation about an un-modulated carrier. It is calculated as $(V_{Bmax} - V_{Bmin}) / (V_{Bmax} + V_{Bmin})$. V_{Bmax} is the smallest amplitude at crest. V_{Bmin} is the largest amplitude at bottom. Minimum amplitude difference B is equal to $V_{Bmax} - V_{Bmin}$.
- Modulation On/Off Ratio (SCPI only) is defined as the ratio of $20\log_{10}((V_{Amax} + V_{Bmax}) / (V_{Amin} + V_{Bmin}))$.

3 VMA Mode

3.1 Digital Demod Measurement

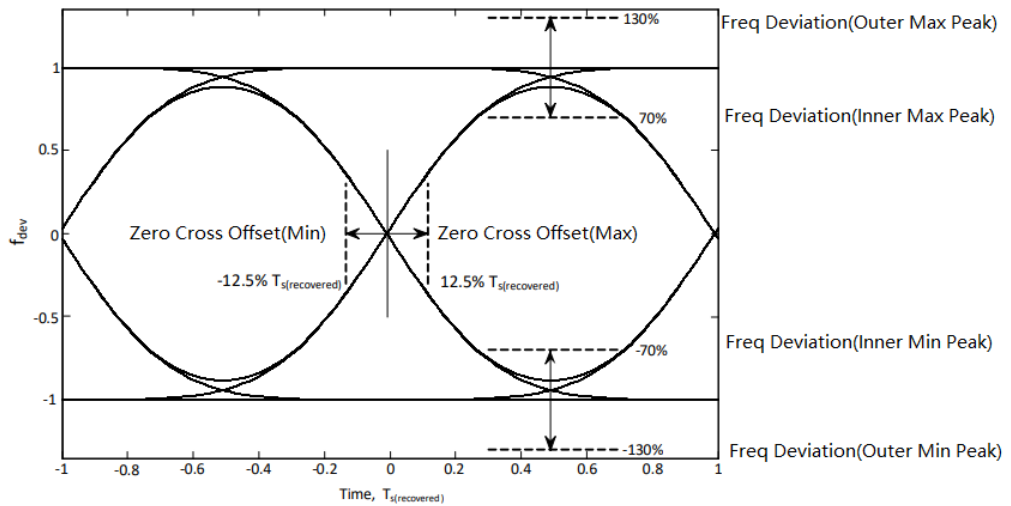

Frequency Deviation Tolerance:

Modulation frequency tolerance is measured as a percentage of the frequency deviation f_{dev} , dictated by the modulation index. In the case of 2-FSK, the measure frequency deviation f at decision point shall be constrained to the range of $70\% f_{dev} < |f| < 130\% f_{dev}$.

- Outer Max Peak is the largest frequency deviation at crest as a percentage of the frequency deviation.
- Inner Max Peak is the smallest frequency deviation at crest as a percentage of the frequency deviation.
- Inner Min Peak is the smallest frequency deviation at bottom as a percentage of the frequency deviation.
- Outer Min Peak is the largest frequency deviation at bottom as a percentage of the frequency deviation.

Zero Crossing Tolerance:

In the case of 2-FSK, the excursions for the zero crossings for all trajectories of the eye diagram shall be constrained to within $\pm 12.5\%$ rms of the symbol time T_s ,

- Zero Crossing Offset(Max) is the maximum zero-crossing offset at the right as the percentage of the symbol time T_s .
- Zero Crossing Offset (Min) is the minimum zero-crossing offset at the left as the percentage of the symbol time T_s .

Demod Bits

Displays the demodulation bits.

Example `:DISP:DDEM:WIND2:DATA DBIT`

Sets the second window data to Demod Bits

When Tx BER is turned on, this table includes BER results:

MS_Demod Bits & BER	
BER	16.17 % (241482 / 1492980)
Index	Demod Bits Data
0	:00000000 00000000 00000000 00000000 00000000 00000000 00000000 00000000 :10101010 10101010 10101010 10101010 10101010 10101010 10101010 10101010
56	:00000000 00000000 00000000 00000000 00000000 00000000 00000000 00000000 :10101010 10101010 10101010 10101010 10101010 10101010 10101010 10101010
112	:00000000 00000000 00000000 00000000 00000000 00000000 00000000 00000000 :10101010 10101010 10101010 10101010 10101010 10101010 10101010 10101010
168	:00000000 00000000 00000000 00000000 00000000 00000000 00000000 00000000 :10101010 10101010 10101010 10101010 10101010 10101010 10101010 10101010
224	:00000000 00000000 00000000 00000000 00000000 00000000 00000000 00000000 :10101010 10101010 10101010 10101010 10101010 10101010 10101010 10101010
280	:00000000 00000000 00000000 00000000 00000000 00000000 00000000 00000000 :10101010 10101010 10101010 10101010 10101010 10101010 10101010 10101010
336	:00000000 00000000 00000000 00000000 00000000 00000000 00000000 00000000 :10101010 10101010 10101010 10101010 10101010 10101010 10101010 10101010

Frame Summary

This table shows the frame summary results.

Example `:DISP:DDEM:WIND2:DATA FRAM`

Sets the second window data to Frame Summary

Demod Traces

Windows:

"IQ Meas Spectrum" on page 216

"FSK Meas Spectrum" on page 218

"IQ Meas Time" on page 215

"FSK Meas Time" on page 217

Dual-window view consists of the above two windows.

Example `:DISP:DDEM:VIEW DTR`

3.1.3.2 Selected Segment / Format

These two elements of the window dropdown enable you to select the segment and the format to be used for displaying the demodulated trace.

Selected Segment

Displays a menu of segment choices for the selected window.

Remote Command	<code>:DISPlay:DDEMod:WINDow[1] 2 ... 6:SEGMent?</code>
Example	<code>:DISP:DDEM:WIND2:SEGM SEGM1</code> Select the segment1 data results for window 2 <code>:DISP:DDEM:WIND2:SEGM?</code>
Couplings	Available only for the following trace Data, otherwise hidden <ul style="list-style-type: none"> - IQ Meas Time - IQ Ref Time - IQ Meas Spectrum - IQ Ref Spectrum - Error Vector Time - Error Vector Spectrum - Mag Error - Phase Error - CH Freq Response - EQ Impulse Response - Metrics - Demod Bits
Preset	<code>SEGM1</code>
State Saved	Yes
Range	<code>SEGM1 SEGM2 SEGM3 SEGM4 SEGM5 SEGM6</code>

Format

Enables you to choose the available format of the selected trace.

The formats are:

Format name	Description
Log Mag (dB)	Data is converted to decibel units and shown on a linear Y axis
Linear Mag (Abs Value)	Magnitude of the data is shown on a linear Y axis
Real (I)	Real part of data is shown on a linear Y axis
Imaginary (Q)	Imaginary part of data is shown on linear Y axis
I-Q	Real part of data is shown on horizontal axis, imaginary part is shown on vertical axis, Independent variable (X axis) is normal to display
Constellation	Same as I-Q, but for data with symbols defined, only the symbol points are shown as dots with no connecting lines
Phase	Phase of complex data is shown on Y axis
I-Eye	Real part of data is shown with X axis segmented (generally into 2 symbol segments) and each segment is overlaid to show signal crossings at symbol boundaries
Q-Eye	Same as I-eye but imaginary part of data is shown
Group Delay	Useful for frequency response and IQ Meas Time traces. Shows the derivative of phase response with respect to frequency or time
Remote Command	<code>:DISPlay:DDEMod:WINDow[1] 2 ... 6[:TRACe]:FORMat MLOG MLINear REAL IMAGinary VECTor CONSTln PHASe IEYE QEYE GDELay</code> <code>:DISPlay:DDEMod:WINDow[1] 2 ... 6[:TRACe]:FORMat?</code>
Example	<code>:DISP:DDEM:WIND2:FORM MLOG</code> Sets the second window data format to Log Mag <code>:DISP:DDEM:WIND2:FORM?</code>
Notes	Real, Imaginary, I-Q, Constellation, I-Eye and Q-Eye are available for IQ Meas Time and IQ Ref Time trace Log Mag, Phase and Group Delay are available for Channel Frequency Response trace Log Mag, Real and Imaginary are available for ccEVM vs Symbole trace
Preset	Depends on trace
State Saved	Yes
Range	Log Mag (dB) Linear Mag (Abs Value) Real (I) (Lin) Imaginary (Q) (Lin) I-Q Constellation Phase I-Eye Q-Eye Group Delay

3.1.4 Amplitude

Activates the **Amplitude** menu and selects **Reference Level** or **Reference Value** as the active function, depending on the measurement.

Some features in this menu apply to multiple measurements. Some other features apply only to specific measurements and their controls are blanked or grayed-out in measurements that do not support the feature.

3.1.4.1 Y Scale

Contains controls that pertain to the Y axis parameters of the measurement. These parameters control how data on the vertical (Y) axis is displayed and control instrument settings that affect the vertical axis.

Auto Scale

Changes the Y reference value and Scale per Division so the full trace is displayed without clipping.

Remote Command	<code>:DISPlay:DDEMod:WINDow[1] 2 ... 6:Y[:SCALE]:AUTO:ONCE</code>
Example	<code>:DISP:DDEMod:WIND3:Y:AUTO:ONCE</code> Do the Y auto scale for the third window

Auto Scale at Restart

Enables or disables automatic Y Auto Scale with measurement restart:

- On – Performs automatic Y Auto Scale when measurement restarted, to let you see complete trace
- Off – Does not perform automatic Y Auto Scale when measurement restarted, retaining existing setting for Y scale

Remote Command	<code>:DISPlay:DDEMod:Y[:SCALE]:AUTO:REStart 0 1 OFF ON</code> <code>:DISPlay:DDEMod:Y[:SCALE]:AUTO:REStart?</code>
Example	<code>:DISP:DDEM:Y:AUTO:REST ON</code> <code>:DISP:DDEM:Y:AUTO:REST?</code>
Preset	OFF
State Saved	Yes
Range	OFF ON

Ref Value

Specifies the amplitude of a signal displayed on the reference graticule line. The reference line is at the top, center, or bottom of the graticule, depending on the value of the Ref Position function.

This setting applies only to the selected window. If a table type window is selected, **Ref Value** is unavailable. The functionality depends on the selected window.

Remote Command	<code>:DISPlay:DDEMod:WINDow[1] 2 ... 6:Y[:SCALE]:RLEVel <real></code> <code>:DISPlay:DDEMod:WINDow[1] 2 ... 6:Y[:SCALE]:RLEVel?</code>
Example	Set the Y ref value of the third window to 20: <code>:DISP:DDEM:WIND3:Y:RLEV 20</code> Query the Y ref value of the third window: <code>:DISP:DDEM:WIND3:Y:RLEV?</code>
Preset	Depends on trace data
State Saved	Saved in instrument state
Min/Max	-9.9E+37/9.9E+37
Annotation	The reference value is displayed above the graticule with the title "Ref Value"

Scale/Div

Controls the Y scale per division of the selected trace.

Remote Command	<code>:DISPlay:DDEMod:WINDow[1] 2 ... 6:Y[:SCALE]:PDIVision <real></code> <code>:DISPlay:DDEMod:WINDow[1] 2 ... 6:Y[:SCALE]:PDIVision?</code>
Example	<code>:DISP:DDEM:WIND3:Y:PDIV 10</code> Set the Y scale/div of the third window to 10 <code>:DISP:DDEM:WIND3:Y:PDIV?</code> Query the Y scale/div of the third window
Preset	Depends on trace data
State Saved	Yes
Min/Max	-9.9E+37/9.9E+37
Annotation	Upper left corner of trace grid, same gray as grid

Ref Position

Positions the reference level at the top, center, or bottom of the Y Scale display.

Changing the reference position does not change the reference level value.

Remote Command	<code>:DISPlay:DDEMod:WINDow[1] 2 ... 6:Y[:SCALE]:RPOSition TOP CENTER BOTTom</code> <code>:DISPlay:DDEMod:WINDow[1] 2 ... 6:Y[:SCALE]:RPOSition?</code>
Example	<code>:DISP:DDEM:WIND3:Y:RPOS TOP</code> Set the Y ref position of the third window to TOP <code>:DISP:DDEM:WIND3:Y:RPOS?</code> Query the Y ref position of the third window

Preset	Depends on trace data
State Saved	Saved in instrument state
Range	Top Ctr Bot

3.1.4.2 Attenuation

Controls the attenuator functions and interactions between the attenuation system components.

There are two attenuator configurations in the X-Series. One is a Dual-Attenuator configuration consisting of a mechanical attenuator and an optional electronic attenuator. The other configuration uses a single attenuator with combined mechanical and electronic sections that controls all the attenuation functions. Different models in the X-Series come with different configurations.

- See ["Dual-Attenuator Configurations" on page 231](#)
- See ["Single-Attenuator Configuration" on page 232](#)

Most attenuation settings are the same for all measurements – they do not change as you change measurements. Settings like these are called “Meas Global” and are unaffected by **Meas Preset**.

Only available when the hardware set includes an input attenuator, which is typically only the case for Keysight’s benchtop instruments. For example, this tab does *not* appear in VXT models M9420A/10A/11A/15A/16A, M9410E/11E/15E/16E, nor in UXM. In UXM, all **Attenuation** and **Range** settings are disabled, as the expected input power level is handled by the Call Processing App that drives the DUT power control.

Dependencies In measurements that support the I/Q inputs, unavailable when I/Q is the selected input. Replaced by the **Range** tab in that case

Dual-Attenuator Configurations

Configuration 1: Mechanical attenuator + optional electronic attenuator

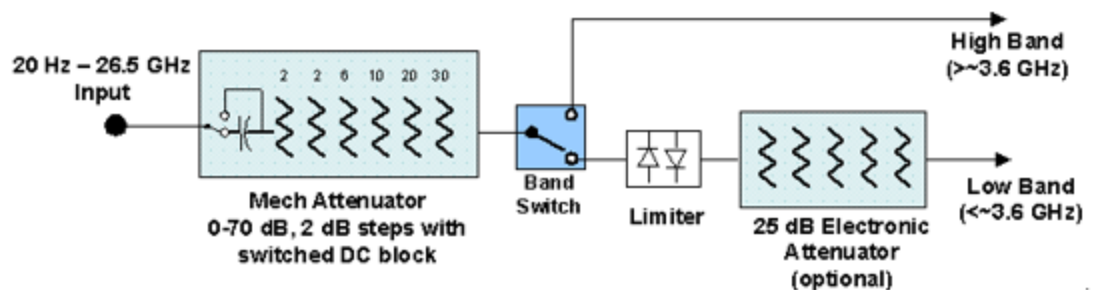

Configuration 2: Mechanical attenuator, no optional electronic attenuator

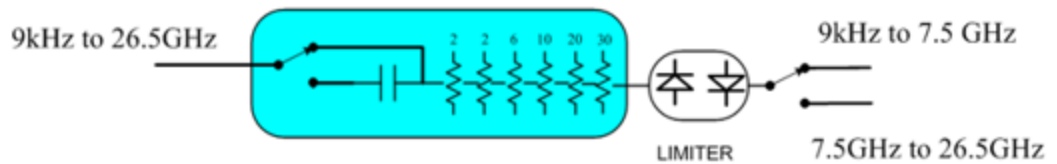

Note that Configuration 2 is not strictly speaking a dual-section attenuator, since there is no electronic section available. However, it behaves exactly like Configuration 1 without the Electronic Attenuator Option EA3, therefore for the sake of this document it is grouped into the “Dual-Attenuator” configuration.

Single-Attenuator Configuration

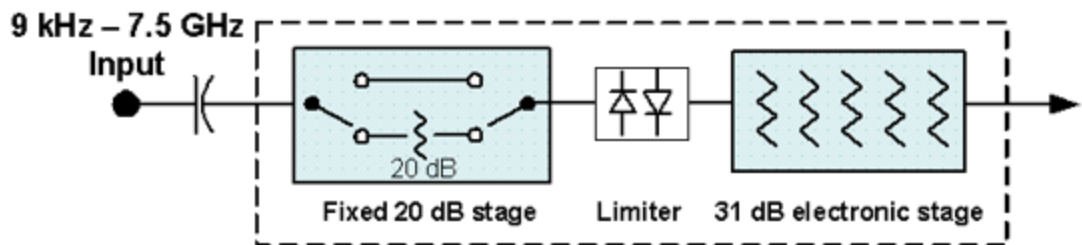

You can tell which attenuator configuration you have by pressing the Attenuation tab, which (in most Modes) opens the Attenuation menu. If the first control in the Attenuation menu says **Mech Atten** you have the Dual-Attenuator configuration. If the first control says **Atten** you have the Single-Attenuator configuration.

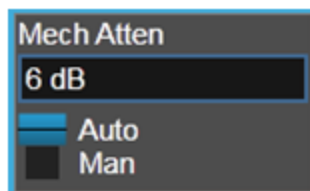

Dual Attenuator



Single Attenuator

(Note that depending on the measurement, there may be no Auto/Man functionality on the Mech Atten control.)

In the Single-Attenuator configuration, you control the attenuation with a single control, as the fixed stage has only two states. In the Dual-Attenuator configuration, both stages have significant range, so you are given separate control of the mechanical and electronic attenuator stages.

When you have the Dual-Attenuator configuration, you may still have only a Single-Attenuator, because unless Option EA3 (the Electronic Attenuator option) is available, and you purchase it, you will have only the mechanical attenuator.

Full Range Atten

This control and **Attenuator Summary** only appear in N9041B, when the RF input is selected, the RF Input Port is set to RF Input 2, and the Full Range Attenuator is installed. The Full Range Attenuator adds a second input attenuator in front of RF Input 2, which enhances the protection and optimizes the performance of the extra internal mixers used by RF Input 2.

Remote Command	<code>[:SENSe]:POWer[:RF]:FRATten <rel_amp1></code> <code>[:SENSe]:POWer[:RF]:FRATten?</code>
Example	<code>:POW:FRAT 14</code> <code>:POW:FRAT?</code>
Notes	When you enter an amplitude value that falls between valid values, the value will be incremented to the next smallest valid value
Dependencies	Only appears if input RF is selected, RF Input Port 2 is selected, and the Full Range Attenuator exists
Couplings	This value is never changed by any coupling, but other couplings use this value. See Reference Level and "Mech Atten" on page 1766 command descriptions
Preset	20 dB
State Saved	Saved in instrument state
Min	0 dB
Max	Only valid values are 0, 6, 14, 20 dB
Annotation	<p>When the Input is RF, and the Input Port is RF Input 2, and the Full Range Attenuator is installed: On the Meas Bar, the field "Atten" displays as follows:</p> <ul style="list-style-type: none"> - If the sweep is entirely < 50 GHz, the value shown after "Atten:" is equal to Mech Atten + Elec Atten + Full Range Atten - If the sweep is entirely > 50 GHz, the value shown after "Atten:" is equal to Full Range Atten - If the sweep straddles 50 GHz, the value shown after "Atten:" is preceded by the symbol ">=" and is equal to Full Range Atten <p>In the Amplitude, "Y Scale" on page 1760 menu, and the Atten Meas Bar dropdown menu panel, a summary is displayed as follows:</p> <p>"Total Atten below 50 GHz" followed by the value of Full Range Atten + Mech Atten + Elec Atten "Total Atten above 50 GHz" followed by the value of Full Range Atten</p> <p>For example, if Mech Atten = 6 dB, Elec Atten = 4 dB, and Full Range Atten = 20 dB, the summary below is shown:</p> <ul style="list-style-type: none"> - Attenuator summary: - Total Atten below 50 GHz: 30 dB - Total Atten above 50 GHz: 20 dB

Mech Atten

Labeled **Mech Atten** in Dual-Attenuator models, and **Atten** in Single-Attenuator models. In the Dual-Attenuator configuration, this control only affects the mechanical attenuator.

Lets you modify the attenuation applied to the RF input signal path. This value is normally auto-coupled to **Ref Level**, "[Internal Preamp](#)" on page 1788 Gain, any External Gain that is entered, and **Max Mixer Level** (if available), as described in the table below.

See "[Attenuator Configurations and Auto/Man](#)" on page 236

Remote Command	<code>[:SENSe]:POWer[:RF]:ATTenuation <rel_amp></code> <code>[:SENSe]:POWer[:RF]:ATTenuation?</code>
Example	<code>:POW:ATT 20</code> Dual-Attenuator configuration: sets the mechanical attenuator to 20 dB Single-Attenuator mode: sets the main attenuation to 20 dB (see below for definition of "main" attenuation) In either case, if the attenuator was in Auto, it is set to Manual
Dependencies	Some measurements do not support Auto setting of Mech Atten . In these measurements, the Auto/Man selection is not available, and the Auto/Man toggle function is not available In Dual-Attenuator configurations, when the electronic attenuator is enabled, the mechanical attenuator has no auto setting, and the Auto/Man toggle function is not available. The state of Auto/Man is remembered and restored when the electronic attenuator is once again disabled. This is described in more detail in " Elec Atten " on page 1769 See " Attenuator Configurations and Auto/Man " on page 236 for more information on the Auto/Man functionality
Couplings	If the RF Input Port is the RF Input: <ul style="list-style-type: none"> - If the USB Preamp is connected to USB, use 0 dB for Mech Atten - Otherwise compute the auto-selected value of Mech Atten based on Reference Level, Int Preamp, External Gain, Ref Level Offset, Max Mixer Level, μW Path Control and IF Gain settings. Limit this value to be no less than 6 dB (total attenuation below 6 dB can never be chosen by Auto) - In N9041B, if the RF Input Port is RF Input 2, use the formula above and subtract the value of "Full Range Atten" on page 1765 from the result to determine the Mech Atten. Limit the value so that it is never lower than 0 dB and so that total attenuation, including Full Range Atten, is never less than 6 dB (total attenuation, including Full Range Atten below 6 dB, can never be chosen by Auto) <p>In External Mixing and BBIQ, where the attenuator is not in the signal path, the attenuator setting changes as described above when Mech Atten is in Auto, but no changes are made to the actual attenuator hardware setting until the input is changed back to the RF Input</p> <p>For CXA-m with Option FSA (Fine-Step Attenuator or 2 dB steps), the FSA-like behavior is only available when the frequency setting is <= 7.5 GHz. So, when the frequency is changed from below</p>

3 VMA Mode

3.1 Digital Demod Measurement

	7.5 GHz to above 7.5 GHz, the attenuation setting changes to a multiple of 10 dB that is no smaller than the previous setting. For example, 4 dB attenuation changes to 10 dB	
Preset	Auto	The Auto value is 10 dB
State Saved	Saved in instrument state	
Min	0 dB The attenuation set by this control cannot be decreased below 6 dB with the knob or step keys. Values below 6 dB must be directly entered from the keypad or via SCPI. This protects against setting a dangerously small attenuation value, which can put the instrument at risk of damage to input circuitry. If the current mechanical attenuation is below 6 dB, it can be increased with the knob and step keys, but not decreased	
Max	CXA Option 503 or 507	50 dB
	EXA	60 dB
	All other models	70 dB
	Note that in the Single-Attenuator configuration, the total of ATT and EATT cannot exceed 50 dB. So, if the EATT is set to 24 dB first, the main attenuation cannot be greater than 26 dB and will be reduced accordingly; if the main attenuator is set to 40 dB first, EATT cannot be greater than 10 dB	
Annotation	<p>The current value for Total Atten is displayed in the Measurement Bar at the top of the display. A value appears for Electronic Attenuation only if the Electronic Attenuator is enabled. The annotation appears as:</p> <p><i>Atten: <total> dB (e<elec>)</i></p> <p>The e letter is in amber in Single-Attenuator configurations</p> <p>For example:</p> <p>Dual-Attenuator configuration:</p> <p><i>Atten: 24 dB (e14)</i></p> <p>Indicating the total attenuation is at 24 dB and the electronic attenuation is at 14 dB</p> <p>Single-Attenuator configuration:</p> <p><i>A: 24 dB (e14)</i></p> <p>Indicating the total attenuation is at 24 dB and the “soft” attenuation is at 14 dB (see below for definition of “soft” attenuation)</p> <p>When in Manual, a # sign appears in front of Atten in the annotation</p>	

Auto Function

Remote Command	<code>[:SENSe]:POWer[:RF]:ATTenuation:AUTO OFF ON 0 1</code> <code>[:SENSe]:POWer[:RF]:ATTenuation:AUTO?</code>
Example	Turn Auto Mech Atten ON: <code>:POW:ATT:AUTO ON</code>
Dependencies	<code>:POW:ATT:AUTO</code> is only available in measurements that support Auto , such as Swept SA
Preset	ON

Attenuator Configurations and Auto/Man

As described under "[Attenuation](#)" on page 1763, there are two distinct attenuator configurations available in the X-Series, the Single Attenuator and Dual-Attenuator configurations.

In Dual-Attenuator configurations, we have mechanical attenuation and electronic attenuation, and current total attenuation is the sum of electronic + mechanical attenuation.

In Single-Attenuator configurations, we refer to the attenuation set using "[Mech Atten](#)" on page 234 (or `:POW:ATT`) as the "main" attenuation; and the attenuation that is set by `:POW:EATT` as the "soft" attenuation (`:POW:EATT` is honored even in the Single-Attenuator configuration, for compatibility purposes). Then current total attenuation is the sum of main + soft attenuation.

See "[Elec Atten](#)" on page 1769 for more about "soft" attenuation.

NOTE

In some measurements, the **Mech Atten** control has an **Auto/Man** function. In these measurements, an **Auto/Man** switch is shown on the **Mech Atten** control:

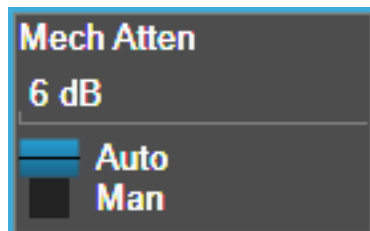

Note that in configurations that include an Electronic Attenuator, this switch is only shown when the Electronic Attenuator is disabled.

In other measurements, **Mech Atten** has no **Auto/Man** function. In these measurements, no switch is shown on the **Mech Atten** control:



Mech Atten also appears with no switch, as above, in configurations that include an Electronic Attenuator but when the Electronic Attenuator is enabled.

Elec Atten

Controls the Electronic Attenuator in Dual-Attenuator configurations. Does not appear in Single-Attenuator configurations, because the control of both the mechanical and electronic stages of the Single-Attenuator is integrated into the single **Atten** control.

3 VMA Mode
 3.1 Digital Demod Measurement

This control includes an **Enable/Disable** toggle switch; it is only possible to enter a value for the Electronic Attenuator when this switch is in the **Enable** position.

For more details of the Electronic Attenuator, see ["More Information" on page 238](#)

Remote Command	<code>[:SENSe]:POWer[:RF]:EATTenuation <rel_amp1></code> <code>[:SENSe]:POWer[:RF]:EATTenuation?</code>
Example	<code>:POW:EATT 10</code> <code>:POW:EATT?</code>
Notes	Electronic Attenuation's specification is defined only when Mech Atten is 6 dB
Dependencies	<p>Only appears in Dual-Attenuator models with an Electronic Attenuator installed and licensed. Does not appear in models with the Single-Attenuator configuration, because in the Single-Attenuator configuration there is no "electronic attenuator"; there is only a single integrated attenuator (which has both a mechanical and electronic stage). However, in the Single-Attenuator configuration, EATT SCPI commands are accepted for compatibility with other X-series instruments, and set a "soft" attenuation. The "soft" attenuation is treated as an addition to the "main" attenuation value set by the Attenuation control or <code>:POW:ATT</code>, and affects the total attenuation displayed on the Attenuation control and the Meas Bar</p> <p>The electronic attenuator, and the "soft" attenuation function provided in Single-Attenuator configurations, are unavailable above the low band (0-3.6 GHz, 0-3.4 GHz, 0-3 GHz, depending on the model). If the low band range is from 0-3.6 GHz, and Stop Frequency of the instrument is > 3.6 GHz, then the Enabled/Disabled section of the Elec Atten control will be OFF and grayed-out</p> <p>If "Internal Preamp" on page 1788 is ON (that is, set to Low Band or Full), the electronic attenuator (and the "soft" attenuation function provided in Single-Attenuator configurations) is unavailable. In this case the Enabled/Disabled section of the Elec Atten control will be OFF and grayed-out</p> <p>If either of the above is true, and the SCPI command is sent, an error indicating that the electronic attenuator is unavailable is returned</p> <p>If both the above are true, pressing the control generates error message -221, in other words, the frequency range lockout takes precedence</p> <p>If the electronic/soft Attenuator is enabled, then the Stop Freq of the instrument is limited to 3.6 GHz and Internal Preamp is unavailable</p> <p>If "LNA" on page 1790 is ON, the electronic attenuator (and the "soft" attenuation function provided in Single-Attenuator configurations) is unavailable. In this case the Enabled/Disabled section of the Elec Atten control will be OFF and grayed-out. This coupling works in the following modes/measurements:</p> <ul style="list-style-type: none"> - Channel Power, Occupied BW, ACP, SEM, Spurious Emissions, Power Stat CCDF measurements in all Modes - Transmit On Off Power measurement in 5G NR Mode - Power vs. Time and Transmit Power measurement in GSM/EDGE Mode - Burst Power measurement in Spectrum Analyzer Mode <p>The SCPI-only "soft" electronic attenuation for the single-attenuator configuration is not available in all measurements; in particular, it is not available in the Swept SA measurement</p>
Couplings	Enabling and disabling the Electronic Attenuator affects the setting of the Mechanical Attenuator (in Dual-Attenuator configurations). This is described in more detail below and in "Mechanical Attenuator

	Transition Rules" on page 239
Preset	0 dB
State Saved	Saved in instrument state
Min	0 dB
Max	Dual-Attenuator configuration: 24 dB Single-Attenuator configuration: the total of ATT and EATT cannot exceed 50 dB. So, if the EATT is set to 24 dB first, the main attenuation cannot be greater than 26 dB and will be reduced accordingly; if the main attenuator is set to 40 dB first, EATT cannot be greater than 10 dB
Annotation	See Annotation under the Mech Atten control description
Auto Function	
Remote Command	<code>[:SENSe]:POWer[:RF]:EATTenuation:STATe OFF ON 0 1</code> <code>[:SENSe]:POWer[:RF]:EATTenuation:STATe?</code>
Example	<code>:POW:EATT:STAT ON</code> <code>:POW:EATT:STAT?</code>
Preset	OFF (Disabled) for Swept SA measurement ON (Enabled) for all other measurements that support the electronic attenuator

NOTE

The maximum **Center Frequency** for Low Band can change based on the selected IFBW for measurements that support IFBW (for example, Waveform measurement across all Modes that support it). In certain models (such as N9042B & N9032B), IFBW values ≤ 40 MHz have a maximum Low Band frequency of 3.6 GHz, while $40 \text{ MHz} < \text{IFBW} \leq 1 \text{ GHz}$ have a maximum of 3.3 GHz, and $1 \text{ GHz} < \text{IFBW} \leq 1.5 \text{ GHz}$ have a maximum of 3.5 GHz. This frequency is reflected in the disabled message displayed for Electrical Attenuator. For N9032B and N9042B IFBW values $> 1.5 \text{ GHz}$ do not support a **Center Frequency** that can reach the Low Band maximum frequency. In these cases, the Electrical Attenuator will remain disabled no matter the Center Frequency.

More Information

The electronic attenuator offers finer steps than the mechanical attenuator, has no acoustical noise, is faster, and is less subject to wear. These advantages primarily aid in remote operation and are negligible for front panel use. See ["Using the Electronic Attenuator: Pros and Cons" on page 240](#) for a detailed discussion of the pros and cons of using the electronic attenuator.

For the Single-Attenuator configuration, for SCPI backwards compatibility, the "soft" attenuation feature replaces the Dual-Attenuator configuration's electronic attenuator. All the same couplings and limitations apply. See ["Attenuator Configurations and Auto/Man" on page 1768](#)

Mechanical Attenuator Transition Rules

When the Electronic Attenuator is enabled, the Mechanical Attenuator transitions to a state that has no Auto function. Below are the rules for transitioning the Mechanical Attenuator. Note that the information below *only* applies to the Dual-Attenuator configurations, and *only* when the Electronic Attenuator is installed:

When the Electronic Attenuation is enabled from a disabled state:

- The Mechanical Attenuator is initialized to 10 dB (this is its optimal performance setting). You can then set it as desired with SCPI, numeric keypad, step keys, or knob, and it behaves as it normally would in manual mode
- The Auto/Man state of (Mech) Atten is saved
- The Auto/Man toggle on the (Mech) Atten control disappears, and the auto rules are disabled
- The Electronic Attenuator is set to 10 dB less than the previous value of the Mechanical Attenuator, within the limitation that it must stay within the range of 0 to 24 dB of attenuation

Examples in the Dual-Attenuator configuration:

- Mech Atten at 20 dB. Elec Atten enabled, Mech Atten set to 10 dB, and Elec Atten set to 10 dB. New total attenuation equals the value before Elec Atten enabled
- Mech Atten at 0 dB. Elec Atten enabled, Mech Atten set to 10 dB, and Elec Atten set to 0 dB. New total attenuation does not equal the value before Elec Atten enabled
- Mech Atten at 40 dB. Elec Atten enabled, Mech Atten set to 10 dB, and Elec Atten set to 24 dB. New total attenuation does not equal the value before Elec Atten enabled

When the Electronic Attenuation is disabled from an enabled state:

- The Elec Atten control is grayed out
- The Auto/Man state of (Mech) Atten is restored
- If now in Auto, (Mech) Atten recouples
- If now in Man, (Mech) Atten is set to the value of total attenuation that existed before the Elec Atten was disabled. The resulting value is rounded up to the smallest value possible given the (Mech) Atten Step setting - (That is, 57 dB changes to 58 dB when (Mech) Atten Step is 2 dB)

Using the Electronic Attenuator: Pros and Cons

The electronic attenuator offers finer steps than the mechanical attenuator, has no acoustical noise, is faster, and is less subject to wear.

The “finer steps” advantage of the electronic attenuator is beneficial in optimizing the alignment of the instrument dynamic range to the signal power in the front panel as well as remote use. Thus, you can achieve improved relative signal measurement accuracy. Compared to a mechanical attenuator with 2 dB steps, the 1 dB resolution of the electronic attenuator only gives better resolution when the odd-decibel steps are used. Those odd-decibel steps are less accurately calibrated than the even-decibel steps, so one tradeoff for this superior relative accuracy is reduced absolute amplitude accuracy.

Another disadvantage of the electronic attenuator is that the spectrum analyzer loses its “Auto” setting, making operation less convenient.

Also, the relationship between the dynamic range specifications (TOI, SHI, compression, and noise) and instrument performance are less well-known with the electrical attenuator. With the mechanical attenuator, TOI, SHI, and compression threshold levels increase dB-for-dB with increasing attenuation, and the noise floor does as well. With the electronic attenuator, there is an excess attenuation of about 1 to 3 dB between 0 and 3.6 GHz, making the effective TOI, SHI, and so forth, less well known. Excess attenuation is the actual attenuation relative to stated attenuation. Excess attenuation is accounted for in the instrument calibration.

Adjust Atten for Min Clipping

Sets the combination of mechanical and electronic attenuation and gain based on the current measured signal level so that clipping will be at a minimum.

This is an immediate action function, that is, it executes once, when the control is pressed.

The algorithms that are used for the adjustment are documented under "[Pre-Adjust for Min Clipping](#)" on page 1773.

Remote Command	<code>[:SENSe]:POWer[:RF]:RANGe:OPTimize IMMEDIATE</code>
Example	<code>:POW:RANG:OPT IMM</code>
Notes	Executing Adjust Atten for Min Clipping initiates the measurement
Dependencies	Does not appear in the Swept SA, RTSA, Monitor Spectrum and Complex Spectrum measurements Appears in the Waveform measurement in BASIC and 5G NR Modes

Adjust Atten

Allows you to select;

3 VMA Mode
3.1 Digital Demod Measurement

- Electric attenuator only
- Combination of Electric attenuator and Mechanical attenuator

when `[:SENSe]:POWer[:RF]:RANGe:OPTimize IMMEDIATE` is executed.

Remote Command	<code>[:SENSe]:POWer[:RF]:RANGe:OPTimize:TYPE EONLY COMBined</code> <code>[:SENSe]:POWer[:RF]:RANGe:OPTimize:TYPE?</code>
Example	<code>:POW:RANG:OPT:TYPE EONL</code> <code>:POW:RANG:OPT:TYPE?</code>
Dependencies	Does not appear in the Swept SA, RTSA, Monitor Spectrum and Complex Spectrum measurements Appears in the Waveform measurement in BASIC and 5G NR Modes
Preset	<code>COMBined</code>
State Saved	Saved in instrument state

Pre-Adjust for Min Clipping

If this function is **ON**, it applies the adjustment described under "[Adjust Atten for Min Clipping](#)" on page 1772 each time a measurement restarts. Therefore, in Continuous measurement mode, it only executes before the first measurement.

In Dual-Attenuator models, you can set **Elec+Mech Atten**, in which case both attenuators participate in the autoranging, or **Elec Atten Only**, in which case the mechanical attenuator does not participate in the autoranging. This latter case results in less wear on the mechanical attenuator and is usually faster.

See "[Adjustment Algorithm](#)" on page 242

Selection	SCPI	Note
Off	<code>OFF</code>	This is the default setting
On	<code>ON</code>	Available in Single-Attenuator instruments. For compatibility with models that do not have an input attenuator, the ON parameter is supported and mapped to <code>COMBined</code>
Elec Atten Only	<code>ELECTrical</code>	Selects only the electric attenuator to participate in auto ranging. This offers less wear on the mechanical attenuator and is usually faster
Elec+Mech Atten	<code>COMBined</code>	In Dual-Attenuator models, this selects both attenuators to participate in the autoranging

Remote Command	<code>[:SENSe]:POWer[:RF]:RANGe:OPTimize:ATTenuation OFF ON ELECTrical COMBined</code> <code>[:SENSe]:POWer[:RF]:RANGe:OPTimize:ATTenuation?</code>
Example	<code>:POW:RANG:OPT:ATT OFF</code> <code>:POW:RANG:OPT:ATT?</code>

Notes	<p>The parameter option ELECTRICAL sets this function to ON in Single-Attenuator models</p> <p>The parameter option COMBINED is mapped to ELECTRICAL in Single-Attenuator models. If you send COMBINED, it sets the function to ON and returns ELEC to a query</p> <p>For SCPI compatibility with models that do not have an input attenuator, the ON parameter is honored and mapped to COMBINED</p>				
Dependencies	<p>Only appears in Dual-Attenuator models with an Electronic Attenuator installed</p> <p>In instruments with Dual-Attenuator model, when "Elec Atten" on page 1769 is OFF or grayed-out, "Pre-Adjust for Min Clipping" on page 241 is grayed-out</p> <p>Does not appear in the Swept SA, RTSA, Monitor Spectrum and Complex Spectrum measurements</p> <p>Appears in the Waveform measurement in BASIC and 5G NR Modes</p>				
Preset	OFF when Elec Atten is Disabled at preset, otherwise ELEC				
State Saved	Saved in instrument state				
Range	<table border="1"> <tr> <td>Dual-Attenuator models:</td> <td>Off Elec Atten Only Mech + Elec Atten</td> </tr> <tr> <td>Single-Attenuator models:</td> <td>Off On</td> </tr> </table>	Dual-Attenuator models:	Off Elec Atten Only Mech + Elec Atten	Single-Attenuator models:	Off On
Dual-Attenuator models:	Off Elec Atten Only Mech + Elec Atten				
Single-Attenuator models:	Off On				

Backwards Compatibility Command

Notes	<p>ON aliases to "Elec Atten Only" (:POW:RANG:OPT:ATT ELEC)</p> <p>OFF aliases to "Off" (:POW:RANG:OPT:ATT OFF)</p> <p>:POW:RANG:AUTO? returns true if :POW:RANG:OPT:ATT is not OFF</p>
Backwards Compatibility SCPI	<pre>[:SENSe]:POWer[:RF]:RANGe:AUTO ON OFF 1 0</pre> <pre>[:SENSe]:POWer[:RF]:RANGe:AUTO?</pre>

Adjustment Algorithm

The algorithms for the adjustment are documented below:

Single-Attenuator Models

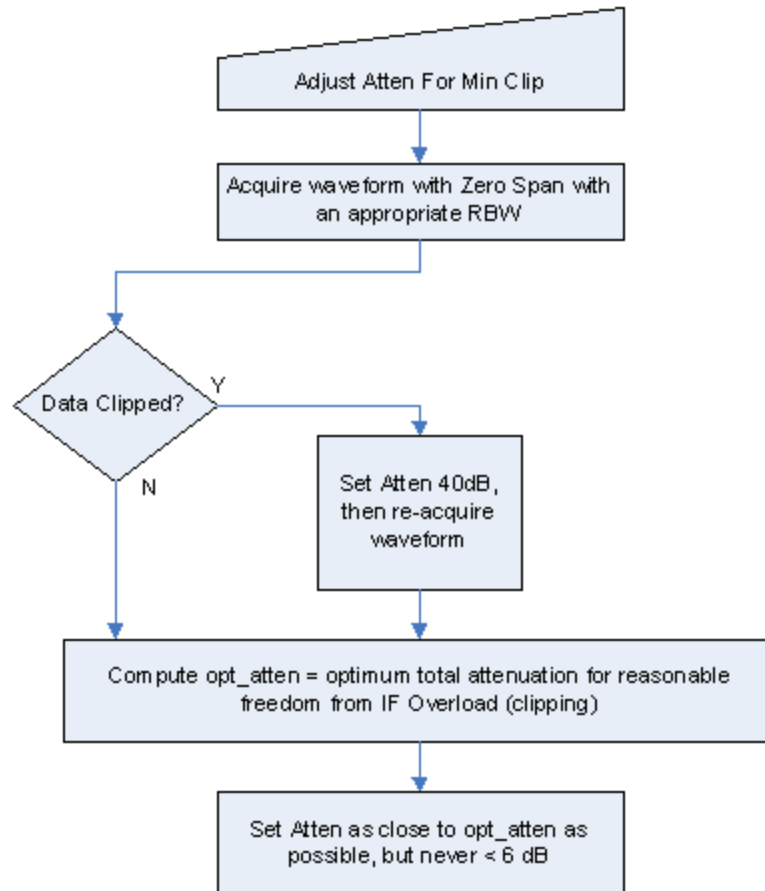

Dual-Attenuator models

"Adjust Atten for Min Clipping" on page 1772 or "Pre-Adjust for Min Clipping" on page 241 selection is Mech + Elec Atten:

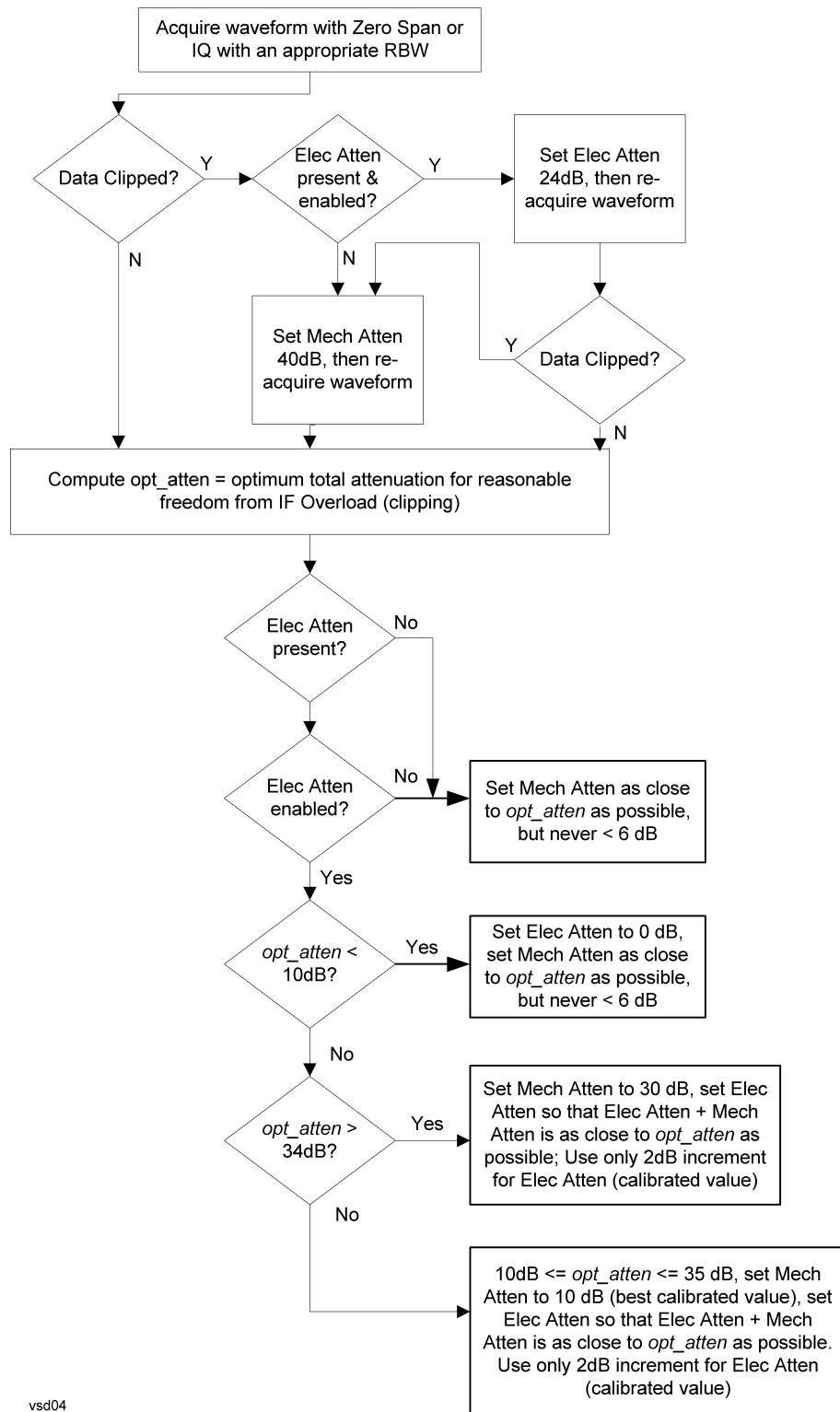

"Pre-Adjust for Min Clipping" on page 241 selection is Elec Only.

Note that the **Mech Atten** value is not adjusted, and the value previously set is used. Therefore, there is a case that IF Overload is still observed depending on the input signal level and the Mech Atten setting.

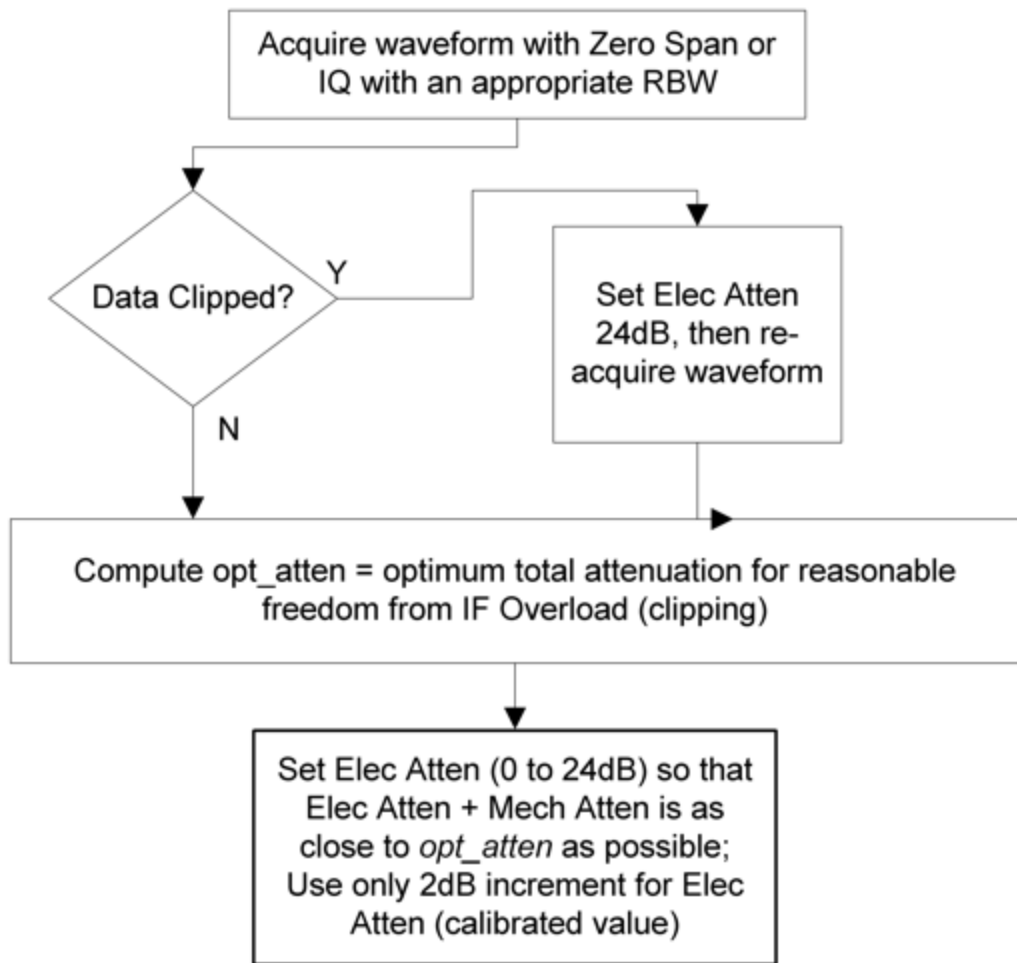

Mech Atten Step

Controls the step size used when making adjustments to the input attenuation.

Labeled **Mech Atten Step** in Dual-Attenuator models and **Atten Step** in Single-Attenuator models. In the Dual-Attenuator configuration, only affects the step size of the mechanical attenuator.

Remote Command `[:SENSe]:POWer[:RF]:ATTenuation:STEP[:INCRement] 10 dB | 2 dB`

	<code>[:SENSe]:POWer[:RF]:ATTenuation:STEP[:INCRement]?</code>
Example	<code>:POW:ATT:STEP 2</code> <code>:POW:ATT:STEP?</code>
Notes	Has a toggle control on the front panel, but takes a specific value (in dB) when used remotely. The only valid values are 2 and 10
Dependencies	Blanked in EXA, CXA and CXA-m if option FSA (2 dB steps) is not present. If blanked, attempts to set it via SCPI yield an error
Couplings	When the attenuation step size changes, the current mechanical attenuation value is adjusted (if necessary) to be quantized to the new step size. That is, if step is set to 10 dB, mech atten is increased if necessary so it is a multiple of 10 dB
Preset	EXA, CXA and CXA-m: 10 dB (2 dB with option FSA) All other models: 2 dB
State Saved	Saved in instrument state

3.1.4.3 Range (Non-attenuator models)

Only available for Keysight's modular signal analyzers and certain other Keysight products, such as VXT and M941xE.

State Saved	No
-------------	----

Range

Represents the amplitude of the largest sinusoidal signal that could be present within the IF without being clipped by the ADC. For signals with high peak-to-average ratios, the range may need to exceed the rms signal power by a significant amount to avoid clipping.

This is a measurement global setting.

Remote Command	<code>[:SENSe]:POWer[:RF]:RANGe <real></code> <code>[:SENSe]:POWer[:RF]:RANGe?</code>
Example	<code>:POW:RANG 10 dBm</code> <code>:POW:RANG?</code>
Notes	The MIN and MAX values are affected by the External Gain parameters, and by the Center Frequency . The hardware compensates for frequency response and alters the Range setting
Preset	0 dBm
State Saved	Yes
Min/Max	-/+100
Annotation	Meas Bar

Adjust Range for Min Clipping

Sets the combination of attenuation and gain based on the current measured signal level so that clipping will be at a minimum.

This is an "immediate action" function, that is, it executes once, when the key is pressed.

This key does not appear in measurements that do not support this functionality.

Remote Command	<code>[:SENSe]:POWer[:RF]:RANGe:OPTimize IMMEDIATE</code>
Notes	Executing Adjust Range for Min Clipping initiates the measurement
Dependencies	Does not appear in the Swept SA and Monitor Spectrum measurements

Pre-Adjust for Min Clipping

If this function is **ON**, it applies the adjustment described under Adjust Range For Min Clipping each time a measurement restarts. Therefore, in Continuous measurement mode, it only executes before the first measurement.

Remote Command	<code>[:SENSe]:POWer[:RF]:RANGe:OPTimize:ATTenuation OFF ON ELECTrical COMBined</code> <code>[:SENSe]:POWer[:RF]:RANGe:OPTimize:ATTenuation?</code>
Notes	Because there is no attenuator control available in these models, the control displays only ON and OFF choices. However, for SCPI compatibility with other platforms, all three parameters (ELECTrical , COMBined , and ON) are honored and all are mapped to ELECTrical , so if any of these three parameters is sent, a subsequent query will return ELEC
Dependencies	Does not appear in the Swept SA and Monitor Spectrum measurements
Preset	OFF for Swept SA measurement; ON for all other measurements that support Pre-Adjust for Min Clipping
State Saved	Saved in instrument state

Adjustment Algorithm

The algorithm for the adjustment is documented below:

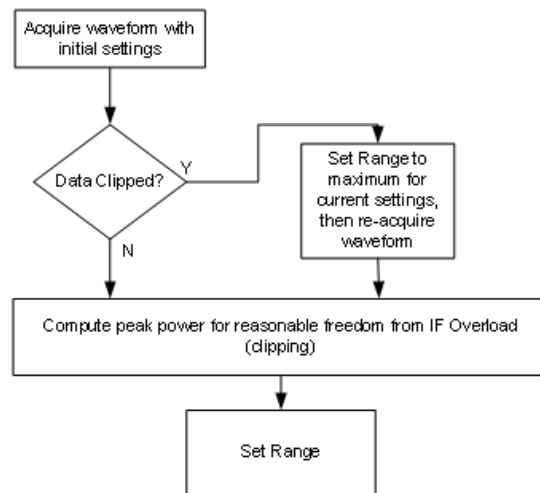

Peak-to-Average Ratio

Used with "[Range \(Non-attenuator models\)](#)" on page 1782 to optimize the level control in the instrument. The value is the ratio, in dB, of the peak power to the average power of the signal to be measured. A ratio of 0 should be used for sinusoidal signals; for 802.11g OFDM signals use 9 dB.

All Modes show the current value of Peak-to-Average ratio on the control. However, some Modes do not permit changing the value. In these situations, the control is grayed-out.

Remote Command	<code>[:SENSe]:POWer[:RF]:RANGe:PARatio <real></code> <code>[:SENSe]:POWer[:RF]:RANGe:PARatio?</code>	
Example	<code>:POW:RANG:PAR 12 dB</code>	
Notes	In some Modes, this parameter is read-only; meaning the value will appear on the control and query via SCPI, but is not changeable. In such applications the control is grayed-out. Attempts to change the value via SCPI are ignored, but no error message is generated	
Dependencies	Does not appear in Spectrum Analyzer Mode	
Preset	VXT Models M9410A/11A	0 dB
	All Others	10 dB
State Saved	Saved in instrument state	
Min	0 dB	
Max	VXT Models M9410A/11A	50 dB
	All Others	20 dB

Mixer Lvl Offset

This is an advanced setting to adjust target Range at the input mixer, which in turn affects the signal level in the instrument's IF. This setting can be used when additional optimization is needed after setting "[Peak-to-Average Ratio](#)" on page 1784. Positive values of offset optimize noise performance over distortion, negative values optimize distortion performance over noise.

Remote Command	<code>[:SENSe]:POWer[:RF]:RANGe:MIXer:OFFSet <real></code> <code>[:SENSe]:POWer[:RF]:RANGe:MIXer:OFFSet?</code>	
Example	<code>:POW:RANG:MIX:OFFS -5 dB</code>	
Preset	0 dB	
State Saved	Saved in instrument state	
Min	VXT Models M9410A/11A	-34 dB
	All Others	-35 dB
Max	30 dB	

3.1.4.4 Range (Baseband Input models)

Only available when Option BBA is present (I/Q Baseband Inputs), the current measurement supports option BBA, and I/Q is the selected input. In these cases, replaces the **Attenuation** tab.

Each input channel (I and Q) has four internal gain ranges. The maximum allowed voltage in each gain range is slightly more than the nominal value, so the break point between ranges is a few millivolts higher than the nominal (setting a peak voltage of 0.502 mV will still map to the 0.5 V Peak range).

Gain Setting	Volts RMS	Volts Peak	Volts Peak - Peak	dBm (50Ω)	Break Point
0 dB	0.7071	1.0	2.0	10	n/a
6 dB	0.3536	0.5	1.0	4	0.502 V Peak
12 dB	0.1768	0.25	0.5	-2	0.252 V Peak
18 dB	0.0884	0.125	0.25	-8	0.127 V Peak

Dependencies	Available only when the selected input is I/Q. If the current measurement does not support baseband inputs, an error will be displayed: "No result; Meas invalid with I/Q inputs"
State Saved	No

Range Auto/Man

The **Auto** setting for **Range** causes the range to be set based on the Y Scale settings. When **Range** is **Auto**, the I & Q Range are set based on the top of the Y Scale when the Y scale is in dB units (for example, power), or to the max(abs(top), abs(bottom)) when the Y scale reference is not at the top of the screen.

Not all measurements support **Range Auto/Man**. If **Auto** is not supported in the current measurement, this control is grayed-out, displaying **Man**, and **MAN** is returned to a SCPI query, but this does *not* change the Auto/Man setting for **Range**. When you switch to a measurement that supports **Auto**, it goes back to **Auto** if it was previously in **Auto** mode.

Remote Command	<code>[:SENSe] :VOLTagE :IQ :RANGe :AUTO OFF ON 0 1</code> <code>[:SENSe] :VOLTagE :IQ :RANGe :AUTO?</code>
Example	Put the I Range and Q Range in manual <code>:VOLT :IQ :RANG :AUTO OFF</code> <code>:VOLT :IQ :RANG :AUTO?</code>
Dependencies	If Auto is not supported, sending the SCPI command generates an error
Couplings	When in Auto , both I Range and Q Range are set to the same value, computed as follows: Maximum absolute value is computed for the Y Scale. The top and bottom of the graph are computed based on Ref Value, Scale/Div, and Ref Position. Formula: $Y_{Max} = \max(\text{abs}(\text{top}), \text{abs}(\text{bottom}))$ The I Range and Q Range are then set to Y_{Max}
Preset	ON
State Saved	Saved in instrument state
Annotation	When in Man, the Range annotation is preceded by "#" This is an alternate form of the command to match the POWer form of the I Range and Q Range SCPI.
Remote Command	<code>[:SENSe] :POWer :IQ :RANGe :AUTO OFF ON 0 1</code> <code>[:SENSe] :POWer :IQ :RANGe :AUTO?</code>
Example	Put the I Range and Q Range in manual <code>:POW :IQ :RANG :AUTO OFF</code> <code>:POW :IQ :RANG :AUTO?</code>
Notes	<code>:POW :IQ :RANG :AUTO</code> is an alternate form of <code>:VOLT :IQ :RANG :AUTO</code> , to maintain consistency with I Range and Q Range, which support both the POWer and VOLTagE forms of the command
Preset	ON
Range	Auto Man

I Range

The internal gain range for the I channel when the Input Path is I Only or I and I/Q. Used for both the I and Q channels when the Input Path is I+jQ.

Remote Command	<code>[:SENSe]:VOLTagE:IQ[:I]:RANGe[:UPPer] <voltage></code> <code>[:SENSe]:VOLTagE:IQ[:I]:RANGe[:UPPer]?</code>
Example	Set the I Range to 0.5 V Peak <code>:VOLT:IQ:RANG 0.5 V</code> <code>:VOLT:IQ:RANG?</code>
Notes	The numeric entries are mapped to the smallest gain range whose break point is greater than or equal to the value, or 1 V Peak if the value is greater than 1 V
Couplings	When " Q Same as I " on page 1782 is On, the I Range value will be copied to " Q Range " on page 1781 Changing the value also sets Range = Man
Preset	Complex SPECTrum Measurement: 0.5 V Peak All others: 1 V Peak
State Saved	Saved in instrument state
Range	1 V Peak (10 dBm @ 50 Ω) 0.5 V Peak (4 dBm @ 50Ω) 0.25 V Peak (-2 dBm @ 50Ω) 0.125 V Peak (-8 dBm @ 50Ω)
Min	0.125 V
Max	1 V
Annotation	The Range annotation replaces the RF Input context's "Atten" annotation "Rng: <I Range>". When Range = Man the annotation is preceded by "#" The I Range is not annotated in Input Path Q Only. When I Range and Q Range are the same, the annotation is "Rng: <Range>". When I Range and Q Range are different and the Input Path is Ind I/Q, the annotation is "Rng: <I Range>, <Q Range>" and "Peak" is removed from the text. Examples: "Rng: 1 V Peak" the I Range is 1 V Peak "Rng: 1 V, 0.5 V" the I Range is 1 V Peak and the Q Range is 0.5 V Peak This is an alternate form of the command to allow entry as a power.
Remote Command	<code>[:SENSe]:POWer:IQ[:I]:RANGe[:UPPer] <amp;l></code> <code>[:SENSe]:POWer:IQ[:I]:RANGe[:UPPer]?</code>
Example	Set the I Range to 0.5 V Peak when Reference Z is 50 Ω, and to 1.0 V Peak when Reference Z is 75 Ω <code>:POW:IQ:RANG 4 dBm</code> <code>:POW:IQ:RANG?</code>
Notes	The POWER form of the command is provided for convenience. It maps to the same underlying gain range parameter as the VOLTagE form The Reference Z (not the I channel Input Z) is used to convert the power to peak voltage, which is then used to set the I Range as with the VOLTagE form of the command. The power values of the 4 range

	states (1V Peak, 0.5V Peak, 0.25V Peak, and 0.125V Peak) will vary with Reference Z. Here are some examples: 50 Ω: 10, 4, -2, -8 75 Ω: 8.2, 2.2, -3.8, -9.8 600 Ω: -0.8, -6.8, -12.8, -18.9
Preset	10.0 dBm
Range	-20 dBm to 10 dBm
Min	-20 dBm
Max	10 dBm

Q Range

The internal gain range for the Q channel. **Q Range** only applies to Input Path Q Only and Ind I/Q. For input I+jQ "[I Range](#)" on page 1779 determines both I and Q channel range settings.

Remote Command	<code>[:SENSe]:VOLTage:IQ:Q:RANGe[:UPPer] <voltage></code> <code>[:SENSe]:VOLTage:IQ:Q:RANGe[:UPPer]?</code>
Example	Set the Q Range to 0.5 V Peak: <code>:VOLT:IQ:Q:RANG 0.5 V</code> <code>:VOLT:IQ:Q:RANG?</code>
Notes	The numeric entries are mapped to the smallest gain range whose break point is greater than or equal to the value, or 1 V Peak if the value is greater than 1 V Q Range is only used for Input Path Q Only and Ind I/Q. For input I+jQ, " I Range " on page 1779 determines both I and Q channel range settings
Couplings	When " Q Same as I " on page 1782 is On, the " I Range " on page 1779 value is copied to Q Range and the range value keys are disabled Changing the value also sets Range = Man
Preset	1 V Peak
State Saved	Saved in instrument state
Range	1 V Peak (10 dBm @ 50Ω) 0.5 V Peak (4 dBm @ 50Ω) 0.25 V Peak (-2 dBm @ 50Ω) 0.125 V Peak (-8 dBm @ 50Ω)
Min	0.125 V
Max	1 V
Annotation	The Range annotation replaces the RF Input context's "Atten" annotation "Rng: <Q Range>". When Range = Man the annotation is preceded by "#" The Q Range is not annotated in Input Path I Only or I+jQ. When I Range and Q Range are the same, the annotation is "Rng: <Range>". When I Range and Q Range are different and the Input Path is Ind I/Q, the annotation is "Rng: <I Range>, <Q Range>" and "Peak" is removed from the text. Examples: "Rng: 1 V Peak" the Q Range is 1 V Peak

3 VMA Mode
3.1 Digital Demod Measurement

"Rng: 1 V, 0.5 V " the I Range is 1 V Peak and the Q Range is 0.5 V Peak

This is an alternate form of the command to allow entry as a power.

Remote Command	<code>[:SENSe] :POWer :IQ :Q :RANGe [:UPPer] <amp;1></code> <code>[:SENSe] :POWer :IQ :Q :RANGe [:UPPer] ?</code>
Example	Sets the Q Range to 0.5 V Peak when Reference Z is 50 Ω , and to 1.0 V Peak when Reference Z is 75 Ω : <code>:POW:IQ:Q:RANG 4 dBm</code> <code>:POW:IQ:Q:RANG?</code>
Notes	The POWer form of the command is provided for convenience. It maps to the same underlying gain range parameter as the VOLTage form of the command The Reference Z (not the Q channel Input Z) is used to convert the power to peak voltage, which is then used to set the Q Range as with the VOLTage form of the command. The power values of the 4 range states (1V Peak, 0.5V Peak, 0.25V Peak, and 0.125V Peak) will vary with Reference Z. Here are some examples: 50 Ω : 10, 4, -2, -8 75 Ω : 8.2, 2.2, -3.8, -9.8 600 Ω : -0.8, -6.8, -12.8, -18.9
Preset	10.0 dBm
Range	-20 dBm to 10 dBm
Min	-20 dBm
Max	10 dBm

Q Same as I

Many, but not all, usages require the I and Q channels to have an identical setup. To simplify channel setup, **Q Same as I** causes the Q channel range to be mirrored from the I channel. That way, you only need to set up one channel (the I channel). The I channel values are copied to the Q channel, so at the time **Q Same as I** is Off, the I and Q channel setups will be identical.

Remote Command	<code>[:SENSe] :VOLTagE POWer :IQ :MIRROred OFF ON 0 1</code> <code>[:SENSe] :VOLTagE POWer :IQ :MIRROred?</code>
Example	Turn off the mirroring of I Range to Q Range <code>:VOLT:IQ:MIRR OFF</code> <code>:POW:IQ:MIRR OFF</code>
Couplings	When ON , the " I Range " on page 1779 value is mirrored (copied) to the " Q Range " on page 1781
Preset	ON
State Saved	Saved in instrument state
Range	OFF ON

3.1.4.5 Signal Path

Contains controls that pertain to the routing of the signal through the frontend of the instrument.

In general, only appears in instruments whose hardware supports this signal routing. For example, this tab does not appear in many of the modular instrument products, including VXT Model M9420A, or UXM.

This tab *does* appear in VXT Models M9410A/11A/15A/16A and M9410E/11E/15E/16E, because ["Software Preselection" on page 1801](#) is under this tab, and VXT Models M9410A/11A/15A/16A and M9410E/11E/15E/16E implement a version of Software Preselection.

Presel Center

Adjusts the centering of the preselector filter to optimize the amplitude accuracy at the frequency of the selected marker. If the selected marker is not on when **Presel Center** is pressed, the instrument turns on the selected marker, performs a peak search, and then performs centering on the marker's center frequency. If the selected marker is already on and between the start and stop frequencies of the instrument, the instrument performs the preselector calibration on that marker's frequency. If the selected marker is already on, but outside the frequency range between **Start Freq** and **Stop Freq**, the instrument first performs a peak search, and then performs centering on the marker's center frequency.

The value displayed on ["Preselector Adjust" on page 1787](#) changes to reflect the new preselector tuning.

Certain considerations should be observed to ensure proper operation, as detailed in ["Proper Preselector Operation" on page 255](#).

Remote Command	<code>[:SENSe] :POWer [:RF] :PCENter</code>
Example	<code>:POW:PCEN</code>
Notes	The rules outlined above under the control description apply for the remote command as well as the key. The result of the command depends on marker position, etc. Any message generated by the control press is also generated in response to the remote command
Dependencies	Does not appear in CXA-m, nor in VXT Models M9410A/11A/15A/16A, M9410E/11E/15E/16E Grayed-out if the microwave preselector is off <ul style="list-style-type: none"> - If the selected marker's frequency is below Band 1, an advisory message is generated "Preselector not used in this frequency range" and no action is taken - Grayed-out if entirely in Band 0, that is, if Stop Freq is below about 3.6 GHz Grayed-out if entirely above 50 GHz, that is, if Start Freq is above 50 GHz - Blanked in models that do not include a preselector, such as Option 503. If the remote command

	is sent in these instruments, accepted without error, and the query always returns 0
	- Grayed-out in the Spectrogram View
Couplings	The active marker position determines where the centering will be attempted If the instrument is in a measurement such as averaging when centering is initiated, the act of centering the preselector restarts averaging, but the first average trace will not be taken until the centering is completed The offset applied to do the centering appears in " Preselector Adjust " on page 1787
Status Bits/OPC dependencies	When centering the preselector, *OPC does not return true until the process is complete and a subsequent measurement has completed, nor are results returned in response to :READ or :MEASure queries The Measuring bit remains set (true) while this command is operating, and does not go false until the subsequent sweep/measurement has completed

Proper Preselector Operation

Certain considerations should be observed to ensure proper operation:

1. If the selected marker is **Off**, the instrument turns on a marker, performs a peak search, and adjusts the preselector using the selected marker's frequency. It uses the "highest peak" peak search method unqualified by threshold or excursion, so that there is no chance of a 'no peak found' error. It continues with that peak, even if it is the peak of just noise. Therefore, for this operation to work properly, there should be a signal on-screen in a preselected range for the peak search to find
2. If the selected marker is already **On**, the instrument attempts the centering at that marker's frequency. There is no preselector for signals below about 3.6 GHz, so if the marker is on a signal below 3.6 GHz, no centering is attempted, and an advisory message is generated
3. In some models, the preselector can be bypassed. If it is bypassed, no centering is attempted in that range and a message is generated

Preselector Adjust

Lets you manually adjust the preselector filter frequency to optimize its response to the signal of interest. Only available when "[Presel Center](#)" on page 1786 is available.

For general purpose signal analysis, using **Presel Center** is recommended. Centering the filter minimizes the impact of long-term preselector drift. **Preselector Adjust** can be used instead to manually optimize the preselector. One application of manual optimization would be to peak the preselector response, which both optimizes the signal-to-noise ratio and minimizes amplitude variations due to small (short-term) preselector drifting.

When **Presel Center** is performed, the offset applied to do the centering becomes the new value of **Preselector Adjust**.

Remote Command	<code>[:SENSe]:POWer[:RF]:PADJust <freq></code> <code>[:SENSe]:POWer[:RF]:PADJust?</code>
Example	<code>:POW:PADJ 100KHz</code> <code>:POW:PADJ?</code>
Notes	The value on the control is displayed to 0.1 MHz resolution
Dependencies	<ul style="list-style-type: none"> - Does not appear in CXA-m - Does not appear in VXT Models M9410A/11A/15A/16A - Does not appear in M9410E/11E/15E/16E - Grayed-out if microwave preselector is off - Grayed-out if entirely in Band 0, that is, if Stop Freq is lower than about 3.6 GHz - Grayed-out if entirely above 50 GHz, that is, if Start Freq is higher than 50 GHz - Blank in models that do not include a preselector, such as Option 503. If the command is sent in these instruments, it is accepted without error, and the query always returns 0 - Grayed-out in the Spectrogram View
Preset	0 MHz
State Saved	The Preselector Adjust value set by " Presel Center " on page 1786, or by manually adjusting Preselector Adjust Not saved in instrument state, and does not survive a Preset or power cycle
Min/Max	-/+500 MHz
Backwards Compatibility SCPI	<code>[:SENSe]:POWer[:RF]:MW:PADJust</code> <code>[:SENSe]:POWer[:RF]:MMW:PADJust</code> Backwards Compatibility Command
Notes	The command has no effect, and the query always returns <code>MWAVE</code>
Backwards Compatibility SCPI	<code>[:SENSe]:POWer[:RF]:PADJust:PRESelector MWAVE MMWave EXTernal</code> <code>[:SENSe]:POWer[:RF]:PADJust:PRESelector?</code>

Internal Preamp

Accesses a menu of controls for the internal preamps. Turning on the preamp gives a better noise figure, but a poorer inter-modulation distortion (TOI) to noise floor dynamic range. You can optimize this setting for your measurement.

3 VMA Mode

3.1 Digital Demod Measurement

The instrument takes the preamp gain into account as it sweeps. If you sweep outside of the range of the preamp, the instrument will also account for that. The displayed result always reflects the correct gain.

For some measurements, when the preamp is on and any part of the displayed frequency range is below the lowest frequency for which the preamp has specifications, a warning condition message appears in the status line. For example, for a preamp with a 9 kHz lowest specified frequency: "Preamp: Accy unspec'd below 9 kHz".

Selection	Example	Note
Off	:POW:GAIN OFF	
Low Band	:POW:GAIN ON :POW:GAIN:BAND LOW	Sets the internal preamp to use only the low band. The frequency range of the installed (optional) low-band preamp is displayed in square brackets on the Low Band selection in the dropdown
Full Range	:POW:GAIN ON :POW:GAIN:BAND FULL	Sets the internal preamp to use its full range. The low band (0-3.6 GHz, 0-3.4 GHz, 0-3 GHz, depending on the model) is supplied by the low band preamp and the frequencies above low band are supplied by the high band preamp The frequency range of the installed (optional) low-band preamp is displayed in square brackets on the Full Range selection in the dropdown. If the high band option is not installed the Full Range selection does not appear

NOTE

The maximum **Center Frequency for Low Band**, displayed in square brackets, can change based on the selected IFBW for measurements that support IFBW (for example, Waveform measurement across all Modes that support it). In certain models (such as N9042B & N9032B), IFBW values ≤ 40 MHz have a maximum **Low Band** frequency of 3.6 GHz, while $40 \text{ MHz} < \text{IFBW} \leq 1 \text{ GHz}$ have a maximum of 3.3 GHz, and $1 \text{ GHz} < \text{IFBW} \leq 1.5 \text{ GHz}$ have a maximum of 3.5 GHz. IFBW values $> 1.5 \text{ GHz}$ do not support a **Center Frequency** that can reach the **Low Band** maximum frequency. In these cases, **N/A** is displayed in the square brackets for **Low Band**.

Remote Command `[:SENSe]:POWer[:RF]:GAIN:BAND LOW | FULL`
`[:SENSe]:POWer[:RF]:GAIN:BAND?`

Example `:POW:GAIN:BAND LOW`
`:POW:GAIN:BAND?`

Dependencies Not available on all hardware platforms. If the preamp is not present or is unlicensed, this control is not shown
Does not appear in VXT Models M9410A/11A/15A/16A nor in M9410E/11E/15E/16E
If `:POW:GAIN:BAND FULL` is sent when a low band preamp is available, the preamp band parameter is set to `LOW` instead of `FULL`, and an "Option not installed" message is generated

	Not available when the electronic/soft attenuator is enabled
Preset	LOW
State Saved	Saved in instrument state
Annotation	<p>When the USB Preamp is not connected to USB, the Preamp annotation in the Meas Bar says “Off” if the preamp is off and displays the frequency range of the low band or full range preamp depending on the setting. For example, if the Preamp is set to Low Band and the Low Band is 3.6 GHz the annotation says “3.6 GHz”. If it is a 13.6 GHz preamp and it is set to Full Range the annotation says “13.6 GHz”</p> <p>When the USB Preamp is connected to USB, the Preamp annotation says “Preamp: USB” if the internal preamp is off or “Preamp: USB, Int” if the internal preamp is on (only for measurements that support the USB preamp)</p>
	Auto Function
Remote Command	[:SENSe]:POWer[:RF]:GAIN[:STATe] OFF ON 0 1 [:SENSe]:POWer[:RF]:GAIN[:STATe]?
Example	:POW:GAIN OFF :POW:GAIN?
Preset	OFF

LNA

Lets you turn the Low Noise Amplifier (LNA) on or off.

LNA is an additional preamplifier that provides superior DANL and frequency range compared to ["Internal Preamp" on page 1788](#). LNA provides lower system noise figure, especially at frequencies above 100 MHz, and can be operated up to the full range of 50 GHz instruments.

For best possible sensitivity, LNA can be turned on *together* with ["Internal Preamp" on page 1788](#), although if you operate both preamps together, note that the TOI (distortion) specifications are impacted. The sensitivity improvement of this combination is substantial when operating in high band (frequencies above 3.6 GHz).

For more details about annotation, see ["More Information" on page 259](#)

Remote Command	[:SENSe]:POWer[:RF]:GAIN:LNA[:STATe] OFF ON 0 1 [:SENSe]:POWer[:RF]:GAIN:LNA[:STATe]?
Example	:POW:GAIN:LNA ON
Dependencies	<p>Requires Option LNA, except for VXT models M9415A/16A</p> <p>Does not appear in VXT models M9420A/10A/11A</p> <p>M9410E/11E/15E/16E support LNA</p> <p>May not appear in some measurements</p> <p>LNA is not available when the electronic/soft attenuator is enabled</p>

3 VMA Mode

3.1 Digital Demod Measurement

Preset	OFF
State Saved	Saved in State

More Information

When **LNA** is installed, the preamp annotation changes to show the state of both **LNA** and **Internal Preamp**. Below is an example:

```
Atten: 8 dB
Pre: Int on, LNA on
μW Path: LNP, On
Source: Off
```

Note that when operating entirely in the low band (below about 3.6 GHz), if **LNA** is on, **Internal Preamp** is switched off (even if you have its switch set to **ON**). This is because the noise performance is actually degraded in low band if both preamps are on. In this case, the annotation reflects the actual state of the two preamps, but the **Internal Preamp** annotation displays in amber, to warn you that the actual state of **Internal Preamp** does not match its switch control display:

```
Atten: 8 dB
Pre: Int off, LNA on
μW Path: LNP, On
Source: Off
```

μW Path Control

Options for this control include **μW Preselector Bypass** (Option MPB), **Low Noise Path** (Option LNP) and **Full Bypass Enable** in the High Band path circuits.

When the μW Preselector is bypassed, flatness is improved, but will be subject to spurs from out of band interfering signals. When **Low Noise Path Enable** is selected, the instrument automatically bypasses certain circuitry in the high frequency bands that can contribute to noise, when it is appropriate based on other instrument settings.

For most applications, the preset state is **Standard Path**, which provides the best remote-control throughput, minimizes acoustic noise from switching and minimizes the risk of wear in the hardware switches, particularly in remote test scenarios where both low band and high band setups will follow in rapid succession. In this path, the bypass of the low band/high band switch and microwave preamp is never activated, which can cause some noise degradation but preserves the life of the bypass switch.

For applications that utilize the wideband IF paths, the preset state is **μW Preselector Bypass**, if option MPB is present. This is because, when using a wideband IF such as the 140 MHz IF, the μW Preselector's bandwidth can be narrower than the available IF bandwidth, causing degraded amplitude flatness and phase linearity, so it is desirable to bypass the preselector in the default case.

You may choose **Low Noise Path Enable** for a lower noise floor, especially in the 21–26.5 GHz region, though without improving many measures of dynamic range, and without giving the best possible noise floor. The preamp, if purchased and used, gives better noise floor than does **Low Noise Path Enable**, but the preamp’s compression threshold and third-order intercept are much poorer than that of **Low Noise Path Enable**.

A fourth choice is **Full Bypass Enable**, which combines **μW Preselector Bypass** and **Low Noise Path Enable**. Because this can bypass most of the circuitry between the input and the first mixer, care should be taken when using this setting to avoid damaging the mixer. **Full Bypass Enable** is only available if both options LNP and MPB are present, as well as option FBP.

Path	Example	Note
Standard Path	:POW:MW:PATH STD	Normal setting for most measurements. μW Preselector in circuit, Low Noise Path disabled
Low Noise Path Enable	:POW:MW:PATH LNP	See " Low Noise Path Enable " on page 264
μW Preselector Bypass	:POW:MW:PATH MPB	See " μW Preselector Bypass " on page 266
Full Bypass Enable	:POW:MW:PATH FULL	See " Full Bypass Enable " on page 266

Remote Command	<code>[:SENSe] :POWer [:RF] :MW:PATH STD LNPath MPBypass FULL</code> <code>[:SENSe] :POWer [:RF] :MW:PATH?</code>
Example	<code>:POW:MW:PATH LNP</code> Enables the Low Noise path <code>:POW:MW:PATH?</code>
Notes	When " Presel Center " on page 1786 is performed, the instrument momentarily switches to the Standard Path, regardless of the setting of μW Path Control The DC Block will always be switched in when the low noise path is switched in, to protect succeeding circuitry from DC. Note that this does not mean “when the low noise path is enabled” but when, based on the Low Noise Path rules, the path is actually switched in. This can happen when the selection is Low Noise Path Enable or Full Bypass Enable . In the case where the DC Block is switched in, the instrument is now AC-coupled. However, if you selected DC coupling, the UI would still behave as though it were DC-coupled, including all annunciation, warnings, status bits, and responses to SCPI queries. This is because, based on other settings, the instrument could switch out the low noise path at any time and hence go back to being DC-coupled Alignment switching ignores the settings in this menu, and restores them when finished
Dependencies	Does not appear in CXA-m, VXT Models M9410A/11A/15A/16A, nor in M9410E/11E/15E/16E, BBIQ and External Mixing <ul style="list-style-type: none"> – The Low Noise Path Enable selection does not appear unless Option LNP is present and licensed – The μW Preselector Bypass selection does not appear unless Option MPB is present and licensed – The Full Bypass Enable selection does not appear unless options LNP and MPB are both present

3 VMA Mode
 3.1 Digital Demod Measurement

as well as option FBP

In any of these cases, if the required options are not present and the SCPI command is sent, error - 241, "Hardware missing; Option not installed" is generated

Low Noise Path Enable and **Full Bypass Enable** are grayed-out if the current measurement does not support them

Low Noise Path Enable and **Full Bypass Enable** are not supported in Avionics and MMR Modes (non-modulation measurements). In any of these cases (that is, the feature is not supported in either measurement or Mode), if the SCPI command is sent, the following error is generated: -221, "Setting Conflict; Feature not supported for this measurement"

Preset	Mode	Value
	IQ Analyzer	MPB option present and licensed: MPB
	Pulse	MPB option not present and licensed: STD
	RTSA	
	Avionics	
	All other Modes	STD
	-	

State Saved Save in instrument state

Range Standard Path | Low Noise Path Enable | μ W Presel Bypass | Full Bypass Enable

Annotation In the Meas Bar, if the Standard path is chosen:
 μ W Path: Standard
 If Low Noise Path is enabled but the LNP switch is not thrown:
 μ W Path: LNP,Off
 If the Low Noise Path is enabled and the LNP switch is thrown:
 μ W Path: LNP,On
 If the preselector is bypassed:
 μ W Path: Bypass
 If Full Bypass Enable is selected but the LNP switch is not thrown:
 μ W Path: FByp,Off
 If Full Bypass Enable is selected and the LNP switch is thrown:
 μ W Path: FByp,On

μ W Path Control Auto

In VMA, WLAN, 5G NR, CQM Modes, an **Auto/Man** switch is added to **μ W Path Control**:



This allows the function to automatically switch based on certain Auto Rules as shown below:

VMA Mode

Measurement	μW Path Control Auto behavior
Digital Demod	Use Standard Path unless tuned frequency > 3.6 GHz and IFBW > 15 MHz, in which case choose Preselector Bypass
Monitor Spectrum	Always Presel Bypass
IQ Waveform	Use Standard Path unless tuned frequency > 3.6 GHz and IFBW > 15 MHz, in which case choose Preselector Bypass
Custom OFDM	Use Standard Path unless tuned frequency > 3.6 GHz and IFBW > 15 MHz, in which case choose Preselector Bypass
Channel Power	Always Presel Bypass
Occupied BW	Always Presel Bypass
CCDF	Use Standard Path unless tuned frequency > 3.6 GHz and IFBW > 15 MHz, in which case choose Preselector Bypass
ACP	Always Presel Bypass
SEM	Always Presel Bypass
Spurious Emissions	Always Standard Path

WLAN Mode

Measurement	μW Path Control Auto behavior
Modulation Analysis	Always Presel Bypass
Spectral Flatness	Always Presel Bypass
Power vs Time	Always Presel Bypass
Monitor Spectrum	Always Presel Bypass
IQ Waveform	Always Presel Bypass
Channel Power	Always Presel Bypass
Occupied BW	Always Presel Bypass
CCDF	Always Presel Bypass
SEM	For 11be 320M, when 'Enabled Wideband IF for FFT' is OFF or 'Sweep Type

3 VMA Mode
 3.1 Digital Demod Measurement

Measurement	μ W Path Control Auto behavior
	Rule' is Best Dynamic Range, auto μ W path is standard For other cases, auto μ W path is preselect bypass if preselect bypass is enabled, auto μ W path is standard if preselect bypass is not enabled
Spurious Emissions	Always Standard Path

5G NR Mode

Measurement	μ W Path Control Auto behavior
Modulation Analysis	Use Standard Path unless tuned frequency > 3.6 GHz and IFBW > 15 MHz, in which case choose Full Bypass if conditions warrant(FBP Option is available and "Allow Full Bypass in Auto" is On), otherwise choose Preselector Bypass
Monitor Spectrum	Always Standard Path
IQ Waveform	Use Standard Path unless tuned frequency > 3.6 GHz and IFBW > 15 MHz, in which case choose Full Bypass if conditions warrant(FBP Option is available and "Allow Full Bypass in Auto" is On), otherwise choose Preselector Bypass
Channel Power	Always Standard Path
Occupied BW	Always Standard Path
CCDF	Use Standard Path unless tuned frequency > 3.6 GHz and IFBW > 15 MHz, in which case choose Preselector Bypass
ACP	Always Standard Path
SEM	Always Standard Path
Spurious Emissions	Always Standard Path
Transmit On Off Power	Use Standard Path unless tuned frequency > 3.6 GHz and Info BW > 15 MHz, in which case choose Preselector Bypass

Channel Quality Mode

Measurement	μ W Path Control Auto behavior
Group Delay	Use Standard Path unless tuned frequency > 3.6 GHz and IFBW > 15 MHz, in which case choose Full Bypass if conditions warrant(FBP Option is available and "Allow Full Bypass in Auto" is On), otherwise choose Preselector Bypass
Monitor Spectrum	Always Standard Path
IQ Waveform	Use Standard Path unless tuned frequency > 3.6 GHz and IFBW > 15 MHz, in which case choose Preselector Bypass
CCDF	Use Standard Path unless tuned frequency > 3.6 GHz and IFBW > 15 MHz, in which case choose Preselector Bypass

Remote Command `[:SENSe]:POWer[:RF]:MW:PATH:AUTO ON | OFF | 1 | 0`
`[:SENSe]:POWer[:RF]:MW:PATH:AUTO?`

Example `:POW:MW:PATH:AUTO ON`

	<code>:POW:MW:PATH:AUTO?</code>
Dependencies	Only appears in VMA, WLAN, 5G NR and CQM Modes
Couplings	See " μW Path Control Auto " on page 261 above
Preset	ON
Range	ON OFF

Low Noise Path Enable

Low Noise Path Enable provides a lower noise floor under some circumstances, particularly when operating in the 21–26.5 GHz region. With the Low Noise Path enabled, the low band/high band switch and microwave preamp are bypassed whenever *all* the following are true:

- The instrument is not in the Low Band, meaning:
- the start frequency is above 3.5 GHz and
- the stop frequency is above 3.6 GHz
- The internal preamp is not installed, or if installed, is set to **Off** or **Low Band**

Note that this means that, when any part of a sweep is done in Low Band, the Low Noise Path is not used, whether or not the **Low Noise Path Enable** is selected in the user interface. Also, if the preamp is turned on, the Low Noise Path is not used, whether or not the **Low Noise Path Enable** is selected in the user interface. The only time the Low Noise Path is used is when **Low Noise Path Enable** is selected, the sweep is completely in High Band (> 3.6 GHz) and no preamp is in use.

For measurements that use IQ acquisition, the low noise path is used when **Center Frequency** is in High Band (> 3.6 GHz) and no preamp is in use. In other words, the rules above are modified to use only the center frequency to qualify which path to switch in. This is not the case for FFTs in the Swept SA measurement; they use the same rules as swept measurements.

Note that the Low Noise Path, while giving improved DANL, has the disadvantage of decreased TOI performance and decreased gain compression performance relative to the standard path.

Note also that the bypass switch is a mechanical switch and has finite life, so if the **Low Noise Path Enable** is selected, it is possible to cause frequent cycling of this switch by frequently changing instrument settings such that the above conditions hold true only some of the time. A user making tests of this nature should consider opting for the **Standard Path**, which will never throw the bypass switch, at the expense of some degraded noise performance.

The low noise path is useful for situations where the signal level is so low that the instrument performance is dominated by noise even with 0 dB attenuation, but still

3 VMA Mode
3.1 Digital Demod Measurement

high enough that the preamp option would have excessive third-order intermodulation or compression. The preamp, if purchased and used, gives better noise floor than does the “Low Noise Path.” However, its compression threshold and third-order intercept are much poorer than that of the non-preamp path.

There are some applications, typically for signals around -30 dBm, for which the third-order dynamic range of the standard path is good enough, but the noise floor is not low enough even with 0 dB input attenuation. When the third-order dynamic range of the preamp path is too little and the noise floor of the standard path is too high, the Low Noise Path can provide the best dynamic range

The graph below illustrates the concept. It shows, in red, the performance of an instrument at different attenuation settings, both with the preamp on and off, in a measurement that is affected by both instrument noise and instrument TOI. The green shows the best available dynamic range, offset by 0.5 dB for clarity. The blue shows how the best available dynamic range improves for moderate signal levels with the low noise path switched in. In this illustration, the preamp improves the noise floor by 15 dB while degrading the third-order intercept by 30 dB, and the low noise path reduces loss by 8 dB. The attenuator step size is 2 dB.

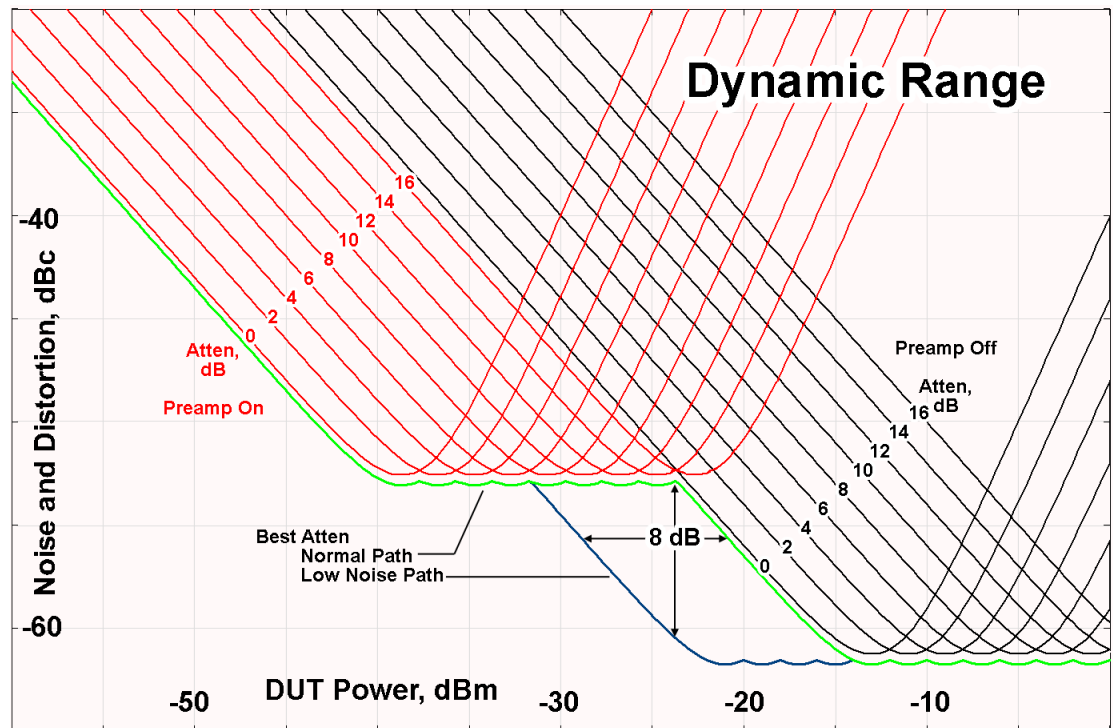

There are other times where selecting the low noise path improves performance, too. Compression-limited measurements such as finding the nulls in a pulsed-RF spectrum can profit from the low noise path in a way similar to the TOI-limited measurement illustrated. Accuracy can be improved when the low noise path allows the optimum attenuation to increase from a small amount like 0, 2 or 4 dB to a larger

amount, giving better return loss at the instrument input. Harmonic measurements, such as second and third harmonic levels, are much improved using the low noise path because of the superiority of that path for harmonic (though not intermodulation) distortion performance.

μW Preselector Bypass

Toggles the preselector bypass switch for band 1 and higher. When the microwave preselect is on, the signal path is preselected. When the microwave preselector is off, the signal path is not preselected. The preselected path is the normal path for the instrument.

The preselector is a tunable bandpass filter which prevents signals away from the frequency of interest from combining in the mixer to generate in-band spurious signals (images). The consequences of using a preselector filter are its limited bandwidth, the amplitude and phase ripple in its passband, and any amplitude and phase instability due to center frequency drift.

Option MPB or pre-selector bypass provides an unpreselected input mixer path for certain X-Series signal analyzers with frequency ranges above 3.6 GHz. This signal path allows a wider bandwidth and less amplitude variability, which is an advantage when doing modulation analysis and broadband signal analysis. The disadvantage is that, without the preselector, image signals will be displayed. Another disadvantage of bypassing the preselector is increased LO emission levels at the front panel input port.

Image responses are separated from the real signal by twice the 1st IF. For IF Paths of 10 MHz and 25 MHz, the 1st IF is 322.5 MHz, so the image response and the real signal will be separated by 645 MHz. The 1st IF will be different for other IF Path settings. When viewing a real signal and its corresponding image response in internal mixing, the image response will be to the left of the real signal.

Also, the image response and the real signal typically have the same amplitude and exhibit the same shape factor.

However, if Option FS1 (Fast Sweep Capability) is enabled, the image response in the Swept SA measurement appears lower in amplitude and has a much wider shape factor compared to the real signal.

Full Bypass Enable

With **Full Bypass Enable** selected, the microwave preselector is bypassed. In addition, the low band/high band switch and microwave preamp are bypassed whenever *all* the following are true:

- The instrument is not in the Low Band, meaning:
- the start frequency is above 3.5 GHz and

3 VMA Mode
 3.1 Digital Demod Measurement

- the stop frequency is above 3.6 GHz.
- the internal preamp is not installed or if installed, is set to **Off** or **Low Band**

Note that this means that, when any part of a sweep is done in Low Band, the Low Noise Path is not used, whether or not the **Full Bypass Enable** is selected in the user interface. Also, if the preamp is turned on, the Low Noise Path is not used, whether or not the **Full Bypass Enable** is selected in the user interface. The only time the Low Noise Path is used is when **Full Bypass Enable** is selected, the sweep is completely in High Band (> 3.6 GHz) and no preamp is in use.

CAUTION

When **Full Bypass Enable** is selected, and "**Y Scale**" on page 1760 is set to 0 dB, there will be a direct AC connection between the input and the first converter when the Low Noise Path switches in (when Start Freq >3.6 GHz and the Preamp is either not licensed, set to Low Band, or Off). This puts the first converter at considerable risk to be damaged by high AC power. Consequently, whenever **Full Bypass Enable** is selected, a warning message appears in the status bar:

“Full Bypass Enabled, maximum safe input power reduced”

Microwave Preselector Bypass Backwards Compatibility

Example	Bypass the microwave preselector: :POW:MW:PRES OFF
Notes	Included for Microwave Preselector Bypass backwards compatibility The ON parameter sets the STD path (:POW:MW:PATH STD) The OFF parameter sets path MPB (:POW:MW:PATH MPB)
Preset	ON
Backwards Compatibility SCPI	[[:SENSe]:POWer[:RF]:MW:PRESelector[:STATe] ON OFF 0 1 [:SENSe]:POWer[:RF]:MW:PRESelector[:STATe]?

Frequency Extender Preselection Bypass

Only applies to the high frequency path of the Frequency Extender, and only if the Frequency Extender allows it. For example, the V3050A high frequency path is 50 – 110 GHz and *does* allow control of the preselector bypass.

When the Frequency Extender’s preselection is bypassed, flatness is improved, but will be subject to spurs from out-of-band interfering signals. For bandwidths greater than 2.5 [GHz], it is recommended that the signal bypass the Frequency Extender Preselector since the max bandwidth of the Preselector can be as narrow as 2.5 [GHz].

For most applications, the preset state is **OFF**, which gives the best remote-control throughput, minimizes acoustic noise from switching, minimizes out of band spurs, and minimizes the risk of wear in the hardware switches.

Preselector and Bandwidth Conflict

When the Frequency Extender Preselector is applied and the signal bandwidth is greater than 2.5 [GHz], then a settings alert message will show to warn the user that the signal may be distorted due to the limitation of the Frequency Extender Preselector bandwidth.

An example of the settings alert message is shown below.

Settings Alert message in the Status Bar at the bottom of the display.



Settings Alert message in the error queue

Type	ID	
	159	Settings Alert - DETECTED; Presel/Meas BW conflict

Allow Full Bypass in Auto

Enable or disable Full Bypass in μ W Path Auto rule. See "[μW Path Control](#)" on page 1791.

When this function is **ON**, and "[μW Path Control](#)" on page 1791 is in **AUTO**, it is possible for the auto rules to select the **FULL** Bypass state, which bypasses both the Preamp and the Microwave Preselector. Otherwise, the auto rules never select the **FULL** Bypass state. This is convenient when making wideband measurements, but it also adds some risk of damage to the first converter.

CAUTION

When **Full Bypass Enable** is selected, and "[Y Scale](#)" on page 1760 is set to 0 dB, there will be a direct AC connection between the input and the first converter when the Low Noise Path switches in (when Start Freq > 3.6 GHz and the Preamp is either not licensed, set to **Low Band** or **Off**). This puts the first converter at considerable risk to be damaged by high AC power. Consequently, whenever **Full Bypass Enable** is selected, a warning message appears in the status bar:

“Full Bypass Enabled, maximum safe input power reduced”

Remote Command	<code>[:SENSe]:POWer[:RF]:MW:PATH:AUTO:FULL ON OFF 1 0</code> <code>[:SENSe]:POWer[:RF]:MW:PATH:AUTO:FULL?</code>
Example	<code>:POW:MW:PATH:AUTO:FULL ON</code> <code>:POW:MW:PATH:AUTO:FULL?</code>
Dependencies	Only appears if Option FBP is installed, and in the following measurements <ul style="list-style-type: none"> - 5GNRMode: Modulation Analysis and IQ Waveform - WLAN Mode: IQ Waveform - Channel Quality Mode: Group Delay and Noise Power Ratio
Preset	<code>OFF</code>
State Saved	Saved in instrument state

Software Preselection

Provided in some instruments, either to compensate for issues with provided hardware preselection or to provide the preselection function when there is no hardware preselector.

N9041B

Software Preselection compensates for the frequency range limit of the microwave preselector. Since the microwave preselector only goes up to 50 GHz, software preselection must be used to suppress and separate images above 50 GHz. The specific algorithm used for software preselection is specified by the SW Preselection Type selection – Normal or Advanced.

In N9041B, **Software Preselection** only applies for frequencies above 50 GHz, therefore it is only used for RF Input 2. Even if turned on, it is not used for other inputs, and never for frequencies below 50 GHz. This is why the label of this control contains the parenthetical note “(>~50 GHz)”.

Note that in N9041B, in Swept SA measurement, **Software Preselection** works even if the measurement is using an FFT Sweep Type. In measurements other than Swept SA, Software Preselection is not used if the measurement is using an FFT sweep type.

N9042B+V3050A

Software Preselection compensates for the frequency range limit of the microwave preselector. Since the microwave preselector only goes up to 50 GHz, software preselection must be used to suppress and separate images above 50 GHz. The

specific algorithm used for software preselection is specified by the SW Preselection Type selection – Normal or Advanced.

For N9042B+V3050A, Software Preselection only applies for frequencies above 50 GHz, therefore it is only used for External RF. Even if it is turned on, it will not be used for other inputs and never for frequencies below 50 GHz. This is why the label of this control contains the parenthetical note “(>~50 GHz)”.

Note that for N9042B+V3050A, in the Swept SA measurement, Software Preselection works even if the measurement is using an FFT Sweep Type. In measurements other than Swept SA, Software Preselection is not used if the measurement is using an FFT Sweep Type.

VXT models M9410A/11A/15A/16A

Software Preselection is used to provide the preselection function, as there is no hardware preselector in these models. Two background traces are taken and compared point by point, and the point with the lowest amplitude from the two traces is used. This provides a method to reduce spurs that are internally generated within the VXT, but you should note the following when using Software Preselection:

- There is some speed cost due to the need to take multiple captures
- Taking the point with the lowest amplitude in each trace will make the average noise level lower at all points that do not have a spur. This can reduce the accuracy of the measurement of noise and noise-like signals

Because of the difficulty in identifying spurs manually, you are recommended to leave Software Preselection **ON** at all times in VXT models M9410A/11A. If you turn it off in order to speed up your measurement or improve noise accuracy, be aware of unwanted onscreen spurs.

Remote Command	<code>[:SENSe]:POWer[:RF]:SWPreSel:STATe 0 1 ON OFF</code> <code>[:SENSe]:POWer[:RF]:SWPreSel:STAT?</code>
Example	<code>:POW:SWPR:STAT 1</code> <code>:POW:SWPR:STAT?</code>
Dependencies	Only appears in N9041B, N9042B+V2050A, VXT models M9410A/11A and M9410E/11E. Does not appear in all measurements
Couplings	Affects Sweep Time Auto Tune supports Software Preselection , so Auto Tune should be performed after setting the Software Preselection state
Preset	N9041B OFF N9042B+V3050A ON M9410A/11A ON

State Saved	Saved in instrument state
-------------	---------------------------

SW Preselection Type

Specifies the algorithm used for software preselection.

Two hidden sweeps occur in succession. The second sweep is offset in LO frequency by $2 * IF / N$. For each point in each trace, the smaller amplitude from the two traces is taken and placed in that point in the selected trace. The Peak detector is auto-selected to improve the image suppression effectiveness. Responses of each trace that lie on top of one another will remain and are valid signals. Other signals are images, which are suppressed. The action of taking the smaller of the two traces will make the average noise level lower in all points that do not have an image, thus reducing the accuracy of the measurement of noise and noise-like signals.

- **NORMa1** - mathematically removes all image and multiple responses of signals present at the input
- **ADVanced** - any trace processing (such as “max hold” or trace averaging) is performed on the points of both candidate traces before the “select minimum” operation occurs. This form of processing works better for non-stationary signals, such as pulsed-RF signals

Remote Command	<code>[:SENSe]:POWer[:RF]:SWPreSel NORMa1 ADVanced</code> <code>[:SENSe]:POWer[:RF]:SWPreSel?</code>
Example	<code>:POW:SWPR NORM</code> <code>:POW:SWPR?</code>
Dependencies	Only appears in N9041B and N9042B+V3050A. Only appears in measurements that use the Swept method Grayed-out when " Software Preselection " on page 1801 is OFF. The grayout message is “Unavailable unless SW Presel enabled”
Preset	N9041B ADVanced N9042B+V3050A NORMa1

State Saved	Saved in instrument state
-------------	---------------------------

SW Preselection BW

Specifies the effective bandwidth to be used for Software Preselection.

The options are:

- **NORMa1** – when making Swept measurements, a software preselection algorithm is used which takes up to 4 background acquisitions, then post-processes the result. This algorithm can remove images from signals with an occupied bandwidth up to around 3 GHz. (Default/Preset setting). When making FFT measurements, this algorithm is not used, instead the same algorithm is used as for **NARRow** (below)
- **NARRow**– a software preselection algorithm is used which takes two background acquisitions, then post-processes the result to detect and remove images from wideband signals with occupied bandwidths up to 2 GHz. This increases the risk of images failing to be rejected, but improves the measurement speed

Remote Command	<code>[:SENSe]:POWer[:RF]:SWPResel:BW NORMa1 NARRow</code> <code>[:SENSe]:POWer[:RF]:SWPResel:BW?</code>
Example	<code>:POW:SWPR:BW NARR</code>
Dependencies	Only appears in N9041B and N9042B+V3050A. Only appears in measurements that use the Swept method Grayed-out when "Software Preselection" on page 1801 is OFF . The grayout message is "Unavailable unless SW Presel enabled" For N9042B+V3050A, the parameter is SCPI-only, and always set to NARRow when Software Preselection is enabled
Preset	N9041B NORMa1 N9042B+V3050A NARRow
State Saved	Saved in instrument state

High Freq Prefilter

Lets you set the state of Prefilter for center frequencies above 1310 MHz.

In VXT Models M9410A/11A and M9410E/11E in bypass frequency range (1310MHz~5GHz), the Receiver RF path has a bank of filters that come after the RF Attenuator in the signal path. Since this bank of filters precedes the mixer they are known as the "Prefilter" bank. Their purpose is to eliminate unwanted in-band mixing products by filtering out all but the desired frequencies before the signals get to the mixer. There are 13 prefilter bands to cover the frequencies between 9 kHz and 6000 MHz. The Prefilter provides the necessary rejection of the unwanted signal.

Remote Command	<code>[:SENSe]:<measurement>:PFILter[:STATe] ON OFF 1 0</code> <code>[:SENSe]:<measurement>:PFILter[:STATe]?</code>
Example	Enable High Freq Prefilter for the Complex Spectrum Measurement in BASIC Mode: <code>:SPEC:PFIL ON</code>

3 VMA Mode

3.1 Digital Demod Measurement

	Enable High Freq Prefilter for the IQ Waveform Measurement, in multiple Modes: :WAV:PFIL ON
	Enable High Freq Prefilter for the Swept SA Measurement in SA Mode: :SAN:PFIL ON
Dependencies	Only appears in VXT models M9410A/11A with center frequency above 1310 MHz, and M9410E/11E in frequency range 1310MHz~5GHz
Preset	See " Prefilter Presets " on page 273 below
State Saved	Saved in instrument state

Prefilter Presets

Meas	Mode	Preset
SPEC	BASIC	OFF
WAV	BASIC, WCDMA, WLAN, LTEAFDD, LTEATDD, 5GNR, VMA	OFF
MON	WCDMA, WLAN, LTEAFDD, LTEATDD, 5GNR, VMA	OFF
RHO	WCDMA	OFF
CDP	WCDMA	OFF
PCON	WCDMA	OFF
EVMQ	WCDMA	OFF
CHP	WCDMA, WLAN, LTEAFDD, LTEATDD, 5GNR, VMA, SA	OFF
OBW	WCDMA, WLAN, LTEAFDD, LTEATDD, 5GNR, VMA, SA	OFF
ACP	WCDMA, LTEAFDD, LTEATDD, 5GNR, VMA, SA	OFF
SEM	WCDMA, WLAN, LTEAFDD, LTEATDD, 5GNR, VMA, SA	OFF
PST	WCDMA, WLAN, LTEAFDD, LTEATDD, 5GNR, VMA, SA	OFF
PVT	WLAN, LTEAFDD, LTEATDD, 5GNR	OFF
EVM	WLAN, LTEAFDD, LTEATDD, 5GNR	OFF
FLAT	WLAN	OFF
EVMM	WLAN	OFF
CEVM	LTEAFDD, LTEATDD	OFF
PAVT	5GNR, VMA	OFF
DDEM	VMA	OFF
OFDM	VMA	OFF
SAN	SA	ON
HARM	SA	ON

3.1.5 BW

Opens the **BW** (Bandwidth) menu, which contains "[Info BW](#)" on page 274.

3.1.5.1 Settings

Contains the basic bandwidth functions. It is the only tab under **BW**.

Info BW

Enables you to enter a frequency value to set the channel bandwidth that will be used for data acquisition.

Remote Command	<code>[:SENSe] :DDEMod :BANDwidth [:RESolution] <freq></code> <code>[:SENSe] :DDEMod :BANDwidth [:RESolution] ?</code>											
Example	<code>:DDEM :BAND 8 MHz</code> <code>:DDEM :BAND ?</code>											
Couplings	Changes when Symbol Rate is larger than Info BW x 10											
Preset	5 MHz											
State Saved	Saved in instrument state											
Min/Max	1 kHz / Max Info BW The Max Info BW depends on Data Source and Input Type:											
	<table border="1"> <thead> <tr> <th>Data Source</th> <th>Input Type</th> <th>Value</th> </tr> </thead> <tbody> <tr> <td rowspan="2">Input</td> <td>RF</td> <td>No Option = 10 MHz WB (25 MHz or wider) = Hardware Option Limit</td> </tr> <tr> <td>I/Q (for I+jQ)</td> <td>No Option = 20 MHz Option B25 = 50 MHz</td> </tr> <tr> <td>File</td> <td>n/a</td> <td>100 GHz</td> </tr> </tbody> </table>	Data Source	Input Type	Value	Input	RF	No Option = 10 MHz WB (25 MHz or wider) = Hardware Option Limit	I/Q (for I+jQ)	No Option = 20 MHz Option B25 = 50 MHz	File	n/a	100 GHz
Data Source	Input Type	Value										
Input	RF	No Option = 10 MHz WB (25 MHz or wider) = Hardware Option Limit										
	I/Q (for I+jQ)	No Option = 20 MHz Option B25 = 50 MHz										
File	n/a	100 GHz										
Backwards Compatibility SCPI	<code>[:SENSe] :DDEMod :BWIDth [:RESolution]</code>											

3.1.6 Display

Enables you to configure display items for the current Mode, Measurement View or Window.

3.1.6.1 Meas Display

Contains controls for setting up the display for the current Measurement, View or Window.

Demod Bits Format

Selects the display format for demodulation bits.

Remote Command	<code>:DISPlay:DDEMod:BITS:FORMat HEX BINary</code> <code>:DISPlay:DDEMod:BITS:FORMat?</code>
Example	<code>:DISP:DDEM:BITS:FORM HEX</code> <code>:DISP:DDEM:BITS:FORM?</code>
Preset	<code>BIN</code>
State Saved	Yes
Range	Hex Binary

Tx Pattern Display

Turns on/off Tx Pattern display in Demod Bits window.

Remote Command	<code>:DISPlay:DDEMod:TXBit:PATTern OFF ON 0 1</code> <code>:DISPlay:DDEMod:TXBit:PATTern?</code>
Example	<code>:DISP:DDEM:TXB:PATT OFF</code> <code>:DISP:DDEM:TXB:PATT?</code>
Preset	<code>ON</code>
State Saved	Yes
Range	Off On

Ideal State Shape

Enables you to choose between a cross, circle, or none to represent the ideal state on the selected trace. Digital Demodulation shows you the location of all ideal symbol states in an I-Q or constellation diagram.

Remote Command	<code>:DISPlay:DDEMod:SYMBol:SHAPE CIRCle CROSS OFF</code> <code>:DISPlay:DDEMod:SYMBol:SHAPE?</code>
Example	<code>:DISP:DDEM:SYMB:SHAP CIRC</code> <code>:DISP:DDEM:SYMB:SHAP?</code>
Preset	<code>CIRC</code>
State Saved	Yes
Range	Circle Cross None

Ideal State Size

Determines the ideal state size, as a percentage of the maximum ideal state distance from the origin (the same way Error Vector Magnitude is defined). Ideal states are shown as circles or crosses in Vector and constellation diagrams, as determined by the Ideal State Shape setting.

The ideal state is where symbols occur if your signal is without error. Showing the ideal states gives a visual indication of the quality of your signal.

You can use this feature to determine if symbols have an EVM above a specified Value. For example, to see if any symbols have an EVM greater than 10%, set the state size to 10% and select Circle as the shape. Any symbols that fall outside of the circle (other than SYNC or PILOT symbols) have an EVM greater than 10%.

Remote Command	<code>:DISPlay:DDEMod:SYMBol:SIZE <real></code> <code>:DISPlay:DDEMod:SYMBol:SIZE?</code>
Example	<code>:DISP:DDEM:SYMB:SIZE 10</code> <code>:DISP:DDEM:SYMB:SIZE?</code>
Notes	Parameter is interpreted as a percent, for example, if you want the ideal size to be 10% send 10, not 0.1
Preset	5
State Saved	Yes
Min	0.1
Max	50

3.1.6.2 View

Contains controls for selecting the current **View**, and for editing User Views.

Views

Lets you choose a **View** from the predefined Views for the current measurement. The Views vary from measurement to measurement. See the “Views” section of your measurement’s help for a list of all the Views supported by your measurement.

If you have modified the current View, using the ["View Editor" on page 156](#), an asterisk appears next to that View in the radio button panel. You can save the modified View as a User View (see ["Save Layout as New View" on page 1808](#)).

3 VMA Mode
3.1 Digital Demod Measurement

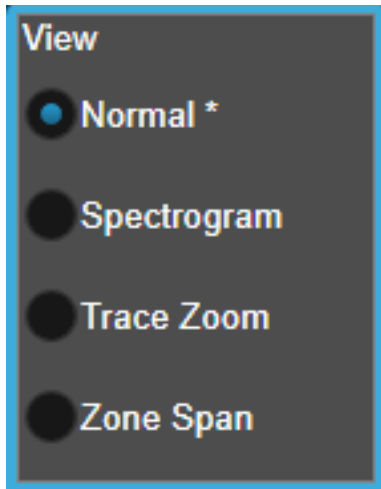

Example	<code>:DISP:VIEW ZSP</code> sets the zone span view in Swept SA
Preset	<code>NORM</code>
State Saved	Saved in Instrument State

User View

Lets you choose a View from the saved User Views for the current measurement. This panel only appears if a User View exists for the current measurement.

Remote Command	<code>:DISPlay:VIEW:ADVanced:SElect <alphanumeric></code> <code>:DISPlay:VIEW:ADVanced:SElect?</code>
Example	Select Baseband as the current View <code>:DISP:VIEW:ADV:SEL "Baseband"</code>
Notes	<p>You must be in the measurement whose View you are trying to set to send the command. You can only set Views for the current measurement using this command</p> <p>For predefined views, the parameter is derived from the view name that is shown in the View list in the user interface. For example, if you are trying to select the Trace Zoom view in the Swept SA measurement, you send:</p> <pre><code>:DISP:VIEW:ADV:SEL "Trace Zoom"</code></pre> <p>because "Trace Zoom" is the name of the View as seen in the Mode/Meas dialog or in the Display, View menu</p> <p>You <i>cannot</i> use the legacy View parameter (which in this case would be <code>TZOOM</code>) with</p> <pre><code>:DISP:VIEW:ADV:SEL</code></pre> <p><code><alphanumeric></code> is case insensitive; you can specify mixed case, however the name will be evaluated on a single case. Thus, both of the following forms work:</p> <pre><code>:DISP:VIEW:ADV:SEL "Trace Zoom"</code> <code>:DISP:VIEW:ADV:SEL "TRACE ZOOM"</code></pre>

	If the specified view is not a valid View, the query returns the error message “-224, Illegal parameter value; View with the name <alphanumeric> does not exist”
	If the display is disabled (via <code>:DISP:ENAB OFF</code>) then the error message “-221, Settings conflict; View SCPI cannot be used while Display is disabled” is generated

Backwards Compatibility SCPI	The legacy node <code>:DISPlay:VIEW[:SElect]</code> is retained for backwards compatibility, but it only supports predefined views
------------------------------	--

Restore Layout to Default

Restores the Layout to the default for Basic.

Modified Views are very temporary; if you exit the current measurement they are discarded, and they are not saved in State. To retain this View for later use, and to be able to return easily to your original Basic View, you can save your edited View as a “User View”.

Save Layout as New View

Saves your new View as a User View. An alpha keyboard appears, which lets you name your new View; the default is the old View name plus a number.

Remote Command	<code>:DISPlay:VIEW:ADVanced:NAME <alphanumeric></code>
----------------	---

Example	<code>:DISP:VIEW:ADV:NAME “Baseband”</code>
---------	---

Creates a new View named **Baseband** from the current View, and selects it as the current View

Notes	<p><code><alphanumeric></code> is case insensitive; you can specify mixed case, however the name will be evaluated on a single case</p> <p>If <code><alphanumeric></code> name already exists as a View, the error message “-224, Illegal parameter value; View <alphanumeric> already exists” is generated</p> <p>If the display is disabled (via <code>:DISP:ENAB OFF</code>) then the error message “-221, Settings conflict; User View SCPI cannot be used while Display is disabled” is generated</p>
-------	--

Re-Save User View

You can re-edit a User View; if you make changes, then an asterisk will appear next to the User View’s name. You can then tap **Re-Save User View** to save it back to its existing name, or **Save Layout as New View** to add another, new User View.

This is a front panel function only, there is no remote command available to perform this function. To do this remotely, you must first perform **Save Layout as New View**, then delete the old User View and rename the new one with the name of the View you just deleted.

Rename User View

You can rename the current View by giving it a new unique name. Only User Views can be renamed, if the current View is a Predefined View, an error occurs.

Remote Command	<code>:DISPlay:VIEW:ADVanced:REName <alphanumeric></code>
Example	<code>:DISP:VIEW:ADV:REN "Baseband"</code>
Notes	<p><code><alphanumeric></code> is case insensitive; you can specify mixed case, however the name will be evaluated on a single case</p> <p>If the <code><alphanumeric></code> specifying the new name is already present in the list of View names, the error message "-224, Illegal parameter value; View <alphanumeric> already exists" is generated</p> <p>If the current View is a Predefined View, the error message "-224, Illegal parameter value; Cannot rename a Predefined View" is generated</p> <p>If the display is disabled (via <code>:DISP:ENAB OFF</code>) then the error message "-221, Settings conflict; View SCPI cannot be used while Display is disabled" is generated</p>

Delete User View

You can delete the current View if it is a User View. The default view becomes the current view for the Measurement.

Remote Command	<code>:DISPlay:VIEW:ADVanced:DElete</code>
Example	<code>:DISP:VIEW:ADV:DEL</code>
Notes	<p><code><alphanumeric></code> is case insensitive; you can specify mixed case, however the name will be evaluated on a single case</p> <p>If the <code><alphanumeric></code> is not present in the list of View names, the error message "-224, Illegal parameter value; View <alphanumeric> does not exist" is generated</p> <p>If the current View is a Predefined View, the error message "-224, Illegal parameter value; Cannot delete a Predefined View" is generated</p> <p>If the display is disabled (via <code>:DISP:ENAB OFF</code>) then the error message "-221, Settings conflict; View SCPI cannot be used while Display is disabled" is generated</p>

Delete All User Views

Deletes all previously saved User Views. The default view becomes the current view for the Measurement if a User View was the current view when this command was executed.

Remote Command	<code>:DISPlay:VIEW:ADVanced:DElete:ALL</code>
----------------	--

Example	<code>:DISP:VIEW:ADV:DEL:ALL</code>
Notes	Disabled if there are no User Views

View Editor Remote Commands

The following remote commands help you manage Views and User Views. Note that the SCPI node for User Views handles both Predefined and User Views. The legacy nodes, `:DISPlay:VIEW[:SElect]` and `:DISPlay:VIEW:NSEL`, are retained for backwards compatibility, but they only support predefined views.

View Listing Query

Returns a string containing a comma-separated list of names for *all* the Views, including User Views, available for the current Measurement.

Remote Command	<code>:DISPlay:VIEW:ADVanced:CATalog?</code>
Example	<code>:DISP:VIEW:ADV:CAT?</code>
Notes	<p>Returns a quoted string of the available Views for the current measurement, separated by commas. The list includes names for <i>all</i> the Views, including User Views, available for the current Measurement</p> <p>Example: <code>"Normal,Trace Zoom,Spectrogram,Baseband,myView1,yourView1"</code></p> <p>No distinction is made between Predefined and User Views</p> <p>If you switch measurements with the display disabled (via <code>:DISP:ENAB OFF</code>), then query the list of available Views, the result is undefined</p>

User View Listing Query

Returns a string containing a comma-separated list of names for *only* the User Views available for the current Measurement.

Remote Command	<code>:DISPlay:VIEW:ADVanced:USER:CATalog?</code>
Example	<code>:DISP:VIEW:ADV:USER:CAT?</code>
Notes	<p>Returns a quoted string of the available User Views for the current measurement, separated by commas.</p> <p>Example: <code>"Baseband,myView1,yourView1"</code></p> <p>If you switch measurements with the display disabled (see "Display Enable (Remote Command Only)" on page 1812), then query the list of available Views, the result is undefined</p>

3.1.6.3 Annotation

Contains controls for setting up the annotation for the current Mode or Measurement.

Graticule

Turns the display graticule On or Off for all windows with graticules in all measurements in the current Mode. Also turns the graticule Y-Axis annotation on and off.

Remote Command	<code>:DISPlay:GRATicule[:STATe] OFF ON 0 1</code> <code>:DISPlay:GRATicule[:STATe]?</code>
Example	<code>:DISP:GRAT OFF</code>
Notes	The graticule is the set of horizontal and vertical lines that make up the grid/divisions for the X-Axis and Y-Axis
Preset	ON
State Saved	Saved in instrument state
Backwards Compatibility SCPI	<code>:DISPlay:WINDow[1]:TRACe:GRATicule:GRID[:STATe] OFF ON 0 1</code> <code>:DISPlay:WINDow[1]:TRACe:GRATicule:GRID[:STATe]?</code> This command is accepted for backwards compatibility with older instruments, but the WINDow , TRACe and GRID parameters are ignored

Screen Annotation

Controls the display of the annunciation and annotation around the graticule, including any annotation on lines (such as the display line, the threshold line, etc.) and the Y-Axis annotation, for all windows with screen annotation in all measurements in the current Mode.

This does *not* include marker annotation (or the N dB result). When **OFF**, the graticule expands to fill the entire graticule area, leaving only the 1.5% gap above the graticule, as described in the **Trace** section.

Remote Command	<code>:DISPlay:ANNotation:SCReen[:STATe] OFF ON 0 1</code> <code>:DISPlay:ANNotation:SCReen[:STATe]?</code>
Example	<code>:DISP:ANN:SCR OFF</code>
Dependencies	Grayed-out and forced to OFF when System Display Settings, Annotation is OFF
Preset	ON This remains OFF through a Preset when System Display Settings, Annotation is set to OFF
State Saved	Saved in instrument state

Trace Annotation

Turns on and off the labels on the traces, showing their detector (or their Math Mode) as described in the **Trace** section, for all windows in all measurements in the current Mode for which Trace Annotation on/off is supported.

If Trace Math is being performed on a trace, then the Trace Math annotation replaces the detector annotation.

For measurements that support limit lines, this key also turns on and off the labels on the Limit Lines. The label is the Limit number annotation and Limit Comment displayed on the graph. If the length of the comment is greater than 20 characters, the first 8 characters and the last 8 characters are displayed, joined with

Remote Command	<code>:DISPlay:ANNotation:TRACe[:STATe] ON OFF 1 0</code> <code>:DISPlay:ANNotation:TRACe[:STATe]?</code>
Example	<code>:DISP:ANN:TRAC OFF</code>
Preset	<code>OFF</code>
State Saved	Saved in instrument state

Control Annotation

Turns on and off the display of values on the Active Function controls for all measurements in the current Mode. This is a security feature.

Remote Command	<code>:DISPlay:ACTivefunc[:STATe] ON OFF 1 0</code> <code>:DISPlay:ACTivefunc[:STATe]?</code>
Example	<code>:DISP:ACT OFF</code>
Dependencies	Grayed out and forced to <code>OFF</code> when System Display Settings, Annotation is <code>OFF</code>
Preset	<code>ON</code> This remains <code>OFF</code> through a Preset when System Display Settings, Annotation is set to <code>OFF</code>
State Saved	Saved in instrument state

Meas Bar

Turns the Measurement Bar at the top of the screen on and off for all measurements in the current Mode. When `OFF`, the graticule area expands to fill the area formerly occupied by the Measurement Bar.

Remote Command	<code>:DISPlay:ANNotation:MBAR[:STATe] OFF ON 0 1</code> <code>:DISPlay:ANNotation:MBAR[:STATe]?</code>
----------------	--

3 VMA Mode
3.1 Digital Demod Measurement

Example	<code>:DISP:ANN:MBAR OFF</code>
Dependencies	Grayed out and forced to OFF when System Display Settings, Annotation is OFF
Preset	ON This remains OFF through a Preset when System Display Settings, Annotation is set to OFF
State Saved	Saved in instrument state

Display Enable (Remote Command Only)

Turns the display on/off, including the display drive circuitry. The backlight stays lit to confirm that the instrument is on. The display enable setting is mode global. There are three reasons for turning the display off:

1. To increase speed as much as possible by freeing the instrument from having to update the display
2. To reduce emissions from the display, drive circuitry
3. For security purposes

If you have turned off the display:

- and you are in local operation, the display can be turned back on by pressing any key or by sending `:SYSTEM:DEFAULTS MISC` or `:DISPLAY:ENABLE ON` (neither `*RST` nor `:SYSTEM:PRESET` enable the display)
- and you are in remote operation, the display can be turned back on by pressing the **Local** or **Esc** keys, or by sending `:SYSTEM:DEFAULTS MISC` or `:DISPLAY:ENABLE ON` (neither `*RST` nor `:SYSTEM:PRESET` enable the display)
- and you are using either the `:SYSTEM:KLOCK` command or GPIB local lockout, then *no* front-panel key press will turn the display back on. You must turn it back on remotely.

If the display is **OFF**, many SCPI commands related to User Views and Multiscreen functionality do not work, and return the error messages “-221, Settings conflict; Screen SCPI cannot be used when Display is disabled” or “221, Settings conflict; View SCPI cannot be used while Display is disabled”. These commands include:

Name	Command
Select User View	<code>:DISPLAY:VIEW:ADVANCED:SELECT</code>
Rename User View	<code>:DISPLAY:VIEW:ADVANCED:RENAME</code>
Delete User View	<code>:DISPLAY:VIEW:ADVANCED:DELETE</code>
Create User View	<code>:DISPLAY:VIEW:ADVANCED:NAME</code>
Select Screen	<code>:INSTRUMENT:SCREEN:SELECT</code>
Delete Screen	<code>:INSTRUMENT:SCREEN:DELETE</code>

Name	Command
Delete All But This Screen	:INSTrument:SCReen:DELeTe:ALL
Add Screen	:INSTrument:SCReen:CREate
Rename Screen	:INSTrument:SCReen:REName
Sequencer On/Off	:SYSTem:SEQuencer
Remote Command	:DISPlay:ENABle OFF ON 0 1 :DISPlay:ENABle?
Example	:DISP:ENAB OFF
Couplings	:DISP:ENAB OFF turns Backlight OFF and :DISP:ENAB ON turns Backlight ON, but changing Backlight settings does <i>not</i> change the state of :DISP:ENAB
Preset	ON Set by :SYST:DEF MISC, but not affected by *RST or :SYSTem:PRESet
State Saved	Not saved in instrument state
Backwards Compatibility Notes	:SYST:PRES no longer turns on :DISPlay:ENABle as it did in legacy analyzers

3.1.7 Frequency

Opens the **Frequency** menu, which contains controls that enable you to control the frequency parameters of the instrument.

Some features in this menu are the same for all measurements in the current Mode – they do not change as you change measurements. Settings like these are called “Meas Global” and are unaffected by **Meas Preset**. For example, “**Center Frequency**” on page 284 is the same for all measurements – it does not change as you change measurements.

3.1.7.1 Settings

Contains controls that pertain to the X axis parameters of the measurement. These parameters control how data on the vertical (X) axis is displayed and control instrument settings that affect the horizontal axis.

Center Frequency

Sets the frequency that corresponds to the horizontal center of the graticule. While adjusting **Center Frequency**, **Span** is held constant.

3 VMA Mode

3.1 Digital Demod Measurement

The **Center Frequency** setting is the same for all measurements within a mode, that is, it is Meas Global. Some Modes are also able to share a Mode Global center frequency value. If this is the case, the Mode will have a Global tab in its Meas Setup menu.

This function sets (and queries) the center frequency for the currently selected input. If your instrument has multiple inputs, and you select another input, **Center Frequency** changes to the value for that input. SCPI commands are available to directly set the center frequency for a specific input.

This setting is remembered as you go from input to input. Thus you can set a **Center Frequency** of 10 GHz with the RF Input selected, change to BBIQ and set a **Center Frequency** of 20 MHz, then switch to External Mixing and set a **Center Frequency** of 60 GHz, and when you go back to the RF Input the **Center Frequency** will revert to 10 GHz; back to BBIQ and it is 20 MHz; back to External Mixing and it is 60 GHz.

Remote Command	<code>[:SENSE]:FREQuency:CENTer <freq></code> <code>[:SENSE]:FREQuency:CENTer?</code>
Example	<code>:FREQ:CENT 50 MHz</code> Sets Center Frequency to 50 MHz <code>:FREQ:CENT UP</code> Increments the Center Frequency by the value of CF Step <code>:FREQ:CENT?</code> Returns the current value of Center Frequency
Notes	Sets the RF, External Mixing or I/Q Center Frequency depending on the selected input: <ul style="list-style-type: none"> – For RF input, equivalent to <code>FREQ:RF:CENT</code> – For I/Q input, equivalent to <code>FREQ:IQ:CENT</code> – For External Mixer, equivalent to <code>FREQ:EMIX:CENT</code> Preset and Max values are dependent on Hardware Options (5xx) If no terminator (for example, MHz) is sent, the terminator Hz is used. If a terminator with unit other than Frequency is sent, an invalid suffix error message is generated
Dependencies	Center Frequency can be limited if the Span is such that the range of the instrument is exceeded
Preset	1 GHz See "RF Center Freq" on page 286 , "Ext Mix Center Freq" on page 286 , and "I/Q Center Freq" on page 287
State Saved	Saved in instrumen
Min/Max	Depends on the selected input See "RF Center Freq" on page 286 , and "I/Q Center Freq" on page 287e
Annotation	Center <value> appears in the lower left corner of the display
Status Bits/OPC dependencies	Non-overlapped

RF Center Freq

Specifies the RF Center Frequency. Sets the Center Frequency to be used when the RF input is selected, even if the RF input is not the input that is selected at the time the command is sent.

Note that **Center Frequency** in the **Frequency** menu on the front panel always applies to the currently selected input.

Remote Command	<code>[:SENSe] :FREQuency:RF:CENTer <freq></code> <code>[:SENSe] :FREQuency:RF:CENTer?</code>
Example	<code>:FREQ:RF:CENT 30 MHz</code> <code>:FREQ:RF:CENT?</code>
Notes	This command is the same in all modes, but the parameter is Measurement Global. So the value is independent in each mode and common across all the measurements in the mode
Dependencies	If the electronic/soft attenuator is enabled, any attempt to set Center Frequency such that the Stop Frequency would be >3.6 GHz fails and results in an advisory message. If the equivalent SCPI command is sent, this same message is generated as part of a “-221, Settings conflict” warning
Preset	See table above
State Saved	Saved in instrument state
Min	-79.999995 MHz
Max	See table above. Basically instrument maximum frequency - 5 Hz If the knob or step keys are being used, also depends on Span

Ext Mix Center Freq

Specifies the External Mixer Center Frequency. Sets the Center Frequency to be used when the External Mixer is selected, even if the External Mixer input is not the input which is selected at the time the command is sent.

Note that **Center Frequency** in the **Frequency** menu on the front panel always applies to the currently selected input.

Remote Command	<code>[:SENSe] :FREQuency:EMIXer:CENTer <freq></code> <code>[:SENSe] :FREQuency:EMIXer:CENTer?</code>
Example	<code>:FREQ:EMIX:CENT 60 GHz</code> <code>:FREQ:EMIX:CENT?</code>
Notes	This command is the same in all modes, but the parameter is Measurement Global. So the value is independent in each mode and common across all the measurements in the mode
Couplings	When returning to External Mixing after having been switched to one of the other inputs (for example, RF), you will come back into the settings that you had when you left External Mixing. So you will come back to the band you were in with the Center Frequency that you had. However, Span is not an input-dependent parameter, therefore you will bring the span over from the other input. Therefore, the instrument comes back with the span from the previous input, limited as necessary by the current mixer

3 VMA Mode
3.1 Digital Demod Measurement

	setup
Preset	<p>When a Mode Preset is performed while in External Mixing, the Start frequency of the current Mode is set to the nominal Min Freq of the lowest harmonic range in the Harmonic Table for the current mixer setup. Similarly, the Stop frequency of the current Mode is set to the nominal Max Freq of the highest harmonic range in the Harmonic Table. The Center Freq thus presets to the point arithmetically equidistant from these two frequencies</p> <p>When Restore Input/Output Defaults is performed, the mixer presets to the 11970A, whose Start and Stop frequencies are 26.5 and 40 GHz respectively. The center of these two frequencies is 33.25 GHz. Therefore, after a Restore Input/Output Defaults, if you go into External Mixing and do a Mode Preset while in the Spectrum Analyzer Mode, the resulting Center Freq is 33.25 GHz</p>
State Saved	Yes
Min	<p>The minimum frequency in the currently selected mixer band + 5 Hz</p> <p>If the knob or step keys are being used, also depends on Span</p>
Max	<p>The maximum frequency in the currently selected mixer band - 5 Hz</p> <p>If the knob or step keys are being used, also depends on Span</p>

I/Q Center Freq

Specifies the I/Q Center Frequency. Sets the Center Frequency to be used when the I/Q input is selected, even if the I/Q input is not the input which is selected at the time the command is sent.

Note that **Center Frequency** in the **Frequency** menu on the front panel always applies to the currently selected input.

Remote Command	<p><code>[:SENSe] :FREQuency :IQ :CENTer <freq></code></p> <p><code>[:SENSe] :FREQuency :IQ :CENTer ?</code></p>
Example	<code>:FREQ :IQ :CENT 30 MHz</code>
Notes	This command is the same in all modes, but the parameter is Measurement Global. So the value is independent in each mode and common across all the measurements in the mode
Preset	0 Hz
State Saved	Saved in instrument state
Min	-40.049995 MHz
Max	40.049995 MHz

CF Step

Changes the step size for the center frequency.

Remote Command	<p><code>[:SENSe] :FREQuency :CENTer :STEP [:INCRement] <freq></code></p> <p><code>[:SENSe] :FREQuency :CENTer :STEP [:INCRement] ?</code></p>
----------------	--

	<code>[:SENSe] :FREQuency :CENTer :STEP :AUTO OFF ON 0 1</code>
	<code>[:SENSe] :FREQuency :CENTer :STEP :AUTO?</code>
Example	<p><code>:FREQ:CENT:STEP 500 MHz</code></p> <p>Increases the current center frequency value by 500 MHz</p> <p><code>:FREQ:CENT:STEP?</code></p> <p><code>:FREQ:CENT:STEP:AUTO ON</code></p> <p><code>:FREQ:CENT:STEP:AUTO?</code></p>
Notes	Preset and Max values depend on Hardware Options (503, 507, 508, 513, 526)
Dependencies	<p>BW, Center frequency</p> <p>If the electronic/soft attenuator is enabled, any attempt to change the value of the center frequency >3.6 GHz by pressing the Up-arrow key, fails and results in an advisory message. If the equivalent SCPI command is sent, this same message is generated as part of a “-221, Settings conflict” warning</p>
Couplings	When auto-coupled, the center frequency step size is set to 10% of the span
Preset	<p>5 MHz</p> <p>ON</p>
State Saved	Saved in instrument state
Min/Max	<p>- /+(Maximum frequency of the instrument)</p> <p>That is, 27 GHz max freq instrument has a CF step range of +/- 27 GHz. Note that this is the maximum frequency given the current settings of the instrument, so in External Mixing, for example, it is the maximum frequency of the current mixer band</p>
Status Bits/OPC dependencies	non-overlapped

3.1.8 Marker

Accesses a menu that enables you to select, set up and control the markers for the current measurement. If there are no active markers, **Marker** selects marker 1, sets it to **Normal** and places it at the center of the display. If the selected marker is **Off**, it is set to **Normal** and placed it at the center of the screen on the trace determined by the Marker Window rules.

3.1.8.1 Select Marker

Specifies the selected marker. The term “selected marker” is used throughout this document to specify which marker will be affected when you change marker settings, perform a Peak Search, etc.

This control appears above the menu panel, indicating that it applies to all controls in the **Marker** menu panels. It is blanked if you select a tab whose controls do *not* depend on the selected marker (for example, Counter).

In any menu in which **Select Marker** appears, the first control is always **Marker X**.

3 VMA Mode
3.1 Digital Demod Measurement

Notes	The selected marker is remembered even when not in the Marker menu and is used if a search is done or a Band Function is turned on, or for Continuous Peak
Preset	Marker 1
State Saved	The number of the selected marker is saved in instrument state

3.1.8.2 Settings

The controls on this tab include the Marker active function and a radio button selection of the marker control mode (**Normal**, **Delta**, **Fixed** or **Off**) for the selected marker, as well as additional functions that help you use markers.

Marker X

Enables you to set or read back the X Axis value of the selected marker in the current X Axis Scale unit. If the marker mode is off, the SCPI command has no affect other than to cause the marker to become selected. Note that the X value can change if the marker is moved to a trace with a different domain.

The Marker X position is absolute if the marker mode is Normal or Fixed. If the mode is Delta, then the X position is relative to the reference marker. The valid X positions are the actual data points in the trace; the marker cannot be located between points. If a SCPI command attempts to place the marker between two points, the X value snaps to the closest point.

Remote Command	<code>:CALCulate:DDEMod:MARKer[1] 2 ... 12:X <real></code> <code>:CALCulate:DDEMod:MARKer[1] 2 ... 12:X?</code>
Example	<code>:CALC:DDEMod:MARK:X 0.325</code> <code>:CALC:DDEMod:MARK:X?</code>
Notes	Does not exceed the bounds of the data unless it is Fixed . If you attempt to set it to a value outside the bounds, it is clipped at the closest limit and Error -222 Data Out of Range is generated If suffix is sent, it must match the X units for the trace the marker is on. Otherwise, error -138, "Suffix not allowed" is generated If you try to read or set the position of a Delta marker, remember that the position is in relative units
Couplings	Coupling of Delta and Reference Markers
Preset	None until marker is turned on
State Saved	Yes
Min/Max	Depends on trace data / Depends on trace data

Marker Y

Enables you to set or read back the selected marker's Y Axis value in the current Y Axis Scale unit. Setting the Y value has no effect (other than to cause the marker to become selected) if the marker mode is other than fixed. The query generates an error if the marker mode is **Off**. Note that the Y value can change if the Y-axis units change, either from a change in format of the trace the marker is on or if the marker is moved to a different trace.

If the selected marker is on a trace that is displayed with Vector or Constellation format, this function controls only the real part of the Y value (i.e., the horizontal axis value). Use "[Marker Y Imag](#)" on page 290 to change the imaginary (vertical) value. **Marker Y** and **Marker Y Imag** always set or get the rectangular form of Y, regardless of whether the marker readout is polar or rectangular.

Remote Command	<code>:CALCulate:DDEMod:MARKer[1] 2 ... 12:Y[:REAL] <real></code> <code>:CALCulate:DDEMod:MARKer[1] 2 ... 12:Y[:REAL]?</code>
Example	<code>:CALC:DDEM:MARK2:Y 0.325</code> <code>:CALC:DDEM:MARK2:Y?</code>
Notes	You cannot set Y unless the marker type is fixed. If the marker becomes fixed after a marker function is turned on, it is set to whatever the Y value was when the marker became fixed If suffix is sent, it must match the Y units for the trace the marker is on. Otherwise, error -138, "Suffix not allowed" is generated
Couplings	Changes if marker is relative to a Delta marker that is turned on
Preset	None until marker is turned on
State Saved	Yes
Min/Max	-9.9E+37 / 9.9E+37

Marker Y Imag

Enables you to set or read back the selected marker's quadrature (imaginary) Y value in the current Y Axis Scale unit. It has no effect (other than to cause the marker to become selected) if the marker mode is other than fixed, or if the current trace format is not complex (Vector or Constellation).

The query generates an error if it is used for a marker that is not on a complex trace. **Marker Y Imag** is not affected by whether the marker readout is polar or rectangular.

Remote Command	<code>:CALCulate:DDEMod:MARKer[1] 2 ... 12:Y:IMAGinary <real></code> <code>:CALCulate:DDEMod:MARKer[1] 2 ... 12:Y:IMAGinary?</code>
Example	<code>:CALC:DDEM:MARK1:Y:IMAG 0.435</code> <code>:CALC:DDEM:MARK1:Y:IMAG?</code>

3 VMA Mode

3.1 Digital Demod Measurement

Notes	Grayed-out unless the marker is fixed and on a vector display If suffix is sent, it must match the Y units for the trace the marker is on. Otherwise, error -138, "Suffix not allowed" is generated. If query is sent while the marker is on a trace whose format is not vector or constellation, NaN (9.91E+37) is returned
Preset	None until marker is turned on
State Saved	Yes
Min/Max	Depends on trace format / Depends on trace format

Marker Mode

There are four control modes for markers:

Mode	Option	Description
Normal	POSition	A marker that can be moved to any point on the X Axis by specifying its X Axis value, and whose absolute Y Axis value is then the value of the trace point at that X Axis value
Delta	DELTA	A marker that can be moved to any point on the X Axis by specifying its X Axis offset from a reference marker, and whose absolute Y Axis value is then the value of the trace point at that X Axis value
Fixed	FIXed	A marker whose X Axis and Y Axis values may be directly or indirectly specified by you, but whose Y Axis value remains fixed, once specified, and does not follow the trace. Fixed markers are useful as reference markers for Delta markers, as operands in a Peak Search operation, and as arbitrary reference points settable by you. These markers are represented on the display by an "X" rather than a diamond
Off	OFF	A marker that is not in use

The SCPI command in the table below selects the marker and sets the marker control mode as described under **Normal**, **Delta**, **Fixed** and **Off**, below. All interactions and dependencies detailed under the control description are enforced when the remote command is sent.

Remote Command	<code>:CALCulate:DDEMod:MARKer[1] 2 ... 12:MODE POSition DELTA FIXed OFF</code> <code>:CALCulate:DDEMod:MARKer[1] 2 ... 12:MODE?</code>
Example	<code>:CALC:DDEM:MARK2:MODE POS</code> <code>:CALC:DDEM:MARK2:MODE?</code>
Couplings	The marker addressed by this command becomes the selected marker on the front panel
Preset	OFF (all markers)
State Saved	The marker control mode (Normal , Delta , Fixed , Off) and X Axis value are saved in instrument state
Range	Normal Delta Fixed Off

Delta Marker (Reset Delta)

Pressing this control has exactly the same effect as pressing **Delta** in **Marker Mode**. The selected marker becomes a **Delta** Marker. If the selected marker is already a **Delta** marker, the reference marker is moved to the current position of the selected marker, thus resetting the Delta to zero.

Marker Settings Diagram

Enables you to configure the Marker system using a visual utility.

All Markers Off

Turns off all markers.

Remote Command :CALCulate:DDEMod:MARKer:AOFF

Example :CALC:DDEM:MARK:AOFF

Couple Markers

When this function is On, moving any marker causes an equal X Axis movement of every other marker that is not **Fixed** or **Off**. By “equal X Axis movement” we mean that we preserve the difference between each marker’s X Axis value (in the fundamental x-axis units of the trace that marker is on) and the X Axis value of the marker being moved (in the same fundamental x-axis units).

Note that **Fixed** markers do not couple. They stay where they were, while all the other markers move. If a **Fixed** marker is being moved, all the non-fixed markers will move with it.

This may result in markers going off-screen.

Remote Command :CALCulate:DDEMod:MARKer:COUPle[:STATe] ON | OFF | 1 | 0
 :CALCulate:DDEMod:MARKer:COUPle[:STATe]?

Example :CALC:DDEM:MARK:COUP ON
 :CALC:DDEM:MARK:COUP?

Notes In general, when coupling is turned on, then all **Normal** or **Delta** markers with the same (or equivalent) domain as the selected marker move in the same manner as the selected marker

Preset **OFF**, presets on Mode Preset and All Markers Off

State Saved Saved in instrument state

3.1.8.3 Peak Search

The controls on this tab enable you to move the marker to selected peaks of the signal, giving you enormous analysis capabilities, particularly when combined with the Delta Marker function.

Marker X

Sets the X Axis value of the selected marker in the current X Axis Scale unit. This is the same as "[Marker X](#)" on [page 289](#) on the **Settings** tab.

Peak Search

Moves the selected marker to the trace point that has the maximum y-axis value for that trace.

NOTE

Pressing the **Peak Search** hardkey automatically moves you to the **Peak Search** page of the **Marker** menu *and* performs a **Peak Search**.

Remote Command	:CALCuLate:DDEMod:MARKer[1] 2 ... 12:MAXimum
Example	:CALC:DDEM:MARK2:MAX
Notes	Sending this command selects the subcoded marker

Next Peak

Moves the selected marker to the peak that is next lower in amplitude than the current marker's value. Only peaks which meet all enabled peak criteria are considered. If there is no valid peak lower than the current marker position, a "No peak found" message is generated and the marker is not moved.

In Digital Demod measurements, if the format is complex (vector or constellation), then the marker moves to the closest point that has a lower magnitude than the marker's current position.

If the selected marker was off, then it is turned on as a **Normal** marker and a peak search is performed.

Remote Command	:CALCuLate:DDEMod:MARKer[1] 2 ... 12:MAXimum:NEXT
Example	:CALC:DDEM:MARK2:MAX:NEXT
Notes	Sending this command selects the subcoded marker
State Saved	Not part of saved state

Next Higher Amplitude

Moves the marker to the peak next higher in Y value than the peak it is currently on. If the format is complex (vector or constellation) then the marker moves to the closest point that has a higher magnitude than the marker's current position. If this function is invoked via SCPI on a marker that is off, the result is the same as if you sent a Peak Search command.

Remote Command :CALCulate:DDEMod:MARKer[1]|2|...|12:MAXimum:PREVIOUS

Example :CALC:DDEM:MARK2:MAX:PREV

Next Pk Right

Moves the selected marker to the nearest peak right of the current marker that meets all enabled peak criteria. If there is no valid peak to the right of the current marker position, a “No peak found” message is generated and the marker is not moved.

If the selected marker was off, then it is turned on as a **Normal** marker and a peak search is performed.

Remote Command :CALCulate:DDEMod:MARKer[1]|2|...|12:MAXimum:RIGHT

Example :CALC:DDEM:MARK2:MAX:RIGH

Notes Sending this command selects the subopcoded marker

State Saved Not part of saved state

Next Pk Left

Moves the selected marker to the nearest peak left of the current marker that meets all enabled peak criteria. If there is no valid peak to the left of the current marker position, a “No peak found” message is generated and the marker is not moved.

If the selected marker was off, then it is turned on as a **Normal** marker and a peak search is performed.

Remote Command :CALCulate:DDEMod:MARKer[1]|2|...|12:MAXimum:LEFT

Example :CALC:DDEM:MARK2:MAX:LEFT

State Saved Not part of saved state

Minimum Peak

Moves the selected marker to the minimum y-axis value on the current trace. Minimum (negative) peak searches do not have to meet the peak search criteria. It just looks for the lowest y-axis value.

If the selected marker is Off, it is turned on before the minimum search is performed.

Remote Command	:CALCulate:DDEMod:MARKer[1] 2 ... 12:MINimum
Example	:CALC:DDEM:MARK2:MIN
Notes	Sending this command selects the subopcoded marker
State Saved	Not part of saved state

Pk-Pk Search

Finds and displays the amplitude and frequency (or time) differences between the highest and lowest y-axis value. It places the selected marker on the minimum value on its selected trace. And it places that marker's reference marker on the peak of its selected trace.

This function turns on the reference marker and sets its mode to **Fixed** or **Normal** if it is not already on. (These markers may be on two different traces.)

The rules for finding the maximum peak are exactly the same as for **Peak Search**, including the use of the peak criteria rules. However, the minimum trace value is not required to meet any criteria other than being the minimum y-axis value in the trace.

If the selected marker is off, a **Delta** type marker is turned on and the peak-to-peak search is done. If the selected marker is on, but it is not a **Delta** marker, then it is changed to delta, which turns on the reference marker if needed, and then it performs the peak-to-peak function.

Remote Command	:CALCulate:DDEMod:MARKer[1] 2 ... 12:PTPeak
Example	:CALC:DDEM:MARK:PTP
Notes	Turns on the Marker D active function Sending this command selects the subopcoded marker
Couplings	The selected marker becomes a delta marker if not already in delta mode
State Saved	Not part of saved state

Marker Delta

Pressing this control has exactly the same effect as pressing **Delta** in **Marker Mode** on the **Settings** tab. The selected marker becomes a **Delta** Marker. If the selected

marker is already a **Delta** marker, the reference marker is moved to the current position of the selected marker, thus resetting the Delta to zero.

The control is duplicated here to enable you to conveniently perform a peak search and change the marker's control mode to Delta without having to access two separate menus.

3.1.8.4 Properties

The controls on this tab are used to set certain properties of the selected marker.

Marker X

This is the fundamental control that you use to move a marker around on the trace. It is the same as "[Marker X](#)" on [page 289](#) on the **Settings** tab.

Relative To

Selects the marker to which the selected marker is relative (its reference marker).

Every marker has another marker to which it is relative. This marker is referred to as the "reference marker" for that marker. This attribute is set by **Marker, Properties, Relative To**. The marker must be a **Delta** marker to make this attribute relevant. If it is a **Delta** marker, the reference marker determines how the marker is controlled and how its value is displayed. A marker cannot be relative to itself.

Remote Command	<code>:CALCulate:DDEMod:MARKer[1] 2 ... 12:REference <integer></code> <code>:CALCulate:DDEMod:MARKer[1] 2 ... 12:REference?</code>
Example	<code>:CALC:DDEM:MARK2:REF 4</code> <code>:CALC:DDEM:MARK2:REF?</code>
Notes	Causes the marker specified with the subopcode to become selected Range (for SCPI command): 1 to 12. If the range is exceeded the value is clipped A marker cannot be relative to itself so that choice is not available, and if sent from SCPI generates error -221: "Settings conflict; marker cannot be relative to itself" When queried a single value is returned (the specified marker numbers relative marker)
Couplings	If the reference marker is off it is turned on in Fixed or Normal mode at the delta marker location
Preset	The preset default "Relative To" marker (reference marker) is the next higher numbered marker (current marker +1). For example, if marker 2 is selected, then it's default reference marker is marker 3. The exception is marker 12, which has a default reference of marker 1 Set to the defaults by Restore Mode Defaults. Not reset by Marker Off, All Markers Off, or Preset
State Saved	Saved in instrument state. Not affected by Marker Off and hence not affected by Preset or power cycle
Min/Max	1 / 12

Marker Window

Assigns the specified marker to the designated trace.

Remote Command	<code>:CALCulate:DDEMod:MARKer[1] 2 ... 12:WINDow <int></code> <code>:CALCulate:DDEMod:MARKer[1] 2 ... 12:WINDow?</code>
Example	<code>:CALC:DDEM:MARK:WIND 2</code> Sets the first marker's trace to window 2 <code>:CALC:DDEM:MARK:WIND?</code> Query the first marker's trace
Notes	Assigns the specified marker to the designated window
Preset	1
State Saved	Yes
Min/Max	1 / 6

Marker Settings Diagram

Enables you to configure the Marker system using a visual utility. This is the same as "[Marker Settings Diagram](#)" on page 292 on the **Settings** tab.

3.1.8.5 Marker Function

The controls on this tab enable you to control the Marker Functions of the instrument. Marker Functions perform post-processing operations on marker data.

Marker X

Set the X Axis value of the selected marker in the current X Axis Scale unit. This is the same as "[Marker X](#)" on page 289 on the **Settings** tab.

Band Function

Enables you to set the marker control function type to one of the following:

<code>NOISe</code>	Marker Noise
<code>BPOWer</code>	Band Power
<code>BDENsity</code>	Band Density
<code>OFF</code>	Marker Function Off

Remote Command	<code>:CALCulate:DDEMod:MARKer[1] 2 ... 12:FUNCTION NOISe BPOwer BDENsity OFF</code> <code>:CALCulate:DDEMod:MARKer[1] 2 ... 12:FUNCTION?</code>
Example	<code>:CALC:DDEM:MARK:FUNC BPOW</code> <code>:CALC:DDEM:MARK:FUNC?</code>
Preset	OFF
State Saved	Yes
Range	Marker Noise Band Power Band Density Marker Function Off
Annotation	Mkr # <X value> and <Marker value> upper right on graph

Band Span

Enables you to set the width of the span for the selected marker. This function defines the span of frequencies or time. The marker position does not change when you adjust the span.

Remote Command	<code>:CALCulate:DDEMod:MARKer[1] 2 ... 12:FUNCTION:BAND:SPAN <real></code> <code>:CALCulate:DDEMod:MARKer[1] 2 ... 12:FUNCTION:BAND:SPAN?</code>
Example	<code>:CALC:DDEM:MARK2:FUNC:BAND:SPAN 1.23E+06</code> <code>:CALC:DDEM:MARK2:FUNC:BAND:SPAN?</code>
Preset	When marker is turned on, 1/20th of current span or displayed time length
State Saved	Yes
Min/Max	100 / 9.9E+37

Band Left

Enables you to adjust the left side of the band. In order to remain centered in the band, the marker position must also change as you change the left edge. The right edge is unaffected.

Remote Command	<code>:CALCulate:DDEMod:MARKer[1] 2 ... 12:FUNCTION:BAND:LEFT <real></code> <code>:CALCulate:DDEMod:MARKer[1] 2 ... 12:FUNCTION:BAND:LEFT?</code>
Example	<code>:CALC:DDEM:MARK2:FUNC:BAND:LEFT 1.23E+06</code> <code>:CALC:DDEM:MARK2:FUNC:BAND:LEFT?</code>
Couplings	Changes marker X to keep the marker centered in the band
Preset	When marker is turned on, 1/40th of current span or displayed time length left of the marker position
State Saved	Yes
Min/Max	-9.9E+37 / 9.9E+37

Band Right

Enables you to adjust the right side of the band. In order to remain centered in the band, the marker position must also change as you change the right edge. The left edge is unaffected.

Remote Command	<code>:CALCulate:DDEMod:MARKer[1] 2 ... 12:FUNction:BAND:RIGHT <real></code> <code>:CALCulate:DDEMod:MARKer[1] 2 ... 12:FUNction:BAND:RIGHT?</code>
Example	<code>:CALC:DDEM:MARK2:FUNC:BAND:RIGHT 1.23E+06</code> <code>:CALC:DDEM:MARK2:FUNC:BAND:RIGHT?</code>
Couplings	Changes marker X to keep the marker centered in the band
Preset	When marker is turned on, 1/40th of current span or displayed time length right of the marker position
State Saved	Yes
Min/Max	-9.9E+37 / 9.9E+37

3.1.8.6 Marker To

The controls on this tab enable you to copy the current marker's value into other instrument parameters (for example, **Center Frequency**). The currently selected marker is made the active function on entry to this menu (if the currently selected marker is not on when you press this control, it will be turned on at the center of the screen as a normal type marker and then made the active function).

Marker X

Sets the X Axis value of the selected marker in the current X Axis Scale unit. This is the same as "**Marker X**" on page 289 on the **Settings** tab.

Mkr -> CF

Enables you to set the **Center Frequency** of the instrument to the frequency of the selected marker. The marker stays at this frequency, so it moves to the center of the display. In delta marker mode, this function sets the center frequency to the x-axis value of the delta marker. When the frequency scale is in log mode, the center frequency is not at the center of the display.

If the currently selected marker is off when this control is pressed, it will be turned on at the center of the screen as a **Normal** type marker.

Remote Command	<code>:CALCulate:DDEMod:MARKer[1] 2 ... 12[:SET]:CENTer</code>
Example	<code>:CALC:DDEM:MARK4:CENT</code>

Notes	Sending this command selects the subopcoded marker
Dependencies	Not available (control is grayed out) when x-axis is the time domain
Couplings	All the usual couplings associated with setting Center Frequency apply

3.1.9 Meas Setup

Contains functions for setting up the measurement parameters and also contains functions for setting up parameters global to all measurements in the mode.

3.1.9.1 Selected Segment

Enables you to select the segment to setup for demodulation. The term “selected segment” is used throughout this document to specify which segment will be affected by changes in the Meas Time and Demod menus.

Selected Segment appears above the menu panel, indicating that it applies to multiple controls in the **Meas Setup** menu. **Selected Segment** is blanked if you select a tab whose controls do *not* depend on the selected segment (for example, **Settings**).

Notes	The selected segment is remembered even when not in the Meas Setup menu
Preset	Segment1
State Saved	Saved in instrument state

3.1.9.2 Settings

Enables you to set measurement parameters.

Avg|Hold Number

Specifies the number of N averages that will be used for the measurement. After the specified number (average counts) have been averaged, the averaging mode (termination control) setting determines the averaging action.

Remote Command	<code>[:SENSe] :DDEMod :AVERAge :COUNT <integer></code> <code>[:SENSe] :DDEMod :AVERAge :COUNT?</code>
Example	<code>:DDEMod :AVER :COUN 1000</code> <code>:DDEMod :AVER :COUN?</code>
Preset	10
State Saved	Yes
Min/Max	1/10000

Averaging On/Off

Turns averaging on or off.

Remote Command	<code>[:SENSe]:DDEMod:AVERage[:STATe] OFF ON 0 1</code> <code>[:SENSe]:DDEMod:AVERage[:STATe]?</code>
Example	<code>:DDEM:AVER OFF</code> <code>:DDEM:AVER?</code>
Preset	<code>OFF</code>
State Saved	Yes
Range	Off On

Averaging Mode

Toggles the averaging mode between **EXponential** and **REpeat**. This selection only affects the averaging result after the number of N averages is reached. The N is set using "**Avg|Hold Number**" on page 300.

EXponential	Each successive data acquisition after the average count is reached, is exponentially weighted and then combined with the existing average
REPeat	After reaching the average count, the averaging is reset and a new average is started

Remote Command	<code>[:SENSe]:DDEMod:AVERage:TCONtrol EXponential REPeat</code> <code>[:SENSe]:DDEMod:AVERage:TCONtrol?</code>
Example	<code>:DDEM:AVER:TCON REP</code> <code>:DDEM:AVER:TCON?</code>
Notes	Selects the type of termination control used for averaging. This determines the averaging action after the specified number of frames (average count) is reached
Preset	<code>EXponential</code>
State Saved	Yes
Range	Exponential Repeat

Spur Avoidance

Because VXT models M9410A/11A are direct-conversion (zero-IF) receivers, feedthrough leakage from the local oscillator appears as a spurious signal (spur) at the center frequency. The Spur Avoidance function is provided to eliminate this spur, at the expense of some measurement speed.

When Spur Avoidance is enabled (the default), the instrument uses a software algorithm to remove this spur from the displayed measurement data, but the algorithm only operates under certain conditions. Specifically, it only operates when the Info BW \leq maxBW/2.5. See "[More Information](#)" on page 302.

You can disable this function to speed up your measurement by setting Spur Avoidance to "Disabled."

Note that when Spur Avoidance is not in effect, either because you have disabled it or because the Info BW $>$ maxBW/2.5, the following warning message will appear in the status bar: "Settings Alert; Spur Avoidance Off". This is to alert you that measurement accuracy might be impacted by the fact that Spur Avoidance is not in effect.

Remote Command	<code>[:SENSe]:DDEMod:SAVoid[:STATe] ON OFF 0 1</code> <code>[:SENSe]:DDEMod:SAVoid[:STATe]?</code>
Example	<code>:DDEMod:SAVoid ON</code> <code>:DDEMod:SAVoid?</code>
Dependencies	Only appears in VXT models M9410A/11A
Preset	ON
State Saved	Saved in instrument state
Range	On Off

More Information

Option	Frequency Range	MaxBW
Option B40	380 MHz ~ 6000 MHz	40 MHz
Option B3X	380 MHz ~ 550 MHz	100 MHz
	550 MHz ~ 1310 MHz	200 MHz
	1310 MHz ~ 5930 MHz	300 MHz
	5930 MHz ~ 6000 MHz	(6080 MHz- center frequency) * 2
Option B6X	380 MHz ~ 550 MHz	100 MHz
	550 MHz ~ 1310 MHz	200 MHz
	1310 MHz ~ 5780 MHz	600 MHz
	5780 MHz ~ 6000 MHz	(6080 MHz- center frequency) * 2
Option B12	380 MHz ~ 550 MHz	100 MHz
	550 MHz ~ 1310 MHz	200 MHz
	1310 MHz ~ 2000 MHz	600 MHz
	2000 MHz ~ 5480 MHz	1200 MHz
	5480 MHz ~ 6000 MHz	(6080 MHz- center frequency) * 2

Optimize EVM

This is an "immediate action" function to optimize EVM for the current input signal. It is used to set the combination of the preamp, mechanical and electronic attenuation, and IF gain value based on the measured signal peak level. Its purpose is to get better EVM results by improving the SNR and avoid ADC overload at the same time.

After this control is pressed, Pre-Adjust for Min Clipping@50227 changes to **Off** and "IF Gain" on page 362 Auto changes to **Manual**.

NOTE

Before selecting this function, the "EVM Optimization Method" on page 303 should be selected.

Remote Command	<code>[:SENSe]:DDEMod:OPTimize</code>
Example	<code>:DDEM:OPT</code>
Dependencies	Does not appear in VXT Models M9410A/11A/15A/16A/20A

EVM Optimization Method

There are 2 methods for EVM Optimization:

- NORMal** Captures input signal, measures its peak power, then the algorithm will find proper setting combination for attenuation, preamp and IF Gain
- ITERative** Captures input signal multiple times in a iteration process, demodulates the signal and calculates EVM for each iteration, then finds setting combination for attenuation, preamp and IF Gain with minimum EVM

The **Iterative** method is slower than the **Normal** method but it can always get better EVM.

Remote Command	<code>[:SENSe]:DDEMod:OPTMethod NORMal ITERative</code> <code>[:SENSe]:DDEMod:OPTMethod?</code>
Example	<code>:DDEM:OPTM NORM</code> <code>:DDEM:OPTM?</code>
Dependencies	Does not appear in VXT Models M9410A/11A/15A/16A/20A
Couplings	Disabled when Segment Number is greater than one
Preset	NORMal
State Saved	Saved in instrument state
Range	Normal Iterative

Iterative EVM Optimization Target

Specify the segment will be used as iterative EVM optimization target.

Remote Command	<code>[:SENSe]:DDEMod:OPTimize:ITERative:TARGet SEGMENT1 ... SEGMENT6</code> <code>[:SENSe]:DDEMod:OPTimize:ITERative:TARGet?</code>
Example	<code>:DDEM:OPT:ITER:TARG SEG1</code> <code>:DDEM:OPT:ITER:TARG?</code>
Dependencies	This control is invalid when EVM Optimization Method is Normal
Preset	<code>SEGMENT1</code>
State Saved	Saved in instrument state
Range	Segment 1 Segment 2 Segment 3 Segment 4 Segment 5 Segment 6

Auto Couple

Immediately puts all **Auto/Man** functions into **Auto**. **Auto Couple** is confined to the current measurement only. It does not affect other measurements in the Mode.

In the **Auto** state, **Auto/Man** functions are said to be “coupled”, meaning their values change as you make changes to other values in the measurement. This helps ensure accurate measurements and optimum dynamic range. **Auto Couple** is an immediate action function, and when it is executed, all the **Auto/Man** controls for the current measurement are set to **Auto**, and all measurement settings coupled to the **Auto/Man** parameters are automatically set to their optimal values.

For further details of measurement-specific settings (if any), see "[Measurement-Specific Details](#)" on page 305 below.

Remote Command	<code>:COUPle ALL</code>
Example	<code>:COUP ALL</code>
Backwards Compatibility SCPI	<code>:COUPLE ALL NONE</code>
Backwards Compatibility Notes	<code>:COUP:NONE</code> puts all Auto/Man parameters in manual mode, decoupling all the coupled instrument parameters. It is retained for backwards compatibility and is <i>not</i> recommended for making measurements or new designs

All **Auto/Man** parameter couplings in the measurement are set to **Auto**. This includes couplings that may be unavailable or grayed-out due to the current state. For example, in the Swept SA measurement, there is no **Auto/Man** coupling for **RBW** while in Zero Span. Nonetheless, if **Auto Couple** were executed while in Zero Span, it

3 VMA Mode

3.1 Digital Demod Measurement

would set **RBW** to Auto "behind the scenes" so that, on exit from Zero Span, it would be in **Auto**.

Any **Auto/Man** selection specific (local) to the other measurements in the current Mode are not affected by **Auto Couple**. Any functions that are *not* coupled with other instrument parameters, such as ranging or leveling variables, such as **AutoRange** or **AutoScale**, are not affected.

Executing **Auto Couple** generates the informational message, "All Auto/Man functions have been set to Auto".

Each parameter, upon being set to **Auto**, selects and sets the appropriate auto-coupled value based on that parameter's coupling rules. The Dependency Resolver orchestrates the couplings for parameters that depend on one or more other parameters. The coupling and dependency rules for each parameter are defined in the section describing that parameter.

Executing **Auto Couple** *does not* affect markers, marker functions, trace or display attributes, or any other instrument setting other than those specifically mentioned above.

Measurement-Specific Details

TOI (SA Mode only)

Parameters affected by **Auto Couple** are:

- Center Frequency Step
- Resolution Bandwidth
- Span/RBW Ratio
- Sweep Time
- Video BANDwidth VBW/RBW ratio
- Upper and Lower Tone (set to Sense)
- Zero span measurement Resolution Bandwidth
- Zero span measurement Dwell Time

Harmonics (SA Mode only)

Parameters affected by **Auto Couple** are:

- Resolution Bandwidth
- Fundamental Frequency
- Dwell Time
- Range Table Resolution Bandwidths
- Range Table Dwell Times

Meas Preset

Restores all measurement parameters to their default values.

Remote Command	:CONFigure:DDEMod
Example	:CONF:DDEM
Notes	Restore all defaults of parameters

3.1.9.3 Meas Standard

Contains controls for setting the radio standard to which the current measurement will be made.

Preset to Std

Displays a menu for selecting preset Digital Demod Setup parameters and BW for measuring a wide variety of standard digital communications formats. Does not prevent you from making adjustments to measurement parameters afterwards.

The following standard presets are available:

Cellular	EDGE, NADC, PDC, PHP (PHS)
Wireless Networking	Wi-SUN FSK & OQPSK, 11ay CB1 MCS12, 11ay CB2 MCS12, 11ay CB3 MCS12, 11ay CB4 MCS 12, 802.15.3d
Video	ATSC 8-VSB, ATSC 16-VSB, DVB-C 16QAM, DVB-C 32QAM, DVB-C 64QAM, DVB128-C 128QAM, DVB-C 256QAM, DVB-S2 QPSK, DVB-S2 8PSK, DVB-S2 16APSK with code rates 2/3, DVB-S2 16APSK with code rates 3/4, DVB-S2 16APSK with code rates 4/5, DVB-S2 16APSK with code rates 5/6, DVB-S2 16APSK with code rates 8/9, DVB-S2 16APSK with code rates 9/10, DVB-S2 32 APSK with code rates 3/4, DVB-S2 32 APSK with code rates 4/5, DVB-S2 32 APSK with code rates 5/6, DVB-S2 32 APSK with code rates 8/9, DVB-S2 32 APSK with code rates 9/10, DVB-S2X 8 APSK with code rate 100/180 (5/9), DVB-S2X 8 APSK with code rate 104/180 (26/45), DVB-S2X 16 APSK with code rate

3 VMA Mode

3.1 Digital Demod Measurement

3/5, DVB-S2X 16 APSK with code rate 13/18, DVB-S2X 16 APSK with code rate 18/30 (3/5-L), DVB-S2X 16 APSK with code rate 20/30 (2/3-L), DVB-S2X 16 APSK with code rate 23/36, DVB-S2X 16 APSK with code rate 25/36, DVB-S2X 16 APSK with code rate 26/45, DVB-S2X 16 APSK with code rate 28/45, DVB-S2X 16 APSK with code rate 90/180 (1/2), DVB-S2X 16 APSK with code rate 96/180 (8/15), DVB-S2X 16 APSK with code rate 100/180 (5/9), DVB-S2X 16 APSK with code rate 140/180 (7/9), DVB-S2X 16 APSK with code rate 154/180 (77/90), DVB-S2X 16 APSK with Short FEC and code rate 3/5, DVB-S2X 16 APSK with Short FEC and code rate 7/15, DVB-S2X 16 APSK with Short FEC and code rate 8/15, DVB-S2X 16 APSK with Short FEC and code rate 26/45, DVB-S2X 16 APSK with Short FEC and code rate 32/45, DVB-S2X 32 APSK with code rate 128/180 (32/45), DVB-S2X 32 APSK with code rate 132/180 (11/15), DVB-S2X 32 APSK with code rate 140/180 (7/9), DVB-S2X 32 APSK with code rate 2/3, DVB-S2X 32 APSK with short FEC and code rate 2/3, DVB-S2X 32 APSK with short FEC and code rate 32/45, DVB-S2X 64 APSK with code rate 4/5, DVB-S2X 64 APSK with code rate 5/6, DVB-S2X 64 APSK with code rate 7/9, DVB-S2X 64 APSK with code rate 128/180 (32/45), DVB-S2X 64 APSK with code rate 132/180 (11/15), DVB-S2X 128 APSK with code rate 135/180 (3/4), DVB-S2X 128 APSK with code rate 140/180 (7/9), DVB-S2X 256 APSK with code rate 116/180 (29/45), DVB-S2X 256 APSK with code rate 124/180 (31/45), DVB-S2X 256 APSK with code rate 128/180 (32/45), DVB-S2X 256 APSK with code rate 135/180 (3/4), DVB-S2X 256 APSK with code rate 20/30 (2/3), DVB-S2X 256 APSK with code rate 22/30 (11/15)

Not that xxx-L= MODCODs optimized for quasi-linear channels

Radio	APCO 25 C4FM/CQPSK Combined, APCO 25 CQPSK EVM, APCO 25 HCPM, APCO 25 HDQPSK, APCO 25 HDQPSK EVM, TETRA, DMR, dPMR
Other	None, DECT, VDL Mode 2/3, MIL-STD CPM (188-181C Opt21), SOQPSK-TG, SOQPSK-A, SOQPSK-B

Remote Command `[:SENSe]:RADio:STANdard:PRESet NONE | EDGE | NADC | PDC | PHS | DTv8 | DTv16 | DVB16 | DVB32 | DVB64 | DVB128 | DVB256 | AP1C4FM | AP1CQPSK | AP2HCPM | AP2HDQPSK | AP2HDQPSKEVM | DMR | DPMR | DECT | TETRA | VDL2 | MILSTDCPM | WS2F50K1 | WS2F100K1 | WS2F100K05 | WS2F150K05 | WS2F200K1 | WS2F200K05 | WS2F300K05 | SOQPSKTG | SOQPSKA | SOQPSKB | S2QPSK | S28PSK | DVB16APSK23 | DVB16APSK34 | DVB16APSK45 | DVB16APSK56 | DVB16APSK89 | DVB16APSK910 | DVB32APSK34 | DVB32APSK45 | DVB32APSK56 | DVB32APSK89 | DVB32APSK910 | S2X8CR59 | S2X8CR2645 | S2X16CR35 | S2X16CR1318 | S2X16CR35L | S2X16CR23L | S2X16CR2336 | S2X16CR2536 | S2X16CR2645 | S2X16CR2845 | S2X16CR12 | S2X16CR815 | S2X16CR59 | S2X16CR79 | S2X16CR7790 | S2X16CR35S | S2X16CR715S | S2X16CR815S | S2X16CR2645S | S2X16CR3245S | S2X32CR3245 | S2X32CR1115 | S2X32CR79 | S2X32CR23 | S2X32CR23S | S2X32CR3245S | S2X64CR45 | S2X64CR56 | S2X64CR79 | S2X64CR3245 | S2X64CR1115 | S2X128CR34 | S2X128CR79 | S2X256CR2945 | S2X256CR3145 | S2X256CR3245 | S2X256CR34 | S2X256CR23 | S2X256CR1115 | WSOQPSKHS | WSOQPSKRC | WL11AYC1M12 | WL11AYC2M12 | WL11AYC3M12 | WL11AYC4M12 | WP153D`

Example `:RAD:STAN:PRES NONE`

Notes `DVB64APSK45` is an alias for `S2X64CR45`

Range	NONE EDGE NADC PDC PHS(PHP) ATSC 8VSB ATSC 16VSB DVB 16QAM DVB 32QAM DVB 64QAM DVB 128QAM DVB 256QAM APC025 C4FM/CQPSK Combined APC025 CQPSK EVM APC025 HCPM APC025 HDQPSK APC025 HDQPSK EVM DMR DPMR DECT TETRA VDL Mode2/3 MI-STD CPM WiSUN 2FSK 50/1 WiSUN 2FSK 100/1 WiSUN 2FSK 100/0.5 WiSUN 2FSK 150/0.5 WiSUN 2FSK 200/1 WiSUN 2FSK 200/0.5 WiSUN 2FSK 300/0.5 SOQPSK-TG SOQPSK-A SOQPSK-B DVB-S2 QPSK DVB-S2 8PSK DVB-S2 16APSK Code Rate 2/3 DVB-S2 16APSK Code Rate 3/4 DVB-S2 16APSK Code Rate 4/5 DVB-S2 16APSK Code Rate 5/6 DVB-S2 16APSK Code Rate 8/9 DVB-S2 16APSK Code Rate 9/10 DVB-S2 32APSK Code Rate 3/4 DVB-S2 32APSK Code Rate 4/5 DVB-S2 32APSK Code Rate 5/6 DVB-S2 32APSK Code Rate 8/9 DVB-S2 32APSK Code Rate 9/10 DVB-S2X 8APSK Code Rate 5/9 DVB-S2X 8APSK Code Rate 26/45 DVB-S2X 16APSK Code Rate 3/5 DVB-S2X 16APSK Code Rate 13/18 DVB-S2X 16APSK Code Rate 3/5-L DVB-S2X 16APSK Code Rate 2/3-L DVB-S2X 16APSK Code Rate 23/36 DVB-S2X 16APSK Code Rate 25/36 DVB-S2X 16APSK Code Rate 26/45 DVB-S2X 16APSK Code Rate 28/45 DVB-S2X 16APSK Code Rate 1/2 DVB-S2X 16APSK Code Rate 8/15 DVB-S2X 16APSK Code Rate 5/9 DVB-S2X 16APSK Code Rate 7/9 DVB-S2X 16APSK Code Rate 77/90 DVB-S2X 16APSK Code Rate 3/5 Short FEC DVB-S2X 16APSK Code Rate 7/15 Short FEC DVB-S2X 16APSK Code Rate 8/15 Short FEC DVB-S2X 16APSK Code Rate 26/45 Short FEC DVB-S2X 16APSK Code Rate 32/45 Short FEC DVB-S2X 32APSK Code Rate 32/45 DVB-S2X 32APSK Code Rate 11/15 DVB-S2X 32APSK Code Rate 7/9 DVB-S2X 32APSK Code Rate 2/3 DVB-S2X 32APSK Code Rate 2/3 Short FEC DVB-S2X 32APSK Code Rate 32/45 Short FEC DVB-S2X 64APSK Code Rate 4/5 DVB-S2X 64APSK Code Rate 5/6 DVB-S2X 64APSK Code Rate 7/9 DVB-S2X 64APSK Code Rate 32/45 DVB-S2X 64APSK Code Rate 11/15 DVB-S2X 128APSK Code Rate 3/4 DVB-S2X 128APSK Code Rate 7/9 DVB-S2X 256APSK Code Rate 29/45 DVB-S2X 256APSK Code Rate 31/45 DVB-S2X 256APSK Code Rate 32/45 DVB-S2X 256APSK Code Rate 3/4 DVB-S2X 256APSK Code Rate 2/3 DVB-S2X 256APSK Code Rate 11/15 WiSUN OQPSK Half Sine WiSUN OQPSK Raise Cosin 802.11ay CB1 MCS12 802.11ay CB2 MCS12 802.11ay CB3 MCS12 802.11ay CB4 MCS12 802.15.3d
Backwards Compatibility SCPI	[:SENSE]:RADio:STANdard:PRESet NONE EDGE NADC PDC PHS DTv8 DTv16 DVB16 DVB32 DVB64 DVB128 DVB256 AP1C4FM AP1CQPSK AP2HCPM AP2HDQPSK AP2HDQPSKEVM DMR DPMR DECT TETRA VDL2 MILSTD CPM WS2F50K1 WS2F100K1 WS2F100K05 WS2F150K05 WS2F200K1 WS2F200K05 WS2F300K05 SOQPSKTG DVB16APSK23 DVB16APSK34 DVB16APSK45 DVB16APSK56 DVB16APSK89 DVB16APSK910 DVB32APSK34 DVB32APSK45 DVB32APSK56 DVB32APSK89 DVB32APSK910 DVB64APSK45 S2X64CR56 S2X64CR79 S2X64CR3245 S2X64CR1115 S2X128CR34 S2X128CR79 S2X256CR2945 S2X256CR3145 S2X256CR3245 S2X256CR34 S2X256CR23 S2X256CR1115

The following tables list the standard presets supported by the VMA:

Preset To Standard - Cellular

Parameter	NADC	EDGE	PDC	PHP (PHS)
Modulation Format	pi/4 DQPSK	EDGE (3p/8 8PSK)	pi/4 DQPSK	pi/4 DQPSK
Info BW	75 kHz	625 kHz	75 kHz	625 kHz
Symbol Rate	24.3 kHz	270.83 kHz	21 kHz	192 kHz
Meas Filter	Root Raised Cosine	EDGE	Root Raised Cosine	Root Raised Cosine

3 VMA Mode
3.1 Digital Demod Measurement

Parameter	NADC	EDGE	PDC	PHP (PHS)
Ref Filter	Raised Cosine	EDGE	Raised Cosine	Raised Cosine
Filter Alpha	0.35		0.5	0.5
Points / Symbol	5	1	5	5
Meas Interval	157 symbols	142 symbols	135 symbols	111 symbols
Search Length	~48.4 ms	~5.29 ms	~47.6 ms	~5.73 ms
Burst Search	On	On	On	On
Sync Search	Off	Off	Off	Off

Preset To Standard - Wireless

Parameter	Wi-SUN 2-FSK 50/1	Wi-SUN 2-FSK 100/1	Wi-SUN 2-FSK 100/0.5	Wi-SUN 2-FSK 150/0.5
Modulation Format	2-FSK	2-FSK	2-FSK	2-FSK
Info BW	200 kHz	400 kHz	400 kHz	600 kHz
Symbol Rate	50 kHz	100 kHz	100 kHz	150 kHz
Meas Filter	None	None	None	None
Ref Filter	Gaussian	Gaussian	Gaussian	Gaussian
Filter BT	0.5	0.5	0.5	0.5
Points / Symbol	20	20	20	20
Meas Interval	2875 symbols	2875 symbols	2875 symbols	2875 symbols
Search Length				
Burst Search	Off	Off	Off	Off
Sync Search	Off	Off	Off	Off
FSK Deviation Reference (Manual)	25 kHz	50 kHz	25 kHz	37.5 kHz

Parameter	Wi-SUN 2-FSK 200/1	Wi-SUN 2-FSK 200/0.5	Wi-SUN 2-FSK 300/0.5	Wi-SUN OQPSK Half Sine
Modulation Format	2-FSK	2-FSK	2-FSK	OQPSK
Info BW	800 kHz	800 kHz	1.2 MHz	5 MHz
Symbol Rate	200 kHz	200 kHz	300 kHz	1 MHz
Meas Filter	None	None	None	None
Ref Filter	Gaussian	Gaussian	Gaussian	Half Sine
Filter BT	0.5	0.5	0.5	NA
Points / Symbol	20	20	20	10
Meas Interval	2875 symbols	2875 symbols	2875 symbols	501 symbols
Search Length				610 usec
Burst Search	Off	Off	Off	Off
Sync Search	Off	Off	Off	Off

Parameter	Wi-SUN 2-FSK 200/1	Wi-SUN 2-FSK 200/0.5	Wi-SUN 2-FSK 300/0.5	Wi-SUN OQPSK Half Sine
FSK Deviation Reference (Manual)	100 kHz	50 kHz	75 kHz	

Parameter	Wi-SUN OQPSK Raise Cosine	802.11ay CB1 MCS12	802.11ay CB2 MCS12	802.11ay CB3 MCS12
Segment		Segment1/2	Segment1/2	Segment1/2
Modulation Format	OQPSK	Pi/2 BPSK(Custom IQ)/16QAM(Custom IQ)	Pi/2 BPSK(Custom IQ)/16QAM(Custom IQ)	QPSK(Custom IQ)/16QAM(Custom IQ)
Info BW	5 MHz	2.4 GHz	4.5 GHz	7.2 GHz
Symbol Rate	1 MHz	1.76 GHz	3.52 GHz	5.28 GHz
Meas Filter	None	Root Raised Cosine	Root Raised Cosine	Root Raised Cosine
Ref Filter	Raised Cosine	Raised Cosine	Raised Cosine	Raised Cosine
Filter Alpha	0.8	0.25	0.25	0.25
Points / Symbol	10	10	10	10
Meas Interval	501 symbols	2176/400 symbols	4864/820 symbols	5000/1024 symbols
Search Length	610 usec	15 usec	15 usec	15 usec
Burst Search	Off	Off	Off	Off
Sync Search	Off	On	On	On

Parameter	802.11ay CB4 MCS12	802.15.3d
Segment	Segment1/2	Segment1/2
Modulation Format	Pi/2 BPSK (Custom IQ)/16QAM(Custom IQ)	Pi/2 BPSK (Custom IQ)/64QAM(Custom IQ)
Info BW	9.6 GHz	40GHz
Symbol Rate	7.04 GHz	25GHz
Meas Filter	Root Raised Cosine	Root Raised Cosine
Ref Filter	Raised Cosine	Raised Cosine
Filter Alpha	0.25	0.5
Points / Symbol	10	10
Meas Interval	9728/1024 symbols	1792/16384 symbols
Search Length	15 usec	2.5 usec
Burst Search	Off	On
Sync Search	On	On

3 VMA Mode
3.1 Digital Demod Measurement

Preset To Standard - Video

Parameter	ATSC 8-VSB	ATSC 16-VSB	DVB-C 16-QAM	DVB-C 32-QAM
Segments	Segment1	Segment1	Segment1	Segment1
Modulation Format	8-VSB	16-VSB	16-QAM	32-QAM
Info BW	7 MHz	7 MHz	8 MHz	8 MHz
Symbol Rate	10.762 MHz	10.762 MHz	6.9 MHz	6.9 MHz
Meas Filter	Root Raised Cosine	Root Raised Cosine	Root Raised Cosine	Root Raised Cosine
Ref Filter	Raised Cosine	Raised Cosine	Raised Cosine	Raised Cosine
Filter Alpha	0.1152	0.1152	0.15	0.15
Points / Symbol	2	2	2	2
Meas Interval	800 symbols	800 symbols	800 symbols	800 symbols
Search Length				
Burst Search	Off	Off	Off	Off
Sync Search	Off	Off	Off	Off
I/Q Offset Compensation			Off	Off

Parameter	DVB-C 64-QAM	DVB-C 128-QAM	DVB-C 256-QAM
Segments	Segment1	Segment1	Segment1
Modulation Format	64-QAM	128-QAM	256-QAM
Info BW	8 MHz	8 MHz	8 MHz
Symbol Rate	6.9 MHz	6.9 MHz	6.9 MHz
Meas Filter	Root Raised Cosine	Root Raised Cosine	Root Raised Cosine
Ref Filter	Raised Cosine	Raised Cosine	Raised Cosine
Filter Alpha	0.15	0.15	0.15
Points / Symbol	2	2	2
Meas Interval	800 symbols	800 symbols	800 symbols
Search Length			
Burst Search	Off	Off	Off
Sync Search	Off	Off	Off
I/Q Offset Compensation	Off	Off	Off
APSK R2/R1	NA	NA	NA
APSK R3/R1	NA	NA	NA

Parameter	DVB-S2 QPSK		DVB-S2 8PSK		DVB-S2 16-APSK Code Rate 2/3	
Segments	Segment1	Segment2	Segment1	Segment2	Segment1	Segment2
Modulation Format	QPSK (Custom IQ)	QPSK (Custom IQ)	QPSK (Custom IQ)	8PSK (Custom IQ)	QPSK (Custom IQ)	16-APSK

Parameter	DVB-S2 QPSK		DVB-S2 8PSK		DVB-S2 16-APSK Code Rate 2/3	
Info BW	25 MHz	25 MHz	25 MHz	25 MHz	25 MHz	25 MHz
Symbol Rate	10 MHz	10 MHz	10 MHz	10 MHz	10 MHz	10 MHz
Meas Filter	Root Raised Cosine	Root Raised Cosine	Root Raised Cosine	Root Raised Cosine	Root Raised Cosine	Root Raised Cosine
Ref Filter	Raised Cosine	Raised Cosine	Raised Cosine	Raised Cosine	Raised Cosine	Raised Cosine
Filter Alpha	0.35	0.35	0.35	0.35	0.35	0.35
Points / Symbol	5	5	5	5	5	5
Meas Interval	90 symbols	1000 symbols	90 symbols	1000 symbols	90 symbols	1000 symbols
Search Length	3.3552 msec	3.3552 msec	3.3552 msec	3.3552 msec	3.3552 msec	3.3552 msec
Burst Search	Off	NA	Off	NA	Off	NA
Sync Search	On	NA	On	NA	On	NA
I/Q Offset Compensation	On	On	On	On	On	On
APSK R2/R1	NA	NA	NA	NA	NA	3.15
APSK R3/R1	NA	NA	NA	NA	NA	5.27

Parameter	DVB-S2 16-APSK Code Rate 3/4		DVB-S2 16-APSK Code Rate 4/5		DVB-S2 16-APSK Code Rate 5/6	
Segments	Segment1	Segment2	Segment1	Segment2	Segment1	Segment2
Modulation Format	QPSK (Custom IQ)	16-APSK	QPSK (Custom IQ)	16-APSK	QPSK (Custom IQ)	16-APSK
Info BW	25 MHz	25 MHz	25 MHz	25 MHz	25 MHz	25 MHz
Symbol Rate	10 MHz	10 MHz	10 MHz	10 MHz	10 MHz	10 MHz
Meas Filter	Root Raised Cosine	Root Raised Cosine	Root Raised Cosine	Root Raised Cosine	Root Raised Cosine	Root Raised Cosine
Ref Filter	Raised Cosine	Raised Cosine	Raised Cosine	Raised Cosine	Raised Cosine	Raised Cosine
Filter Alpha	0.35	0.35	0.35	0.35	0.35	0.35
Points / Symbol	5	5	5	5	5	5
Meas Interval	90 symbols	1000 symbols	90 symbols	1000 symbols	90 symbols	1000 symbols
Search Length	3.3552 msec	3.3552 msec	3.3552 msec	3.3552 msec	3.3552 msec	3.3552 msec
Burst Search	Off	NA	Off	NA	Off	NA
Sync Search	On	NA	On	NA	On	NA
I/Q Offset Compensation	On	On	On	On	On	On

3 VMA Mode
3.1 Digital Demod Measurement

Parameter	DVB-S2 16-APSK Code Rate 3/4		DVB-S2 16-APSK Code Rate 4/5		DVB-S2 16-APSK Code Rate 5/6	
APSK R2/R1	NA	2.85	NA	2.75	NA	2.70
APSK R3/R1	NA	5.27	NA	5.27	NA	5.27

Parameter	DVB-S2 16-APSK Code Rate 8/9		DVB-S2 16-APSK Code Rate 9/10		DVB-S2 32-APSK Code Rate 3/4	
Segments	Segment1	Segment2	Segment1	Segment2	Segment1	Segment2
Modulation Format	QPSK (Custom IQ)	16-APSK	QPSK (Custom IQ)	16-APSK	QPSK (Custom IQ)	32-APSK
Info BW	25 MHz	25 MHz	25 MHz	25 MHz	25 MHz	25 MHz
Symbol Rate	10 MHz	10 MHz	10 MHz	10 MHz	10 MHz	10 MHz
Meas Filter	Root Raised Cosine	Root Raised Cosine	Root Raised Cosine	Root Raised Cosine	Root Raised Cosine	Root Raised Cosine
Ref Filter	Raised Cosine	Raised Cosine	Raised Cosine	Raised Cosine	Raised Cosine	Raised Cosine
Filter Alpha	0.35	0.35	0.35	0.35	0.35	0.35
Points / Symbol	5	5	5	5	5	5
Meas Interval	90 symbols	1000 symbols	90 symbols	1000 symbols	90 symbols	1000 symbols
Search Length	3.3552 msec	3.3552 msec	3.3552 msec	3.3552 msec	3.3552 msec	3.3552 msec
Burst Search	Off	NA	Off	NA	Off	NA
Sync Search	On	NA	On	NA	On	NA
I/Q Offset Compensation	On	On	On	On	On	On
APSK R2/R1	NA	2.60	NA	2.57	NA	2.84
APSK R3/R1	NA	5.27	NA	5.27	NA	5.27

Parameter	DVB-S2 32-APSK Code Rate 4/5		DVB-S2 32-APSK Code Rate 5/6		DVB-S2 32-APSK Code Rate 8/9	
Segments	Segment1	Segment2	Segment1	Segment2	Segment1	Segment2
Modulation Format	QPSK (Custom IQ)	32-APSK	QPSK (Custom IQ)	32-APSK	QPSK (Custom IQ)	32-APSK
Info BW	25 MHz	25 MHz	25 MHz	25 MHz	25 MHz	25 MHz
Symbol Rate	10 MHz	10 MHz	10 MHz	10 MHz	10 MHz	10 MHz
Meas Filter	Root Raised Cosine	Root Raised Cosine	Root Raised Cosine	Root Raised Cosine	Root Raised Cosine	Root Raised Cosine
Ref Filter	Raised Cosine	Raised Cosine	Raised Cosine	Raised Cosine	Raised Cosine	Raised Cosine
Filter Alpha	0.35	0.35	0.35	0.35	0.35	0.35

Parameter	DVB-S2 32-APSK Code Rate 4/5		DVB-S2 32-APSK Code Rate 5/6		DVB-S2 32-APSK Code Rate 8/9	
Points / Symbol	5	5	5	5	5	5
Meas Interval	90 symbols	1000 symbols	90 symbols	1000 symbols	90 symbols	1000 symbols
Search Length	3.3552 msec	3.3552 msec	3.3552 msec	3.3552 msec	3.3552 msec	3.3552 msec
Burst Search	Off	NA	Off	NA	Off	NA
Sync Search	On	NA	On	NA	On	NA
I/Q Offset Compensation	On	On	On	On	On	On
APSK R2/R1	NA	2.72	NA	2.64	NA	2.54
APSK R3/R1	NA	4.87	NA	4.64	NA	4.33

Parameter	DVB-S2X 16-APSK Code Rate 3/5		DVB-S2X 16-APSK Code Rate 13/18		DVB-S2X 16-APSK Code Rate 18/30 (3/5-L)	
Segments	Segment1	Segment2	Segment1	Segment2	Segment1	Segment2
Modulation Format	QPSK (Custom IQ)	16-APSK (Custom IQ)	QPSK (Custom IQ)	16-APSK (Custom IQ)	QPSK (Custom IQ)	16-APSK (Custom IQ)
Info BW	25 MHz	25 MHz	25 MHz	25 MHz	25 MHz	25 MHz
Symbol Rate	10 MHz	10 MHz	10 MHz	10 MHz	10 MHz	10 MHz
Meas Filter	Root Raised Cosine	Root Raised Cosine	Root Raised Cosine	Root Raised Cosine	Root Raised Cosine	Root Raised Cosine
Ref Filter	Raised Cosine	Raised Cosine	Raised Cosine	Raised Cosine	Raised Cosine	Raised Cosine
Filter Alpha	0.35	0.35	0.35	0.35	0.35	0.35
Points / Symbol	5	5	5	5	5	5
Meas Interval	90 symbols	1000 symbols	90 symbols	1000 symbols	90 symbols	1000 symbols
Search Length	3.3552 msec	3.3552 msec	3.3552 msec	3.3552 msec	3.3552 msec	3.3552 msec
Burst Search	Off	NA	Off	NA	Off	NA
Sync Search	On	NA	On	NA	On	NA

Parameter	DVB-S2X 16-APSK Code Rate 20/30 (2/3-L)		DVB-S2X 16-APSK Code Rate 23/36		DVB-S2X 16-APSK Code Rate 25/36	
Segments	Segment1	Segment2	Segment1	Segment2	Segment1	Segment2
Modulation Format	QPSK (Custom IQ)	16-APSK (Custom IQ)	QPSK (Custom IQ)	16-APSK (Custom IQ)	QPSK (Custom IQ)	16-APSK (Custom IQ)
Info BW	25 MHz	25 MHz	25 MHz	25 MHz	25 MHz	25 MHz
Symbol Rate	10 MHz	10 MHz	10 MHz	10 MHz	10 MHz	10 MHz
Meas Filter	Root Raised	Root Raised	Root Raised	Root Raised	Root Raised	Root Raised

3 VMA Mode
3.1 Digital Demod Measurement

Parameter	DVB-S2X 16-APSK Code Rate 20/30 (2/3-L)		DVB-S2X 16-APSK Code Rate 23/36		DVB-S2X 16-APSK Code Rate 25/36	
	Cosine	Cosine	Cosine	Cosine	Cosine	Cosine
Ref Filter	Raised Cosine	Raised Cosine	Raised Cosine	Raised Cosine	Raised Cosine	Raised Cosine
Filter Alpha	0.35	0.35	0.35	0.35	0.35	0.35
Points / Symbol	5	5	5	5	5	5
Meas Interval	90 symbols	1000 symbols	90 symbols	1000 symbols	90 symbols	1000 symbols
Search Length	3.3552 msec	3.3552 msec	3.3552 msec	3.3552 msec	3.3552 msec	3.3552 msec
Burst Search	Off	NA	Off	NA	Off	NA
Sync Search	On	NA	On	NA	On	NA

Parameter	DVB-S2X 16-APSK Code Rate 26/45		DVB-S2X 16-APSK Code Rate 28/45		DVB-S2X 16-APSK Code Rate 90/180 (1/2)	
Segments	Segment1	Segment2	Segment1	Segment2	Segment1	Segment2
Modulation Format	QPSK (Custom IQ)	16-APSK (Custom IQ)	QPSK (Custom IQ)	16-APSK (Custom IQ)	QPSK (Custom IQ)	16-APSK (Custom IQ)
Info BW	25 MHz	25 MHz	25 MHz	25 MHz	25 MHz	25 MHz
Symbol Rate	10 MHz	10 MHz	10 MHz	10 MHz	10 MHz	10 MHz
Meas Filter	Root Raised Cosine	Root Raised Cosine	Root Raised Cosine	Root Raised Cosine	Root Raised Cosine	Root Raised Cosine
Ref Filter	Raised Cosine	Raised Cosine	Raised Cosine	Raised Cosine	Raised Cosine	Raised Cosine
Filter Alpha	0.35	0.35	0.35	0.35	0.35	0.35
Points / Symbol	5	5	5	5	5	5
Meas Interval	90 symbols	1000 symbols	90 symbols	1000 symbols	90 symbols	1000 symbols
Search Length	3.3552 msec	3.3552 msec	3.3552 msec	3.3552 msec	3.3552 msec	3.3552 msec
Burst Search	Off	NA	Off	NA	Off	NA
Sync Search	On	NA	On	NA	On	NA

Parameter	DVB-S2X 16-APSK Code Rate 96/180 (8/15)		DVB-S2X 16-APSK Code Rate 100/180 (5/9)		DVB-S2X 16-APSK Code Rate 140/180 (7/9)	
Segments	Segment1	Segment2	Segment1	Segment2	Segment1	Segment2
Modulation Format	QPSK (Custom IQ)	16-APSK (Custom IQ)	QPSK (Custom IQ)	16-APSK (Custom IQ)	QPSK (Custom IQ)	16-APSK (Custom IQ)
Info BW	25 MHz	25 MHz	25 MHz	25 MHz	25 MHz	25 MHz
Symbol Rate	10 MHz	10 MHz	10 MHz	10 MHz	10 MHz	10 MHz
Meas Filter	Root Raised	Root Raised	Root Raised	Root Raised	Root Raised	Root Raised

Parameter	DVB-S2X 16-APSK Code Rate 96/180 (8/15)		DVB-S2X 16-APSK Code Rate 100/180 (5/9)		DVB-S2X 16-APSK Code Rate 140/180 (7/9)	
	Cosine	Cosine	Cosine	Cosine	Cosine	Cosine
Ref Filter	Raised	Raised	Raised	Raised	Raised	Raised
	Cosine	Cosine	Cosine	Cosine	Cosine	Cosine
Filter Alpha	0.35	0.35	0.35	0.35	0.35	0.35
Points / Symbol	5	5	5	5	5	5
Meas Interval	90 symbols	1000 symbols	90 symbols	1000 symbols	90 symbols	1000 symbols
Search Length	3.3552 msec	3.3552 msec	3.3552 msec	3.3552 msec	3.3552 msec	3.3552 msec
Burst Search	Off	NA	Off	NA	Off	NA
Sync Search	On	NA	On	NA	On	NA

Parameter	DVB-S2X 16-APSK Code Rate 154/180 (77/90)		DVB-S2X 16-APSK Code Rate 3/5 Short FEC		DVB-S2X 16-APSK Code Rate 7/15 Short FEC	
Segments	Segment1	Segment2	Segment1	Segment2	Segment1	Segment2
Modulation	QPSK	16-APSK	QPSK	16-APSK	QPSK	16-APSK
Format	(Custom IQ)	(Custom IQ)	(Custom IQ)	(Custom IQ)	(Custom IQ)	(Custom IQ)
Info BW	25 MHz	25 MHz	25 MHz	25 MHz	25 MHz	25 MHz
Symbol Rate	10 MHz	10 MHz	10 MHz	10 MHz	10 MHz	10 MHz
Meas Filter	Root Raised	Root Raised	Root Raised	Root Raised	Root Raised	Root Raised
	Cosine	Cosine	Cosine	Cosine	Cosine	Cosine
Ref Filter	Raised	Raised	Raised	Raised	Raised	Raised
	Cosine	Cosine	Cosine	Cosine	Cosine	Cosine
Filter Alpha	0.35	0.35	0.35	0.35	0.35	0.35
Points / Symbol	5	5	5	5	5	5
Meas Interval	90 symbols	1000 symbols	90 symbols	1000 symbols	90 symbols	1000 symbols
Search Length	3.3552 msec	3.3552 msec	3.3552 msec	3.3552 msec	3.3552 msec	3.3552 msec
Burst Search	Off	NA	Off	NA	Off	NA
Sync Search	On	NA	On	NA	On	NA

Parameter	DVB-S2X 16-APSK Code Rate 8/15 Short FEC		DVB-S2X 16-APSK Code Rate 26/45 Short FEC		DVB-S2X 16-APSK Code Rate 32/45 Short FEC	
Segments	Segment1	Segment2	Segment1	Segment2	Segment1	Segment2
Modulation	QPSK	16-APSK	QPSK	16-APSK	QPSK	16-APSK
Format	(Custom IQ)	(Custom IQ)	(Custom IQ)	(Custom IQ)	(Custom IQ)	(Custom IQ)
Info BW	25 MHz	25 MHz	25 MHz	25 MHz	25 MHz	25 MHz

3 VMA Mode
3.1 Digital Demod Measurement

Parameter	DVB-S2X 16-APSK Code Rate 8/15 Short FEC		DVB-S2X 16-APSK Code Rate 26/45 Short FEC		DVB-S2X 16-APSK Code Rate 32/45 Short FEC	
Symbol Rate	10 MHz	10 MHz	10 MHz	10 MHz	10 MHz	10 MHz
Meas Filter	Root Raised Cosine	Root Raised Cosine	Root Raised Cosine	Root Raised Cosine	Root Raised Cosine	Root Raised Cosine
Ref Filter	Raised Cosine	Raised Cosine	Raised Cosine	Raised Cosine	Raised Cosine	Raised Cosine
Filter Alpha	0.35	0.35	0.35	0.35	0.35	0.35
Points / Symbol	5	5	5	5	5	5
Meas Interval	90 symbols	1000 symbols	90 symbols	1000 symbols	90 symbols	1000 symbols
Search Length	3.3552 msec	3.3552 msec	3.3552 msec	3.3552 msec	3.3552 msec	3.3552 msec
Burst Search	Off	NA	Off	NA	Off	NA
Sync Search	On	NA	On	NA	On	NA

Parameter	DVB-S2X 32-APSK Code Rate 128/180 (32/45)		DVB-S2X 32-APSK Code Rate 132/180 (11/15)		DVB-S2X 32-APSK Code Rate 140/180 (7/9)	
Segments	Segment1	Segment2	Segment1	Segment2	Segment1	Segment2
Modulation Format	QPSK (Custom IQ)	32-APSK (Custom IQ)	QPSK (Custom IQ)	32-APSK (Custom IQ)	QPSK (Custom IQ)	32-APSK (Custom IQ)
Info BW	25 MHz	25 MHz	25 MHz	25 MHz	25 MHz	25 MHz
Symbol Rate	10 MHz	10 MHz	10 MHz	10 MHz	10 MHz	10 MHz
Meas Filter	Root Raised Cosine	Root Raised Cosine	Root Raised Cosine	Root Raised Cosine	Root Raised Cosine	Root Raised Cosine
Ref Filter	Raised Cosine	Raised Cosine	Raised Cosine	Raised Cosine	Raised Cosine	Raised Cosine
Filter Alpha	0.35	0.35	0.35	0.35	0.35	0.35
Points / Symbol	5	5	5	5	5	5
Meas Interval	90 symbols	1000 symbols	90 symbols	1000 symbols	90 symbols	1000 symbols
Search Length	3.3552 msec	3.3552 msec	3.3552 msec	3.3552 msec	3.3552 msec	3.3552 msec
Burst Search	Off	NA	Off	NA	Off	NA
Sync Search	On	NA	On	NA	On	NA

Parameter	DVB-S2X 32-APSK Code Rate 2/3		DVB-S2X 32-APSK Code Rate 2/3 Short FEC		DVB-S2X 32-APSK Code Rate 32/45 Short FEC	
Segments	Segment1	Segment2	Segment1	Segment2	Segment1	Segment2
Modulation	QPSK	32-APSK	QPSK	32-APSK	QPSK	32-APSK

Parameter	DVB-S2X 32-APSK Code Rate 2/3		DVB-S2X 32-APSK Code Rate 2/3 Short FEC		DVB-S2X 32-APSK Code Rate 32/45 Short FEC	
Format	(Custom IQ)	(Custom IQ)	(Custom IQ)	(Custom IQ)	(Custom IQ)	(Custom IQ)
Info BW	25 MHz	25 MHz	25 MHz	25 MHz	25 MHz	25 MHz
Symbol Rate	10 MHz	10 MHz	10 MHz	10 MHz	10 MHz	10 MHz
Meas Filter	Root Raised Cosine	Root Raised Cosine	Root Raised Cosine	Root Raised Cosine	Root Raised Cosine	Root Raised Cosine
Ref Filter	Raised Cosine	Raised Cosine	Raised Cosine	Raised Cosine	Raised Cosine	Raised Cosine
Filter Alpha	0.35	0.35	0.35	0.35	0.35	0.35
Points / Symbol	5	5	5	5	5	5
Meas Interval	90 symbols	1000 symbols	90 symbols	1000 symbols	90 symbols	1000 symbols
Search Length	3.3552 msec	3.3552 msec	3.3552 msec	3.3552 msec	3.3552 msec	3.3552 msec
Burst Search	Off	NA	Off	NA	Off	NA
Sync Search	On	NA	On	NA	On	NA

Parameter	DVB-S2X 64-APSK Code Rate 4/5		DVB-S2X 64-APSK Code Rate 5/6	
Segments	Segment1	Segment2	Segment1	Segment2
Modulation Format	QPSK (Custom IQ)	64-APSK (Custom IQ)	QPSK (Custom IQ)	64-APSK (Custom IQ)
Info BW	25 MHz	25 MHz	25 MHz	25 MHz
Symbol Rate	10 MHz	10 MHz	10 MHz	10 MHz
Meas Filter	Root Raised Cosine	Root Raised Cosine	Root Raised Cosine	Root Raised Cosine
Ref Filter	Raised Cosine	Raised Cosine	Raised Cosine	Raised Cosine
Filter Alpha	0.35	0.35	0.35	0.35
Points / Symbol	5	5	5	5
Meas Interval	90 symbols	1000 symbols	90 symbols	1000 symbols
Search Length	3.3552 msec	3.3552 msec	3.3552 msec	3.3552 msec
Burst Search	Off	NA	Off	NA
Sync Search	On	NA	On	NA

Parameter	DVB-S2X 64-APSK Code Rate 7/9		DVB-S2X 64-APSK Code Rate 128/180 (32/45)		DVB-S2X 64-APSK Code Rate 132/180 (11/15)	
Segments	Segment1	Segment2	Segment1	Segment2	Segment1	Segment2
Modulation Format	QPSK (Custom IQ)	64-APSK (Custom IQ)	QPSK (Custom IQ)	64-APSK (Custom IQ)	QPSK (Custom IQ)	64-APSK (Custom IQ)

3 VMA Mode
3.1 Digital Demod Measurement

Parameter	DVB-S2X 64-APSK Code Rate 7/9		DVB-S2X 64-APSK Code Rate 128/180 (32/45)		DVB-S2X 64-APSK Code Rate 132/180 (11/15)	
Info BW	25 MHz	25 MHz	25 MHz	25 MHz	25 MHz	25 MHz
Symbol Rate	10 MHz	10 MHz	10 MHz	10 MHz	10 MHz	10 MHz
Meas Filter	Root Raised Cosine	Root Raised Cosine	Root Raised Cosine	Root Raised Cosine	Root Raised Cosine	Root Raised Cosine
Ref Filter	Raised Cosine	Raised Cosine	Raised Cosine	Raised Cosine	Raised Cosine	Raised Cosine
Filter Alpha	0.35	0.35	0.35	0.35	0.35	0.35
Points / Symbol	5	5	5	5	5	5
Meas Interval	90 symbols	180 symbols	90 symbols	180 symbols	90 symbols	180 symbols
Search Length	3.3552 msec	3.3552 msec	3.3552 msec	3.3552 msec	3.3552 msec	3.3552 msec
Burst Search	Off	NA	Off	NA	Off	NA
Sync Search	On	NA	On	NA	On	NA

Parameter	DVB-S2X 128-APSK Code Rate 135/180 (3/4)		DVB-S2X 128-APSK Code Rate 140/180 (7/9)		DVB-S2X 256-APSK Code Rate 116/180 (29/45)	
Segments	Segment1	Segment2	Segment1	Segment2	Segment1	Segment2
Modulation Format	QPSK (Custom IQ)	64-APSK (Custom IQ)	QPSK (Custom IQ)	64-APSK (Custom IQ)	QPSK (Custom IQ)	64-APSK (Custom IQ)
Info BW	25 MHz	25 MHz	25 MHz	25 MHz	25 MHz	25 MHz
Symbol Rate	10 MHz	10 MHz	10 MHz	10 MHz	10 MHz	10 MHz
Meas Filter	Root Raised Cosine	Root Raised Cosine	Root Raised Cosine	Root Raised Cosine	Root Raised Cosine	Root Raised Cosine
Ref Filter	Raised Cosine	Raised Cosine	Raised Cosine	Raised Cosine	Raised Cosine	Raised Cosine
Filter Alpha	0.35	0.35	0.35	0.35	0.35	0.35
Points / Symbol	5	5	5	5	5	5
Meas Interval	90 symbols	180 symbols	90 symbols	180 symbols	90 symbols	180 symbols
Search Length	3.3552 msec	3.3552 msec	3.3552 msec	3.3552 msec	3.3552 msec	3.3552 msec
Burst Search	Off	NA	Off	NA	Off	NA
Sync Search	On	NA	On	NA	On	NA

Parameter	DVB-S2X 256-APSK Code Rate 124/180 (31/45)		DVB-S2X 256-APSK Code Rate 128/180 (32/45)		DVB-S2X 256-APSK Code Rate 135/180 (3/4)	
Segments	Segment1	Segment2	Segment1	Segment2	Segment1	Segment2
Modulation Format	QPSK (Custom IQ)	64-APSK (Custom IQ)	QPSK (Custom IQ)	64-APSK (Custom IQ)	QPSK (Custom IQ)	64-APSK (Custom IQ)

Parameter	DVB-S2X 256-APSK Code Rate 124/180 (31/45)		DVB-S2X 256-APSK Code Rate 128/180 (32/45)		DVB-S2X 256-APSK Code Rate 135/180 (3/4)	
Info BW	25 MHz	25 MHz	25 MHz	25 MHz	25 MHz	25 MHz
Symbol Rate	10 MHz	10 MHz	10 MHz	10 MHz	10 MHz	10 MHz
Meas Filter	Root Raised Cosine	Root Raised Cosine	Root Raised Cosine	Root Raised Cosine	Root Raised Cosine	Root Raised Cosine
Ref Filter	Raised Cosine	Raised Cosine	Raised Cosine	Raised Cosine	Raised Cosine	Raised Cosine
Filter Alpha	0.35	0.35	0.35	0.35	0.35	0.35
Points / Symbol	5	5	5	5	5	5
Meas Interval	90 symbols	180 symbols	90 symbols	180 symbols	90 symbols	180 symbols
Search Length	3.3552 msec	3.3552 msec	3.3552 msec	3.3552 msec	3.3552 msec	3.3552 msec
Burst Search	Off	NA	Off	NA	Off	NA
Sync Search	On	NA	On	NA	On	NA

Parameter	DVB-S2X 256-APSK Code Rate 20/30 (2/3)		DVB-S2X 256-APSK Code Rate 22/30 (11/15)	
Segments	Segment1	Segment2	Segment1	Segment2
Modulation Format	QPSK (Custom IQ)	64-APSK (Custom IQ)	QPSK (Custom IQ)	64-APSK (Custom IQ)
Info BW	25 MHz	25 MHz	25 MHz	25 MHz
Symbol Rate	10 MHz	10 MHz	10 MHz	10 MHz
Meas Filter	Root Raised Cosine	Root Raised Cosine	Root Raised Cosine	Root Raised Cosine
Ref Filter	Raised Cosine	Raised Cosine	Raised Cosine	Raised Cosine
Filter Alpha	0.35	0.35	0.35	0.35
Points / Symbol	5	5	5	5
Meas Interval	90 symbols	180 symbols	90 symbols	180 symbols
Search Length	3.3552 msec	3.3552 msec	3.3552 msec	3.3552 msec
Burst Search	Off	NA	Off	NA
Sync Search	On	NA	On	NA

Preset To Standard - Radio

Parameter	APCO-25 C4FM/CQPSK Combined	APCO-25 HCPM	APCO-25 HDQPSK	APCO-25 CQPSK EVM
Modulation Format	4-FSK	CPM (FM)	4-FSK	pi/4 DQPSK
Info BW	40 kHz	25 kHz	25 kHz	40 kHz
Symbol Rate	4.8 kHz	6 kHz	6 kHz	4.8 kHz
Meas Filter	Rectangular	None	Rectangular	None

3 VMA Mode
3.1 Digital Demod Measurement

Parameter	APCO-25 C4FM/CQPSK Combined	APCO-25 HCPM	APCO-25 HDQPSK	APCO-25 CQPSK EVM
Ref Filter	Raised Cosine	4RC	Rectangular	Raised Cosine
Filter Alpha	0.2	0.75		0.2
Points / Symbol	5	5	5	5
Meas Interval	200 symbols	168 symbols	180 symbols	200 symbols
Search Length		~63.3 ms	~63.3 ms	
Burst Search	Off	On	On	Off
Sync Search	Off	Off	Off	Off

Parameter	APCO-25 HDQPSK EVM	Tetra	DMR	DPMR
Modulation Format	pi/4 DQPSK	pi/4 DQPSK	4-FSK	4-FSK
Info BW	25 kHz	40 kHz	40 kHz	40 kHz
Symbol Rate	6 kHz	18 kHz	4.8 kHz	2.4 kHz
Meas Filter	None	Root Raised Cosine	Root Raised Cosine	Root Raised Cosine
Ref Filter	APCO-25 Phase 2 RC	Raised Cosine	Raised Cosine	Raised Cosine
Filter Alpha		0.35	0.2	0.2
Points / Symbol	5	4	5	5
Meas Interval	180 symbols	231 symbols	132 symbols	200 symbols
Search Length	~63.3 ms	~72.2 ms	~100 ms	
Burst Search	On	On	On	Off
Sync Search	Off	Off	Off	Off

Preset To Standard - Others

Parameter	None	DECT	VDL Model 2/3	MIL-STD CPM (188-181C Opt21)
Modulation Format	QPSK	2-FSK	D8PSK	CPM (FM)
Info BW	5 MHz	5 MHz	25 kHz	25 kHz
Symbol Rate	1 MHz	1.152 MHz	10.5 kHz	4.8 kHz
Meas Filter	Root Raised Cosine	None	None	None
Ref Filter	Raised Cosine	Gaussian	Raised Cosine	1REC (CPM)
Alpha / BT	0.5	0.5	0.6	
Points / Symbol	10	4	5	5
Meas Interval	501 symbols	480 symbols	315 symbols	500 symbols
Search Length		~9.72 ms	~120 ms	
Burst Search	Off	On	On	Off
Sync Search	Off	Off	Off	Off

Parameter	SOQPSK-TG	SOQPSK-A	SOQPSK-B
Modulation Format	Shaped Offset QPSK	Shaped Offset QPSK	Shaped Offset QPSK
Info BW	12.8 MHz	12.8 MHz	12.8 MHz
Symbol Rate	5 MHz	5 MHz	5 MHz
Meas Filter	None	None	None
Ref Filter	OQPSK-TG (IRIG 106-04)	SOQPSK-A	SOQPSK-B
Filter Alpha			
Points / Symbol	10	10	10
Meas Interval	1000 symbols	1000 symbols	1000 symbols
Search Length			
Burst Search	Off	Off	Off
Sync Search	Off	Off	Off

If the acquisition hardware does not support the default Info BW, then the Info BW will be set to the closest value that the acquisition hardware can support.

3.1.9.4 Frame

Enables you to set frame structure for measurement.

Search Length

Defines the time length that the instrument searches for a burst and/or sync word.

There are two **Search Length** modes:

- Manual: Lets you manually set the Search Length
- Automatic: Sets Search Length automatically according to Meas Interval, Meas Offset and Symbol Rate (longest Segment for multiple Segment case). This is recommended mode for wide band signal (>1GHz) analysis, to avoid unnecessary long Search Length setting leads to slow measurement speed

Remote Command	<code>[:SENSe]:DDEMod:SYNC:SLEngth <time></code> <code>[:SENSe]:DDEMod:SYNC:SLEngth?</code> <code>[:SENSe]:DDEMod:SYNC:SLEngth:AUTO OFF ON 0 1</code> <code>[:SENSe]:DDEMod:SYNC:SLEngth:AUTO?</code>
Example	<code>:DDEMod:SYNC:SLEN 3.0 ms</code> Set the search length to 3 ms <code>:DDEMod:SYNC:SLEN?</code> <code>:DDEMod:SYNC:SLEN:AUTO OFF</code>

3 VMA Mode
3.1 Digital Demod Measurement

:DDEM:SYNC:SLEN:AUTO?

Couplings	Manual: Changing Meas Interval, Meas Offset or Symbol Rate will changes Search Length if Search Length is less than $(1.2 * (\text{Meas Interval} + \text{Meas Offset}) / \text{Symbol Rate})$, no matter what status of the Burst Search or Sync Search is Changing Search Length checks with current allowable minimum value $(1.2 * (\text{Meas Interval} + \text{Meas Offset}) / \text{Symbol Rate})$, if the input value is less than it, the value is clipped to the minimum value, and a data out of range message "Data out of range; Search Length was clipped to the minimum value of xxx ms based on current Meas Interval and Symbol Rate" is displayed Auto: $\text{Search Length} = (3.1 * (\text{Meas Interval} + \text{Meas Offset}) / \text{Symbol Rate})$
Preset	3.0E-3 OFF
State Saved	Yes Yes
Range	Auto Man
Min	1.0E-7
Max	9.9E+37

Segment Number

Specifies the number of segments in one frame.

Remote Command	[:SENSe]:DDEMod:SNUMBER <integer> [:SENSe]:DDEMod:SNUMBER?
Example	:DDEM:SNUM 1 :DDEM:SNUM?
Preset	1
State Saved	Yes
Min	1
Max	6

Capture Time Diagram (Segment Number = 1)

Accesses a menu that enables you to set up time parameters.

Symbol Rate

Enables you to set the symbol rate (symbols per second) for the instrument's digital demodulator. Set this parameter to match the symbol rate of your system.

Remote Command	<code>[:SENSe]:DDEMod:SEGMent1 ... 6:SRATe <frequency></code> <code>[:SENSe]:DDEMod:SEGMent1 ... 6:SRATe?</code>
Example	<code>:DDEM:SEGM1:SRAT 1 MHz</code> <code>:DDEM:SEGM1:SRAT?</code>
Couplings	Changes when Info BW is smaller than Symbol Rate/10
Preset	1.0 MHz
State Saved	Yes
Min	1.0Hz
Max	Max Info BW (hardware dependent)
Backwards Compatibility SCPI	<code>[:SENSe]:DDEMod:SRATe</code>

Burst Search

Turns burst search on or off.

Remote Command	<code>[:SENSe]:DDEMod:SYNC:BURSt[:STATe] OFF ON 0 1</code> <code>[:SENSe]:DDEMod:SYNC:BURSt[:STATe]?</code>
Example	<code>:DDEM:SYNC:BURS OFF</code> Turn off the burst search <code>:DDEM:SYNC:BURS?</code>
Preset	<code>OFF</code>
State Saved	Yes
Range	<code>Off On</code>
Annotation	PULSE NOT FOUND appears in the corner of demod result traces if burst search fails

Search Length

Defines the time length that the instrument searches for a burst and/or sync word.

There are two **Search Length** modes:

- Manual: Lets you manually set the Search Length
- Automatic: Sets Search Length automatically according to Meas Interval, Meas Offset and Symbol Rate (longest Segment for multiple Segment case). This is recommended mode for wide band signal (>1GHz) analysis, to avoid unnecessary long Search Length setting leads to slow measurement speed

Remote Command	<code>[:SENSe]:DDEMod:SYNC:SLENgth <time></code> <code>[:SENSe]:DDEMod:SYNC:SLENgth?</code>
----------------	--

3 VMA Mode
3.1 Digital Demod Measurement

	<code>[:SENSe]:DDEMod:SYNC:SLENgth:AUTO OFF ON 0 1</code> <code>[:SENSe]:DDEMod:SYNC:SLENgth:AUTO?</code>
Example	<code>:DDEM:SYNC:SLEN 3.0 ms</code> Set the search length to 3 ms <code>:DDEM:SYNC:SLEN?</code> <code>:DDEM:SYNC:SLEN:AUTO OFF</code> <code>:DDEM:SYNC:SLEN:AUTO?</code>
Couplings	Manual: Changing Meas Interval, Meas Offset or Symbol Rate will changes Search Length if Search Length is less than $(1.2 * (\text{Meas Interval} + \text{Meas Offset}) / \text{Symbol Rate})$, no matter what status of the Burst Search or Sync Search is Changing Search Length checks with current allowable minimum value $(1.2 * (\text{Meas Interval} + \text{Meas Offset}) / \text{Symbol Rate})$, if the input value is less than it, the value is clipped to the minimum value, and a data out of range message "Data out of range; Search Length was clipped to the minimum value of xxx ms based on current Meas Interval and Symbol Rate" is displayed Auto: $\text{Search Length} = (3.1 * (\text{Meas Interval} + \text{Meas Offset}) / \text{Symbol Rate})$
Preset	3.0E-3 OFF
State Saved	Yes Yes
Range	Auto Man
Min	1.0E-7
Max	9.9E+37

Meas Interval

Sets the number of symbols that the demodulation will analyze. This and the symbol rate set the overall time record length (in seconds) that is used by the demodulator. It also indirectly sets the resolution bandwidth for the various spectrum results. (ResBW cannot be set independently.)

The resolution bandwidth is annotated below any spectrum trace.

Remote Command	<code>[:SENSe]:DDEMod:SEGMENT1 ... 6:SWEEP:POINTS <integer></code> <code>[:SENSe]:DDEMod:SEGMENT1 ... 6:SWEEP:POINTS?</code>
Example	<code>:DDEM:SEG1:SWE:POIN 100</code> <code>:DDEM:SEG1:SWE:POIN?</code>
Preset	501
State Saved	Yes
Min/Max	10/10000000

Backwards Compatibility [:SENSe]:DDEMod:SWEEP:POINTs
SCPI

Segment Config Diagram (Segment Number >1)

Accesses a menu that enables you to set up segments in frame.

Seg Name

Modify the name of each segment.

Remote Command	[:SENSe]:DDEMod:SEGment1 ... 6:NAME <string> [:SENSe]:DDEMod:SEGment1 ... 6:NAME?
Example	:DDEM:SEG1:NAME 'SYNC' :DDEM:SEG1:NAME?
Preset	SEGmentX X is segment index
State Saved	Yes

Modulation Format

Displays a menu for selecting the digital communication format that is used by the demodulator. Available selections are:

QAM	QAM 16, QAM 32, QAM 64, QAM 128, QAM 256, QAM 512, QAM 1024
PSK	BPSK, DBPSK, QPSK, Offset QPSK, Shaped Offset QPSK, $\pi/4$ DQPSK, DQPSK, 8PSK, $\pi/8$ D8PSK, D8PSK
MSK	Type 1, Type 2
FSK	FSK 2, FSK 4, FSK 8, FSK 16, FSK 32, FSK 64
ASK	ASK 2
DVB QAM	DVB QAM 16, DVB QAM 32, DVB QAM 64, DVB QAM 128, DVB QAM 256
VSB	VSB 8, VSB 16
APSK (amplitude/phase shift keying)	APSK 16, APSK 32
EDGE	
CPM (FM)	
Custom IQ	

Remote Command	[:SENSe]:DDEMod:SEGment1 ... 6:MODulation BPSK QPSK OQPSK SOQPSK PI4DQPSK DQPSK PSK8 PI8DPSK8 DPSK8 QAM16 QAM32 QAM64 QAM128 QAM256 QAM512 QAM1024 FSK2 FSK4 FSK8 FSK16 FSK32 FSK64
----------------	---

3 VMA Mode

3.1 Digital Demod Measurement

	<p>MSK1 MSK2 APSK16 APSK32 ASK2 VSB8 VSB16 CPMFM EDGE DVBQAM16 DVBQAM32 DVBQAM64 DVBQAM128 DVBQAM256 DBPSK CUSTOMIQ</p> <p>[:SENSe] :DDEMod:SEGMENT1 ... 6 :MODulation?</p>
Example	<p>:DDEM:SEG1:MOD QPSK</p> <p>:DDEM:SEG1:MOD?</p>
Preset	QPSK
State Saved	Yes
Range	<p>BPSK QPSK Offset QPSK Shaped Offset QPSK $\pi/4$DQPSK DQPSK 8PSK $\pi/8$ DPSK8 D8PSK QAM 16 QAM 32 QAM 64 QAM 128 QAM 256 QAM 512 QAM 1024 FSK 2 FSK 4 FSK 8 FSK 16 FSK 32 FSK 64 MSK Type 1 MSK Type 2 APSK 16 APSK 32 ASK 2 VSB 8 VSB 16 CPM (FM) EDGE DVB QAM 16 DVB QAM 32 DVB QAM 64 DVB QAM 128 DVB QAM 256 DBPSK CUSTOMIQ</p>
Backwards Compatibility SCPI	[:SENSe] :DDEMod:MODulation

NOTE

DVB QAM formats conform to Digital Video Broadcast standard EN 300 429. The standard defines the bits that represent each state as follows:

The first two bits are differentially encoded so that $\pi/2$ rotations in the QAM constellation do not affect detection of the two MSBs.

The LSBs are positioned to be rotation-invariant as defined in EN 300 429.

Unlike QAM, DVB QAM does not compensate for I/Q offset. When the format is DVB QAM, the measurement reports I/Q offset in the metrics table, but doesn't remove it from the other results calculation. When the format is QAM, the measurement reports I/Q offset in the metrics table AND removes it from the other results calculation. So the EVM result for DVB QAM will be higher than QAM.

Symbol Rate

Enables you to set the symbol rate (symbols per second) for the instrument's digital demodulator. Set this parameter to match the symbol rate of your system.

Remote Command	<p>[:SENSe] :DDEMod:SEGMENT1 ... 6 :SRATe <frequency></p> <p>[:SENSe] :DDEMod:SEGMENT1 ... 6 :SRATe?</p>
Example	<p>:DDEM:SEG1:SRAT 1 MHz</p> <p>:DDEM:SEG1:SRAT?</p>
Couplings	Changes when Info BW is smaller than Symbol Rate/10
Preset	1.0 MHz
State Saved	Yes

Min	1.0Hz
Max	Max Info BW (hardware dependent)
Backwards Compatibility SCPI	[:SENSe] :DDEMod :SRATe

Meas Offset

Specifies the time (in symbols) between the start of segment data and its reference. For segment1, the reference is always the start of the capture data, meas offset is always 0. And for segment2, the reference depends on the selection of Meas Offset Reference, meas offset could be positive or negative. If positive, the segment2 starts after the reference. If negative, the segment2 starts before the reference.

Remote Command	[:SENSe] :DDEMod :SEGMENT1 ... 6 : TIME : OFFSet <integer> [:SENSe] :DDEMod :SEGMENT1 ... 6 : TIME : OFFSet?
Example	:DDEM : SEG1 : TIME : OFFS 10 :DDEM : SEG1 : TIME : OFFS?
Couplings	Max and min constrained by Search Length, Meas Interval, Sync Pattern and Sync Search
Preset	0
State Saved	Yes
Min/Max	For segment1, it is 0 For segment2, it depends on Search Length, Meas Interval and Meas Offset Reference

Meas Interval

Sets the number of symbols that the demodulation will analyze. This and the symbol rate set the overall time record length (in seconds) that is used by the demodulator. It also indirectly sets the resolution bandwidth for the various spectrum results. (ResBW cannot be set independently.)

The resolution bandwidth is annotated below any spectrum trace.

Remote Command	[:SENSe] :DDEMod :SEGMENT1 ... 6 : SWEep : POINTs <integer> [:SENSe] :DDEMod :SEGMENT1 ... 6 : SWEep : POINTs?
Example	:DDEM : SEG1 : SWE : POIN 100 :DDEM : SEG1 : SWE : POIN?
Preset	501
State Saved	Yes
Min/Max	10/10000000
Backwards Compatibility SCPI	[:SENSe] :DDEMod :SWEep : POINTs

Meas Offset Reference

Selects the reference position of segment2 from the following two selections:

- Relative To Capture (Default Setting) - Enables you to specify the segment2 offset from the start of the acquisition data
- Relative To Sync Pattern - Enables you to specify the segment2 offset from the start position of the sync pattern

Remote Command	<code>[:SENSe] :DDEMod:SEGment1 ... 6:TIME:OFFSet:REference RCAPture RSYnc</code> <code>[:SENSe] :DDEMod:SEGment1 ... 6:TIME:OFFSet:REference?</code>
Example	<code>:DDEM:SEGM2:TIME:OFFS:REF RCAP</code> <code>:DDEM:SEGM2:TIME:OFFS:REF?</code>
Notes	Relative To Sync Pattern is only available when sync search is on, otherwise it's grayed out
Dependencies	Only appears when Selected Segment is Segment2
Preset	<code>RCAPture</code>
State Saved	Saved in instrument state
Range	Relative To Capture Relative To Sync Pattern

Equalizer

Turns the adaptive equalization filter on or off. Adaptive equalization uses the measured signal to determine the coefficients of the equalization filter.

When equalization is on, the equalization filter has a unit impulse response. The length of the filter determines the position of the unit impulse response in the filter. The impulse is located in the center of the filter for short filter lengths. As the filter length increases, the impulse moves, proportionally, towards the start of the filter to handle channels with large delay-spread.

If Adaptive is set to run, the instrument uses the results of the current measurement to update the filter coefficients for the next measurement. The instrument chooses coefficients that produce a modulation quality metric that is less impacted by the presence of linear distortion.

If Adaptive is set to hold, the instrument does not update the filter coefficients. Instead, the instrument uses the last updated coefficients before selecting hold.

You can select run or hold at any time to continue or stop updating filter coefficients.

Note that the instrument does not redefine the equalization filter to have a unit impulse response when you select run or when you turn the equalization filter off and then on; instead, the instrument uses the last updated filter coefficients.

Equalization is applied to time-domain data. For best results, make sure you select a frequency span that contains all the energy of your signal. If significant energy from your signal falls outside of the displayed frequency span, equalization will not work on your signal.

You can define the length of the equalization filter (in symbols) and set the convergence (convergence determines the size of the steps used to reshape the equalization filter). For additional details about these parameters, see ["Convergence" on page 343](#) and ["Filter Length" on page 342](#).

The following parameters affect measurement speed when using adaptive equalization:

- meas interval
- filter length (for the equalization filter)
- points/symbol

Remote Command	<code>[:SENSe]:DDEMod:SEGMent1 ... 6:EQUalization:STATe OFF ON 0 1</code> <code>[:SENSe]:DDEMod:SEGMent1 ... 6:EQUalization:STATe?</code>
Example	<code>:DDEM:SEGM1:EQU:STAT ON</code> <code>:DDEM:SEGM1:EQU:STAT?</code>
Preset	OFF
State Saved	Yes
Backwards Compatibility SCPI	<code>[:SENSe]:DDEMod:EQUalization:STATe</code>

Sync Search

Turns the Sync Word search on or off. **Sync Search** enables you to use a synchronization pattern to isolate a segment of your signal for display and analysis.

NOTE

The sync pattern must be a multiple of the number of bits-per-symbol. For example, if the number of bits-per-symbol is 4 (as with 16 QAM), then the number of bits in the sync pattern must be a multiple of four. Sync search enables you to specify any number of bits for the sync pattern; however, bits that are not a multiple of the bits-per-symbol are truncated.

Remote Command	<code>[:SENSe]:DDEMod:SYNC:SWORd[:STATe] OFF ON 0 1</code> <code>[:SENSe]:DDEMod:SYNC:SWORd[:STATe]?</code>
Example	<code>:DDEM:SYNC:SWOR OFF</code> Turn off the sync word search

3 VMA Mode
3.1 Digital Demod Measurement

	<code>:DDEM:SYNC:SWOR?</code>
Preset	OFF
State Saved	Yes
Annotation	SYNC NOT FOUND appears in the corner of demod result traces if sync search fails

EQ Source

Specify which segment's EQ coefficient will be applied to current segment.

Remote Command	<code>[:SENSe]:DDEMod:SEGMent1 ... 6:EQUalization:SOURce SEGMent1 ... SEGMent6</code> <code>[:SENSe]:DDEMod:SEGMent1 ... 6:EQUalization:SOURce?</code>
Example	<code>:DDEM:SEGM1:EQU:SOUR SEGM1</code> <code>:DDEM:SEGM1:EQU:SOUR?</code>
Preset	SEGMentX X is segment index
State Saved	Yes
Range	Segment 1 Segment 2 Segment 3 Segment 4 Segment 5 Segment 6

Burst Search

Turns burst search on or off.

Remote Command	<code>[:SENSe]:DDEMod:SYNC:BURSt[:STATe] OFF ON 0 1</code> <code>[:SENSe]:DDEMod:SYNC:BURSt[:STATe]?</code>
Example	<code>:DDEM:SYNC:BURS OFF</code> Turn off the burst search <code>:DDEM:SYNC:BURS?</code>
Preset	OFF
State Saved	Yes
Range	Off On
Annotation	PULSE NOT FOUND appears in the corner of demod result traces if burst search fails

Burst Search Threshold

Sets the relative power threshold from the peak power, which is used by the burst search algorithm to determine the burst rising edge and falling edge.

Remote Command	<code>[:SENSe]:DDEMod:SYNC:BURSt:THREshold <real></code> <code>[:SENSe]:DDEMod:SYNC:BURSt:THREshold?</code>
----------------	--

Example	<code>:DDEM:SYNC:BURS:THR -10</code> Set the burst search relative power to -10 dB <code>:DDEM:SYNC:BURS:THR?</code>
Preset	-15.00 dB
State Saved	Yes
Min	-200.0
Max	200.0

Sync Search

Turns the Sync Word search on or off. **Sync Search** enables you to use a synchronization pattern to isolate a segment of your signal for display and analysis.

NOTE

The sync pattern must be a multiple of the number of bits-per-symbol. For example, if the number of bits-per-symbol is 4 (as with 16 QAM), then the number of bits in the sync pattern must be a multiple of four. Sync search enables you to specify any number of bits for the sync pattern; however, bits that are not a multiple of the bits-per-symbol are truncated.

Remote Command	<code>[:SENSe] :DDEMod:SYNC:SWORd[:STATe] OFF ON 0 1</code> <code>[:SENSe] :DDEMod:SYNC:SWORd[:STATe] ?</code>
Example	<code>:DDEM:SYNC:SWOR OFF</code> Turn off the sync word search <code>:DDEM:SYNC:SWOR?</code>
Preset	OFF
State Saved	Yes
Annotation	SYNC NOT FOUND appears in the corner of demod result traces if sync search fails

Sync Offset

Specifies the time (in symbols) between the start of the measurement data and the start of the sync word. If positive, the sync word starts after the start of the measurement data. If negative, the sync word starts before the start of the measurement data.

Remote Command	<code>[:SENSe] :DDEMod:SYNC:SWORd:OFFSet <integer></code> <code>[:SENSe] :DDEMod:SYNC:SWORd:OFFSet?</code>
Example	<code>:DDEM:SYNC:SWOR:OFFS -3</code> Set the start of the measurement to the position that is 3 symbols later than the start of the sync word

3 VMA Mode
3.1 Digital Demod Measurement

	<code>:DDEM:SYNC:SWOR:OFFS?</code>
Couplings	Max and min constrained by Search Length, Sync Pattern length
Preset	0
State Saved	Yes
Min	-32768
Max	32767

Sync Pattern

Enables you to define a bit pattern for the sync word search. The maximum length of the pattern is 32 symbols. When you press this control, an editor dialog appears that enables you to define the pattern in binary or hexadecimal.

The instrument can only search for search patterns that are a multiple of the number of bits-per-symbol. The instrument assembles the bits in the search pattern into an integer number of symbols, ignoring any trailing bits that cannot complete a full symbol.

For example, if the number of bits-per-symbol is 4 (as with 16 QAM), and your search pattern contains 18 bits, the instrument only uses the first 16 bits during sync search and ignores the last two bits.

Although the underlying sync pattern is binary, the editor enables you to enter bit patterns in either binary or hexadecimal.

Hexadecimal entries are in symbol table hex format. In this format, each symbol is represented by 1 to 3 hex digits. The least significant bits make up the symbol and any extra bits are ignored. Thus, for 6 bits per symbol, the binary value of 101101 is encoded in hex as 2D. If you enter AD as the symbol value, it is converted to the same binary value as 2D because the upper 2 bits are ignored. 3-bit-wide symbols are represented by 1 hex digit with the most significant bit ignored.

Remote Command	<code>[:SENSe]:DDEMod:SYNC:SWORd:PATtern <string></code> <code>[:SENSe]:DDEMod:SYNC:SWORd:PATtern?</code>
Example	<code>:DDEM:SYNC:SWOR:PATT '1011010'</code> Set the sync pattern to '1011010' <code>:DDEM:SYNC:SWOR:PATT?</code>
Notes	<string> must be a string of 1s and 0s only. The maximum string length is 320 bits. Any string that violates these requirements will return error -224 "Illegal parameter value"
State Saved	Yes

3.1.9.5 Meas Time

Enables you to set measurement time parameters.

Meas Interval

Sets the number of symbols that the demodulation will analyze. This and the symbol rate set the overall time record length (in seconds) that is used by the demodulator. It also indirectly sets the resolution bandwidth for the various spectrum results. (ResBW cannot be set independently.)

The resolution bandwidth is annotated below any spectrum trace.

Remote Command	<code>[:SENSe] :DDEMod:SEGMent1 ... 6:SWEEp:POINTs <integer></code> <code>[:SENSe] :DDEMod:SEGMent1 ... 6:SWEEp:POINTs?</code>
Example	<code>:DDEM:SEGM1:SWE:POIN 100</code> <code>:DDEM:SEGM1:SWE:POIN?</code>
Preset	501
State Saved	Yes
Min/Max	10/10000000
Backwards Compatibility SCPI	<code>[:SENSe] :DDEMod:SWEEp:POINTs</code>

Meas Offset

Specifies the time (in symbols) between the start of segment data and its reference. For segment1, the reference is always the start of the capture data, meas offset is always 0. And for segment2, the reference depends on the selection of Meas Offset Reference, meas offset could be positive or negative. If positive, the segment2 starts after the reference. If negative, the segment2 starts before the reference.

Remote Command	<code>[:SENSe] :DDEMod:SEGMent1 ... 6:TIME:OFFSet <integer></code> <code>[:SENSe] :DDEMod:SEGMent1 ... 6:TIME:OFFSet?</code>
Example	<code>:DDEM:SEGM1:TIME:OFFS 10</code> <code>:DDEM:SEGM1:TIME:OFFS?</code>
Couplings	Max and min constrained by Search Length, Meas Interval, Sync Pattern and Sync Search
Preset	0
State Saved	Yes
Min/Max	For segment1, it is 0 For segment2, it depends on Search Length, Meas Interval and Meas Offset Reference

Meas Offset Reference

Selects the reference position of segment2 from the following two selections:

3 VMA Mode
 3.1 Digital Demod Measurement

- Relative To Capture (Default Setting) - Enables you to specify the segment2 offset from the start of the acquisition data
- Relative To Sync Pattern - Enables you to specify the segment2 offset from the start position of the sync pattern

Remote Command	<code>[:SENSe]:DDEMod:SEGMent1 ... 6:TIME:OFFSet:REFeRence RCAPture RSYnc</code> <code>[:SENSe]:DDEMod:SEGMent1 ... 6:TIME:OFFSet:REFeRence?</code>
Example	<code>:DDEM:SEGM2:TIME:OFFS:REF RCAP</code> <code>:DDEM:SEGM2:TIME:OFFS:REF?</code>
Notes	Relative To Sync Pattern is only available when sync search is on, otherwise it's grayed out
Dependencies	Only appears when Selected Segment is Segment2
Preset	<code>RCAPture</code>
State Saved	Saved in instrument state
Range	Relative To Capture Relative To Sync Pattern

3.1.9.6 Demod

Enables you to set demodulation parameters.

Modulation Format

Displays a menu for selecting the digital communication format that is used by the demodulator. Available selections are:

QAM	QAM 16, QAM 32, QAM 64, QAM 128, QAM 256, QAM 512, QAM 1024
PSK	BPSK, DBPSK, QPSK, Offset QPSK, Shaped Offset QPSK, $\pi/4$ DQPSK, DQPSK, 8PSK, $\pi/8$ D8PSK, D8PSK
MSK	Type 1, Type 2
FSK	FSK 2, FSK 4, FSK 8, FSK 16, FSK 32, FSK 64
ASK	ASK 2
DVB QAM	DVB QAM 16, DVB QAM 32, DVB QAM 64, DVB QAM 128, DVB QAM 256
VSB	VSB 8, VSB 16
APSK (amplitude/phase shift keying)	APSK 16, APSK 32
EDGE	
CPM (FM)	
Custom IQ	

Remote Command	<code>[:SENSe]:DDEMod:SEGMent1 ... 6:MODulation BPSK QPSK OQPSK SOQPSK PI4DQPSK DQPSK PSK8 PI8DPSK8 DPSK8 QAM16 QAM32 QAM64 QAM128</code>
----------------	--

	<p> QAM256 QAM512 QAM1024 FSK2 FSK4 FSK8 FSK16 FSK32 FSK64 MSK1 MSK2 APSK16 APSK32 ASK2 VSB8 VSB16 CPMFM EDGE DVBQAM16 DVBQAM32 DVBQAM64 DVBQAM128 DVBQAM256 DBPSK CUSTOMIQ</p> <p>[:SENSe] :DDEMod :SEGMENT1 ... 6 :MODulation ?</p>
Example	<p>:DDEM :SEGM1 :MOD QPSK</p> <p>:DDEM :SEGM1 :MOD ?</p>
Preset	QPSK
State Saved	Yes
Range	<p>BPSK QPSK Offset QPSK Shaped Offset QPSK $\pi/4$DQPSK DQPSK 8PSK $\pi/8$ DPSK8 D8PSK QAM 16 QAM 32 QAM 64 QAM 128 QAM 256 QAM 512 QAM 1024 FSK 2 FSK 4 FSK 8 FSK 16 FSK 32 FSK 64 MSK Type 1 MSK Type 2 APSK 16 APSK 32 ASK 2 VSB 8 VSB 16 CPM (FM) EDGE DVB QAM 16 DVB QAM 32 DVB QAM 64 DVB QAM 128 DVB QAM 256 DBPSK CUSTOMIQ</p>
Backwards Compatibility SCPI	[:SENSe] :DDEMod :MODulation

NOTE

DVB QAM formats conform to Digital Video Broadcast standard EN 300 429. The standard defines the bits that represent each state as follows:

The first two bits are differentially encoded so that $\pi/2$ rotations in the QAM constellation do not affect detection of the two MSBs.

The LSBs are positioned to be rotation-invariant as defined in EN 300 429.

Unlike QAM, DVB QAM does not compensate for I/Q offset. When the format is DVB QAM, the measurement reports I/Q offset in the metrics table, but doesn't remove it from the other results calculation. When the format is QAM, the measurement reports I/Q offset in the metrics table AND removes it from the other results calculation. So the EVM result for DVB QAM will be higher than QAM.

Symbol Rate

Enables you to set the symbol rate (symbols per second) for the instrument's digital demodulator. Set this parameter to match the symbol rate of your system.

Remote Command	<p>[:SENSe] :DDEMod :SEGMENT1 ... 6 :SRATe <frequency></p> <p>[:SENSe] :DDEMod :SEGMENT1 ... 6 :SRATe ?</p>
Example	<p>:DDEM :SEGM1 :SRAT 1 MHz</p> <p>:DDEM :SEGM1 :SRAT ?</p>
Couplings	Changes when Info BW is smaller than Symbol Rate/10
Preset	1.0 MHz

3 VMA Mode

3.1 Digital Demod Measurement

State Saved	Yes
Min	1.0Hz
Max	Max Info BW (hardware dependent)
Backwards Compatibility SCPI	[:SENSe]:DDEMod:SRATe

Points / Symbol

Enables you to set how many points are displayed per symbol in time displays of demodulated data. The available values are 1, 2, 4, 5, 10 and 20.

Minimum (except OQPSK):	1 point per symbol
Minimum (OQPSK):	2 points per symbol
Maximum:	20 points per symbol

For example, if the value of Points/Symbol is 1, each display point corresponds to a symbol. If the value is 5, the 5th display point corresponds to a symbol—in this case, an IQ diagram would show 4 display points between each symbol.

OQPSK Demodulation: For OQPSK, an even number of Points/Symbol are required due to the offset between I and Q. If you specify an odd value for Points/Symbol, the instrument chooses the next, lower, even value.

Remote Command	[:SENSe]:DDEMod:SEGMENT1 ... 6:PPSYmbol <integer> [:SENSe]:DDEMod:SEGMENT1 ... 6:PPSYmbol?
Example	:DDEM:SEGM1:PPSY 2 :DDEM:SEGM1:PPSY?
Couplings	If Modulation Format is Edge, this value is fixed to 1 and the control is grayed out. If Modulation Format is Offset QPSK or Shaped Offset QPSK, the available values are 2, 4, 10, and 20. Otherwise, the available values are 1, 2, 4, 5, 10 and 20 Numeric entries are rounded to the nearest valid value
Preset	10
State Saved	Yes
Min	1
Max	20
Backwards Compatibility SCPI	[:SENSe]:DDEMod:PPSYmbol

Meas Filter

Accesses a menu for selecting the Meas Filter used by the receiver.

See "More Information" on page 338

Remote Command	<code>[:SENSe]:DDEMod:SEGMent1 ... 6:FILTer:MEASurement NONE RRCosine GAUSSian EDGE RECTangle LPASs USER</code> <code>[:SENSe]:DDEMod:SEGMent1 ... 6:FILTer:MEASurement?</code>
Example	<code>:DDEM:SEGM1:FILT:MEAS GAUS</code> <code>:DDEM:SEGM1:FILT:MEAS?</code>
Notes	Meas filter types that are not available for a particular selection of modulation format are grayed-out as below: <code>EDGE</code> is only available for EDGE format, grayed-out for other formats
Preset	<code>RRC</code>
State Saved	Yes
Range	No Filter Root Raised Cosine Gaussian EDGE Rectangular Low Pass User Defined
Backwards Compatibility SCPI	<code>[:SENSe]:DDEMod:FILTer:MEASurement</code>

More Information

Data filtering is used in digital demodulation to limit bandwidth and reduce inter symbol interference. This instrument includes several commonly used filter types and has the ability to apply user-defined filters. All filters are computed to 20 symbols in length. If the filter alpha is < 0.2, the instrument uses 40 symbols to compute filter length (for most formats).

The shape and width of a filter is defined by the alpha (for cosine filters) or the BT (for Gaussian filters). The alpha or BT indicates the filter roll-off (or excess bandwidth) of the selected filter that occurs due to the practical inability of filter technology to build a perfectly square (brick-wall) filter that would have an alpha of 0 (no excess bandwidth). For example, a typical filter with an alpha of 0.3 has a bandwidth 30% greater than the theoretical minimum.

The instrument's digital demodulator produces two signals: a measured and a reference signal. These signals are called I/Q Measured and I/Q Reference or, for FSK measurements, FSK Measured and FSK Reference.

You can select different filters for the measured and reference signals, as shown in the following generic block diagram.

3 VMA Mode
 3.1 Digital Demod Measurement

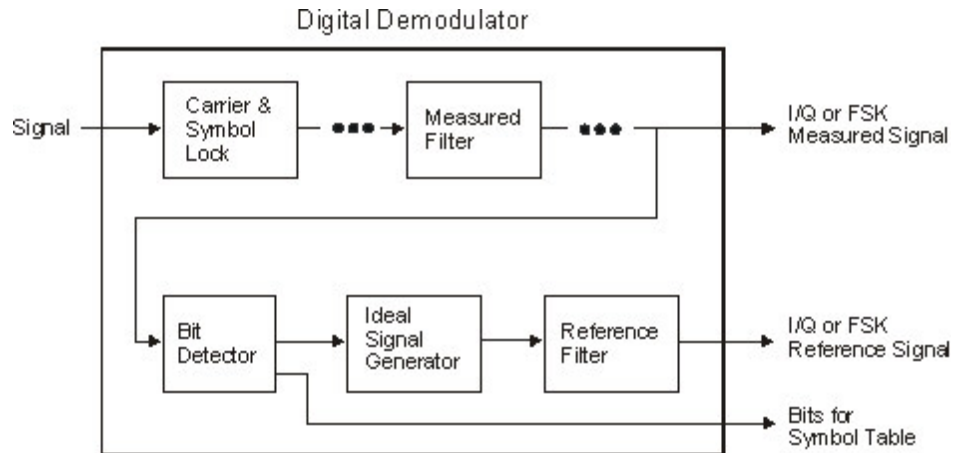

Note that for FSK signals, filtering is baseband and occurs after the FM demodulator.

The measured signal is the signal that results after demodulating your waveform. The reference signal is the signal that would result after demodulating your signal if your signal were ideal (contained no errors).

Notice that there are separate filters for the measured and reference signals. You MUST select the correct filter for both signals. Otherwise, a settings conflict message “The Meas/Ref Filter combination is not allowable!” is generated.

Filtering for various communication systems can occur either at the transmitter or the receiver; or the filtering can be distributed between the transmitter and the receiver. This is an important concept that affects your filter selection for the measured and reference signals. The instrument's measured filter represents filtering in the system's receiver while the reference filter represents filtering in the entire system. Both filters share the same alpha/BT. The following table shows some examples of filter selection:

If the transmitter filter is:	The measure filter should be:	The reference filter should be:
root raised cosine	root raised cosine	raised cosine
Raised cosine	none	raised cosine
Gaussian	none	Gaussian
any type	user defined	any type

You can modify the shape and width of Gaussian and Nyquist (cosine) filters. The shape and width is defined by the alpha (for cosine filters) or the BT (for Gaussian filters). All filters are computed to 20 symbols in length. If the filter alpha is < 0.2, the instrument uses 40 symbols to compute filter length (for most formats).

Ref Filter

Selects the Ref Filter that represents the cascaded transmit and receive filter.

Remote Command	<code>[:SENSe]:DDEMod:SEGMent1 ... 6:FILTer:REFeRence RCOSine RRCosine GAUSSian EDGE RECTangle HSINe USER F1REC F3RC F4RC SOQPSKTG SOQPSKA SOQPSKB APCOP2RC</code> <code>[:SENSe]:DDEMod:SEGMent1 ... 6:FILTer:REFeRence?</code>
Example	<code>:DDEM:SEGM1:FILT:REF GAUS</code> <code>:DDEM:SEGM1:FILT:REF?</code>
Notes	Reference filter types that are not available for a particular selection of modulation format are grayed-out as below: <ul style="list-style-type: none"> - EDGE is only available for EDGE format, grayed-out for other formats - 1REC (CPM), 3RC (CPM) and 4RC (CPM) are only available for CPM (FM) format, grayed-out for other formats - SOQPSK-TG (IRIG 106-04), SOQPSKA and SOQPSKB are only available for Shaped OQPSK format, grayed-out for other formats
Preset	RCOS
State Saved	Yes
Range	Raised Cosine Root Raised Cosine Gaussian EDGE Rectangular Half Sine User Defined 1REC (CPM) 3RC (CPM) 4RC (CPM) SOQPSK-TG (IRIG 106-04) SOQPSK-A SOQPSK-B APCO-25 P2 RC
Backwards Compatibility SCPI	<code>[:SENSe]:DDEMod:FILTer:REFeRence</code>

Alpha

Determines the filter characteristics of the Raised cosine and Root-raised cosine filters used by the instrument's digital demodulator. These characteristics apply to both the Ref filters.

Remote Command	<code>[:SENSe]:DDEMod:SEGMent1 ... 6:FILTer:ALPHA <real></code> <code>[:SENSe]:DDEMod:SEGMent1 ... 6:FILTer:ALPHA?</code>
Example	<code>:DDEM:SEGM1:FILT:ALPH 0.5</code> <code>:DDEM:SEGM1:FILT:ALPH?</code>
Dependencies	Available for Raised Cosine and Root Raised Cosine filter only
Preset	0.5
State Saved	Yes
Min	0.05

3 VMA Mode
3.1 Digital Demod Measurement

Max	1
Backwards Compatibility SCPI	<code>[:SENSe] :DDEMod :FILTer :ALPHA</code>

BT

Determines the filter characteristics of the Gaussian filters used by the instrument's digital demodulator. These characteristics apply to both the Ref filters.

Remote Command	<code>[:SENSe] :DDEMod :SEGMENT1 ... 6 :FILTer :BT <real></code> <code>[:SENSe] :DDEMod :SEGMENT1 ... 6 :FILTer :BT?</code>
Example	<code>:DDEMod :SEGMENT1 :FILTer :BT 0.5</code> <code>:DDEMod :SEGMENT1 :FILTer :BT?</code>
Dependencies	Available for Gaussian filter only
Preset	0.6
State Saved	Yes
Min	0.05
Max	100
Backwards Compatibility SCPI	<code>[:SENSe] :DDEMod :FILTer :BT</code>

Advanced Setup

Enables you to access advanced demodulation parameters on one screen.

General

Allows you to configure general advanced parameters for de-modulation algorithm.

Equalizer

Turns the adaptive equalization filter on or off. Adaptive equalization uses the measured signal to determine the coefficients of the equalization filter.

When equalization is on, the equalization filter has a unit impulse response. The length of the filter determines the position of the unit impulse response in the filter. The impulse is located in the center of the filter for short filter lengths. As the filter length increases, the impulse moves, proportionally, towards the start of the filter to handle channels with large delay-spread.

If Adaptive is set to run, the instrument uses the results of the current measurement to update the filter coefficients for the next measurement. The instrument chooses coefficients that produce a modulation quality metric that is less impacted by the presence of linear distortion.

If Adaptive is set to hold, the instrument does not update the filter coefficients. Instead, the instrument uses the last updated coefficients before selecting hold.

You can select run or hold at any time to continue or stop updating filter coefficients.

Note that the instrument does not redefine the equalization filter to have a unit impulse response when you select run or when you turn the equalization filter off and then on; instead, the instrument uses the last updated filter coefficients.

Equalization is applied to time-domain data. For best results, make sure you select a frequency span that contains all the energy of your signal. If significant energy from your signal falls outside of the displayed frequency span, equalization will not work on your signal.

You can define the length of the equalization filter (in symbols) and set the convergence (convergence determines the size of the steps used to reshape the equalization filter). For additional details about these parameters, see ["Convergence" on page 343](#) and ["Filter Length" on page 342](#).

The following parameters affect measurement speed when using adaptive equalization:

- meas interval
- filter length (for the equalization filter)
- points/symbol

Remote Command	<code>[:SENSe]:DDEMod:SEGMent1 ... 6:EQUalization:STATe OFF ON 0 1</code> <code>[:SENSe]:DDEMod:SEGMent1 ... 6:EQUalization:STATe?</code>
Example	<code>:DDEM:SEGM1:EQU:STAT ON</code> <code>:DDEM:SEGM1:EQU:STAT?</code>
Preset	OFF
State Saved	Yes
Backwards Compatibility SCPI	<code>[:SENSe]:DDEMod:EQUalization:STATe</code>

Filter Length

Sets the length (in symbols) for the instrument's equalization filter.

3 VMA Mode
 3.1 Digital Demod Measurement

In general, the best filter length is the smallest that meets your measurement requirements. For measurements at the transmitter, the filter length may only need to be a few symbols in length. Longer filter lengths may be needed to measure multi-path environments.

The filter length also determines the placement of the impulse response in the equalization filter. For longer filter lengths, the instrument puts the initial, unit impulse response closer to the beginning of the time record to accommodate multi-path measurements, as follows:

Filter Length (symbol)	Unit Impulse Response Position (symbol)
3 to 31	$(\text{length} - 1)/2$
31 to 75	15
75 to 99	$(\text{length})/5$

For example, if the filter length is 11, the unit impulse response is positioned at symbol 5. If the filter length is 35, the unit impulse response is positioned at symbol 15.

Remote Command	<code>[:SENSe]:DDEMod:SEGMent1 ... 6:EQualization:FLEngth <integer></code> <code>[:SENSe]:DDEMod:SEGMent1 ... 6:EQualization:FLEngth?</code>
Example	<code>:DDEM:SEGM1:EQU:FLEN 21</code> <code>:DDEM:SEGM1:EQU:FLEN?</code>
Notes	Must be an odd number. If an even number is entered, it is rounded up to the next odd
Preset	21
State Saved	Yes
Min	3
Max	99
Backwards Compatibility SCPI	<code>[:SENSe]:DDEMod:EQualization:FLEngth</code>

Convergence

Sets the adaptive filter convergence factor higher to converge faster. Note that too high a value can cause the filter to not converge. Set the convergence factor smaller for better accuracy.

This value is normalized, to convert the Convergence value in the VSA to the normalized value, divide the 89600 VSA Convergence value by 1e-07.

Remote Command	<code>[:SENSe]:DDEMod:SEGMent1 ... 6:EQualization:CONvergence <real></code> <code>[:SENSe]:DDEMod:SEGMent1 ... 6:EQualization:CONvergence?</code>
----------------	--

Example	<code>:DDEM:SEGM1:EQU:CONV 0.5</code> <code>:DDEM:SEGM1:EQU:CONV?</code>
Preset	1
State Saved	Yes
Min	0.000001
Max	10000000
Backwards Compatibility SCPI	<code>[:SENSe]:DDEMod:EQUalization:CONVergence</code>

Equalizer Hold

Turns the filter coefficient updates on or off. Normally the adaptation algorithm updates the filter coefficients after each scan. When Hold is on, the coefficients of the equalization filter are frozen; that is, the adaptive filter becomes fixed. When you turn Hold off again, the coefficients are again allowed to adapt, starting from where they currently are.

Remote Command	<code>[:SENSe]:DDEMod:SEGMENT1 ... 6:EQUalization:HOLD OFF ON 0 1</code> <code>[:SENSe]:DDEMod:SEGMENT1 ... 6:EQUalization:HOLD?</code>
Example	<code>:DDEM:SEGM1:EQU:HOLD ON</code> <code>:DDEM:SEGM1:EQU:HOLD?</code>
Couplings	Hold will be on automatically after recall Equalizer Coefficients
Preset	OFF
State Saved	Yes
Backwards Compatibility SCPI	<code>[:SENSe]:DDEMod:EQUalization:HOLD</code>

Equalizer Reset

Resets the adaptive filter coefficients to 1

Remote Command	<code>[:SENSe]:DDEMod:EQUalization:RESet</code>
Example	<code>:DDEM:EQU:RES</code>

FFT Window

Enables you to choose the Window function that is applied to the time data prior to the FFT calculation used for Spectrum, Error Vector Spectrum, IQ Meas Spectrum, and IQ Ref Spectrum results.

Remote Command	<code>[:SENSe]:DDEMod:SEGMent1 ... 6:FFT:WINDow:TYPE UNIFORM HANNing GAUSSian FLATtop</code> <code>[:SENSe]:DDEMod:SEGMent1 ... 6:FFT:WINDow:TYPE?</code>
Example	<code>:DDEM:SEGM1:FFT:WIND:TYPE FLAT</code> <code>:DDEM:SEGM1:FFT:WIND:TYPE?</code>
Preset	<code>FLAT</code>
State Saved	Yes
Range	Uniform Hanning Gaussian Flat top
Backwards Compatibility SCPI	<code>[:SENSe]:DDEMod:FFT:WINDow:TYPE</code>

Spectrum

Sets a spectrum to either **Normal** or **Inverted** for demodulation related measurements. If set to **INVert**, the upper and lower spectrums are swapped.

The invert function conjugates the spectrum, which is equivalent to taking the negative of the quadrature component in demodulation. The correct setting (**Normal** or **Inverted**) depends on whether the signal at the input of the instrument has a high or a low side mix.

Remote Command	<code>[:SENSe]:DDEMod:SEGMent1 ... 6:SPECTrum INVert NORMal</code> <code>[:SENSe]:DDEMod:SEGMent1 ... 6:SPECTrum?</code>
Example	<code>:DDEM:SEGM1:SPEC INV</code> <code>:DDEM:SEGM1:SPEC?</code>
Preset	<code>NORMal</code>
State Saved	Saved in instrument state
Range	<code>Normal Invert</code>
Backwards Compatibility SCPI	<code>[:SENSe]:DDEMod:SPECTrum</code>

Gain Imb/Quad Skew Coupling

Controls what measurement data is included in the Quadrature Skew Error and IQ Gain Imbalance error data calculations.

- Off: Calculations use one Point per Symbol
- On: Calculations use the value shown in the Points per Symbol parameter box

Remote Command	<code>:CALCulate:DDEMod:SEGMent1 ... 6:PPSYmbol:COUPle OFF ON 0 1</code>
Example	<code>:CALC:DDEM:SEGM1:PPSY:COUP ON</code> <code>:CALC:DDEM:SEGM1:PPSY:COUP?</code>
Notes	Available for all IQ formats except Custom IQ format
Preset	OFF
State Saved	Yes
Backwards Compatibility SCPI	<code>:CALCulate:DDEMod:PPSYmbol:COUPle</code>

Clock Adjust

Enables you to adjust symbol clock timing in fractions of a symbol. The adjustment is relative to the symbol clock time that is computed by the demodulation algorithm. Some digital communications systems contain nonlinearities that can bias the digital demodulator's estimation of the symbol clock position. You can use clock adjust to compensate for this offset and obtain a lower EVM (Error Vector Magnitude).

Specifying a clock adjust only affects the I/Q measured trace. It does not affect the I/Q reference trace.

Use the eye diagram with an eye length of one (1) to observe the accuracy of the symbol clock timing. You can also monitor the EVM (Error Vector Magnitude) in the metrics table while adjusting clock adjust to obtain the optimum symbol timing.

Clock adjust is reset to 0.0 on power-up or when you select Preset.

Remote Command	<code>[:SENSe] :DDEMod:SEGMent1 ... 6:CADJust <real></code> <code>[:SENSe] :DDEMod:SEGMent1 ... 6:CADJust?</code>
Example	<code>:DDEM:SEGM1:CADJ 0.5</code> <code>:DDEM:SEGM1:CADJ?</code>
Preset	0.0

3 VMA Mode
3.1 Digital Demod Measurement

State Saved	Yes
Min	-0.5
Max	0.5
Backwards Compatibility SCPI	<code>[:SENSe] :DDEMod :CADJust</code>

IQ Rotation

Rotates the IQ Meas/Ref Time data and corresponding ideal state positions by a user defined amount ranging from -360 degrees to 360 degrees. The Rotation parameter affects the IQ Gain Imbalance and Quadrature Skew error data results.

Remote Command	<code>:CALCulate:DDEMod:SEGMENT1 ... 6:IQRotation <real></code> <code>:CALCulate:DDEMod:SEGMENT1 ... 6:IQRotation?</code>
Example	<code>:CALC:DDEM:SEGM1:IQR 45</code> <code>:CALC:DDEM:SEGM1:IQR?</code>
Preset	0 deg
State Saved	Yes
Min	-360 deg
Max	360 deg
Backwards Compatibility SCPI	<code>:CALCulate:DDEMod:IQRotation</code>

IQ Normalize

Turns IQ Normalize on or off. When **IQ Normalize** is on, the Meas Time and Ref Time data is normalized so the extreme points have a value of 1. For quadrature modulation types, the outermost points of the constellation are normalized to 1. For FSK constellations, the deviation is normalized to 1.

When **IQ Normalize** is turned off, the actual data values based on the input signal level are plotted on the constellation.

When normalization is **ON**, the instrument normalizes or scales the demodulated trace data results to a nominal value of 1. Normalization is performed on these traces:

- IQ measured time and IQ measured spectrum
- IQ reference time and IQ reference spectrum
- Error vector time and Error vector spectrum

- Magnitude error
- FSK measured time and FSK measured spectrum (FSK measurements)
- FSK reference time and FSK reference spectrum (FSK measurements)
- FSK error time and FSK error spectrum (FSK measurements)
- Magnitude error (carrier) (FSK measurements)

Remote Command	<code>:CALCulate:DDEMod:SEGMent1 ... 6:NORMalize OFF ON 0 1</code> <code>:CALCulate:DDEMod:SEGMent1 ... 6:NORMalize?</code>
Example	<code>:CALC:DDEM:SEGM1:NORM ON</code> <code>:CALC:DDEM:SEGM1:NORM?</code>
Preset	ON
State Saved	Yes
Annunciation	When this is on, ideal state positions are identified by graphics on the constellation diagram
Backwards Compatibility SCPI	<code>:CALCulate:DDEMod:NORMalize</code>

Low SNR Enhancement

Enhances the ability of the demodulator to lock on to signals with low SNR. This process reduces the frequency lock range and provides additional filtering. This filtering enables the demodulator to lock in the presence of more. To compensate for the smaller frequency lock range, the frequency estimate is tracked from measurement to measurement. An exponential average is used and the output of this average becomes the starting point for the next frequency estimate for the next measurement.

Remote Command	<code>[:SENSe]:DDEMod:SEGMent1 ... 6:LSNR OFF ON 0 1</code> <code>[:SENSe]:DDEMod:SEGMent1 ... 6:LSNR?</code>
Example	<code>:DDEM:SEGM1:LSNR ON</code> <code>:DDEM:SEGM1:LSNR?</code>
Preset	OFF
State Saved	Yes
Backwards Compatibility SCPI	<code>[:SENSe]:DDEMod:LSNR</code>

EVM Normalization Reference

Sets the normalization value for certain error summary metrics.

3 VMA Mode
3.1 Digital Demod Measurement

EVM Normalization Reference also affects the normalization value used for traces when normalize is turned on. Note that the normalization value used for traces differs from the normalization value used for error summary metrics when EVM Normalization Reference is set to Reference RMS.

These scalar results are normalized by the EVM Normalization Reference:

- EVM
- Mag Err

There are two possible values for EVM Normalization Reference:

Constellation Maximum (Default)	Sets the normalization value to the maximum constellation magnitude For example, the normalization value would be the level of the corner point in a 16QAM constellation. For "cross-QAM" constellations (32QAM, 128QAM, 512QAM), the normalization value would be set to the magnitude of the outer corners of a square that encompasses the constellation, even though the constellation itself does not actually use the outer corners
Reference RMS	Sets the normalization value to the RMS level of the IQ Reference symbol points If the only impairment in the input signal is Additive White Gaussian Noise, using Reference RMS will make the averaged EVM approach the inverse of the Signal-to-Noise ratio of the signal. Using Reference RMS also makes it easier to compare EVM values between signals of different modulation formats

Remote Command	<code>[:SENSe] :DDEMod :SEGMENT1 ... 6 :COMPensate :NREference CMAXimum RRMS</code> <code>[:SENSe] :DDEMod :SEGMENT1 ... 6 :COMPensate :NREference ?</code>
Example	<code>:DDEM :SEG1 :COMP :NREF RRMS</code> <code>:DDEM :SEG1 :COMP :NREF ?</code>
Couplings	Reference RMS is only available for Custom IQ format and I/Q modulation formats with more than one constellation magnitude level (16QAM, 32APSK, etc.)
Preset	<code>CMAX</code>
State Saved	Yes
Range	Constellation Maximum Reference RMS
Backwards Compatibility SCPI	<code>[:SENSe] :DDEMod :COMPensate :NREference</code>

IQ Offset Compensation

Selects whether to compensate IQ Offset at parameter estimation and compensation time prior to metrics like EVM calculation.

Remote Command	<code>:CALCulate :DDEMod :SEGMENT1 ... 6 :COMPensate :IQOffset [:STATE] OFF ON 0 1</code> <code>:CALCulate :DDEMod :SEGMENT1 ... 6 :COMPensate :IQOffset [:STATE] ?</code>
----------------	---

Example	<code>:CALC:DDEM:SEGM1:COMP:IQOF ON</code> <code>:CALC:DDEM:SEGM1:COMP:IQOF?</code>
Dependencies	Only available for IQ modulation format except FSK, ASK, CPM (FM) and DVB QAMs Turned on automatically if the modulation format is changed to the formats except MSK Type1. For MSK Type1 format, turned off automatically
Preset	ON
State Saved	Yes
Backwards Compatibility SCPI	<code>:CALCulate:DDEMod:COMPensate:IQOFset[:STATE]</code>

Report EVM in DB

Remote Command	<code>[:SENSe]:DDEMod:SEGMENT1 ... 6:EVM:REPort:DB OFF ON 0 1</code> <code>[:SENSe]:DDEMod:SEGMENT1 ... 6:EVM:REPort:DB?</code>
Example	<code>:DDEM:SEGM1:EVM:REP:DB ON</code> <code>:DDEM:SEGM1:EVM:REP:DB?</code>
Preset	OFF
State Saved	Yes
Range	OFF ON

Multi-Carrier Filter

Specifies whether or not to apply a filter to the acquisition IQ data to filter out adjacent carriers.

When other carriers are expected to be adjacent to the carrier of interest, this multi-carrier filter can be used to filter out the unwanted carrier and minimize leakage into the carrier of interest.

Remote Command	<code>[:SENSe]:DDEMod:SEGMENT1 ... 6:MCFilter:BANDwidth <freq></code> <code>[:SENSe]:DDEMod:SEGMENT1 ... 6:MCFilter:BANDwidth?</code> <code>[:SENSe]:DDEMod:SEGMENT1 2:MCFilter[:STATE] OFF ON 0 1</code> <code>[:SENSe]:DDEMod:SEGMENT1 2:MCFilter[:STATE]?</code>
Example	<code>:DDEM:SEGM1:MCF:BAND 50 kHz</code> <code>:DDEM:SEGM1:MCF:BAND?</code> <code>:DDEM:SEGM1:MCF OFF</code> <code>:DDEM:SEGM1:MCF?</code>
Dependencies	The filter's bandwidth cannot exceed the current information bandwidth
Preset	5 MHz

3 VMA Mode
3.1 Digital Demod Measurement

	OFF
State Saved	Saved in instrument state Yes
Range	On Off
Min	1 kHz
Max	Max Info BW (hardware dependent)
Backwards Compatibility SCPI	<code>[:SENSe]:DDEMod:MCFilter:BANDwidth</code> <code>[:SENSe]:DDEMod:MCFilter[:STATE]</code>

FSK

Allows you to configure advanced parameters for FSK modulation format.

Tx Frequency Offset

Enables you to set the transmitter frequency offset. It will be subtracted in carrier frequency offset calculation. Set this parameter to match the Tx frequency offset of your system.

Available only when the demodulation format is FSK formats.

Remote Command	<code>[:SENSe]:DDEMod:SEGMENT1 ... 6:FSK:TXFrequency:OFFSet <frequency></code> <code>[:SENSe]:DDEMod:SEGMENT1 ... 6:FSK:TXFrequency:OFFSet?</code>
Example	<code>:DDEMod:SEG1:FSK:TXFR:OFFS 1 kHz</code> <code>:DDEMod:SEG1:FSK:TXFR:OFFS?</code>
Couplings	If the modulation format is not FSK formats, this control is grayed-out
Preset	0.0 Hz
State Saved	Yes
Min	-1 GHz
Max	1 GHz
Backwards Compatibility SCPI	<code>[:SENSe]:DDEMod:FSK:TXFrequency:OFFSet</code>

FSK Deviation Ref

Sets the value of the FSK deviation reference when the 2-FSK modulation format is selected.

There are two possible FSK Deviation Reference modes:

- Manual: This selection enables the user to manually set the deviation reference
- Automatic: This selection uses an average measured frequency deviation

Available only when the demodulation format is 2-FSK.

Remote Command	<pre>[:SENSe]:DDEMod:SEGMent1 ... 6:FSK:DEViation:REFeRence <freq> [:SENSe]:DDEMod:SEGMent1 ... 6:FSK:DEViation:REFeRence? [:SENSe]:DDEMod:SEGMent1 2:FSK:DEViation:REFeRence:AUTO OFF ON 0 1 [:SENSe]:DDEMod:SEGMent1 2:FSK:DEViation:REFeRence:AUTO?</pre>
Example	<pre>:DDEM:SEGM1:FSK:DEV:REF 50 kHz :DDEM:SEGM1:FSK:DEV:REF? :DDEM:SEGM1:FSK:DEV:REF:AUTO ON :DDEM:SEGM1:FSK:DEV:REF:AUTO?</pre>
Couplings	If the modulation format is not FSK formats, this control is grayed-out When the user manually changes the FSK Deviation Reference, this set automatically goes to 'Man'
Preset	20 kHz ON
State Saved	Saved in instrument state Yes
Range	Auto Man
Min	10 Hz
Max	1 GHz
Backwards Compatibility SCPI	<pre>[:SENSe]:DDEMod:FSK:DEViation:REFeRence [:SENSe]:DDEMod:FSK:DEViation:REFeRence:AUTO</pre>

APSK

Allows you to configure advanced parameters for APSK modulation format.

APSK R2 / R1

Enables you to specify the expected ratio between the two inner rings for APSK modulation formats.

APSK R2 / R1 determines the Ring 2 to Ring 1 ratio for APSK format measurements.

The ring ratio is the ratio of the magnitude of symbol states on a ring (R2) to the magnitude of symbol states on the inner ring (R1). R2 / R1 is a valid parameter for both 16 APSK and 32 APSK format measurements.

3 VMA Mode

3.1 Digital Demod Measurement

Remote Command	<code>[:SENSe]:DDEMod:SEGMent1 ... 6:APSK:R2Ratio <real></code> <code>[:SENSe]:DDEMod:SEGMent1 ... 6:APSK:R2Ratio?</code>
Example	<code>:DDEM:SEGM1:APSK:R2R 3.0</code> <code>:DDEM:SEGM1:APSK:R2R?</code>
Notes	Affects the position of the ideal state indicators on constellation diagrams
Couplings	If the modulation format is not APSK formats, this control is grayed-out
Preset	2.84
State Saved	Yes
Min	1.25
Max	8
Backwards Compatibility SCPI	<code>[:SENSe]:DDEMod:APSK:R2Ratio</code>

APSK R3 / R1

Enables you to specify the expected ratio between the outer and inner rings for APSK32 modulation formats.

APSK R3 / R1 determines the Ring 3 to Ring 1 ratio for APSK format measurements.

The ring ratio is the ratio of the magnitude of symbol states on a ring (R3) to the magnitude of symbol states on the inner ring (R1). R3 / R1 is a valid parameter only for 32 APSK format measurements.

Remote Command	<code>[:SENSe]:DDEMod:SEGMent1 ... 6:APSK:R3Ratio <real></code> <code>[:SENSe]:DDEMod:SEGMent1 ... 6:APSK:R3Ratio?</code>
Example	<code>:DDEM:SEGM1:APSK:R3R 5.0</code> <code>:DDEM:SEGM1:APSK:R3R?</code>
Notes	Affects the position of the ideal state indicators on constellation diagrams
Couplings	If the modulation format is not APSK formats, this control is grayed-out
Preset	5.27
State Saved	Yes
Min	1.5625
Max	10
Backwards Compatibility SCPI	<code>[:SENSe]:DDEMod:APSK:R3Ratio</code>

CPM

Allows you to configure advanced parameters for CPM modulation format.

CPM Auto

Turns modulation indices auto-detected on or off.

Remote Command	<code>[:SENSe]:DDEMod:SEGMent1 ... 6:CPMindex:AUTO OFF ON 0 1</code> <code>[:SENSe]:DDEMod:SEGMent1 ... 6:CPMindex:AUTO?</code>
Example	<code>:DDEM:SEGM1:CPM:AUTO OFF</code> <code>:DDEM:SEGM1:CPM:AUTO?</code>
Couplings	If the modulation format is not CPM, this control is grayed-out
Preset	OFF
State Saved	Yes
Range	Off On
Backwards Compatibility SCPI	<code>[:SENSe]:DDEMod:CPMindex:AUTO</code>

CPM Index

Sets the value of the modulation indices, h1 and h2 when the CPM (FM) modulation format is selected. The modulation indices determine the amount of phase change for each symbol.

Remote Command	<code>[:SENSe]:DDEMod:SEGMent1 ... 6:CPMindex I12I13 I7I10 I6I7 I5I6 I4I5 MSK HCPM</code> <code>[:SENSe]:DDEMod:SEGMent1 ... 6:CPMindex?</code>
Example	<code>:DDEM:MAST:CPM HCPM</code> <code>:DDEM:MAST:CPM?</code>
Couplings	If the modulation format is not CPM, this control is grayed-out
Preset	I4I5
State Saved	Yes
Range	12/16,13/16 7/16,10/16 6/16,7/16 5/16,6/16 4/16,5/16 1/2 (MSK) 1/3 (HCPM)
Backwards Compatibility SCPI	<code>[:SENSe]:DDEMod:CPMindex</code>

MSK

Allows you to configure advanced parameters for MSK modulation format.

Differential Decoder Anchor State

Specific anchor bit for MSK Type 1 differential decoder.

Remote Command	<code>[:SENSe] :DDEMod :SEGMENT1 ... 6 :MSK :DDECCode :ANCHor 1 0</code>
Example	<code>:DDEM :SEGM1 :MSK :DDEC :ANCH 1</code> <code>:DDEM :SEGM1 :MSK :DDEC :ANCH ?</code>
Couplings	If the modulation format is not MSK Type1, this control is grayed-out
Preset	1
State Saved	Yes
Backwards Compatibility SCPI	<code>[:SENSe] :DDEMod :MSK :DDECCode :ANCHor</code>

OQPSK

Allows you to configure advanced parameters for OQPSK modulation format.

OQPSK Align I & Q

Selects whether to align I and Q decision points for OQPSK. When this control is turned on, the Q part will be shifted by a half ($\frac{1}{2}$) symbol.

Remote Command	<code>:CALCulate :DDEMod :SEGMENT1 ... 6 :OQPSk :IQALign [:STATe] OFF ON 0 1</code>
Example	<code>:CALC :DDEM :SEGM1 :OQPS :IQAL ON</code> <code>:CALC :DDEM :SEGM1 :OQPS :IQAL ?</code>
Couplings	If the modulation format is not Offset QPSK or Shaped Offset QPSK, this control is grayed-out
Preset	OFF
State Saved	Yes

Custom IQ

Allows you to configure advanced parameters for Custom IQ modulation format.

Sync Persistence Target

Allows you to tune the algorithm for higher frequency lock range (0.0) or higher constellation lock consistency (1.0). Values closer to 0.0 optimize towards higher frequency lock range while values closer to 1 optimize towards higher constellation lock consistency.

Remote Command	<code>[:SENSe]:DDEMod:SEGMent1 ... 6:CONStIn:PERsistence <real></code> <code>[:SENSe]:DDEMod:SEGMent1 ... 6:CONStIn:PERsistence?</code>
Example	<code>:DDEM:SEGM1:CONS:PERs 0.1</code> <code>:DDEM:SEGM1:CONS:PERs?</code>
Couplings	If the modulation format is not Custom IQ, this control is grayed-out
Preset	0.05
State Saved	Yes
Min	0.0
Max	1.0
Backwards Compatibility SCPI	<code>:SERVice[:PRODUCTION]:DDEMod:CONStIn:PERsistence</code>

Phase Rotation

Sets an additional phase rotation to be applied to the defined constellation.

Remote Command	<code>[:SENSe]:DDEMod:SEGMent1 ... 6:CIQ:PHASe:ROTation <real></code> <code>[:SENSe]:DDEMod:SEGMent1 ... 6:CIQ:PHASe:ROTation?</code>
Example	<code>:DDEM:SEGM1:CIQ:PHAS:ROT 45</code> <code>:DDEM:SEGM1:CIQ:PHAS:ROT?</code>
Preset	0 deg
State Saved	Yes
Min	-360 deg
Max	360 deg

Shift

Enables or disables shift for phase rotation. When enabled, the phase rotation is only applied to the odd symbol, for example pi/2 shift BPSK, pi/4 shift QPSK.

Remote Command	<code>[:SENSe]:DDEMod:SEGMent1 ... 6:CIQ:PHASe:ROTation:SODD ON OFF 1 0</code>
----------------	---

3 VMA Mode

3.1 Digital Demod Measurement

	<code>[:SENSe]:DDEMod:SEGMent1 ... 6:CIQ:PHASe:ROTation:SODD?</code>
Example	<code>:DDEM:SEGM1:CIQ:PHAS:ROT:SODD ON</code> <code>:DDEM:SEGM1:CIQ:PHAS:ROT:SODD?</code>
Preset	OFF
State Saved	Yes

Differential

Enables or disables the differential encoding for the segment. This should only be enabled for the BPSK, QPSK and 8PSK constellations.

Remote Command	<code>[:SENSe]:DDEMod:SEGMent1 ... 6:CIQ:DIFFerential:STATe OFF ON 0 1</code> <code>[:SENSe]:DDEMod:SEGMent1 ... 6:CIQ:DIFFerential:STATe?</code>
Example	<code>:DDEM:SEGM1:CIQ:DIFF:STAT ON</code> <code>:DDEM:SEGM1:CIQ:DIFF:STAT?</code>
Couplings	When Offset is ON , this control is OFF
Preset	OFF
State Saved	Yes

Offset

Enables or disables an IQ offset by half the symbol time. This should only be enabled for the QPSK constellation.

Remote Command	<code>[:SENSe]:DDEMod:SEGMent1 ... 6:CIQ:OFFSet:STATe OFF ON 0 1</code> <code>[:SENSe]:DDEMod:SEGMent1 ... 6:CIQ:OFFSet:STATe?</code>
Example	<code>:DDEM:SEGM1:CIQ:OFFS:STAT ON</code> <code>:DDEM:SEGM1:CIQ:OFFS:STAT?</code>
Couplings	When Differential is ON , this control is OFF
Preset	OFF
State Saved	Yes

Insert Pilot

Enables or disables insertion of pilot (with repeated patten) to data segment.

Remote Command	<code>[:SENSe]:DDEMod:SEGMent1 ... 6:CIQ:PILot ON OFF 1 0</code> <code>[:SENSe]:DDEMod:SEGMent1 ... 6:CIQ:PILot?</code>
Example	<code>:DDEM:SEGM1:CIQ:PIL ON</code>

	<code>:DDEM:SEGM1:CIQ:PIL?</code>
Preset	OFF
State Saved	Yes

Pilot Repeat Cycle

Specifies pilot pattern repeat cycle in data segment.

Remote Command	<code>[:SENSe]:DDEMod:SEGMent1 ... 6:CIQ:PILot:CYCLe <int></code> <code>[:SENSe]:DDEMod:SEGMent1 ... 6:CIQ:PILot:CYCLe?</code>
Example	<code>:DDEM:SEGM1:CIQ:PIL:CYCL 100</code> <code>:DDEM:SEGM1:CIQ:PIL:CYCL?</code>
Couplings	If " Modulation Format " on page 335 is not Custom IQ, or " Insert Pilot " on page 357 is not On, this control is grayed-out
Preset	1476
State Saved	Yes
Min	1
Max	10000000

Pilot Start Symbol

Specifies start position of repeated pilot pattern in data segment.

Remote Command	<code>[:SENSe]:DDEMod:SEGMent1 ... 6:CIQ:PILot:STARt <int></code> <code>[:SENSe]:DDEMod:SEGMent1 ... 6:CIQ:PILot:STARt?</code>
Example	<code>:DDEM:SEGM1:CIQ:PIL:STAR 10</code> <code>:DDEM:SEGM1:CIQ:PIL:STAR?</code>
Couplings	If Modulation Format is not Custom IQ, or Insert Pilot is not On, this control is grayed-out
Preset	0
State Saved	Yes
Min	0
Max	10000000

Pilot Active Symbols

Specifies a string to specify pilot symbols within one repeat cycle.

Remote Command	<code>[:SENSe]:DDEMod:SEGMent1 ... 6:CIQ:PILot:PATTern <string></code> <code>[:SENSe]:DDEMod:SEGMent1 ... 6:CIQ:PILot:PATTern?</code>
----------------	--

3 VMA Mode
3.1 Digital Demod Measurement

Example	<code>:DDEM:SEGM1:CIQ:PIL:PATT '100:200'</code> <code>:DDEM:SEGM1:CIQ:PIL:PATT?</code>
Couplings	If Modulation Format is not Custom IQ, or Insert Pilot is not On, this control is grayed-out
Preset	"1440:1475"
State Saved	Yes

Pilot Modulation

Specifies modulation type for pilot symbols in data segment.

Remote Command	<code>[[:SENSe]:DDEMod:SEGMENT1 ... 6:CIQ:PILOt:MODulation AUTO BPSK QPSK</code> <code>[[:SENSe]:DDEMod:SEGMENT1 ... 6:CIQ:PILOt:MODulation?</code>
Example	<code>:DDEM:SEGM1:CIQ:PIL:MOD QPSK</code> <code>:DDEM:SEGM1:CIQ:PIL:MOD?</code>
Couplings	If Modulation Format is not Custom IQ, or Insert Pilot is not On, this control is grayed-out
Preset	QPSK
State Saved	Yes
Range	Auto BPSK QPSK

Constellation Settings (Except Custom IQ)

Enables you to edit the constellation state mapping. It's only available for the format except CPM(FM), QAM 256, QAM 512, QAM 1024 and DVB QAM 256.

Constellation Settings (Custom IQ)

Preset To Standard Constellation

Accesses a menu to fill the table by copying one of these typical modulation formats: BPSK\QPSK\8PSK\16PSK\32PSK\64PSK\4QAM\16QAM\64QAM.

Range	BPSK\QPSK\8PSK\16PSK\32PSK\64PSK\4QAM\16QAM\64QAM
-------	---

Axis Type

Selects Constellation Axis between I vs Q and Magnitude vs Phase.

Go to Row

Enables you to move through the table to edit the desired point.

Min	1
Max	2000

Insert Row Below

Inserts a row below the current row. The new row is a copy of the current row and becomes the current row. The new row is not yet entered into the underlying table, and the data in the row is displayed in light gray.

Delete Row

This is an immediate action control. It immediately deletes the currently-selected row regardless of the row is being edited or not. The row following the currently-selected row (or the row preceding if there is none) will be selected.

Clear Table

This is an immediate action control. It immediately clears the table.

Phase Rotation

Specifies the phase to rotate the constellation.

Couplings	This control is only available when Axis Type is Magnitude vs Phase
Preset	0.0
State Saved	Saved in instrument state, survives Preset
Min	-360
Max	360

Apply Phase Rotation

Updates the phase column and rotates constellation per Phase Rotation value, the Phase Rotation will then be reset to zero.

Couplings	Only available when Axis Type is Magnitude vs Phase
-----------	---

Normalize RMS

Scales the magnitude of the constellation states to have a unitless RMS of 1. This assumes all constellation states have equal probability.

Validate

Checks the current constellation definition for validity and enables the OK button. It will also calculate Mag RMS and Symmetry based on current constellation.

Mag RMS calculation assumes equally probable constellation states.

Symmetry means angle in degrees by which constellation can be rotated to achieve an equivalent constellation.

User-Defined Filter Coefficient

Enables you to edit the user-defined filter's coefficient. Only available when the meas or ref filter is user-defined.

User-Defined Meas Filter Coefficient List Data (Remote Command Only)

Defines a list of coefficient values for a user-defined measure filter. Up to 1000 points may be defined using the following parameters.

Remote Command	<code>:CALCulate:DDEMod:SEGMENT1 ... 6:FILTer:COEFFicient:MEASure[:DATA] <real>, <real>, ...</code> <code>:CALCulate:DDEMod:SEGMENT1 ... 6:FILTer:COEFFicient:MEASure[:DATA]?</code>
Example	<code>:CALC:DDEM:SEG1:FILT:COEF:MEAS -0.1124, -0.1545, -0.2458, -0.325</code> <code>:CALC:DDEM:SEG1:FILT:COEF:MEAS?</code>
Preset	Unaffected by Preset
State Saved	Saved in instrument state
Backwards Compatibility SCPI	<code>:CALCulate:FILTer:COEFFicient:MEASure[:DATA]</code>

User-Defined Ref Filter Coefficient List Data (Remote Command Only)

Defines a list of coefficient values for a user-defined reference filter. Up to 1000 points may be defined using the following parameters.

Remote	<code>:CALCulate:DDEMod:SEGMENT1 ... 6:FILTer:COEFFicient:REFerence[:DATA] <real>, ...</code>
--------	---

Command	<real>, ... :CALCulate:DDEMod:SEGMent1 ... 6:FILTer:COEFficient:REFeRence[:DATA]?
Example	:CALC:DDEM:SEGM1:FILT:COEF:REF -0.1124, -0.1545, -0.2458, -0.325 :CALC:DDEM:SEGM1:FILT:COEF:REF?
Preset	Unaffected by Preset
State Saved	Saved in instrument state
Backwards Compatibility SCPI	:CALCulate:FILTer:COEFficient:REFeRence[:DATA]

3.1.9.7 Advanced

Enables you to configure advanced parameters.

IF Gain

To take full advantage of the RF dynamic range of the instrument, a switched IF amplifier with approximately 10 dB of gain is available. When it can be turned on without an overload, the dynamic range is always better with it on than off. The control “IF Gain” can be used to set the IF Gain function to Auto, or to On (the extra 10 dB) or Off. These settings affect sensitivity and IF overloads.

Sets the IF Gain function to Auto, Low Gain or High Gain. These settings affect sensitivity and IF overloads.

This only applies to the RF input. It does not apply to baseband I/Q input.

IF Gain Auto

Activates the auto rules for IF Gain

Remote Command	[:SENSe]:DDEMod:IF:GAIN:AUTO[:STATe] ON OFF 1 0 [:SENSe]:DDEMod:IF:GAIN:AUTO[:STATe]?
Example	:DDEM:IF:GAIN:AUTO OFF :DDEM:IF:GAIN:AUTO?
Dependencies	The IF Gain control has no effect when the U7227A USB Preamplifier is connected. This is not annotated or reflected on any control; there are no controls grayed out nor any SCPI locked out. The instrument simply behaves as though IF Gain is set to Low regardless of the setting on the control This control, and the Auto/Man toggle, do not appear in VXT
Preset	OFF
State Saved	Yes
Range	Auto Man

IF Gain Select

Selects the range of IF gain:

- High gain - Set 10 dB IF gain for better noise level measurements
- Low gain - Set 0 dB IF gain for large signals
- Other - enables you to set the arbitrary IF gain value within -12 dB to 12 dB. This selection is not available for the B25 If bandwidth option

When this parameter is changed, IF Gain Auto will become Man.

Remote Command	<code>[:SENSe]:DDEMod:IF:GAIN:SElect LOW HIGH OTHER</code> <code>[:SENSe]:DDEMod:IF:GAIN:SElect?</code>
Example	<code>:DDEMod:IF:GAIN:SEL LOW</code> <code>:DDEMod:IF:GAIN:SEL?</code>
Preset	LOW
State Saved	Yes
Range	LOW HIGH OTHER
Backwards Compatibility SCPI	<code>[:SENSe]:DDEMod:IF:GAIN[:STATE] ON OFF 1 0</code>

Other IF Gain

Specifies the IF gain value. When IF gain is set to Other, this value will be used.

Remote Command	<code>[:SENSe]:DDEMod:IF:GAIN:LEVel <rel_amp1></code> <code>[:SENSe]:DDEMod:IF:GAIN:LEVel?</code>
Example	<code>:DDEMod:IF:GAIN:LEV -10</code> <code>:DDEMod:IF:GAIN:LEV?</code>
Notes	It is not available for B25 IF bandwidth option
Preset	0
State Saved	Saved in instrument state
Min/Max	-12/12

Spur Avoidance

Option H1G has a spur at the -50 MHz offset of the Center Frequency. The Spur Avoidance function is provided to eliminate this spur.

- Auto: move the spur completely out of analysis bandwidth. The tradeoff is that the available analysis bandwidth will be reduced to 400 MHz and EVM could be worse as the edge of the passband is used for analysis
- Manual: move the spur by a specified value, or turn off this feature by setting the value to 0

Remote Command	<code>[:SENSe]:DDEMod:SAVoid:FREQuency <freq ></code> <code>[:SENSe]:DDEMod:SAVoid:FREQuency?</code> <code>[:SENSe]:DDEMod:SAVoid:AUTO ON OFF 1 0</code> <code>[:SENSe]:DDEMod:SAVoid:AUTO?</code>
Example	<code>:DDEM:SAV:FREQ 50MHz</code> <code>:DDEM:SAV:FREQ?</code> <code>:DDEM:SAV:AUTO ON</code> <code>:DDEM:SAV:AUTO?</code>
Couplings	Grayed-out when Mixer Mode is Alternate When Acquisition mode is changed from Sequential to Simultaneous, this control is reset (manual, 0 Hz) for all component carriers
Preset	0 Hz OFF
State Saved	Saved in instrument state Yes
Range	Auto Manual
Min	$-(1\text{GHz} - \text{BW})/2$
Max	$(1\text{GHz} - \text{BW})/2$

LO Dither

When **LO Dither** is turned on, the local oscillator frequency is rapidly changed by small, random amounts. This helps spread the power of spurious signals within the passband, which lowers their level, thus increasing dynamic range. This is only required in very wide passbands, so this feature only appears with option H1G.

Remote Command	<code>[:SENSe]:DDEMod:LO:DITHer[:STATe] ON OFF 1 0</code> <code>[:SENSe]:DDEMod:LO:DITHer[:STATe]?</code>
Example	<code>:DDEM:LO:DITH 1</code> <code>:DDEM:LO:DITH?</code>
Dependencies	Only available when the instrument has Option H1G installed. If you try to turn ON LO Dither in any other case, an error message is generated, -241,"Hardware missing; Option H1G required" Only appears in some Modes (for example, 5GNR, VMA and IQ Analyzer)

3 VMA Mode

3.1 Digital Demod Measurement

	<p>Turned Off and grayed-out when the IF Path is set to a path other than 1 GHz. If you press the grayed-out control, a warning message "LO Dither only available with IF Path 1 GHz" is shown. If you try to set LO Dither to ON remotely while it is grayed-out, a message "-221,Settings conflict; LO Dither only available with IF Path 1 GHz" is returned</p> <p>When LO Dither is turned on, the Phase Noise Optimization control is grayed-out. If you try to change the PNO value via the front panel or SCPI in that case, an error is generated, "LO Dither must be turned off to change this value"</p>
Couplings	<p>As with most parameters with an AUTO state, AUTO COUPLE sets it to Auto, which then selects AUTOorange. Setting any specific value (AUTOorange, LOW or HIGH) will set the AUTO state to false</p> <p>When LO Dither is turned ON, Phase Noise Optimization is set to "Best Close-In". If the Phase Noise Optimization value changes due to turning on LO Dither, a warning message "Phase Noise Optimization changed due to LO Dither activation" is shown</p>
Preset	OFF
State Saved	Saved in instrument state

PhNoise Opt

Selects the LO (local oscillator) phase noise behavior for various desired operating conditions.

For full details, see "[Parameter Options, Installed Options & Auto Rules](#)" on page 365 and "[Ranges](#)" on page 370 below.

Remote Command	<p>[:SENSe] :DDEMod:FREQuency:SYNThesis[:STATe] 1 ... 5</p> <p>For the meaning of each numeric option value, see "Parameter Options, Installed Options & Auto Rules" on page 365 below</p> <p>[:SENSe] :DDEMod:FREQuency:SYNThesis[:STATe]?</p>
Example	<p>:DDEM:FREQ:SYNT 2</p> <p>Selects optimization for best wide offset phase noise</p>
Dependencies	Does not appear in all models. The control is blank in those models, but the SCPI command is accepted for compatibility (although no action is taken)
Preset	2
State Saved	Yes
Range	See " Ranges " on page 370 below

Parameter Options, Installed Options & Auto Rules

The Phase Noise Optimization control lets you optimize the setup and behavior of the Local Oscillator (LO) depending on your specific measurement conditions. You may wish to trade off noise and speed, for example, to make a measurement faster without regard to noise or with optimum noise characteristics without regard to speed.

Parameter Values Summary

Option	#	Description
"Balanced" on page 367	1	<ul style="list-style-type: none"> - In instruments with EPO, balances close-in phase noise with spur avoidance - In instruments without EPO optimizes phase noise for small frequency offsets from the carrier
"Best Wide-offset" on page 367	2	Optimizes phase noise for wide frequency offsets from the carrier
"Fast Tuning" on page 368	3	Optimizes LO for tuning speed
"Best Close-in" on page 366	4 or 1*	<ul style="list-style-type: none"> - In instruments with EPO, emphasizes close-in phase noise performance without regard to spur avoidance - In instruments without EPO, this setting is accepted but no action is taken
"Best Spurs" on page 367	5	<ul style="list-style-type: none"> - In instruments with EPO, emphasizes spur avoidance over close-in phase noise performance - In instruments without EPO, this setting is accepted but no action taken
Auto	-	Automatically selects LO (local oscillator) phase noise behavior to optimize dynamic range and speed for various instrument operating conditions

*Dependent on Option EPO installation. See "Best Close-in" on page 366 below.

The actual behavior varies somewhat depending on model number and option; for example, you always get Fast Tuning by choosing Option #3, but in some models, "Fast Tuning" on page 368 is identical in effect to "Best Close-in" on page 366.

Best Close-in

Without option EPO

`:FREQ:SYNT 1`

The LO phase noise is optimized for smaller offsets from the carrier, at the expense of phase noise farther out.

The actual frequency offset within which noise is optimized is shown with in square brackets, as this can vary depending on the hardware set in use. For example, in some instruments this annotation appears as [offset <20 kHz]

With option EPO

`:FREQ:SYNT 4`

In instruments with Option EPO, the LO is configured for the best possible close-in phase noise (offsets up to 600 kHz from the carrier), regardless of spurious products

3 VMA Mode

3.1 Digital Demod Measurement

that occur with some center frequencies. Because this is generally less desirable for close-in measurements than the "Balanced" on page 367 setting, parameter 1 selects "Balanced" on page 367 in EPO instruments, in the interests of optimizing code compatibility across the family. Parameter 4 selects "Best Close-in" on page 366, which is usually not as good a choice as "Balanced" on page 367.

Balanced

:FREQ:SYNT 1

In instruments with EPO, the LO is configured for the best possible phase noise at offsets up to 600 kHz from the carrier whenever there are no significant spurs within the span observed with an on-screen carrier. When there will be such a spur, the LO is reconfigured in a way that allows the phase noise to increase by 7 dB mostly within ± 1 octave around 400 kHz offset. The spurs will always be below -70 dBc.

Best Spurs

:FREQ:SYNT 5

In instruments with EPO, the LO is configured for better phase noise than the "Best Wide-offset" on page 367 case close to the carrier, but the configuration has 11 dB worse phase noise than the "Best Close-in" on page 366 case mostly within ± 1 octave around 300 kHz offset. Spurs are even lower than in the "Balanced" on page 367 case at better than -90 dBc, whether or not the carrier is on-screen.

This setting is never selected when Phase Noise Optimization is in Auto, you must select it manually.

Best Wide-offset

:FREQ:SYNT 2

The LO phase noise is optimized for wider offsets from the carrier. Optimization is especially improved for offsets from 70 kHz to 300 kHz. Closer offsets are compromised and the throughput of measurements (especially remote measurements where the center frequency is changing rapidly), is reduced.

The actual frequency offset beyond which noise is optimized is shown with in square brackets, as this can vary depending on the hardware set in use. For example, in some instruments this annotation appears as [offset >30 kHz]

In instruments with Option EPO, the LO is configured for the best possible phase noise at offsets up to 600 kHz from the carrier whenever there are no significant spurs within the span observed with an on-screen carrier. When there will be such a spur, the LO is reconfigured in a way that allows the phase noise to increase by 7 dB mostly within ± 1 octave around 400 kHz offset. The spurs will always be below -70 dBc.

Fast Tuning

`:FREQ:SYNT 3`

In this mode, the LO behavior compromises phase noise at many offsets from the carrier in order to allow rapid measurement throughput when changing the center frequency or span. The term "[Fast Tuning](#)" on page 368 refers to the time it takes to move the local oscillator to the start frequency and begin a sweep; this setting does not impact the actual sweep time in any way.

In instruments with EP1, the LO behavior compromises phase noise at offsets below 4 MHz in order to improve measurement throughput. The throughput is especially affected when moving the LO more than 2.5 MHz and up to 10 MHz from the stop frequency to the next start frequency.

In instruments with Option EPO, this is the same configuration as "[Best Spurs](#)" on page 367. It is available with the "[Fast Tuning](#)" on page 368 label for convenience, and to make the user interface more consistent with other X-Series instrument family members.

(In models whose hardware does not provide for a "[Fast Tuning](#)" on page 368 option, the settings for "[Best Close-in](#)" on page 366 are used if "[Fast Tuning](#)" on page 368 is selected. This gives the fastest possible tuning for that hardware set.)

Auto

`:FREQ:SYNT:AUTO ON`

Selects the LO (local oscillator) phase noise behavior to optimize dynamic range and speed for various instrument operating conditions. The selection rules are as follows.

Auto Optimization Rules

X-Series instruments have several grades of LO, offering different configurations when in the Auto Mode. The rules for Auto selection are as follows:

Models with Option	Conditions	Selection
EPO	Center frequency is < 699.9 kHz	"Balanced" on page 367
Models with option EPO have a two stage local oscillator, which switches to a single loop for fast tuning (available in UXA)	Span > 114.1 MHz, <i>or</i> RBW > 800 kHz	"Fast Tuning" on page 368
	RBW > 290 kHz, <i>or</i> Span > 4.2 MHz	"Best Wide-offset" on page 367
	Other conditions	"Balanced" on page 367

3 VMA Mode
3.1 Digital Demod Measurement

Models with Option	Conditions	Selection
<p>EP1</p> <p>Models with option EP1 have a two-loop local oscillator, which switches to a single loop for fast tuning (available in PXA)</p>	<p>Span > 44.44 MHz, <i>or</i></p> <p>RBW > 1.9 MHz, <i>or</i></p> <p>Source Mode is set to "Tracking"</p> <p>Center frequency is < 195 kHz, <i>or</i></p> <p>CF >= 1 MHz <i>and</i> Span <= 1.3 MHz <i>and</i> RBW <= 75 kHz</p> <p>All other conditions</p>	<p>"Fast Tuning" on page 368</p> <p>"Best Close-in" on page 366</p> <p>"Best Wide-offset" on page 367</p>
<p>EP2</p> <p>Models with option EP2 use a different loop bandwidth for the fast-tuning choice, which is a compromise between tuning speed and phase noise, giving good tuning speed at all offsets. Although not as good as for "Best Close-in" on page 366; this is useful when you have to look across a wide range of spans (available, for example, in MXA for excellent phase noise)</p>	<p>CF < 130 kHz, <i>or</i></p> <p>CF > 12 MHz <i>and</i> Span < 495 kHz <i>and</i> RBW < 40 kHz</p> <p>Span > 22 MHz, <i>or</i></p> <p>RBW > 400 kHz, <i>or</i></p> <p>CF ≤ 12 MHz <i>and</i> Span < 495 kHz <i>and</i> RBW < 23 kHz</p> <p>All other conditions</p>	<p>"Best Close-in" on page 366</p> <p>"Fast Tuning" on page 368</p> <p>"Best Wide-offset" on page 367</p>
<p>EP4</p> <p>(available in CXA for improved phase noise)</p>	<p>Span > 101 MHz <i>or</i></p> <p>RBW > 1.15 MHz <i>or</i></p> <p>Source Mode is set to "Tracking"</p> <p>CF is < 109 kHz <i>or</i></p> <p>CF >= 4.95 MHz <i>and</i> Span <= 666 kHz <i>and</i> RBW < 28 kHz</p> <p>All other conditions</p>	<p>"Fast Tuning" on page 368</p> <p>"Best Close-in" on page 366</p> <p>"Best Wide-offset" on page 367</p>
<p>All Other Models</p> <p>Note that in these models, the hardware does not actually provide for an extra-fast tuning option, so the settings for "Fast Tuning" on page 368 are actually the same as "Best Close-in" on page 366, but the rules are implemented this way so that the user who doesn't care about phase noise but does care about tuning speed doesn't have to remember which of the other two settings gives faster tuning</p>	<p>Span > 12.34 MHz, <i>or</i></p> <p>RBW > 250 kHz, <i>or</i></p> <p>Source Mode is set to "Tracking"</p> <p>Center frequency is < 25 kHz, <i>or</i></p> <p>CF >= 1 MHz <i>and</i> Span <= 141.4 kHz <i>and</i> RBW <= 5 kHz</p> <p>All other conditions</p>	<p>"Fast Tuning" on page 368</p> <p>"Best Close-in" on page 366</p> <p>"Best Wide-offset" on page 367</p>

In all the above cases:

- The RBW to be used in the calculations is the equivalent –3 dB bandwidth of the current RBW filter
- The rules apply whether in swept spans, zero span, or FFT spans

Ranges

Option	Option #	Phase Noise Option	Range
No EPx Option	1	Best Close-in	[offset < 20 kHz]
	2	Best Wide-offset	[offset > 30 kHz]
	3	Fast Tuning	[same as Best Close-In]
EP0	4	Best Close-in	[offset < 600 kHz]
	1	Balanced	[offset < 600 kHz]
	5	Best Spurs	[offset < 600 kHz]
	2	Best Wide-offset	[offset > 800 kHz]
	3	Fast Tuning	[same as Best Close-In]
	1	Best Close-in	[offset < 140 kHz]
EP1	2	Best Wide-offset	[offset > 160 kHz]
	3	Fast Tuning	[single loop]
	1	Best Close-in	[offset < 70 kHz]
EP2, EP3, EP5	2	Best Wide-offset	[offset > 100 kHz]
	3	Fast Tuning	[medium loop bw]
	1	Best Close-in	[offset < 90 kHz]
EP4	2	Best Wide-offset	[offset > 130 kHz]
	3	Fast Tuning	[same as Best Close-In]

Mixing Mode

Changing LO mixing from high-side to low-side or vice versa.

Remote Command	<code>[:SENSe]:DDEMod:LO:MIXMode NORMal ALTeRNate</code> <code>[:SENSe]:DDEMod:LO:MIXMode?</code>
Example	<code>:DDEM:LO:MIXM NORM</code> <code>:DDEM:LO:MIXM?</code>
Dependencies	The Mixing Mode, the control is grayed out when the RF Input is set to something other than “RF” (such as External Mixer). If you press the grayed out control, a warning message “Feature only available with Signal Input RF” is shown If you try to set Mixing Mode via SCPI when disabled, a message -221, “Settings conflict; Feature only

3 VMA Mode

3.1 Digital Demod Measurement

	available with signal input RF" is returned
Preset	NORMa1
State Saved	Yes
Range	Normal Alternate

Spectrum Stitching

When Spectrum Stitching is turned on, multiple acquisitions overlapped in frequency domain will be performed and then combined to get wide band IQ data. This enables the instrument to capture and analysis wider signal, it may slow down the measurement speed and it requires the signal to occupy the major part of the analysis bandwidth.

Note: accurate trigger is needed to align multiple acquisitions in time domain, and input signal need to be repeated and aligned with trigger precisely.

Remote Command	[:SENSe]:DDEMod:STITching:SPECTrum[:STATe] ON OFF 1 0 [:SENSe]:DDEMod:STITching:SPECTrum[:STATe]?
Example	:DDEM:STIT:SPEC 1 :DDEM:STIT:SPEC?
Preset	OFF
State Saved	Saved in instrument state

Cross-Correlated EVM

Enables Cross-Corelated EVM.

Remote Command	[:SENSe]:DDEMod:CCEVm[:ENABle] ON OFF 1 0 [:SENSe]:DDEMod:CCEVm[:ENABle]?
Example	:DDEM:CCEV 1 :DDEM:CCEV?
Preset	OFF
State Saved	Saved in instrument state

Multi Channel Config

Lets you perform a detailed configuration of your component carriers, including number of carriers, bandwidth, offset, integration bandwidth, and so on.

Multi Channel Config

This menu is only available for the Modulation Analysis measurement. It enables you to configure multiple channel receiver. Different hardware platforms have different parameters.

Input Channel IP address

Sets instrument IP address for channel configuration, "local" is used for current instrument.

Remote Command	<code>[:SENSe] :DDEMod :MCHannel :IPAddress1 2 <String></code> <code>[:SENSe] :DDEMod :MCHannel :IPAddress1 2 ?</code>
Example	<code>:DDEM :MCH :IPAD1 '192.168.1.2'</code>
Preset	Local
State Saved	Yes
Backwards Compatibility SCPI	<code>[:SENSe] :DDEMod :MIMO :IPAddress1 2</code>

Input Channel Instrument port

Remote Command	<code>[:SENSe] :DDEMod :MCHannel :IPAddress1 2 <String></code> <code>[:SENSe] :DDEMod :MCHannel :IPAddress1 2 ?</code>
Example	<code>:DDEM :MCH :IPAD1 '192.168.1.2'</code>
Preset	Local
State Saved	Yes
Backwards Compatibility SCPI	<code>[:SENSe] :DDEMod :MIMO :IPAddress1 2</code>

Lock

Locks instrument and assigns to a channel in sequence.

Remote Command	<code>[:SENSe] :DDEMod :MCHannel :IPAddress1 2 :LOCKed OFF ON 0 1</code> <code>[:SENSe] :DDEMod :MCHannel :IPAddress1 2 :LOCKed ?</code>
Example	<code>:DDEM :MCH :IPAD1 :LOCK 1</code> <code>:DDEM :MCH :IPAD1 :LOCK ?</code>
Preset	0

3 VMA Mode
3.1 Digital Demod Measurement

State Saved	Yes
Backwards Compatibility SCPI	[:SENSe] :DDEMod:MIMO:IPADdress1 2:LOCKed

Channel Configuration Information (Remote Query only)

Reads back channel configuration information.

Remote Command	[:SENSe] :DDEMod:MCHannel:CHANnel:INFO?
Example	:DDEM:MCH:CHAN:INFO?
Backwards Compatibility SCPI	[:SENSe] :DDEMod:MIMO:CHANnel:INFO

3.1.9.8 BER

Enables you to set Tx BER parameters.

BER

Turns Tx BER on or off. When Tx BER is on, the results of BER, Error Bits, and Total Bits are displayed in Demod Bits window.

NOTE

When segment2 is enabled, Tx BER measurement will be only performed on segment2.

Remote Command	[:SENSe] :DDEMod:SEGMENT1 ... 6:BER:STATe OFF ON 0 1 [:SENSe] :DDEMod:SEGMENT1 ... 6:BER:STATe?
Example	:DDEM:SEGM1:BER:STAT ON :DDEM:SEGM1:BER:STAT?
Couplings	Available only when Tx Pattern has been recalled
Preset	OFF
State Saved	Yes
Backwards Compatibility SCPI	[:SENSe] :DDEMod:BER:STATe

Total Bit Num

Determines the maximum total bit number that is used for Tx BER calculation. Once this number is achieved, the BER measurement stops accumulation.

Remote Command	<code>[:SENSe] :DDEMod :SEGMENT1 ... 6 :BER :COUNT :BITS <real></code> <code>[:SENSe] :DDEMod :SEGMENT1 ... 6 :BER :COUNT :BITS ?</code>
Example	<code>:DDEM :SEGM1 :BER :COUN :BITS 1.0E8</code> <code>:DDEM :SEGM1 :BER :COUN :BITS ?</code>
Preset	1.0e8
State Saved	Yes
Min/Max	1.0e2 / 1.0e25
Backwards Compatibility SCPI	<code>[:SENSe] :DDEMod :BER :COUNT :BITS</code>

3.1.9.9 Limits

Accesses a menu that enables you to set the following limits:

- Tx Power
- RMS EVM
- Frequency Error
- Clock Error
- RMS Offset EVM

Limit Test

Selects whether to test the scalar limits and the trace limits. For scalar results that fail the limit, a red F is appended. And for trace results that pass or fail the displayed limit (i.e. those for which Limit On/Off is set to On), a message will be displayed in the upper-left corner of the graticule of the window as below:

- If the trace is at or within the bounds of all applicable limits and margins, the text "Trace Pass" will be displayed in green
- If the trace is at or within the bounds of all applicable limits, but outside the bounds of some applicable margin, the text "Trace Fail Margin" will be displayed in amber

3 VMA Mode
 3.1 Digital Demod Measurement

- If the trace is outside the bounds of some applicable limits, the text “Trace Fail” will be displayed in red
- If the window has no enabled limits, or the trace itself is not displayed, no message is displayed for that trace

`:CALCulate:DDEMod:LLINE[1]|2|3|4|5|6:FAIL?` returns the trace limit testing results.

`:READ|FETCh|MEASure:DDEMod2?` returns the scalar limit testing results.

Remote Command	<code>:CALCulate:DDEMod:LIMit:STATe OFF ON 0 1</code> <code>:CALCulate:DDEMod:LIMit:STATe?</code>
Example	<code>:CALC:DDEM:LIM:STAT OFF</code> <code>:CALC:DDEM:LIM:STAT?</code>
Preset	<code>OFF</code>
State Saved	Saved in instrument state
Range	<code>On Off</code>

Edit Scalar Limits

Enables you to edit the limit value for the scalar results.

Tx Power

Sets the limit for the transmit power pass/fail test. It fails when the measured power is less than this limit value.

Remote Command	<code>:CALCulate:DDEMod:SEGment1 ... 6:LIMit:POWer <amp></code> <code>:CALCulate:DDEMod:SEGment1 ... 6:LIMit:POWer?</code>
Example	<code>:CALC:DDEM:SEGM1:LIM:POW -30.0 dBm</code> Set the transmit power limit of segment1 to -30 dBm <code>:CALC:DDEM:SEGM1:LIM:POW?</code> query the transmit power limit of segment1
Preset	-50.0
State Saved	Yes
Min	-200.0
Max	200.0
Backwards Compatibility SCPI	<code>:CALCulate:DDEMod:LIMit:POWer</code>

RMS EVM

Sets the limit for the RMS EVM or FSK Error measurement pass/fail test.

Remote Command	<code>:CALCulate:DDEMod:SEGMent1 ... 6:LIMit:EVM:RMS <real></code> <code>:CALCulate:DDEMod:SEGMent1 ... 6:LIMit:EVM:RMS?</code>
Example	<code>:CALC:DDEM:SEGM1:LIM:EVM:RMS 10.0</code> Set the RMS EVM limit of segment1 to 10 % <code>:CALC:DDEM:SEGM1:LIM:EVM:RMS?</code> query the RMS EVM limit of segment1
Notes	The control label is "RMS EVM" for all modulation format except FSK formats When modulation format is FSK formats, it is "FSK Error"
Preset	35.0
State Saved	Yes
Min	0.00
Max	100.0
Backwards Compatibility SCPI	<code>:CALCulate:DDEMod:LIMit:EVM:RMS</code>

Frequency Error

Sets the limit for the frequency error measurement pass/fail test.

Remote Command	<code>:CALCulate:DDEMod:SEGMent1 ... 6:LIMit:FERRor[:HERTZ] <real></code> <code>:CALCulate:DDEMod:SEGMent1 ... 6:LIMit:FERRor[:HERTZ]?</code>
Example	<code>:CALC:DDEM:SEGM1:LIM:FERR 40.0</code> Set the frequency error limit of segment1 to 40.0 Hz <code>:CALC:DDEM:SEGM1:LIM:FERR?</code> Query the frequency error limit of segment1
Preset	100.0
State Saved	Yes
Min	0 Hz
Max	500 kHz
Backwards Compatibility SCPI	<code>:CALCulate:DDEMod:LIMit:FERRor[:HERTZ]</code>

Clock Error

Sets the limit for the symbol clock error measurement pass/fail test.

Remote Command	<code>:CALCulate:DDEMod:SEGMent1 ... 6:LIMit:CERRor[:HERTZ] <real></code> <code>:CALCulate:DDEMod:SEGMent1 ... 6:LIMit:CERRor[:HERTZ]?</code>
Example	<code>:CALC:DDEM:SEGM1:LIM:CERR 40.0</code> Set the clock error limit of segment1 to 40.0 Hz <code>:CALC:DDEM:SEGM1:LIM:CERR?</code> Query the clock error limit of segment1
Preset	100.0
State Saved	Yes
Min	0 Hz
Max	500 kHz
Backwards Compatibility SCPI	<code>:CALCulate:DDEMod:LIMit:CERRor[:HERTZ]</code>

RMS Offset EVM

Available only when the modulation format is Offset QPSK or Shaped Offset QPSK.

Sets the limit for the RMS Offset EVM measurement pass/fail test.

Remote Command	<code>:CALCulate:DDEMod:SEGMent1 ... 6:LIMit:OEVM:RMS <real></code> <code>:CALCulate:DDEMod:SEGMent1 ... 6:LIMit:OEVM:RMS?</code>
Example	<code>:CALC:DDEM:SEGM1:LIM:OEVM:RMS 10.0</code> Set the RMS Offset EVM limit of segment1 to 10 % <code>:CALC:DDEM:SEGM1:LIM:OEVM:RMS?</code> Query the RMS Offset EVM limit of segment1
Preset	35.0
State Saved	Yes
Min	0.00
Min/Max	0.00/100.0
Backwards Compatibility SCPI	<code>:CALCulate:DDEMod:LIMit:OEVM:RMS</code>

Deviation Accuracy

Sets the limit for the Deviation Accuracy result pass/fail test.

Remote Command	<code>:CALCulate:DDEMod:SEGMent1 ... 6:LIMit:DEVIation:OFFSet <real></code>
Example	<p><code>:CALC:DDEM:SEGM1:LIM:DEV:OFFS 10.0</code></p> <p>Set the deviation accuracy limit of segment1 to 10 %</p> <p><code>:CALC:DDEM:SEGM1:LIM:DEV:OFFS?</code></p> <p>Query the deviation accuracy limit of segment1</p>
Couplings	<p>Available only when the modulation format is FSK formats or CPM (FM)</p> <p>If FSK Deviation Reference is Auto, this control is grayed-out. Pressing this control in this case generates a message "It's not available while FSK Reference Deviation is Auto"</p>
Preset	20.0
State Saved	Yes
Min/Max	0.00/100.0
Backwards Compatibility SCPI	<code>:CALCulate:DDEMod:LIMit:DEVIation:OFFSet</code>

Select Limit

Specifies the selected limit. The term "selected limit" is used throughout this document to specify which trace limit will be affected by the functions.

Notes	The selected limit is remembered even when not in the Limit Menu
Preset	Limit 1, not affected by Mode Preset, preset by Restore Mode Defaults
State Saved	Saved in instrument state

Limit On/Off

Selects whether the limit is turned on or off. While trying to turn on the trace limit, it will check whether the limit's x/y axis unit and the selected window's x/y axis unit match. If matched, the limit line will be turned on. If not, the limit will be turned off and a settings conflict message "The unit of the limit and the selected window doesn't match." will be displayed.

The limit will be turned off if the data of the selected window is changed and its x/y units do not match those of the current limit.

Remote Command	<code>:CALCulate:DDEMod:LLINE[1] 2 ... 6:DISPlay OFF ON 0 1</code>
----------------	--

	<code>:CALCulate:DDEMod:LLINe[1] 2 ... 6:DISPlay?</code>
Example	<code>:CALC:DDEM:LLIN:DISP ON</code> <code>:CALC:DDEM:LLIN:DISP?</code>
Preset	OFF
State Saved	Saved in instrument state

Edit Trace Limit

Enables you to edit the content and the properties of the trace Limit Line.

Limits are turned off by a Preset, but the Limits arrays (data) are only reset (deleted) by Restore Mode Defaults. They survive shutdown and restarting of the instrument application, which means they will survive a power cycle.

When editing a limit, the editor remembers which limit and which element in the limit array you were editing, and returns you to that limit and that element when you return to the editor after leaving it.

Select Limit

Specifies the selected limit. The term “selected limit” is used throughout this document to specify which trace limit will be affected by the functions.

Notes	The selected limit is remembered even when not in the Limit Menu
Preset	Limit 1, not affected by Mode Preset, preset by Restore Mode Defaults
State Saved	Saved in instrument state

Go to Row

Enables you to move through the table to edit the desired point.

Min	1
Max	2000

Insert Row Below

Inserts a row below the current row. The new row is a copy of the current row and becomes the current row. The new row is not yet entered into the underlying table, and the data in the row is displayed in light gray.

X Axis Unit

Selects how the limit-line x segments are defined. Pressing **X Axis Unit** selects which unit of the selected limit line's x axis will be.

Changing X Axis Unit changes the below control's unit accordingly but doesn't change their values.

- X Offset
- Cells in table's x column

Remote Command	<code>:CALCulate:DDEMod:LLINE[1] 2 ... 6:X:UNIT HZ SECond SYMBol</code> <code>:CALCulate:DDEMod:LLINE[1] 2 ... 6:X:UNIT?</code>
Example	<code>:CALC:DDEM:LLIN:X:UNIT HZ</code> Sets the selected limit line's x values to be specified in unit of Hz
Couplings	Affects the unit of X Offset and x list of the selected limit line
Preset	<code>HZ</code>
State Saved	Saved in instrument state

Y Axis Unit

Selects how the limit-line y segments are defined. Pressing **Y Axis Unit** selects which unit of the selected limit line's y axis will be.

Changing Y Axis Unit changes the below control's unit accordingly but doesn't change their values.

- Y Offset
- Margin
- Cells in table's y column

Remote Command	<code>:CALCulate:DDEMod:LLINE[1] 2 ... 6:Y:UNIT DBM DB V HZ PERCent DEGRee</code> <code> SECond NONE</code> <code>:CALCulate:DDEMod:LLINE[1] 2 ... 6:Y:UNIT?</code>
Example	<code>:CALC:DDEM:LLIN:Y:UNIT DB</code> Sets the selected limit line's y values to be specified in unit of dB
Couplings	Affects the unit of Y Offset, Margin and y list of the selected limit line
Preset	<code>DBM</code>
State Saved	Saved in instrument state

X Offset

Offsets the limit trace by some specified frequency (for frequency-based limit lines) or a time (for time-based limit lines).

Remote Command	<code>:CALCulate:DDEMod:LLINe[1] 2 ... 6:OFFSet:X <real></code> <code>:CALCulate:DDEMod:LLINe[1] 2 ... 6:OFFSet:X?</code>
Example	<code>:CALC:DDEM:LLIN:OFFS:X -50.0</code> Sets the X axis offset to -50 MHz if the limit's X Axis Unit is Hz <code>:CALC:DDEM:LLIN:OFFS:UPD</code> will apply the X axis offset to all points in the limit line, then reset the X axis offset to zero
Couplings	The unit of X Offset depends on the selected X Axis Unit
Preset	0.0
State Saved	Saved in instrument state, survives Preset
Min	-9.9E+37
Max	9.9E+37

Y Offset

Offsets all segments in the limit line by some specified amplitude.

Remote Command	<code>:CALCulate:DDEMod:LLINe[1] 2 ... 6:OFFSet:Y <real></code> <code>:CALCulate:DDEMod:LLINe[1] 2 ... 6:OFFSet:Y?</code>
Example	<code>:CALC:DDEM:LLIN:OFFS:Y 10.0</code> Sets the Y axis offset to -10 dB if the limit's Y Axis Unit is dBm or dB <code>:CALC:DDEM:LLIN:OFFS:Y?</code>
Preset	0.0
State Saved	Saved in instrument state
Min	-9.9E+37
Max	9.9E+37

Apply Offset to Limit Table

Adds the X offset and Y offset to each point in the limit table, then resets the X offset and Y offset value to zero. This has no effect on the position of the limit trace. For example, if the Y offset is 1 dB, 1 dB will be added to each Y value in the limit table. The offset value will then be reset to zero.

Remote Command	:CALCulate:DDEMod:LLINe[1] 2 ... 6:OFFSet:UPDate
Example	:CALC:DDEM:LLIN:OFFS:UPD
State Saved	No state

Delete Row

This is an immediate action control. It immediately deletes the currently-selected row regardless of the row is being edited or not. The row following the currently-selected row (or the row preceding if there is none) will be selected.

Delete Limit

Deletes the currently selected limit line. Pressing **Delete Limit** purges the data from the limit line tables.

Limit data – including secondary parameters such as description, margin value, etc. - will be cleared and returned to factory preset settings.

When this control is pressed, a prompt appears on the screen that says “Please press Enter or OK to delete limit. Press ESC or Cancel to close this dialog.” The deletion is only performed if you press **OK** or **Enter**; if so, after the deletion, the informational message “Limit deleted” appears in the MSG line.

Remote Command	:CALCulate:DDEMod:LLINe[1] 2 ... 6:DElete
Example	:CALC:DDEM:LLIN2:DEL
	Deletes all data for limit line 2

Edit Trace Limit Settings

This is the second page of the Edit Trace Limits dialog. You access it by pressing **Settings** on the **Edit Trace Limits** dialog.

Select Limit

Specifies the selected limit. The term “selected limit” is used throughout this document to specify which trace limit will be affected by the functions.

Notes	The selected limit is remembered even when not in the Limit Menu
Preset	Limit 1, not affected by Mode Preset, preset by Restore Mode Defaults
State Saved	Saved in instrument state

X Reference

Chooses whether the limit line x points are fixed, or relative to center frequency when x axis unit is Hz, or relative to trigger when x axis unit is time unit and trigger source is not free run, or relative to sync pattern when x axis unit is time unit and sync search is on.

For example, assume you have a frequency limit line, and the instrument center frequency is at 1 GHz. If Relative to CF is “Off”, entering a limit line segment with a frequency coordinate of 300 MHz displays the limit line segment at 300 MHz, and the limit line segment will not change frequency if the center frequency changes. If Relative to CF is “On”, entering a limit line segment with a frequency coordinate of 300 MHz displays the limit line segment at CF + 300 MHz, or 1.3 GHz. Furthermore, if the center frequency changes to 2 GHz, the limit line segment will be displayed at CF + 300 MHz, or 2.3 GHz.

It is possible to change this setting after a limit line has been entered. When changing from On to Off or vice-versa, the x values in the limit line table change so that the limit line remains in the same position for the current settings of the instrument.

Remote Command	<code>:CALCulate:DDEMod:LLINE[1] 2 ... 6:X:REference FIXed RCF RTRigger RSYnc</code> <code>:CALCulate:DDEMod:LLINE[1] 2 ... 6:X:REference?</code>
Example	<code>:CALC:DDEM:LLIN:X:REF RTR</code> makes limit line 1 relative to the trigger
Notes	Relative to CF is only available when x axis unit is Hz, otherwise it is grayed-out Relative to Trigger is only available when x axis unit is time unit and trigger source is not free run, otherwise it is grayed-out Relative to Sync is only available when x axis unit is time unit and sync search is on, otherwise it is grayed-out
Preset	FIXed , not affected by Mode Preset, preset by Restore Mode Defaults
State Saved	Saved in instrument state

Copy from Limit

Copies an existing limit into the current limit, including all secondary parameters (Description, Comment, Associated Window, X Axis Unit, Y Axis Unit, X Offset, Y Offset, Type, Margin, X Reference). The destination limit is specified as a subcoded LLINe parameter and the source limit is specified as a numeric parameter.

Remote Command	<code>:CALCulate:DDEMod:LLINE[1] 2 ... 6:COpy 1 ... 6</code>
Example	<code>:CALC:DDEM:LLINE2:COpy 1</code>

copies the data from line 1 into line 2

Copy

Copies a Limit from the Limit specified in Copy From Limit.

Description

Provides a description of up to 60 characters by which the operator can easily identify the limit. Will be stored in the exported file. Can be displayed in the active function area by selecting as the active function, if desired to be in a screen dump.

Remote Command	<code>:CALCulate:DDEMod:LLINE[1] 2 ... 6:DESCription "Description"</code> <code>:CALCulate:DDEMod:LLINE[1] 2 ... 6:DESCription?</code>
Example	<code>:CALC:DDEM:LLIN:DESC "European Emissions"</code>
Dependencies	60 characters max
Preset	"" (null String), not affected by Mode Preset, preset by Restore Mode Defaults
State Saved	Saved in instrument state

Comment

Sets an ASCII comment field, which will be stored in an exported file. Can be displayed in the active function area by selecting as the active function, if desired to be in a screen capture. The Limits CSV file supports this field.

Remote Command	<code>:CALCulate:DDEMod:LLINE[1] 2 ... 6:COMMENT "text"</code> <code>:CALCulate:DDEMod:LLINE[1] 2 ... 6:COMMENT?</code>
Example	<code>:CALC:DDEM:LLIN:COMM "this is a comment"</code>
Dependencies	60 characters max
Preset	"" (null String), not affected by Mode Preset, preset by Restore Mode Defaults
State Saved	Saved in instrument state

Apply to Window

Selects the window you want the limit to apply. A limit is applied to one and only one trace in the selected; each trace can have both an upper and a lower limit. When executing Limit Test, the limit is applied only to the specified trace.

A trace in the selected window can have multiple limit lines simultaneously; in that case, only one upper and one lower limit line will affect the color of the trace. Other

3 VMA Mode
3.1 Digital Demod Measurement

limit lines will be displayed, and will affect the pass/fail status, but the trace will not turn red if it crosses a secondary limit line.

Remote Command	<code>:CALCulate:DDEMod:LLINe[1] 2 ... 6:WINDow <int></code> <code>:CALCulate:DDEMod:LLINe[1] 2 ... 6:WINDow?</code>
Example	<code>:CALC:DDEMod:LLIN:WIND 1</code> Selects the 1 st window as the target window that the limit line 1 will be displayed
Preset	1
State Saved	Saved in instrument state
Min	1
Max	6

Margin

Selects a margin for this limit, which will cause a trace to Fail Margin when the trace is between the limit line and the margin line. Portions of the traces which pass the limit but fail the margin will be displayed in an amber color.

Remote Command	<code>:CALCulate:DDEMod:LLINe[1] 2 ... 6:MARGin <real></code> <code>:CALCulate:DDEMod:LLINe[1] 2 ... 6:MARGin?</code> <code>:CALCulate:DDEMod:LLINe[1] 2 ... 6:MARGin:STATe OFF ON 0 1</code> <code>:CALCulate:DDEMod:LLINe[1] 2 ... 6:MARGin:STATe?</code>
Example	<code>:CALC:DDEM:LLIN1:MARG 2</code> Sets limit line 1's margin to 2 dB when the limit line 1's Y axis unit is dBm or dB <code>:CALC:DDEM:LLIN2:MARG:STAT OFF</code> turns off the margin for limit line 2 and removes any tests associated with that margin line
Notes	The queries "Limit Line Pass/Fail?" (<code>:CALCulate:DDEMod:LLINe[1] 2 3 4 5 6:FAIL?</code>) return 1 if the margin fails
Couplings	The unit of the margin depends on the limit's Y Axis Unit. Changing the Y Axis Unit of the limit changes its Margin's unit, but doesn't change its value
Preset	Not affected by Mode Preset, set to 0.0 for all Limits by Restore Mode Defaults OFF
State Saved	Saved in instrument state Saved in instrument state
Min	-9.9E+37
Max	9.9E+37

Type

Selects whether the limit you are editing is an upper or lower limit. An upper limit fails if the trace exceeds the limit. A lower limit fails if the trace falls below the limit.

Remote Command	<code>:CALCulate:DDEMod:LLINe[1] 2 ... 6:TYPE UPPER LOWer</code> <code>:CALCulate:DDEMod:LLINe[1] 2 ... 6:TYPE?</code>
Example	<code>:CALC:DDEM:LLIN2:TYPE LOW</code> Sets limit line 2 to act as a lower limit
Couplings	If a margin has already been set for this limit line, and this control is used to change the limit type, then the margin value will reverse sign
Preset	UPPer for Line 1, 3, and 5; LOWer for Line 2, 4, 6 Not affected by Mode Preset, preset by Restore Mode Defaults
State Saved	Saved in instrument state

Delete All Limits

Deletes all limit lines. Pressing **Delete All Limits** purges the data from all limit line tables.

All limit data will be cleared and returned to factory preset settings.

When this control is pressed a prompt appears on the screen that says “Please press Enter or OK to delete all limits. Press ESC or Cancel to close this dialog.” The deletion is only performed if you press **OK** or **Enter**; if so, after the deletion, the informational message “All Limits deleted” appears in the MSG line.

Remote Command	<code>:CALCulate:DDEMod:LLINe:ALL:DElete</code>
Example	<code>:CALC:DDEM:LLIN:ALL:DEL</code> Deletes all data for all limit lines

Limit Line Fail? (Remote Command Only)

Tests a limit line against its associated trace window. It performs the test when both Limit and Limit Test are On, returns a 0 if the trace is within the limit, a 1 if the trace exceeds the limit. If either or both Limit and Limit Test is Off, it returns a 0.

Note that this command only tests one limit line – other limit lines are not tested when executing this command. To see whether a trace passed all limits, use `:CALCulate:DDEMod:WINDow[1]|2|3|4|5|6:FAIL?`.

Remote Command	<code>:CALCulate:DDEMod:LLINe[1] 2 ... 6:FAIL?</code>
----------------	---

Command	
Example	<code>:CALC:DDEM:LLIN:FAIL?</code> Returns a zero if limit line 1's associated trace has no failure, 1 if there is a limit failure

Limit Line X List Data (Remote Command Only)

Defines a list of x values for a given limit line. Up to 2000 points may be defined for each limit using the following parameters.

Note that x values may be repeated if a vertical step in the limit line is desired.

Remote Command	<code>:CALCulate:DDEMod:LLINe[1] 2 ... 6:X[:DATA] <real>, <real>, ...</code> <code>:CALCulate:DDEMod:LLINe[1] 2 ... 6:X[:DATA]?</code>
Example	<code>:CALC:DDEM:LLIN:X 1000,2000,2000,3000</code> Describes the X values of a stair-stepped limit line
Preset	Limit line data is cleared by Restore Mode Defaults
State Saved	Saved in instrument state
Backwards Compatibility SCPI	<code>:CALCulate:DDEMod:LLINe[1] 2 ... 6:CONTRol[:DATA]</code>

Number of Limit X List Points Query (Remote Query Only)

Returns the number of points in the x list. It should match the number of points in the y list, that is, the number of values for the X axis and for the corresponding Y UPPER and/or Y LOWER limit lines must be identical. If one array is larger than the other, the limit trace is built using only as much data as is contained in the smaller array.

An empty array returns not a number (9.91e+37 to a data query), 0 to a **POINTS** query.

Remote Command	<code>:CALCulate:DDEMod:LLINe[1] 2 ... 6:X:POINTs?</code>
Example	<code>:CALC:DDEM:LLIN:X:POIN?</code> Returns the number of x list points in the limit line
Preset	Limit line X list data/points is cleared by Restore Mode Defaults
State Saved	Saved in instrument state
Backwards Compatibility SCPI	<code>:CALCulate:DDEMod:LLINe[1] 2 ... 6:CONTRol:POINTs</code>

Limit Line Y List Data (Remote Command Only)

Defines a list of y values for a given limit line. Changing the number of elements in the list, the limit line will be automatically turned off. Up to 200 points may be defined for each limit using the following parameters.

Remote Command	<code>:CALCulate:DDEMod:LLINe[1] 2 ... 6:Y[:DATA] <real>, <real>, ...</code> <code>:CALCulate:DDEMod:LLINe[1] 2 ... 6:Y[:DATA]?</code>
Example	<code>:CALC:DDEM:LLIN:Y -10, -10, -20, -20</code> Describes the y values of an limit line
Preset	Limit line y list data is cleared by Restore Mode Defaults
State Saved	Saved in instrument state
Backwards Compatibility SCPI	<code>:CALCulate:DDEMod:LLINe[1] 2 ... 6:UPPer[:DATA]</code> <code>:CALCulate:DDEMod:LLINe[1] 2 ... 6:Y:UPPer[:DATA]</code> <code>:CALCulate:DDEMod:LLINe[1] 2 ... 6:LOWer[:DATA]</code> <code>:CALCulate:DDEMod:LLINe[1] 2 ... 6:Y:LOWer[:DATA]</code>

Number of Limit Y List Points Query (Remote Query Only)

Returns the number of points in the limit y list. It should match the number of points in the control, that is, the number of values for the x axis and for the corresponding y axis must be identical. If one array is larger than the other, the limit trace is built using only as much data as is contained in the smaller array.

An empty array returns the system error message “list is empty” to a data query, 0 to a **POINTS** query.

Remote Command	<code>:CALCulate:DDEMod:LLINe[1] 2 ... 6:Y:POINTs?</code>
Example	<code>:CALC:DDEM:LLIN:Y:POIN?</code> Returns the number of y list points in the limit line 1
Preset	Limit line Y list data/points is cleared by Restore Mode Defaults
State Saved	Saved in instrument state
Backwards Compatibility SCPI	<code>:CALCulate:DDEMod:LLINe[1] 2 ... 6:UPPer:POINTs</code> <code>:CALCulate:DDEMod:LLINe[1] 2 ... 6:Y:UPPer:POINTs</code> <code>:CALCulate:DDEMod:LLINe[1] 2 ... 6:LOWer:POINTs</code> <code>:CALCulate:DDEMod:LLINe[1] 2 ... 6:Y:LOWer:POINTs?</code>

Trace Fail (Remote Query Only)

Tests the trace in the window against all associated limit lines when Limit Test is On. Returns a 0 if the trace is within all limits and margins, a 1 if the trace exceed either the limit or the margin. If no limits apply to the selected trace, this will automatically return a 0.

Only applies to limits that are turned on, if a Limit is off it will not be tested.

This query ignores limit lines that are assigned to other traces.

Remote Command	<code>:CALCulate:DDEMod:WINDow[1] 2 ... 6:FAIL?</code>
Example	<code>:CALC:DDEM:WIND3:FAIL?</code>

Returns a zero if there is no failure, 1 if the trace exceeds the limit

3.1.9.10 Global

The controls in this menu apply to all Modes in the instrument.

Some controls (for example, "[Global Center Freq](#)" on page 1828) allow you to switch certain Meas Global parameters to a Mode Global state. These switches apply to all Modes that support global settings. For example, no matter what Mode you are in when you set **Global Center Freq** to **ON**, it applies to all Modes that support Global settings.

Other controls (for example, **Extend Low Band**) are actually set in this menu, but apply to all Modes.

Global Center Freq

The software maintains a Mode Global value called **Global Center Freq**.

When **Global Center Freq** is switched **ON**, the current Mode's center frequency is copied into the **Global Center Frequency**, and from then on all Modes that support global settings use the **Global Center Frequency**, so you can switch between any of these Modes and the **Center Frequency** remains unchanged.

Adjusting the **Center Frequency** of any Mode that supports Global Settings, while **Global Center Freq** is **ON**, modifies the **Global Center Freq**.

When **Global Center Freq** is switched **OFF**, the **Center Frequency** of the current Mode is unchanged, but now the **Center Frequency** of each Mode is once again independent.

When **Mode Preset** is pressed while **Global Center Freq** is **ON**, the **Global Center Freq** is preset to the preset **Center Frequency** of the current Mode.

This function resets to **OFF** when "**Restore Defaults**" on page 1829 is pressed, or when **System, Restore Defaults, All Modes** is pressed.

Remote Command	:INSTRUMENT:COUPLE:FREQUENCY:CENTER ALL NONE
Example	:INST:COUP:FREQ:CENT ALL :INST:COUP:FREQ:CENT?
Preset	Set to OFF on Global Settings, Restore Defaults and System, Restore Defaults, All Modes
Range	ALL NONE
Preset	OFF
Backwards Compatibility SCPI	:GLOBal:FREQUENCY:CENTER[:STATE] 1 0 ON OFF :GLOBal:FREQUENCY:CENTER[:STATE]?

Restore Defaults

Resets all functions in the **Global** settings menu to **OFF**. Pressing **System, Restore Defaults, All Modes** has the same effect.

Remote Command	:INSTRUMENT:COUPLE:DEFAULT
Example	:INST:COUP:DEF
Backwards Compatibility SCPI	:GLOBal:DEFAULT

3.1.10 Sweep

Accesses controls to configure and control the acquisition of data, and the X-axis parameters of the instrument.

Depending on the selected mode and measurement, these controls might include: **Sweep Time, Continuous/Single, Pause/Resume, X Scale** and **Number of Points**.

3.1.10.1 Sweep/Control

Accesses controls that let you operate the sweep and control functions of the instrument, such as **Sweep Time** and **Continuous/Single**.

Sweep/Measure

Lets you toggle between **Continuous** and **Single** sweep or measurement operation. The single/continuous state is Meas Global, so the setting affects all measurements.

The front-panel key **Single/Cont** performs exactly the same function

3 VMA Mode
3.1 Digital Demod Measurement

See "[More Information](#)" on page 391

Remote Command	<code>:INITiate:CONTinuous OFF ON 0 1</code> <code>:INITiate:CONTinuous?</code>
Example	Put instrument into Single measurement operation: <code>:INIT:CONT 0</code> <code>:INIT:CONT OFF</code> Put instrument into Continuous measurement operation: <code>:INIT:CONT 1</code> <code>:INIT:CONT ON</code>
Preset	ON Note that <code>:SYST:PRES</code> sets <code>:INIT:CONT</code> to ON , but <code>*RST</code> sets <code>:INIT:CONT</code> to OFF
State Saved	Saved in instrument state
Annunciation	The Single/Continuous icon in the Meas Bar changes depending on the setting: <ul style="list-style-type: none"> - A line with an arrow is Single - A loop with an arrow is Continuous
Backwards Compatibility Notes	X-Series A-models had Single and Cont hardkeys in place of the SweepSingleCont softkey. In the X-Series A-models, if in single measurement, the Cont hardkey (and <code>INIT:CONT ON</code>) switched to continuous measurement, but never restarted a measurement and never reset a sweep X-Series B-models have a Cont/Single toggle control instead of Single and Cont hardkeys, but it is still true that, if in single measurement, the Cont/Single toggle control never restarts a measurement and never resets a sweep

More Information

Continuous Mode	The instrument takes repetitive sweeps, averages, measurements, etc., when in continuous mode. If in average or Max/Min Hold, and the average/hold count reaches the Average/Hold Num , the count stops incrementing, but the instrument keeps sweeping See the Trace key description under Trace Average for the averaging formula used both before and after the Average/Hold Num is reached. The trigger condition must be met prior to each sweep The type of trace processing for multiple sweeps is set under the Trace key, with choices of Trace Average , Max Hold , or Min Hold
Single Mode	The instrument takes a single sweep when in Single mode, or if in average or Max/Min Hold, or if there is a Waterfall window displayed, it takes multiple sweeps until the average/hold count reaches the Average/Hold Num , then the count stops incrementing, and the instrument stops sweeping See the Trace key description under Trace Average for the averaging formula used. The trigger condition must be met prior to the sweep The type of trace processing for multiple sweeps is set under the Trace key, with choices of Trace Average , Max Hold , or Min Hold

If the instrument is in **Single** measurement mode, pressing the **Cont/Single** toggle control does not zero the count and does not cause the sweep to be reset; the only action is to put the instrument into Continuous measurement operation.

If the instrument is already in **Continuous** sweep:

- `:INIT:CONT 1` has no effect
- `:INIT:CONT 0` places the instrument in Single Sweep but has no effect on the current sequence until $k = N$, at which point the current sequence will stop and the instrument will go to the idle state

See "[Restart](#)" on page 1832 for details of `:INIT:IMMEDIATE`.

If the instrument is already in **Single** sweep, `:INIT:CONT OFF` has no effect.

If the instrument is already in **Single** sweep, then pressing **Cont/Single** in the middle of a sweep does not restart the sweep or sequence. Similarly, pressing **Cont/Single** does not restart the sweep or sequence if the sweep is not in the idle state (for example, if you are taking a very slow sweep, or the instrument is waiting for a trigger). Even though pressing **Cont/Single** in the middle of a sweep does not restart the sweep, sending `:INIT:IMM` does reset it.

If the instrument is in **Single** sweep, and *not* Averaging/Holding, and you want to take one more sweep, press **Restart**.

If the instrument is in **Single** sweep, *and* Averaging/Holding, and you want to take one more sweep without resetting the Average trace or count, go to **Meas Setup** and increment the average count by 1 by pressing the **Step-Up** key while **Average/Hold Num** is the active function. You can also do this by sending `:CALC:AVER:TCON UP`.

Restart

Restarts the current sweep, or measurement, or set of averaged/held sweeps or measurements. If you are Paused, pressing **Restart** performs a Resume.

The front-panel key **Restart** performs exactly the same function.

The **Restart** function is accessed in several ways:

- Pressing the **Restart** key
- Sending `:INIT:IMM`
- Sending `:INIT:REST`

See "[More Information](#)" on page 393

3 VMA Mode

3.1 Digital Demod Measurement

Remote Command	:INITiate[:IMMEDIATE]
Example	:INIT:IMM :INIT:REST
Notes	:INIT:REST and :INIT:IMM perform exactly the same function
Couplings	Resets average/hold count k. For the first sweep overwrites all active (update = on) traces with new current data. For application modes, it resets other parameters as required by the measurement
Status Bits/OPC dependencies	This is an Overlapped command The STATUS:OPERation register bits 0 through 8 are cleared , <i>except</i> bit 6 (Waiting for Periodic Sync). Initiating a measurement and Waiting for Periodic Sync could be asynchronous The STATUS:QUESTionable register bit 9 (INTEGRity sum) is cleared The SWEEPING bit is set The MEASURING bit is set
Backwards Compatibility Notes	For Spectrum Analysis Mode in ESA and PSA, the Restart hardkey and the :INIT:REST command restarted trace averages (displayed average count reset to 1) for a trace in Clear Write , but did not restart Max Hold and Min Hold In X-Series, the Restart hardkey and the :INIT:REST command restart not only Trace Average , but MaxHold and MinHold traces as well

More Information

The **Restart** function first aborts the current sweep or measurement as quickly as possible. It then resets the sweep and trigger systems, sets up the measurement and initiates a new data measurement sequence with a new data acquisition (sweep) taken once the trigger condition is met.

If the instrument is in the process of aligning when a **Restart** is executed, the alignment finishes before the restart function is performed.

Even when set for **Single** operation, multiple sweeps may be taken when **Restart** is pressed (for example, when averaging/holding is on). Thus, when we say that **Restart** "restarts a measurement", depending on the current settings, we may mean that it:

- Restarts the current sweep
- Restarts the current measurement
- Restarts the current set of sweeps if any trace is in Trace Average, Max Hold or Min Hold
- Restarts the current set of measurements if Averaging, or Max Hold, or Min Hold is on for the measurement

If there is no Average or Max/Min Hold function (no trace in Trace Average or Hold, or **Average/Hold Num** set to 1), and no **Waterfall** window is being displayed, a single sweep is equivalent to a single measurement. A single sweep is taken after the trigger condition is met; and the instrument stops sweeping once that sweep has completed. However, with **Average/Hold Num** >1, and at least one trace set to Trace Average, Max Hold, or Min Hold, or a **Waterfall** window being displayed, multiple sweeps/data acquisitions are taken for a single measurement. The trigger condition must be met prior to each sweep. The sweep is stopped when the average count k equals the number N set for **Average/Hold Num**.

Once the full set of sweeps has been taken, the instrument goes to the idle state. To take one more sweep without resetting the average count, increment the average count by 1, by pressing the **Step-Up** key while **Average/Hold Number** is the active function, or by sending the remote command **:CALC: AVER: TCON UP**.

Trace Update

The numeric results are not blanked at any time during the restart cycle.

For slow sweeps (see **Trace Update** section in **Trace/Detector**), the traces are updated real-time during the sweep. There may be a special circumstance in application mode measurements where an exception is made and the traces and/or results need to be blanked before displaying the new results.

To summarize, the following list shows what happens to the trace data on various events:

Event	Trace Effect
Clear/Write pressed (even if already in Clear/Write)	Set to mintracevalue
Max Hold pressed (even if already in Max Hold)	Set to mintracevalue
Min Hold pressed (even if already in Min Hold)	Set to maxtracevalue
Trace Average pressed (even if already in Trace Average)	Trace data unaffected but start new sweep/avg/hold
Restart pressed	Trace data unaffected but start new sweep/avg/hold
Parameter requiring restart changed (e.g., RBW)	Trace data unaffected but start new sweep/avg/hold

Sweep and Trigger Reset

Resetting the sweep system resets the average/hold count k to 0. It also resets the set point counter to 0. Resetting the trigger system resets the internal auto trig timer to the value set by the **Auto Trig** control.

Averaging

The weighting factor used for averaging is k . This k is also the average/hold count for how many valid sweeps (data acquisitions) have been done. This k is used for comparisons with N , as those comparisons always needs to be based on valid completed sweeps.

The displayed average/hold, K , shows the count for the sweep (data acquisition) in progress. $K = k + 1$, with a limit of N . The displayed value K changes from its previous value to 1 as soon as the trigger condition for the first data acquisition (sweep) is met.

Pause/Resume

Pauses a measurement after the current data acquisition is complete.

When paused, the label on the control changes to **Resume**. Pressing **Resume** unpauses the measurement. When paused, pressing **Restart** performs a Resume.

Remote Command	<code>:INITiate:PAUSE</code> <code>:INITiate:RESume</code>
Example	<code>:INIT:PAUS</code> <code>:INIT:RES</code>
Dependencies	Not displayed in Modes that do not support pausing
Annotation	Only on control

Abort (Remote Command Only)

Stops the current measurement. Aborts the current measurement as quickly as possible, resets the sweep and trigger systems, and puts the measurement into an "idle" state. If the instrument is in the process of aligning when `:ABORT` is sent, the alignment finishes *before* the abort function is performed, so `:ABORT` does not abort an alignment.

If the instrument is set for **Continuous** measurement, it sets up the measurement and initiates a new data measurement sequence with a new data acquisition (sweep) taken once the trigger condition is met.

If the instrument is set for **Single** measurement, it remains in the "idle" state until an `:INIT:IMM` command is received.

Remote Command	<code>:ABORT</code>
Example	<code>:ABOR</code>

Notes	<p>If :INIT:CONT is ON, then a new continuous measurement will start immediately, with sweep (data acquisition) occurring once the trigger condition has been met</p> <p>If :INIT:CONT is OFF, then :INIT:IMM is used to start a single measurement, with sweep (data acquisition) occurring once the trigger condition has been met</p>
Dependencies	<p>For continuous measurement, :ABORT is equivalent to the Restart key</p> <p>Not all measurements support this command</p>
Status Bits/OPC dependencies	<p>The STATus:OPERation register bits 0 through 8 are cleared, <i>except</i> bit 6 (Waiting for Periodic Sync). Initiating a measurement and Waiting for Periodic Sync could be asynchronous</p> <p>The STATus:QUEStionable register bit 9 (INTEGRity sum) is cleared</p> <p>Since all the bits that feed into OPC are cleared by :ABORT, the Abort command will cause the *OPC query to return true</p>

3.1.10.2 X Scale

Accesses controls that enable you to set the horizontal scale parameters.

X Width

Set the width of the X axis which is displayed for the selected trace. The X width can be set less than the span for frequency-domain traces, enabling you to zoom in on just a portion of the measured values. Likewise, it can be less than time span covered by time-domain data. This plus the X Reference Value and X Reference Position control the range of X values that can be displayed on a trace.

Remote Command	<pre>:DISPlay:DDEMod:WINDow[1] 2 ... 6:X[:SCALE]:WIDTh <real> :DISPlay:DDEMod:WINDow[1] 2 ... 6:X[:SCALE]:WIDTh?</pre>
Example	<pre>:DISP:DDEM:WIND3:X:WIDT 10e6</pre> <p>Set the X width of the third window to 10 MHz</p> <pre>:DISP:DDEM:WIND3:X:WIDT?</pre> <p>Query the X width of the third window</p>
Couplings	If Auto Scaling is On, the X Width is determined by the trace data
Preset	Depends on trace data
State Saved	Yes
Min/Max	-9.9E+37 / 9.9E+37

Ref Value

Controls the X value of the selected trace at the chosen X Reference Position.

Remote Command	<pre>:DISPlay:DDEMod:WINDow[1] 2 ... 6:X[:SCALE]:RLEVel <real></pre>
----------------	--

3 VMA Mode
3.1 Digital Demod Measurement

	<code>:DISPlay:DDEMod:WINDow[1] 2 ... 6:X[:SCALE]:RLeV1?</code>
Example	<p><code>:DISP:DDEM:WIND3:X:RLEV 10</code></p> <p>Set the X ref value of the third window to 10</p> <p><code>:DISP:DDEM:WIND3:X:RLEV?</code></p> <p>Query the X ref value of the third window</p>
Couplings	If Auto Scaling is On, the X Reference Value is determined by the trace data
Preset	Depends on trace data
State Saved	Yes
Min/Max	-9.9E+37 / 9.9E+37

Ref Position

Determines the position from which the X scaling is calculated for the selected trace. It can be set to the left side, center, or right side of the grid.

Remote Command	<code>:DISPlay:DDEMod:WINDow[1] 2 ... 6:X[:SCALE]:RPOsition LEFT CENTer RIGHT</code> <code>:DISPlay:DDEMod:WINDow[1] 2 ... 6:X[:SCALE]:RPOsition?</code>
Example	<p><code>:DISP:DDEM:WIND3:X:RPOS CENT</code></p> <p>Set the X ref position of the third window to CENT</p> <p><code>:DISP:DDEM:WIND3:X:RPOS?</code></p> <p>Query the X ref position of the third window</p>
Preset	Depends on trace data
State Saved	Yes
Range	Left Ctr Right

Auto Scaling

Toggles the Auto Scaling function On or Off.

Remote Command	<code>:DISPlay:DDEMod:WINDow[1] 2 ... 6:X[:SCALE]:COUPle 0 1 OFF ON</code> <code>:DISPlay:DDEMod:WINDow[1] 2 ... 6:X[:SCALE]:COUPle?</code>
Example	<p><code>:DISP:DDEM:WIND3:X:COUP ON</code></p> <p>Do the X auto scale for the third window</p> <p><code>:DISP:DDEM:WIND3:X:COUP?</code></p> <p>Query the X auto scale state of the third window</p>
Couplings	When this parameter is On, pressing the front-panel Restart key activates the scale coupling function, that automatically determines scale per division and reference values based on the measurement results. When you set a value to either X Width or Ref Value manually, Auto Scaling is automatically set to Off

Preset	ON
State Saved	Yes
Range	On Off

Symbol Interval

Controls how many symbols are used to display in eye diagram window.

Remote Command	<code>:DISPlay:DDEMod:EYE:TRACe:INTerval <real></code>
Example	<code>:DISP:DDEM:EYE:TRAC:INT 300</code> <code>:DISP:DDEM:EYE:TRAC:INT?</code>
Preset	1000
State Saved	Yes
Min	1
Max	10000000

Time Unit

Enables you to select the time units that are applied to x-axis annotations and marker readouts for the selected trace, whenever it is assigned data with (demodulation) symbol information. The available measurement units are sym (symbols) or sec (seconds).

Remote Command	<code>:DISPlay:DDEMod:WINDow[1] 2 ... 6:X[:SCALE]:UNIT:TIME SEC SYMBol</code>
Example	<code>:DISP:DDEM:WIND3:X:UNIT:TIME SYMB</code> Set the X scale unit of the third window to symbol <code>:DISP:DDEM:WIND3:X:UNIT:TIME?</code> Query the X scale unit of the third window
Preset	Depend on trace data
State Saved	Yes
Range	symbols seconds

3.1.10.3 Recording

Displays the Sample Rate, Sample Points and Sample Time of the saved IQ data file.

Recording and playback of signal data files is a multi-step process that involves controls in several menus:

3 VMA Mode
3.1 Digital Demod Measurement

- **Save, Recording** (under the **Save** hardkey or the **Save** icon in the **File** panel)
- **Recall, Recording** (under the **Recall** hardkey or the **Recall** icon in the **File** panel)
- **Sweep, Recording** (this tab)
- **Sweep, "Playback"** on page 556
- **Input/Output, "Data Source"** on page 2195

NOTE

A complete tutorial for **Record/Playback** functionality, including how to load and save recording files, can be found in the help for the tab **"Data Source"** on page 2195 under **Input/Output**.

This menu includes the following display-only fields:

Sample Rate

Displays the sample rate of the saved IQ data file. If you have not saved an IQ data file, the value is 0.

Sample Points

Displays the total number of sample points in the saved IQ data file. If you have not saved an IQ data file, the value is 0.

Sampling Time

Displays the total sample time of the saved IQ data file. If you have not saved an IQ data file, the value is 0.

Saved Channels [Mode: 5G NR, VMA, WLAN]

Displays the channel index/number of the saved IQ data file. If you have not saved an IQ data file, no value is displayed.

This control is designed for multi-channel I/Q data recording and playback.

3.1.10.4 Playback

Contains parameters for playback of saved recording files recalled to the instrument.

Recording and playback of signal data files is a multi-step process that involves controls in several menus:

- **Save, Recording** (under the **Save** hardkey or the **Save** icon in the **File** panel)
- **Recall, Recording** (under the **Recall** hardkey or the **Recall** icon in the **File** panel)
- **Sweep, "Recording" on page 555**
- **Sweep, Playback** (this tab)
- **Input/Output, "Data Source" on page 2195**

NOTE

A complete tutorial for **Record/Playback** functionality, including how to load and save recording files, can be found in the help for the tab **"Data Source" on page 2195** under the **Input/Output** menu.

This menu includes the following display-only fields:

Sample Points

Displays the total number of sample points in the recalled IQ data file. If you have not recalled an IQ data file, the value is 0.

Sampling Time

Displays the total sample time of the recalled IQ data file. If you have not recalled an IQ data file, the value is 0.

Input Channels [Mode: 5G NR, VMA, WLAN]

Displays the input channel number of the recalled IQ data file. If you have not recalled an IQ data file, the default value of 1 is displayed.

This control is designed for multi-channel I/Q data recording and playback.

Playback Mode

Specifies the mode of IQ data to be played back and analyzed:

- **Fixed:** Playback Stop value is ignored. Measurement will analyze the first chunk of IQ data start from Playback Start repeatedly

3 VMA Mode
 3.1 Digital Demod Measurement

- Iterative: Measurement will analyze the IQ data chunk by chunk between Playback Start and Playback Stop, if the last chunk is not complete it will be ignored and start from the first chunk again

Remote Command	<code>:CALCulate:<meas>:PLAY:MODE FIXed ITERative</code> <code>:CALCulate:<meas>:PLAY:MODE?</code>
Example	Where <code><meas></code> is the mnemonic for the current measurement, for example, <code>EVM</code> For EVM measurement in 5G NR Mode: <code>:CALC:EVM:PLAY:MODE CONT</code> <code>:CALC:EVM:PLAY:MODE?</code>
Preset	<code>FIX</code>
State Saved	Saved in instrument state
Range	Fixed Iterative

Playback Start

Once you have loaded an IQ data file using **Recall**, **Recording**, this control enables you to specify the start position of the IQ data playback range to be analyzed. If its value is less than zero, an additional zero is inserted at the beginning of the IQ data.

To go to a specific location in the recalled I/Q data, enter the desired **Playback Start** point.

You can use this control to examine the data you recalled from the recording file. How you proceed depends on whether you are in **Continuous** or **Single** mode. To determine which mode you are in, look at the first panel on the left in the **Meas Bar** above the data display.

If the panel looks like this, you are in **Continuous** mode:



If the panel looks like this, you are in **Single** mode:

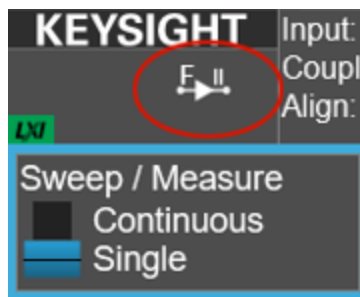

The **F** indicates that the instrument is using data from a file (if you wish to return to looking at data at the analyzer input, change the **Data Source** control in the **Input/Output, Data Source** menu from **File** back to **Input**.)

To examine the data you loaded:

Continuous mode

In this mode, turn the knob or use the **Up/Down** keys on the front panel to move through records in the recording. You will see **Playback Start** change from 0 to successively higher values as you move deeper into the data.

Single mode

In this mode, you can only look at one record. Set the **Playback Start** time to the desired offset from zero, then press **Restart**. A single record will be displayed. Note that until you press **Restart**, the “invalid data” indicator (yellow asterisk) is displayed in each window. After you press **Restart**, the invalid data indicator disappears.

Remote Command	<code>:CALCulate:<meas>:PLAY:START <time></code> <code>:CALCulate:<meas>:PLAY:START?</code>
	Where <code><meas></code> is the mnemonic for the current measurement, for example, <code>EVM</code>
Example	For EVM measurement in 5G NR Mode: <code>:CALC:EVM:PLAY:STAR 0.01 s</code> <code>:CALC:EVM:PLAY:STAR?</code>
Preset	0
State Saved	Saved in instrument state
Min/Max	-/+Sample Points in IQ file / Sample Rate in IQ file

Playback Stop

Specifies the stop position of the IQ data playback range to be analyzed, when “Playback Mode” is iterative.

Remote Command	<code>:CALCulate:<meas>:PLAY:STOP <time></code> <code>:CALCulate:<meas>:PLAY:STOP?</code>
	Where <code><meas></code> is the mnemonic for the current measurement, for example, <code>EVM</code>
Example	For EVM measurement in 5G NR Mode: <code>:CALC:EVM:PLAY:STOP 0.01 s</code> <code>:CALC:EVM:PLAY:STOP?</code>
Preset	0
State Saved	No
Min	0
Max	Sample Points in IQ file x Sample Rate

Step Forward

Move to next chunk of IQ data when "Playback Mode" on page 557 is iterative.

Remote Command	<code>:CALCulate:<meas>:PLAY:STEP:FORward</code>
Example	Where <code><meas></code> is the mnemonic for the current measurement, for example, <code>EVM</code> For EVM measurement in 5G NR Mode: <code>:CALC:EVM:PLAY:STEP:FORW</code>
State Saved	Saved in instrument state

Sample Rate

Displays the sample rate of the recalled IQ data file if the recalled file format contains sampling rate information (`.csv`, `.sdf`, `.txt`). In this case, the *control* is grayed-out.

`BIN` and `BINX` files do not include sampling rate information inside the file, so after recalling one of these files, you must set **Sample Rate** manually. When you save a file in these formats, you must specify the sample rate, as displayed under **Sweep, Recording**.

Remote Command	<code>:CALCulate:<meas>:PLAY:SRATe <freq></code> <code>:CALCulate:<meas>:PLAY:SRATe?</code>
Example	Where <code><meas></code> is the mnemonic for the current measurement, for example, <code>EVM</code> For EVM measurement in 5G NR Mode: <code>:CALC:EVM:PLAY:SRAT 122.88MHz</code> <code>:CALC:EVM:PLAY:SRAT?</code>
Couplings	Displays only after recalling <code>.csv</code> , <code>.sdf</code> , or <code>.txt</code> files Settable after recalling <code>.bin</code> or <code>.binx</code> files
Preset	0
State Saved	No
Min	0

3.1.11 Trace

Contains controls that enable you to control the trace operations, such as trace alignment.

3.1.11.1 Trace Align

Accesses controls that enable you to configure the trace alignment.

Reference

Displays a menu for selecting the reference type that is used to generate the Search Time trace from the Raw Main Time trace. The selection includes:

- Auto – auto select the reference according to Burst Search and Sync Search state
- Burst Rise Edge – select the rise edge of the burst as the reference
- Burst Fall Edge – select the fall edge of the burst as the reference
- Sync Pattern – select the start position of the founded sync pattern as the reference
- Off – doesn't align the trace (Search Time trace = Raw Main Time trace)

Details

Works with Offset and Interval to determine the trace alignment region. If the region is out of the acquisition data range, the trace stops updating, and a trace indicator "DATA?" (which means "Data is questionable relative to current setup.") will be displayed at the top right of the graph.

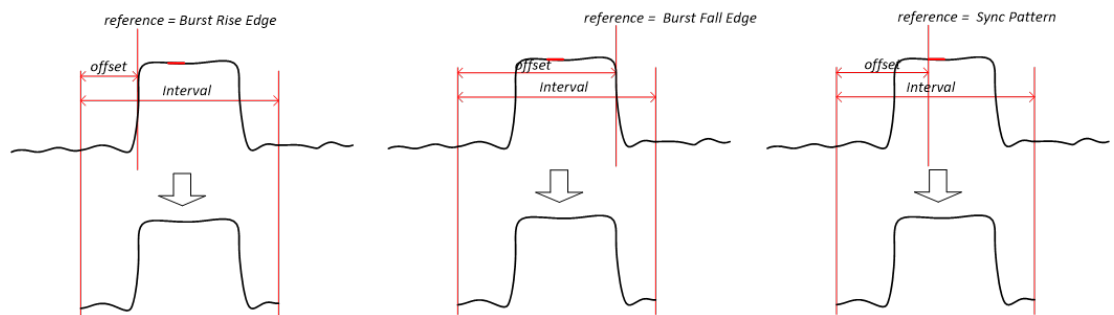

Remote Command	:CALCulate:DDEMod:TRACe:SEARCh:TIME:REFerence AUTO BRISe BFALl SWOrd OFF :CALCulate:DDEMod:TRACe:SEARCh:TIME:REFerence?
Example	:CALC:DDEM:TRAC:SEAR:TIME:REF AUTO :CALC:DDEM:TRAC:SEAR:TIME:REF?
Notes	The align Reference, Offset and Interval determine the trace alignment region, and if the region is out of

3 VMA Mode

3.1 Digital Demod Measurement

the acquisition data range, the trace will stop updating, and a trace indicator “DATA?” (which means “Data is questionable relative to current setup.”) will be displayed at the top right of the graph

The query returns a name that corresponds to the reference type as follows:

String Returned	Definition
AUTO	Auto
BRIS	Burst Rise Edge
BFAL	Burst Fall Edge
SWOR	Sync Pattern
OFF	Off

Couplings

If the align reference is in Auto, the selected reference depends upon Burst Search state and Sync Search state:

- If the Sync Search is On, the reference is the start time of the founded sync pattern, no matter what state of the Burst Search is; if there is no sync pattern found, the trace stops updating until the sync pattern is found, and a message “Sync Error; Sync Pattern not found” is generated
- If the Sync Search is Off and the Burst Search is On, the reference is the rise edge of the burst; if there is no burst found, the trace stops updating until the burst is found, and a message “Burst Not Found” is generated
- If neither the Sync Search nor the Burst Search are On, the reference is the start time of the acquisition, the Search Time trace is the same as the Raw Main Time trace in this case

If the align reference is in Off, the trace alignment will not apply, the Search Time trace will be the same as the Raw Main Time trace

Preset **AUTO**

State Saved Saved in instrument state

Offset

Specifies the time offset in seconds from the selected reference. It works with Reference and Interval, determine the trace alignment region.

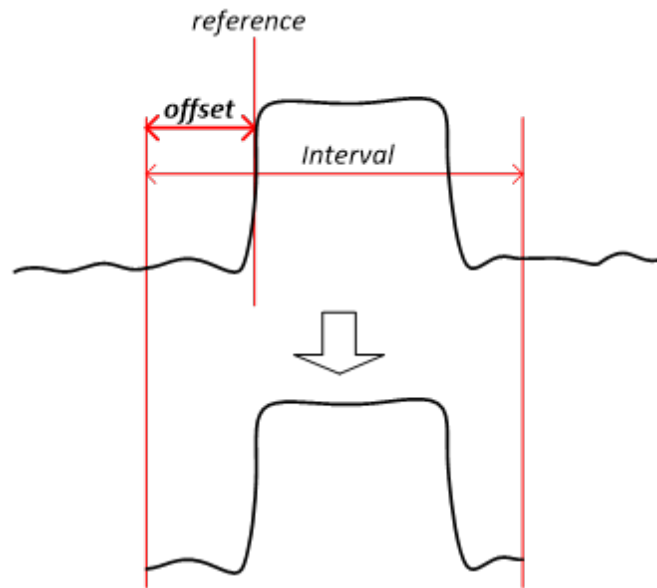

Remote Command	<code>:CALCulate:DDEMod:TRACe:SEARch:TIME:OFFSet <time></code> <code>:CALCulate:DDEMod:TRACe:SEARch:TIME:OFFSet?</code>
Example	<code>:CALC:DDEM:TRAC:SEAR:TIME:OFFS 10 us</code> <code>:CALC:DDEM:TRAC:SEAR:TIME:OFFS?</code>
Notes	The align Reference, Offset and Interval determine the trace alignment region, and if the region is out of the acquisition data range, the trace will stop updating, and a trace indicator "DATA?" (which means "Data is questionable relative to current setup.") will be displayed at the top right of the graph
Preset	0 s
State Saved	Saved in instrument state
Min	-1.0e6 s
Max	1.0e6 s

Interval

Specifies the trace alignment interval. It works with Reference and Offset, determine the trace alignment region.

3 VMA Mode
 3.1 Digital Demod Measurement

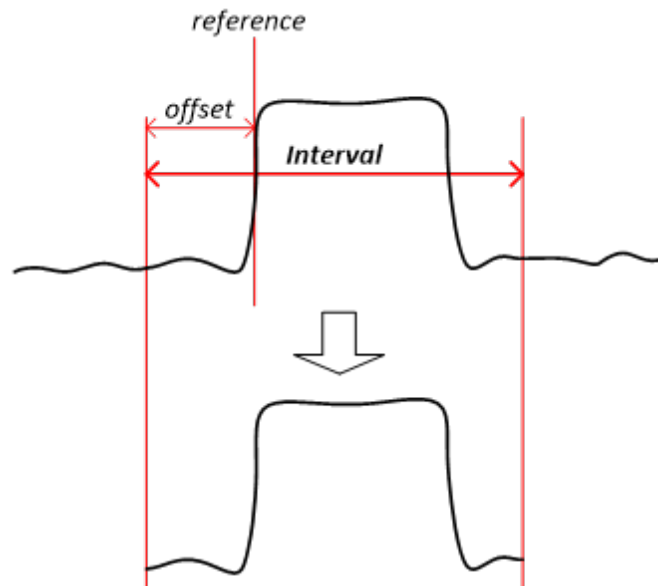

Remote Command	<code>:CALCulate:DDEMod:TRACe:SEARch:TIME:LENGth <time></code> <code>:CALCulate:DDEMod:TRACe:SEARch:TIME:LENGth?</code>
Example	<code>:CALC:DDEM:TRAC:SEAR:TIME:LENG 1.0 ms</code> <code>:CALC:DDEM:TRAC:SEAR:TIME:LENG?</code>
Notes	The align Reference, Offset and Interval determine the trace alignment region, and if the region is out of the acquisition data range, the trace will stop updating, and a trace indicator "DATA?" (which means "Data is questionable relative to current setup.") will be displayed at the top right of the graph
Preset	1 ms
State Saved	Saved in instrument state
Min	0.0 s
Max	1.0e6 s

3.2 Custom OFDM Measurement

Custom OFDM modulation analysis is used to analyze a user-defined custom OFDM signal.

Measurement Commands

The following measurement commands and queries are used to configure the measurement:

<code>:INITiate:OFDM</code>	Initiates a trigger cycle for the OFDM measurement, but does not return any data. You must then use <code>:FETC:OFDM[n]?</code> to retrieve data
<code>:CONFigure?</code>	Does not change any measurement settings Returns the long form name of current measurement, in this case, OFDM
<code>:CONFigure:OFDM</code>	Selects OFDM measurement with Meas Setup settings in preset state – same as " Meas Preset " on page 495
<code>:CONFigure:OFDM:NDEFault</code>	Selects OFDM measurement <i>without</i> affecting settings

The following queries are used to retrieve the results:

<code>:FETCh:OFDM?</code>	Retrieves the data specified by n
<code>:MEASure:OFDM [n]?</code>	Switches to OFDM measurement, restores default values, starts the measurement, then retrieves the data specified by n
<code>:READ:OFDM[n]?</code>	Starts the measurement, then retrieves the data specified by n

The general functionality of "[CONFigure](#)" on page 2551, "[INITiate](#)" on page 2552, "[FETCh](#)" on page 2552, "[MEASure](#)" on page 2554, and "[READ](#)" on page 2553 are described in the section **SCPI Operation and Results Query** in the topic **Programming the Instrument**.

Remote Command Results for Custom OFDM

For the FETCh, MEASure, and READ queries listed above, the results returned depend on the value of n. For this measurement, the value of n is derived by concatenating two 2-digit sub-fields: Component Carrier Index (CC) and Result Index (RI).

Index Sub-Fields

The general formula for calculating the desired value of n is:

$$n = 100 * CC + RI$$

3 VMA Mode
3.2 Custom OFDM Measurement

Sub-field	Variable	Definition	
Most Significant 2 Digits	CC	Component Carrier Index , the current valid range is 00-07:	
		00	CC0
		01	CC1
		02	CC2
		03	CC3
		04	CC4
		05	CC5
		06	CC6
Least Significant 2 Digits	RI	Result Index for each CC, the current valid range is 01-03 The information returned is for the specified CC:	
		01	Error Summary (SISO)
		02	Burst Info
		03	Error Summary (MIMO)
		04	ccEVM per symbol magnitude

Index: RI

01
or not specified

Results Returned

Returns the SISO Error Summary results for Component Carrier CC when it is active
All the return values are floating-point
If no result is available, NaN (9.91E+37) is returned

#	Result	Unit, if any
1	RMS EVM	%
2	EVM Pk	%
3	Pilot EVM	%
4	Data EVM	%
5	Preamble EVM	%
6	Frequency Error	Hz
7	Symbol Clock Error	ppm
8	RMS CPE	%
9	Sync Correlation	%
10	IQ Offset	dB
11	IQ Quad Error	deg
12	IQ Gain Imbalance	dB

#	Result	Unit, if any
13	CC Tx Power	dBm
14	All Measured CC Tx Power	dBm
15	SNR (MER)	dB
16	ccEVM	%
17	Valid Points	
18	Total Points	
19	Improvement Factor	dB

If "Report EVM in dB" is set to true, the EVM result is in "dB"

02

Returns the Burst Info results for Component Carrier CC when it is active

#	Result	Value Range	Unit, if any
1	Column Number	5 for current version	
2	Row Index	0 Null 1 All 2 Preamble 3 Pilot 4 Unknown Pilot 5 Data 6 Unspecified	
3	User1 ... User200	1001 ... 1200	
4	EVM		%
5	Power		dB
6	Modulation Format	0 N/A 2 BPSK 3 $\pi/4$ BPSK 4 QPSK 5 $\pi/4$ QPSK 8 8PSK 16 16QAM 32 32QAM 64 64QAM	

3 VMA Mode
 3.2 Custom OFDM Measurement

#	Result	Value Range	Unit, if any
		128	128QAM
		256	256QAM
		512	512QAM
		1024	1024QAM
		2048	2048QAM
		4096	4096QAM

7 RU number

Note: Items 2- 7 repeat for each row of Burst Info table

If "Report EVM in dB" is set to true, the EVM result is in "dB"

03

Returns the MIMO Error Summary results for Component Carrier CC when it is active

All the return values are floating-point

If no result is available, NaN (9.91E+37) is returned

#	Result	Unit, if any
1	Column Number (15 for current version)	
2	RMS EVM	%
3	EVM Pk	%
4	Pilot EVM	%
5	Data EVM	%
6	Preamble EVM	%
7	Frequency Error	Hz
8	Symbol Clock Error	ppm
9	RMS CPE	%
10	Sync Correlation	%
11	IQ Offset	dB
12	IQ Quad Error	deg
13	IQ Gain Imbalance	dB
14	CC Tx Power	dBm
15	All Measured CC Tx Power	dBm
16	SNR (MER)	dB

2- 16 will repeat for each layer

If no result is available, NaN (9.91E+37) is returned.

The EVM result will be in "dB" if "Report EVM in dB" is set to true

04

Return ccEVM per symbol magnitude

3.2.1 Views

The Custom OFDM measurement has four pre-defined views – Normal view, Channel Response view, Demod Error view and Result Summary view.

Some of these are multiple-window Views.

When in a multiple window View, you select a window by touching it. The menu controls may sometimes change depending on which window is selected.

Whenever the View changes, the default menu is Frequency, unless otherwise specified in the View description.

View - Selection by Enum

Remote Command	<code>:DISPlay:OFDM:VIEW[:SElect] NORMal CRESponse DERRor NRESults</code> <code>:DISPlay:OFDM:VIEW[:SElect]?</code>
Example	<code>:DISP:OFDM:VIEW NORM</code> Sets the normal view
Preset	NORM
State Saved	Saved in instrument state

Normal

Windows: "IQ Meas Time" on page 415, "Raw Main Time" on page 415, "Spectrum" on page 415, "Demod Results" on page 418

Multiple windows view consists of the above four windows.

Example `:DISP:OFDM:VIEW NORM`

Response

Windows: "CH Freq Response" on page 417, "EQ Impulse Response" on page 417

Dual windows view consists of the above two windows.

Example `:DISP:OFDM:VIEW CRES`

Demod Error

Windows: "Error Vector Time" on page 416, "Error Vector Spectrum" on page 416, "Common Pilot Error" on page 417, "Demod Results" on page 418

Multiple windows view consists of the above four windows.

Example `:DISP:OFDM:VIEW DERR`

Result Summary

Windows: "Demod Results" on page 418, "Burst Info" on page 418

Single window view consists of the above window.

Example :DISP:OFDM:VIEW NRES

3.2.2 Windows

There are 6 window types available. Each window has three properties. The Data and Format properties allow you to select the trace data and trace display format. The Component Carrier property allows you to select the trace data of the CC to be displayed. The Format selection is hidden if the selected Data doesn't support any format.

:DISPlay:OFDM:WINDow[1]|2|3|4|5|6:DATA <enum> is used to configure the trace data. For example, the following command sets the first window data to Spectrum.

```
:DISP:OFDM:WIND1:DATA SPEC
```

:DISPlay:OFDM:WINDow[1]|2|3|4|5|6:FORMat <enum> is used to configure the trace display format. For example, the following command sets the first window trace display format to Constellation.

```
:DISP:OFDM:WIND1:FORM CONS
```

:DISPlay:OFDM:WINDow[1]|2|3|4|5|6:CC <enum> is used to configure the trace data of the CC to be displayed. For example, the following command sets the CC0 trace data to be displayed.

```
:DISP:OFDM:WIND1:CC 0
```

3.2.2.1 Data

Provides a menu of trace data choices for the selected window.

Remote Command	:DISPlay:OFDM:WINDow[1] 2 ... 6[:TRACe]:DATA RMTIME SPECTrum MTIME RTIME ERR3D EVTime EVSpectrum CPERror REVTime REVSpectrum CHFResponse EQIResponse DRESults BINfo CESymbol NONE
	:DISPlay:OFDM:WINDow[1] 2 ... 6[:TRACe]:DATA?

Example	:DISP:OFDM:WIND2:DATA SPEC
	Sets the second window data to Spectrum
	:DISP:OFDM:WIND2:DATA?

Couplings	Depends on window
-----------	-------------------

Preset	Depends on window
--------	-------------------

State Saved	Yes
Range	Raw Main Time Spectrum IQ Meas IQ Ref Error Vector 3D Error Vector Time Error Vector Spectrum RMS Error Vector Time RMS Error Vector Spectrum Common pilot error CH Freq Response EQ Impulse Response Demod Results Burst Info ccEVM vs Symbol No Data

Trace Data Results

Trace Data	SCPI	Description
Raw Main Time	RMTIME	The envelope of the captured data record
Spectrum	SPECTRUM	Spectrum is the FFT of the Raw Main Time waveform
IQ Meas	MTIME	IQ Meas trace is the measured IQ symbol values used to calculate the EVM data results. There is one complex value for each subcarrier for each OFDM symbol in the measurement burst
IQ Ref	RTIME	IQ Ref trace is the reference IQ values for computing the signal EVM values. There is one complex value for each subcarrier for each symbol in the measurement burst
Error Vector Time	EVTIME	Error Vector Time trace shows the OFDM symbol and subcarrier Error Vector Magnitude vs. Symbol (time) and Subcarrier (frequency)
Error Vector Spectrum	EVSPSPECTRUM	Error Vector Spectrum trace shows the OFDM symbol and subcarrier Error Vector Magnitude (EVM) vs. subcarrier (frequency) and Symbol (time)
RMS Error Vector Time	REVTIME	RMS Error Vector Time is a plot of the Root Mean Square (RMS) average of multiple "RMS symbol EVM" data results
RMS Error Vector Spectrum	REVSPECTRUM	RMS Error Vector Spectrum is a plot of the Root Mean Square (RMS) average of multiple "RMS subcarrier EVM" data results
Common Pilot Error	CPERROR	Common Pilot Error trace data shows the difference between the measured and ideal pilot subcarrier symbols
EQ Impulse Response	EQIRESPONSE	Eq Impulse Response trace for Custom modulation is the equalizer impulse response
CH Freq Response	CHFRESPONSE	Ch Frequency Response trace for Custom modulation is the channel frequency response
Burst Info	BINFO	OFDM Burst Info trace is a summary table of basic burst information grouped by subcarrier type. Burst information includes EVM, Power, modulation format and resource unit information
ccEVM vs Symbol	CESYMBOL	ccEVM per symbol trace
No Data	NONE	Blank Trace

Pre Demod

Displays the trace data choices that show pre-demodulation results.

Raw Main Time

The envelope of the captured raw data. This data is unprocessed and includes additional points acquired for settling of the filters involved in subsequent processing, such as the demodulation filtering.

Example `:DISP:OFDM:WIND2:DATA RMT`
Sets the second window data to Raw Main Time

Spectrum

Shows the FFT of the Meas Interval part of Raw Main Time waveform, note when synchronization failed Meas Interval part will start from captured IQ data.

Example `:DISP:OFDM:WIND3:DATA SPEC`
Sets the third window data to Spectrum

Demod

Displays the general demodulation results.

IQ Meas Time

The measured time data results for the input signal.

Example `:DISP:OFDM:WIND:DATA MTIM`
Sets the first window data to IQ Meas Time
`:DISP:OFDM:WIND:FORM CONS`
Selects Constellation as the first window data format

IQ Ref Time

The reconstructed ideal time waveform to compare IQ Meas Time against.

Example `:DISP:OFDM:WIND:DATA RTIM`
Sets the first window data to IQ Ref Time
`:DISP:OFDM:WIND:FORM CONS`
Selects Constellation as the first window data format

Demod Error

Displays the general demodulation error results.

Error Vector Time

Shows the time domain error vector trace data results. The trace contains the computed error vectors between IQ Meas Time and IQ Ref Time at each point in time. The values of the error vectors are usually plotted as a magnitude.

Example `:DISP:OFDM:WIND2:DATA EVT`
Sets the second window data to Error Vector Time

Error Vector Spectrum

The frequency spectrum of the Error Vector Time trace data. The demodulator produces the spectrum by windowing and FFT of the Error Vector Time data. On this trace, the individual error vectors are plotted vs frequency.

Example `:DISP:OFDM:WIND2:DATA EVSP`
Sets the second window data to Error Vector Spectrum

RMS Error Vector Time

Shows the time domain error vector trace data results. The trace contains the computed error vectors between IQ Meas Time and IQ Ref Time at each point in time. The values of the error vectors are usually plotted as a magnitude.

Example `:DISP:OFDM:WIND2:DATA REVT`
Sets the second window data to RMS Error Vector Time

RMS Error Vector Spectrum

Shows the time domain error vector trace data results. The trace contains the computed error vectors between IQ Meas Time and IQ Ref Time at each point in time. The values of the error vectors are usually plotted as a magnitude.

Example `:DISP:OFDM:WIND2:DATA REVS`
Sets the second window data to RMS Error Vector Spectrum

Common Pilot Error

Shows the time domain error vector trace data results. The trace contains the computed error vectors between IQ Meas Time and IQ Ref Time at each point in time. The values of the error vectors are usually plotted as a magnitude.

Example `:DISP:OFDM:WIND2:DATA CPER`
Sets the second window data to Common Pilot Error

Error Vector 3D

Shows modulation error for each resource element

Example `:DISP:OFDM:WIND3:DATA ERR3D`
Sets the third window data to Error Vector 3D trace

ccEVM vs Symbol

This trace shows ccEVM result per Symbol.

Example `:DISP:OFDM:WIND2:DATA CES`
Sets the second window data to ccEVM vs Symbol

Response

Displays the trace data choices that show equalizer response results.

CH Freq Response

Shows the channel frequency response for which the equalizer is correcting. It is computed as the inverse of the equalization filter's frequency response.

Example `:DISP:OFDM:WIND2:DATA CHFR`
Sets the second window data to CH Freq Response

EQ Impulse Response

Shows the impulse response of the equalization filter.

Example `:DISP:OFDM:WIND2:DATA EQIR`
Sets the second window data to EQ Impulse Response

Tables

Displays the trace data choices that are in tabular form, including Demod Results, Demod Bits.

Demod Results

Shows the measurement numeric results. The available tabular data changes depending on the modulation format chosen.

Example `:DISP:OFDM:WIND4:DATA DRES`
Sets the fourth window data to Demod Results

Burst Info

Shows the measurement numeric results. The available tabular data changes depending on the modulation format chosen.

Example `:DISP:OFDM:WIND4:DATA DRES`
Sets the fourth window data to Demod Results

3.2.2.2 Format

Enables you to choose the available format of the selected trace.

The formats are:

Format Name	Description
Log Mag (dB)	Data is converted to decibel units and shown on a linear Y axis
Phase	Phase of complex data is shown on Y axis
Group Delay	Useful for frequency response displays. Shows the derivative of phase response with respect to frequency
Real (I)	Real part of ccEVM per symbol
Imaginary (Q)	Imaginary part of ccEVM per symbol
Remote Command	<code>:DISP:OFDM:WINDow[1] 2 ... 6[:TRACe]:FORMat MLOG PHASe GDELay REAL IMAGinary</code> <code>:DISP:OFDM:WINDow[1] 2 ... 6[:TRACe]:FORMat?</code>
Example	<code>:DISP:OFDM:WIND2:FORM MLOG</code> Sets the second window data format to Log Mag <code>:DISP:OFDM:WIND2:FORM?</code>
Notes	Log Mag, Phase and Group Delay are available for Channel Frequency Response trace

	Log Mag, Real and Imaginary are available for ccEVM vs Symbol trace
Preset	Depends on trace
State Saved	Yes
Range	Log Mag (dB) Phase Group Delay Real Imaginary

3.2.2.3 Component Carrier

Provides a menu of component carrier choices for the selected window.

Remote Command	<code>:DISPlay:OFDM:WINDow[1] 2 ... 6:CCARrier CC0 ... CC7</code> <code>:DISPlay:OFDM:WINDow[1] 2 ... 6:CCARrier?</code>
Example	<code>:DISP:OFDM:WIND2:CCAR CC0</code> <code>:DISP:OFDM:WIND2:CCAR?</code>
Couplings	Depends on window
Preset	Depends on window
State Saved	Yes
Range	CC0 CC1 CC2 CC3 CC4 CC5 CC6 CC7

3.2.3 Amplitude

Activates the **Amplitude** menu and selects **Reference Level** or **Reference Value** as the active function, depending on the measurement.

Some features in this menu apply to multiple measurements. Some other features apply only to specific measurements and their controls are blanked or grayed-out in measurements that do not support the feature.

3.2.3.1 Y Scale

Contains controls that pertain to the Y axis parameters of the measurement. These parameters control how data on the vertical (Y) axis is displayed and control instrument settings that affect the vertical axis.

Auto Scale

Changes the Y reference value and Scale per Division so the full trace is displayed without clipping.

Remote Command	<code>:DISPlay:OFDM:WINDow[1] 2 ... 6:Y[:SCALE]:AUTO:ONCE</code>
Example	<code>:DISP:OFDM:WIND3:Y:AUTO:ONCE</code> Do the Y auto scale for the third window

Auto Scale at Restart

Enable and disable automatic Y Auto Scale with measurement restart:

- ON – Does automatic Y Auto Scale when measurement is restarted, to let you see the complete trace
- OFF – Does not do automatic Y Auto Scale when measurement is restarted, to retain user setting for Y scale

Remote Command	<code>:DISPlay:OFDM:Y[:SCALE]:AUTO:REStart 0 1 OFF ON</code> <code>:DISPlay:OFDM:Y[:SCALE]:AUTO:REStart?</code>
Example	<code>:DISP:OFDM:Y:AUTO:REST ON</code> <code>:DISP:OFDM:Y:AUTO:REST?</code>
Preset	OFF
State Saved	Yes
Range	On Off

Ref Value

Specifies the amplitude of a signal displayed on the reference graticule line. The reference line is at the top, center, or bottom of the graticule, depending on the value of "Ref Position" on page 421.

Applies only to the selected window. If the table type window is selected, this control is unavailable. The functionality depends on the selected window.

Remote Command	<code>:DISPlay:OFDM:WINDow[1] 2 ... 6:Y[:SCALE]:RLEVel <real></code> <code>:DISPlay:OFDM:WINDow[1] 2 ... 6:Y[:SCALE]:RLEVel?</code>
Example	<code>:DISP:OFDM:WIND3:Y:RLEV 20</code> Set the Y ref value of the third window to 20 <code>:DISP:OFDM:WIND3:Y:RLEV?</code> Query the Y ref value of the third window
Preset	Depends on trace data
State Saved	Saved in instrument state
Min	-9.9E+37
Max	9.9E+37
Annotation	The reference value is displayed above the graticule with the title "Ref Value"

Scale/Div

Controls the Y scale per division of the selected trace.

Remote Command	<code>:DISPlay:OFDM:WINDow[1] 2 ... 6:Y[:SCALE]:PDIVision <real></code> <code>:DISPlay:OFDM:WINDow[1] 2 ... 6:Y[:SCALE]:PDIVision?</code>
Example	<code>:DISP:OFDM:WIND3:Y:PDIV 10</code> Set the Y scale/div of the third window to 10 <code>:DISP:OFDM:WIND3:Y:PDIV?</code> Query the Y scale/div of the third window
Preset	Depends on trace data
State Saved	Yes
Min	-9.9E+37
Max	9.9E+37
Annotation	Upper left corner of trace grid, same gray as grid

Ref Position

Positions the reference level at the top, center, or bottom of the Y Scale display. Changing the reference position does not change "Ref Value" on page 420.

Remote Command	<code>:DISPlay:OFDM:WINDow[1] 2 ... 6:Y[:SCALE]:RPOsition TOP CeNTER BOTTom</code> <code>:DISPlay:OFDM:WINDow[1] 2 ... 6:Y[:SCALE]:RPOsition?</code>
Example	<code>:DISP:OFDM:WIND3:Y:RPOS TOP</code> Set the Y ref position of the third window to TOP <code>:DISP:OFDM:WIND3:Y:RPOS?</code> Query the Y ref position of the third window
Preset	Depends on trace data
State Saved	Saved in instrument state
Range	Top Ctr Bot

3.2.3.2 Attenuation

Controls the attenuator functions and interactions between the attenuation system components.

There are two attenuator configurations in the X-Series. One is a Dual-Attenuator configuration consisting of a mechanical attenuator and an optional electronic attenuator. The other configuration uses a single attenuator with combined

mechanical and electronic sections that controls all the attenuation functions. Different models in the X-Series come with different configurations.

- See "Dual-Attenuator Configurations" on page 422
- See "Single-Attenuator Configuration" on page 423

Most attenuation settings are the same for all measurements – they do not change as you change measurements. Settings like these are called “Meas Global” and are unaffected by **Meas Preset**.

Only available when the hardware set includes an input attenuator, which is typically only the case for Keysight’s benchtop instruments. For example, this tab does *not* appear in VXT models M9420A/10A/11A/15A/16A, M9410E/11E/15E/16E, nor in UXM. In UXM, all **Attenuation** and **Range** settings are disabled, as the expected input power level is handled by the Call Processing App that drives the DUT power control.

Dependencies In measurements that support the I/Q inputs, unavailable when I/Q is the selected input. Replaced by the **Range** tab in that case

Dual-Attenuator Configurations

Configuration 1: Mechanical attenuator + optional electronic attenuator

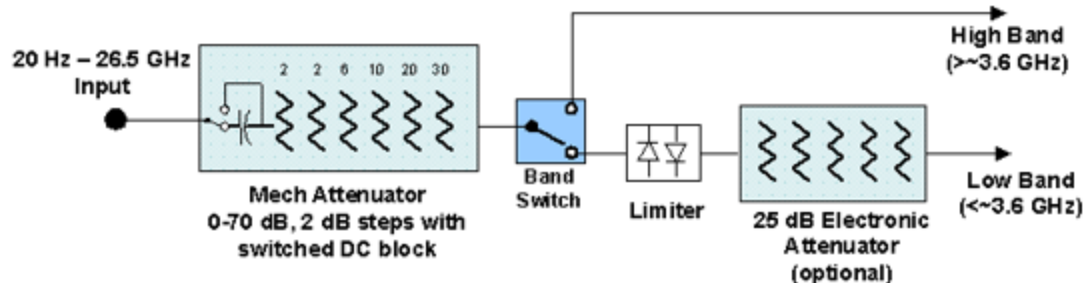

Configuration 2: Mechanical attenuator, no optional electronic attenuator

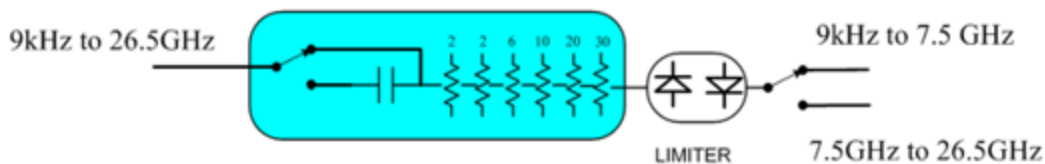

Note that Configuration 2 is not strictly speaking a dual-section attenuator, since there is no electronic section available. However, it behaves exactly like Configuration 1 without the Electronic Attenuator Option EA3, therefore for the sake of this document it is grouped into the “Dual-Attenuator” configuration.

Single-Attenuator Configuration

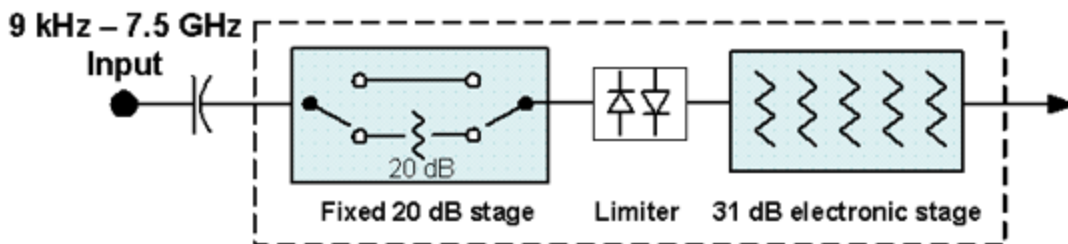

You can tell which attenuator configuration you have by pressing the Attenuation tab, which (in most Modes) opens the Attenuation menu. If the first control in the Attenuation menu says **Mech Atten** you have the Dual-Attenuator configuration. If the first control says **Atten** you have the Single-Attenuator configuration.



Dual Attenuator

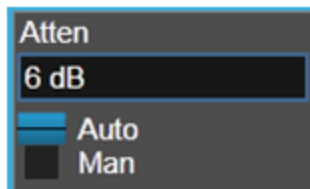

Single Attenuator

(Note that depending on the measurement, there may be no Auto/Man functionality on the Mech Atten control.)

In the Single-Attenuator configuration, you control the attenuation with a single control, as the fixed stage has only two states. In the Dual-Attenuator configuration, both stages have significant range, so you are given separate control of the mechanical and electronic attenuator stages.

When you have the Dual-Attenuator configuration, you may still have only a Single-Attenuator, because unless Option EA3 (the Electronic Attenuator option) is available, and you purchase it, you will have only the mechanical attenuator.

Full Range Atten

This control and **Attenuator Summary** only appear in N9041B, when the RF input is selected, the RF Input Port is set to RF Input 2, and the Full Range Attenuator is installed. The Full Range Attenuator adds a second input attenuator in front of RF Input 2, which enhances the protection and optimizes the performance of the extra internal mixers used by RF Input 2.

Remote Command `[:SENSe]:POWer[:RF]:FRATten <rel_amp>`
`[:SENSe]:POWer[:RF]:FRATten?`

Example `:POW:FRAT 14`

: POW: FRAT?	
Notes	When you enter an amplitude value that falls between valid values, the value will be incremented to the next smallest valid value
Dependencies	Only appears if input RF is selected, RF Input Port 2 is selected, and the Full Range Attenuator exists
Couplings	This value is never changed by any coupling, but other couplings use this value. See Reference Level and " Mech Atten " on page 1766 command descriptions
Preset	20 dB
State Saved	Saved in instrument state
Min	0 dB
Max	Only valid values are 0, 6, 14, 20 dB
Annotation	<p>When the Input is RF, and the Input Port is RF Input 2, and the Full Range Attenuator is installed: On the Meas Bar, the field "Atten" displays as follows:</p> <ul style="list-style-type: none"> - If the sweep is entirely < 50 GHz, the value shown after "Atten:" is equal to Mech Atten + Elec Atten + Full Range Atten - If the sweep is entirely > 50 GHz, the value shown after "Atten:" is equal to Full Range Atten - If the sweep straddles 50 GHz, the value shown after "Atten:" is preceded by the symbol ">=" and is equal to Full Range Atten <p>In the Amplitude, "Y Scale" on page 1760 menu, and the Atten Meas Bar dropdown menu panel, a summary is displayed as follows:</p> <p>"Total Atten below 50 GHz" followed by the value of Full Range Atten + Mech Atten + Elec Atten "Total Atten above 50 GHz" followed by the value of Full Range Atten</p> <p>For example, if Mech Atten = 6 dB, Elec Atten = 4 dB, and Full Range Atten = 20 dB, the summary below is shown:</p> <ul style="list-style-type: none"> - Attenuator summary: - Total Atten below 50 GHz: 30 dB - Total Atten above 50 GHz: 20 dB

Mech Atten

Labeled **Mech Atten** in Dual-Attenuator models, and **Atten** in Single-Attenuator models. In the Dual-Attenuator configuration, this control only affects the mechanical attenuator.

Lets you modify the attenuation applied to the RF input signal path. This value is normally auto-coupled to **Ref Level**, "**Internal Preamp**" on page 1788 Gain, any External Gain that is entered, and **Max Mixer Level** (if available), as described in the table below.

See "**Attenuator Configurations and Auto/Man**" on page 426

3 VMA Mode
 3.2 Custom OFDM Measurement

Remote Command	<code>[:SENSe]:POWer[:RF]:ATTenuation <rel_amp1></code> <code>[:SENSe]:POWer[:RF]:ATTenuation?</code>
Example	<code>:POW:ATT 20</code> <p>Dual-Attenuator configuration: sets the mechanical attenuator to 20 dB Single-Attenuator mode: sets the main attenuation to 20 dB (see below for definition of “main” attenuation) In either case, if the attenuator was in Auto, it is set to Manual</p>
Dependencies	<p>Some measurements do not support Auto setting of Mech Atten. In these measurements, the Auto/Man selection is not available, and the Auto/Man toggle function is not available</p> <p>In Dual-Attenuator configurations, when the electronic attenuator is enabled, the mechanical attenuator has no auto setting, and the Auto/Man toggle function is not available. The state of Auto/Man is remembered and restored when the electronic attenuator is once again disabled. This is described in more detail in "Elec Atten" on page 1769</p> <p>See "Attenuator Configurations and Auto/Man" on page 426 for more information on the Auto/Man functionality</p>
Couplings	<p>If the RF Input Port is the RF Input:</p> <ul style="list-style-type: none"> – If the USB Preamp is connected to USB, use 0 dB for Mech Atten – Otherwise compute the auto-selected value of Mech Atten based on Reference Level, Int Preamp, External Gain, Ref Level Offset, Max Mixer Level, μW Path Control and IF Gain settings. Limit this value to be no less than 6 dB (total attenuation below 6 dB can never be chosen by Auto) – In N9041B, if the RF Input Port is RF Input 2, use the formula above and subtract the value of "Full Range Atten" on page 1765 from the result to determine the Mech Atten. Limit the value so that it is never lower than 0 dB and so that total attenuation, including Full Range Atten, is never less than 6 dB (total attenuation, including Full Range Atten below 6 dB, can never be chosen by Auto) <p>In External Mixing and BBIQ, where the attenuator is not in the signal path, the attenuator setting changes as described above when Mech Atten is in Auto, but no changes are made to the actual attenuator hardware setting until the input is changed back to the RF Input</p> <p>For CXA-m with Option FSA (Fine-Step Attenuator or 2 dB steps), the FSA-like behavior is only available when the frequency setting is <= 7.5 GHz. So, when the frequency is changed from below 7.5 GHz to above 7.5 GHz, the attenuation setting changes to a multiple of 10 dB that is no smaller than the previous setting. For example, 4 dB attenuation changes to 10 dB</p>
Preset	Auto The Auto value is 10 dB
State Saved	Saved in instrument state
Min	0 dB The attenuation set by this control cannot be decreased below 6 dB with the knob or step keys. Values below 6 dB must be directly entered from the keypad or via SCPI. This protects against setting a dangerously small attenuation value, which can put the instrument at risk of damage to input circuitry. If the current mechanical attenuation is below 6 dB, it can be increased with the knob and step keys, but not decreased

Max	CXA Option 503 or 507	50 dB
	EXA	60 dB
	All other models	70 dB
<p>Note that in the Single-Attenuator configuration, the total of ATT and EATT cannot exceed 50 dB. So, if the EATT is set to 24 dB first, the main attenuation cannot be greater than 26 dB and will be reduced accordingly; if the main attenuator is set to 40 dB first, EATT cannot be greater than 10 dB</p>		
Annotation	<p>The current value for Total Atten is displayed in the Measurement Bar at the top of the display. A value appears for Electronic Attenuation only if the Electronic Attenuator is enabled. The annotation appears as:</p> <p><i>Atten: <total> dB (e<elec>)</i></p> <p>The e letter is in amber in Single-Attenuator configurations</p> <p>For example:</p> <p>Dual-Attenuator configuration:</p> <p><i>Atten: 24 dB (e14)</i></p> <p>Indicating the total attenuation is at 24 dB and the electronic attenuation is at 14 dB</p> <p>Single-Attenuator configuration:</p> <p><i>A: 24 dB (e14)</i></p> <p>Indicating the total attenuation is at 24 dB and the “soft” attenuation is at 14 dB (see below for definition of “soft” attenuation)</p> <p>When in Manual, a # sign appears in front of Atten in the annotation</p> <p>Auto Function</p>	
Remote Command	<pre>[:SENSe]:POWer[:RF]:ATTenuation:AUTO OFF ON 0 1 [:SENSe]:POWer[:RF]:ATTenuation:AUTO?</pre>	
Example	<p>Turn Auto Mech Atten ON:</p> <pre>:POW:ATT:AUTO ON</pre>	
Dependencies	<pre>:POW:ATT:AUTO</pre> <p>is only available in measurements that support Auto, such as Swept SA</p>	
Preset	<pre>ON</pre>	

Attenuator Configurations and Auto/Man

As described under "[Attenuation](#)" on page 1763, there are two distinct attenuator configurations available in the X-Series, the Single Attenuator and Dual-Attenuator configurations.

In Dual-Attenuator configurations, we have mechanical attenuation and electronic attenuation, and current total attenuation is the sum of electronic + mechanical attenuation.

In Single-Attenuator configurations, we refer to the attenuation set using "[Mech Atten](#)" on page 424 (or `:POW:ATT`) as the “main” attenuation; and the attenuation that is set by `:POW:EATT` as the “soft” attenuation (`:POW:EATT` is honored even in

the Single-Attenuator configuration, for compatibility purposes). Then current total attenuation is the sum of main + soft attenuation.

See "[Elec Atten](#)" on page 1769 for more about “soft” attenuation.

NOTE

In some measurements, the **Mech Atten** control has an **Auto/Man** function. In these measurements, an **Auto/Man** switch is shown on the **Mech Atten** control:

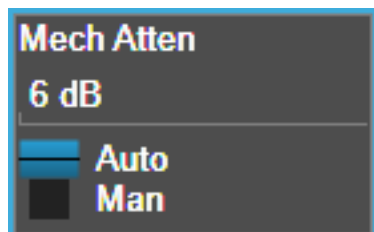

Note that in configurations that include an Electronic Attenuator, this switch is only shown when the Electronic Attenuator is disabled.

In other measurements, **Mech Atten** has no **Auto/Man** function. In these measurements, no switch is shown on the **Mech Atten** control:



Mech Atten also appears with no switch, as above, in configurations that include an Electronic Attenuator but when the Electronic Attenuator is enabled.

Elec Atten

Controls the Electronic Attenuator in Dual-Attenuator configurations. Does not appear in Single-Attenuator configurations, because the control of both the mechanical and electronic stages of the Single-Attenuator is integrated into the single **Atten** control.

This control includes an **Enable/Disable** toggle switch; it is only possible to enter a value for the Electronic Attenuator when this switch is in the **Enable** position.

For more details of the Electronic Attenuator, see "[More Information](#)" on page 429

Remote Command	<code>[:SENSe]:POWer[:RF]:EATTenuation <rel_amp></code> <code>[:SENSe]:POWer[:RF]:EATTenuation?</code>
Example	<code>:POW:EATT 10</code> <code>:POW:EATT?</code>
Notes	Electronic Attenuation's specification is defined only when Mech Atten is 6 dB

Dependencies	<p>Only appears in Dual-Attenuator models with an Electronic Attenuator installed and licensed. Does not appear in models with the Single-Attenuator configuration, because in the Single-Attenuator configuration there is no “electronic attenuator”; there is only a single integrated attenuator (which has both a mechanical and electronic stage). However, in the Single-Attenuator configuration, EATT SCPI commands are accepted for compatibility with other X-series instruments, and set a “soft” attenuation. The “soft” attenuation is treated as an addition to the “main” attenuation value set by the Attenuation control or :POW:ATT, and affects the total attenuation displayed on the Attenuation control and the Meas Bar</p> <p>The electronic attenuator, and the “soft” attenuation function provided in Single-Attenuator configurations, are unavailable above the low band (0-3.6 GHz, 0-3.4 GHz, 0-3 GHz, depending on the model). If the low band range is from 0-3.6 GHz, and Stop Frequency of the instrument is > 3.6 GHz, then the Enabled/Disabled section of the Elec Atten control will be OFF and grayed-out</p> <p>If "Internal Preamp" on page 1788 is ON (that is, set to Low Band or Full), the electronic attenuator (and the “soft” attenuation function provided in Single-Attenuator configurations) is unavailable. In this case the Enabled/Disabled section of the Elec Atten control will be OFF and grayed-out</p> <p>If either of the above is true, and the SCPI command is sent, an error indicating that the electronic attenuator is unavailable is returned</p> <p>If both the above are true, pressing the control generates error message -221, in other words, the frequency range lockout takes precedence</p> <p>If the electronic/soft Attenuator is enabled, then the Stop Freq of the instrument is limited to 3.6 GHz and Internal Preamp is unavailable</p> <p>If "LNA" on page 1790 is ON, the electronic attenuator (and the “soft” attenuation function provided in Single-Attenuator configurations) is unavailable. In this case the Enabled/Disabled section of the Elec Atten control will be OFF and grayed-out. This coupling works in the following modes/measurements:</p> <ul style="list-style-type: none"> - Channel Power, Occupied BW, ACP, SEM, Spurious Emissions, Power Stat CCDF measurements in all Modes - Transmit On Off Power measurement in 5GNR Mode - Power vs. Time and Transmit Power measurement in GSM/EDGE Mode - Burst Power measurement in Spectrum Analyzer Mode <p>The SCPI-only “soft” electronic attenuation for the single-attenuator configuration is not available in all measurements; in particular, it is not available in the Swept SA measurement</p>
Couplings	Enabling and disabling the Electronic Attenuator affects the setting of the Mechanical Attenuator (in Dual-Attenuator configurations). This is described in more detail below and in "Mechanical Attenuator Transition Rules" on page 429
Preset	0 dB
State Saved	Saved in instrument state
Min	0 dB
Max	<p>Dual-Attenuator configuration: 24 dB</p> <p>Single-Attenuator configuration: the total of ATT and EATT cannot exceed 50 dB. So, if the EATT is set to 24 dB first, the main attenuation cannot be greater than 26 dB and will be reduced accordingly; if the main attenuator is set to 40 dB first, EATT cannot be greater than 10 dB</p>
Annotation	See Annotation under the Mech Atten control description

Auto Function

Remote Command	<code>[:SENSe]:POWer[:RF]:EATTenuation:STATe OFF ON 0 1</code> <code>[:SENSe]:POWer[:RF]:EATTenuation:STATe?</code>
Example	<code>:POW:EATT:STAT ON</code> <code>:POW:EATT:STAT?</code>
Preset	<code>OFF</code> (Disabled) for Swept SA measurement <code>ON</code> (Enabled) for all other measurements that support the electronic attenuator

NOTE

The maximum **Center Frequency** for Low Band can change based on the selected IFBW for measurements that support IFBW (for example, Waveform measurement across all Modes that support it). In certain models (such as N9042B & N9032B), IFBW values ≤ 40 MHz have a maximum Low Band frequency of 3.6 GHz, while $40 \text{ MHz} < \text{IFBW} \leq 1 \text{ GHz}$ have a maximum of 3.3 GHz, and $1 \text{ GHz} < \text{IFBW} \leq 1.5 \text{ GHz}$ have a maximum of 3.5 GHz. This frequency is reflected in the disabled message displayed for Electrical Attenuator. For N9032B and N9042B IFBW values $> 1.5 \text{ GHz}$ do not support a **Center Frequency** that can reach the Low Band maximum frequency. In these cases, the Electrical Attenuator will remain disabled no matter the Center Frequency.

More Information

The electronic attenuator offers finer steps than the mechanical attenuator, has no acoustical noise, is faster, and is less subject to wear. These advantages primarily aid in remote operation and are negligible for front panel use. See ["Using the Electronic Attenuator: Pros and Cons" on page 430](#) for a detailed discussion of the pros and cons of using the electronic attenuator.

For the Single-Attenuator configuration, for SCPI backwards compatibility, the “soft” attenuation feature replaces the Dual-Attenuator configuration’s electronic attenuator. All the same couplings and limitations apply. See ["Attenuator Configurations and Auto/Man" on page 1768](#)

Mechanical Attenuator Transition Rules

When the Electronic Attenuator is enabled, the Mechanical Attenuator transitions to a state that has no Auto function. Below are the rules for transitioning the Mechanical Attenuator. Note that the information below *only* applies to the Dual-Attenuator configurations, and *only* when the Electronic Attenuator is installed:

When the Electronic Attenuation is enabled from a disabled state:

- The Mechanical Attenuator is initialized to 10 dB (this is its optimal performance setting). You can then set it as desired with SCPI, numeric keypad, step keys, or

knob, and it behaves as it normally would in manual mode

- The Auto/Man state of (Mech) Atten is saved
- The Auto/Man toggle on the (Mech) Atten control disappears, and the auto rules are disabled
- The Electronic Attenuator is set to 10 dB less than the previous value of the Mechanical Attenuator, within the limitation that it must stay within the range of 0 to 24 dB of attenuation

Examples in the Dual-Attenuator configuration:

- Mech Atten at 20 dB. Elec Atten enabled, Mech Atten set to 10 dB, and Elec Atten set to 10 dB. New total attenuation equals the value before Elec Atten enabled
- Mech Atten at 0 dB. Elec Atten enabled, Mech Atten set to 10 dB, and Elec Atten set to 0 dB. New total attenuation does not equal the value before Elec Atten enabled
- Mech Atten at 40 dB. Elec Atten enabled, Mech Atten set to 10 dB, and Elec Atten set to 24 dB. New total attenuation does not equal the value before Elec Atten enabled

When the Electronic Attenuation is disabled from an enabled state:

- The Elec Atten control is grayed out
- The Auto/Man state of (Mech) Atten is restored
- If now in Auto, (Mech) Atten recouples
- If now in Man, (Mech) Atten is set to the value of total attenuation that existed before the Elec Atten was disabled. The resulting value is rounded up to the smallest value possible given the (Mech) Atten Step setting - (That is, 57 dB changes to 58 dB when (Mech) Atten Step is 2 dB)

Using the Electronic Attenuator: Pros and Cons

The electronic attenuator offers finer steps than the mechanical attenuator, has no acoustical noise, is faster, and is less subject to wear.

The “finer steps” advantage of the electronic attenuator is beneficial in optimizing the alignment of the instrument dynamic range to the signal power in the front panel as well as remote use. Thus, you can achieve improved relative signal measurement accuracy. Compared to a mechanical attenuator with 2 dB steps, the 1 dB resolution of the electronic attenuator only gives better resolution when the odd-decibel steps are used. Those odd-decibel steps are less accurately calibrated

than the even-decibel steps, so one tradeoff for this superior relative accuracy is reduced absolute amplitude accuracy.

Another disadvantage of the electronic attenuator is that the spectrum analyzer loses its “Auto” setting, making operation less convenient.

Also, the relationship between the dynamic range specifications (TOI, SHI, compression, and noise) and instrument performance are less well-known with the electrical attenuator. With the mechanical attenuator, TOI, SHI, and compression threshold levels increase dB-for-dB with increasing attenuation, and the noise floor does as well. With the electronic attenuator, there is an excess attenuation of about 1 to 3 dB between 0 and 3.6 GHz, making the effective TOI, SHI, and so forth, less well known. Excess attenuation is the actual attenuation relative to stated attenuation. Excess attenuation is accounted for in the instrument calibration.

Adjust Atten for Min Clipping

Sets the combination of mechanical and electronic attenuation and gain based on the current measured signal level so that clipping will be at a minimum.

This is an immediate action function, that is, it executes once, when the control is pressed.

The algorithms that are used for the adjustment are documented under ["Pre-Adjust for Min Clipping" on page 1773](#).

Remote Command	<code>[:SENSe]:POWer[:RF]:RANGe:OPTimize IMMEDIATE</code>
Example	<code>:POW:RANG:OPT IMM</code>
Notes	Executing Adjust Atten for Min Clipping initiates the measurement
Dependencies	Does not appear in the Swept SA, RTSA, Monitor Spectrum and Complex Spectrum measurements Appears in the Waveform measurement in BASIC and 5G NR Modes

Adjust Atten

Allows you to select;

- Electric attenuator only
- Combination of Electric attenuator and Mechanical attenuator

when `[:SENSe]:POWer[:RF]:RANGe:OPTimize IMMEDIATE` is executed.

Remote Command	<code>[:SENSe]:POWer[:RF]:RANGe:OPTimize:TYPE EONLY COMBined</code> <code>[:SENSe]:POWer[:RF]:RANGe:OPTimize:TYPE?</code>
Example	<code>:POW:RANG:OPT:TYPE EONL</code>

	<code>:POW:RANG:OPT:TYPE?</code>
Dependencies	Does not appear in the Swept SA, RTSA, Monitor Spectrum and Complex Spectrum measurements Appears in the Waveform measurement in BASIC and 5G NR Modes
Preset	<code>COMBined</code>
State Saved	Saved in instrument state

Pre-Adjust for Min Clipping

If this function is `ON`, it applies the adjustment described under "[Adjust Atten for Min Clipping](#)" on page 1772 each time a measurement restarts. Therefore, in Continuous measurement mode, it only executes before the first measurement.

In Dual-Attenuator models, you can set `Elec+Mech Atten`, in which case both attenuators participate in the autoranging, or `Elec Atten Only`, in which case the mechanical attenuator does not participate in the autoranging. This latter case results in less wear on the mechanical attenuator and is usually faster.

See "[Adjustment Algorithm](#)" on page 433

Selection	SCPI	Note
Off	<code>OFF</code>	This is the default setting
On	<code>ON</code>	Available in Single-Attenuator instruments. For compatibility with models that do not have an input attenuator, the <code>ON</code> parameter is supported and mapped to <code>COMBined</code>
Elec Atten Only	<code>ELECTrical</code>	Selects only the electric attenuator to participate in auto ranging. This offers less wear on the mechanical attenuator and is usually faster
Elec+Mech Atten	<code>COMBined</code>	In Dual-Attenuator models, this selects both attenuators to participate in the autoranging

Remote Command	<code>[:SENSe]:POWer[:RF]:RANGe:OPTimize:ATTenuation OFF ON ELECTrical COMBined</code> <code>[:SENSe]:POWer[:RF]:RANGe:OPTimize:ATTenuation?</code>
Example	<code>:POW:RANG:OPT:ATT OFF</code> <code>:POW:RANG:OPT:ATT?</code>
Notes	The parameter option <code>ELECTrical</code> sets this function to <code>ON</code> in Single-Attenuator models The parameter option <code>COMBined</code> is mapped to <code>ELECTrical</code> in Single-Attenuator models. If you send <code>COMBined</code> , it sets the function to <code>ON</code> and returns <code>ELEC</code> to a query For SCPI compatibility with models that do not have an input attenuator, the <code>ON</code> parameter is honored and mapped to <code>COMBined</code>
Dependencies	Only appears in Dual-Attenuator models with an Electronic Attenuator installed In instruments with Dual-Attenuator model, when " Elec Atten " on page 1769 is <code>OFF</code> or grayed-out,

3 VMA Mode
 3.2 Custom OFDM Measurement

	"Pre-Adjust for Min Clipping" on page 432 is grayed-out Does not appear in the Swept SA, RTSA, Monitor Spectrum and Complex Spectrum measurements Appears in the Waveform measurement in BASIC and 5G NR Modes
Preset	OFF when Elec Atten is Disabled at preset, otherwise ELEC
State Saved	Saved in instrument state
Range	Dual-Attenuator models: Off Elec Atten Only Mech + Elec Atten Single-Attenuator models: Off On

Backwards Compatibility Command

Notes	ON aliases to "Elec Atten Only" (:POW:RANG:OPT:ATT ELEC) OFF aliases to "Off" (:POW:RANG:OPT:ATT OFF) :POW:RANG:AUTO? returns true if :POW:RANG:OPT:ATT is not OFF
Backwards Compatibility SCPI	[:SENSe] :POWer [:RF] :RANGe :AUTO ON OFF 1 0 [:SENSe] :POWer [:RF] :RANGe :AUTO?

Adjustment Algorithm

The algorithms for the adjustment are documented below:

Single-Attenuator Models

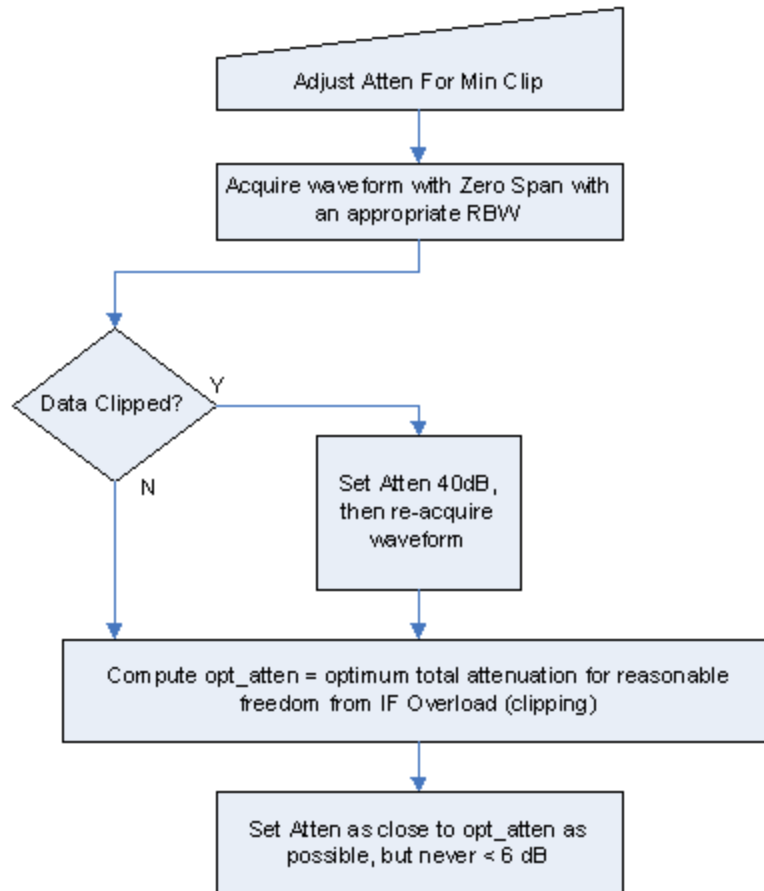

Dual-Attenuator models

"Adjust Atten for Min Clipping" on page 1772 or "Pre-Adjust for Min Clipping" on page 432 selection is Mech + Elec Atten:

3 VMA Mode
 3.2 Custom OFDM Measurement

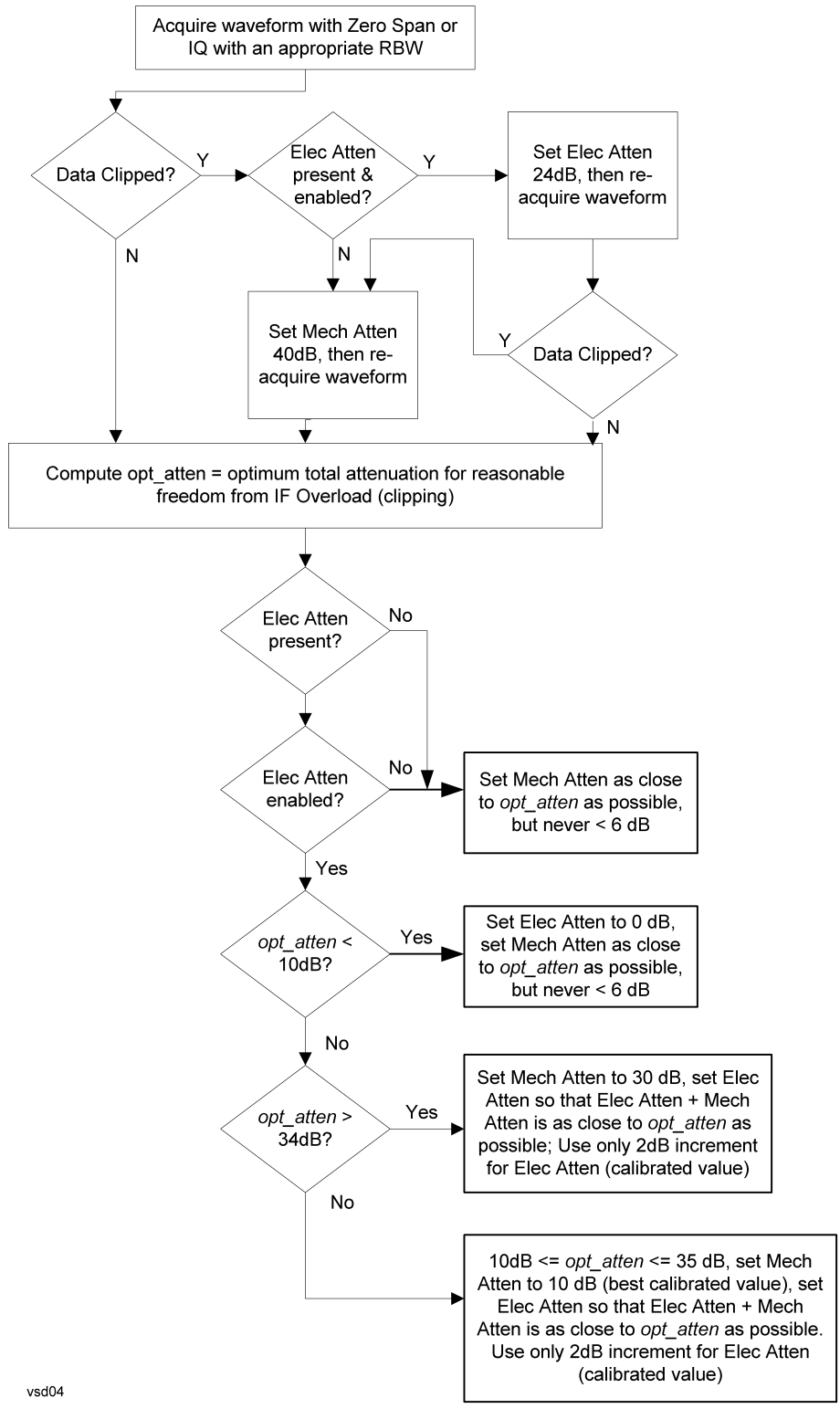

vsd04

"Pre-Adjust for Min Clipping" on page 432 selection is Elec Only.

Note that the **Mech Atten** value is not adjusted, and the value previously set is used. Therefore, there is a case that IF Overload is still observed depending on the input signal level and the Mech Atten setting.

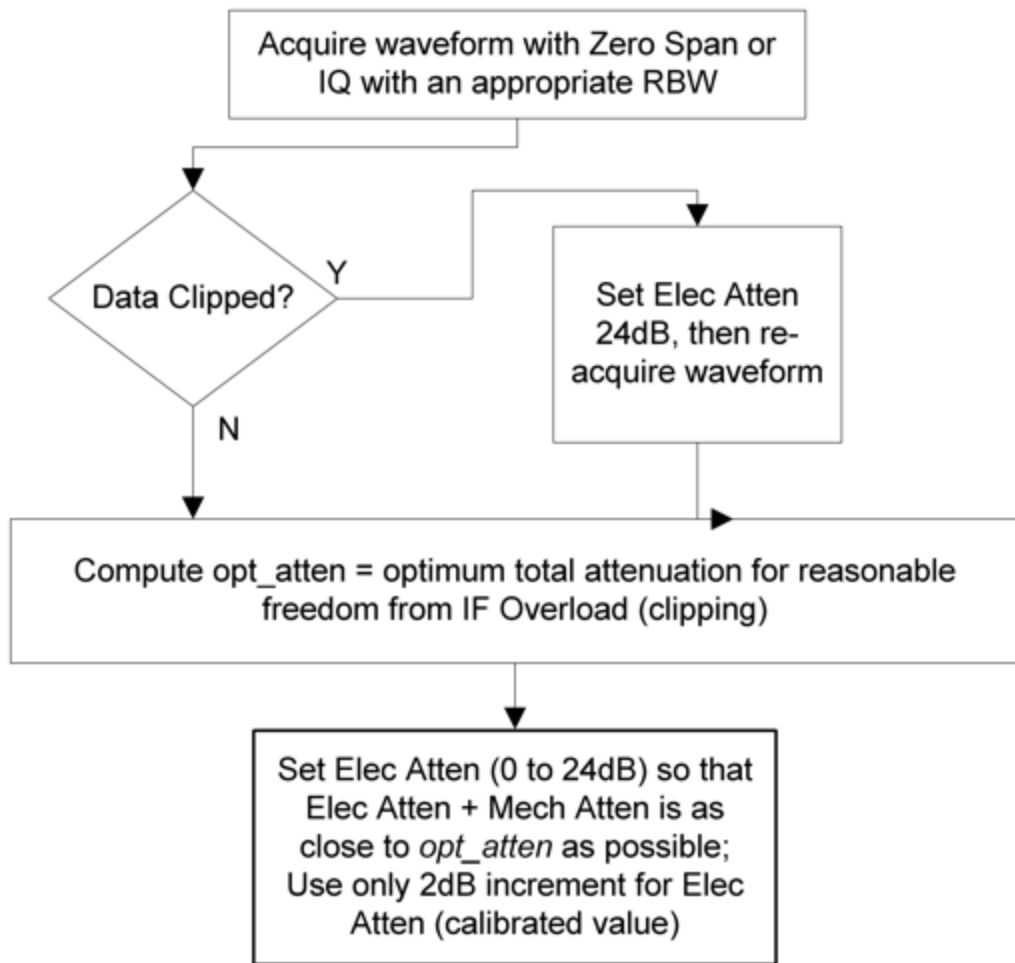

Mech Atten Step

Controls the step size used when making adjustments to the input attenuation.

Labeled **Mech Atten Step** in Dual-Attenuator models and **Atten Step** in Single-Attenuator models. In the Dual-Attenuator configuration, only affects the step size of the mechanical attenuator.

Remote Command `[:SENSe]:POWer[:RF]:ATTenuation:STEP[:INCRement] 10 dB | 2 dB`

3 VMA Mode
3.2 Custom OFDM Measurement

	<code>[:SENSe]:POWer[:RF]:ATTenuation:STEP[:INCRement]?</code>
Example	<code>:POW:ATT:STEP 2</code> <code>:POW:ATT:STEP?</code>
Notes	Has a toggle control on the front panel, but takes a specific value (in dB) when used remotely. The only valid values are 2 and 10
Dependencies	Blanked in EXA, CXA and CXA-m if option FSA (2 dB steps) is not present. If blanked, attempts to set it via SCPI yield an error
Couplings	When the attenuation step size changes, the current mechanical attenuation value is adjusted (if necessary) to be quantized to the new step size. That is, if step is set to 10 dB, mech atten is increased if necessary so it is a multiple of 10 dB
Preset	EXA, CXA and CXA-m: 10 dB (2 dB with option FSA) All other models: 2 dB
State Saved	Saved in instrument state

3.2.3.3 Range (Baseband Input models)

Only available when Option BBA is present (I/Q Baseband Inputs), the current measurement supports option BBA, and I/Q is the selected input. In these cases, replaces the **Attenuation** tab.

Each input channel (I and Q) has four internal gain ranges. The maximum allowed voltage in each gain range is slightly more than the nominal value, so the break point between ranges is a few millivolts higher than the nominal (setting a peak voltage of 0.502 mV will still map to the 0.5 V Peak range).

Gain Setting	Volts RMS	Volts Peak	Volts Peak - Peak	dBm (50Ω)	Break Point
0 dB	0.7071	1.0	2.0	10	n/a
6 dB	0.3536	0.5	1.0	4	0.502 V Peak
12 dB	0.1768	0.25	0.5	-2	0.252 V Peak
18 dB	0.0884	0.125	0.25	-8	0.127 V Peak

Dependencies	Available only when the selected input is I/Q. If the current measurement does not support baseband inputs, an error will be displayed: "No result; Meas invalid with I/Q inputs"
State Saved	No

Range Auto/Man

The **Auto** setting for **Range** causes the range to be set based on the Y Scale settings. When **Range** is **Auto**, the I & Q Range are set based on the top of the Y Scale when the Y scale is in dB units (for example, power), or to the max(abs(top), abs(bottom)) when the Y scale reference is not at the top of the screen.

Not all measurements support **Range Auto/Man**. If **Auto** is not supported in the current measurement, this control is grayed-out, displaying **Man**, and **MAN** is returned to a SCPI query, but this does *not* change the Auto/Man setting for **Range**. When you switch to a measurement that supports **Auto**, it goes back to **Auto** if it was previously in **Auto** mode.

Remote Command	<code>[:SENSe]:VOLTage:IQ:RANGe:AUTO OFF ON 0 1</code> <code>[:SENSe]:VOLTage:IQ:RANGe:AUTO?</code>
Example	Put the I Range and Q Range in manual <code>:VOLT:IQ:RANG:AUTO OFF</code> <code>:VOLT:IQ:RANG:AUTO?</code>
Dependencies	If Auto is not supported, sending the SCPI command generates an error
Couplings	When in Auto , both I Range and Q Range are set to the same value, computed as follows: Maximum absolute value is computed for the Y Scale. The top and bottom of the graph are computed based on Ref Value, Scale/Div, and Ref Position. Formula: $Y_{Max} = \max(\text{abs}(\text{top}), \text{abs}(\text{bottom}))$ The I Range and Q Range are then set to YMax
Preset	ON
State Saved	Saved in instrument state
Annotation	When in Man, the Range annotation is preceded by "#" This is an alternate form of the command to match the POWer form of the I Range and Q Range SCPI.

Remote Command	<code>[:SENSe]:POWer:IQ:RANGe:AUTO OFF ON 0 1</code> <code>[:SENSe]:POWer:IQ:RANGe:AUTO?</code>
Example	Put the I Range and Q Range in manual <code>:POW:IQ:RANG:AUTO OFF</code> <code>:POW:IQ:RANG:AUTO?</code>
Notes	<code>:POW:IQ:RANG:AUTO</code> is an alternate form of <code>:VOLT:IQ:RANG:AUTO</code> , to maintain consistency with I Range and Q Range, which support both the POWer and VOLTage forms of the command
Preset	ON
Range	Auto Man

I Range

The internal gain range for the I channel when the Input Path is I Only or I and I/Q. Used for both the I and Q channels when the Input Path is I+jQ.

Remote Command	<code>[:SENSe]:VOLTage:IQ[:I]:RANGe[:UPPer] <voltage></code> <code>[:SENSe]:VOLTage:IQ[:I]:RANGe[:UPPer]?</code>
Example	Set the I Range to 0.5 V Peak <code>:VOLT:IQ:RANG 0.5 V</code>

3 VMA Mode
3.2 Custom OFDM Measurement

	<code>:VOLT:IQ:RANG?</code>
Notes	The numeric entries are mapped to the smallest gain range whose break point is greater than or equal to the value, or 1 V Peak if the value is greater than 1 V
Couplings	When " Q Same as I " on page 1782 is On, the I Range value will be copied to " Q Range " on page 1781 Changing the value also sets Range = Man
Preset	Complex SPECTrum Measurement: 0.5 V Peak All others: 1 V Peak
State Saved	Saved in instrument state
Range	1 V Peak (10 dBm @ 50 Ω) 0.5 V Peak (4 dBm @ 50Ω) 0.25 V Peak (-2 dBm @ 50Ω) 0.125 V Peak (-8 dBm @ 50Ω)
Min	0.125 V
Max	1 V
Annotation	The Range annotation replaces the RF Input context's "Atten" annotation "Rng: <I Range>". When Range = Man the annotation is preceded by "#" The I Range is not annotated in Input Path Q Only. When I Range and Q Range are the same, the annotation is "Rng: <Range>". When I Range and Q Range are different and the Input Path is Ind I/Q, the annotation is "Rng: <I Range>, <Q Range>" and "Peak" is removed from the text. Examples: "Rng: 1 V Peak" the I Range is 1 V Peak "Rng: 1 V, 0.5 V " the I Range is 1 V Peak and the Q Range is 0.5 V Peak This is an alternate form of the command to allow entry as a power.
Remote Command	<code>[:SENSe]:POWer:IQ[:I]:RANGe[:UPPer] <amp;pl></code> <code>[:SENSe]:POWer:IQ[:I]:RANGe[:UPPer]?</code>
Example	Set the I Range to 0.5 V Peak when Reference Z is 50 Ω, and to 1.0 V Peak when Reference Z is 75 Ω <code>:POW:IQ:RANG 4 dBm</code> <code>:POW:IQ:RANG?</code>
Notes	The POWer form of the command is provided for convenience. It maps to the same underlying gain range parameter as the VOLTage form The Reference Z (not the I channel Input Z) is used to convert the power to peak voltage, which is then used to set the I Range as with the VOLTage form of the command. The power values of the 4 range states (1V Peak, 0.5V Peak, 0.25V Peak, and 0.125V Peak) will vary with Reference Z. Here are some examples: 50 Ω: 10, 4, -2, -8 75 Ω: 8.2, 2.2, -3.8, -9.8 600 Ω: -0.8, -6.8, -12.8, -18.9
Preset	10.0 dBm
Range	-20 dBm to 10 dBm
Min	-20 dBm
Max	10 dBm

Q Range

The internal gain range for the Q channel. **Q Range** only applies to Input Path Q Only and Ind I/Q. For input I+jQ "[I Range](#)" on page 1779 determines both I and Q channel range settings.

Remote Command	<code>[:SENSe]:VOLTage:IQ:Q:RANGe[:UPPer] <voltage></code> <code>[:SENSe]:VOLTage:IQ:Q:RANGe[:UPPer]?</code>
Example	Set the Q Range to 0.5 V Peak: <code>:VOLT:IQ:Q:RANG 0.5 V</code> <code>:VOLT:IQ:Q:RANG?</code>
Notes	The numeric entries are mapped to the smallest gain range whose break point is greater than or equal to the value, or 1 V Peak if the value is greater than 1 V Q Range is only used for Input Path Q Only and Ind I/Q. For input I+jQ, " I Range " on page 1779 determines both I and Q channel range settings
Couplings	When " Q Same as I " on page 1782 is On, the " I Range " on page 1779 value is copied to Q Range and the range value keys are disabled Changing the value also sets Range = Man
Preset	1 V Peak
State Saved	Saved in instrument state
Range	1 V Peak (10 dBm @ 50Ω) 0.5 V Peak (4 dBm @ 50Ω) 0.25 V Peak (-2 dBm @ 50Ω) 0.125 V Peak (-8 dBm @ 50Ω)
Min	0.125 V
Max	1 V
Annotation	The Range annotation replaces the RF Input context's "Atten" annotation "Rng: <Q Range>". When Range = Man the annotation is preceded by "#" The Q Range is not annotated in Input Path I Only or I+jQ. When I Range and Q Range are the same, the annotation is "Rng: <Range>". When I Range and Q Range are different and the Input Path is Ind I/Q, the annotation is "Rng: <I Range>, <Q Range>" and "Peak" is removed from the text. Examples: "Rng: 1 V Peak" the Q Range is 1 V Peak "Rng: 1 V, 0.5 V " the I Range is 1 V Peak and the Q Range is 0.5 V Peak This is an alternate form of the command to allow entry as a power.
Remote Command	<code>[:SENSe]:POWer:IQ:Q:RANGe[:UPPer] <amp;gt;</code> <code>[:SENSe]:POWer:IQ:Q:RANGe[:UPPer]?</code>
Example	Sets the Q Range to 0.5 V Peak when Reference Z is 50 Ω , and to 1.0 V Peak when Reference Z is 75 Ω : <code>:POW:IQ:Q:RANG 4 dBm</code> <code>:POW:IQ:Q:RANG?</code>
Notes	The POWer form of the command is provided for convenience. It maps to the same underlying gain

3 VMA Mode
 3.2 Custom OFDM Measurement

range parameter as the **VOLTage** form of the command

The Reference Z (not the Q channel Input Z) is used to convert the power to peak voltage, which is then used to set the Q Range as with the **VOLTage** form of the command. The power values of the 4 range states (1V Peak, 0.5V Peak, 0.25V Peak, and 0.125V Peak) will vary with Reference Z. Here are some examples:

50 Ω: 10, 4, -2, -8

75 Ω: 8.2, 2.2, -3.8, -9.8

600 Ω: -0.8, -6.8, -12.8, -18.9

Preset	10.0 dBm
Range	-20 dBm to 10 dBm
Min	-20 dBm
Max	10 dBm

Q Same as I

Many, but not all, usages require the I and Q channels to have an identical setup. To simplify channel setup, **Q Same as I** causes the Q channel range to be mirrored from the I channel. That way, you only need to set up one channel (the I channel). The I channel values are copied to the Q channel, so at the time **Q Same as I** is Off, the I and Q channel setups will be identical.

Remote Command	<code>[:SENSe] :VOLTage POWer:IQ:MIRROred OFF ON 0 1</code> <code>[:SENSe] :VOLTage POWer:IQ:MIRROred?</code>
Example	Turn off the mirroring of I Range to Q Range <code>:VOLT:IQ:MIRR OFF</code> <code>:POW:IQ:MIRR OFF</code>
Couplings	When ON , the " I Range " on page 1779 value is mirrored (copied) to the " Q Range " on page 1781
Preset	ON
State Saved	Saved in instrument state
Range	OFF ON

3.2.3.4 Range (Non-attenuator models)

Only available for Keysight's modular signal analyzers and certain other Keysight products, such as VXT and M941xE.

State Saved	No
-------------	----

Range

Represents the amplitude of the largest sinusoidal signal that could be present within the IF without being clipped by the ADC. For signals with high peak-to-average ratios, the range may need to exceed the rms signal power by a significant amount to avoid clipping.

This is a measurement global setting.

Remote Command	<code>[:SENSe]:POWer[:RF]:RANGe <real></code> <code>[:SENSe]:POWer[:RF]:RANGe?</code>
Example	<code>:POW:RANG 10 dBm</code> <code>:POW:RANG?</code>
Notes	The MIN and MAX values are affected by the External Gain parameters, and by the Center Frequency . The hardware compensates for frequency response and alters the Range setting.
Preset	0 dBm
State Saved	Yes
Min/Max	-/+100
Annotation	Meas Bar

Adjust Range for Min Clipping

Sets the combination of attenuation and gain based on the current measured signal level so that clipping will be at a minimum.

This is an "immediate action" function, that is, it executes once, when the key is pressed.

This key does not appear in measurements that do not support this functionality.

Remote Command	<code>[:SENSe]:POWer[:RF]:RANGe:OPTimize IMMEDIATE</code>
Notes	Executing Adjust Range for Min Clipping initiates the measurement.
Dependencies	Does not appear in the Swept SA and Monitor Spectrum measurements.

Pre-Adjust for Min Clipping

If this function is **ON**, it applies the adjustment described under Adjust Range For Min Clipping each time a measurement restarts. Therefore, in Continuous measurement mode, it only executes before the first measurement.

Remote Command	<code>[:SENSe]:POWer[:RF]:RANGe:OPTimize:ATTenuation OFF ON ELECTRICAL COMBined</code>
----------------	---

	<code>[:SENSe]:POWer[:RF]:RANGe:OPTimize:ATTenuation?</code>
Notes	Because there is no attenuator control available in these models, the control displays only ON and OFF choices. However, for SCPI compatibility with other platforms, all three parameters (ELECTrical , COMBined , and ON) are honored and all are mapped to ELECTrical , so if any of these three parameters is sent, a subsequent query will return ELEC
Dependencies	Does not appear in the Swept SA and Monitor Spectrum measurements
Preset	OFF for Swept SA measurement; ON for all other measurements that support Pre-Adjust for Min Clipping
State Saved	Saved in instrument state

Adjustment Algorithm

The algorithm for the adjustment is documented below:

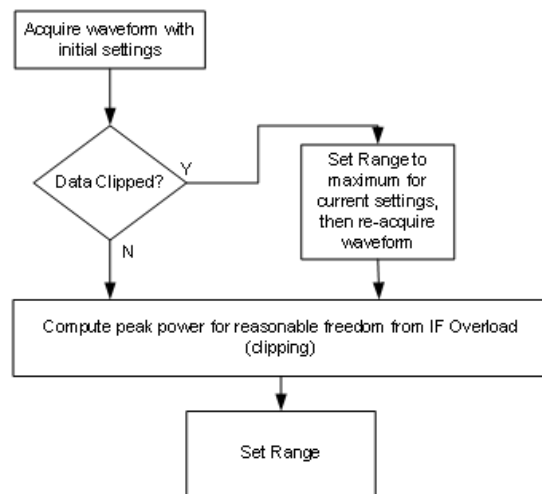

Peak-to-Average Ratio

Used with "[Range \(Non-attenuator models\)](#)" on page 1782 to optimize the level control in the instrument. The value is the ratio, in dB, of the peak power to the average power of the signal to be measured. A ratio of 0 should be used for sinusoidal signals; for 802.11g OFDM signals use 9 dB.

All Modes show the current value of Peak-to-Average ratio on the control. However, some Modes do not permit changing the value. In these situations, the control is grayed-out.

Remote Command	<code>[:SENSe]:POWer[:RF]:RANGe:PARatio <real></code> <code>[:SENSe]:POWer[:RF]:RANGe:PARatio?</code>
Example	<code>:POW:RANG:PAR 12 dB</code>
Notes	In some Modes, this parameter is read-only; meaning the value will appear on the control and query

	via SCPI, but is not changeable. In such applications the control is grayed-out. Attempts to change the value via SCPI are ignored, but no error message is generated	
Dependencies	Does not appear in Spectrum Analyzer Mode	
Preset	VXT Models M9410A/11A	0 dB
	All Others	10 dB
State Saved	Saved in instrument state	
Min	0 dB	
Max	VXT Models M9410A/11A	50 dB
	All Others	20 dB

Mixer Lvl Offset

This is an advanced setting to adjust target Range at the input mixer, which in turn affects the signal level in the instrument's IF. This setting can be used when additional optimization is needed after setting "[Peak-to-Average Ratio](#)" on page 1784. Positive values of offset optimize noise performance over distortion, negative values optimize distortion performance over noise.

Remote Command	<code>[:SENSe]:POWer[:RF]:RANGe:MIXer:OFFSet <real></code> <code>[:SENSe]:POWer[:RF]:RANGe:MIXer:OFFSet?</code>	
Example	<code>:POW:RANG:MIX:OFFS -5 dB</code>	
Preset	0 dB	
State Saved	Saved in instrument state	
Min	VXT Models M9410A/11A	-34 dB
	All Others	-35 dB
Max	30 dB	

3.2.3.5 Signal Path

Contains controls that pertain to the routing of the signal through the frontend of the instrument.

In general, only appears in instruments whose hardware supports this signal routing. For example, this tab does not appear in many of the modular instrument products, including VXT Model M9420A, or UXM.

This tab *does* appear in VXT Models M9410A/11A/15A/16A and M9410E/11E/15E/16E, because ["Software Preselection" on page 1801](#) is under this tab, and VXT Models M9410A/11A/15A/16A and M9410E/11E/15E/16E implement a version of Software Preselection.

Presel Center

Adjusts the centering of the preselector filter to optimize the amplitude accuracy at the frequency of the selected marker. If the selected marker is not on when **Presel Center** is pressed, the instrument turns on the selected marker, performs a peak search, and then performs centering on the marker's center frequency. If the selected marker is already on and between the start and stop frequencies of the instrument, the instrument performs the preselector calibration on that marker's frequency. If the selected marker is already on, but outside the frequency range between **Start Freq** and **Stop Freq**, the instrument first performs a peak search, and then performs centering on the marker's center frequency.

The value displayed on ["Preselector Adjust" on page 1787](#) changes to reflect the new preselector tuning.

Certain considerations should be observed to ensure proper operation, as detailed in ["Proper Preselector Operation" on page 446](#).

Remote Command	<code>[:SENSe] :POWer [:RF] :PCENter</code>
Example	<code>:POW:PCEN</code>
Notes	The rules outlined above under the control description apply for the remote command as well as the key. The result of the command depends on marker position, etc. Any message generated by the control press is also generated in response to the remote command
Dependencies	Does not appear in CXA-m, nor in VXT Models M9410A/11A/15A/16A, M9410E/11E/15E/16E Grayed-out if the microwave preselector is off <ul style="list-style-type: none"> - If the selected marker's frequency is below Band 1, an advisory message is generated "Preselector not used in this frequency range" and no action is taken - Grayed-out if entirely in Band 0, that is, if Stop Freq is below about 3.6 GHz Grayed-out if entirely above 50 GHz, that is, if Start Freq is above 50 GHz - Blanked in models that do not include a preselector, such as Option 503. If the remote command is sent in these instruments, accepted without error, and the query always returns 0 - Grayed-out in the Spectrogram View
Couplings	The active marker position determines where the centering will be attempted If the instrument is in a measurement such as averaging when centering is initiated, the act of centering the preselector restarts averaging, but the first average trace will not be taken until the centering is completed The offset applied to do the centering appears in "Preselector Adjust" on page 1787
Status Bits/OPC	When centering the preselector, *OPC does not return true until the process is complete and a

dependencies subsequent measurement has completed, nor are results returned in response to `:READ` or `:MEASure` queries
The **Measuring** bit remains set (true) while this command is operating, and does not go false until the subsequent sweep/measurement has completed

Proper Preselector Operation

Certain considerations should be observed to ensure proper operation:

1. If the selected marker is **Off**, the instrument turns on a marker, performs a peak search, and adjusts the preselector using the selected marker's frequency. It uses the "highest peak" peak search method unqualified by threshold or excursion, so that there is no chance of a 'no peak found' error. It continues with that peak, even if it is the peak of just noise. Therefore, for this operation to work properly, there should be a signal on-screen in a preselected range for the peak search to find
2. If the selected marker is already **On**, the instrument attempts the centering at that marker's frequency. There is no preselector for signals below about 3.6 GHz, so if the marker is on a signal below 3.6 GHz, no centering is attempted, and an advisory message is generated
3. In some models, the preselector can be bypassed. If it is bypassed, no centering is attempted in that range and a message is generated

Preselector Adjust

Lets you manually adjust the preselector filter frequency to optimize its response to the signal of interest. Only available when **"Presel Center"** on page 1786 is available.

For general purpose signal analysis, using **Presel Center** is recommended. Centering the filter minimizes the impact of long-term preselector drift. **Preselector Adjust** can be used instead to manually optimize the preselector. One application of manual optimization would be to peak the preselector response, which both optimizes the signal-to-noise ratio and minimizes amplitude variations due to small (short-term) preselector drifting.

When **Presel Center** is performed, the offset applied to do the centering becomes the new value of **Preselector Adjust**.

Remote Command	<code>[:SENSe]:POWer[:RF]:PADJust <freq></code> <code>[:SENSe]:POWer[:RF]:PADJust?</code>
Example	<code>:POW:PADJ 100KHz</code> <code>:POW:PADJ?</code>
Notes	The value on the control is displayed to 0.1 MHz resolution
Dependencies	- Does not appear in CXA-m

3 VMA Mode
 3.2 Custom OFDM Measurement

- Does not appear in VXT Models M9410A/11A/15A/16A
- Does not appear in M9410E/11E/15E/16E
- Grayed-out if microwave preselector is off
- Grayed-out if entirely in Band 0, that is, if Stop Freq is lower than about 3.6 GHz
- Grayed-out if entirely above 50 GHz, that is, if Start Freq is higher than 50 GHz
- Blank in models that do not include a preselector, such as Option 503. If the command is sent in these instruments, it is accepted without error, and the query always returns 0
- Grayed-out in the **Spectrogram View**

Preset	0 MHz
State Saved	The Preselector Adjust value set by " Presel Center " on page 1786, or by manually adjusting Preselector Adjust Not saved in instrument state, and does not survive a Preset or power cycle
Min/Max	-/+500 MHz
Backwards Compatibility SCPI	<code>[:SENSe]:POWer[:RF]:MW:PADJust</code> <code>[:SENSe]:POWer[:RF]:MMW:PADJust</code> Backwards Compatibility Command
Notes	The command has no effect, and the query always returns MWAVE
Backwards Compatibility SCPI	<code>[:SENSe]:POWer[:RF]:PADJust:PRESelector MWAVE MMWave EXTERNAL</code> <code>[:SENSe]:POWer[:RF]:PADJust:PRESelector?</code>

Internal Preamp

Accesses a menu of controls for the internal preamps. Turning on the preamp gives a better noise figure, but a poorer inter-modulation distortion (TOI) to noise floor dynamic range. You can optimize this setting for your measurement.

The instrument takes the preamp gain into account as it sweeps. If you sweep outside of the range of the preamp, the instrument will also account for that. The displayed result always reflects the correct gain.

For some measurements, when the preamp is on and any part of the displayed frequency range is below the lowest frequency for which the preamp has specifications, a warning condition message appears in the status line. For example, for a preamp with a 9 kHz lowest specified frequency: "Preamp: Accy unspec'd below 9 kHz".

Selection	Example	Note
Off	:POW:GAIN OFF	
Low Band	:POW:GAIN ON :POW:GAIN:BAND LOW	Sets the internal preamp to use only the low band. The frequency range of the installed (optional) low-band preamp is displayed in square brackets on the Low Band selection in the dropdown
Full Range	:POW:GAIN ON :POW:GAIN:BAND FULL	Sets the internal preamp to use its full range. The low band (0-3.6 GHz, 0-3.4 GHz, 0-3 GHz, depending on the model) is supplied by the low band preamp and the frequencies above low band are supplied by the high band preamp The frequency range of the installed (optional) low-band preamp is displayed in square brackets on the Full Range selection in the dropdown. If the high band option is not installed the Full Range selection does not appear

NOTE

The maximum **Center Frequency for Low Band**, displayed in square brackets, can change based on the selected IFBW for measurements that support IFBW (for example, Waveform measurement across all Modes that support it). In certain models (such as N9042B & N9032B), IFBW values ≤ 40 MHz have a maximum **Low Band** frequency of 3.6 GHz, while $40 \text{ MHz} < \text{IFBW} \leq 1 \text{ GHz}$ have a maximum of 3.3 GHz, and $1 \text{ GHz} < \text{IFBW} \leq 1.5 \text{ GHz}$ have a maximum of 3.5 GHz. IFBW values $> 1.5 \text{ GHz}$ do not support a **Center Frequency** that can reach the **Low Band** maximum frequency. In these cases, **N/A** is displayed in the square brackets for **Low Band**.

Remote Command	<code>[:SENSe]:POWer[:RF]:GAIN:BAND LOW FULL</code> <code>[:SENSe]:POWer[:RF]:GAIN:BAND?</code>
Example	<code>:POW:GAIN:BAND LOW</code> <code>:POW:GAIN:BAND?</code>
Dependencies	Not available on all hardware platforms. If the preamp is not present or is unlicensed, this control is not shown Does not appear in VXT Models M9410A/11A/15A/16A nor in M9410E/11E/15E/16E If <code>:POW:GAIN:BAND FULL</code> is sent when a low band preamp is available, the preamp band parameter is set to <code>LOW</code> instead of <code>FULL</code> , and an "Option not installed" message is generated Not available when the electronic/soft attenuator is enabled
Preset	<code>LOW</code>
State Saved	Saved in instrument state
Annotation	When the USB Preamp is not connected to USB, the Preamp annotation in the Meas Bar says "Off" if the preamp is off and displays the frequency range of the low band or full range preamp depending on the setting. For example, if the Preamp is set to Low Band and the Low Band is 3.6 GHz the annotation says "3.6 GHz". If it is a 13.6 GHz preamp and it is set to Full Range the annotation says "13.6 GHz"

3 VMA Mode
3.2 Custom OFDM Measurement

When the USB Preamp is connected to USB, the Preamp annotation says "Preamp: USB" if the internal preamp is off or "Preamp: USB, Int" if the internal preamp is on (only for measurements that support the USB preamp)

Auto Function

Remote Command	<code>[:SENSe]:POWer[:RF]:GAIN[:STATe] OFF ON 0 1</code> <code>[:SENSe]:POWer[:RF]:GAIN[:STATe]?</code>
Example	<code>:POW:GAIN OFF</code> <code>:POW:GAIN?</code>
Preset	<code>OFF</code>

LNA

Lets you turn the Low Noise Amplifier (**LNA**) on or off.

LNA is an additional preamplifier that provides superior DANL and frequency range compared to "[Internal Preamp](#)" on page 1788. LNA provides lower system noise figure, especially at frequencies above 100 MHz, and can be operated up to the full range of 50 GHz instruments.

For best possible sensitivity, **LNA** can be turned on *together* with "[Internal Preamp](#)" on page 1788, although if you operate both preamps together, note that the TOI (distortion) specifications are impacted. The sensitivity improvement of this combination is substantial when operating in high band (frequencies above 3.6 GHz).

For more details about annotation, see "[More Information](#)" on page 450

Remote Command	<code>[:SENSe]:POWer[:RF]:GAIN:LNA[:STATe] OFF ON 0 1</code> <code>[:SENSe]:POWer[:RF]:GAIN:LNA[:STATe]?</code>
Example	<code>:POW:GAIN:LNA ON</code>
Dependencies	Requires Option LNA, except for VXT models M9415A/16A Does not appear in VXT models M9420A/10A/11A M9410E/11E/15E/16E support LNA May not appear in some measurements LNA is not available when the electronic/soft attenuator is enabled
Preset	<code>OFF</code>
State Saved	Saved in State

More Information

When **LNA** is installed, the preamp annotation changes to show the state of both **LNA** and **Internal Preamp**. Below is an example:

```
Atten: 8 dB
Pre: Int on, LNA on
μW Path: LNP, On
Source: Off
```

Note that when operating entirely in the low band (below about 3.6 GHz), if **LNA** is on, **Internal Preamp** is switched off (even if you have its switch set to **ON**). This is because the noise performance is actually degraded in low band if both preamps are on. In this case, the annotation reflects the actual state of the two preamps, but the **Internal Preamp** annotation displays in amber, to warn you that the actual state of **Internal Preamp** does not match its switch control display:

```
Atten: 8 dB
Pre: Int off, LNA on
μW Path: LNP, On
Source: Off
```

μW Path Control

Options for this control include **μW Preselector Bypass** (Option MPB), **Low Noise Path** (Option LNP) and **Full Bypass Enable** in the High Band path circuits.

When the μW Preselector is bypassed, flatness is improved, but will be subject to spurs from out of band interfering signals. When **Low Noise Path Enable** is selected, the instrument automatically bypasses certain circuitry in the high frequency bands that can contribute to noise, when it is appropriate based on other instrument settings.

For most applications, the preset state is **Standard Path**, which provides the best remote-control throughput, minimizes acoustic noise from switching and minimizes the risk of wear in the hardware switches, particularly in remote test scenarios where both low band and high band setups will follow in rapid succession. In this path, the bypass of the low band/high band switch and microwave preamp is never activated, which can cause some noise degradation but preserves the life of the bypass switch.

For applications that utilize the wideband IF paths, the preset state is **μW Preselector Bypass**, if option MPB is present. This is because, when using a wideband IF such as the 140 MHz IF, the μW Preselector's bandwidth can be narrower than the available IF bandwidth, causing degraded amplitude flatness and phase linearity, so it is desirable to bypass the preselector in the default case.

You may choose **Low Noise Path Enable** for a lower noise floor, especially in the 21-26.5 GHz region, though without improving many measures of dynamic range, and

3 VMA Mode
 3.2 Custom OFDM Measurement

without giving the best possible noise floor. The preamp, if purchased and used, gives better noise floor than does **Low Noise Path Enable**, but the preamp's compression threshold and third-order intercept are much poorer than that of **Low Noise Path Enable**.

A fourth choice is **Full Bypass Enable**, which combines **μW Preselector Bypass** and **Low Noise Path Enable**. Because this can bypass most of the circuitry between the input and the first mixer, care should be taken when using this setting to avoid damaging the mixer. **Full Bypass Enable** is only available if both options LNP and MPB are present, as well as option FBP.

Path	Example	Note
Standard Path	:POW:MW:PATH STD	Normal setting for most measurements. μW Preselector in circuit, Low Noise Path disabled
Low Noise Path Enable	:POW:MW:PATH LNP	See " Low Noise Path Enable " on page 455
μW Preselector Bypass	:POW:MW:PATH MPB	See " μW Preselector Bypass " on page 457
Full Bypass Enable	:POW:MW:PATH FULL	See " Full Bypass Enable " on page 457

Remote Command	<code>[:SENSe]:POWer[:RF]:MW:PATH STD LNPath MPBypass FULL</code> <code>[:SENSe]:POWer[:RF]:MW:PATH?</code>
Example	<code>:POW:MW:PATH LNP</code> Enables the Low Noise path <code>:POW:MW:PATH?</code>
Notes	When " Presel Center " on page 1786 is performed, the instrument momentarily switches to the Standard Path, regardless of the setting of μW Path Control The DC Block will always be switched in when the low noise path is switched in, to protect succeeding circuitry from DC. Note that this does not mean "when the low noise path is enabled" but when, based on the Low Noise Path rules, the path is actually switched in. This can happen when the selection is Low Noise Path Enable or Full Bypass Enable . In the case where the DC Block is switched in, the instrument is now AC-coupled. However, if you selected DC coupling, the UI would still behave as though it were DC-coupled, including all annunciation, warnings, status bits, and responses to SCPI queries. This is because, based on other settings, the instrument could switch out the low noise path at any time and hence go back to being DC-coupled Alignment switching ignores the settings in this menu, and restores them when finished
Dependencies	Does not appear in CXA-m, VXT Models M9410A/11A/15A/16A, nor in M9410E/11E/15E/16E, BBIQ and External Mixing <ul style="list-style-type: none"> - The Low Noise Path Enable selection does not appear unless Option LNP is present and licensed - The μW Preselector Bypass selection does not appear unless Option MPB is present and licensed - The Full Bypass Enable selection does not appear unless options LNP and MPB are both present as well as option FBP

In any of these cases, if the required options are not present and the SCPI command is sent, error - 241, "Hardware missing; Option not installed" is generated

Low Noise Path Enable and **Full Bypass Enable** are grayed-out if the current measurement does not support them

Low Noise Path Enable and **Full Bypass Enable** are not supported in Avionics and MMR Modes (non-modulation measurements). In any of these cases (that is, the feature is not supported in either measurement or Mode), if the SCPI command is sent, the following error is generated: -221, "Setting Conflict; Feature not supported for this measurement"

Preset	Mode	Value
	IQ Analyzer	MPB option present and licensed: MPB
	Pulse	MPB option not present and licensed: STD
	RTSA	
	Avionics	
	All other Modes	STD
	-	

State Saved Save in instrument state

Range Standard Path | Low Noise Path Enable | μ W Presel Bypass | Full Bypass Enable

Annotation In the Meas Bar, if the Standard path is chosen:
 μ W Path: Standard
 If Low Noise Path is enabled but the LNP switch is not thrown:
 μ W Path: LNP,Off
 If the Low Noise Path is enabled and the LNP switch is thrown:
 μ W Path: LNP,On
 If the preselector is bypassed:
 μ W Path: Bypass
 If Full Bypass Enable is selected but the LNP switch is not thrown:
 μ W Path: FByp,Off
 If Full Bypass Enable is selected and the LNP switch is thrown:
 μ W Path: FByp,On

μ W Path Control Auto

In VMA, WLAN, 5G NR, CQM Modes, an **Auto/Man** switch is added to μ W Path Control:



3 VMA Mode
 3.2 Custom OFDM Measurement

This allows the function to automatically switch based on certain Auto Rules as shown below:

VMA Mode

Measurement	μ W Path Control Auto behavior
Digital Demod	Use Standard Path unless tuned frequency > 3.6 GHz and IFBW > 15 MHz, in which case choose Preselector Bypass
Monitor Spectrum	Always Presel Bypass
IQ Waveform	Use Standard Path unless tuned frequency > 3.6 GHz and IFBW > 15 MHz, in which case choose Preselector Bypass
Custom OFDM	Use Standard Path unless tuned frequency > 3.6 GHz and IFBW > 15 MHz, in which case choose Preselector Bypass
Channel Power	Always Presel Bypass
Occupied BW	Always Presel Bypass
CCDF	Use Standard Path unless tuned frequency > 3.6 GHz and IFBW > 15 MHz, in which case choose Preselector Bypass
ACP	Always Presel Bypass
SEM	Always Presel Bypass
Spurious Emissions	Always Standard Path

WLAN Mode

Measurement	μ W Path Control Auto behavior
Modulation Analysis	Always Presel Bypass
Spectral Flatness	Always Presel Bypass
Power vs Time	Always Presel Bypass
Monitor Spectrum	Always Presel Bypass
IQ Waveform	Always Presel Bypass
Channel Power	Always Presel Bypass
Occupied BW	Always Presel Bypass
CCDF	Always Presel Bypass
SEM	For 11be 320M, when 'Enabled Wideband IF for FFT' is OFF or 'Sweep Type Rule' is Best Dynamic Range, auto μ W path is standard For other cases, auto μ W path is presel bypass if presel bypass is enabled, auto μ W path is standard if presel bypass is not enabled
Spurious Emissions	Always Standard Path

5G NR Mode

Measurement	μ W Path Control Auto behavior
Modulation Analysis	Use Standard Path unless tuned frequency > 3.6 GHz and IFBW > 15 MHz, in which case choose Full Bypass if conditions warrant(FBP Option is available and "Allow Full Bypass in Auto" is On), otherwise choose Preselector Bypass
Monitor Spectrum	Always Standard Path
IQ Waveform	Use Standard Path unless tuned frequency > 3.6 GHz and IFBW > 15 MHz, in which case choose Full Bypass if conditions warrant(FBP Option is available and "Allow Full Bypass in Auto" is On), otherwise choose Preselector Bypass
Channel Power	Always Standard Path
Occupied BW	Always Standard Path
CCDF	Use Standard Path unless tuned frequency > 3.6 GHz and IFBW > 15 MHz, in which case choose Preselector Bypass
ACP	Always Standard Path
SEM	Always Standard Path
Spurious Emissions	Always Standard Path
Transmit On Off Power	Use Standard Path unless tuned frequency > 3.6 GHz and Info BW > 15 MHz, in which case choose Preselector Bypass

Channel Quality Mode

Measurement	μ W Path Control Auto behavior
Group Delay	Use Standard Path unless tuned frequency > 3.6 GHz and IFBW > 15 MHz, in which case choose Full Bypass if conditions warrant(FBP Option is available and "Allow Full Bypass in Auto" is On), otherwise choose Preselector Bypass
Monitor Spectrum	Always Standard Path
IQ Waveform	Use Standard Path unless tuned frequency > 3.6 GHz and IFBW > 15 MHz, in which case choose Preselector Bypass
CCDF	Use Standard Path unless tuned frequency > 3.6 GHz and IFBW > 15 MHz, in which case choose Preselector Bypass

Remote Command	<code>[:SENSe]:POWer[:RF]:MW:PATH:AUTO ON OFF 1 0</code> <code>[:SENSe]:POWer[:RF]:MW:PATH:AUTO?</code>
Example	<code>:POW:MW:PATH:AUTO ON</code> <code>:POW:MW:PATH:AUTO?</code>
Dependencies	Only appears in VMA, WLAN, 5G NR and CQM Modes
Couplings	See " μW Path Control Auto " on page 452 above
Preset	ON
Range	ON OFF

Low Noise Path Enable

Low Noise Path Enable provides a lower noise floor under some circumstances, particularly when operating in the 21–26.5 GHz region. With the Low Noise Path enabled, the low band/high band switch and microwave preamp are bypassed whenever *all* the following are true:

- The instrument is not in the Low Band, meaning:
- the start frequency is above 3.5 GHz and
- the stop frequency is above 3.6 GHz
- The internal preamp is not installed, or if installed, is set to **Off** or **Low Band**

Note that this means that, when any part of a sweep is done in Low Band, the Low Noise Path is not used, whether or not the **Low Noise Path Enable** is selected in the user interface. Also, if the preamp is turned on, the Low Noise Path is not used, whether or not the **Low Noise Path Enable** is selected in the user interface. The only time the Low Noise Path is used is when **Low Noise Path Enable** is selected, the sweep is completely in High Band (> 3.6 GHz) and no preamp is in use.

For measurements that use IQ acquisition, the low noise path is used when **Center Frequency** is in High Band (> 3.6 GHz) and no preamp is in use. In other words, the rules above are modified to use only the center frequency to qualify which path to switch in. This is not the case for FFTs in the Swept SA measurement; they use the same rules as swept measurements.

Note that the Low Noise Path, while giving improved DANL, has the disadvantage of decreased TOI performance and decreased gain compression performance relative to the standard path.

Note also that the bypass switch is a mechanical switch and has finite life, so if the **Low Noise Path Enable** is selected, it is possible to cause frequent cycling of this switch by frequently changing instrument settings such that the above conditions hold true only some of the time. A user making tests of this nature should consider opting for the **Standard Path**, which will never throw the bypass switch, at the expense of some degraded noise performance.

The low noise path is useful for situations where the signal level is so low that the instrument performance is dominated by noise even with 0 dB attenuation, but still high enough that the preamp option would have excessive third-order intermodulation or compression. The preamp, if purchased and used, gives better noise floor than does the “Low Noise Path.” However, its compression threshold and third-order intercept are much poorer than that of the non-preamp path.

There are some applications, typically for signals around –30 dBm, for which the third-order dynamic range of the standard path is good enough, but the noise floor is not low enough even with 0 dB input attenuation. When the third-order dynamic

range of the preamp path is too little and the noise floor of the standard path is too high, the Low Noise Path can provide the best dynamic range

The graph below illustrates the concept. It shows, in red, the performance of an instrument at different attenuation settings, both with the preamp on and off, in a measurement that is affected by both instrument noise and instrument TOI. The green shows the best available dynamic range, offset by 0.5 dB for clarity. The blue shows how the best available dynamic range improves for moderate signal levels with the low noise path switched in. In this illustration, the preamp improves the noise floor by 15 dB while degrading the third-order intercept by 30 dB, and the low noise path reduces loss by 8 dB. The attenuator step size is 2 dB.

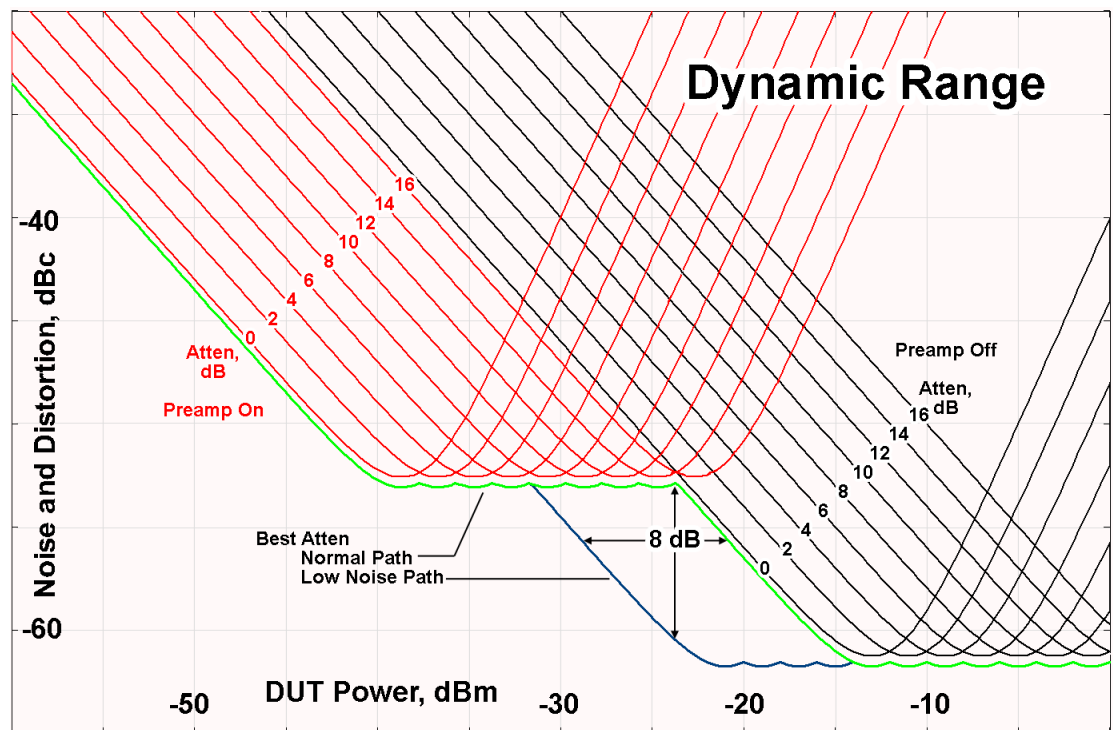

There are other times where selecting the low noise path improves performance, too. Compression-limited measurements such as finding the nulls in a pulsed-RF spectrum can profit from the low noise path in a way similar to the TOI-limited measurement illustrated. Accuracy can be improved when the low noise path allows the optimum attenuation to increase from a small amount like 0, 2 or 4 dB to a larger amount, giving better return loss at the instrument input. Harmonic measurements, such as second and third harmonic levels, are much improved using the low noise path because of the superiority of that path for harmonic (though not intermodulation) distortion performance.

μW Preselector Bypass

Toggles the preselector bypass switch for band 1 and higher. When the microwave preselector is on, the signal path is preselected. When the microwave preselector is off, the signal path is not preselected. The preselected path is the normal path for the instrument.

The preselector is a tunable bandpass filter which prevents signals away from the frequency of interest from combining in the mixer to generate in-band spurious signals (images). The consequences of using a preselector filter are its limited bandwidth, the amplitude and phase ripple in its passband, and any amplitude and phase instability due to center frequency drift.

Option MPB or pre-selector bypass provides an unpreselected input mixer path for certain X-Series signal analyzers with frequency ranges above 3.6 GHz. This signal path allows a wider bandwidth and less amplitude variability, which is an advantage when doing modulation analysis and broadband signal analysis. The disadvantage is that, without the preselector, image signals will be displayed. Another disadvantage of bypassing the preselector is increased LO emission levels at the front panel input port.

Image responses are separated from the real signal by twice the 1st IF. For IF Paths of 10 MHz and 25 MHz, the 1st IF is 322.5 MHz, so the image response and the real signal will be separated by 645 MHz. The 1st IF will be different for other IF Path settings. When viewing a real signal and its corresponding image response in internal mixing, the image response will be to the left of the real signal.

Also, the image response and the real signal typically have the same amplitude and exhibit the same shape factor.

However, if Option FS1 (Fast Sweep Capability) is enabled, the image response in the Swept SA measurement appears lower in amplitude and has a much wider shape factor compared to the real signal.

Full Bypass Enable

With **Full Bypass Enable** selected, the microwave preselector is bypassed. In addition, the low band/high band switch and microwave preamp are bypassed whenever *all* the following are true:

- The instrument is not in the Low Band, meaning:
- the start frequency is above 3.5 GHz and
- the stop frequency is above 3.6 GHz.
- the internal preamp is not installed or if installed, is set to **Off** or **Low Band**

Note that this means that, when any part of a sweep is done in Low Band, the Low Noise Path is not used, whether or not the **Full Bypass Enable** is selected in the user

interface. Also, if the preamp is turned on, the Low Noise Path is not used, whether or not the **Full Bypass Enable** is selected in the user interface. The only time the Low Noise Path is used is when **Full Bypass Enable** is selected, the sweep is completely in High Band (> 3.6 GHz) and no preamp is in use.

CAUTION

When **Full Bypass Enable** is selected, and "**Y Scale**" on page 1760 is set to 0 dB, there will be a direct AC connection between the input and the first converter when the Low Noise Path switches in (when Start Freq >3.6 GHz and the Preamp is either not licensed, set to Low Band, or Off). This puts the first converter at considerable risk to be damaged by high AC power. Consequently, whenever **Full Bypass Enable** is selected, a warning message appears in the status bar:

"Full Bypass Enabled, maximum safe input power reduced"

Microwave Preselector Bypass Backwards Compatibility

Example	Bypass the microwave preselector: <code>:POW:MW:PRES OFF</code>
Notes	Included for Microwave Preselector Bypass backwards compatibility The ON parameter sets the STD path (<code>:POW:MW:PATH STD</code>) The OFF parameter sets path MPB (<code>:POW:MW:PATH MPB</code>)
Preset	ON
Backwards Compatibility SCPI	<code>[:SENSe]:POWer[:RF]:MW:PRESelector[:STATe] ON OFF 0 1</code> <code>[:SENSe]:POWer[:RF]:MW:PRESelector[:STATe]?</code>

Frequency Extender Preselection Bypass

Only applies to the high frequency path of the Frequency Extender, and only if the Frequency Extender allows it. For example, the V3050A high frequency path is 50 – 110 GHz and *does* allow control of the preselector bypass.

When the Frequency Extender's preselection is bypassed, flatness is improved, but will be subject to spurs from out-of-band interfering signals. For bandwidths greater than 2.5 [GHz], it is recommended that the signal bypass the Frequency Extender Preselector since the max bandwidth of the Preselector can be as narrow as 2.5 [GHz].

For most applications, the preset state is **OFF**, which gives the best remote-control throughput, minimizes acoustic noise from switching, minimizes out of band spurs, and minimizes the risk of wear in the hardware switches.

Preselector and Bandwidth Conflict

When the Frequency Extender Preselector is applied and the signal bandwidth is greater than 2.5 [GHz], then a settings alert message will show to warn the user that the signal may be distorted due to the limitation of the Frequency Extender Preselector bandwidth.

An example of the settings alert message is shown below.

Settings Alert message in the Status Bar at the bottom of the display.



Settings Alert message in the error queue

Type	ID	
	159	Settings Alert - DETECTED; Presel/Meas BW conflict

Allow Full Bypass in Auto

Enable or disable Full Bypass in μ W Path Auto rule. See " [\$\mu\$ W Path Control](#)" on page 1791.

When this function is **ON**, and " [\$\mu\$ W Path Control](#)" on page 1791 is in **AUTO**, it is possible for the auto rules to select the **FULL** Bypass state, which bypasses both the Preamp and the Microwave Preselector. Otherwise, the auto rules never select the **FULL** Bypass state. This is convenient when making wideband measurements, but it also adds some risk of damage to the first converter.

CAUTION

When **Full Bypass Enable** is selected, and "[Y Scale](#)" on page 1760 is set to 0 dB, there will be a direct AC connection between the input and the first converter when the Low Noise Path switches in (when Start Freq > 3.6 GHz and the Preamp is either not licensed, set to **Low Band** or **Off**). This puts the first converter at considerable risk to be damaged by high AC power. Consequently, whenever **Full Bypass Enable** is selected, a warning message appears in the status bar:

"Full Bypass Enabled, maximum safe input power reduced"

Remote Command `[:SENSe] :POWer [:RF] :MW :PATH :AUTO :FULL ON | OFF | 1 | 0`
`[:SENSe] :POWer [:RF] :MW :PATH :AUTO :FULL ?`

Example	<code>:POW:MW:PATH:AUTO:FULL ON</code> <code>:POW:MW:PATH:AUTO:FULL?</code>
Dependencies	Only appears if Option FBP is installed, and in the following measurements <ul style="list-style-type: none"> - 5GNRMode: Modulation Analysis and IQ Waveform - WLAN Mode: IQ Waveform - Channel Quality Mode: Group Delay and Noise Power Ratio
Preset	<code>OFF</code>
State Saved	Saved in instrument state

Software Preselection

Provided in some instruments, either to compensate for issues with provided hardware preselection or to provide the preselection function when there is no hardware preselector.

N9041B

Software Preselection compensates for the frequency range limit of the microwave preselector. Since the microwave preselector only goes up to 50 GHz, software preselection must be used to suppress and separate images above 50 GHz. The specific algorithm used for software preselection is specified by the SW Preselection Type selection – Normal or Advanced.

In N9041B, **Software Preselection** only applies for frequencies above 50 GHz, therefore it is only used for RF Input 2. Even if turned on, it is not used for other inputs, and never for frequencies below 50 GHz. This is why the label of this control contains the parenthetical note “(>~50 GHz)”.

Note that in N9041B, in Swept SA measurement, **Software Preselection** works even if the measurement is using an FFT Sweep Type. In measurements other than Swept SA, Software Preselection is not used if the measurement is using an FFT sweep type.

N9042B+V3050A

Software Preselection compensates for the frequency range limit of the microwave preselector. Since the microwave preselector only goes up to 50 GHz, software preselection must be used to suppress and separate images above 50 GHz. The specific algorithm used for software preselection is specified by the SW Preselection Type selection – Normal or Advanced.

For N9042B+V3050A, Software Preselection only applies for frequencies above 50 GHz, therefore it is only used for External RF. Even if it is turned on, it will not be

3 VMA Mode
 3.2 Custom OFDM Measurement

used for other inputs and never for frequencies below 50 GHz. This is why the label of this control contains the parenthetical note “(>~50 GHz)”.

Note that for N9042B+V3050A, in the Swept SA measurement, Software Preselection works even if the measurement is using an FFT Sweep Type. In measurements other than Swept SA, Software Preselection is not used if the measurement is using an FFT Sweep Type.

VXT models M9410A/11A/15A/16A

Software Preselection is used to provide the preselection function, as there is no hardware preselector in these models. Two background traces are taken and compared point by point, and the point with the lowest amplitude from the two traces is used. This provides a method to reduce spurs that are internally generated within the VXT, but you should note the following when using Software Preselection:

- There is some speed cost due to the need to take multiple captures
- Taking the point with the lowest amplitude in each trace will make the average noise level lower at all points that do not have a spur. This can reduce the accuracy of the measurement of noise and noise-like signals

Because of the difficulty in identifying spurs manually, you are recommended to leave Software Preselection **ON** at all times in VXT models M9410A/11A. If you turn it off in order to speed up your measurement or improve noise accuracy, be aware of unwanted onscreen spurs.

Remote Command	<code>[:SENSe]:POWer[:RF]:SWPResel:STATe 0 1 ON OFF</code> <code>[:SENSe]:POWer[:RF]:SWPResel:STAT?</code>
Example	<code>:POW:SWPR:STAT 1</code> <code>:POW:SWPR:STAT?</code>
Dependencies	Only appears in N9041B, N9042B+V2050A, VXT models M9410A/11A and M9410E/11E. Does not appear in all measurements
Couplings	Affects Sweep Time Auto Tune supports Software Preselection , so Auto Tune should be performed after setting the Software Preselection state
Preset	N9041B OFF N9042B+V3050A ON M9410A/11A ON
State Saved	Saved in instrument state

SW Preselection Type

Specifies the algorithm used for software preselection.

Two hidden sweeps occur in succession. The second sweep is offset in LO frequency by $2 * IF / N$. For each point in each trace, the smaller amplitude from the two traces is taken and placed in that point in the selected trace. The Peak detector is auto-selected to improve the image suppression effectiveness. Responses of each trace that lie on top of one another will remain and are valid signals. Other signals are images, which are suppressed. The action of taking the smaller of the two traces will make the average noise level lower in all points that do not have an image, thus reducing the accuracy of the measurement of noise and noise-like signals.

- **NORMa1** - mathematically removes all image and multiple responses of signals present at the input
- **ADVanced** - any trace processing (such as “max hold” or trace averaging) is performed on the points of both candidate traces before the “select minimum” operation occurs. This form of processing works better for non-stationary signals, such as pulsed-RF signals

Remote Command	<code>[:SENSe]:POWer[:RF]:SWPreSel NORMa1 ADVanced</code> <code>[:SENSe]:POWer[:RF]:SWPreSel?</code>
Example	<code>:POW:SWPR NORM</code> <code>:POW:SWPR?</code>
Dependencies	Only appears in N9041B and N9042B+V3050A. Only appears in measurements that use the Swept method Grayed-out when "Software Preselection" on page 1801 is OFF. The grayout message is “Unavailable unless SW Presel enabled”
Preset	N9041B ADVanced N9042B+V3050A NORMa1
State Saved	Saved in instrument state

SW Preselection BW

Specifies the effective bandwidth to be used for Software Preselection.

The options are:

- **NORMa1** – when making Swept measurements, a software preselection algorithm is used which takes up to 4 background acquisitions, then post-processes the result. This algorithm can remove images from signals with an occupied

3 VMA Mode
 3.2 Custom OFDM Measurement

bandwidth up to around 3 GHz. (Default/Preset setting). When making FFT measurements, this algorithm is not used, instead the same algorithm is used as for **NARRow** (below)

- **NARRow**– a software preselection algorithm is used which takes two background acquisitions, then post-processes the result to detect and remove images from wideband signals with occupied bandwidths up to 2 GHz. This increases the risk of images failing to be rejected, but improves the measurement speed

Remote Command	<code>[:SENSe]:POWer[:RF]:SWPreSel:BW NORMa1 NARRow</code> <code>[:SENSe]:POWer[:RF]:SWPreSel:BW?</code>
Example	<code>:POW:SWPR:BW NARR</code>
Dependencies	Only appears in N9041B and N9042B+V3050A. Only appears in measurements that use the Swept method Grayed-out when " Software Preselection " on page 1801 is OFF . The grayout message is "Unavailable unless SW Presel enabled" For N9042B+V3050A, the parameter is SCPI-only, and always set to NARRow when Software Preselection is enabled
Preset	N9041B NORMa1 N9042B+V3050A NARRow
State Saved	Saved in instrument state

High Freq Prefilter

Lets you set the state of Prefilter for center frequencies above 1310 MHz.

In VXT Models M9410A/11A and M9410E/11E in bypass frequency range (1310MHz~5GHz), the Receiver RF path has a bank of filters that come after the RF Attenuator in the signal path. Since this bank of filters precedes the mixer they are known as the "Prefilter" bank. Their purpose is to eliminate unwanted in-band mixing products by filtering out all but the desired frequencies before the signals get to the mixer. There are 13 prefilter bands to cover the frequencies between 9 kHz and 6000 MHz. The Prefilter provides the necessary rejection of the unwanted signal.

Remote Command	<code>[:SENSe]:<measurement>:PFILter[:STATe] ON OFF 1 0</code> <code>[:SENSe]:<measurement>:PFILter[:STATe]?</code>
Example	Enable High Freq Prefilter for the Complex Spectrum Measurement in BASIC Mode: <code>:SPEC:PFIL ON</code> Enable High Freq Prefilter for the IQ Waveform Measurement, in multiple Modes: <code>:WAV:PFIL ON</code>

	Enable High Freq Prefilter for the Swept SA Measurement in SA Mode: :SAN:PFIL ON
Dependencies	Only appears in VXT models M9410A/11A with center frequency above 1310 MHz, and M9410E/11E in frequency range 1310MHz~5GHz
Preset	See " Prefilter Presets " on page 464 below
State Saved	Saved in instrument state

Prefilter Presets

Meas	Mode	Preset
SPEC	BASIC	OFF
WAV	BASIC, WCDMA, WLAN, LTEAFDD, LTEATDD, 5GNR, VMA	OFF
MON	WCDMA, WLAN, LTEAFDD, LTEATDD, 5GNR, VMA	OFF
RHO	WCDMA	OFF
CDP	WCDMA	OFF
PCON	WCDMA	OFF
EVMQ	WCDMA	OFF
CHP	WCDMA, WLAN, LTEAFDD, LTEATDD, 5GNR, VMA, SA	OFF
OBW	WCDMA, WLAN, LTEAFDD, LTEATDD, 5GNR, VMA, SA	OFF
ACP	WCDMA, LTEAFDD, LTEATDD, 5GNR, VMA, SA	OFF
SEM	WCDMA, WLAN, LTEAFDD, LTEATDD, 5GNR, VMA, SA	OFF
PST	WCDMA, WLAN, LTEAFDD, LTEATDD, 5GNR, VMA, SA	OFF
PVT	WLAN, LTEAFDD, LTEATDD, 5GNR	OFF
EVM	WLAN, LTEAFDD, LTEATDD, 5GNR	OFF
FLAT	WLAN	OFF
EVMM	WLAN	OFF
CEVM	LTEAFDD, LTEATDD	OFF
PAVT	5GNR, VMA	OFF
DDEM	VMA	OFF
OFDM	VMA	OFF
SAN	SA	ON
HARM	SA	ON

3.2.4 BW

BW is not supported in this measurement.

3.2.5 Display

Opens the **Display** menu, which enables you to configure display items for the current Mode, Measurement View or Window.

3.2.5.1 Meas Display

Contains controls for setting up the display for the current Measurement, View or Window.

Display Null Subcarriers

Enables/disables display of null subcarriers in IQ traces. Null subcarriers have zero amplitude; often this is just the DC subcarrier.

Remote Command	<code>:DISPlay:OFDM:NULL:SUBCarrier OFF ON 0 1</code> <code>:DISPlay:OFDM:NULL:SUBCarrier?</code>
Example	<code>:DISP:OFDM:NULL:SUBC 1</code> <code>:DISP:OFDM:NULL:SUBC?</code>
Preset	OFF
State Saved	Yes
Range	OFF ON

Display Data Subcarriers

Enables/disables display of data subcarriers in IQ traces.

Remote Command	<code>:DISPlay:OFDM:DATA:SUBCarrier OFF ON 0 1</code> <code>:DISPlay:OFDM:DATA:SUBCarrier?</code>
Example	<code>:DISP:OFDM:DATA:SUBC 1</code> <code>:DISP:OFDM:DATA:SUBC?</code>
Preset	ON
State Saved	Yes
Range	OFF ON

Display Pilot Subcarriers

Enables/disables display of pilot subcarriers in IQ traces.

Remote Command	<code>:DISPlay:OFDM:PILot:SUBCarrier OFF ON 0 1</code> <code>:DISPlay:OFDM:PILot:SUBCarrier?</code>
Example	<code>:DISP:OFDM:PIL:SUBC 1</code> <code>:DISP:OFDM:PIL:SUBC?</code>
Preset	ON
State Saved	Yes
Range	OFF ON

Display Preamble Subcarriers

Enables/disables display of preamble subcarriers in IQ traces.

Remote Command	<code>:DISPlay:OFDM:PREamble:SUBCarrier OFF ON 0 1</code> <code>:DISPlay:OFDM:PREamble:SUBCarrier?</code>
Example	<code>:DISP:OFDM:PRE:SUBC 1</code> <code>:DISP:OFDM:PRE:SUBC?</code>
Preset	ON
State Saved	Yes
Range	OFF ON

Display Sync Correlation in Percent

Enables/disables display of sync correlation values in percent. When true, sync correlation values are displayed in percent.

Remote Command	<code>:DISPlay:OFDM:SYNC:CORRelation:PERCent OFF ON 0 1</code> <code>:DISPlay:OFDM:SYNC:CORRelation:PERCent?</code>
Example	<code>:DISP:OFDM:SYNC:CORR:PERC 1</code> <code>:DISP:OFDM:SYNC:CORR:PERC?</code>
Preset	OFF
State Saved	Yes
Range	OFF ON

Display EVM in Percent (SCPI only)

Enables/disables display of EVM in percent. When false, the EVM values are displayed in dB.

Remote Command	<code>:DISPlay:OFDM:EVM:PERCent OFF ON 0 1</code>
----------------	---

3 VMA Mode
3.2 Custom OFDM Measurement

	<code>:DISPlay:OFDM:EVM:PERCent?</code>
Example	<code>:DISP:OFDM:EVM:PERC ON</code> <code>:DISP:OFDM:EVM:PERC?</code>
Preset	ON
State Saved	Yes
Range	OFF ON

3.2.5.2 View

Contains controls for selecting the current **View**, and for editing User Views.

View

See "Views" on page 412

User View

Lets you choose a View from the saved User Views for the current measurement. This panel only appears if a User View exists for the current measurement.

Remote Command	<code>:DISPlay:VIEW:ADVanced:SElect <alphanumeric></code> <code>:DISPlay:VIEW:ADVanced:SElect?</code>
Example	Select Baseband as the current View <code>:DISP:VIEW:ADV:SEL "Baseband"</code>
Notes	<p>You must be in the measurement whose View you are trying to set to send the command. You can only set Views for the current measurement using this command</p> <p>For predefined views, the parameter is derived from the view name that is shown in the View list in the user interface. For example, if you are trying to select the Trace Zoom view in the Swept SA measurement, you send:</p> <pre><code>:DISP:VIEW:ADV:SEL "Trace Zoom"</code></pre> <p>because "Trace Zoom" is the name of the View as seen in the Mode/Meas dialog or in the Display, View menu</p> <p>You <i>cannot</i> use the legacy View parameter (which in this case would be <code>TZOom</code>) with</p> <pre><code>:DISP:VIEW:ADV:SEL</code></pre> <p><code><alphanumeric></code> is case insensitive; you can specify mixed case, however the name will be evaluated on a single case. Thus, both of the following forms work:</p> <pre><code>:DISP:VIEW:ADV:SEL "Trace Zoom"</code> <code>:DISP:VIEW:ADV:SEL "TRACE ZOOM"</code></pre> <p>If the specified view is not a valid View, the query returns the error message "-224, Illegal parameter value; View with the name <alphanumeric> does not exist"</p>

	If the display is disabled (via <code>:DISP:ENAB OFF</code>) then the error message “-221, Settings conflict; View SCPI cannot be used while Display is disabled” is generated
Backwards Compatibility SCPI	The legacy node <code>:DISPlay:VIEW[:SElect]</code> is retained for backwards compatibility, but it only supports predefined views

Restore Layout to Default

Restores the Layout to the default for Basic.

Modified Views are very temporary; if you exit the current measurement they are discarded, and they are not saved in State. To retain this View for later use, and to be able to return easily to your original Basic View, you can save your edited View as a “User View”.

Save Layout as New View

Saves your new View as a User View. An alpha keyboard appears, which lets you name your new View; the default is the old View name plus a number.

Remote Command	<code>:DISPlay:VIEW:ADVanced:NAME <alphanumeric></code>
Example	<code>:DISP:VIEW:ADV:NAME “Baseband”</code> Creates a new View named Baseband from the current View, and selects it as the current View
Notes	<code><alphanumeric></code> is case insensitive; you can specify mixed case, however the name will be evaluated on a single case If <code><alphanumeric></code> name already exists as a View, the error message “-224, Illegal parameter value; View <alphanumeric> already exists” is generated If the display is disabled (via <code>:DISP:ENAB OFF</code>) then the error message “-221, Settings conflict; User View SCPI cannot be used while Display is disabled” is generated

Re-Save User View

You can re-edit a User View; if you make changes, then an asterisk will appear next to the User View’s name. You can then tap **Re-Save User View** to save it back to its existing name, or **Save Layout as New View** to add another, new User View.

This is a front panel function only, there is no remote command available to perform this function. To do this remotely, you must first perform **Save Layout as New View**, then delete the old User View and rename the new one with the name of the View you just deleted.

Rename User View

You can rename the current View by giving it a new unique name. Only User Views can be renamed, if the current View is a Predefined View, an error occurs.

Remote Command	<code>:DISPlay:VIEW:ADVanced:REName <alphanumeric></code>
Example	<code>:DISP:VIEW:ADV:REN "Baseband"</code>
Notes	<p><code><alphanumeric></code> is case insensitive; you can specify mixed case, however the name will be evaluated on a single case</p> <p>If the <code><alphanumeric></code> specifying the new name is already present in the list of View names, the error message "-224, Illegal parameter value; View <alphanumeric> already exists" is generated</p> <p>If the current View is a Predefined View, the error message "-224, Illegal parameter value; Cannot rename a Predefined View" is generated</p> <p>If the display is disabled (via <code>:DISP:ENAB OFF</code>) then the error message "-221, Settings conflict; View SCPI cannot be used while Display is disabled" is generated</p>

Delete User View

You can delete the current View if it is a User View. The default view becomes the current view for the Measurement.

Remote Command	<code>:DISPlay:VIEW:ADVanced:DElete</code>
Example	<code>:DISP:VIEW:ADV:DEL</code>
Notes	<p><code><alphanumeric></code> is case insensitive; you can specify mixed case, however the name will be evaluated on a single case</p> <p>If the <code><alphanumeric></code> is not present in the list of View names, the error message "-224, Illegal parameter value; View <alphanumeric> does not exist" is generated</p> <p>If the current View is a Predefined View, the error message "-224, Illegal parameter value; Cannot delete a Predefined View" is generated</p> <p>If the display is disabled (via <code>:DISP:ENAB OFF</code>) then the error message "-221, Settings conflict; View SCPI cannot be used while Display is disabled" is generated</p>

Delete All User Views

Deletes all previously saved User Views. The default view becomes the current view for the Measurement if a User View was the current view when this command was executed.

Remote Command	<code>:DISPlay:VIEW:ADVanced:DElete:ALL</code>
----------------	--

Example	<code>:DISP:VIEW:ADV:DEL:ALL</code>
Notes	Disabled if there are no User Views

View Editor Remote Commands

The following remote commands help you manage Views and User Views. Note that the SCPI node for User Views handles both Predefined and User Views. The legacy nodes, `:DISPlay:VIEW[:SElect]` and `:DISPlay:VIEW:NSEL`, are retained for backwards compatibility, but they only support predefined views.

View Listing Query

Returns a string containing a comma-separated list of names for *all* the Views, including User Views, available for the current Measurement.

Remote Command	<code>:DISPlay:VIEW:ADVanced:CATalog?</code>
Example	<code>:DISP:VIEW:ADV:CAT?</code>
Notes	<p>Returns a quoted string of the available Views for the current measurement, separated by commas. The list includes names for <i>all</i> the Views, including User Views, available for the current Measurement</p> <p>Example: <code>"Normal,Trace Zoom,Spectrogram,Baseband,myView1,yourView1"</code></p> <p>No distinction is made between Predefined and User Views</p> <p>If you switch measurements with the display disabled (via <code>:DISP:ENAB OFF</code>), then query the list of available Views, the result is undefined</p>

User View Listing Query

Returns a string containing a comma-separated list of names for *only* the User Views available for the current Measurement.

Remote Command	<code>:DISPlay:VIEW:ADVanced:USER:CATalog?</code>
Example	<code>:DISP:VIEW:ADV:USER:CAT?</code>
Notes	<p>Returns a quoted string of the available User Views for the current measurement, separated by commas.</p> <p>Example: <code>"Baseband,myView1,yourView1"</code></p> <p>If you switch measurements with the display disabled (see "Display Enable (Remote Command Only)" on page 1812), then query the list of available Views, the result is undefined</p>

3.2.5.3 Annotation

Contains controls for setting up the annotation for the current Mode or Measurement.

Graticule

Turns the display graticule On or Off for all windows with graticules in all measurements in the current Mode. Also turns the graticule Y-Axis annotation on and off.

Remote Command	<code>:DISPlay:GRATicule[:STATe] OFF ON 0 1</code> <code>:DISPlay:GRATicule[:STATe]?</code>
Example	<code>:DISP:GRAT OFF</code>
Notes	The graticule is the set of horizontal and vertical lines that make up the grid/divisions for the X-Axis and Y-Axis
Preset	ON
State Saved	Saved in instrument state
Backwards Compatibility SCPI	<code>:DISPlay:WINDow[1]:TRACe:GRATicule:GRID[:STATe] OFF ON 0 1</code> <code>:DISPlay:WINDow[1]:TRACe:GRATicule:GRID[:STATe]?</code> This command is accepted for backwards compatibility with older instruments, but the WINDow , TRACe and GRID parameters are ignored

Screen Annotation

Controls the display of the annunciation and annotation around the graticule, including any annotation on lines (such as the display line, the threshold line, etc.) and the Y-Axis annotation, for all windows with screen annotation in all measurements in the current Mode.

This does *not* include marker annotation (or the N dB result). When **OFF**, the graticule expands to fill the entire graticule area, leaving only the 1.5% gap above the graticule, as described in the **Trace** section.

Remote Command	<code>:DISPlay:ANNotation:SCReen[:STATe] OFF ON 0 1</code> <code>:DISPlay:ANNotation:SCReen[:STATe]?</code>
Example	<code>:DISP:ANN:SCR OFF</code>
Dependencies	Grayed-out and forced to OFF when System Display Settings, Annotation is OFF
Preset	ON This remains OFF through a Preset when System Display Settings, Annotation is set to OFF
State Saved	Saved in instrument state

Trace Annotation

Turns on and off the labels on the traces, showing their detector (or their Math Mode) as described in the **Trace** section, for all windows in all measurements in the current Mode for which Trace Annotation on/off is supported.

If Trace Math is being performed on a trace, then the Trace Math annotation replaces the detector annotation.

For measurements that support limit lines, this key also turns on and off the labels on the Limit Lines. The label is the Limit number annotation and Limit Comment displayed on the graph. If the length of the comment is greater than 20 characters, the first 8 characters and the last 8 characters are displayed, joined with

Remote Command	<code>:DISPlay:ANNotation:TRACe[:STATe] ON OFF 1 0</code> <code>:DISPlay:ANNotation:TRACe[:STATe]?</code>
Example	<code>:DISP:ANN:TRAC OFF</code>
Preset	<code>OFF</code>
State Saved	Saved in instrument state

Control Annotation

Turns on and off the display of values on the Active Function controls for all measurements in the current Mode. This is a security feature.

Remote Command	<code>:DISPlay:ACTivefunc[:STATe] ON OFF 1 0</code> <code>:DISPlay:ACTivefunc[:STATe]?</code>
Example	<code>:DISP:ACT OFF</code>
Dependencies	Grayed out and forced to <code>OFF</code> when System Display Settings, Annotation is <code>OFF</code>
Preset	<code>ON</code> This remains <code>OFF</code> through a Preset when System Display Settings, Annotation is set to <code>OFF</code>
State Saved	Saved in instrument state

Meas Bar

Turns the Measurement Bar at the top of the screen on and off for all measurements in the current Mode. When `OFF`, the graticule area expands to fill the area formerly occupied by the Measurement Bar.

Remote Command	<code>:DISPlay:ANNotation:MBAR[:STATe] OFF ON 0 1</code> <code>:DISPlay:ANNotation:MBAR[:STATe]?</code>
----------------	--

Example	<code>:DISP:ANN:MBAR OFF</code>
Dependencies	Grayed out and forced to OFF when System Display Settings, Annotation is OFF
Preset	ON This remains OFF through a Preset when System Display Settings, Annotation is set to OFF
State Saved	Saved in instrument state

Display Enable (Remote Command Only)

Turns the display on/off, including the display drive circuitry. The backlight stays lit to confirm that the instrument is on. The display enable setting is mode global. There are three reasons for turning the display off:

1. To increase speed as much as possible by freeing the instrument from having to update the display
2. To reduce emissions from the display, drive circuitry
3. For security purposes

If you have turned off the display:

- and you are in local operation, the display can be turned back on by pressing any key or by sending `:SYSTEM:DEFAULTS MISC` or `:DISPLAY:ENABLE ON` (neither `*RST` nor `:SYSTEM:PRESET` enable the display)
- and you are in remote operation, the display can be turned back on by pressing the **Local** or **Esc** keys, or by sending `:SYSTEM:DEFAULTS MISC` or `:DISPLAY:ENABLE ON` (neither `*RST` nor `:SYSTEM:PRESET` enable the display)
- and you are using either the `:SYSTEM:KLOCK` command or GPIB local lockout, then *no* front-panel key press will turn the display back on. You must turn it back on remotely.

If the display is **OFF**, many SCPI commands related to User Views and Multiscreen functionality do not work, and return the error messages “-221, Settings conflict; Screen SCPI cannot be used when Display is disabled” or “221, Settings conflict; View SCPI cannot be used while Display is disabled”. These commands include:

Name	Command
Select User View	<code>:DISPLAY:VIEW:ADVANCED:SELECT</code>
Rename User View	<code>:DISPLAY:VIEW:ADVANCED:RENAME</code>
Delete User View	<code>:DISPLAY:VIEW:ADVANCED:DELETE</code>
Create User View	<code>:DISPLAY:VIEW:ADVANCED:NAME</code>
Select Screen	<code>:INSTRUMENT:SCREEN:SELECT</code>
Delete Screen	<code>:INSTRUMENT:SCREEN:DELETE</code>

Name	Command
Delete All But This Screen	:INSTrument:SCReen:DELeTe:ALL
Add Screen	:INSTrument:SCReen:CREate
Rename Screen	:INSTrument:SCReen:REName
Sequencer On/Off	:SYSTem:SEQuencer
Remote Command	:DISPlay:ENABle OFF ON 0 1 :DISPlay:ENABle?
Example	:DISP:ENAB OFF
Couplings	:DISP:ENAB OFF turns Backlight OFF and :DISP:ENAB ON turns Backlight ON, but changing Backlight settings does <i>not</i> change the state of :DISP:ENAB
Preset	ON Set by :SYST:DEF MISC, but not affected by *RST or :SYSTem:PRESet
State Saved	Not saved in instrument state
Backwards Compatibility Notes	:SYST:PRES no longer turns on :DISPlay:ENABle as it did in legacy analyzers

3.2.6 Frequency

Opens the **Frequency** menu, which contains controls that allow you to control the Frequency parameters of the instrument.

Some features in this menu are the same for all measurements in the current Mode – they do not change as you change measurements. Settings like these are called “Meas Global” and are unaffected by Meas Preset. For example, the Center Freq setting is the same for all measurements – it does not change as you change measurements.

3.2.6.1 Settings

Contains controls that pertain to the X axis parameters of the measurement. These parameters control how data on the vertical (X) axis is displayed and control instrument settings that affect the horizontal axis.

Carrier Reference Frequency

Sets the reference frequency of all the carriers. The center frequencies of carriers are defined as an offset frequency from this value.

3 VMA Mode
3.2 Custom OFDM Measurement

Remote Command	<code>[:SENSe] :OFDM :CCARrier :REFerence <freq></code> <code>[:SENSe] :OFDM :CCARrier :REFerence ?</code>
Example	<code>:OFDM :CCAR :REF 2GHz</code> <code>:OFDM :CCAR :REF ?</code>
Preset	1GHz
State Saved	Saved in instrument state
Min/Max	Depends on the instrument minimum/maximum center frequency. Same as Center Frequency

3.2.7 Marker

Accesses a menu that enables you to select, set up and control the markers for the current measurement. If there are no active markers, Marker selects marker 1, sets it to Normal and places it at the center of the display. If the selected marker is Off, it is set to Normal and placed it at the center of the screen on the trace determined by the Marker Window rules.

3.2.7.1 Select Marker

Specifies the selected marker. The term “selected marker” is used throughout this document to specify which marker will be affected when you change marker settings, perform a Peak Search, etc.

Select Marker appears above the menu panel, indicating that it applies to all controls in the **Marker** menu panels. It is blanked if you select a tab whose controls do *not* depend on the selected marker (e.g., Counter).

In any menu tab that includes **Select Marker**, the first control is always "**Marker X**" on [page 480](#).

Notes	The selected marker is remembered even when not in the Marker menu and is used if a Search is done or a Band Function is turned on or for Continuous Peak
Preset	Marker 1
State Saved	The number of the selected marker is saved in instrument state

3.2.7.2 Settings

The controls on this tab include the Marker active function and a radio button selection of the marker control mode (**Normal**, **Delta**, **Fixed** or **Off**) for the selected marker, as well as additional functions that help you use markers.

Marker X

Sets the X Axis value of the selected marker in the current X Axis Scale unit. If the marker mode is off, the SCPI command has no affect other than to cause the marker to become selected. Note that the X value can change if the marker is moved to a trace with a different domain.

The Marker X position is absolute if the marker mode is Normal or Fixed. If the mode is Delta, then the X position is relative to the reference marker. The valid X positions are the actual data points in the trace; the marker cannot be located between points. If a SCPI command attempts to place the marker between two points, the X value snaps to the closest point.

Remote Command	<code>:CALCulate:OFDM:MARKer[1] 2 ... 12:X <real></code> <code>:CALCulate:OFDM:MARKer[1] 2 ... 12:X?</code>
Example	<code>:CALC:OFDM:MARK:X 0.325</code> <code>:CALC:OFDM:MARK:X?</code>
Notes	Cannot be set outside the bounds of the data unless it is Fixed . If you attempt to set it to a value outside the bounds, it is clipped at the closest limit and error -222 Data Out of Range is generated If a suffix is sent, it must match the X units for the trace the marker is on. Otherwise, error -138, "Suffix not allowed" is generated If you try to read or set the position of a Delta marker, remember that the position is in relative units
Couplings	Coupling of Delta and Reference Markers
Preset	None until marker is turned on
State Saved	Yes
Min	Depends on trace data
Max	Depends on trace data

Marker Z

Sets the selected markers Z Axis value in the current Z Axis Scale unit for markers on traces with a 2-dimensional domain. In each case the marker that is addressed becomes the selected marker. It has no affect (other than to cause the marker to become selected) if the control mode is Off or if the trace has no Z domain. Note that the Z value can change or become irrelevant if the marker is moved to a trace with a different Z domain or no Z domain.

Note that this Z value is affected if the SCPI command to set marker point position is used.

Remote Command	<code>:CALCulate:OFDM:MARKer[1] 2 ... 12:Z <real></code> <code>:CALCulate:OFDM:MARKer[1] 2 ... 12:Z?</code>
----------------	--

3 VMA Mode
3.2 Custom OFDM Measurement

Example	<code>:CALC:OFDM:MARK:Z 0.325</code> <code>:CALC:OFDM:MARK:Z?</code>
Notes	Cannot be set outside the bounds of the data unless it is Fixed . If you attempt to set it to a value outside the bounds it is clipped at the closest limit, and error -222 Data Out of Range is generated If a suffix is sent, it must match the Z units for the trace the marker is on. Otherwise, error -138, "Suffix not allowed" is generated
Couplings	Coupling of Delta and Reference Markers
Preset	None until marker is turned on
State Saved	Yes
Min	Depends on trace data
Max	Depends on trace data

Marker Y

Enables you to set or read back the selected marker's Y Axis value in the current Y Axis Scale unit. Setting the Y value has no affect (other than to cause the marker to become selected) if the marker mode is other than fixed. The query form generates an error if the marker mode is Off. Note that the Y value can change if the Y-axis units change, either from a change in format of the trace the marker is on or if the marker is moved to a different trace.

If the selected marker is on a trace that is displayed with Vector or Constellation format, this function controls only the real part of the Y value (i.e., the horizontal axis value). Use the Marker Y (imag) control to change the imaginary (vertical) value. Marker Y and Marker Y Imag always set or get the rectangular form of Y, regardless of whether the marker readout is polar or rectangular.

Remote Command	<code>:CALCulate:OFDM:MARKer[1] 2 ... 12:Y[:REAL] <real></code> <code>:CALCulate:OFDM:MARKer[1] 2 ... 12:Y[:REAL]?</code>
Example	<code>:CALC:OFDM:MARK2:Y 0.325</code> <code>:CALC:OFDM:MARK2:Y?</code>
Notes	You cannot set Y unless the marker type is Fixed . If the marker becomes Fixed after a marker function is turned on, it is set to whatever the Y value was when the marker became fixed If a suffix is sent, it must match the Y units for the trace the marker is on. Otherwise, error -138, "Suffix not allowed" is generated
Couplings	Changes if marker is relative to a Delta marker that is turned on
Preset	None until marker is turned on
State Saved	Yes
Min	-9.9E+37
Max	9.9E+37

Marker Y Imag

Enables you to set or read back the selected marker's quadrature (imaginary) Y value in the current Y Axis Scale unit. It has no affect (other than to cause the marker to become selected) if the marker mode is other than fixed or if the current trace format is not complex (Vector or Constellation). The query form generates an error if it is used for a marker that is not on a complex trace. Marker Y Imag is not affected by whether the marker readout is polar or rectangular.

Remote Command	<code>:CALCulate:OFDM:MARKer[1] 2 ... 12:Y:IMAGinary <real></code> <code>:CALCulate:OFDM:MARKer[1] 2 ... 12:Y:IMAGinary?</code>
Example	<code>:CALC:OFDM:MARK1:Y:IMAG 0.435</code> <code>:CALC:OFDM:MARK1:Y:IMAG?</code>
Notes	Grayed-out unless the marker is fixed and on a vector display If a suffix is sent, it must match the Y units for the trace the marker is on. Otherwise, an Invalid Suffix error is generated. Otherwise, error -138, "Suffix not allowed" is generated If a query is sent while the marker is on a trace whose format is not vector or constellation, NaN (9.91E+37) is returned
Preset	None until marker is turned on
State Saved	Yes
Min	Depends on trace format
Max	Depends on trace format

Marker Mode

There are four control modes for markers:

Normal (POSition) – A marker that can be moved to any point on the X Axis by specifying its X Axis value, and whose absolute Y Axis value is then the value of the trace point at that X Axis value

Delta (DELTA) – A marker that can be moved to any point on the X Axis by specifying its X Axis offset from a reference marker, and whose absolute Y Axis value is then the value of the trace point at that X Axis value

Fixed (FIXed) – A marker whose X Axis and Y Axis values may be directly or indirectly specified by you, but whose Y Axis value remains fixed, once specified, and does not follow the trace. Fixed markers are useful as reference markers for Delta markers, as operands in a Peak Search operation, and as arbitrary reference points settable by you. These markers are represented on the display by an "X" rather than a diamond

Off (OFF) – A marker which is not in use

3 VMA Mode
3.2 Custom OFDM Measurement

The SCPI command in the table below selects the marker and sets the marker control mode as described under Normal, Delta, Fixed and Off, below. All interactions and dependencies detailed under the control description are enforced when the remote command is sent.

Remote Command	<code>:CALCulate:OFDM:MARKer[1] 2 ... 12:MODE POSition DELTa FIXed =OFF</code> <code>:CALCulate:OFDM:MARKer[1] 2 ... 12:MODE?</code>
Example	<code>:CALC:OFDM:MARK2:MODE POS</code> <code>:CALC:OFDM:MARK2:MODE?</code>
Couplings	The marker addressed by this command becomes the selected marker on the front panel
Preset	OFF
State Saved	The marker control mode (Normal, Delta, Fixed, Off) and X Axis value are saved in instrument state
Range	Normal Delta Fixed Off

Delta Marker (Reset Delta)

Pressing this button has exactly the same effect as pressing **Delta** in "**Marker Mode**" on page 478. The selected marker becomes a **Delta** marker. If the selected marker is already a **Delta** marker, the reference marker is moved to the current position of the selected marker, thus resetting the Delta to zero.

Marker Settings Diagram

Lets you configure the **Marker** system using a visual utility.

All Markers Off

Turns off all markers.

Remote Command	<code>:CALCulate:OFDM:MARKer:AOFF</code>
Example	<code>:CALC:OFDM:MARK:AOFF</code>

Couple Markers

When this function is ON, moving any marker causes an equal X Axis movement of every other marker that is not Fixed or Off. By "equal X Axis movement" we mean that we preserve the difference between each marker's X Axis value (in the fundamental x-axis units of the trace that marker is on) and the X Axis value of the marker being moved (in the same fundamental x-axis units).

Note that **Fixed** markers do not couple. They stay where they were while all the other markers move. Of course, if a **Fixed** marker is being moved, all the non-fixed markers *do* move with it.

This may result in markers going off screen.

Remote Command	:CALCulate:OFDM:MARKer:COUPlE[:STATe] ON OFF 1 0 :CALCulate:OFDM:MARKer:COUPlE[:STATe]?
Example	:CALC:OFDM:MARK:COUP ON :CALC:OFDM:MARK:COUP?
Notes	In general, when coupling is turned on, all Normal or Delta markers with the same (or equivalent) domain as the selected marker move in the same manner as the selected marker
Preset	OFF, presets on Mode Preset and All Markers Off
State Saved	Saved in instrument state

3.2.7.3 Peak Search

The controls on this tab let you move the marker to selected peaks of the signal, giving you enormous analysis capabilities, particularly when combined with the Delta Marker function.

Marker X

Sets the X Axis value of the selected marker in the current X Axis Scale unit. This is the same as "[Marker X](#)" on page 476 on the **Settings** tab.

Marker Z

Sets the selected markers Z Axis value in the current Z Axis Scale unit for markers on traces with a 2-dimensional domain. This is the same as "[Marker Z](#)" on page 476 in the **Settings** tab.

Peak Search

Moves the selected marker to the trace point which has the maximum y-axis value for that trace.

NOTE

Pressing the **Peak Search** hardkey automatically moves you to the **Peak Search** page of the **Marker** menu *and* performs a Peak Search.

Remote Command	:CALCulate:OFDM:MARKer[1] 2 ... 12:MAXimum
----------------	--

Example	<code>:CALC:OFDM:MARK2:MAX</code>
Notes	Sending this command selects the subopcoded marker

Next Peak

Moves the selected marker to the peak that is next lower in amplitude than the current marker's value. Only peaks that meet all enabled peak criteria are considered. If there is no valid peak lower than the current marker position, a "No peak found" message is generated and the marker is not moved.

In the Digital Demod measurements, if the format is complex (vector or constellation) then the marker moves to the closest point that has a lower magnitude than the marker's current position.

If the selected marker was **Off**, then it is turned on as a **Normal** marker and a peak search is performed.

Remote Command	<code>:CALCulate:OFDM:MARKer[1] 2 ... 12:MAXimum:NEXT</code>
Example	<code>:CALC:OFDM:MARK2:MAX:NEXT</code>
Notes	Sending this command selects the subopcoded marker
State Saved	Not part of saved state

Next Higher Amplitude

Moves the marker to the peak next higher in Y value than the peak it is currently on. If the format is complex (vector or constellation) then the marker moves to the closest point that has a higher magnitude than the marker's current position. If this function is invoked via SCPI on a marker that is **Off**, the result is the same as if you sent a **Peak Search** command.

Remote Command	<code>:CALCulate:OFDM:MARKer[1] 2 ... 12:MAXimum:PREVious</code>
Example	<code>:CALC:OFDM:MARK2:MAX:PREV</code>

Next Pk Right

Moves the selected marker to the nearest peak right of the current marker that meets all enabled peak criteria. If there is no valid peak to the right of the current marker position, a "No peak found" message is generated and the marker is not moved.

If the selected marker was **Off**, then it is turned on as a **Normal** marker and a peak search is performed.

Remote Command	:CALCulate:OFDM:MARKer[1] 2 ... 12:MAXimum:RIGHT
Example	:CALC:OFDM:MARK2:MAX:RIGH
Notes	Sending this command selects the subopcoded marker
State Saved	Not part of saved state

Next Pk Left

Moves the selected marker to the nearest peak left of the current marker that meets all enabled peak criteria. If there is no valid peak to the left of the current marker position, a “No peak found” message is generated and the marker is not moved.

If the selected marker was **Off**, then it is turned on as a **Normal** marker and a peak search is performed.

Remote Command	:CALCulate:OFDM:MARKer[1] 2 ... 12:MAXimum:LEFT
Example	:CALC:OFDM:MARK2:MAX:LEFT
State Saved	Not part of saved state

Minimum Peak

Moves the selected marker to the minimum y-axis value on the current trace. Minimum (negative) peak searches do not have to meet the peak search criteria. It just looks for the lowest y-axis value.

If the selected marker is **Off**, it is turned on before the minimum search is performed.

Remote Command	:CALCulate:OFDM:MARKer[1] 2 ... 12:MINimum
Example	:CALC:OFDM:MARK2:MIN
Notes	Sending this command selects the subopcoded marker
State Saved	Not part of saved state

Pk-Pk Search

Finds and displays the amplitude and frequency (or time) differences between the highest and lowest y-axis value. Places the selected marker on the minimum value on its selected trace, and places that marker's reference marker on the peak of its selected trace.

This function turns on the reference marker and sets its mode to **Fixed** or **Normal** if it is not already on. (These markers may be on two different traces.)

The rules for finding the maximum peak are exactly the same as for Peak Search, including the use of the peak criteria rules. However, the minimum trace value is not required to meet any criteria other than being the minimum y-axis value in the trace.

If the selected marker is **Off**, a **Delta** type marker is turned on and the peak-to-peak search is done. If the selected marker is on, but it is not a **Delta** marker, then it is changed to **Delta**, which turns on the reference marker if needed, and then it performs the peak-to-peak function.

Remote Command	:CALCulate:OFDM:MARKer[1] 2 ... 12:PTPeak
Example	:CALC:OFDM:MARK:PTP
Notes	Turns on the Marker D active function Sending this command selects the subopcoded marker
Couplings	The selected marker becomes a Delta marker if not already in delta mode
State Saved	Not part of saved state

Marker Delta

Pressing this control has exactly the same effect as pressing **Delta** in "**Marker Mode**" on page 478 on the **Settings** tab. The selected marker becomes a **Delta** Marker. If the selected marker is already a **Delta** marker, the reference marker is moved to the current position of the selected marker, thus resetting the delta to zero.

The control is duplicated here to allow you to conveniently perform a peak search and change the marker's control mode to **Delta** without having to access two separate menus.

3.2.7.4 Properties

The controls on this tab are used to set certain properties of the selected marker.

Marker X

This is the fundamental control that you use to move a marker around on the trace. It is the same as "**Marker X**" on page 476 on the **Settings** tab.

Relative To

Selects the marker to which the selected marker is relative (its reference marker).

Every marker has another marker to which it is relative. This marker is referred to as the "reference marker" for that marker. This attribute is set by **Marker, Properties, Relative To**. The marker must be a **Delta** marker to make this attribute relevant. If it

is a **Delta** marker, the reference marker determines how the marker is controlled and how its value is displayed. A marker cannot be relative to itself.

Remote Command	<code>:CALCulate:OFDM:MARKer[1] 2 ... 12:REFerence <integer></code> <code>:CALCulate:OFDM:MARKer[1] 2 ... 12:REFerence?</code>
Example	<code>:CALC:OFDM:MARK2:REF 4</code> <code>:CALC:OFDM:MARK2:REF?</code>
Notes	Causes the marker specified with the subopcode to become selected Range (for SCPI command): 1 to 12. If the range is exceeded the value is clipped A marker cannot be relative to itself so that choice is not available, and if sent from SCPI generates error -221: "Settings conflict; marker cannot be relative to itself" When queried a single value is returned (the specified marker numbers relative marker)
Couplings	If the reference marker is Off , it is turned on in Fixed or Normal mode at the delta marker location
Preset	The preset default "Relative To" marker (reference marker) is the next higher numbered marker (current marker +1). For example, if marker 2 is selected, then it's default reference marker is marker 3. The exception is marker 12, which has a default reference of marker 1 Set to the defaults by Restore Mode Defaults . <i>Not</i> reset by Marker Off , All Markers Off , or Preset
State Saved	Saved in instrument state. Not affected by Marker Off and hence not affected by Preset or power cycle
Min	1
Max	12

Marker Window

Assigns the specified marker to the designated trace.

Remote Command	<code>:CALCulate:OFDM:MARKer[1] 2 ... 12:WINDow <int></code> <code>:CALCulate:OFDM:MARKer[1] 2 ... 12:WINDow?</code>
Example	<code>:CALC:OFDM:MARK:WIND 2</code> Sets the first marker's trace to window 2 <code>:CALC:OFDM:MARK:WIND?</code> Query the first marker's trace
Notes	Assigns the specified marker to the designated window
Preset	1
State Saved	Yes
Min	1
Max	6

Marker Settings Diagram

Lets you configure the **Marker** system using a visual utility. It is the same as "[Marker Settings Diagram](#)" on page 479 on the **Settings** tab.

3.2.7.5 Marker Function

The controls on this tab let you control the Marker Functions of the instrument. Marker Functions perform post-processing operations on marker data.

Marker X

Sets the X Axis value of the selected marker in the current X Axis Scale unit. It is the same as "[Marker X](#)" on page 476 on the **Settings** tab.

Marker Function/Interval Function

Sets the marker control function type to one of the following:

NOISe	Marker Noise
BPOWer	Band Power/Interval Power
BDENsity	Band Density/Interval Density
OFF	Marker Function Off

Remote Command	<code>:CALCulate:OFDM:MARKer[1] 2 ... 12:FUNCTION NOISe BPOWer BDENsity OFF</code> <code>:CALCulate:OFDM:MARKer[1] 2 ... 12:FUNCTION?</code>
Example	<code>:CALC:OFDM:MARK:FUNC BPOW</code> <code>:CALC:OFDM:MARK:FUNC?</code>
Preset	OFF
State Saved	Yes
Range	Marker Noise Band Power Band Density Marker Function Off
Annotation	Mkr # <X value> and <Marker value> upper right on graph

Band Span/Interval Span

Band Span

Sets the width of the span for the selected marker. This function defines the span of frequencies. The marker position does not change when you adjust the span.

Remote Command	<code>:CALCulate:OFDM:MARKer[1] 2 ... 12:FUNCTION:BAND:SPAN <real></code> <code>:CALCulate:OFDM:MARKer[1] 2 ... 12:FUNCTION:BAND:SPAN?</code>
Example	<code>:CALC:OFDM:MARK2:FUNC:BAND:SPAN 1.23E+06</code> <code>:CALC:OFDM:MARK2:FUNC:BAND:SPAN?</code>
Preset	When marker is turned on, 1/20 th of current span
State Saved	Yes
Min	100
Max	9.9E+37

Interval Span

Sets the width of the span for the selected marker. This function defines the span of time. The marker position does not change when you adjust the span.

Remote Command	<code>:CALCulate:OFDM:MARKer[1] 2 ... 12:FUNCTION:INTERval:SPAN <real></code> <code>:CALCulate:OFDM:MARKer[1] 2 ... 12:FUNCTION:INTERval:SPAN?</code>
Example	<code>:CALC:OFDM:MARK2:FUNC:INT:SPAN 1.23E+06</code> <code>:CALC:OFDM:MARK2:FUNC:INT:SPAN?</code>
Preset	When marker turned on, 1/20 th of current displayed time length
State Saved	Yes
Min	100
Max	9.9E+37

Band Left/Interval Left

Band Left

Lets you adjust the left side of the band. In order to remain centered in the band, the marker position must also change as you change the left edge. The right edge is unaffected.

Remote Command	<code>:CALCulate:OFDM:MARKer[1] 2 ... 12:FUNCTION:BAND:LEFT <real></code> <code>:CALCulate:OFDM:MARKer[1] 2 ... 12:FUNCTION:BAND:LEFT?</code>
Example	<code>:CALC:OFDM:MARK2:FUNC:BAND:LEFT 1.23E+06</code> <code>:CALC:OFDM:MARK2:FUNC:BAND:LEFT?</code>
Couplings	Changes marker X to keep the marker centered in the band
Preset	When marker turned on, 1/40 th of current span left of the marker position

3 VMA Mode
3.2 Custom OFDM Measurement

State Saved	Yes
Min	-9.9E+37
Max	9.9E+37

Interval Left

Lets you adjust the left side of the band. In order to remain centered in the band, the marker position must also change as you change the left edge. The right edge is unaffected.

Remote Command	<code>:CALCulate:OFDM:MARKer[1] 2 ... 12:FUNCTION:INTERval:LEFT <real></code> <code>:CALCulate:OFDM:MARKer[1] 2 ... 12:FUNCTION:INTERval:LEFT?</code>
Example	<code>:CALC:OFDM:MARK2:FUNC:INT:LEFT 1.23E+06</code> <code>:CALC:OFDM:MARK2:FUNC:INT:LEFT?</code>
Couplings	Changes marker X to keep the marker centered in the band
Preset	When marker turned on, 1/40 th of current displayed time length left of the marker position
State Saved	Yes
Min	-9.9E+37
Max	9.9E+37

Band Right/Interval Right

Band Right

Lets you adjust the right side of the band. In order to remain centered in the band, the marker position must also change as you change the right edge. The left edge is unaffected.

Remote Command	<code>:CALCulate:OFDM:MARKer[1] 2 ... 12:FUNCTION:BAND:RIGHT <real></code> <code>:CALCulate:OFDM:MARKer[1] 2 ... 12:FUNCTION:BAND:RIGHT?</code>
Example	<code>:CALC:OFDM:MARK2:FUNC:BAND:RIGHT 1.23E+06</code> <code>:CALC:OFDM:MARK2:FUNC:BAND:RIGHT?</code>
Couplings	Changes marker X to keep the marker centered in the band
Preset	When marker turned on, 1/40 th of current span right of the marker position
State Saved	Yes
Min	-9.9E+37
Max	9.9E+37

Interval Right

Lets you adjust the right side of the band. In order to remain centered in the band, the marker position must also change as you change the right edge. The left edge is unaffected.

Remote Command	:CALCulate:OFDM:MARKer[1] 2 ... 12:FUNCtion:INTerval:RIGHT <real> :CALCulate:OFDM:MARKer[1] 2 ... 12:FUNCtion:INTerval:RIGHT?
Example	:CALC:OFDM:MARK2:FUNC:INT:RIGHT 1.23E+06 :CALC:OFDM:MARK2:FUNC:INT:RIGHT?
Couplings	Changes marker X to keep the marker centered in the band
Preset	When marker turned on, 1/40 th of current displayed time length right of the marker position
State Saved	Yes
Min	-9.9E+37
Max	9.9E+37

3.2.7.6 Marker To

The controls on this tab let you copy the current marker's value into other instrument parameters (for example, **Center Frequency**). The currently selected marker is made the active function on entry to this menu (if the currently selected marker is not on when you press this front panel key, it will be turned on at the center of the screen as a **Normal** marker, then made the active function).

Marker X

Sets the X Axis value of the selected marker in the current X Axis Scale unit. It is the same as "**Marker X**" on page 476 on the **Settings** tab.

Mkr -> CF

Sets the center frequency of the analyzer to the frequency of the selected marker. The marker stays at this frequency, so it moves to the center of the display. In **Delta** marker mode, this function sets the center frequency to the x-axis value of the delta marker. When the frequency scale is in log mode, the center frequency is not at the center of the display.

If the currently selected marker is not on when this control is pressed, it will be turned on at the center of the screen as a **Normal** type marker.

Remote Command	<code>:CALCulate:OFDM:MARKer[1] 2 ... 12[:SET]:CENTer</code>
Example	<code>:CALC:OFDM:MARK4:CENT</code>
Notes	Sending this command selects the subopcoded marker If specified marker is Off , this command turns it on at the center of the screen as a Normal type marker
Dependencies	Not available (grayed-out) when x-axis is the time domain
Couplings	All the usual couplings associated with setting Center Frequency apply

3.2.8 Meas Setup

Contains functions for setting up the measurement parameters, and also contains functions for setting up parameters global to all measurements in the Mode.

3.2.8.1 Component Carrier

Lists the available component carriers.

3.2.8.2 Settings

Lets you set measurement parameters.

Avg|Hold Number

Specifies the number of N averages that will be used for the measurement. After the specified number (average counts) have been averaged, the averaging mode (termination control) setting determines the averaging action.

Remote Command	<code>[:SENSe]:OFDM:AVERage:COUNT <integer></code> <code>[:SENSe]:OFDM:AVERage:COUNT?</code>
Example	<code>:OFDM:AVER:COUN 1000</code> <code>:OFDM:AVER:COUN?</code>
Preset	10
State Saved	Yes
Min	1
Max	10000

Averaging On/Off

Turns averaging on or off.

Remote Command	<code>[:SENSe]:OFDM:AVERage[:STATe] OFF ON 0 1</code> <code>[:SENSe]:OFDM:AVERage[:STATe]?</code>
Example	<code>:OFDM:AVER OFF</code> <code>:OFDM:AVER?</code>
Preset	OFF
State Saved	Yes
Range	Off On

Average Mode

Toggles the averaging mode between Exp (exponential) and Repeat. This selection only affects the averaging result after the number of N averages is reached. The value of N is set using the control “Avg|Hold Number.”

- EXPOnential - Each successive data acquisition after the average count is reached, is exponentially weighted and then combined with the existing average
- REPeat - After reaching the average count, averaging is reset and a new average is started

Remote Command	<code>[:SENSe]:OFDM:AVERage:TCONtrol EXPOnential REPeat</code> <code>[:SENSe]:OFDM:AVERage:TCONtrol?</code>
Example	<code>:OFDM:AVER:TCON REP</code> <code>:OFDM:AVER:TCON?</code>
Notes	Selects the type of termination control used for averaging. This determines the averaging action after the specified number of frames (average count) is reached
Preset	EXPOnential
State Saved	Yes
Range	EXPOnential REPeat

Copy CC To

Copies Custom OFDM demodulation parameters from the selected Component Carrier to another Component Carrier (CC0 – CC7), or to all Component Carriers (ALL).

Remote Command	<code>[:SENSe]:OFDM:CCARrier0 ... 7:COpy CC0 CC1 CC2 CC3 CC4 CC5 CC6 CC7 ALL</code>
Example	<code>:OFDM:CCAR0:COpy ALL</code>
Couplings	Copies the parameters settings of the selected Component Carrier to the target Component Carrier

Preset	ALL
State Saved	Yes
Range	CC0 CC1 CC2 CC3 CC4 CC5 CC6 CC7 ALL

Spur Avoidance

Because VXT models M9410A/11A are direct-conversion (zero-IF) receivers, feedthrough leakage from the local oscillator appears as a spurious signal (spur) at the center frequency. The **Spur Avoidance** function is provided to eliminate this spur, at the expense of some measurement speed.

When **Spur Avoidance** is enabled (the default), the analyzer uses a software algorithm to remove this spur from the displayed measurement data, but the algorithm only operates under certain conditions. Specifically, it only operates when the Component Carriers Bandwidth $\leq \text{maxBW}/2.5$. See ["More Information" on page 491](#).

You can disable this function to speed up your measurement by setting Spur Avoidance to "Disabled."

Note that when **Spur Avoidance** is not in effect, either because you have disabled it or because the Component Carriers Bandwidth $> \text{maxBW}/2.5$, the following warning message will appear in the status bar: "Settings Alert; Spur Avoidance Off". This is to alert you that measurement accuracy might be impacted by the fact that Spur Avoidance is not in effect.

Remote Command	<code>[:SENSe]:OFDM:SAVoid[:STATe] ON OFF 0 1</code> <code>[:SENSe]:OFDM:SAVoid[:STATe]?</code>
Example	<code>:OFDM:SAVoid ON</code> <code>:OFDM:SAVoid?</code>
Dependencies	Only appears in VXT models M9410A/11A
Preset	ON
State Saved	Saved in instrument state
Range	ON OFF

More Information

Option	Frequency Range	MaxBW
Option B40	380 MHz ~ 6000 MHz	40 MHz

Option	Frequency Range	MaxBW
Option B3X	380 MHz ~ 550 MHz	100 MHz
	550 MHz ~ 1310 MHz	200 MHz
	1310 MHz ~ 5930 MHz	300 MHz
	5930 MHz ~ 6000 MHz	(6080 MHz- center frequency) * 2
Option B6X	380 MHz ~ 550 MHz	100 MHz
	550 MHz ~ 1310 MHz	200 MHz
	1310 MHz ~ 5780 MHz	600 MHz
	5780 MHz ~ 6000 MHz	(6080 MHz- center frequency) * 2
Option B12	380 MHz ~ 550 MHz	100 MHz
	550 MHz ~ 1310 MHz	200 MHz
	1310 MHz ~ 2000 MHz	600 MHz
	2000 MHz ~ 5480 MHz	1200 MHz
	5480 MHz ~ 6000 MHz	(6080 MHz- center frequency) * 2

Optimize EVM

This is an "immediate action" function to optimize EVM for the current input signal. It is used to set the combination of the preamp, mechanical and electronic attenuation, and IF gain value based on the measured signal peak level. Its purpose is to get better EVM results by improving the SNR and avoid ADC overload at the same time.

After this control is pressed, "Pre-Adjust for Min Clipping" on page 1773 changes to OFF and "IF Gain" on page 535 Auto changes to Manual.

NOTE

Before selecting the **Optimize EVM** function, the "EVM Optimization Method" on page 492 should be selected.

Remote Command `[:SENSe] :OFDM:OPTimize`

Example `:OFDM:OPT`

EVM Optimization Method

There are 2 methods for EVM Optimization:

NORMAL	Adjusts hardware settings to minimize EVM by an algorithm that is dependent on the measured peak power of input signal
ITERative	Adjusts hardware settings to minimize EVM by an algorithm that iterates measured EVM of input signal

3 VMA Mode
3.2 Custom OFDM Measurement

The **Iterative** method is slower than the **Normal** method, but always results in better EVM.

NOTE

"Optimize EVM" on page 492 is an "immediate action" function. Before selecting the function, the **EVM Optimization Method** should be selected.

Remote Command	<code>[:SENSe]:OFDM:OPTMethod NORMal ITERative</code> <code>[:SENSe]:OFDM:OPTMethod?</code>
Example	<code>:OFDM:OPTM NORM</code> <code>:OFDM:OPTM?</code>
Couplings	Disabled when Component Carrier number is greater than one
Preset	NORMal
State Saved	Saved in instrument state
Range	NORMal ITERative

Iterative EVM Optimization Target

Specifies the component carrier that will be used as iterative EVM optimization target.

Remote Command	<code>[:SENSe]:OFDM:OPTimize:ITERative:TARGet CC0 ... CC7</code> <code>[:SENSe]:OFDM:OPTimize:ITERative:TARGet?</code>
Example	<code>:OFDM:OPT:ITER:TARG CC0</code> <code>:OFDM:OPT:ITER:TARG?</code>
Dependencies	Invalid when EVM Optimization Method is Normal
Preset	CC0
State Saved	Saved in instrument state
Range	CC0 CC1 CC2 CC3 CC4 CC5 CC6 CC7

Auto Couple

Immediately puts all **Auto/Man** functions into **Auto**. **Auto Couple** is confined to the current measurement only. It does not affect other measurements in the Mode.

In the **Auto** state, **Auto/Man** functions are said to be "coupled", meaning their values change as you make changes to other values in the measurement. This helps ensure accurate measurements and optimum dynamic range. **Auto Couple** is an immediate action function, and when it is executed, all the **Auto/Man** controls for the current measurement are set to **Auto**, and all measurement settings coupled to the **Auto/Man** parameters are automatically set to their optimal values.

For further details of measurement-specific settings (if any), see "[Measurement-Specific Details](#)" on page 494 below.

Remote Command	:COUPlE ALL
Example	:COUP ALL
Backwards Compatibility SCPI	:COUPLE ALL NONE
Backwards Compatibility Notes	:COUP:NONE puts all Auto/Man parameters in manual mode, decoupling all the coupled instrument parameters. It is retained for backwards compatibility and is <i>not</i> recommended for making measurements or new designs

All **Auto/Man** parameter couplings in the measurement are set to **Auto**. This includes couplings that may be unavailable or grayed-out due to the current state. For example, in the Swept SA measurement, there is no **Auto/Man** coupling for **RBW** while in Zero Span. Nonetheless, if **Auto Couple** were executed while in Zero Span, it would set **RBW** to Auto "behind the scenes" so that, on exit from Zero Span, it would be in **Auto**.

Any **Auto/Man** selection specific (local) to the other measurements in the current Mode are not affected by **Auto Couple**. Any functions that are *not* coupled with other instrument parameters, such as ranging or leveling variables, such as **AutoRange** or **AutoScale**, are not affected.

Executing **Auto Couple** generates the informational message, "All Auto/Man functions have been set to Auto".

Each parameter, upon being set to **Auto**, selects and sets the appropriate auto-coupled value based on that parameter's coupling rules. The Dependency Resolver orchestrates the couplings for parameters that depend on one or more other parameters. The coupling and dependency rules for each parameter are defined in the section describing that parameter.

Executing **Auto Couple** *does not* affect markers, marker functions, trace or display attributes, or any other instrument setting other than those specifically mentioned above.

Measurement-Specific Details

TOI (SA Mode only)

Parameters affected by **Auto Couple** are:

- Center Frequency Step
- Resolution Bandwidth

3 VMA Mode
3.2 Custom OFDM Measurement

- Span/RBW Ratio
- Sweep Time
- Video BANDwidth VBW/RBW ratio
- Upper and Lower Tone (set to Sense)
- Zero span measurement Resolution Bandwidth
- Zero span measurement Dwell Time

Harmonics (SA Mode only)

Parameters affected by **Auto Couple** are:

- Resolution Bandwidth
- Fundamental Frequency
- Dwell Time
- Range Table Resolution Bandwidths
- Range Table Dwell Times

Meas Preset

Restores all measurement parameters to their default values.

Remote Command	:CONFigure:OFDM
Example	:CONF:OFDM
Notes	Restore all defaults of parameters

3.2.8.3 Meas Standard

Contains controls for setting the radio standard to which the current measurement will be made.

Preset to Std

Displays a menu for selecting preset Custom OFDM Setup parameters. Does *not* prevent you from making adjustments to measurement parameters afterwards. The following standard presets are available:

Cellular	V5G	TFPUSCHQPSK TFPUSCH16QAM TFPUSCH64QAM LTEFDDDL5M
Wireless	WLAN, Wi-SUN	WLAN80211A WISUN01I0 WISUN01I1 WISUN02I0 WISUN02I1 WISUN03 WISUN04
Radio	DAB, CDR, DRM	DABMODE1 DABMODE2 DABMODE3 DABMODE4 CDRTX1SPEC2 CDRTX1SPEC9 CDRTX1SPEC10 DRMA9K DRMB9K
Video	DOCSIS, DVB-TH, ISDB-T	DOCSIS31UP DOCSIS31DOWN DVBTH2K ISDBTM03

Remote Command `[:SENSE]:OFDM:RADio:STANdard:PRESet NONE | TFPUSCHQPSK | TFPUSCH16QAM | TFPUSCH64QAM | DABMODE1 | DABMODE2 | DABMODE3 | DABMODE4 | CDRTX1SPEC2 | CDRTX1SPEC9 | CDRTX1SPEC10 | DOCSIS31UP | DOCSIS31DOWN | WLAN80211A | LTEFDDDL5M | WISUN01I0 | WISUN01I1 | WISUN02I0 | WISUN02I1 | WISUN03 | WISUN04 | DRMA9K | DRMB9K | DVBTH2K | ISDBTM03`

Example `:OFDM:RAD:STAN:PRES TFPUSCH64QAM`

Range `NONE | 5GTF PUSCH QPSK | 5GTF PUSCH 16QAM | 5GTF PUSCH 64QAM | DAB MODE 1 | DAB MODE 2 | DAB MODE 3 | DAB MODE 4 | CDR TxMode1 SpectrumMode 2 | CDR TxMode1 Spectrum Mode 9 | CDR TxMode1 SpectrumMode10 | DOCSIS3.1 Upstream | DOCSIS3.1 Downstream | WLAN80211A | LTE FDD DL5M | WISUN Option1 Interleaving0 | WISUN Option1 Interleaving1 | WISUN Option2 Interleaving0 | WISUN Option2 Interleaving1 | WISUN Option3 | WISUN Option4 | DRM ModeA 9K | DRM ModeB 9K | DVB-TH 2K | ISDB-T Mode3`

3.2.8.4 Component Carrier

Lets you set the component carrier parameters.

Measure Carrier

Specifies whether or not to measure this component carrier.

Remote Command	<code>[:SENSe]:OFDM:CCARrier0 ... 7[:STATe] OFF ON 0 1</code> <code>[:SENSe]:OFDM:CCARrier0 ... 7[:STATe]?</code>
Example	<code>:OFDM:CCAR0 ON</code> <code>:OFDM:CCAR0?</code>
Notes	Used with a sub-op code <n> (default = 0) to specify the component carrier for configuration. The range of the sub-op code is determined by the number of component carriers
Preset	ON
State Saved	Saved in instrument state
Range	OFF ON

Frequency Offset

Sets the component carrier center frequency as the offset from the "Carrier Reference Frequency" on page 474.

Remote Command	<code>[:SENSe]:OFDM:CCARrier<n>:FREQuency:OFFSet <freq></code> <code>[:SENSe]:OFDM:CCARrier<n>:FREQuency:OFFSet?</code>
Example	<code>:OFDM:CCAR4:FREQ:OFFS 10MHz</code> <code>:OFDM:CCAR4:FREQ:OFFS?</code>
Notes	Used with a sub-op code <n> (default = 0) to specify the component carrier for configuration. The range of the sub-op code is determined by the number of component carriers
Preset	0Hz
State Saved	Saved in instrument state
Min	-100 GHz
Max	100 GHz

Bandwidth

Lets you set the bandwidth of each component carrier for the OFDM signal.

Remote Command	<code>[:SENSe]:OFDM:CCARrier0 ... 7:BANDwidth <freq></code> <code>[:SENSe]:OFDM:CCARrier0 ... 7:BANDwidth?</code>
Example	<code>:OFDM:CCAR4:BAND 80MHz</code>
Preset	100 MHz

State Saved	Yes
Min	1 kHz
Max	Hardware dependent:
	RF Input
	No Option = 10 MHz
	WB (25 MHz or wider) = Hardware Option Limit
	I/Q Input (for I+jQ)
	No Option = 20 MHz
	Option B25 = 50 MHz

Spectrum

Sets a spectrum to either normal or to inverted for demodulation related measurements. If set to **INVert**, the upper and lower spectrums are swapped.

The invert function conjugates the spectrum, which is equivalent to taking the negative of the quadrature component in demodulation. The correct setting (**Normal** or **Invert**) depends on whether the signal at the input of the instrument has a high or a low side mix.

Remote Command	<code>[:SENSe]:OFDM:CCARrier0 ... 7:SPECTrum INVert NORMal</code> <code>[:SENSe]:OFDM:CCARrier0 ... 7:SPECTrum?</code>
Example	<code>:OFDM:CCAR0:SPEC INV</code> <code>:OFDM:CCAR0:SPEC?</code>
Preset	NORMal
State Saved	Yes
Range	Normal Invert

Configure Comp Carriers

Lets you configure all component carriers, including bandwidth, offset, spectrum and also lets you exclude certain carriers from the measurement.

Configure CCs

Lets you configure bandwidth, frequency offsets, and spectrum type, and also lets you exclude certain carriers from the measurement.

Advanced Acquisition

Lets you configure bandwidth, frequency offsets, and integration bandwidth, and also lets you exclude certain carriers from the measurement.

Input Channel (GUI only)

Select the input channel to configure its settings.

State Saved No

Use Advanced Acquisition Table

Specify if the settings in Advanced Acquisition Table will be applied.

Remote Command `[:SENSe]:OFDM:RF:ACQuistion:ATABle OFF | ON | 0 | 1`

Command `[:SENSe]:OFDM:RF:ACQuistion:ATABle?`

Example `:OFDM:RF:ACQ:ATAB 1`

`:OFDM:RF:ACQ:ATAB?`

Preset OFF

State Saved Yes

Range OFF|ON

IF Path Auto

Specify if the IF path in Advanced Acquisition Table will be automatically or manually selected.

Remote Command `[:SENSe]:OFDM:RF:ACQuistion:ATABle:IFPath:AUTO ON | OFF | 1 | 0`

Command `[:SENSe]:OFDM:RF:ACQuistion:ATABle:IFPath:AUTO?`

Example `:OFDM:RF:ACQ:ATAB:IFP:AUTO 1`

`:OFDM:RF:ACQ:ATAB:IFP:AUTO?`

Preset ON

State Saved Yes

Range OFF|ON

Mechanical Attenuation

Set mechanical attenuation for each component carriers.

Remote Command `[:SENSe]:OFDM:CCARrier[0]|1|...|7:RF:CHANne1|...|8:ATTenuation <rel_amp>`

Command `[:SENSe]:OFDM:CCARrier[0]|1|...|7:RF:CHANne1|...|8:ATTenuation?`

Example `:OFDM:CCAR0:RF:CHAN1:ATT 20`

Preset 10 dB

State Saved	Saved in instrument state
Min	0 dB The attenuation set by this control cannot be decreased below 6 dB with the knob or step keys. To get to a value below 6 dB it has to be directly entered from the keypad or via SCPI. This protects from adjusting the attenuation to a dangerously small value which can put the instrument at risk of damage to input circuitry. However, if the current mechanical attenuation is below 6 dB it can be increased with the knob and step keys, but not decreased
Max	CXA Option 503 or 507: 50 dB EXA: 60 dB All other models: 70 dB

Elec Attenuation

Set electronic attenuation for each component carriers.

Remote Command	<code>[:SENSe]:OFDM:CCARrier[0] 1 ... 7:RF:CHANne1 ... 8:EATTenuation <rel_amp></code> <code>[:SENSe]:OFDM:CCARrier[0] 1 ... 7:RF:CHANne1 ... 8:EATTenuation?</code>
Example	<code>:OFDM:CCAR0:RF:CHAN1:EATT 20</code>
Preset	0 dB
State Saved	Saved in instrument state
Min	0 dB
Max	Dual attenuator configuration: 24 dB Single attenuator configuration: the total of ATT and EATT cannot exceed 50 dB, so if the EATT is set to 24 dB first, the main attenuation cannot be greater than 26 dB and will be reduced accordingly; if the main attenuator is set to 40 dB first, EATT cannot be greater than 10 dB

LNA

Turn on/off Low Noise Amplifier (LNA) for each component carriers.

Remote Command	<code>[:SENSe]:OFDM:CCARrier[0] 1 ... 7:RF:CHANne1 ... 8:GAIN:LNA OFF ON 0 1</code> <code>[:SENSe]:OFDM:CCARrier[0] 1 ... 7:RF:CHANne1 ... 8:GAIN:LNA?</code>
Example	<code>:OFDM:CCAR0:RF:CHAN1:GAIN:LNA ON</code>
Dependencies	Requires option LNA
Preset	OFF
State Saved	Saved in State

Internal Preamp

Turn on/off internal preamp for each component carriers.

3 VMA Mode
3.2 Custom OFDM Measurement

Remote Command	<code>[:SENSe]:OFDM:CCARrier[0] 1 ... 7:RF:CHANne11 ... 8:GAIN:PREamp OFF LOW FULL</code> <code>[:SENSe]:OFDM:CCARrier[0] 1 ... 7:RF:CHANne11 ... 8:GAIN:PREamp?</code>
Example	<code>:OFDM:CCAR0:RF:CHAN1:GAIN:PRE LOW</code> <code>:OFDM:CCAR0:RF:CHAN1:GAIN:PRE?</code>
Dependencies	Preamp is not available on all hardware platforms. If the preamp is not present or is unlicensed, the control is not shown
Preset	OFF
State Saved	Saved in instrument state

uW Path Control

Select uW Path for each component carriers.

Remote Command	<code>[:SENSe]:OFDM:CCARrier[0] 1 ... 7:RF:CHANne11 ... 8:MW:PATH STD LNPath MPBypass FULL</code> <code>[:SENSe]:OFDM:CCARrier[0] 1 ... 7:RF:CHANne11 ... 8:MW:PATH?</code>
Example	<code>:OFDM:CCAR0:RF:CHAN1:MW:PATH LNP</code> <code>:OFDM:CCAR0:RF:CHAN1:MW:PATH?</code>
Preset	MPB option present and licensed: MPB MPB option not present and licensed: STD
State Saved	Save in instrument state
Range	Standard Path Low Noise Path Enable uW Preset Bypass Full Bypass Enable

IF Gain

Set IF Gain for each component carriers.

Remote Command	<code>[:SENSe]:OFDM:CCARrier[0] 1 ... 7:RF:CHANne11 ... 8:IF:GAIN:LEVel <rel_amp1></code> <code>[:SENSe]:OFDM:CCARrier[0] 1 ... 7:RF:CHANne11 ... 8:IF:GAIN:LEVel?</code>
Example	<code>:OFDM:CCAR0:RF:CHAN1:IF:GAIN:LEV -10</code> <code>:OFDM:CCAR0:RF:CHAN1:IF:GAIN:LEV?</code>
Notes	Not available for B25 IF bandwidth option
Preset	0
State Saved	Save in instrument state
Min	Depends on CC Bandwidth
Max	Depends on CC Bandwidth

IF Path

Specify IF path manually for each component carriers.

Remote Command	[:SENSe]:OFDM:CCARrier[0] 1 ... 7:RF:CHANne1 ... 8:IFPath B10M B25M B40M B85M B125M B140M B160M B255M B510M B1G B1500M B2G B4G EXT [:SENSe]:OFDM:CCARrier[0] 1 ... 7:RF:CHANne1 ... 8:IFPath?																															
Example	:OFDM:CCAR0:RF:CHAN1:IFP B160M :OFDM:CCAR0:RF:CHAN1:IFP?																															
Notes	<table border="1"> <thead> <tr> <th>Option</th> <th>Path</th> </tr> </thead> <tbody> <tr><td>B10M</td><td>10 MHz</td></tr> <tr><td>B25M</td><td>25 MHz</td></tr> <tr><td>B40M</td><td>40 MHz</td></tr> <tr><td>B85M</td><td>85 MHz</td></tr> <tr><td>B125M</td><td>125 MHz</td></tr> <tr><td>B140M</td><td>140 MHz</td></tr> <tr><td>B160M</td><td>160 MHz</td></tr> <tr><td>B255M</td><td>255 MHz</td></tr> <tr><td>B510M</td><td>510 MHz</td></tr> <tr><td>R10</td><td>1 GHz</td></tr> <tr><td>R15</td><td>1.5 GHz</td></tr> <tr><td>R20</td><td>2 GHz</td></tr> <tr><td>R40</td><td>4 GHz</td></tr> <tr><td>EXT</td><td>Depends on hardware</td></tr> </tbody> </table> <p>In cases where the path is not available but is selected from SCPI, error -241, "Hardware missing; Option not installed" is generated</p>		Option	Path	B10M	10 MHz	B25M	25 MHz	B40M	40 MHz	B85M	85 MHz	B125M	125 MHz	B140M	140 MHz	B160M	160 MHz	B255M	255 MHz	B510M	510 MHz	R10	1 GHz	R15	1.5 GHz	R20	2 GHz	R40	4 GHz	EXT	Depends on hardware
Option	Path																															
B10M	10 MHz																															
B25M	25 MHz																															
B40M	40 MHz																															
B85M	85 MHz																															
B125M	125 MHz																															
B140M	140 MHz																															
B160M	160 MHz																															
B255M	255 MHz																															
B510M	510 MHz																															
R10	1 GHz																															
R15	1.5 GHz																															
R20	2 GHz																															
R40	4 GHz																															
EXT	Depends on hardware																															
Dependencies	Grayed-out if IF Path Auto is On																															
Preset	Automatically selected IF path according to measurement required IFBW and available HW bandwidth																															
State Saved	Saved in instrument state																															

3.2.8.5 Meas Time

Lets you set time parameters of the measurement.

Search Length

Specifies the amount or length of the Search Time input data that is included in the measurement pulse search.

Remote Command	<code>[:SENSe]:OFDM:CCARrier0 ... 7:TIME:LENGth:SEARCh <time></code> <code>[:SENSe]:OFDM:OFDM:CCARrier0 ... 7:TIME:LENGth:SEARCh?</code>
Example	<code>:OFDM:CCAR0:TIME:LENG:SEAR 1ms</code> <code>:OFDM:CCAR0:TIME:LENG:SEAR?</code>
Preset	4 ms
State Saved	Yes
Min	Depends on Result Length
Max	Depends on System BW

Result Length

Used to specify the amount of acquired time data (in symbols) that is available for measurement analysis.

Remote Command	<code>[:SENSe]:OFDM:CCARrier0 ... 7:TIME:LENGth:RESUlt <integer></code> <code>[:SENSe]:OFDM:CCARrier0 ... 7:TIME:LENGth:RESUlt?</code> <code>[:SENSe]:OFDM:CCARrier0 ... 7:TIME:LENGth:RESUlt:AUTO OFF ON 0 1</code> <code>[:SENSe]:OFDM:CCARrier0 ... 7:TIME:LENGth:RESUlt:AUTO?</code>
Example	<code>:OFDM:CCAR0:TIME:LENG:RES 10</code> <code>:OFDM:CCAR0:TIME:LENG:RES?</code> <code>:OFDM:CCAR0:TIME:LENG:RES:AUTO ON</code> <code>:OFDM:CCAR0:TIME:LENG:RES:AUTO?</code>
Preset	60 ON
State Saved	Yes Yes
Range	Auto Man
Min	1
Max	Depends on System BW

Meas Interval

Specifies how much time data (in symbols), within "[Result Length](#)" on page 503, is used for measurement analysis data (computing the trace and symbol table data results). **Meas Interval** is entered as an integer number of symbols.

Remote Command	<code>[:SENSe]:OFDM:CCARrier0 ... 7:TIME:INTERval <integer></code> <code>[:SENSe]:OFDM:CCARrier0 ... 7:TIME:INTERval?</code>
Example	<code>:OFDM:CCAR0:TIME:INT 15</code> <code>:OFDM:CCAR0:TIME:INT?</code>
Preset	60
State Saved	Yes
Min	1
Max	Depends on the Result Length

Meas Offset

Specifies the start position of the "[Meas Interval](#)" on page 504 with respect to the first symbol within "[Result Length](#)" on page 503. **Meas Interval** is entered as an integer number of symbols.

The sum of **Meas Interval** and **Meas Offset** must not exceed **Result Length**.

Remote Command	<code>[:SENSe]:OFDM:CCARrier0 ... 7:TIME:OFFSet <integer></code> <code>[:SENSe]:CCARrier0 ... 7:OFDM:TIME:OFFSet?</code>
Example	<code>:OFDM:CCAR0:TIME:OFFS 0</code> <code>:OFDM:CCAR0:TIME:OFFS?</code>
Preset	0
State Saved	Yes
Min	0
Max	Depends on " Result Length " on page 503

Capture Time Diagram

Accesses a menu that lets you set up time parameters.

Burst Search

Used by the pulse search algorithm to detect the start and end of the analyzed burst (or pulse).

3 VMA Mode
3.2 Custom OFDM Measurement

Remote Command	<code>[:SENSe]:OFDM:CCARrier0 ... 7:TIME:BURSt[:STATe] OFF ON 0 1</code> <code>[:SENSe]:OFDM:CCARrier0 ... 7:TIME:BURSt[:STATe]?</code>
Example	<code>:OFDM:CCAR0:TIME:BURS OFF</code> <code>:OFDM:CCAR0:TIME:BURS?</code>
Preset	ON
State Saved	Yes
Range	Off On

Burst Search Threshold

Specifies the burst search threshold level (-dB) used in the pulse search threshold mode.

Remote Command	<code>[:SENSe]:OFDM:CCARrier0 ... 7:TIME:BURSt:THReshold <double></code> <code>[:SENSe]:OFDM:CCARrier0 ... 7:TIME:BURSt:THReshold?</code> <code>[:SENSe]:OFDM:CCARrier0 ... 7:TIME:BURSt:THReshold:AUTO OFF ON 0 1</code> <code>[:SENSe]:OFDM:CCARrier0 ... 7:TIME:BURSt:THReshold:AUTO?</code>
Example	<code>:OFDM:CCAR0:TIME:BURS:THR -15dB</code> <code>:OFDM:CCAR0:TIME:BURS:THR?</code> <code>:OFDM:CCAR0:TIME:BURS:THR:AUTO ON</code> <code>:OFDM:CCAR0:TIME:BURS:THR:AUTO?</code>
Preset	-20 ON
State Saved	Yes Yes
Range	Auto Man
Min	-200 dB
Max	0 dB

3.2.8.6 Demod

Lets you set demodulation parameters.

Demod Settings

Accesses a window that lets you format demod parameters.

Format

Lets you configure format parameters.

FFT Length

Specifies the FFT length for the OFDM transmission.

Remote Command	<code>[:SENSe]:OFDM:CCARrier0 ... 7:FFT:LENGth <integer></code> <code>[:SENSe]:OFDM:CCARrier0 ... 7:FFT:LENGth?</code>
Example	<code>:OFDM:CCAR0:FFT:LENG 64</code> <code>:OFDM:CCAR0:FFT:LENG?</code>
Preset	64
State Saved	Yes
Min	4
Max	65536

System Sample Frequency

The OFDM **System Sample Frequency** parameter specifies the FFT sample rate (Hz).

Remote Command	<code>[:SENSe]:OFDM:CCARrier0 ... 7:SAMPle:FREQuency <freq></code> <code>[:SENSe]:OFDM:CCARrier0 ... 7:SAMPle:FREQuency?</code>
Example	<code>:OFDM:CCAR0:SAMP:FREQ 1MHz</code> <code>:OFDM:CCAR0:SAMP:FREQ?</code>
Preset	10 MHz
State Saved	Yes
Min	Depends on System BW
Max	10 GHz

Guard Lower Subcarriers

Specifies the number of lower guard subcarriers. The Guard Lower Subcarriers are not included in any Trace data result.

Remote Command	<code>[:SENSe]:OFDM:CCARrier0 ... 7:GUARd:LOWer <integer></code> <code>[:SENSe]:OFDM:CCARrier0 ... 7:GUARd:LOWer?</code>
Example	<code>:OFDM:CCAR0:GUAR:LOW 5</code> <code>:OFDM:CCAR0:GUAR:LOW?</code>
Couplings	Total Guard Subcarriers (Guard Lower Subcarriers + Guard Upper Subcarriers) should be less than the FFT Length

3 VMA Mode
3.2 Custom OFDM Measurement

	The Max value of the Guard Lower/Upper Subcarriers is equal to the FFT Length - 1
Preset	6
State Saved	Yes
Min	0
Max	Depends on FFT Length

Guard Upper Subcarriers

Specifies the number of upper guard subcarriers. The Guard Lower Subcarriers are not included in any Trace data result.

Remote Command	<code>[:SENSe]:OFDM:CCARrier0 ... 7:GUARd:UPPer <integer></code> <code>[:SENSe]:OFDM:CCARrier0 ... 7:GUARd:UPPer?</code>
Example	<code>:OFDM:CCAR0:GUAR:UPP 6</code> <code>:OFDM:CCAR0:GUAR:UPP?</code>

Couplings	Total Guard Subcarriers (Guard Lower Subcarriers + Guard Upper Subcarriers) should be less than the FFT Length The Max value of the Guard Lower/Upper Subcarriers is equal to the FFT Length - 1
Preset	5
State Saved	Yes
Min	0
Max	Depends on the FFT Length

DFT Spread

Enables/Disables DFT spread.

Remote Command	<code>[:SENSe]:OFDM:CCARrier0 ... 7:DFTSspread OFF ON 0 1</code> <code>[:SENSe]:OFDM:CCARrier0 ... 7:DFTSspread?</code>
Example	<code>:OFDM:CCAR0:DFTS 1</code> <code>:OFDM:CCAR0:DFTS?</code>

Preset	OFF
State Saved	Yes
Range	Off On

Half Subcarrier Shift

Enables/Disables half subcarrier shift.

Remote Command	<code>[:SENSe]:OFDM:CCARrier0 ... 7:HSCShift OFF ON 0 1</code> <code>[:SENSe]:OFDM:CCARrier0 ... 7:HSCShift?</code>
----------------	--

Example	:OFDM:CCAR0:HSCS 1 :OFDM:CCAR0:HSCS?
Preset	OFF
State Saved	Yes
Range	Off On

Edit Guard Interval per Symbol

Specifies the Guard Intervals (also referred to as the cyclic prefix) as an array of values, one value for each symbol in the signal. The array is constrained to always contain at least one value. The default value is an array of length equal to one, with a value equal to 0.25.

Guard Interval is specified as a fraction of the FFT length. The value is unitless (not as percent). Guard intervals are used to ensure that distinct transmissions do not interfere with one another. The purpose of the guard interval is to introduce immunity to propagation delays, echoes and reflections, to which digital data is normally very sensitive.

Go to Row

Enables you to move through the table to edit the desired point.

Min	1
Max	2000

Insert Row Below

Inserts a row below the current row. The new row is a copy of the current row and becomes the current row. The new row is not yet entered into the underlying table, and the data in the row is displayed in light gray.

Delete Row

This is an immediate action control, which deletes the currently-selected row, even if the row is being edited. The row following the currently-selected row (or the row preceding if there is none) will be selected.

Clear Table

This is an immediate action control, which clears the table.

Repeat Index

If the Guard Interval Per Symbol array is at least as long as the measurement result length, it provides a guard interval value for each symbol. If the array is shorter than the measurement result length, processing loops back and re-uses the array (and keeps looping back every time the end of the array is reached again). The location within the array that is looped back to is determined by the Repeat Index. There are four possible cases:

1	RepeatIndex ≥ 0 and RepeatIndex < ArrayLength	<p>This is the normal case</p> <p>The repeat index specifies which entry in the array to loop back to (the index is zero-based). Each time the end of the array is reached, it loops back to this entry in the array. A value of zero (which is the default) therefore means that it loops back to the start of the array. A value of ArrayLength-1 means that it loops back to the last value in the array, so the last value is used over and over</p>
2	RepeatIndex \geq ArrayLength	<p>The repeat index points beyond the end of the array. It is treated as though RepeatIndex = ArrayLength-1, so the last value in the array is repeated over and over</p>
3	RepeatIndex < 0 and RepeatIndex $\geq -$ ArrayLength	<p>A negative value means the repeat index is an offset from the end of the array. A value of -1 means the last value in the array is repeated over and over. A value of -ArrayLength means that it loops back to the start of the array</p>
4	RepeatIndex < -ArrayLength	<p>The negative value is larger than the array length, so it is too large to be an offset from the end of the array. It is treated as though RepeatIndex = -ArrayLength, so that it loops back to the start of the array</p>

Remote Command	<pre>[:SENSe]:OFDM:CCARrier0 ... 7:GUARd:INTerval:RINDEX <integer></pre> <p>See table above for <integer> values</p> <pre>[:SENSe]:OFDM:CCARrier0 ... 7:GUARd:INTerval:RINDEX?</pre>
Example	<pre>:OFDM:CCAR0:GUAR:INT:RIND 1</pre>
Preset	1
Min	1
Max	2147483647

Guard Interval Values (Remote Command Only)

Specifies the guard intervals (also called cyclic prefix) separately for each symbol. Each is specified as a fraction of the OFDM FFT length. The values are unitless (*not* percent).

Remote Command	<pre>[:SENSe]:OFDM:CCARrier0 ... 7:GUARd:INTerval <real>, <real>, ...</pre> <pre>[:SENSe]:OFDM:CCARrier0 ... 7:GUARd:INTerval?</pre>
----------------	--

Example	:OFDM:CCAR0:GUAR:INT 0.25,0.2
Preset	Guard Interval Values is cleared by Restore Mode Defaults
State Saved	Saved in instrument state
Min	0
Max	1

Edit Time Gaps

Sets an array of gaps between symbols. Some OFDM signal formats may have empty gaps or other non-OFDM signal content between OFDM symbols. Time Gap allows for proper demodulation of these signals.

The Time Gaps property is an array, with one value for each symbol in the signal. Each value specifies the number of samples of the time gap, at the OFDM system sample frequency, at the start of the OFDM symbol.

Go to Row

Lets you move through the table to edit the desired point.

Min	1
Max	2000

Insert Row Below

Inserts a row below the current row. The new row is a copy of the current row and becomes the current row. The new row is not yet entered into the underlying table, and the data in the row is displayed in light gray.

Delete Row

This is an immediate action control, which deletes the currently-selected row, even if the row is being edited. The row following the currently-selected row (or the row preceding if there is none) will be selected.

Clear Table

This is an immediate action key, which clears the table.

Repeat Index

If the Time Gaps array is at least as long as the measurement result length, it provides a time gap value for each symbol. If the array is shorter than the measurement result length, processing loops back and re-uses the array (and keeps

3 VMA Mode
 3.2 Custom OFDM Measurement

looping back every time the end of the array is reached again). The location within the array that is looped back to is determined by the Time Gaps Repeat Index. There are four possible cases:

- | | | |
|---|--|---|
| 1 | RepeatIndex ≥ 0
and RepeatIndex
< ArrayLength | This is the normal case

The repeat index specifies which entry in the array to loop back to (the index is zero-based). Each time the end of the array is reached, it loops back to this entry in the array. A value of zero (which is the default) therefore means that it loops back to the start of the array. A value of ArrayLength-1 means that it loops back to the last value in the array, so the last value is used over and over |
| 2 | RepeatIndex \geq
ArrayLength | The repeat index points beyond the end of the array. It is treated as though RepeatIndex = ArrayLength-1, so the last value in the array is repeated over and over |
| 3 | RepeatIndex < 0
and RepeatIndex
$\geq -$ ArrayLength | A negative value means the repeat index is an offset from the end of the array. A value of -1 means the last value in the array is repeated over and over. A value of -ArrayLength means that it loops back to the start of the array |
| 4 | RepeatIndex <
-ArrayLength | The negative value is larger than the array length, so it is too large to be an offset from the end of the array. It is treated as though RepeatIndex = -ArrayLength, so that it loops back to the start of the array |

Remote Command	<code>[:SENSe]:OFDM:CCARrier0 ... 7:TGAP:RINdex <integer></code> <code>[:SENSe]:OFDM:CCARrier0 ... 7:TGAP:RINdex?</code>
Example	<code>:OFDM:CCAR0:TGAP:RIND 1</code>
Preset	1
Min	1
Max	2147483647

Time Gaps Values (Remote Command Only)

Specifies the time gaps before the start of each OFDM symbol. Each is specified as a number of samples at the OFDM system sample frequency.

Remote Command	<code>[:SENSe]:OFDM:CCARrier0 ... 7:TGAP <int>, <int>, ...</code> <code>[:SENSe]:OFDM:CCARrier0 ... 7:TGAP?</code>
Example	<code>:OFDM:CCAR0:TGAP 2,1</code>
Preset	Time Gaps Values is cleared by Restore Mode Defaults
State Saved	Saved in instrument state
Min	1
Max	2147483647

Edit Pilot IQ Values

The Pilot IQ list may contain a very large number of IQ pairs, so it may not be feasible to display all IQ pairs in one table.

The table displays up to 50 IQ pairs for modification. IQ Pair Start is used to specify which part of the Pilot IQ list will be loaded into the table. The table's index column displays the mapping between the table row index and the IQ pair index in the Pilot IQ list.

IQ Pair Start

Specifies the index of the Pilot IQ value list from which to generate the table.

Min	1
Max	Depends on the Pilot IQ list length

Go to Row

Lets you move through the table to edit the desired point.

Min	1
Max	2000

Insert Row Below

Inserts a row below the current row. The new row is a copy of the current row and becomes the current row. The new row is not yet entered into the underlying table, and the data in the row is displayed in light gray.

Delete Row

This is an immediate action key, which deletes the currently-selected row, even if the row is being edited. The row following the currently-selected row (or the row preceding if there is none) will be selected.

Clear Table

This is an immediate action control, which clears the table.

Pilot IQ Values (Remote Command Only)

Defines the expected I and Q values for each pilot subcarrier.

Remote Command	<code>[:SENSE]:OFDM:CCARrier0 ... 7:PIlot:IQ <real>, <real>, ...</code> <code>[:SENSE]:OFDM:CCARrier0 ... 7:PIlot:IQ?</code>
----------------	---

Example	:OFDM:CCAR0:PIL:IQ 1,0,1,0
Preset	Pilot IQ Values is cleared by Restore Mode Defaults
State Saved	Saved in instrument state

Layer Index

Specifies the layer which Pilot IQ value list is shown in the table.

Couplings	Only valid when MIMO = On
Min	0
Max	7

Edit Preamble IQ Values

The Preamble IQ list may contain a very large number of IQ pairs, so it may not be feasible to display all IQ pairs in one table.

The table displays up to 50 IQ pairs for modification. IQ Pair Start is used to specify which part of the Preamble IQ list will be loaded into the table. This table's index column displays the mapping between the table row index and the IQ pair index in the Preamble IQ list.

IQ Pair Start

Specifies the index of the Pilot IQ value list from which to generate the table.

Min	1
Max	Depends on Pilot IQ list length

Go to Row

Lets you move through the table to edit the desired point.

Min	1
Max	2000

Insert Row Below

Inserts a row below the current row. The new row is a copy of the current row and becomes the current row. The new row is not yet entered into the underlying table, and the data in the row is displayed in light gray.

Delete Row

This is an immediate action control, which deletes the currently-selected row, even if the row is being edited. The row following the currently-selected row (or the row preceding if there is none) will be selected.

Clear Table

This is an immediate action control, which clears the table.

Preamble IQ values (Remote Command Only)

Defines the expected I and Q values for each preamble subcarrier.

Remote Command	<code>[:SENSe]:OFDM:CCARrier0 ... 7:PREamble:IQ <real>, <real>, ...</code> <code>[:SENSe]:OFDM:CCARrier0 ... 7:PREamble:IQ?</code>
Example	<code>:OFDM:CCAR0:PRE:IQ 1.2,-1.2,1.2,-1.2</code>
Preset	Preamble IQ Values is cleared by Restore Mode Defaults
State Saved	Saved in instrument state

Layer Index

Specifies the layer which Preamble IQ value list is shown in the table.

Couplings	Only valid when MIMO = On
Min	0
Max	7

Resource Mapping

Defines the function of each subcarrier in each symbol, describing whether it is a preamble, pilot, data or null subcarrier type.

The Resource Map file must contain one value for each active (that is, non-guard) subcarrier, including the "DC" center subcarrier.

Edit User Mapping

Takes you to the logical user mapping page.

Dependencies	Invalid when " MIMO On/Off " on page 531 is ON
--------------	--

Back

Takes you to the resource mapping page.

Add User

Inserts a row into the User Mapping table.

Delete User

Deletes the selected row of the User Mapping table.

Clear Table

Deletes all rows of the User Mapping table.

User Name

Lets you specify the name of one logic user.

Symbol Index

Lets you specify the time range of the resource assigned to one logic user in terms of the OFDM symbol.

Subcarriers Index

Lets you specify the frequency range of the resource assigned to one logic user in terms of the OFDM sub carrier.

Boost Level

Lets you specify the boost level of one logic user.

Add Allocation

Inserts a row into the Resource Mapping table.

Delete Allocation

Deletes the selected row of the Resource Mapping table.

Clear Table

Deletes all rows of the Resource Mapping table.

Apply

Applies all resource mapping settings to the measurement.

Type

Lets you specify the type of one resource allocation: Data, Pilot, Preamble, Unknown Pilot, Zero, Unspecified.

Active Layer

Lets you specify the layer of the resource allocation in MIMO mode.

Symbol Index

Lets you specify the time range of one resource allocation in terms of the OFDM symbol.

Subcarriers Index

Lets you specify the frequency range of one resource allocation in terms of the OFDM sub carrier.

Modulation

Specify the modulation type of one resource allocation: BPSK to 4096QAM.

Boost Level

Lets you specify the boost level of one modulation type. When the resource type is Unknown Pilot, it specifies the boost level for the Unknown Pilot, regardless of the modulation type.

NOTE

If multiple allocations have the same modulation type, the boost level is the same.

If the modulation type is Auto, the boost level is blank.

If the resource type is Pilot or Preamble, the boost level is blank. It can be determined by Pilot or Preamble IQ values.

All Unknown Pilot resources share the same boost level.

Resource Mapping values (Remote Command Only)

Specifies the type of each "resource" (each used subcarrier and symbol time). 0 = Data, 1 = Pilot, 2 = Unknown Pilot, 3 = Preamble, 4 = Null, 5 = Unspecified.

NOTE

The resource map information set through this command is not visible/editable under **Meas Setup, Demod, Demod Settings, Resource Mapping**.

3 VMA Mode
3.2 Custom OFDM Measurement

Remote Command	<code>[[:SENSe]:OFDM:CCARrier0 ... 7:RMAP <int>, <int>, ...</code> <code>[[:SENSe]:OFDM:CCARrier0 ... 7:RMAP?</code>
Example	<code>:OFDM:CCAR0:RMAP 4,3,1,0</code>
Preset	Cleared by Restore Mode Defaults
State Saved	Saved in instrument state

Resource Modulation Values (Remote Command Only)

Specifies the type of each “resource” (each used subcarrier and symbol time). 0 = Auto, 1 = BPSK, 2 = QPSK, 3 = 8PSK, 4 = 16QAM, 5 = 32QAM, 6 = 64QAM,..., 12 = 4096QAM

NOTE

The resource modulation information set through this SCPI is not visible/editable under Meas Setup, Demod, Demod Settings, Resource Mapping.

Remote Command	<code>[[:SENSe]:OFDM:CCARrier0 ... 7:RMOdulation <int>, <int>, ...</code> <code>[[:SENSe]:OFDM:CCARrier0 ... 7:RMOdulation?</code>
Example	<code>:OFDM:CCAR0:RMOD 4,3,1,1</code>
Preset	Cleared by Restore Mode Defaults
State Saved	Saved in instrument state

Equalizer & Tracking

Lets you set the Equalizer and Tracking parameters.

Equalizer Use Data

Lets you specify if the equalizer training includes the Data subcarriers or not.

Remote Command	<code>[[:SENSe]:OFDM:CCARrier0 ... 7:EQUalizer:USE:DATA OFF ON 0 1</code> <code>[[:SENSe]:OFDM:CCARrier0 ... 7:EQUalizer:USE:DATA?</code>
Example	<code>:OFDM:CCAR0:EQU:USE:DATA 0</code> <code>:OFDM:CCAR0:EQU:USE:DATA?</code>
Preset	OFF
State Saved	Yes

Equalizer Use DC Pilot

Lets you specify whether the equalizer training includes the DC pilot subcarriers or not, when the Equalizer Use Pilot is selected.

Remote Command	<code>[:SENSe]:OFDM:CCARrier0 ... 7:EQUalizer:USE:DCPilot OFF ON 0 1</code> <code>[:SENSe]:OFDM:CCARrier0 ... 7:EQUalizer:USE:DCPilot?</code>
Example	<code>:OFDM:CCAR0:EQU:USE:DCP 1</code> <code>:OFDM:CCAR0:EQU:USE:DCP?</code>
Preset	ON
State Saved	Yes

Equalizer Use Pilot

Lets you specify if the equalizer training includes the pilot subcarriers or not.

Remote Command	<code>[:SENSe]:OFDM:CCARrier0 ... 7:EQUalizer:USE:PILOt OFF ON 0 1</code> <code>[:SENSe]:OFDM:CCARrier0 ... 7:EQUalizer:USE:PILOt?</code>
Example	<code>:OFDM:CCAR0:EQU:USE:PIL 1</code> <code>:OFDM:CCAR0:EQU:USE:PIL?</code>
Preset	OFF
State Saved	Yes

Equalizer Use Preamble

The equalizer uses the Channel Estimation Sequence in the preamble of the burst. After this initialization, the equalizer coefficients are held constant while demodulating the rest of the burst.

Remote Command	<code>[:SENSe]:OFDM:CCARrier0 ... 7:EQUalizer:USE:PREAmbLe OFF ON 0 1</code> <code>[:SENSe]:OFDM:CCARrier0 ... 7:EQUalizer:USE:PREAmbLe?</code>
Example	<code>:OFDM:CCAR0:EQU:USE:PRE 1</code> <code>:OFDM:CCAR0:EQU:USE:PRE?</code>
Preset	ON
State Saved	Yes

Equalizer Averaging Mode

Selects the averaging method used to determine the equalizer filter coefficients across multiple symbols:

Equal Weight	EWEight	Equalizer averaging calculated using the equal weighted least squares method
Least Squares	LSquares	Equalizer training calculated using the Least Squares method

Remote	<code>[:SENSe]:OFDM:CCARrier0 ... 7:EQUalizer:AVERAge:MODE EWEight LSquares</code>
--------	---

3 VMA Mode
3.2 Custom OFDM Measurement

Command	<code>[:SENSe]:OFDM:CCARrier0 ... 7:EQUalizer:AVERage:MODE?</code>
Example	<code>:OFDM:CCAR0:EQU:AVER:MODE EWEight</code> <code>:OFDM:CCAR0:EQU:AVER:MODE?</code>
Preset	EWE
State Saved	Saved in instrument state

Initial Equalizer Mode

When creating the initial channel equalizer, the measurement tries to use any available information from known pilot and preamble subcarriers. **Initial Equalizer Mode** controls which symbols are included when looking for known pilot and preamble subcarriers. It can be set to either Auto or Manual:

AUTO	Tries to use all symbols that contain known pilot or preamble subcarriers This is the default
MANual	You specify the number of symbols to use. The number of symbols is specified by "Initial Equalizer Symbols" on page 519 This mode may be useful for signals that have no preamble, and have known pilots in many symbols. If there is significant frequency drift, the initial equalizer might be more accurate when constructed using fewer symbols

Remote Command	<code>[:SENSe]:OFDM:CCARrier0 ... 7:EQUalizer:INITial:MODE AUTO MANual</code> <code>[:SENSe]:OFDM:CCARrier0 ... 7:EQUalizer:INITial:MODE?</code>
Example	<code>:OFDM:CCAR0:EQU:INIT:MODE AUTO</code> <code>:OFDM:CCAR0:EQU:INIT:MODE?</code>
Preset	AUTO
State Saved	Saved in instrument state

Initial Equalizer Symbols

Specifies the number of symbols used when the Initial Equalizer Mode is set to Manual

Remote Command	<code>[:SENSe]:OFDM:CCARrier0 ... 7:EQUalizer:INITial:SYMBols <integer></code> <code>[:SENSe]:OFDM:CCARrier0 ... 7:EQUalizer:INITial:SYMBols?</code>
Example	<code>:OFDM:CCAR0:EQU:INIT:SYMB 1</code> <code>:OFDM:CCAR0:EQU:INIT:SYMB?</code>
Preset	1
State Saved	Yes
Min	0
Max	Depends on Meas Interval

Include Data Subcarriers

Enables/disables use of data subcarriers in phase, amplitude and timing tracking.

Remote Command	<code>[:SENSe]:OFDM:CCARrier0 ... 7:TRACk:DATA OFF ON 0 1</code> <code>[:SENSe]:OFDM:CCARrier0 ... 7:TRACk:DATA?</code>
Example	<code>:OFDM:CCAR0:TRAC:DATA 1</code> <code>:OFDM:CCAR0:TRAC:DATA?</code>
Preset	OFF
State Saved	Yes

Track Amplitude

When **Track Amplitude** is turned on, the measurement applies pilot subcarrier amplitude error correction to the pilot and data subcarriers (default is true).

Remote Command	<code>[:SENSe]:OFDM:CCARrier0 ... 7:TRACk:AMPLitude OFF ON 0 1</code> <code>[:SENSe]:OFDM:CCARrier0 ... 7:TRACk:AMPLitude?</code>
Example	<code>:OFDM:CCAR0:TRAC:AMPL 1</code> <code>:OFDM:CCAR0:TRAC:AMPL?</code>
Preset	ON
State Saved	Yes
Range	Hex Binary

Track Phase

When Track Phase is turned on, the measurement applies pilot subcarrier phase error correction to the pilot and data subcarriers (default is true).

Remote Command	<code>[:SENSe]:OFDM:CCARrier0 ... 7:TRACk:PHASe OFF ON 0 1</code> <code>[:SENSe]:OFDM:CCARrier0 ... 7:TRACk:PHASe?</code>
Example	<code>:OFDM:CCAR0:TRAC:PHAS 1</code> <code>:OFDM:CCAR0:TRAC:PHAS?</code>
Preset	ON
State Saved	Yes
Range	Hex Binary

Track Timing

When this is on, the measurement applies pilot subcarrier timing error correction (frequency offset correction) to the pilot and data subcarriers (default is true).

Remote Command	<code>[:SENSe]:OFDM:CCARrier0 ... 7:TRACk:TIMing OFF ON 0 1</code>
----------------	---

3 VMA Mode
3.2 Custom OFDM Measurement

Command	<code>[:SENSe]:OFDM:CCARrier0 ... 7:TRACk:TIMing?</code>
Example	<code>:OFDM:CCAR0:TRAC:TIM 1</code> <code>:OFDM:CCAR0:TRAC:TIM?</code>
Preset	ON
State Saved	Yes
Range	Hex Binary

Filter

In some circumstances, signal energy from outside the bandwidth of the analyzed signal can leak into the analysis, producing artificially high EVM. This may be due to aliasing that is a byproduct of the sampling and filtering done by the analyzer, or it may be due to similar issues in the signal generator, or perhaps something else entirely.

The **Filter** settings are used to configure and apply equalizer multi-carrier filtering to the measurement. The multi-carrier filter is a FIR filter that is applied to the measured signal before synchronization and demodulation.

Filter Type

Lets you specify the characteristics of the multi-carrier signal, by selecting a filter type.

None	NONE	No multi-carrier filter is applied (default)
"Arbitrary" on page 522	ARbitrary	You supply a set of filter coefficients to apply
"Windowed Sinc" on page 523	WSINc	The filter is designed by starting with an ideal sinc filter shape and then applying a window to the time-domain coefficients. You specify the bandwidth, the number of coefficients, and the window type
"Remez" on page 523	REMez	The filter is designed using the Remez-exchange method. You specify the pass-band ripple, pass-band bandwidth, transition bandwidth, and stop-band attenuation

Remote Command	<code>[:SENSe]:OFDM:CCARrier0 ... 7:FILTer:TYPE NONE ARbitrary REMez WSINc</code> <code>[:SENSe]:OFDM:CCARrier0 ... 7:FILTer:TYPE?</code>
Example	<code>:OFDM:CCAR0:FILT:TYPE NONE</code> <code>:OFDM:CCAR0:FILT:TYPE?</code>
State Saved	Saved in instrument state
Range	None Arbitrary Remez Windowed Sinc

Arbitrary

The following functions are available when this is the selected filter type.

Edit Filter Coefficients

Enables you to specify an array of floating-point values Arbitrary Coefficients that are used as the FIR filter coefficients, this is only available when Filter Type is Arbitrary.

Go to Row

Enables you to move through the table to edit the desired point.

Min	1
Max	2000

Insert Row Below

Inserts a row below the current row. The new row is a copy of the current row and becomes the current row. The new row is not yet entered into the underlying table, and the data in the row is displayed in light gray.

Delete Row

This is an immediate action control. It immediately deletes the currently-selected row regardless if the row is being edited or not. The row following the currently-selected row (or the row preceding if there is none) will be selected.

Clear Table

This is an immediate action control. It immediately clears the table.

Sample Ratio

Enables you to specify the sample rate for the coefficients. The sample rate is specified as a ratio from the OFDM System Sample Frequency. The default value is 1 (or 1:1 ratio), meaning that the sample rate of the coefficients matches the OFDM System Sample Frequency.

Remote Command	<code>[:SENSe]:OFDM:CCARrier0 ... 7:FILTer:SRATio <integer></code>
Example	<code>:OFDM:CCAR0:FILT:SRAT 1</code>
Preset	1
Min	0.0625

Max 65536

Remez

The following functions are available when this is the selected filter type.

Attenuation

Enables you to specify the stop-band attenuation of the filter in dB.

Remote Command	<code>[[:SENSe]:OFDM:CCARrier0 ... 7:REMez:ATTenuation <rel_ampl></code> <code>[[:SENSe]:OFDM:CCARrier0 ... 7:REMez:ATTenuation?</code>
Example	<code>:OFDM:CCAR0:REM:ATT -20dB</code>
Preset	-60
State Saved	Saved in instrument state
Min	-300 dB
Max	0 dB

Ripple

Enables you to specify the peak-to-peak ripple of the pass-band in dB.

Remote Command	<code>[[:SENSe]:OFDM:CCARrier0 ... 7:REMez:RIPple <double></code> <code>[[:SENSe]:OFDM:CCARrier0 ... 7:REMez:RIPple?</code>
Example	<code>:OFDM:CCAR0:REM:RIPP 0.1dB</code>
Preset	0.1
State Saved	Saved in instrument state
Min	0.0001 dB
Max	20 dB

Windowed Sinc

The following functions are available when this is the selected filter type.

Length

Enables you to specify the windowed sinc length (number of coefficients).

Remote Command	<code>[[:SENSe]:OFDM:CCARrier0 ... 7:WSINc:LENGth <int></code> <code>[[:SENSe]:OFDM:CCARrier0 ... 7:WSINc:LENGth?</code>
----------------	---

	<code>[:SENSe]:OFDM:CCARrier0 ... 7:WSINc:LENGth:AUTO OFF ON 0 1</code>
	<code>[:SENSe]:OFDM:CCARrier0 ... 7:WSINc:LENGth:AUTO?</code>
Example	<code>:OFDM:CCAR0:WSIN:LENG 32</code> <code>:OFDM:CCAR0:WSIN:LENG?</code>
Preset	32 ON
State Saved	Saved in instrument state
Min	1
Max	1000

Window

Enables you to specify the window type for the windowed sinc filter.

UNIFORM	A Uniform window type is applied
HANNing	A Hanning window type is applied (default)
HAMMING	A Hamming window type is applied

Remote Command	<code>[:SENSe]:OFDM:CCARrier0 ... 7:WSINc:WINDow UNIFORM HANNing HAMMING</code> <code>[:SENSe]:OFDM:CCARrier0 ... 7:WSINc:WINDow?</code>
Example	<code>:OFDM:CCAR0:WSIN:WIND HAMM</code> <code>:OFDM:CCAR0:WSIN:WIND?</code>
Preset	HANNing
State Saved	Saved in instrument state
Range	Uniform Hanning Hamming

Remez & Windowed Sinc

The following functions are available when this is the selected filter type.

Passband

Enables you to specify the pass bandwidth for either Remez or Windowed Sinc filtering as a fraction of the OFDM System Sample Frequency.

Remote Command	<code>[:SENSe]:OFDM:CCARrier0 ... 7:FILTer:PBANd <double></code> <code>[:SENSe]:OFDM:CCARrier0 ... 7:FILTer:PBANd?</code>
Example	<code>:OFDM:CCAR0:FILT:PBAN 0.8</code> <code>:OFDM:CCAR0:FILT:PBAN?</code>

3 VMA Mode
3.2 Custom OFDM Measurement

Preset	0.8
State Saved	Saved in instrument state
Min	0
Max	1

Transition Bandwidth

Enables you to specify the transition bandwidth for either Remez or Windowed Sinc filtering as a fraction of the OFDM System Sample Frequency.

Remote Command	<code>[[:SENSe]:OFDM:CCARrier0 ... 7:FILTer:TBANd <double></code> <code>[[:SENSe]:OFDM:CCARrier0 ... 7:FILTer:TBANd?</code>
Example	<code>:OFDM:CCAR0:FILT:TBAN 0.1</code> <code>:OFDM:CCAR0:FILT:TBAN?</code>
Preset	0.1
State Saved	Saved in instrument state
Min	0
Max	1

Advanced

Contains advanced formatting functions.

Symbol Time Adjustment

Shifts the start of the TFFT period earlier in the symbols. You specify the amount of TFFT shift as a percentage of the TFFT length.

Remote Command	<code>[[:SENSe]:OFDM:CCARrier0 ... 7:SYMBol:ADJust <percent></code> <code>[[:SENSe]:OFDM:CCARrier0 ... 7:SYMBol:ADJust?</code>
Example	<code>:OFDM:CCAR0:SYMB:ADJ -3.125</code> <code>:OFDM:CCAR0:SYMB:ADJ?</code>
Preset	-3.125
State Saved	Saved in instrument state
Min	- The Minimum value of current Guard Interval * 100 %
Max	0

Synchronization Mode

Controls the type of synchronization used to synchronize to the start of an OFDM burst. The two available choices are:

Time Correlation	TCORrelation	The measurement uses Time Correlation between the user-defined preamble and the measured signal to synchronize to the start of the OFDM burst
Cyclic Prefix	CP	Synchronizes the start of the OFDM burst to the Cyclic Prefix

Remote Command	<code>[:SENSe]:OFDM:CCARrier0 ... 7:SYNChronize:MODE TCORrelation CP</code> <code>[:SENSe]:OFDM:CCARrier0 ... 7:SYNChronize:MODE?</code>
Example	<code>:OFDM:CCAR0:SYNC:MODE CP</code> <code>:OFDM:CCAR0:SYNC:MODE?</code>
Preset	TCORrelation
State Saved	Saved in instrument state
Range	Time Correlation Cyclic Prefix

Synchronization Region Selection

Enables you to set the Synchronization Region selection mode.

AUTO	The measurement utilizes the full resource map to define the reference signal for synchronization, and searches over the acquisition to synchronize the measured signal with the reference signal
MANual	The measurement uses the manual Synchronization Region settings. This mode is for the case when you want to use only a specific part of the resource map for synchronization

Remote Command	<code>[:SENSe]:OFDM:CCARrier0 ... 7:SYNChronize:REGion:SELECTION AUTO MANual</code> <code>[:SENSe]:OFDM:CCARrier0 ... 7:SYNChronize:REGion:SELECTION?</code>
Example	<code>:OFDM:CCAR0:SYNC:REG:SEL AUTO</code> <code>:OFDM:CCAR0:SYNC:REG:SEL?</code>
Preset	AUTO
State Saved	Saved in instrument state

Synchronization Reference Interval

Sets the interval of the reference signal to use for synchronization.

3 VMA Mode
3.2 Custom OFDM Measurement

Remote Command	<code>[:SENSe]:OFDM:CCARrier0 ... 7:SYNChronize:REFerence:INTerval <int></code> <code>[:SENSe]:OFDM:CCARrier0 ... 7:SYNChronize:REFerence:INTerval?</code>
Example	<code>:OFDM:CCAR0:SYNC:REF:INT 10</code> <code>:OFDM:CCAR0:SYNC:REF:INT?</code>
Preset	10
State Saved	Saved in instrument state
Min	1
Max	Depends on Max Result Length

Synchronization Reference Offset

Sets the offset of the reference signal to use for synchronization.

Remote Command	<code>[:SENSe]:OFDM:CCARrier0 ... 7:SYNChronize:REFerence:OFFSet <int></code> <code>[:SENSe]:OFDM:CCARrier0 ... 7:SYNChronize:REFerence:OFFSet?</code>
Example	<code>:OFDM:CCAR0:SYNC:REF:OFFS 0</code> <code>:OFDM:CCAR0:SYNC:REF:OFFS?</code>
Preset	0
State Saved	Saved in instrument state
Min	0
Max	Depends on Max Result Length

Synchronization Search Interval

Sets the synchronization search interval (in symbols) used when synchronizing to the signal.

Remote Command	<code>[:SENSe]:OFDM:CCARrier0 ... 7:SYNChronize:SEARch:INTerval <int></code> <code>[:SENSe]:OFDM:CCARrier0 ... 7:SYNChronize:SEARch:INTerval?</code>
Example	<code>:OFDM:CCAR0:SYNC:SEAR:INT 10</code> <code>:OFDM:CCAR0:SYNC:SEAR:INT?</code>
Preset	10
State Saved	Saved in instrument state
Min	1
Max	Depends on Max Result Length

Synchronization Search Offset

Sets the synchronization search offset (in symbols) used when synchronizing to the signal.

Remote Command	<code>[[:SENSe]:OFDM:CCARrier0 ... 7:SYNChronize:SEARch:OFFSet <int></code> <code>[[:SENSe]:OFDM:CCARrier0 ... 7:SYNChronize:SEARch:OFFSet?</code>
Example	<code>:OFDM:CCAR0:SYNC:SEAR:OFFS 0</code> <code>:OFDM:CCAR0:SYNC:SEAR:OFFS?</code>
Preset	0
State Saved	Saved in instrument state
Min	0
Max	Depends on Max Result Length

Compensate Symbol Clock Error

Enables or disables the internal adjustment in the timing of the symbol clock.

Remote Command	<code>[[:SENSe]:OFDM:CCARrier0 ... 7:SYMBol:COMPensate:CERRor OFF ON 0 1</code> <code>[[:SENSe]:OFDM:CCARrier0 ... 7:SYMBol:COMPensate:CERRor?</code>
Example	<code>:OFDM:CCAR0:SYMB:COMP:CERR 0</code> <code>:OFDM:CCAR0:SYMB:COMP:CERR?</code>
Preset	OFF
State Saved	Yes
Range	Hex Binary

EVM Normalized by Reference

Specifies EVM normalized to the IQ Reference signal power.

Remote Command	<code>[[:SENSe]:OFDM:CCARrier0 ... 7:EVMNorm OFF ON 0 1</code> <code>[[:SENSe]:OFDM:CCARrier0 ... 7:EVMNorm?</code>
Example	<code>:OFDM:CCAR0:EVMN 1</code> <code>:OFDM:CCAR0:EVMN?</code>
Preset	ON
State Saved	Yes

Report EVM in DB

Enables/disables display of EVM in percent. When OFF (false), the EVM values are displayed in dB.

Remote Command	<code>[[:SENSe]:OFDM:CCARrier0 ... 7:EVM:REPort:DB OFF ON 0 1</code> <code>[[:SENSe]:OFDM:CCARrier0 ... 7:EVM:REPort:DB?</code>
Example	<code>:OFDM:CCAR0:EVM:REP:DB 1</code> <code>:OFDM:CCAR0:EVM:REP:DB?</code>
Preset	OFF
State Saved	Yes
Range	OFF ON

Extended Frequency Lock Range

Increases the range in which the demodulator will be able to lock onto the signal. This parameter uses the value of "[Extended Frequency Lock Range Width](#)" on page 529 to specify the extended frequency offset lock range (in subcarriers). Selecting **Extended Frequency Lock Range** increases the frequency offset lock range to \pm the **Extended Frequency Lock Range Width** subcarrier spacing on either side of the center frequency.

Use if the measurement is failing to lock onto the measurement signal.

NOTE

Extending the frequency lock range causes the measurement to take longer, so this feature should be selected only when necessary.

Remote Command	<code>[[:SENSe]:OFDM:CCARrier0 ... 7:EFLock:RANGe OFF ON 0 1</code> <code>[[:SENSe]:OFDM:CCARrier0 ... 7:EFLock:RANGe?</code>
Example	<code>:OFDM:CCAR0:EFL:RANG 1</code> <code>:OFDM:CCAR0:EFL:RANG?</code>
Preset	ON
State Saved	Yes

Extended Frequency Lock Range Width

Specifies the number of subcarriers used to extend the VSA frequency lock range when "[Extended Frequency Lock Range](#)" on page 529 is selected.

Remote	<code>[[:SENSe]:OFDM:CCARrier0 ... 7:EFLock:RANGe:WIDTh <int></code>
--------	--

Command	<code>[:SENSe]:OFDM:CCARrier0 ... 7:EFLoCK:RANGe:WIDTh?</code>
Example	<code>:OFDM:CCAR0:EFL:RANG:WIDT 10</code> <code>:OFDM:CCAR0:EFL:RANG:WIDT?</code>
Couplings	Max value equals FFT Length
Preset	10
State Saved	Saved in instrument state
Min	1
Max	Depends on FFT Length

Phase Compensation Mode

Set the phase compensation mode on the baseband signal before upconversion.

AUTO	Use the CF of current component carrier for symbol phase compensation
MANual	Use the Phase Compensation Frequency for symbol phase compensation
OFF	No symbol phase compensation

Remote Command	<code>[:SENSe]:OFDM:CCARrier0 ... 7:PHASe:COMPensation:MODE AUTO MANUal OFF</code> <code>[:SENSe]:OFDM:CCARrier0 ... 7:PHASe:COMPensation:MODE?</code>
Example	<code>:OFDM:CCAR0:PHAS:COMP:MODE AUTO</code> <code>:OFDM:CCAR0:PHAS:COMP:MODE?</code>
Preset	OFF
State Saved	Saved in instrument state

Phase Compensation Frequency

Set the phase compensation frequency on the baseband signal before upconversion, when Phase Compensation Mode is MANual.

Remote Command	<code>[:SENSe]:OFDM:CCARrier0 ... 7:PHASe:COMPensation:FREQuency <freq></code> <code>[:SENSe]:OFDM:CCARrier0 ... 7:PHASe:COMPensation:FREQuency?</code>
Example	<code>:OFDM:CCAR0:PHAS:COMP:FREQ 1 GHz</code> <code>:OFDM:CCAR0:PHAS:COMP:FREQ?</code>
Preset	1 GHz
State Saved	Saved in instrument state
Min	0
Max	100 GHz

Pilot in Time Domain

Enables or disables the pilot in the time domain for phase tracking purpose. When enabled, a single DFT is performed over all the Pilot and Data subcarriers in any OFDM symbol, where no Preamble type of resource is allocated.

Remote Command	<code>[:SENSe]:OFDM:CCARrier0 ... 7:PITDomain OFF ON 0 1</code> <code>[:SENSe]:OFDM:CCARrier0 ... 7:PITDomain?</code>
Example	<code>:OFDM:CCAR0:PITD 1</code> <code>:OFDM:CCAR0:PITD?</code>
Preset	OFF
State Saved	Saved in instrument state

MIMO On/Off

Turns MIMO on or off.

Remote Command	<code>[:SENSe]:OFDM:MIMO[:STATe] OFF ON 0 1</code> <code>[:SENSe]:OFDM:MIMO[:STATe]?</code>
Example	<code>:OFDM:MIMO OFF</code> <code>:OFDM:MIMO?</code>
Preset	OFF
State Saved	Yes
Range	OFF ON

MIMO Transmitter Antennas

Specifies the Transmitter Antennas for MIMO signal.

Remote Command	<code>[:SENSe]:OFDM:MIMO:TXANtennas <integer></code> <code>[:SENSe]:OFDM:MIMO:TXANtennas?</code>
Example	<code>:OFDM:MIMO:TXAN 2</code> <code>:OFDM:MIMO:TXAN?</code>
Dependencies	This control only appears when " MIMO On/Off " on page 531 is on
Preset	1
State Saved	Yes
Min	1
Max	8

MIMO Scheme

Enables you to specify and configure MIMO scheme.

MIMO Type

Specify MIMO type according to how reference signal (preamble/pilot) generated. it is assumed that data subcarriers are transmitted simultaneously on all antennas, and have the same modulation format on all antennas.

- Non-overlapping: Any given pilot or preamble subcarrier is transmitted on only one antenna at a time, and is null on all other antennas. (Examples: WiMAX, LTE)

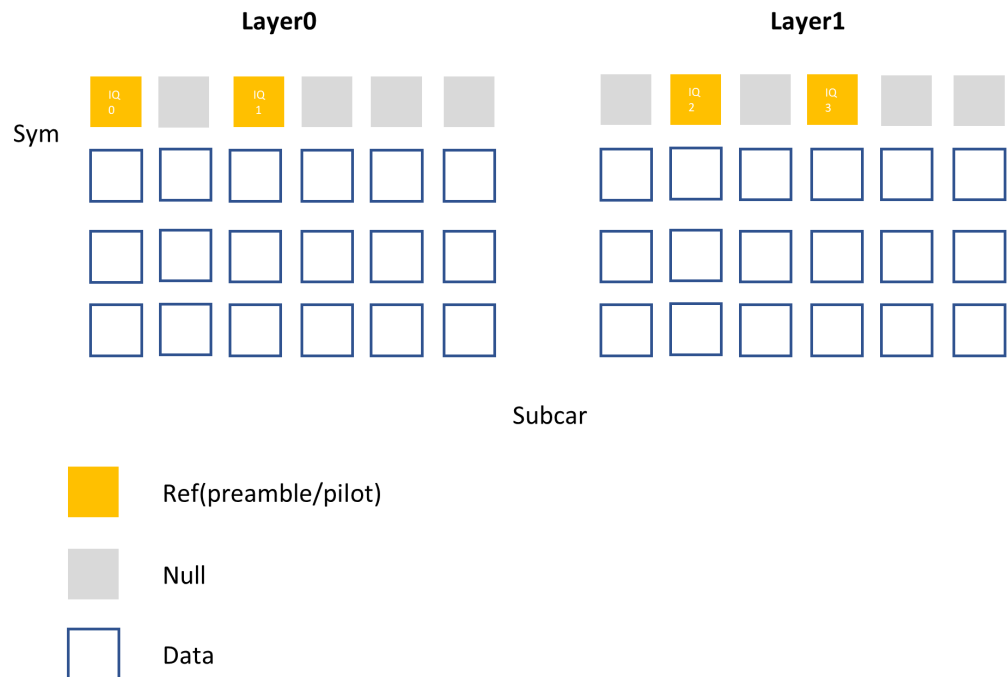

- Overlapping All: All preamble and pilot subcarriers are transmitted on all antennas at all times. (Example: 802.11n)

3 VMA Mode
 3.2 Custom OFDM Measurement

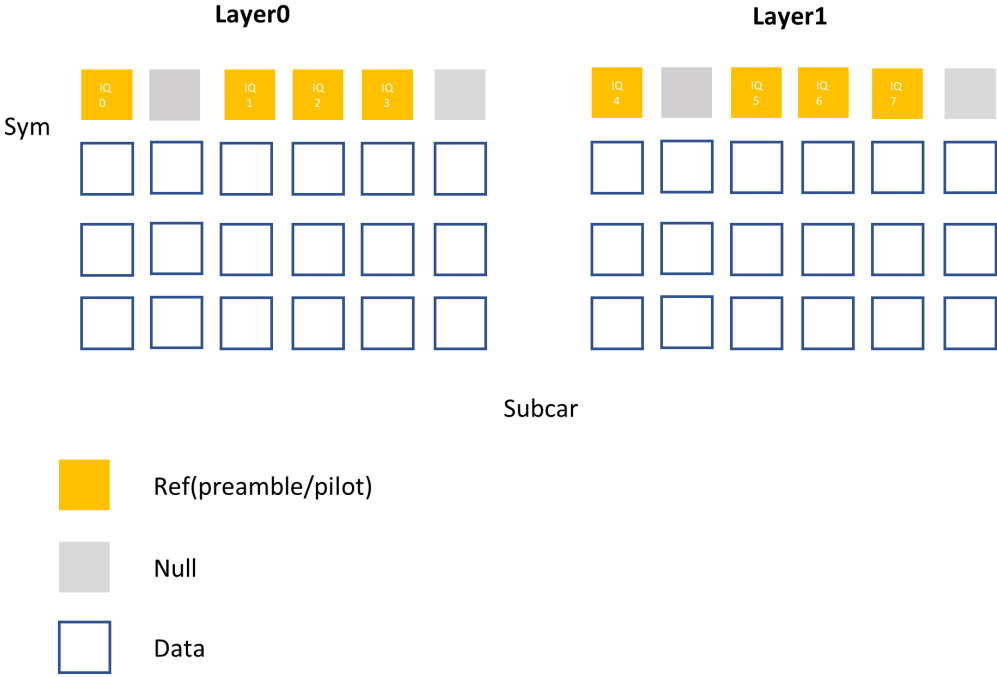

- Partially Overlapping: Preamble and pilot subcarriers are transmitted with specified overlapping pattern on all antennas. (Example: 5GNR CDM group mode)

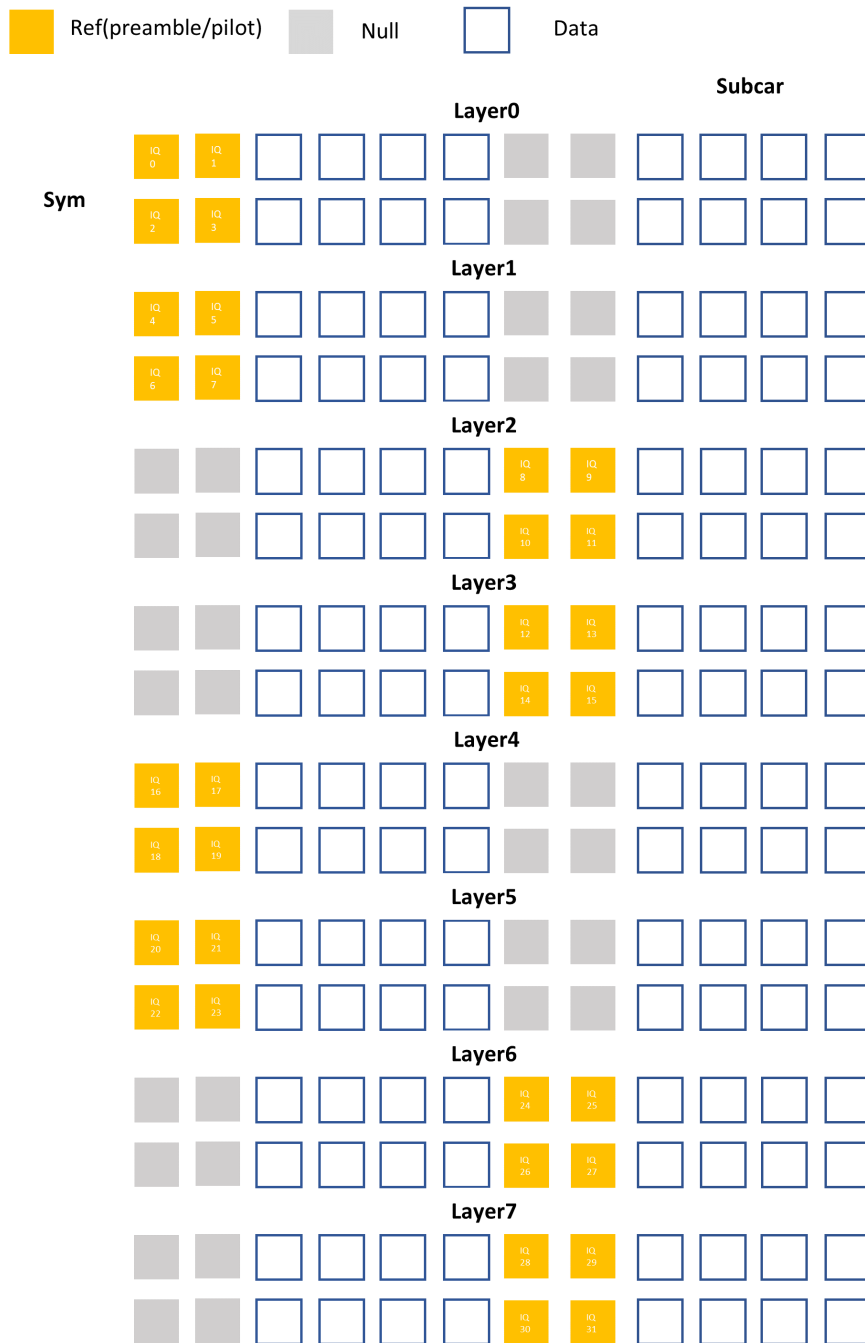

Remote Command `[:SENSe]:OFDM:MIMO:TYPE NONE | ALL | PARTIALLY`

`[:SENSe]:OFDM:MIMO:TYPE?`

Example `:OFDM:MIMO:TYPE NONE`

`:OFDM:MIMO:TYPE?`

State Saved	Saved in instrument state
Range	Non-Overlapping Overlapping All Partially Overlapping

Subcarrier Count Per Channel Estimation Unit

For partially overlapping mode, specify subcarrier number of channel estimation unit according to reference (preamble/pilot) overlapping pattern.

Remote Command	<code>[:SENSe]:OFDM:MIMO:PARTially:SUBCount <integer></code>
	<code>[:SENSe]:OFDM:MIMO:PARTially:SUBCount?</code>
Example	<code>:OFDM:MIMO:PART:SUBC 4</code> <code>:OFDM:MIMO:PART:SUBC?</code>
Preset	1
State Saved	Yes
Min	1
Max	65536

Symbol Count Per Channel Estimation Unit

For partially overlapping mode, specify symbol number of channel estimation unit according to reference (preamble/pilot) overlapping pattern.

Remote Command	<code>[:SENSe]:OFDM:MIMO:PARTially:SYMCount <integer></code>
	<code>[:SENSe]:OFDM:MIMO:PARTially:SYMCount?</code>
Example	<code>:OFDM:MIMO:PART:SYMC 2</code> <code>:OFDM:MIMO:PART:SYMC?</code>
Preset	1
State Saved	Yes
Min	1

3.2.8.7 Advanced

Enables you to configure advanced parameters.

IF Gain

To take full advantage of the RF dynamic range of the analyzer, a switched IF amplifier with approximately 10 dB of gain is available. When it can be turned on without an overload, the dynamic range is always better with it on than off.

IF Gain can be used to set this function to Auto, or to On (the extra 10 dB) or Off. These settings affect sensitivity and IF overloads.

Only applies to the RF input. Does not apply to baseband I/Q input.

IF Gain Auto

Activates the auto rules for IF Gain.

Remote Command	<code>[:SENSe]:OFDM:IF:GAIN:AUTO[:STATe] ON OFF 1 0</code> <code>[:SENSe]:OFDM:IF:GAIN:AUTO[:STATe]?</code>
Example	<code>:OFDM:IF:GAIN:AUTO OFF</code> <code>:OFDM:IF:GAIN:AUTO?</code>
Couplings	When either the auto attenuation works (for example, with electrical attenuator), or the optimized mechanical attenuator range is requested, IF Gain is changed as follows: Auto sets IF Gain to ON if the input attenuator is set to 0 dB For other settings, Auto sets IF Gain to OFF
Preset	OFF
State Saved	Yes
Range	Auto Man

IF Gain Select

Selects the range of IF gain.

High gain	HIGH	Set 10dB IF gain for better noise level measurements
Low gain	LOW	Set 0dB IF gain for large signals
Other	OTHer	Enables you to set the arbitrary IF gain value within -12 dB to 12 dB. This selection is not available for the B25 If bandwidth option

When this parameter is changed, IF Gain Auto will become Man.

Remote Command	<code>[:SENSe]:OFDM:IF:GAIN:SElect LOW HIGH OTHer</code> <code>[:SENSe]:OFDM:IF:GAIN:SElect?</code>
Example	<code>:OFDM:IF:GAIN:SEL LOW</code> <code>:OFDM:IF:GAIN:SEL?</code>
Preset	LOW
State Saved	Yes
Range	LOW HIGH OTHer

Other IF Gain

When "**IF Gain**" on page 535 is set to OTHer, specifies the **IF Gain** value.

3 VMA Mode
3.2 Custom OFDM Measurement

Remote Command	<code>[:SENSe]:OFDM:IF:GAIN:LEVel <rel_amp1></code> <code>[:SENSe]:OFDM:IF:GAIN:LEVel?</code>
Example	<code>:OFDM:IF:GAIN:LEV -10</code> <code>:OFDM:IF:GAIN:LEV?</code>
Notes	Not available for B25 IF bandwidth option
Preset	0
State Saved	Saved in instrument state
Min/Max	-12/12

Adjust IF Gain For

Specifies the reference component carrier for adjustment of "IF Gain" on page 535.

Remote Command	<code>[:SENSe]:OFDM:IF:GAIN:REFerence:CCARrier CC0 ... CC7</code> <code>[:SENSe]:OFDM:IF:GAIN:REFerence:CCARrier?</code>
Example	<code>:OFDM:IF:GAIN:REF:CCAR CC0</code>
Preset	CC0
State Saved	Yes
Range	CC0 CC1 CC2 CC3 CC4 CC5 CC6 CC7

Spur Avoidance

Option H1G has a spur at the -50 MHz offset of the **Center Frequency**, so this Spur Avoidance function is provided to eliminate this spur.

- **Auto**: move the spur completely out of analysis bandwidth, the trade-off is that the available analysis bandwidth will be reduced to 400 MHz. And EVM could be worse as the edge of the passband is used for analysis
- **Manual**: move the spur by a specified value or turn off this feature by setting the value to 0

Remote Command	<code>[:SENSe]:OFDM:CCARrier0 ... 7:SAVoid:FREQuency <freq></code> <code>[:SENSe]:OFDM:CCARrier0 ... 7:SAVoid:FREQuency?</code> <code>[:SENSe]:OFDM:CCARrier0 ... 7:SAVoid:AUTO ON OFF 1 0</code> <code>[:SENSe]:OFDM:CCARrier0 ... 7:SAVoid:AUTO?</code>
Example	<code>:OFDM:CCAR0:SAV:FREQ 50MHz</code> <code>:OFDM:CCAR0:SAV:FREQ?</code> <code>:OFDM:CCAR0:SAV:AUTO ON</code> <code>:OFDM:CCAR0:SAV:AUTO?</code>

Couplings	Grayed-out when Mixer Mode is Alternate When the Acquisition mode is changed from Sequential to Simultaneous, this control is reset (manual, 0 Hz) for all component carriers
Preset	0 Hz OFF
State Saved	Saved in instrument state Yes
Range	Auto Manual
Min	-(1GHz – BW)/2
Max	(1GHz – BW)/2

LO Dither

When ON, the local oscillator frequency is rapidly changed by small, random amounts. This helps spread the power of spurious signals within the passband, which lowers their level, thus increasing dynamic range.

This is only required in very wide passbands, so this feature *only* appears with option H1G.

Remote Command	<code>[:SENSe]:OFDM:LO:DITHer[:STATe] ON OFF 1 0</code> <code>[:SENSe]:OFDM:LO:DITHer[:STATe]?</code>
Example	<code>:OFDM:LO:DITH 1</code> <code>:OFDM:LO:DITH?</code>
Dependencies	Only available when the instrument has Option H1G installed. If you try to turn LO Dither ON in any other case, an error message is generated, -241, "Hardware missing; Option H1G required" Appears only in certain Modes (for example, 5GNR, VMA and IQ Analyzer) Turned Off and grayed-out when the IF Path is set to a path other than 1 GHz. If you press the grayed-out control, a warning message "LO Dither only available with IF Path 1 GHz" is shown. If you try to set LO Dither to ON remotely while it is grayed-out, a message "-221,Settings conflict; LO Dither only available with IF Path 1 GHz" is returned When LO Dither is ON, " Phase Noise Optimization " on page 539 is grayed-out. If you try to change the PNO value via the front panel or SCPI in that case, an error is generated, "LO Dither must be turned off to change this value"
Couplings	As with most parameters with an AUTO state, " Auto Couple " on page 1825 sets it to Auto, which then selects AUTOrange, and setting any specific value (AUTOrange, LOW or HIGH) will set the AUTO state to false When LO Dither is ON, Phase Noise Optimization is set to "Best Close-In". If the Phase Noise Optimization value changes due to turning on LO Dither, a warning message "Phase Noise Optimization changed due to LO Dither activation" is shown See also: " Iterative EVM Optimization Target " on page 493

Preset	OFF
State Saved	Saved in instrument state

Phase Noise Optimization

Enables you to select the LO (local oscillator) phase noise behavior for various operating conditions.

Remote Command	<code>[:SENSe]:OFDM:FREQuency:SYNThesis[:STATe] 1 ... 5</code> For the meaning of each numeric option value, see "Parameter Options, Installed Options & Auto Rules" on page 539 below <code>[:SENSe]:OFDM:FREQuency:SYNThesis[:STATe]?</code>
Example	<code>:OFDM:FREQ:SYNT 1</code> <code>:OFDM:FREQ:SYNT?</code>
Preset	2
State Saved	Saved in instrument state

Parameter Options, Installed Options & Auto Rules

The Phase Noise Optimization control lets you optimize the setup and behavior of the Local Oscillator (LO) depending on your specific measurement conditions. You may wish to trade off noise and speed, for example, to make a measurement faster without regard to noise or with optimum noise characteristics without regard to speed.

Parameter Values Summary

Option	#	Description
"Balanced" on page 540	1	<ul style="list-style-type: none"> - In instruments with EPO, balances close-in phase noise with spur avoidance - In instruments without EPO optimizes phase noise for small frequency offsets from the carrier
"Best Wide-offset" on page 541	2	Optimizes phase noise for wide frequency offsets from the carrier
"Fast Tuning" on page 541	3	Optimizes LO for tuning speed
"Best Close-in" on page 540	4 or 1*	<ul style="list-style-type: none"> - In instruments with EPO, emphasizes close-in phase noise performance without regard to spur avoidance - In instruments without EPO, this setting is accepted but no action is taken

Option	#	Description
"Best Spurs" on page 541	5	<ul style="list-style-type: none"> - In instruments with EPO, emphasizes spur avoidance over close-in phase noise performance - In instruments without EPO, this setting is accepted but no action taken
Auto	-	Automatically selects LO (local oscillator) phase noise behavior to optimize dynamic range and speed for various instrument operating conditions

*Dependent on Option EPO installation. See "Best Close-in" on page 540 below.

The actual behavior varies somewhat depending on model number and option; for example, you always get Fast Tuning by choosing Option #3, but in some models, "Fast Tuning" on page 541 is identical in effect to "Best Close-in" on page 540.

Best Close-in

Without option EPO

:FREQ:SYNT 1

The LO phase noise is optimized for smaller offsets from the carrier, at the expense of phase noise farther out.

The actual frequency offset within which noise is optimized is shown with in square brackets, as this can vary depending on the hardware set in use. For example, in some instruments this annotation appears as [offset <20 kHz]

With option EPO

:FREQ:SYNT 4

In instruments with Option EPO, the LO is configured for the best possible close-in phase noise (offsets up to 600 kHz from the carrier), regardless of spurious products that occur with some center frequencies. Because this is generally less desirable for close-in measurements than the "Balanced" on page 540 setting, parameter 1 selects "Balanced" on page 540 in EPO instruments, in the interests of optimizing code compatibility across the family. Parameter 4 selects "Best Close-in" on page 540, which is usually not as good a choice as "Balanced" on page 540.

Balanced

:FREQ:SYNT 1

In instruments with EPO, the LO is configured for the best possible phase noise at offsets up to 600 kHz from the carrier whenever there are no significant spurs within the span observed with an on-screen carrier. When there will be such a spur, the LO is reconfigured in a way that allows the phase noise to increase by 7 dB mostly within ± 1 octave around 400 kHz offset. The spurs will always be below -70 dBc.

Best Spurs

`:FREQ:SYNT 5`

In instruments with EP0, the LO is configured for better phase noise than the "Best Wide-offset" on page 541 case close to the carrier, but the configuration has 11 dB worse phase noise than the "Best Close-in" on page 540 case mostly within ± 1 octave around 300 kHz offset. Spurs are even lower than in the "Balanced" on page 540 case at better than -90 dBc, whether or not the carrier is on-screen.

This setting is never selected when Phase Noise Optimization is in Auto, you must select it manually.

Best Wide-offset

`:FREQ:SYNT 2`

The LO phase noise is optimized for wider offsets from the carrier. Optimization is especially improved for offsets from 70 kHz to 300 kHz. Closer offsets are compromised and the throughput of measurements (especially remote measurements where the center frequency is changing rapidly), is reduced.

The actual frequency offset beyond which noise is optimized is shown with in square brackets, as this can vary depending on the hardware set in use. For example, in some instruments this annotation appears as [offset >30 kHz]

In instruments with Option EP0, the LO is configured for the best possible phase noise at offsets up to 600 kHz from the carrier whenever there are no significant spurs within the span observed with an on-screen carrier. When there will be such a spur, the LO is reconfigured in a way that allows the phase noise to increase by 7 dB mostly within ± 1 octave around 400 kHz offset. The spurs will always be below -70 dBc.

Fast Tuning

`:FREQ:SYNT 3`

In this mode, the LO behavior compromises phase noise at many offsets from the carrier in order to allow rapid measurement throughput when changing the center frequency or span. The term "Fast Tuning" on page 541 refers to the time it takes to move the local oscillator to the start frequency and begin a sweep; this setting does not impact the actual sweep time in any way.

In instruments with EP1, the LO behavior compromises phase noise at offsets below 4 MHz in order to improve measurement throughput. The throughput is especially affected when moving the LO more than 2.5 MHz and up to 10 MHz from the stop frequency to the next start frequency.

In instruments with Option EP0, this is the same configuration as "Best Spurs" on page 541. It is available with the "Fast Tuning" on page 541 label for convenience,

and to make the user interface more consistent with other X-Series instrument family members.

(In models whose hardware does not provide for a "Fast Tuning" on page 541 option, the settings for "Best Close-in" on page 540 are used if "Fast Tuning" on page 541 is selected. This gives the fastest possible tuning for that hardware set.)

Auto

:FREQ:SYNT:AUTO ON

Selects the LO (local oscillator) phase noise behavior to optimize dynamic range and speed for various instrument operating conditions. The selection rules are as follows.

Auto Optimization Rules

X-Series instruments have several grades of LO, offering different configurations when in the Auto Mode. The rules for Auto selection are as follows:

Models with Option	Conditions	Selection
EPO Models with option EPO have a two stage local oscillator, which switches to a single loop for fast tuning (available in UXA)	Center frequency is < 699.9 kHz Span > 114.1 MHz, <i>or</i> RBW > 800 kHz RBW > 290 kHz, <i>or</i> Span > 4.2 MHz Other conditions	"Balanced" on page 540 "Fast Tuning" on page 541 "Best Wide-offset" on page 541 "Balanced" on page 540
EP1 Models with option EP1 have a two-loop local oscillator, which switches to a single loop for fast tuning (available in PXA)	Span > 44.44 MHz, <i>or</i> RBW > 1.9 MHz, <i>or</i> Source Mode is set to "Tracking" Center frequency is < 195 kHz, <i>or</i> CF >= 1 MHz <i>and</i> Span <= 1.3 MHz <i>and</i> RBW <= 75 kHz All other conditions	"Fast Tuning" on page 541 "Best Close-in" on page 540 "Best Wide-offset" on page 541
EP2 Models with option EP2 use a different loop bandwidth for the fast-tuning choice, which is a compromise	CF < 130 kHz, <i>or</i> CF > 12 MHz <i>and</i> Span < 495 kHz <i>and</i> RBW < 40 kHz	"Best Close-in" on page 540

3 VMA Mode
 3.2 Custom OFDM Measurement

Models with Option	Conditions	Selection
<p>between tuning speed and phase noise, giving good tuning speed at all offsets. Although not as good as for "Best Close-in" on page 540; this is useful when you have to look across a wide range of spans (available, for example, in MXA for excellent phase noise)</p> <p>EP4 (available in CXA for improved phase noise)</p>	<p>Span > 22 MHz, <i>or</i> RBW > 400 kHz, <i>or</i> CF ≤ 12 MHz <i>and</i> Span < 495 kHz <i>and</i> RBW < 23 kHz All other conditions</p>	<p>"Fast Tuning" on page 541</p> <p>"Best Wide-offset" on page 541</p>
<p>All Other Models</p> <p>Note that in these models, the hardware does not actually provide for an extra-fast tuning option, so the settings for "Fast Tuning" on page 541 are actually the same as "Best Close-in" on page 540, but the rules are implemented this way so that the user who doesn't care about phase noise but does care about tuning speed doesn't have to remember which of the other two settings gives faster tuning</p>	<p>Span > 101 MHz <i>or</i> RBW > 1.15 MHz <i>or</i> Source Mode is set to "Tracking" CF is < 109 kHz <i>or</i> CF ≥ 4.95 MHz <i>and</i> Span ≤ 666 kHz <i>and</i> RBW < 28 kHz All other conditions</p>	<p>"Fast Tuning" on page 541</p> <p>"Best Close-in" on page 540</p> <p>"Best Wide-offset" on page 541</p>
	<p>Span > 12.34 MHz, <i>or</i> RBW > 250 kHz, <i>or</i> Source Mode is set to "Tracking"</p> <p>Center frequency is < 25 kHz, <i>or</i> CF ≥ 1 MHz <i>and</i> Span ≤ 141.4 kHz <i>and</i> RBW ≤ 5 kHz</p> <p>All other conditions</p>	<p>"Fast Tuning" on page 541</p> <p>"Best Close-in" on page 540</p> <p>"Best Wide-offset" on page 541</p>

In all the above cases:

- The RBW to be used in the calculations is the equivalent -3 dB bandwidth of the current RBW filter
- The rules apply whether in swept spans, zero span, or FFT spans

Ranges

Option	Option #	Phase Noise Option	Range
No EPx Option	1	Best Close-in	[offset < 20 kHz]
	2	Best Wide-offset	[offset > 30 kHz]
	3	Fast Tuning	[same as Best Close-In]
EP0	4	Best Close-in	[offset < 600 kHz]
	1	Balanced	[offset < 600 kHz]
	5	Best Spurs	[offset < 600 kHz]
EP1	2	Best Wide-offset	[offset > 800 kHz]
	3	Fast Tuning	[same as Best Close-In]
	1	Best Close-in	[offset < 140 kHz]
EP2, EP3, EP5	2	Best Wide-offset	[offset > 160 kHz]
	3	Fast Tuning	[single loop]
	1	Best Close-in	[offset < 70 kHz]
EP4	2	Best Wide-offset	[offset > 100 kHz]
	3	Fast Tuning	[medium loop bw]
	1	Best Close-in	[offset < 90 kHz]
	2	Best Wide-offset	[offset > 130 kHz]
	3	Fast Tuning	[same as Best Close-In]

Mixing Mode

Changes LO mixing from high-side to low-side or *vice versa*.

Remote Command	<code>[[:SENSe]:OFDM:CCARrier0 ... 7:LO:MIXMode NORMal ALTernate [:SENSe]:OFDM:CCARrier0 ... 7:LO:MIXMode?</code>
Example	<code>:OFDM:CCAR:LO:MIXM NORM :OFDM:CCAR:LO:MIXM?</code>
Dependencies	Grayed-out when the RF Input is set to something other than “RF” (such as External Mixer). If you press the grayed-out control, a warning message “Feature only available with Signal Input RF” appears If you try to set Mixing Mode via SCPI when disabled, a message -221, “Settings conflict; Feature only available with signal input RF” is returned
Preset	NORMal
State Saved	Yes
Range	NORMal ALTernate

Mixing Mode Auto

Activates the auto rules for **Mixing Mode**.

Remote Command	<code>[:SENSe]:OFDM:CCARrier0 ... 7LO:MIXMode:AUTO ON OFF 1 0</code> <code>[:SENSe]:OFDM:CCARrier0 ... 7LO:MIXMode:AUTO?</code>
Example	<code>:OFDM:CARR:LO:MIXM:AUTO OFF</code> <code>:OFDM:CARR:LO:MIXM:AUTO?</code>
Preset	ON
State Saved	Yes
Range	Auto Man

Spectrum Stitching

When ON, multiple acquisitions overlapped in frequency domain will be performed and then combined to get wide band IQ data. This enables the instrument to capture and analyze wider signals, but it may slow down the measurement speed and it requires the signal to occupy the majority of the analysis bandwidth.

NOTE

Accurate trigger is needed to align multiple acquisitions in the time domain, and the input signal must be repeated and aligned with trigger precisely.

Remote Command	<code>[:SENSe]:OFDM:STITching:SPECTrum[:STATE] ON OFF 1 0</code> <code>[:SENSe]:OFDM:STITching:SPECTrum[:STATE]?</code>
Example	<code>:OFDM:STIT:SPEC 1</code> <code>:OFDM:STIT:SPEC?</code>
Preset	OFF
State Saved	Saved in instrument state

Cross-Correlated EVM

Enables Cross-Correlated EVM.

Remote Command	<code>[:SENSe]:OFDM:CCEVm[:ENABLE] ON OFF 1 0</code> <code>[:SENSe]:OFDM:CCEVm[:ENABLE]?</code>
Example	<code>:OFDM:CCEV 1</code> <code>:OFDM:CCEV?</code>
Preset	OFF
State Saved	Saved in instrument state

Multi Channel Config

Lets you perform a detailed configuration of your component carriers, including number of carriers, bandwidth, offset, integration bandwidth, and so on.

Multi Channel Config

Only available for the Modulation Analysis measurement. Enables you to configure multiple channel receiver. Different hardware platforms have different parameters.

Input Channel IP address

Sets instrument IP address for channel configuration, "local" is used for current instrument.

Remote Command	<code>[:SENSe]:OFDM:MCHannel:IPAddress1 2 <String></code> <code>[:SENSe]:OFDM:MCHannel:IPAddress1 2?</code>
Example	<code>:OFDM:MCH:IPAD1 '192.168.1.2'</code>
Preset	Local
State Saved	Yes
Backwards Compatibility SCPI	<code>[:SENSe]:OFDM:MIMO:IPAddress1 2</code>

Input Channel Instrument port

Sets instrument port for channel configuration.

Remote Command	<code>[:SENSe]:OFDM:MCHannel:IPAddress1 2:PORT <int></code> <code>[:SENSe]:OFDM:MCHannel:IPAddress1 2:PORT?</code>
Example	<code>:OFDM:MCH:IPAD1:PORT 3574</code>
Dependencies	Only visible on VXT platforms
Preset	3574
State Saved	Yes
Backwards Compatibility SCPI	<code>[:SENSe]:OFDM:MIMO:IPAddress1 2:PORT</code>

Lock

Locks the instrument and assigns to a channel in sequence.

3 VMA Mode
3.2 Custom OFDM Measurement

Remote Command	<code>[:SENSe]:OFDM:MCHannel:IPADdress1 2:LOCKed OFF ON 0 1</code>
Example	<code>:OFDM:MCH:IPAD1:LOCK 1</code> <code>:OFDM:MCH:IPAD1:LOCK?</code>
Preset	0
State Saved	Yes
Backwards Compatibility SCPI	<code>[:SENSe]:OFDM:MIMO:IPADdress1 2:LOCKed</code>

Channel Configuration Information (Remote Query only)

Returns channel configuration information.

Remote Command	<code>[:SENSe]:OFDM:MCHannel:CHANnel:INFO?</code>
Example	<code>:OFDM:MCH:CHAN:INFO?</code>
Backwards Compatibility SCPI	<code>[:SENSe]:OFDM:MIMO:CHANnel:INFO</code>

3.2.9 Sweep

Accesses controls to configure and control the acquisition of data, and the X-axis parameters of the instrument.

Depending on the selected mode and measurement, these controls might include: **Sweep Time**, **Continuous/Single**, **Pause/Resume**, **X Scale** and **Number of Points**.

3.2.9.1 Sweep/Control

Accesses controls that let you operate the sweep and control functions of the instrument, such as **Sweep Time** and **Continuous/Single**.

Sweep/Measure

Lets you toggle between **Continuous** and **Single** sweep or measurement operation. The single/continuous state is Meas Global, so the setting affects all measurements.

The front-panel key **Single/Cont** performs exactly the same function

See "[More Information](#)" on page 548

Remote	<code>:INITiate:CONTinuous OFF ON 0 1</code>
--------	--

Command	<code>:INITiate:CONTinuous?</code>
Example	<p>Put instrument into Single measurement operation:</p> <pre><code>:INIT:CONT 0</code></pre> <pre><code>:INIT:CONT OFF</code></pre> <p>Put instrument into Continuous measurement operation:</p> <pre><code>:INIT:CONT 1</code></pre> <pre><code>:INIT:CONT ON</code></pre>
Preset	<p>ON</p> <p>Note that <code>:SYST:PRES</code> sets <code>:INIT:CONT</code> to ON, but <code>*RST</code> sets <code>:INIT:CONT</code> to OFF</p>
State Saved	Saved in instrument state
Annunciation	<p>The Single/Continuous icon in the Meas Bar changes depending on the setting:</p> <ul style="list-style-type: none"> - A line with an arrow is Single - A loop with an arrow is Continuous
Backwards Compatibility Notes	<p>X-Series A-models had Single and Cont hardkeys in place of the SweepSingleCont softkey. In the X-Series A-models, if in single measurement, the Cont hardkey (and <code>INIT:CONT ON</code>) switched to continuous measurement, but never restarted a measurement and never reset a sweep</p> <p>X-Series B-models have a Cont/Single toggle control instead of Single and Cont hardkeys, but it is still true that, if in single measurement, the Cont/Single toggle control never restarts a measurement and never resets a sweep</p>

More Information

Continuous Mode	<p>The instrument takes repetitive sweeps, averages, measurements, etc., when in continuous mode. If in average or Max/Min Hold, and the average/hold count reaches the Average/Hold Num, the count stops incrementing, but the instrument keeps sweeping</p> <p>See the Trace key description under Trace Average for the averaging formula used both before and after the Average/Hold Num is reached. The trigger condition must be met prior to each sweep</p> <p>The type of trace processing for multiple sweeps is set under the Trace key, with choices of Trace Average, Max Hold, or Min Hold</p>
Single Mode	<p>The instrument takes a single sweep when in Single mode, or if in average or Max/Min Hold, or if there is a Waterfall window displayed, it takes multiple sweeps until the average/hold count reaches the Average/Hold Num, then the count stops incrementing, and the instrument stops sweeping</p> <p>See the Trace key description under Trace Average for the averaging formula used. The trigger condition must be met prior to the sweep</p> <p>The type of trace processing for multiple sweeps is set under the Trace key, with choices of Trace Average, Max Hold, or Min Hold</p>

If the instrument is in **Single** measurement mode, pressing the **Cont/Single** toggle control does not zero the count and does not cause the sweep to be reset; the only action is to put the instrument into Continuous measurement operation.

If the instrument is already in **Continuous** sweep:

- `:INIT:CONT 1` has no effect
- `:INIT:CONT 0` places the instrument in Single Sweep but has no effect on the current sequence until $k = N$, at which point the current sequence will stop and the instrument will go to the idle state

See "[Restart](#)" on page 1832 for details of `:INIT:IMMEDIATE`.

If the instrument is already in **Single** sweep, `:INIT:CONT OFF` has no effect.

If the instrument is already in **Single** sweep, then pressing **Cont/Single** in the middle of a sweep does not restart the sweep or sequence. Similarly, pressing **Cont/Single** does not restart the sweep or sequence if the sweep is not in the idle state (for example, if you are taking a very slow sweep, or the instrument is waiting for a trigger). Even though pressing **Cont/Single** in the middle of a sweep does not restart the sweep, sending `:INIT:IMM` *does* reset it.

If the instrument is in **Single** sweep, and *not* Averaging/Holding, and you want to take one more sweep, press **Restart**.

If the instrument is in **Single** sweep, *and* Averaging/Holding, and you want to take one more sweep without resetting the Average trace or count, go to **Meas Setup** and increment the average count by 1 by pressing the **Step-Up** key while **Average/Hold Num** is the active function. You can also do this by sending `:CALC:AVER:TCON UP`.

Restart

Restarts the current sweep, or measurement, or set of averaged/held sweeps or measurements. If you are Paused, pressing **Restart** performs a Resume.

The front-panel key **Restart** performs exactly the same function.

The **Restart** function is accessed in several ways:

- Pressing the **Restart** key
- Sending `:INIT:IMM`
- Sending `:INIT:REST`

See "[More Information](#)" on page 550

Remote `:INITiate[:IMMEDIATE]`

Command	:INITiate:REStart
Example	:INIT:IMM :INIT:REST
Notes	:INIT:REST and :INIT:IMM perform exactly the same function
Couplings	Resets average/hold count k. For the first sweep overwrites all active (update = on) traces with new current data. For application modes, it resets other parameters as required by the measurement
Status Bits/OPC dependencies	This is an Overlapped command The STATUS:OPERation register bits 0 through 8 are cleared , <i>except</i> bit 6 (Waiting for Periodic Sync). Initiating a measurement and Waiting for Periodic Sync could be asynchronous The STATUS:QUEStionable register bit 9 (INTEgrity sum) is cleared The SWEEPING bit is set The MEASURING bit is set
Backwards Compatibility Notes	For Spectrum Analysis Mode in ESA and PSA, the Restart hardkey and the :INIT:REST command restarted trace averages (displayed average count reset to 1) for a trace in Clear Write , but did not restart Max Hold and Min Hold In X-Series, the Restart hardkey and the :INIT:REST command restart not only Trace Average , but MaxHold and MinHold traces as well

More Information

The **Restart** function first aborts the current sweep or measurement as quickly as possible. It then resets the sweep and trigger systems, sets up the measurement and initiates a new data measurement sequence with a new data acquisition (sweep) taken once the trigger condition is met.

If the instrument is in the process of aligning when a **Restart** is executed, the alignment finishes before the restart function is performed.

Even when set for **Single** operation, multiple sweeps may be taken when **Restart** is pressed (for example, when averaging/holding is on). Thus, when we say that **Restart** "restarts a measurement", depending on the current settings, we may mean that it:

- Restarts the current sweep
- Restarts the current measurement
- Restarts the current set of sweeps if any trace is in Trace Average, Max Hold or Min Hold
- Restarts the current set of measurements if Averaging, or Max Hold, or Min Hold is on for the measurement

If there is no Average or Max/Min Hold function (no trace in Trace Average or Hold, or **Average/Hold Num** set to 1), and no **Waterfall** window is being displayed, a single

sweep is equivalent to a single measurement. A single sweep is taken after the trigger condition is met; and the instrument stops sweeping once that sweep has completed. However, with **Average/Hold Num** >1, and at least one trace set to Trace Average, Max Hold, or Min Hold, or a **Waterfall** window being displayed, multiple sweeps/data acquisitions are taken for a single measurement. The trigger condition must be met prior to each sweep. The sweep is stopped when the average count k equals the number N set for **Average/Hold Num**.

Once the full set of sweeps has been taken, the instrument goes to the idle state. To take one more sweep without resetting the average count, increment the average count by 1, by pressing the **Step-Up** key while **Average/Hold Number** is the active function, or by sending the remote command **:CALC:AVER:TCON UP**.

Trace Update

The numeric results are not blanked at any time during the restart cycle.

For slow sweeps (see **Trace Update** section in **Trace/Detector**), the traces are updated real-time during the sweep. There may be a special circumstance in application mode measurements where an exception is made and the traces and/or results need to be blanked before displaying the new results.

To summarize, the following list shows what happens to the trace data on various events:

Event	Trace Effect
Clear/Write pressed (even if already in Clear/Write)	Set to mintracevalue
Max Hold pressed (even if already in Max Hold)	Set to mintracevalue
Min Hold pressed (even if already in Min Hold)	Set to maxtracevalue
Trace Average pressed (even if already in Trace Average)	Trace data unaffected but start new sweep/avg/hold
Restart pressed	Trace data unaffected but start new sweep/avg/hold
Parameter requiring restart changed (e.g., RBW)	Trace data unaffected but start new sweep/avg/hold

Sweep and Trigger Reset

Resetting the sweep system resets the average/hold count k to 0. It also resets the set point counter to 0. Resetting the trigger system resets the internal auto trig timer to the value set by the **Auto Trig** control.

Averaging

The weighting factor used for averaging is k . This k is also the average/hold count for how many valid sweeps (data acquisitions) have been done. This k is used for comparisons with N , as those comparisons always needs to be based on valid completed sweeps.

The displayed average/hold, K , shows the count for the sweep (data acquisition) in progress. $K = k + 1$, with a limit of N . The displayed value K changes from its previous value to 1 as soon as the trigger condition for the first data acquisition (sweep) is met.

Pause/Resume

Pauses a measurement after the current data acquisition is complete.

When paused, the label on the control changes to **Resume**. Pressing **Resume** unpauses the measurement. When paused, pressing **Restart** performs a Resume.

Remote Command	<code>:INITiate:PAUSE</code> <code>:INITiate:RESume</code>
Example	<code>:INIT:PAUS</code> <code>:INIT:RES</code>
Dependencies	Not displayed in Modes that do not support pausing
Annotation	Only on control

Abort (Remote Command Only)

Stops the current measurement. Aborts the current measurement as quickly as possible, resets the sweep and trigger systems, and puts the measurement into an "idle" state. If the instrument is in the process of aligning when `:ABORT` is sent, the alignment finishes *before* the abort function is performed, so `:ABORT` does not abort an alignment.

If the instrument is set for **Continuous** measurement, it sets up the measurement and initiates a new data measurement sequence with a new data acquisition (sweep) taken once the trigger condition is met.

If the instrument is set for **Single** measurement, it remains in the "idle" state until an `:INIT:IMM` command is received.

Remote Command	<code>:ABORT</code>
Example	<code>:ABOR</code>

3 VMA Mode
3.2 Custom OFDM Measurement

Notes	<p>If :INIT:CONT is ON, then a new continuous measurement will start immediately, with sweep (data acquisition) occurring once the trigger condition has been met</p> <p>If :INIT:CONT is OFF, then :INIT:IMM is used to start a single measurement, with sweep (data acquisition) occurring once the trigger condition has been met</p>
Dependencies	<p>For continuous measurement, :ABORT is equivalent to the Restart key</p> <p>Not all measurements support this command</p>
Status Bits/OPC dependencies	<p>The STATUS:OPERation register bits 0 through 8 are cleared, <i>except</i> bit 6 (Waiting for Periodic Sync). Initiating a measurement and Waiting for Periodic Sync could be asynchronous</p> <p>The STATUS:QUESTionable register bit 9 (INTEGRity sum) is cleared</p> <p>Since all the bits that feed into OPC are cleared by :ABORT, the Abort command will cause the *OPC query to return true</p>

3.2.9.2 X Scale

Accesses controls that enable you to set the horizontal scale parameters.

X Width

Sets the width of the X axis which is displayed for the selected trace. The X width can be set to less than the span for frequency-domain traces, enabling you to zoom in on just a portion of the measured values. Likewise, it can be less than the time span covered by the time-domain data. This, plus X **"Ref Value"** on page 554 and X **"Ref Position"** on page 554, control the range of X values that can be displayed on a trace.

Remote Command	<pre>:DISP:OFDM:WINDow[1] 2 ... 6:X[:SCALE]:WIDTh <real></pre> <pre>:DISP:OFDM:WINDow[1] 2 ... 6:X[:SCALE]:WIDTh?</pre>
Example	<pre>:DISP:OFDM:WIND3:X:WIDT 10e6</pre> <p>Set the X width of the third window to 10 MHz</p> <pre>:DISP:OFDM:WIND3:X:WIDT?</pre> <p>Query the X width of the third window</p>
Couplings	If "Auto Scaling" on page 554 is ON, X Width is determined by the trace data
Preset	Depends on trace data
State Saved	Yes
Min	-9.9E+37
Max	9.9E+37

Ref Value

Controls the X value of the selected trace at the chosen X "Ref Position" on page 554.

Remote Command	<code>:DISPlay:OFDM:WINDow[1] 2 ... 6:X[:SCALE]:RLEVel <real></code> <code>:DISPlay:OFDM:WINDow[1] 2 ... 6:X[:SCALE]:RLEVel?</code>
Example	<code>:DISP:OFDM:WIND3:X:RLEV 10</code> Set the X ref value of the third window to 10 <code>:DISP:OFDM:WIND3:X:RLEV?</code> Query the X ref value of the third window
Couplings	If "Auto Scaling" on page 554 is ON, X Ref Value is determined by the trace data
Preset	Depends on trace data
State Saved	Yes
Min	-9.9E+37
Max	9.9E+37

Ref Position

Determines the position from which the X scaling is calculated for the selected trace. It can be set to the left side, center, or right side of the grid.

Remote Command	<code>:DISPlay:OFDM:WINDow[1] 2 ... 6:X[:SCALE]:RPOsition LEFT CENTER RIGHT</code> <code>:DISPlay:OFDM:WINDow[1] 2 ... 6:X[:SCALE]:RPOsition?</code>
Example	<code>:DISP:OFDM:WIND3:X:RPOS CENT</code> Set the X ref position of the third window to CENT <code>:DISP:OFDM:WIND3:X:RPOS?</code> Query the X ref position of the third window
Preset	Depends on trace data
State Saved	Yes
Range	Left Ctr Right

Auto Scaling

Toggles this function On or Off.

Remote Command	<code>:DISPlay:OFDM:WINDow[1] 2 ... 6:X[:SCALE]:COUPle 0 1 OFF ON</code> <code>:DISPlay:OFDM:WINDow[1] 2 ... 6:X[:SCALE]:COUPle?</code>
----------------	--

Example	<code>:DISP:OFDM:WIND3:X:COUP ON</code> Do the X auto scale for the third window <code>:DISP:OFDM:WIND3:X:COUP?</code> Query the X auto scale state of the third window
Couplings	When this is ON, pressing the front-panel Restart key activates the scale coupling function, that automatically determines scale per division and reference values based on the measurement results. When you set the value of either "X Width" on page 553 or "Ref Value" on page 554 manually, Auto Scaling is automatically set to OFF
Preset	ON
State Saved	Yes
Range	On Off

3.2.9.3 Recording

Displays the Sample Rate, Sample Points and Sample Time of the saved IQ data file.

Recording and playback of signal data files is a multi-step process that involves controls in several menus:

- **Save, Recording** (under the **Save** hardkey or the **Save** icon in the **File** panel)
- **Recall, Recording** (under the **Recall** hardkey or the **Recall** icon in the **File** panel)
- **Sweep, Recording** (this tab)
- **Sweep, "Playback"** on page 556
- **Input/Output, "Data Source"** on page 2195

NOTE

A complete tutorial for **Record/Playback** functionality, including how to load and save recording files, can be found in the help for the tab "**Data Source**" on page 2195 under **Input/Output**.

This menu includes the following display-only fields:

Sample Rate

Displays the sample rate of the saved IQ data file. If you have not saved an IQ data file, the value is 0.

Sample Points

Displays the total number of sample points in the saved IQ data file. If you have not saved an IQ data file, the value is 0.

Sampling Time

Displays the total sample time of the saved IQ data file. If you have not saved an IQ data file, the value is 0.

Saved Channels [Mode: 5GNR, VMA, WLAN]

Displays the channel index/number of the saved IQ data file. If you have not saved an IQ data file, no value is displayed.

This control is designed for multi-channel I/Q data recording and playback.

3.2.9.4 Playback

Contains parameters for playback of saved recording files recalled to the instrument.

Recording and playback of signal data files is a multi-step process that involves controls in several menus:

- **Save, Recording** (under the **Save** hardkey or the **Save** icon in the **File** panel)
- **Recall, Recording** (under the **Recall** hardkey or the **Recall** icon in the **File** panel)
- **Sweep, "Recording"** on page 555
- **Sweep, Playback** (this tab)
- **Input/Output, "Data Source"** on page 2195

NOTE

A complete tutorial for **Record/Playback** functionality, including how to load and save recording files, can be found in the help for the tab **"Data Source"** on page 2195 under the **Input/Output** menu.

This menu includes the following display-only fields:

Sample Points

Displays the total number of sample points in the recalled IQ data file. If you have not recalled an IQ data file, the value is 0.

Sampling Time

Displays the total sample time of the recalled IQ data file. If you have not recalled an IQ data file, the value is 0.

Input Channels [Mode: 5GNR, VMA, WLAN]

Displays the input channel number of the recalled IQ data file. If you have not recalled an IQ data file, the default value of 1 is displayed.

This control is designed for multi-channel I/Q data recording and playback.

Playback Mode

Specifies the mode of IQ data to be played back and analyzed:

- Fixed: Playback Stop value is ignored. Measurement will analyze the first chunk of IQ data start from Playback Start repeatedly
- Iterative: Measurement will analyze the IQ data chunk by chunk between Playback Start and Playback Stop, if the last chunk is not complete it will be ignored and start from the first chunk again

Remote Command	<code>:CALCulate:<meas>:PLAY:MODE FIXed ITERative</code> <code>:CALCulate:<meas>:PLAY:MODE?</code>
	Where <code><meas></code> is the mnemonic for the current measurement, for example, <code>EVM</code>
Example	For EVM measurement in 5G NR Mode: <code>:CALC:EVM:PLAY:MODE CONT</code> <code>:CALC:EVM:PLAY:MODE?</code>
Preset	<code>FIX</code>
State Saved	Saved in instrument state
Range	Fixed Iterative

Playback Start

Once you have loaded an IQ data file using **Recall, Recording**, this control enables you to specify the start position of the IQ data playback range to be analyzed. If its value is less than zero, an additional zero is inserted at the beginning of the IQ data.

To go to a specific location in the recalled I/Q data, enter the desired **Playback Start** point.

You can use this control to examine the data you recalled from the recording file. How you proceed depends on whether you are in **Continuous** or **Single** mode. To determine which mode you are in, look at the first panel on the left in the **Meas Bar** above the data display.

If the panel looks like this, you are in **Continuous** mode:



If the panel looks like this, you are in **Single** mode:

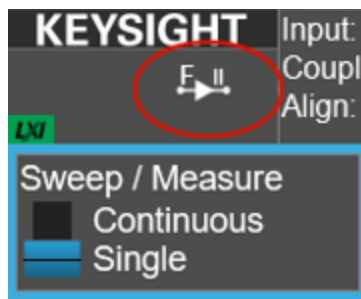

The **F** indicates that the instrument is using data from a file (if you wish to return to looking at data at the analyzer input, change the **Data Source** control in the **Input/Output, Data Source** menu from **File** back to **Input**.)

To examine the data you loaded:

Continuous mode

In this mode, turn the knob or use the **Up/Down** keys on the front panel to move through records in the recording. You will see **Playback Start** change from 0 to successively higher values as you move deeper into the data.

Single mode

In this mode, you can only look at one record. Set the **Playback Start** time to the desired offset from zero, then press **Restart**. A single record will be displayed. Note

3 VMA Mode
3.2 Custom OFDM Measurement

that until you press **Restart**, the “invalid data” indicator (yellow asterisk) is displayed in each window. After you press **Restart**, the invalid data indicator disappears.

Remote Command	<code>:CALCulate:<meas>:PLAY:START <time></code> <code>:CALCulate:<meas>:PLAY:START?</code>
	Where <code><meas></code> is the mnemonic for the current measurement, for example, <code>EVM</code>
Example	For EVM measurement in 5G NR Mode: <code>:CALC:EVM:PLAY:STAR 0.01 s</code> <code>:CALC:EVM:PLAY:STAR?</code>
Preset	0
State Saved	Saved in instrument state
Min/Max	-/+Sample Points in IQ file / Sample Rate in IQ file

Playback Stop

Specifies the stop position of the IQ data playback range to be analyzed, when “Playback Mode” is iterative.

Remote Command	<code>:CALCulate:<meas>:PLAY:STOP <time></code> <code>:CALCulate:<meas>:PLAY:STOP?</code>
	Where <code><meas></code> is the mnemonic for the current measurement, for example, <code>EVM</code>
Example	For EVM measurement in 5G NR Mode: <code>:CALC:EVM:PLAY:STOP 0.01 s</code> <code>:CALC:EVM:PLAY:STOP?</code>
Preset	0
State Saved	No
Min	0
Max	Sample Points in IQ file x Sample Rate

Step Forward

Move to next chunk of IQ data when "[Playback Mode](#)" on page 557 is iterative.

Remote Command	<code>:CALCulate:<meas>:PLAY:STEP:FORward</code>
	Where <code><meas></code> is the mnemonic for the current measurement, for example, <code>EVM</code>
Example	For EVM measurement in 5G NR Mode: <code>:CALC:EVM:PLAY:STEP:FORW</code>
State Saved	Saved in instrument state

Sample Rate

Displays the sample rate of the recalled IQ data file if the recalled file format contains sampling rate information (`.csv`, `.sdf`, `.txt`). In this case, the *control* is grayed-out.

`BIN` and `BINX` files do not include sampling rate information inside the file, so after recalling one of these files, you must set **Sample Rate** manually. When you save a file in these formats, you must specify the sample rate, as displayed under **Sweep, Recording**.

Remote Command	<code>:CALCulate:<meas>:PLAY:SRATe <freq></code> <code>:CALCulate:<meas>:PLAY:SRATe?</code>
	Where <code><meas></code> is the mnemonic for the current measurement, for example, <code>EVM</code>
Example	For EVM measurement in 5G NR Mode: <code>:CALC:EVM:PLAY:SRAT 122.88MHz</code> <code>:CALC:EVM:PLAY:SRAT?</code>
Couplings	Displays only after recalling <code>.csv</code> , <code>.sdf</code> , or <code>.txt</code> files Settable after recalling <code>.bin</code> or <code>.binx</code> files
Preset	0
State Saved	No
Min	0

3.2.10 Trace

Trace functionality is not supported in this measurement.

3.3 Monitor Spectrum Measurement

The Monitor Spectrum measurement provides a quick, convenient means of looking at the entire spectrum. While the look and feel are similar to Spectrum Analyzer Mode, the functionality is greatly reduced for easy operation. The main purpose of this measurement is to show the spectrum. The default span should cover an appropriate frequency range of the application.

Measurement Commands

The following commands can be used to configure the measurement and retrieve results:

```
:CONFigure:MONitor  
:CONFigure:MONitor:NDEFault  
:INITiate:MONitor  
:FETCh:MONitor[n]?  
:READ:MONitor[n]?  
:MEASure:MONitor[n]?
```

Remote Command Results

The following table describes the results returned by the queries listed above, according to the index value **n**.

n	Results Returned
1 (or not specified)	Returns trace1 data with comma separated floating numbers
2	Returns trace2 data with comma separated floating numbers
3	Returns trace3 data with comma separated floating numbers

3.3.1 Views

For modes other than MSR, LTEAFDD/LTEATDD and 5GNR, there is a single view, **Normal**.

["Normal" on page 561](#)

This is a single window view of the spectrum

3.3.1.1 Normal

Windows: ["Spectrum" on page 562](#)

Single window view of the graph.

Example	<code>:DISP:MON:VIEW RTR</code>
Dependencies	This command is only available in the MSR, LTE-A FDD/TDD and 5G NR modes. In other Modes this is the only View

3.3.2 Windows

This section describes the windows used in the Monitor Spectrum measurement.

3.3.2.1 Spectrum

In all modes except MSR, LTEAFDD/LTEATDD, and 5GNR, this is a single trace window showing the spectrum.

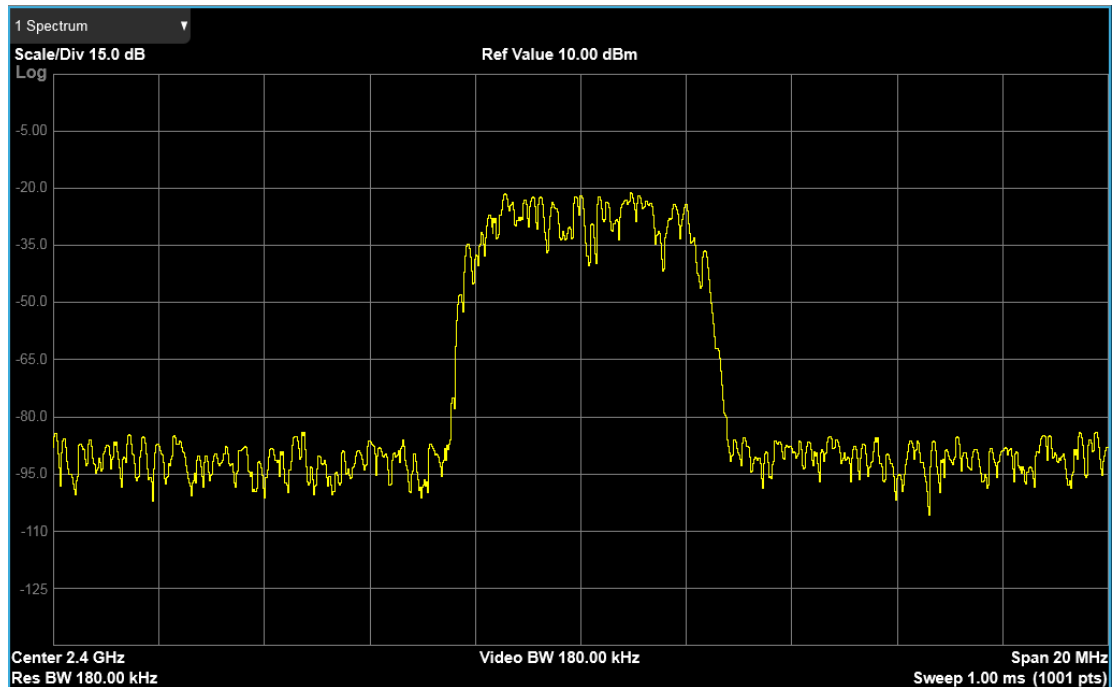

In LTEAFDD/LTEATDD, MSR and 5GNR Modes, multi-carriers are supported. The Carrier Attribute on/off and Sub-block Attribute on/off settings (under Display, Meas Display) are defined to allow the carrier and sub-block legends to display.

When the Carrier Attribute is on, the carrier identification and name are shown on the spectrum trace:

3 VMA Mode
3.3 Monitor Spectrum Measurement

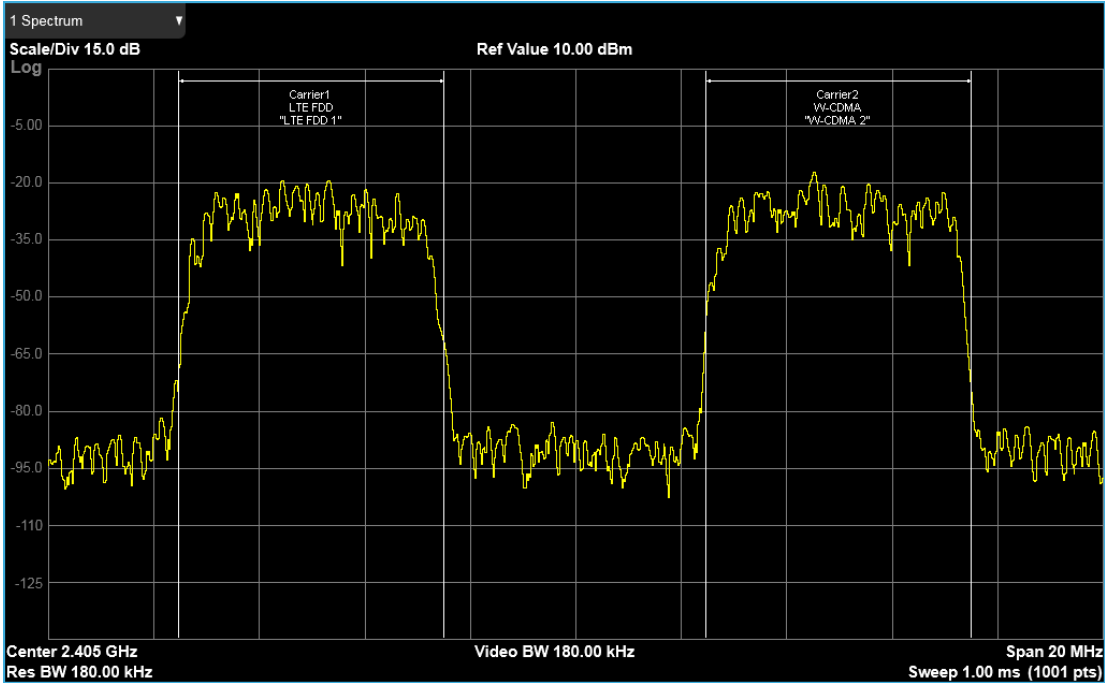

When Carrier and Sub-block attributes are both on, the sub-block scope and name are also shown on the spectrum trace:

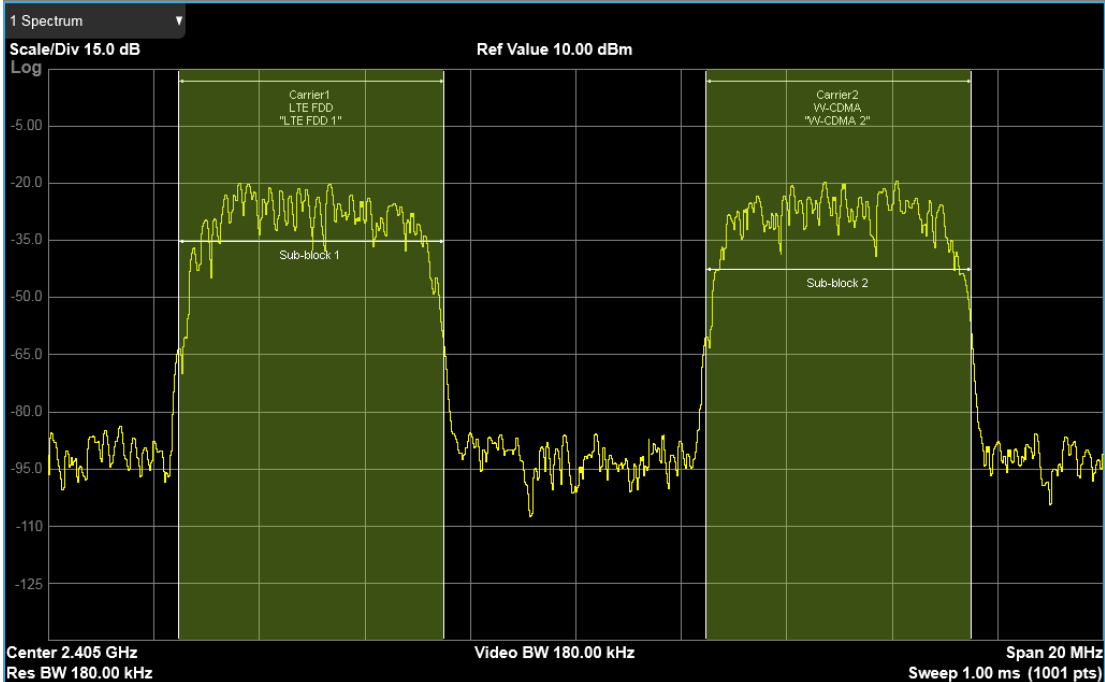

3.3.3 Amplitude

Activates the **Amplitude** menu and selects **Reference Level** or **Reference Value** as the active function, depending on the measurement.

Some features in this menu apply to multiple measurements. Some other features apply only to specific measurements and their controls are blanked or grayed-out in measurements that do not support the feature.

3.3.3.1 Y Scale

Contains controls that pertain to the Y axis parameters of the measurement. These parameters control how data on the vertical (Y) axis is displayed and control instrument settings that affect the vertical axis.

Ref Value

Sets the value for the absolute power reference. The reference line is at the top, center, or bottom of the graticule, depending on the value of **"Ref Position"** on page 566.

Remote Command	<code>:DISPlay:MONitor:WINDow[1]:TRACe:Y[:SCALe]:RLEVel <real></code> <code>:DISPlay:MONitor:WINDow[1]:TRACe:Y[:SCALe]:RLEVel?</code>
Example	<code>:DISP:MON:WIND:TRAC:Y:RLEV 2.0</code> <code>:DISP:MON:WIND:TRAC:Y:RLEV?</code>
Couplings	When "Auto Scaling" on page 566 is ON (default), this value is automatically determined by the measurement result. When you set a value manually, Auto Scaling changes to OFF . Attenuation is not coupled to "Ref Value" on page 564.
Preset	10.00 dBm
State Saved	Saved in instrument state
Min/Max	-250.00 dBm / 250.00 dBm
Annotation	Ref <value> top left of graph
Backwards Compatibility SCPI	<code>:DISPlay:MONitor:VIEW[1]:WINDow[1]:TRACe:Y[:SCALe]:RLEVel</code>

Scale/Div

For measurements that support a logarithmic Y-Axis, **Scale/Div** sets the height of one division of the graticule in the current Y-Axis unit.

3 VMA Mode
3.3 Monitor Spectrum Measurement

Scale/Div also determines the displayed amplitude range in the log plot graph. Since there are usually 10 vertical graticule division on the display, the total amplitude range of the graph is typically 10x this amount. For example, if **Scale/Div** is 10 dB, then the total range of the graph is 100 dB.

Remote Command	<code>:DISPlay:MONitor:WINDow[1]:TRACe:Y[:SCALe]:PDIVision <rel_ampl></code> <code>:DISPlay:MONitor:WINDow[1]:TRACe:Y[:SCALe]:PDIVision?</code>
Example	<code>:DISP:MON:WIND:TRAC:Y:PDIV 5.0 dB</code> <code>:DISP:MON:WIND:TRAC:Y:PDIV?</code>
Couplings	Coupled to Scale Range as follows Scale/Div = Scale Range/10 (number of divisions) When "Auto Scaling" on page 566 is ON , this value is automatically determined by the measurement result When you change a value, Auto Scaling automatically changes to OFF
Preset	10.00 dB / Div
State Saved	Saved in instrument state
Min	0.10 dB
Max	20 dB
Annotation	<value> dB/ left upper of graph
Backwards Compatibility SCPI	<code>:DISPlay:MONitor:VIEW[1]:WINDow[1]:TRACe:Y[:SCALe]:PDIVision</code>

Scale Range

Sets the Y Axis scale range.

Remote Command	<code>:DISPlay:MONitor:WINDow[1]:TRACe:Y[:SCALe]:RANGe <rel_ampl></code> <code>:DISPlay:MONitor:WINDow[1]:TRACe:Y[:SCALe]:RANGe?</code>
Example	<code>:DISP:MON:WIND:TRAC:Y:RANG 100</code> <code>:DISP:MON:WIND:TRAC:Y:RANG?</code>
Couplings	Coupled to Scale/Div as follows Scale Range = Scale/Div * 10 (number of divisions) When you change a value, Auto Scaling automatically changes to OFF
Preset	100 dB
State Saved	Saved in instrument state
Min	1
Max	200

Ref Position

Positions the reference level at the top, center, or bottom of the Y Scale display. Changing the reference position does not change the reference level value.

Remote Command	<code>:DISPlay:MONitor:WINDow[1]:TRACe:Y[:SCALe]:RPOSition TOP CENTer BOTTom</code> <code>:DISPlay:MONitor:WINDow[1]:TRACe:Y[:SCALe]:RPOSition?</code>
Example	<code>:DISP:MON:WIND:TRAC:Y:RPOS CENT</code> <code>:DISP:MON:WIND:TRAC:Y:RPOS?</code>
Preset	TOP
State Saved	Saved in instrument state
Range	TOP CENTER BOTTOM
Annotation	The greater than (>) and less than (<) symbols are displayed on both sides of the graph to indicate the Reference Position
Backwards Compatibility SCPI	<code>:DISPlay:MONitor:VIEW[1]:WINDow[1]:TRACe:Y[:SCALe]:RPOSition</code>

Auto Scaling

Toggles the **Auto Scaling** function On or Off.

Remote Command	<code>:DISPlay:MONitor:WINDow[1]:TRACe:Y[:SCALe]:COUPle 0 1 OFF ON</code> <code>:DISPlay:MONitor:WINDow[1]:TRACe:Y[:SCALe]:COUPle?</code>
Example	<code>:DISP:MON:WIND:TRAC:Y:COUP OFF</code> <code>:DISP:MON:WIND:TRAC:Y:COUP?</code>
Couplings	When Auto Scaling is ON , and the Restart front-panel key is pressed, this function automatically sets the scale per division to 10 dB and determines the reference values based on the measurement results When you change a value of Scale/Div , Ref Value , or Scale Range , Auto Scaling automatically changes to OFF
Preset	1
State Saved	Saved in instrument state
Range	OFF ON
Backwards Compatibility SCPI	<code>:DISPlay:MONitor:VIEW[1]:WINDow[1]:TRACe:Y[:SCALe]:COUPle</code>

3.3.3.2 Attenuation

Controls the attenuator functions and interactions between the attenuation system components.

There are two attenuator configurations in the X-Series. One is a Dual-Attenuator configuration consisting of a mechanical attenuator and an optional electronic attenuator. The other configuration uses a single attenuator with combined mechanical and electronic sections that controls all the attenuation functions. Different models in the X-Series come with different configurations.

- See ["Dual-Attenuator Configurations"](#) on page 567
- See ["Single-Attenuator Configuration"](#) on page 568

Most attenuation settings are the same for all measurements – they do not change as you change measurements. Settings like these are called “Meas Global” and are unaffected by **Meas Preset**.

Only available when the hardware set includes an input attenuator, which is typically only the case for Keysight’s benchtop instruments. For example, this tab does *not* appear in VXT models M9420A/10A/11A/15A/16A, M9410E/11E/15E/16E, nor in UXM. In UXM, all **Attenuation** and **Range** settings are disabled, as the expected input power level is handled by the Call Processing App that drives the DUT power control.

Dependencies In measurements that support the I/Q inputs, unavailable when I/Q is the selected input. Replaced by the **Range** tab in that case

Dual-Attenuator Configurations

Configuration 1: Mechanical attenuator + optional electronic attenuator

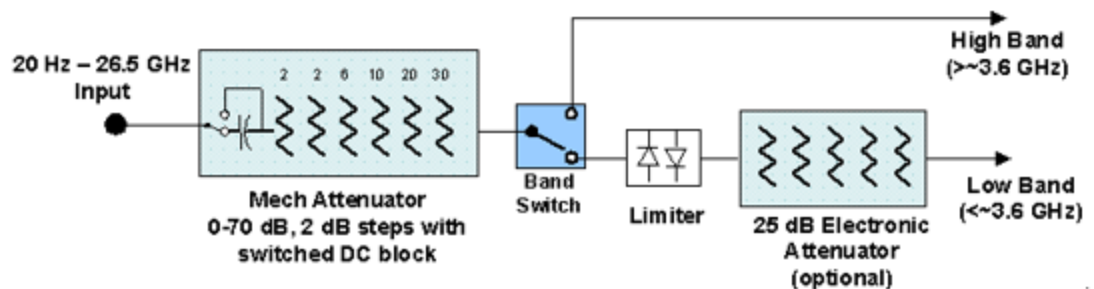

Configuration 2: Mechanical attenuator, no optional electronic attenuator

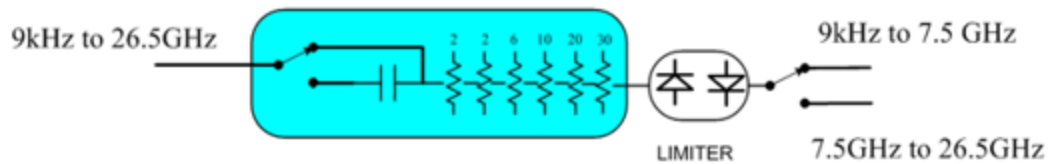

Note that Configuration 2 is not strictly speaking a dual-section attenuator, since there is no electronic section available. However, it behaves exactly like Configuration 1 without the Electronic Attenuator Option EA3, therefore for the sake of this document it is grouped into the “Dual-Attenuator” configuration.

Single-Attenuator Configuration

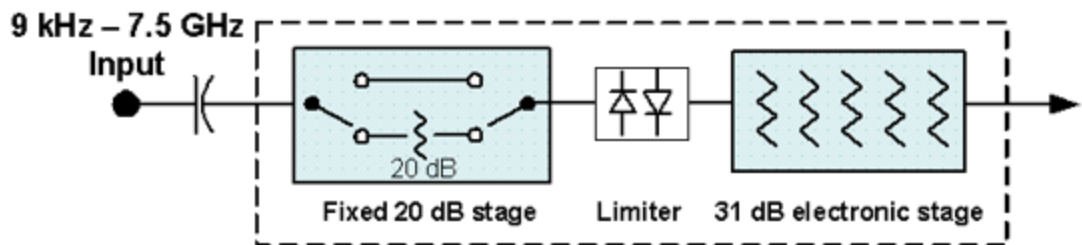

You can tell which attenuator configuration you have by pressing the Attenuation tab, which (in most Modes) opens the Attenuation menu. If the first control in the Attenuation menu says **Mech Atten** you have the Dual-Attenuator configuration. If the first control says **Atten** you have the Single-Attenuator configuration.

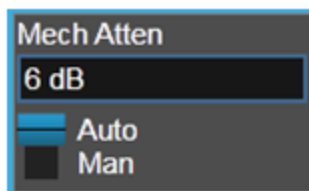

Dual Attenuator

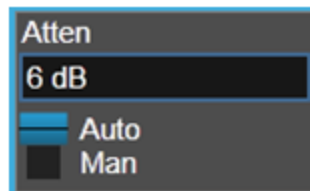

Single Attenuator

(Note that depending on the measurement, there may be no Auto/Man functionality on the Mech Atten control.)

In the Single-Attenuator configuration, you control the attenuation with a single control, as the fixed stage has only two states. In the Dual-Attenuator configuration, both stages have significant range, so you are given separate control of the mechanical and electronic attenuator stages.

When you have the Dual-Attenuator configuration, you may still have only a Single-Attenuator, because unless Option EA3 (the Electronic Attenuator option) is available, and you purchase it, you will have only the mechanical attenuator.

Full Range Atten

This control and **Attenuator Summary** only appear in N9041B, when the RF input is selected, the RF Input Port is set to RF Input 2, and the Full Range Attenuator is installed. The Full Range Attenuator adds a second input attenuator in front of RF Input 2, which enhances the protection and optimizes the performance of the extra internal mixers used by RF Input 2.

Remote Command	<code>[:SENSe]:POWer[:RF]:FRATten <rel_amp1></code> <code>[:SENSe]:POWer[:RF]:FRATten?</code>
Example	<code>:POW:FRAT 14</code> <code>:POW:FRAT?</code>
Notes	When you enter an amplitude value that falls between valid values, the value will be incremented to the next smallest valid value
Dependencies	Only appears if input RF is selected, RF Input Port 2 is selected, and the Full Range Attenuator exists
Couplings	This value is never changed by any coupling, but other couplings use this value. See Reference Level and "Mech Atten" on page 1766 command descriptions
Preset	20 dB
State Saved	Saved in instrument state
Min	0 dB
Max	Only valid values are 0, 6, 14, 20 dB
Annotation	<p>When the Input is RF, and the Input Port is RF Input 2, and the Full Range Attenuator is installed: On the Meas Bar, the field "Atten" displays as follows:</p> <ul style="list-style-type: none"> - If the sweep is entirely < 50 GHz, the value shown after "Atten:" is equal to Mech Atten + Elec Atten + Full Range Atten - If the sweep is entirely > 50 GHz, the value shown after "Atten:" is equal to Full Range Atten - If the sweep straddles 50 GHz, the value shown after "Atten:" is preceded by the symbol ">=" and is equal to Full Range Atten <p>In the Amplitude, "Y Scale" on page 1760 menu, and the Atten Meas Bar dropdown menu panel, a summary is displayed as follows:</p> <p>"Total Atten below 50 GHz" followed by the value of Full Range Atten + Mech Atten + Elec Atten "Total Atten above 50 GHz" followed by the value of Full Range Atten</p> <p>For example, if Mech Atten = 6 dB, Elec Atten = 4 dB, and Full Range Atten = 20 dB, the summary below is shown:</p> <ul style="list-style-type: none"> - Attenuator summary: - Total Atten below 50 GHz: 30 dB - Total Atten above 50 GHz: 20 dB

Mech Atten

Labeled **Mech Atten** in Dual-Attenuator models, and **Atten** in Single-Attenuator models. In the Dual-Attenuator configuration, this control only affects the mechanical attenuator.

Lets you modify the attenuation applied to the RF input signal path. This value is normally auto-coupled to **Ref Level**, "[Internal Preamp](#)" on page 1788 Gain, any External Gain that is entered, and **Max Mixer Level** (if available), as described in the table below.

See "[Attenuator Configurations and Auto/Man](#)" on page 572

Remote Command	<code>[:SENSe]:POWer[:RF]:ATTenuation <rel_amp></code> <code>[:SENSe]:POWer[:RF]:ATTenuation?</code>
Example	<code>:POW:ATT 20</code> Dual-Attenuator configuration: sets the mechanical attenuator to 20 dB Single-Attenuator mode: sets the main attenuation to 20 dB (see below for definition of "main" attenuation) In either case, if the attenuator was in Auto, it is set to Manual
Dependencies	Some measurements do not support Auto setting of Mech Atten . In these measurements, the Auto/Man selection is not available, and the Auto/Man toggle function is not available In Dual-Attenuator configurations, when the electronic attenuator is enabled, the mechanical attenuator has no auto setting, and the Auto/Man toggle function is not available. The state of Auto/Man is remembered and restored when the electronic attenuator is once again disabled. This is described in more detail in " Elec Atten " on page 1769 See " Attenuator Configurations and Auto/Man " on page 572 for more information on the Auto/Man functionality
Couplings	If the RF Input Port is the RF Input: <ul style="list-style-type: none"> - If the USB Preamp is connected to USB, use 0 dB for Mech Atten - Otherwise compute the auto-selected value of Mech Atten based on Reference Level, Int Preamp, External Gain, Ref Level Offset, Max Mixer Level, μW Path Control and IF Gain settings. Limit this value to be no less than 6 dB (total attenuation below 6 dB can never be chosen by Auto) - In N9041B, if the RF Input Port is RF Input 2, use the formula above and subtract the value of "Full Range Atten" on page 1765 from the result to determine the Mech Atten. Limit the value so that it is never lower than 0 dB and so that total attenuation, including Full Range Atten, is never less than 6 dB (total attenuation, including Full Range Atten below 6 dB, can never be chosen by Auto) <p>In External Mixing and BBIQ, where the attenuator is not in the signal path, the attenuator setting changes as described above when Mech Atten is in Auto, but no changes are made to the actual attenuator hardware setting until the input is changed back to the RF Input</p> <p>For CXA-m with Option FSA (Fine-Step Attenuator or 2 dB steps), the FSA-like behavior is only available when the frequency setting is ≤ 7.5 GHz. So, when the frequency is changed from below</p>

3 VMA Mode
3.3 Monitor Spectrum Measurement

	7.5 GHz to above 7.5 GHz, the attenuation setting changes to a multiple of 10 dB that is no smaller than the previous setting. For example, 4 dB attenuation changes to 10 dB	
Preset	Auto	The Auto value is 10 dB
State Saved	Saved in instrument state	
Min	0 dB The attenuation set by this control cannot be decreased below 6 dB with the knob or step keys. Values below 6 dB must be directly entered from the keypad or via SCPI. This protects against setting a dangerously small attenuation value, which can put the instrument at risk of damage to input circuitry. If the current mechanical attenuation is below 6 dB, it can be increased with the knob and step keys, but not decreased	
Max	CXA Option 503 or 507	50 dB
	EXA	60 dB
	All other models	70 dB
	Note that in the Single-Attenuator configuration, the total of ATT and EATT cannot exceed 50 dB. So, if the EATT is set to 24 dB first, the main attenuation cannot be greater than 26 dB and will be reduced accordingly; if the main attenuator is set to 40 dB first, EATT cannot be greater than 10 dB	
Annotation	<p>The current value for Total Atten is displayed in the Measurement Bar at the top of the display. A value appears for Electronic Attenuation only if the Electronic Attenuator is enabled. The annotation appears as:</p> <p><i>Atten: <total> dB (e<elec>)</i></p> <p>The e letter is in amber in Single-Attenuator configurations</p> <p>For example:</p> <p>Dual-Attenuator configuration:</p> <p><i>Atten: 24 dB (e14)</i></p> <p>Indicating the total attenuation is at 24 dB and the electronic attenuation is at 14 dB</p> <p>Single-Attenuator configuration:</p> <p><i>A: 24 dB (e14)</i></p> <p>Indicating the total attenuation is at 24 dB and the “soft” attenuation is at 14 dB (see below for definition of “soft” attenuation)</p> <p>When in Manual, a # sign appears in front of Atten in the annotation</p>	

Auto Function

Remote Command	<code>[:SENSe]:POWer[:RF]:ATTenuation:AUTO OFF ON 0 1</code> <code>[:SENSe]:POWer[:RF]:ATTenuation:AUTO?</code>
Example	Turn Auto Mech AttenON : <code>:POW:ATT:AUTO ON</code>
Dependencies	<code>:POW:ATT:AUTO</code> is only available in measurements that support Auto , such as Swept SA
Preset	ON

Attenuator Configurations and Auto/Man

As described under "Attenuation" on page 1763, there are two distinct attenuator configurations available in the X-Series, the Single Attenuator and Dual-Attenuator configurations.

In Dual-Attenuator configurations, we have mechanical attenuation and electronic attenuation, and current total attenuation is the sum of electronic + mechanical attenuation.

In Single-Attenuator configurations, we refer to the attenuation set using "Mech Atten" on page 570 (or :POW:ATT) as the "main" attenuation; and the attenuation that is set by :POW:EATT as the "soft" attenuation (:POW:EATT is honored even in the Single-Attenuator configuration, for compatibility purposes). Then current total attenuation is the sum of main + soft attenuation.

See "Elec Atten" on page 1769 for more about "soft" attenuation.

NOTE

In some measurements, the **Mech Atten** control has an **Auto/Man** function. In these measurements, an **Auto/Man** switch is shown on the **Mech Atten** control:

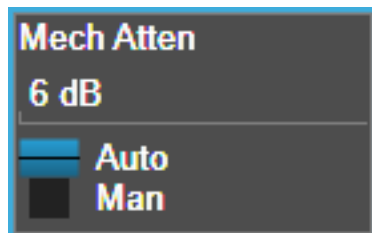

Note that in configurations that include an Electronic Attenuator, this switch is only shown when the Electronic Attenuator is disabled.

In other measurements, **Mech Atten** has no **Auto/Man** function. In these measurements, no switch is shown on the **Mech Atten** control:

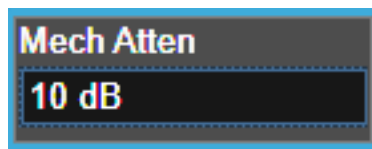

Mech Atten also appears with no switch, as above, in configurations that include an Electronic Attenuator but when the Electronic Attenuator is enabled.

Elec Atten

Controls the Electronic Attenuator in Dual-Attenuator configurations. Does not appear in Single-Attenuator configurations, because the control of both the mechanical and electronic stages of the Single-Attenuator is integrated into the single **Atten** control.

3 VMA Mode
3.3 Monitor Spectrum Measurement

This control includes an **Enable/Disable** toggle switch; it is only possible to enter a value for the Electronic Attenuator when this switch is in the **Enable** position.

For more details of the Electronic Attenuator, see ["More Information" on page 574](#)

Remote Command	<code>[:SENSe]:POWer[:RF]:EATTenuation <rel_amp1></code> <code>[:SENSe]:POWer[:RF]:EATTenuation?</code>
Example	<code>:POW:EATT 10</code> <code>:POW:EATT?</code>
Notes	Electronic Attenuation's specification is defined only when Mech Atten is 6 dB
Dependencies	<p>Only appears in Dual-Attenuator models with an Electronic Attenuator installed and licensed. Does not appear in models with the Single-Attenuator configuration, because in the Single-Attenuator configuration there is no "electronic attenuator"; there is only a single integrated attenuator (which has both a mechanical and electronic stage). However, in the Single-Attenuator configuration, EATT SCPI commands are accepted for compatibility with other X-series instruments, and set a "soft" attenuation. The "soft" attenuation is treated as an addition to the "main" attenuation value set by the Attenuation control or <code>:POW:ATT</code>, and affects the total attenuation displayed on the Attenuation control and the Meas Bar</p> <p>The electronic attenuator, and the "soft" attenuation function provided in Single-Attenuator configurations, are unavailable above the low band (0-3.6 GHz, 0-3.4 GHz, 0-3 GHz, depending on the model). If the low band range is from 0-3.6 GHz, and Stop Frequency of the instrument is > 3.6 GHz, then the Enabled/Disabled section of the Elec Atten control will be OFF and grayed-out</p> <p>If "Internal Preamp" on page 1788 is ON (that is, set to Low Band or Full), the electronic attenuator (and the "soft" attenuation function provided in Single-Attenuator configurations) is unavailable. In this case the Enabled/Disabled section of the Elec Atten control will be OFF and grayed-out</p> <p>If either of the above is true, and the SCPI command is sent, an error indicating that the electronic attenuator is unavailable is returned</p> <p>If both the above are true, pressing the control generates error message -221, in other words, the frequency range lockout takes precedence</p> <p>If the electronic/soft Attenuator is enabled, then the Stop Freq of the instrument is limited to 3.6 GHz and Internal Preamp is unavailable</p> <p>If "LNA" on page 1790 is ON, the electronic attenuator (and the "soft" attenuation function provided in Single-Attenuator configurations) is unavailable. In this case the Enabled/Disabled section of the Elec Atten control will be OFF and grayed-out. This coupling works in the following modes/measurements:</p> <ul style="list-style-type: none"> - Channel Power, Occupied BW, ACP, SEM, Spurious Emissions, Power Stat CCDF measurements in all Modes - Transmit On Off Power measurement in 5G NR Mode - Power vs. Time and Transmit Power measurement in GSM/EDGE Mode - Burst Power measurement in Spectrum Analyzer Mode <p>The SCPI-only "soft" electronic attenuation for the single-attenuator configuration is not available in all measurements; in particular, it is not available in the Swept SA measurement</p>
Couplings	Enabling and disabling the Electronic Attenuator affects the setting of the Mechanical Attenuator (in Dual-Attenuator configurations). This is described in more detail below and in "Mechanical Attenuator

	Transition Rules" on page 575
Preset	0 dB
State Saved	Saved in instrument state
Min	0 dB
Max	Dual-Attenuator configuration: 24 dB Single-Attenuator configuration: the total of ATT and EATT cannot exceed 50 dB. So, if the EATT is set to 24 dB first, the main attenuation cannot be greater than 26 dB and will be reduced accordingly; if the main attenuator is set to 40 dB first, EATT cannot be greater than 10 dB
Annotation	See Annotation under the Mech Atten control description
Auto Function	
Remote Command	<code>[:SENSe]:POWer[:RF]:EATTenuation:STATe OFF ON 0 1</code> <code>[:SENSe]:POWer[:RF]:EATTenuation:STATe?</code>
Example	<code>:POW:EATT:STAT ON</code> <code>:POW:EATT:STAT?</code>
Preset	OFF (Disabled) for Swept SA measurement ON (Enabled) for all other measurements that support the electronic attenuator

NOTE

The maximum **Center Frequency** for Low Band can change based on the selected IFBW for measurements that support IFBW (for example, Waveform measurement across all Modes that support it). In certain models (such as N9042B & N9032B), IFBW values ≤ 40 MHz have a maximum Low Band frequency of 3.6 GHz, while $40 \text{ MHz} < \text{IFBW} \leq 1 \text{ GHz}$ have a maximum of 3.3 GHz, and $1 \text{ GHz} < \text{IFBW} \leq 1.5 \text{ GHz}$ have a maximum of 3.5 GHz. This frequency is reflected in the disabled message displayed for Electrical Attenuator. For N9032B and N9042B IFBW values $> 1.5 \text{ GHz}$ do not support a **Center Frequency** that can reach the Low Band maximum frequency. In these cases, the Electrical Attenuator will remain disabled no matter the Center Frequency.

More Information

The electronic attenuator offers finer steps than the mechanical attenuator, has no acoustical noise, is faster, and is less subject to wear. These advantages primarily aid in remote operation and are negligible for front panel use. See ["Using the Electronic Attenuator: Pros and Cons" on page 576](#) for a detailed discussion of the pros and cons of using the electronic attenuator.

For the Single-Attenuator configuration, for SCPI backwards compatibility, the "soft" attenuation feature replaces the Dual-Attenuator configuration's electronic attenuator. All the same couplings and limitations apply. See ["Attenuator Configurations and Auto/Man" on page 1768](#)

Mechanical Attenuator Transition Rules

When the Electronic Attenuator is enabled, the Mechanical Attenuator transitions to a state that has no Auto function. Below are the rules for transitioning the Mechanical Attenuator. Note that the information below *only* applies to the Dual-Attenuator configurations, and *only* when the Electronic Attenuator is installed:

When the Electronic Attenuation is enabled from a disabled state:

- The Mechanical Attenuator is initialized to 10 dB (this is its optimal performance setting). You can then set it as desired with SCPI, numeric keypad, step keys, or knob, and it behaves as it normally would in manual mode
- The Auto/Man state of (Mech) Atten is saved
- The Auto/Man toggle on the (Mech) Atten control disappears, and the auto rules are disabled
- The Electronic Attenuator is set to 10 dB less than the previous value of the Mechanical Attenuator, within the limitation that it must stay within the range of 0 to 24 dB of attenuation

Examples in the Dual-Attenuator configuration:

- Mech Atten at 20 dB. Elec Atten enabled, Mech Atten set to 10 dB, and Elec Atten set to 10 dB. New total attenuation equals the value before Elec Atten enabled
- Mech Atten at 0 dB. Elec Atten enabled, Mech Atten set to 10 dB, and Elec Atten set to 0 dB. New total attenuation does not equal the value before Elec Atten enabled
- Mech Atten at 40 dB. Elec Atten enabled, Mech Atten set to 10 dB, and Elec Atten set to 24 dB. New total attenuation does not equal the value before Elec Atten enabled

When the Electronic Attenuation is disabled from an enabled state:

- The Elec Atten control is grayed out
- The Auto/Man state of (Mech) Atten is restored
- If now in Auto, (Mech) Atten recouples
- If now in Man, (Mech) Atten is set to the value of total attenuation that existed before the Elec Atten was disabled. The resulting value is rounded up to the smallest value possible given the (Mech) Atten Step setting - (That is, 57 dB changes to 58 dB when (Mech) Atten Step is 2 dB)

Using the Electronic Attenuator: Pros and Cons

The electronic attenuator offers finer steps than the mechanical attenuator, has no acoustical noise, is faster, and is less subject to wear.

The “finer steps” advantage of the electronic attenuator is beneficial in optimizing the alignment of the instrument dynamic range to the signal power in the front panel as well as remote use. Thus, you can achieve improved relative signal measurement accuracy. Compared to a mechanical attenuator with 2 dB steps, the 1 dB resolution of the electronic attenuator only gives better resolution when the odd-decibel steps are used. Those odd-decibel steps are less accurately calibrated than the even-decibel steps, so one tradeoff for this superior relative accuracy is reduced absolute amplitude accuracy.

Another disadvantage of the electronic attenuator is that the spectrum analyzer loses its “Auto” setting, making operation less convenient.

Also, the relationship between the dynamic range specifications (TOI, SHI, compression, and noise) and instrument performance are less well-known with the electrical attenuator. With the mechanical attenuator, TOI, SHI, and compression threshold levels increase dB-for-dB with increasing attenuation, and the noise floor does as well. With the electronic attenuator, there is an excess attenuation of about 1 to 3 dB between 0 and 3.6 GHz, making the effective TOI, SHI, and so forth, less well known. Excess attenuation is the actual attenuation relative to stated attenuation. Excess attenuation is accounted for in the instrument calibration.

Adjust Atten for Min Clipping

Sets the combination of mechanical and electronic attenuation and gain based on the current measured signal level so that clipping will be at a minimum.

This is an immediate action function, that is, it executes once, when the control is pressed.

The algorithms that are used for the adjustment are documented under "[Pre-Adjust for Min Clipping](#)" on page 1773.

Remote Command	<code>[:SENSe]:POWer[:RF]:RANGe:OPTimize IMMEDIATE</code>
Example	<code>:POW:RANG:OPT IMM</code>
Notes	Executing Adjust Atten for Min Clipping initiates the measurement
Dependencies	Does not appear in the Swept SA, RTSA, Monitor Spectrum and Complex Spectrum measurements Appears in the Waveform measurement in BASIC and 5G NR Modes

Adjust Atten

Allows you to select;

3 VMA Mode
3.3 Monitor Spectrum Measurement

- Electric attenuator only
- Combination of Electric attenuator and Mechanical attenuator

when `[:SENSe]:POWer[:RF]:RANGe:OPTimize IMMEDIATE` is executed.

Remote Command	<code>[:SENSe]:POWer[:RF]:RANGe:OPTimize:TYPE EONLY COMBined</code> <code>[:SENSe]:POWer[:RF]:RANGe:OPTimize:TYPE?</code>
Example	<code>:POW:RANG:OPT:TYPE EONL</code> <code>:POW:RANG:OPT:TYPE?</code>
Dependencies	Does not appear in the Swept SA, RTSA, Monitor Spectrum and Complex Spectrum measurements Appears in the Waveform measurement in BASIC and 5G NR Modes
Preset	<code>COMBined</code>
State Saved	Saved in instrument state

Pre-Adjust for Min Clipping

If this function is **ON**, it applies the adjustment described under "[Adjust Atten for Min Clipping](#)" on page 1772 each time a measurement restarts. Therefore, in Continuous measurement mode, it only executes before the first measurement.

In Dual-Attenuator models, you can set **Elec+Mech Atten**, in which case both attenuators participate in the autoranging, or **Elec Atten Only**, in which case the mechanical attenuator does not participate in the autoranging. This latter case results in less wear on the mechanical attenuator and is usually faster.

See "[Adjustment Algorithm](#)" on page 578

Selection	SCPI	Note
Off	<code>OFF</code>	This is the default setting
On	<code>ON</code>	Available in Single-Attenuator instruments. For compatibility with models that do not have an input attenuator, the ON parameter is supported and mapped to <code>COMBined</code>
Elec Atten Only	<code>ELECTrical</code>	Selects only the electric attenuator to participate in auto ranging. This offers less wear on the mechanical attenuator and is usually faster
Elec+Mech Atten	<code>COMBined</code>	In Dual-Attenuator models, this selects both attenuators to participate in the autoranging

Remote Command	<code>[:SENSe]:POWer[:RF]:RANGe:OPTimize:ATTenuation OFF ON ELECTrical COMBined</code> <code>[:SENSe]:POWer[:RF]:RANGe:OPTimize:ATTenuation?</code>
Example	<code>:POW:RANG:OPT:ATT OFF</code> <code>:POW:RANG:OPT:ATT?</code>

Notes	<p>The parameter option ELECTRICAL sets this function to ON in Single-Attenuator models</p> <p>The parameter option COMBINED is mapped to ELECTRICAL in Single-Attenuator models. If you send COMBINED, it sets the function to ON and returns ELEC to a query</p> <p>For SCPI compatibility with models that do not have an input attenuator, the ON parameter is honored and mapped to COMBINED</p>				
Dependencies	<p>Only appears in Dual-Attenuator models with an Electronic Attenuator installed</p> <p>In instruments with Dual-Attenuator model, when "Elec Atten" on page 1769 is OFF or grayed-out, "Pre-Adjust for Min Clipping" on page 577 is grayed-out</p> <p>Does not appear in the Swept SA, RTSA, Monitor Spectrum and Complex Spectrum measurements</p> <p>Appears in the Waveform measurement in BASIC and 5G NR Modes</p>				
Preset	OFF when Elec Atten is Disabled at preset, otherwise ELEC				
State Saved	Saved in instrument state				
Range	<table border="1"> <tr> <td>Dual-Attenuator models:</td> <td>Off Elec Atten Only Mech + Elec Atten</td> </tr> <tr> <td>Single-Attenuator models:</td> <td>Off On</td> </tr> </table>	Dual-Attenuator models:	Off Elec Atten Only Mech + Elec Atten	Single-Attenuator models:	Off On
Dual-Attenuator models:	Off Elec Atten Only Mech + Elec Atten				
Single-Attenuator models:	Off On				

Backwards Compatibility Command

Notes	<p>ON aliases to "Elec Atten Only" (:POW:RANG:OPT:ATT ELEC)</p> <p>OFF aliases to "Off" (:POW:RANG:OPT:ATT OFF)</p> <p>:POW:RANG:AUTO? returns true if :POW:RANG:OPT:ATT is not OFF</p>
Backwards Compatibility SCPI	<pre>[:SENSe]:POWer[:RF]:RANGe:AUTO ON OFF 1 0</pre> <pre>[:SENSe]:POWer[:RF]:RANGe:AUTO?</pre>

Adjustment Algorithm

The algorithms for the adjustment are documented below:

Single-Attenuator Models

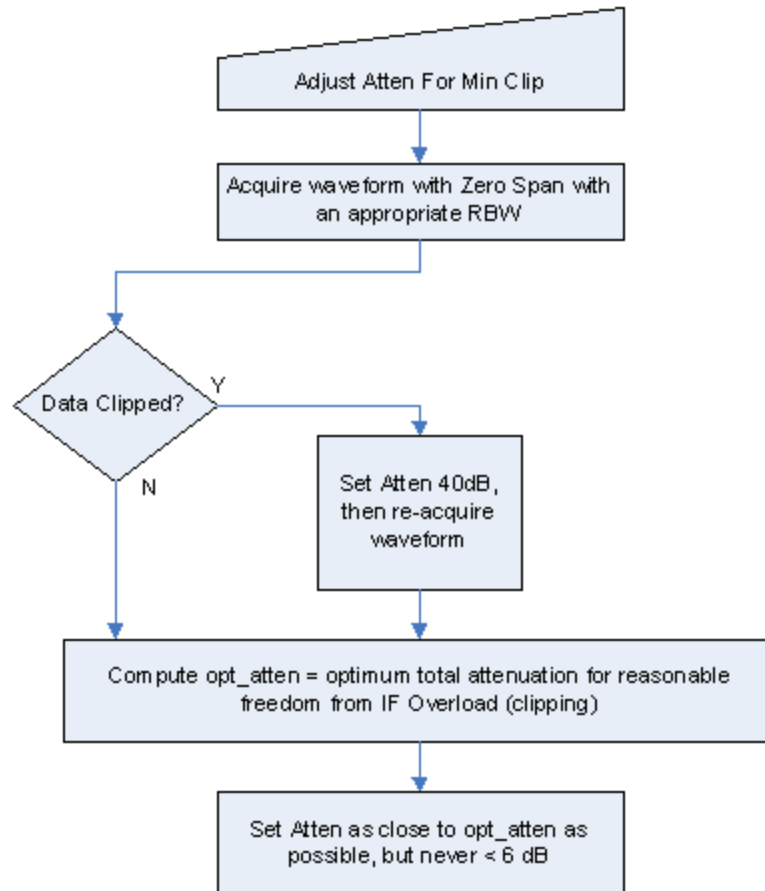

Dual-Attenuator models

"Adjust Atten for Min Clipping" on page 1772 or "Pre-Adjust for Min Clipping" on page 577 selection is Mech + Elec Atten:

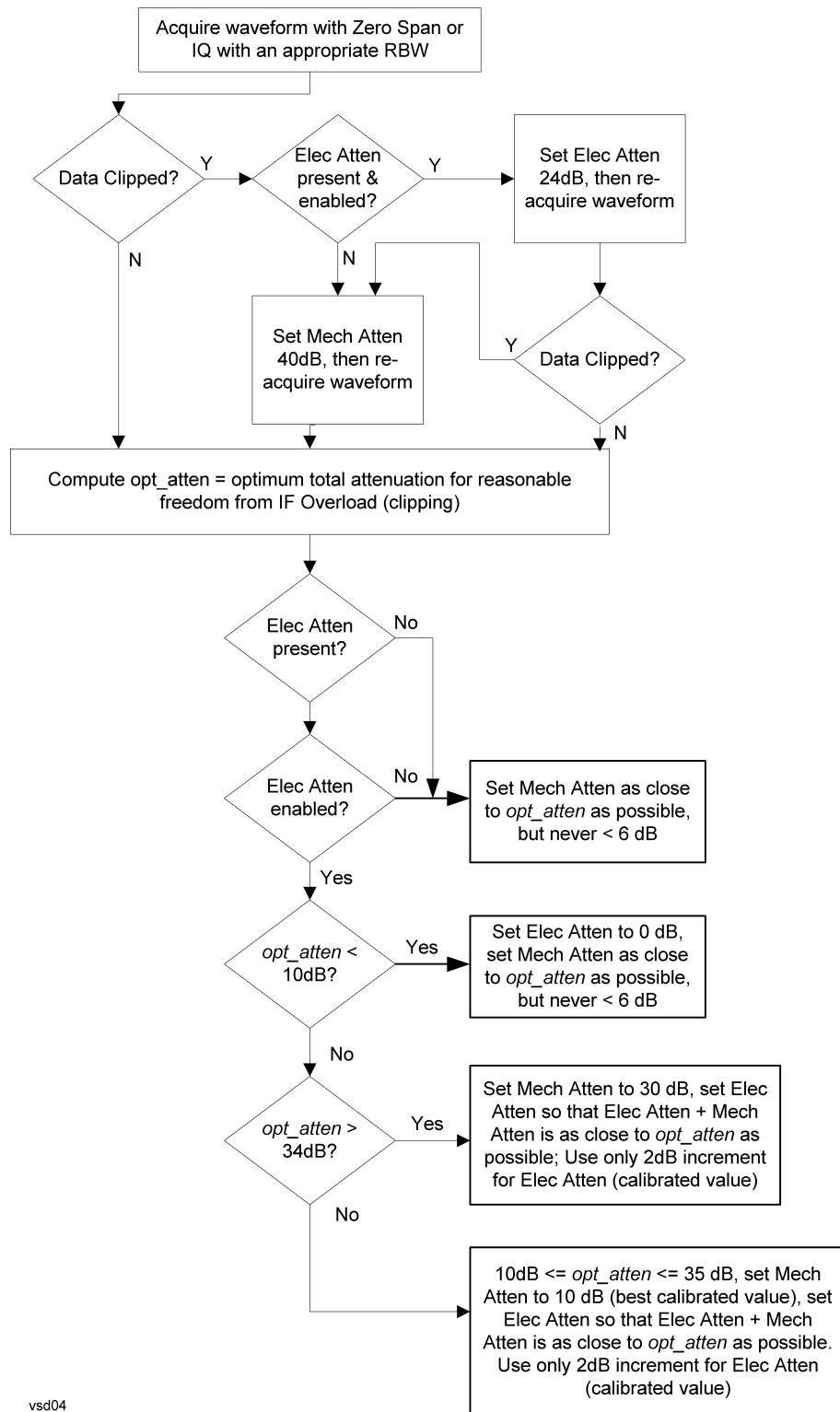

vsd04

"Pre-Adjust for Min Clipping" on page 577 selection is Elec Only.

Note that the **Mech Atten** value is not adjusted, and the value previously set is used. Therefore, there is a case that IF Overload is still observed depending on the input signal level and the Mech Atten setting.

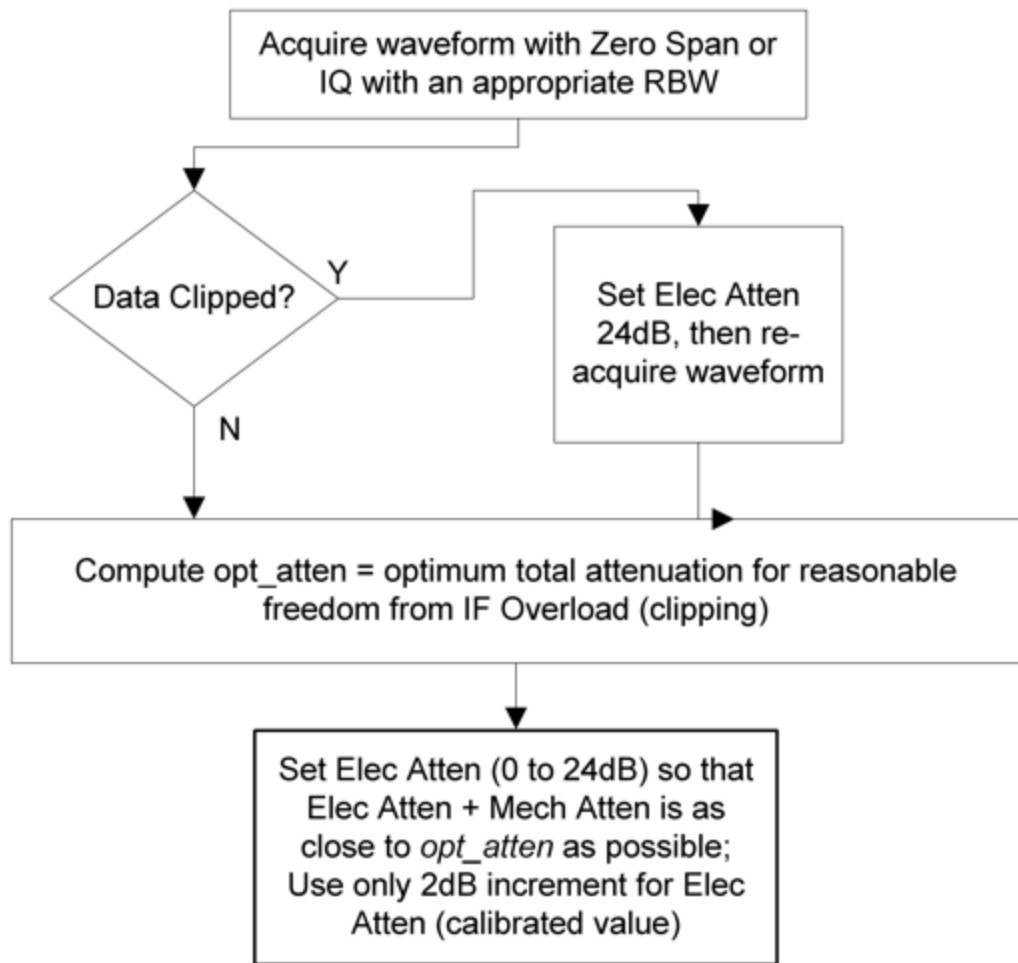

Mech Atten Step

Controls the step size used when making adjustments to the input attenuation.

Labeled **Mech Atten Step** in Dual-Attenuator models and **Atten Step** in Single-Attenuator models. In the Dual-Attenuator configuration, only affects the step size of the mechanical attenuator.

Remote Command `[:SENSe]:POWer[:RF]:ATTenuation:STEP[:INCRement] 10 dB | 2 dB`

	<code>[:SENSe]:POWer[:RF]:ATTenuation:STEP[:INCRement]?</code>
Example	<code>:POW:ATT:STEP 2</code> <code>:POW:ATT:STEP?</code>
Notes	Has a toggle control on the front panel, but takes a specific value (in dB) when used remotely. The only valid values are 2 and 10
Dependencies	Blanked in EXA, CXA and CXA-m if option FSA (2 dB steps) is not present. If blanked, attempts to set it via SCPI yield an error
Couplings	When the attenuation step size changes, the current mechanical attenuation value is adjusted (if necessary) to be quantized to the new step size. That is, if step is set to 10 dB, mech atten is increased if necessary so it is a multiple of 10 dB
Preset	EXA, CXA and CXA-m: 10 dB (2 dB with option FSA) All other models: 2 dB
State Saved	Saved in instrument state

3.3.3.3 Range (Non-attenuator models)

Only available for Keysight's modular signal analyzers and certain other Keysight products, such as VXT and M941xE.

State Saved	No
-------------	----

Range

Represents the amplitude of the largest sinusoidal signal that could be present within the IF without being clipped by the ADC. For signals with high peak-to-average ratios, the range may need to exceed the rms signal power by a significant amount to avoid clipping.

This is a measurement global setting.

Remote Command	<code>[:SENSe]:POWer[:RF]:RANGe <real></code> <code>[:SENSe]:POWer[:RF]:RANGe?</code>
Example	<code>:POW:RANG 10 dBm</code> <code>:POW:RANG?</code>
Notes	The MIN and MAX values are affected by the External Gain parameters, and by the Center Frequency . The hardware compensates for frequency response and alters the Range setting
Preset	0 dBm
State Saved	Yes
Min/Max	-/+100
Annotation	Meas Bar

Adjust Range for Min Clipping

Sets the combination of attenuation and gain based on the current measured signal level so that clipping will be at a minimum.

This is an "immediate action" function, that is, it executes once, when the key is pressed.

This key does not appear in measurements that do not support this functionality.

Remote Command	<code>[:SENSe]:POWer[:RF]:RANGe:OPTimize IMMEDIATE</code>
Notes	Executing Adjust Range for Min Clipping initiates the measurement
Dependencies	Does not appear in the Swept SA and Monitor Spectrum measurements

Pre-Adjust for Min Clipping

If this function is **ON**, it applies the adjustment described under Adjust Range For Min Clipping each time a measurement restarts. Therefore, in Continuous measurement mode, it only executes before the first measurement.

Remote Command	<code>[:SENSe]:POWer[:RF]:RANGe:OPTimize:ATTenuation OFF ON ELECTrical COMBined</code> <code>[:SENSe]:POWer[:RF]:RANGe:OPTimize:ATTenuation?</code>
Notes	Because there is no attenuator control available in these models, the control displays only ON and OFF choices. However, for SCPI compatibility with other platforms, all three parameters (ELECTrical , COMBined , and ON) are honored and all are mapped to ELECTrical , so if any of these three parameters is sent, a subsequent query will return ELEC
Dependencies	Does not appear in the Swept SA and Monitor Spectrum measurements
Preset	OFF for Swept SA measurement; ON for all other measurements that support Pre-Adjust for Min Clipping
State Saved	Saved in instrument state

Adjustment Algorithm

The algorithm for the adjustment is documented below:

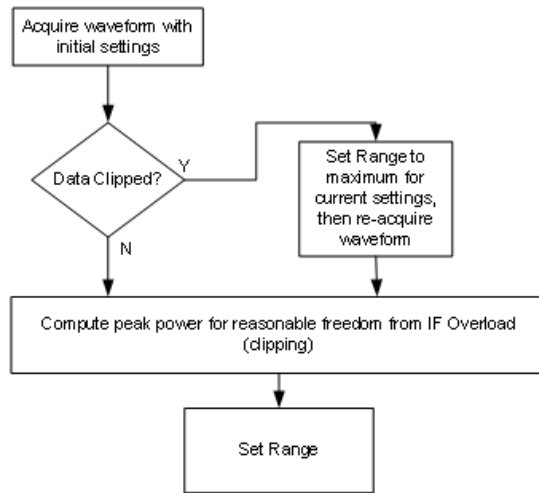

Peak-to-Average Ratio

Used with "[Range \(Non-attenuator models\)](#)" on page 1782 to optimize the level control in the instrument. The value is the ratio, in dB, of the peak power to the average power of the signal to be measured. A ratio of 0 should be used for sinusoidal signals; for 802.11g OFDM signals use 9 dB.

All Modes show the current value of Peak-to-Average ratio on the control. However, some Modes do not permit changing the value. In these situations, the control is grayed-out.

Remote Command	<code>[:SENSe]:POWer[:RF]:RANGe:PARatio <real></code> <code>[:SENSe]:POWer[:RF]:RANGe:PARatio?</code>	
Example	<code>:POW:RANG:PAR 12 dB</code>	
Notes	In some Modes, this parameter is read-only; meaning the value will appear on the control and query via SCPI, but is not changeable. In such applications the control is grayed-out. Attempts to change the value via SCPI are ignored, but no error message is generated	
Dependencies	Does not appear in Spectrum Analyzer Mode	
Preset	VXT Models M9410A/11A	0 dB
	All Others	10 dB
State Saved	Saved in instrument state	
Min	0 dB	
Max	VXT Models M9410A/11A	50 dB
	All Others	20 dB

Mixer Lvl Offset

This is an advanced setting to adjust target Range at the input mixer, which in turn affects the signal level in the instrument's IF. This setting can be used when additional optimization is needed after setting "[Peak-to-Average Ratio](#)" on page 1784. Positive values of offset optimize noise performance over distortion, negative values optimize distortion performance over noise.

Remote Command	<code>[:SENSe]:POWer[:RF]:RANGe:MIXer:OFFSet <real></code> <code>[:SENSe]:POWer[:RF]:RANGe:MIXer:OFFSet?</code>	
Example	<code>:POW:RANG:MIX:OFFS -5 dB</code>	
Preset	0 dB	
State Saved	Saved in instrument state	
Min	VXT Models M9410A/11A	-34 dB
	All Others	-35 dB
Max	30 dB	

3.3.3.4 Signal Path

Contains controls that pertain to the routing of the signal through the frontend of the instrument.

In general, only appears in instruments whose hardware supports this signal routing. For example, this tab does not appear in many of the modular instrument products, including VXT Model M9420A, or UXM.

This tab *does* appear in VXT Models M9410A/11A/15A/16A and M9410E/11E/15E/16E, because "[Software Preselection](#)" on page 1801 is under this tab, and VXT Models M9410A/11A/15A/16A and M9410E/11E/15E/16E implement a version of Software Preselection.

Presel Center

Adjusts the centering of the preselector filter to optimize the amplitude accuracy at the frequency of the selected marker. If the selected marker is not on when **Presel Center** is pressed, the instrument turns on the selected marker, performs a peak search, and then performs centering on the marker's center frequency. If the selected marker is already on and between the start and stop frequencies of the instrument, the instrument performs the preselector calibration on that marker's frequency. If the selected marker is already on, but outside the frequency range

between **Start Freq** and **Stop Freq**, the instrument first performs a peak search, and then performs centering on the marker's center frequency.

The value displayed on "[Preselector Adjust](#)" on page 1787 changes to reflect the new preselector tuning.

Certain considerations should be observed to ensure proper operation, as detailed in "[Proper Preselector Operation](#)" on page 586.

Remote Command	<code>[:SENSe] :POWer [:RF] :PCENter</code>
Example	<code>:POW:PCEN</code>
Notes	The rules outlined above under the control description apply for the remote command as well as the key. The result of the command depends on marker position, etc. Any message generated by the control press is also generated in response to the remote command
Dependencies	Does not appear in CXA-m, nor in VXT Models M9410A/11A/15A/16A, M9410E/11E/15E/16E Grayed-out if the microwave preselector is off <ul style="list-style-type: none"> - If the selected marker's frequency is below Band 1, an advisory message is generated "Preselector not used in this frequency range" and no action is taken - Grayed-out if entirely in Band 0, that is, if Stop Freq is below about 3.6 GHz Grayed-out if entirely above 50 GHz, that is, if Start Freq is above 50 GHz - Blanked in models that do not include a preselector, such as Option 503. If the remote command is sent in these instruments, accepted without error, and the query always returns 0 - Grayed-out in the Spectrogram View
Couplings	The active marker position determines where the centering will be attempted If the instrument is in a measurement such as averaging when centering is initiated, the act of centering the preselector restarts averaging, but the first average trace will not be taken until the centering is completed The offset applied to do the centering appears in " Preselector Adjust " on page 1787
Status Bits/OPC dependencies	When centering the preselector, *OPC does not return true until the process is complete and a subsequent measurement has completed, nor are results returned in response to <code>:READ</code> or <code>:MEASure</code> queries The Measuring bit remains set (true) while this command is operating, and does not go false until the subsequent sweep/measurement has completed

Proper Preselector Operation

Certain considerations should be observed to ensure proper operation:

1. If the selected marker is **Off**, the instrument turns on a marker, performs a peak search, and adjusts the preselector using the selected marker's frequency. It uses the "highest peak" peak search method unqualified by threshold or excursion, so that there is no chance of a 'no peak found' error. It continues with that peak, even if it is the peak of just noise. Therefore, for this operation to work properly, there should be a signal on-screen in a preselected range for the peak

3 VMA Mode
 3.3 Monitor Spectrum Measurement

search to find

2. If the selected marker is already **On**, the instrument attempts the centering at that marker's frequency. There is no preselector for signals below about 3.6 GHz, so if the marker is on a signal below 3.6 GHz, no centering is attempted, and an advisory message is generated
3. In some models, the preselector can be bypassed. If it is bypassed, no centering is attempted in that range and a message is generated

Preselector Adjust

Lets you manually adjust the preselector filter frequency to optimize its response to the signal of interest. Only available when "[Presel Center](#)" on page 1786 is available.

For general purpose signal analysis, using **Presel Center** is recommended. Centering the filter minimizes the impact of long-term preselector drift. **Preselector Adjust** can be used instead to manually optimize the preselector. One application of manual optimization would be to peak the preselector response, which both optimizes the signal-to-noise ratio and minimizes amplitude variations due to small (short-term) preselector drifting.

When **Presel Center** is performed, the offset applied to do the centering becomes the new value of **Preselector Adjust**.

Remote Command	<code>[:SENSe]:POWer[:RF]:PADJust <freq></code> <code>[:SENSe]:POWer[:RF]:PADJust?</code>
Example	<code>:POW:PADJ 100KHz</code> <code>:POW:PADJ?</code>
Notes	The value on the control is displayed to 0.1 MHz resolution
Dependencies	<ul style="list-style-type: none"> - Does not appear in CXA-m - Does not appear in VXT Models M9410A/11A/15A/16A - Does not appear in M9410E/11E/15E/16E - Grayed-out if microwave preselector is off - Grayed-out if entirely in Band 0, that is, if Stop Freq is lower than about 3.6 GHz - Grayed-out if entirely above 50 GHz, that is, if Start Freq is higher than 50 GHz - Blank in models that do not include a preselector, such as Option 503. If the command is sent in these instruments, it is accepted without error, and the query always returns 0 - Grayed-out in the Spectrogram View
Preset	0 MHz

State Saved	The Preselector Adjust value set by " Presel Center " on page 1786, or by manually adjusting Preselector Adjust Not saved in instrument state, and does not survive a Preset or power cycle
Min/Max	-/+500 MHz
Backwards Compatibility SCPI	<code>[:SENSe]:POWer[:RF]:MW:PADJust</code> <code>[:SENSe]:POWer[:RF]:MMW:PADJust</code> Backwards Compatibility Command
Notes	The command has no effect, and the query always returns MWAVE
Backwards Compatibility SCPI	<code>[:SENSe]:POWer[:RF]:PADJust:PRESelector MWAVE MMWave EXTERNAL</code> <code>[:SENSe]:POWer[:RF]:PADJust:PRESelector?</code>

Internal Preamp

Accesses a menu of controls for the internal preamps. Turning on the preamp gives a better noise figure, but a poorer inter-modulation distortion (TOI) to noise floor dynamic range. You can optimize this setting for your measurement.

The instrument takes the preamp gain into account as it sweeps. If you sweep outside of the range of the preamp, the instrument will also account for that. The displayed result always reflects the correct gain.

For some measurements, when the preamp is on and any part of the displayed frequency range is below the lowest frequency for which the preamp has specifications, a warning condition message appears in the status line. For example, for a preamp with a 9 kHz lowest specified frequency: "Preamp: Accy unspec'd below 9 kHz".

Selection	Example	Note
Off	<code>:POW:GAIN OFF</code>	
Low Band	<code>:POW:GAIN ON</code> <code>:POW:GAIN:BAND LOW</code>	Sets the internal preamp to use only the low band. The frequency range of the installed (optional) low-band preamp is displayed in square brackets on the Low Band selection in the dropdown
Full Range	<code>:POW:GAIN ON</code> <code>:POW:GAIN:BAND FULL</code>	Sets the internal preamp to use its full range. The low band (0-3.6 GHz, 0-3.4 GHz, 0-3 GHz, depending on the model) is supplied by the low band preamp and the frequencies above low band are supplied by the high band preamp The frequency range of the installed (optional) low-band preamp is displayed in square brackets on the Full Range selection in the dropdown. If the high band option is not installed the Full Range selection does not appear

NOTE

The maximum **Center Frequency for Low Band**, displayed in square brackets, can change based on the selected IFBW for measurements that support IFBW (for example, Waveform measurement across all Modes that support it). In certain models (such as N9042B & N9032B), IFBW values ≤ 40 MHz have a maximum **Low Band** frequency of 3.6 GHz, while $40 \text{ MHz} < \text{IFBW} \leq 1 \text{ GHz}$ have a maximum of 3.3 GHz, and $1 \text{ GHz} < \text{IFBW} \leq 1.5 \text{ GHz}$ have a maximum of 3.5 GHz. IFBW values $> 1.5 \text{ GHz}$ do not support a **Center Frequency** that can reach the **Low Band** maximum frequency. In these cases, **N/A** is displayed in the square brackets for **Low Band**.

Remote Command	<code>[:SENSe]:POWer[:RF]:GAIN:BAND LOW FULL</code> <code>[:SENSe]:POWer[:RF]:GAIN:BAND?</code>
Example	<code>:POW:GAIN:BAND LOW</code> <code>:POW:GAIN:BAND?</code>
Dependencies	Not available on all hardware platforms. If the preamp is not present or is unlicensed, this control is not shown Does not appear in VXT Models M9410A/11A/15A/16A nor in M9410E/11E/15E/16E If <code>:POW:GAIN:BAND FULL</code> is sent when a low band preamp is available, the preamp band parameter is set to LOW instead of FULL , and an "Option not installed" message is generated Not available when the electronic/soft attenuator is enabled
Preset	LOW
State Saved	Saved in instrument state
Annotation	When the USB Preamp is not connected to USB, the Preamp annotation in the Meas Bar says "Off" if the preamp is off and displays the frequency range of the low band or full range preamp depending on the setting. For example, if the Preamp is set to Low Band and the Low Band is 3.6 GHz the annotation says "3.6 GHz". If it is a 13.6 GHz preamp and it is set to Full Range the annotation says "13.6 GHz" When the USB Preamp is connected to USB, the Preamp annotation says "Preamp: USB" if the internal preamp is off or "Preamp: USB, Int" if the internal preamp is on (only for measurements that support the USB preamp)

Auto Function

Remote Command	<code>[:SENSe]:POWer[:RF]:GAIN[:STATe] OFF ON 0 1</code> <code>[:SENSe]:POWer[:RF]:GAIN[:STATe]?</code>
Example	<code>:POW:GAIN OFF</code> <code>:POW:GAIN?</code>
Preset	OFF

LNA

Lets you turn the Low Noise Amplifier (**LNA**) on or off.

LNA is an additional preamplifier that provides superior DANL and frequency range compared to "Internal Preamp" on page 1788. LNA provides lower system noise figure, especially at frequencies above 100 MHz, and can be operated up to the full range of 50 GHz instruments.

For best possible sensitivity, LNA can be turned on *together* with "Internal Preamp" on page 1788, although if you operate both preamps together, note that the TOI (distortion) specifications are impacted. The sensitivity improvement of this combination is substantial when operating in high band (frequencies above 3.6 GHz).

For more details about annotation, see "More Information" on page 590

Remote Command	<code>[:SENSe]:POWer[:RF]:GAIN:LNA[:STATe] OFF ON 0 1</code> <code>[:SENSe]:POWer[:RF]:GAIN:LNA[:STATe]?</code>
Example	<code>:POW:GAIN:LNA ON</code>
Dependencies	Requires Option LNA, except for VXT models M9415A/16A Does not appear in VXT models M9420A/10A/11A M9410E/11E/15E/16E support LNA May not appear in some measurements LNA is not available when the electronic/soft attenuator is enabled
Preset	OFF
State Saved	Saved in State

More Information

When LNA is installed, the preamp annotation changes to show the state of both LNA and Internal Preamp. Below is an example:

```
Atten: 8 dB
Pre: Int on, LNA on
µW Path: LNP, On
Source: Off
```

Note that when operating entirely in the low band (below about 3.6 GHz), if LNA is on, Internal Preamp is switched off (even if you have its switch set to ON). This is because the noise performance is actually degraded in low band if both preamps are on. In this case, the annotation reflects the actual state of the two preamps, but the Internal Preamp annotation displays in amber, to warn you that the actual state of Internal Preamp does not match its switch control display:

```
Atten: 8 dB
Pre: Int off, LNA on
µW Path: LNP, On
Source: Off
```

μW Path Control

Options for this control include **μW Preselector Bypass** (Option MPB), **Low Noise Path** (Option LNP) and **Full Bypass Enable** in the High Band path circuits.

When the μW Preselector is bypassed, flatness is improved, but will be subject to spurs from out of band interfering signals. When **Low Noise Path Enable** is selected, the instrument automatically bypasses certain circuitry in the high frequency bands that can contribute to noise, when it is appropriate based on other instrument settings.

For most applications, the preset state is **Standard Path**, which provides the best remote-control throughput, minimizes acoustic noise from switching and minimizes the risk of wear in the hardware switches, particularly in remote test scenarios where both low band and high band setups will follow in rapid succession. In this path, the bypass of the low band/high band switch and microwave preamp is never activated, which can cause some noise degradation but preserves the life of the bypass switch.

For applications that utilize the wideband IF paths, the preset state is **μW Preselector Bypass**, if option MPB is present. This is because, when using a wideband IF such as the 140 MHz IF, the μW Preselector's bandwidth can be narrower than the available IF bandwidth, causing degraded amplitude flatness and phase linearity, so it is desirable to bypass the preselector in the default case.

You may choose **Low Noise Path Enable** for a lower noise floor, especially in the 21–26.5 GHz region, though without improving many measures of dynamic range, and without giving the best possible noise floor. The preamp, if purchased and used, gives better noise floor than does **Low Noise Path Enable**, but the preamp's compression threshold and third-order intercept are much poorer than that of **Low Noise Path Enable**.

A fourth choice is **Full Bypass Enable**, which combines **μW Preselector Bypass** and **Low Noise Path Enable**. Because this can bypass most of the circuitry between the input and the first mixer, care should be taken when using this setting to avoid damaging the mixer. **Full Bypass Enable** is only available if both options LNP and MPB are present, as well as option FBP.

Path	Example	Note
Standard Path	:POW:MW:PATH STD	Normal setting for most measurements. μW Preselector in circuit, Low Noise Path disabled
Low Noise Path Enable	:POW:MW:PATH LNP	See " Low Noise Path Enable " on page 595
μW Preselector Bypass	:POW:MW:PATH MPB	See " μW Preselector Bypass " on page 597
Full Bypass Enable	:POW:MW:PATH FULL	See " Full Bypass Enable " on page 598

Remote Command	<code>[:SENSe]:POWer[:RF]:MW:PATH STD LNPath MPBypass FULL</code> <code>[:SENSe]:POWer[:RF]:MW:PATH?</code>														
Example	<code>:POW:MW:PATH LNP</code> Enables the Low Noise path <code>:POW:MW:PATH?</code>														
Notes	<p>When "Presel Center" on page 1786 is performed, the instrument momentarily switches to the Standard Path, regardless of the setting of μW Path Control</p> <p>The DC Block will always be switched in when the low noise path is switched in, to protect succeeding circuitry from DC. Note that this does not mean “when the low noise path is enabled” but when, based on the Low Noise Path rules, the path is actually switched in. This can happen when the selection is Low Noise Path Enable or Full Bypass Enable. In the case where the DC Block is switched in, the instrument is now AC-coupled. However, if you selected DC coupling, the UI would still behave as though it were DC-coupled, including all annunciation, warnings, status bits, and responses to SCPI queries. This is because, based on other settings, the instrument could switch out the low noise path at any time and hence go back to being DC-coupled</p> <p>Alignment switching ignores the settings in this menu, and restores them when finished</p>														
Dependencies	<p>Does not appear in CXA-m, VXT Models M9410A/11A/15A/16A, nor in M9410E/11E/15E/16E, BBIQ and External Mixing</p> <ul style="list-style-type: none"> - The Low Noise Path Enable selection does not appear unless Option LNP is present and licensed - The μW Preselector Bypass selection does not appear unless Option MPB is present and licensed - The Full Bypass Enable selection does not appear unless options LNP and MPB are both present as well as option FBP <p>In any of these cases, if the required options are not present and the SCPI command is sent, error - 241, "Hardware missing; Option not installed" is generated</p> <p>Low Noise Path Enable and Full Bypass Enable are grayed-out if the current measurement does not support them</p> <p>Low Noise Path Enable and Full Bypass Enable are not supported in Avionics and MMR Modes (non-modulation measurements). In any of these cases (that is, the feature is not supported in either measurement or Mode), if the SCPI command is sent, the following error is generated: -221, “Setting Conflict; Feature not supported for this measurement”</p>														
Preset	<table border="1"> <thead> <tr> <th>Mode</th> <th>Value</th> </tr> </thead> <tbody> <tr> <td>IQ Analyzer</td> <td>MPB option present and licensed: MPB</td> </tr> <tr> <td>Pulse</td> <td>MPB option not present and licensed: STD</td> </tr> <tr> <td>RTSA</td> <td></td> </tr> <tr> <td>Avionics</td> <td></td> </tr> <tr> <td>All other Modes</td> <td>STD</td> </tr> <tr> <td>-</td> <td></td> </tr> </tbody> </table>	Mode	Value	IQ Analyzer	MPB option present and licensed: MPB	Pulse	MPB option not present and licensed: STD	RTSA		Avionics		All other Modes	STD	-	
Mode	Value														
IQ Analyzer	MPB option present and licensed: MPB														
Pulse	MPB option not present and licensed: STD														
RTSA															
Avionics															
All other Modes	STD														
-															
State Saved	Save in instrument state														
Range	Standard Path Low Noise Path Enable μW Presel Bypass Full Bypass Enable														

3 VMA Mode
 3.3 Monitor Spectrum Measurement

Annotation In the Meas Bar, if the Standard path is chosen:
 μW Path: Standard
 If Low Noise Path is enabled but the LNP switch is not thrown:
 μW Path: LNP,Off
 If the Low Noise Path is enabled and the LNP switch is thrown:
 μW Path: LNP,On
 If the preselector is bypassed:
 μW Path: Bypass
 If Full Bypass Enable is selected but the LNP switch is not thrown:
 μW Path: FByp,Off
 If Full Bypass Enable is selected and the LNP switch is thrown:
 μW Path: FByp,On

μW Path Control Auto

In VMA, WLAN, 5G NR, CQM Modes, an **Auto/Man** switch is added to **μW Path Control**:



This allows the function to automatically switch based on certain Auto Rules as shown below:

VMA Mode

Measurement	μW Path Control Auto behavior
Digital Demod	Use Standard Path unless tuned frequency > 3.6 GHz and IFBW > 15 MHz, in which case choose Preselector Bypass
Monitor Spectrum	Always Presel Bypass
IQ Waveform	Use Standard Path unless tuned frequency > 3.6 GHz and IFBW > 15 MHz, in which case choose Preselector Bypass
Custom OFDM	Use Standard Path unless tuned frequency > 3.6 GHz and IFBW > 15 MHz, in which case choose Preselector Bypass
Channel Power	Always Presel Bypass
Occupied BW	Always Presel Bypass
CCDF	Use Standard Path unless tuned frequency > 3.6 GHz and IFBW > 15 MHz, in which case choose Preselector Bypass

Measurement	μ W Path Control Auto behavior
ACP	Always Presel Bypass
SEM	Always Presel Bypass
Spurious Emissions	Always Standard Path

WLAN Mode

Measurement	μ W Path Control Auto behavior
Modulation Analysis	Always Presel Bypass
Spectral Flatness	Always Presel Bypass
Power vs Time	Always Presel Bypass
Monitor Spectrum	Always Presel Bypass
IQ Waveform	Always Presel Bypass
Channel Power	Always Presel Bypass
Occupied BW	Always Presel Bypass
CCDF	Always Presel Bypass
SEM	For 11be 320M, when 'Enabled Wideband IF for FFT' is OFF or 'Sweep Type Rule' is Best Dynamic Range, auto μ W path is standard For other cases, auto μ W path is presel bypass if presel bypass is enabled, auto μ W path is standard if presel bypass is not enabled
Spurious Emissions	Always Standard Path

5G NR Mode

Measurement	μ W Path Control Auto behavior
Modulation Analysis	Use Standard Path unless tuned frequency > 3.6 GHz and IFBW > 15 MHz, in which case choose Full Bypass if conditions warrant(FBP Option is available and "Allow Full Bypass in Auto" is On), otherwise choose Preselector Bypass
Monitor Spectrum	Always Standard Path
IQ Waveform	Use Standard Path unless tuned frequency > 3.6 GHz and IFBW > 15 MHz, in which case choose Full Bypass if conditions warrant(FBP Option is available and "Allow Full Bypass in Auto" is On), otherwise choose Preselector Bypass
Channel Power	Always Standard Path
Occupied BW	Always Standard Path
CCDF	Use Standard Path unless tuned frequency > 3.6 GHz and IFBW > 15 MHz, in which case choose Preselector Bypass
ACP	Always Standard Path
SEM	Always Standard Path
Spurious	Always Standard Path

3 VMA Mode
3.3 Monitor Spectrum Measurement

Measurement	μ W Path Control Auto behavior
Emissions	
Transmit On Off Power	Use Standard Path unless tuned frequency > 3.6 GHz and Info BW > 15 MHz, in which case choose Preselector Bypass
Channel Quality Mode	
Measurement	μ W Path Control Auto behavior
Group Delay	Use Standard Path unless tuned frequency > 3.6 GHz and IFBW > 15 MHz, in which case choose Full Bypass if conditions warrant(FBP Option is available and "Allow Full Bypass in Auto" is On), otherwise choose Preselector Bypass
Monitor Spectrum	Always Standard Path
IQ Waveform	Use Standard Path unless tuned frequency > 3.6 GHz and IFBW > 15 MHz, in which case choose Preselector Bypass
CCDF	Use Standard Path unless tuned frequency > 3.6 GHz and IFBW > 15 MHz, in which case choose Preselector Bypass

Remote Command	<code>[:SENSe]:POWer[:RF]:MW:PATH:AUTO ON OFF 1 0</code> <code>[:SENSe]:POWer[:RF]:MW:PATH:AUTO?</code>
Example	<code>:POW:MW:PATH:AUTO ON</code> <code>:POW:MW:PATH:AUTO?</code>
Dependencies	Only appears in VMA, WLAN, 5G NR and CQM Modes
Couplings	See " μW Path Control Auto " on page 593 above
Preset	ON
Range	ON OFF

Low Noise Path Enable

Low Noise Path Enable provides a lower noise floor under some circumstances, particularly when operating in the 21–26.5 GHz region. With the Low Noise Path enabled, the low band/high band switch and microwave preamp are bypassed whenever *all* the following are true:

- The instrument is not in the Low Band, meaning:
- the start frequency is above 3.5 GHz and
- the stop frequency is above 3.6 GHz
- The internal preamp is not installed, or if installed, is set to **Off** or **Low Band**

Note that this means that, when any part of a sweep is done in Low Band, the Low Noise Path is not used, whether or not the **Low Noise Path Enable** is selected in the user interface. Also, if the preamp is turned on, the Low Noise Path is not used,

whether or not the **Low Noise Path Enable** is selected in the user interface. The only time the Low Noise Path is used is when **Low Noise Path Enable** is selected, the sweep is completely in High Band (> 3.6 GHz) and no preamp is in use.

For measurements that use IQ acquisition, the low noise path is used when **Center Frequency** is in High Band (> 3.6 GHz) and no preamp is in use. In other words, the rules above are modified to use only the center frequency to qualify which path to switch in. This is not the case for FFTs in the Swept SA measurement; they use the same rules as swept measurements.

Note that the Low Noise Path, while giving improved DANL, has the disadvantage of decreased TOI performance and decreased gain compression performance relative to the standard path.

Note also that the bypass switch is a mechanical switch and has finite life, so if the **Low Noise Path Enable** is selected, it is possible to cause frequent cycling of this switch by frequently changing instrument settings such that the above conditions hold true only some of the time. A user making tests of this nature should consider opting for the **Standard Path**, which will never throw the bypass switch, at the expense of some degraded noise performance.

The low noise path is useful for situations where the signal level is so low that the instrument performance is dominated by noise even with 0 dB attenuation, but still high enough that the preamp option would have excessive third-order intermodulation or compression. The preamp, if purchased and used, gives better noise floor than does the “Low Noise Path.” However, its compression threshold and third-order intercept are much poorer than that of the non-preamp path.

There are some applications, typically for signals around –30 dBm, for which the third-order dynamic range of the standard path is good enough, but the noise floor is not low enough even with 0 dB input attenuation. When the third-order dynamic range of the preamp path is too little and the noise floor of the standard path is too high, the Low Noise Path can provide the best dynamic range

The graph below illustrates the concept. It shows, in red, the performance of an instrument at different attenuation settings, both with the preamp on and off, in a measurement that is affected by both instrument noise and instrument TOI. The green shows the best available dynamic range, offset by 0.5 dB for clarity. The blue shows how the best available dynamic range improves for moderate signal levels with the low noise path switched in. In this illustration, the preamp improves the noise floor by 15 dB while degrading the third-order intercept by 30 dB, and the low noise path reduces loss by 8 dB. The attenuator step size is 2 dB.

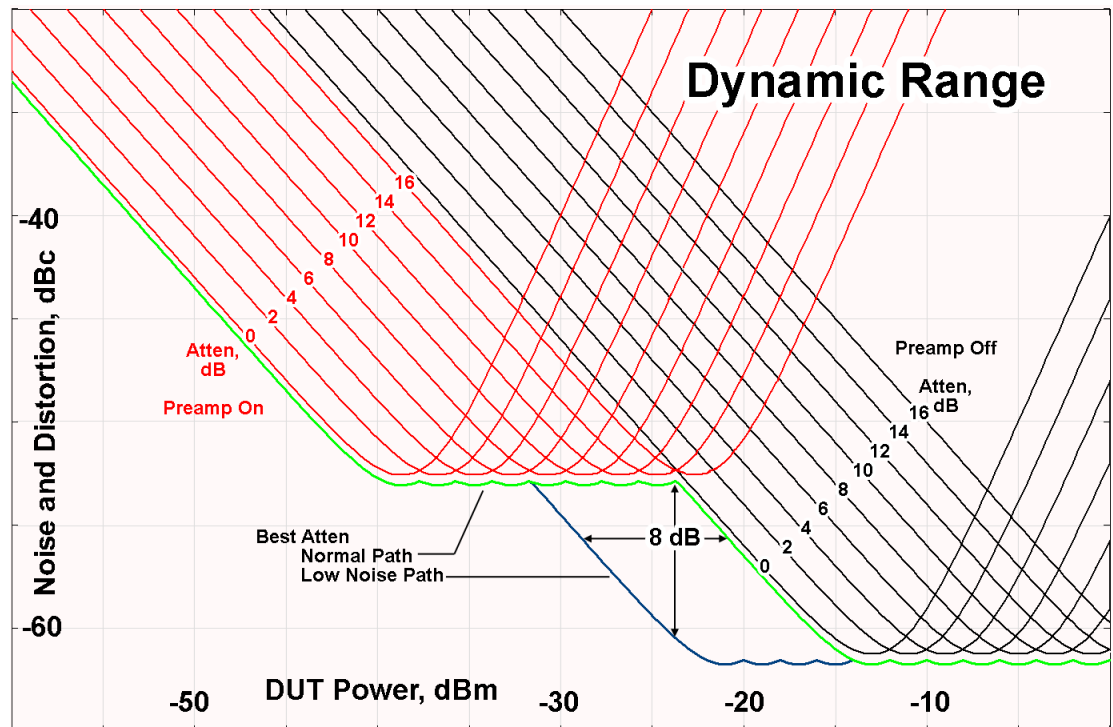

There are other times where selecting the low noise path improves performance, too. Compression-limited measurements such as finding the nulls in a pulsed-RF spectrum can profit from the low noise path in a way similar to the TOI-limited measurement illustrated. Accuracy can be improved when the low noise path allows the optimum attenuation to increase from a small amount like 0, 2 or 4 dB to a larger amount, giving better return loss at the instrument input. Harmonic measurements, such as second and third harmonic levels, are much improved using the low noise path because of the superiority of that path for harmonic (though not intermodulation) distortion performance.

μW Preselector Bypass

Toggles the preselector bypass switch for band 1 and higher. When the microwave preselector is on, the signal path is preselected. When the microwave preselector is off, the signal path is not preselected. The preselected path is the normal path for the instrument.

The preselector is a tunable bandpass filter which prevents signals away from the frequency of interest from combining in the mixer to generate in-band spurious signals (images). The consequences of using a preselector filter are its limited bandwidth, the amplitude and phase ripple in its passband, and any amplitude and phase instability due to center frequency drift.

Option MPB or pre-selector bypass provides an unpreselected input mixer path for certain X-Series signal analyzers with frequency ranges above 3.6 GHz. This signal path allows a wider bandwidth and less amplitude variability, which is an advantage when doing modulation analysis and broadband signal analysis. The disadvantage is that, without the preselector, image signals will be displayed. Another disadvantage of bypassing the preselector is increased LO emission levels at the front panel input port.

Image responses are separated from the real signal by twice the 1st IF. For IF Paths of 10 MHz and 25 MHz, the 1st IF is 322.5 MHz, so the image response and the real signal will be separated by 645 MHz. The 1st IF will be different for other IF Path settings. When viewing a real signal and its corresponding image response in internal mixing, the image response will be to the left of the real signal.

Also, the image response and the real signal typically have the same amplitude and exhibit the same shape factor.

However, if Option FS1 (Fast Sweep Capability) is enabled, the image response in the Swept SA measurement appears lower in amplitude and has a much wider shape factor compared to the real signal.

Full Bypass Enable

With **Full Bypass Enable** selected, the microwave preselector is bypassed. In addition, the low band/high band switch and microwave preamp are bypassed whenever *all* the following are true:

- The instrument is not in the Low Band, meaning:
- the start frequency is above 3.5 GHz and
- the stop frequency is above 3.6 GHz.
- the internal preamp is not installed or if installed, is set to **Off** or **Low Band**

Note that this means that, when any part of a sweep is done in Low Band, the Low Noise Path is not used, whether or not the **Full Bypass Enable** is selected in the user interface. Also, if the preamp is turned on, the Low Noise Path is not used, whether or not the **Full Bypass Enable** is selected in the user interface. The only time the Low Noise Path is used is when **Full Bypass Enable** is selected, the sweep is completely in High Band (> 3.6 GHz) and no preamp is in use.

CAUTION

When **Full Bypass Enable** is selected, and **"Y Scale" on page 1760** is set to 0 dB, there will be a direct AC connection between the input and the first converter when the Low Noise Path switches in (when Start Freq >3.6 GHz and the Preamp is either not licensed, set to Low Band, or Off). This puts the first converter at considerable risk to be damaged by high AC power. Consequently,

whenever **Full Bypass Enable** is selected, a warning message appears in the status bar:

“Full Bypass Enabled, maximum safe input power reduced”

Microwave Preselector Bypass Backwards Compatibility

Example	Bypass the microwave preselector: <code>:POW:MW:PRES OFF</code>
Notes	Included for Microwave Preselector Bypass backwards compatibility The ON parameter sets the STD path (<code>:POW:MW:PATH STD</code>) The OFF parameter sets path MPB (<code>:POW:MW:PATH MPB</code>)
Preset	ON
Backwards Compatibility SCPI	<code>[:SENSe]:POWer[:RF]:MW:PRESelector[:STATe] ON OFF 0 1</code> <code>[:SENSe]:POWer[:RF]:MW:PRESelector[:STATe]?</code>

Frequency Extender Preselection Bypass

Only applies to the high frequency path of the Frequency Extender, and only if the Frequency Extender allows it. For example, the V3050A high frequency path is 50 – 110 GHz and *does* allow control of the preselector bypass.

When the Frequency Extender’s preselection is bypassed, flatness is improved, but will be subject to spurs from out-of-band interfering signals. For bandwidths greater than 2.5 [GHz], it is recommended that the signal bypass the Frequency Extender Preselector since the max bandwidth of the Preselector can be as narrow as 2.5 [GHz].

For most applications, the preset state is **OFF**, which gives the best remote-control throughput, minimizes acoustic noise from switching, minimizes out of band spurs, and minimizes the risk of wear in the hardware switches.

Preselector and Bandwidth Conflict

When the Frequency Extender Preselector is applied and the signal bandwidth is greater than 2.5 [GHz], then a settings alert message will show to warn the user that the signal may be distorted due to the limitation of the Frequency Extender Preselector bandwidth.

An example of the settings alert message is shown below.

Settings Alert message in the Status Bar at the bottom of the display.



Settings Alert message in the error queue

Type	ID	
	159	Settings Alert - DETECTED;Presel/Meas BW conflict

Allow Full Bypass in Auto

Enable or disable Full Bypass in μ W Path Auto rule. See " [\$\mu\$ W Path Control](#)" on page 1791.

When this function is **ON**, and " [\$\mu\$ W Path Control](#)" on page 1791 is in **AUTO**, it is possible for the auto rules to select the **FULL** Bypass state, which bypasses both the Preamp and the Microwave Preselector. Otherwise, the auto rules never select the **FULL** Bypass state. This is convenient when making wideband measurements, but it also adds some risk of damage to the first converter.

CAUTION

When **Full Bypass Enable** is selected, and "[Y Scale](#)" on page 1760 is set to 0 dB, there will be a direct AC connection between the input and the first converter when the Low Noise Path switches in (when Start Freq > 3.6 GHz and the Preamp is either not licensed, set to **Low Band** or **Off**). This puts the first converter at considerable risk to be damaged by high AC power. Consequently, whenever **Full Bypass Enable** is selected, a warning message appears in the status bar:

"Full Bypass Enabled, maximum safe input power reduced"

Remote Command `[:SENSe] :POWer [:RF] :MW :PATH :AUTO :FULL ON | OFF | 1 | 0`
`[:SENSe] :POWer [:RF] :MW :PATH :AUTO :FULL ?`

Example `:POW :MW :PATH :AUTO :FULL ON`
`:POW :MW :PATH :AUTO :FULL ?`

Dependencies Only appears if Option FBP is installed, and in the following measurements

- 5GNRMode: Modulation Analysis and IQ Waveform
- WLAN Mode: IQ Waveform
- Channel Quality Mode: Group Delay and Noise Power Ratio

Preset **OFF**

State Saved Saved in instrument state

Software Preselection

Provided in some instruments, either to compensate for issues with provided hardware preselection or to provide the preselection function when there is no hardware preselector.

N9041B

Software Preselection compensates for the frequency range limit of the microwave preselector. Since the microwave preselector only goes up to 50 GHz, software preselection must be used to suppress and separate images above 50 GHz. The specific algorithm used for software preselection is specified by the SW Preselection Type selection – Normal or Advanced.

In N9041B, **Software Preselection** only applies for frequencies above 50 GHz, therefore it is only used for RF Input 2. Even if turned on, it is not used for other inputs, and never for frequencies below 50 GHz. This is why the label of this control contains the parenthetical note “(>~50 GHz)”.

Note that in N9041B, in Swept SA measurement, **Software Preselection** works even if the measurement is using an FFT Sweep Type. In measurements other than Swept SA, Software Preselection is not used if the measurement is using an FFT sweep type.

N9042B+V3050A

Software Preselection compensates for the frequency range limit of the microwave preselector. Since the microwave preselector only goes up to 50 GHz, software preselection must be used to suppress and separate images above 50 GHz. The specific algorithm used for software preselection is specified by the SW Preselection Type selection – Normal or Advanced.

For N9042B+V3050A, Software Preselection only applies for frequencies above 50 GHz, therefore it is only used for External RF. Even if it is turned on, it will not be used for other inputs and never for frequencies below 50 GHz. This is why the label of this control contains the parenthetical note “(>~50 GHz)”.

Note that for N9042B+V3050A, in the Swept SA measurement, Software Preselection works even if the measurement is using an FFT Sweep Type. In measurements other than Swept SA, Software Preselection is not used if the measurement is using an FFT Sweep Type.

VXT models M9410A/11A/15A/16A

Software Preselection is used to provide the preselection function, as there is no hardware preselector in these models. Two background traces are taken and compared point by point, and the point with the lowest amplitude from the two

traces is used. This provides a method to reduce spurs that are internally generated within the VXT, but you should note the following when using Software Preselection:

- There is some speed cost due to the need to take multiple captures
- Taking the point with the lowest amplitude in each trace will make the average noise level lower at all points that do not have a spur. This can reduce the accuracy of the measurement of noise and noise-like signals

Because of the difficulty in identifying spurs manually, you are recommended to leave Software Preselection **ON** at all times in VXT models M9410A/11A. If you turn it off in order to speed up your measurement or improve noise accuracy, be aware of unwanted onscreen spurs.

Remote Command	<code>[:SENSe]:POWer[:RF]:SWPrese1:STATe 0 1 ON OFF</code> <code>[:SENSe]:POWer[:RF]:SWPrese1:STAT?</code>
Example	<code>:POW:SWPR:STAT 1</code> <code>:POW:SWPR:STAT?</code>
Dependencies	Only appears in N9041B, N9042B+V2050A, VXT models M9410A/11A and M9410E/11E. Does not appear in all measurements
Couplings	Affects Sweep Time Auto Tune supports Software Preselection , so Auto Tune should be performed after setting the Software Preselection state
Preset	N9041B OFF N9042B+V3050A ON M9410A/11A ON
State Saved	Saved in instrument state

SW Preselection Type

Specifies the algorithm used for software preselection.

Two hidden sweeps occur in succession. The second sweep is offset in LO frequency by $2 * IF / N$. For each point in each trace, the smaller amplitude from the two traces is taken and placed in that point in the selected trace. The Peak detector is auto-selected to improve the image suppression effectiveness. Responses of each trace that lie on top of one another will remain and are valid signals. Other signals are images, which are suppressed. The action of taking the smaller of the two traces will make the average noise level lower in all points that do not have an image, thus reducing the accuracy of the measurement of noise and noise-like signals.

3 VMA Mode
 3.3 Monitor Spectrum Measurement

- **NORMa1** - mathematically removes all image and multiple responses of signals present at the input
- **ADVanced** - any trace processing (such as “max hold” or trace averaging) is performed on the points of both candidate traces before the “select minimum” operation occurs. This form of processing works better for non-stationary signals, such as pulsed-RF signals

Remote Command	<code>[:SENSe]:POWer[:RF]:SWPreSel NORMa1 ADVanced</code> <code>[:SENSe]:POWer[:RF]:SWPreSel?</code>
Example	<code>:POW:SWPR NORM</code> <code>:POW:SWPR?</code>
Dependencies	Only appears in N9041B and N9042B+V3050A. Only appears in measurements that use the Swept method Grayed-out when "Software Preselection" on page 1801 is OFF. The grayout message is “Unavailable unless SW Presel enabled”
Preset	N9041B ADVanced N9042B+V3050A NORMa1
State Saved	Saved in instrument state

SW Preselection BW

Specifies the effective bandwidth to be used for Software Preselection.

The options are:

- **NORMa1** – when making Swept measurements, a software preselection algorithm is used which takes up to 4 background acquisitions, then post-processes the result. This algorithm can remove images from signals with an occupied bandwidth up to around 3 GHz. (Default/Preset setting). When making FFT measurements, this algorithm is not used, instead the same algorithm is used as for **NARRow** (below)
- **NARRow**– a software preselection algorithm is used which takes two background acquisitions, then post-processes the result to detect and remove images from wideband signals with occupied bandwidths up to 2 GHz. This increases the risk of images failing to be rejected, but improves the measurement speed

Remote Command	<code>[:SENSe]:POWer[:RF]:SWPreSel:BW NORMa1 NARRow</code> <code>[:SENSe]:POWer[:RF]:SWPreSel:BW?</code>
Example	<code>:POW:SWPR:BW NARR</code>
Dependencies	Only appears in N9041B and N9042B+V3050A. Only appears in measurements that use the Swept

	method	
	Grayed-out when " Software Preselection " on page 1801 is OFF . The grayout message is "Unavailable unless SW Presel enabled"	
	For N9042B+V3050A, the parameter is SCPI-only, and always set to NARRow when Software Preselection is enabled	
Preset	N9041B	NORMa1
	N9042B+V3050A	NARRow
State Saved	Saved in instrument state	

High Freq Prefilter

Lets you set the state of Prefilter for center frequencies above 1310 MHz.

In VXT Models M9410A/11A and M9410E/11E in bypass frequency range (1310MHz~5GHz), the Receiver RF path has a bank of filters that come after the RF Attenuator in the signal path. Since this bank of filters precedes the mixer they are known as the "Prefilter" bank. Their purpose is to eliminate unwanted in-band mixing products by filtering out all but the desired frequencies before the signals get to the mixer. There are 13 prefilter bands to cover the frequencies between 9 kHz and 6000 MHz. The Prefilter provides the necessary rejection of the unwanted signal.

Remote Command	<code>[:SENSe]:<measurement>:PFILter[:STATe] ON OFF 1 0</code> <code>[:SENSe]:<measurement>:PFILter[:STATe]?</code>
Example	Enable High Freq Prefilter for the Complex Spectrum Measurement in BASIC Mode: <code>:SPEC:PFIL ON</code> Enable High Freq Prefilter for the IQ Waveform Measurement, in multiple Modes: <code>:WAV:PFIL ON</code> Enable High Freq Prefilter for the Swept SA Measurement in SA Mode: <code>:SAN:PFIL ON</code>
Dependencies	Only appears in VXT models M9410A/11A with center frequency above 1310 MHz, and M9410E/11E in frequency range 1310MHz~5GHz
Preset	See " Prefilter Presets " on page 604 below
State Saved	Saved in instrument state

Prefilter Presets

Meas	Mode	Preset
SPEC	BASIC	OFF

3 VMA Mode
 3.3 Monitor Spectrum Measurement

Meas	Mode	Preset
WAV	BASIC, WCDMA, WLAN, LTEAFDD, LTEATDD, 5GNR, VMA	OFF
MON	WCDMA, WLAN, LTEAFDD, LTEATDD, 5GNR, VMA	OFF
RHO	WCDMA	OFF
CDP	WCDMA	OFF
PCON	WCDMA	OFF
EVMQ	WCDMA	OFF
CHP	WCDMA, WLAN, LTEAFDD, LTEATDD, 5GNR, VMA, SA	OFF
OBW	WCDMA, WLAN, LTEAFDD, LTEATDD, 5GNR, VMA, SA	OFF
ACP	WCDMA, LTEAFDD, LTEATDD, 5GNR, VMA, SA	OFF
SEM	WCDMA, WLAN, LTEAFDD, LTEATDD, 5GNR, VMA, SA	OFF
PST	WCDMA, WLAN, LTEAFDD, LTEATDD, 5GNR, VMA, SA	OFF
PVT	WLAN, LTEAFDD, LTEATDD, 5GNR	OFF
EVM	WLAN, LTEAFDD, LTEATDD, 5GNR	OFF
FLAT	WLAN	OFF
EVMM	WLAN	OFF
CEVM	LTEAFDD, LTEATDD	OFF
PAVT	5GNR, VMA	OFF
DDEM	VMA	OFF
OFDM	VMA	OFF
SAN	SA	ON
HARM	SA	ON

3.3.4 BW

Opens the Bandwidth (**BW**) menu, which contains controls for the Resolution Bandwidth and Video Bandwidth functions of the instrument.

3.3.4.1 Settings

Contains the basic bandwidth functions. It is the only tab under **BW**.

Res BW

Activates the resolution bandwidth active function, which allows you to manually set the Resolution Bandwidth (RBW) of the instrument.

Normally, **Res BW** (Auto) selects automatic coupling of the Res BW to Span using the ratio set by the Span:3 dB RBW control (some measurements do not have a Span:3 dB RBW control, in which case the measurement chooses the optimal ratio).

To decouple the resolution bandwidth, press the **Auto/Man** toggle on the **Res BW** control, or simply enter a different value for **Res BW**.

When the **Res BW** is manually selected, it may be returned to the coupled state by pressing the **Auto/Man** toggle on the **Res BW** control. This may also be done by pressing Auto Couple or by performing a **Preset**.

Only certain discrete resolution bandwidths are available. The available bandwidths are dependent on the **EMC Standard**. If an unavailable bandwidth is entered with the numeric keypad, the closest available bandwidth is selected.

See "[RBW Presets](#)" on page 607

Remote Command	<pre>[:SENSe]:MONitor:BANDwidth[:RESolution] <bandwidth> [:SENSe]:MONitor:BANDwidth[:RESolution]? [:SENSe]:MONitor:BANDwidth[:RESolution]:AUTO ON OFF 1 0 [:SENSe]:MONitor:BANDwidth[:RESolution]:AUTO?</pre>
Example	<pre>:MON:BAND 5 MHz :MON:BAND? :MON:BAND:AUTO ON :MON:BAND:AUTO?</pre>
Notes	<p>For numeric entries, all RBW Types choose the nearest (arithmetically, on a linear scale, rounding up) available RBW to the value entered</p> <p>The setting and querying of values depends on the current bandwidth type</p>
Couplings	<p>Sweep time is coupled to the RBW. As the RBW changes, the sweep time (if set to Auto) is changed to maintain amplitude calibration</p> <p>Video bandwidth (VBW) is coupled to the RBW. As the resolution bandwidth changes, the video bandwidth (if set to Auto) changes to maintain the ratio of VBW/RBW (10:1)</p> <p>When the Res BW is set to Auto, the resolution bandwidth is auto-coupled to the span. The ratio of Span/RBW is approximately 106:1 when auto coupled. When Res BW is set to Man, and the bandwidths are entered manually, these bandwidths are used regardless of other instrument settings</p>
Preset	<p>Auto (unless noted in the table below)</p> <p>See "RBW Presets" on page 607 below</p>
State Saved	Saved in instrument state
Min	1 Hz
Max	8 MHz is the max equivalent -3 dB RBW, which means that the named RBW (the one shown on the control etc.) can actually exceed 8 MHz if using a filter other than -3 dB Gaussian
Annotation	A “#” mark appears before “RBW” in the annotation when it is switched from Auto to Manual coupling
Backwards Compatibility Notes	<p>For backwards compatibility this command obeys both the BANDwidth and BWIDth forms</p> <p>For ESA, the maximum Res BW was 5 MHz; on X-Series it is 8 MHz</p>

RBW Presets

Unless noted in the table below, the Preset value of RBW is **Auto**.

Mode	Preset RBW
WLAN	100 kHz
LTE, LTETDD, LTEAFDD, LTEATDD	100 kHz
5GNR	100 kHz

Video BW

Lets you change the instrument post-detection filter (VBW or “video bandwidth”) from 1 Hz to 8 MHz in approximately 10% steps. In addition, a wide-open video filter bandwidth may be chosen by selecting 50 MHz. The VBW is annotated at the bottom of the display, in the center.

Normally, **Video BW (Auto)** selects automatic coupling of the Video BW to RBW using the ratio set by the VBW:3 dB RBW control. To decouple the resolution bandwidth, press the **Auto/Man** toggle on the **Video BW** control, or simply enter a different value for **Video BW**.

When the **Video BW** is manually selected, it may be returned to the coupled state by pressing the **Auto/Man** toggle on the **Video BW** control. This may also be done by pressing Auto Couple or by performing a **Preset**.

Remote Command	<pre>[:SENSe]:MONitor:BANDwidth:VIDeo <bandwidth> [:SENSe]:MONitor:BANDwidth:VIDeo? [:SENSe]:MONitor:BANDwidth:VIDeo:AUTO ON OFF 1 0 [:SENSe]:MONitor:BANDwidth:VIDeo:AUTO?</pre>
Example	<pre>:MON:BAND:VID 2.4 MHz :MON:BAND:VID? :MON:BAND:VID:AUTO ON :MON:BAND:VID:AUTO?</pre>
Notes	<p>For numeric entries, the instrument chooses the nearest (arithmetically, on a linear scale, rounding up) available VBW to the value entered. The 50 MHz VBW is defined to mean “wide open”</p> <p>The values shown in this table reflect the conditions after a Mode Preset</p>
Dependencies	<p>Sometimes the displayed Video BW is not actually used to process the trace data:</p> <ul style="list-style-type: none"> – When the Average Detector is selected and Sweep Type is set to Swept, the video bandwidth filter cannot be used, because it uses the same hardware as the Average Detector – When the Quasi-Peak, EMI Average or RMS Average detector is selected the VBW is implemented by the digital IF as part of the detector

	When this is the case, the VBW still acts to change the Sweep Time, if Sweep Time is in Auto, and still affects the data on other traces for which this is not the case
Couplings	Video bandwidth (VBW) is normally coupled to RBW. If VBW is set to Auto, then the VBW is changed as the RBW changes, to maintain the ratio set by the VBW:3 dB RBW control (usually 10:1 for measurements that do not have a VBW:3 dB RBW control)
Preset	Auto (unless noted in table below) ON
State Saved	Saved in instrument state
Min	1 Hz
Max	50 MHz
Annunciation	A “#” mark appears before “VBW” in the annotation when it is not coupled
Annotation	In the bottom center of the screen, “VBW <value> <units>” indicates the current video bandwidth value. Note that for some detectors this is not the value actually used for VBW (see above)
Backwards Compatibility Notes	For backwards compatibility this command obeys both the BANDwidth and BWIDth forms

VBW Presets

Unless noted in the table below, the Preset value of VBW is **Auto**.

Mode	Preset VBW
WLAN	1 MHz
LTE, LTETDD, LTEAFDD, LTEATDD	1 MHz
5GNR	1 MHz

VBW:3dB RBW

Selects the ratio between the video bandwidth and the equivalent 3 dB resolution bandwidth to be used for setting VBW when VBW is in Auto.

VBW:3dB RBW (Auto) selects automatic coupling of the VBW:3 dB RBW ratio to Detector using the rules described below in "[Coupling Auto Rules](#)" on page 609. To decouple the ratio, press the **Auto/Man** toggle on the VBW:3 dB RBW control, or simply enter a different value for VBW:3 dB RBW.

When the VBW:3dB RBW is manually selected, it may be returned to the coupled state by setting the toggle on the VBW:3 dB RBW control back to **Auto**. This may also be done by pressing Auto Couple or by performing a **Preset**.

Remote Command	<code>[:SENSe]:MONitor: BANDwidth: VIDEo: RATio <real></code> <code>[:SENSe]:MONitor: BANDwidth: VIDEo: RATio?</code>
----------------	--

3 VMA Mode
3.3 Monitor Spectrum Measurement

	<code>[:SENSe] :MONitor :BANDwidth :VIDeo :RATio :AUTO OFF ON 0 1</code>
	<code>[:SENSe] :MONitor :BANDwidth :VIDeo :RATio :AUTO?</code>
Example	<code>:MON :BAND :VID :RAT 2</code> <code>:MON :BAND :VID :RAT?</code> <code>:MON :BAND :VID :RAT :AUTO 0</code> <code>:MON :BAND :VID :RAT :AUTO?</code>
Notes	The values shown in this table reflect the conditions after a Mode Preset
Couplings	See "Coupling Auto Rules" on page 609
Preset	1 ON
State Saved	Saved in instrument state
Min	0.00001
Max	3000000
Backwards Compatibility Notes	For backwards compatibility this command accepts both the <code>BANDwidth</code> and <code>BWIDth</code> forms

Coupling Auto Rules

The Auto Rules for the **VBW:3dB RBW** function are as follows.

First, if Source Mode is set to "Tracking": Use 1.0

Otherwise, we go through the following list of detector numbers and find the lowest numbered detector being used on any active traces (traces for which Update is On):

1. Peak
2. Normal
3. Average
4. Sample
5. Negative Peak
6. EMI Average
7. Quasi Peak
8. RMS Average

Use that detector to pick the ratio based on the following criteria:

1. If the measurement supports EMC Standard, and the detector is Peak and the EMC Standard is set to either CISPR or MIL, use 10.0 (we use wide VBWs to capture peak levels accurately).
2. Otherwise, if the detector is **Negative Peak**, use 1.0 (in the Negative Peak case, there are no known significant use models so we use a medium ratio).
3. Otherwise, if the detector is **Normal**, use 1.0.
4. Otherwise, if the detector is **Average**, and the span is nonzero, use 0.1. The use of a small ratio in Average detection is desirable because of its effect on the sweep time equations. The VBW filter is not actually in-circuit when the average detector is on. If the detector is Average, and the span is zero, use 10.0, which gives optimal behavior for Interval Markers in zero span. Note that only the Swept SA measurement supports Zero Span.
5. Otherwise, if the detector is EMI Average, Quasi Peak or RMS Average, use 10.0. In fact, this is a “don’t care” since no VBW is used for these detectors, as noted under “Dependencies” for the VBW control
6. Otherwise, the detector is simply **Peak** or **Sample**. These two detectors can use the same rules. In these cases, if any active trace is in max hold or min hold, use 10.0, because Max and Min Hold operations will usually be intended to capture peaks and pits without smoothing from the VBW filter; otherwise, use 1.0 as a compromise, because you have not set the instrument in a way that implies that you are measuring noise, pulsed-RF or CW signals, and for backward compatibility with earlier instruments.

Note that because the above couplings depend on which traces are active, they are re-examined whenever any trace goes active or inactive, except when this leaves no traces active. Transitioning to the state where no traces are active should not affect the couplings; in that way, the annotation will always reflect the state of the last trace which was active.

Note also that some detectors are not available in some measurements, but because of the way the above rules that does not change the logic of the rules.

Span:3dB RBW

Selects the ratio between span and resolution bandwidth.

Normally, Span:3dB RBW (Auto) selects a Span:3 dB RBW ratio of 106:1. If you manually enter the ratio, the toggle on the Span:3dB RBW control will change to **Man**. This enables you to manually select ratios more suitable for certain measurements.

3 VMA Mode
3.3 Monitor Spectrum Measurement

When the Span:3dB RBW is manually selected, it may be returned to the coupled state by setting the toggle on the RBW:3 dB RBW control back to **Auto**. This may also be done by pressing Auto Couple or by performing a **Preset**.

Remote Command	<pre>[:SENSe]:MONitor:FREQuency:SPAN:BANDwidth[:RESolution]:RATio <integer> [:SENSe]:MONitor:FREQuency:SPAN:BANDwidth[:RESolution]:RATio? [:SENSe]:MONitor:FREQuency:SPAN:BANDwidth[:RESolution]:RATio:AUTO OFF ON 0 1 [:SENSe]:MONitor:FREQuency:SPAN:BANDwidth[:RESolution]:RATio:AUTO?</pre>
Example	<pre>:MON:FREQ:SPAN:BAND:RAT 200 :MON:FREQ:SPAN:BAND:RAT? :MON:FREQ:SPAN:BAND:RAT:AUTO ON :MON:FREQ:SPAN:BAND:RAT:AUTO?</pre>
Notes	The values shown in this table reflect the conditions after a Mode Preset
Preset	106 ON
State Saved	Saved in instrument state
Min	2
Max	10000
Backwards Compatibility SCPI	<pre>[:SENSe]:MONitor:FREQuency:SPAN:BWIDth[:RESolution]:RATio</pre>

3.3.5 Display

Opens the **Display** menu, which lets you configure display items for the current Mode, Measurement View or Window.

3.3.5.1 Meas Display

Contains controls for setting up the display for the current Measurement, View or Window.

3.3.5.2 View

Contains controls for selecting the current **View**, and for editing User Views.

View

See "[Views](#)" on page 561

User View

Lets you choose a View from the saved User Views for the current measurement. This panel only appears if a User View exists for the current measurement.

Remote Command	<code>:DISPlay:VIEW:ADVanced:SElect <alphanumeric></code> <code>:DISPlay:VIEW:ADVanced:SElect?</code>
Example	Select Baseband as the current View <code>:DISP:VIEW:ADV:SEL "Baseband"</code>
Notes	<p>You must be in the measurement whose View you are trying to set to send the command. You can only set Views for the current measurement using this command</p> <p>For predefined views, the parameter is derived from the view name that is shown in the View list in the user interface. For example, if you are trying to select the Trace Zoom view in the Swept SA measurement, you send:</p> <pre>:DISP:VIEW:ADV:SEL "Trace Zoom"</pre> <p>because "Trace Zoom" is the name of the View as seen in the Mode/Meas dialog or in the Display, View menu</p> <p>You <i>cannot</i> use the legacy View parameter (which in this case would be <code>TZOOM</code>) with</p> <pre>:DISP:VIEW:ADV:SEL</pre> <p><code><alphanumeric></code> is case insensitive; you can specify mixed case, however the name will be evaluated on a single case. Thus, both of the following forms work:</p> <pre>:DISP:VIEW:ADV:SEL "Trace Zoom"</pre> <pre>:DISP:VIEW:ADV:SEL "TRACE ZOOM"</pre> <p>If the specified view is not a valid View, the query returns the error message "-224, Illegal parameter value; View with the name <alphanumeric> does not exist"</p> <p>If the display is disabled (via <code>:DISP:ENAB OFF</code>) then the error message "-221, Settings conflict; View SCPI cannot be used while Display is disabled" is generated</p>
Backwards Compatibility SCPI	<p>The legacy node</p> <pre>:DISPlay:VIEW[:SElect]</pre> <p>is retained for backwards compatibility, but it only supports predefined views</p>

Restore Layout to Default

Restores the Layout to the default for Basic.

Modified Views are very temporary; if you exit the current measurement they are discarded, and they are not saved in State. To retain this View for later use, and to be able to return easily to your original Basic View, you can save your edited View as a "User View".

Save Layout as New View

Saves your new View as a User View. An alpha keyboard appears, which lets you name your new View; the default is the old View name plus a number.

Remote Command	<code>:DISPlay:VIEW:ADVanced:NAME <alphanumeric></code>
Example	<code>:DISP:VIEW:ADV:NAME "Baseband"</code> Creates a new View named Baseband from the current View, and selects it as the current View
Notes	<code><alphanumeric></code> is case insensitive; you can specify mixed case, however the name will be evaluated on a single case If <code><alphanumeric></code> name already exists as a View, the error message "-224, Illegal parameter value; View <alphanumeric> already exists" is generated If the display is disabled (via <code>:DISP:ENAB OFF</code>) then the error message "-221, Settings conflict; User View SCPI cannot be used while Display is disabled" is generated

Re-Save User View

You can re-edit a User View; if you make changes, then an asterisk will appear next to the User View's name. You can then tap **Re-Save User View** to save it back to its existing name, or **Save Layout as New View** to add another, new User View.

This is a front panel function only, there is no remote command available to perform this function. To do this remotely, you must first perform **Save Layout as New View**, then delete the old User View and rename the new one with the name of the View you just deleted.

Rename User View

You can rename the current View by giving it a new unique name. Only User Views can be renamed, if the current View is a Predefined View, an error occurs.

Remote Command	<code>:DISPlay:VIEW:ADVanced:REName <alphanumeric></code>
Example	<code>:DISP:VIEW:ADV:REN "Baseband"</code>
Notes	<code><alphanumeric></code> is case insensitive; you can specify mixed case, however the name will be evaluated on a single case If the <code><alphanumeric></code> specifying the new name is already present in the list of View names, the error message "-224, Illegal parameter value; View <alphanumeric> already exists" is generated If the current View is a Predefined View, the error message "-224, Illegal parameter value; Cannot rename a Predefined View" is generated If the display is disabled (via <code>:DISP:ENAB OFF</code>) then the error message "-221, Settings conflict; View SCPI cannot be used while Display is disabled" is generated

Delete User View

You can delete the current View if it is a User View. The default view becomes the current view for the Measurement.

Remote Command	<code>:DISPlay:VIEW:ADVanced:DElete</code>
Example	<code>:DISP:VIEW:ADV:DEL</code>
Notes	<p><code><alphanumeric></code> is case insensitive; you can specify mixed case, however the name will be evaluated on a single case</p> <p>If the <code><alphanumeric></code> is not present in the list of View names, the error message “-224, Illegal parameter value; View <alphanumeric> does not exist” is generated</p> <p>If the current View is a Predefined View, the error message “-224, Illegal parameter value; Cannot delete a Predefined View” is generated</p> <p>If the display is disabled (via <code>:DISP:ENAB OFF</code>) then the error message “-221, Settings conflict; View SCPI cannot be used while Display is disabled” is generated</p>

Delete All User Views

Deletes all previously saved User Views. The default view becomes the current view for the Measurement if a User View was the current view when this command was executed.

Remote Command	<code>:DISPlay:VIEW:ADVanced:DElete:ALL</code>
Example	<code>:DISP:VIEW:ADV:DEL:ALL</code>
Notes	Disabled if there are no User Views

View Editor Remote Commands

The following remote commands help you manage Views and User Views. Note that the SCPI node for User Views handles both Predefined and User Views. The legacy nodes, `:DISPlay:VIEW[:SElect]` and `:DISPlay:VIEW:NSEL`, are retained for backwards compatibility, but they only support predefined views.

View Listing Query

Returns a string containing a comma-separated list of names for *all* the Views, including User Views, available for the current Measurement.

Remote Command	<code>:DISPlay:VIEW:ADVanced:CATalog?</code>
----------------	--

3 VMA Mode
3.3 Monitor Spectrum Measurement

Example	<code>:DISP:VIEW:ADV:CAT?</code>
Notes	Returns a quoted string of the available Views for the current measurement, separated by commas. The list includes names for <i>all</i> the Views, including User Views, available for the current Measurement Example: <code>"Normal,Trace Zoom,Spectrogram,Baseband,myView1,yourView1"</code> No distinction is made between Predefined and User Views If you switch measurements with the display disabled (via <code>:DISP:ENAB OFF</code>), then query the list of available Views, the result is undefined

User View Listing Query

Returns a string containing a comma-separated list of names for *only* the User Views available for the current Measurement.

Remote Command	<code>:DISPlay:VIEW:ADVanced:USER:CATalog?</code>
Example	<code>:DISP:VIEW:ADV:USER:CAT?</code>
Notes	Returns a quoted string of the available User Views for the current measurement, separated by commas. Example: <code>"Baseband,myView1,yourView1"</code> If you switch measurements with the display disabled (see "Display Enable (Remote Command Only)" on page 1812), then query the list of available Views, the result is undefined

3.3.5.3 Annotation

Contains controls for setting up the annotation for the current Mode or Measurement.

Graticule

Turns the display graticule On or Off for all windows with graticules in all measurements in the current Mode. Also turns the graticule Y-Axis annotation on and off.

Remote Command	<code>:DISPlay:GRATICule[:STATe] OFF ON 0 1</code> <code>:DISPlay:GRATICule[:STATe]?</code>
Example	<code>:DISP:GRAT OFF</code>
Notes	The graticule is the set of horizontal and vertical lines that make up the grid/divisions for the X-Axis and Y-Axis

Preset	ON
State Saved	Saved in instrument state
Backwards Compatibility SCPI	:DISPlay:WINDow[1]:TRACe:GRATicule:GRID[:STATe] OFF ON 0 1 :DISPlay:WINDow[1]:TRACe:GRATicule:GRID[:STATe]? This command is accepted for backwards compatibility with older instruments, but the WINDow , TRACe and GRID parameters are ignored

Screen Annotation

Controls the display of the annunciation and annotation around the graticule, including any annotation on lines (such as the display line, the threshold line, etc.) and the Y-Axis annotation, for all windows with screen annotation in all measurements in the current Mode.

This does *not* include marker annotation (or the N dB result). When **OFF**, the graticule expands to fill the entire graticule area, leaving only the 1.5% gap above the graticule, as described in the **Trace** section.

Remote Command	:DISPlay:ANNotation:SCReem[:STATe] OFF ON 0 1 :DISPlay:ANNotation:SCReem[:STATe]?
Example	:DISP:ANN:SCR OFF
Dependencies	Grayed-out and forced to OFF when System Display Settings, Annotation is OFF
Preset	ON This remains OFF through a Preset when System Display Settings, Annotation is set to OFF
State Saved	Saved in instrument state

Trace Annotation

Turns on and off the labels on the traces, showing their detector (or their Math Mode) as described in the **Trace** section, for all windows in all measurements in the current Mode for which Trace Annotation on/off is supported.

If Trace Math is being performed on a trace, then the Trace Math annotation replaces the detector annotation.

For measurements that support limit lines, this key also turns on and off the labels on the Limit Lines. The label is the Limit number annotation and Limit Comment displayed on the graph. If the length of the comment is greater than 20 characters, the first 8 characters and the last 8 characters are displayed, joined with

Remote Command	:DISPlay:ANNotation:TRACe[:STATe] ON OFF 1 0 :DISPlay:ANNotation:TRACe[:STATe]?
----------------	--

3 VMA Mode
3.3 Monitor Spectrum Measurement

Example	<code>:DISP:ANN:TRAC OFF</code>
Preset	<code>OFF</code>
State Saved	Saved in instrument state

Control Annotation

Turns on and off the display of values on the Active Function controls for all measurements in the current Mode. This is a security feature.

Remote Command	<code>:DISPlay:ACTivefunc[:STATe] ON OFF 1 0</code> <code>:DISPlay:ACTivefunc[:STATe]?</code>
Example	<code>:DISP:ACT OFF</code>
Dependencies	Grayed out and forced to <code>OFF</code> when System Display Settings, Annotation is <code>OFF</code>
Preset	<code>ON</code> This remains <code>OFF</code> through a Preset when System Display Settings, Annotation is set to <code>OFF</code>
State Saved	Saved in instrument state

Meas Bar

Turns the Measurement Bar at the top of the screen on and off for all measurements in the current Mode. When `OFF`, the graticule area expands to fill the area formerly occupied by the Measurement Bar.

Remote Command	<code>:DISPlay:ANNotation:MBAR[:STATe] OFF ON 0 1</code> <code>:DISPlay:ANNotation:MBAR[:STATe]?</code>
Example	<code>:DISP:ANN:MBAR OFF</code>
Dependencies	Grayed out and forced to <code>OFF</code> when System Display Settings, Annotation is <code>OFF</code>
Preset	<code>ON</code> This remains <code>OFF</code> through a Preset when System Display Settings, Annotation is set to <code>OFF</code>
State Saved	Saved in instrument state

Display Enable (Remote Command Only)

Turns the display on/off, including the display drive circuitry. The backlight stays lit to confirm that the instrument is on. The display enable setting is mode global. There are three reasons for turning the display off:

1. To increase speed as much as possible by freeing the instrument from having to update the display

2. To reduce emissions from the display, drive circuitry
3. For security purposes

If you have turned off the display:

- and you are in local operation, the display can be turned back on by pressing any key or by sending `:SYSTem:DEFaults MISC` or `:DISPlay:ENABle ON` (neither `*RST` nor `:SYSTem:PRESet` enable the display)
- and you are in remote operation, the display can be turned back on by pressing the **Local** or **Esc** keys, or by sending `:SYSTem:DEFaults MISC` or `:DISPlay:ENABle ON` (neither `*RST` nor `:SYSTem:PRESet` enable the display)
- and you are using either the `:SYSTem:KLOCK` command or GPIB local lockout, then *no* front-panel key press will turn the display back on. You must turn it back on remotely.

If the display is **OFF**, many SCPI commands related to User Views and Multiscreen functionality do not work, and return the error messages “-221, Settings conflict; Screen SCPI cannot be used when Display is disabled” or “221, Settings conflict; View SCPI cannot be used while Display is disabled”. These commands include:

Name	Command
Select User View	<code>:DISPlay:VIEW:ADVanced:SElect</code>
Rename User View	<code>:DISPlay:VIEW:ADVanced:REName</code>
Delete User View	<code>:DISPlay:VIEW:ADVanced:DElete</code>
Create User View	<code>:DISPlay:VIEW:ADVanced:NAME</code>
Select Screen	<code>:INSTrument:SCReen:SElect</code>
Delete Screen	<code>:INSTrument:SCReen:DElete</code>
Delete All But This Screen	<code>:INSTrument:SCReen:DElete:ALL</code>
Add Screen	<code>:INSTrument:SCReen:CREate</code>
Rename Screen	<code>:INSTrument:SCReen:REName</code>
Sequencer On/Off	<code>:SYSTem:SEQuencer</code>

Remote Command	<code>:DISPlay:ENABle OFF ON 0 1</code>
Example	<code>:DISP:ENAB OFF</code>
Couplings	<code>:DISP:ENAB OFF</code> turns Backlight OFF and <code>:DISP:ENAB ON</code> turns Backlight ON , but changing Backlight settings does <i>not</i> change the state of <code>:DISP:ENAB</code>
Preset	ON Set by <code>:SYST:DEF MISC</code> , but not affected by <code>*RST</code> or <code>:SYSTem:PRESet</code>

State Saved	Not saved in instrument state
Backwards Compatibility Notes	:SYST:PRES no longer turns on :DISPlay:ENABLe as it did in legacy analyzers

3.3.6 Frequency

Opens the **Frequency** menu, which contains controls that allow you to control the Frequency and Channel parameters of the instrument.

Some features in this menu are the same for all measurements in the current Mode – they do not change as you change measurements. Settings like these are called “Meas Global” and are unaffected by Meas Preset. For example, the Center Freq setting is the same for all measurements - it does not change as you change measurements.

3.3.6.1 Settings

The Settings tab contains the basic Bandwidth functions. In most measurements it is the only tab under Bandwidth.

Center Frequency

Sets the frequency that corresponds to the horizontal center of the graticule. While adjusting the Center Frequency the Span is held constant.

The center frequency setting is the same for all measurements within a mode, that is, it is Meas Global. Some modes are also able to share a Mode Global center frequency value. If this is the case, the Mode will have a **Global** tab in its **Meas Setup** menu.

The **Center Freq** function sets (and queries) the Center Frequency for the currently selected input. If your instrument has multiple inputs, and you select another input, the Center Freq changes to the value for that input. SCPI commands are available to directly set the Center Freq for a specific input.

Center Freq is remembered as you go from input to input. Thus, you can set a Center Freq of 10 GHz with the RF Input selected, change to BBIQ, and set a Center Freq of 20 MHz, then switch to External Mixing and set a Center Freq of 60 GHz, and when you go back to the RF Input the Center Freq will go back to 10 GHz; back to BBIQ and it is 20 MHz; back to External Mixing and it is 60 GHz.

See:

- "Center Frequency Presets" on page 622
- "VXT Models with Radio Heads/CIU Frequency Range" on page 624
- "RF Center Freq" on page 624
- "Ext Mix Center Freq" on page 625
- "I/Q Center Freq" on page 625

Remote Command	<code>[:SENSe]:FREQuency:CENTer <freq></code> <code>[:SENSe]:FREQuency:CENTer?</code>
Example	<code>:FREQ:CENT 50 MHz</code> Sets Center Frequency to 50 MHz <code>:FREQ:CENT UP</code> Increments the Center Frequency by the value of CF Step <code>:FREQ:CENT?</code> Returns the current value of Center Frequency
Notes	Sets the RF, External Mixing or I/Q Center Frequency depending on the selected input: <ul style="list-style-type: none"> - For RF input it is equivalent to <code>:FREQ:RF:CENT</code> - For I/Q input it is equivalent to <code>:FREQ:IQ:CENT</code> - For External Mixer it is equivalent to <code>:FREQ:EMIX:CENT</code> Preset and Max values are dependent on Hardware Options (5xx) If no terminator (for example, MHz) is sent, the terminator Hz is used. If a terminator with unit other than Frequency is used, an invalid suffix error message is generated
Couplings	In LTEAFDD/LTEATDD and 5GNR Modes: Center Frequency, Center Frequency Offset and Carrier Reference Frequency are coupled with the following equation: Center Frequency = Carrier Reference Frequency + Center Frequency Offset If the following conditions are satisfied at the same time: <ul style="list-style-type: none"> - the Num Component Carrier equals to 1 - the Center Frequency Offset equals to 0 Hz - the mode of the Center Frequency is Auto The Center Frequency is equivalent to Carrier Reference Frequency The major purpose of this coupling is to keep BWCC with legacy LTE, in which <code>:SENSe:FREQuency:CENTer</code> is used to set up the Frequency of the measurement Otherwise, the Center Frequency Offset is changed following the Center Frequency and the Carrier Reference Frequency keeps intact

3 VMA Mode

3.3 Monitor Spectrum Measurement

In MSR, Center Freq, Center Freq Offset and Carrier Ref Freq are coupled with the equation, Center Freq = Carrier Ref Freq + Center Freq Offset. When Center Freq is changed, Center Freq Offset is updated and Carrier Ref Freq is not changed

When auto, Center Freq Offset remains the same value. Thus, Center Freq changes the same amount of Carrier Ref Freq change when Carrier Ref Freq is changed. The auto state changes to manual when either Center Freq is changed

In Bluetooth Mode:

Center Frequency is coupled to Channel and Geography

- If Geography is France: Center Frequency 2454 MHz + (channel number* channel space) MHz
- If Geography is Others: Center Frequency 2402 MHz + (channel number* channel space) MHz
- If Radio Stand is Basic or EDR, channel space is 1 MHz
- If Radio Stand is Low Energy, channel space is 2 MHz

In other modes:

Any value of the Center Frequency or Span that keeps start frequency and stop frequency within the frequency range of the instrument is allowed when the value is being set through the front panel numeric keypad or the SCPI command. Other frequency parameters are forced to different values if needed, to keep the start and stop frequencies within the instrument's frequency range

Preset	Depends on instrument maximum frequency, mode, measurement, and selected input See "Center Frequency Presets" on page 622 , "RF Center Freq" on page 624 , "Ext Mix Center Freq" on page 625 , "I/Q Center Freq" on page 625 and "VXT Models with Radio Heads/CIU Frequency Range" on page 624
State Saved	Saved in instrument state
Min/Max	Depends on instrument maximum frequency, mode, measurement, and selected input See "Center Frequency Presets" on page 622 , "RF Center Freq" on page 624 , "Ext Mix Center Freq" on page 625 , "I/Q Center Freq" on page 625 and "VXT Models with Radio Heads/CIU Frequency Range" on page 624
Annotation	Center <value> appears in the lower left corner of the display
Status Bits/OPC dependencies	Non-overlapped

Center Frequency Auto State

Remote Command	<code>[:SENSe] :FREQuency:CENTer:AUTO ON OFF 1 0</code> <code>[:SENSe] :FREQuency:CENTer:AUTO?</code>
Example	<code>:FREQ:CENT:AUTO OFF</code> <code>:FREQ:CENT:AUTO?</code>
Dependencies	This is only available in MSR, LTEAFDD/LTEATDD and 5GNR Modes
Couplings	When the Center Frequency is changed, the state is automatically changed to Manual

Center Frequency, Center Frequency Offset and **Carrier Reference Frequency** are coupled. When Carrier Reference Frequency changes:

- Center Frequency : Auto Center Frequency = Carrier Reference Frequency + Center Frequency Offset (fixed)
- Center Frequency : Man Center Frequency (fixed) = Carrier Reference Frequency + Center Frequency Offset

Preset	ON
State Saved	Saved in instrument state
Range	Auto Man

Center Frequency Presets

The following table provides the Center Frequency Presets for the Spectrum Analyzer mode, and the Max Freq, for the various frequency options:

Freq Option	CF after Mode Preset	Stop Freq after Mode Preset	Max Freq (can't tune above)
503 (all but CXA)	1.805 GHz	3.6 GHz	3.7 GHz
503 (CXA)	1.505 GHz	3.0 GHz	3.08 GHz
507 (all but CXA)	3.505 GHz	7.0 GHz	7.1 GHz
507 (CXA)	3.755 GHz	7.5 GHz	7.58 GHz
508 (all but MXE)	1.805 GHz	3.6 GHz	8.5 GHz
508 (MXE)	4.205 GHz	8.4 GHz	8.5 GHz
513	6.805 GHz	13.6 GHz	13.8 GHz
526 (except CXA and MXE)	13.255 GHz	26.5 GHz	27.0 GHz*
526 (CXA)	13.255 GHz	26.5 GHz	26.55 GHz
526 (MXE)	1.805 GHz	3.6 GHz	27.0 GHz
532	16.005 GHz	32.0 GHz	32.5 GHz
540	20.005 GHz	40.0 GHz	40.5 GHz
543	21.505 GHz	43.0 GHz	43.0 GHz
544	22.005 GHz	44.0 GHz	45.0 GHz
550	25.005 GHz	50.0 GHz	52 GHz
F03 (CXA-m)	1.505 GHz	3.0 GHz	3.08 GHz
F07 (CXA-m)	3.755 GHz	7.5 GHz	7.575 GHz
F13 (CXA-m)	6.805 GHz	13.6 GHz	13.8 GHz
F26 (CXA-m)	13.255 GHz	26.5 GHz	26.55 GHz
504 (M9421A, M8920A)	2.145 GHz	3.88GHz	3.88 GHz

3 VMA Mode
 3.3 Monitor Spectrum Measurement

Freq Option	CF after Mode Preset	Stop Freq after Mode Preset	Max Freq (can't tune above)
506 (M9421A, M8920A)	3.245 GHz	6.08GHz	6.08 GHz
F06 (M9410A/11A)	1.0 GHz	6.08 GHz	6.08 GHz
F06 (M9415A)	1 GHz	1.08 GHz	6.6 GHz
F08 (M9415A)	1 GHz	1.08 GHz	8.6 GHz
F12 (M9415A)	1 GHz	1.08 GHz	12.9 GHz

*For option 526, the Max CF in RTSA is 26.999999995 GHz.

N9041B Center Freq Presets

Input	CF after Mode Preset	Stop Freq after Mode Preset	Max Freq (can't tune above)
Input 1, all models	25.005 GHz	50.0 GHz	52 GHz
Input 2, opt 585	42.505 GHz	85.0 GHz	86 GHz
Input 2, opt 590	45.005 GHz	90.0 GHz	92 GHz
Input 2, opt 5CX	55.005 GHz	110.0 GHz	110 GHz

Input 2, CXA and MXE

Model	CF after Mode Preset	Stop Freq after Mode Preset	Max Freq (can't tune above)
CXA opt C75	0.7505 GHz	1.5 GHz	1.58 GHz
MXE	505 MHz	1 GHz	1.000025 GHz

Tracking Generator Frequency Limits (CXA only)

Tracking Generator Option	Min Freq (clips to this freq when turn TG on and can't tune below while TG on)	If above this Freq, Stop Freq clipped to this Freq when TG turned on	Max Freq (can't tune above) while TG on
T03	9 kHz	3.0 GHz	3.08 GHz
T06	9 kHz	6.0 GHz	6.05 GHz

Tracking Generator Frequency Limits(CXA-m only)

Tracking Generator Option	Min Freq (clips to this freq when turn TG on and can't tune below while TG on)	If above this Freq, Stop Freq clipped to this Freq when TG turned on	Max Freq (can't tune above) while TG on
T03	2 MHz	3.08 GHz	3.08 GHz
T07	2 MHz	7.575 GHz	7.575 GHz

Tracking Generator Option	Min Freq (clips to this freq when turn TG on and can't tune below while TG on)	If above this Freq, Stop Freq clipped to this Freq when TG turned on	Max Freq (can't tune above) while TG on
T13	2 MHz	13.8 GHz	13.8 GHz
T26	2 MHz	26.55 GHz	26.55 GHz

VXT Models with Radio Heads/CIU Frequency Range

The following table shows the Center Frequency Presets and Range for VXT modes with Radio Heads/CIU.

Products with Radio Heads/CIU	Preset	Start frequency	Stop frequency
M9421A + CIU	6 GHz	5.9 GHz	12 GHz
M9410A + CIU	6 GHz	5.9 GHz	12 GHz
M9410A + CIU + RRH	25 GHz	24.25 GHz	43.5 GHz

RF Center Freq

Specifies the RF Center Frequency. This command sets the Center Frequency to be used when the RF input is selected, even if the RF input is not the input that is selected at the time the command is sent. Note that **"Center Frequency" on page 619** in the **Frequency** menu on the front panel always applies to the currently selected input.

Remote Command	<code>[:SENSe] :FREQuency :RF :CENTer <freq></code> <code>[:SENSe] :FREQuency :RF :CENTer?</code>
Example	<code>:FREQ:RF:CENT 30 MHz</code> <code>:FREQ:RF:CENT?</code>
Notes	This command is the same in all Modes, but the parameter is Measurement Global, so the value is independent in each Mode and common across all the measurements in the Mode
Dependencies	If the electronic/soft attenuator is enabled, any attempt to set Center Frequency such that the Stop Frequency would be >3.6 GHz fails and results in an advisory message. If the equivalent SCPI command is sent, this same message is generated as part of a "-221, Settings conflict" warning
Preset	See "Center Frequency Presets" on page 622 above
State Saved	Saved in instrument state
Min	-79.999995 MHz
Max	See table above. Basically, instrument maximum frequency - 5 Hz If the knob or step keys are being used, also depends on the value of Span

Ext Mix Center Freq

Specifies the External Mixer Center Frequency. This command sets the Center Frequency to be used when the External Mixer is selected, even if the External Mixer input is not the input that is selected at the time the command is sent. Note that **"Center Frequency" on page 619** in the **Frequency** menu on the front panel always applies to the currently selected input.

Remote Command	<code>[:SENSe] :FREQuency:EMIXer:CENTer <freq></code> <code>[:SENSe] :FREQuency:EMIXer:CENTer?</code>
Example	<code>:FREQ:EMIX:CENT 60 GHz</code> <code>:FREQ:EMIX:CENT?</code>
Notes	This command is the same in all Modes, but the parameter is Measurement Global, so the value is independent in each Mode and common across all the measurements in the Mode
Couplings	When returning to External Mixing after having been switched to one of the other inputs (e.g., RF), you will come back into the settings that you had when you left External Mixing. So, you will come back to the band you were in with the Center Frequency that you had. However, Span is not an input-dependent parameter, therefore you will bring the span over from the other input. Therefore, the instrument comes back with the span from the previous input, limited as necessary by the current mixer setup
Preset	When a Mode Preset is performed while in External Mixing, the Start frequency of the current Mode is set to the nominal Min Freq of the lowest harmonic range in the Harmonic Table for the current mixer setup. Similarly, the Stop frequency of the current Mode is set to the nominal Max Freq of the highest harmonic range in the Harmonic Table. The Center Freq thus presets to the point arithmetically equidistant from these two frequencies Note that, if the current measurement has a limited Span available to it, and cannot achieve the Span shown in the table (Span=Stop Freq – Start Freq), the instrument uses the maximum Span the measurement allows, and still sets the Center Freq to the midpoint of the Start and Stop Freq values in the Harmonic Table When Restore Input/Output Defaults is performed, the mixer presets to the 11970A, whose Start and Stop frequencies are 26.5 and 40 GHz respectively. The center of these two frequencies is 33.25 GHz. Therefore, after a Restore Input/Output Defaults, if you go into External Mixing and do a Mode Preset while in the Spectrum Analyzer Mode, the resulting Center Freq is 33.25 GHz
State Saved	Yes
Min	The minimum frequency in the currently selected mixer band + 5 Hz If the knob or step keys are being used, also depends on Span
Max	The maximum frequency in the currently selected mixer band - 5 Hz If the knob or step keys are being used, also depends on Span

I/Q Center Freq

Specifies the I/Q Center Frequency. This command sets the Center Frequency to be used when the I/Q input is selected, even if the I/Q input is not the input that is selected at the time the command is sent. Note that **"Center Frequency" on page 619** in the **Frequency** menu on the front panel always applies to the currently

selected input.

Remote Command	<code>[:SENSe]:FREQuency:IQ:CENTer <freq></code> <code>[:SENSe]:FREQuency:IQ:CENTer?</code>
Example	<code>:FREQ:IQ:CENT 30 MHz</code>
Notes	This command is the same in all Modes, but the parameter is Measurement Global, so the value is independent in each Mode and common across all the measurements in the Mode
Preset	0 Hz
State Saved	Saved in instrument state
Min	-40.049995 MHz
Max	40.049995 MHz

Span

Changes the displayed frequency range symmetrically about the center frequency. While adjusting the Span, the Center Frequency is held constant, this means that both Start Frequency and Stop Frequency will change.

If the Span is set to a value greater than the maximum allowable span of the instrument, an error message is generated indicating the data is out of range and was clipped to upper limit.

See ["Span Presets" on page 627](#)

Remote Command	<code>[:SENSe]:MONitor:FREQuency:SPAN <freq></code> <code>[:SENSe]:MONitor:FREQuency:SPAN?</code>
Example	<code>:MON:FREQ:SPAN 10 MHz</code> <code>:MON:FREQ:SPAN?</code>
Dependencies	If the electrical attenuator is enabled, any attempt to set Span such that the Stop Frequency would be >3.6 GHz results in an error In instruments with an RF Preselector, such as MXE, you cannot sweep across the band break at 3.6 GHz while the RF Preselector is on in Continuous sweep, as there is a mechanical switch which bypasses the RF Preselector above 3.6 GHz
Couplings	Span affects RBW, sweeptime, FFT & Sweep choice (including FFT Width, Phase Noise Optimization and ADC Dither auto couplings) <ul style="list-style-type: none"> - Any value of the Center Frequency or Span that is within the frequency range of the instrument is allowed when the value is being set through the front panel numeric keypad or the SCPI command. The other parameter is forced to a different value if needed, to keep the Start and the Stop Frequencies within the instrument's frequency range - When using the knob or the step up/down keys or the UP DOWN keywords in SCPI, the value that is being changed i.e., the Center Frequency or Span, is limited so that the other parameter is not forced to a new value

3 VMA Mode
3.3 Monitor Spectrum Measurement

Preset	Depends on instrument maximum frequency, mode, measurement, and selected input See " Span Presets " on page 627
State Saved	Saved in instrument state
Min	10 Hz
Max	Depends on instrument maximum frequency, mode, measurement, and selected input; see " Span Presets " on page 627 If the knob or step keys are being used, depends on the value of the other three interdependent parameters Center Frequency, Start Frequency, Stop Frequency
Annunciation	Data out of range, value clipped to upper limit
Annotation	Span <value> appears on the first line of the annotation in the lower right corner of display

Span Presets

The following table provides the Max Span, for the various frequency options:

Freq Option	Max Span (can't set higher than this)
503 (all but CXA)	3.7 GHz
503, F03 (CXA, CXA-m)	3.08 GHz
507 (all but CXA)	7.1 GHz
507 (CXA, CXA-m)	7.575 GHz
508 (all but MXE)	8.5 GHz
508 (MXE)	8.5 GHz
513, F13	13.8 GHz
526 (all but CXA and MXE)	27.0 GHz
526 (MXE)	27.0 GHz
526, F26 (CXA, CXA-m)	26.55 GHz
544	44.5 GHz
550	52 GHz
M9415A-F06	6.27 GHz
M9415A-F08	8.27 GHz
M9415A-F12	12.57 GHz

Input 2:

Model	Max Span (can't set higher than this)
CXA opt C75	1.58 GHz
MXE	1.000025 GHz

Note that if you are in External Mixing, the maximum Span will be equal to the Maximum Stop Frequency – Minimum Start Frequency for the currently selected mixer.

Span Presets by Mode

Mode	Radio Std	Preset Value
WCDMA		10.0 MHz
PN		1.0 MHz
GSM/EDGE		1.0 MHz
WLAN	802.11a/b/g/n/ac/ax/be (20 MHz)	25 MHz
	802.11n/ac/ax/be (40MHz)	50 MHz
	802.11ac/ax/be (80MHz)	100 MHz
	802.11ac /ax/be (160MHz)	200 MHz
	802.11be (320MHz)	400 MHz
MSR		20 MHz
LTEAFDD, LTEATDD		20 MHz
5G NR		150 MHz
RTS		40 kHz
CQM		10 MHz

CF Step

Changes the step size for the center frequency and start and stop frequency functions. Once a step size has been selected and the center frequency function is active, the step keys (and the UP/DOWN parameters for Center Frequency from remote commands) change the center frequency by the step-size value. The step size function is useful for finding harmonics and sidebands beyond the current frequency span of the instrument.

Note that the start and stop frequencies also step by the CF Step value.

Remote Command `[:SENSe]:FREQuency:CENTer:STEP[:INCRement] <freq>`
 `[:SENSe]:FREQuency:CENTer:STEP[:INCRement]?`
 `[:SENSe]:FREQuency:CENTer:STEP:AUTO OFF | ON | 0 | 1`
 `[:SENSe]:FREQuency:CENTer:STEP:AUTO?`

Example `:FREQ:CENT:STEP 500 MHz`
 `:FREQ:CENT UP`
 Increases the current center frequency value by 500 MHz
 `:FREQ:CENT:STEP?`
 `:FREQ:CENT:STEP:AUTO ON`

3 VMA Mode

3.3 Monitor Spectrum Measurement

:FREQ:CENT:STEP:AUTO?	
Notes	Preset and Max values are dependent on Hardware Options
Dependencies	Not available in MSR, LTEAFDD/LTEATDD, 5GNR and Channel Quality Modes If the electronic/soft attenuator is enabled, any attempt to change the value of the center frequency >3.6 GHz by pressing the Up-arrow key, fails and results in an advisory message. If the equivalent SCPI command is sent, this same message is generated as part of a "-221, Settings conflict" warning
Couplings	When auto-coupled, the center frequency step size is set to 10% of the span
Preset	Auto ON
State Saved	Saved in instrument state
Min	– (the maximum frequency of the instrument). That is, 27 GHz max freq instrument has a CF step range of +/- 27 GHz. Note that this is the maximum frequency given the current settings of the instrument, so in External Mixing, for example, it is the maximum frequency of the current mixer band
Max	The maximum frequency of the instrument. That is, 27 GHz max freq instrument has a CF step range of +/- 27 GHz. Note that this is the maximum frequency given the current settings of the instrument, so in External Mixing, for example, it is the maximum frequency of the current mixer band
Status Bits/OPC dependencies	non-overlapped

3.3.7 Marker

Accesses a menu that enables you to select, set up and control the markers for the current measurement. If there are no active markers, **Marker** selects marker 1, sets it to Normal and places it at the center of the display. If the selected marker is Off, it is set to Normal and placed it at the center of the screen on the trace determined by the **Marker Trace** rules.

For more detailed information on the types of Markers and the interaction between Markers, see the Marker section of the Swept SA measurement.

3.3.7.1 Select Marker

Specifies the *selected marker*. The term “selected marker” is used throughout this document to specify which marker will be affected when you change marker settings, perform a Peak Search, etc.

This control appears above the menu panel, indicating that it applies to all controls in the Marker menu panels. Select Marker is blanked if you select a tab whose controls do *not* depend on the selected marker (for example, Counter).

On any menu tab for which Select Marker displays, the first control is always **Marker Frequency|Time**.

Notes	The selected marker is remembered even when not in the Marker menu and is used if a Search is done or a Band Function is turned on or for Signal Track or Continuous Peak
Preset	Marker 1
State Saved	The number of the selected marker is saved in instrument state
Annunciation	Appears in the marker results block label for Normal and Delta markers

3.3.7.2 Settings

The controls on this tab include the Marker active function and a radio button selection of the marker control mode (Normal, Delta, or Off) for the selected marker, as well as additional functions that help you use markers.

Marker Frequency

Sets the marker X Axis value in the current marker X Axis Scale unit. It has no effect if the control mode is **Off**, but is the SCPI equivalent of entering an X value if the control mode is **Normal** or **Delta**.

Remote Command	<code>:CALCulate:MONitor:MARKer[1] 2 ... 12:X <freq></code> <code>:CALCulate:MONitor:MARKer[1] 2 ... 12:X?</code>
Example	<code>:CALC:MON:MARK3:X 0</code> <code>:CALC:MON:MARK3:X?</code>
Notes	If no suffix is sent, uses the fundamental units for the current marker X Axis Scale. If a suffix is sent that does not match the current marker X Axis Scale unit, an error "Invalid suffix" is generated The query returns the marker's absolute X Axis value if the control mode is Normal , or the offset from the marker's reference marker if the control mode is Delta . The query is returned in the fundamental units for the current marker X Axis scale: Hz for Frequency and Inverse Time, seconds for Period and Time
Preset	After a preset, all markers are turned OFF, so Marker X Axis Value query returns a not a number (NAN)
State Saved	Saved in instrument state
Min	-9.9E+37
Max	9.9E+37
Annotation	Mkr # <X value> and <Marker value> upper right on graph

Marker X Axis Position (Remote Command Only)

Sets the marker X Axis Scale position in trace points. This setting has no effect if the control mode is Off, but is the SCPI equivalent of entering a value if the control mode is Normal or Delta – except in trace points rather than X Axis Scale units. The entered value is immediately translated into the current X Axis Scale units for setting the value of the marker.

3 VMA Mode

3.3 Monitor Spectrum Measurement

Remote Command	<code>:CALCulate:MONitor:MARKer[1] 2 ... 12:X:POSition <real></code> <code>:CALCulate:MONitor:MARKer[1] 2 ... 12:X:POSition?</code>
Example	<code>:CALC:MON:MARK:X:POS 0</code> <code>:CALC:MON:MARK:X:POS?</code>
Notes	The query returns the marker's absolute X Axis value in trace points if the control mode is Normal , or the offset from the marker's reference marker in trace points if the control mode is Delta . The value is returned as a real number, not an integer, corresponding to the translation from X Axis Scale units to trace points. When a Marker is turned on, it is placed center of the screen on the trace. Therefore, the default value depends on instrument condition. If the marker is Off the response is not a number
Preset	After a preset, all markers are turned OFF , so Marker X Axis Value query returns a not a number (NAN)
State Saved	Saved in instrument state
Min	-9.9E+37
Max	9.9E+37

Marker Y Axis Value (Remote Command only)

Returns the marker Y Axis value in the current marker Y Axis unit.

Remote Command	<code>:CALCulate:MONitor:MARKer[1] 2 ... 12:Y?</code>
Example	<code>:CALC:MON:MARK11:Y?</code>
Notes	Returns the marker Y-axis result if the control mode is Normal or Delta . If the marker is Off , the response is Not A Number
Preset	Result dependent on Markers setup and signal source
State Saved	No
Backwards Compatibility SCPI	<code>:CALCulate:MONitor:MARKer[1] 2 ... 12:FUNCTION:RESult?</code>

Marker Mode

Sets the marker control mode to **Normal (Position)**, **Delta**, or **Off**. All interactions and dependencies detailed under the control description are enforced when the remote command is sent. If the selected marker is Off, pressing Marker sets it to Normal and places it at the center of the screen on the trace determined by the **Marker Trace** rules. At the same time, **Marker X Axis Value** appears on the Active Function area.

The default active function is the active function for the currently selected marker control mode. If the current control mode is **Off**, there is no active function and the active function is turned off.

Remote Command	:CALCulate:MONitor:MARKer[1] 2 ... 12:MODE POSition DELTa OFF
Example	:CALC:MON:MARK:MODE POS :CALC:MON:MARK:MODE?
Preset	OFF
State Saved	Saved in instrument state
Range	POSition DELTA OFF
Annotation	Mkr # <X value> and <Marker value> upper right on graph

Backward Compatibility SCPI Commands

Sets or queries the state of a marker. Setting a marker that is **OFF** to **ON** (1) puts it in **Normal** mode and places it at the center of the screen.

Remote Command	:CALCulate:MONitor:MARKer[1] 2 ... 12:STATe OFF ON 0 1
Example	:CALC:MON:MARK3:STAT ON :CALC:MON:MARK3:STAT?
Preset	OFF
State Saved	Saved in instrument state
Range	OFF ON

Delta Marker (Reset Delta)

Pressing this button has exactly the same effect as selecting the **Delta** selection in **"Marker Mode" on page 631**. The selected marker becomes a Delta Marker. If the selected marker is already a Delta marker, the reference marker is moved to the current position of the selected marker, thus resetting the Delta to zero.

Marker Settings Diagram

Lets you configure the Marker system using a visual utility.

All Markers Off

Turns off all markers.

Remote Command	:CALCulate:MONitor:MARKer:AOFF
Example	:CALC:MON:MARK:AOFF

Couple Markers

When this function is **ON**, moving any marker causes an equal X Axis movement of every other marker that is not Off. By “equal X Axis movement” we mean that we preserve the difference between each marker’s X Axis value (in the fundamental x-axis units of the trace that marker is on) and the X Axis value of the marker being moved (in the same fundamental x-axis units).

This may result in markers going off screen.

Remote Command	:CALCulate:MONitor:MARKer:COUPle[:STATe] ON OFF 1 0 :CALCulate:MONitor:MARKer:COUPle[:STATe]?
Example	:CALC:MON:MARK:COUP ON :CALC:MON:MARK:COUP?
Preset	OFF Presets on Mode Preset and All Markers Off
State Saved	Saved in instrument state

3.3.7.3 Peak Search

The controls on this tab allow you to move the marker to selected peaks of the signal, giving you enormous analysis capabilities, particularly when combined with the Delta Marker function.

NOTE

Pressing the **Peak Search** hardkey automatically moves you to the **Peak Search** page of the **Marker** menu and performs a Peak Search.
 Pressing the **Peak Search** tab once you are already *in* the **Marker** menu does *not* perform a Peak Search.

Marker Frequency

This is the fundamental control that you use to move a marker around on the trace. This is the same as "**Marker Frequency**" on page 630 on the **Settings** tab.

Peak Search

Moves the selected marker to the trace point which has the maximum y-axis value for that marker’s trace.

NOTE

Pressing the **Peak Search** hardkey automatically moves you to the **Peak Search** page of the **Marker** menu and performs a Peak Search. If the selected marker was off, then it is turned on as a normal marker, and a Peak Search is performed.

Remote Command	<code>:CALCulate:MONitor:MARKer[1] 2 ... 12:MAXimum</code>
Example	<code>:CALC:MON:MARK2:MAX</code> <code>:SYST:ERR?</code> can be used to query the errors to determine if a peak is found. If a search is unsuccessful, then the message "Execution error; No peak found" (-200) will be returned
Notes	Sending this command selects the subopcoded marker

Next Peak

Moves the selected marker to the peak that is next lower in amplitude than the current marker value. If there is no valid peak lower than the current marker value, an "Execution error; No peak found" message is generated and the marker is not moved.

If the selected marker was off, then it is turned on as a normal marker and a peak search is performed.

Remote Command	<code>:CALCulate:MONitor:MARKer[1] 2 ... 12:MAXimum:NEXT</code>
Example	<code>:CALC:MON:MARK2:MAX:NEXT</code> selects marker 2 and moves it to the peak that is next lower in amplitude than the current marker value
Notes	Sending this command selects the subopcoded marker
State Saved	Not part of saved state

Marker Delta

Pressing this control has exactly the same effect as selecting the **Delta** selection in "**Marker Mode**" on page 631 on the **Settings** tab. The selected marker becomes a Delta Marker. If the selected marker is already a Delta marker, the reference marker is moved to the current position of the selected marker, thus resetting the Delta to zero.

The control is duplicated here to allow you to conveniently perform a peak search and change the marker's control mode to Delta without having to access two separate menus.

3.3.7.4 Properties

The controls on this tab are used to set certain properties of the selected marker.

Marker Frequency

This is the fundamental control that you use to move a marker around on the trace. This is the same as "[Marker Frequency](#)" on page 630 on the **Settings** tab.

Relative To

Selects the marker to which the selected marker is relative (its reference marker).

Every marker has another marker to which it is relative. This marker is referred to as the "reference marker" for that marker. This attribute is set by the **Marker, Properties, Relative To** key. The marker must be a **Delta** marker to make this attribute relevant. If it is a **Delta** marker, the reference marker determines how the marker is controlled and how its value is displayed. A marker cannot be relative to itself.

Remote Command	<code>:CALCulate:MONitor:MARKer[1] 2 ... 12:REference <integer></code> <code>:CALCulate:MONitor:MARKer[1] 2 ... 12:REference?</code>
Example	<code>:CALC:MON:MARK2:REF 1</code> <code>:CALC:MON:MARK2:REF?</code>
Notes	This command causes the marker specified with the subopcode to become selected Range (for SCPI command): 1 to 12. If the range is exceeded the value is clipped A marker cannot be relative to itself so that choice is not available, and if sent from SCPI generates error -221: "Settings conflict; marker cannot be relative to itself" When queried a single value is returned (the specified marker numbers relative marker)
Couplings	The act of specifying the selected marker's reference marker makes the selected marker a Delta marker If the reference marker is off it is turned on in Normal mode at the delta marker location
Preset	The preset default "Relative To" marker (reference marker) is the next higher numbered marker (current marker +1). For example, if marker 2 is selected, then it's default reference marker is marker 3. The exception is marker 12, which has a default reference of marker 1 Set to the defaults by using Restore Mode Defaults . This is not reset by Marker Off, All Markers Off, or Preset
State Saved	Saved in instrument state. Not affected by Marker Off and hence not affected by Preset or power cycle
Min	1
Max	12
Annunciation	Appears in the marker label of a Delta marker

Marker Trace

Selects the trace on which you want your marker placed. A marker is associated with one and only one trace. This trace is used to determine the placement, result, and X-Axis Scale of the marker. All markers have an associated trace; it is from that trace that they determine their attributes and behaviors, and it is to that trace that they go when they become Normal markers.

Specifying a Marker Trace manually or with this command associates the marker with the specified trace. If the marker is not **OFF**, it moves the marker from the trace it was on to the new trace. If the marker is **OFF**, it stays off but is now associated with the specified trace.

The query returns the number of the trace on which the marker is currently placed.

Remote Command	<code>:CALCulate:MONitor:MARKer[1] 2 ... 12:TRACe 1 2 3</code> <code>:CALCulate:MONitor:MARKer[1] 2 ... 12:TRACe?</code>
Example	<code>:CALC:MON:MARK:TRAC 1</code> <code>:CALC:MON:MARK:TRAC?</code>
Notes	A marker may be placed on a blanked and/or inactive trace, even though the trace is not visible and/or updating An application may register a trace name to be displayed on the control instead of a trace number
Couplings	The state of Marker Trace is not affected by the "Auto Couple" on page 1825 key Sending the remote command causes the addressed marker to become selected
Preset	1
State Saved	Saved in instrument state
Min	1
Max	3

Marker Settings Diagram

Lets you configure the Marker system using a visual utility. This is the same as the **"Marker Settings Diagram" on page 632** control on the **Settings** tab.

3.3.7.5 Marker Function

The controls on this tab allow you to control the Marker Functions of the instrument. Marker Functions perform post-processing operations on marker data.

The **Marker Function** menu controls which marker functions are turned on and allows you to adjust the setup parameters for each function. These parameters include the following, but only one parameter can be assigned to a given marker:

3 VMA Mode
 3.3 Monitor Spectrum Measurement

- Marker Noise
- Band Power
- Band Density
- Off

Marker Frequency

This is the fundamental control that you use to move a marker around on the trace. This is the same as "Marker Frequency" on page 630 on the **Settings** tab.

Marker Function

Sets the marker control function type to one of the following:

NOISe	Marker Noise
BPOWer	Band Power
BDENsity	Band Density
OFF	Marker Function Off

Remote Command	<code>:CALCulate:MONitor:MARKer[1] 2 ... 12:FUNCtion NOISe BPOWer BDENsity OFF</code> <code>:CALCulate:MONitor:MARKer[1] 2 ... 12:FUNCtion?</code>
Example	<code>:CALC:MON:MARK:FUNC NOIS</code> <code>:CALC:MON:MARK:FUNC?</code>
Preset	OFF
State Saved	Yes
Range	NOISe BPOWer BDENsity OFF
Annotation	Mkr # <X value> and <Marker value> upper right on graph

Band Span

Sets the width of the frequency span for the selected marker.

Remote Command	<code>:CALCulate:MONitor:MARKer[1] 2 ... 12:FUNCtion:BAND:SPAN <freq></code> <code>:CALCulate:MONitor:MARKer[1] 2 ... 12:FUNCtion:BAND:SPAN?</code>
Example	<code>:CALC:MON:MARK12:FUNC:BAND:SPAN 20 MHz</code> <code>:CALC:MON:MARK12:FUNC:BAND:SPAN?</code>
Couplings	Changing the Band Span necessarily changes the Band Left and Band Right values

Preset	Depends on X axis range of selected Trace 10% of Span
State Saved	Yes
Min	-9.9E+37 0
Max	9.9E+37 26.5GHz

Band Left

Sets the left edge frequency or time value for the band of the selected marker.

Remote Command	<code>:CALCulate:MONitor:MARKer[1] 2 ... 12:FUNCTION:BAND:LEFT <freq></code> <code>:CALCulate:MONitor:MARKer[1] 2 ... 12:FUNCTION:BAND:LEFT?</code>
Example	<code>:CALC:MON:MARK12:FUNC:BAND:LEFT 20 GHz</code> <code>:CALC:MON:MARK12:FUNC:BAND:LEFT?</code>
Couplings	Changing the Band Left necessarily changes the Band Span value
Preset	Depends on X axis range of selected Trace
State Saved	Yes
Min	-9.9E+37
Max	9.9E+37

Band Right

Sets the right edge frequency or time value for the band of the selected marker.

Remote Command	<code>:CALCulate:MONitor:MARKer[1] 2 ... 12:FUNCTION:BAND:RIGHT <freq></code> <code>:CALCulate:MONitor:MARKer[1] 2 ... 12:FUNCTION:BAND:RIGHT?</code>
Example	<code>:CALC:MON:MARK12:FUNC:BAND:RIGH 20 GHz</code> <code>:CALC:MON:MARK12:FUNC:BAND:RIGH?</code>
Couplings	Changing the Band Right necessarily changes the Band Span value
Preset	Depends on X axis range of selected Trace
State Saved	Yes
Min	-9.9E+37
Max	9.9E+37

3.3.8 Meas Setup

This menu panel contains functions for setting up the measurement parameters and also contains functions for setting up parameters global to all measurements in the Mode.

3.3.8.1 Settings

Contains frequently used Meas Setup functions to which you will want the fastest access.

Avg|Hold Num

Specifies the number of measurement averages used when calculating the measurement result. The average is displayed at the end of each sweep.

After the specified number of average counts, the averaging mode (terminal control) setting determines the averaging action.

Remote Command	<code>[:SENSe]:MONitor:AVERage:COUNT <integer></code> <code>[:SENSe]:MONitor:AVERage:COUNT?</code>
Example	<code>:MON:AVER:COUN 25</code> <code>:MON:AVER:COUN?</code>
Preset	10
State Saved	Yes
Min/Max	1/1000
Annotation	The average count is displayed in the measurement bar on the front panel display. The annotation appears in the format n/N where n is the current average and N is the average count

Averaging On/Off

Turns averaging on or off.

Remote Command	<code>[:SENSe]:MONitor:AVERage[:STATe] OFF ON 0 1</code> <code>[:SENSe]:MONitor:AVERage[:STATe]?</code>
Example	<code>:MON:AVER ON</code> <code>:MON:AVER?</code>
Preset	OFF
State Saved	Yes
Range	OFF ON

Average Mode

Toggles the Average Mode:

- **EXponential**- continues measurement averaging, using the specified number of averages to compute each averaged value. The average is displayed at the end of each sweep
- **REPeat**- causes the measurement to reset the average counter each time the specified number of averages is reached

Remote Command	<code>[:SENSe]:MONitor:AVERage:TCONtrol EXPonential REPeat</code> <code>[:SENSe]:MONitor:AVERage:TCONtrol?</code>
Example	<code>:MON:AVER:TCON EXP</code> <code>:MON:AVER:TCON?</code>
Preset	<code>EXPonential</code>
State Saved	Yes
Range	<code>EXPonential REPeat</code>

Spur Avoidance

Because the VXT models M9410A/11A/15A are direct-conversion (zero-IF) receivers, feedthrough leakage from the local oscillator appears as a spurious signal (spur) at the center frequency. The **Spur Avoidance** function is provided to eliminate this spur, at the expense of some measurement speed. For Spur Avoidance, the instrument uses a software algorithm to remove this spur from the displayed measurement data.

Some measurements allow you to turn off **Spur Avoidance**, but in this measurement it is always enabled. Therefore, in this measurement the Spur Avoidance switch is unavailable (grayed out) and set to Enabled.

Furthermore, if you press the grayed-out switch, this popup message appears:

`Always enabled in this measurement. See manual for details`

Remote Command	<code>[:SENSe]:MONitor:SAVoid[:STATe]?</code>
Example	<code>:MON:SAV?</code> Always returns <code>ON</code>
Dependencies	This control only appears in VXT models M9410A/11A/15A
Preset	<code>ON</code>
State Saved	Saved in instrument state
Range	<code>ON</code>

Meas Setup Summary Table

Lets you view and access many of the parameters in the Meas Setup menus on one screen.

Auto Couple

Immediately puts all **Auto/Man** functions into **Auto**. **Auto Couple** is confined to the current measurement only. It does not affect other measurements in the Mode.

In the **Auto** state, **Auto/Man** functions are said to be “coupled”, meaning their values change as you make changes to other values in the measurement. This helps ensure accurate measurements and optimum dynamic range. **Auto Couple** is an immediate action function, and when it is executed, all the **Auto/Man** controls for the current measurement are set to **Auto**, and all measurement settings coupled to the **Auto/Man** parameters are automatically set to their optimal values.

For further details of measurement-specific settings (if any), see "[Measurement-Specific Details](#)" on page 642 below.

Remote Command	:COUPle ALL
Example	:COUP ALL
Backwards Compatibility SCPI	:COUPLE ALL NONE
Backwards Compatibility Notes	:COUP:NONE puts all Auto/Man parameters in manual mode, decoupling all the coupled instrument parameters. It is retained for backwards compatibility and is <i>not</i> recommended for making measurements or new designs

All **Auto/Man** parameter couplings in the measurement are set to **Auto**. This includes couplings that may be unavailable or grayed-out due to the current state. For example, in the Swept SA measurement, there is no **Auto/Man** coupling for **RBW** while in Zero Span. Nonetheless, if **Auto Couple** were executed while in Zero Span, it would set **RBW** to Auto "behind the scenes" so that, on exit from Zero Span, it would be in **Auto**.

Any **Auto/Man** selection specific (local) to the other measurements in the current Mode are not affected by **Auto Couple**. Any functions that are *not* coupled with other instrument parameters, such as ranging or leveling variables, such as **AutoRange** or **AutoScale**, are not affected.

Executing **Auto Couple** generates the informational message, "All Auto/Man functions have been set to Auto".

Each parameter, upon being set to **Auto**, selects and sets the appropriate auto-coupled value based on that parameter's coupling rules. The Dependency Resolver orchestrates the couplings for parameters that depend on one or more other parameters. The coupling and dependency rules for each parameter are defined in the section describing that parameter.

Executing **Auto Couple** does not affect markers, marker functions, trace or display attributes, or any other instrument setting other than those specifically mentioned above.

Measurement-Specific Details

TOI (SA Mode only)

Parameters affected by **Auto Couple** are:

- Center Frequency Step
- Resolution Bandwidth
- Span/RBW Ratio
- Sweep Time
- Video BANDwidth VBW/RBW ratio
- Upper and Lower Tone (set to Sense)
- Zero span measurement Resolution Bandwidth
- Zero span measurement Dwell Time

Harmonics (SA Mode only)

Parameters affected by **Auto Couple** are:

- Resolution Bandwidth
- Fundamental Frequency
- Dwell Time
- Range Table Resolution Bandwidths
- Range Table Dwell Times

Meas Preset

Restores all the measurement parameters to their default values.

Remote Command `:CONFigure:MONitor`

Example `:CONF:MON`

3.3.8.2 Advanced

Contains controls for setting advanced functions of the instrument.

This tab does not appear in EXM or VXT.

Noise Floor Extension

When this function is **ON**, the expected noise power of the instrument (derived from a factory calibration) is subtracted from the trace data. This will usually reduce the apparent noise level by about 10 dB in low band, and 8 dB in high band (>~3.6 GHz).

Noise Floor Extension works with any RBW, VBW, detector, any setting of Average Type, any amount of trace averaging, and any signal type. It is ineffective when the trace is not smoothed (smoothing processes include narrow VBWs, trace averaging, and long sweep times with the detector set to Average or Peak). It works best with extreme amounts of smoothing, and with the average detector, with the Average Type set to Power.

NOTE

Noise Floor Extensions has no effect unless the RF Input is selected, therefore it does nothing when External Mixing is selected.

In those cases where the cancellation is ineffective, it nonetheless has no undesirable side-effects. There is no significant speed impact to having **Noise Floor Extension** on.

The best accuracy is achieved when substantial smoothing occurs in each point before trace averaging. Thus, when using the average detector, results are better with long sweep times and fewer trace averages. When using the sample detector, the VBW filter should be set narrow with less trace averaging, instead of a wide VBW filter with more trace averaging.

See "[More Information](#)" on page 644.

Remote Command `[:SENSe]:CORRection:NOISe:FLOor ON | OFF | 1 | 0`
`[:SENSe]:CORRection:NOISe:FLOor?`

Example	<code>:CORR:NOIS:FLO ON</code>
Dependencies	This control only appears in instruments with the NFE or NF2 license installed. In all others, the control does not appear, however the SCPI command will be accepted without error (but will have no effect)
Couplings	When NFE is enabled in any mode manually, a prompt will be displayed reminding you to perform the Characterize Noise Floor operation if it is needed. If NFE is enabled through SCPI and a Characterize Noise Floor operation is needed, an error will be entered in the system error queue
Preset	Unaffected by Mode Preset. Turned off by Restore Mode Defaults
State Saved	No

More Information

The instrument is characterized in the factory (or during a field calibration) with a model of the noise, referred to the input mixer, versus frequency in each band and path combination. Bands are 0 (low band) and 1 through 4 (high band) in a 26.5 GHz instrument, for example. Paths include normal paths, preamp paths, the electronic attenuator, etc.

In most band/path combinations, the noise can be well characterized based on just two parameters and the instrument frequency response before compensation for frequency-dependent losses.

After the noise density at the input mixer is estimated, the effects of the input attenuator, RBW, detector, etc. are computed to get the estimated input-port-referred noise level.

In the simplest case, the measured power (signal plus analyzer noise) in each display point (bucket) is compensated by subtracting the estimated noise power, leaving just the signal power. This is the operation when the detector is Average and the Average Type is set to Power.

In other cases, operation is often not quite as good but still highly effective. With peak detection, the noise floor is estimated based on the RBW and the duration of the bucket using the same equations used in the noise marker function. The voltage of the noise is subtracted from the voltage of the observed signal-plus-noise measurement to compute the estimated signal voltage. The peak detector is one example of processing that varies with detector to give good estimates of the signal level without the analyzer noise.

For best operation, the average detector and the power scale are recommended, as already stated. Peak detection for pulsed-RF can still give excellent effectiveness. FFT analysis does not work well, and does not do NFE well, with pulsed-RF signals, so this combination is not recommended. Negative peak detection is not very useful, either. Sample detection works well, but is never better than the average detector because it doesn't smooth as well. The Normal detector is a combination of peak and negative peak behaviors, and works about as well as these.

3 VMA Mode

3.3 Monitor Spectrum Measurement

For best operation, extreme smoothing is desirable, as already stated. Using narrow VBWs works well, but using very long bucket durations and the average detector works best. Reducing the number of trace points will make the buckets longer.

For best operation, the power scale (Average Type = Power) is optimum. When making CW measurements in the presence of noise without NFE, averaging on the decibel scale has the advantage of reducing the effect of noise. When using NFE, the NFE does an even better job than using the log scale ever could. Using NFE with the log scale is not synergistic, though; NFE with the power scale works a little better than NFE with log averaging type.

The results from NFE with internal preamp can often be lower than the theoretical noise in a signal source at room temperature, a noise density of -174 dBm/Hz. This is expected and useful behavior, because NFE is designed to report the amount of input signal that is in excess of the thermal noise, not the amount that includes the thermal noise. This can be a useful behavior because thermal noise often interferes with what you want to measure, instead of being part of what you want to measure. Note that NFE is not adequately accurate to always be able to read below kTB.

On instruments with the NF2 license installed, the calibrated Noise Floor used by Noise Floor Extensions should be refreshed periodically. Keysight recommends that the **Characterize Noise Floor** operation be performed after the first 500 hours of operation, and once every calendar year. The key to perform this is located in the **System, Alignments, Advanced** menu. If you have not done this yourself at the recommended interval, then when you turn on Noise Floor Extensions, the instrument will prompt you to do so with a dialog that says:

This action will take several minutes to perform. Please disconnect all cables from the RF input and press Enter to proceed. Press ESC to cancel, or Postpone to postpone for a week

If you Cancel, you will be prompted again the next time you turn NFE on. If you postpone, you will be prompted again after a week passes and you then turn NFE on.

Conversion

Access a menu of functions that enable you to control the frequency conversion type for the current measurement. The following choices are available:

Auto	AUTO	Auto optimizes demodulation quality by selecting single conversion when available. Default value
Single High Side	SHSide	Single downconversion with the LO frequency above the receiver frequency. Not image protected, and available only above 400 MHz or at all frequencies under specific condition
Single Low Side	SLSide	Single downconversion with the LO frequency below the receiver frequency. Not image protected, and available only above 1.1 GHz
Image Protect	IPRotect	Double downconversion with pre-selection filtering. Available at all frequencies

Remote Command	<code>[:SENSE]:MONitor:CONversion:TYPE AUTO SHSide SLSide IPRotect</code> <code>[:SENSE]:MONitor:CONversion:TYPE?</code>
Example	<code>:MON:CON:TYPE AUTO</code> <code>:MON:CON:TYPE?</code>
Dependencies	This control only appears in the M9391A
Couplings	The availabilities of SingleHighSide and SingleLowSide depend on the current Sweep Parameters such as Center Freq, Span, Res BW and Points
Preset	<code>AUTO</code>
State Saved	Yes
Range	<code>AUTO SHSide SLSide IPRotect</code>

Phase Noise Optimization

Access a menu of functions that enable you to control the phase noise optimization for the current measurement. The following choices are available:

Normal	<code>NORmal</code>	Sets the Synthesizer's Phase Lock Loop to the Normal setting (Best Close-In)
Best Wide Offset	<code>BWOffset</code>	Sets the Synthesizer's Phase Lock Loop for narrow bandwidth to improve ORFS and EVM measurements for wide modulation

Remote Command	<code>[:SENSE]:MONitor:PNOise:OPTion NORmal BWOffset</code> <code>[:SENSE]:MONitor:PNOise:OPTion?</code>
Example	<code>:MON:PNO:OPT NOR</code> <code>:MON:PNO:OPT?</code>
Dependencies	This control only appears in the M9391A
Preset	<code>NORmal</code>
State Saved	Yes
Range	<code>NORmal BWOffset</code>

3.3.8.3 Global

The controls in this menu apply to all Modes in the instrument.

Some controls (for example, "**Global Center Freq**" on page 1828) allow you to switch certain Meas Global parameters to a Mode Global state. These switches apply to all Modes that support global settings. For example, no matter what Mode you are in when you set **Global Center Freq** to **ON**, it applies to all Modes that support Global settings.

Other controls (for example, **Extend Low Band**) are actually set in this menu, but apply to all Modes.

Global Center Freq

The software maintains a Mode Global value called **Global Center Freq**.

When **Global Center Freq** is switched **ON**, the current Mode's center frequency is copied into the **Global Center Frequency**, and from then on all Modes that support global settings use the **Global Center Frequency**, so you can switch between any of these Modes and the **Center Frequency** remains unchanged.

Adjusting the **Center Frequency** of any Mode that supports Global Settings, while **Global Center Freq** is **ON**, modifies the **Global Center Freq**.

When **Global Center Freq** is switched **OFF**, the **Center Frequency** of the current Mode is unchanged, but now the **Center Frequency** of each Mode is once again independent.

When **Mode Preset** is pressed while **Global Center Freq** is **ON**, the **Global Center Freq** is preset to the preset **Center Frequency** of the current Mode.

This function resets to **OFF** when "**Restore Defaults**" on page 1829 is pressed, or when **System, Restore Defaults, All Modes** is pressed.

Remote Command	<code>:INSTrument:COUPle:FREQuency:CENTer ALL NONE</code> <code>:INSTrument:COUPle:FREQuency:CENTer?</code>
Example	<code>:INST:COUP:FREQ:CENT ALL</code> <code>:INST:COUP:FREQ:CENT?</code>
Preset	Set to OFF on Global Settings, Restore Defaults and System, Restore Defaults, All Modes
Range	ALL NONE
Preset	OFF
Backwards Compatibility SCPI	<code>:GLOBal:FREQuency:CENTer[:STATe] 1 0 ON OFF</code> <code>:GLOBal:FREQuency:CENTer[:STATe]?</code>

Global EMC Std

When this control is switched **ON**, the current Mode's EMC Std is copied into the **Global EMC Std**, and from then on all Modes that support global settings use the **Global EMC Std**, so you can switch between any of these Modes and the EMC Std remains unchanged.

Adjusting the EMC Std of any Mode that supports Global settings, while **Global EMC Std** is **ON** modifies the **Global EMC Std**.

When **Global EMC Std** is switched **OFF**, the EMC Std of the current Mode remains unchanged, but now the EMC Std of each Mode is once again independent. When

Mode Preset is pressed while **Global EMC Std** is **ON**, **Global EMC Std** is preset to the preset EMC Std of the current Mode.

This function resets to **OFF** when "**Restore Defaults**" on page 1829 is pressed, or when **System, Restore Defaults, All Modes** is pressed.

Remote Command	<code>:INSTrument:COUPle:EMC:STANdard ALL NONE</code> <code>:INSTrument:COUPle:EMC:STANdard?</code>
Example	<code>:INST:COUP:EMC:STAN ALL</code> <code>:INST:COUP:EMC:STAN?</code>
Dependencies	Only available if Option EMC is installed
Preset	Set to OFF on Global Settings, Restore Defaults and System, Restore Defaults, All Modes
Range	ALL NONE

Restore Defaults

Resets all functions in the **Global** settings menu to **OFF**. Pressing **System, Restore Defaults, All Modes** has the same effect.

Remote Command	<code>:INSTrument:COUPle:DEFault</code>
Example	<code>:INST:COUP:DEF</code>
Backwards Compatibility SCPI	<code>:GLOBal:DEFault</code>

3.3.9 Sweep

Accesses controls that enable you configure and control the acquisition of data and the X-axis parameters of the instrument. These controls might include Sweep Time, Continuous/Single, Pause/Resume, X Scale, and number of Points.

3.3.9.1 Sweep/Control

Accesses controls that let you operate the sweep and control functions of the instrument, such as **Sweep Time** and **Continuous/Single**.

Sweep Time

Controls the time the instrument takes to sweep the current frequency span in swept measurements, displays the sweep time in swept measurements, and displays the equivalent Sweep Time in FFT measurements.

When **Sweep Time** is in Auto, the instrument computes a time that will give accurate measurements based on other settings, such as RBW and VBW.

3 VMA Mode
3.3 Monitor Spectrum Measurement

You can select a shorter sweep time to improve the measurement throughput (with some potential unspecified accuracy reduction), but the **Meas Uncal** indicator will appear if the sweep time you set is less than the calculated Auto Sweep time.

You can also select a longer sweep time, which can be useful (for example) for obtaining accurate insertion loss measurements on very narrowband filters.

NOTE

Significantly faster sweep times are available with Option FS1.

NOTE

The **Meas Uncal** (measurement uncalibrated) warning is displayed in the Status Bar at the bottom of the screen when the manual Sweep time entered is faster than the time computed by the instrument's Sweep time equations, that is, the Auto Sweep Time. The instrument's computed Sweep time will provide accurate measurements; if you sweep faster than this your measurements may be inaccurate. A **Meas Uncal** condition may be corrected by returning the Sweep Time to Auto; by entering a longer Sweep Time; or by choosing a wider RBW and/or VBW.

NOTE

On non-sweeping hardware, this control is grayed-out. The value shown on this control is an estimate. It is the measurement's turnaround time, which is the sum of signal acquisition time, FFT time, and other overhead time, to complete the entire span of the measurement. If you need to specify the same "Sweep Time" as you would for sweeping hardware, send `[:SENSe] : <meas> : SWEep : TIME <time>`. The measurement emulates the "Sweep Time" effect, but this emulation is not straightforward, and therefore the behavior is not specified. Instead, we recommend using Minimum Acquisition Time, which provides better control.

Remote Command `[:SENSe] : <meas> : SWEep : TIME <time>`
`[:SENSe] : <meas> : SWEep : TIME ?`

Example Channel Power measurement:
`:CHP : SWE : TIME 25ms`
`:CHP : SWE : TIME ?`

Notes In the ACP measurement in WCDMA Mode, this parameter is preset by **Meas Method** selection. Preset values are as follows:

- IBW: 29 ms
- IBWR: 108 ms
- FAST 7.5 ms

Dependencies On non-sweeping hardware, this control is grayed out, and the Auto/Man toggle disappears. The read-only control shows estimated sweep time
In those instruments, "[Minimum Acquisition Time](#)" on page 1357 is available

Couplings Coupled to **Span**, **RBW**, **VBW**, and **Sweep Time Rules** when **Sweep Time** is set to Auto; **Sweep Time**

	changes when these parameters are changed When you manually set a value when in the Auto state, the state automatically changes to Man
Preset	Automatically Calculated unless noted below WCDMA Mode <ul style="list-style-type: none"> - Channel Power: 1.0 msOBW: 32.6 ms - ACP: 29 ms
State Saved	Saved in instrument state
Min	Other than non-sweeping hardware: Typically, 1 ms Non-sweeping hardware: N/A In the ACP measurement, when Meas Method is Fast Power , the minimum sweep time is span-dependent and automatically calculated
Max	Other than non-sweeping hardware: 4000 s Non-sweeping hardware: N/A
Annotation	The sweep time is displayed in the lower-right corner of the screen. The number of points is displayed parenthetically, as: Sweep 13.3 ms (1001 points) A “#” mark appears before “Sweep” in the annotation when it is switched from Auto to Manual coupling
Status Bits/OPC dependencies	Meas Uncal is Bit 0 in the register: STATus:QUESTionable:INTEgrity:UNCalibrated Auto Function
Remote Command	[:SENSe]:<meas>:SWEep:TIME:AUTO OFF ON 0 1 [:SENSe]:<meas>:SWEep:TIME:AUTO?
Example	Channel Power measurement: :CHP:SWE:TIME:AUTO OFF :CHP:SWE:TIME:AUTO?
Preset	WCDMA Mode OFF All others ON

Minimum Acquisition Time

Available on non-sweeping hardware.

Specifies the minimum acquisition time for each “chunk” of the measurement result. The instrument automatically divides Span into multiple chunks if needed. Therefore, the total signal acquisition time for the entire Span is:

$$\sim(\sim\text{Minimum Acquisition Time}) * (\text{The number of chunks})$$

3 VMA Mode
3.3 Monitor Spectrum Measurement

When in Auto, this parameter's value is determined by other parameters, such as **Span**, **RBW** and **VBW**.

You can manually increase this parameter value from this Auto value.

If increased, the instrument acquires signal for the specified time duration for each chunk. It performs additional FFTs, and averages or peak-holds the FFT results for a chunk, depending on **Detector** settings.

Note that the actual acquisition time for each chunk may exceed the **Minimum Acquisition Time** value, in order to satisfy FFT time required by other parameters, and to perform an integer number of FFTs.

Remote Command	<pre>[:SENSe]:<meas>:SWEep:ACQuisition:TIME <time> [:SENSe]:<meas>:SWEep:ACQuisition:TIME? <meas> is the identifier for the current measurement; any one of CHPower- ACPower OBwidth MONitor</pre>
Example	<pre>Channel Power measurement :CHP:SWE:ACQ:TIME 500 ms :CHP:SWE:ACQ:TIME?</pre>
Dependencies	Available only on non-sweeping hardware
Couplings	Coupled to Span , RBW , and VBW when in the Auto state When you manually set a value when in the Auto state, the state automatically changes to Man
Preset	Automatically calculated
State Saved	Saved in instrument state
Min	100 ns
Max	4.00 ks
Auto Function	
Remote Command	<pre>[:SENSe]:<meas>:SWEep:ACQuisition:TIME:AUTO OFF ON 0 1 [:SENSe]:<meas>:SWEep:ACQuisition:TIME:AUTO? <meas> is the identifier for the current measurement; any one of CHPower- ACPower OBwidth MONitor</pre>
Example	<pre>Channel Power measurement: :CHP:SWE:ACQ:TIME:AUTO OFF</pre>
Preset	ON

Sweep/Measure

Lets you toggle between **Continuous** and **Single** sweep or measurement operation. The single/continuous state is Meas Global, so the setting affects all measurements.

The front-panel key **Single/Cont** performs exactly the same function

See ["More Information" on page 652](#)

Remote Command	<code>:INITiate:CONTinuous OFF ON 0 1</code> <code>:INITiate:CONTinuous?</code>
Example	Put instrument into Single measurement operation: <code>:INIT:CONT 0</code> <code>:INIT:CONT OFF</code> Put instrument into Continuous measurement operation: <code>:INIT:CONT 1</code> <code>:INIT:CONT ON</code>
Preset	ON Note that <code>:SYST:PRES</code> sets <code>:INIT:CONT</code> to ON , but <code>*RST</code> sets <code>:INIT:CONT</code> to OFF
State Saved	Saved in instrument state
Annunciation	The Single/Continuous icon in the Meas Bar changes depending on the setting: <ul style="list-style-type: none"> - A line with an arrow is Single - A loop with an arrow is Continuous
Backwards Compatibility Notes	X-Series A-models had Single and Cont hardkeys in place of the SweepSingleCont softkey. In the X-Series A-models, if in single measurement, the Cont hardkey (and <code>INIT:CONT ON</code>) switched to continuous measurement, but never restarted a measurement and never reset a sweep X-Series B-models have a Cont/Single toggle control instead of Single and Cont hardkeys, but it is still true that, if in single measurement, the Cont/Single toggle control never restarts a measurement and never resets a sweep

More Information

Continuous Mode	The instrument takes repetitive sweeps, averages, measurements, etc., when in continuous mode. If in average or Max/Min Hold, and the average/hold count reaches the Average/Hold Num , the count stops incrementing, but the instrument keeps sweeping See the Trace key description under Trace Average for the averaging formula used both before and after the Average/Hold Num is reached. The trigger condition must be met prior to each sweep The type of trace processing for multiple sweeps is set under the Trace key, with choices of Trace Average , Max Hold , or Min Hold
Single Mode	The instrument takes a single sweep when in Single mode, or if in average or Max/Min Hold, or if there is a Waterfall window displayed, it takes multiple sweeps until the average/hold count reaches the Average/Hold Num , then the count stops incrementing, and the instrument stops sweeping See the Trace key description under Trace Average for the averaging formula used. The trigger condition must be met prior to the sweep The type of trace processing for multiple sweeps is set under the Trace key, with choices of Trace Average , Max Hold , or Min Hold

If the instrument is in **Single** measurement mode, pressing the **Cont/Single** toggle control does not zero the count and does not cause the sweep to be reset; the only action is to put the instrument into Continuous measurement operation.

If the instrument is already in **Continuous** sweep:

- `:INIT:CONT 1` has no effect
- `:INIT:CONT 0` places the instrument in Single Sweep but has no effect on the current sequence until $k = N$, at which point the current sequence will stop and the instrument will go to the idle state

See "[Restart](#)" on page 1832 for details of `:INIT:IMMEDIATE`.

If the instrument is already in **Single** sweep, `:INIT:CONT OFF` has no effect.

If the instrument is already in **Single** sweep, then pressing **Cont/Single** in the middle of a sweep does not restart the sweep or sequence. Similarly, pressing **Cont/Single** does not restart the sweep or sequence if the sweep is not in the idle state (for example, if you are taking a very slow sweep, or the instrument is waiting for a trigger). Even though pressing **Cont/Single** in the middle of a sweep does not restart the sweep, sending `:INIT:IMM` *does* reset it.

If the instrument is in **Single** sweep, and *not* Averaging/Holding, and you want to take one more sweep, press **Restart**.

If the instrument is in **Single** sweep, *and* Averaging/Holding, and you want to take one more sweep without resetting the Average trace or count, go to **Meas Setup** and increment the average count by 1 by pressing the **Step-Up** key while **Average/Hold Num** is the active function. You can also do this by sending `:CALC:AVER:TCON UP`.

Restart

Restarts the current sweep, or measurement, or set of averaged/held sweeps or measurements. If you are Paused, pressing **Restart** performs a Resume.

The front-panel key **Restart** performs exactly the same function.

The **Restart** function is accessed in several ways:

- Pressing the **Restart** key
- Sending `:INIT:IMM`
- Sending `:INIT:REST`

See "[More Information](#)" on page 654

Remote `:INITiate[:IMMEDIATE]`

Command	:INITiate:REStart
Example	:INIT:IMM :INIT:REST
Notes	:INIT:REST and :INIT:IMM perform exactly the same function
Couplings	Resets average/hold count k. For the first sweep overwrites all active (update = on) traces with new current data. For application modes, it resets other parameters as required by the measurement
Status Bits/OPC dependencies	This is an Overlapped command The STATUS:OPERation register bits 0 through 8 are cleared , except bit 6 (Waiting for Periodic Sync). Initiating a measurement and Waiting for Periodic Sync could be asynchronous The STATUS:QUEStionable register bit 9 (INTEgrity sum) is cleared The SWEEPING bit is set The MEASURING bit is set
Backwards Compatibility Notes	For Spectrum Analysis Mode in ESA and PSA, the Restart hardkey and the :INIT:REST command restarted trace averages (displayed average count reset to 1) for a trace in Clear Write, but did not restart Max Hold and Min Hold In X-Series, the Restart hardkey and the :INIT:REST command restart not only Trace Average, but MaxHold and MinHold traces as well

More Information

The **Restart** function first aborts the current sweep or measurement as quickly as possible. It then resets the sweep and trigger systems, sets up the measurement and initiates a new data measurement sequence with a new data acquisition (sweep) taken once the trigger condition is met.

If the instrument is in the process of aligning when a **Restart** is executed, the alignment finishes before the restart function is performed.

Even when set for **Single** operation, multiple sweeps may be taken when **Restart** is pressed (for example, when averaging/holding is on). Thus, when we say that **Restart** "restarts a measurement", depending on the current settings, we may mean that it:

- Restarts the current sweep
- Restarts the current measurement
- Restarts the current set of sweeps if any trace is in Trace Average, Max Hold or Min Hold
- Restarts the current set of measurements if Averaging, or Max Hold, or Min Hold is on for the measurement

If there is no Average or Max/Min Hold function (no trace in Trace Average or Hold, or **Average/Hold Num** set to 1), and no **Waterfall** window is being displayed, a single

sweep is equivalent to a single measurement. A single sweep is taken after the trigger condition is met; and the instrument stops sweeping once that sweep has completed. However, with **Average/Hold Num** >1, and at least one trace set to Trace Average, Max Hold, or Min Hold, or a **Waterfall** window being displayed, multiple sweeps/data acquisitions are taken for a single measurement. The trigger condition must be met prior to each sweep. The sweep is stopped when the average count k equals the number N set for **Average/Hold Num**.

Once the full set of sweeps has been taken, the instrument goes to the idle state. To take one more sweep without resetting the average count, increment the average count by 1, by pressing the **Step-Up** key while **Average/Hold Number** is the active function, or by sending the remote command **:CALC:AVER:TCON UP**.

Trace Update

The numeric results are not blanked at any time during the restart cycle.

For slow sweeps (see **Trace Update** section in **Trace/Detector**), the traces are updated real-time during the sweep. There may be a special circumstance in application mode measurements where an exception is made and the traces and/or results need to be blanked before displaying the new results.

To summarize, the following list shows what happens to the trace data on various events:

Event	Trace Effect
Clear/Write pressed (even if already in Clear/Write)	Set to mintracevalue
Max Hold pressed (even if already in Max Hold)	Set to mintracevalue
Min Hold pressed (even if already in Min Hold)	Set to maxtracevalue
Trace Average pressed (even if already in Trace Average)	Trace data unaffected but start new sweep/avg/hold
Restart pressed	Trace data unaffected but start new sweep/avg/hold
Parameter requiring restart changed (e.g., RBW)	Trace data unaffected but start new sweep/avg/hold

Sweep and Trigger Reset

Resetting the sweep system resets the average/hold count k to 0. It also resets the set point counter to 0. Resetting the trigger system resets the internal auto trig timer to the value set by the **Auto Trig** control.

Averaging

The weighting factor used for averaging is k . This k is also the average/hold count for how many valid sweeps (data acquisitions) have been done. This k is used for comparisons with N , as those comparisons always needs to be based on valid completed sweeps.

The displayed average/hold, K , shows the count for the sweep (data acquisition) in progress. $K = k + 1$, with a limit of N . The displayed value K changes from its previous value to 1 as soon as the trigger condition for the first data acquisition (sweep) is met.

Pause/Resume

Pauses a measurement after the current data acquisition is complete.

When paused, the label on the control changes to **Resume**. Pressing **Resume** unpauses the measurement. When paused, pressing **Restart** performs a Resume.

Remote Command	<code>:INITiate:PAUSE</code> <code>:INITiate:RESume</code>
Example	<code>:INIT:PAUS</code> <code>:INIT:RES</code>
Dependencies	Not displayed in Modes that do not support pausing
Annotation	Only on control

Abort (Remote Command Only)

Stops the current measurement. Aborts the current measurement as quickly as possible, resets the sweep and trigger systems, and puts the measurement into an "idle" state. If the instrument is in the process of aligning when `:ABORT` is sent, the alignment finishes *before* the abort function is performed, so `:ABORT` does not abort an alignment.

If the instrument is set for **Continuous** measurement, it sets up the measurement and initiates a new data measurement sequence with a new data acquisition (sweep) taken once the trigger condition is met.

If the instrument is set for **Single** measurement, it remains in the "idle" state until an `:INIT:IMM` command is received.

Remote Command	<code>:ABORT</code>
Example	<code>:ABOR</code>

3 VMA Mode

3.3 Monitor Spectrum Measurement

Notes	<p>If :INIT:CONT is ON, then a new continuous measurement will start immediately, with sweep (data acquisition) occurring once the trigger condition has been met</p> <p>If :INIT:CONT is OFF, then :INIT:IMM is used to start a single measurement, with sweep (data acquisition) occurring once the trigger condition has been met</p>
Dependencies	<p>For continuous measurement, :ABORT is equivalent to the Restart key</p> <p>Not all measurements support this command</p>
Status Bits/OPC dependencies	<p>The STATus:OPERation register bits 0 through 8 are cleared, <i>except</i> bit 6 (Waiting for Periodic Sync). Initiating a measurement and Waiting for Periodic Sync could be asynchronous</p> <p>The STATus:QUESTionable register bit 9 (INTegrity sum) is cleared</p> <p>Since all the bits that feed into OPC are cleared by :ABORT, the Abort command will cause the *OPC query to return true</p>

Sweep Time Annotation (Remote Query Only)

Returns the **Sweep Time Annotation** value. Available only on non-sweeping hardware.

This value is also displayed in the result trace window.

The value returned is the estimated turnaround time of each measurement cycle, in seconds. The turnaround time is the sum of the signal acquisition time, FFT time, and other overhead time, to complete the entire span of each measurement cycle.

Remote Command	<p>[:SENSe] : <meas> : SWEEp : ETIME?</p> <p><meas> is the identifier for the current measurement; any one of CHPower- ACPower OBWidth MONitor</p>
Example	<p>Channel Power measurement</p> <p>:CHP:SWEE:ETIME?</p>
Dependencies	Available only on non-sweeping hardware
Preset	Automatically calculated

3.3.9.2 Sweep Config

Accesses controls that enable you to configure the Sweep and Control functions of the instrument, such as Sweep Rules.

Points

Sets the number of points taken per sweep, and displayed in the traces. The current value of points is displayed parenthetically, next to the sweep time in the lower-right corner of the display. Using more points provides greater resolution. Using fewer

points compacts the data and decreases the time required to access a trace over the remote interface.

Increasing the number of points does not increase the sweep time. However, it can slightly impact the trace processing time and therefore the overall measurement speed. Decreasing the number of points does not decrease the sweep time, but it may speed up the measurement, depending on the other sweep settings (for example, in FFT sweeps). Fewer points will always speed up the I/O.

Due to minimum sweep rate limitations of the hardware, the minimum sweep time available to the user will increase above its normal value of 1 ms as the number of sweep points increases above 15001.

Changing the number of sweep points has several effects on the instrument. Since markers are read at the point location, the marker reading may change. The sweep time resolution will change. Trace data for all the traces will be cleared and, if Sweep is in Cont, a new trace taken. If any trace is in average or hold, the averaging starts over.

Because of sweep time quantization issues, the knob and up/down keys cannot be used to adjust the number of points.

When in a split screen display each window may have its own value for points.

When sweep points is changed, an informational message "Sweep points changed, all traces cleared" is displayed and in the 5G NR mode, Auto Sweep Points is set to OFF(0).

Remote Command	<code>[:SENSe]:MONitor:SWEEp:POINTs <integer></code> <code>[:SENSe]:MONitor:SWEEp:POINTs?</code>
Example	<code>:MON:SWE:POIN 1000</code> <code>:MON:SWE:POIN?</code>
Dependencies	This function is not available when Signal ID is set to On in External Mixing Neither the knob nor the step keys can be used to change this value. If it is tried, a warning is given Not displayed in modes that do not support Swept
Couplings	Whenever the number of sweep points change: <ul style="list-style-type: none"> - All trace data is erased - Any traces with Update Off will also go to Display Off (like going from View to Blank in the older instruments) - Sweep time is re-quantized - Any limit lines that are on will be updated - If averaging/hold is on, averaging/hold starts over - Auto Sweep Points is OFF (Only 5G NR) <p>The resolution of setting the sweep time depends on the number of points selected</p>

3 VMA Mode
3.3 Monitor Spectrum Measurement

Preset	1001 unless noted below 2001: 5GNR
State Saved	Saved in instrument state
Min	1
Max	20001
Annotation	On second line of annotations, in lower right corner in parenthesis behind the sweep annotation

Auto Sweep Points

When **Auto Sweep Points** is **ON**, the instrument determines the points using the following calculation formula:

$$\# \text{ points} = \text{ceil}(\text{Span} / (\text{Rbw} * 1\text{e}3)) * 1000 + 1$$

Where $\text{ceil}(x)$ returns the smallest possible integer value that is greater than or equal to x .

Remote Command	<code>[:SENSe]:MONitor:SWEEp:POINts:AUTO[:STATe] OFF ON 0 1</code> <code>[:SENSe]:MONitor:SWEEp:POINts:AUTO[:STATe]?</code>
Example	<code>:MON:SWE:POIN:AUTO 0</code> <code>:MON:SWE:POIN:AUTO?</code>
Dependencies	This parameter is available only in the 5GNR mode
Preset	ON
State Saved	Yes
Range	OFF ON

3.3.10 Trace

Lets you control the acquisition, display, storage, detection, and manipulation of trace data for the available traces.

The "**Trace Control**" on [page 1736](#) tab in this menu contains radio-button selections for the trace type (**Clear/Write**, **Trace Average**, **Max Hold**, **Min Hold**) and **View/Blank** setting for the selected trace.

3.3.10.1 Select Trace

Specifies the *selected trace*, which is the trace that will be affected when you change trace settings.

Select Trace appears above the menu panel, indicating that it applies to *all* controls in the menu panel. **Select Trace** is blanked if you select a tab whose controls do *not* depend on the selected trace (for example, **Trace Function**).

Notes	The selected trace is remembered even when not in the Trace menu
Dependencies	For the Swept SA measurement: <ul style="list-style-type: none"> - In Image Suppress mode, when you select a trace it becomes the active trace, and the formerly active trace goes into View - When you turn on Image Suppress, Update turns off for all traces except the selected trace For the ACP measurement, when Meas Method is RBW , FAST or FPOwer , Select Trace is disabled
Preset	Trace 1
State Saved	Yes

3.3.10.2 Trace Control

The controls on this tab allow you to set the "Trace Type" on page 1737 and its update mode.

There are four Trace Types:

- Clear/Write
- Trace Average
- Max Hold
- Min Hold

Each type handles data in a different way.

Each trace also has two values that determine whether it is being written or not, and whether it is being displayed or not. These values, **Update** and **Display**, are described fully in the "View/Blank" on page 1742 control description. Essentially, when **Update** is **ON**, a trace is updating, and when **Update** is **OFF** it is not. When **Display** is **ON**, it is visible and when **Display** is **OFF** it is not. These terms are used throughout the descriptions in this section.

Trace Type

There are four trace Types:

Option	Parameter	SCPI Example	Details
Clear/Write	WRITE	:TRAC2:TYPE WRIT	See: "Clear/Write" on page 663
Trace Average	AVERage	:TRAC2:TYPE AVER	See: "Trace Average" on page 664

3 VMA Mode
3.3 Monitor Spectrum Measurement

Option	Parameter	SCPI Example	Details
Maximum Hold	MAXHold	:TRAC3:TYPE MAXH	See: "Max Hold" on page 665
Minimum Hold	MINHold	:TRAC5:TYPE MINH	See: "Min Hold" on page 665

Full descriptions of each type are provided below. You may select one of these types for each trace. Re-selecting the current **Trace Type** initiates the same action that selecting it the first time did, even though it is already selected. For example, selecting **Clear/Write** while **Clear/Write** is already selected will nonetheless clear the trace and begin rewriting it.

Besides the **Trace Type**, the "**View/Blank**" on page 1742 state must be set to **Active** (**Update: ON, Display: ON**) for a trace to be updating and visible. Selecting any **Trace Type** automatically makes the trace **Active**.

See also: "**Trace Mode Backwards Compatibility Commands**" on page 661

Remote Command	<p>For Swept SA Measurement (in SA Mode):</p> <pre>:TRACe[1] 2 ... 6:TYPE WRITe AVERAge MAXHold MINHold</pre> <pre>:TRACe[1] 2 ... 6:TYPE?</pre> <p>For all other measurements:</p> <pre>:TRACe[1] 2 3:<meas>:TYPE WRITe AVERAge MAXHold MINHold</pre> <pre>:TRACe[1] 2 3:<meas>:TYPE?</pre> <p>where <meas> is the identifier for the current measurement</p>
Example	<pre>:TRAC:TYPE WRIT</pre> <pre>:TRAC:TYPE?</pre>
Couplings	<p>Selecting a Trace Type (by pressing any of the Trace Type selections or sending :TRAC:TYPE) sets the Trace to Active (Update: ON, Display: OFF), even if the same trace type was already selected</p> <p>When Detector setting is "Auto" ([:SENSe] :<meas>:DETECTOR:AUTO?), Detector ([:SENSe] :<meas>:DETECTOR[:FUNCTION]?) switches aligning with the switch of this parameter: "NORMAL" with WRITe (Clear Write), "AVERAge" with AVERAge, "POSitive (peak)" with MAXHold, and "NEGative (peak)" with MINHold</p>
Preset	<p>Swept SA and Monitor Spectrum: WRITe</p> <p>All other measurements: AVERAge</p> <p>Following Preset, all traces are cleared (all trace points set to mintracevalue)</p>
State Saved	The type of each trace is saved in instrument state
Annunciation	The type for each trace is indicated in the Trace annunciator panel on the Measurement Bar

Trace Mode Backwards Compatibility Commands

In earlier instruments, the "Trace Modes" were: Clear/Write, Max Hold, Min Hold, View and Blank. Averaging was global to all traces and was controlled under the **BW/Avg** menu.

In X-Series, trace averaging can be done on a per-trace basis. The Trace Modes (now called Trace Types) are Clear/Write, Trace Average, Max Hold and Min Hold. View and Blank are set separately under "[View/Blank](#)" on page 1742.

While this provides more flexibility, it also gives rise to potential backwards compatibility problems. To mitigate these, the old Trace Mode command has been retained and a new Trace Type command has been added. The `:TRACe:MODE` command is retained for backwards compatibility, and the `:TRACe:TYPE`, `:TRACe:UPDate` and `:TRACe:DISPlay` commands introduced for ongoing use. The old Trace Modes are selected using `:TRAC:MODE`, whose parameters are mapped into calls to `:TRACe:TYPE`, `:TRACe:UPDate` and `:TRACe:DISPlay`, and the old global Averaging command `[:SENSe]:AVERage[:STATe]` is provided for backwards compatibility. See the individual command descriptions for details.

When **Average/Hold** in the **Meas Setup, Legacy Compatibility** menu is **ON**, the following is true for traces in Max Hold and Min Hold:

- They ignore the **Average/Hold** number; **Single** for Max Hold causes one sweep only, so switching to **Single** stops after the current sweep, and switching to **Cont** starts again without clearing the accumulated result
- Max Hold is not cleared on a **Restart**, **Single** or `:INIT:IMM`, but changing a measurement parameter, like frequency or bandwidth etc., still restarts the Max Hold

Preset	<code>WRITE</code>
State Saved	The trace mode is an alias only
Backwards Compatibility SCPI	<code>:TRACe[1] 2 ... 6:MODE WRITE MAXHold MINHold VIEW BLANK</code> <code>:TRACe[1] 2 ... 6:MODE?</code>
Backwards Compatibility Notes	<p>The legacy <code>:TRACe:MODE</code> command is retained for backwards compatibility. In conjunction with the legacy <code>:AVERage</code> command, it works as follows:</p> <ul style="list-style-type: none"> - <code>:AVERage ON OFF</code> sets/clears a variable that we will call average for the sake of this discussion. This variable is maintained by the instrument solely for backwards compatibility. See the <code>[:SENSe]:AVERage[:STATe]</code> command description below - <code>:TRACe:MODE WRITE</code> sets <code>:TRACe:TYPE WRITE</code> (Clear/Write) unless average is true, in which case it sets it to <code>:TRACe:TYPE AVERage</code>. It also sets <code>:TRACe:UPDate ON</code>, <code>:TRACe:DISPlay ON</code>, for the selected trace - <code>:TRACe:MODE MAXHold</code> sets <code>:TRACe:TYPE MAXHold</code> (Max Hold). It also sets <code>:TRACe:UPDate ON</code>, <code>:TRACe:DISPlay ON</code>, for the selected trace - <code>:TRACe:MODE MINHold</code> sets <code>:TRACe:TYPE MINHold</code> (Min Hold). It also sets <code>:TRACe:UPDate ON</code>, <code>:TRACe:DISPlay ON</code>, for the selected trace - <code>:TRACe:MODE VIEW</code> sets <code>:TRACe:UPDate OFF</code>, <code>:TRACe:DISPlay ON</code>, for the selected trace

3 VMA Mode

3.3 Monitor Spectrum Measurement

-
- `:TRACe:MODE BLANK` sets `:TRACe:UPDate OFF`, `:TRACe:DISPlay OFF`, for the selected trace

The query returns the same value as `:TRACe:TYPE?`, meaning that if you set `:TRACe:MODE:VIEW` or `:TRACe:MODE:BLANK`, the query response will not be what you sent

`:TRACe[n]:MODE` was formerly used to set the type or “writing mode” of the trace. At that time, View and Blank were writing modes. The new `:TRACe:TYPE` command should be used in the future, but `:TRACe:MODE` is retained to provide backwards compatibility

In X-Series, unlike earlier instruments, Max Hold and Min Hold now obey the Average Number and counts up to a terminal value as Average always has

As the **Average/Hold Number** now affects **Min Hold** and **Max Hold**, the operations that restart Averaging (for example, the **Restart** key) now also restart **Min Hold** and **Max Hold**

As a result of these changes, legacy code that restarts averaging while retaining a running Max Hold will need to be rewritten, because the Max Hold will now restart when the Average does

Also, previous to X-Series:

- Pressing **Max Hold** while already in **Max Hold** (or doing so remotely) had no effect. Now it will clear the trace and restart the sweep and the Max Hold sequence
- Changing the vertical scale (Log/Lin or dB/div) of the display restarted **Max Hold** and **Min Hold**. This is no longer the case

Preset	<code>OFF</code>
State Saved	The state of Average is saved in Instrument State for ghosting purposes
Backwards Compatibility SCPI	<code>[:SENSe]:AVERage[:STATe] ON OFF 1 0</code> <code>[:SENSe]:AVERage[:STATe]?</code>
Backwards Compatibility Notes	<p>Previous to X-Series, Averaging (also sometimes known as trace averaging) was global to all traces, that is, it was either on or off for all active traces. The legacy command <code>[:SENSe]:AVERage[:STATe] ON OFF 1 0</code> was used to turn Averaging on or off</p> <p>In X-Series, Averaging is turned on or off on a per-trace basis, so it can be on for one trace and off for another</p> <p>For backwards compatibility, the old global Average State variable is retained solely as a legacy variable, turned on and off and queried by the legacy command <code>[:SENSe]:AVERage[:STATe] OFF ON 0 1</code>. When Average is turned on, any trace in Clear/Write will get put into Average. While Average is on, any trace put into Clear/Write by the old <code>:TRAC:MODE</code> command will instead get put into Average. When Average is turned off, any trace in Average will get put into Clear/Write</p>

Trace Type Details

Clear/Write

Each trace update replaces the old data in the trace with new data.

Pressing **Clear/Write** for the selected trace, or sending `:TRAC:TYPE WRIT` for the specified trace, sets the trace type to **Clear/Write** and clears the trace, even if you are already in **Clear/Write**. Then a new sweep is initiated. Trigger conditions must be met before the sweep actually starts, and if in **Single** the sweep won't start until **Restart** is pressed.

Pressing **Clear/Write** stops the current sweep and initiates a new one, so **Trace Average**, **Max Hold** and **Min Hold** data may be interrupted in mid-sweep when **Clear/Write** is pressed, and therefore may not accurately reflect the displayed count. Therefore, when **Clear/Write** is pressed for one trace, **Trace Average**, **Max Hold** and **Min Hold** must restart for all traces.

When in **Clear/Write**, if a measurement-related instrument setting is changed (that is, one which requires new data to be taken, like **Center Frequency** or **Attenuation**), a new sweep is initiated but the trace is not cleared.

Trace Average

The instrument maintains and displays an average trace, which represents the cumulative average on a point-by-point basis of the new trace data and previous averaged trace data.

Pressing **Trace Average** (for the selected trace), or sending `:TRAC:TYPE AVER` (for the specified trace), sets the trace type to **Trace Average**, clears the trace, initiates a new sweep, and restarts the Average sequence.

Details of the count limiting behavior and the averaging calculations may be found under **Avg|Hold Number** and **Average Type** under **Meas Setup**.

When in **Trace Average**, if a measurement-related instrument setting is changed (that is, one which requires new data to be taken, like **Center Frequency** or **Attenuation**), the average restarts and a new sweep is initiated but the trace is not cleared.

Restarting the average means:

- The average/hold count k is set to 1, so that the next time the average trace is displayed it simply represents one trace of new data
- A new sweep is initiated
- Once the new sweep starts, the trace is overwritten with current trace data as the first trace of the new average

Remember that restarting averaging also restarts **Max Hold** and **Min Hold**, as there is only one count for Trace Average and Hold.

Max Hold

The instrument maintains and displays a max hold trace, which represents the maximum data value on a point-by-point basis of the new trace data and previous trace data. Details of the count limiting behavior may be found under **Avg|Hold Number** under **Meas Setup**.

Pressing **Max Hold** for the selected trace, or sending `:TRAC:TYPE MAXH` for the specified trace, sets the Trace Type to **Max Hold**, clears the trace, initiates a new sweep, and restarts the hold sequence, even if you are already in **Max Hold**.

When in **Max Hold**, if a measurement-related instrument setting is changed (that is, one which requires new data to be taken, like **Center Frequency** or **Attenuation**), the **Max Hold** sequence restarts and a new sweep is initiated but the trace is not cleared.

Restarting the **Max Hold** sequence means:

- The average/hold count k is set to 1, so that the next time the max hold trace is displayed it simply represents one trace of new data
- A new sweep is initiated.

Remember that restarting **Max Hold** also restarts averaging and **Min Hold**, as there is only one count for Trace Average and Hold.

Min Hold

The instrument maintains and displays a min hold trace, which represents the minimum data value on a point-by-point basis of the new trace data and previous trace data. Details of the count limiting behavior may be found under **Avg|Hold Number** under the **Meas Setup** functions.

Pressing **Min Hold** for the selected trace, or sending `:TRAC:TYPE MINH` for the specified trace, sets the Trace Type to **Min Hold**, clears the trace, initiates a new sweep, and restarts the hold sequence, even if you are already in **Min Hold**.

When in **Min Hold**, if a measurement-related instrument setting is changed (that is, one which requires new data to be taken, like **Center Frequency** or **Attenuation**), the **Min Hold** sequence restarts and a new sweep is initiated but the trace is not cleared.

Restarting the **Min Hold** sequence means:

- The average/hold count k is set to 1, so that the next time the min hold trace is displayed it simply represents one trace of new data
- A new sweep is initiated

Remember that restarting **Min Hold** also restarts **Max Hold** and averaging, because there is only one count for Trace Average and Hold.

Clear and Write | Restart Averaging | Restart Max/Min Hold

Starts the trace writing, as though the "Trace Type" on page 1737 had just been selected. The effect is exactly the same as reselecting the current Trace Type again – the control is provided because it may not be obvious that reselecting the same selection from a radio button menu will take any action.

This control displays different labels, depending on the selected Trace Type:

- **Clear/Write:** Clear and Write
- **Trace Average:** Restart Averaging
- **Max Hold:** Restart Max Hold
- **Min Hold:** Restart Min Hold

View/Blank

Lets you set the state of the two trace variables: **Update** and **Display**. The choices available in this dropdown menu are:

Active	Update and Display both ON
View	Update OFF ; Display ON
Blank	Update OFF ; Display OFF
Background	Update ON , Display OFF Allows a trace to be blanked <i>and</i> continue to update “in the background”, which was not possible in the past

In the Swept SA measurement, a trace with **DisplayOFF** is indicated by a strikethrough of the type letter in the trace annotation panel in the Measurement Bar. A trace with **UpdateOFF** is indicated by dimming the type letter in the trace annotation panel in the Measurement Bar. In the example below, Traces 3, 4, 5 and 6 have **UpdateOFF**, and Traces 4 and 6 have **DisplayOFF**.

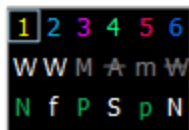

See: "[More Information](#)" on page 668

Notes	For the commands to control the two variables, Update and Display, see " Trace Update State On/Off " on page 667 and " Trace Display State On/Off " on page 667 below
Dependencies	When Signal ID is on, this key is grayed-out

3 VMA Mode
3.3 Monitor Spectrum Measurement

Couplings

Selecting a Trace Type for a trace (pressing the key or sending the equivalent command) puts the trace in **Active** (Update **ON** and Display **ON**), even if that trace type was already selected

Selecting a detector for a trace (pressing the key or sending [:SENS] :DET :TRAC) puts the trace in **Active** (Update**ON** and Display**ON**), even if that detector was already selected

Selecting a "Math Function" on page 1745 other than **OFF** for a trace (pressing the key or sending the equivalent command) puts the trace in **Active** (Update**ON** and Display**ON**), even if that Math Mode was already selected

Loading a trace from a file puts that trace in **View** regardless of the state it was in when it was saved; as does being the target of a **Copy** or a participant in an **Exchange**

Trace Update State On/Off

Remote Command

For Swept SA Measurement (in SA Mode):
:TRACe[1]|2|...|6:UPDate[:STATe] ON | OFF | 1 | 0
:TRACe[1]|2|...|6:UPDate[:STATe]?

For all other measurements:
:TRACe[1]|2|3:<meas>:UPDate[:STATe] ON | OFF | 1 | 0
:TRACe[1]|2|3:<meas>:UPDate[:STATe]?

where <meas> is the identifier for the current measurement

Example

Make trace 2 inactive (stop updating):
:TRAC2:UPD 0

Couplings

Whenever you set **Update** to **ON** for any trace, the **Display** is set to **ON** for that trace

Preset

For Swept SA Measurement (in SA Mode):
1|0|0|0|0|0

ON for Trace 1; **OFF** for 2–6

For all other measurements:
1|0|0

ON for Trace 1; **OFF** for 2 & 3

State Saved

Saved in instrument state

Trace Display State On/Off

Remote Command

For Swept SA Measurement (in SA Mode):
:TRACe[1]|2|...|6:DISPlay[:STATe] ON | OFF | 1 | 0
:TRACe[1]|2|...|6:DISPlay[:STATe]?

For all other measurements:
:TRACe[1]|2|3:<meas>:DISPlay[:STATe] ON | OFF | 1 | 0
:TRACe[1]|2|3:<meas>:DISPlay[:STATe]?

where <meas> is the identifier for the current measurement

Example	<p>Make trace 1 visible: :TRAC2:DISP 1</p> <p>Blank trace 3: :TRAC3:DISP 3</p>
Couplings	Whenever you set Update to ON for any trace, the Display is set to ON for that trace
Preset	<p>For Swept SA Measurement (in SA Mode): 1 0 0 0 0 0</p> <p>ON for Trace 1; OFF for 2–6</p> <p>For all other measurements: 1 0 0</p> <p>ON for Trace 1; OFF for 2 & 3</p>
State Saved	Saved in instrument state

More Information

When a trace becomes inactive, any update from the **:SENSe** system (detectors) immediately stops, without waiting for the end of the sweep. The trace data remains unchanged, but stops updating. If the trace is blanked, this still does not affect the data in the trace. Traces that are blanked (**Display=OFF**) do not display nor appear on printouts, but their data stays intact, they may be queried, and markers may be placed on them

In most cases, inactive traces are static and unchanging; however, there are cases when an inactive trace will update, specifically:

- if data is written to that trace from remote
- if trace data is loaded from mass storage
- if the trace is the target of a **Copy** or participant in an **Exchange**
- if the trace is cleared using **Clear Trace**

Inactive traces that are also being displayed (traces in **View**) are displayed at half intensity. Traces in **View** display across the entire X-Axis of the instrument. Their horizontal placement does not change, even if X-Axis settings subsequently are changed, although Y-Axis settings do affect the vertical placement of data.

When a trace becomes active (**Update=ON**), the trace is cleared, the average count is reset, and a new sweep is initiated.

Note that putting a trace into **Display=OFF** and/or **Update=OFF** does *not* restart the sweep and does *not* restart Averaging or Hold functions for any traces.

Trace Settings Table

Lets you configure the Trace system using a visual utility.

Clear All Traces

Clears all traces from the display.

Remote Command	:TRACe:MONitor:CLEAr:ALL
Example	:TRAC:MON:CLE:ALL
Backwards Compatibility SCPI	:DISPLay:MONitor:VIEW:WINDow:TRACe:CLEAr:ALL

3.3.10.3 Detector

Lets you choose and configure detectors for the selected trace.

Detector

Allows you to select a specific detector for the current measurement. When the detector choice is Auto, the instrument selects the detector. The selected detector depends on marker functions, trace functions, and trace averaging functions for the current measurement.

The following options are available:

AUTO	The detector selected depends on marker functions, trace functions, average type, and the trace averaging function In the ACP measurement, when in AUTO, the detector selected is set to AVERage, unless the Radio Standard defaults state otherwise e.g., it is set to Peak for Radio Standard = PDC when Device = both MS and BTS, and when Radio Standard = NADC and Device = MS
NORMal	The detector determines the peak of the CW-like signals, and it yields alternating maximums and minimums of noise-like signals. This is also referred to as Rosenfell detection
AVERage	The detector determines the average of the signal within the sweep points, using RMS averaging
POSitive Peak	The detector determines the maximum of the signal within the sweep points
SAMPLE	The detector indicates the instantaneous level of the signal at the center of the sweep points represented by each display point
NEGative	The detector determines the minimum of the signal within the sweep points

Peak

Because they may not find a spectral component's true peak, neither **AVERage** nor **SAMPle** detectors measure amplitudes of CW signals as accurately as Peak or **NORMal**, but they do measure noise without the biases of Peak detection.

Remote Command	<code>[:SENSe]:MONitor:DETEctor:TRACe[1]2 3 AVERage NEGative NORMal POSitive SAMPle RMS</code> <code>[:SENSe]:MONitor:DETEctor:TRACe?</code>												
Example	<code>:MON:DET:TRAC NORM</code> <code>:MON:DET:TRAC?</code> <code>:MON:DET RMS</code> Sets the detector to AVERage . AVERage uses RMS averaging, so this is equivalent to selecting RMS												
Notes	The query returns a string corresponding to the detector type as shown below <table border="1" data-bbox="393 814 1406 1071"> <thead> <tr> <th>String Returned</th> <th>Definition</th> </tr> </thead> <tbody> <tr> <td>NORM</td> <td>Normal</td> </tr> <tr> <td>AVER</td> <td>Average (RMS)</td> </tr> <tr> <td>POS</td> <td>Peak</td> </tr> <tr> <td>SAMP</td> <td>Sample</td> </tr> <tr> <td>NEG</td> <td>Negative Peak</td> </tr> </tbody> </table> <p>The RMS selection sets the detector type to AVERage with RMS averaging. Therefore, if RMS has been selected, the query returns “AVER”</p>	String Returned	Definition	NORM	Normal	AVER	Average (RMS)	POS	Peak	SAMP	Sample	NEG	Negative Peak
String Returned	Definition												
NORM	Normal												
AVER	Average (RMS)												
POS	Peak												
SAMP	Sample												
NEG	Negative Peak												
Couplings	When " Detector Select Auto/Man " on page 670 is ON , the detector selected depends on the Trace (Average) type												
Preset	NORMal												
State Saved	Yes												
Range	AVERage NEGative NORMal POSitive SAMPle RMS												
Annotation	The four letter mnemonic for the detector appears in the trace window next to the trace it applies to												
Backwards Compatibility	<code>[:SENSe]:MONitor:DETEctor[:FUNCTION]</code>												
SCPI	Applied to Trace 1 only												

Detector Select Auto/Man

Sets the Detector mode to Auto or Manual. In Auto, the proper detector is chosen based on rules that take into account the measurement settings and other instrument settings.

When any detector is selected by the user, this toggles automatically set to Man (manual).

3 VMA Mode

3.3 Monitor Spectrum Measurement

Remote Command	<code>[:SENSe]:MONitor:DETEctor:TRACe[1] 2 3:AUTO ON OFF 1 0</code> <code>[:SENSe]:MONitor:DETEctor:TRACe[1] 2 3:AUTO?</code>
Example	<code>:MON:DET:TRAC2:AUTO ON</code> <code>:MON:DET:TRAC2:AUTO?</code>
Couplings	When this function is ON , the "Detector" on page 669 and "Trace Type" on page 1737 settings automatically align as follows: <ul style="list-style-type: none"> - "NORMa1" with Clear Write - "AVERAge" with AVERAge - "POSitive (Peak)" with MAXHold - "NEGative (Peak)" with MINHold
Preset	ON
State Saved	Yes
Backwards Compatibility SCPI	<code>[:SENSe]:MONitor:DETEctor:AUTO</code> Applied to Trace 1 only

3.4 IQ Waveform Measurement

The IQ Waveform measurement is a time-domain measurement that lets you view the envelope, real and imaginary components of an RF or baseband signal. It is similar in many respects to the zero-span measurement in traditional spectrum analysis but gives you direct access to the I/Q pairs of the signal, such as those that make up modern communications signals. The IQ Waveform measurement can also be used to perform general purpose power measurements to a high degree of accuracy.

You can examine the RF envelope (magnitude) of the signal, or open an I/Q Waveform window, which shows the I and Q signal waveform voltage versus time, to disclose the voltages that comprise the complex modulated waveform of a digital signal.

Measurement Commands

The general functionality of ["CONFigure" on page 2551](#), ["INITiate" on page 2552](#), ["FETCh" on page 2552](#), ["MEASure" on page 2554](#), and ["READ" on page 2553](#) are described in the section **SCPI Operation and Results Query** in the topic **Programming the Instrument**.

The following measurement commands and queries are used to configure the measurement:

<code>:INITiate:WAVeform</code>	Initiates a trigger cycle for the WAV measurement, but does not return any data. You must then use <code>:FETC:WAV[n]?</code> to retrieve data Does not change any measurement settings
<code>:CONFigure?</code>	Returns the long form name of current measurement, in this case, WAVeform
<code>:CONFigure:WAVeform</code>	Selects WAV measurement with Meas Setup settings in preset state – same as "Meas Preset" on page 767
<code>:CONFigure:WAVeform:NDEFault</code>	Selects WAV measurement <i>without</i> affecting settings

The following queries are used to retrieve the results:

<code>:FETCh:WAVeform?</code>	Retrieves the data defined by n
<code>:MEASure:WAVeform [n]?</code>	Switches to WAV measurement, restores default values, starts the measurement, then retrieves the data defined by n
<code>:READ:WAVeform[n]?</code>	Starts the measurement, then retrieves the data defined by n

Remote Command Results

For the **:FETCH**, **:MEASure** and **:READ** queries above, the results returned depend on the **n** parameter value as follows:

n	Results Returned																								
0	Returns unprocessed I/Q trace data, as a series of trace point pairs, in Volts Each pair consists of an I value (even-indexed, starting at 0), followed by a Q value (odd-indexed)																								
1	Returns the following scalar results:																								
	<table border="1"> <thead> <tr> <th>#</th> <th>Item</th> <th>Unit, if any</th> </tr> </thead> <tbody> <tr> <td>1</td> <td> Sample Time A floating-point number representing the time between samples. This value is important when analyzing signal results (that is, when you send a query using n = 0, 2, etc.) </td> <td></td> </tr> <tr> <td>2</td> <td> Mean Power The power across the entire trace. If Averaging State is ON, as set by "Avg/Hold Number (Averaging On/Off)" on page 757, the power is for the latest acquisition </td> <td>dBm</td> </tr> <tr> <td>3</td> <td> Mean Power Averaged The power across the entire trace If Averaging State is ON, the power for N averages (the latest acquisition), as set by "Avg/Hold Number (Averaging On/Off)" on page 757 If Averaging State is OFF, the value of the mean power averaged is the same as the value of the mean power </td> <td>dBm</td> </tr> <tr> <td>4</td> <td> Number of samples The number of data points in the captured signal. This value is important when analyzing signal results (that is, when you send a query using n = 0, 2, etc.) </td> <td></td> </tr> <tr> <td>5</td> <td> Peak-to-mean ratio The ratio of the maximum signal level to the mean power. Valid values are only obtained with Averaging State OFF. If Averaging State is ON, the peak-to-mean ratio is calculated using the highest peak value, rather than the displayed average peak value </td> <td>dB</td> </tr> <tr> <td>6</td> <td> Maximum value The maximum of the most recently acquired data </td> <td>dBm</td> </tr> <tr> <td>7</td> <td> Minimum value The minimum of the most recently acquired data </td> <td>dBm</td> </tr> </tbody> </table>	#	Item	Unit, if any	1	Sample Time A floating-point number representing the time between samples. This value is important when analyzing signal results (that is, when you send a query using n = 0, 2, etc.)		2	Mean Power The power across the entire trace. If Averaging State is ON , as set by " Avg/Hold Number (Averaging On/Off) " on page 757, the power is for the latest acquisition	dBm	3	Mean Power Averaged The power across the entire trace If Averaging State is ON , the power for N averages (the latest acquisition), as set by " Avg/Hold Number (Averaging On/Off) " on page 757 If Averaging State is OFF , the value of the mean power averaged is the same as the value of the mean power	dBm	4	Number of samples The number of data points in the captured signal. This value is important when analyzing signal results (that is, when you send a query using n = 0, 2, etc.)		5	Peak-to-mean ratio The ratio of the maximum signal level to the mean power. Valid values are only obtained with Averaging State OFF . If Averaging State is ON , the peak-to-mean ratio is calculated using the highest peak value, rather than the displayed average peak value	dB	6	Maximum value The maximum of the most recently acquired data	dBm	7	Minimum value The minimum of the most recently acquired data	dBm
#	Item	Unit, if any																							
1	Sample Time A floating-point number representing the time between samples. This value is important when analyzing signal results (that is, when you send a query using n = 0, 2, etc.)																								
2	Mean Power The power across the entire trace. If Averaging State is ON , as set by " Avg/Hold Number (Averaging On/Off) " on page 757, the power is for the latest acquisition	dBm																							
3	Mean Power Averaged The power across the entire trace If Averaging State is ON , the power for N averages (the latest acquisition), as set by " Avg/Hold Number (Averaging On/Off) " on page 757 If Averaging State is OFF , the value of the mean power averaged is the same as the value of the mean power	dBm																							
4	Number of samples The number of data points in the captured signal. This value is important when analyzing signal results (that is, when you send a query using n = 0, 2, etc.)																								
5	Peak-to-mean ratio The ratio of the maximum signal level to the mean power. Valid values are only obtained with Averaging State OFF . If Averaging State is ON , the peak-to-mean ratio is calculated using the highest peak value, rather than the displayed average peak value	dB																							
6	Maximum value The maximum of the most recently acquired data	dBm																							
7	Minimum value The minimum of the most recently acquired data	dBm																							
2	Returns trace point values of the entire captured signal envelope trace data Floating-point numbers, representing the power of the signal (in dBm). There are N data points, where N is the number of samples. The period between the samples is defined by the Sample Time (see n = 1 above)																								
3	Returns unprocessed I/Q trace data, as a series of trace point values, in volts The I values are listed first in each pair, as the even-indexed values (starting at 0). The Q values are odd-indexed. The number of points returned is defined by " Meas Time " on page 760 * " Sample Rate " on page 760, and is one point less than index 0																								

n Results Returned

4 Returns conjugated I/Q trace data, in Volts, if "Invert Spectrum" on page 779 is set to **INVert**. Otherwise, returns the same unprocessed I/Q trace data as n = 0 above

3.4.1 Views

You can select the measurement view you want to use from the **Mode/Measurement/View** selector screen. You can also specify the view programmatically, using one of these commands:

View Selection by name

Specify the desired View by its name:

Remote Command	<code>:DISPlay:WAVeform:VIEW[:SElect] RFENvelope IQ</code> <code>:DISPlay:WAVeform:VIEW[:SElect]?</code>
Example	<code>:DISP:WAV:VIEW RFEN</code> <code>:DISP:WAV:VIEW?</code>
Preset	<code>RFENvelope</code>
State Saved	Saved in instrument state
Range	RF Envelope I/Q Waveform

View Selection by number

Specify the desired View by its number:

Remote Command	<code>:DISPlay:WAVeform:VIEW:NSElect <integer></code> <code>:DISPlay:WAVeform:VIEW:NSElect?</code>
Example	<code>:DISP:WAV:VIEW:NSEL 1</code> <code>:DISP:WAV:VIEW:NSEL?</code>
Notes	View 1 is the RF Envelope View View 2 is the I/Q Waveform View
Preset	1
State Saved	Saved in instrument state
Min/Max	1/2

3.4.1.1 RF Envelope

Windows: "RF Envelope" on page 675, "Metrics" on page 676

3 VMA Mode
3.4 IQ Waveform Measurement

Shows an RF envelope (magnitude) window and a metrics table showing the measured values for the mean power and peak-to-mean power.

3.4.1.2 I/Q Waveform

Windows: ["I/Q Waveform" on page 676](#)

Shows a window with I and Q voltages vs time. SCPI commands can also be used to query the I/Q pairs while in this View.

3.4.2 Windows

The following windows are available in this measurement.

- ["RF Envelope" on page 675](#)
- ["Metrics" on page 676](#)
- ["I/Q Waveform" on page 676](#)

3.4.2.1 RF Envelope

Displays an amplitude-vs time (time domain) graph of the envelope (magnitude) of the RF waveform:

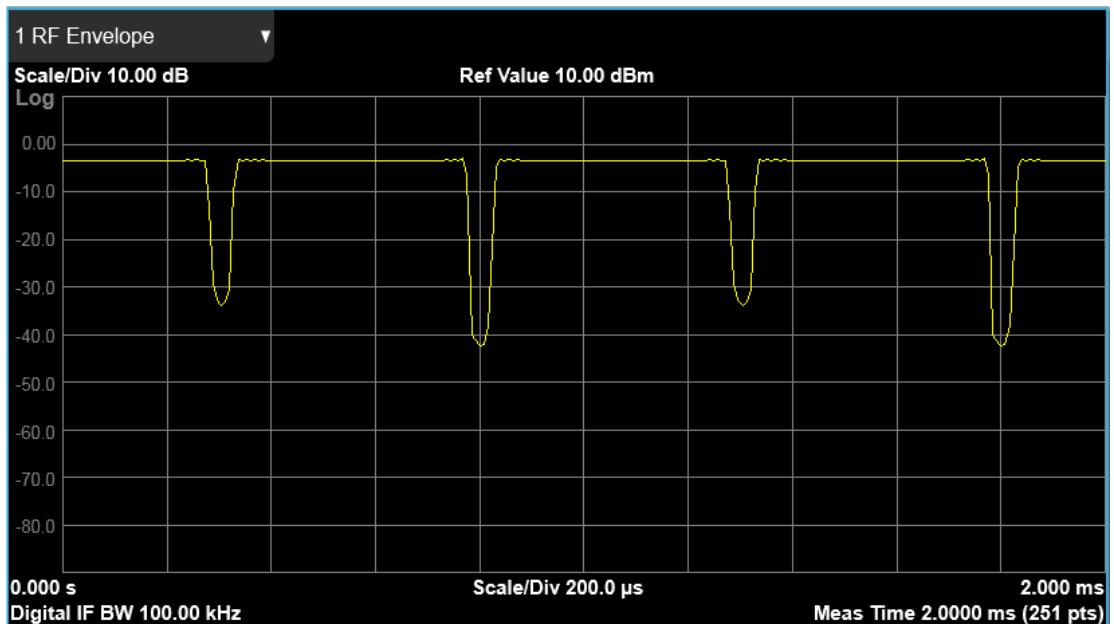

3.4.2.2 Metrics

Shows the measured values for the mean power and peak-to-mean power of the RF Envelope result of the waveform (time domain) measurements.



Numeric Results

Name	Type	Description	Unit	Format
Mean Pwr	Float64	The mean power (dBm). This is either the power across the entire trace, or the power between markers if the markers are enabled	dBm	XX.XX dBm
Pk-to-Mean	Float64	This is the ratio of the maximum signal level to the mean power	dB	XX.XX dB
Max Pt	Float64	The maximum of the most recently acquired data	dBm	XX.XX dBm
Min Pt	Float64	The minimum of the most recently acquired data	dBm	XX.XX dBm

3.4.2.3 I/Q Waveform

Shows an amplitude-vs time (time domain) graph of the quadrature (I and Q) components of the RF waveform. This allows you to measure the phase of the waveform as well as its magnitude. The yellow trace is the I (real) component and the blue trace is the Q (imaginary) component.

3 VMA Mode
3.4 IQ Waveform Measurement

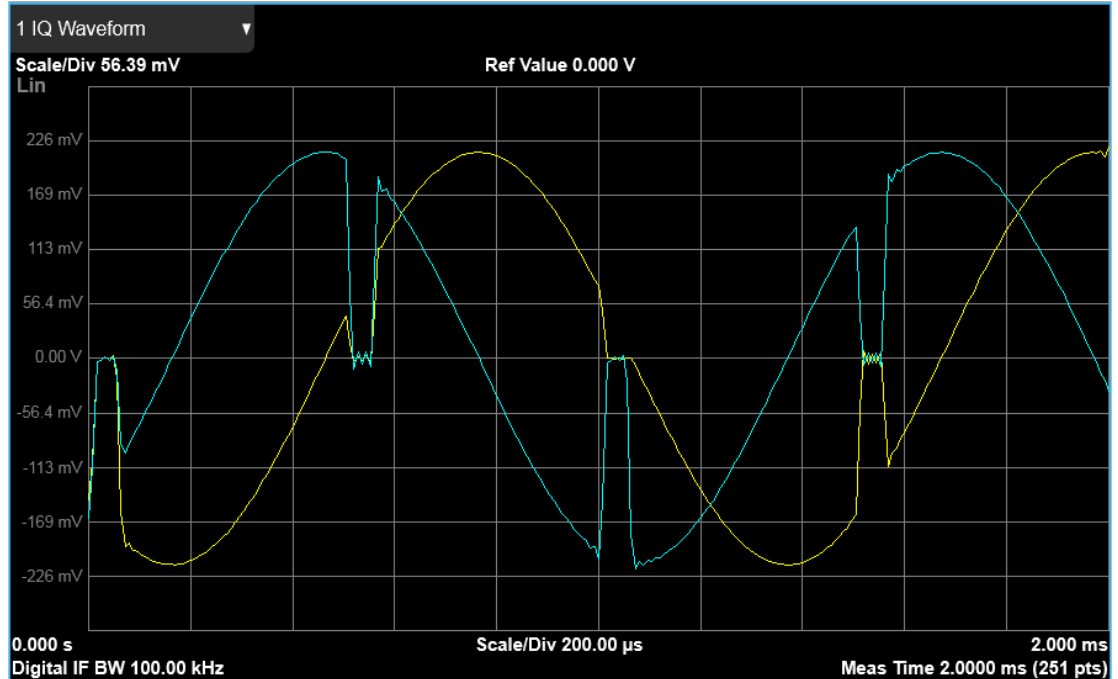

3.4.3 Amplitude

Activates the **Amplitude** menu and selects **Reference Level** or **Reference Value** as the active function, depending on the measurement.

Some features in this menu apply to multiple measurements. Some other features apply only to specific measurements and their controls are blanked or grayed-out in measurements that do not support the feature.

3.4.3.1 Y Scale

Contains controls that pertain to the Y axis parameters of the measurement. These parameters control how data on the vertical (Y) axis is displayed and control instrument settings that affect the vertical axis.

Ref Value

Sets the value for the absolute power reference. The functionality depends on the selected window. The reference line is at the top, center, or bottom of the graticule, depending on the value of "**Ref Position**" on page 680.

RF Envelope

Remote Command	<code>:DISPlay:WAVeform:VIEW[1]:WINDow[1]:TRACe:Y[:SCALE]:RLEVel <amptd></code>
Example	<code>:DISP:WAV:VIEW:WIND:TRAC:Y:RLEV -50 dBm</code>
Couplings	When " Auto Scaling " on page 681 is ON (default), this value is automatically determined by the measurement result. When you set a value manually, Auto Scaling changes to OFF
Preset	10.00 dBm
State Saved	Saved in instrument state
Min/Max	-/+250.00 dBm
Annotation	Ref <value> top of graph

IQ Waveform

Remote Command	<code>:DISPlay:WAVeform:VIEW2:WINDow[1]:TRACe:Y[:SCALE]:RLEVel <voltage></code>
Example	<code>:DISP:WAV:VIEW2:WIND:TRAC:Y:RLEV 25 V</code>
Couplings	When " Auto Scaling " on page 681 is On (default), this value is automatically determined by the measurement result. When you set a value manually, Auto Scaling changes to Off
Preset	0 V
State Saved	Saved in instrument state
Min/Max	-/+250.00 V
Annotation	Ref <value> top of graph

Scale/Div

Enables you to set the units per division of vertical scale in the logarithmic display. However, since "**Auto Scaling**" on page 681 defaults to **ON**, this value is automatically determined by the measurement result. When you set a value manually, **Auto Scaling** automatically changes to **OFF**.

The SCPI command and default parameters are dependent on whether the View is "**RF Envelope**" on page 674 or "**I/Q Waveform**" on page 675.

RF Envelope

Remote Command	<code>:DISPlay:WAVeform:VIEW[1]:WINDow[1]:TRACe:Y[:SCALE]:PDIVision <rel_amp1></code>
----------------	---

3 VMA Mode
3.4 IQ Waveform Measurement

Command	<code>:DISPlay:WAVeform:VIEW[1]:WINDow[1]:TRACe:Y[:SCALe]:PDIVision?</code>
Example	<code>:DISP:WAV:VIEW:WIND:TRAC:Y:PDIV 5</code> <code>:DISP:WAV:VIEW:WIND:TRAC:Y:PDIV?</code>
Couplings	Coupled to "Scale Range" on page 679 as follows Scale/Div = Scale Range/10 (number of divisions) When "Auto Scaling" on page 681 is On, this value is automatically determined by the measurement result When you change a value, Auto Scaling automatically changes to Off
Preset	10.00 dB
State Saved	Saved in instrument state
Min	0.10 dB
Max	20.00 dB
Annotation	<value> dB/ left upper of graph

IQ Waveform

Remote Command	<code>:DISPlay:WAVeform:VIEW2:WINDow[1]:TRACe:Y[:SCALe]:PDIVision <voltage></code> <code>:DISPlay:WAVeform:VIEW2:WINDow[1]:TRACe:Y[:SCALe]:PDIVision?</code>
Example	<code>:DISP:WAV:VIEW2:WIND:TRAC:Y:PDIV 25mV</code> <code>:DISP:WAV:VIEW2:WIND:TRAC:Y:PDIV?</code>
Couplings	Coupled to "Scale Range" on page 679 as follows Scale/Div = Scale Range/10 (number of divisions) When "Auto Scaling" on page 681 is On, this value is automatically determined by the measurement result When you change a value, Auto Scaling automatically changes to Off
Preset	100.0 mV
State Saved	Saved in instrument state
Min	1.0 nV
Max	20 V
Annotation	<value> dB/ left upper of graph

Scale Range

Sets the Y-Axis scale range.

The SCPI command and default parameters depend on whether the View is "RF Envelope" on page 674 or "I/Q Waveform" on page 675.

RF Envelope

Remote Command	<code>:DISPlay:WAVeform:VIEW[1]:WINDow[1]:TRACe:Y[:SCALE]:RANGe <rel_amp1></code> <code>:DISPlay:WAVeform:VIEW[1]:WINDow[1]:TRACe:Y[:SCALE]:RANGe?</code>
Example	<code>:DISP:WAV:VIEW:WIND:TRAC:Y:RANG 100</code> <code>:DISP:WAV:VIEW:WIND:TRAC:Y:RANG?</code>
Couplings	Coupled to "Scale/Div" on page 678 as follows Scale Range = Scale/Div * 10 (number of divisions) When you change a value, "Auto Scaling" on page 681 automatically changes to OFF
Preset	100 dB
State Saved	Saved in instrument state
Min	1
Max	200

IQ Waveform

Remote Command	<code>:DISPlay:WAVeform:VIEW2:WINDow[1]:TRACe:Y[:SCALE]:RANGe <voltage></code> <code>:DISPlay:WAVeform:VIEW2:WINDow[1]:TRACe:Y[:SCALE]:RANGe?</code>
Example	<code>:DISP:WAV:VIEW:WIND:TRAC:Y:RANG 1000</code> <code>:DISP:WAV:VIEW:WIND:TRAC:Y:RANG?</code>
Couplings	Coupled to "Scale/Div" on page 678 as follows Scale Range = Scale/Div * 10 (number of divisions) When you change a value, "Auto Scaling" on page 681 automatically changes to OFF
Preset	1 V
State Saved	Saved in instrument state
Min	10 nV
Max	200 V

Ref Position

Enables you to position the reference level at the top, center, or bottom of the Y Scale display. Changing the reference position does not change the reference level value.

The SCPI command and default parameters depend on whether the View is "RF Envelope" on page 674 or "I/Q Waveform" on page 675.

RF Envelope

Remote Command	<code>:DISPlay:WAVeform:VIEW[1]:WINDow[1]:TRACe:Y[:SCALe]:RPOSition TOP CENTER BOTTom</code> <code>:DISPlay:WAVeform:VIEW[1]:WINDow[1]:TRACe:Y[:SCALe]:RPOSition?</code>
Example	<code>:DISP:WAV:VIEW:WIND:TRAC:Y:RPOS CENT</code> <code>:DISP:WAV:VIEW:WIND:TRAC:Y:RPOS?</code>
Preset	<code>TOP</code>
State Saved	Saved in instrument state
Range	<code>Top Center Bottom</code>
Annotation	> and < are displayed both side of graph to indicate Reference Position

IQ Waveform

Remote Command	<code>:DISPlay:WAVeform:VIEW2:WINDow[1]:TRACe:Y[:SCALe]:RPOSition TOP CENTer BOTTom</code> <code>:DISPlay:WAVeform:VIEW2:WINDow[1]:TRACe:Y[:SCALe]:RPOSition?</code>
Example	<code>:DISP:WAV:VIEW2:WIND:TRAC:Y:RPOS CENT</code> <code>:DISP:WAV:VIEW2:WIND:TRAC:Y:RPOS?</code>
Preset	<code>CENT</code>
State Saved	Saved in instrument state
Range	<code>Top Center Bottom</code>
Annotation	> and < are displayed both side of graph to indicate Reference Position

Auto Scaling

Enables you to toggle Auto Scaling On or Off. When the **Restart** front-panel key is pressed, this function automatically determines the scale per division and reference values based on the measurement results.

Remote Command	<code>:DISPlay:WAVeform:VIEW[1] 2:WINDow[1]:TRACe:Y[:SCALe]:COUPle 0 1 OFF ON</code> <code>:DISPlay:WAVeform:VIEW[1] 2:WINDow[1]:TRACe:Y[:SCALe]:COUPle?</code>
Example	<code>:DISP:WAV:VIEW:WIND:TRAC:Y:COUP OFF</code> <code>:DISP:WAV:VIEW:WIND:TRAC:Y:COUP?</code>
Couplings	When " Auto Scaling " on page 681 is On, and the Restart front-panel key is pressed, this function automatically sets the scale per division to 10 dB and determines the reference values based on the measurement results When you change a value of Scale/Div , Ref Value , or Scale Range , Auto Scaling automatically changes

	to OFF
Preset	OFF
State Saved	Saved in instrument state
Range	OFF ON

3.4.3.2 Attenuation

Controls the attenuator functions and interactions between the attenuation system components.

There are two attenuator configurations in the X-Series. One is a Dual-Attenuator configuration consisting of a mechanical attenuator and an optional electronic attenuator. The other configuration uses a single attenuator with combined mechanical and electronic sections that controls all the attenuation functions. Different models in the X-Series come with different configurations.

- See ["Dual-Attenuator Configurations"](#) on page 682
- See ["Single-Attenuator Configuration"](#) on page 683

Most attenuation settings are the same for all measurements – they do not change as you change measurements. Settings like these are called “Meas Global” and are unaffected by **Meas Preset**.

Only available when the hardware set includes an input attenuator, which is typically only the case for Keysight’s benchtop instruments. For example, this tab does *not* appear in VXT models M9420A/10A/11A/15A/16A, M9410E/11E/15E/16E, nor in UXM. In UXM, all **Attenuation** and **Range** settings are disabled, as the expected input power level is handled by the Call Processing App that drives the DUT power control.

Dependencies	In measurements that support the I/Q inputs, unavailable when I/Q is the selected input. Replaced by the Range tab in that case
--------------	--

Dual-Attenuator Configurations

Configuration 1: Mechanical attenuator + optional electronic attenuator

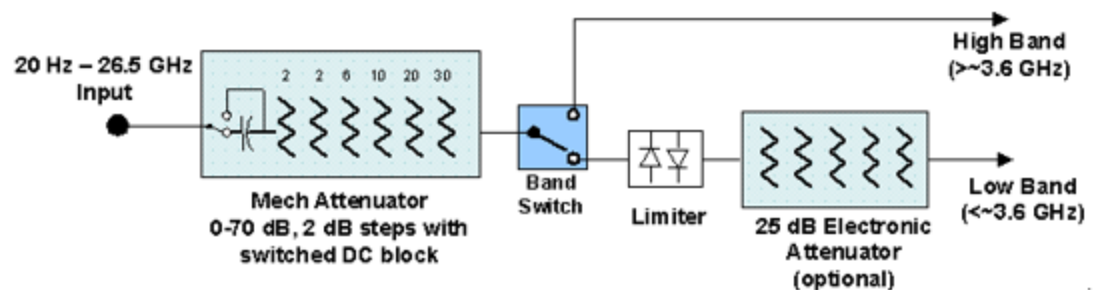

Configuration 2: Mechanical attenuator, no optional electronic attenuator

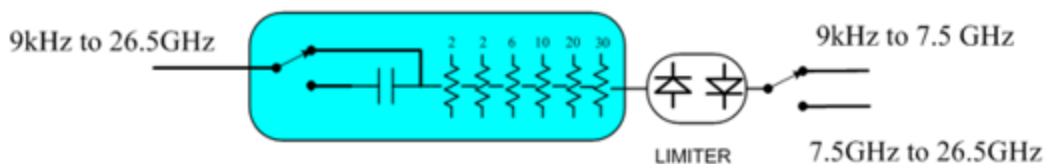

Note that Configuration 2 is not strictly speaking a dual-section attenuator, since there is no electronic section available. However, it behaves exactly like Configuration 1 without the Electronic Attenuator Option EA3, therefore for the sake of this document it is grouped into the “Dual-Attenuator” configuration.

Single-Attenuator Configuration

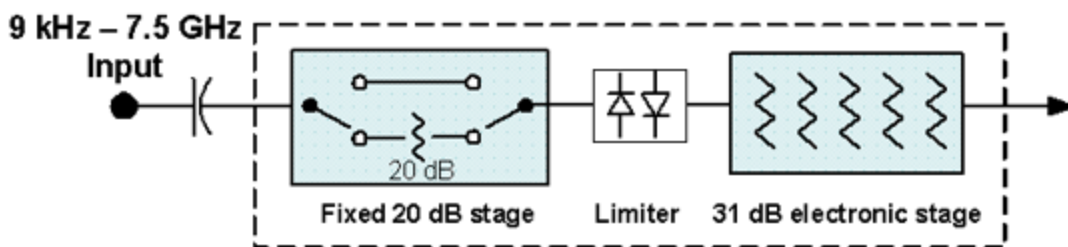

You can tell which attenuator configuration you have by pressing the Attenuation tab, which (in most Modes) opens the Attenuation menu. If the first control in the Attenuation menu says **Mech Atten** you have the Dual-Attenuator configuration. If the first control says **Atten** you have the Single-Attenuator configuration.



Dual Attenuator

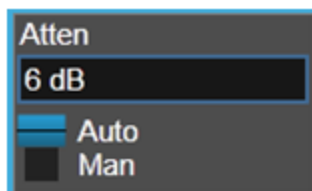

Single Attenuator

(Note that depending on the measurement, there may be no Auto/Man functionality on the Mech Atten control.)

In the Single-Attenuator configuration, you control the attenuation with a single control, as the fixed stage has only two states. In the Dual-Attenuator configuration, both stages have significant range, so you are given separate control of the mechanical and electronic attenuator stages.

When you have the Dual-Attenuator configuration, you may still have only a Single-Attenuator, because unless Option EA3 (the Electronic Attenuator option) is available, and you purchase it, you will have only the mechanical attenuator.

Full Range Atten

This control and **Attenuator Summary** only appear in N9041B, when the RF input is selected, the RF Input Port is set to RF Input 2, and the Full Range Attenuator is installed. The Full Range Attenuator adds a second input attenuator in front of RF Input 2, which enhances the protection and optimizes the performance of the extra internal mixers used by RF Input 2.

Remote Command	<code>[:SENSe]:POWer[:RF]:FRATten <rel_amp1></code> <code>[:SENSe]:POWer[:RF]:FRATten?</code>
Example	<code>:POW:FRAT 14</code> <code>:POW:FRAT?</code>
Notes	When you enter an amplitude value that falls between valid values, the value will be incremented to the next smallest valid value
Dependencies	Only appears if input RF is selected, RF Input Port 2 is selected, and the Full Range Attenuator exists
Couplings	This value is never changed by any coupling, but other couplings use this value. See Reference Level and " Mech Atten " on page 1766 command descriptions
Preset	20 dB
State Saved	Saved in instrument state
Min	0 dB
Max	Only valid values are 0, 6, 14, 20 dB
Annotation	<p>When the Input is RF, and the Input Port is RF Input 2, and the Full Range Attenuator is installed: On the Meas Bar, the field "Atten" displays as follows:</p> <ul style="list-style-type: none"> - If the sweep is entirely < 50 GHz, the value shown after "Atten:" is equal to Mech Atten + Elec Atten + Full Range Atten - If the sweep is entirely > 50 GHz, the value shown after "Atten:" is equal to Full Range Atten - If the sweep straddles 50 GHz, the value shown after "Atten:" is preceded by the symbol ">=" and is equal to Full Range Atten <p>In the Amplitude, "Y Scale" on page 1760 menu, and the Atten Meas Bar dropdown menu panel, a summary is displayed as follows: "Total Atten below 50 GHz" followed by the value of Full Range Atten + Mech Atten + Elec Atten "Total Atten above 50 GHz" followed by the value of Full Range Atten For example, if Mech Atten = 6 dB, Elec Atten = 4 dB, and Full Range Atten = 20 dB, the summary below is shown:</p> <ul style="list-style-type: none"> - Attenuator summary:

-
- Total Atten below 50 GHz: 30 dB
 - Total Atten above 50 GHz: 20 dB

Mech Atten

Labeled **Mech Atten** in Dual-Attenuator models, and **Atten** in Single-Attenuator models. In the Dual-Attenuator configuration, this control only affects the mechanical attenuator.

Lets you modify the attenuation applied to the RF input signal path. This value is normally auto-coupled to **Ref Level**, "[Internal Preamp](#)" on page 1788 Gain, any External Gain that is entered, and **Max Mixer Level** (if available), as described in the table below.

See "[Attenuator Configurations and Auto/Man](#)" on page 687

Remote Command	<code>[:SENSe]:POWer[:RF]:ATTenuation <rel_amp1></code> <code>[:SENSe]:POWer[:RF]:ATTenuation?</code>
Example	<code>:POW:ATT 20</code> Dual-Attenuator configuration: sets the mechanical attenuator to 20 dB Single-Attenuator mode: sets the main attenuation to 20 dB (see below for definition of "main" attenuation) In either case, if the attenuator was in Auto, it is set to Manual
Dependencies	Some measurements do not support Auto setting of Mech Atten . In these measurements, the Auto/Man selection is not available, and the Auto/Man toggle function is not available In Dual-Attenuator configurations, when the electronic attenuator is enabled, the mechanical attenuator has no auto setting, and the Auto/Man toggle function is not available. The state of Auto/Man is remembered and restored when the electronic attenuator is once again disabled. This is described in more detail in " Elec Atten " on page 1769 See " Attenuator Configurations and Auto/Man " on page 687 for more information on the Auto/Man functionality
Couplings	If the RF Input Port is the RF Input: <ul style="list-style-type: none"> - If the USB Preamp is connected to USB, use 0 dB for Mech Atten - Otherwise compute the auto-selected value of Mech Atten based on Reference Level, Int Preamp, External Gain, Ref Level Offset, Max Mixer Level, μW Path Control and IF Gain settings. Limit this value to be no less than 6 dB (total attenuation below 6 dB can never be chosen by Auto) - In N9041B, if the RF Input Port is RF Input 2, use the formula above and subtract the value of "Full Range Atten" on page 1765 from the result to determine the Mech Atten. Limit the value so that it is never lower than 0 dB and so that total attenuation, including Full Range Atten, is never less than 6 dB (total attenuation, including Full Range Atten below 6 dB, can never be chosen by Auto) <p>In External Mixing and BBIQ, where the attenuator is not in the signal path, the attenuator setting changes as described above when Mech Atten is in Auto, but no changes are made to the actual</p>

	<p>attenuator hardware setting until the input is changed back to the RF Input</p> <p>For CXA-m with Option FSA (Fine-Step Attenuator or 2 dB steps), the FSA-like behavior is only available when the frequency setting is ≤ 7.5 GHz. So, when the frequency is changed from below 7.5 GHz to above 7.5 GHz, the attenuation setting changes to a multiple of 10 dB that is no smaller than the previous setting. For example, 4 dB attenuation changes to 10 dB</p>							
Preset	<p>Auto</p> <p>The Auto value is 10 dB</p>							
State Saved	<p>Saved in instrument state</p>							
Min	<p>0 dB</p> <p>The attenuation set by this control cannot be decreased below 6 dB with the knob or step keys. Values below 6 dB must be directly entered from the keypad or via SCPI. This protects against setting a dangerously small attenuation value, which can put the instrument at risk of damage to input circuitry. If the current mechanical attenuation is below 6 dB, it can be increased with the knob and step keys, but not decreased</p>							
Max	<table border="1"> <tr> <td>CXA Option 503 or 507</td> <td>50 dB</td> </tr> <tr> <td>EXA</td> <td>60 dB</td> </tr> <tr> <td>All other models</td> <td>70 dB</td> </tr> </table> <p>Note that in the Single-Attenuator configuration, the total of ATT and EATT cannot exceed 50 dB. So, if the EATT is set to 24 dB first, the main attenuation cannot be greater than 26 dB and will be reduced accordingly; if the main attenuator is set to 40 dB first, EATT cannot be greater than 10 dB</p>		CXA Option 503 or 507	50 dB	EXA	60 dB	All other models	70 dB
CXA Option 503 or 507	50 dB							
EXA	60 dB							
All other models	70 dB							
Annotation	<p>The current value for Total Atten is displayed in the Measurement Bar at the top of the display. A value appears for Electronic Attenuation only if the Electronic Attenuator is enabled. The annotation appears as:</p> <p><i>Atten: <total> dB (e<elec>)</i></p> <p>The e letter is in amber in Single-Attenuator configurations</p> <p>For example:</p> <p>Dual-Attenuator configuration:</p> <p><i>Atten: 24 dB (e14)</i></p> <p>Indicating the total attenuation is at 24 dB and the electronic attenuation is at 14 dB</p> <p>Single-Attenuator configuration:</p> <p><i>A: 24 dB (e14)</i></p> <p>Indicating the total attenuation is at 24 dB and the “soft” attenuation is at 14 dB (see below for definition of “soft” attenuation)</p> <p>When in Manual, a # sign appears in front of Atten in the annotation</p> <p>Auto Function</p>							
Remote Command	<pre>[:SENSe]:POWer[:RF]:ATTenuation:AUTO OFF ON 0 1 [:SENSe]:POWer[:RF]:ATTenuation:AUTO?</pre>							
Example	<p>Turn Auto Mech AttenON:</p> <pre>:POW:ATT:AUTO ON</pre>							

Dependencies	:POW:ATT:AUTO is only available in measurements that support Auto , such as Swept SA
Preset	ON

Attenuator Configurations and Auto/Man

As described under "[Attenuation](#)" on page 1763, there are two distinct attenuator configurations available in the X-Series, the Single Attenuator and Dual-Attenuator configurations.

In Dual-Attenuator configurations, we have mechanical attenuation and electronic attenuation, and current total attenuation is the sum of electronic + mechanical attenuation.

In Single-Attenuator configurations, we refer to the attenuation set using "[Mech Atten](#)" on page 685 (or :POW:ATT) as the "main" attenuation; and the attenuation that is set by :POW:EATT as the "soft" attenuation (:POW:EATT is honored even in the Single-Attenuator configuration, for compatibility purposes). Then current total attenuation is the sum of main + soft attenuation.

See "[Elec Atten](#)" on page 1769 for more about "soft" attenuation.

NOTE

In some measurements, the **Mech Atten** control has an **Auto/Man** function. In these measurements, an **Auto/Man** switch is shown on the **Mech Atten** control:

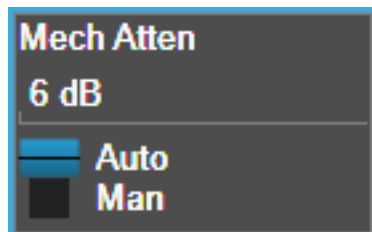

Note that in configurations that include an Electronic Attenuator, this switch is only shown when the Electronic Attenuator is disabled.

In other measurements, **Mech Atten** has no **Auto/Man** function. In these measurements, no switch is shown on the **Mech Atten** control:



Mech Atten also appears with no switch, as above, in configurations that include an Electronic Attenuator but when the Electronic Attenuator is enabled.

Elec Atten

Controls the Electronic Attenuator in Dual-Attenuator configurations. Does not appear in Single-Attenuator configurations, because the control of both the mechanical and electronic stages of the Single-Attenuator is integrated into the single **Atten** control.

This control includes an **Enable/Disable** toggle switch; it is only possible to enter a value for the Electronic Attenuator when this switch is in the **Enable** position.

For more details of the Electronic Attenuator, see "[More Information](#)" on page 689

Remote Command	<code>[:SENSe]:POWer[:RF]:EATTenuation <rel_amp1></code> <code>[:SENSe]:POWer[:RF]:EATTenuation?</code>
Example	<code>:POW:EATT 10</code> <code>:POW:EATT?</code>
Notes	Electronic Attenuation's specification is defined only when Mech Atten is 6 dB
Dependencies	<p>Only appears in Dual-Attenuator models with an Electronic Attenuator installed and licensed. Does not appear in models with the Single-Attenuator configuration, because in the Single-Attenuator configuration there is no "electronic attenuator"; there is only a single integrated attenuator (which has both a mechanical and electronic stage). However, in the Single-Attenuator configuration, EATT SCPI commands are accepted for compatibility with other X-series instruments, and set a "soft" attenuation. The "soft" attenuation is treated as an addition to the "main" attenuation value set by the Attenuation control or <code>:POW:ATT</code>, and affects the total attenuation displayed on the Attenuation control and the Meas Bar</p> <p>The electronic attenuator, and the "soft" attenuation function provided in Single-Attenuator configurations, are unavailable above the low band (0-3.6 GHz, 0-3.4 GHz, 0-3 GHz, depending on the model). If the low band range is from 0-3.6 GHz, and Stop Frequency of the instrument is > 3.6 GHz, then the Enabled/Disabled section of the Elec Atten control will be OFF and grayed-out</p> <p>If "Internal Preamp" on page 1788 is ON (that is, set to Low Band or Full), the electronic attenuator (and the "soft" attenuation function provided in Single-Attenuator configurations) is unavailable. In this case the Enabled/Disabled section of the Elec Atten control will be OFF and grayed-out</p> <p>If either of the above is true, and the SCPI command is sent, an error indicating that the electronic attenuator is unavailable is returned</p> <p>If both the above are true, pressing the control generates error message -221, in other words, the frequency range lockout takes precedence</p> <p>If the electronic/soft Attenuator is enabled, then the Stop Freq of the instrument is limited to 3.6 GHz and Internal Preamp is unavailable</p> <p>If "LNA" on page 1790 is ON, the electronic attenuator (and the "soft" attenuation function provided in Single-Attenuator configurations) is unavailable. In this case the Enabled/Disabled section of the Elec Atten control will be OFF and grayed-out. This coupling works in the following modes/measurements:</p> <ul style="list-style-type: none"> - Channel Power, Occupied BW, ACP, SEM, Spurious Emissions, Power Stat CCDF measurements in all Modes - Transmit On Off Power measurement in 5G NR Mode

3 VMA Mode
3.4 IQ Waveform Measurement

- Power vs. Time and Transmit Power measurement in GSM/EDGE Mode
- Burst Power measurement in Spectrum Analyzer Mode

The SCPI-only “soft” electronic attenuation for the single-attenuator configuration is not available in all measurements; in particular, it is not available in the Swept SA measurement

Couplings	Enabling and disabling the Electronic Attenuator affects the setting of the Mechanical Attenuator (in Dual-Attenuator configurations). This is described in more detail below and in " Mechanical Attenuator Transition Rules " on page 690
Preset	0 dB
State Saved	Saved in instrument state
Min	0 dB
Max	Dual-Attenuator configuration: 24 dB Single-Attenuator configuration: the total of ATT and EATT cannot exceed 50 dB. So, if the EATT is set to 24 dB first, the main attenuation cannot be greater than 26 dB and will be reduced accordingly; if the main attenuator is set to 40 dB first, EATT cannot be greater than 10 dB
Annotation	See Annotation under the Mech Atten control description
Auto Function	
Remote Command	<code>[:SENSe]:POWer[:RF]:EATTenuation:STATe OFF ON 0 1</code> <code>[:SENSe]:POWer[:RF]:EATTenuation:STATe?</code>
Example	<code>:POW:EATT:STAT ON</code> <code>:POW:EATT:STAT?</code>
Preset	OFF (Disabled) for Swept SA measurement ON (Enabled) for all other measurements that support the electronic attenuator

NOTE

The maximum **Center Frequency** for Low Band can change based on the selected IFBW for measurements that support IFBW (for example, Waveform measurement across all Modes that support it). In certain models (such as N9042B & N9032B), IFBW values ≤ 40 MHz have a maximum Low Band frequency of 3.6 GHz, while $40 \text{ MHz} < \text{IFBW} \leq 1 \text{ GHz}$ have a maximum of 3.3 GHz, and $1 \text{ GHz} < \text{IFBW} \leq 1.5 \text{ GHz}$ have a maximum of 3.5 GHz. This frequency is reflected in the disabled message displayed for Electrical Attenuator. For N9032B and N9042B IFBW values $> 1.5 \text{ GHz}$ do not support a **Center Frequency** that can reach the Low Band maximum frequency. In these cases, the Electrical Attenuator will remain disabled no matter the Center Frequency.

More Information

The electronic attenuator offers finer steps than the mechanical attenuator, has no acoustical noise, is faster, and is less subject to wear. These advantages primarily

aid in remote operation and are negligible for front panel use. See ["Using the Electronic Attenuator: Pros and Cons" on page 691](#) for a detailed discussion of the pros and cons of using the electronic attenuator.

For the Single-Attenuator configuration, for SCPI backwards compatibility, the “soft” attenuation feature replaces the Dual-Attenuator configuration’s electronic attenuator. All the same couplings and limitations apply. See ["Attenuator Configurations and Auto/Man" on page 1768](#)

Mechanical Attenuator Transition Rules

When the Electronic Attenuator is enabled, the Mechanical Attenuator transitions to a state that has no Auto function. Below are the rules for transitioning the Mechanical Attenuator. Note that the information below *only* applies to the Dual-Attenuator configurations, and *only* when the Electronic Attenuator is installed:

When the Electronic Attenuation is enabled from a disabled state:

- The Mechanical Attenuator is initialized to 10 dB (this is its optimal performance setting). You can then set it as desired with SCPI, numeric keypad, step keys, or knob, and it behaves as it normally would in manual mode
- The Auto/Man state of (Mech) Atten is saved
- The Auto/Man toggle on the (Mech) Atten control disappears, and the auto rules are disabled
- The Electronic Attenuator is set to 10 dB less than the previous value of the Mechanical Attenuator, within the limitation that it must stay within the range of 0 to 24 dB of attenuation

Examples in the Dual-Attenuator configuration:

- Mech Atten at 20 dB. Elec Atten enabled, Mech Atten set to 10 dB, and Elec Atten set to 10 dB. New total attenuation equals the value before Elec Atten enabled
- Mech Atten at 0 dB. Elec Atten enabled, Mech Atten set to 10 dB, and Elec Atten set to 0 dB. New total attenuation does not equal the value before Elec Atten enabled
- Mech Atten at 40 dB. Elec Atten enabled, Mech Atten set to 10 dB, and Elec Atten set to 24 dB. New total attenuation does not equal the value before Elec Atten enabled

When the Electronic Attenuation is disabled from an enabled state:

3 VMA Mode

3.4 IQ Waveform Measurement

- The Elec Atten control is grayed out
- The Auto/Man state of (Mech) Atten is restored
- If now in Auto, (Mech) Atten recouples
- If now in Man, (Mech) Atten is set to the value of total attenuation that existed before the Elec Atten was disabled. The resulting value is rounded up to the smallest value possible given the (Mech) Atten Step setting - (That is, 57 dB changes to 58 dB when (Mech) Atten Step is 2 dB)

Using the Electronic Attenuator: Pros and Cons

The electronic attenuator offers finer steps than the mechanical attenuator, has no acoustical noise, is faster, and is less subject to wear.

The “finer steps” advantage of the electronic attenuator is beneficial in optimizing the alignment of the instrument dynamic range to the signal power in the front panel as well as remote use. Thus, you can achieve improved relative signal measurement accuracy. Compared to a mechanical attenuator with 2 dB steps, the 1 dB resolution of the electronic attenuator only gives better resolution when the odd-decibel steps are used. Those odd-decibel steps are less accurately calibrated than the even-decibel steps, so one tradeoff for this superior relative accuracy is reduced absolute amplitude accuracy.

Another disadvantage of the electronic attenuator is that the spectrum analyzer loses its “Auto” setting, making operation less convenient.

Also, the relationship between the dynamic range specifications (TOI, SHI, compression, and noise) and instrument performance are less well-known with the electrical attenuator. With the mechanical attenuator, TOI, SHI, and compression threshold levels increase dB-for-dB with increasing attenuation, and the noise floor does as well. With the electronic attenuator, there is an excess attenuation of about 1 to 3 dB between 0 and 3.6 GHz, making the effective TOI, SHI, and so forth, less well known. Excess attenuation is the actual attenuation relative to stated attenuation. Excess attenuation is accounted for in the instrument calibration.

Adjust Atten for Min Clipping

Sets the combination of mechanical and electronic attenuation and gain based on the current measured signal level so that clipping will be at a minimum.

This is an immediate action function, that is, it executes once, when the control is pressed.

The algorithms that are used for the adjustment are documented under ["Pre-Adjust for Min Clipping" on page 1773](#).

Remote Command	<code>[:SENSe]:POWer[:RF]:RANGe:OPTimize IMMEDIATE</code>
Example	<code>:POW:RANG:OPT IMM</code>
Notes	Executing Adjust Atten for Min Clipping initiates the measurement
Dependencies	Does not appear in the Swept SA, RTSA, Monitor Spectrum and Complex Spectrum measurements Appears in the Waveform measurement in BASIC and 5G NR Modes

Adjust Atten

Allows you to select;

- Electric attenuator only
- Combination of Electric attenuator and Mechanical attenuator

when `[:SENSe]:POWer[:RF]:RANGe:OPTimize IMMEDIATE` is executed.

Remote Command	<code>[:SENSe]:POWer[:RF]:RANGe:OPTimize:TYPE EONLY COMBined</code> <code>[:SENSe]:POWer[:RF]:RANGe:OPTimize:TYPE?</code>
Example	<code>:POW:RANG:OPT:TYPE EONL</code> <code>:POW:RANG:OPT:TYPE?</code>
Dependencies	Does not appear in the Swept SA, RTSA, Monitor Spectrum and Complex Spectrum measurements Appears in the Waveform measurement in BASIC and 5G NR Modes
Preset	<code>COMBined</code>
State Saved	Saved in instrument state

Pre-Adjust for Min Clipping

If this function is **ON**, it applies the adjustment described under "**Adjust Atten for Min Clipping**" on page 1772 each time a measurement restarts. Therefore, in Continuous measurement mode, it only executes before the first measurement.

In Dual-Attenuator models, you can set **Elec+Mech Atten**, in which case both attenuators participate in the autoranging, or **Elec Atten Only**, in which case the mechanical attenuator does not participate in the autoranging. This latter case results in less wear on the mechanical attenuator and is usually faster.

See "**Adjustment Algorithm**" on page 693

Selection	SCPI	Note
Off	<code>OFF</code>	This is the default setting
On	<code>ON</code>	Available in Single-Attenuator instruments. For compatibility with models that do not have an input attenuator, the ON parameter is supported and mapped to

3 VMA Mode
 3.4 IQ Waveform Measurement

Selection	SCPI	Note
Elec Atten Only	ELECTrical	COMBined Selects only the electric attenuator to participate in auto ranging. This offers less wear on the mechanical attenuator and is usually faster
Elec+Mech Atten	COMBined	In Dual-Attenuator models, this selects both attenuators to participate in the autoranging
Remote Command	[:SENSe]:POWer[:RF]:RANGe:OPTimize:ATTenuation OFF ON ELECTrical COMBined [:SENSe]:POWer[:RF]:RANGe:OPTimize:ATTenuation?	
Example	:POW:RANG:OPT:ATT OFF :POW:RANG:OPT:ATT?	
Notes	The parameter option ELECTrical sets this function to ON in Single-Attenuator models The parameter option COMBined is mapped to ELECTrical in Single-Attenuator models. If you send COMBined , it sets the function to ON and returns ELEC to a query For SCPI compatibility with models that do not have an input attenuator, the ON parameter is honored and mapped to COMBined	
Dependencies	Only appears in Dual-Attenuator models with an Electronic Attenuator installed In instruments with Dual-Attenuator model, when "Elec Atten" on page 1769 is OFF or grayed-out, "Pre-Adjust for Min Clipping" on page 692 is grayed-out Does not appear in the Swept SA, RTSA, Monitor Spectrum and Complex Spectrum measurements Appears in the Waveform measurement in BASIC and 5G NR Modes	
Preset	OFF when Elec Atten is Disabled at preset, otherwise ELEC	
State Saved	Saved in instrument state	
Range	Dual-Attenuator models:	Off Elec Atten Only Mech + Elec Atten
	Single-Attenuator models:	Off On

Backwards Compatibility Command

Notes	ON aliases to "Elec Atten Only" (:POW:RANG:OPT:ATT ELEC) OFF aliases to "Off" (:POW:RANG:OPT:ATT OFF) :POW:RANG:AUTO? returns true if :POW:RANG:OPT:ATT is not OFF
Backwards Compatibility SCPI	[:SENSe]:POWer[:RF]:RANGe:AUTO ON OFF 1 0 [:SENSe]:POWer[:RF]:RANGe:AUTO?

Adjustment Algorithm

The algorithms for the adjustment are documented below:

Single-Attenuator Models

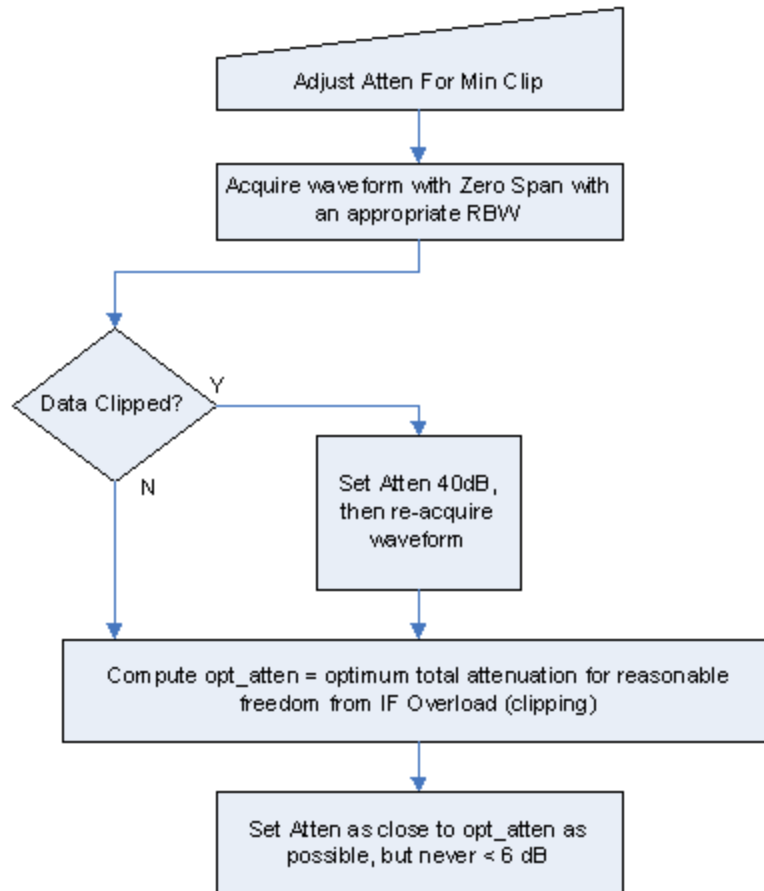

Dual-Attenuator models

"Adjust Atten for Min Clipping" on page 1772 or "Pre-Adjust for Min Clipping" on page 692 selection is Mech + Elec Atten:

3 VMA Mode
 3.4 IQ Waveform Measurement

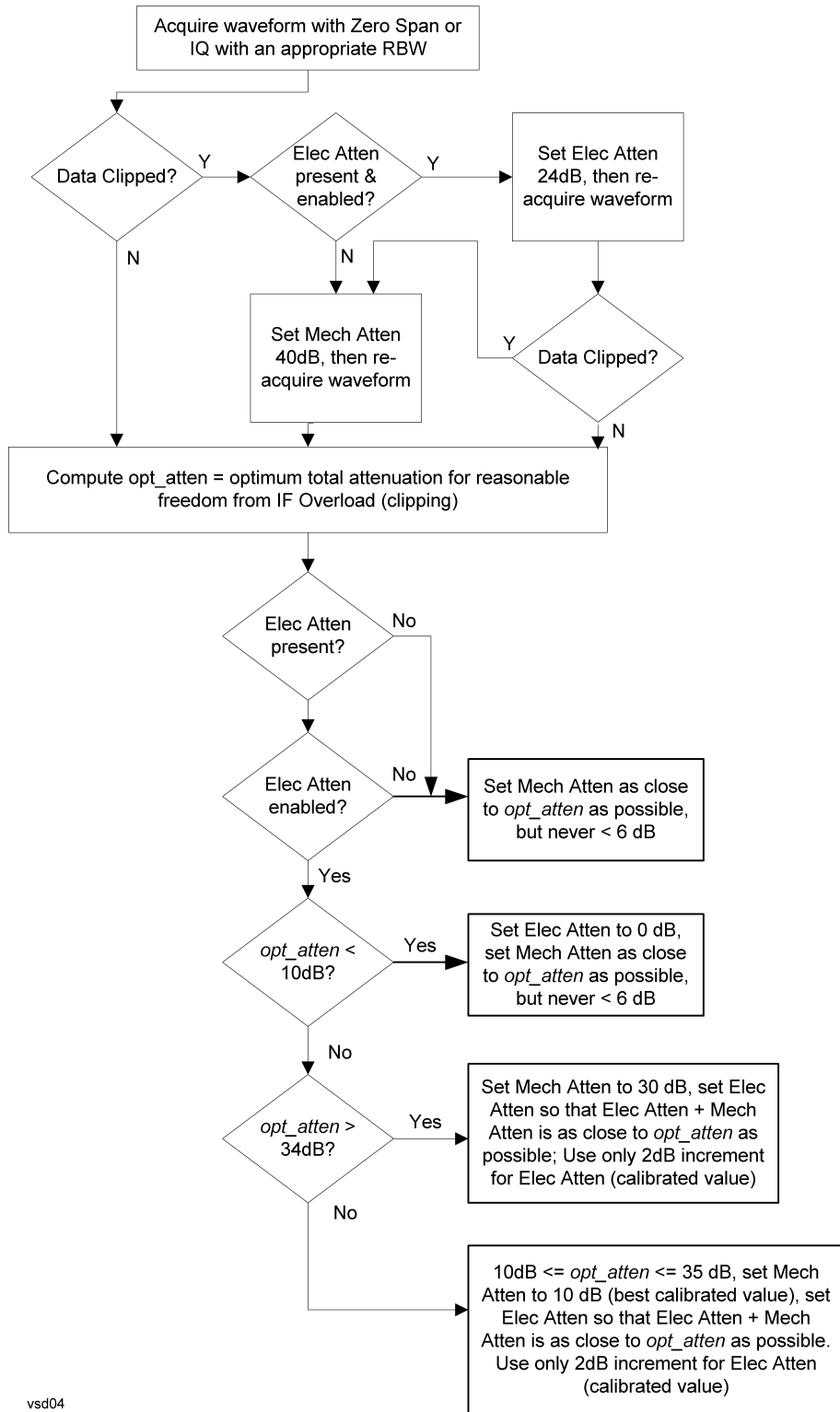

vsd04

"Pre-Adjust for Min Clipping" on page 692 selection is Elec Only.

Note that the **Mech Atten** value is not adjusted, and the value previously set is used. Therefore, there is a case that IF Overload is still observed depending on the input signal level and the Mech Atten setting.

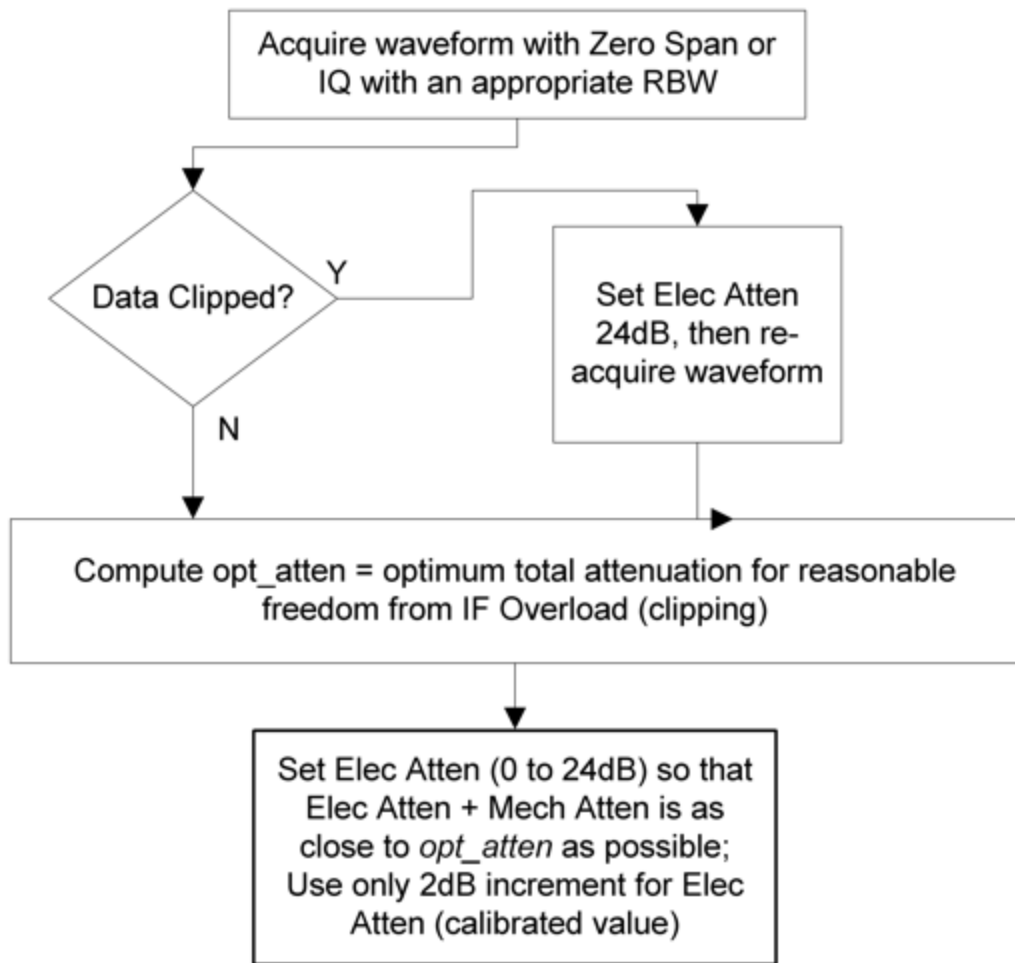

Mech Atten Step

Controls the step size used when making adjustments to the input attenuation.

Labeled **Mech Atten Step** in Dual-Attenuator models and **Atten Step** in Single-Attenuator models. In the Dual-Attenuator configuration, only affects the step size of the mechanical attenuator.

Remote Command `[:SENSe]:POWer[:RF]:ATTenuation:STEP[:INCRement] 10 dB | 2 dB`

3 VMA Mode
3.4 IQ Waveform Measurement

	<code>[:SENSe]:POWer[:RF]:ATTenuation:STEP[:INCRement]?</code>
Example	<code>:POW:ATT:STEP 2</code> <code>:POW:ATT:STEP?</code>
Notes	Has a toggle control on the front panel, but takes a specific value (in dB) when used remotely. The only valid values are 2 and 10
Dependencies	Blanked in EXA, CXA and CXA-m if option FSA (2 dB steps) is not present. If blanked, attempts to set it via SCPI yield an error
Couplings	When the attenuation step size changes, the current mechanical attenuation value is adjusted (if necessary) to be quantized to the new step size. That is, if step is set to 10 dB, mech atten is increased if necessary so it is a multiple of 10 dB
Preset	EXA, CXA and CXA-m: 10 dB (2 dB with option FSA) All other models: 2 dB
State Saved	Saved in instrument state

3.4.3.3 Range (Baseband Input models)

Only available when Option BBA is present (I/Q Baseband Inputs), the current measurement supports option BBA, and I/Q is the selected input. In these cases, replaces the **Attenuation** tab.

Each input channel (I and Q) has four internal gain ranges. The maximum allowed voltage in each gain range is slightly more than the nominal value, so the break point between ranges is a few millivolts higher than the nominal (setting a peak voltage of 0.502 mV will still map to the 0.5 V Peak range).

Gain Setting	Volts RMS	Volts Peak	Volts Peak - Peak	dBm (50Ω)	Break Point
0 dB	0.7071	1.0	2.0	10	n/a
6 dB	0.3536	0.5	1.0	4	0.502 V Peak
12 dB	0.1768	0.25	0.5	-2	0.252 V Peak
18 dB	0.0884	0.125	0.25	-8	0.127 V Peak

Dependencies	Available only when the selected input is I/Q. If the current measurement does not support baseband inputs, an error will be displayed: "No result; Meas invalid with I/Q inputs"
State Saved	No

Range Auto/Man

The **Auto** setting for **Range** causes the range to be set based on the Y Scale settings. When **Range** is **Auto**, the I & Q Range are set based on the top of the Y Scale when the Y scale is in dB units (for example, power), or to the max(abs(top), abs(bottom)) when the Y scale reference is not at the top of the screen.

Not all measurements support **Range Auto/Man**. If **Auto** is not supported in the current measurement, this control is grayed-out, displaying **Man**, and **MAN** is returned to a SCPI query, but this does *not* change the Auto/Man setting for **Range**. When you switch to a measurement that supports **Auto**, it goes back to **Auto** if it was previously in **Auto** mode.

Remote Command	<code>[:SENSe]:VOLTage:IQ:RANGe:AUTO OFF ON 0 1</code> <code>[:SENSe]:VOLTage:IQ:RANGe:AUTO?</code>
Example	Put the I Range and Q Range in manual <code>:VOLT:IQ:RANG:AUTO OFF</code> <code>:VOLT:IQ:RANG:AUTO?</code>
Dependencies	If Auto is not supported, sending the SCPI command generates an error
Couplings	When in Auto , both I Range and Q Range are set to the same value, computed as follows: Maximum absolute value is computed for the Y Scale. The top and bottom of the graph are computed based on Ref Value, Scale/Div, and Ref Position. Formula: $Y_{Max} = \max(\text{abs}(\text{top}), \text{abs}(\text{bottom}))$ The I Range and Q Range are then set to YMax
Preset	ON
State Saved	Saved in instrument state
Annotation	When in Man, the Range annotation is preceded by "#" This is an alternate form of the command to match the POWer form of the I Range and Q Range SCPI.

Remote Command	<code>[:SENSe]:POWer:IQ:RANGe:AUTO OFF ON 0 1</code> <code>[:SENSe]:POWer:IQ:RANGe:AUTO?</code>
Example	Put the I Range and Q Range in manual <code>:POW:IQ:RANG:AUTO OFF</code> <code>:POW:IQ:RANG:AUTO?</code>
Notes	<code>:POW:IQ:RANG:AUTO</code> is an alternate form of <code>:VOLT:IQ:RANG:AUTO</code> , to maintain consistency with I Range and Q Range, which support both the POWer and VOLTage forms of the command
Preset	ON
Range	Auto Man

I Range

The internal gain range for the I channel when the Input Path is I Only or I and I/Q. Used for both the I and Q channels when the Input Path is I+jQ.

Remote Command	<code>[:SENSe]:VOLTage:IQ[:I]:RANGe[:UPPer] <voltage></code> <code>[:SENSe]:VOLTage:IQ[:I]:RANGe[:UPPer]?</code>
Example	Set the I Range to 0.5 V Peak <code>:VOLT:IQ:RANG 0.5 V</code>

3 VMA Mode
3.4 IQ Waveform Measurement

	<code>:VOLT:IQ:RANG?</code>
Notes	The numeric entries are mapped to the smallest gain range whose break point is greater than or equal to the value, or 1 V Peak if the value is greater than 1 V
Couplings	When " Q Same as I " on page 1782 is On, the I Range value will be copied to " Q Range " on page 1781 Changing the value also sets Range = Man
Preset	Complex SPECTrum Measurement: 0.5 V Peak All others: 1 V Peak
State Saved	Saved in instrument state
Range	1 V Peak (10 dBm @ 50 Ω) 0.5 V Peak (4 dBm @ 50Ω) 0.25 V Peak (-2 dBm @ 50Ω) 0.125 V Peak (-8 dBm @ 50Ω)
Min	0.125 V
Max	1 V
Annotation	The Range annotation replaces the RF Input context's "Atten" annotation "Rng: <I Range>". When Range = Man the annotation is preceded by "#" The I Range is not annotated in Input Path Q Only. When I Range and Q Range are the same, the annotation is "Rng: <Range>". When I Range and Q Range are different and the Input Path is Ind I/Q, the annotation is "Rng: <I Range>, <Q Range>" and "Peak" is removed from the text. Examples: "Rng: 1 V Peak" the I Range is 1 V Peak "Rng: 1 V, 0.5 V" the I Range is 1 V Peak and the Q Range is 0.5 V Peak This is an alternate form of the command to allow entry as a power.
Remote Command	<code>[:SENSe]:POWer:IQ[:I]:RANGe[:UPPer] <amp;pl></code> <code>[:SENSe]:POWer:IQ[:I]:RANGe[:UPPer]?</code>
Example	Set the I Range to 0.5 V Peak when Reference Z is 50 Ω, and to 1.0 V Peak when Reference Z is 75 Ω <code>:POW:IQ:RANG 4 dBm</code> <code>:POW:IQ:RANG?</code>
Notes	The POWer form of the command is provided for convenience. It maps to the same underlying gain range parameter as the VOLTage form The Reference Z (not the I channel Input Z) is used to convert the power to peak voltage, which is then used to set the I Range as with the VOLTage form of the command. The power values of the 4 range states (1V Peak, 0.5V Peak, 0.25V Peak, and 0.125V Peak) will vary with Reference Z. Here are some examples: 50 Ω: 10, 4, -2, -8 75 Ω: 8.2, 2.2, -3.8, -9.8 600 Ω: -0.8, -6.8, -12.8, -18.9
Preset	10.0 dBm
Range	-20 dBm to 10 dBm
Min	-20 dBm
Max	10 dBm

Q Range

The internal gain range for the Q channel. **Q Range** only applies to Input Path Q Only and Ind I/Q. For input I+jQ "[I Range](#)" on page 1779 determines both I and Q channel range settings.

Remote Command	<code>[:SENSe]:VOLTage:IQ:Q:RANGe[:UPPer] <voltage></code> <code>[:SENSe]:VOLTage:IQ:Q:RANGe[:UPPer]?</code>
Example	Set the Q Range to 0.5 V Peak: <code>:VOLT:IQ:Q:RANG 0.5 V</code> <code>:VOLT:IQ:Q:RANG?</code>
Notes	The numeric entries are mapped to the smallest gain range whose break point is greater than or equal to the value, or 1 V Peak if the value is greater than 1 V Q Range is only used for Input Path Q Only and Ind I/Q. For input I+jQ, " I Range " on page 1779 determines both I and Q channel range settings
Couplings	When " Q Same as I " on page 1782 is On, the " I Range " on page 1779 value is copied to Q Range and the range value keys are disabled Changing the value also sets Range = Man
Preset	1 V Peak
State Saved	Saved in instrument state
Range	1 V Peak (10 dBm @ 50Ω) 0.5 V Peak (4 dBm @ 50Ω) 0.25 V Peak (-2 dBm @ 50Ω) 0.125 V Peak (-8 dBm @ 50Ω)
Min	0.125 V
Max	1 V
Annotation	The Range annotation replaces the RF Input context's "Atten" annotation "Rng: <Q Range>". When Range = Man the annotation is preceded by "#" The Q Range is not annotated in Input Path I Only or I+jQ. When I Range and Q Range are the same, the annotation is "Rng: <Range>". When I Range and Q Range are different and the Input Path is Ind I/Q, the annotation is "Rng: <I Range>, <Q Range>" and "Peak" is removed from the text. Examples: "Rng: 1 V Peak" the Q Range is 1 V Peak "Rng: 1 V, 0.5 V" the I Range is 1 V Peak and the Q Range is 0.5 V Peak This is an alternate form of the command to allow entry as a power.
Remote Command	<code>[:SENSe]:POWer:IQ:Q:RANGe[:UPPer] <amp;gt;</code> <code>[:SENSe]:POWer:IQ:Q:RANGe[:UPPer]?</code>
Example	Sets the Q Range to 0.5 V Peak when Reference Z is 50 Ω, and to 1.0 V Peak when Reference Z is 75 Ω: <code>:POW:IQ:Q:RANG 4 dBm</code> <code>:POW:IQ:Q:RANG?</code>
Notes	The POWer form of the command is provided for convenience. It maps to the same underlying gain

3 VMA Mode
3.4 IQ Waveform Measurement

range parameter as the **VOLTage** form of the command

The Reference Z (not the Q channel Input Z) is used to convert the power to peak voltage, which is then used to set the Q Range as with the **VOLTage** form of the command. The power values of the 4 range states (1V Peak, 0.5V Peak, 0.25V Peak, and 0.125V Peak) will vary with Reference Z. Here are some examples:

50 Ω: 10, 4, -2, -8

75 Ω: 8.2, 2.2, -3.8, -9.8

600 Ω: -0.8, -6.8, -12.8, -18.9

Preset	10.0 dBm
Range	-20 dBm to 10 dBm
Min	-20 dBm
Max	10 dBm

Q Same as I

Many, but not all, usages require the I and Q channels to have an identical setup. To simplify channel setup, **Q Same as I** causes the Q channel range to be mirrored from the I channel. That way, you only need to set up one channel (the I channel). The I channel values are copied to the Q channel, so at the time **Q Same as I** is Off, the I and Q channel setups will be identical.

Remote Command	<code>[:SENSe] :VOLTage POWer:IQ:MIRROred OFF ON 0 1</code> <code>[:SENSe] :VOLTage POWer:IQ:MIRROred?</code>
Example	Turn off the mirroring of I Range to Q Range <code>:VOLT:IQ:MIRR OFF</code> <code>:POW:IQ:MIRR OFF</code>
Couplings	When ON , the " I Range " on page 1779 value is mirrored (copied) to the " Q Range " on page 1781
Preset	ON
State Saved	Saved in instrument state
Range	OFF ON

3.4.3.4 Range (Non-attenuator models)

Only available for Keysight's modular signal analyzers and certain other Keysight products, such as VXT and M941xE.

State Saved	No
-------------	----

Range

Represents the amplitude of the largest sinusoidal signal that could be present within the IF without being clipped by the ADC. For signals with high peak-to-average ratios, the range may need to exceed the rms signal power by a significant amount to avoid clipping.

This is a measurement global setting.

Remote Command	<code>[:SENSe]:POWer[:RF]:RANGe <real></code> <code>[:SENSe]:POWer[:RF]:RANGe?</code>
Example	<code>:POW:RANG 10 dBm</code> <code>:POW:RANG?</code>
Notes	The MIN and MAX values are affected by the External Gain parameters, and by the Center Frequency . The hardware compensates for frequency response and alters the Range setting.
Preset	0 dBm
State Saved	Yes
Min/Max	-/+100
Annotation	Meas Bar

Adjust Range for Min Clipping

Sets the combination of attenuation and gain based on the current measured signal level so that clipping will be at a minimum.

This is an "immediate action" function, that is, it executes once, when the key is pressed.

This key does not appear in measurements that do not support this functionality.

Remote Command	<code>[:SENSe]:POWer[:RF]:RANGe:OPTimize IMMEDIATE</code>
Notes	Executing Adjust Range for Min Clipping initiates the measurement.
Dependencies	Does not appear in the Swept SA and Monitor Spectrum measurements.

Pre-Adjust for Min Clipping

If this function is **ON**, it applies the adjustment described under Adjust Range For Min Clipping each time a measurement restarts. Therefore, in Continuous measurement mode, it only executes before the first measurement.

Remote Command	<code>[:SENSe]:POWer[:RF]:RANGe:OPTimize:ATTenuation OFF ON ELECTRICAL COMBined</code>
----------------	---

	<code>[:SENSe]:POWer[:RF]:RANGe:OPTimize:ATTenuation?</code>
Notes	Because there is no attenuator control available in these models, the control displays only ON and OFF choices. However, for SCPI compatibility with other platforms, all three parameters (ELEctrical , COMBined , and ON) are honored and all are mapped to ELEctrical , so if any of these three parameters is sent, a subsequent query will return ELEC
Dependencies	Does not appear in the Swept SA and Monitor Spectrum measurements
Preset	OFF for Swept SA measurement; ON for all other measurements that support Pre-Adjust for Min Clipping
State Saved	Saved in instrument state

Adjustment Algorithm

The algorithm for the adjustment is documented below:

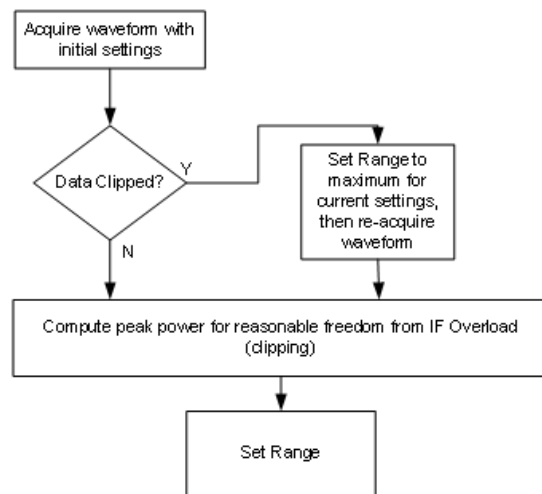

Peak-to-Average Ratio

Used with "[Range \(Non-attenuator models\)](#)" on page 1782 to optimize the level control in the instrument. The value is the ratio, in dB, of the peak power to the average power of the signal to be measured. A ratio of 0 should be used for sinusoidal signals; for 802.11g OFDM signals use 9 dB.

All Modes show the current value of Peak-to-Average ratio on the control. However, some Modes do not permit changing the value. In these situations, the control is grayed-out.

Remote Command	<code>[:SENSe]:POWer[:RF]:RANGe:PARatio <real></code> <code>[:SENSe]:POWer[:RF]:RANGe:PARatio?</code>
Example	<code>:POW:RANG:PAR 12 dB</code>
Notes	In some Modes, this parameter is read-only; meaning the value will appear on the control and query

	via SCPI, but is not changeable. In such applications the control is grayed-out. Attempts to change the value via SCPI are ignored, but no error message is generated	
Dependencies	Does not appear in Spectrum Analyzer Mode	
Preset	VXT Models M9410A/11A	0 dB
	All Others	10 dB
State Saved	Saved in instrument state	
Min	0 dB	
Max	VXT Models M9410A/11A	50 dB
	All Others	20 dB

Mixer Lvl Offset

This is an advanced setting to adjust target Range at the input mixer, which in turn affects the signal level in the instrument's IF. This setting can be used when additional optimization is needed after setting "[Peak-to-Average Ratio](#)" on page 1784. Positive values of offset optimize noise performance over distortion, negative values optimize distortion performance over noise.

Remote Command	<code>[:SENSe]:POWer[:RF]:RANGe:MIXer:OFFSet <real></code> <code>[:SENSe]:POWer[:RF]:RANGe:MIXer:OFFSet?</code>	
Example	<code>:POW:RANG:MIX:OFFS -5 dB</code>	
Preset	0 dB	
State Saved	Saved in instrument state	
Min	VXT Models M9410A/11A	-34 dB
	All Others	-35 dB
Max	30 dB	

3.4.3.5 Signal Path

Contains controls that pertain to the routing of the signal through the frontend of the instrument.

In general, only appears in instruments whose hardware supports this signal routing. For example, this tab does not appear in many of the modular instrument products, including VXT Model M9420A, or UXM.

This tab *does* appear in VXT Models M9410A/11A/15A/16A and M9410E/11E/15E/16E, because ["Software Preselection" on page 1801](#) is under this tab, and VXT Models M9410A/11A/15A/16A and M9410E/11E/15E/16E implement a version of Software Preselection.

Presel Center

Adjusts the centering of the preselector filter to optimize the amplitude accuracy at the frequency of the selected marker. If the selected marker is not on when **Presel Center** is pressed, the instrument turns on the selected marker, performs a peak search, and then performs centering on the marker's center frequency. If the selected marker is already on and between the start and stop frequencies of the instrument, the instrument performs the preselector calibration on that marker's frequency. If the selected marker is already on, but outside the frequency range between **Start Freq** and **Stop Freq**, the instrument first performs a peak search, and then performs centering on the marker's center frequency.

The value displayed on ["Preselector Adjust" on page 1787](#) changes to reflect the new preselector tuning.

Certain considerations should be observed to ensure proper operation, as detailed in ["Proper Preselector Operation" on page 706](#).

Remote Command	<code>[:SENSe] :POWer [:RF] :PCENter</code>
Example	<code>:POW:PCEN</code>
Notes	The rules outlined above under the control description apply for the remote command as well as the key. The result of the command depends on marker position, etc. Any message generated by the control press is also generated in response to the remote command
Dependencies	Does not appear in CXA-m, nor in VXT Models M9410A/11A/15A/16A, M9410E/11E/15E/16E Grayed-out if the microwave preselector is off <ul style="list-style-type: none"> - If the selected marker's frequency is below Band 1, an advisory message is generated "Preselector not used in this frequency range" and no action is taken - Grayed-out if entirely in Band 0, that is, if Stop Freq is below about 3.6 GHz Grayed-out if entirely above 50 GHz, that is, if Start Freq is above 50 GHz - Blanked in models that do not include a preselector, such as Option 503. If the remote command is sent in these instruments, accepted without error, and the query always returns 0 - Grayed-out in the Spectrogram View
Couplings	The active marker position determines where the centering will be attempted If the instrument is in a measurement such as averaging when centering is initiated, the act of centering the preselector restarts averaging, but the first average trace will not be taken until the centering is completed The offset applied to do the centering appears in "Preselector Adjust" on page 1787
Status Bits/OPC	When centering the preselector, *OPC does not return true until the process is complete and a

dependencies subsequent measurement has completed, nor are results returned in response to `:READ` or `:MEASure` queries
The **Measuring** bit remains set (true) while this command is operating, and does not go false until the subsequent sweep/measurement has completed

Proper Preselector Operation

Certain considerations should be observed to ensure proper operation:

1. If the selected marker is **Off**, the instrument turns on a marker, performs a peak search, and adjusts the preselector using the selected marker's frequency. It uses the "highest peak" peak search method unqualified by threshold or excursion, so that there is no chance of a 'no peak found' error. It continues with that peak, even if it is the peak of just noise. Therefore, for this operation to work properly, there should be a signal on-screen in a preselected range for the peak search to find
2. If the selected marker is already **On**, the instrument attempts the centering at that marker's frequency. There is no preselector for signals below about 3.6 GHz, so if the marker is on a signal below 3.6 GHz, no centering is attempted, and an advisory message is generated
3. In some models, the preselector can be bypassed. If it is bypassed, no centering is attempted in that range and a message is generated

Preselector Adjust

Lets you manually adjust the preselector filter frequency to optimize its response to the signal of interest. Only available when **"Presel Center"** on page 1786 is available.

For general purpose signal analysis, using **Presel Center** is recommended. Centering the filter minimizes the impact of long-term preselector drift. **Preselector Adjust** can be used instead to manually optimize the preselector. One application of manual optimization would be to peak the preselector response, which both optimizes the signal-to-noise ratio and minimizes amplitude variations due to small (short-term) preselector drifting.

When **Presel Center** is performed, the offset applied to do the centering becomes the new value of **Preselector Adjust**.

Remote Command	<code>[:SENSe] :POWer [:RF] :PADJust <freq></code> <code>[:SENSe] :POWer [:RF] :PADJust?</code>
Example	<code>:POW:PADJ 100KHz</code> <code>:POW:PADJ?</code>
Notes	The value on the control is displayed to 0.1 MHz resolution
Dependencies	- Does not appear in CXA-m

3 VMA Mode

3.4 IQ Waveform Measurement

- Does not appear in VXT Models M9410A/11A/15A/16A
- Does not appear in M9410E/11E/15E/16E
- Grayed-out if microwave preselector is off
- Grayed-out if entirely in Band 0, that is, if Stop Freq is lower than about 3.6 GHz
- Grayed-out if entirely above 50 GHz, that is, if Start Freq is higher than 50 GHz
- Blank in models that do not include a preselector, such as Option 503. If the command is sent in these instruments, it is accepted without error, and the query always returns 0
- Grayed-out in the **Spectrogram View**

Preset	0 MHz
State Saved	The Preselector Adjust value set by " Presel Center " on page 1786, or by manually adjusting Preselector Adjust Not saved in instrument state, and does not survive a Preset or power cycle
Min/Max	-/+500 MHz
Backwards Compatibility SCPI	<code>[:SENSe]:POWer[:RF]:MW:PADJust</code> <code>[:SENSe]:POWer[:RF]:MMW:PADJust</code> Backwards Compatibility Command
Notes	The command has no effect, and the query always returns MWAVE
Backwards Compatibility SCPI	<code>[:SENSe]:POWer[:RF]:PADJust:PRESelector MWAVE MMWave EXTERNAL</code> <code>[:SENSe]:POWer[:RF]:PADJust:PRESelector?</code>

Internal Preamp

Accesses a menu of controls for the internal preamps. Turning on the preamp gives a better noise figure, but a poorer inter-modulation distortion (TOI) to noise floor dynamic range. You can optimize this setting for your measurement.

The instrument takes the preamp gain into account as it sweeps. If you sweep outside of the range of the preamp, the instrument will also account for that. The displayed result always reflects the correct gain.

For some measurements, when the preamp is on and any part of the displayed frequency range is below the lowest frequency for which the preamp has specifications, a warning condition message appears in the status line. For example, for a preamp with a 9 kHz lowest specified frequency: "Preamp: Accy unspec'd below 9 kHz".

Selection	Example	Note
Off	:POW:GAIN OFF	
Low Band	:POW:GAIN ON :POW:GAIN:BAND LOW	Sets the internal preamp to use only the low band. The frequency range of the installed (optional) low-band preamp is displayed in square brackets on the Low Band selection in the dropdown
Full Range	:POW:GAIN ON :POW:GAIN:BAND FULL	Sets the internal preamp to use its full range. The low band (0-3.6 GHz, 0-3.4 GHz, 0-3 GHz, depending on the model) is supplied by the low band preamp and the frequencies above low band are supplied by the high band preamp The frequency range of the installed (optional) low-band preamp is displayed in square brackets on the Full Range selection in the dropdown. If the high band option is not installed the Full Range selection does not appear

NOTE

The maximum **Center Frequency for Low Band**, displayed in square brackets, can change based on the selected IFBW for measurements that support IFBW (for example, Waveform measurement across all Modes that support it). In certain models (such as N9042B & N9032B), IFBW values ≤ 40 MHz have a maximum **Low Band** frequency of 3.6 GHz, while $40 \text{ MHz} < \text{IFBW} \leq 1 \text{ GHz}$ have a maximum of 3.3 GHz, and $1 \text{ GHz} < \text{IFBW} \leq 1.5 \text{ GHz}$ have a maximum of 3.5 GHz. IFBW values $> 1.5 \text{ GHz}$ do not support a **Center Frequency** that can reach the **Low Band** maximum frequency. In these cases, **N/A** is displayed in the square brackets for **Low Band**.

Remote Command	<code>[:SENSe]:POWer[:RF]:GAIN:BAND LOW FULL</code> <code>[:SENSe]:POWer[:RF]:GAIN:BAND?</code>
Example	<code>:POW:GAIN:BAND LOW</code> <code>:POW:GAIN:BAND?</code>
Dependencies	Not available on all hardware platforms. If the preamp is not present or is unlicensed, this control is not shown Does not appear in VXT Models M9410A/11A/15A/16A nor in M9410E/11E/15E/16E If <code>:POW:GAIN:BAND FULL</code> is sent when a low band preamp is available, the preamp band parameter is set to <code>LOW</code> instead of <code>FULL</code> , and an "Option not installed" message is generated Not available when the electronic/soft attenuator is enabled
Preset	<code>LOW</code>
State Saved	Saved in instrument state
Annotation	When the USB Preamp is not connected to USB, the Preamp annotation in the Meas Bar says "Off" if the preamp is off and displays the frequency range of the low band or full range preamp depending on the setting. For example, if the Preamp is set to Low Band and the Low Band is 3.6 GHz the annotation says "3.6 GHz". If it is a 13.6 GHz preamp and it is set to Full Range the annotation says "13.6 GHz"

3 VMA Mode
3.4 IQ Waveform Measurement

When the USB Preamp is connected to USB, the Preamp annotation says "Preamp: USB" if the internal preamp is off or "Preamp: USB, Int" if the internal preamp is on (only for measurements that support the USB preamp)

Auto Function

Remote Command	<code>[:SENSe]:POWer[:RF]:GAIN[:STATe] OFF ON 0 1</code> <code>[:SENSe]:POWer[:RF]:GAIN[:STATe]?</code>
Example	<code>:POW:GAIN OFF</code> <code>:POW:GAIN?</code>
Preset	<code>OFF</code>

LNA

Lets you turn the Low Noise Amplifier (LNA) on or off.

LNA is an additional preamplifier that provides superior DANL and frequency range compared to "[Internal Preamp](#)" on page 1788. LNA provides lower system noise figure, especially at frequencies above 100 MHz, and can be operated up to the full range of 50 GHz instruments.

For best possible sensitivity, LNA can be turned on *together* with "[Internal Preamp](#)" on page 1788, although if you operate both preamps together, note that the TOI (distortion) specifications are impacted. The sensitivity improvement of this combination is substantial when operating in high band (frequencies above 3.6 GHz).

For more details about annotation, see "[More Information](#)" on page 710

Remote Command	<code>[:SENSe]:POWer[:RF]:GAIN:LNA[:STATe] OFF ON 0 1</code> <code>[:SENSe]:POWer[:RF]:GAIN:LNA[:STATe]?</code>
Example	<code>:POW:GAIN:LNA ON</code>
Dependencies	Requires Option LNA, except for VXT models M9415A/16A Does not appear in VXT models M9420A/10A/11A M9410E/11E/15E/16E support LNA May not appear in some measurements LNA is not available when the electronic/soft attenuator is enabled
Preset	<code>OFF</code>
State Saved	Saved in State

More Information

When **LNA** is installed, the preamp annotation changes to show the state of both **LNA** and **Internal Preamp**. Below is an example:

```
Atten: 8 dB
Pre: Int on, LNA on
μW Path: LNP, On
Source: Off
```

Note that when operating entirely in the low band (below about 3.6 GHz), if **LNA** is on, **Internal Preamp** is switched off (even if you have its switch set to **ON**). This is because the noise performance is actually degraded in low band if both preamps are on. In this case, the annotation reflects the actual state of the two preamps, but the **Internal Preamp** annotation displays in amber, to warn you that the actual state of **Internal Preamp** does not match its switch control display:

```
Atten: 8 dB
Pre: Int off, LNA on
μW Path: LNP, On
Source: Off
```

μW Path Control

Options for this control include **μW Preselector Bypass** (Option MPB), **Low Noise Path** (Option LNP) and **Full Bypass Enable** in the High Band path circuits.

When the μW Preselector is bypassed, flatness is improved, but will be subject to spurs from out of band interfering signals. When **Low Noise Path Enable** is selected, the instrument automatically bypasses certain circuitry in the high frequency bands that can contribute to noise, when it is appropriate based on other instrument settings.

For most applications, the preset state is **Standard Path**, which provides the best remote-control throughput, minimizes acoustic noise from switching and minimizes the risk of wear in the hardware switches, particularly in remote test scenarios where both low band and high band setups will follow in rapid succession. In this path, the bypass of the low band/high band switch and microwave preamp is never activated, which can cause some noise degradation but preserves the life of the bypass switch.

For applications that utilize the wideband IF paths, the preset state is **μW Preselector Bypass**, if option MPB is present. This is because, when using a wideband IF such as the 140 MHz IF, the μW Preselector's bandwidth can be narrower than the available IF bandwidth, causing degraded amplitude flatness and phase linearity, so it is desirable to bypass the preselector in the default case.

You may choose **Low Noise Path Enable** for a lower noise floor, especially in the 21-26.5 GHz region, though without improving many measures of dynamic range, and

3 VMA Mode
3.4 IQ Waveform Measurement

without giving the best possible noise floor. The preamp, if purchased and used, gives better noise floor than does **Low Noise Path Enable**, but the preamp's compression threshold and third-order intercept are much poorer than that of **Low Noise Path Enable**.

A fourth choice is **Full Bypass Enable**, which combines **μW Preselector Bypass** and **Low Noise Path Enable**. Because this can bypass most of the circuitry between the input and the first mixer, care should be taken when using this setting to avoid damaging the mixer. **Full Bypass Enable** is only available if both options LNP and MPB are present, as well as option FBP.

Path	Example	Note
Standard Path	:POW:MW:PATH STD	Normal setting for most measurements. μW Preselector in circuit, Low Noise Path disabled
Low Noise Path Enable	:POW:MW:PATH LNP	See " Low Noise Path Enable " on page 715
μW Preselector Bypass	:POW:MW:PATH MPB	See " μW Preselector Bypass " on page 717
Full Bypass Enable	:POW:MW:PATH FULL	See " Full Bypass Enable " on page 717

Remote Command	<code>[:SENSe]:POWer[:RF]:MW:PATH STD LNPath MPBypass FULL</code> <code>[:SENSe]:POWer[:RF]:MW:PATH?</code>
Example	<code>:POW:MW:PATH LNP</code> Enables the Low Noise path <code>:POW:MW:PATH?</code>
Notes	When " Presel Center " on page 1786 is performed, the instrument momentarily switches to the Standard Path, regardless of the setting of μW Path Control The DC Block will always be switched in when the low noise path is switched in, to protect succeeding circuitry from DC. Note that this does not mean "when the low noise path is enabled" but when, based on the Low Noise Path rules, the path is actually switched in. This can happen when the selection is Low Noise Path Enable or Full Bypass Enable . In the case where the DC Block is switched in, the instrument is now AC-coupled. However, if you selected DC coupling, the UI would still behave as though it were DC-coupled, including all annunciation, warnings, status bits, and responses to SCPI queries. This is because, based on other settings, the instrument could switch out the low noise path at any time and hence go back to being DC-coupled Alignment switching ignores the settings in this menu, and restores them when finished
Dependencies	Does not appear in CXA-m, VXT Models M9410A/11A/15A/16A, nor in M9410E/11E/15E/16E, BBIQ and External Mixing <ul style="list-style-type: none"> - The Low Noise Path Enable selection does not appear unless Option LNP is present and licensed - The μW Preselector Bypass selection does not appear unless Option MPB is present and licensed - The Full Bypass Enable selection does not appear unless options LNP and MPB are both present as well as option FBP

In any of these cases, if the required options are not present and the SCPI command is sent, error - 241, "Hardware missing; Option not installed" is generated

Low Noise Path Enable and **Full Bypass Enable** are grayed-out if the current measurement does not support them

Low Noise Path Enable and **Full Bypass Enable** are not supported in Avionics and MMR Modes (non-modulation measurements). In any of these cases (that is, the feature is not supported in either measurement or Mode), if the SCPI command is sent, the following error is generated: -221, "Setting Conflict; Feature not supported for this measurement"

Preset	Mode	Value
	IQ Analyzer	MPB option present and licensed: MPB
	Pulse	MPB option not present and licensed: STD
	RTSA	
	Avionics	
	All other Modes	STD
	-	

State Saved Save in instrument state

Range Standard Path | Low Noise Path Enable | μ W Presel Bypass | Full Bypass Enable

Annotation In the Meas Bar, if the Standard path is chosen:
 μ W Path: Standard
 If Low Noise Path is enabled but the LNP switch is not thrown:
 μ W Path: LNP,Off
 If the Low Noise Path is enabled and the LNP switch is thrown:
 μ W Path: LNP,On
 If the preselector is bypassed:
 μ W Path: Bypass
 If Full Bypass Enable is selected but the LNP switch is not thrown:
 μ W Path: FByp,Off
 If Full Bypass Enable is selected and the LNP switch is thrown:
 μ W Path: FByp,On

μ W Path Control Auto

In VMA, WLAN, 5G NR, CQM Modes, an **Auto/Man** switch is added to μ W Path Control:



3 VMA Mode

3.4 IQ Waveform Measurement

This allows the function to automatically switch based on certain Auto Rules as shown below:

VMA Mode

Measurement	μ W Path Control Auto behavior
Digital Demod	Use Standard Path unless tuned frequency > 3.6 GHz and IFBW > 15 MHz, in which case choose Preselector Bypass
Monitor Spectrum	Always Presel Bypass
IQ Waveform	Use Standard Path unless tuned frequency > 3.6 GHz and IFBW > 15 MHz, in which case choose Preselector Bypass
Custom OFDM	Use Standard Path unless tuned frequency > 3.6 GHz and IFBW > 15 MHz, in which case choose Preselector Bypass
Channel Power	Always Presel Bypass
Occupied BW	Always Presel Bypass
CCDF	Use Standard Path unless tuned frequency > 3.6 GHz and IFBW > 15 MHz, in which case choose Preselector Bypass
ACP	Always Presel Bypass
SEM	Always Presel Bypass
Spurious Emissions	Always Standard Path

WLAN Mode

Measurement	μ W Path Control Auto behavior
Modulation Analysis	Always Presel Bypass
Spectral Flatness	Always Presel Bypass
Power vs Time	Always Presel Bypass
Monitor Spectrum	Always Presel Bypass
IQ Waveform	Always Presel Bypass
Channel Power	Always Presel Bypass
Occupied BW	Always Presel Bypass
CCDF	Always Presel Bypass
SEM	For 11be 320M, when 'Enabled Wideband IF for FFT' is OFF or 'Sweep Type Rule' is Best Dynamic Range, auto μ W path is standard For other cases, auto μ W path is presel bypass if presel bypass is enabled, auto μ W path is standard if presel bypass is not enabled
Spurious Emissions	Always Standard Path

5G NR Mode

Measurement	μ W Path Control Auto behavior
Modulation Analysis	Use Standard Path unless tuned frequency > 3.6 GHz and IFBW > 15 MHz, in which case choose Full Bypass if conditions warrant(FBP Option is available and "Allow Full Bypass in Auto" is On), otherwise choose Preselector Bypass
Monitor Spectrum	Always Standard Path
IQ Waveform	Use Standard Path unless tuned frequency > 3.6 GHz and IFBW > 15 MHz, in which case choose Full Bypass if conditions warrant(FBP Option is available and "Allow Full Bypass in Auto" is On), otherwise choose Preselector Bypass
Channel Power	Always Standard Path
Occupied BW	Always Standard Path
CCDF	Use Standard Path unless tuned frequency > 3.6 GHz and IFBW > 15 MHz, in which case choose Preselector Bypass
ACP	Always Standard Path
SEM	Always Standard Path
Spurious Emissions	Always Standard Path
Transmit On Off Power	Use Standard Path unless tuned frequency > 3.6 GHz and Info BW > 15 MHz, in which case choose Preselector Bypass

Channel Quality Mode

Measurement	μ W Path Control Auto behavior
Group Delay	Use Standard Path unless tuned frequency > 3.6 GHz and IFBW > 15 MHz, in which case choose Full Bypass if conditions warrant(FBP Option is available and "Allow Full Bypass in Auto" is On), otherwise choose Preselector Bypass
Monitor Spectrum	Always Standard Path
IQ Waveform	Use Standard Path unless tuned frequency > 3.6 GHz and IFBW > 15 MHz, in which case choose Preselector Bypass
CCDF	Use Standard Path unless tuned frequency > 3.6 GHz and IFBW > 15 MHz, in which case choose Preselector Bypass

Remote Command	<code>[:SENSe]:POWer[:RF]:MW:PATH:AUTO ON OFF 1 0</code> <code>[:SENSe]:POWer[:RF]:MW:PATH:AUTO?</code>
Example	<code>:POW:MW:PATH:AUTO ON</code> <code>:POW:MW:PATH:AUTO?</code>
Dependencies	Only appears in VMA, WLAN, 5G NR and CQM Modes
Couplings	See " μW Path Control Auto " on page 712 above
Preset	ON
Range	ON OFF

Low Noise Path Enable

Low Noise Path Enable provides a lower noise floor under some circumstances, particularly when operating in the 21–26.5 GHz region. With the Low Noise Path enabled, the low band/high band switch and microwave preamp are bypassed whenever *all* the following are true:

- The instrument is not in the Low Band, meaning:
- the start frequency is above 3.5 GHz and
- the stop frequency is above 3.6 GHz
- The internal preamp is not installed, or if installed, is set to **Off** or **Low Band**

Note that this means that, when any part of a sweep is done in Low Band, the Low Noise Path is not used, whether or not the **Low Noise Path Enable** is selected in the user interface. Also, if the preamp is turned on, the Low Noise Path is not used, whether or not the **Low Noise Path Enable** is selected in the user interface. The only time the Low Noise Path is used is when **Low Noise Path Enable** is selected, the sweep is completely in High Band (> 3.6 GHz) and no preamp is in use.

For measurements that use IQ acquisition, the low noise path is used when **Center Frequency** is in High Band (> 3.6 GHz) and no preamp is in use. In other words, the rules above are modified to use only the center frequency to qualify which path to switch in. This is not the case for FFTs in the Swept SA measurement; they use the same rules as swept measurements.

Note that the Low Noise Path, while giving improved DANL, has the disadvantage of decreased TOI performance and decreased gain compression performance relative to the standard path.

Note also that the bypass switch is a mechanical switch and has finite life, so if the **Low Noise Path Enable** is selected, it is possible to cause frequent cycling of this switch by frequently changing instrument settings such that the above conditions hold true only some of the time. A user making tests of this nature should consider opting for the **Standard Path**, which will never throw the bypass switch, at the expense of some degraded noise performance.

The low noise path is useful for situations where the signal level is so low that the instrument performance is dominated by noise even with 0 dB attenuation, but still high enough that the preamp option would have excessive third-order intermodulation or compression. The preamp, if purchased and used, gives better noise floor than does the “Low Noise Path.” However, its compression threshold and third-order intercept are much poorer than that of the non-preamp path.

There are some applications, typically for signals around –30 dBm, for which the third-order dynamic range of the standard path is good enough, but the noise floor is not low enough even with 0 dB input attenuation. When the third-order dynamic

range of the preamp path is too little and the noise floor of the standard path is too high, the Low Noise Path can provide the best dynamic range

The graph below illustrates the concept. It shows, in red, the performance of an instrument at different attenuation settings, both with the preamp on and off, in a measurement that is affected by both instrument noise and instrument TOI. The green shows the best available dynamic range, offset by 0.5 dB for clarity. The blue shows how the best available dynamic range improves for moderate signal levels with the low noise path switched in. In this illustration, the preamp improves the noise floor by 15 dB while degrading the third-order intercept by 30 dB, and the low noise path reduces loss by 8 dB. The attenuator step size is 2 dB.

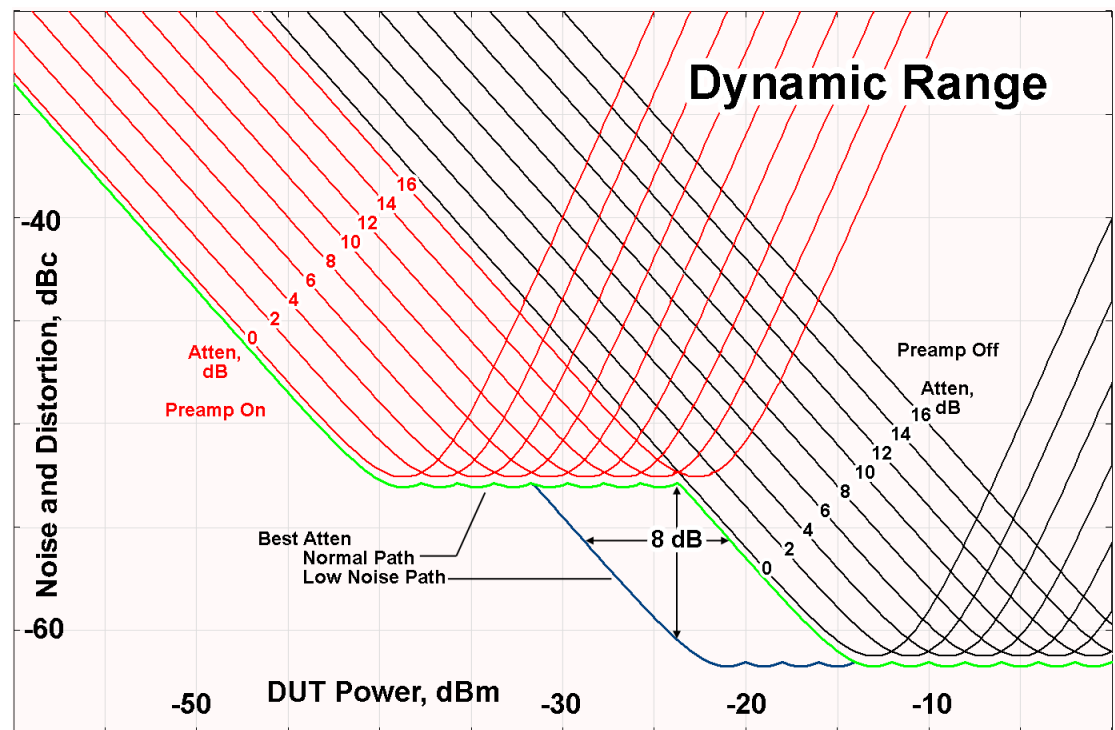

There are other times where selecting the low noise path improves performance, too. Compression-limited measurements such as finding the nulls in a pulsed-RF spectrum can profit from the low noise path in a way similar to the TOI-limited measurement illustrated. Accuracy can be improved when the low noise path allows the optimum attenuation to increase from a small amount like 0, 2 or 4 dB to a larger amount, giving better return loss at the instrument input. Harmonic measurements, such as second and third harmonic levels, are much improved using the low noise path because of the superiority of that path for harmonic (though not intermodulation) distortion performance.

μW Preselector Bypass

Toggles the preselector bypass switch for band 1 and higher. When the microwave preselector is on, the signal path is preselected. When the microwave preselector is off, the signal path is not preselected. The preselected path is the normal path for the instrument.

The preselector is a tunable bandpass filter which prevents signals away from the frequency of interest from combining in the mixer to generate in-band spurious signals (images). The consequences of using a preselector filter are its limited bandwidth, the amplitude and phase ripple in its passband, and any amplitude and phase instability due to center frequency drift.

Option MPB or pre-selector bypass provides an unpreselected input mixer path for certain X-Series signal analyzers with frequency ranges above 3.6 GHz. This signal path allows a wider bandwidth and less amplitude variability, which is an advantage when doing modulation analysis and broadband signal analysis. The disadvantage is that, without the preselector, image signals will be displayed. Another disadvantage of bypassing the preselector is increased LO emission levels at the front panel input port.

Image responses are separated from the real signal by twice the 1st IF. For IF Paths of 10 MHz and 25 MHz, the 1st IF is 322.5 MHz, so the image response and the real signal will be separated by 645 MHz. The 1st IF will be different for other IF Path settings. When viewing a real signal and its corresponding image response in internal mixing, the image response will be to the left of the real signal.

Also, the image response and the real signal typically have the same amplitude and exhibit the same shape factor.

However, if Option FS1 (Fast Sweep Capability) is enabled, the image response in the Swept SA measurement appears lower in amplitude and has a much wider shape factor compared to the real signal.

Full Bypass Enable

With **Full Bypass Enable** selected, the microwave preselector is bypassed. In addition, the low band/high band switch and microwave preamp are bypassed whenever *all* the following are true:

- The instrument is not in the Low Band, meaning:
- the start frequency is above 3.5 GHz and
- the stop frequency is above 3.6 GHz.
- the internal preamp is not installed or if installed, is set to **Off** or **Low Band**

Note that this means that, when any part of a sweep is done in Low Band, the Low Noise Path is not used, whether or not the **Full Bypass Enable** is selected in the user

interface. Also, if the preamp is turned on, the Low Noise Path is not used, whether or not the **Full Bypass Enable** is selected in the user interface. The only time the Low Noise Path is used is when **Full Bypass Enable** is selected, the sweep is completely in High Band (> 3.6 GHz) and no preamp is in use.

CAUTION

When **Full Bypass Enable** is selected, and "**Y Scale**" on page 1760 is set to 0 dB, there will be a direct AC connection between the input and the first converter when the Low Noise Path switches in (when Start Freq >3.6 GHz and the Preamp is either not licensed, set to Low Band, or Off). This puts the first converter at considerable risk to be damaged by high AC power. Consequently, whenever **Full Bypass Enable** is selected, a warning message appears in the status bar:

"Full Bypass Enabled, maximum safe input power reduced"

Microwave Preselector Bypass Backwards Compatibility

Example	Bypass the microwave preselector: <code>:POW:MW:PRES OFF</code>
Notes	Included for Microwave Preselector Bypass backwards compatibility The ON parameter sets the STD path (<code>:POW:MW:PATH STD</code>) The OFF parameter sets path MPB (<code>:POW:MW:PATH MPB</code>)
Preset	ON
Backwards Compatibility SCPI	<code>[:SENSe]:POWer[:RF]:MW:PRESelector[:STATe] ON OFF 0 1</code> <code>[:SENSe]:POWer[:RF]:MW:PRESelector[:STATe]?</code>

Frequency Extender Preselection Bypass

Only applies to the high frequency path of the Frequency Extender, and only if the Frequency Extender allows it. For example, the V3050A high frequency path is 50 – 110 GHz and *does* allow control of the preselector bypass.

When the Frequency Extender's preselection is bypassed, flatness is improved, but will be subject to spurs from out-of-band interfering signals. For bandwidths greater than 2.5 [GHz], it is recommended that the signal bypass the Frequency Extender Preselector since the max bandwidth of the Preselector can be as narrow as 2.5 [GHz].

For most applications, the preset state is **OFF**, which gives the best remote-control throughput, minimizes acoustic noise from switching, minimizes out of band spurs, and minimizes the risk of wear in the hardware switches.

Preselector and Bandwidth Conflict

When the Frequency Extender Preselector is applied and the signal bandwidth is greater than 2.5 [GHz], then a settings alert message will show to warn the user that the signal may be distorted due to the limitation of the Frequency Extender Preselector bandwidth.

An example of the settings alert message is shown below.

Settings Alert message in the Status Bar at the bottom of the display.



Settings Alert message in the error queue

Type	ID	
	159	Settings Alert - DETECTED; Presel/Meas BW conflict

Allow Full Bypass in Auto

Enable or disable Full Bypass in μ W Path Auto rule. See " [\$\mu\$ W Path Control](#)" on page 1791.

When this function is **ON**, and " [\$\mu\$ W Path Control](#)" on page 1791 is in **AUTO**, it is possible for the auto rules to select the **FULL** Bypass state, which bypasses both the Preamp and the Microwave Preselector. Otherwise, the auto rules never select the **FULL** Bypass state. This is convenient when making wideband measurements, but it also adds some risk of damage to the first converter.

CAUTION

When **Full Bypass Enable** is selected, and "[Y Scale](#)" on page 1760 is set to 0 dB, there will be a direct AC connection between the input and the first converter when the Low Noise Path switches in (when Start Freq > 3.6 GHz and the Preamp is either not licensed, set to **Low Band** or **Off**). This puts the first converter at considerable risk to be damaged by high AC power. Consequently, whenever **Full Bypass Enable** is selected, a warning message appears in the status bar:

"Full Bypass Enabled, maximum safe input power reduced"

Remote Command [:SENSe]:POWer[:RF]:MW:PATH:AUTO:FULL ON | OFF | 1 | 0
[:SENSe]:POWer[:RF]:MW:PATH:AUTO:FULL?

Example	<code>:POW:MW:PATH:AUTO:FULL ON</code> <code>:POW:MW:PATH:AUTO:FULL?</code>
Dependencies	Only appears if Option FBP is installed, and in the following measurements <ul style="list-style-type: none"> - 5GNRMode: Modulation Analysis and IQ Waveform - WLAN Mode: IQ Waveform - Channel Quality Mode: Group Delay and Noise Power Ratio
Preset	<code>OFF</code>
State Saved	Saved in instrument state

Software Preselection

Provided in some instruments, either to compensate for issues with provided hardware preselection or to provide the preselection function when there is no hardware preselector.

N9041B

Software Preselection compensates for the frequency range limit of the microwave preselector. Since the microwave preselector only goes up to 50 GHz, software preselection must be used to suppress and separate images above 50 GHz. The specific algorithm used for software preselection is specified by the SW Preselection Type selection – Normal or Advanced.

In N9041B, **Software Preselection** only applies for frequencies above 50 GHz, therefore it is only used for RF Input 2. Even if turned on, it is not used for other inputs, and never for frequencies below 50 GHz. This is why the label of this control contains the parenthetical note “(>~50 GHz)”.

Note that in N9041B, in Swept SA measurement, **Software Preselection** works even if the measurement is using an FFT Sweep Type. In measurements other than Swept SA, Software Preselection is not used if the measurement is using an FFT sweep type.

N9042B+V3050A

Software Preselection compensates for the frequency range limit of the microwave preselector. Since the microwave preselector only goes up to 50 GHz, software preselection must be used to suppress and separate images above 50 GHz. The specific algorithm used for software preselection is specified by the SW Preselection Type selection – Normal or Advanced.

For N9042B+V3050A, Software Preselection only applies for frequencies above 50 GHz, therefore it is only used for External RF. Even if it is turned on, it will not be

3 VMA Mode
 3.4 IQ Waveform Measurement

used for other inputs and never for frequencies below 50 GHz. This is why the label of this control contains the parenthetical note “(>~50 GHz)”.

Note that for N9042B+V3050A, in the Swept SA measurement, Software Preselection works even if the measurement is using an FFT Sweep Type. In measurements other than Swept SA, Software Preselection is not used if the measurement is using an FFT Sweep Type.

VXT models M9410A/11A/15A/16A

Software Preselection is used to provide the preselection function, as there is no hardware preselector in these models. Two background traces are taken and compared point by point, and the point with the lowest amplitude from the two traces is used. This provides a method to reduce spurs that are internally generated within the VXT, but you should note the following when using Software Preselection:

- There is some speed cost due to the need to take multiple captures
- Taking the point with the lowest amplitude in each trace will make the average noise level lower at all points that do not have a spur. This can reduce the accuracy of the measurement of noise and noise-like signals

Because of the difficulty in identifying spurs manually, you are recommended to leave Software Preselection **ON** at all times in VXT models M9410A/11A. If you turn it off in order to speed up your measurement or improve noise accuracy, be aware of unwanted onscreen spurs.

Remote Command	<code>[:SENSe]:POWer[:RF]:SWPResel:STATe 0 1 ON OFF</code> <code>[:SENSe]:POWer[:RF]:SWPResel:STAT?</code>
Example	<code>:POW:SWPR:STAT 1</code> <code>:POW:SWPR:STAT?</code>
Dependencies	Only appears in N9041B, N9042B+V2050A, VXT models M9410A/11A and M9410E/11E. Does not appear in all measurements
Couplings	Affects Sweep Time Auto Tune supports Software Preselection , so Auto Tune should be performed after setting the Software Preselection state
Preset	N9041B OFF N9042B+V3050A ON M9410A/11A ON
State Saved	Saved in instrument state

SW Preselection Type

Specifies the algorithm used for software preselection.

Two hidden sweeps occur in succession. The second sweep is offset in LO frequency by $2 * IF / N$. For each point in each trace, the smaller amplitude from the two traces is taken and placed in that point in the selected trace. The Peak detector is auto-selected to improve the image suppression effectiveness. Responses of each trace that lie on top of one another will remain and are valid signals. Other signals are images, which are suppressed. The action of taking the smaller of the two traces will make the average noise level lower in all points that do not have an image, thus reducing the accuracy of the measurement of noise and noise-like signals.

- **NORMa1** - mathematically removes all image and multiple responses of signals present at the input
- **ADVanced** - any trace processing (such as “max hold” or trace averaging) is performed on the points of both candidate traces before the “select minimum” operation occurs. This form of processing works better for non-stationary signals, such as pulsed-RF signals

Remote Command	<code>[:SENSe]:POWer[:RF]:SWPreSel NORMa1 ADVanced</code> <code>[:SENSe]:POWer[:RF]:SWPreSel?</code>
Example	<code>:POW:SWPR NORM</code> <code>:POW:SWPR?</code>
Dependencies	Only appears in N9041B and N9042B+V3050A. Only appears in measurements that use the Swept method Grayed-out when "Software Preselection" on page 1801 is OFF. The grayout message is “Unavailable unless SW Presel enabled”
Preset	N9041B ADVanced N9042B+V3050A NORMa1
State Saved	Saved in instrument state

SW Preselection BW

Specifies the effective bandwidth to be used for Software Preselection.

The options are:

- **NORMa1** – when making Swept measurements, a software preselection algorithm is used which takes up to 4 background acquisitions, then post-processes the result. This algorithm can remove images from signals with an occupied

3 VMA Mode
 3.4 IQ Waveform Measurement

bandwidth up to around 3 GHz. (Default/Preset setting). When making FFT measurements, this algorithm is not used, instead the same algorithm is used as for **NARRow** (below)

- **NARRow**– a software preselection algorithm is used which takes two background acquisitions, then post-processes the result to detect and remove images from wideband signals with occupied bandwidths up to 2 GHz. This increases the risk of images failing to be rejected, but improves the measurement speed

Remote Command	<code>[:SENSe]:POWer[:RF]:SWPreSel:BW NORMa1 NARRow</code> <code>[:SENSe]:POWer[:RF]:SWPreSel:BW?</code>
Example	<code>:POW:SWPR:BW NARR</code>
Dependencies	Only appears in N9041B and N9042B+V3050A. Only appears in measurements that use the Swept method Grayed-out when " Software Preselection " on page 1801 is OFF . The grayout message is "Unavailable unless SW Presel enabled" For N9042B+V3050A, the parameter is SCPI-only, and always set to NARRow when Software Preselection is enabled
Preset	N9041B NORMa1 N9042B+V3050A NARRow
State Saved	Saved in instrument state

High Freq Prefilter

Lets you set the state of Prefilter for center frequencies above 1310 MHz.

In VXT Models M9410A/11A and M9410E/11E in bypass frequency range (1310MHz~5GHz), the Receiver RF path has a bank of filters that come after the RF Attenuator in the signal path. Since this bank of filters precedes the mixer they are known as the "Prefilter" bank. Their purpose is to eliminate unwanted in-band mixing products by filtering out all but the desired frequencies before the signals get to the mixer. There are 13 prefilter bands to cover the frequencies between 9 kHz and 6000 MHz. The Prefilter provides the necessary rejection of the unwanted signal.

Remote Command	<code>[:SENSe]:<measurement>:PFILter[:STATe] ON OFF 1 0</code> <code>[:SENSe]:<measurement>:PFILter[:STATe]?</code>
Example	Enable High Freq Prefilter for the Complex Spectrum Measurement in BASIC Mode: <code>:SPEC:PFIL ON</code> Enable High Freq Prefilter for the IQ Waveform Measurement, in multiple Modes: <code>:WAV:PFIL ON</code>

	Enable High Freq Prefilter for the Swept SA Measurement in SA Mode: :SAN:PFIL ON
Dependencies	Only appears in VXT models M9410A/11A with center frequency above 1310 MHz, and M9410E/11E in frequency range 1310MHz~5GHz
Preset	See " Prefilter Presets " on page 724 below
State Saved	Saved in instrument state

Prefilter Presets

Meas	Mode	Preset
SPEC	BASIC	OFF
WAV	BASIC, WCDMA, WLAN, LTEAFDD, LTEATDD, 5GNR, VMA	OFF
MON	WCDMA, WLAN, LTEAFDD, LTEATDD, 5GNR, VMA	OFF
RHO	WCDMA	OFF
CDP	WCDMA	OFF
PCON	WCDMA	OFF
EVMQ	WCDMA	OFF
CHP	WCDMA, WLAN, LTEAFDD, LTEATDD, 5GNR, VMA, SA	OFF
OBW	WCDMA, WLAN, LTEAFDD, LTEATDD, 5GNR, VMA, SA	OFF
ACP	WCDMA, LTEAFDD, LTEATDD, 5GNR, VMA, SA	OFF
SEM	WCDMA, WLAN, LTEAFDD, LTEATDD, 5GNR, VMA, SA	OFF
PST	WCDMA, WLAN, LTEAFDD, LTEATDD, 5GNR, VMA, SA	OFF
PVT	WLAN, LTEAFDD, LTEATDD, 5GNR	OFF
EVM	WLAN, LTEAFDD, LTEATDD, 5GNR	OFF
FLAT	WLAN	OFF
EVMM	WLAN	OFF
CEVM	LTEAFDD, LTEATDD	OFF
PAVT	5GNR, VMA	OFF
DDEM	VMA	OFF
OFDM	VMA	OFF
SAN	SA	ON
HARM	SA	ON

3.4.4 BW

Opens the **BW** (Bandwidth) menu. The Digital IF BW functions control filter bandwidth and filter type. There are two filter types: Gaussian and Flattop. The Gaussian filters have a response curve that is parabolic on a log scale. The Flattop filter shape is a close approximation of a rectangular filter.

3.4.4.1 Settings

Contains the basic bandwidth functions. It is the only tab under **Bandwidth**.

Digital IF BW

Sets the Digital IF (formerly Info BW) bandwidth of the instrument. When in Auto, it is set to the value that covers carriers set by carrier configuration.

Remote Command	<code>[:SENSe]:WAVeform:DIF:BA NDwidth <freq></code> <code>[:SENSe]:WAVeform:DIF:BA NDwidth?</code>								
Example	<code>:WAV:DIF:BA ND 1kHz</code> <code>:WAV:DIF:BA ND?</code>								
Notes	Auto/Man is available only for 5G NR, LTE, LTETDD, LTEAFDD, LTEA TDD Modes								
Dependencies	To set a 2 GHz Span with option R20, the Center Frequency must be equal to or greater than 3.5 GHz To set a 4 GHz Span with option R40, the Center Frequency must be equal to or greater than 10 GHz For applications that have the IF Path Selection menu, such as the BASIC mode:								
	<table border="1"> <thead> <tr> <th>IF Path</th> <th>Maximum Value Criteria</th> </tr> </thead> <tbody> <tr> <td>Auto State</td> <td></td> </tr> <tr> <td>OFF</td> <td>The maximum value depends on which IF Path is currently selected If 10 MHz, 25 MHz, 40 MHz, 85 MHz, 125 MHz, 140 MHz or 160 MHz, 255 MHz, or 510 MHz paths are selected, the maximum value of this parameter is 10, 25, 40, 85, 125, 140 or 160 MHz, 255 MHz, or 510 MHz respectively</td> </tr> <tr> <td>ON</td> <td>The maximum value is the maximum Digital IF BW available in the instrument, regardless of the current IF Path Selection For example, if the instrument has the options B25, B40, and B1X installed, the maximum available Digital IF BW of the instrument is 160 MHz. Thus, if IF Path Auto is ON and IF Path Selection is 25 MHz, the maximum Digital IF BW is <i>not</i> limited to 25 MHz, but is 160 MHz</td> </tr> </tbody> </table>	IF Path	Maximum Value Criteria	Auto State		OFF	The maximum value depends on which IF Path is currently selected If 10 MHz, 25 MHz, 40 MHz, 85 MHz, 125 MHz, 140 MHz or 160 MHz, 255 MHz, or 510 MHz paths are selected, the maximum value of this parameter is 10, 25, 40, 85, 125, 140 or 160 MHz, 255 MHz, or 510 MHz respectively	ON	The maximum value is the maximum Digital IF BW available in the instrument, regardless of the current IF Path Selection For example, if the instrument has the options B25, B40, and B1X installed, the maximum available Digital IF BW of the instrument is 160 MHz. Thus, if IF Path Auto is ON and IF Path Selection is 25 MHz, the maximum Digital IF BW is <i>not</i> limited to 25 MHz, but is 160 MHz
IF Path	Maximum Value Criteria								
Auto State									
OFF	The maximum value depends on which IF Path is currently selected If 10 MHz, 25 MHz, 40 MHz, 85 MHz, 125 MHz, 140 MHz or 160 MHz, 255 MHz, or 510 MHz paths are selected, the maximum value of this parameter is 10, 25, 40, 85, 125, 140 or 160 MHz, 255 MHz, or 510 MHz respectively								
ON	The maximum value is the maximum Digital IF BW available in the instrument, regardless of the current IF Path Selection For example, if the instrument has the options B25, B40, and B1X installed, the maximum available Digital IF BW of the instrument is 160 MHz. Thus, if IF Path Auto is ON and IF Path Selection is 25 MHz, the maximum Digital IF BW is <i>not</i> limited to 25 MHz, but is 160 MHz								
Couplings	Changing " Sample Rate " on page 760 automatically changes the state to Man								
Preset	See " Preset Values " on page 727 below								
State Saved	Saved in instrument state								
Min	All others: 10 Hz								

Max	Input	Option	Value
RF		None	10 MHz
		B25	25 MHz
		B40	40 MHz
		B85	85.0 MHz
		B1A	125.0 MHz
		B1X	140 MHz
		B1Y	160 MHz
		B2X	255 MHz
		B5X	510 MHz
		R10	1 GHz
		R15	1.5 GHz
		R20	2 GHz
		R40	4 GHz
		VXT models M9410A/11A	
M941xA-B6X	600 MHz		
M941xA-B12	1.2 GHz		
VXT models M9415A/16A		M941xA-B4X	400 MHz
		M941xA-B8X	800 MHz
		M941xA-B12	1.2 GHz
M9410E/11E:		M941xE-B3X	300 MHz
		M941xE-B6X	600 MHz
		M941xE-B12	1.2 GHz
M9415A/16A:		M941xE-B4X	400 MHz
		M941xE-B8X	800 MHz
		M941xE-B12	1.2 GHz
I/Q		None	10 MHz per channel 20 MHz for I+jQ
		B25	25 MHz per channel 50 MHz for I+jQ
		S40	40 MHz per channel 80 MHz for I+jQ
	All others		Hardware Dependent
	-		
Backwards Compatibility SCPI	[:SENSe]:WAVeform:BANDwidth[:RESolution]		
	[:SENSe]:WAVeform:BWIDth[:RESolution]		

3 VMA Mode
3.4 IQ Waveform Measurement

Auto Function

Remote Command	<code>[:SENSe]:WAVeform:DIF:BANDwidth:AUTO ON OFF 1 0</code>
Example	<code>:WAV:DIF:BAND:AUTO 0</code> <code>:WAV:DIF:BAND:AUTO?</code>
Preset	ON

Preset Values

Mode	Option	Radio Std	Value
GSM/EDGE			510 kHz
LTE, LTEFDD, LTEAFDD, LTEATDD, 5G NR			Automatically calculated
WLAN	None		10 MHz
	B25		25 MHz
	B40	802.11a/b/g/n/ac/ax//be (20 MHz)	25 MHz
		802.11n/ac/ax/be (40 MHz)	40 MHz
		802.11ac/ax/be (80 MHz)	80 MHz
		802.11ac/ax/be (160 MHz)	160 MHz
		802.11be (320 MHz)	320 MHz
	B1X	802.11ac(80 MHz)	80 MHz
B1Y	802.11ac(160 MHz)	160 MHz	
All others			100 kHz

Filter Type

Lets you select the type of bandwidth filter that is used.

The following types are available:

Type	SCPI	Notes
Gaussian	<code>GAUSSian</code>	See " Gaussian " on page 728
Flat Top	<code>FLATtop</code>	See " Flattop " on page 728
Short Nyquist	<code>SNYquist</code>	Available only when Option B40, B85, B1A, or B1X WBDIF installed
Raised Short Nyquist	<code>RSNYquist</code>	
Raised Cosine	<code>RCOSine</code>	
Root Raised Cosine	<code>RRCosine</code>	

Remote Command	<pre>[:SENSe]:WAVeform:DIF:FILTer:TYPE GAUSSian FLATtop [:SENSe]:WAVeform:DIF:FILTer:TYPE? With DIF40 and/or WBDIF: [:SENSe]:WAVeform:DIF:FILTer:TYPE GAUSSian FLATtop SNYquist RSNYquist RCOSine RRCosine [:SENSe]:WAVeform:DIF:FILTer:TYPE?</pre>								
Example	<pre>:WAV:DIF:FILT:TYPE GAUS :WAV:DIF:FILT:TYPE?</pre>								
Dependencies	<p>Gaussian and Flattop are available in all DIF configurations. For the other filter types, the filters are only available when Option DP2, B40, or a wider IF Bandwidth option is installed</p> <p>When you select a filter type other than Gaussian or Flattop when using Option B40, B85, B1A, or B1X WBDIF, but then you either explicitly select an IF Path Selection of 10 MHz or 25 MHz (B10M/B25M), or set a Digital IF BW equal to or narrower than 25 MHz with IF Path Selection Auto ON, the default filter type (FLATtop) is automatically selected. If you then again set the IF Path Selection to 85 MHz (B85), 125 MHz (B125M), or 140 MHz (B140M), the filter type remains as FLATtop</p>								
Couplings	See the description above								
Preset	<table border="1"> <thead> <tr> <th>Modes</th> <th>Value</th> </tr> </thead> <tbody> <tr> <td>BASIC with DP2, B40, or wider, IF Bandwidth option</td> <td>FLATtop</td> </tr> <tr> <td>5G NR, WLAN, Channel Quality</td> <td>FLATtop</td> </tr> <tr> <td>All others</td> <td>GAUSSian</td> </tr> </tbody> </table>	Modes	Value	BASIC with DP2, B40, or wider, IF Bandwidth option	FLATtop	5G NR, WLAN, Channel Quality	FLATtop	All others	GAUSSian
Modes	Value								
BASIC with DP2, B40, or wider, IF Bandwidth option	FLATtop								
5G NR, WLAN, Channel Quality	FLATtop								
All others	GAUSSian								
State Saved	Saved in instrument state								
Range	<pre>GAUSSian FLATtop</pre> <p>When Option DP2, B40, or wider IF Bandwidth option is installed, the range is as follows</p> <pre>GAUSSian FLATtop SNYquist RSNYquist RCOSine RRCosine</pre>								
Backwards Compatibility SCPI	<pre>[:SENSe]:WAVeform:BANDwidth:SHAPE [:SENSe]:WAVeform:BWIDth:SHAPE [:SENSe]:WAVeform:BANDwidth BWIDth [:RESolution]:TYPE</pre>								

Gaussian

When Option DP2, B40, or wider IF Bandwidth option is installed, the capability for arbitrary Digital IF bandwidths is available. However, for instruments without DP2, B40, or wider IF Bandwidth option, the selectable Gaussian filter bandwidths are predetermined. There are 160 Info BWs (RBWs) arranged in a 24-per-decade sequence from 1 Hz through 3 MHz, plus 4, 5, 6 and 8 MHz settings.

Flattop

When Option DP2, B40, or wider IF Bandwidth option is installed, the capability for arbitrary Digital IF bandwidths is available. However, for instruments without Option

3 VMA Mode
 3.4 IQ Waveform Measurement

DP2, B40 or wider IF Bandwidth option, , the selectable Flattop filter bandwidths are predefined. There are 134 Digital IF BWs (RBWs) arranged in a 6-per-decade sequence from 3 Hz through 3 MHz, plus 4, 5, 6 and 8 MHz settings.

Filter BW

This feature is only available when Option DP2, B40, or wider IF Bandwidth option is installed.

Remote Command	<code>[:SENSe] :WAVeform:DIF:FILTer:BANDwidth <freq></code> <code>[:SENSe] :WAVeform:DIF:FILTer:BANDwidth?</code>
Example	<code>:WAV:DIF:FILT:BAND 1MHz</code> <code>:WAV:DIF:FILT:BAND?</code>
Dependencies	Only available when Option DP2, B40, or wider IF Bandwidth option is installed. Disabled when the Filter Type is FLATtop
Couplings	Sets the same value as the current Digital IF BW value on Preset, or when Channel Filter Bandwidth Auto is ON
Preset	Same value as Digital IF BW
State Saved	Saved in instrument state
Min	10 Hz
Max	Clipped to the current Digital IF BW value

Auto Function

Remote Command	<code>[:SENSe] :WAVeform:DIF:FILTer:BANDwidth:AUTO ON OFF 1 0</code> <code>[:SENSe] :WAVeform:DIF:FILTer:BANDwidth:AUTO?</code>
Example	<code>:WAV:DIF:FILT:BAND:AUTO 0</code> <code>:WAV:DIF:FILT:BAND:AUTO?</code>
Preset	ON
Range	Auto Man

Filter Alpha

Sets the filter alpha for the DIF filter. This feature is only available when Option DP2, B40, or wider IF Bandwidth option is installed.

Remote Command	<code>[:SENSe] :WAVeform:DIF:FILTer:ALPHa <real></code> <code>[:SENSe] :WAVeform:DIF:FILTer:ALPHa?</code>
Example	<code>:WAV:DIF:FILT:ALPH 0.5</code> <code>:WAV:DIF:FILT:ALPH?</code>

Preset	0.2
State Saved	Saved in instrument state
Min	0.01
Max	1.00
Backwards Compatibility SCPI	<code>[:SENSe] :WAVeform:WBIF:FILTer:ALPHA</code>

Channel Filter Bandwidth (Backwards Compatibility Remote Command Only)

Dependencies	Only available when Option DP2, B40, or wider IF Bandwidth option is installed
Couplings	The value is determined by the following equation $\text{ChannelFilterBwBwcc} = (\text{ChannelFilterBw} / (\text{DigitalIFBw} * \text{OverSampleRatio}))$
Preset	0.8
State Saved	Saved in instrument state
Min	0.01
Max	1.0
Backwards Compatibility SCPI	<code>[:SENSe] :WAVeform:WBIF:FILTer:BANDwidth <real></code> <code>[:SENSe] :WAVeform:WBIF:FILTer:BANDwidth?</code>

3.4.5 Display

Lets you configure display items for the current Mode, Measurement, View, or Window.

3.4.5.1 View

Contains controls for selecting the current **View**, and for editing User Views.

View

See "[Views](#)" on page 674.

User View

Lets you choose a View from the saved User Views for the current measurement. This panel only appears if a User View exists for the current measurement.

Remote	<code>:DISPlay:VIEW:ADVanced:SElect <alphanumeric></code>
--------	---

3 VMA Mode
3.4 IQ Waveform Measurement

Command	<code>:DISPlay:VIEW:ADVanced:SElect?</code>
Example	Select Baseband as the current View <code>:DISP:VIEW:ADV:SEL "Baseband"</code>
Notes	<p>You must be in the measurement whose View you are trying to set to send the command. You can only set Views for the current measurement using this command</p> <p>For predefined views, the parameter is derived from the view name that is shown in the View list in the user interface. For example, if you are trying to select the Trace Zoom view in the Swept SA measurement, you send:</p> <pre>:DISP:VIEW:ADV:SEL "Trace Zoom"</pre> <p>because "Trace Zoom" is the name of the View as seen in the Mode/Meas dialog or in the Display, View menu</p> <p>You <i>cannot</i> use the legacy View parameter (which in this case would be <code>TZOOM</code>) with</p> <pre>:DISP:VIEW:ADV:SEL</pre> <p><code><alphanumeric></code> is case insensitive; you can specify mixed case, however the name will be evaluated on a single case. Thus, both of the following forms work:</p> <pre>:DISP:VIEW:ADV:SEL "Trace Zoom"</pre> <pre>:DISP:VIEW:ADV:SEL "TRACE ZOOM"</pre> <p>If the specified view is not a valid View, the query returns the error message "-224, Illegal parameter value; View with the name <alphanumeric> does not exist"</p> <p>If the display is disabled (via <code>:DISP:ENAB OFF</code>) then the error message "-221, Settings conflict; View SCPI cannot be used while Display is disabled" is generated</p>
Backwards Compatibility SCPI	<p>The legacy node</p> <pre>:DISPlay:VIEW[:SElect]</pre> <p>is retained for backwards compatibility, but it only supports predefined views</p>

Restore Layout to Default

Restores the Layout to the default for Basic.

Modified Views are very temporary; if you exit the current measurement they are discarded, and they are not saved in State. To retain this View for later use, and to be able to return easily to your original Basic View, you can save your edited View as a "User View".

Save Layout as New View

Saves your new View as a User View. An alpha keyboard appears, which lets you name your new View; the default is the old View name plus a number.

Remote Command	<code>:DISPlay:VIEW:ADVanced:NAME <alphanumeric></code>
Example	<code>:DISP:VIEW:ADV:NAME "Baseband"</code>

	Creates a new View named Baseband from the current View, and selects it as the current View
Notes	<p><code><alphanumeric></code> is case insensitive; you can specify mixed case, however the name will be evaluated on a single case</p> <p>If <code><alphanumeric></code> name already exists as a View, the error message “-224, Illegal parameter value; View <alphanumeric> already exists” is generated</p> <p>If the display is disabled (via <code>:DISP:ENAB OFF</code>) then the error message “-221, Settings conflict; User View SCPI cannot be used while Display is disabled” is generated</p>

Re-Save User View

You can re-edit a User View; if you make changes, then an asterisk will appear next to the User View’s name. You can then tap **Re-Save User View** to save it back to its existing name, or **Save Layout as New View** to add another, new User View.

This is a front panel function only, there is no remote command available to perform this function. To do this remotely, you must first perform **Save Layout as New View**, then delete the old User View and rename the new one with the name of the View you just deleted.

Rename User View

You can rename the current View by giving it a new unique name. Only User Views can be renamed, if the current View is a Predefined View, an error occurs.

Remote Command	<code>:DISPlay:VIEW:ADVanced:REName <alphanumeric></code>
Example	<code>:DISP:VIEW:ADV:REN “Baseband”</code>
Notes	<p><code><alphanumeric></code> is case insensitive; you can specify mixed case, however the name will be evaluated on a single case</p> <p>If the <code><alphanumeric></code> specifying the new name is already present in the list of View names, the error message “-224, Illegal parameter value; View <alphanumeric> already exists” is generated</p> <p>If the current View is a Predefined View, the error message “-224, Illegal parameter value; Cannot rename a Predefined View” is generated</p> <p>If the display is disabled (via <code>:DISP:ENAB OFF</code>) then the error message “-221, Settings conflict; View SCPI cannot be used while Display is disabled” is generated</p>

Delete User View

You can delete the current View if it is a User View. The default view becomes the current view for the Measurement.

Remote Command	<code>:DISPlay:VIEW:ADVanced:DElete</code>
----------------	--

Example	<code>:DISP:VIEW:ADV:DEL</code>
Notes	<p><code><alphanumeric></code> is case insensitive; you can specify mixed case, however the name will be evaluated on a single case</p> <p>If the <code><alphanumeric></code> is not present in the list of View names, the error message “-224, Illegal parameter value; View <alphanumeric> does not exist” is generated</p> <p>If the current View is a Predefined View, the error message “-224, Illegal parameter value; Cannot delete a Predefined View” is generated</p> <p>If the display is disabled (via <code>:DISP:ENAB OFF</code>) then the error message “-221, Settings conflict; View SCPI cannot be used while Display is disabled” is generated</p>

Delete All User Views

Deletes all previously saved User Views. The default view becomes the current view for the Measurement if a User View was the current view when this command was executed.

Remote Command	<code>:DISPlay:VIEW:ADVanced:DELeTe:ALL</code>
Example	<code>:DISP:VIEW:ADV:DEL:ALL</code>
Notes	Disabled if there are no User Views

View Editor Remote Commands

The following remote commands help you manage Views and User Views. Note that the SCPI node for User Views handles both Predefined and User Views. The legacy nodes, `:DISPlay:VIEW[:SElect]` and `:DISPlay:VIEW:NSEL`, are retained for backwards compatibility, but they only support predefined views.

View Listing Query

Returns a string containing a comma-separated list of names for *all* the Views, including User Views, available for the current Measurement.

Remote Command	<code>:DISPlay:VIEW:ADVanced:CATalog?</code>
Example	<code>:DISP:VIEW:ADV:CAT?</code>
Notes	<p>Returns a quoted string of the available Views for the current measurement, separated by commas. The list includes names for <i>all</i> the Views, including User Views, available for the current Measurement</p> <p>Example:</p> <p><code>"Normal,Trace Zoom,Spectrogram,Baseband,myView1,yourView1"</code></p> <p>No distinction is made between Predefined and User Views</p>

If you switch measurements with the display disabled (via `:DISP:ENAB OFF`), then query the list of available Views, the result is undefined

User View Listing Query

Returns a string containing a comma-separated list of names for *only* the User Views available for the current Measurement.

Remote Command	<code>:DISPlay:VIEW:ADVanced:USER:CATalog?</code>
Example	<code>:DISP:VIEW:ADV:USER:CAT?</code>
Notes	<p>Returns a quoted string of the available User Views for the current measurement, separated by commas.</p> <p>Example: <code>"Baseband,myView1,yourView1"</code></p> <p>If you switch measurements with the display disabled (see "Display Enable (Remote Command Only)" on page 1812), then query the list of available Views, the result is undefined</p>

3.4.5.2 Annotation

Contains controls for setting up the annotation for the current Mode or Measurement.

Graticule

Turns the display graticule On or Off for all windows with graticules in all measurements in the current Mode. Also turns the graticule Y-Axis annotation on and off.

Remote Command	<code>:DISPlay:GRATicule[:STATe] OFF ON 0 1</code> <code>:DISPlay:GRATicule[:STATe]?</code>
Example	<code>:DISP:GRAT OFF</code>
Notes	The graticule is the set of horizontal and vertical lines that make up the grid/divisions for the X-Axis and Y-Axis
Preset	<code>ON</code>
State Saved	Saved in instrument state
Backwards Compatibility SCPI	<p><code>:DISPlay:WINDow[1]:TRACe:GRATicule:GRID[:STATe] OFF ON 0 1</code> <code>:DISPlay:WINDow[1]:TRACe:GRATicule:GRID[:STATe]?</code></p> <p>This command is accepted for backwards compatibility with older instruments, but the <code>WINDow</code>, <code>TRACe</code> and <code>GRID</code> parameters are ignored</p>

Screen Annotation

Controls the display of the annunciation and annotation around the graticule, including any annotation on lines (such as the display line, the threshold line, etc.) and the Y-Axis annotation, for all windows with screen annotation in all measurements in the current Mode.

This does *not* include marker annotation (or the N dB result). When **OFF**, the graticule expands to fill the entire graticule area, leaving only the 1.5% gap above the graticule, as described in the **Trace** section.

Remote Command	<code>:DISPlay:ANNotation:SCReen[:STATe] OFF ON 0 1</code> <code>:DISPlay:ANNotation:SCReen[:STATe]?</code>
Example	<code>:DISP:ANN:SCR OFF</code>
Dependencies	Grayed-out and forced to OFF when System Display Settings, Annotation is OFF
Preset	ON This remains OFF through a Preset when System Display Settings, Annotation is set to OFF
State Saved	Saved in instrument state

Trace Annotation

Turns on and off the labels on the traces, showing their detector (or their Math Mode) as described in the **Trace** section, for all windows in all measurements in the current Mode for which Trace Annotation on/off is supported.

If Trace Math is being performed on a trace, then the Trace Math annotation replaces the detector annotation.

For measurements that support limit lines, this key also turns on and off the labels on the Limit Lines. The label is the Limit number annotation and Limit Comment displayed on the graph. If the length of the comment is greater than 20 characters, the first 8 characters and the last 8 characters are displayed, joined with

Remote Command	<code>:DISPlay:ANNotation:TRACe[:STATe] ON OFF 1 0</code> <code>:DISPlay:ANNotation:TRACe[:STATe]?</code>
Example	<code>:DISP:ANN:TRAC OFF</code>
Preset	OFF
State Saved	Saved in instrument state

Control Annotation

Turns on and off the display of values on the Active Function controls for all measurements in the current Mode. This is a security feature.

Remote Command	<code>:DISPlay:ACTivefunc[:STATe] ON OFF 1 0</code> <code>:DISPlay:ACTivefunc[:STATe]?</code>
Example	<code>:DISP:ACT OFF</code>
Dependencies	Grayed out and forced to OFF when System Display Settings, Annotation is OFF
Preset	ON This remains OFF through a Preset when System Display Settings, Annotation is set to OFF
State Saved	Saved in instrument state

Meas Bar

Turns the Measurement Bar at the top of the screen on and off for all measurements in the current Mode. When **OFF**, the graticule area expands to fill the area formerly occupied by the Measurement Bar.

Remote Command	<code>:DISPlay:ANNotation:MBAR[:STATe] OFF ON 0 1</code> <code>:DISPlay:ANNotation:MBAR[:STATe]?</code>
Example	<code>:DISP:ANN:MBAR OFF</code>
Dependencies	Grayed out and forced to OFF when System Display Settings, Annotation is OFF
Preset	ON This remains OFF through a Preset when System Display Settings, Annotation is set to OFF
State Saved	Saved in instrument state

Display Enable (Remote Command Only)

Turns the display on/off, including the display drive circuitry. The backlight stays lit to confirm that the instrument is on. The display enable setting is mode global. There are three reasons for turning the display off:

1. To increase speed as much as possible by freeing the instrument from having to update the display
2. To reduce emissions from the display, drive circuitry
3. For security purposes

If you have turned off the display:

3 VMA Mode
 3.4 IQ Waveform Measurement

- and you are in local operation, the display can be turned back on by pressing any key or by sending `:SYSTEM:DEFAULTS MISC` or `:DISPLAY:ENABLE ON` (neither `*RST` nor `:SYSTEM:PRESET` enable the display)
- and you are in remote operation, the display can be turned back on by pressing the **Local** or **Esc** keys, or by sending `:SYSTEM:DEFAULTS MISC` or `:DISPLAY:ENABLE ON` (neither `*RST` nor `:SYSTEM:PRESET` enable the display)
- and you are using either the `:SYSTEM:KLOCK` command or GPIB local lockout, then *no* front-panel key press will turn the display back on. You must turn it back on remotely.

If the display is **OFF**, many SCPI commands related to User Views and Multiscreen functionality do not work, and return the error messages “-221, Settings conflict; Screen SCPI cannot be used when Display is disabled” or “221, Settings conflict; View SCPI cannot be used while Display is disabled”. These commands include:

Name	Command
Select User View	<code>:DISPLAY:VIEW:ADVANCED:SELECT</code>
Rename User View	<code>:DISPLAY:VIEW:ADVANCED:RENAME</code>
Delete User View	<code>:DISPLAY:VIEW:ADVANCED:DELETE</code>
Create User View	<code>:DISPLAY:VIEW:ADVANCED:NAME</code>
Select Screen	<code>:INSTRUMENT:SCREEN:SELECT</code>
Delete Screen	<code>:INSTRUMENT:SCREEN:DELETE</code>
Delete All But This Screen	<code>:INSTRUMENT:SCREEN:DELETE:ALL</code>
Add Screen	<code>:INSTRUMENT:SCREEN:CREATE</code>
Rename Screen	<code>:INSTRUMENT:SCREEN:RENAME</code>
Sequencer On/Off	<code>:SYSTEM:SEQUENCER</code>

Remote Command	<code>:DISPLAY:ENABLE OFF ON 0 1</code> <code>:DISPLAY:ENABLE?</code>
Example	<code>:DISP:ENAB OFF</code>
Couplings	<code>:DISP:ENAB OFF</code> turns Backlight OFF and <code>:DISP:ENAB ON</code> turns Backlight ON , but changing Backlight settings does <i>not</i> change the state of <code>:DISP:ENAB</code>
Preset	ON Set by <code>:SYST:DEF MISC</code> , but not affected by <code>*RST</code> or <code>:SYSTEM:PRESET</code>
State Saved	Not saved in instrument state
Backwards Compatibility Notes	<code>:SYST:PRES</code> no longer turns on <code>:DISPLAY:ENABLE</code> as it did in legacy analyzers

3.4.6 Frequency

Opens the **Frequency** menu, which contains controls that allow you to control the Frequency and Channel parameters of the instrument.

Some features in the **Frequency** menu are the same for all measurements in the current Mode – they do not change as you change measurements. Settings like these are called “Meas Global” and are unaffected by Meas Preset. For example, the Center Freq setting is the same for all measurements – it does not change as you change measurements.

3.4.6.1 Settings

Contains controls that pertain to the X axis parameters of the measurement. These parameters control how data on the vertical (X) axis is displayed and control instrument settings that affect the horizontal axis.

Center Frequency

Sets the frequency that corresponds to the horizontal center of the graticule. While adjusting **Center Frequency**, **Span** is held constant.

The center frequency setting is the same for all measurements within a mode, that is, it is Meas Global. Some modes are also able to share a Mode Global center frequency value. If this is the case, the Mode will have a Global tab in its Meas Setup menu.

The Center Freq function sets (and queries) the Center Frequency for the currently selected input. If your instrument has multiple inputs, and you select another input, the Center Freq changes to the value for that input. SCPI commands are available to directly set the Center Freq for a specific input.

Center Freq is remembered as you go from input to input. Thus, you can set a Center Freq of 10 GHz with the RF Input selected, change to BBIQ, and set a Center Freq of 20 MHz, then switch to External Mixing and set a Center Freq of 60 GHz, and when you go back to the RF Input the Center Freq will go back to 10 GHz; back to BBIQ and it is 20 MHz; back to External Mixing and it is 60 GHz.

For more details, see the following:

- ["RF Center Freq \(Remote Command Only\)" on page 742](#)
- ["Ext Mix Center Freq \(Remote Command Only\)" on page 742](#)
- ["I/Q Center Freq \(Remote Command Only\)" on page 743](#)

3 VMA Mode
 3.4 IQ Waveform Measurement

- ["Center Frequency Presets" on page 740](#)
- ["VXT Models with Radio Heads/CIU Frequency Range" on page 742](#)

Remote Command	<code>[:SENSe] :FREQuency:CENTer <freq></code> <code>[:SENSe] :FREQuency:CENTer?</code>
Example	Set Center Frequency to 50 MHz: <code>:FREQ:CENT 50 MHz</code> Increment Center Frequency by the value of CF Step : <code>:FREQ:CENT UP</code> Return the current value of Center Frequency : <code>:FREQ:CENT?</code>
Notes	Sets the RF, External Mixing or I/Q Center Frequency depending on the selected input <ul style="list-style-type: none"> – For RF input it is equivalent to <code>FREQ:RF:CENT</code> – For I/Q input it is equivalent to <code>FREQ:IQ:CENT</code> – For External Mixer it is equivalent to <code>FREQ:EMIX:CENT</code> Preset and Max values depend on Hardware Options If no terminator (for example, MHz) is sent the terminator Hz is used. If a terminator with unit other than Frequency is used, an invalid suffix error message is generated
Preset	Depends on instrument maximum frequency, mode, measurement, and selected input See "Center Frequency Presets" on page 740 , "RF Center Freq (Remote Command Only)" on page 742 , "Ext Mix Center Freq (Remote Command Only)" on page 742 , "I/Q Center Freq (Remote Command Only)" on page 743 and "VXT Models with Radio Heads/CIU Frequency Range" on page 742
State Saved	Saved in instrument state
Min/Max	Depends on instrument minimum/maximum frequency, mode, measurement, and selected input See "Center Frequency Presets" on page 740 , "RF Center Freq (Remote Command Only)" on page 742 , "Ext Mix Center Freq (Remote Command Only)" on page 742 , "I/Q Center Freq (Remote Command Only)" on page 743 and "VXT Models with Radio Heads/CIU Frequency Range" on page 742
Status Bits/OPC dependencies	Non-overlapped Auto Function (MSR, LTE-Advanced FDD/TDD and 5G NR Modes Only)
Remote Command	<code>[:SENSe] :FREQuency:CENTer:AUTO ON OFF 1 0</code> <code>[:SENSe] :FREQuency:CENTer:AUTO?</code>
Example	<code>:FREQ:CENT:AUTO OFF</code> <code>:FREQ:CENT:AUTO?</code>
Dependencies	Only available for Monitor Spectrum, Power Stat CCDF and IQ waveform measurements in the MSR, LTE-Advanced FDD/TDD and 5G NR Modes
Couplings	When Center Frequency is changed, state is automatically changed to Manual

Center Frequency, Center Frequency Offset and Carrier Reference Frequency are coupled. When **Carrier Reference Frequency** changes:

Center Frequency : Auto **Center Frequency = Carrier Reference Frequency + Center Frequency Offset** (fixed)

Center Frequency : Man **Center Frequency (fixed) = Carrier Reference Frequency + Center Frequency Offset**

Preset	ON
State Saved	Saved in instrument state
Range	Auto Man

Center Frequency Presets

The following table provides the Center Frequency Presets for the Spectrum Analyzer mode, and the Max Freq, for the various frequency options:

Freq Option	CF after Mode Preset	Stop Freq after Mode Preset	Max Freq (can't tune above)
503 (all but CXA)	1.805 GHz	3.6 GHz	3.7 GHz
503 (CXA)	1.505 GHz	3.0 GHz	3.08 GHz
507 (all but CXA)	3.505 GHz	7.0 GHz	7.1 GHz
507 (CXA)	3.755 GHz	7.5 GHz	7.58 GHz
508 (all but MXE)	1.805 GHz	3.6 GHz	8.5 GHz
508 (MXE)	4.205 GHz	8.4 GHz	8.5 GHz
513	6.805 GHz	13.6 GHz	13.8 GHz
526 (except CXA and MXE)	13.255 GHz	26.5 GHz	27.0 GHz*
526 (CXA)	13.255 GHz	26.5 GHz	26.55 GHz
526 (MXE)	1.805 GHz	3.6 GHz	27.0 GHz
532	16.005 GHz	32.0 GHz	32.5 GHz
540	20.005 GHz	40.0 GHz	40.5 GHz
543	21.505 GHz	43.0 GHz	43.0 GHz
544	22.005 GHz	44.0 GHz	45.0 GHz
550	25.005 GHz	50.0 GHz	52 GHz
F03 (CXA-m)	1.505 GHz	3.0 GHz	3.08 GHz
F07 (CXA-m)	3.755 GHz	7.5 GHz	7.575 GHz
F13 (CXA-m)	6.805 GHz	13.6 GHz	13.8 GHz
F26 (CXA-m)	13.255 GHz	26.5 GHz	26.55 GHz
504 (M9421A, M8920A)	2.145 GHz	3.88GHz	3.88 GHz
506 (M9421A, M8920A)	3.245 GHz	6.08GHz	6.08 GHz

3 VMA Mode
 3.4 IQ Waveform Measurement

Freq Option	CF after Mode Preset	Stop Freq after Mode Preset	Max Freq (can't tune above)
F06 (M9410A/11A)	1.0 GHz	6.08 GHz	6.08 GHz
F06 (M9415A)	1 GHz	1.08 GHz	6.6 GHz
F08 (M9415A)	1 GHz	1.08 GHz	8.6 GHz
F12 (M9415A)	1 GHz	1.08 GHz	12.9 GHz

*For option 526, the Max CF in RTSA is 26.999999995 GHz.

N9041B Center Freq Presets

Input	CF after Mode Preset	Stop Freq after Mode Preset	Max Freq (can't tune above)
Input 1, all models	25.005 GHz	50.0 GHz	52 GHz
Input 2, opt 585	42.505 GHz	85.0 GHz	86 GHz
Input 2, opt 590	45.005 GHz	90.0 GHz	92 GHz
Input 2, opt 5CX	55.005 GHz	110.0 GHz	110 GHz

Input 2, CXA and MXE

Model	CF after Mode Preset	Stop Freq after Mode Preset	Max Freq (can't tune above)
CXA opt C75	0.7505 GHz	1.5 GHz	1.58 GHz
MXE	505 MHz	1 GHz	1.000025 GHz

Tracking Generator Frequency Limits (CXA only)

Tracking Generator Option	Min Freq (clips to this freq when turn TG on and can't tune below while TG on)	If above this Freq, Stop Freq clipped to this Freq when TG turned on	Max Freq (can't tune above) while TG on
T03	9 kHz	3.0 GHz	3.08 GHz
T06	9 kHz	6.0 GHz	6.05 GHz

Tracking Generator Frequency Limits(CXA-m only)

Tracking Generator Option	Min Freq (clips to this freq when turn TG on and can't tune below while TG on)	If above this Freq, Stop Freq clipped to this Freq when TG turned on	Max Freq (can't tune above) while TG on
T03	2 MHz	3.08 GHz	3.08 GHz
T07	2 MHz	7.575 GHz	7.575 GHz
T13	2 MHz	13.8 GHz	13.8 GHz
T26	2 MHz	26.55 GHz	26.55 GHz

VXT Models with Radio Heads/CIU Frequency Range

The following table shows the Center Frequency Presets and Range for VXT modes with Radio Heads/CIU.

Products with Radio Heads/CIU	Preset	Start frequency	Stop frequency
M9421A + CIU	6 GHz	5.9 GHz	12 GHz
M9410A + CIU	6 GHz	5.9 GHz	12 GHz
M9410A + CIU + RRH	25 GHz	24.25 GHz	43.5 GHz

RF Center Freq (Remote Command Only)

Specifies the RF Center Frequency. Sets the **Center Frequency** to use when the RF input is selected, even if the RF input is not the input that is selected at the time the command is sent. Note that the **Center Frequency** function in the **Frequency** menu on the front panel always applies to the currently selected input.

Remote Command	<code>[:SENSe] :FREQuency:RF:CENTer <freq></code> <code>[:SENSe] :FREQuency:RF:CENTer?</code>
Example	<code>:FREQ:RF:CENT 30 MHz</code> <code>:FREQ:RF:CENT?</code>
Notes	This command is the same in all Modes, but the parameter is Measurement Global. So, the value is independent in each Mode and common across all the measurements in the Mode
Dependencies	If the electronic/soft attenuator is enabled, any attempt to set Center Frequency such that the Stop Frequency would be >3.6 GHz fails and results in an advisory message. If the equivalent SCPI command is sent, this same message is generated as part of a “-221, Settings conflict” warning
Preset	See table above
State Saved	Saved in instrument state
Min	-79.999995 MHz
Max	See table above. Basically, instrument maximum frequency - 5 Hz

Ext Mix Center Freq (Remote Command Only)

Specifies the External Mixer Center Frequency. Sets the **Center Frequency** to use when the External Mixer is selected, even if the External Mixer input is not the input that is selected at the time the command is sent. Note that the **Center Frequency** function in the **Frequency** menu on the front panel always applies to the currently selected input.

Remote Command	<code>[:SENSe] :FREQuency:EMIXer:CENTer <freq></code> <code>[:SENSe] :FREQuency:EMIXer:CENTer?</code>
Example	<code>:FREQ:EMIX:CENT 60 GHz</code> <code>:FREQ:EMIX:CENT?</code>

3 VMA Mode
3.4 IQ Waveform Measurement

Notes	This command is the same in all Modes, but the parameter is Measurement Global. So, the value is independent in each Mode and common across all the measurements in the Mode
Couplings	When returning to External Mixing after having been switched to one of the other inputs (for example, RF), you return to the settings that existed when you left External Mixing. So, you return to the band you were in, with the Center Frequency that you had. However, Span is not an input-dependent parameter, therefore the Span setting from the other input is retained. Thus, the instrument returns to the Span setting from the previous input, limited as necessary by the current mixer setup
Preset	<p>When a Mode Preset is performed while in External Mixing, the Start frequency of the current Mode is set to the nominal Min Freq of the lowest harmonic range in the Harmonic Table for the current mixer setup. Similarly, the Stop frequency of the current Mode is set to the nominal Max Freq of the highest harmonic range in the Harmonic Table. Center Frequency thus presets to the point arithmetically equidistant from these two frequencies</p> <p>Note that, if the current measurement has a limited Span available to it, and cannot achieve the span shown in the table (Span = Stop Freq – Start Freq), the instrument uses the maximum Span the measurement allows, and still sets Center Frequency to the midpoint of the Start and Stop Freq values in the Harmonic Table</p> <p>When Restore Input/Output Defaults is performed, the mixer presets to the 11970A, whose Start and Stop frequencies are 26.5 and 40 GHz respectively. The center of these two frequencies is 33.25 GHz. Therefore, after Restore Input/Output Defaults, if you go into External Mixing and do a <i>Mode Preset</i> while in the Spectrum Analyzer Mode, the resulting Center Frequency is 33.25 GHz</p>
State Saved	Yes
Min	The minimum frequency in the currently selected mixer band +5 Hz
Max	The maximum frequency in the currently selected mixer band –5 Hz

I/Q Center Freq (Remote Command Only)

Specifies the I/Q Center Frequency. Sets the **Center Frequency** to be used when the I/Q input is selected, even if the I/Q input is not the input that is selected at the time the command is sent. Note that the **Center Frequency** function in the **Frequency** menu on the front panel always applies to the currently selected input.

Remote Command	<code>[:SENSe] :FREQuency :IQ :CENTer <freq></code> <code>[:SENSe] :FREQuency :IQ :CENTer?</code>
Example	<code>:FREQ:IQ:CENT: 30 MHz</code>
Notes	This command is the same in all Modes, but the parameter is Measurement Global. So, the value is independent in each Mode and common across all the measurements in the Mode
Preset	0 Hz
State Saved	Saved in instrument state
Min/Max	-/+40.049995 MHz

CF Step

Lets you change the step size for "**Center Frequency**" on page 738, and Start/Stop frequency. Once a step size has been selected and the **Center Frequency** function is active, the step keys (and the **UP | DOWN** parameters for **Center Frequency** from remote commands) change the center frequency by the step-size value. The step size function is useful for finding harmonics and sidebands beyond the current frequency span of the instrument.

Note that the Start and Stop frequencies also step by the **CF Step** value.

Remote Command	<code>[:SENSe]:FREQuency:CENTer:STEP[:INCRement] <freq></code> <code>[:SENSe]:FREQuency:CENTer:STEP[:INCRement]?</code>
Example	Increase the current Center Frequency value by 500 MHz: <code>:FREQ:CENT:STEP 500 MHz</code> <code>:FREQ:CENT UP</code>
Notes	Preset and Max values depend on Hardware Options
Dependencies	Only available in VMA, W-CDMA, and WLAN Modes If the electronic/soft attenuator is enabled, any attempt to change the value of the center frequency >3.6 GHz by pressing the Up-arrow key fails, and results in an advisory message. If the equivalent SCPI command is sent, this same message is generated as part of a "-221, Settings conflict" warning
Preset	Auto
State Saved	Saved in instrument state
Min/Max	-/+ (the maximum frequency of the instrument). That is, 27 GHz max freq instrument has a CF step range of +/- 27 GHz. Note that this is the maximum frequency given the current settings of the instrument, so in External Mixing, for example, it is the maximum frequency of the current mixer band
Status Bits/OPC dependencies	non-overlapped
Auto Function	
Remote Command	<code>[:SENSe]:FREQuency:CENTer:STEP:AUTO OFF ON 0 1</code> <code>[:SENSe]:FREQuency:CENTer:STEP:AUTO?</code>
Example	<code>:FREQ:CENT:STEP:AUTO ON</code> <code>:FREQ:CENT:STEP:AUTO?</code>
Preset	ON

3.4.7 Marker

Displays a menu that enables you to select, set up and control the markers for the current measurement.

If there are no active markers, **Marker** selects **Marker 1**, sets it to **POSiTion** (Normal) mode, and places it at the center of the display. If the selected marker is **OFF**, it is set to **POSiTion** mode and placed at the center of the screen, on the trace determined by the Marker Trace rules.

For details of the **POSiTion**, **DELTA**, and **OFF** mode options, see "**Marker Mode**" on page 747.

3.4.7.1 Select Marker

Sets the selected marker. The term “selected marker” is used throughout this document to specify which marker will be affected when you change marker settings, perform a **Peak Search**, etc.

The **Select Marker** control appears above the menu panel, indicating that it applies to all controls in the **Marker** menu panels. **Select Marker** is blanked if you select a tab whose controls do *not* depend on the selected marker (for example, **Counter**).

For any menu that includes **Select Marker**, the first control is always "**Marker Time**" on page 745.

Notes	The selected marker is remembered even when not in the Marker menu and is used if a Search is done or a Band Function is turned on or for Signal Track or Continuous Peak
Preset	Marker 1
State Saved	The number of the selected marker is saved in instrument state
Annunciation	Appears in the marker results block label for POSiTion and Delta markers

3.4.7.2 Settings

The controls on this tab include the Marker active function and a radio button selection for "**Marker Mode**" on page 747 (**POSiTion**, **DELTA**, or **OFF**) for the selected marker, as well as additional functions that help you use markers.

Marker Time

This is the fundamental control that you use to move a marker around on the trace. Because it is the default active function in the **Marker** menu, all you need to do is press **Marker** and turn the knob to move the marker left and right on the display. This is always the first control on any **Marker** menu page that follows the Selected Marker.

The SCPI command sets the marker X-Axis value in the current marker X-Axis Scale unit. The marker that is addressed becomes the selected marker. It has no effect (other than to cause the marker to become selected) if the control mode is **OFF**, but it is the SCPI equivalent of entering an X value if the control mode is **POSiTion** or **DELTA**.

Remote Command	<code>:CALCulate:WAVeform:MARKer[1] 2 ... 12:X <time></code> <code>:CALCulate:WAVeform:MARKer[1] 2 ... 12:X?</code>
Example	<code>:CALC:WAV:MARK1:X 1</code> <code>:CALC:WAV:MARK1:X?</code>
Notes	If no suffix is sent it will use the fundamental units for the current marker X Axis Scale. If a suffix is sent that does not match the current marker X Axis Scale unit, an invalid suffix message will be generated The query returns the marker's absolute X-Axis value if the control mode is POStion . It returns the offset from the marker's reference marker if the control mode is DELTA . The query is returned in the fundamental units for the current marker X-Axis scale: seconds for Time . If the marker is OFF the response is Not A Number
Dependencies	Grayed-out, and displays three dashes, for the value when the selected Marker is OFF
Preset	LTE, LTE-A, 5G NR Modes: 5ms All other Modes: 1.0 ms
Min/Max	-/+infinity Unlike legacy instruments, where the markers were forced to be on screen, X-Series marker values are not limited and do not clip
Backwards Compatibility SCPI	<code>:CALCulate:MARKer[1] 2 ... 4:X:CENTer</code> This alias is provided for compatibility with the Band Power function in PSA and ESA

Marker X Axis Position (Remote Command Only)

Sets the marker X position in trace points. It has no effect if the control mode is **OFF**, but is the SCPI equivalent of entering a value if the control mode is Normal or Delta. The entered value is immediately translated into the current X Axis Scale units for setting the value of the marker.

Remote Command	<code>:CALCulate:WAVeform:MARKer[1] 2 ... 12:X:POStion <real></code> <code>:CALCulate:WAVeform:MARKer[1] 2 ... 12:X:POStion?</code>
Example	<code>:CALC:WAV:MARK:X:POS 500</code> <code>:CALC:WAV:MARK:X:POS?</code>
Notes	The query returns the marker's absolute X-Axis value in trace points if the control mode is POStion , or the offset from the marker's reference marker in trace points if the control mode is DELTA . The value is returned as a real number, not an integer, corresponding to the translation from X-Axis Scale units to trace points
Preset	After a preset, all markers are turned OFF , so the query returns a <i>Not A Number (NAN)</i>
State Saved	No
Min/Max	-/+9.9E+37

Marker Y Axis Value (Remote Query Only)

Queries the marker Y-Axis result value in the current marker Y-Axis unit. The “result” of a marker is the value that is displayed on the second line of the Marker Result

3 VMA Mode
 3.4 IQ Waveform Measurement

block. To properly interpret the returned value, you must also know how the instrument's Y-Axis Unit is set, as described below.

A marker can have up to two results, only one of which is displayed or returned in a query, as follows:

- **Absolute** Result: every marker has an Absolute Result. For **POSition** and **DELTA** markers, the Y-axis value of the trace point the marker is currently on. The Absolute Result is displayed in the result block or returned as a query, unless the marker control mode is **DELTA**
- **Relative** Result: if a marker's control mode is **DELTA**, the *relative* result is displayed in the result block or returned in a query. This is the ratio of the Absolute Result of a delta marker to the Absolute Result of its reference marker. The ratio is expressed in dB

Remote Command	<code>:CALCulate:WAVeform:MARKer[1] 2 ... 12:Y?</code>
Example	<code>:CALC:WAV:MARK11:Y?</code>
Notes	<p>When the marker is on, IQ waveform returns I and Q values</p> <p>Case #1 - Trace RF, I or Q: returns a single double value</p> <pre>>:CALC:WAV:MARK1:Y? -2.402406506109E+001</pre> <p>Case #2 - Trace IQ: returns a double array of two values, the first is I, and the second is Q</p> <pre>>:CALC:WAV:MARK1:Y? -3.006944493834E-003,+9.9870666467354E-004</pre> <p>The IQ selection is for backwards compatibility purposes. For new designs, use the I and/or Q selection instead</p> <p>You must be in a Mode that includes the Waveform measurement to use this command. Use <code>:INSTru-ment:SElect</code> to set the Mode</p>
Preset	Result depends on the marker setup and signal source
State Saved	No
Backwards Compatibility SCPI	<code>:CALCulate:WAVeform:MARKer[1] 2 ... 12:FUNCTion:RESult?</code>

Marker Mode

Sets the marker control mode to **POSition**, **DELTA**, or **OFF**. All interactions and dependencies detailed under the control description are enforced when the remote command is sent. If the selected marker is **OFF**, pressing **Marker** sets it to **POSition (Normal)** and places it at the center of the screen on the trace determined by the

Marker Trace rules. At the same time, Marker X-Axis Value appears on the Active Function area.

The default active function is the active function for the currently selected marker control mode. If the current control mode is **OFF**, there is no active function, and the active function is turned off.

Remote Command	<code>:CALCulate:WAVeform:MARKer[1] 2 ... 12:MODE POSition DELTa OFF</code> <code>:CALCulate:WAVeform:MARKer[1] 2 ... 12:MODE?</code>
Example	<code>:CALC:WAV:MARK:MODE OFF</code> <code>:CALC:WAV:MARK:MODE?</code>
Preset	OFF
State Saved	Saved in instrument state
Range	POSition DELTA OFF
Annotation	Mkr # <X value> and <Marker value> upper right on graph When Marker Trace is Polar in WCDMA mode: Mkr # <Chip Value (RHO & QPSKEVM)/Symbol Value (CDP)>, <X value> and <Y value> upper right on graph

Backwards Compatibility SCPI Command

Sets or queries the state of a marker. Setting a marker that is **OFF** to state **ON** or 1 puts it in **POSition** mode and places it at the center of the screen.

Preset	OFF
State Saved	Saved in instrument state
Range	OFF ON
Backwards Compatibility SCPI	<code>:CALCulate:WAVeform:MARKer[1] 2 ... 12:STATe OFF ON 0 1</code> <code>:CALCulate:WAVeform:MARKer[1] 2 ... 12:STATe?</code>

Delta Marker (Reset Delta)

Pressing this control has the same effect as pressing the **DELTA** selection in "**Marker Mode**" on page 747. The selected marker becomes a **Delta** marker. If the selected marker is already a **Delta** marker, the reference marker is moved to the current position of the selected marker, thus resetting the delta to zero.

Marker Settings Diagram

Lets you configure the **Marker** system using a visual utility.

All Markers Off

Turns off all markers.

Remote Command	:CALCulate:WAVeform:MARKer:AOff
Example	:CALC:WAV:MARK:AOff

Couple Markers

When this function is **ON**, moving any marker causes an equal X-Axis movement of every other marker that is not **OFF**. By “equal X-Axis movement” we mean that we preserve the difference between each marker’s X-Axis value (in the fundamental x-axis units of the trace that marker is on), and the X-Axis value of the marker being moved (in the same fundamental x-axis units).

This may result in markers going off-screen.

Remote Command	:CALCulate:WAVeform:MARKer:COUPle[:STATe] ON OFF 1 0
Example	:CALC:WAV:MARK:COUP ON :CALC:WAV:MARK:COUP?
Preset	OFF Presets on Mode Preset and "All Markers Off" on page 749
State Saved	Saved in instrument state

3.4.7.3 Peak Search

The controls on this tab allow you to move the marker to selected peaks of the signal, giving you enormous analysis capabilities, particularly when combined with the **Delta** marker function.

NOTE

Pressing the **Peak Search** hardkey automatically moves you to the **Peak Search** page of the **Marker** menu *and* performs a peak search.
 Pressing the **Peak Search** tab once you are already *in* the **Marker** menu does *not* perform a peak search.

Marker Time

This is the fundamental control that you use to move a marker around on the trace. It is the same as "Marker Time" on page 745 in Settings.

Peak Search

Moves the selected marker to the trace point that has the maximum Y-Axis value for that marker's trace.

NOTE

Pressing the **Peak Search** hardkey automatically moves you to the **Peak Search** page of the **Marker** menu *and* performs a peak search.

Remote Command	<code>:CALCulate:WAVeform:MARKer[1] 2 ... 12:MAXimum</code>
Example	<code>:CALC:WAV:MARK2:MAX</code> <code>:SYST:ERR?</code> can be used to query the errors to determine if a peak is found. The message "No peak found" (-200) will be returned after an unsuccessful search
Notes	Sending this command selects the subopcoded marker In W-CDMA Mode, this command does <i>not</i> work when the selected marker is located on the Polar trace. In this case, the command is ignored

Next Peak

Moves the selected marker to the peak that is next lower in amplitude than the current marker value.

If the selected marker was **OFF**, then it is turned **ON** as a **POSition** marker, and a peak search is performed.

Remote Command	<code>:CALCulate:WAVeform:MARKer[1] 2 ... 12:MAXimum:NEXT</code>
Example	<code>:CALC:WAV:MARK:MAX:NEXT</code>
Notes	Sending this command selects the subopcoded marker
State Saved	Not part of saved state

Minimum Peak

Moves the selected marker to the minimum Y-Axis value on the current trace.

3 VMA Mode
 3.4 IQ Waveform Measurement

If the selected marker is **OFF**, it is turned **ON** before the minimum search is performed.

Remote Command	:CALCulate:WAVeform:MARKer[1] 2 ... 12:MINimum
Example	:CALC:WAV:MARK:MIN
Notes	Sending this command selects the subopcoded marker
State Saved	Not part of saved state

Marker Delta

Pressing this control has the same effect as pressing **Delta** in "**Marker Mode**" on [page 747](#) on the **Settings** tab. The selected marker becomes a **Delta** marker. If the selected marker is already a **Delta** marker, the reference marker is moved to the current position of the selected marker, thus resetting the delta to zero.

The control is duplicated here to allow you to conveniently perform a **Peak Search** and change the marker's control mode to **Delta**, without having to access two separate menus.

3.4.7.4 Pk Search Config

Contains controls that let you set up the **Peak Search** functions.

Since the **Pk Search Config** functions are independent of the selected **Marker**, the **Select Marker** control does not appear while in **Pk Search Config**.

Peak Search Range

Lets you specify the range of trace to perform peak search actions specified in the **Peak Search** menu.

Option	SCPI	Behavior
Full	FULL	Peak Search actions will be performed on the entire trace
Manual	MANual	Specifies the range of the trace to which Peak Search actions will apply

Remote Command	:CALCulate:WAVeform:MARKer:PEAK:SEARch:RANGe FULL MANual
Example	:CALC:WAV:MARK:PEAK:SEAR:RANG FULL
Preset	FULL
State Saved	Saved in instrument state
Range	FULL MANual

Peak Search Range Start

Specifies the start of the range, in seconds, to which **Peak Search** actions are applied. Displays as a green vertical line, with the label **Pk Search Start** on the left, as shown below.

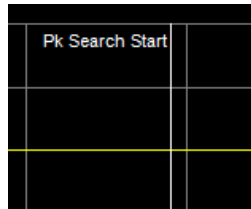

Remote Command	<code>:CALCulate:WAVEform:MARKer:PEAK:SEARch:RANGe:STARt <time></code> <code>:CALCulate:WAVEform:MARKer:PEAK:SEARch:RANGe:STARt?</code>
Example	<code>:CALC:WAV:MARK:PEAK:SEAR:RANG:STAR 0.001</code>
Dependencies	Disabled when Peak Search Range is set to Full.
Preset	0.0 ms
Min/Max	0.0/+Meas Time

Peak Search Range Stop

Specifies the end of the range, in seconds, to which **Peak Search** actions are applied. Displays as a green vertical line, with the label **Pk Search Stop** on the left, as shown below.

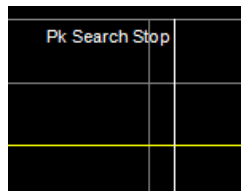

Remote Command	<code>:CALCulate:WAVEform:MARKer:PEAK:SEARch:RANGe:STOP <time></code> <code>:CALCulate:WAVEform:MARKer:PEAK:SEARch:RANGe:STOP?</code>
Example	<code>:CALC:WAV:MARK:PEAK:SEAR:RANG:STOP 0.001</code>
Dependencies	Disabled when Peak Search Range is set to Full.
Preset	0.0 ms
Min/Max	0.0/+Meas Time

3.4.7.5 Marker Function

The controls in this tab perform post-processing operations on marker data.

The **Marker Function** menu controls which marker functions are turned on, and allows you to adjust the setup parameters for each function. These parameters include the following, but only one parameter can be assigned to a given marker:

- Marker Noise
- Interval Power
- Interval Density
- Off

More Information

In the Waveform measurement, post-processing operations on markers are based on the measurement specifications. **Marker Functions** are distinct from measurement functions, which automatically perform complex sequences of setup, data acquisition, and display operations, to measure specified signal characteristics. **Marker Functions** are specified for each individual marker, and may be turned on individually for each marker.

Marker Time

This is the fundamental control that you use to move a marker around on the trace. It is the same as ["Marker Time" on page 745](#) in **Settings**.

Interval Function

Sets the marker control function type to one of:

Option	Parameter
Marker Noise	NOISe
Interval Power	BPOWer
Interval Density	BDENsity
Marker Function Off	OFF

All interactions and dependencies detailed under the control description are enforced when the remote command is sent.

Remote Command	:CALCulate:WAVEform:MARKer[1] 2 ... 12:FUNctIon NOISe BPOWer BDENsity OFF :CALCulate:WAVEform:MARKer[1] 2 ... 12:FUNctIon?
Example	:CALC:WAV:MARK:FUNC BPOW :CALC:WAV:MARK:FUNC?
Preset	OFF

State Saved	Saved in instrument state
Range	Marker Noise Interval Power Interval Density Off
Annotation	Mkr # <X value> and <Marker value> upper right on graph

Interval Span

Sets the width of the Span for the selected marker.

Remote Command	<code>:CALCulate:WAVEform:MARKer[1] 2 ... 12:FUNCtion:BAND:SPAN <time></code> <code>:CALCulate:WAVEform:MARKer[1] 2 ... 12:FUNCtion:BAND:SPAN?</code>
Example	<code>:CALC:WAV:MARK:FUNC:BAND:SPAN 20 ms</code> <code>:CALC:WAV:MARK:FUNC:BAND:SPAN?</code>
Couplings	Changing Interval Span necessarily changes " Interval Left " on page 754 and " Interval Right " on page 754
Preset	10% of Meas Time
State Saved	Saved in instrument state
Min	0
Max	100 s

Interval Left

Sets the left edge time for the band of the selected marker.

Remote Command	<code>:CALCulate:WAVEform:MARKer[1] 2 ... 12:FUNCtion:BAND:LEFT <time></code> <code>:CALCulate:WAVEform:MARKer[1] 2 ... 12:FUNCtion:BAND:LEFT?</code>
Example	<code>:CALC:WAV:MARK12:FUNC:BAND:LEFT 1 s</code> <code>:CALC:WAV:MARK12:FUNC:BAND:LEFT?</code>
Couplings	Changing Interval Left necessarily changes " Interval Span " on page 754 and " Interval Right " on page 754
Preset	5% of Meas Time
State Saved	Yes
Min	0
Max	100 s

Interval Right

Sets the right edge time for the band of the selected marker.

Remote	<code>:CALCulate:WAVEform:MARKer[1] 2 ... 12:FUNCtion:BAND:RIGHT <time></code>
--------	--

Command	:CALCulate:WAVeform:MARKer[1] 2 ... 12:FUNCtion:BAND:RIGHT?
Example	:CALC:WAV:MARK12:FUNC:BAND:RIGH 1 s :CALC:WAV:MARK12:FUNC:BAND:RIGH?
Notes	You must be in the IQ Waveform measurement to use this command
Couplings	Changing Interval Right necessarily changes " Interval Left " on page 754 and " Interval Span " on page 754
Preset	5% of Meas Time
State Saved	Yes
Min	0
Max	100 s

3.4.7.6 Properties

The controls on this tab are used to set certain properties of the selected marker.

Marker Time

This is the fundamental control that you use to move a marker around on the trace. It is the same as "**Marker Time**" on page 745 in **Settings**.

Relative To

Selects the marker to which the selected marker is relative (its reference marker).

Every marker has another marker to which it is relative. This marker is referred to as the "*reference marker*" for that marker. This attribute is set by the **Marker, Properties, Relative To** key. The marker must be a **Delta** marker to make this attribute relevant. If it is a **Delta** marker, the reference marker determines how the marker is controlled and how its value is displayed. A marker cannot be relative to itself.

Remote Command	:CALCulate:WAVeform:MARKer[1] 2 ... 12:REFerence <integer> :CALCulate:WAVeform:MARKer[1] 2 ... 12:REFerence?
Example	:CALC:WAV:MARK:REF 8 :CALC:WAV:MARK:REF?
Notes	This command causes the marker specified with the subopcode to become selected A marker cannot be relative to itself so that choice is not available, and if sent from SCPI generates error -221: "Settings conflict; marker cannot be relative to itself" When queried, a single value is returned (the specified marker number's relative marker)
Couplings	The act of specifying the selected marker's reference marker makes the selected marker a Delta marker

	If the reference marker is OFF , it is turned on in POSition mode at the Delta marker location
Preset	The preset default “Relative To” marker (reference marker) is the next higher numbered marker (current marker +1). For example, if Marker 2 is selected, then its default reference marker is Marker 3. The exception is Marker 12, which has a default reference of Marker 1 Set to default by Restore Mode Defaults . Not reset by Marker Off , All Markers Off , or Preset
State Saved	Saved in instrument state. Not affected by Marker Off and hence not affected by Preset or power cycle
Range	1 to 12 Remote Command only: if the range is exceeded, then the value is clipped
Min	1
Max	12
Annunciation	Appears in the marker label of a Delta marker

Marker Trace

Assigns the specified marker to the designated trace.

Remote Command	<code>:CALCulate:WAVeform:MARKer[1] 2 ... 12:TRACe RFENvelope I Q IQ</code> <code>:CALCulate:WAVeform:MARKer[1] 2 ... 12:TRACe?</code>
Example	<code>:CALC:WAV:MARK:TRAC RFEN</code> <code>:CALC:WAV:MARK:TRAC?</code>
Notes	The IQ selection is for backwards compatibility. For new designs, use the I and/or Q selection instead
Preset	RFEN
State Saved	Yes
Range	RFEN velope I Q IQ

Marker Settings Diagram

Lets you configure the Marker system using a visual utility. It is the same as "[Marker Settings Diagram](#)" on page 748 in **Settings**.

3.4.8 Meas Setup

Contains functions for setting up the measurement parameters, and for setting up parameters global to all measurements in the Mode.

3.4.8.1 Settings

Contains frequently used **Meas Setup** functions to which you will want the fastest access.

Avg/Hold Number (Averaging On/Off)

Sets the number of sweeps (average counts) that are averaged. After the specified number of sweeps, the "Average Mode" on page 757 (terminal control) setting determines the averaging action.

Also lets you turn Averaging on or off.

Remote Command	<code>[:SENSe]:WAVeform:AVERage:COUNT <integer></code> <code>[:SENSe]:WAVeform:AVERage:COUNT?</code>
Example	<code>:WAV:AVER:COUN 1001</code> <code>:WAV:AVER:COUN?</code>
Preset	10
State Saved	Saved in instrument state
Min/Max	1/20001
Annotation	The average count is displayed in the measurement bar on the front panel display. The annotation appears in the format n/N, where n is the current average and N is the average count

Auto Function

Remote Command	<code>[:SENSe]:WAVeform:AVERage[:STATe] OFF ON 0 1</code> <code>[:SENSe]:WAVeform:AVERage[:STATe]?</code>
Example	<code>:WAV:AVER ON</code> <code>:WAV:AVER?</code>
Preset	OFF
State Saved	Saved in instrument state
Range	OFF ON

Average Mode

Sets the Average Mode:

- **EXponential**, The measurement averaging continues using the specified number of averages to compute each averaged value. The average is displayed at the end of each sweep
- **REPeat**: The measurement resets the average counter each time the specified number of averages is reached

Remote Command	<code>[:SENSe]:WAVeform:AVERage:TCONtrol EXponential REPeat</code> <code>[:SENSe]:WAVeform:AVERage:TCONtrol?</code>
Example	<code>:WAV:AVER:TCON REP</code>

	<code>:WAV:AVER:TCON?</code>
Preset	<code>EXPonential</code>
State Saved	Saved in instrument state
Range	<code>EXPonential REPeat</code>

Average Type

Sets the type of averaging. When **AUTO** is selected, the instrument chooses the type of averaging. Available Average Types are:

Option	Parameter
Log-Pwr Avg	<code>LOG</code>
Power (RMS)	<code>RMS</code>
Voltage	<code>SCALar</code>

When one of the average types is selected manually, the instrument uses that type regardless of other instrument settings, and shows **Man** on the **Average Type** control.

Remote Command	<code>[:SENSe] :WAVeform:AVERage:TYPE LOG MAXimum MINimum RMS SCALar</code> <code>[:SENSe] :WAVeform:AVERage:TYPE?</code> For EXT-C, E6630A, E6640A, M90XA, use the following command <code>[:SENSe] :WAVeform:AVERage:TYPE LOG RMS SCALar</code>
Example	<code>:WAV:AVER:TYPE RMS</code> <code>:WAV:AVER:TYPE?</code>
Notes	The selections MAX and MIN are retained for backwards compatibility, but they are removed from the front panel access because they are not an Average function
Couplings	AUTO selects Power (RMS) averaging if a Marker Function (Marker Noise, Band/Intvl Power) is on
Preset	<code>RMS</code>
State Saved	Saved in instrument state
Range	Log-Pwr Avg Power (RMS) Voltage Auto Function
Remote Command	<code>[:SENSe] :WAVeform:AVERage:TYPE:AUTO ON OFF 1 0</code> <code>[:SENSe] :WAVeform:AVERage:TYPE:AUTO?</code>
Example	<code>:WAV:AVER:TYPE:AUTO 0</code> <code>:WAV:AVER:TYPE:AUTO?</code>
Preset	<code>ON</code>

Time Avg Num

Sets the number of HW averages to be executed per each data acquisition.

HW Averaging

Changes the number of time averages to be made using hardware. This averaging is much faster than the standard averaging done in software. The hardware averaging is done on the complex voltage time trace data before any measurement application averaging is done. Both types of averaging (HW and SW) can be done on the same measurement data.

When time averaging is being done in HW, each trace update represents N fresh data acquisitions averaged together, where N is the number of time averages. You cannot access the individual time data. Note that this averaging is done prior to the SW averaging done within the application. Thus, if time averaging is turned on, the trace in this measurement shows the result of HW averaging even if the normal (SW) averaging is turned off. Subsequent normal (SW) averaging is orthogonal to this hardware-based time averaging.

Thus, it is possible to turn off normal (SW) averaging within the application but still have the HW averaging set to a certain number greater than 1. In other words, turning averaging off within the measurement will not affect HW averaging. If HW averaging needs to be turned off, simply set the HW Averaging parameter to 1.

The **Auto/Man** feature of **Time Avg Num** works differently than other parameters. Since it is time averaging, a trigger source something other than **Free Run** should be used to synchronize successive data acquisitions to avoid cancelling out the signal to be measured. It is most useful for a periodic signal with known periods used in conjunction with the Periodic trigger. Thus, when in **Auto**, the Trigger Source automatically changes to **Periodic** trigger when **Time Avg Num** is turned **ON**. The trigger period is set to the current Meas Time value. Any changes to Meas Time change the **Periodic** trigger period to the same value and vice versa. If a trigger source other than **Periodic** trigger is manually selected, the **Time Avg Num Auto/Man** toggle is set to **Man**.

Remote Command	<code>[:SENSe]:WAVeform:AVERage:TACount <integer></code> <code>[:SENSe]:WAVeform:AVERage:TACount?</code>
Example	<code>:WAV:AVER:TAC 10</code> <code>:WAV:AVER:TAC?</code>
Notes	Only available when Option DP2, B40, or wider IF Bandwidth option is installed
Preset	1
State Saved	Saved in instrument state
Min/Max	1/65535

Auto Function

Remote Command	<code>[:SENSe]:WAVeform:AVERage:TACount:AUTO OFF ON 0 1</code> <code>[:SENSe]:WAVeform:AVERage:TACount:AUTO?</code>
Example	<code>:WAV:AVER:TAC:AUTO ON</code> <code>:WAV:AVER:TAC:AUTO?</code>
Preset	ON
Range	Auto Man

Meas Time

Lets you set how long the measurement is performed. X Scale *only* changes the scale of the display.

Remote Command	<code>[:SENSe]:WAVeform:SWEp:TIME <time></code> <code>[:SENSe]:WAVeform:SWEp:TIME?</code>
Example	<code>:WAV:SWE:TIME 50 ms</code> <code>:WAV:SWE:TIME?</code>
Notes	Specifies and returns how long the measurement is performed. It is the time record length of the measurement waveform. The Max time may be reduced when the sample frequency is high due to the memory limitation
Preset	LTE, LTETDD, LTEAFDD, LTEATDD, 5G NR Modes: 10 ms All other Modes: 2.000000 ms
State Saved	Saved in instrument state
Range	1.000 us to 100.00 s
Min/Max	1.000 us/100.0 s 1.000 us/3200 s

Sample Rate

Sets an arbitrary sample rate for the acquired data to be processed.

Remote Command	<code>[:SENSe]:WAVeform:SRATe <freq></code> <code>[:SENSe]:WAVeform:SRATe?</code>
Example	<code>:WAV:SRAT 1.3636 MHz</code>
Notes	The command and query are available when Option DP2, B40, or wider IF Bandwidth option is installed. For other configurations, only the query is available
Dependencies	To set a 2.4 GHz Sample Rate with Options R15 or R20, Center Frequency must be greater than or equal to 3.5 GHz To set a 5.1 GHz Sample Rate with Option R40, Center Frequency must be greater than or equal to 10 GHz

3 VMA Mode
3.4 IQ Waveform Measurement

Preset	Mode	Value
	5G NR, LTEA FDD/TDD	Automatically calculated
	BASIC	125.0 kHz
	BASIC	100 MHz
	EDGE GSM	637.5 kHz
	MSR	125.0 kHz
	PNOISE	125.0 kHz
	WCDMA	125.0 kHz
	WLAN	31.25 MHz
Min/Max	12.5 Hz/Option dependent For Option DP2, B40 or wider IF Bandwidth option:	
	Digital IF 10 MHz path	12.5 MHz
	Digital IF 25 MHz path	31.25 MHz
	Digital IF 40 MHz path	50 MHz
	Option B85 85 MHz path	106.25 MHz
	Option B1A 125 MHz path	156.25 MHz
	Option B1X 140 MHz path	175 MHz
	Option B1Y 160 MHz path	200 MHz
	Option B2X 255 MHz path	300 MHz
	Option B5X 510 MHz path	600 MHz
	Option R10 1 GHz path	1.2 GHz
	Option R15 1.5 GHz path	2.4 GHz
	Option R20 2 GHz path	2.4 GHz
	Option R40 4 GHz path	5.1 GHz
	For all other configurations:	
	10 MHz path	15 MHz
	Option B25 25 MHz path	45 MHz

Meas Setup Summary Table

Lets you view and access many of the parameters in the **Meas Setup** menus on one screen.

Spur Avoidance

Because VXT models M9410A/11A/15A/16A are direct-conversion (zero-IF) receivers, feedthrough leakage from the local oscillator appears as a spurious signal (spur) at the center frequency. The **Spur Avoidance** function is provided to eliminate this spur, at the expense of some measurement speed.

When **Spur Avoidance** is enabled (the default), the instrument uses a software algorithm to remove this spur from the displayed measurement data, but the algorithm only operates under certain conditions. Specifically, it only operates when the Digital IF BW \leq maxBW/2.5. See "[More Information](#)" on page 762.

You can disable this function to speed up your measurement, by setting **Spur Avoidance** to **Disabled**.

Note that when **Spur Avoidance** is not in effect, either because you have disabled it or because the Digital IF BW $>$ maxBW/2.5, the following warning message appears in the status bar: "Settings Alert; Spur Avoidance Off". This is to alert you that measurement accuracy might be impacted by the fact that **Spur Avoidance** is not in effect.

The spur avoidance function is not available for:

- M9410A/11A with EP6 option at frequency above 6 GHz
- M9415A/16A at frequency below 380 MHz and above 12.3 GHz
- M9410E/11E/15E/16E at frequency below 380 MHz and above 25.9 GHz

Remote Command	<code>[:SENSe]:WAVeform:SAVoid[:STATe] ON OFF 0 1</code> <code>[:SENSe]:WAVeform:SAVoid[:STATe]?</code>
Example	<code>:WAV:SAVoid ON</code> <code>:WAV:SAVoid?</code>
Dependencies	Only appears in VXT models M9410A/11A/15A/16A and M9410E/11E/15E/16E
Preset	<code>OFF</code>
State Saved	Saved in instrument state
Range	<code>ON OFF</code>

More Information

The Maximum Digital IF BW depends on the installed options, and selected **Center Frequency**.

VXT models M9410A/11A

Option limitation:

Option	Max Digital IF BW
B40	40 MHz
B3X	300 MHz
B6X	600 MHz
B12	1200 MHz

Center frequency limitation:

Center Frequency	Max Digital IF BW
330 MHz ~ 380 MHz	(CF - 330 MHz) * 2
380 MHz ~ 550 MHz	100 MHz
550 MHz ~ 1310 MHz	200 MHz
1310 MHz ~ 2000 MHz (without Option EP6)	600 MHz
2000 MHz ~ 5480 MHz (without Option EP6)	1200 MHz
5480 MHz ~ 6080 MHz (without Option EP6)	(6080 MHz - CF) * 2
1310 MHz ~ 1900 MHz (Option EP6)	600 MHz
1900 MHz ~ 6000 MHz (Option EP6)	1200 MHz
6000 MHz ~ 6600 MHz (Option EP6)	(6600 MHz - CF) * 2

VXT models M9415A/16A

Option limitation:

Option	Max Digital IF BW
B4X	400 MHz
B8X	800 MHz
B12	1200 MHz

Center frequency limitation:

Center Frequency	Max Digital IF BW
330 MHz ~ 380 MHz	(CF - 330 MHz) * 2
380 MHz ~ 550 MHz	100 MHz
550 MHz ~ 1310 MHz	200 MHz
1310 MHz ~ 2000 MHz	600 MHz
2000 MHz ~ 12300 MHz	1200 MHz
12300 MHz ~ 12900 MHz	(12900 MHz - CF) * 2

M9410E/11E

Option Limitation:

Option	Maximum IF BW
B40	40 MHz
B3X	300 MHz
B6X	600 MHz
B12	1200 MHz

Center Frequency Limitation:

Center Frequency	Maximum IF BW
1 MHz ~ 10 MHz (Option LFE)	500 kHz
10 MHz ~ 20 MHz (Option LFE)	5 MHz
20 MHz ~ 60 MHz (Option LFE)	10 MHz
60 MHz ~ 80 MHz (Option LFE)	20 MHz
80 MHz ~ 380 MHz (Option LFE)	40 MHz
330 MHz ~ 380 MHz (without Option LFE)	(CF - 330 MHz) * 2
380 MHz ~ 550 MHz	100 MHz
550 MHz ~ 1310 MHz	200 MHz
1310 MHz ~ 2000 MHz (without Option EP6)	600 MHz
2000 MHz ~ 25.9 GHz (without Option EP6)	1200 MHz
1310 MHz ~ 1900 MHz (Option EP6)	600 MHz
1900 MHz ~ 25.9 GHz (Option EP6)	1200 MHz
25.9 GHz ~ 26.5 GHz	Min(Max BW by option, 2*(26.5 GHz-Center Freq))

M9415E/16E

Option Limitation:

Option	Maximum IF BW
B4X	400 MHz
B8X	800 MHz
B12	1200 MHz

Center Frequency Limitation:

Center Frequency	Maximum IF BW
1 MHz ~ 10 MHz (Option LFE)	500 kHz

3 VMA Mode
 3.4 IQ Waveform Measurement

Center Frequency	Maximum IF BW
10 MHz ~ 20 MHz (Option LFE)	5 MHz
20 MHz ~ 60 MHz (Option LFE)	10 MHz
60 MHz ~ 80 MHz (Option LFE)	20 MHz
80 MHz ~ 380 MHz (Option LFE)	40 MHz
330 MHz ~ 380 MHz (without Option LFE)	(CF - 330 MHz) * 2
380 MHz ~ 550 MHz	100 MHz
550 MHz ~ 1310 MHz	200 MHz
1310 MHz ~ 2000 MHz	600 MHz
2000 MHz ~ 25.9 GHz	1200 MHz
25.9 GHz ~ 26.5 GHz	Min(Max BW by option, 2*(26.5 GHz-Center Freq))

Auto Couple

Immediately puts all **Auto/Man** functions into **Auto**. **Auto Couple** is confined to the current measurement only. It does not affect other measurements in the Mode.

In the **Auto** state, **Auto/Man** functions are said to be “coupled”, meaning their values change as you make changes to other values in the measurement. This helps ensure accurate measurements and optimum dynamic range. **Auto Couple** is an immediate action function, and when it is executed, all the **Auto/Man** controls for the current measurement are set to **Auto**, and all measurement settings coupled to the **Auto/Man** parameters are automatically set to their optimal values.

For further details of measurement-specific settings (if any), see "[Measurement-Specific Details](#)" on page 766 below.

Remote Command	:COUPle ALL
Example	:COUP ALL
Backwards Compatibility SCPI	:COUPLE ALL NONE
Backwards Compatibility Notes	:COUP:NONE puts all Auto/Man parameters in manual mode, decoupling all the coupled instrument parameters. It is retained for backwards compatibility and is <i>not</i> recommended for making measurements or new designs

All **Auto/Man** parameter couplings in the measurement are set to **Auto**. This includes couplings that may be unavailable or grayed-out due to the current state. For example, in the Swept SA measurement, there is no **Auto/Man** coupling for **RBW** while in Zero Span. Nonetheless, if **Auto Couple** were executed while in Zero Span, it would set **RBW** to Auto "behind the scenes" so that, on exit from Zero Span, it would be in **Auto**.

Any **Auto/Man** selection specific (local) to the other measurements in the current Mode are not affected by **Auto Couple**. Any functions that are *not* coupled with other instrument parameters, such as ranging or leveling variables, such as **AutoRange** or **AutoScale**, are not affected.

Executing **Auto Couple** generates the informational message, "All Auto/Man functions have been set to Auto".

Each parameter, upon being set to **Auto**, selects and sets the appropriate auto-coupled value based on that parameter's coupling rules. The Dependency Resolver orchestrates the couplings for parameters that depend on one or more other parameters. The coupling and dependency rules for each parameter are defined in the section describing that parameter.

Executing **Auto Couple** *does not* affect markers, marker functions, trace or display attributes, or any other instrument setting other than those specifically mentioned above.

Measurement-Specific Details

TOI (SA Mode only)

Parameters affected by **Auto Couple** are:

- Center Frequency Step
- Resolution Bandwidth
- Span/RBW Ratio
- Sweep Time
- Video BANDwidth VBW/RBW ratio
- Upper and Lower Tone (set to Sense)
- Zero span measurement Resolution Bandwidth
- Zero span measurement Dwell Time

Harmonics (SA Mode only)

Parameters affected by **Auto Couple** are:

- Resolution Bandwidth
- Fundamental Frequency

3 VMA Mode
 3.4 IQ Waveform Measurement

- Dwell Time
- Range Table Resolution Bandwidths
- Range Table Dwell Times

Meas Preset

Restores all measurement parameters to their default values.

Remote Command	:CONFigure:WAVeform
Example	:CONF:WAV
Notes	Restore default values of all parameters

3.4.8.2 Advanced

Contains advanced functions that are used for specific applications. These settings should not be changed for most measurements.

Does not appear in VXT.

Phase Noise Optimization

Sets the LO (local oscillator) phase noise behavior for various desired operating conditions.

Remote Command	[:SENSe]:WAVeform:FREQuency:SYNThesis[:STATe] 1 ... 5 For the meaning of each numeric option value, see "Parameter Options & Installed Options" on page 768 below [:SENSe]:WAVeform:FREQuency:SYNThesis[:STATe]?
Example	:WAV:FREQ:SYNT 2 Selects optimization for best wide offset phase noise
Dependencies	Does not appear in all models. For models that do not display this control, the SCPI command is accepted for compatibility, but no action is taken Not available in VXT models M9410A/11A/15A/16A and M9410E/11E/15E/116E
Preset	Because this function is in AUTO after Preset , the state of this function after Preset will be automatically calculated
State Saved	Saved in instrument state
Range	See "Ranges" on page 772 below

Auto Function

Remote Command	<code>[:SENSe]:WAVeform:FREQuency:SYNThesis:AUTO[:STATe] OFF ON 0 1</code>
Example	<code>:WAV:FREQ:SYNT:AUTO ON</code>
Preset	ON

Parameter Options & Installed Options

The Phase Noise Optimization control lets you optimize the setup and behavior of the Local Oscillator (LO) depending on your specific measurement conditions. You may wish to trade off noise and speed, for example, to make a measurement faster without regard to noise or with optimum noise characteristics without regard to speed.

Parameter Values Summary

Option	#	Description
"Balanced" on page 769	1	<ul style="list-style-type: none"> - In instruments with EPO, balances close-in phase noise with spur avoidance - In instruments without EPO optimizes phase noise for small frequency offsets from the carrier
"Best Wide-offset" on page 769	2	Optimizes phase noise for wide frequency offsets from the carrier
"Fast Tuning" on page 770	3	Optimizes LO for tuning speed
"Best Close-in" on page 769	4 or 1*	<ul style="list-style-type: none"> - In instruments with EPO, emphasizes close-in phase noise performance without regard to spur avoidance - In instruments without EPO, this setting is accepted but no action is taken
"Best Spurs" on page 769	5	<ul style="list-style-type: none"> - In instruments with EPO, emphasizes spur avoidance over close-in phase noise performance - In instruments without EPO, this setting is accepted but no action taken
Auto	-	Automatically selects LO (local oscillator) phase noise behavior to optimize dynamic range and speed for various instrument operating conditions

*Dependent on Option EPO installation. See "Best Close-in" on page 769 below.

The actual behavior varies somewhat depending on model number and option; for example, you always get Fast Tuning by choosing Option #3, but in some models, "Fast Tuning" on page 770 is identical in effect to "Best Close-in" on page 769.

Best Close-in

Without option EPO

`:FREQ:SYNT 1`

The LO phase noise is optimized for smaller offsets from the carrier, at the expense of phase noise farther out.

The actual frequency offset within which noise is optimized is shown with in square brackets, as this can vary depending on the hardware set in use. For example, in some instruments this annotation appears as [offset <20 kHz]

With option EPO

`:FREQ:SYNT 4`

In instruments with Option EPO, the LO is configured for the best possible close-in phase noise (offsets up to 600 kHz from the carrier), regardless of spurious products that occur with some center frequencies. Because this is generally less desirable for close-in measurements than the "Balanced" on page 769 setting, parameter 1 selects "Balanced" on page 769 in EPO instruments, in the interests of optimizing code compatibility across the family. Parameter 4 selects "Best Close-in" on page 769, which is usually not as good a choice as "Balanced" on page 769.

Balanced

`:FREQ:SYNT 1`

In instruments with EPO, the LO is configured for the best possible phase noise at offsets up to 600 kHz from the carrier whenever there are no significant spurs within the span observed with an on-screen carrier. When there will be such a spur, the LO is reconfigured in a way that allows the phase noise to increase by 7 dB mostly within ± 1 octave around 400 kHz offset. The spurs will always be below -70 dBc.

Best Spurs

`:FREQ:SYNT 5`

In instruments with EPO, the LO is configured for better phase noise than the "Best Wide-offset" on page 769 case close to the carrier, but the configuration has 11 dB worse phase noise than the "Best Close-in" on page 769 case mostly within ± 1 octave around 300 kHz offset. Spurs are even lower than in the "Balanced" on page 769 case at better than -90 dBc, whether or not the carrier is on-screen.

This setting is never selected when Phase Noise Optimization is in Auto, you must select it manually.

Best Wide-offset

`:FREQ:SYNT 2`

The LO phase noise is optimized for wider offsets from the carrier. Optimization is especially improved for offsets from 70 kHz to 300 kHz. Closer offsets are compromised and the throughput of measurements (especially remote measurements where the center frequency is changing rapidly), is reduced.

The actual frequency offset beyond which noise is optimized is shown with in square brackets, as this can vary depending on the hardware set in use. For example, in some instruments this annotation appears as [offset >30 kHz]

In instruments with Option EPO, the LO is configured for the best possible phase noise at offsets up to 600 kHz from the carrier whenever there are no significant spurs within the span observed with an on-screen carrier. When there will be such a spur, the LO is reconfigured in a way that allows the phase noise to increase by 7 dB mostly within ± 1 octave around 400 kHz offset. The spurs will always be below -70 dBc.

Fast Tuning

`:FREQ:SYNT 3`

In this mode, the LO behavior compromises phase noise at many offsets from the carrier in order to allow rapid measurement throughput when changing the center frequency or span. The term "[Fast Tuning](#)" on page 770 refers to the time it takes to move the local oscillator to the start frequency and begin a sweep; this setting does not impact the actual sweep time in any way.

In instruments with EP1, the LO behavior compromises phase noise at offsets below 4 MHz in order to improve measurement throughput. The throughput is especially affected when moving the LO more than 2.5 MHz and up to 10 MHz from the stop frequency to the next start frequency.

In instruments with Option EPO, this is the same configuration as "[Best Spurs](#)" on page 769. It is available with the "[Fast Tuning](#)" on page 770 label for convenience, and to make the user interface more consistent with other X-Series instrument family members.

(In models whose hardware does not provide for a "[Fast Tuning](#)" on page 770 option, the settings for "[Best Close-in](#)" on page 769 are used if "[Fast Tuning](#)" on page 770 is selected. This gives the fastest possible tuning for that hardware set.)

Auto

`:FREQ:SYNT:AUTO ON`

Selects the LO (local oscillator) phase noise behavior to optimize dynamic range and speed for various instrument operating conditions. The selection rules are as follows.

Auto Optimization Rules

X-Series instruments have several grades of LO, offering different configurations when in the Auto Mode. The rules for Auto selection are as follows:

Models with Option	Conditions	Selection
EPO Models with option EPO have a two stage local oscillator, which switches to a single loop for fast tuning (available in UXA)	Center frequency is < 699.9 kHz Span > 114.1 MHz, <i>or</i> RBW > 800 kHz RBW > 290 kHz, <i>or</i> Span > 4.2 MHz Other conditions	"Balanced" on page 769 "Fast Tuning" on page 770 "Best Wide-offset" on page 769 "Balanced" on page 769
EP1 Models with option EP1 have a two-loop local oscillator, which switches to a single loop for fast tuning (available in PXA)	Span > 44.44 MHz, <i>or</i> RBW > 1.9 MHz, <i>or</i> Source Mode is set to "Tracking" Center frequency is < 195 kHz, <i>or</i> CF >= 1 MHz and Span <= 1.3 MHz and RBW <= 75 kHz All other conditions	"Fast Tuning" on page 770 "Best Close-in" on page 769 "Best Wide-offset" on page 769
EP2 Models with option EP2 use a different loop bandwidth for the fast-tuning choice, which is a compromise between tuning speed and phase noise, giving good tuning speed at all offsets. Although not as good as for "Best Close-in" on page 769; this is useful when you have to look across a wide range of spans (available, for example, in MXA for excellent phase noise)	CF < 130 kHz, <i>or</i> CF > 12 MHz and Span < 495 kHz and RBW < 40 kHz Span > 22 MHz, <i>or</i> RBW > 400 kHz, <i>or</i> CF ≤ 12 MHz and Span < 495 kHz and RBW < 23 kHz All other conditions	"Best Close-in" on page 769 "Fast Tuning" on page 770 "Best Wide-offset" on page 769
EP4 (available in CXA for improved phase noise)	Span > 101 MHz <i>or</i> RBW > 1.15 MHz <i>or</i> Source Mode is set to "Tracking" CF is < 109 kHz <i>or</i> CF >= 4.95 MHz and Span <= 666 kHz and RBW < 28 kHz	"Fast Tuning" on page 770 "Best Close-in" on page 769

Models with Option	Conditions	Selection
	All other conditions	"Best Wide-offset" on page 769
All Other Models Note that in these models, the hardware does not actually provide for an extra-fast tuning option, so the settings for "Fast Tuning" on page 770 are actually the same as "Best Close-in" on page 769, but the rules are implemented this way so that the user who doesn't care about phase noise but does care about tuning speed doesn't have to remember which of the other two settings gives faster tuning	Span > 12.34 MHz, or RBW > 250 kHz, or Source Mode is set to "Tracking"	"Fast Tuning" on page 770
	Center frequency is < 25 kHz, or CF >= 1 MHz and Span <= 141.4 kHz and RBW <= 5 kHz	"Best Close-in" on page 769
	All other conditions	"Best Wide-offset" on page 769

In all the above cases:

- The RBW to be used in the calculations is the equivalent -3 dB bandwidth of the current RBW filter
- The rules apply whether in swept spans, zero span, or FFT spans

Ranges

Option	Option #	Phase Noise Option	Range
No EPx Option	1	Best Close-in	[offset < 20 kHz]
	2	Best Wide-offset	[offset > 30 kHz]
	3	Fast Tuning	[same as Best Close-In]
EPO	4	Best Close-in	[offset < 600 kHz]
	1	Balanced	[offset < 600 kHz]
	5	Best Spurs	[offset < 600 kHz]
	2	Best Wide-offset	[offset > 800 kHz]
	3	Fast Tuning	[same as Best Close-In]
EP1	1	Best Close-in	[offset < 140 kHz]
	2	Best Wide-offset	[offset > 160 kHz]
	3	Fast Tuning	[single loop]

3 VMA Mode
3.4 IQ Waveform Measurement

Option	Option #	Phase Noise Option	Range
EP2, EP3, EP5	1	Best Close-in	[offset < 70 kHz]
	2	Best Wide-offset	[offset > 100 kHz]
	3	Fast Tuning	[medium loop bw]
EP4	1	Best Close-in	[offset < 90 kHz]
	2	Best Wide-offset	[offset > 130 kHz]
	3	Fast Tuning	[same as Best Close-In]

ADC Dither

Toggles the dither function On and Off. The dither function improves linearity for low level signals, at the expense of a higher noise floor.

The reduced clipping-to-noise ratio results in higher noise because the clipping level of the ADC relative to the front terminals remains unchanged with the introduction of dither. The enhanced linearity is mostly improved scale fidelity.

With dither on, the third-order distortions are usually invisible for mixer levels below -35 dBm. With dither off, these distortions can be visible, with typical power levels of -110 dBm referred to the mixer. Detection nonlinearity can reach 1 dB for dither off at mixer levels around -70 dBm and lower, while the specified nonlinearity is many times smaller with dither on.

Remote Command	<code>[:SENSe] :WAVeform:ADC:DITHer [:STATe] OFF ON 0 1</code> <code>[:SENSe] :WAVeform:ADC:DITHer [:STATe] ?</code>
Example	<code>:WAV:ADC:DITH ON</code> <code>:WAV:ADC:DITH?</code>
Notes	The dither function improves linearity for low level signals, at the expense of a higher noise floor
Preset	OFF
State Saved	Saved in instrument state
Range	ON OFF
Backwards Compatibility SCPI	<code>[:SENSe] :WAVeform:WBIF:ADC:DITHer</code> <code>[:SENSe] :WAVeform:PDITHer</code>

Auto Function

Remote Command	<code>[:SENSe] :WAVeform:ADC:DITHer:AUTO [:STATe] OFF ON 0 1</code> <code>[:SENSe] :WAVeform:ADC:DITHer:AUTO [:STATe] ?</code>
Example	<code>:WAV:ADC:DITH:AUTO ON</code> <code>:WAV:ADC:DITH:AUTO?</code>
Notes	Sets ADC dithering to automatically select whether dithering is needed

	The dither function improves linearity for low level signals, at the expense of a higher noise floor
Preset	OFF
State Saved	Saved in instrument state
Range	Auto Man

LO Dither

When **LO Dither** is turned on, the local oscillator frequency is rapidly changed by small, random amounts. This helps spread the power of spurious signals within the passband, which lowers their level, thus increasing dynamic range. This is only required in very wide passbands, so this feature only appears with Option H1G.

Remote Command	<code>[:SENSe]:WAVeform:LO:DITHer[:STATe] ON OFF 1 0</code> <code>[:SENSe]:WAVeform:LO:DITHer[:STATe]?</code>
Example	<code>:WAV:LO:DITH 1</code> <code>:WAV:LO:DITH?</code>
Dependencies	Only available when the instrument has the Option H1G installed. If you try to turn ON LO Dither in any other case, an error message is generated, "-241, "Hardware missing; Option H1G required" Only appears in some Modes (for example, VMA and IQ Analyzer) The LO Dither function is turned OFF and grayed-out when the IF Path is set to a path other than 1 GHz. If you press the grayed-out control, a warning message "LO Dither only available with IF Path 1 GHz" is shown. If you try to set LO Dither to ON remotely while it is grayed-out, a message "-221, Settings conflict; LO Dither only available with IF Path 1 GHz" is returned When LO Dither is turned ON , the Phase Noise Optimization control is grayed-out. If you try to change the PNO value via front panel or SCPI in that case, an error is generated, "LO Dither must be turned off to change this value"
Couplings	As with most parameters with an AUTO state, " Auto Couple " on page 1825 sets it to Auto, which then selects AUTOorange . Setting any specific value (AUTOorange , LOW or HIGH) sets the AUTO state to false When LO Dither is turned ON , Phase Noise Optimization is set to "Best Close-In". If the Phase Noise Optimization value changes due to turning on LO Dither , a warning message "Phase Noise Optimization changed due to LO Dither activation" is displayed
Preset	OFF
State Saved	Saved in instrument state

IF Gain

Selects the range of IF gain.

When in **AUTOorange** mode, the IF checks its range once for data acquisition, to provide the best signal to noise ratio. You can specify the range for the best speed, and optimize for noise or for large signals.

3 VMA Mode
3.4 IQ Waveform Measurement

When **IF Gain** is set to **AUTOorange**, the IF Gain is set to **HIGH** initially for each chunk of data. The data is then acquired. If the IF overloads, then the IF Gain is set to **LOW**, and the data is re-acquired. Because of this operation, the **AUTOorange** setting requires more measurement time, as the instrument checks/resets its range. You can get faster measurement speed by forcing the range to either the **HIGH** or **LOW** gain setting, *but* you must ensure that your measurement conditions will not overload the IF (in the **HIGH** gain range), that your signals are well above the noise floor (for the **LOW** gain range), and that the signals are not changing.

When **Digital Bus Out** (under the **Input/Output** menu) is **ON**, the IF Gain State **AUTOorange** selection is not allowed. Thus, in this case IF Gain State will be set to **LOW**.

This only applies to the RF input. It does not apply to baseband I/Q input.

Remote Command	<code>[:SENSe]:WAVeform:IF:GAIN[:STATe] AUTOorange LOW HIGH OTHer</code> <code>[:SENSe]:WAVeform:IF:GAIN[:STATe]?</code>
Example	<code>:WAV:IF:GAIN HIGH</code> <code>:WAV:IF:GAIN?</code>
Notes	Only applies to the RF input. Does not apply to baseband I/Q input
Dependencies	If you try to select AUTOorange via SCPI while Digital Bus Out is ON , an error message -224, "Illegal parameter value; "IF Gain Autorange not allowed when Digital Bus Out is on" is displayed If you try to select AUTOorange via the front panel while Digital Bus Out is ON , an error message -221 "Settings conflict; "IF Gain Autorange not allowed when Digital Bus Out is ON" is displayed Other IF Gain is available only in models with DIF40
Couplings	As for most parameters that have an AUTO state, " Auto Couple " on page 1825 sets it to AUTOorange , which then selects LOW or HIGH depending on the IF Path. Setting any specific value (AUTOorange , LOW , HIGH , or OTHer) sets the AUTO state to OFF
Preset	LOW
State Saved	Saved in instrument state
Range	Autorange (Slower Follows Signals) Low (Best for Large Signals) High (Best Noise Level) Other (Explicit)

Auto Function

Remote Command	<code>[:SENSe]:WAVeform:IF:GAIN:AUTO[:STATe] ON OFF 1 0</code> <code>[:SENSe]:WAVeform:IF:GAIN:AUTO[:STATe]?</code>
Example	<code>:WAV:IF:GAIN:AUTO ON</code> <code>:WAV:IF:GAIN:AUTO?</code>
Notes	Activates the auto rules for IF Gain
Preset	ON
Range	OFF ON

IF Gain Offset

Sets **IF Gain Offset** for the 40 MHz, 140 MHz, 160 MHz IF Paths in 1 dB steps from the minimum gain available to the maximum. Increasing the gain can increase the amplitude of small signals, as long as you do not overdrive the hardware. Wideband gain should usually be adjusted after setting the input attenuation.

Internally, the **IF Gain** value will change based on the current configuration of the Hardware. You can choose to offset this value with this parameter. Hence the value specified is not an absolute value but relative to the current internal **IF Gain** setting.

For example:

- IF Gain Low + IF Gain Offset +4 dB = Total IF Gain of +4 dB (0 + 4 = 4)
- IF Gain High + IF Gain Offset +4 dB = Total IF Gain of +14 dB (10 + 4 = 14)
- IF Gain Low + IF Gain Offset -6 dB = Total IF Gain of -6 dB (0 - 6 = -6)
- IF Gain High + IF Gain Offset -6 dB = Total IF Gain of +6dB (10 - 6 = 4)

The available **IF Gain** depends on the **IF Path** and center frequency. The maximum **IF Gain** may not be achievable at all times, depending on the configuration.

Remote Command	<code>[:SENSe] :WAVeform:IF:GAIN:OFFSet <rel_amp1></code> <code>[:SENSe] :WAVeform:IF:GAIN:OFFSet?</code>
Example	Set IF Gain Offset to 2: <code>:WAV:IF:GAIN:OFFS 2</code>
Couplings	Not available in EXM, or UXM When " IF Gain " on page 774 State is set to OTHer , the " Other IF Gain " on page 776 value is used and IF Gain Offset is ignored
Preset	0
State Saved	Saved in instrument state
Min/Max	Depends on hardware present

Other IF Gain

Explicitly specifies the IF gain value.

Only applies when "**IF Gain**" on page 774 is set to **OTHer**. When **IF Gain** is set to **AUTOrange**, **LOW**, or **HIGH**, this value is ignored.

Available only in models with DIF40.

Remote	<code>[:SENSe] :WAVeform:IF:GAIN:LEVe1 <rel_amp1></code>
--------	--

3 VMA Mode
3.4 IQ Waveform Measurement

Command	<code>[:SENSe] :WAVeform:IF:GAIN:LEVel?</code>
Example	<code>:WAV:IF:GAIN:LEV -10</code> <code>:WAV:IF:GAIN:LEV?</code>
Preset	0
State Saved	Saved in instrument state
Min/Max	Depends upon hardware present

Mixing Mode

Lets you alternate between mixing modes for the Local Oscillator (LO). The default setting is **NORMa1** LO mixing mode, which is determined by the instrument configuration to be either “high side” or “low side”. Typically, “high side” mixing mode is used for the **NORMa1** LO mixing mode. Selecting the **ALTeRnate** mixing mode selects “low side” mixing when the **NORMa1** mixing mode is “high side” mixing, and selects “high side” mixing mode when the **NORMa1** mixing mode is “low side” mixing.

This function can be useful in eliminating images that may be seen from adjacent channels. Whenever you have signals that are twice the IF above your signal of interest, they will alias on top of your signal. To eliminate this issue, switch to **ALTeRnate** side mixing and your measurement will be image free.

Example

When testing a 5G signal with all 8 channels **ON**, where each channel is 100 MHz wide, there may be cases where you see images from adjacent channels. To measure the highest frequency carrier, you will need to switch to alternate side mixing, to avoid the 8th carrier from aliasing on top of other carriers.

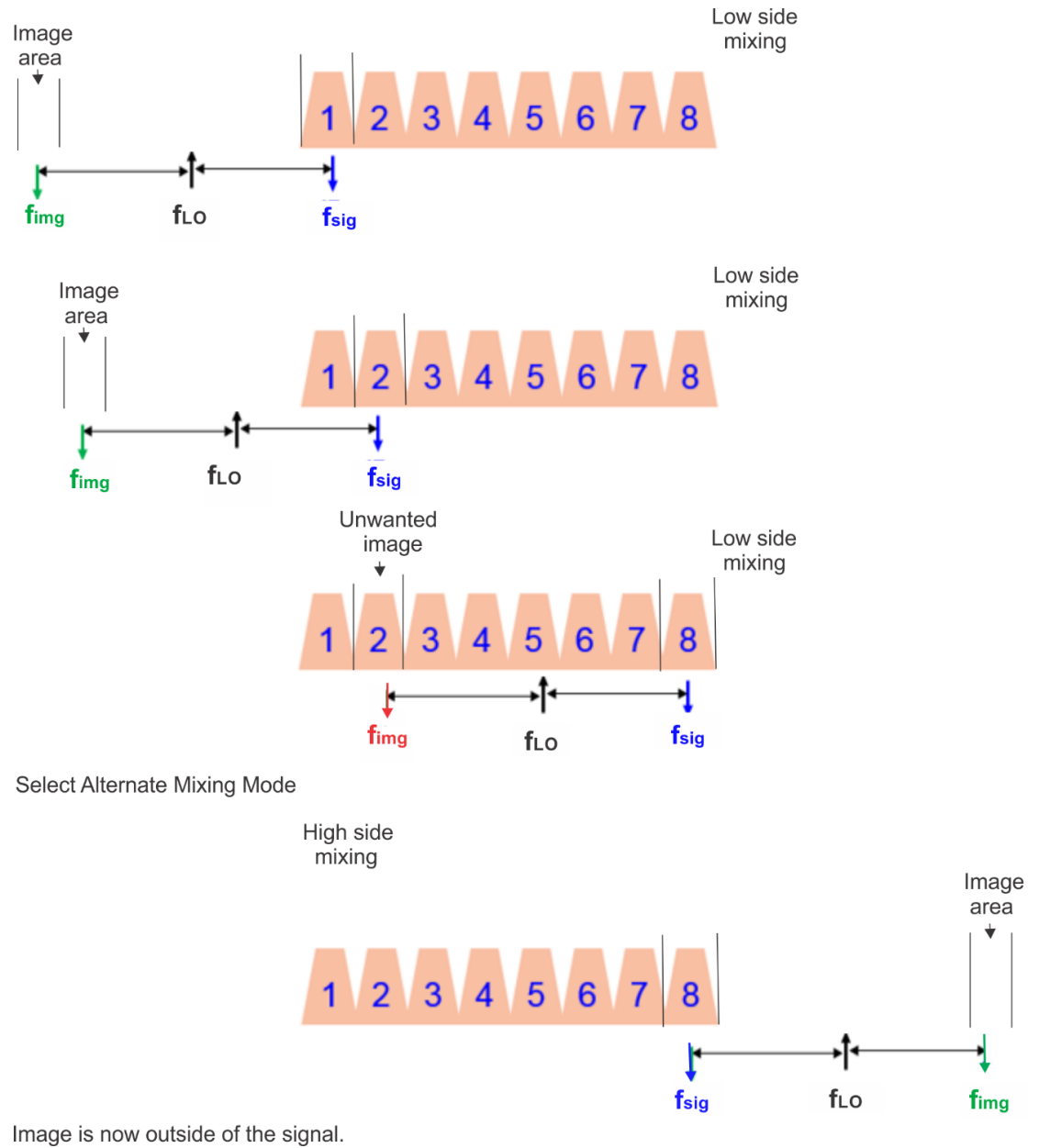

Remote Command	<code>[:SENSe] :WAVeform:LO:MIXMode NORMal ALTeRNate</code> <code>[:SENSe] :WAVeform:LO:MIXMode?</code>
Example	<code>:WAV:LO:MIXM NORM</code> <code>:WAV:LO:MIXM?</code>
Dependencies	Not available in N9000B Grayed-out when the RF Input is set to something other than RF (such as External Mixer). If you press

3 VMA Mode
3.4 IQ Waveform Measurement

the grayed-out control, a warning message “Feature only available with Signal Input RF” appears
If you try to set **Mixing Mode** via SCPI when disabled, a message -221, "Settings conflict; Feature only available with signal input RF" is returned

Preset	NORMa1
State Saved	Yes
Range	NORMa1 ALTErnate

Invert Spectrum

When set to **NORMa1**, the Spectrum toggle has no effect on the measurement. When set to **INVert**, the I/Q data is conjugated, which inverts the spectrum. This parameter also affects the results of the **:MEASure**, **:READ**, and **:FETCh** queries for **WAVEform4** data. If set to **INVert**, the I/Q data returned is conjugated, otherwise the data is raw I/Q.

Remote Command	[:SENSe] :WAVEform :SPECTrum NORMa1 INVert [:SENSe] :WAVEform :SPECTrum ?
Example	:WAV :SPEC INVert
Preset	NORMAL
State Saved	Saved in instrument state

Power Reference Plane

Allows you to increase the power by 3 dB for Baseband I+jQ measurements. Options are:

Menu	SCPI
Baseband	BASEband
RF	RF

Remote Command	For valid <meas> values, see " Valid Measurement Keywords " on page 780 [:SENSe] :<meas> :POWer :IQ :REFerence :PLANe RF BASEband [:SENSe] :<meas> :POWer :IQ :REFerence :PLANe ?
Example	(Complex Spectrum measurement) SPEC :POW :IQ :REF :PLAN BAS SPEC :POW :IQ :REF :PLAN ?
Dependencies	Only available if the I/Q input exists Enabled only when the input is I/Q and I/Q Path is I+jQ Disabled for all other conditions
Preset	RF
State Saved	Saved in instrument state

Valid Measurement Keywords

This function is available *only* in certain Modes and measurements. Only the following listed values of `<meas>` are valid.

Mode(s)	Meas	<meas>
BASIC	Complex Spectrum	SPECTrum
BASIC	IQ Waveform	WAVEform
CQM		
EDGE GSM		
LTEAFDD		
LTEATDD		
MSR		
NR5G		
PNOISE		
SRCOMMS		
VMA		
WCDMA		
WLAN		
WLAN	Modulation Analysis	EVM
WLAN	MIMO Modulation Analysis	EVMMimo

Mixing Mode State (Remote Command Only)

Available *only* in the Complex Spectrum, Streaming, and Waveform measurements.

Lets you alternate between mixing modes for the Local Oscillator (LO). The default setting is **NORMa1** LO mixing mode, which is determined by the instrument configuration to be either “high side” or “low side”. The query returns “High” or “Low” to determine whether the mixing is “high side” or “low side”. If **Mixing Mode** is toggled between **NORMa1** and **ALternate**, then **Mixing Mode State** also toggles between “High” and “Low”.

Remote Command	<code>[:SENSe] :SPECTrum:LO:MIXMode:SIDE?</code> <code>[:SENSe] :WAVEform:LO:MIXMode:SIDE?</code>
Example	<code>:SPEC:LO:MIXM:SIDE?</code> <code>:WAV:LO:MIXM:SIDE?</code>
Dependencies	Not available in N9000B
Couplings	When Mixing Mode is toggled between NORMa1 and ALternate , Mixing Mode State also toggles

	between High and Low
Range	High Low

IF Frequency (Remote Command Only)

Available *only* in the Complex Spectrum, Streaming, and Waveform measurements.
 Returns the current IF Frequency used in the IF Path.

Remote Command	<code>[:SENSe] :SPECTrum: IF: FREQuency?</code> <code>[:SENSe] :WAVeform: IF: FREQuency?</code>
Example	<code>:SPEC: IF: FREQ?</code> <code>:WAV: IF: FREQ?</code>
Couplings	A change in Span , Digital IF BW or IF Path parameters can result in a change of the IF Frequency value

3.4.8.3 Global

The controls in this menu apply to all Modes in the instrument.

Some controls (for example, "**Global Center Freq**" on page 1828) allow you to switch certain Meas Global parameters to a Mode Global state. These switches apply to all Modes that support global settings. For example, no matter what Mode you are in when you set **Global Center Freq** to **ON**, it applies to all Modes that support Global settings.

Other controls (for example, **Extend Low Band**) are actually set in this menu, but apply to all Modes.

Global Center Freq

The software maintains a Mode Global value called **Global Center Freq**.

When **Global Center Freq** is switched **ON**, the current Mode's center frequency is copied into the **Global Center Frequency**, and from then on all Modes that support global settings use the **Global Center Frequency**, so you can switch between any of these Modes and the **Center Frequency** remains unchanged.

Adjusting the **Center Frequency** of any Mode that supports Global Settings, while **Global Center Freq** is **ON**, modifies the **Global Center Freq**.

When **Global Center Freq** is switched **OFF**, the **Center Frequency** of the current Mode is unchanged, but now the **Center Frequency** of each Mode is once again independent.

When **Mode Preset** is pressed while **Global Center Freq** is **ON**, the **Global Center Freq** is preset to the preset **Center Frequency** of the current Mode.

This function resets to **OFF** when "**Restore Defaults**" on page 1829 is pressed, or when **System, Restore Defaults, All Modes** is pressed.

Remote Command	<code>:INSTrument:COUPle:FREQuency:CENTer ALL NONE</code> <code>:INSTrument:COUPle:FREQuency:CENTer?</code>
Example	<code>:INST:COUP:FREQ:CENT ALL</code> <code>:INST:COUP:FREQ:CENT?</code>
Preset	Set to OFF on Global Settings, Restore Defaults and System, Restore Defaults, All Modes
Range	ALL NONE
Preset	OFF
Backwards Compatibility SCPI	<code>:GLOBal:FREQuency:CENTer[:STATE] 1 0 ON OFF</code> <code>:GLOBal:FREQuency:CENTer[:STATE]?</code>

Global EMC Std

When this control is switched **ON**, the current Mode's EMC Std is copied into the **Global EMC Std**, and from then on all Modes that support global settings use the **Global EMC Std**, so you can switch between any of these Modes and the EMC Std remains unchanged.

Adjusting the EMC Std of any Mode that supports Global settings, while **Global EMC Std** is **ON** modifies the **Global EMC Std**.

When **Global EMC Std** is switched **OFF**, the EMC Std of the current Mode remains unchanged, but now the EMC Std of each Mode is once again independent. When **Mode Preset** is pressed while **Global EMC Std** is **ON**, **Global EMC Std** is preset to the preset EMC Std of the current Mode.

This function resets to **OFF** when "**Restore Defaults**" on page 1829 is pressed, or when **System, Restore Defaults, All Modes** is pressed.

Remote Command	<code>:INSTrument:COUPle:EMC:STANdard ALL NONE</code> <code>:INSTrument:COUPle:EMC:STANdard?</code>
Example	<code>:INST:COUP:EMC:STAN ALL</code> <code>:INST:COUP:EMC:STAN?</code>
Dependencies	Only available if Option EMC is installed
Preset	Set to OFF on Global Settings, Restore Defaults and System, Restore Defaults, All Modes
Range	ALL NONE

Restore Defaults

Resets all functions in the **Global** settings menu to **OFF**. Pressing **System, Restore Defaults, All Modes** has the same effect.

Remote Command	:INSTrument:COUPlE:DEFault
Example	:INST:COUP:DEF
Backwards Compatibility SCPI	:GLOBal:DEFault

3.4.8.4 Sample Period (Aperture) Setting (Remote Query Only)

Returns the time between samples (sample period or aperture).

Remote Command	[:SENSe] :WAVeform:APERture?
Example	:WAV:APER?
Couplings	Coupled to Sample Rate by the following equation Sample Period = 1/(Sample Rate)
Preset	1/(Sample Rate Default)
Min/Max	1/(Max Sample Rate)/1/(Min Sample Rate)

3.4.9 Sweep

Accesses controls to configure and control the acquisition of data, and the X-axis parameters of the instrument.

Depending on the selected mode and measurement, these controls might include: **Sweep Time, Continuous/Single, Pause/Resume, X Scale and Number of Points.**

3.4.9.1 Sweep/Control

Accesses controls that let you operate the sweep and control functions of the instrument, such as **Sweep Time** and **Continuous/Single**.

Restart

Restarts the current sweep, or measurement, or set of averaged/held sweeps or measurements. If you are Paused, pressing **Restart** performs a Resume.

The front-panel key **Restart** performs exactly the same function.

The **Restart** function is accessed in several ways:

- Pressing the **Restart** key
- Sending `:INIT:IMM`
- Sending `:INIT:REST`

See "[More Information](#)" on page 784

Remote Command	<code>:INITiate[:IMMediate]</code> <code>:INITiate:REStart</code>
Example	<code>:INIT:IMM</code> <code>:INIT:REST</code>
Notes	<code>:INIT:REST</code> and <code>:INIT:IMM</code> perform exactly the same function
Couplings	Resets average/hold count k. For the first sweep overwrites all active (update = on) traces with new current data. For application modes, it resets other parameters as required by the measurement
Status Bits/OPC dependencies	This is an Overlapped command The <code>STATUS:OPERation</code> register bits 0 through 8 are cleared , <i>except</i> bit 6 (Waiting for Periodic Sync). Initiating a measurement and Waiting for Periodic Sync could be asynchronous The <code>STATUS:QUEStionable</code> register bit 9 (<code>INTEgrity</code> sum) is cleared The <code>SWEEPING</code> bit is set The <code>MEASURING</code> bit is set
Backwards Compatibility Notes	For Spectrum Analysis Mode in ESA and PSA, the Restart hardkey and the <code>:INIT:REST</code> command restarted trace averages (displayed average count reset to 1) for a trace in Clear Write , but did not restart Max Hold and Min Hold In X-Series, the Restart hardkey and the <code>:INIT:REST</code> command restart not only Trace Average , but MaxHold and MinHold traces as well

More Information

The **Restart** function first aborts the current sweep or measurement as quickly as possible. It then resets the sweep and trigger systems, sets up the measurement and initiates a new data measurement sequence with a new data acquisition (sweep) taken once the trigger condition is met.

If the instrument is in the process of aligning when a **Restart** is executed, the alignment finishes before the restart function is performed.

Even when set for **Single** operation, multiple sweeps may be taken when **Restart** is pressed (for example, when averaging/holding is on). Thus, when we say that **Restart** "restarts a measurement", depending on the current settings, we may mean that it:

3 VMA Mode
 3.4 IQ Waveform Measurement

- Restarts the current sweep
- Restarts the current measurement
- Restarts the current set of sweeps if any trace is in Trace Average, Max Hold or Min Hold
- Restarts the current set of measurements if Averaging, or Max Hold, or Min Hold is on for the measurement

If there is no Average or Max/Min Hold function (no trace in Trace Average or Hold, or **Average/Hold Num** set to 1), and no **Waterfall** window is being displayed, a single sweep is equivalent to a single measurement. A single sweep is taken after the trigger condition is met; and the instrument stops sweeping once that sweep has completed. However, with **Average/Hold Num** >1, and at least one trace set to Trace Average, Max Hold, or Min Hold, or a **Waterfall** window being displayed, multiple sweeps/data acquisitions are taken for a single measurement. The trigger condition must be met prior to each sweep. The sweep is stopped when the average count k equals the number N set for **Average/Hold Num**.

Once the full set of sweeps has been taken, the instrument goes to the idle state. To take one more sweep without resetting the average count, increment the average count by 1, by pressing the **Step-Up** key while **Average/Hold Number** is the active function, or by sending the remote command **:CALC:AVER:TCON UP**.

Trace Update

The numeric results are not blanked at any time during the restart cycle.

For slow sweeps (see **Trace Update** section in **Trace/Detector**), the traces are updated real-time during the sweep. There may be a special circumstance in application mode measurements where an exception is made and the traces and/or results need to be blanked before displaying the new results.

To summarize, the following list shows what happens to the trace data on various events:

Event	Trace Effect
Clear/Write pressed (even if already in Clear/Write)	Set to mintracevalue
Max Hold pressed (even if already in Max Hold)	Set to mintracevalue
Min Hold pressed (even if already in Min Hold)	Set to maxtracevalue
Trace Average pressed (even if already in Trace Average)	Trace data unaffected but start new sweep/avg/hold
Restart pressed	Trace data unaffected but start new sweep/avg/hold
Parameter requiring restart changed (e.g., RBW)	Trace data unaffected but start new sweep/avg/hold

Sweep and Trigger Reset

Resetting the sweep system resets the average/hold count k to 0. It also resets the set point counter to 0. Resetting the trigger system resets the internal auto trig timer to the value set by the **Auto Trig** control.

Averaging

The weighting factor used for averaging is k . This k is also the average/hold count for how many valid sweeps (data acquisitions) have been done. This k is used for comparisons with N , as those comparisons always needs to be based on valid completed sweeps.

The displayed average/hold, K , shows the count for the sweep (data acquisition) in progress. $K = k + 1$, with a limit of N . The displayed value K changes from its previous value to 1 as soon as the trigger condition for the first data acquisition (sweep) is met.

Pause/Resume

Pauses a measurement after the current data acquisition is complete.

When paused, the label on the control changes to **Resume**. Pressing **Resume** unpauses the measurement. When paused, pressing **Restart** performs a Resume.

Remote Command	<code>:INITiate:PAUSE</code> <code>:INITiate:RESume</code>
Example	<code>:INIT:PAUS</code> <code>:INIT:RES</code>
Dependencies	Not displayed in Modes that do not support pausing
Annotation	Only on control

Sweep/Measure

Lets you toggle between **Continuous** and **Single** sweep or measurement operation. The single/continuous state is Meas Global, so the setting affects all measurements.

The front-panel key **Single/Cont** performs exactly the same function

See "[More Information](#)" on page 787

Remote Command	<code>:INITiate:CONTinuous OFF ON 0 1</code> <code>:INITiate:CONTinuous?</code>
----------------	--

3 VMA Mode
3.4 IQ Waveform Measurement

Example	<p>Put instrument into Single measurement operation:</p> <pre>:INIT:CONT 0</pre> <pre>:INIT:CONT OFF</pre> <p>Put instrument into Continuous measurement operation:</p> <pre>:INIT:CONT 1</pre> <pre>:INIT:CONT ON</pre>
Preset	<p>ON</p> <p>Note that :SYST:PRES sets :INIT:CONT to ON, but *RST sets :INIT:CONT to OFF</p>
State Saved	Saved in instrument state
Annunciation	<p>The Single/Continuous icon in the Meas Bar changes depending on the setting:</p> <ul style="list-style-type: none"> - A line with an arrow is Single - A loop with an arrow is Continuous
Backwards Compatibility Notes	<p>X-Series A-models had Single and Cont hardkeys in place of the SweepSingleCont softkey. In the X-Series A-models, if in single measurement, the Cont hardkey (and INIT:CONT ON) switched to continuous measurement, but never restarted a measurement and never reset a sweep</p> <p>X-Series B-models have a Cont/Single toggle control instead of Single and Cont hardkeys, but it is still true that, if in single measurement, the Cont/Single toggle control never restarts a measurement and never resets a sweep</p>

More Information

Continuous Mode	<p>The instrument takes repetitive sweeps, averages, measurements, etc., when in continuous mode. If in average or Max/Min Hold, and the average/hold count reaches the Average/Hold Num, the count stops incrementing, but the instrument keeps sweeping</p> <p>See the Trace key description under Trace Average for the averaging formula used both before and after the Average/Hold Num is reached. The trigger condition must be met prior to each sweep</p> <p>The type of trace processing for multiple sweeps is set under the Trace key, with choices of Trace Average, Max Hold, or Min Hold</p>
Single Mode	<p>The instrument takes a single sweep when in Single mode, or if in average or Max/Min Hold, or if there is a Waterfall window displayed, it takes multiple sweeps until the average/hold count reaches the Average/Hold Num, then the count stops incrementing, and the instrument stops sweeping</p> <p>See the Trace key description under Trace Average for the averaging formula used. The trigger condition must be met prior to the sweep</p> <p>The type of trace processing for multiple sweeps is set under the Trace key, with choices of Trace Average, Max Hold, or Min Hold</p>

If the instrument is in **Single** measurement mode, pressing the **Cont/Single** toggle control does not zero the count and does not cause the sweep to be reset; the only action is to put the instrument into Continuous measurement operation.

If the instrument is already in **Continuous** sweep:

- `:INIT:CONT 1` has no effect
- `:INIT:CONT 0` places the instrument in Single Sweep but has no effect on the current sequence until $k = N$, at which point the current sequence will stop and the instrument will go to the idle state

See "[Restart](#)" on page 1832 for details of `:INIT:IMMEDIATE`.

If the instrument is already in **Single** sweep, `:INIT:CONT OFF` has no effect.

If the instrument is already in **Single** sweep, then pressing **Cont/Single** in the middle of a sweep does not restart the sweep or sequence. Similarly, pressing **Cont/Single** does not restart the sweep or sequence if the sweep is not in the idle state (for example, if you are taking a very slow sweep, or the instrument is waiting for a trigger). Even though pressing **Cont/Single** in the middle of a sweep does not restart the sweep, sending `:INIT:IMM` does reset it.

If the instrument is in **Single** sweep, and *not* Averaging/Holding, and you want to take one more sweep, press **Restart**.

If the instrument is in **Single** sweep, *and* Averaging/Holding, and you want to take one more sweep without resetting the Average trace or count, go to **Meas Setup** and increment the average count by 1 by pressing the **Step-Up** key while **Average/Hold Num** is the active function. You can also do this by sending `:CALC:AVER:TCON UP`.

Abort (Remote Command Only)

Stops the current measurement. Aborts the current measurement as quickly as possible, resets the sweep and trigger systems, and puts the measurement into an "idle" state. If the instrument is in the process of aligning when `:ABORT` is sent, the alignment finishes *before* the abort function is performed, so `:ABORT` does not abort an alignment.

If the instrument is set for **Continuous** measurement, it sets up the measurement and initiates a new data measurement sequence with a new data acquisition (sweep) taken once the trigger condition is met.

If the instrument is set for **Single** measurement, it remains in the "idle" state until an `:INIT:IMM` command is received.

Remote Command	<code>:ABORT</code>
Example	<code>:ABOR</code>
Notes	If <code>:INIT:CONT</code> is ON , then a new continuous measurement will start immediately, with sweep (data acquisition) occurring once the trigger condition has been met

3 VMA Mode
3.4 IQ Waveform Measurement

	If :INIT:CONT is OFF , then :INIT:IMM is used to start a single measurement, with sweep (data acquisition) occurring once the trigger condition has been met
Dependencies	For continuous measurement, :ABORT is equivalent to the Restart key Not all measurements support this command
Status Bits/OPC dependencies	The STATUS:OPERation register bits 0 through 8 are cleared , <i>except</i> bit 6 (Waiting for Periodic Sync). Initiating a measurement and Waiting for Periodic Sync could be asynchronous The STATUS:QUEStionable register bit 9 (INTEgrity sum) is cleared Since all the bits that feed into OPC are cleared by :ABORT , the Abort command will cause the *OPC query to return true

3.4.9.2 X Scale

Accesses controls that enable you to set the horizontal scale parameters.

Ref Value

Sets the display X reference value.

Remote Command	:DISPlay:WAVeform:VIEW[1] 2:WINDow[1]:TRACe:X[:SCALe]:RLEVe1 <time> :DISPlay:WAVeform:VIEW[1] 2:WINDow[1]:TRACe:X[:SCALe]:RLEVe1?
Example	:DISP:WAV:VIEW:WIND:TRAC:X:RLEV 10 ms :DISP:WAV:VIEW:WIND:TRAC:X:RLEV?
Notes	View 1 is the RF Envelope View View 2 is the I/Q Waveform View
Couplings	If X " Auto Scaling " on page 790 is ON , this value is automatically determined by the measurement result. When you set a value manually, X Auto Scaling automatically changes to OFF
Preset	0.000 s
State Saved	Saved in instrument state
Min/Max	-1 s /10.0 s
Annotation	<value> s bottom left of graph

Scale/Div

Sets the display X scale/division value.

Remote Command	:DISPlay:WAVeform:VIEW[1] 2:WINDow[1]:TRACe:X[:SCALe]:PDIVision <time> :DISPlay:WAVeform:VIEW[1] 2:WINDow[1]:TRACe:X[:SCALe]:PDIVision?
Example	:DISP:WAV:VIEW:WIND:TRAC:X:PDIV 500 us :DISP:WAV:VIEW:WIND:TRAC:X:PDIV?

Notes	View 1 is the RF Envelope View View 2 is the I/Q Waveform View
Couplings	If X "Auto Scaling" on page 790 is ON , this value is automatically determined by the measurement result. When you set a value manually, X Auto Scaling automatically changes to OFF
Preset	200.0 us
State Saved	Saved in instrument state
Min	1.00 ns
Max	320 s

Ref Position

Sets the reference position for the X axis to **LEFT**, **CENTer** or **RIGHT**.

Remote Command	<code>:DISPlay:WAVeForm:VIEW[1] 2:WINDow[1]:TRACe:X[:SCALe]:RPOSition LEFT CENTer RIGHT</code> <code>:DISPlay:WAVeForm:VIEW[1] 2:WINDow[1]:TRACe:X[:SCALe]:RPOSition?</code>
Example	<code>:DISP:WAV:VIEW:WIND:TRAC:X:RPOS LEFT</code> <code>:DISP:WAV:VIEW:WIND:TRAC:X:RPOS?</code>
Preset	LEFT
State Saved	Saved in instrument state
Range	LEFT CENTer RIGHT

Auto Scaling

Toggles the scale coupling function **ON** or **OFF**.

Remote Command	<code>:DISPlay:WAVeForm:VIEW[1] 2:WINDow[1]:TRACe:X[:SCALe]:COUPle 0 1 OFF ON</code> <code>:DISPlay:WAVeForm:VIEW[1] 2:WINDow[1]:TRACe:X[:SCALe]:COUPle?</code>
Example	<code>:DISP:WAV:VIEW:WIND:TRAC:X:COUP ON</code> <code>:DISP:WAV:VIEW:WIND:TRAC:X:COUP?</code>
Couplings	When Auto Scaling is ON and the Restart front-panel key is pressed, this function automatically determines the scale per division and reference values based on the measurement results When you set the value of either "Scale/Div" on page 789 or "Ref Value" on page 789 manually, Auto Scaling automatically changes to OFF
Preset	ON
State Saved	Saved in instrument state
Range	OFF ON

- 3 VMA Mode
- 3.4 IQ Waveform Measurement

3.4.10 Trace

There are no **Trace** controls in this measurement.

3.5 Channel Power Measurement

This measurement is used to find the total power present in a specified bandwidth. Power Spectral Density (signal power normalized to 1 Hz) is also reported.

When in WLAN Mode, or when WLAN radio standard is selected in SA Mode, the peak Power Spectral Density for 1 MHz is reported.

Measurement Commands

The general functionality of "CONFigure" on page 2551, "INITiate" on page 2552, "FETCh" on page 2552, "MEASure" on page 2554, and "READ" on page 2553 are described in the section **SCPI Operation and Results Query** in the topic **Programming the Instrument**.

Note that, in general, `:CONF: <Measurement>` resets the specified measurement settings to their defaults. X-Series permits the addition of the `NDEFault` node to the command, which prevents a measurement preset after a measurement switch.

The tables below list setup commands for this measurement and queries to retrieve results.

Command	Function
<code>:INITiate:CHPower</code>	Initiates a trigger cycle for the CHP measurement, but does not return any data. You must then use <code>:FETC:CHP[n]?</code> to retrieve data Does not change any measurement settings
<code>:CONFigure?</code>	Returns the long form name of current measurement, in this case, CHPower
<code>:CONFigure:CHPower</code>	Selects CHP measurement with Meas Setup settings in preset state – same as "Meas Preset" on page 882
<code>:CONFigure:CHPower:NDEFault</code>	Selects CHP measurement <i>without</i> affecting settings

The following queries are used to retrieve data. The type of data returned depends on the value of `n`.

Query	Function
<code>:FETCh:CHPower[n]?</code>	Retrieves the data defined by <code>n</code>
<code>:MEASure:CHPower[n]?</code>	Switches to CHP measurement, restores default values, starts the measurement, then retrieves the data defined by <code>n</code>
<code>:READ:CHPower[n]?</code>	Starts the measurement, then retrieves the data defined by <code>n</code>

Backwards Compatibility Queries

Query	Return Value
:FETCh:CHPower:CHPower?	Returns the Channel Power (dBm)
:MEASure:CHPower:CHPower?	
:READ:CHPower:CHPower?	
:FETCh:CHPower:DENSity?	Returns the Power Spectral Density (dBm/Hz)
:MEASure:CHPower:DENSity?	
:READ:CHPower:DENSity?	

The results returned by the queries depend on the currently-selected Mode and the value of *n* (where required). The sections below provide mode-specific details for each Mode.

SA Mode Measurement Results

n	Results Returned						
1 or not specified	Returns scalar results: <table border="1" data-bbox="357 966 1315 1134"> <tr> <td>1</td> <td>Channel Power</td> <td>A floating-point number representing the total channel power in the specified integration bandwidth</td> </tr> <tr> <td>2</td> <td>PSD (Power Spectral Density)</td> <td>The power in the specified unit bandwidth. The unit bandwidth is selected by "PSD Unit" on page 879; either dBm/Hz or dBm/MHz</td> </tr> </table>	1	Channel Power	A floating-point number representing the total channel power in the specified integration bandwidth	2	PSD (Power Spectral Density)	The power in the specified unit bandwidth. The unit bandwidth is selected by "PSD Unit" on page 879; either dBm/Hz or dBm/MHz
1	Channel Power	A floating-point number representing the total channel power in the specified integration bandwidth					
2	PSD (Power Spectral Density)	The power in the specified unit bandwidth. The unit bandwidth is selected by "PSD Unit" on page 879; either dBm/Hz or dBm/MHz					
2	Returns floating point numbers that are the captured trace data of the power (in dBm/resolution BW) of the signal for Trace 1. The frequency span of the captured trace data is specified by "Span" on page 865						
3	n/a						
4	n/a						
5	Returns floating point numbers that are the captured trace data of the power (in dBm/resolution BW) of the signal for Trace 2. The frequency span of the captured trace data is specified by Span						
6	Returns floating point numbers that are the captured trace data of the power (in dBm/resolution BW) of the signal for Trace 3. The frequency span of the captured trace data is specified by Span						
7	Returns Marker Table data as a series of comma separated values in the following form: <Marker Number>,<Marker Trace>,<X>,<Y>,<Reserved>,<Reserved> Only markers that are enabled are included. <Reserved> are returned as NaN ("Not a Number", 9.91e+37). The data is returned in the current sort order as displayed in the Marker Table						

MSR Mode Measurement Results

n	Results Returned
1 or not specified	Returns scalar results:

n Results Returned

- 1 Channel Power A floating-point number representing the total channel power in the specified integration bandwidth
- 2 PSD (Power Spectral Density) The power in the specified unit bandwidth. The unit bandwidth is selected by "PSD Unit" on page 879; either dBm/Hz or dBm/MHz
- 2 Returns floating point numbers that are the captured trace data of the power (in dBm/resolution BW) of the signal for Trace 1. The frequency span of the captured trace data is specified by "Span" on page 865
- 3 Returns [Carriers] comma-separated scalar results, in the following order

#	Item	Unit
1	Total Power of Carrier 1	dBm
2	Total Power of Carrier 2	dBm
...	...	
[Carriers]	Total Power of Carrier [Carriers]	dBm

If the result is not available, NaN (9.91E+37) is returned. Number of returned values might be changed in future releases

- 4 Returns comma-separated scalar results, in the following order

#	Item	Unit
1	Total Power of LTE FDD carriers	dBm
2	Total Power of W-CDMA carriers	dBm
3	Total Power of GSM/EDGE carriers	dBm
4	Total Power of cdma2000 carriers	dBm
5	Total Power of 1xEV-DO carriers	dBm
6	...	

The number of results is incremented by one when a new format is supported

If the result is not available, NaN (9.91E+37) is returned. Number of returned values will be changed in future releases if the number of supported radio format is increased

- 5 Returns floating point numbers that are the captured trace data of the power (in dBm/resolution BW) of the signal for Trace 2. The frequency span of the captured trace data is specified by the Span control
- 6 Returns floating point numbers that are the captured trace data of the power (in dBm/resolution BW) of the signal for Trace 3. The frequency span of the captured trace data is specified by the Span control
- 7 Returns Marker Table data as a series of comma separated values in the following form:
<Marker Number>,<Marker Trace>,<X>,<Y>,<Reserved>,<Reserved>
Only markers that are enabled are included. <Reserved> are returned as NaN ("Not a Number", 9.91e+37). The data is returned in the current sort order as displayed in the Marker Table

LTE-Advanced FDD/TDD Mode Measurement Results

n	Results Returned																		
1 or not specified	Returns scalar results: <table border="1"> <tr> <td>1</td> <td>Channel Power</td> <td>A floating-point number representing the total channel power in the specified integration bandwidth</td> </tr> <tr> <td>2</td> <td>PSD (Power Spectral Density)</td> <td>The power in the specified unit bandwidth. The unit bandwidth is selected by "PSD Unit" on page 879; either dBm/Hz or dBm/MHz</td> </tr> </table>	1	Channel Power	A floating-point number representing the total channel power in the specified integration bandwidth	2	PSD (Power Spectral Density)	The power in the specified unit bandwidth. The unit bandwidth is selected by "PSD Unit" on page 879; either dBm/Hz or dBm/MHz												
1	Channel Power	A floating-point number representing the total channel power in the specified integration bandwidth																	
2	PSD (Power Spectral Density)	The power in the specified unit bandwidth. The unit bandwidth is selected by "PSD Unit" on page 879; either dBm/Hz or dBm/MHz																	
2	Returns floating point numbers that are the captured trace data of the power (in dBm/resolution BW) of the signal for Trace 1. The frequency span of the captured trace data is specified by "Span" on page 865																		
3	Returns comma-separated scalar results, in the following order <table border="1"> <thead> <tr> <th>#</th> <th>Item</th> <th>Unit</th> </tr> </thead> <tbody> <tr> <td>1</td> <td>Total Power of Component Carrier 0</td> <td>dBm</td> </tr> <tr> <td>2</td> <td>Total Power of Component Carrier 1</td> <td>dBm</td> </tr> <tr> <td>3</td> <td>Total Power of Component Carrier 2</td> <td>dBm</td> </tr> <tr> <td>4</td> <td>Total Power of Component Carrier 3</td> <td>dBm</td> </tr> <tr> <td>5</td> <td>Total Power of Component Carrier 4</td> <td>dBm</td> </tr> </tbody> </table> <p>If the result is not available, NaN (9.91E+37) is returned</p>	#	Item	Unit	1	Total Power of Component Carrier 0	dBm	2	Total Power of Component Carrier 1	dBm	3	Total Power of Component Carrier 2	dBm	4	Total Power of Component Carrier 3	dBm	5	Total Power of Component Carrier 4	dBm
#	Item	Unit																	
1	Total Power of Component Carrier 0	dBm																	
2	Total Power of Component Carrier 1	dBm																	
3	Total Power of Component Carrier 2	dBm																	
4	Total Power of Component Carrier 3	dBm																	
5	Total Power of Component Carrier 4	dBm																	
4	Returns comma-separated scalar results, in the following order. The unit bandwidth is selected by "PSD Unit" on page 879, either dBm/Hz or dBm/MHz <table border="1"> <thead> <tr> <th>#</th> <th>Item</th> <th>Unit</th> </tr> </thead> <tbody> <tr> <td>1</td> <td>Total Power Spectral Density of Component Carrier 0</td> <td>PSD Unit</td> </tr> <tr> <td>2</td> <td>Total Power Spectral Density of Component Carrier 1</td> <td>PSD Unit</td> </tr> <tr> <td>3</td> <td>Total Power Spectral Density of Component Carrier 2</td> <td>PSD Unit</td> </tr> <tr> <td>4</td> <td>Total Power Spectral Density of Component Carrier 3</td> <td>PSD Unit</td> </tr> <tr> <td>5</td> <td>Total Power Spectral Density of Component Carrier 4</td> <td>PSD Unit</td> </tr> </tbody> </table> <p>If the result is not available, NaN (9.91E+37) is returned</p>	#	Item	Unit	1	Total Power Spectral Density of Component Carrier 0	PSD Unit	2	Total Power Spectral Density of Component Carrier 1	PSD Unit	3	Total Power Spectral Density of Component Carrier 2	PSD Unit	4	Total Power Spectral Density of Component Carrier 3	PSD Unit	5	Total Power Spectral Density of Component Carrier 4	PSD Unit
#	Item	Unit																	
1	Total Power Spectral Density of Component Carrier 0	PSD Unit																	
2	Total Power Spectral Density of Component Carrier 1	PSD Unit																	
3	Total Power Spectral Density of Component Carrier 2	PSD Unit																	
4	Total Power Spectral Density of Component Carrier 3	PSD Unit																	
5	Total Power Spectral Density of Component Carrier 4	PSD Unit																	
5	Returns floating point numbers that are the captured trace data of the power (in dBm/resolution BW) of the signal for Trace 2. The frequency span of the captured trace data is specified by Span																		
6	Returns floating point numbers that are the captured trace data of the power (in dBm/resolution BW) of the signal for Trace 3. The frequency span of the captured trace data is specified by Span																		
7	Returns Marker Table data as a series of comma separated values in the following form: <Marker Number>,<Marker Trace>,<X>,<Y>,<Reserved>,<Reserved> Only markers that are enabled are included. <Reserved> are returned as NaN ("Not a Number", 9.91e+37). The data is returned in the current sort order as displayed in the Marker Table																		

5G NR Mode Measurement Results

n	Results Returned																		
1 or not specified	Returns scalar results: <table border="1"> <tr> <td>1</td> <td>Channel Power</td> <td>A floating-point number representing the total channel power in the specified integration bandwidth</td> </tr> <tr> <td>2</td> <td>PSD (Power Spectral Density)</td> <td>The power in the specified unit bandwidth. The unit bandwidth is selected by "PSD Unit" on page 879; either dBm/Hz or dBm/MHz</td> </tr> </table>	1	Channel Power	A floating-point number representing the total channel power in the specified integration bandwidth	2	PSD (Power Spectral Density)	The power in the specified unit bandwidth. The unit bandwidth is selected by "PSD Unit" on page 879; either dBm/Hz or dBm/MHz												
1	Channel Power	A floating-point number representing the total channel power in the specified integration bandwidth																	
2	PSD (Power Spectral Density)	The power in the specified unit bandwidth. The unit bandwidth is selected by "PSD Unit" on page 879; either dBm/Hz or dBm/MHz																	
2	Returns floating point numbers that are the captured trace data of the power (in dBm/resolution BW) of the signal for Trace 1. The frequency span of the captured trace data is specified by "Span" on page 865																		
3	Returns comma-separated scalar results, in the following order <table border="1"> <thead> <tr> <th>#</th> <th>Item</th> <th>Unit</th> </tr> </thead> <tbody> <tr> <td>1</td> <td>Total Power of Component Carrier 0</td> <td>dBm</td> </tr> <tr> <td>2</td> <td>Total Power of Component Carrier 1</td> <td>dBm</td> </tr> <tr> <td>3</td> <td>Total Power of Component Carrier 2</td> <td>dBm</td> </tr> <tr> <td>...</td> <td>...</td> <td></td> </tr> <tr> <td>16</td> <td>Total Power of Component Carrier 15</td> <td>dBm</td> </tr> </tbody> </table> <p>If the result is not available, NaN (9.91E+37) is returned</p>	#	Item	Unit	1	Total Power of Component Carrier 0	dBm	2	Total Power of Component Carrier 1	dBm	3	Total Power of Component Carrier 2	dBm		16	Total Power of Component Carrier 15	dBm
#	Item	Unit																	
1	Total Power of Component Carrier 0	dBm																	
2	Total Power of Component Carrier 1	dBm																	
3	Total Power of Component Carrier 2	dBm																	
...	...																		
16	Total Power of Component Carrier 15	dBm																	
4	Returns comma-separated scalar results, in the following order. The unit bandwidth is selected by PSD Unit in either dBm/Hz or dBm/MHz <table border="1"> <thead> <tr> <th>#</th> <th>Item</th> <th>Unit</th> </tr> </thead> <tbody> <tr> <td>1</td> <td>Total Power of Component Carrier 0</td> <td>PSD Unit</td> </tr> <tr> <td>2</td> <td>Total Power of Component Carrier 1</td> <td>PSD Unit</td> </tr> <tr> <td>3</td> <td>Total Power of Component Carrier 2</td> <td>PSD Unit</td> </tr> <tr> <td>...</td> <td>...</td> <td></td> </tr> <tr> <td>16</td> <td>Total Power of Component Carrier 15</td> <td>PSD Unit</td> </tr> </tbody> </table> <p>If the result is not available, NaN (9.91E+37) is returned</p>	#	Item	Unit	1	Total Power of Component Carrier 0	PSD Unit	2	Total Power of Component Carrier 1	PSD Unit	3	Total Power of Component Carrier 2	PSD Unit		16	Total Power of Component Carrier 15	PSD Unit
#	Item	Unit																	
1	Total Power of Component Carrier 0	PSD Unit																	
2	Total Power of Component Carrier 1	PSD Unit																	
3	Total Power of Component Carrier 2	PSD Unit																	
...	...																		
16	Total Power of Component Carrier 15	PSD Unit																	
5	Returns floating point numbers that are the captured trace data of the power (in dBm/resolution BW) of the signal for Trace 2. The frequency span of the captured trace data is specified by "Span" on page 865																		
6	Returns floating point numbers that are the captured trace data of the power (in dBm/resolution BW) of the signal for Trace 3. The frequency span of the captured trace data is specified by Span																		
7	Returns Marker Table data as a series of comma separated values in the following form: <Marker Number>,<Marker Trace>,<X>,<Y>,<Reserved>,<Reserved> Only markers that are enabled are included. <Reserved> are returned as NaN ("Not a Number", 9.91e+37). The data is returned in the current sort order as displayed in the Marker Table																		

WLAN Channel Power Measurement Results

n	Results Returned
1 or not specified	<p>Returns scalar results:</p> <p>When the radio standard is <i>not</i> 802.11ac 80 + 80 MHz or 802.11ax 80 + 80 MHz:</p> <p>Channel Power A floating-point number representing the total channel power in the specified integration bandwidth</p> <p>Peak PSD (Power Spectral Density) The peak PSD over the integration bandwidth. The unit bandwidth is selected by "PSD Unit" on page 879 in either dBm/Hz or dBm/MHz</p> <p>Mean PSD (Power Spectral Density) The mean PSD over the integration bandwidth. The unit bandwidth is selected by PSD Unit in either dBm/Hz or dBm/MHz</p> <p>When the radio standard is 802.11ac 80 + 80 MHz or 802.11ax 80 + 80 MHz:</p> <p>Channel Power of the carrier of which the center frequency is indicated by Freq Segment 1 A floating-point number representing the total channel power of the first segment in the specified integration bandwidth</p> <p>Peak PSD (Power Spectral Density) of the carrier of which the center frequency is indicated by Freq Segment 1 The power in the specified unit bandwidth of the first segment. The unit bandwidth is selected by PSD Unit in either dBm/Hz or dBm/MHz</p> <p>Channel Power of the carrier of which the center frequency is indicated by Freq Segment 2 A floating-point number representing the total channel power of the second segment in the specified integration bandwidth</p> <p>Peak PSD (Power Spectral Density) of the carrier of which the center frequency is indicated by Freq Segment 2 The power in the specified unit bandwidth of the second segment. The unit bandwidth is selected by PSD Unit in either dBm/Hz or dBm/MHz</p> <p>Mean PSD (Power Spectral Density) of the carrier of which the center frequency is indicated by Freq Segment 1 The power in the specified unit bandwidth of the first segment. The unit bandwidth is selected by PSD Unit in either dBm/Hz or dBm/MHz</p> <p>Mean PSD (Power Spectral Density) of the carrier of which the center frequency is indicated by Freq Segment 2 The power in the specified unit bandwidth of the second segment. The unit bandwidth is selected by PSD Unit in either dBm/Hz or dBm/MHz</p>
2	Returns floating point numbers that are the captured trace data of the power (in dBm/resolution BW) of the signal for Trace 1. The frequency span of the captured trace data is specified by "Span" on page 865
3	n/a
4	n/a

n	Results Returned
5	Returns floating point numbers that are the captured trace data of the power (in dBm/resolution BW) of the signal for Trace 2. The frequency span of the captured trace data is specified by Span
6	Returns floating point numbers that are the captured trace data of the power (in dBm/resolution BW) of the signal for Trace 3. The frequency span of the captured trace data is specified by Span
7	Returns Marker Table data as a series of comma separated values in the following form: <Marker Number>,<Marker Trace>,<X>,<Y>,<Reserved>,<Reserved> Only markers that are enabled are included. <Reserved> are returned as NaN ("Not a Number", 9.91e+37). The data is returned in the current sort order as displayed in the Marker Table

Additionally, WLAN Mode supports an **n** parameter for the following queries:

```
:FETCh:CHPower:DENSity[n]?
:MEASure:CHPower:DENSity[n]?
:READ:CHPower:DENSity[n]?
```

For these queries *in WLAN Mode only*, the results returned depend on the value of **n** as follows:

n	Radio Standard	Results Returned
1 or not specified	Not 802.11ac 80 +80 MHz or 802.11ax80 +80 MHz	Peak PSD (Power Spectral Density) The Peak PSD over the integration bandwidth. The unit bandwidth is selected by "PSD Unit" on page 879 in either dBm/Hz or dBm/MHz
	802.11ac 80 +80 MHz or 802.11ax80 +80 MHz	The first value is the peak PSD for segment 1, the second value is the peak PSD for segment 2
2	Not 802.11ac 80 +80 MHz or 802.11ax80 +80 MHz	Mean PSD (Power Spectral Density) The Mean PSD over the integration bandwidth. The unit bandwidth is selected by PSD Unit in either dBm/Hz or dBm/MHz
	802.11ac 80 +80 MHz or 802.11ax80 +80 MHz	The first value is the mean PSD for segment 1, the second value is the mean PSD for segment 2

3.5.1 Views

In SA, WCDMA, WLAN, SRCOMMS, and VMA Modes, there is only one predefined view, the "Normal" on page 798 view.

3.5.1.1 Normal

Windows: "Graph" on page 799, "Metrics" on page 800

Dual window view: Channel Power graph and Channel Power metrics.

Example :DISP:CHP:VIEW PRES

3.5.1.2 Carrier Info

Windows: "Graph" on page 799, "Metrics" on page 800

Dual window view: Channel Power graph and Carrier Info table.

Example	:DISP:CHP:VIEW CINF
Dependencies	Only available in MSR, LTE-A FDD/TDD and 5G NR Modes

3.5.2 Windows

This section describes the windows that are available in the Channel Power measurement:

Window	Number
"Graph" on page 799	1
"Metrics" on page 800	2
"Gate" on page 804	3
"Marker Table" on page 804	4

3.5.2.1 Graph

Window #1

Used to display the spectrum trace and power bars.

The results of the measurement can be displayed as a single spectrum trace view or displayed with a Bar Graph trace on the spectrum trace. The Bar Graph appears between the markers that indicate the measured output power level. The bar graph is activated when the "Bar Graph" control is set to ON under the Display menu. The Graph window appears in the following views.

View	Size	Position
Normal	Two thirds, full width	Top
Gate View	One third, full width	Middle

Spectrum View with Bar Graph Off

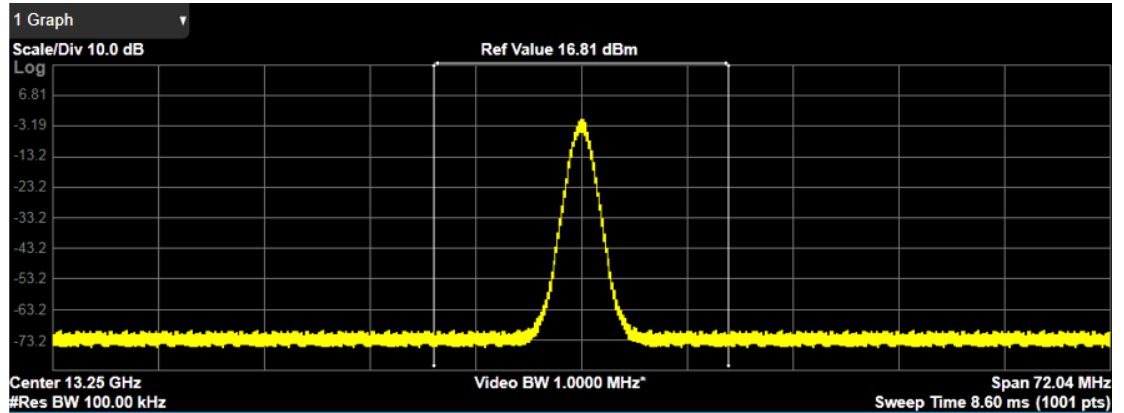

Spectrum View with Bar Graph On

This is the same as the **Spectrum** view, but has a blue bar between the markers that indicates the measured output power level. The bar graph is activated when the “Bar Graph” control is set to **ON** under the **Display** hardkey. The actual measured output power level is displayed on the display at the top of the bar.

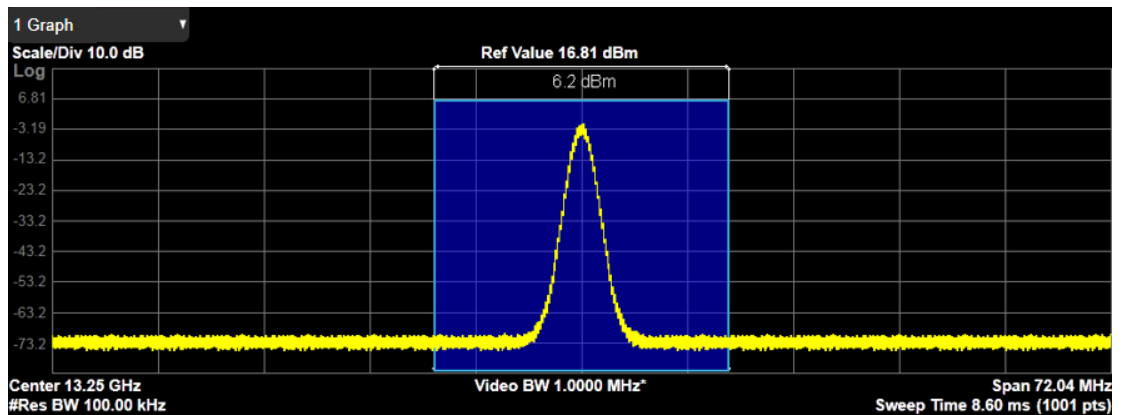

If the current Mode is WLAN and the format is WLAN 802.11ac 80+80 MHz, Spectrum View is slightly different so that the results of both carrier segments can be displayed.

3.5.2.2 Metrics

Window #2

The actual measured output power level is displayed in the Metrics window

The **Metrics** window appears in the following Views.

View	Size	Position
Normal	One third, full width	Bottom
Gate View	One third, full width	Bottom

3 VMA Mode
3.5 Channel Power Measurement

2 Metrics		Component Carrier	
Total Channel Power	-13.69 dBm/100.000 MHz	Carrier Power	
Total Power Spectral Density	-93.69 dBm/Hz	CC0	-13.69 dBm/100.000 MHz
Measure Trace	Trace 1		

Measure Trace

See: "[Measure Trace](#)" on page 1755.

Power Results

Total carrier power, total PSD and total format carrier power are displayed in the lower window. Total format carrier power is total power of carriers of the same Radio Format. If there is no carrier of the corresponding format, it is not displayed. Thus, items in the total format power table changes depending on the carrier configuration. Since the metrics window of MSR, LTE-Advanced FDD/TDD and 5G NR is slightly denser than that for common CHP, the vertical positions of total power and power spectral density are raised.

Carrier Info: LTE-Advanced FDD/TDD and 5G NR Modes

The following diagram shows the Metrics Window in the Carrier Info view for LTE-Advanced FDD/TDD and 5G NR. The Power Results window is replaced by the carrier info table.

2 Carrier Info							
Total Car Pwr	-6.70 dBm/500.000 MHz						
Total PSD	-93.69 dBm/Hz						
RF-BW	99.970 MHz						
	Carrier Power	Carrier PSD	Integ BW	Filter	Offset Freq	Measure	
CC0	-13.69 dBm	-93.69 dBm/Hz	100.000 MHz	OFF	0.0 Hz	On	
CC1	-13.69 dBm	-93.69 dBm/Hz	100.000 MHz	OFF	0.0 Hz	On	
CC2	-13.69 dBm	-93.69 dBm/Hz	100.000 MHz	OFF	0.0 Hz	On	
CC3	-13.69 dBm	-93.69 dBm/Hz	100.000 MHz	OFF	0.0 Hz	On	
CC4	-13.69 dBm	-93.69 dBm/Hz	100.000 MHz	OFF	0.0 Hz	On	

The text window displays the following results:

Total Carrier Power

This is the total power of all the carriers with carrier measure state setting to On. The power is calculated by integrating across the bandwidth declared by the Carrier Integ Bw parameter for each carrier and then totaling the sums. The total integration bandwidth is shown as part of the result. This will be the total of the Carrier Integ Bw of the carriers used in calculating the total carrier power. If the RRC Filter is on, then the integration bandwidth used is $(1 + \alpha)/T$ where $T = 1/(\text{Carrier}$

Integ Bw) multiplied by the number of carriers with carrier measure state setting to yes.

RF-BW

Displays the total bandwidth from the lowest carrier to the highest carrier, whether their measurement states are on or off.

Carrier Power

This is the power in all the currently defined carriers. If the carrier is with measurement state being on, the power will be absolute. If the carrier is defined as not having power present, the power will be shown up as dash. The power is calculated by integrating across the bandwidth declared by the Carrier Integ Bw parameter. The integration bandwidth is shown as part of the result. This is the value of the Carrier Integ Bw for the carrier unless the RRC Filter is on, then the integration.

Integration Bandwidth

Displays the channel bandwidth of each carrier.

Filter

Displays whether RRC filter is used or not.

Offset Frequency

Shows the offset frequency from the carrier reference frequency in multi-carrier measurements. The carrier frequency display type determines whether the relative frequency or absolute frequency will be displayed.

Sub-block (LTE-Advanced FDD/TDD Modes only)

For intra-band non-contiguous spectrum operation, the sub-block concept is introduced, which refers to one contiguous allocated block of spectrum for transmission and reception in the intra-band non-contiguous aggregation mode. We support two sub-blocks. It displays which sub-block the carrier belongs to in the intra-band non-contiguous aggregation mode. The column is displayed when the carrier allocation mode is non-contiguous.

Measure

Shows whether the carrier power presents or not.

The highlighted row changes as either Carrier Result or Select Carrier is changed. The highlighted row and these keys are not coupled.

Carrier Info: MSR Mode

The text window displays the following results:

Total Carrier Power

3 VMA Mode

3.5 Channel Power Measurement

This is the total power of all the carriers with carrier measure state setting to On. The power is calculated by integrating across the bandwidth declared by the Carrier Integ Bw parameter for each carrier and then totaling the sums. The total integration bandwidth is shown as part of the result. This will be the total of the Carrier Integ Bw of the carriers used in calculating the total carrier power. If the RRC Filter is on, then the integration bandwidth used is $(1 + \alpha)/T$ where $T = 1/(\text{Carrier Integ Bw})$ multiplied by the number of carriers with carrier measure state setting to yes.

RF-BW

Displays the total bandwidth from the lowest carrier to the highest carrier, whether their measurement states are on or off.

Carrier Power

This is the power in all the currently defined carriers. If the carrier is with measurement state being on, the power will be absolute. If the carrier is defined as not having power present, the power will be shown up as dash. The power is calculated by integrating across the bandwidth declared by the Carrier Integ Bw parameter. The integration bandwidth is shown as part of the result. This is the value of the Carrier Integ Bw for the carrier unless the RRC Filter is on, then the integration.

Integration Bandwidth

Displays the channel bandwidth of each carrier.

Filter

Displays whether RRC filter is used or not.

Offset Frequency

Shows the offset frequency from the carrier reference frequency in multi-carrier measurements. The carrier frequency display type determines whether the relative frequency or absolute frequency will be displayed.

Sub-block

For intra-band non-contiguous spectrum operation, the sub-block concept is introduced, which refers to one contiguous allocated block of spectrum for transmission and reception in the intra-band non-contiguous aggregation mode. We support two sub-blocks. It displays which sub-block the carrier belongs to in the intra-band non-contiguous aggregation mode. The column is displayed when the carrier allocation mode is non-contiguous.

Measure

Shows whether the carrier power presents or not.

The highlighted row changes according to whether Carrier Result or Select Carrier is changed. The highlighted row and these keys are not coupled.

Parameter Set

Displays which format parameter set is selected.

3.5.2.3 Gate

Window #3

Turning on **Gate** View displays the **Gate** Window, which allows you to see your gating signal at the same time as the measured data. See the description under "[Gate View On/Off](#)" on page 2484 in **Trigger, Gate Settings**.

View	Size	Position
Gate View	One third, full width	Top

3.5.2.4 Marker Table

Window #4

Displays a table containing detailed information about all the markers in the current measurement. It can be selected from the Data control on the Window Title. There is no specific view in which the **Marker Table** window turns on, it is on by demand.

3.5.3 Amplitude

Activates the **Amplitude** menu and selects **Reference Level** or **Reference Value** as the active function, depending on the measurement.

Some features in this menu apply to multiple measurements. Some other features apply only to specific measurements and their controls are blanked or grayed-out in measurements that do not support the feature.

3.5.3.1 Y Scale

Contains controls that pertain to the Y axis parameters of the measurement. These parameters control how data on the vertical (Y) axis is displayed and control instrument settings that affect the vertical axis.

Ref Value

Sets the value for the absolute power reference. The reference line is at the top, center, or bottom of the graticule, depending on the value of "[Ref Position](#)" on page 806.

3 VMA Mode
3.5 Channel Power Measurement

Remote Command	<code>:DISPlay:CHPower:WINDow[1]:TRACe:Y[:SCALe]:RLEVel <real></code> <code>:DISPlay:CHPower:WINDow[1]:TRACe:Y[:SCALe]:RLEVel?</code>
Example	<code>:DISP:CHP:WIND:TRAC:Y:RLEV 10 dBm</code> <code>:DISP:CHP:WIND:TRAC:Y:RLEV?</code>
Couplings	When "Auto Scaling" on page 806 is ON (default), this value is automatically determined by the measurement result. When you set a value manually, Auto Scaling changes to OFF Attenuation is not coupled to Ref Value
Preset	10.00 dBm
State Saved	Saved in instrument state
Min/Max	-/+250.00 dBm
Annotation	Ref <value> top left of graph
Backwards Compatibility SCPI	<code>:DISPlay:CHPower:VIEW[1]:WINDow[1]:TRACe:Y[:SCALe]:RLEVel</code>

Scale/Div

Sets the height of one division of the graticule in the current Y-Axis unit.

Scale/Div also determines the displayed amplitude range in the log plot graph. Since there are usually 10 vertical graticule divisions on the display, the total amplitude range of the graph is typically 10x this amount. For example, if **Scale/Div** is 10 dB, then the total range of the graph is 100 dB.

Remote Command	<code>:DISPlay:CHPower:WINDow[1]:TRACe:Y[:SCALe]:PDIVision <rel_amp></code> <code>:DISPlay:CHPower:WINDow[1]:TRACe:Y[:SCALe]:PDIVision?</code>
Example	<code>:DISP:CHP:WIND:TRAC:Y:PDIV 5</code> <code>:DISP:CHP:WIND:TRAC:Y:PDIV?</code>
Couplings	Coupled to "Scale Range" on page 1612 as follows: Scale/Div = Scale Range/10 (number of divisions) When "Auto Scaling" on page 806 is ON, this value is automatically determined by the measurement result When you change a value, Auto Scaling automatically changes to OFF
Preset	10.00 dB / Div
State Saved	Saved in instrument state
Min	0.10 dB
Max	20 dB
Annotation	<value> dB/ left upper of graph
Backwards Compatibility SCPI	<code>:DISPlay:CHPower:VIEW[1]:WINDow[1]:TRACe:Y[:SCALe]:PDIVision</code>

Scale Range

Sets the Y-Axis scale range.

Remote Command	Replace <meas> with the identifier for the current measurement :DISPlay:<meas>:WINDow[1]:TRACe:Y[:SCALe]:RANGe <rel_amp1> :DISPlay:<meas>:WINDow[1]:TRACe:Y[:SCALe]:RANGe?
Example	:DISP:CHP:WIND:TRAC:Y:RANG 100 :DISP:CHP:WIND:TRAC:Y:RANG?
Couplings	Coupled to Scale/Div as follows Scale Range = Scale/Div * 10 (number of divisions) When you change this value, Auto Scaling automatically changes to OFF
Preset	100 dB
State Saved	Saved in instrument state
Min	1
Max	200

Ref Position

Positions the reference level at the top, center, or bottom of the Y Scale display. Changing the reference position does not change the reference level value.

Remote Command	:DISPlay:CHPower:WINDow[1]:TRACe:Y[:SCALe]:RPOSition TOP CENTer BOTTom :DISPlay:CHPower:WINDow[1]:TRACe:Y[:SCALe]:RPOSition?
Example	:DISP:CHP:WIND:TRAC:Y:RPOS CENT :DISP:CHP:WIND:TRAC:Y:RPOS?
Preset	TOP
State Saved	Saved in instrument state
Range	TOP CENTer BOTTom
Annotation	The greater than (>) and less than (<) symbols are displayed on both sides of the graph to indicate the Reference Position
Backwards Compatibility SCPI	:DISPlay:CHPower:VIEW[1]:WINDow[1]:TRACe:Y[:SCALe]:RPOSition

Auto Scaling

Toggles **Auto Scaling** On or Off.

3 VMA Mode
3.5 Channel Power Measurement

Remote Command	<code>:DISPlay:CHPower:WINDow[1]:TRACe:Y[:SCALe]:COUPle 0 1 OFF ON</code> <code>:DISPlay:CHPower:WINDow[1]:TRACe:Y[:SCALe]:COUPle?</code>
Example	<code>:DISP:CHP:WIND:TRAC:Y:COUP OFF</code> <code>:DISP:CHP:WIND:TRAC:Y:COUP?</code>
Couplings	When Auto Scaling is ON , and the Restart front-panel key is pressed, this function automatically sets the scale per division to 10 dB and determines the reference values based on the measurement results When you change the value of Scale/Div , Ref Value , or Scale Range , Auto Scaling automatically changes to OFF
Preset	1
State Saved	Saved in instrument state
Range	OFF ON
Backwards Compatibility SCPI	<code>:DISPlay:CHPower:VIEW[1]:WINDow[1]:TRACe:Y[:SCALe]:COUPle</code>

3.5.3.2 Attenuation

Controls the attenuator functions and interactions between the attenuation system components.

There are two attenuator configurations in the X-Series. One is a Dual-Attenuator configuration consisting of a mechanical attenuator and an optional electronic attenuator. The other configuration uses a single attenuator with combined mechanical and electronic sections that controls all the attenuation functions. Different models in the X-Series come with different configurations.

- See ["Dual-Attenuator Configurations" on page 808](#)
- See ["Single-Attenuator Configuration" on page 808](#)

Most attenuation settings are the same for all measurements – they do not change as you change measurements. Settings like these are called “Meas Global” and are unaffected by **Meas Preset**.

Only available when the hardware set includes an input attenuator, which is typically only the case for Keysight’s benchtop instruments. For example, this tab does *not* appear in VXT models M9420A/10A/11A/15A/16A, M9410E/11E/15E/16E, nor in UXM. In UXM, all **Attenuation** and **Range** settings are disabled, as the expected input power level is handled by the Call Processing App that drives the DUT power control.

Dependencies	In measurements that support the I/Q inputs, unavailable when I/Q is the selected input. Replaced by the Range tab in that case
--------------	--

Dual-Attenuator Configurations

Configuration 1: Mechanical attenuator + optional electronic attenuator

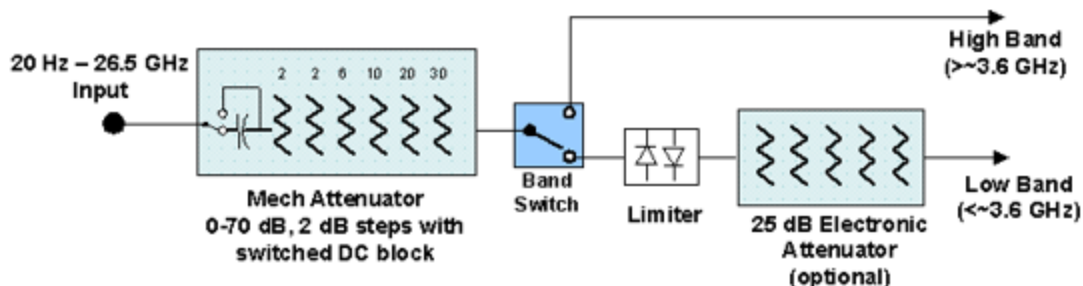

Configuration 2: Mechanical attenuator, no optional electronic attenuator

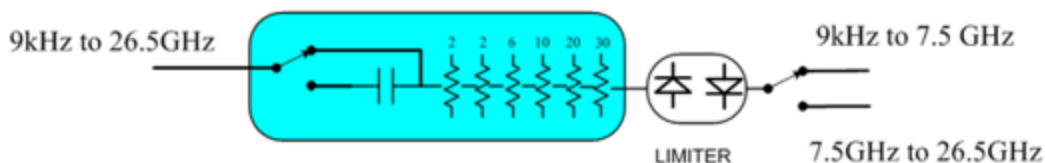

Note that Configuration 2 is not strictly speaking a dual-section attenuator, since there is no electronic section available. However, it behaves exactly like Configuration 1 without the Electronic Attenuator Option EA3, therefore for the sake of this document it is grouped into the “Dual-Attenuator” configuration.

Single-Attenuator Configuration

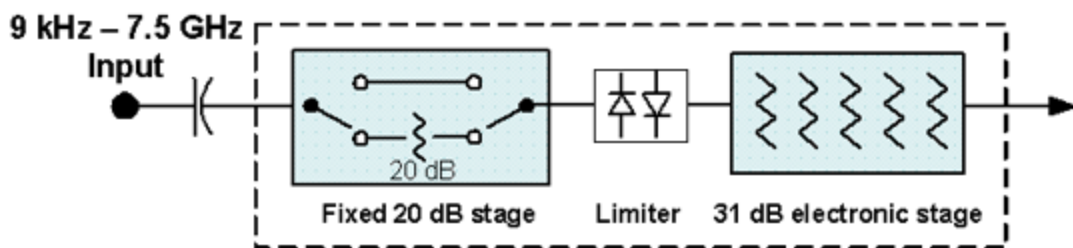

You can tell which attenuator configuration you have by pressing the Attenuation tab, which (in most Modes) opens the Attenuation menu. If the first control in the Attenuation menu says **Mech Atten** you have the Dual-Attenuator configuration. If the first control says **Atten** you have the Single-Attenuator configuration.



(Note that depending on the measurement, there may be no Auto/Man functionality on the Mech Atten control.)

In the Single-Attenuator configuration, you control the attenuation with a single control, as the fixed stage has only two states. In the Dual-Attenuator configuration, both stages have significant range, so you are given separate control of the mechanical and electronic attenuator stages.

When you have the Dual-Attenuator configuration, you may still have only a Single-Attenuator, because unless Option EA3 (the Electronic Attenuator option) is available, and you purchase it, you will have only the mechanical attenuator.

Full Range Atten

This control and **Attenuator Summary** only appear in N9041B, when the RF input is selected, the RF Input Port is set to RF Input 2, and the Full Range Attenuator is installed. The Full Range Attenuator adds a second input attenuator in front of RF Input 2, which enhances the protection and optimizes the performance of the extra internal mixers used by RF Input 2.

Remote Command	<code>[:SENSe]:POWer[:RF]:FRATten <rel_ampl></code> <code>[:SENSe]:POWer[:RF]:FRATten?</code>
Example	<code>:POW:FRAT 14</code> <code>:POW:FRAT?</code>
Notes	When you enter an amplitude value that falls between valid values, the value will be incremented to the next smallest valid value
Dependencies	Only appears if input RF is selected, RF Input Port 2 is selected, and the Full Range Attenuator exists
Couplings	This value is never changed by any coupling, but other couplings use this value. See Reference Level and " Mech Atten " on page 1766 command descriptions
Preset	20 dB
State Saved	Saved in instrument state
Min	0 dB
Max	Only valid values are 0, 6, 14, 20 dB
Annotation	When the Input is RF, and the Input Port is RF Input 2, and the Full Range Attenuator is installed:

On the Meas Bar, the field “Atten” displays as follows:

- If the sweep is entirely < 50 GHz, the value shown after “Atten:” is equal to Mech Atten + Elec Atten + Full Range Atten
- If the sweep is entirely > 50 GHz, the value shown after “Atten:” is equal to Full Range Atten
- If the sweep straddles 50 GHz, the value shown after “Atten:” is preceded by the symbol “>=” and is equal to Full Range Atten

In the **Amplitude**, **"Y Scale"** on page 1760 menu, and the Atten **Meas Bar** dropdown menu panel, a summary is displayed as follows:

“Total Atten below 50 GHz” followed by the value of Full Range Atten + Mech Atten + Elec Atten

“Total Atten above 50 GHz” followed by the value of Full Range Atten

For example, if Mech Atten = 6 dB, Elec Atten = 4 dB, and Full Range Atten = 20 dB, the summary below is shown:

- Attenuator summary:
- Total Atten below 50 GHz: 30 dB
- Total Atten above 50 GHz: 20 dB

Mech Atten

Labeled **Mech Atten** in Dual-Attenuator models, and **Atten** in Single-Attenuator models. In the Dual-Attenuator configuration, this control only affects the mechanical attenuator.

Lets you modify the attenuation applied to the RF input signal path. This value is normally auto-coupled to **Ref Level**, **"Internal Preamp"** on page 1788 Gain, any External Gain that is entered, and **Max Mixer Level** (if available), as described in the table below.

See **"Attenuator Configurations and Auto/Man"** on page 812

Remote Command	<code>[:SENSe]:POWer[:RF]:ATTenuation <rel_amp></code> <code>[:SENSe]:POWer[:RF]:ATTenuation?</code>
Example	<code>:POW:ATT 20</code> Dual-Attenuator configuration: sets the mechanical attenuator to 20 dB Single-Attenuator mode: sets the main attenuation to 20 dB (see below for definition of “main” attenuation) In either case, if the attenuator was in Auto, it is set to Manual
Dependencies	Some measurements do not support Auto setting of Mech Atten . In these measurements, the Auto/Man selection is not available, and the Auto/Man toggle function is not available In Dual-Attenuator configurations, when the electronic attenuator is enabled, the mechanical attenuator has no auto setting, and the Auto/Man toggle function is not available. The state of

3 VMA Mode
 3.5 Channel Power Measurement

Auto/Man is remembered and restored when the electronic attenuator is once again disabled. This is described in more detail in ["Elec Atten" on page 1769](#)

See ["Attenuator Configurations and Auto/Man" on page 812](#) for more information on the **Auto/Man** functionality

Couplings	<p>If the RF Input Port is the RF Input:</p> <ul style="list-style-type: none"> - If the USB Preamp is connected to USB, use 0 dB for Mech Atten - Otherwise compute the auto-selected value of Mech Atten based on Reference Level, Int Preamp, External Gain, Ref Level Offset, Max Mixer Level, μW Path Control and IF Gain settings. Limit this value to be no less than 6 dB (total attenuation below 6 dB can never be chosen by Auto) - In N9041B, if the RF Input Port is RF Input 2, use the formula above and subtract the value of "Full Range Atten" on page 1765 from the result to determine the Mech Atten. Limit the value so that it is never lower than 0 dB and so that total attenuation, including Full Range Atten, is never less than 6 dB (total attenuation, including Full Range Atten below 6 dB, can never be chosen by Auto) <p>In External Mixing and BBIQ, where the attenuator is not in the signal path, the attenuator setting changes as described above when Mech Atten is in Auto, but no changes are made to the actual attenuator hardware setting until the input is changed back to the RF Input</p> <p>For CXA-m with Option FSA (Fine-Step Attenuator or 2 dB steps), the FSA-like behavior is only available when the frequency setting is ≤ 7.5 GHz. So, when the frequency is changed from below 7.5 GHz to above 7.5 GHz, the attenuation setting changes to a multiple of 10 dB that is no smaller than the previous setting. For example, 4 dB attenuation changes to 10 dB</p>						
Preset	<p>Auto</p> <p>The Auto value is 10 dB</p>						
State Saved	Saved in instrument state						
Min	<p>0 dB</p> <p>The attenuation set by this control cannot be decreased below 6 dB with the knob or step keys. Values below 6 dB must be directly entered from the keypad or via SCPI. This protects against setting a dangerously small attenuation value, which can put the instrument at risk of damage to input circuitry. If the current mechanical attenuation is below 6 dB, it can be increased with the knob and step keys, but not decreased</p>						
Max	<table border="1"> <tr> <td>CXA Option 503 or 507</td> <td>50 dB</td> </tr> <tr> <td>EXA</td> <td>60 dB</td> </tr> <tr> <td>All other models</td> <td>70 dB</td> </tr> </table> <p>Note that in the Single-Attenuator configuration, the total of ATT and EATT cannot exceed 50 dB. So, if the EATT is set to 24 dB first, the main attenuation cannot be greater than 26 dB and will be reduced accordingly; if the main attenuator is set to 40 dB first, EATT cannot be greater than 10 dB</p>	CXA Option 503 or 507	50 dB	EXA	60 dB	All other models	70 dB
CXA Option 503 or 507	50 dB						
EXA	60 dB						
All other models	70 dB						
Annotation	<p>The current value for Total Atten is displayed in the Measurement Bar at the top of the display. A value appears for Electronic Attenuation only if the Electronic Attenuator is enabled. The annotation appears as:</p> <p><i>Atten: <total> dB (e<elec>)</i></p> <p>The e letter is in amber in Single-Attenuator configurations</p>						

For example:
 Dual-Attenuator configuration:
Atten: 24 dB (e14)
 Indicating the total attenuation is at 24 dB and the electronic attenuation is at 14 dB
 Single-Attenuator configuration:
A: 24 dB (e14)
 Indicating the total attenuation is at 24 dB and the “soft” attenuation is at 14 dB (see below for definition of “soft” attenuation)
 When in Manual, a # sign appears in front of Atten in the annotation

Auto Function

Remote Command	<code>[:SENSe]:POWer[:RF]:ATTenuation:AUTO OFF ON 0 1</code> <code>[:SENSe]:POWer[:RF]:ATTenuation:AUTO?</code>
Example	Turn Auto Mech Atten ON: <code>:POW:ATT:AUTO ON</code>
Dependencies	<code>:POW:ATT:AUTO</code> is only available in measurements that support Auto , such as Swept SA
Preset	<code>ON</code>

Attenuator Configurations and Auto/Man

As described under "[Attenuation](#)" on page 1763, there are two distinct attenuator configurations available in the X-Series, the Single Attenuator and Dual-Attenuator configurations.

In Dual-Attenuator configurations, we have mechanical attenuation and electronic attenuation, and current total attenuation is the sum of electronic + mechanical attenuation.

In Single-Attenuator configurations, we refer to the attenuation set using "[Mech Atten](#)" on page 810 (or `:POW:ATT`) as the “main” attenuation; and the attenuation that is set by `:POW:EATT` as the “soft” attenuation (`:POW:EATT` is honored even in the Single-Attenuator configuration, for compatibility purposes). Then current total attenuation is the sum of main + soft attenuation.

See "[Elec Atten](#)" on page 1769 for more about “soft” attenuation.

NOTE

In some measurements, the **Mech Atten** control has an **Auto/Man** function. In these measurements, an **Auto/Man** switch is shown on the **Mech Atten** control:

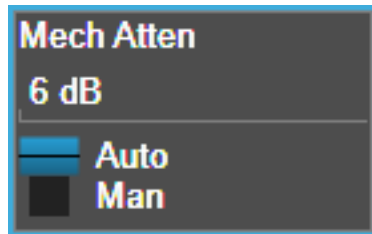

Note that in configurations that include an Electronic Attenuator, this switch is only shown when the Electronic Attenuator is disabled.

In other measurements, **Mech Atten** has no **Auto/Man** function. In these measurements, no switch is shown on the **Mech Atten** control:



Mech Atten also appears with no switch, as above, in configurations that include an Electronic Attenuator but when the Electronic Attenuator is enabled.

Elec Atten

Controls the Electronic Attenuator in Dual-Attenuator configurations. Does not appear in Single-Attenuator configurations, because the control of both the mechanical and electronic stages of the Single-Attenuator is integrated into the single **Atten** control.

This control includes an **Enable/Disable** toggle switch; it is only possible to enter a value for the Electronic Attenuator when this switch is in the **Enable** position.

For more details of the Electronic Attenuator, see ["More Information" on page 815](#)

Remote Command	<code>[:SENSe]:POWer[:RF]:EATTenuation <rel_amp1></code> <code>[:SENSe]:POWer[:RF]:EATTenuation?</code>
Example	<code>:POW:EATT 10</code> <code>:POW:EATT?</code>
Notes	Electronic Attenuation's specification is defined only when Mech Atten is 6 dB
Dependencies	Only appears in Dual-Attenuator models with an Electronic Attenuator installed and licensed. Does not appear in models with the Single-Attenuator configuration, because in the Single-Attenuator configuration there is no "electronic attenuator"; there is only a single integrated attenuator (which has both a mechanical and electronic stage). However, in the Single-Attenuator configuration, EATT SCPI commands are accepted for compatibility with other X-series instruments, and set a "soft" attenuation. The "soft" attenuation is treated as an addition to the "main" attenuation value set by the Attenuation control or <code>:POW:ATT</code> , and affects the total attenuation displayed on the Attenuation

control and the Meas Bar

The electronic attenuator, and the “soft” attenuation function provided in Single-Attenuator configurations, are unavailable above the low band (0-3.6 GHz, 0-3.4 GHz, 0-3 GHz, depending on the model). If the low band range is from 0-3.6 GHz, and Stop Frequency of the instrument is > 3.6 GHz, then the **Enabled/Disabled** section of the **Elec Atten** control will be **OFF** and grayed-out

If "**Internal Preamp**" on page 1788 is **ON** (that is, set to Low Band or Full), the electronic attenuator (and the “soft” attenuation function provided in Single-Attenuator configurations) is unavailable. In this case the **Enabled/Disabled** section of the **Elec Atten** control will be **OFF** and grayed-out

If either of the above is true, and the SCPI command is sent, an error indicating that the electronic attenuator is unavailable is returned

If both the above are true, pressing the control generates error message -221, in other words, the frequency range lockout takes precedence

If the electronic/soft Attenuator is enabled, then the **Stop Freq** of the instrument is limited to 3.6 GHz and **Internal Preamp** is unavailable

If "**LNA**" on page 1790 is **ON**, the electronic attenuator (and the “soft” attenuation function provided in Single-Attenuator configurations) is unavailable. In this case the **Enabled/Disabled** section of the **Elec Atten** control will be **OFF** and grayed-out. This coupling works in the following modes/measurements:

- Channel Power, Occupied BW, ACP, SEM, Spurious Emissions, Power Stat CCDF measurements in all Modes
- Transmit On|Off Power measurement in 5GNR Mode
- Power vs. Time and Transmit Power measurement in GSM/EDGE Mode
- Burst Power measurement in Spectrum Analyzer Mode

The SCPI-only “soft” electronic attenuation for the single-attenuator configuration is not available in all measurements; in particular, it is not available in the Swept SA measurement

Couplings	Enabling and disabling the Electronic Attenuator affects the setting of the Mechanical Attenuator (in Dual-Attenuator configurations). This is described in more detail below and in " Mechanical Attenuator Transition Rules " on page 815
Preset	0 dB
State Saved	Saved in instrument state
Min	0 dB
Max	Dual-Attenuator configuration: 24 dB Single-Attenuator configuration: the total of ATT and EATT cannot exceed 50 dB. So, if the EATT is set to 24 dB first, the main attenuation cannot be greater than 26 dB and will be reduced accordingly; if the main attenuator is set to 40 dB first, EATT cannot be greater than 10 dB
Annotation	See Annotation under the Mech Atten control description

Auto Function

Remote Command	<code>[:SENSe] :POWer [:RF] :EATTenuation :STATe OFF ON 0 1</code> <code>[:SENSe] :POWer [:RF] :EATTenuation :STATe?</code>
Example	<code>:POW:EATT:STAT ON</code>

:POW:EATT:STAT?

Preset **OFF** (Disabled) for Swept SA measurement
 ON (Enabled) for all other measurements that support the electronic attenuator

NOTE

The maximum **Center Frequency** for Low Band can change based on the selected IFBW for measurements that support IFBW (for example, Waveform measurement across all Modes that support it). In certain models (such as N9042B & N9032B), IFBW values ≤ 40 MHz have a maximum Low Band frequency of 3.6 GHz, while $40 \text{ MHz} < \text{IFBW} \leq 1 \text{ GHz}$ have a maximum of 3.3 GHz, and $1 \text{ GHz} < \text{IFBW} \leq 1.5 \text{ GHz}$ have a maximum of 3.5 GHz. This frequency is reflected in the disabled message displayed for Electrical Attenuator. For N9032B and N9042B IFBW values $> 1.5 \text{ GHz}$ do not support a **Center Frequency** that can reach the Low Band maximum frequency. In these cases, the Electrical Attenuator will remain disabled no matter the Center Frequency.

More Information

The electronic attenuator offers finer steps than the mechanical attenuator, has no acoustical noise, is faster, and is less subject to wear. These advantages primarily aid in remote operation and are negligible for front panel use. See ["Using the Electronic Attenuator: Pros and Cons" on page 816](#) for a detailed discussion of the pros and cons of using the electronic attenuator.

For the Single-Attenuator configuration, for SCPI backwards compatibility, the "soft" attenuation feature replaces the Dual-Attenuator configuration's electronic attenuator. All the same couplings and limitations apply. See ["Attenuator Configurations and Auto/Man" on page 1768](#)

Mechanical Attenuator Transition Rules

When the Electronic Attenuator is enabled, the Mechanical Attenuator transitions to a state that has no Auto function. Below are the rules for transitioning the Mechanical Attenuator. Note that the information below *only* applies to the Dual-Attenuator configurations, and *only* when the Electronic Attenuator is installed:

When the Electronic Attenuation is enabled from a disabled state:

- The Mechanical Attenuator is initialized to 10 dB (this is its optimal performance setting). You can then set it as desired with SCPI, numeric keypad, step keys, or knob, and it behaves as it normally would in manual mode
- The Auto/Man state of (Mech) Atten is saved
- The Auto/Man toggle on the (Mech) Atten control disappears, and the auto rules are disabled

- The Electronic Attenuator is set to 10 dB less than the previous value of the Mechanical Attenuator, within the limitation that it must stay within the range of 0 to 24 dB of attenuation

Examples in the Dual-Attenuator configuration:

- Mech Atten at 20 dB. Elec Atten enabled, Mech Atten set to 10 dB, and Elec Atten set to 10 dB. New total attenuation equals the value before Elec Atten enabled
- Mech Atten at 0 dB. Elec Atten enabled, Mech Atten set to 10 dB, and Elec Atten set to 0 dB. New total attenuation does not equal the value before Elec Atten enabled
- Mech Atten at 40 dB. Elec Atten enabled, Mech Atten set to 10 dB, and Elec Atten set to 24 dB. New total attenuation does not equal the value before Elec Atten enabled

When the Electronic Attenuation is disabled from an enabled state:

- The Elec Atten control is grayed out
- The Auto/Man state of (Mech) Atten is restored
- If now in Auto, (Mech) Atten recouples
- If now in Man, (Mech) Atten is set to the value of total attenuation that existed before the Elec Atten was disabled. The resulting value is rounded up to the smallest value possible given the (Mech) Atten Step setting - (That is, 57 dB changes to 58 dB when (Mech) Atten Step is 2 dB)

Using the Electronic Attenuator: Pros and Cons

The electronic attenuator offers finer steps than the mechanical attenuator, has no acoustical noise, is faster, and is less subject to wear.

The “finer steps” advantage of the electronic attenuator is beneficial in optimizing the alignment of the instrument dynamic range to the signal power in the front panel as well as remote use. Thus, you can achieve improved relative signal measurement accuracy. Compared to a mechanical attenuator with 2 dB steps, the 1 dB resolution of the electronic attenuator only gives better resolution when the odd-decibel steps are used. Those odd-decibel steps are less accurately calibrated than the even-decibel steps, so one tradeoff for this superior relative accuracy is reduced absolute amplitude accuracy.

Another disadvantage of the electronic attenuator is that the spectrum analyzer loses its “Auto” setting, making operation less convenient.

Also, the relationship between the dynamic range specifications (TOI, SHI, compression, and noise) and instrument performance are less well-known with the

electrical attenuator. With the mechanical attenuator, TOI, SHI, and compression threshold levels increase dB-for-dB with increasing attenuation, and the noise floor does as well. With the electronic attenuator, there is an excess attenuation of about 1 to 3 dB between 0 and 3.6 GHz, making the effective TOI, SHI, and so forth, less well known. Excess attenuation is the actual attenuation relative to stated attenuation. Excess attenuation is accounted for in the instrument calibration.

Adjust Atten for Min Clipping

Sets the combination of mechanical and electronic attenuation and gain based on the current measured signal level so that clipping will be at a minimum.

This is an immediate action function, that is, it executes once, when the control is pressed.

The algorithms that are used for the adjustment are documented under ["Pre-Adjust for Min Clipping" on page 1773](#).

Remote Command	<code>[:SENSe]:POWer[:RF]:RANGe:OPTimize IMMEDIATE</code>
Example	<code>:POW:RANG:OPT IMM</code>
Notes	Executing Adjust Atten for Min Clipping initiates the measurement
Dependencies	Does not appear in the Swept SA, RTSA, Monitor Spectrum and Complex Spectrum measurements Appears in the Waveform measurement in BASIC and 5G NR Modes

Adjust Atten

Allows you to select;

- Electric attenuator only
- Combination of Electric attenuator and Mechanical attenuator

when `[:SENSe]:POWer[:RF]:RANGe:OPTimize IMMEDIATE` is executed.

Remote Command	<code>[:SENSe]:POWer[:RF]:RANGe:OPTimize:TYPE EONLY COMBined</code> <code>[:SENSe]:POWer[:RF]:RANGe:OPTimize:TYPE?</code>
Example	<code>:POW:RANG:OPT:TYPE EONL</code> <code>:POW:RANG:OPT:TYPE?</code>
Dependencies	Does not appear in the Swept SA, RTSA, Monitor Spectrum and Complex Spectrum measurements Appears in the Waveform measurement in BASIC and 5G NR Modes
Preset	<code>COMBined</code>
State Saved	Saved in instrument state

Pre-Adjust for Min Clipping

If this function is **ON**, it applies the adjustment described under "[Adjust Atten for Min Clipping](#)" on page 1772 each time a measurement restarts. Therefore, in Continuous measurement mode, it only executes before the first measurement.

In Dual-Attenuator models, you can set **Elec+Mech Atten**, in which case both attenuators participate in the autoranging, or **Elec Atten Only**, in which case the mechanical attenuator does not participate in the autoranging. This latter case results in less wear on the mechanical attenuator and is usually faster.

See "[Adjustment Algorithm](#)" on page 819

Selection	SCPI	Note
Off	OFF	This is the default setting
On	ON	Available in Single-Attenuator instruments. For compatibility with models that do not have an input attenuator, the ON parameter is supported and mapped to COMBined
Elec Atten Only	ELECTrical	Selects only the electric attenuator to participate in auto ranging. This offers less wear on the mechanical attenuator and is usually faster
Elec+Mech Atten	COMBined	In Dual-Attenuator models, this selects both attenuators to participate in the autoranging

Remote Command	<code>[:SENSe]:POWer[:RF]:RANGe:OPTimize:ATTenuation OFF ON ELECTrical COMBined</code> <code>[:SENSe]:POWer[:RF]:RANGe:OPTimize:ATTenuation?</code>
Example	<code>:POW:RANG:OPT:ATT OFF</code> <code>:POW:RANG:OPT:ATT?</code>
Notes	The parameter option ELECTrical sets this function to ON in Single-Attenuator models The parameter option COMBined is mapped to ELECTrical in Single-Attenuator models. If you send COMBined , it sets the function to ON and returns ELEC to a query For SCPI compatibility with models that do not have an input attenuator, the ON parameter is honored and mapped to COMBined
Dependencies	Only appears in Dual-Attenuator models with an Electronic Attenuator installed In instruments with Dual-Attenuator model, when " Elec Atten " on page 1769 is OFF or grayed-out, " Pre-Adjust for Min Clipping " on page 818 is grayed-out Does not appear in the Swept SA, RTSA, Monitor Spectrum and Complex Spectrum measurements Appears in the Waveform measurement in BASIC and 5G NR Modes
Preset	OFF when Elec Atten is Disabled at preset, otherwise ELEC
State Saved	Saved in instrument state

3 VMA Mode
 3.5 Channel Power Measurement

Range	Dual-Attenuator models:	Off Elec Atten Only Mech + Elec Atten
	Single-Attenuator models:	Off On

Backwards Compatibility Command

Notes	<p>ON aliases to "Elec Atten Only" (:POW:RANG:OPT:ATT ELEC)</p> <p>OFF aliases to "Off" (:POW:RANG:OPT:ATT OFF)</p> <p>:POW:RANG:AUTO? returns true if :POW:RANG:OPT:ATT is not OFF</p>
Backwards Compatibility SCPI	<p>[:SENSe]:POWer[:RF]:RANGe:AUTO ON OFF 1 0</p> <p>[:SENSe]:POWer[:RF]:RANGe:AUTO?</p>

Adjustment Algorithm

The algorithms for the adjustment are documented below:

Single-Attenuator Models

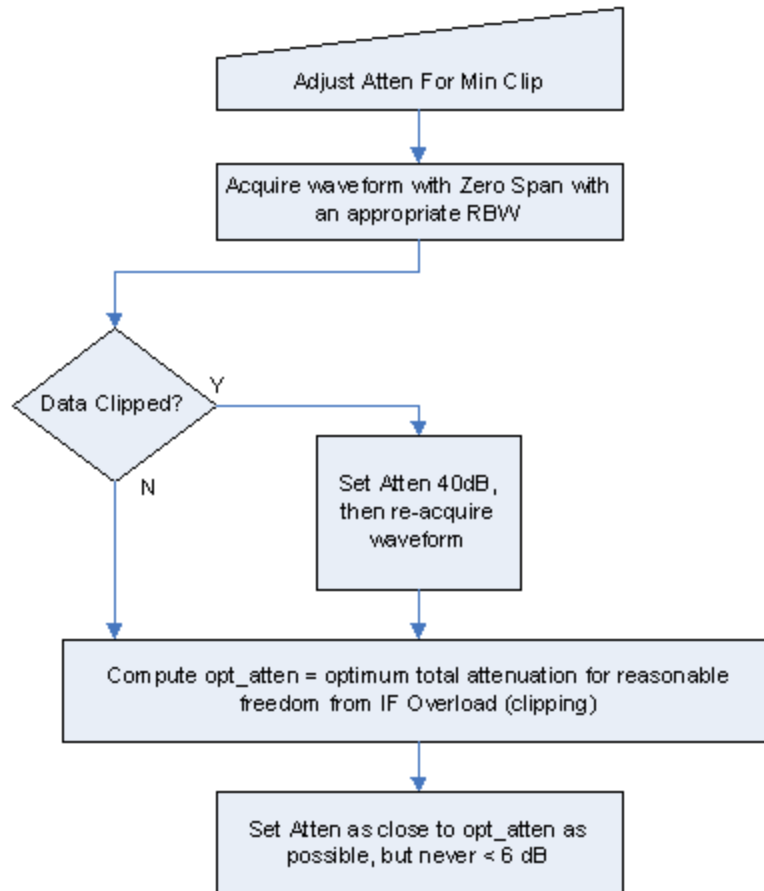

Dual-Attenuator models

"Adjust Atten for Min Clipping" on page 1772 or "Pre-Adjust for Min Clipping" on page 818 selection is Mech + Elec Atten:

3 VMA Mode
 3.5 Channel Power Measurement

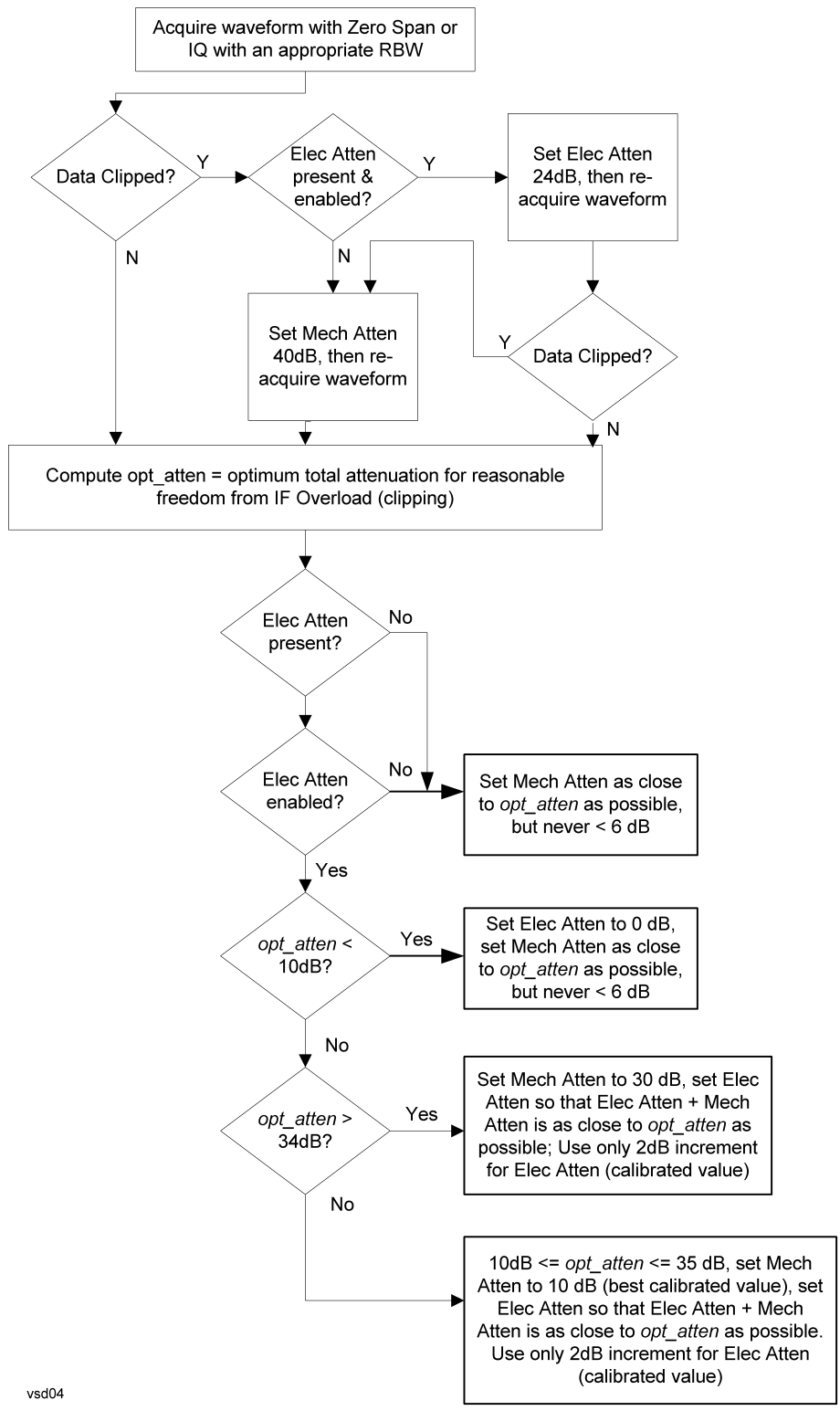

vsd04

"Pre-Adjust for Min Clipping" on page 818 selection is Elec Only.

Note that the **Mech Atten** value is not adjusted, and the value previously set is used. Therefore, there is a case that IF Overload is still observed depending on the input signal level and the Mech Atten setting.

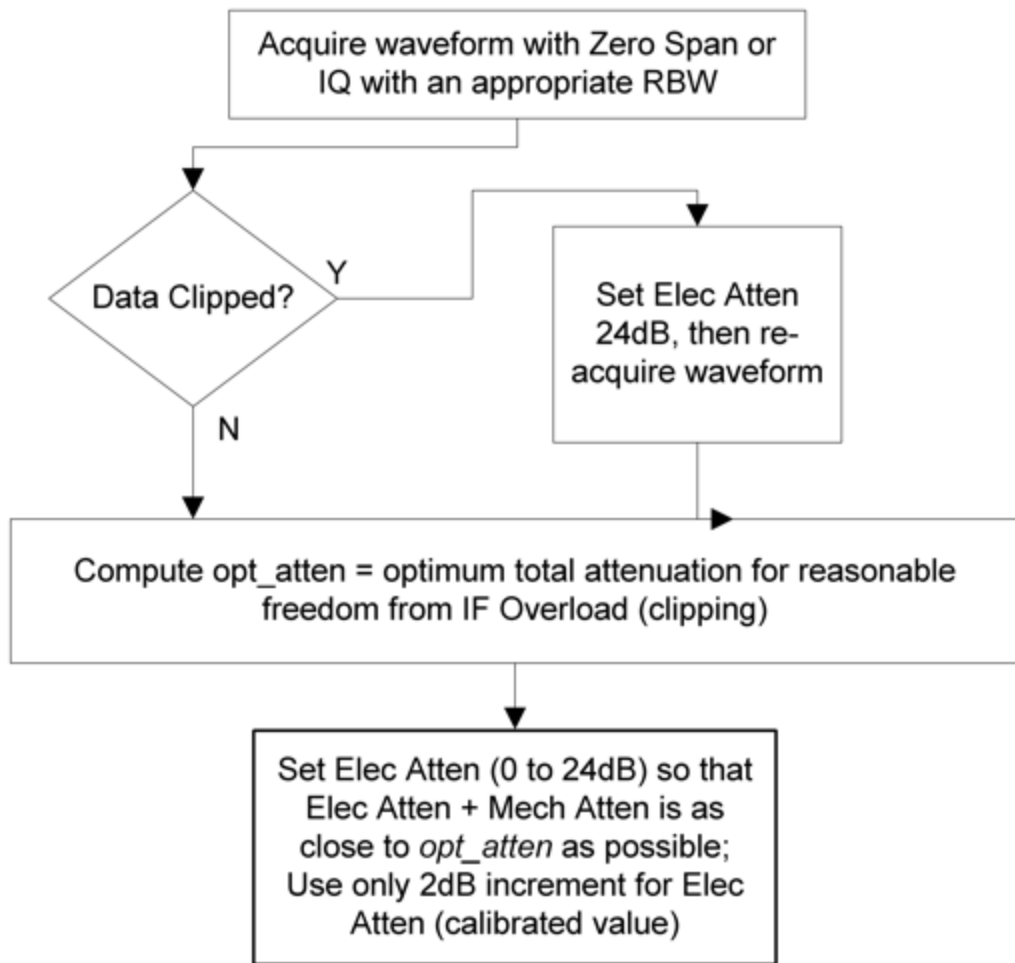

Mech Atten Step

Controls the step size used when making adjustments to the input attenuation.

Labeled **Mech Atten Step** in Dual-Attenuator models and **Atten Step** in Single-Attenuator models. In the Dual-Attenuator configuration, only affects the step size of the mechanical attenuator.

Remote Command `[:SENSe]:POWer[:RF]:ATTenuation:STEP[:INCRement] 10 dB | 2 dB`

3 VMA Mode
3.5 Channel Power Measurement

	<code>[:SENSe]:POWer[:RF]:ATTenuation:STEP[:INCRement]?</code>
Example	<code>:POW:ATT:STEP 2</code> <code>:POW:ATT:STEP?</code>
Notes	Has a toggle control on the front panel, but takes a specific value (in dB) when used remotely. The only valid values are 2 and 10
Dependencies	Blanked in EXA, CXA and CXA-m if option FSA (2 dB steps) is not present. If blanked, attempts to set it via SCPI yield an error
Couplings	When the attenuation step size changes, the current mechanical attenuation value is adjusted (if necessary) to be quantized to the new step size. That is, if step is set to 10 dB, mech atten is increased if necessary so it is a multiple of 10 dB
Preset	EXA, CXA and CXA-m: 10 dB (2 dB with option FSA) All other models: 2 dB
State Saved	Saved in instrument state

3.5.3.3 Range (Non-attenuator models)

Only available for Keysight's modular signal analyzers and certain other Keysight products, such as VXT and M941xE.

State Saved	No
-------------	----

Range

Represents the amplitude of the largest sinusoidal signal that could be present within the IF without being clipped by the ADC. For signals with high peak-to-average ratios, the range may need to exceed the rms signal power by a significant amount to avoid clipping.

This is a measurement global setting.

Remote Command	<code>[:SENSe]:POWer[:RF]:RANGe <real></code> <code>[:SENSe]:POWer[:RF]:RANGe?</code>
Example	<code>:POW:RANG 10 dBm</code> <code>:POW:RANG?</code>
Notes	The MIN and MAX values are affected by the External Gain parameters, and by the Center Frequency The hardware compensates for frequency response and alters the Range setting
Preset	0 dBm
State Saved	Yes
Min/Max	-/+100
Annotation	Meas Bar

Adjust Range for Min Clipping

Sets the combination of attenuation and gain based on the current measured signal level so that clipping will be at a minimum.

This is an "immediate action" function, that is, it executes once, when the key is pressed.

This key does not appear in measurements that do not support this functionality.

Remote Command	<code>[:SENSe]:POWer[:RF]:RANGe:OPTimize IMMEDIATE</code>
Notes	Executing Adjust Range for Min Clipping initiates the measurement
Dependencies	Does not appear in the Swept SA and Monitor Spectrum measurements

Pre-Adjust for Min Clipping

If this function is **ON**, it applies the adjustment described under Adjust Range For Min Clipping each time a measurement restarts. Therefore, in Continuous measurement mode, it only executes before the first measurement.

Remote Command	<code>[:SENSe]:POWer[:RF]:RANGe:OPTimize:ATTenuation OFF ON ELECTrical COMBined</code> <code>[:SENSe]:POWer[:RF]:RANGe:OPTimize:ATTenuation?</code>
Notes	Because there is no attenuator control available in these models, the control displays only ON and OFF choices. However, for SCPI compatibility with other platforms, all three parameters (ELECTrical , COMBined , and ON) are honored and all are mapped to ELECTrical , so if any of these three parameters is sent, a subsequent query will return ELEC
Dependencies	Does not appear in the Swept SA and Monitor Spectrum measurements
Preset	OFF for Swept SA measurement; ON for all other measurements that support Pre-Adjust for Min Clipping
State Saved	Saved in instrument state

Adjustment Algorithm

The algorithm for the adjustment is documented below:

3 VMA Mode
3.5 Channel Power Measurement

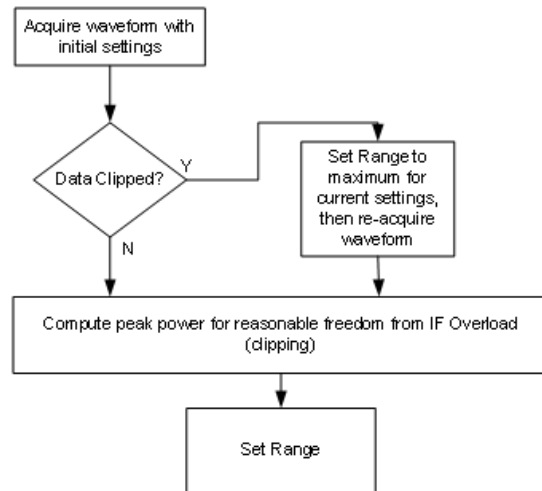

Peak-to-Average Ratio

Used with "[Range \(Non-attenuator models\)](#)" on page 1782 to optimize the level control in the instrument. The value is the ratio, in dB, of the peak power to the average power of the signal to be measured. A ratio of 0 should be used for sinusoidal signals; for 802.11g OFDM signals use 9 dB.

All Modes show the current value of Peak-to-Average ratio on the control. However, some Modes do not permit changing the value. In these situations, the control is grayed-out.

Remote Command	[:SENSe]:POWer[:RF]:RANGe:PARatio <real> [:SENSe]:POWer[:RF]:RANGe:PARatio?	
Example	:POW:RANG:PAR 12 dB	
Notes	In some Modes, this parameter is read-only; meaning the value will appear on the control and query via SCPI, but is not changeable. In such applications the control is grayed-out. Attempts to change the value via SCPI are ignored, but no error message is generated	
Dependencies	Does not appear in Spectrum Analyzer Mode	
Preset	VXT Models M9410A/11A	0 dB
	All Others	10 dB
State Saved	Saved in instrument state	
Min	0 dB	
Max	VXT Models M9410A/11A	50 dB
	All Others	20 dB

Mixer Lvl Offset

This is an advanced setting to adjust target Range at the input mixer, which in turn affects the signal level in the instrument's IF. This setting can be used when additional optimization is needed after setting "[Peak-to-Average Ratio](#)" on page 1784. Positive values of offset optimize noise performance over distortion, negative values optimize distortion performance over noise.

Remote Command	<code>[:SENSe]:POWer[:RF]:RANGe:MIXer:OFFSet <real></code> <code>[:SENSe]:POWer[:RF]:RANGe:MIXer:OFFSet?</code>	
Example	<code>:POW:RANG:MIX:OFFS -5 dB</code>	
Preset	0 dB	
State Saved	Saved in instrument state	
Min	VXT Models M9410A/11A	-34 dB
	All Others	-35 dB
Max	30 dB	

3.5.3.4 Signal Path

Contains controls that pertain to the routing of the signal through the frontend of the instrument.

In general, only appears in instruments whose hardware supports this signal routing. For example, this tab does not appear in many of the modular instrument products, including VXT Model M9420A, or UXM.

This tab *does* appear in VXT Models M9410A/11A/15A/16A and M9410E/11E/15E/16E, because "[Software Preselection](#)" on page 1801 is under this tab, and VXT Models M9410A/11A/15A/16A and M9410E/11E/15E/16E implement a version of Software Preselection.

Presel Center

Adjusts the centering of the preselector filter to optimize the amplitude accuracy at the frequency of the selected marker. If the selected marker is not on when **Presel Center** is pressed, the instrument turns on the selected marker, performs a peak search, and then performs centering on the marker's center frequency. If the selected marker is already on and between the start and stop frequencies of the instrument, the instrument performs the preselector calibration on that marker's frequency. If the selected marker is already on, but outside the frequency range

3 VMA Mode
3.5 Channel Power Measurement

between **Start Freq** and **Stop Freq**, the instrument first performs a peak search, and then performs centering on the marker's center frequency.

The value displayed on "**Preselector Adjust**" on page 1787 changes to reflect the new preselector tuning.

Certain considerations should be observed to ensure proper operation, as detailed in "**Proper Preselector Operation**" on page 827.

Remote Command	<code>[:SENSe] :POWer [:RF] :PCENter</code>
Example	<code>:POW:PCEN</code>
Notes	The rules outlined above under the control description apply for the remote command as well as the key. The result of the command depends on marker position, etc. Any message generated by the control press is also generated in response to the remote command
Dependencies	Does not appear in CXA-m, nor in VXT Models M9410A/11A/15A/16A, M9410E/11E/15E/16E Grayed-out if the microwave preselector is off <ul style="list-style-type: none"> - If the selected marker's frequency is below Band 1, an advisory message is generated "Preselector not used in this frequency range" and no action is taken - Grayed-out if entirely in Band 0, that is, if Stop Freq is below about 3.6 GHz Grayed-out if entirely above 50 GHz, that is, if Start Freq is above 50 GHz - Blanked in models that do not include a preselector, such as Option 503. If the remote command is sent in these instruments, accepted without error, and the query always returns 0 - Grayed-out in the Spectrogram View
Couplings	The active marker position determines where the centering will be attempted If the instrument is in a measurement such as averaging when centering is initiated, the act of centering the preselector restarts averaging, but the first average trace will not be taken until the centering is completed The offset applied to do the centering appears in " Preselector Adjust " on page 1787
Status Bits/OPC dependencies	When centering the preselector, *OPC does not return true until the process is complete and a subsequent measurement has completed, nor are results returned in response to <code>:READ</code> or <code>:MEASure</code> queries The Measuring bit remains set (true) while this command is operating, and does not go false until the subsequent sweep/measurement has completed

Proper Preselector Operation

Certain considerations should be observed to ensure proper operation:

1. If the selected marker is **Off**, the instrument turns on a marker, performs a peak search, and adjusts the preselector using the selected marker's frequency. It uses the "highest peak" peak search method unqualified by threshold or excursion, so that there is no chance of a 'no peak found' error. It continues with that peak, even if it is the peak of just noise. Therefore, for this operation to work properly, there should be a signal on-screen in a preselected range for the peak

search to find

2. If the selected marker is already **On**, the instrument attempts the centering at that marker's frequency. There is no preselector for signals below about 3.6 GHz, so if the marker is on a signal below 3.6 GHz, no centering is attempted, and an advisory message is generated
3. In some models, the preselector can be bypassed. If it is bypassed, no centering is attempted in that range and a message is generated

Preselector Adjust

Lets you manually adjust the preselector filter frequency to optimize its response to the signal of interest. Only available when "**Presel Center**" on page 1786 is available.

For general purpose signal analysis, using **Presel Center** is recommended. Centering the filter minimizes the impact of long-term preselector drift. **Preselector Adjust** can be used instead to manually optimize the preselector. One application of manual optimization would be to peak the preselector response, which both optimizes the signal-to-noise ratio and minimizes amplitude variations due to small (short-term) preselector drifting.

When **Presel Center** is performed, the offset applied to do the centering becomes the new value of **Preselector Adjust**.

Remote Command	<code>[:SENSe]:POWer[:RF]:PADJust <freq></code> <code>[:SENSe]:POWer[:RF]:PADJust?</code>
Example	<code>:POW:PADJ 100KHz</code> <code>:POW:PADJ?</code>
Notes	The value on the control is displayed to 0.1 MHz resolution
Dependencies	<ul style="list-style-type: none"> - Does not appear in CXA-m - Does not appear in VXT Models M9410A/11A/15A/16A - Does not appear in M9410E/11E/15E/16E - Grayed-out if microwave preselector is off - Grayed-out if entirely in Band 0, that is, if Stop Freq is lower than about 3.6 GHz - Grayed-out if entirely above 50 GHz, that is, if Start Freq is higher than 50 GHz - Blank in models that do not include a preselector, such as Option 503. If the command is sent in these instruments, it is accepted without error, and the query always returns 0 - Grayed-out in the Spectrogram View
Preset	0 MHz

State Saved	The Preselector Adjust value set by " Presel Center " on page 1786, or by manually adjusting Preselector Adjust Not saved in instrument state, and does not survive a Preset or power cycle
Min/Max	-/+500 MHz
Backwards Compatibility SCPI	<code>[:SENSe] :POWer [:RF] :MW :PADJust</code> <code>[:SENSe] :POWer [:RF] :MMW :PADJust</code> Backwards Compatibility Command
Notes	The command has no effect, and the query always returns MWAVE
Backwards Compatibility SCPI	<code>[:SENSe] :POWer [:RF] :PADJust :PRESelector MWAVE MMWave EXTERNAL</code> <code>[:SENSe] :POWer [:RF] :PADJust :PRESelector?</code>

Internal Preamp

Accesses a menu of controls for the internal preamps. Turning on the preamp gives a better noise figure, but a poorer inter-modulation distortion (TOI) to noise floor dynamic range. You can optimize this setting for your measurement.

The instrument takes the preamp gain into account as it sweeps. If you sweep outside of the range of the preamp, the instrument will also account for that. The displayed result always reflects the correct gain.

For some measurements, when the preamp is on and any part of the displayed frequency range is below the lowest frequency for which the preamp has specifications, a warning condition message appears in the status line. For example, for a preamp with a 9 kHz lowest specified frequency: "Preamp: Accy unspec'd below 9 kHz".

Selection	Example	Note
Off	<code>:POW:GAIN OFF</code>	
Low Band	<code>:POW:GAIN ON</code> <code>:POW:GAIN:BAND LOW</code>	Sets the internal preamp to use only the low band. The frequency range of the installed (optional) low-band preamp is displayed in square brackets on the Low Band selection in the dropdown
Full Range	<code>:POW:GAIN ON</code> <code>:POW:GAIN:BAND FULL</code>	Sets the internal preamp to use its full range. The low band (0-3.6 GHz, 0-3.4 GHz, 0-3 GHz, depending on the model) is supplied by the low band preamp and the frequencies above low band are supplied by the high band preamp The frequency range of the installed (optional) low-band preamp is displayed in square brackets on the Full Range selection in the dropdown. If the high band option is not installed the Full Range selection does not appear

NOTE

The maximum **Center Frequency for Low Band**, displayed in square brackets, can change based on the selected IFBW for measurements that support IFBW (for example, Waveform measurement across all Modes that support it). In certain models (such as N9042B & N9032B), IFBW values ≤ 40 MHz have a maximum **Low Band** frequency of 3.6 GHz, while $40 \text{ MHz} < \text{IFBW} \leq 1 \text{ GHz}$ have a maximum of 3.3 GHz, and $1 \text{ GHz} < \text{IFBW} \leq 1.5 \text{ GHz}$ have a maximum of 3.5 GHz. IFBW values $> 1.5 \text{ GHz}$ do not support a **Center Frequency** that can reach the **Low Band** maximum frequency. In these cases, **N/A** is displayed in the square brackets for **Low Band**.

Remote Command	<code>[:SENSe]:POWer[:RF]:GAIN:BAND LOW FULL</code> <code>[:SENSe]:POWer[:RF]:GAIN:BAND?</code>
Example	<code>:POW:GAIN:BAND LOW</code> <code>:POW:GAIN:BAND?</code>
Dependencies	Not available on all hardware platforms. If the preamp is not present or is unlicensed, this control is not shown Does not appear in VXT Models M9410A/11A/15A/16A nor in M9410E/11E/15E/16E If <code>:POW:GAIN:BAND FULL</code> is sent when a low band preamp is available, the preamp band parameter is set to <code>LOW</code> instead of <code>FULL</code> , and an "Option not installed" message is generated Not available when the electronic/soft attenuator is enabled
Preset	<code>LOW</code>
State Saved	Saved in instrument state
Annotation	When the USB Preamp is not connected to USB, the Preamp annotation in the Meas Bar says "Off" if the preamp is off and displays the frequency range of the low band or full range preamp depending on the setting. For example, if the Preamp is set to Low Band and the Low Band is 3.6 GHz the annotation says "3.6 GHz". If it is a 13.6 GHz preamp and it is set to Full Range the annotation says "13.6 GHz" When the USB Preamp is connected to USB, the Preamp annotation says "Preamp: USB" if the internal preamp is off or "Preamp: USB, Int" if the internal preamp is on (only for measurements that support the USB preamp)

Auto Function

Remote Command	<code>[:SENSe]:POWer[:RF]:GAIN[:STATe] OFF ON 0 1</code> <code>[:SENSe]:POWer[:RF]:GAIN[:STATe]?</code>
Example	<code>:POW:GAIN OFF</code> <code>:POW:GAIN?</code>
Preset	<code>OFF</code>

LNA

Lets you turn the Low Noise Amplifier (LNA) on or off.

3 VMA Mode
3.5 Channel Power Measurement

LNA is an additional preamplifier that provides superior DANL and frequency range compared to "Internal Preamp" on page 1788. LNA provides lower system noise figure, especially at frequencies above 100 MHz, and can be operated up to the full range of 50 GHz instruments.

For best possible sensitivity, LNA can be turned on *together* with "Internal Preamp" on page 1788, although if you operate both preamps together, note that the TOI (distortion) specifications are impacted. The sensitivity improvement of this combination is substantial when operating in high band (frequencies above 3.6 GHz).

For more details about annotation, see "More Information" on page 831

Remote Command	<code>[:SENSe]:POWer[:RF]:GAIN:LNA[:STATe] OFF ON 0 1</code> <code>[:SENSe]:POWer[:RF]:GAIN:LNA[:STATe]?</code>
Example	<code>:POW:GAIN:LNA ON</code>
Dependencies	Requires Option LNA, except for VXT models M9415A/16A Does not appear in VXT models M9420A/10A/11A M9410E/11E/15E/16E support LNA May not appear in some measurements LNA is not available when the electronic/soft attenuator is enabled
Preset	OFF
State Saved	Saved in State

More Information

When LNA is installed, the preamp annotation changes to show the state of both LNA and Internal Preamp. Below is an example:

```
Atten: 8 dB
Pre: Int on, LNA on
µW Path: LNP, On
Source: Off
```

Note that when operating entirely in the low band (below about 3.6 GHz), if LNA is on, **Internal Preamp** is switched off (even if you have its switch set to ON). This is because the noise performance is actually degraded in low band if both preamps are on. In this case, the annotation reflects the actual state of the two preamps, but the **Internal Preamp** annotation displays in amber, to warn you that the actual state of **Internal Preamp** does not match its switch control display:

```
Atten: 8 dB
Pre: Int off, LNA on
µW Path: LNP, On
Source: Off
```

μW Path Control

Options for this control include **μW Preselector Bypass** (Option MPB), **Low Noise Path** (Option LNP) and **Full Bypass Enable** in the High Band path circuits.

When the μW Preselector is bypassed, flatness is improved, but will be subject to spurs from out of band interfering signals. When **Low Noise Path Enable** is selected, the instrument automatically bypasses certain circuitry in the high frequency bands that can contribute to noise, when it is appropriate based on other instrument settings.

For most applications, the preset state is **Standard Path**, which provides the best remote-control throughput, minimizes acoustic noise from switching and minimizes the risk of wear in the hardware switches, particularly in remote test scenarios where both low band and high band setups will follow in rapid succession. In this path, the bypass of the low band/high band switch and microwave preamp is never activated, which can cause some noise degradation but preserves the life of the bypass switch.

For applications that utilize the wideband IF paths, the preset state is **μW Preselector Bypass**, if option MPB is present. This is because, when using a wideband IF such as the 140 MHz IF, the μW Preselector's bandwidth can be narrower than the available IF bandwidth, causing degraded amplitude flatness and phase linearity, so it is desirable to bypass the preselector in the default case.

You may choose **Low Noise Path Enable** for a lower noise floor, especially in the 21–26.5 GHz region, though without improving many measures of dynamic range, and without giving the best possible noise floor. The preamp, if purchased and used, gives better noise floor than does **Low Noise Path Enable**, but the preamp's compression threshold and third-order intercept are much poorer than that of **Low Noise Path Enable**.

A fourth choice is **Full Bypass Enable**, which combines **μW Preselector Bypass** and **Low Noise Path Enable**. Because this can bypass most of the circuitry between the input and the first mixer, care should be taken when using this setting to avoid damaging the mixer. **Full Bypass Enable** is only available if both options LNP and MPB are present, as well as option FBP.

Path	Example	Note
Standard Path	:POW:MW:PATH STD	Normal setting for most measurements. μW Preselector in circuit, Low Noise Path disabled
Low Noise Path Enable	:POW:MW:PATH LNP	See " Low Noise Path Enable " on page 836
μW Preselector Bypass	:POW:MW:PATH MPB	See " μW Preselector Bypass " on page 838
Full Bypass Enable	:POW:MW:PATH FULL	See " Full Bypass Enable " on page 839

3 VMA Mode
3.5 Channel Power Measurement

Remote Command	<code>[:SENSe]:POWer[:RF]:MW:PATH STD LNPath MPBypass FULL</code> <code>[:SENSe]:POWer[:RF]:MW:PATH?</code>														
Example	<code>:POW:MW:PATH LNP</code> Enables the Low Noise path <code>:POW:MW:PATH?</code>														
Notes	<p>When "Presel Center" on page 1786 is performed, the instrument momentarily switches to the Standard Path, regardless of the setting of μW Path Control</p> <p>The DC Block will always be switched in when the low noise path is switched in, to protect succeeding circuitry from DC. Note that this does not mean "when the low noise path is enabled" but when, based on the Low Noise Path rules, the path is actually switched in. This can happen when the selection is Low Noise Path Enable or Full Bypass Enable. In the case where the DC Block is switched in, the instrument is now AC-coupled. However, if you selected DC coupling, the UI would still behave as though it were DC-coupled, including all annunciation, warnings, status bits, and responses to SCPI queries. This is because, based on other settings, the instrument could switch out the low noise path at any time and hence go back to being DC-coupled</p> <p>Alignment switching ignores the settings in this menu, and restores them when finished</p>														
Dependencies	<p>Does not appear in CXA-m, VXT Models M9410A/11A/15A/16A, nor in M9410E/11E/15E/16E, BBIQ and External Mixing</p> <ul style="list-style-type: none"> - The Low Noise Path Enable selection does not appear unless Option LNP is present and licensed - The μW Preselector Bypass selection does not appear unless Option MPB is present and licensed - The Full Bypass Enable selection does not appear unless options LNP and MPB are both present as well as option FBP <p>In any of these cases, if the required options are not present and the SCPI command is sent, error - 241, "Hardware missing; Option not installed" is generated</p> <p>Low Noise Path Enable and Full Bypass Enable are grayed-out if the current measurement does not support them</p> <p>Low Noise Path Enable and Full Bypass Enable are not supported in Avionics and MMR Modes (non-modulation measurements). In any of these cases (that is, the feature is not supported in either measurement or Mode), if the SCPI command is sent, the following error is generated: -221, "Setting Conflict; Feature not supported for this measurement"</p>														
Preset	<table border="1"> <thead> <tr> <th>Mode</th> <th>Value</th> </tr> </thead> <tbody> <tr> <td>IQ Analyzer</td> <td>MPB option present and licensed: MPB</td> </tr> <tr> <td>Pulse</td> <td>MPB option not present and licensed: STD</td> </tr> <tr> <td>RTSA</td> <td></td> </tr> <tr> <td>Avionics</td> <td></td> </tr> <tr> <td>All other Modes</td> <td>STD</td> </tr> <tr> <td>-</td> <td></td> </tr> </tbody> </table>	Mode	Value	IQ Analyzer	MPB option present and licensed: MPB	Pulse	MPB option not present and licensed: STD	RTSA		Avionics		All other Modes	STD	-	
Mode	Value														
IQ Analyzer	MPB option present and licensed: MPB														
Pulse	MPB option not present and licensed: STD														
RTSA															
Avionics															
All other Modes	STD														
-															
State Saved	Save in instrument state														
Range	Standard Path Low Noise Path Enable μW Presel Bypass Full Bypass Enable														

Annotation In the Meas Bar, if the Standard path is chosen:
 μ W Path: Standard
 If Low Noise Path is enabled but the LNP switch is not thrown:
 μ W Path: LNP,Off
 If the Low Noise Path is enabled and the LNP switch is thrown:
 μ W Path: LNP,On
 If the preselector is bypassed:
 μ W Path: Bypass
 If Full Bypass Enable is selected but the LNP switch is not thrown:
 μ W Path: FByp,Off
 If Full Bypass Enable is selected and the LNP switch is thrown:
 μ W Path: FByp,On

μ W Path Control Auto

In VMA, WLAN, 5G NR, CQM Modes, an **Auto/Man** switch is added to μ W Path Control:



This allows the function to automatically switch based on certain Auto Rules as shown below:

VMA Mode

Measurement	μ W Path Control Auto behavior
Digital Demod	Use Standard Path unless tuned frequency > 3.6 GHz and IFBW > 15 MHz, in which case choose Preselector Bypass
Monitor Spectrum	Always Presel Bypass
IQ Waveform	Use Standard Path unless tuned frequency > 3.6 GHz and IFBW > 15 MHz, in which case choose Preselector Bypass
Custom OFDM	Use Standard Path unless tuned frequency > 3.6 GHz and IFBW > 15 MHz, in which case choose Preselector Bypass
Channel Power	Always Presel Bypass
Occupied BW	Always Presel Bypass
CCDF	Use Standard Path unless tuned frequency > 3.6 GHz and IFBW > 15 MHz, in which case choose Preselector Bypass

3 VMA Mode
 3.5 Channel Power Measurement

Measurement	μ W Path Control Auto behavior
ACP	Always Presel Bypass
SEM	Always Presel Bypass
Spurious Emissions	Always Standard Path

WLAN Mode

Measurement	μ W Path Control Auto behavior
Modulation Analysis	Always Presel Bypass
Spectral Flatness	Always Presel Bypass
Power vs Time	Always Presel Bypass
Monitor Spectrum	Always Presel Bypass
IQ Waveform	Always Presel Bypass
Channel Power	Always Presel Bypass
Occupied BW	Always Presel Bypass
CCDF	Always Presel Bypass
SEM	For 11be 320M, when 'Enabled Wideband IF for FFT' is OFF or 'Sweep Type Rule' is Best Dynamic Range, auto μ W path is standard For other cases, auto μ W path is presel bypass if presel bypass is enabled, auto μ W path is standard if presel bypass is not enabled
Spurious Emissions	Always Standard Path

5G NR Mode

Measurement	μ W Path Control Auto behavior
Modulation Analysis	Use Standard Path unless tuned frequency > 3.6 GHz and IFBW > 15 MHz, in which case choose Full Bypass if conditions warrant(FBP Option is available and "Allow Full Bypass in Auto" is On), otherwise choose Preselector Bypass
Monitor Spectrum	Always Standard Path
IQ Waveform	Use Standard Path unless tuned frequency > 3.6 GHz and IFBW > 15 MHz, in which case choose Full Bypass if conditions warrant(FBP Option is available and "Allow Full Bypass in Auto" is On), otherwise choose Preselector Bypass
Channel Power	Always Standard Path
Occupied BW	Always Standard Path
CCDF	Use Standard Path unless tuned frequency > 3.6 GHz and IFBW > 15 MHz, in which case choose Preselector Bypass
ACP	Always Standard Path
SEM	Always Standard Path
Spurious	Always Standard Path

Measurement	μ W Path Control Auto behavior
Emissions	
Transmit On Off Power	Use Standard Path unless tuned frequency > 3.6 GHz and Info BW > 15 MHz, in which case choose Preselector Bypass
Channel Quality Mode	
Measurement	μ W Path Control Auto behavior
Group Delay	Use Standard Path unless tuned frequency > 3.6 GHz and IFBW > 15 MHz, in which case choose Full Bypass if conditions warrant(FBP Option is available and "Allow Full Bypass in Auto" is On), otherwise choose Preselector Bypass
Monitor Spectrum	Always Standard Path
IQ Waveform	Use Standard Path unless tuned frequency > 3.6 GHz and IFBW > 15 MHz, in which case choose Preselector Bypass
CCDF	Use Standard Path unless tuned frequency > 3.6 GHz and IFBW > 15 MHz, in which case choose Preselector Bypass

Remote Command	<code>[:SENSE]:POWER[:RF]:MW:PATH:AUTO ON OFF 1 0</code> <code>[:SENSE]:POWER[:RF]:MW:PATH:AUTO?</code>
Example	<code>:POW:MW:PATH:AUTO ON</code> <code>:POW:MW:PATH:AUTO?</code>
Dependencies	Only appears in VMA, WLAN, 5G NR and CQM Modes
Couplings	See " μW Path Control Auto " on page 834 above
Preset	ON
Range	ON OFF

Low Noise Path Enable

Low Noise Path Enable provides a lower noise floor under some circumstances, particularly when operating in the 21–26.5 GHz region. With the Low Noise Path enabled, the low band/high band switch and microwave preamp are bypassed whenever *all* the following are true:

- The instrument is not in the Low Band, meaning:
- the start frequency is above 3.5 GHz and
- the stop frequency is above 3.6 GHz
- The internal preamp is not installed, or if installed, is set to **Off** or **Low Band**

Note that this means that, when any part of a sweep is done in Low Band, the Low Noise Path is not used, whether or not the **Low Noise Path Enable** is selected in the user interface. Also, if the preamp is turned on, the Low Noise Path is not used,

3 VMA Mode

3.5 Channel Power Measurement

whether or not the **Low Noise Path Enable** is selected in the user interface. The only time the Low Noise Path is used is when **Low Noise Path Enable** is selected, the sweep is completely in High Band (> 3.6 GHz) and no preamp is in use.

For measurements that use IQ acquisition, the low noise path is used when **Center Frequency** is in High Band (> 3.6 GHz) and no preamp is in use. In other words, the rules above are modified to use only the center frequency to qualify which path to switch in. This is not the case for FFTs in the Swept SA measurement; they use the same rules as swept measurements.

Note that the Low Noise Path, while giving improved DANL, has the disadvantage of decreased TOI performance and decreased gain compression performance relative to the standard path.

Note also that the bypass switch is a mechanical switch and has finite life, so if the **Low Noise Path Enable** is selected, it is possible to cause frequent cycling of this switch by frequently changing instrument settings such that the above conditions hold true only some of the time. A user making tests of this nature should consider opting for the **Standard Path**, which will never throw the bypass switch, at the expense of some degraded noise performance.

The low noise path is useful for situations where the signal level is so low that the instrument performance is dominated by noise even with 0 dB attenuation, but still high enough that the preamp option would have excessive third-order intermodulation or compression. The preamp, if purchased and used, gives better noise floor than does the “Low Noise Path.” However, its compression threshold and third-order intercept are much poorer than that of the non-preamp path.

There are some applications, typically for signals around –30 dBm, for which the third-order dynamic range of the standard path is good enough, but the noise floor is not low enough even with 0 dB input attenuation. When the third-order dynamic range of the preamp path is too little and the noise floor of the standard path is too high, the Low Noise Path can provide the best dynamic range

The graph below illustrates the concept. It shows, in red, the performance of an instrument at different attenuation settings, both with the preamp on and off, in a measurement that is affected by both instrument noise and instrument TOI. The green shows the best available dynamic range, offset by 0.5 dB for clarity. The blue shows how the best available dynamic range improves for moderate signal levels with the low noise path switched in. In this illustration, the preamp improves the noise floor by 15 dB while degrading the third-order intercept by 30 dB, and the low noise path reduces loss by 8 dB. The attenuator step size is 2 dB.

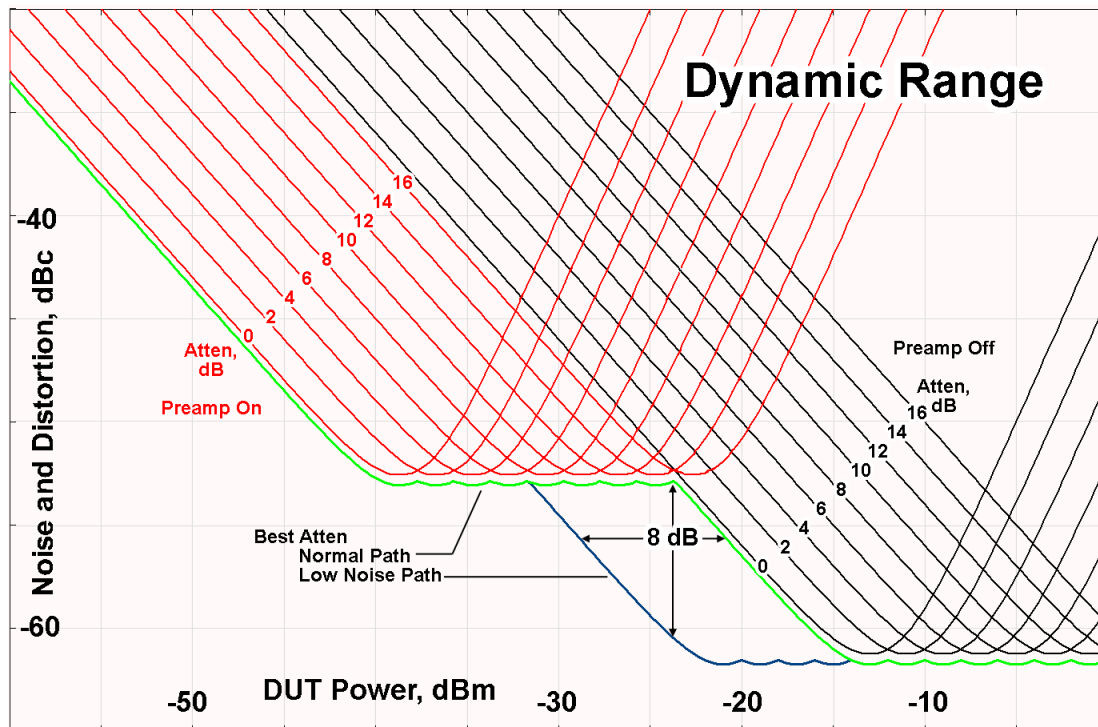

There are other times where selecting the low noise path improves performance, too. Compression-limited measurements such as finding the nulls in a pulsed-RF spectrum can profit from the low noise path in a way similar to the TOI-limited measurement illustrated. Accuracy can be improved when the low noise path allows the optimum attenuation to increase from a small amount like 0, 2 or 4 dB to a larger amount, giving better return loss at the instrument input. Harmonic measurements, such as second and third harmonic levels, are much improved using the low noise path because of the superiority of that path for harmonic (though not intermodulation) distortion performance.

μW Preselector Bypass

Toggles the preselector bypass switch for band 1 and higher. When the microwave preselector is on, the signal path is preselected. When the microwave preselector is off, the signal path is not preselected. The preselected path is the normal path for the instrument.

The preselector is a tunable bandpass filter which prevents signals away from the frequency of interest from combining in the mixer to generate in-band spurious signals (images). The consequences of using a preselector filter are its limited bandwidth, the amplitude and phase ripple in its passband, and any amplitude and phase instability due to center frequency drift.

Option MPB or pre-selector bypass provides an unpreselected input mixer path for certain X-Series signal analyzers with frequency ranges above 3.6 GHz. This signal path allows a wider bandwidth and less amplitude variability, which is an advantage when doing modulation analysis and broadband signal analysis. The disadvantage is that, without the preselector, image signals will be displayed. Another disadvantage of bypassing the preselector is increased LO emission levels at the front panel input port.

Image responses are separated from the real signal by twice the 1st IF. For IF Paths of 10 MHz and 25 MHz, the 1st IF is 322.5 MHz, so the image response and the real signal will be separated by 645 MHz. The 1st IF will be different for other IF Path settings. When viewing a real signal and its corresponding image response in internal mixing, the image response will be to the left of the real signal.

Also, the image response and the real signal typically have the same amplitude and exhibit the same shape factor.

However, if Option FS1 (Fast Sweep Capability) is enabled, the image response in the Swept SA measurement appears lower in amplitude and has a much wider shape factor compared to the real signal.

Full Bypass Enable

With **Full Bypass Enable** selected, the microwave preselector is bypassed. In addition, the low band/high band switch and microwave preamp are bypassed whenever *all* the following are true:

- The instrument is not in the Low Band, meaning:
- the start frequency is above 3.5 GHz and
- the stop frequency is above 3.6 GHz.
- the internal preamp is not installed or if installed, is set to **Off** or **Low Band**

Note that this means that, when any part of a sweep is done in Low Band, the Low Noise Path is not used, whether or not the **Full Bypass Enable** is selected in the user interface. Also, if the preamp is turned on, the Low Noise Path is not used, whether or not the **Full Bypass Enable** is selected in the user interface. The only time the Low Noise Path is used is when **Full Bypass Enable** is selected, the sweep is completely in High Band (> 3.6 GHz) and no preamp is in use.

CAUTION

When **Full Bypass Enable** is selected, and "**Y Scale**" on page 1760 is set to 0 dB, there will be a direct AC connection between the input and the first converter when the Low Noise Path switches in (when Start Freq >3.6 GHz and the Preamp is either not licensed, set to Low Band, or Off). This puts the first converter at considerable risk to be damaged by high AC power. Consequently,

whenever **Full Bypass Enable** is selected, a warning message appears in the status bar:

“Full Bypass Enabled, maximum safe input power reduced”

Microwave Preselector Bypass Backwards Compatibility

Example	Bypass the microwave preselector: <code>:POW:MW:PRES OFF</code>
Notes	Included for Microwave Preselector Bypass backwards compatibility The ON parameter sets the STD path (<code>:POW:MW:PATH STD</code>) The OFF parameter sets path MPB (<code>:POW:MW:PATH MPB</code>)
Preset	ON
Backwards Compatibility SCPI	<code>[:SENSe]:POWer[:RF]:MW:PRESelector[:STATe] ON OFF 0 1</code> <code>[:SENSe]:POWer[:RF]:MW:PRESelector[:STATe]?</code>

Frequency Extender Preselection Bypass

Only applies to the high frequency path of the Frequency Extender, and only if the Frequency Extender allows it. For example, the V3050A high frequency path is 50 – 110 GHz and *does* allow control of the preselector bypass.

When the Frequency Extender’s preselection is bypassed, flatness is improved, but will be subject to spurs from out-of-band interfering signals. For bandwidths greater than 2.5 [GHz], it is recommended that the signal bypass the Frequency Extender Preselector since the max bandwidth of the Preselector can be as narrow as 2.5 [GHz].

For most applications, the preset state is **OFF**, which gives the best remote-control throughput, minimizes acoustic noise from switching, minimizes out of band spurs, and minimizes the risk of wear in the hardware switches.

Preselector and Bandwidth Conflict

When the Frequency Extender Preselector is applied and the signal bandwidth is greater than 2.5 [GHz], then a settings alert message will show to warn the user that the signal may be distorted due to the limitation of the Frequency Extender Preselector bandwidth.

An example of the settings alert message is shown below.

Settings Alert message in the Status Bar at the bottom of the display.

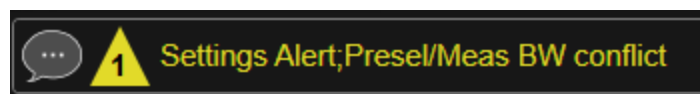

Settings Alert message in the error queue

Type	ID	
	159	Settings Alert - DETECTED; Presel/Meas BW conflict

Allow Full Bypass in Auto

Enable or disable Full Bypass in μ W Path Auto rule. See " [\$\mu\$ W Path Control](#)" on page 1791.

When this function is **ON**, and " [\$\mu\$ W Path Control](#)" on page 1791 is in **AUTO**, it is possible for the auto rules to select the **FULL** Bypass state, which bypasses both the Preamp and the Microwave Preselector. Otherwise, the auto rules never select the **FULL** Bypass state. This is convenient when making wideband measurements, but it also adds some risk of damage to the first converter.

CAUTION

When **Full Bypass Enable** is selected, and "[Y Scale](#)" on page 1760 is set to 0 dB, there will be a direct AC connection between the input and the first converter when the Low Noise Path switches in (when Start Freq > 3.6 GHz and the Preamp is either not licensed, set to **Low Band** or **Off**). This puts the first converter at considerable risk to be damaged by high AC power. Consequently, whenever **Full Bypass Enable** is selected, a warning message appears in the status bar:

"Full Bypass Enabled, maximum safe input power reduced"

Remote Command	<code>[:SENSe] :POWer [:RF] :MW :PATH :AUTO :FULL ON OFF 1 0</code> <code>[:SENSe] :POWer [:RF] :MW :PATH :AUTO :FULL ?</code>
Example	<code>:POW :MW :PATH :AUTO :FULL ON</code> <code>:POW :MW :PATH :AUTO :FULL ?</code>
Dependencies	Only appears if Option FBP is installed, and in the following measurements <ul style="list-style-type: none"> - 5GNRMode: Modulation Analysis and IQ Waveform - WLAN Mode: IQ Waveform - Channel Quality Mode: Group Delay and Noise Power Ratio
Preset	OFF
State Saved	Saved in instrument state

Software Preselection

Provided in some instruments, either to compensate for issues with provided hardware preselection or to provide the preselection function when there is no hardware preselector.

N9041B

Software Preselection compensates for the frequency range limit of the microwave preselector. Since the microwave preselector only goes up to 50 GHz, software preselection must be used to suppress and separate images above 50 GHz. The specific algorithm used for software preselection is specified by the SW Preselection Type selection – Normal or Advanced.

In N9041B, **Software Preselection** only applies for frequencies above 50 GHz, therefore it is only used for RF Input 2. Even if turned on, it is not used for other inputs, and never for frequencies below 50 GHz. This is why the label of this control contains the parenthetical note “(>~50 GHz)”.

Note that in N9041B, in Swept SA measurement, **Software Preselection** works even if the measurement is using an FFT Sweep Type. In measurements other than Swept SA, Software Preselection is not used if the measurement is using an FFT sweep type.

N9042B+V3050A

Software Preselection compensates for the frequency range limit of the microwave preselector. Since the microwave preselector only goes up to 50 GHz, software preselection must be used to suppress and separate images above 50 GHz. The specific algorithm used for software preselection is specified by the SW Preselection Type selection – Normal or Advanced.

For N9042B+V3050A, Software Preselection only applies for frequencies above 50 GHz, therefore it is only used for External RF. Even if it is turned on, it will not be used for other inputs and never for frequencies below 50 GHz. This is why the label of this control contains the parenthetical note “(>~50 GHz)”.

Note that for N9042B+V3050A, in the Swept SA measurement, Software Preselection works even if the measurement is using an FFT Sweep Type. In measurements other than Swept SA, Software Preselection is not used if the measurement is using an FFT Sweep Type.

VXT models M9410A/11A/15A/16A

Software Preselection is used to provide the preselection function, as there is no hardware preselector in these models. Two background traces are taken and compared point by point, and the point with the lowest amplitude from the two

traces is used. This provides a method to reduce spurs that are internally generated within the VXT, but you should note the following when using Software Preselection:

- There is some speed cost due to the need to take multiple captures
- Taking the point with the lowest amplitude in each trace will make the average noise level lower at all points that do not have a spur. This can reduce the accuracy of the measurement of noise and noise-like signals

Because of the difficulty in identifying spurs manually, you are recommended to leave Software Preselection **ON** at all times in VXT models M9410A/11A. If you turn it off in order to speed up your measurement or improve noise accuracy, be aware of unwanted onscreen spurs.

Remote Command	<code>[:SENSe]:POWer[:RF]:SWPrese1:STATe 0 1 ON OFF</code> <code>[:SENSe]:POWer[:RF]:SWPrese1:STAT?</code>
Example	<code>:POW:SWPR:STAT 1</code> <code>:POW:SWPR:STAT?</code>
Dependencies	Only appears in N9041B, N9042B+V2050A, VXT models M9410A/11A and M9410E/11E. Does not appear in all measurements
Couplings	Affects Sweep Time Auto Tune supports Software Preselection , so Auto Tune should be performed after setting the Software Preselection state
Preset	N9041B OFF N9042B+V3050A ON M9410A/11A ON
State Saved	Saved in instrument state

SW Preselection Type

Specifies the algorithm used for software preselection.

Two hidden sweeps occur in succession. The second sweep is offset in LO frequency by $2 * IF / N$. For each point in each trace, the smaller amplitude from the two traces is taken and placed in that point in the selected trace. The Peak detector is auto-selected to improve the image suppression effectiveness. Responses of each trace that lie on top of one another will remain and are valid signals. Other signals are images, which are suppressed. The action of taking the smaller of the two traces will make the average noise level lower in all points that do not have an image, thus reducing the accuracy of the measurement of noise and noise-like signals.

- **NORMa1** - mathematically removes all image and multiple responses of signals present at the input
- **ADVanced** - any trace processing (such as “max hold” or trace averaging) is performed on the points of both candidate traces before the “select minimum” operation occurs. This form of processing works better for non-stationary signals, such as pulsed-RF signals

Remote Command	<code>[:SENSe]:POWer[:RF]:SWPResel NORMa1 ADVanced</code> <code>[:SENSe]:POWer[:RF]:SWPResel?</code>
Example	<code>:POW:SWPR NORM</code> <code>:POW:SWPR?</code>
Dependencies	Only appears in N9041B and N9042B+V3050A. Only appears in measurements that use the Swept method Grayed-out when "Software Preselection" on page 1801 is OFF. The grayout message is “Unavailable unless SW Presel enabled”
Preset	N9041B ADVanced N9042B+V3050A NORMa1
State Saved	Saved in instrument state

SW Preselection BW

Specifies the effective bandwidth to be used for Software Preselection.

The options are:

- **NORMa1** – when making Swept measurements, a software preselection algorithm is used which takes up to 4 background acquisitions, then post-processes the result. This algorithm can remove images from signals with an occupied bandwidth up to around 3 GHz. (Default/Preset setting). When making FFT measurements, this algorithm is not used, instead the same algorithm is used as for **NARRow** (below)
- **NARRow**– a software preselection algorithm is used which takes two background acquisitions, then post-processes the result to detect and remove images from wideband signals with occupied bandwidths up to 2 GHz. This increases the risk of images failing to be rejected, but improves the measurement speed

Remote Command	<code>[:SENSe]:POWer[:RF]:SWPResel:BW NORMa1 NARRow</code> <code>[:SENSe]:POWer[:RF]:SWPResel:BW?</code>
Example	<code>:POW:SWPR:BW NARR</code>
Dependencies	Only appears in N9041B and N9042B+V3050A. Only appears in measurements that use the Swept

3 VMA Mode
3.5 Channel Power Measurement

	method	
	Grayed-out when " Software Preselection " on page 1801 is OFF . The grayout message is "Unavailable unless SW Presel enabled"	
	For N9042B+V3050A, the parameter is SCPI-only, and always set to NARRow when Software Preselection is enabled	
Preset	N9041B	NORMa1
	N9042B+V3050A	NARRow
State Saved	Saved in instrument state	

High Freq Prefilter

Lets you set the state of Prefilter for center frequencies above 1310 MHz.

In VXT Models M9410A/11A and M9410E/11E in bypass frequency range (1310MHz~5GHz), the Receiver RF path has a bank of filters that come after the RF Attenuator in the signal path. Since this bank of filters precedes the mixer they are known as the "Prefilter" bank. Their purpose is to eliminate unwanted in-band mixing products by filtering out all but the desired frequencies before the signals get to the mixer. There are 13 prefilter bands to cover the frequencies between 9 kHz and 6000 MHz. The Prefilter provides the necessary rejection of the unwanted signal.

Remote Command	<code>[:SENSe]:<measurement>:PFILter[:STATe] ON OFF 1 0</code> <code>[:SENSe]:<measurement>:PFILter[:STATe]?</code>
Example	Enable High Freq Prefilter for the Complex Spectrum Measurement in BASIC Mode: <code>:SPEC:PFIL ON</code> Enable High Freq Prefilter for the IQ Waveform Measurement, in multiple Modes: <code>:WAV:PFIL ON</code> Enable High Freq Prefilter for the Swept SA Measurement in SA Mode: <code>:SAN:PFIL ON</code>
Dependencies	Only appears in VXT models M9410A/11A with center frequency above 1310 MHz, and M9410E/11E in frequency range 1310MHz~5GHz
Preset	See " Prefilter Presets " on page 845 below
State Saved	Saved in instrument state

Prefilter Presets

Meas	Mode	Preset
SPEC	BASIC	OFF

Meas	Mode	Preset
WAV	BASIC, WCDMA, WLAN, LTEAFDD, LTEATDD, 5GNR, VMA	OFF
MON	WCDMA, WLAN, LTEAFDD, LTEATDD, 5GNR, VMA	OFF
RHO	WCDMA	OFF
CDP	WCDMA	OFF
PCON	WCDMA	OFF
EVMQ	WCDMA	OFF
CHP	WCDMA, WLAN, LTEAFDD, LTEATDD, 5GNR, VMA, SA	OFF
OBW	WCDMA, WLAN, LTEAFDD, LTEATDD, 5GNR, VMA, SA	OFF
ACP	WCDMA, LTEAFDD, LTEATDD, 5GNR, VMA, SA	OFF
SEM	WCDMA, WLAN, LTEAFDD, LTEATDD, 5GNR, VMA, SA	OFF
PST	WCDMA, WLAN, LTEAFDD, LTEATDD, 5GNR, VMA, SA	OFF
PVT	WLAN, LTEAFDD, LTEATDD, 5GNR	OFF
EVM	WLAN, LTEAFDD, LTEATDD, 5GNR	OFF
FLAT	WLAN	OFF
EVMM	WLAN	OFF
CEVM	LTEAFDD, LTEATDD	OFF
PAVT	5GNR, VMA	OFF
DDEM	VMA	OFF
OFDM	VMA	OFF
SAN	SA	ON
HARM	SA	ON

3.5.4 BW

Opens the Bandwidth (**BW**) menu, which contains controls for the Resolution Bandwidth and Video Bandwidth functions of the instrument.

The Resolution BW functions control filter bandwidth and filter type. There are two filter types, Gaussian and Flattop. The Gaussian filters have a response curve that is parabolic on a log scale. The Flattop filter shape is a close approximation of a rectangular filter.

3.5.4.1 Settings

Contains the basic bandwidth functions. In most measurements it is the only tab under Bandwidth.

Res BW

Activates the resolution bandwidth active function, which allows you to manually set the resolution bandwidth (RBW) of the instrument.

Normally, **Res BW (Auto)** selects automatic coupling of **Res BW** to **"Span"** on page 865, using the ratio set by **Span:3 dB RBW** (some measurements do not have a Span:3 dB RBW control, in which case the measurement chooses the optimal ratio). To decouple the resolution bandwidth, press the **Auto/Man** toggle on **Res BW**, or simply enter a different value for **Res BW**.

When **Res BW** is manually selected, you can return it to the coupled state by pressing the **Auto/Man** toggle on **Res BW**. This may also be done by pressing **"Auto Couple"** on page 1825 or by performing a **Preset**.

For more details, see **"More Information"** on page 848

Remote Command	<code>[:SENSe]:CHPower:BANDwidth[:RESolution] <bandwidth></code> <code>[:SENSe]:CHPower:BANDwidth[:RESolution]?</code>
Example	<code>:CHP:BAND 5 MHz</code> <code>:CHP:BAND?</code>
Notes	For numeric entries, all RBW Types choose the nearest (arithmetically, on a linear scale, rounding up) available RBW to the value entered The setting and querying of values depend on the current bandwidth type
Couplings	Sweep time is coupled to RBW. As RBW changes, the sweep time (if set to Auto) is changed to maintain amplitude calibration Video bandwidth (VBW) is coupled to RBW. As the resolution bandwidth changes, the video bandwidth (if set to Auto) changes to maintain the ratio of VBW/RBW (10:1) When Res BW is set to Auto , the resolution bandwidth is auto-coupled to the span. The ratio of Span/RBW is approximately 106:1 when auto coupled. When Res BW is set to Man, and the bandwidths are entered manually, these bandwidths are used regardless of other instrument settings
Preset	See "RBW Presets" on page 848
State Saved	Saved in instrument state
Min	1 Hz
Max	8 MHz is the max equivalent -3 dB RBW, which means that the named RBW (the one shown on the control etc.) can actually exceed 8 MHz if using a filter other than -3 dB Gaussian
Annotation	A "#" mark appears before "RBW" in the annotation when it is switched from Auto to Manual coupling
Backwards Compatibility Notes	For backwards compatibility, this command supports both the BANDwidth and BWIDth forms
Auto Function	
Remote	<code>[:SENSe]:CHPower:BANDwidth[:RESolution]:AUTO ON OFF 1 0</code>

Command	<code>[:SENSe] :CHPower :BANDwidth [:RESolution] :AUTO?</code>
Example	<code>:CHP :BAND :AUTO ON</code> <code>:CHP :BAND :AUTO?</code>

RBW Presets

Mode	Preset Value
LTEAFDD	Auto
LTEATDD	Auto
MSR	100 kHz
NR5G	Auto
SA	Auto
SRCOMMS	3.9 kHz
VMA	240 kHz
WCDMA	240 kHz
WLAN	100 kHz

More Information

When **Res BW** is set to **Auto**, the bandwidth selected depends on "**RBW Filter Type**" on page 851.

Only certain discrete resolution bandwidths are available. The available bandwidths are dependent on **Filter Type** or **EMC Standard**. If an unavailable bandwidth is entered with the numeric keypad, the closest available bandwidth is selected.

In some PowerSuite measurements, in the LTE-Advanced (both FDD and TDD) and 5G NR modes, when **Res BW** is in **Auto**, the resolution bandwidth is predefined based on the corresponding bandwidth of the single carrier, as shown in the table below. In the Multi-carrier case, the narrowest RBW among the active carriers is used.

LTE-A FDD/TDD Modes

Carrier BW	Auto RBW, kHz
1.4 MHz	20
3 MHz	43
5 MHz	68
10 MHz	150
15 MHz	220
20 MHz	270
200 kHz (NB-IoT in FDD)	10

5G NR Mode

3 VMA Mode
 3.5 Channel Power Measurement

Bandwidth	Auto RBW, kHz
5 MHz	68
10 MHz	150
15 MHz	220
20 MHz	270
25 MHz	360
30 MHz	430
35 MHz	510
40 MHz	560
45 MHz	620
50 MHz	680
60 MHz	820
70 MHz	1000
80 MHz	1100
90 MHz	1300
100 MHz	1500
200 MHz	2700
400 MHz	3000
800 MHz	3000
1600 MHz	3000
2000 MHz	3000

Video BW

Lets you change the instrument post-detection filter (VBW or “Video Bandwidth”) from 1 Hz to 8 MHz in approximately 10% steps. In addition, a wide-open video filter bandwidth may be chosen by selecting 50 MHz. The VBW is annotated at the bottom of the display, in the center.

Normally, **Video BW (Auto)** selects automatic coupling of the Video BW to RBW using the ratio set by **VBW:3 dB RBW**. To decouple the resolution bandwidth, press the **Auto/Man** toggle on **Video BW**, or simply enter a different value for **Video BW**.

When the **Video BW** is manually selected, it may be returned to the coupled state by pressing the **Auto/Man** toggle on **Video BW**. This may also be done by pressing **"Auto Couple"** on page 1825 or by performing a **Preset**.

Remote Command `[:SENSe]:CHPower:BANDwidth:VIDeo <bandwidth>`
 `[:SENSe]:CHPower:BANDwidth:VIDeo?`

Example `:CHP:BAND:VID 2.4 MHz`

<code>:CHP:BAND:VID?</code>	
Notes	For numeric entries, the instrument chooses the nearest (arithmetically, on a linear scale, rounding up) available VBW to the value entered. The 50 MHz VBW is defined to mean “wide open” The values shown in this table reflect the conditions after a Mode Preset
Dependencies	Sometimes the displayed Video BW is not actually used to process the trace data: When the Average Detector is selected and Sweep Type is set to Swept , the video bandwidth filter cannot be used, because it uses the same hardware as the Average Detector When the Quasi-Peak, EMI Average or RMS Average detector is selected the VBW is implemented by the digital IF as part of the detector When this is the case, VBW still acts to change the Sweep Time, if "Sweep Time" on page 1355 is in Auto , and still affects the data on other traces for which this is not the case
Couplings	Video bandwidth (VBW) is normally coupled to "Res BW" on page 847. If VBW is set to Auto , then VBW is changed as RBW changes, to maintain the ratio set by VBW:3 dB RBW (usually 10:1 for measurements that do not have a VBW:3 dB RBW control)
Preset	Auto (unless noted in table below)
State Saved	Saved in instrument state
Min	1 Hz
Max	50 MHz
Annunciation	A “#” mark appears before “VBW” in the annotation when it is not coupled
Annotation	In the bottom center of the screen, “VBW <value> <units>” indicates the current video bandwidth value. Note that for some detectors this is not the value actually used for VBW (see above)
Backwards Compatibility Notes	For backwards compatibility, this command supports both the BANDwidth and BWIDth forms

Auto Function

Remote Command	<code>[:SENSe] :CHPower :BANDwidth :VIDeo :AUTO ON OFF 1 0</code> <code>[:SENSe] :CHPower :BANDwidth :VIDeo :AUTO?</code>
Example	<code>:CHP:BAND:VID:AUTO OFF</code> <code>:CHP:BAND:VID:AUTO?</code>
Preset	ON

VBW Presets

Unless noted in the table below, the Preset value of VBW is **Auto**.

Mode	Preset Value
WCDMA	2.40 MHz

RBW Filter Type

Selects the type for the resolution bandwidth filters. Historically, the Res BW filters in HP/Agilent/Keysight spectrum instruments were Gaussian filters, specified using the -3 dB bandwidth of the filter. That is, a 10 MHz Res BW filter was a Gaussian shape with its -3 dB points 10 MHz apart. In X-Series, the **RBW Filter BW** menu lets you choose between a Gaussian and Flat Top filter shape, for varying measurement conditions.

Filter Type	SCPI Example														
Gaussian	<code>:BAND:SHAP GAUS</code>														
Flattop	<code>:BAND:SHAP FLAT</code>														
Remote Command	<code>[:SENSe]:CHPower:BANDwidth:SHAPE GAUSSian FLATtop</code> <code>[:SENSe]:CHPower:BANDwidth:SHAPE?</code>														
Example	<code>:CHP:BAND:SHAP GAUS</code> <code>:CHP:BAND:SHAP?</code>														
Notes	GAUSSian = Gaussian FLATtop = Flattop We use SHAPE instead of TYPE (even though the control name uses Type) because TYPE is used for backwards compatibility														
Preset	"Auto Couple" on page 1825 selects the preset value														
State Saved	Saved in instrument state														
Annotation	The annotation under RBW in the bottom left of the screen shows the type of filter or bandwidth that is being used. The following examples illustrate this:														
	<table border="1"> <tbody> <tr> <td>-3 dB (Normal) filter BW</td> <td>Res BW 300 Hz</td> </tr> <tr> <td>-6 dB filter BW</td> <td>Res BW (-6 dB) 422 Hz</td> </tr> <tr> <td>Noise filter BW</td> <td>Res BW (Noise) 317 Hz</td> </tr> <tr> <td>Impulse filter BW</td> <td>Res BW (Impulse) 444 Hz</td> </tr> <tr> <td>CISPR filter BW</td> <td>Res BW (CISPR) 200 Hz</td> </tr> <tr> <td>MIL filter BW</td> <td>Res BW (MIL) 1 kHz</td> </tr> <tr> <td>Flattop filter type</td> <td>Res BW (Flattop) 300 Hz</td> </tr> </tbody> </table>	-3 dB (Normal) filter BW	Res BW 300 Hz	-6 dB filter BW	Res BW (-6 dB) 422 Hz	Noise filter BW	Res BW (Noise) 317 Hz	Impulse filter BW	Res BW (Impulse) 444 Hz	CISPR filter BW	Res BW (CISPR) 200 Hz	MIL filter BW	Res BW (MIL) 1 kHz	Flattop filter type	Res BW (Flattop) 300 Hz
-3 dB (Normal) filter BW	Res BW 300 Hz														
-6 dB filter BW	Res BW (-6 dB) 422 Hz														
Noise filter BW	Res BW (Noise) 317 Hz														
Impulse filter BW	Res BW (Impulse) 444 Hz														
CISPR filter BW	Res BW (CISPR) 200 Hz														
MIL filter BW	Res BW (MIL) 1 kHz														
Flattop filter type	Res BW (Flattop) 300 Hz														
Backwards Compatibility SCPI	<code>[:SENSe]:CHPower:BWIDth:SHAPE</code>														

3.5.5 Display

Lets you configure display items for the current Mode, Measurement View or Window.

3.5.5.1 Meas Display

Contains controls for setting up the display for the current Measurement, View or Window.

Bar Graph On/Off

Turns the Bar Graph On or Off.

Remote Command	<code>:DISPlay:CHPower:WINDow[1]:BGRaph ON OFF 1 0</code> <code>:DISPlay:CHPower:WINDow[1]:BGRaph?</code>
Example	<code>:DISP:CHP:WIND:BGR ON</code> <code>:DISP:CHP:WIND:BGR?</code>
Preset	OFF
State Saved	Saved in instrument state
Range	ON OFF
Backwards Compatibility SCPI	<code>:DISPlay:CHPower:VIEW[1]:WINDow[1]:BGRaph</code>

3.5.5.2 Annotation

Contains controls for setting up the annotation for the current Mode or Measurement.

Graticule

Turns the display graticule On or Off for all windows with graticules in all measurements in the current Mode. Also turns the graticule Y-Axis annotation on and off.

Remote Command	<code>:DISPlay:GRATICule[:STATe] OFF ON 0 1</code> <code>:DISPlay:GRATICule[:STATe]?</code>
Example	<code>:DISP:GRAT OFF</code>
Notes	The graticule is the set of horizontal and vertical lines that make up the grid/divisions for the X-Axis and Y-Axis

Preset	ON
State Saved	Saved in instrument state
Backwards Compatibility SCPI	:DISPlay:WINDow[1]:TRACe:GRATicule:GRID[:STATe] OFF ON 0 1 :DISPlay:WINDow[1]:TRACe:GRATicule:GRID[:STATe]? This command is accepted for backwards compatibility with older instruments, but the WINDow , TRACe and GRID parameters are ignored

Screen Annotation

Controls the display of the annunciation and annotation around the graticule, including any annotation on lines (such as the display line, the threshold line, etc.) and the Y-Axis annotation, for all windows with screen annotation in all measurements in the current Mode.

This does *not* include marker annotation (or the N dB result). When **OFF**, the graticule expands to fill the entire graticule area, leaving only the 1.5% gap above the graticule, as described in the **Trace** section.

Remote Command	:DISPlay:ANNOtation:SCReem[:STATe] OFF ON 0 1 :DISPlay:ANNOtation:SCReem[:STATe]?
Example	:DISP:ANN:SCR OFF
Dependencies	Grayed-out and forced to OFF when System Display Settings, Annotation is OFF
Preset	ON This remains OFF through a Preset when System Display Settings, Annotation is set to OFF
State Saved	Saved in instrument state

Trace Annotation

Turns on and off the labels on the traces, showing their detector (or their Math Mode) as described in the **Trace** section, for all windows in all measurements in the current Mode for which Trace Annotation on/off is supported.

If Trace Math is being performed on a trace, then the Trace Math annotation replaces the detector annotation.

For measurements that support limit lines, this key also turns on and off the labels on the Limit Lines. The label is the Limit number annotation and Limit Comment displayed on the graph. If the length of the comment is greater than 20 characters, the first 8 characters and the last 8 characters are displayed, joined with

Remote Command	:DISPlay:ANNOtation:TRACe[:STATe] ON OFF 1 0 :DISPlay:ANNOtation:TRACe[:STATe]?
----------------	--

Example	<code>:DISP:ANN:TRAC OFF</code>
Preset	<code>OFF</code>
State Saved	Saved in instrument state

Control Annotation

Turns on and off the display of values on the Active Function controls for all measurements in the current Mode. This is a security feature.

Remote Command	<code>:DISPlay:ACTivefunc[:STATe] ON OFF 1 0</code> <code>:DISPlay:ACTivefunc[:STATe]?</code>
Example	<code>:DISP:ACT OFF</code>
Dependencies	Grayed out and forced to <code>OFF</code> when System Display Settings, Annotation is <code>OFF</code>
Preset	<code>ON</code> This remains <code>OFF</code> through a Preset when System Display Settings, Annotation is set to <code>OFF</code>
State Saved	Saved in instrument state

Meas Bar

Turns the Measurement Bar at the top of the screen on and off for all measurements in the current Mode. When `OFF`, the graticule area expands to fill the area formerly occupied by the Measurement Bar.

Remote Command	<code>:DISPlay:ANNotation:MBAR[:STATe] OFF ON 0 1</code> <code>:DISPlay:ANNotation:MBAR[:STATe]?</code>
Example	<code>:DISP:ANN:MBAR OFF</code>
Dependencies	Grayed out and forced to <code>OFF</code> when System Display Settings, Annotation is <code>OFF</code>
Preset	<code>ON</code> This remains <code>OFF</code> through a Preset when System Display Settings, Annotation is set to <code>OFF</code>
State Saved	Saved in instrument state

Display Enable (Remote Command Only)

Turns the display on/off, including the display drive circuitry. The backlight stays lit to confirm that the instrument is on. The display enable setting is mode global. There are three reasons for turning the display off:

1. To increase speed as much as possible by freeing the instrument from having to update the display

3 VMA Mode
 3.5 Channel Power Measurement

2. To reduce emissions from the display, drive circuitry
3. For security purposes

If you have turned off the display:

- and you are in local operation, the display can be turned back on by pressing any key or by sending `:SYSTem:DEFaults MISC` or `:DISPlay:ENABle ON` (neither `*RST` nor `:SYSTem:PRESet` enable the display)
- and you are in remote operation, the display can be turned back on by pressing the **Local** or **Esc** keys, or by sending `:SYSTem:DEFaults MISC` or `:DISPlay:ENABle ON` (neither `*RST` nor `:SYSTem:PRESet` enable the display)
- and you are using either the `:SYSTem:KLOCK` command or GPIB local lockout, then *no* front-panel key press will turn the display back on. You must turn it back on remotely.

If the display is **OFF**, many SCPI commands related to User Views and Multiscreen functionality do not work, and return the error messages “-221, Settings conflict; Screen SCPI cannot be used when Display is disabled” or “221, Settings conflict; View SCPI cannot be used while Display is disabled”. These commands include:

Name	Command
Select User View	<code>:DISPlay:VIEW:ADVanced:SElect</code>
Rename User View	<code>:DISPlay:VIEW:ADVanced:REName</code>
Delete User View	<code>:DISPlay:VIEW:ADVanced:DELeTe</code>
Create User View	<code>:DISPlay:VIEW:ADVanced:NAME</code>
Select Screen	<code>:INSTrument:SCReen:SElect</code>
Delete Screen	<code>:INSTrument:SCReen:DELeTe</code>
Delete All But This Screen	<code>:INSTrument:SCReen:DELeTe:ALL</code>
Add Screen	<code>:INSTrument:SCReen:CREate</code>
Rename Screen	<code>:INSTrument:SCReen:REName</code>
Sequencer On/Off	<code>:SYSTem:SEQuencer</code>

Remote Command	<code>:DISPlay:ENABle OFF ON 0 1</code> <code>:DISPlay:ENABle?</code>
Example	<code>:DISP:ENAB OFF</code>
Couplings	<code>:DISP:ENAB OFF</code> turns Backlight OFF and <code>:DISP:ENAB ON</code> turns Backlight ON , but changing Backlight settings does <i>not</i> change the state of <code>:DISP:ENAB</code>
Preset	ON Set by <code>:SYST:DEF MISC</code> , but not affected by <code>*RST</code> or <code>:SYSTem:PRESet</code>
State Saved	Not saved in instrument state

Backwards Compatibility Notes **:SYST:PRES** no longer turns on **:DISPlay:ENABLe** as it did in legacy analyzers

3.5.5.3 View

Contains controls for selecting the current **View**, and for editing User Views.

View

See "[Views](#)" on page 798.

User View

Lets you choose a View from the saved User Views for the current measurement. This panel only appears if a User View exists for the current measurement.

Remote Command	:DISPlay:VIEW:ADVanced:SElect <alphanumeric> :DISPlay:VIEW:ADVanced:SElect?
Example	Select Baseband as the current View :DISP:VIEW:ADV:SEL "Baseband"
Notes	<p>You must be in the measurement whose View you are trying to set to send the command. You can only set Views for the current measurement using this command</p> <p>For predefined views, the parameter is derived from the view name that is shown in the View list in the user interface. For example, if you are trying to select the Trace Zoom view in the Swept SA measurement, you send:</p> <p>:DISP:VIEW:ADV:SEL "Trace Zoom"</p> <p>because "Trace Zoom" is the name of the View as seen in the Mode/Meas dialog or in the Display, View menu</p> <p>You <i>cannot</i> use the legacy View parameter (which in this case would be TZOOM) with :DISP:VIEW:ADV:SEL</p> <p><alphanumeric> is case insensitive; you can specify mixed case, however the name will be evaluated on a single case. Thus, both of the following forms work:</p> <p>:DISP:VIEW:ADV:SEL "Trace Zoom"</p> <p>:DISP:VIEW:ADV:SEL "TRACE ZOOM"</p> <p>If the specified view is not a valid View, the query returns the error message "-224, Illegal parameter value; View with the name <alphanumeric> does not exist"</p> <p>If the display is disabled (via :DISP:ENAB OFF) then the error message "-221, Settings conflict; View SCPI cannot be used while Display is disabled" is generated</p>
Backwards Compatibility SCPI	<p>The legacy node :DISPlay:VIEW[:SElect]</p> <p>is retained for backwards compatibility, but it only supports predefined views</p>

Restore Layout to Default

Restores the Layout to the default for Basic.

Modified Views are very temporary; if you exit the current measurement they are discarded, and they are not saved in State. To retain this View for later use, and to be able to return easily to your original Basic View, you can save your edited View as a “User View”.

Save Layout as New View

Saves your new View as a User View. An alpha keyboard appears, which lets you name your new View; the default is the old View name plus a number.

Remote Command	<code>:DISPlay:VIEW:ADVanced:NAME <alphanumeric></code>
Example	<code>:DISP:VIEW:ADV:NAME "Baseband"</code> Creates a new View named Baseband from the current View, and selects it as the current View
Notes	<code><alphanumeric></code> is case insensitive; you can specify mixed case, however the name will be evaluated on a single case If <code><alphanumeric></code> name already exists as a View, the error message “-224, Illegal parameter value; View <alphanumeric> already exists” is generated If the display is disabled (via <code>:DISP:ENAB OFF</code>) then the error message “-221, Settings conflict; User View SCPI cannot be used while Display is disabled” is generated

Re-Save User View

You can re-edit a User View; if you make changes, then an asterisk will appear next to the User View’s name. You can then tap **Re-Save User View** to save it back to its existing name, or **Save Layout as New View** to add another, new User View.

This is a front panel function only, there is no remote command available to perform this function. To do this remotely, you must first perform **Save Layout as New View**, then delete the old User View and rename the new one with the name of the View you just deleted.

Rename User View

You can rename the current View by giving it a new unique name. Only User Views can be renamed, if the current View is a Predefined View, an error occurs.

Remote Command	<code>:DISPlay:VIEW:ADVanced:REName <alphanumeric></code>
----------------	---

Example	<code>:DISP:VIEW:ADV:REN "Baseband"</code>
Notes	<p><code><alphanumeric></code> is case insensitive; you can specify mixed case, however the name will be evaluated on a single case</p> <p>If the <code><alphanumeric></code> specifying the new name is already present in the list of View names, the error message "-224, Illegal parameter value; View <alphanumeric> already exists" is generated</p> <p>If the current View is a Predefined View, the error message "-224, Illegal parameter value; Cannot rename a Predefined View" is generated</p> <p>If the display is disabled (via <code>:DISP:ENAB OFF</code>) then the error message "-221, Settings conflict; View SCPI cannot be used while Display is disabled" is generated</p>

Delete User View

You can delete the current View if it is a User View. The default view becomes the current view for the Measurement.

Remote Command	<code>:DISPlay:VIEW:ADVanced:DELeTe</code>
Example	<code>:DISP:VIEW:ADV:DEL</code>
Notes	<p><code><alphanumeric></code> is case insensitive; you can specify mixed case, however the name will be evaluated on a single case</p> <p>If the <code><alphanumeric></code> is not present in the list of View names, the error message "-224, Illegal parameter value; View <alphanumeric> does not exist" is generated</p> <p>If the current View is a Predefined View, the error message "-224, Illegal parameter value; Cannot delete a Predefined View" is generated</p> <p>If the display is disabled (via <code>:DISP:ENAB OFF</code>) then the error message "-221, Settings conflict; View SCPI cannot be used while Display is disabled" is generated</p>

Delete All User Views

Deletes all previously saved User Views. The default view becomes the current view for the Measurement if a User View was the current view when this command was executed.

Remote Command	<code>:DISPlay:VIEW:ADVanced:DELeTe:ALL</code>
Example	<code>:DISP:VIEW:ADV:DEL:ALL</code>
Notes	Disabled if there are no User Views

View Editor Remote Commands

The following remote commands help you manage Views and User Views. Note that the SCPI node for User Views handles both Predefined and User Views. The legacy

nodes, `:DISPlay:VIEW[:SElect]` and `:DISPlay:VIEW:NSEL`, are retained for backwards compatibility, but they only support predefined views.

View Listing Query

Returns a string containing a comma-separated list of names for *all* the Views, including User Views, available for the current Measurement.

Remote Command	<code>:DISPlay:VIEW:ADVanced:CATalog?</code>
Example	<code>:DISP:VIEW:ADV:CAT?</code>
Notes	Returns a quoted string of the available Views for the current measurement, separated by commas. The list includes names for <i>all</i> the Views, including User Views, available for the current Measurement Example: <code>"Normal,Trace Zoom,Spectrogram,Baseband,myView1,yourView1"</code> No distinction is made between Predefined and User Views If you switch measurements with the display disabled (via <code>:DISP:ENAB OFF</code>), then query the list of available Views, the result is undefined

User View Listing Query

Returns a string containing a comma-separated list of names for *only* the User Views available for the current Measurement.

Remote Command	<code>:DISPlay:VIEW:ADVanced:USER:CATalog?</code>
Example	<code>:DISP:VIEW:ADV:USER:CAT?</code>
Notes	Returns a quoted string of the available User Views for the current measurement, separated by commas. Example: <code>"Baseband,myView1,yourView1"</code> If you switch measurements with the display disabled (see "Display Enable (Remote Command Only)" on page 1812), then query the list of available Views, the result is undefined

3.5.6 Frequency

Contains controls that allow you to control the frequency and channel parameters of the instrument.

Some features in the **Frequency** menu are the same for all measurements in the current Mode – they do not change as you change measurements. Settings like these are called “Meas Global” and are unaffected by ["Meas Preset" on page 882](#).

For example, **Center Frequency** is the same for all measurements – it does not change as you change measurements.

3.5.6.1 Settings

Contains controls that pertain to the X axis parameters of the measurement. These parameters control how data on the vertical (X) axis is displayed and control instrument settings that affect the horizontal axis.

Center Frequency

Sets the frequency that corresponds to the horizontal center of the graticule. While adjusting **Center Frequency**, "[Span](#)" on page 865 is held constant.

The **Center Frequency** setting is the same for all measurements within a mode, that is, it is Meas Global. Some Modes are also able to share a Mode Global Center Frequency value. If this is the case, the Mode will have a **Global** tab in its **Meas Setup** menu.

The **Center Frequency** function sets (and queries) the center frequency for the currently selected input. If your instrument has multiple inputs, and you select another input, **Center Frequency** changes to the value for that input. SCPI commands are available to directly set **Center Frequency** for a specific input.

Center Frequency is remembered as you go from input to input. Thus, you can set a **Center Frequency** of 10 GHz with the RF Input selected, change to BBIQ and set a **Center Frequency** of 20 MHz, then switch to External Mixing and set a **Center Frequency** of 60 GHz, and when you go back to the RF Input, **Center Frequency** will go back to 10 GHz; back to BBIQ and it is 20 MHz; back to External Mixing and it is 60 GHz.

See:

- ["RF Center Freq" on page 863](#)
- ["Ext Mix Center Freq" on page 864](#)
- ["I/Q Center Freq" on page 865](#)
- ["Center Frequency Presets" on page 861](#)
- ["VXT Models with Radio Heads/CIU Frequency Range" on page 863](#)

Remote Command	<code>[:SENSe] :FREQuency :CENTer <freq></code> <code>[:SENSe] :FREQuency :CENTer?</code>
----------------	--

Example	Set Center Frequency to 50 MHz: <code>:FREQ:CENT 50 MHz</code>
---------	---

3 VMA Mode
3.5 Channel Power Measurement

	<p>Increment the Center Frequency by the value of CF Step: :FREQ:CENT UP</p> <p>Return the current value of Center Frequency: :FREQ:CENT?</p>
Notes	<p>Sets the RF, External Mixing or I/Q Center Frequency depending on the selected input:</p> <ul style="list-style-type: none"> - For RF input, equivalent to :FREQ:RF:CENT - For I/Q input, equivalent to :FREQ:IQ:CENT - For External Mixer, equivalent to :FREQ:EMIX:CENT <p>Preset and Max values depend on Hardware Options If no terminator (for example, MHz) is sent, the terminator Hz is used. If a terminator with unit other than frequency is used, an invalid suffix error message is generated</p>
Dependencies	Not available in MSR, LTE-Advanced FDD/TDD and 5G NR Modes
Preset	<p>Depends on instrument maximum frequency, mode, measurement, and selected input</p> <p>See "Center Frequency Presets" on page 861 and "RF Center Freq" on page 863 and "Ext Mix Center Freq" on page 864 and "I/Q Center Freq" on page 865 and "VXT Models with Radio Heads/CIU Frequency Range" on page 863</p>
State Saved	Saved in instrument state
Min/Max	<p>Depends on instrument maximum frequency, mode, measurement, and selected input</p> <p>See "Center Frequency Presets" on page 861 and "RF Center Freq" on page 863 and "I/Q Center Freq" on page 865 and "VXT Models with Radio Heads/CIU Frequency Range" on page 863</p>
Annotation	Center <value> appears in the lower left corner of the display
Status Bits/OPC dependencies	Non-overlapped

Center Frequency Presets

The following table provides the Center Frequency Presets for the Spectrum Analyzer mode, and the Max Freq, for the various frequency options:

Freq Option	CF after Mode Preset	Stop Freq after Mode Preset	Max Freq (can't tune above)
503 (all but CXA)	1.805 GHz	3.6 GHz	3.7 GHz
503 (CXA)	1.505 GHz	3.0 GHz	3.08 GHz
507 (all but CXA)	3.505 GHz	7.0 GHz	7.1 GHz
507 (CXA)	3.755 GHz	7.5 GHz	7.58 GHz
508 (all but MXE)	1.805 GHz	3.6 GHz	8.5 GHz
508 (MXE)	4.205 GHz	8.4 GHz	8.5 GHz
513	6.805 GHz	13.6 GHz	13.8 GHz

Freq Option	CF after Mode Preset	Stop Freq after Mode Preset	Max Freq (can't tune above)
526 (except CXA and MXE)	13.255 GHz	26.5 GHz	27.0 GHz*
526 (CXA)	13.255 GHz	26.5 GHz	26.55 GHz
526 (MXE)	1.805 GHz	3.6 GHz	27.0 GHz
532	16.005 GHz	32.0 GHz	32.5 GHz
540	20.005 GHz	40.0 GHz	40.5 GHz
543	21.505 GHz	43.0 GHz	43.0 GHz
544	22.005 GHz	44.0 GHz	45.0 GHz
550	25.005 GHz	50.0 GHz	52 GHz
F03 (CXA-m)	1.505 GHz	3.0 GHz	3.08 GHz
F07 (CXA-m)	3.755 GHz	7.5 GHz	7.575 GHz
F13 (CXA-m)	6.805 GHz	13.6 GHz	13.8 GHz
F26 (CXA-m)	13.255 GHz	26.5 GHz	26.55 GHz
504 (M9421A, M8920A)	2.145 GHz	3.88GHz	3.88 GHz
506 (M9421A, M8920A)	3.245 GHz	6.08GHz	6.08 GHz
F06 (M9410A/11A)	1.0 GHz	6.08 GHz	6.08 GHz
F06 (M9415A)	1 GHz	1.08 GHz	6.6 GHz
F08 (M9415A)	1 GHz	1.08 GHz	8.6 GHz
F12 (M9415A)	1 GHz	1.08 GHz	12.9 GHz

*For option 526, the Max CF in RTSA is 26.999999995 GHz.

N9041B Center Freq Presets

Input	CF after Mode Preset	Stop Freq after Mode Preset	Max Freq (can't tune above)
Input 1, all models	25.005 GHz	50.0 GHz	52 GHz
Input 2, opt 585	42.505 GHz	85.0 GHz	86 GHz
Input 2, opt 590	45.005 GHz	90.0 GHz	92 GHz
Input 2, opt 5CX	55.005 GHz	110.0 GHz	110 GHz

Input 2, CXA and MXE

Model	CF after Mode Preset	Stop Freq after Mode Preset	Max Freq (can't tune above)
CXA opt C75	0.7505 GHz	1.5 GHz	1.58 GHz
MXE	505 MHz	1 GHz	1.000025 GHz

Tracking Generator Frequency Limits (CXA only)

3 VMA Mode
 3.5 Channel Power Measurement

Tracking Generator Option	Min Freq (clips to this freq when turn TG on and can't tune below while TG on)	If above this Freq, Stop Freq clipped to this Freq when TG turned on	Max Freq (can't tune above) while TG on
T03	9 kHz	3.0 GHz	3.08 GHz
T06	9 kHz	6.0 GHz	6.05 GHz

Tracking Generator Frequency Limits(CXA-m only)

Tracking Generator Option	Min Freq (clips to this freq when turn TG on and can't tune below while TG on)	If above this Freq, Stop Freq clipped to this Freq when TG turned on	Max Freq (can't tune above) while TG on
T03	2 MHz	3.08 GHz	3.08 GHz
T07	2 MHz	7.575 GHz	7.575 GHz
T13	2 MHz	13.8 GHz	13.8 GHz
T26	2 MHz	26.55 GHz	26.55 GHz

VXT Models with Radio Heads/CIU Frequency Range

The following table shows the Center Frequency Presets and Range for VXT modes with Radio Heads/CIU.

Products with Radio Heads/CIU	Preset	Start frequency	Stop frequency
M9421A + CIU	6 GHz	5.9 GHz	12 GHz
M9410A + CIU	6 GHz	5.9 GHz	12 GHz
M9410A + CIU + RRH	25 GHz	24.25 GHz	43.5 GHz

RF Center Freq

Sets the **Center Frequency** to use when the RF input is selected, even if the RF input is not the input that is selected at the time the command is sent. Note that **Center Frequency** in the **Frequency** menu on the front panel *always* applies to the currently selected input.

Remote Command	<code>[:SENSe] :FREQuency:RF:CENTer <freq></code> <code>[:SENSe] :FREQuency:RF:CENTer?</code>
Example	<code>:FREQ:RF:CENT 30 MHz</code> <code>:FREQ:RF:CENT?</code>
Notes	This command is the same in all Modes, but the parameter is Measurement Global, so the value is independent in each mode and common across all the measurements in the mode
Dependencies	If the electronic/soft attenuator is enabled, any attempt to set Center Frequency such that the Stop Frequency would be >3.6 GHz fails and results in an advisory message

	If the equivalent SCPI command is sent, this same message is generated as part of a “-221, Settings conflict” warning
Preset	See table above
State Saved	Saved in instrument state
Min	-79.999995 MHz
Max	26.99999995 GHz See " Center Frequency Presets " on page 861. Basically, instrument maximum frequency - 5 Hz If the knob or step keys are being used, also depends on " Span " on page 865

Ext Mix Center Freq

Sets the **Center Frequency** to use when the External Mixer is selected, even if the External Mixer input is not the input which is selected at the time the command is sent. Note that **Center Frequency** in the **Frequency** menu on the front panel *always* applies to the currently selected input.

Remote Command	<code>[:SENSe] :FREQUency :EMIXer :CENTer <freq></code> <code>[:SENSe] :FREQUency :EMIXer :CENTer?</code>
Example	<code>:FREQ:EMIX:CENT 60 GHz</code> <code>:FREQ:EMIX:CENT?</code>
Notes	This command is the same in all Modes, but the parameter is Measurement Global, so the value is independent in each Mode and common across all measurements in the Mode
Couplings	When returning to External Mixing after having been switched to one of the other inputs (for example, RF), you will return to the settings that you had when you left External Mixing, so you will return to the band you were in, with the Center Frequency that you had. However, " Span " on page 865 is not an input-dependent parameter, so you will retain the span from the other input. Therefore, the instrument comes back with the span from the previous input, limited as necessary by the current mixer setup
Preset	When a Mode Preset is performed while in External Mixing, the Start frequency of the current Mode is set to the nominal Min Freq of the lowest harmonic range in the Harmonic Table for the current mixer setup. Similarly, the Stop frequency of the current Mode is set to the nominal Max Freq of the highest harmonic range in the Harmonic Table. Center Frequency thus presets to the point arithmetically equidistant from these two frequencies Note that, if the current measurement has a limited Span available to it, and cannot achieve the Span shown in the table ($\text{Span} = \text{Stop Freq} - \text{Start Freq}$), the instrument uses the maximum Span the measurement allows, and still sets Center Frequency to the midpoint of the Start and Stop Freq values in the Harmonic Table When Restore Input/Output Defaults is performed, the mixer presets to the 11970A values, whose Start and Stop frequencies are 26.5 and 40 GHz respectively. The center of these two frequencies is 33.25 GHz Therefore, following Restore Input/Output Defaults , if you go into External Mixing and do a Mode Preset while in Spectrum Analyzer Mode, the resulting Center Frequency is 33.25 GHz
State Saved	Yes

3 VMA Mode
3.5 Channel Power Measurement

Min	The minimum frequency in the currently selected mixer band + 5 Hz If the knob or step keys are being used, also depends on Span
Max	The maximum frequency in the currently selected mixer band – 5 Hz If the knob or step keys are being used, also depends on Span

I/Q Center Freq

Sets the **Center Frequency** to use when the I/Q input is selected, even if the I/Q input is not the input which is selected at the time the command is sent. Note that **Center Frequency** in the **Frequency** menu on the front panel always applies to the currently selected input.

Remote Command	<code>[:SENSe] :FREQUency :IQ :CENTer <freq></code> <code>[:SENSe] :FREQUency :IQ :CENTer ?</code>
Example	<code>:FREQ :IQ :CENT 30 MHz</code>
Notes	This command is the same in all Modes, but the parameter is Measurement Global, so the value is independent in each Mode and common across all measurements in the Mode
Preset	0 Hz
State Saved	Saved in instrument state
Min/Max	-/+40.049995 MHz

Span

Changes the displayed frequency range symmetrically about the center frequency. While adjusting **Span**, **Center Frequency** is held constant, which means that both Start Frequency and Stop Frequency will change.

If **Span** is set to a value greater than the maximum allowable span of the instrument, an error message is generated indicating the data is out of range and was clipped to upper limit.

The default (and minimum) **Span** is calculated using the number of carriers and the carrier width where;

$$\text{Span} = (\text{Upper Carrier Freq} + (\text{max offset IBW} * (1 + \alpha)) / 2) - (\text{Lower Carrier Freq} - (\text{max offset IBW} * (1 + \alpha)) / 2)$$

If the RRC Filter is on, then span is increased by a factor of 1 + Filter Alpha.

See "[Span Presets](#)" on page 867

Remote Command	<code>[:SENSe] :CHPower :FREQUency :SPAN <freq></code> <code>[:SENSe] :CHPower :FREQUency :SPAN ?</code>
Example	<code>:CHP :FREQ :SPAN 10 MHz</code>

:CHP:FREQ:SPAN?	
Dependencies	<p>If the electrical attenuator is enabled, any attempt to set Span such that the Stop Frequency would be >3.6 GHz results in an error</p> <p>In instruments with an RF Preselector, such as MXE, you cannot sweep across the band break at 3.6 GHz while the RF Preselector is on in Continuous sweep, as there is a mechanical switch which bypasses the RF Preselector above 3.6 GHz. See the Stop Frequency control description for details of this limitation</p> <p>For MSR Mode, this control is not shown</p> <p>For WLAN 802.11ac (80 MHz + 80 MHz), the control is not enabled, and its value is coupled with the spacing between the center frequencies of the two carriers</p> <p>$\text{Span} = \text{Center Frequency 1} - \text{Center Frequency 2} + \text{Integ BW} + 40 \text{ MHz Margin}$</p> <p>When the calculated span is over 1 GHz, it is still coupled to its maximum value, which is 1 GHz</p>
Couplings	<p>Span affects "Res BW" on page 847, Sweep Time, FFT & Sweep choice (including FFT Width, Phase Noise Optimization and ADC Dither auto couplings)</p> <p>Any value of Center Frequency or Span that is within the frequency range of the instrument is allowed <i>when</i> the value is being set through the front panel numeric keypad or the SCPI command. The other parameter is forced to a different value if needed, to keep the Start and the Stop Frequencies within the instrument's frequency range</p> <p>When using the knob or the step up/down keys or the UP DOWN keywords in SCPI, the value that is being changed, that is, Center Frequency or Span, is limited so that the other parameter is not forced to a new value</p> <p>When Res BW is set to Auto, the resolution bandwidth is auto-coupled to span. The ratio of span /RBW is approximately 106:1. When Res BW is set to Man, bandwidths are entered by the user, and these bandwidths are used regardless of other instrument settings</p> <p>Since Span is coupled to Integ BW in the factory default condition, if you change the Integ BW setting, the span setting changes by a proportional amount until a limit value is reached. However, the span can be individually set. The minimum value of the span is coupled with the integration bandwidth</p> <p>Span cannot be set less than the Integ BW value. When Span is changed, the ratio of Span/Integ BW is set, and retained when Integ BW is changed</p>
Preset	<p>Depends on instrument maximum frequency, mode, measurement, and selected input</p> <p>See "Span Presets" on page 867</p>
State Saved	Saved in instrument state
Min	<p>100 Hz</p> <p>In 5G NR, LTEAFDD, and LTEATDD Modes, this value is the minimum value required for the measurement, which depends on the Component Carrier configuration</p>
Max	<p>Depends on instrument maximum frequency, mode, measurement, and selected input. See "Span Presets" on page 867</p> <p>If the knob or step keys are being used, depends on the value of the other three interdependent parameters Center Frequency, Start Frequency, Stop Frequency</p>
Annunciation	Data out of range, value clipped to upper limit
Annotation	Span <value> appears on the first line of the annotation in the lower right corner of display

LTE, 5G NR Modes only:

3 VMA Mode
3.5 Channel Power Measurement

Remote Command	<code>[:SENSe]:CHPower:FREQuency:SPAN:AUTO ON OFF 1 0</code> <code>[:SENSe]:CHPower:FREQuency:SPAN:AUTO?</code>
Example	<code>:CHP:FREQ:SPAN:AUTO OFF</code> <code>:CHP:FREQ:SPAN:AUTO?</code>
Notes	The span value is adjusted when the relevant carrier parameters such as bandwidth, integration bandwidth, number of component carriers etc., are changed, whatever the span state (Auto or Man) When in Man state, if the input value is less than the required sum of total integration bandwidths and gaps of the multi-carriers, the required span value is set
Dependencies	Only available in LTE/LTE-Advanced FDD/TDD Modes and 5G NR Mode, CHP measurement
Preset	ON
State Saved	Saved in instrument state
Range	Auto Man

Span Presets

The following table provides the Max Span, for the various frequency options:

Freq Option	Max Span (can't set higher than this)
503 (all but CXA)	3.7 GHz
503, F03 (CXA, CXA-m)	3.08 GHz
507 (all but CXA)	7.1 GHz
507 (CXA, CXA-m)	7.575 GHz
508 (all but MXE)	8.5 GHz
508 (MXE)	8.5 GHz
513, F13	13.8 GHz
526 (all but CXA and MXE)	27.0 GHz
526 (MXE)	27.0 GHz
526, F26 (CXA, CXA-m)	26.55 GHz
544	44.5 GHz
550	52 GHz

Freq Option	Max Span (can't set higher than this)
F06 (VXT models M9410A/11A)	5.75 GHz
F06 & EP6 (VXT models M9410A/11A)	6.27 GHz
F06 & LFE & EP6 (VXT models M9411A)	6.5999935 GHz
M9415A-F06	6.27 GHz
M9415A-F08	8.27 GHz
M9415A-F12	12.57 GHz

Input 2:

Model	Max Span (can't set higher than this)
CXA opt C75	1.58 GHz
MXE	1.000025 GHz

Note that if you are in External Mixing, the maximum Span will be equal to the Maximum Stop Frequency – Minimum Start Frequency for the currently selected mixer.

Span Presets by Mode

Mode	Radio Std	Preset Value
SA		3 MHz
WCDMA		7.5 MHz
LTE		7.5 MHz
LTETDD		7.5 MHz
5G NR		150 MHz
WLAN	802.11a/g(OFDM/DSSS-OFDM)	30 MHz
	802.11b	37.5 MHz
	802.11n/ac/ax/be 20MHz	30 MHz
	802.11n/ac/ax/be 40MHz	60 MHz
	802.11n/ac/ax/be 80 MHz	120 MHz
	802.11n/ac/ax/be 160 MHz	240 MHz
	802.11n/ac/ax/be 80 MHz + 80 MHz	360 MHz
	802.11be 320 MHz	480MHz
	802.11be 160MHz + 160MHz	440MHz

CF Step

Changes the step size for **Center Frequency** and start and stop frequency functions. Once a step size has been selected and the center frequency function is active, the step keys (and the **UP | DOWN** parameters for **Center Frequency** from remote commands) change the center frequency by the step-size value. The step size function is useful for finding harmonics and sidebands beyond the current frequency span of the instrument.

Note that the start and stop frequencies also step by the **CF Step** value.

Remote Command	<code>[:SENSe]:FREQuency:CENTer:STEP[:INCRement] <freq></code> <code>[:SENSe]:FREQuency:CENTer:STEP[:INCRement]?</code>
Example	Increase the current center frequency value by 500 MHz: <code>:FREQ:CENT:STEP 500 MHz</code> <code>:FREQ:CENT UP</code>
Notes	Preset and Max values depend on Hardware Options
Dependencies	If the electronic/soft attenuator is enabled, any attempt to change the value of the center frequency >3.6 GHz by pressing the Up-arrow key, fails and results in an advisory message. If the equivalent SCPI command is sent, this same message is generated as part of a “-221, Settings conflict” warning Not available in the MSR, LTE-A FDD/TDD and 5G NR Modes
Couplings	When auto-coupled, the center frequency step size is set to 10% of the span
Preset	Auto
State Saved	Saved in instrument state
Min/Max	-/+ (the maximum frequency of the instrument) That is, 27 GHz max freq instrument has a CF step range of ±27 GHz. Note that this is the maximum frequency given the current settings of the instrument, so in External Mixing, for example, it is the maximum frequency of the current mixer band
Status Bits/OPC dependencies	non-overlapped

Auto Function

Remote Command	<code>[:SENSe]:FREQuency:CENTer:STEP:AUTO OFF ON 0 1</code> <code>[:SENSe]:FREQuency:CENTer:STEP:AUTO?</code>
Example	<code>:FREQ:CENT:STEP:AUTO ON</code> <code>:FREQ:CENT:STEP:AUTO?</code>

Full Span (Remote Command Only)

Changes the span to show the full frequency range of the instrument. It maximizes the span within a range not changing the center frequency.

Remote Command	<code>[:SENSe] :CHPower:FREQuency:SPAN:FULL</code>
Example	<code>:CHP:FREQ:SPAN:FULL</code>
Couplings	Selecting full span changes the measurement span value

3.5.7 Marker

Accesses a menu that enables you to select, set up and control the markers for the current measurement. If there are no active markers, **Marker** selects marker 1, sets it to Normal and places it at the center of the display. If the selected marker is Off, it is set to Normal and placed it at the center of the screen on the trace determined by the **Marker Trace** rules.

3.5.7.1 Select Marker

Specifies the *selected marker*. The term “selected marker” is used throughout this document to specify which marker will be affected when you change marker settings, perform a Peak Search, etc.

This control appears above the menu panel, indicating that it applies to all controls in the **Marker** menu panels. If you select a tab whose controls do *not* depend on the selected marker (for example, Counter), then this control is blanked.

For any menu that includes **Select Marker**, the first control is always **Marker Frequency**.

Notes	The selected marker is remembered even when not in the Marker menu and is used if a Search is done or a Band Function is turned on or for Signal Track or Continuous Peak
Preset	Marker 1
State Saved	The number of the selected marker is saved in instrument state
Annunciation	Appears in the marker results block label for Normal , Delta and Fixed markers

3.5.7.2 Settings

The controls on this tab include the Marker active function and a radio button selection of the marker control mode (**Normal**, **Delta**, or **Off**) for the selected marker, as well as additional functions that help you use markers.

Marker Frequency

Sets the marker X Axis value in the current marker X Axis Scale unit. It has no effect if the control mode is **Off**, but is the SCPI equivalent of entering an X value if the

control mode is **Normal** or **Delta**.

Remote Command	<code>:CALCulate:CHPower:MARKer[1] 2 ... 12:X <freq></code> <code>:CALCulate:CHPower:MARKer[1] 2 ... 12:X?</code>
Example	<code>:CALC:CHP:MARK3:X 0</code> <code>:CALC:CHP:MARK3:X?</code>
Notes	If no suffix is sent, uses the fundamental units for the current marker X Axis Scale. If a suffix is sent that does not match the current marker X Axis Scale unit, an error "Invalid suffix" is generated The query returns the marker's absolute X Axis value if the control mode is Normal , or the offset from the marker's reference marker if the control mode is Delta . The query is returned in the fundamental units for the current marker X Axis scale: Hz for Frequency and Inverse Time, seconds for Period and Time
Preset	After a preset, all markers are turned OFF , so Marker X-Axis Value query returns Not A Number (NAN)
State Saved	Saved in instrument state
Min/Max	-/+9.9E+37
Annotation	Mkr # <X value> and <Marker value> upper right on graph

Marker X Axis Position (Remote Command Only)

Sets the marker X-Axis Scale position in trace points. This setting has no effect if the control mode is **Off**, but is the SCPI equivalent of entering a value if the control mode is **Normal** or **Delta**, except in trace points rather than X-Axis Scale units. The entered value is immediately translated into the current X-Axis Scale units for setting the value of the marker.

Remote Command	<code>:CALCulate:CHPower:MARKer[1] 2 ... 12:X:POSition <real></code> <code>:CALCulate:CHPower:MARKer[1] 2 ... 12:X:POSition?</code>
Example	<code>:CALC:CHP:MARK10:X:POS 0</code> <code>:CALC:CHP:MARK10:X:POS?</code>
Notes	The query returns the marker's absolute X-Axis value in trace points if the control mode is Normal , or the offset from the marker's reference marker in trace points if the control mode is Delta . The value is returned as a real number, not an integer, corresponding to the translation from X-Axis Scale units to trace points. When a marker is turned on, it is placed at the center of the screen on the trace. Therefore, the default value depends on instrument condition. If the marker is Off , the response is Not A Number
Preset	After a preset, all markers are turned Off , so the query returns Not A Number (NAN)
State Saved	Saved in instrument state
Min/Max	-/+9.9E+37

Marker Y Axis Value (Remote Query only)

Returns the marker Y Axis value in the current marker Y-Axis unit.

Remote Command	:CALCulate:CHPower:MARKer[1] 2 ... 12:Y?
Example	:CALC:CHP:MARK11:Y?
Notes	Returns the marker Y-Axis result if the control mode is Normal or Delta If the marker is Off , then the response is Not A Number
Preset	Result dependent on Markers setup and signal source
State Saved	No
Backwards Compatibility SCPI	:CALCulate:CHPower:MARKer[1] 2 ... 12:FUNCTION:RESult?

Marker Mode

Sets the marker control mode to **POSITION** (**Normal**), **DELTA**, or **OFF**. All interactions and dependencies detailed under the control description are enforced when the remote command is sent. If the selected marker is **OFF**, pressing **Marker** sets it to **POSITION** and places it at the center of the screen on the trace determined by the **Marker Trace** rules. At the same time, **Marker X Axis Value** appears on the Active Function area.

The default active function is the active function for the currently selected marker control mode. If the current control mode is **OFF**, there is no active function, and the active function is turned off.

Remote Command	:CALCulate:CHPower:MARKer[1] 2 ... 12:MODE Position DELTa OFF :CALCulate:CHPower:MARKer[1] 2 ... 12:MODE?
Example	:CALC:CHP:MARK3:MODE POS :CALC:CHP:MARK3:MODE?
Preset	OFF
State Saved	Saved in instrument state
Range	POSITION DELTA OFF
Annotation	Mkr # <X value> and <Marker value> upper right on graph When Marker Trace is Polar in WCDMA mode: Mkr # <Chip Value (RHO & QPSKEVM)/Symbol Value (CDP)>, <X value> and <Y value> upper right on graph

Backwards Compatibility SCPI Commands

Sets or queries the state of a marker. Setting a marker that is **OFF** to **ON** (1) puts it in **POSITION** (**Normal**) mode and places it at the center of the screen.

Example	<code>:CALC:CHP:MARK3:STAT ON</code> <code>:CALC:CHP:MARK3:STAT?</code>
Preset	OFF
State Saved	Saved in instrument state
Range	OFF ON
Backwards	<code>:CALCulate:CHPower:MARKer[1] 2 ... 12:STATe OFF ON 0 1</code>
Compatibility SCPI	<code>:CALCulate:CHPower:MARKer[1] 2 ... 12:STATe?</code>

Delta Marker (Reset Delta)

This control has the same effect as pressing **Delta** in "**Marker Mode**" on page 872. The selected marker becomes a **Delta** marker. If the selected marker is already a **Delta** marker, the reference marker is moved to the current position of the selected marker, thus resetting the Delta to zero.

Marker Settings Diagram

Lets you configure the Marker system using a visual utility.

All Markers Off

Turns off all markers.

Remote Command	<code>:CALCulate:CHPower:MARKer:AOFF</code>
Example	<code>:CALC:CHP:MARK:AOFF</code>

3.5.7.3 Peak Search

The controls on this tab let you move the marker to selected peaks of the signal, giving you enormous analysis capabilities, particularly when combined with "**Marker Delta**" on page 874.

NOTE Pressing the **Peak Search** hardkey automatically moves you to the **Peak Search** page of the **Marker** menu *and* performs a peak search. Pressing the **Peak Search** tab once you are already *in* the **Marker** menu does *not* perform a peak search.

Marker Frequency

This is the fundamental control that you use to move a marker around on the trace. It is the same as "[Marker Frequency](#)" on [page 870](#) in the **Settings** tab.

Peak Search

Moves the selected marker to the trace point that has the maximum Y-Axis value for that marker's trace.

NOTE

Pressing the **Peak Search** hardkey automatically moves you to the **Peak Search** page of the **Marker** menu *and* performs a peak search.

Remote Command	<code>:CALCulate:CHPower:MARKer[1] 2 ... 12:MAXimum</code>
Example	<code>:CALC:CHP:MARK2:MAX</code> <code>:SYST:ERR?</code> can be used to query the errors to determine if a peak is found. Following an unsuccessful search, the message "No peak found" is returned
Notes	Sending this command selects the subopcoded marker In W-CDMA Mode, this command does not work when the selected marker is located on the polar trace. In this case, the command is ignored

Marker Delta

Pressing this button has the same effect as pressing **Delta** in "[Marker Mode](#)" on [page 872](#) on the **Settings** tab. The selected marker becomes a **Delta** marker. If the selected marker is already a **Delta** marker, the reference marker is moved to the current position of the selected marker, thus resetting the delta to zero.

The control is duplicated here to allow you to conveniently perform a peak search and change the marker's control mode to **Delta** without having to access two separate menus.

3.5.7.4 Properties

The controls on this tab are used to set certain properties of the selected marker.

Marker Frequency

This is the fundamental control that you use to move a marker around on the trace. It is the same as "[Marker Frequency](#)" on page 870 in the **Settings** tab.

Relative To

Selects the marker to which the selected marker is relative (its reference marker).

Every marker has another marker to which it is relative. This marker is referred to as the "reference marker" for that marker. The marker must be a **Delta** marker to make this attribute relevant. If it is a **Delta** marker, the reference marker determines how the marker is controlled and how its value is displayed. A marker cannot be relative to itself.

Remote Command	<code>:CALCulate:CHPower:MARKer[1] 2 ... 12:REFerence <integer></code>
Example	<code>:CALC:CHP:MARK:REF 5</code> <code>:CALC:CHP:MARK:REF?</code>
Notes	Causes the marker specified with the subopcode to become selected Range (for SCPI command): 1 to 12. If the range is exceeded the value is clipped A marker cannot be relative to itself so that choice is not available, and if sent from SCPI generates error -221: "Settings conflict; marker cannot be relative to itself" When queried a single value is returned (the specified marker numbers relative marker)
Couplings	If the reference marker is Off , it is turned on in Normal mode at the delta marker location
Preset	The preset default "Relative To" marker (reference marker) is the next higher numbered marker (current marker +1). For example, if marker 2 is selected, then its default reference marker is marker 3. The exception is marker 12, which has a default reference of marker 1 Set to the defaults by using Restore Mode Defaults . Not reset by Marker Off , All Markers Off , or Preset
State Saved	Saved in instrument state. Not affected by Marker Off, and hence not affected by Preset or power cycle
Min	1
Max	12
Annunciation	Appears in the marker label of a Delta marker

Marker Trace

Selects the trace on which you want your marker placed. A marker is associated with one and only one trace. This trace is used to determine the placement, result, and X-Axis Scale of the marker. All markers have an associated trace; it is from that trace that they determine their attributes and behaviors, and it is to that trace that they go when they become **Normal** or **Delta** markers.

Specifying a **Marker Trace** manually or with this command associates the marker with the specified trace. If the marker is not **Off**, it moves the marker from the trace it was on to the new trace. If the marker is **Off**, it stays off but is now associated with the specified trace.

The query returns the number of the trace on which the marker is currently placed.

Remote Command	<code>:CALCulate:CHPower:MARKer[1] 2 ... 12:TRACe 1 2 3</code> <code>:CALCulate:CHPower:MARKer[1] 2 ... 12:TRACe?</code>
Example	<code>:CALC:CHP:MARK2:TRAC 2</code> <code>:CALC:CHP:MARK2:TRAC?</code>
Notes	A marker may be placed on a blanked and/or inactive trace, even though the trace is not visible and/or updating An application may register a trace name to be displayed on the control instead of a trace number
Couplings	The state of Marker Trace is not affected by " Auto Couple " on page 1825 Sending the remote command causes the addressed marker to become selected
Preset	1
State Saved	Saved in instrument state

Marker Settings Diagram

Lets you configure the **Marker** system using a visual utility. It is the same as "[Marker Settings Diagram](#)" on page 873 in the **Settings** tab.

3.5.8 Meas Setup

Contains functions for setting up the measurement parameters and also contains functions for setting up parameters global to all measurements in the Mode.

3.5.8.1 Settings

Contains frequently used **Meas Setup** functions to which you will want the fastest access.

Avg/Hold Number

Specifies the number of measurement averages used to calculate the measurement result. The average is displayed at the end of each sweep. After the specified number of average counts, the averaging mode (terminal control) setting determines the averaging action.

Remote	<code>[[:SENSe]:CHPower:AVERage:COUNT <integer></code>
--------	--

Command	<code>[:SENSe] :CHPower:AVERage:COUNT?</code>
Example	<code>:CHP:AVER:COUN 15</code> <code>:CHP:AVER:COUN?</code>
Preset	SA, WLAN: 10 WCDMA, LTEAFDD, LTEATDD, 5G NR, MSR: 200
State Saved	Saved in instrument state
Min/Max	1 / 10000
Annotation	The average count is displayed in the measurement bar on the front panel display. The annotation appears in the format n/N where n is the current average and N is the average count

Averaging On/Off

Turns averaging on or off for this measurement.

NOTE

In this measurement, the **Average Type** is preset to the **Log-Pwr Avg (Video)** method. Other averaging methods are not available.

Remote Command	<code>[:SENSe] :CHPower:AVERage[:STATe] ON OFF 1 0</code> <code>[:SENSe] :CHPower:AVERage[:STATe]?</code>
Example	<code>:CHP:AVER ON</code> <code>:CHP:AVER?</code>
Preset	ON
State Saved	Yes
Range	ON OFF

Avg Mode

Allows you to select the type of termination control used for the averaging function. This determines the averaging action after the specified number of data acquisitions (average count) is reached. Options are:

- **EXponential**: The measurement averaging continues using the specified number of averages to compute each exponentially-weighted averaged value. The average is displayed at the end of each sweep
- **REPeat**: The measurement resets the average counter each time the specified number of averages is reached

Remote Command	<code>[:SENSe] :CHPower:AVERage:TCONtrol EXponential REPeat</code> <code>[:SENSe] :CHPower:AVERage:TCONtrol?</code>
----------------	--

Example	<code>:CHP:AVER:TCON EXP</code> <code>:CHP:AVER:TCON?</code>
Preset	EXP
State Saved	Yes
Range	EXPonential REPeat

Integ BW

Specifies the range of integration used in calculating the power in the channel. The integration bandwidth (IBW) is displayed on the trace as two markers connected by an arrow.

Remote Command	<code>[:SENSe] :CHPower :BANDwidth :INTEgration <bandwidth></code> <code>[:SENSe] :CHPower :BANDwidth :INTEgration?</code>		
Example	<code>:CHP :BAND :INT 10MHz</code> <code>:CHP :BAND :INT?</code>		
Dependencies	For LTE-Advanced FDD/TDD, 5G NR and MSR Modes, this control is not shown		
Couplings	The minimum value of the span is coupled with Integ BW When you change Integ BW, the span changes accordingly by keeping the same ratio of Span/Integ BW		
Preset	Mode	Radio Std	Integ BW
	SA		2 MHz
	WCDMA		5 MHz
	LTEAFDD, LTEATDD		5 MHz
	WLAN	802.11a/g(OFDM/DSSS-OFDM)	20 MHz
		802.11b	25 MHz
		802.11n/ac/ax/be (20MHz)	20 MHz
		802.11n/ac/ax/be (40MHz)	40 MHz
		802.11n/ac/ax/be (80MHz)	80 MHz
		802.11ax/be (80 MHz + 80 MHz)	80 MHz
		802.11ac/ax/be (160 MHz)	160 MHz
		802.11be (160 MHz + 160MHz)	160 MHz
		802.11be (320MHz)	320 MHz
State Saved	Saved in instrument state		
Min/Max	100 Hz / Hardware Maximum Span		
Backwards Compatibility SCPI	<code>[:SENSe] :CHPower :BWIDth :INTEgration</code>		

PSD Unit

Sets the unit bandwidth for Power Spectral Density. The available units are dBm/Hz (**DBMHZ**) and dBm/MHz (**DBMMHZ**).

Remote Command	<code>:UNIT:CHPower:POWer:PSD DBMHZ DBMMHZ</code> <code>:UNIT:CHPower:POWer:PSD?</code>
Example	<code>:UNIT:CHP:POW:PSD DBMMHZ</code> <code>:UNIT:CHP:POW:PSD?</code>
Couplings	When the PSD unit is changed, the response to <code>:MEAS READ FETCH:CHP1?</code> also changes by the PSD unit basis (either dBm/Hz or dBm/MHz)
Preset	WLAN mode or SA mode with WLAN radio standard: DBMMHZ Otherwise: DBMHZ
State Saved	Saved in instrument state
Range	dBm/Hz dBm/MHz

IF Gain

Sets **IF Gain** to Auto, Low Gain or High Gain. These settings affect sensitivity and IF overloads.

Remote Command	<code>[:SENSe]:CHPower:IF:GAIN[:STATe] ON OFF 1 0</code> <code>[:SENSe]:CHPower:IF:GAIN[:STATe]?</code>
Example	<code>:CHP:IF:GAIN ON</code> <code>:CHP:IF:GAIN?</code>
Notes	ON = high gain OFF = low gain
Dependencies	The IF Gain controls (FFT IF Gain and Swept IF Gain) have no effect when the U7227A USB Preamp-lifier is connected. This is not annotated or reflected on any control; there are no controls grayed out nor any SCPI locked out. The instrument simply behaves as though both FFT IF Gain and Swept IF Gain are set to Low regardless of the setting on the controls Not available in VXT model M9421A
Preset	OFF
State Saved	Saved in instrument state
Range	Low Gain High Gain Auto Function
Remote Command	<code>[:SENSe]:CHPower:IF:GAIN:AUTO[:STATe] ON OFF 1 0</code> <code>[:SENSe]:CHPower:IF:GAIN:AUTO[:STATe]?</code>

Example	<code>:CHP:IF:GAIN:AUTO ON</code> <code>:CHP:IF:GAIN:AUTO?</code>
Couplings	Auto sets IF Gain to High Gain if the input attenuator is set to 0 dB, or if the preamp is turned on and the frequency range is under 3.6 GHz For other conditions, Auto sets IF Gain to Low Gain
Preset	<code>OFF</code>

Spur Avoidance

Because VXT models M9410A/11A/15A are direct-conversion (zero-IF) receivers, feedthrough leakage from the local oscillator appears as a spurious signal (spur) at the center frequency. The **Spur Avoidance** function is provided to eliminate this spur, at the expense of some measurement speed.

When **Spur Avoidance** is **Enabled** (the default), the instrument uses a software algorithm to remove this spur from the displayed measurement data, but the algorithm only operates under certain conditions. Specifically, it only operates in the multiple capture case.

You can disable this function to speed up your measurement by setting **Spur Avoidance** to **Disabled** (`OFF`).

Note that when **Spur Avoidance** is not in effect, either because you have disabled it or because you are not in multiple capture, the following warning message will appear in the status bar:

`Settings Alert;Spur Avoidance Off`

This is to alert you that measurement accuracy might be negatively impacted.

Remote Command	<code>[:SENSe]:CHPower:SAVoid[:STATe] ON OFF 0 1</code> <code>[:SENSe]:CHPower:SAVoid[:STATe]?</code>
Example	<code>:CHP:SAV ON</code> <code>:CHP:SAV?</code>
Dependencies	Only appears in VXT models M9410A/11A/15A
Preset	<code>OFF</code>
State Saved	Saved in instrument state
Range	<code>ON OFF</code>

Meas Setup Summary Table

Lets you view and access many of the parameters in the **Meas Setup** menus on one screen.

Auto Couple

Immediately puts all **Auto/Man** functions into **Auto**. **Auto Couple** is confined to the current measurement only. It does not affect other measurements in the Mode.

In the **Auto** state, **Auto/Man** functions are said to be “coupled”, meaning their values change as you make changes to other values in the measurement. This helps ensure accurate measurements and optimum dynamic range. **Auto Couple** is an immediate action function, and when it is executed, all the **Auto/Man** controls for the current measurement are set to **Auto**, and all measurement settings coupled to the **Auto/Man** parameters are automatically set to their optimal values.

For further details of measurement-specific settings (if any), see "[Measurement-Specific Details](#)" on page 882 below.

Remote Command	:COUPle ALL
Example	:COUP ALL
Backwards Compatibility SCPI	:COUPLE ALL NONE
Backwards Compatibility Notes	: COUP :NONE puts all Auto/Man parameters in manual mode, decoupling all the coupled instrument parameters. It is retained for backwards compatibility and is <i>not</i> recommended for making measurements or new designs

All **Auto/Man** parameter couplings in the measurement are set to **Auto**. This includes couplings that may be unavailable or grayed-out due to the current state. For example, in the Swept SA measurement, there is no **Auto/Man** coupling for **RBW** while in Zero Span. Nonetheless, if **Auto Couple** were executed while in Zero Span, it would set **RBW** to Auto "behind the scenes" so that, on exit from Zero Span, it would be in **Auto**.

Any **Auto/Man** selection specific (local) to the other measurements in the current Mode are not affected by **Auto Couple**. Any functions that are *not* coupled with other instrument parameters, such as ranging or leveling variables, such as **AutoRange** or **AutoScale**, are not affected.

Executing **Auto Couple** generates the informational message, "All Auto/Man functions have been set to Auto".

Each parameter, upon being set to **Auto**, selects and sets the appropriate auto-coupled value based on that parameter's coupling rules. The Dependency Resolver orchestrates the couplings for parameters that depend on one or more other parameters. The coupling and dependency rules for each parameter are defined in the section describing that parameter.

Executing **Auto Couple** does not affect markers, marker functions, trace or display attributes, or any other instrument setting other than those specifically mentioned above.

Measurement-Specific Details

TOI (SA Mode only)

Parameters affected by **Auto Couple** are:

- Center Frequency Step
- Resolution Bandwidth
- Span/RBW Ratio
- Sweep Time
- Video BANDwidth VBW/RBW ratio
- Upper and Lower Tone (set to Sense)
- Zero span measurement Resolution Bandwidth
- Zero span measurement Dwell Time

Harmonics (SA Mode only)

Parameters affected by **Auto Couple** are:

- Resolution Bandwidth
- Fundamental Frequency
- Dwell Time
- Range Table Resolution Bandwidths
- Range Table Dwell Times

Meas Preset

Restores all measurement parameters to their default values.

Remote Command `:CONFigure:CHPower`

Example `:CONF:CHP`

3.5.8.2 Meas Method

Allows you to choose between Integration Bandwidth and RRC Weighted methods of making the measurement, and to set certain other relevant parameters.

In MSR, LTE-A FDD/TDD and 5G NR Modes, this feature is not supported.

Meas Method

Selects either the Integration BW (**OFF**) or RRC Weighted (**ON**) methods. Selecting the RRC Weighted method turns the Root Raised Cosine (RRC) filter on. The α value (roll off) for the filter is set to the value of "RRC Filter Alpha" on page 883, and the RRC filter bandwidth is set to "RRC Filter BW" on page 884.

Remote Command	<code>[:SENSe]:CHPower:FILTer[:RRC][:STATe] OFF ON 0 1</code> <code>[:SENSe]:CHPower:FILTer[:RRC][:STATe]?</code>
Example	<code>:CHP:FILT OFF</code> <code>:CHP:FILT?</code>
Notes	This parameter is normally used when TETRA is selected as the Radio Std
Dependencies	For WLAN 802.11 ac (80 + 80 MHz), RRC Weighted is not supported
Preset	OFF
State Saved	Saved in instrument state
Range	Integration BW RRC Weighted

RRC Filter Alpha

Inputs the alpha value for the Root Raised Cosine (RRC) filter.

Remote Command	<code>[:SENSe]:CHPower:FILTer[:RRC]:ALPHa <real></code> <code>[:SENSe]:CHPower:FILTer[:RRC]:ALPHa?</code>
Example	<code>:CHP:FILT:ALPH 0.5</code> <code>:CHP:FILT:ALPH?</code>
Notes	This parameter is normally used when TETRA is selected as the Radio Std
Preset	0.22
State Saved	Saved in instrument state
Min/Max	0.01 / 1.00

RRC Filter BW

Sets the Root Raised Cosine (RRC) filter bandwidth. Normally, the filter bandwidth is the same as the symbol rate of the signal.

Remote Command	<code>[:SENSe]:CHPower:FILTer[:RRC]:BANDwidth <real></code> <code>[:SENSe]:CHPower:FILTer[:RRC]:BANDwidth?</code>										
Example	<code>:CHP:FILT:BAND 10MHz</code> <code>:CHP:FILT:BAND?</code>										
Notes	This parameter is normally used when TETRA is selected as the Radio Std										
Preset	SA, WCDMA, LTE, LTETDD Modes: 3.84 MHz WLAN Mode:										
	<table border="1"> <thead> <tr> <th>Radio Std</th> <th>Value</th> </tr> </thead> <tbody> <tr> <td>802.11a/g (OFDM/DSSS-OFDM)</td> <td>16.6 MHz</td> </tr> <tr> <td>802.11b</td> <td>22 MHz</td> </tr> <tr> <td>802.11n (20MHz)</td> <td>17.8 MHz</td> </tr> <tr> <td>802.11n (40MHz)</td> <td>36.6 MHz</td> </tr> </tbody> </table>	Radio Std	Value	802.11a/g (OFDM/DSSS-OFDM)	16.6 MHz	802.11b	22 MHz	802.11n (20MHz)	17.8 MHz	802.11n (40MHz)	36.6 MHz
Radio Std	Value										
802.11a/g (OFDM/DSSS-OFDM)	16.6 MHz										
802.11b	22 MHz										
802.11n (20MHz)	17.8 MHz										
802.11n (40MHz)	36.6 MHz										
State Saved	Saved in instrument state										
Min/Max	100 Hz / 100 MHz										
Backwards Compatibility SCPI	<code>[:SENSe]:CHPower:FILTer[:RRC]:BWIDth</code>										

3.5.8.3 Limits

Lets you set up the test limit for channel power or power spectral density.

When DVB-T radio standard is selected in SA Mode, this functionality is disabled, and the input signal is instead compared against a pre-defined spectrum mask.

In LTE-A FDD/TDD and 5G NR Modes, this feature is not supported.

In MSR Mode, this feature is not supported, because the power of each carrier may be different.

Power Limit

If **Power Limit** state is **ON**, this setting is a threshold to determine whether the real measured channel power can be passed or not. If real measured channel power exceeds **Power Limit**, the channel power test fails, otherwise, it passes.

If **Power Limit** state is **OFF**, the channel power test always passes.

3 VMA Mode
3.5 Channel Power Measurement

Remote Command	<code>:CALCulate:CHPower:LIMit:POWer <ampl></code> <code>:CALCulate:CHPower:LIMit:POWer?</code>															
Example	<code>:CALC:CHP:LIM:POW 16.00</code> <code>:CALC:CHP:LIM:POW?</code>															
Notes	This parameter and PSD Limit can determine Pass/Fail criteria <table border="1"> <thead> <tr> <th>Power Limit state</th> <th>PSD Limit state</th> <th>Result</th> </tr> </thead> <tbody> <tr> <td>ON</td> <td>OFF</td> <td>Pass if power test passes Fail if power test fails</td> </tr> <tr> <td>ON</td> <td>ON</td> <td>Pass if both power test and PSD test pass Fail if either of power test or PSD test fails</td> </tr> <tr> <td>OFF</td> <td>ON</td> <td>Pass if PSD test passes Fail if PSD test fails</td> </tr> <tr> <td>OFF</td> <td>OFF</td> <td>Always Pass</td> </tr> </tbody> </table> <p>For WLAN 802.11ac (80 MHz + 80 MHz), the power test and the PSD test are performed to both carriers, which means the power (or PSD) readouts of both carriers should be compared with the power (or PSD) limit individually, and the test passes only when <i>both</i> values are lower than the limit</p>	Power Limit state	PSD Limit state	Result	ON	OFF	Pass if power test passes Fail if power test fails	ON	ON	Pass if both power test and PSD test pass Fail if either of power test or PSD test fails	OFF	ON	Pass if PSD test passes Fail if PSD test fails	OFF	OFF	Always Pass
Power Limit state	PSD Limit state	Result														
ON	OFF	Pass if power test passes Fail if power test fails														
ON	ON	Pass if both power test and PSD test pass Fail if either of power test or PSD test fails														
OFF	ON	Pass if PSD test passes Fail if PSD test fails														
OFF	OFF	Always Pass														
Preset	16.00															
State Saved	Saved in instrument state															
Min/Max	-/+200.0 Auto Function															
Remote Command	<code>:CALCulate:CHPower:LIMit:POWer:StAtE OFF ON 0 1</code> <code>:CALCulate:CHPower:LIMit:POWer:StAtE?</code>															
Example	<code>:CALC:CHP:LIM:POW:STAT ON</code> <code>:CALC:CHP:LIM:POW:STAT?</code>															
Preset	WLAN Mode: ON All other Modes: OFF															
State Saved	Yes															
Range	OFF ON															

PSD Limit

Power Spectral Density Limit.

If **PSD Limit** state is **ON**, **PSD Limit** is a threshold to determine whether the real measured PSD will pass or not. If real measured PSD exceeds PSD Limit, the test fails, otherwise, it passes.

If **PSD Limit** state is **OFF**, the test always passes.

Remote Command	<code>:CALCulate:CHPower:LIMit:PSDensity <real></code> <code>:CALCulate:CHPower:LIMit:PSDensity?</code>															
Example	<code>:CALC:CHP:LIM:PSD 4.00</code> <code>:CALC:CHP:LIM:PSD?</code>															
Notes	This parameter and Power Limit can determine Pass/Fail criteria <table border="1" data-bbox="393 508 1406 840"> <thead> <tr> <th>Power Limit state</th> <th>PSD Limit state</th> <th>Result</th> </tr> </thead> <tbody> <tr> <td>ON</td> <td>OFF</td> <td>Pass if power test passes Fail if power test fails</td> </tr> <tr> <td>ON</td> <td>ON</td> <td>Pass if both power test and PSD test pass Fail if either of power test or PSD test fails</td> </tr> <tr> <td>OFF</td> <td>ON</td> <td>Pass if PSD test passes Fail if PSD test fails</td> </tr> <tr> <td>OFF</td> <td>OFF</td> <td>Always Pass</td> </tr> </tbody> </table> <p>For WLAN 802.11ac (80 MHz + 80 MHz), the power test and the PSD test are performed to both carriers. Which means the PSD (or power) readouts of both carriers should be compared with the PSD (or power) limit individually, and the test passes only when both values are lower than the limit</p>	Power Limit state	PSD Limit state	Result	ON	OFF	Pass if power test passes Fail if power test fails	ON	ON	Pass if both power test and PSD test pass Fail if either of power test or PSD test fails	OFF	ON	Pass if PSD test passes Fail if PSD test fails	OFF	OFF	Always Pass
Power Limit state	PSD Limit state	Result														
ON	OFF	Pass if power test passes Fail if power test fails														
ON	ON	Pass if both power test and PSD test pass Fail if either of power test or PSD test fails														
OFF	ON	Pass if PSD test passes Fail if PSD test fails														
OFF	OFF	Always Pass														
Couplings	The value is automatically converted when PSD Unit is changed															
Preset	WLAN mode or SA mode with WLAN radio standard: 4.00 dBm/MHz Otherwise: 4.00 dBm/Hz															
State Saved	Saved in instrument state															
Min/Max	-/+200.0 Auto Function															
Remote Command	<code>:CALCulate:CHPower:LIMit:PSDensity:STATe OFF ON 0 1</code> <code>:CALCulate:CHPower:LIMit:PSDensity:STATe?</code>															
Example	<code>:CALC:CHP:LIM:POW:STAT ON</code> <code>:CALC:CHP:LIM:POW:STAT?</code>															
Preset	WLAN Mode: ON All other Modes: OFF															
State Saved	Yes															
Range	OFF ON															

Power Limit Fail (Remote Query Only)

Queries whether a power test passes or fails. When DVB-T radio standard is selected in SA Mode, the result of this query has no meaning.

3 VMA Mode
3.5 Channel Power Measurement

While implementing the scpi, don't try to remove the SCPI command from the SCPI tree when DVB-T is selected as current radio standard.

Remote Command	<code>:CALCulate:CHPower:LIMit:POWer:FAIL?</code>
Example	<code>:CALC:CHP:LIM:POW:FAIL?</code>
Notes	Query only When "Power Limit" on page 884 state is OFF , the returned value is always 0 (pass) When Power Limit state is ON , the returned value is 0 (pass) if power test passes and 1(fail) if power test fails

PSD Limit Fail (Remote Query only)

Queries whether PSD test passes or fails. When DVB-T radio standard is selected in SA Mode, the result of this query has no meaning.

While implementing the scpi, don't try to remove the SCPI command from the SCPI tree when DVB-T is selected as current radio standard.

Remote Command	<code>:CALCulate:CHPower:LIMit:PSD:FAIL?</code>
Example	<code>:CALC:CHP:LIM:PSD:FAIL?</code>
Notes	Query only When "PSD Limit" on page 885 state is OFF , the returned value is always 0 (pass) When PSD Limit state is ON , the returned value is 0 (pass) if PSD test passes and 1(fail) if PSD test fails

3.5.8.4 Advanced

Contains controls for setting advanced functions of the instrument.

Does not appear in VXT.

Phase Noise Optimization

Lets you select the LO (local oscillator) phase noise behavior for various operating conditions. When in Auto, selects the LO (local oscillator) phase noise behavior to optimize dynamic range and speed for various instrument operating conditions.

For full details, see "Parameter Options, Installed Options & Ranges" on page 888 below.

Remote Command	<code>[:SENSe] :CHPower:FREQuency:SYNThesis[:STATe] 1 ... 5</code> For the meaning of each numeric option value, see "Parameter Options, Installed Options & Ranges" on page 888 below
----------------	---

	<code>[:SENSe]:CHPower:FREQuency:SYNThesis[:STATe]?</code>
Example	<code>:CHP:FREQ:SYNT 1</code> <code>:CHP:FREQ:SYNT?</code>
Dependencies	Does not appear in all models. For models in which the control is not displayed, the SCPI command is accepted for compatibility, although no action is taken
Preset	3
State Saved	Saved in instrument state
Range	See "Ranges" on page 893 below
Auto Function	
Remote Command	<code>[:SENSe]:CHPower:FREQuency:SYNThesis:AUTO[:STATe] OFF ON 0 1</code> <code>[:SENSe]:CHPower:FREQuency:SYNThesis:AUTO[:STATe]?</code>
Example	<code>:CHP:FREQ:SYNT:AUTO 1</code> <code>:CHP:FREQ:SYNT:AUTO?</code>
Preset	OFF

Parameter Options, Installed Options & Ranges

The Phase Noise Optimization control lets you optimize the setup and behavior of the Local Oscillator (LO) depending on your specific measurement conditions. You may wish to trade off noise and speed, for example, to make a measurement faster without regard to noise or with optimum noise characteristics without regard to speed.

Parameter Values Summary

Option	#	Description
"Balanced" on page 889	1	<ul style="list-style-type: none"> In instruments with EPO, balances close-in phase noise with spur avoidance In instruments without EPO optimizes phase noise for small frequency offsets from the carrier
"Best Wide-offset" on page 890	2	Optimizes phase noise for wide frequency offsets from the carrier
"Fast Tuning" on page 890	3	Optimizes LO for tuning speed
"Best Close-in" on page 889	4 or 1*	<ul style="list-style-type: none"> In instruments with EPO, emphasizes close-in phase noise performance without regard to spur avoidance In instruments without EPO, this setting is accepted but no action is taken
"Best Spurs"	5	<ul style="list-style-type: none"> In instruments with EPO, emphasizes spur avoidance over close-in

Option	#	Description
on page 890		phase noise performance - In instruments without EPO, this setting is accepted but no action taken
Auto	-	Automatically selects LO (local oscillator) phase noise behavior to optimize dynamic range and speed for various instrument operating conditions

*Dependent on Option EPO installation. See "Best Close-in" on page 889 below.

The actual behavior varies somewhat depending on model number and option; for example, you always get Fast Tuning by choosing Option #3, but in some models, "Fast Tuning" on page 890 is identical in effect to "Best Close-in" on page 889.

Best Close-in

Without option EPO

:FREQ:SYNT 1

The LO phase noise is optimized for smaller offsets from the carrier, at the expense of phase noise farther out.

The actual frequency offset within which noise is optimized is shown with in square brackets, as this can vary depending on the hardware set in use. For example, in some instruments this annotation appears as [offset <20 kHz]

With option EPO

:FREQ:SYNT 4

In instruments with Option EPO, the LO is configured for the best possible close-in phase noise (offsets up to 600 kHz from the carrier), regardless of spurious products that occur with some center frequencies. Because this is generally less desirable for close-in measurements than the "Balanced" on page 889 setting, parameter 1 selects "Balanced" on page 889 in EPO instruments, in the interests of optimizing code compatibility across the family. Parameter 4 selects "Best Close-in" on page 889, which is usually not as good a choice as "Balanced" on page 889.

Balanced

:FREQ:SYNT 1

In instruments with EPO, the LO is configured for the best possible phase noise at offsets up to 600 kHz from the carrier whenever there are no significant spurs within the span observed with an on-screen carrier. When there will be such a spur, the LO is reconfigured in a way that allows the phase noise to increase by 7 dB mostly within ± 1 octave around 400 kHz offset. The spurs will always be below -70 dBc.

Best Spurs

:FREQ:SYNT 5

In instruments with EPO, the LO is configured for better phase noise than the "Best Wide-offset" on page 890 case close to the carrier, but the configuration has 11 dB worse phase noise than the "Best Close-in" on page 889 case mostly within ± 1 octave around 300 kHz offset. Spurs are even lower than in the "Balanced" on page 889 case at better than -90 dBc, whether or not the carrier is on-screen.

This setting is never selected when Phase Noise Optimization is in Auto, you must select it manually.

Best Wide-offset

:FREQ:SYNT 2

The LO phase noise is optimized for wider offsets from the carrier. Optimization is especially improved for offsets from 70 kHz to 300 kHz. Closer offsets are compromised and the throughput of measurements (especially remote measurements where the center frequency is changing rapidly), is reduced.

The actual frequency offset beyond which noise is optimized is shown with in square brackets, as this can vary depending on the hardware set in use. For example, in some instruments this annotation appears as [offset >30 kHz]

In instruments with Option EPO, the LO is configured for the best possible phase noise at offsets up to 600 kHz from the carrier whenever there are no significant spurs within the span observed with an on-screen carrier. When there will be such a spur, the LO is reconfigured in a way that allows the phase noise to increase by 7 dB mostly within ± 1 octave around 400 kHz offset. The spurs will always be below -70 dBc.

Fast Tuning

:FREQ:SYNT 3

In this mode, the LO behavior compromises phase noise at many offsets from the carrier in order to allow rapid measurement throughput when changing the center frequency or span. The term "Fast Tuning" on page 890 refers to the time it takes to move the local oscillator to the start frequency and begin a sweep; this setting does not impact the actual sweep time in any way.

In instruments with EP1, the LO behavior compromises phase noise at offsets below 4 MHz in order to improve measurement throughput. The throughput is especially affected when moving the LO more than 2.5 MHz and up to 10 MHz from the stop frequency to the next start frequency.

In instruments with Option EPO, this is the same configuration as "Best Spurs" on page 890. It is available with the "Fast Tuning" on page 890 label for convenience,

and to make the user interface more consistent with other X-Series instrument family members.

(In models whose hardware does not provide for a "Fast Tuning" on page 890 option, the settings for "Best Close-in" on page 889 are used if "Fast Tuning" on page 890 is selected. This gives the fastest possible tuning for that hardware set.)

Auto

:FREQ:SYNT:AUTO ON

Selects the LO (local oscillator) phase noise behavior to optimize dynamic range and speed for various instrument operating conditions. The selection rules are as follows.

Auto Optimization Rules

X-Series instruments have several grades of LO, offering different configurations when in the Auto Mode. The rules for Auto selection are as follows:

Models with Option	Conditions	Selection
EPO Models with option EPO have a two stage local oscillator, which switches to a single loop for fast tuning (available in UXA)	Center frequency is < 699.9 kHz Span > 114.1 MHz, <i>or</i> RBW > 800 kHz RBW > 290 kHz, <i>or</i> Span > 4.2 MHz Other conditions	"Balanced" on page 889 "Fast Tuning" on page 890 "Best Wide-offset" on page 890 "Balanced" on page 889
EP1 Models with option EP1 have a two-loop local oscillator, which switches to a single loop for fast tuning (available in PXA)	Span > 44.44 MHz, <i>or</i> RBW > 1.9 MHz, <i>or</i> Source Mode is set to "Tracking" Center frequency is < 195 kHz, <i>or</i> CF >= 1 MHz <i>and</i> Span <= 1.3 MHz <i>and</i> RBW <= 75 kHz All other conditions	"Fast Tuning" on page 890 "Best Close-in" on page 889 "Best Wide-offset" on page 890
EP2 Models with option EP2 use a different loop bandwidth for the fast-tuning choice, which is a compromise	CF < 130 kHz, <i>or</i> CF > 12 MHz <i>and</i> Span < 495 kHz <i>and</i> RBW < 40 kHz	"Best Close-in" on page 889

Models with Option	Conditions	Selection
between tuning speed and phase noise, giving good tuning speed at all offsets. Although not as good as for "Best Close-in" on page 889; this is useful when you have to look across a wide range of spans (available, for example, in MXA for excellent phase noise)	Span > 22 MHz, <i>or</i> RBW > 400 kHz, <i>or</i> CF ≤ 12 MHz <i>and</i> Span < 495 kHz <i>and</i> RBW < 23 kHz All other conditions	"Fast Tuning" on page 890 "Best Wide-offset" on page 890
EP4 (available in CXA for improved phase noise)	Span > 101 MHz <i>or</i> RBW > 1.15 MHz <i>or</i> Source Mode is set to "Tracking" CF is < 109 kHz <i>or</i> CF ≥ 4.95 MHz <i>and</i> Span ≤ 666 kHz <i>and</i> RBW < 28 kHz All other conditions	"Fast Tuning" on page 890 "Best Close-in" on page 889 "Best Wide-offset" on page 890
All Other Models Note that in these models, the hardware does not actually provide for an extra-fast tuning option, so the settings for "Fast Tuning" on page 890 are actually the same as "Best Close-in" on page 889, but the rules are implemented this way so that the user who doesn't care about phase noise but does care about tuning speed doesn't have to remember which of the other two settings gives faster tuning	Span > 12.34 MHz, <i>or</i> RBW > 250 kHz, <i>or</i> Source Mode is set to "Tracking" Center frequency is < 25 kHz, <i>or</i> CF ≥ 1 MHz <i>and</i> Span ≤ 141.4 kHz <i>and</i> RBW ≤ 5 kHz All other conditions	"Fast Tuning" on page 890 "Best Close-in" on page 889 "Best Wide-offset" on page 890

In all the above cases:

- The RBW to be used in the calculations is the equivalent –3 dB bandwidth of the current RBW filter
- The rules apply whether in swept spans, zero span, or FFT spans

Ranges

Option	Option #	Phase Noise Option	Range
No EPx Option	1	Best Close-in	[offset < 20 kHz]
	2	Best Wide-offset	[offset > 30 kHz]
	3	Fast Tuning	[same as Best Close-In]
EP0	4	Best Close-in	[offset < 600 kHz]
	1	Balanced	[offset < 600 kHz]
	5	Best Spurs	[offset < 600 kHz]
	2	Best Wide-offset	[offset > 800 kHz]
	3	Fast Tuning	[same as Best Close-In]
	1	Best Close-in	[offset < 140 kHz]
EP1	2	Best Wide-offset	[offset > 160 kHz]
	3	Fast Tuning	[single loop]
	1	Best Close-in	[offset < 70 kHz]
EP2, EP3, EP5	2	Best Wide-offset	[offset > 100 kHz]
	3	Fast Tuning	[medium loop bw]
	1	Best Close-in	[offset < 90 kHz]
EP4	2	Best Wide-offset	[offset > 130 kHz]
	3	Fast Tuning	[same as Best Close-In]

Noise Floor Extension

Lets you turn on/configure the **Noise Floor Extension** (NFE) function. Some Modes (such as Spectrum Analyzer Mode), support two states of NFE, Full and Adaptive. The **ON** state (in Modes which do not support Adaptive NFE) matches the **FULL** state (in Modes that *do* support Adaptive NFE).

In **ON** or **FULL** NFE, the expected noise power of the instrument (derived from a factory calibration) is subtracted from the trace data. This will usually reduce the apparent noise level by about 10 dB in low band, and 8 dB in high band (>~3.6 GHz).

In Adaptive NFE, there is not the same dramatic visual impact on the noise floor as there is in Full NFE. Adaptive NFE controls the amount of correction that is applied based on other instrument settings like RBW, averaging and sweep time. Adaptive NFE controls the degree of potential improvement in the noise floor to give more improvement for those instrument settings that can make good use of the potential improvement, such as settings that provide more averaging. The result is that when not much averaging is being performed, the signal displays more like the NFE-off case; and when lots of averaging is being performed, the signal displays more like the full-NFE case.

Adaptive NFE (in Modes which support it) is recommended for general-purpose use. For fully ATE (automatic test equipment) applications, where the distraction of a person using the instrument is not a risk, Full NFE is recommended.

NFE works with any RBW, VBW, detector, any setting of Average Type, any amount of trace averaging, and any signal type. It is ineffective when the trace is not smoothed (smoothing processes include narrow VBWs, trace averaging, and long sweep times with the detector set to Average or Peak). It works best with extreme amounts of smoothing, and with the average detector, with the Average Type set to Power.

In those cases where the cancellation is ineffective, it nonetheless has no undesirable side-effects. There is no significant speed impact to having **Noise Floor Extension** on.

The best accuracy is achieved when substantial smoothing occurs in each point before trace averaging. Thus, when using the average detector, results are better with long sweep times and fewer trace averages. When using the sample detector, the VBW filter should be set narrow with less trace averaging, instead of a wide VBW filter with more trace averaging.

NOTE

Noise Floor Extension has no effect unless the RF Input is selected, so it does nothing when **External Mixing** is selected.

In Modes that support Adaptive NFE, the default state of NFE is Adaptive (**ON**). In Modes that do not support Adaptive NFE, the default state of NFE is **OFF**. Prior to the introduction of Adaptive NFE (firmware version A.18.00), the default state of NFE was **OFF** for all Modes.

With the introduction of Adaptive NFE, the menu control is changed from **On|Off** to **Full|Adaptive|Off**. For SCPI Backwards Compatibility, the existing SCPI command to turn NFE on or off was retained, and a new command was added to set the state to turn Adaptive On or Off:

- `[:SENSe]:CORRection:NOISe:FLOOr ON|OFF|1|0` is retained, default changed to On for modes that support Adaptive NFE
- `[:SENSe]:CORRection:NOISe:FLOOr:ADAPtive ON|OFF|1|0` is added (for certain Modes), default = On
- **FULL = `:CORRection:NOISe:FLOOr ON` plus `:CORRection:NOISe:FLOOr:ADAPtive ON`**

See "[More Information](#)" on page 895

Remote Command	<code>[:SENSe]:CORRection:NOISe:FLOOr ON OFF 1 0</code> <code>[:SENSe]:CORRection:NOISe:FLOOr?</code>
Example	<code>:CORR:NOIS:FLO ON</code>
Dependencies	Only appears in instruments with the NFE or NF2 license installed. In all others, does not appear, but

3 VMA Mode
3.5 Channel Power Measurement

	the SCPI command will be accepted without error but has no effect
Couplings	When NFE is enabled in any mode manually, a prompt will be displayed reminding you to perform the Characterize Noise Floor operation if it is needed. If NFE is enabled through SCPI and a Characterize Noise Floor operation is needed, an error will be entered in the system error queue
Preset	Unaffected by Mode Preset . Turned ON at startup and by Restore Mode Defaults in Modes that support Adaptive. Turned OFF at startup and by Restore Mode Defaults in Modes that do not support Adaptive
State Saved	No
Remote Command	<code>[:SENSe]:CORRection:NOISe:FLOor:ADAPtive ON OFF 1 0</code> <code>[:SENSe]:CORRection:NOISe:FLOor:ADAPtive?</code>
Example	Turn NFE ON (Full mode): <code>:CORR:NOIS:FLO ON</code> Set to Adaptive: <code>:CORR:NOIS:FLO:ADAP ON</code>
Dependencies	Only available in Modes that support Adaptive NFE Only appears in instruments with the NFE or NF2 license installed. In all others, the control does not appear, but the SCPI command is accepted without error (but has no effect)
Couplings	For backwards compatibility, sending <code>:CORR:NOIS:FLO ON</code> turns NFE Adaptive OFF . To turn Adaptive ON , you must issue the commands in the proper order, as shown in the example above
Preset	Not affected by Mode Preset , but set to ON at startup and by Restore Mode Defaults
State Saved	No

More Information

The instrument is characterized in the factory (or during a field calibration) with a model of the noise, referred to the input mixer, versus frequency in each band and path combination. Bands are 0 (low band) and 1 through 4 (high band) in a 26.5 GHz instrument, for example. Paths include normal paths, preamp paths, the electronic attenuator, etc.

In most band/path combinations, the noise can be well characterized based on just two parameters and the instrument frequency response before compensation for frequency-dependent losses.

After the noise density at the input mixer is estimated, the effects of the input attenuator, RBW, detector, etc. are computed to get the estimated input-port-referred noise level.

In the simplest case, the measured power (signal plus instrument noise) in each display point (bucket) is compensated by subtracting the estimated noise power, leaving just the signal power. This is the operation when the detector is Average, and the Average Type is set to Power.

In other cases, operation is often not quite as good but still highly effective. With peak detection, the noise floor is estimated based on the RBW and the duration of the bucket using the same equations used in the noise marker function. The voltage of the noise is subtracted from the voltage of the observed signal-plus-noise measurement to compute the estimated signal voltage. The peak detector is one example of processing that varies with detector to give good estimates of the signal level without the instrument noise.

For best operation, the average detector and the power scale are recommended, as already stated. Peak detection for pulsed-RF can still give excellent effectiveness. FFT analysis does not work well, and does not do NFE well, with pulsed-RF signals, so this combination is not recommended. Negative peak detection is not very useful, either. Sample detection works well, but is never better than the average detector because it doesn't smooth as well. The Normal detector is a combination of peak and negative peak behaviors, and works about as well as these.

For best operation, extreme smoothing is desirable, as already stated. Using narrow VBWs works well, but using very long bucket durations and the average detector works best. Reducing the number of trace points will make the buckets longer.

For best operation, the power scale (Average Type = Power) is optimum. When making CW measurements in the presence of noise without NFE, averaging on the decibel scale has the advantage of reducing the effect of noise. When using NFE, the NFE does an even better job than using the log scale ever could. Using NFE with the log scale is not synergistic, though; NFE with the power scale works a little better than NFE with log averaging type.

The results from NFE with internal preamp can often be lower than the theoretical noise in a signal source at room temperature, a noise density of -174 dBm/Hz. This is expected and useful behavior, because NFE is designed to report the amount of input signal that is in excess of the thermal noise, not the amount that includes the thermal noise. This can be a useful behavior because thermal noise often interferes with what you want to measure, instead of being part of what you want to measure. Note that NFE is not adequately accurate to always be able to read below kTB.

Adaptive NFE provides an alternative to fully-on and -off NFE. Fully-on NFE can, notably in cases with little or no averaging of the spectrum, result in a display that is distractingly unfamiliar in the variability in response to low level signals. Fully-off NFE fails to achieve the potential improvement in dynamic range and associated accuracy of measurement of low-level signals. Adaptive NFE controls the degree of potential improvement in the noise floor to give more improvement for those instrument settings that can make good use of the potential improvement—those settings with high degrees of variance reduction through some variant of averaging. When the potential improvement is small, the display acts like the NFE-off case, and when it is high, it acts like the fully-on case, and in-between, application is a compromise between attractiveness and effectiveness.

On instruments with the NF2 license installed, the calibrated Noise Floor used by Noise Floor Extensions should be refreshed periodically. Keysight recommends that the **Characterize Noise Floor** operation be performed after the first 500 hours of operation, *and* once every calendar year. The control to perform this is located in the **System, Alignments, Advanced** menu. If you have not done this yourself at the recommended interval, then when you turn on Noise Floor Extensions, the instrument will prompt you to do so with a dialog that says:

“This action will take several minutes to perform. Please disconnect all cables from the RF input and press Enter to proceed. Press ESC to cancel, or Postpone to postpone for a week”

If you **Cancel**, you will be prompted again the next time you turn NFE **ON**. If you **Postpone**, you will be prompted again after a week passes and you then turn NFE **ON**.

3.5.8.5 Global

The controls in this menu apply to all Modes in the instrument.

Some controls (for example, **"Global Center Freq"** on page 1828) allow you to switch certain Meas Global parameters to a Mode Global state. These switches apply to all Modes that support global settings. For example, no matter what Mode you are in when you set **Global Center Freq** to **ON**, it applies to all Modes that support Global settings.

Other controls (for example, **Extend Low Band**) are actually set in this menu, but apply to all Modes.

Global Center Freq

The software maintains a Mode Global value called **Global Center Freq**.

When **Global Center Freq** is switched **ON**, the current Mode's center frequency is copied into the **Global Center Frequency**, and from then on all Modes that support global settings use the **Global Center Frequency**, so you can switch between any of these Modes and the **Center Frequency** remains unchanged.

Adjusting the **Center Frequency** of any Mode that supports Global Settings, while **Global Center Freq** is **ON**, modifies the **Global Center Freq**.

When **Global Center Freq** is switched **OFF**, the **Center Frequency** of the current Mode is unchanged, but now the **Center Frequency** of each Mode is once again independent.

When **Mode Preset** is pressed while **Global Center Freq** is **ON**, the **Global Center Freq** is preset to the preset **Center Frequency** of the current Mode.

This function resets to **OFF** when "Restore Defaults" on page 1829 is pressed, or when **System, Restore Defaults, All Modes** is pressed.

Remote Command	:INSTRUMENT:COUPLE:FREQUENCY:CENTER ALL NONE :INSTRUMENT:COUPLE:FREQUENCY:CENTER?
Example	:INST:COUP:FREQ:CENT ALL :INST:COUP:FREQ:CENT?
Preset	Set to OFF on Global Settings, Restore Defaults and System, Restore Defaults, All Modes
Range	ALL NONE
Preset	OFF
Backwards Compatibility SCPI	:GLOBAL:FREQUENCY:CENTER[:STATE] 1 0 ON OFF :GLOBAL:FREQUENCY:CENTER[:STATE]?

Global EMC Std

When this control is switched **ON**, the current Mode's EMC Std is copied into the **Global EMC Std**, and from then on all Modes that support global settings use the **Global EMC Std**, so you can switch between any of these Modes and the EMC Std remains unchanged.

Adjusting the EMC Std of any Mode that supports Global settings, while **Global EMC Std** is **ON** modifies the **Global EMC Std**.

When **Global EMC Std** is switched **OFF**, the EMC Std of the current Mode remains unchanged, but now the EMC Std of each Mode is once again independent. When **Mode Preset** is pressed while **Global EMC Std** is **ON**, **Global EMC Std** is preset to the preset EMC Std of the current Mode.

This function resets to **OFF** when "Restore Defaults" on page 1829 is pressed, or when **System, Restore Defaults, All Modes** is pressed.

Remote Command	:INSTRUMENT:COUPLE:EMC:STANDARD ALL NONE :INSTRUMENT:COUPLE:EMC:STANDARD?
Example	:INST:COUP:EMC:STAN ALL :INST:COUP:EMC:STAN?
Dependencies	Only available if Option EMC is installed
Preset	Set to OFF on Global Settings, Restore Defaults and System, Restore Defaults, All Modes
Range	ALL NONE

Restore Defaults

Resets all functions in the **Global** settings menu to **OFF**. Pressing **System, Restore Defaults, All Modes** has the same effect.

Remote Command	:INSTRument:COUPle:DEFault
Example	:INST:COUP:DEF
Backwards Compatibility SCPI	:GLOBal:DEFault

3.5.9 Sweep

Accesses controls to configure and control the acquisition of data, and the X-axis parameters of the instrument.

Depending on the selected mode and measurement, these controls might include: **Sweep Time**, **Continuous/Single**, **Pause/Resume**, **X Scale** and **Number of Points**.

3.5.9.1 Sweep/Control

Accesses controls that let you operate the sweep and control functions of the instrument, such as **Sweep Time** and **Continuous/Single**.

Sweep Time

Controls the time the instrument takes to sweep the current frequency span in swept measurements, displays the sweep time in swept measurements, and displays the equivalent Sweep Time in FFT measurements.

When **Sweep Time** is in Auto, the instrument computes a time that will give accurate measurements based on other settings, such as RBW and VBW.

You can select a shorter sweep time to improve the measurement throughput (with some potential unspecified accuracy reduction), but the **Meas Uncal** indicator will appear if the sweep time you set is less than the calculated Auto Sweep time.

You can also select a longer sweep time, which can be useful (for example) for obtaining accurate insertion loss measurements on very narrowband filters.

NOTE

Significantly faster sweep times are available with Option FS1.

NOTE

The **Meas Uncal** (measurement uncalibrated) warning is displayed in the Status Bar at the bottom of the screen when the manual Sweep time entered is faster than the time computed by the instrument's Sweep time equations, that is, the Auto Sweep Time. The instrument's computed Sweep time will provide accurate measurements; if you sweep faster than this your measurements may be inaccurate. A **Meas Uncal** condition may be corrected by returning the Sweep Time to Auto; by entering a longer Sweep Time; or by choosing a wider RBW

and/or VBW.

NOTE	On non-sweeping hardware, this control is grayed-out. The value shown on this control is an estimate. It is the measurement's turnaround time, which is the sum of signal acquisition time, FFT time, and other overhead time, to complete the entire span of the measurement. If you need to specify the same "Sweep Time" as you would for sweeping hardware, send <code>[:SENSe] :<meas> :SWEEp:TIME <time></code> . The measurement emulates the "Sweep Time" effect, but this emulation is not straightforward, and therefore the behavior is not specified. Instead, we recommend using Minimum Acquisition Time, which provides better control.
Remote Command	<code>[:SENSe] :<meas> :SWEEp:TIME <time></code> <code>[:SENSe] :<meas> :SWEEp:TIME?</code>
Example	Channel Power measurement: <code>:CHP:SWE:TIME 25ms</code> <code>:CHP:SWE:TIME?</code>
Notes	In the ACP measurement in WCDMA Mode, this parameter is preset by Meas Method selection. Preset values are as follows: <ul style="list-style-type: none"> - IBW: 29 ms - IBWR: 108 ms - FAST 7.5 ms
Dependencies	On non-sweeping hardware, this control is grayed out, and the Auto/Man toggle disappears. The read-only control shows estimated sweep time In those instruments, " Minimum Acquisition Time " on page 1357 is available
Couplings	Coupled to Span , RBW , VBW , and Sweep Time Rules when Sweep Time is set to Auto; Sweep Time changes when these parameters are changed When you manually set a value when in the Auto state, the state automatically changes to Man
Preset	Automatically Calculated unless noted below WCDMA Mode <ul style="list-style-type: none"> - Channel Power: 1.0 msOBW: 32.6 ms - ACP: 29 ms
State Saved	Saved in instrument state
Min	Other than non-sweeping hardware: Typically, 1 ms Non-sweeping hardware: N/A In the ACP measurement, when Meas Method is Fast Power , the minimum sweep time is span-dependent and automatically calculated
Max	Other than non-sweeping hardware: 4000 s

3 VMA Mode
3.5 Channel Power Measurement

	Non-sweeping hardware: N/A
Annotation	The sweep time is displayed in the lower-right corner of the screen. The number of points is displayed parenthetically, as: Sweep 13.3 ms (1001 points) A “#” mark appears before “Sweep” in the annotation when it is switched from Auto to Manual coupling
Status Bits/OPC dependencies	Meas Uncal is Bit 0 in the register: <code>STATus:QUEStionable:INTEgrity:UNCalibrated</code>
	Auto Function
Remote Command	<code>[:SENSe]:<meas>:SWEep:TIME:AUTO OFF ON 0 1</code> <code>[:SENSe]:<meas>:SWEep:TIME:AUTO?</code>
Example	Channel Power measurement: <code>:CHP:SWE:TIME:AUTO OFF</code> <code>:CHP:SWE:TIME:AUTO?</code>
Preset	WCDMA Mode <code>OFF</code> All others <code>ON</code>

Minimum Acquisition Time

Available on non-sweeping hardware.

Specifies the minimum acquisition time for each “chunk” of the measurement result. The instrument automatically divides Span into multiple chunks if needed. Therefore, the total signal acquisition time for the entire Span is:

$$\sim(\sim\text{Minimum Acquisition Time}) * (\text{The number of chunks})$$

When in Auto, this parameter’s value is determined by other parameters, such as **Span**, **RBW** and **VBW**.

You can manually increase this parameter value from this Auto value.

If increased, the instrument acquires signal for the specified time duration for each chunk. It performs additional FFTs, and averages or peak-holds the FFT results for a chunk, depending on **Detector** settings.

Note that the actual acquisition time for each chunk may exceed the **Minimum Acquisition Time** value, in order to satisfy FFT time required by other parameters, and to perform an integer number of FFTs.

Remote Command	<code>[:SENSe]:<meas>:SWEep:ACQuisition:TIME <time></code> <code>[:SENSe]:<meas>:SWEep:ACQuisition:TIME?</code>
----------------	--

	<code><meas></code> is the identifier for the current measurement; any one of CHPower- ACPower OBWidth MONitor
Example	Channel Power measurement <code>:CHP:SWE:ACQ:TIME 500 ms</code> <code>:CHP:SWE:ACQ:TIME?</code>
Dependencies	Available only on non-sweeping hardware
Couplings	Coupled to Span , RBW , and VBW when in the Auto state When you manually set a value when in the Auto state, the state automatically changes to Man
Preset	Automatically calculated
State Saved	Saved in instrument state
Min	100 ns
Max	4.00 ks

Auto Function

Remote Command	<code>[[:SENSe]:<meas>:SWEep:ACQquisition:TIME:AUTO OFF ON 0 1</code> <code>[[:SENSe]:<meas>:SWEep:ACQquisition:TIME:AUTO?</code> <code><meas></code> is the identifier for the current measurement; any one of CHPower- ACPower OBWidth MONitor
Example	Channel Power measurement: <code>:CHP:SWE:ACQ:TIME:AUTO OFF</code>
Preset	ON

Sweep/Measure

Lets you toggle between **Continuous** and **Single** sweep or measurement operation. The single/continuous state is Meas Global, so the setting affects all measurements.

The front-panel key **Single/Cont** performs exactly the same function

See "[More Information](#)" on page 903

Remote Command	<code>:INITiate:CONTinuous OFF ON 0 1</code> <code>:INITiate:CONTinuous?</code>
Example	Put instrument into Single measurement operation: <code>:INIT:CONT 0</code> <code>:INIT:CONT OFF</code> Put instrument into Continuous measurement operation: <code>:INIT:CONT 1</code> <code>:INIT:CONT ON</code>
Preset	ON

Note that **:SYST:PRES** sets **:INIT:CONT** to **ON**, but ***RST** sets **:INIT:CONT** to **OFF**

State Saved	Saved in instrument state
Annunciation	The Single/Continuous icon in the Meas Bar changes depending on the setting: <ul style="list-style-type: none"> - A line with an arrow is Single - A loop with an arrow is Continuous
Backwards Compatibility Notes	X-Series A-models had Single and Cont hardkeys in place of the SweepSingleCont softkey. In the X-Series A-models, if in single measurement, the Cont hardkey (and INIT:CONT ON) switched to continuous measurement, but never restarted a measurement and never reset a sweep X-Series B-models have a Cont/Single toggle control instead of Single and Cont hardkeys, but it is still true that, if in single measurement, the Cont/Single toggle control never restarts a measurement and never resets a sweep

More Information

Continuous Mode	<p>The instrument takes repetitive sweeps, averages, measurements, etc., when in continuous mode. If in average or Max/Min Hold, and the average/hold count reaches the Average/Hold Num, the count stops incrementing, but the instrument keeps sweeping</p> <p>See the Trace key description under Trace Average for the averaging formula used both before and after the Average/Hold Num is reached. The trigger condition must be met prior to each sweep</p> <p>The type of trace processing for multiple sweeps is set under the Trace key, with choices of Trace Average, Max Hold, or Min Hold</p>
Single Mode	<p>The instrument takes a single sweep when in Single mode, or if in average or Max/Min Hold, or if there is a Waterfall window displayed, it takes multiple sweeps until the average/hold count reaches the Average/Hold Num, then the count stops incrementing, and the instrument stops sweeping</p> <p>See the Trace key description under Trace Average for the averaging formula used. The trigger condition must be met prior to the sweep</p> <p>The type of trace processing for multiple sweeps is set under the Trace key, with choices of Trace Average, Max Hold, or Min Hold</p>

If the instrument is in **Single** measurement mode, pressing the **Cont/Single** toggle control does not zero the count and does not cause the sweep to be reset; the only action is to put the instrument into Continuous measurement operation.

If the instrument is already in **Continuous** sweep:

- **:INIT:CONT 1** has no effect
- **:INIT:CONT 0** places the instrument in Single Sweep but has no effect on the current sequence until $k = N$, at which point the current sequence will stop and the instrument will go to the idle state

See "**Restart**" on page 1832 for details of **:INIT:IMmediate**.

If the instrument is already in **Single** sweep, **:INIT:CONT OFF** has no effect.

If the instrument is already in **Single** sweep, then pressing **Cont/Single** in the middle of a sweep does not restart the sweep or sequence. Similarly, pressing **Cont/Single** does not restart the sweep or sequence if the sweep is not in the idle state (for example, if you are taking a very slow sweep, or the instrument is waiting for a trigger). Even though pressing **Cont/Single** in the middle of a sweep does not restart the sweep, sending **:INIT:IMM** does reset it.

If the instrument is in **Single** sweep, and *not* Averaging/Holding, and you want to take one more sweep, press **Restart**.

If the instrument is in **Single** sweep, *and* Averaging/Holding, and you want to take one more sweep without resetting the Average trace or count, go to **Meas Setup** and increment the average count by 1 by pressing the **Step-Up** key while **Average/Hold Num** is the active function. You can also do this by sending **:CALC:AVER:TCON UP**.

Restart

Restarts the current sweep, or measurement, or set of averaged/hold sweeps or measurements. If you are Paused, pressing **Restart** performs a Resume.

The front-panel key **Restart** performs exactly the same function.

The **Restart** function is accessed in several ways:

- Pressing the **Restart** key
- Sending **:INIT:IMM**
- Sending **:INIT:REST**

See "[More Information](#)" on page 905

Remote Command	:INITiate[:IMMEDIATE] :INITiate:REStart
Example	:INIT:IMM :INIT:REST
Notes	:INIT:REST and :INIT:IMM perform exactly the same function
Couplings	Resets average/hold count k. For the first sweep overwrites all active (update = on) traces with new current data. For application modes, it resets other parameters as required by the measurement
Status Bits/OPC dependencies	This is an Overlapped command The STATus:OPERation register bits 0 through 8 are cleared, <i>except</i> bit 6 (Waiting for Periodic Sync). Initiating a measurement and Waiting for Periodic Sync could be asynchronous The STATus:QUEStionable register bit 9 (INTegrity sum) is cleared

	The Sweeping bit is set
	The Measuring bit is set
Backwards Compatibility Notes	For Spectrum Analysis Mode in ESA and PSA, the Restart hardkey and the :INIT:REST command restarted trace averages (displayed average count reset to 1) for a trace in Clear Write , but did not restart Max Hold and Min Hold In X-Series, the Restart hardkey and the :INIT:REST command restart not only Trace Average , but MaxHold and MinHold traces as well

More Information

The **Restart** function first aborts the current sweep or measurement as quickly as possible. It then resets the sweep and trigger systems, sets up the measurement and initiates a new data measurement sequence with a new data acquisition (sweep) taken once the trigger condition is met.

If the instrument is in the process of aligning when a **Restart** is executed, the alignment finishes before the restart function is performed.

Even when set for **Single** operation, multiple sweeps may be taken when **Restart** is pressed (for example, when averaging/holding is on). Thus, when we say that **Restart** "restarts a measurement", depending on the current settings, we may mean that it:

- Restarts the current sweep
- Restarts the current measurement
- Restarts the current set of sweeps if any trace is in Trace Average, Max Hold or Min Hold
- Restarts the current set of measurements if Averaging, or Max Hold, or Min Hold is on for the measurement

If there is no Average or Max/Min Hold function (no trace in Trace Average or Hold, or **Average/Hold Num** set to 1), and no **Waterfall** window is being displayed, a single sweep is equivalent to a single measurement. A single sweep is taken after the trigger condition is met; and the instrument stops sweeping once that sweep has completed. However, with **Average/Hold Num** >1, and at least one trace set to Trace Average, Max Hold, or Min Hold, or a **Waterfall** window being displayed, multiple sweeps/data acquisitions are taken for a single measurement. The trigger condition must be met prior to each sweep. The sweep is stopped when the average count k equals the number N set for **Average/Hold Num**.

Once the full set of sweeps has been taken, the instrument goes to the idle state. To take one more sweep without resetting the average count, increment the average count by 1, by pressing the **Step-Up** key while **Average/Hold Number** is the active function, or by sending the remote command **:CALC:AVER:TCON UP**.

Trace Update

The numeric results are not blanked at any time during the restart cycle.

For slow sweeps (see **Trace Update** section in **Trace/Detector**), the traces are updated real-time during the sweep. There may be a special circumstance in application mode measurements where an exception is made and the traces and/or results need to be blanked before displaying the new results.

To summarize, the following list shows what happens to the trace data on various events:

Event	Trace Effect
Clear/Write pressed (even if already in Clear/Write)	Set to mintracevalue
Max Hold pressed (even if already in Max Hold)	Set to mintracevalue
Min Hold pressed (even if already in Min Hold)	Set to maxtracevalue
Trace Average pressed (even if already in Trace Average)	Trace data unaffected but start new sweep/avg/hold
Restart pressed	Trace data unaffected but start new sweep/avg/hold
Parameter requiring restart changed (e.g., RBW)	Trace data unaffected but start new sweep/avg/hold

Sweep and Trigger Reset

Resetting the sweep system resets the average/hold count k to 0. It also resets the set point counter to 0. Resetting the trigger system resets the internal auto trig timer to the value set by the **Auto Trig** control.

Averaging

The weighting factor used for averaging is k . This k is also the average/hold count for how many valid sweeps (data acquisitions) have been done. This k is used for comparisons with N , as those comparisons always needs to be based on valid completed sweeps.

The displayed average/hold, K , shows the count for the sweep (data acquisition) in progress. $K = k + 1$, with a limit of N . The displayed value K changes from its previous value to 1 as soon as the trigger condition for the first data acquisition (sweep) is met.

Pause/Resume

Pauses a measurement after the current data acquisition is complete.

When paused, the label on the control changes to **Resume**. Pressing **Resume** unpauses the measurement. When paused, pressing **Restart** performs a Resume.

Remote Command	<code>:INITiate:PAUSE</code> <code>:INITiate:RESume</code>
Example	<code>:INIT:PAUS</code> <code>:INIT:RES</code>
Dependencies	Not displayed in Modes that do not support pausing
Annotation	Only on control

Abort (Remote Command Only)

Stops the current measurement. Aborts the current measurement as quickly as possible, resets the sweep and trigger systems, and puts the measurement into an "idle" state. If the instrument is in the process of aligning when `:ABORt` is sent, the alignment finishes *before* the abort function is performed, so `:ABORt` does not abort an alignment.

If the instrument is set for **Continuous** measurement, it sets up the measurement and initiates a new data measurement sequence with a new data acquisition (sweep) taken once the trigger condition is met.

If the instrument is set for **Single** measurement, it remains in the "idle" state until an `:INIT:IMM` command is received.

Remote Command	<code>:ABORt</code>
Example	<code>:ABOR</code>
Notes	If <code>:INIT:CONT</code> is ON , then a new continuous measurement will start immediately, with sweep (data acquisition) occurring once the trigger condition has been met If <code>:INIT:CONT</code> is OFF , then <code>:INIT:IMM</code> is used to start a single measurement, with sweep (data acquisition) occurring once the trigger condition has been met
Dependencies	For continuous measurement, <code>:ABORt</code> is equivalent to the Restart key Not all measurements support this command
Status Bits/OPC dependencies	The <code>STATus:OPERation</code> register bits 0 through 8 are cleared, <i>except</i> bit 6 (Waiting for Periodic Sync). Initiating a measurement and Waiting for Periodic Sync could be asynchronous The <code>STATus:QUEStionable</code> register bit 9 (INTEGRity sum) is cleared Since all the bits that feed into OPC are cleared by <code>:ABORt</code> , the Abort command will cause the <code>*OPC</code> query to return true

Sweep Time Annotation (Remote Query Only)

Returns the **Sweep Time Annotation** value. Available only on non-sweeping hardware.

This value is also displayed in the result trace window.

The value returned is the estimated turnaround time of each measurement cycle, in seconds. The turnaround time is the sum of the signal acquisition time, FFT time, and other overhead time, to complete the entire span of each measurement cycle.

Remote Command	<code>[:SENSe] : < meas > : SWEep : ETIME ?</code> <code>< meas ></code> is the identifier for the current measurement; any one of CHPower - ACPower OBWidth MONitor
Example	Channel Power measurement <code>:CHP : SWE : ETIME ?</code>
Dependencies	Available only on non-sweeping hardware
Preset	Automatically calculated

3.5.9.2 Sweep Config

Accesses controls that enable you to configure the Sweep and Control functions of the instrument, such as Sweep Rules.

Sweep Time Rules

Switches the instrument between **NORMa1** and **ACCuracy** sweep states.

Setting **Auto Sweep Time** to **ACCuracy** results in slower sweep times (usually about three times as long) but yields better amplitude accuracy for CW signals. The instrument amplitude accuracy specifications only apply when **Auto Sweep Time** is set to **ACCuracy**.

Additional amplitude errors that occur when **Auto Sweep Time** is set to **NORMa1** are usually well under 0.1 dB, though this is not guaranteed. Because of the faster sweep times and still low errors, **NORMa1** is the preferred setting of **Auto Sweep Time**. **Auto Sweep Time** is set to **NORMa1** on a **Preset**. This means that in the Preset state, instrument amplitude accuracy specifications do not apply.

Remote Command	<code>[:SENSe] : CHPower : SWEep : TIME : AUTO : RULEs NORMa1 ACCuracy</code> <code>[:SENSe] : CHPower : SWEep : TIME : AUTO : RULEs ?</code>
Example	<code>:CHP : SWE : TIME : AUTO : RUL NORM</code> <code>:CHP : SWE : TIME : AUTO : RUL ?</code>

3 VMA Mode
 3.5 Channel Power Measurement

Dependencies	Does not appear in Spectrum Analyzer Mode in VXT model M9421A
Preset	NORMa1
State Saved	Saved in instrument state
Range	NORMa1 ACCuracy

Points

Sets the number of points taken per sweep, and displayed in the traces. The current value of **Points** is displayed parenthetically, next to the sweep time in the lower-right corner of the display. Using more points provides greater resolution. Using fewer points compacts the data and decreases the time required to access a trace over the remote interface.

Increasing the number of points does not increase the sweep time. However, it can slightly impact the trace processing time and therefore the overall measurement speed. Decreasing the number of points does not decrease the sweep time, but it may speed up the measurement, depending on the other sweep settings (for example, in FFT sweeps). Fewer points will always speed up the I/O.

Due to minimum sweep rate limitations of the hardware, the minimum sweep time available to the user will increase above its normal value of 1 ms as the number of sweep points increases above 15001.

Changing the number of sweep points has several effects on the instrument. Since markers are read at the point location, the marker reading may change. The sweep time resolution will change. Trace data for all the traces will be cleared and, if **"Sweep/Measure" on page 1830** is **Cont**, a new trace taken. If any trace is in average or hold, the averaging starts over.

Due to sweep time quantization issues, the knob and up/down keys cannot be used to adjust the number of points.

When in a split screen display each window may have its own value for points.

When sweep points is changed, an informational message is displayed, "Sweep points changed, all traces cleared."

Remote Command	<code>[:SENSe] :CHPower :SWEep :POINts <integer></code> <code>[:SENSe] :CHPower :SWEep :POINts ?</code>
Example	<code>:CHP :SWE :POIN 501</code> <code>:CHP :SWE :POIN ?</code>
Dependencies	Not available when Signal ID is ON in External Mixing Neither the knob nor the step keys can be used to change this value. If it is tried, a warning is given Not displayed in Modes that do not support Swept
Couplings	Whenever the number of sweep points change:

- All trace data is erased
- Any traces with Update Off also switch to Display Off (equivalent to switching from View to Blank in older instruments)
- Sweep time is re-quantized
- Any limit lines that are on will be updated
- If averaging/hold is on, averaging/hold starts over

The resolution of setting the sweep time depends on the number of points selected

Preset	1001
State Saved	Saved in instrument state
Min	11
Max	20001
Annotation	On second line of annotations, in lower right corner in parenthesis behind the sweep annotation

IF Dithering

Lets you turn IF Dithering on or off. This is a technique used in unpreselected instruments (such as Keysight's modular instruments) to enhance the rejection of images and internally-generated spurious signals.

Remote Command	<code>[:SENSe] :SWEep:IF:DITHer OFF ON 0 1</code> <code>[:SENSe] :SWEep:IF:DITHer?</code>
Dependencies	Only appears in Spectrum Analyzer Mode in VXT models
Preset	OFF
State Saved	Saved in instrument state

Image Protection

Lets you turn IF Protection on or off. This is a technique used in unpreselected instruments (such as Keysight's modular instruments) to detect and suppress images and spurs that may be present in non-preselected hardware.

IF Protection takes two sweeps and by correlating the data between them, provides a single, correct power-versus-frequency trace.

Remote Command	<code>[:SENSe] :SWEep:IMAGeprot OFF ON 0 1</code> <code>[:SENSe] :SWEep:IMAGeprot?</code>
Dependencies	Only appears in Spectrum Analyzer Mode in VXT models
Preset	ON
State Saved	Saved in instrument state

3.5.10 Trace

Lets you control the acquisition, display, storage, detection and manipulation of trace data for the available traces. The Trace Control tab of this menu contains radio-button selections for the trace type (**Clear/Write**, **Trace Average**, **Max Hold**, **Min Hold**) and **View/Blank** setting for the selected trace.

3.5.10.1 Select Trace

Specifies the *selected trace*, which is the trace that will be affected when you change trace settings.

Select Trace appears above the menu panel, indicating that it applies to *all* controls in the menu panel. **Select Trace** is blanked if you select a tab whose controls do *not* depend on the selected trace (for example, **Trace Function**).

Notes	The selected trace is remembered even when not in the Trace menu
Dependencies	For the Swept SA measurement: <ul style="list-style-type: none">- In Image Suppress mode, when you select a trace it becomes the active trace, and the formerly active trace goes into View- When you turn on Image Suppress, Update turns off for all traces except the selected trace For the ACP measurement, when Meas Method is RBW , FAST or FPOwer , Select Trace is disabled
Preset	Trace 1
State Saved	Yes

3.5.10.2 Trace Control

The controls on this tab allow you to set the "**Trace Type**" on page 1737 and its update mode.

There are four Trace Types:

- **Clear/Write**
- **Trace Average**
- **Max Hold**
- **Min Hold**

Each type handles data in a different way.

Each trace also has two values that determine whether it is being written or not, and whether it is being displayed or not. These values, **Update** and **Display**, are described fully in the "[View/Blank](#)" on page 1742 control description. Essentially, when **Update** is **ON**, a trace is updating, and when **Update** is **OFF** it is not. When **Display** is **ON**, it is visible and when **Display** is **OFF** it is not. These terms are used throughout the descriptions in this section.

Trace Type

There are four trace Types:

Option	Parameter	SCPI Example	Details
Clear/Write	<code>WRITE</code>	<code>:TRAC2:TYPE WRIT</code>	See: " Clear/Write " on page 915
Trace Average	<code>AVERage</code>	<code>:TRAC2:TYPE AVER</code>	See: " Trace Average " on page 915
Maximum Hold	<code>MAXHold</code>	<code>:TRAC3:TYPE MAXH</code>	See: " Max Hold " on page 916
Minimum Hold	<code>MINHold</code>	<code>:TRAC5:TYPE MINH</code>	See: " Min Hold " on page 916

Full descriptions of each type are provided below. You may select one of these types for each trace. Re-selecting the current **Trace Type** initiates the same action that selecting it the first time did, even though it is already selected. For example, selecting **Clear/Write** while **Clear/Write** is already selected will nonetheless clear the trace and begin rewriting it.

Besides the **Trace Type**, the "[View/Blank](#)" on page 1742 state must be set to **Active** (**Update**: **ON**, **Display**: **ON**) for a trace to be updating and visible. Selecting any **Trace Type** automatically makes the trace **Active**.

See also: "[Trace Mode Backwards Compatibility Commands](#)" on page 913

Remote Command	<p>For Swept SA Measurement (in SA Mode):</p> <pre>:TRACe[1] 2 ... 6:TYPE WRITE AVERage MAXHold MINHold :TRACe[1] 2 ... 6:TYPE?</pre> <p>For all other measurements:</p> <pre>:TRACe[1] 2 3:<meas>:TYPE WRITE AVERage MAXHold MINHold :TRACe[1] 2 3:<meas>:TYPE?</pre> <p>where <code><meas></code> is the identifier for the current measurement</p>
Example	<pre>:TRAC:TYPE WRIT :TRAC:TYPE?</pre>
Couplings	<p>Selecting a Trace Type (by pressing any of the Trace Type selections or sending <code>:TRAC:TYPE</code>) sets the Trace to Active (Update: ON, Display: OFF), even if the same trace type was already selected</p> <p>When Detector setting is "Auto" (<code>[:SENSe] : <meas> : DETector : AUTO?</code>), Detector (<code>[:SENSe] : <meas> : DETector [:FUNCTION]?</code>) switches aligning with the switch of this parameter: "NORMal" with <code>WRITE</code> (Clear Write), "AVERage" with <code>AVERage</code>, "POSitive (peak)" with <code>MAXHold</code>, and "NEGative (peak)" with <code>MINHold</code></p>

Preset	Swept SA and Monitor Spectrum: WRITe All other measurements: AVERage Following Preset , all traces are cleared (all trace points set to mintracevalue)
State Saved	The type of each trace is saved in instrument state
Annunciation	The type for each trace is indicated in the Trace annunciator panel on the Measurement Bar

Trace Mode Backwards Compatibility Commands

In earlier instruments, the “Trace Modes” were: Clear/Write, Max Hold, Min Hold, View and Blank. Averaging was global to all traces and was controlled under the **BW/Avg** menu.

In X-Series, trace averaging can be done on a per-trace basis. The Trace Modes (now called Trace Types) are Clear/Write, Trace Average, Max Hold and Min Hold. View and Blank are set separately under "**View/Blank**" on page 1742.

While this provides more flexibility, it also gives rise to potential backwards compatibility problems. To mitigate these, the old Trace Mode command has been retained and a new Trace Type command has been added. The **:TRACe:MODE** command is retained for backwards compatibility, and the **:TRACe:TYPE**, **:TRACe:UPDate** and **:TRACe:DISPlay** commands introduced for ongoing use. The old Trace Modes are selected using **:TRAC:MODE**, whose parameters are mapped into calls to **:TRACe:TYPE**, **:TRACe:UPDate** and **:TRACe:DISPlay**, and the old global Averaging command **[:SENSe]:AVERage[:STATe]** is provided for backwards compatibility. See the individual command descriptions for details.

When **Average/Hold** in the **Meas Setup, Legacy Compatibility** menu is **ON**, the following is true for traces in Max Hold and Min Hold:

- They ignore the **Average/Hold** number; **Single** for Max Hold causes one sweep only, so switching to **Single** stops after the current sweep, and switching to **Cont** starts again without clearing the accumulated result
- Max Hold is not cleared on a **Restart, Single** or **:INIT:IMM**, but changing a measurement parameter, like frequency or bandwidth etc., still restarts the Max Hold

Preset	WRITe
State Saved	The trace mode is an alias only
Backwards Compatibility SCPI	:TRACe[1] 2 ... 6:MODE WRITe MAXHold MINHold VIEW BLANK :TRACe[1] 2 ... 6:MODE?
Backwards Compatibility Notes	The legacy :TRACe:MODE command is retained for backwards compatibility. In conjunction with the legacy :AVERage command, it works as follows: <ul style="list-style-type: none"> – :AVERage ON OFF sets/clears a variable that we will call average for the sake of this discussion. This variable is maintained by the instrument solely for backwards compatibility. See the

`[:SENSe]:AVERage[:STATe]` command description below

- `:TRACe:MODE WRITe` sets `:TRACe:TYPE WRITe` (Clear/Write) unless average is true, in which case it sets it to `:TRACe:TYPE AVERage`. It also sets `:TRACe:UPDate ON`, `:TRACe:DISPlay ON`, for the selected trace
- `:TRACe:MODE MAXHold` sets `:TRACe:TYPE MAXHold` (Max Hold). It also sets `:TRACe:UPDate ON`, `:TRACe:DISPlay ON`, for the selected trace
- `:TRACe:MODE MINHold` sets `:TRACe:TYPE MINHold` (Min Hold). It also sets `:TRACe:UPDate ON`, `:TRACe:DISPlay ON`, for the selected trace
- `:TRACe:MODE VIEW` sets `:TRACe:UPDate OFF`, `:TRACe:DISPlay ON`, for the selected trace
- `:TRACe:MODE BLANK` sets `:TRACe:UPDate OFF`, `:TRACe:DISPlay OFF`, for the selected trace

The query returns the same value as `:TRACe:TYPE?`, meaning that if you set `:TRACe:MODE:VIEW` or `:TRACe:MODE:BLANK`, the query response will not be what you sent

`:TRACe[n]:MODE` was formerly used to set the type or “writing mode” of the trace. At that time, View and Blank were writing modes. The new `:TRACe:TYPE` command should be used in the future, but `:TRACe:MODE` is retained to provide backwards compatibility

In X-Series, unlike earlier instruments, Max Hold and Min Hold now obey the Average Number and counts up to a terminal value as Average always has

As the **Average/Hold Number** now affects **Min Hold** and **Max Hold**, the operations that restart Averaging (for example, the **Restart** key) now also restart **Min Hold** and **Max Hold**

As a result of these changes, legacy code that restarts averaging while retaining a running Max Hold will need to be rewritten, because the Max Hold will now restart when the Average does

Also, previous to X-Series:

- Pressing **Max Hold** while already in **Max Hold** (or doing so remotely) had no effect. Now it will clear the trace and restart the sweep and the Max Hold sequence
- Changing the vertical scale (Log/Lin or dB/div) of the display restarted **Max Hold** and **Min Hold**. This is no longer the case

Preset	<code>OFF</code>
State Saved	The state of Average is saved in Instrument State for ghosting purposes
Backwards Compatibility SCPI	<code>[:SENSe]:AVERage[:STATe] ON OFF 1 0</code> <code>[:SENSe]:AVERage[:STATe]?</code>
Backwards Compatibility Notes	Previous to X-Series, Averaging (also sometimes known as trace averaging) was global to all traces, that is, it was either on or off for all active traces. The legacy command <code>[:SENSe]:AVERage [:STATe] ON OFF 1 0</code> was used to turn Averaging on or off In X-Series, Averaging is turned on or off on a per-trace basis, so it can be on for one trace and off for another For backwards compatibility, the old global Average State variable is retained solely as a legacy

variable, turned on and off and queried by the legacy command `[:SENSe] :AVERage [:STATe] OFF | ON | 0 | 1`. When Average is turned on, any trace in Clear/Write will get put into Average. While Average is on, any trace put into Clear/Write by the old `:TRAC:MODE` command will instead get put into Average. When Average is turned off, any trace in Average will get put into Clear/Write

Trace Type Details

Clear/Write

Each trace update replaces the old data in the trace with new data.

Pressing **Clear/Write** for the selected trace, or sending `:TRAC:TYPE WRIT` for the specified trace, sets the trace type to **Clear/Write** and clears the trace, even if you are already in **Clear/Write**. Then a new sweep is initiated. Trigger conditions must be met before the sweep actually starts, and if in **Single** the sweep won't start until **Restart** is pressed.

Pressing **Clear/Write** stops the current sweep and initiates a new one, so **Trace Average**, **Max Hold** and **Min Hold** data may be interrupted in mid-sweep when **Clear/Write** is pressed, and therefore may not accurately reflect the displayed count. Therefore, when **Clear/Write** is pressed for one trace, **Trace Average**, **Max Hold** and **Min Hold** must restart for all traces.

When in **Clear/Write**, if a measurement-related instrument setting is changed (that is, one which requires new data to be taken, like **Center Frequency** or **Attenuation**), a new sweep is initiated but the trace is not cleared.

Trace Average

The instrument maintains and displays an average trace, which represents the cumulative average on a point-by-point basis of the new trace data and previous averaged trace data.

Pressing **Trace Average** (for the selected trace), or sending `:TRAC:TYPE AVER` (for the specified trace), sets the trace type to **Trace Average**, clears the trace, initiates a new sweep, and restarts the Average sequence.

Details of the count limiting behavior and the averaging calculations may be found under **Avg|Hold Number** and **Average Type** under **Meas Setup**.

When in **Trace Average**, if a measurement-related instrument setting is changed (that is, one which requires new data to be taken, like **Center Frequency** or **Attenuation**), the average restarts and a new sweep is initiated but the trace is not cleared.

Restarting the average means:

- The average/hold count k is set to 1, so that the next time the average trace is displayed it simply represents one trace of new data
- A new sweep is initiated
- Once the new sweep starts, the trace is overwritten with current trace data as the first trace of the new average

Remember that restarting averaging also restarts **Max Hold** and **Min Hold**, as there is only one count for Trace Average and Hold.

Max Hold

The instrument maintains and displays a max hold trace, which represents the maximum data value on a point-by-point basis of the new trace data and previous trace data. Details of the count limiting behavior may be found under **Avg|Hold Number** under **Meas Setup**.

Pressing **Max Hold** for the selected trace, or sending `:TRAC:TYPE MAXH` for the specified trace, sets the Trace Type to **Max Hold**, clears the trace, initiates a new sweep, and restarts the hold sequence, even if you are already in **Max Hold**.

When in **Max Hold**, if a measurement-related instrument setting is changed (that is, one which requires new data to be taken, like **Center Frequency** or **Attenuation**), the **Max Hold** sequence restarts and a new sweep is initiated but the trace is not cleared.

Restarting the **Max Hold** sequence means:

- The average/hold count k is set to 1, so that the next time the max hold trace is displayed it simply represents one trace of new data
- A new sweep is initiated.

Remember that restarting **Max Hold** also restarts averaging and **Min Hold**, as there is only one count for Trace Average and Hold.

Min Hold

The instrument maintains and displays a min hold trace, which represents the minimum data value on a point-by-point basis of the new trace data and previous trace data. Details of the count limiting behavior may be found under **Avg|Hold Number** under the **Meas Setup** functions.

Pressing **Min Hold** for the selected trace, or sending `:TRAC:TYPE MINH` for the specified trace, sets the Trace Type to **Min Hold**, clears the trace, initiates a new sweep, and restarts the hold sequence, even if you are already in **Min Hold**.

When in **Min Hold**, if a measurement-related instrument setting is changed (that is, one which requires new data to be taken, like **Center Frequency** or **Attenuation**), the **Min Hold** sequence restarts and a new sweep is initiated but the trace is not cleared.

Restarting the **Min Hold** sequence means:

- The average/hold count k is set to 1, so that the next time the min hold trace is displayed it simply represents one trace of new data
- A new sweep is initiated

Remember that restarting **Min Hold** also restarts **Max Hold** and averaging, because there is only one count for Trace Average and Hold.

Clear and Write | Restart Averaging | Restart Max/Min Hold

Starts the trace writing, as though the "**Trace Type**" on page 1737 had just been selected. The effect is exactly the same as reselecting the current **Trace Type** again – the control is provided because it may not be obvious that reselecting the same selection from a radio button menu will take any action.

This control displays different labels, depending on the selected Trace Type:

- **Clear/Write**: Clear and Write
- **Trace Average**: Restart Averaging
- **Max Hold**: Restart Max Hold
- **Min Hold**: Restart Min Hold

View/Blank

Lets you set the state of the two trace variables: **Update** and **Display**. The choices available in this dropdown menu are:

Active	Update and Display both ON
View	Update OFF ; Display ON
Blank	Update OFF ; Display OFF
Background	Update ON , Display OFF Allows a trace to be blanked <i>and</i> continue to update "in the background", which was not possible in the past

In the Swept SA measurement, a trace with **DisplayOFF** is indicated by a strikethrough of the type letter in the trace annotation panel in the Measurement Bar. A trace with **UpdateOFF** is indicated by dimming the type letter in the trace

annotation panel in the Measurement Bar. In the example below, Traces 3, 4, 5 and 6 have **UpdateOFF**, and Traces 4 and 6 have **DisplayOFF**.

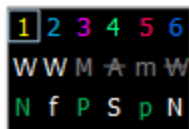

See: ["More Information" on page 919](#)

Notes	For the commands to control the two variables, Update and Display, see "Trace Update State On/Off" on page 918 and "Trace Display State On/Off" on page 919 below
Dependencies	When Signal ID is on, this key is grayed-out
Couplings	<p>Selecting a Trace Type for a trace (pressing the key or sending the equivalent command) puts the trace in Active (Update ON and Display ON), even if that trace type was already selected</p> <p>Selecting a detector for a trace (pressing the key or sending <code>[:SENS] :DET :TRAC</code>) puts the trace in Active (UpdateON and DisplayON), even if that detector was already selected</p> <p>Selecting a "Math Function" on page 1745 other than OFF for a trace (pressing the key or sending the equivalent command) puts the trace in Active (UpdateON and DisplayON), even if that Math Mode was already selected</p> <p>Loading a trace from a file puts that trace in View regardless of the state it was in when it was saved; as does being the target of a Copy or a participant in an Exchange</p>

Trace Update State On/Off

Remote Command	<p>For Swept SA Measurement (in SA Mode):</p> <pre>:TRACe[1] 2 ... 6:UPDate[:STATe] ON OFF 1 0</pre> <pre>:TRACe[1] 2 ... 6:UPDate[:STATe]?</pre> <p>For all other measurements:</p> <pre>:TRACe[1] 2 3:<meas>:UPDate[:STATe] ON OFF 1 0</pre> <pre>:TRACe[1] 2 3:<meas>:UPDate[:STATe]?</pre> <p>where <meas> is the identifier for the current measurement</p>
Example	<p>Make trace 2 inactive (stop updating):</p> <pre>:TRAC2:UPD 0</pre>
Couplings	Whenever you set Update to ON for any trace, the Display is set to ON for that trace
Preset	<p>For Swept SA Measurement (in SA Mode):</p> <pre>1 0 0 0 0 0</pre> <p>ON for Trace 1; OFF for 2–6</p> <p>For all other measurements:</p> <pre>1 0 0</pre> <p>ON for Trace 1; OFF for 2 & 3</p>
State Saved	Saved in instrument state

Trace Display State On/Off

Remote Command	<p>For Swept SA Measurement (in SA Mode):</p> <pre>:TRACe[1] 2 ... 6:DISPlay[:STATe] ON OFF 1 0</pre> <pre>:TRACe[1] 2 ... 6:DISPlay[:STATe]?</pre> <p>For all other measurements:</p> <pre>:TRACe[1] 2 3:<meas>:DISPlay[:STATe] ON OFF 1 0</pre> <pre>:TRACe[1] 2 3:<meas>:DISPlay[:STATe]?</pre> <p>where <meas> is the identifier for the current measurement</p>
Example	<p>Make trace 1 visible:</p> <pre>:TRAC2:DISP 1</pre> <p>Blank trace 3:</p> <pre>:TRAC3:DISP 3</pre>
Couplings	Whenever you set Update to ON for any trace, the Display is set to ON for that trace
Preset	<p>For Swept SA Measurement (in SA Mode):</p> <pre>1 0 0 0 0 0</pre> <p>ON for Trace 1; OFF for 2–6</p> <p>For all other measurements:</p> <pre>1 0 0</pre> <p>ON for Trace 1; OFF for 2 & 3</p>
State Saved	Saved in instrument state

More Information

When a trace becomes inactive, any update from the **:SENSe** system (detectors) immediately stops, without waiting for the end of the sweep. The trace data remains unchanged, but stops updating. If the trace is blanked, this still does not affect the data in the trace. Traces that are blanked (**Display=OFF**) do not display nor appear on printouts, but their data stays intact, they may be queried, and markers may be placed on them

In most cases, inactive traces are static and unchanging; however, there are cases when an inactive trace will update, specifically:

- if data is written to that trace from remote
- if trace data is loaded from mass storage
- if the trace is the target of a **Copy** or participant in an **Exchange**
- if the trace is cleared using **Clear Trace**

Inactive traces that are also being displayed (traces in **View**) are displayed at half intensity. Traces in **View** display across the entire X-Axis of the instrument. Their horizontal placement does not change, even if X-Axis settings subsequently are changed, although Y-Axis settings do affect the vertical placement of data.

When a trace becomes active (**Update=ON**), the trace is cleared, the average count is reset, and a new sweep is initiated.

Note that putting a trace into **Display=OFF** and/or **Update=OFF** does *not* restart the sweep and does *not* restart Averaging or Hold functions for any traces.

3.5.10.3 Math

Lets you turn on and configure Trace Math functions.

Math Function

Trace Math functions perform mathematical operations between traces and, in some cases, user-specified offsets. When in a Trace Math function, the indicated function is performed during the sweep with the math function used in place of a detector. The trace operands for the math function are set using the "[Operand 1 / Operand 2](#)" on page 1751 controls.

- See "[How trace math is processed](#)" on page 924

Remote Command	<p>For option details, see "Trace Math Options" on page 922</p> <p>For Swept SA Measurement (in SA Mode):</p> <pre style="font-family: monospace;">:CALCulate:MATH <trace_num>, PDIFference PSUM LOFFset LDIFference OFF, <trace_num>, <trace_num>, <real>,<real> :CALCulate:MATH? <trace_num></pre> <p>where <trace_num> is any one of:</p> <pre style="font-family: monospace;">TRACE1 ... TRACE6</pre> <p>For all other measurements:</p> <pre style="font-family: monospace;">:CALCulate:<meas>:MATH <trace_num>, PDIFference PSUM LOFFset LDIFference OFF, <trace_num>, <trace_num>, <real>,<real> :CALCulate[:<meas>]:MATH? <trace_num></pre> <p>where:</p> <p><meas> is the identifier for the current measurement, and</p> <p><trace_num> is any one of:</p> <pre style="font-family: monospace;">TRACe1 TRACe2 TRACe3</pre> <p>Note that the format of the TRACe<n> parameter differs from that for the Swept SA Measurement</p>
----------------	--

Example	<pre style="font-family: monospace;">:CALC:MATH TRACe3,PDIF,TRACe1,TRACe2,0,0</pre>
---------	---

3 VMA Mode
 3.5 Channel Power Measurement

	<p>Sets Trace 3 to Power Diff trace math function, and sets the First Trace operand (for Trace 3) to Trace 1 and the Second Trace operand (for Trace 3) to Trace 2</p> <p><code>:CALC:MATH TRACE3,PSUM,TRACE1,TRACE2,0,0</code></p> <p>Sets Trace 3 to Power Sum trace math function and sets the First Trace operand (for Trace 3) to Trace 1 and the Second Trace operand (for Trace 3) to Trace 2</p> <p><code>:CALC:MATH TRACE3,LOFF,TRACE1,TRACE2,-6.00,0</code></p> <p>Sets Trace 3 to Log Offset trace math function, sets the First Trace operand (for Trace 3) to Trace 1, leaves the Second Trace operand (for Trace 3) unchanged (it is irrelevant for this function) and sets the Log Offset (for Trace 3) to -6 dB</p> <p><code>:CALC:MATH TRACE3,LDIF,TRACE1,TRACE2,0,-6.00</code></p> <p>Sets Trace 3 to Log Diff trace math function, sets the First Trace operand (for Trace 3) to Trace 1, sets the Second Trace operand (for Trace 3) to Trace 2, and sets the Log Difference reference (for Trace 3) to -6 dBm</p> <p><code>:CALC:MATH TRACE1,OFF,TRACE2,TRACE3,0,0</code></p> <p>Turns off trace math for trace 1</p>
Notes	<p>The Trace Math Function command has 6 main set of parameters:</p> <ul style="list-style-type: none"> - Set 1 defines the “result trace”: <code>TRACE1 ... TRACE6</code> - Set 2 defines the “function”: <code>PDIFference PSUM LOFFset LDIFference OFF</code> - Set 3 is a “trace operand” (1): <code>TRACE1 ... TRACE6</code> - Set 4 is a “trace operand” (2): <code>TRACE1 ... TRACE6</code> - Set 5 defines the “Log Offset” (in dB) - Set 6 defines the “Log Difference Reference” (in dBm) <p>Note that the trace math mode is an enumeration; that is, when a math function is set for a trace, it turns off any math function that is on for that trace, then sets the new math function</p> <p>The parameters sent in the command are reflected in the values in the control menu. There is no default for any parameter; all 6 parameters must be sent to satisfy the parser. Failure to specify a parameter will result in a missing parameter message</p> <p>The query returns the math mode, the operand traces, the offset and the reference for the specified trace, all separated by commas</p>
Dependencies	<p>Trace Math is not available if Normalize is on</p> <p>Trace Math is not available if Signal ID is on</p> <p>None of the trace operands can be the destination trace. If any of the three trace math commands is sent with a destination trace number matching one of the operands, a warning is generated and the function does not turn on</p>
Couplings	When a math function is changed for a trace, that trace is set to Display = ON ; and Update = ON
Preset	For Swept SA Measurement (in SA Mode):

	<code>OFF, TRACE5, TRACE6, 0, 0 OFF, TRACE6, TRACE1, 0, 0 OFF, TRACE1, TRACE2, 0, 0 </code> <code>OFF, TRACE2, TRACE3, 0, 0 OFF, TRACE3, TRACE4, 0, 0 OFF, TRACE4, TRACE5, 0, 0</code>
	For all other measurements: <code>OFF, TRACE2, TRACE3, 0, 0 OFF, TRACE3, TRACE1, 0, 0 OFF, TRACE1, TRACE2, 0, 0</code>
State Saved	The trace math function for each trace is saved in instrument state
Annunciation	An “F” is shown on the trace annunciation panel in the Measurement Bar when a math function is on; and the function is annotated on the trace if Trace Annotation is on
Status Bits/OPC dependencies	*OPC can be used to detect the completion of a sweep, which will also correspond to the completion of the math operation, since all math takes place during the sweep

Trace Math Options

IMPORTANT

To generate a trace math result, *you must take a sweep*. The trace math engine, described below, operates in concert with the sweep engine in the instrument. Until a sweep has been taken, even if the constituent traces are not in Update mode, no result is generated.

Note that certain events can affect the trace in ways that affects all points at once. This can happen in any number of ways, including:

- A trace clear taking place
- A trace being loaded from the file system
- Trace data being sent in from the remote interface
- A copy or exchange of trace data

You should try to avoid these occurrences during a sweep, as they will tend to invalidate the math result being accumulated.

The Trace Math functions are:

Power Diff (Op1 - Op2)

Calculates a power difference between the **First Trace** operand and the **Second Trace** operand and puts the result in the destination trace.

During the sweep, the following formula is executed for each point in the trace operands, and the corresponding point is generated for the destination trace:

$$\text{DestinationTrace} = 10 \log_{10}(1/10)(\text{FirstTrace}) - 10(1/10)(\text{SecondTrace})$$

The values of the trace points are assumed to be in a decibel scale, as they are internally stored.

If a point in **FirstTrace** is equal to **maxtracevalue**, the resultant point is also **maxtracevalue**.

Otherwise, if the result of the subtraction is less than or equal to 0, the resultant point is **mintracevalue**.

Power Sum (Op1 + Op2)

Calculates a power sum between the **First Trace** operand and the **Second Trace** operand and puts the result in the destination trace.

During the sweep, the following formula is executed for each point in the trace operands, and the corresponding point is generated for the destination trace.

$$\text{DestinationTrace} = 10 \log_{10}(10^{(1/10)(\text{FirstTrace})} + 10^{(1/10)(\text{SecondTrace})})$$

The values of the trace points are assumed to be in a decibel scale, as they are internally stored.

If a point in either trace operand is equal to **maxtracevalue**, the resultant point is also **maxtracevalue**.

Log Offset (Op1 + Offset)

Calculates a log offset from the **First Trace** operand and puts the result in the destination trace. This is like the B-DL function in some older instruments. The offset is entered on the **Offset** control, which only appears when this math function is in force for the selected trace. Each destination trace has its own offset.

During the sweep, the following formula is executed for each point in the trace operand, and the corresponding point is generated for the destination trace.

$$\text{DestinationTrace} = \text{FirstTrace} + \text{Offset}$$

The values of the trace points are assumed to be in dBm (as they are internally stored) and the offset is in dB.

If a point in the trace operand is equal to **maxtracevalue**, the resultant point is also **maxtracevalue**.

If a point in the trace operand is equal to **mintracevalue**, the resultant point is also **mintracevalue**.

Example: If offset is 25 dB, then our destination trace will be higher than the operand trace by 25 dB.

Note that the **Second Trace** operand is not used for this function.

Log Diff (Op1 - Op2 + Ref)

Offsets the difference between the **First Trace** operand and the **Second Trace** operand by a reference and puts the result in the destination trace. This is like the A-B+DL function in some older instruments. The Reference is entered on the **Reference** control, which only appears when this math function is in force for the selected trace. Each destination trace has its own reference.

Offsets the difference between the **First Trace** operand and the **Second Trace** operand by a reference and puts the result in the destination trace. This is like the A-B+DL function in some older instruments. The Reference is entered on the **Reference** control, which only appears when this math function is in force for the selected trace. Each destination trace has its own reference.

During the sweep, the following formula is executed for each point in the trace operands, and the corresponding point is generated for the destination trace.

$$\text{DestinationTrace} = (\text{FirstTrace} - \text{SecondTrace}) + \text{Reference}$$

The values of the operand trace points are assumed to be in decibel units (as they are internally stored) and the reference is in dBm so the result is in dBm.

Example: If the first operand trace 1 is at 5 dBm, the second operand trace 2 is at -5 dBm, and the reference is -25 dBm, then the destination trace will be -15 dBm.

Example: If the first operand trace 1 is at 60 dBuV, the second operand trace 2 is at 50 dBuV, and the reference is 35 dBuV, then the destination trace will be 45 dBuV.

If a point in **FirstTrace** is equal to **maxtracevalue**, the resultant point is also **maxtracevalue**.

If a point in **FirstTrace** is equal to **mintracevalue**, the resultant point is also **mintracevalue**.

If neither of the above is true for a given point, then:

- If that point in **SecondTrace** is equal to **maxtracevalue**, the resultant point is **mintracevalue**.
- If that point in **SecondTrace** is equal to **mintracevalue**, the resultant point is **maxtracevalue**.

How trace math is processed

Whenever a trace math function is turned on, or the parameters and/or operands of an existing trace math function are changed, the destination trace is cleared. After the trace is cleared, all x-axis values in the trace, and the domain of the trace, are set to match the X-Axis settings of the first trace operand. When this is complete, a new sweep is initiated.

3 VMA Mode
 3.5 Channel Power Measurement

The process of acquiring data, processing it using the math and Average/Hold functions, and presenting it as trace data, consists of several functional blocks, as shown below:

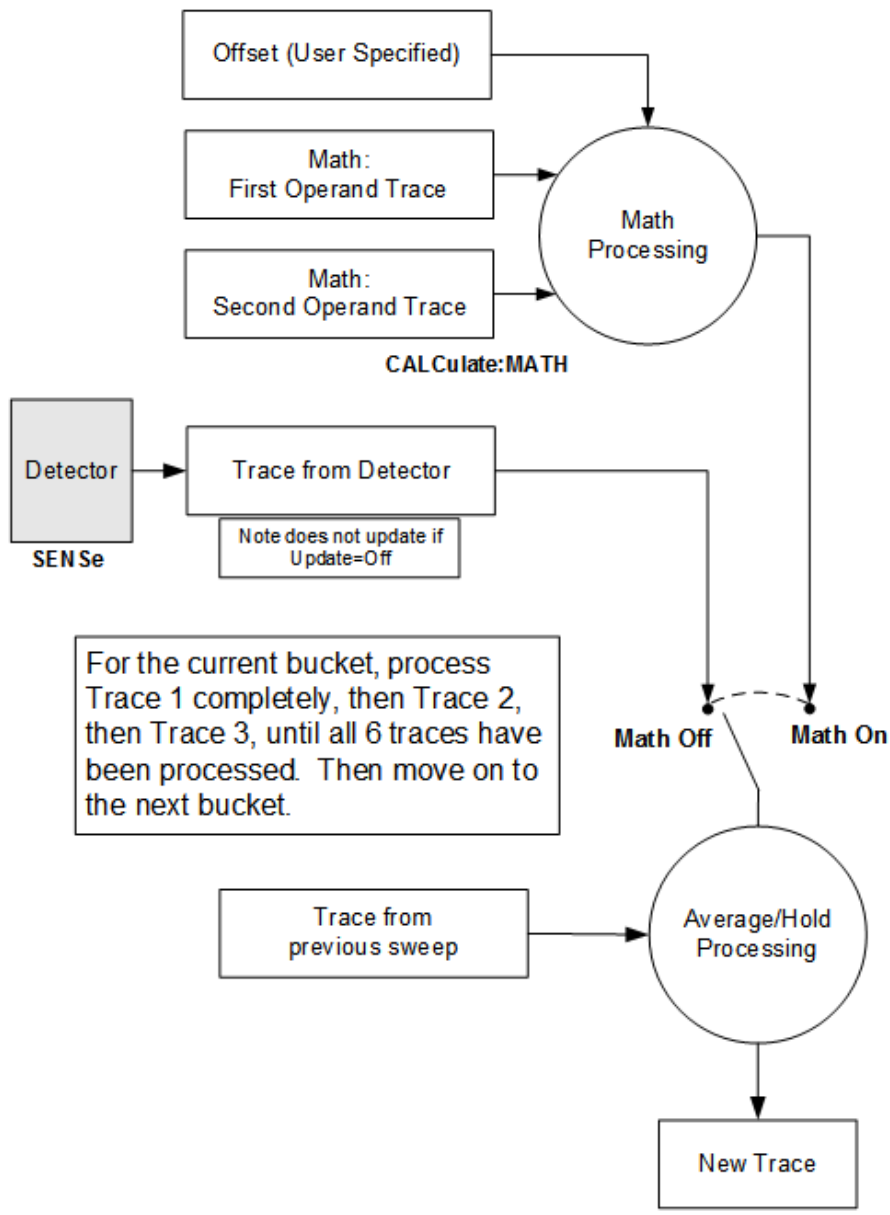

NOTE ABOUT OFFSETS: When either External Gain or Ref Level Offset is on, an offset is applied to the trace operands, and when Trace Math is on this offset is applied before any math processing is performed. Since the operands have already been offset the result trace should NOT be offset. Therefore when any Trace Math operation is performed, the sum of (External Gain - Ref Level Offset) is added to the result before it is stored in the result trace.

For each active trace, the current trace point is processed for **Trace 1**, then **Trace 2**, then **Trace 3**, etc. Trace data is taken from either the detector for that trace, or from the mathematical result of up to two other traces and an offset, depending on whether trace math is on or not. The resultant data is then fed to the Average/Hold processing block, where (if the trace type is **Average**, **Max Hold**, or **Min Hold**) it is processed with previous trace data. The new trace data resulting from this process is then available for display, storage or remote output.

When the processing is complete for **Trace 1**, **Trace 2** is processed, and so on until all six traces have been processed. This allows a downstream trace to use as one of its math components a fully processed upstream trace. In other words, if math is **ON** for **Trace 4**, and its operand traces are **Trace 2** and **Trace 3**, then all detector, math, average and hold processing for Traces 2 and 3 is completed before the math is performed for **Trace 4**. When the current trace point is completed for all traces, the instrument moves on to the next trace point.

This allows very flexible and powerful math functions to be configured. For example, **Trace 1** can be an average trace, which can be fed with an offset to **Trace 2**, which can also be in **Max Hold**, allowing you to obtain the **Max Hold** of an Average trace.

Note that none of this processing is performed on inactive traces.

Note also that for any active trace with math **ON**, the Operand traces should have *lower* numbers than the trace (for example, using **Trace 4** as an operand for **Trace 1** will cause the data coming from **Trace 4** to be delayed by one sweep).

Operand 1 / Operand 2

These two controls select the first and second trace operands to be used for the trace math functions for the destination trace. The operands are common to all math functions for a given trace. The most recently sent **:CALCulate:MATH** command for a given trace sets the operands for that trace. Those settings are displayed on the trace operand controls for that trace.

Example	<p>The following examples are for the Swept SA measurement</p> <p>Set Trace 3 to Power Diff trace math function. Set the First Trace operand (for Trace 3) to Trace 1 and the Second Trace operand (for Trace 3) to Trace 2:</p> <pre>:CALC:MATH TRACE3,PDIF,TRACE1,TRACE2,0,0</pre> <p>Set Trace 3 to Log Offset trace math function. Set the First Trace operand (for Trace 3) to Trace 1, leave the Second Trace operand (for Trace 3) unchanged (it is irrelevant for this function) and set the Log Offset (for Trace 3) to -6 dB:</p> <pre>:CALC:MATH TRACE3,LOFF,TRACE1,TRACE2,-6.00,0</pre>
Notes	See " Math Function " on page 1745 for how to specify Operands 1 and 2 using :CALCulate:MATH
Dependencies	The destination trace cannot be an operand. The destination trace number is grayed-out on the

	dropdown
Preset	Operand 1: Trace number minus 2 (wraps at 1). For example, for Trace 1, Operand 1 presets to Trace 5; for Trace 6, it presets to Trace 4 Operand 2: Trace number minus 1 (wraps at 1). For example, for Trace 1, Operand 2 presets to Trace 6; for Trace 6, it presets to Trace 5
State Saved	Operands 1 and 2 for each trace are stored in instrument state

Offset

Used by the Log Offset math function.

Example	The following example is for the Swept SA measurement Set Trace 3 to Log Offset trace math function, set the First Trace operand (for Trace 3) to Trace 1, leave the Second Trace operand (for Trace 3) unchanged (it is irrelevant for this function) and set the Log Offset (for Trace 3) to -6 dB: <code>:CALC:MATH TRACE3,LOFF,TRACE1,TRACE2,-6.00,0</code>
State Saved	The Log Offset value for each trace is saved in Instrument State
Min	-100 dB
Max	100 dB

Reference

Used by the Log Diff math function.

Example	The following example is for the Swept SA measurement Set Trace 3 to Log Diff trace math function, set the First Trace operand (for Trace 3) to Trace 1, set the Second Trace operand (for Trace 3) to Trace 2, and set the Log Difference reference (for Trace 3) to -6 dBm: <code>:CALC:MATH TRACE3,LDIF,TRACE1,TRACE2,0,-6.00</code>
State Saved	The Log Difference reference value for each trace is saved in instrument state
Min/Max	Same as reference level

3.5.10.4 Detector

Lets you choose and configure detectors for the selected trace.

Detector

Selects a detector to be used by the instrument for the current measurement. The following choices are available:

Option	Parameter	Detector Behavior
Auto	n/a	The detector selected depends on marker functions, trace functions, average type, and the trace averaging function This option is set using " Detector Select Auto/Man " on page 929
Normal	NORMa1	The detector determines the peak of the CW-like signals, and it yields alternating maximums and minimums of noise-like signals. This is also referred to as Rosenfell detection
Average	AVERage	The detector determines the average of the signal within the sweep points, using RMS averaging
Peak (Positive)	POSitive	The detector determines the maximum of the signal within the sweep points
Sample	SAMPle	The detector indicates the instantaneous level of the signal at the center of the sweep points represented by each display point
Negative Peak	NEGative	The detector determines the minimum of the signal within the sweep points
RMS	RMS	Equivalent to Average . See Notes below

Because they may not find a spectral component's true peak, neither **Average** nor **Sample** detectors measure amplitudes of CW signals as accurately as **Peak** or **Normal**, but they do measure noise without the biases of peak detection.

Remote Command `[:SENSe]:CHPower:DETEctor[:FUNction] NORMa1 | AVERage | POSitive | SAMPle | NEGative | RMS`
`[:SENSe]:CHPower:DETEctor[:FUNction]?`

Example `:CHP:DET NORM`
`:CHP:DET?`
Set the detector to **Average**, which uses RMS averaging, so this is equivalent to selecting an **RMS** detector:
`:CHP:DET RMS`

Notes The query returns a name that corresponds to the detector type, as shown below
The **RMS** selection sets the detector type to **AVERage** with **RMS** averaging. Therefore, if **RMS** has been selected, the query returns **AVER**

String Returned	Definition
NORM	Normal
AVER	Average (RMS)
POS	Peak
SAMP	Sample
NEG	Negative Peak

Couplings When the **Detector** setting is **Auto**, switches to align with "[Trace Type](#)" on page 1737:
– [NORMa1](#) with Clear Write

- **AVERage** with **AVERage**
- **POSitive** (peak) with **MAXHold**
- **NEGative** (peak) with **MINHold**

Preset	AVERage
State Saved	Saved in instrument state
Range	NORMal AVERage POSitive SAMPle NEGative RMS

Detector Select Auto/Man

Sets the Detector mode to **Auto** or **Manual**. In **Auto**, the proper detector is chosen based on rules that take into account the measurement settings and other instrument settings.

When you select any detector explicitly, this setting switches automatically to **Man** (manual).

Remote Command	[:SENSe] :CHPower:DETECTOR:AUTo ON OFF 1 0 [:SENSe] :CHPower:DETECTOR:AUTo?
Example	:CHP:DET:AUTo ON :CHP:DET:AUTo?
Couplings	When the Detector setting is Auto , switches to align with " Trace Type " on page 1737: <ul style="list-style-type: none"> - NORMal with Clear Write - AVERage with AVERage - POSitive (peak) with MAXHold - NEGative (peak) with MINHold
Preset	ON
State Saved	Yes

3.5.10.5 Trace Function

Contains controls to:

- Copy and Exchange traces
- Preset or Clear all traces

From Trace

Selects the trace to be copied to or exchanged with the **"To Trace" on page 1753** when a **"Copy" on page 1753** or **"Exchange" on page 1754** is performed

Preset 1

To Trace

Selects the trace to be copied from or exchanged with the **"From Trace" on page 1753** when a **"Copy" on page 1753** or **"Exchange" on page 1754** is performed

Preset 2

Copy

Executes a Trace Copy based on the **"From Trace" on page 1753** and **"To Trace" on page 1753** parameters. The copy operation is from the **From Trace** to the **To Trace**. The action is performed once.

The X-Axis settings and domain of a trace are also copied.

Remote Command For Swept SA Measurement (in SA Mode):
`:TRACe:COPIY TRACE1 | ... | TRACE6, TRACE1 | ... | TRACE6`
 For all other measurements:
`:TRACe:<meas>:COPIY TRACe1 | TRACe2 | TRACe3, TRACe1 | TRACe2 | TRACe3`
 where **<meas>** is the identifier for the current measurement
 Note that the format of the **TRACe<n>** parameter differs from that for the Swept SA Measurement

Example Copy Trace 1 to Trace 3 and put Trace 3 in Update=Off, Display=On
`:TRAC:COPIY TRACE1, TRACE3`

Notes The command is of the form:
`:TRACe:COPIY <source_trace>, <dest_trace>`

Dependencies When Signal ID is on, this key is grayed-out

Couplings The destination trace is put in **View** (Update = Off, Display = On) after the copy

Preset For Swept SA Measurement (in SA Mode):
`TRACE1, TRACE2`
 For all other measurements:
`TRACe1, TRACe2`

Exchange

Executes a Trace Exchange based on the "From Trace" on page 1753 and "To Trace" on page 1753 parameters. The **From Trace** and **To Trace** values are exchanged with each other. The action is performed once.

The X-Axis settings and domain of a trace are also copied when it is exchanged with another trace.

Remote Command	<p>For Swept SA Measurement (in SA Mode): <code>:TRACe:EXCHange TRACE1 ... TRACE6, TRACE1 ... TRACE6</code></p> <p>For all other measurements: <code>:TRACe:<meas>:EXCHange TRACe1 TRACe2 TRACe3, TRACe1 TRACe2 TRACe3</code></p> <p>where <code><meas></code> is the identifier for the current measurement</p> <p>Note that the format of the <code>:TRACe<n></code> parameter differs from that for the Swept SA Measurement</p>
Example	<p>Exchange Trace 1 and Trace 2 and put both traces in Update=OFF, Display=ON: <code>:TRAC:EXCH TRACE1, TRACE2</code></p>
Notes	<p>The command is of the form: <code>:TRACe:EXCHange <trace_1>, <trace_2></code></p>
Couplings	Both traces are put in View (Update=Off, Display=On) after the exchange

Preset All Traces

Turns on Trace 1 and blanks all other traces. This is useful when you have many traces on and you want to return to having only Trace 1 on the display. Does not affect the trace type, detector or any other aspect of the trace system.

Remote Command	<code>:TRACe[:<meas>]:PRESet:ALL</code>
Example	<code>:TRAC:PRE:ALL</code>
Dependencies	When Signal ID is on, this key is grayed-out

Clear All Traces

Clears all traces. Does not affect the state of any function or variable in the instrument. Loads `mintracevalue` into all of the points for all traces, except traces in **Min Hold**, in which case it loads `maxtracevalue`, even if **Update = OFF**.

Remote Command	<code>:TRACe[:<meas>]:CLEar:ALL</code>
Example	<code>:TRAC:CLE:ALL</code>
Dependencies	When Signal ID is on, this key is grayed-out

3.5.10.6 Advanced

Contains controls for setting advanced trace functions of the instrument.

Measure Trace

Specifies which trace's scalar results are displayed in the **Metrics** window, and retrieved by sending a **:READ** or **:FETCh** query:

- Trace 1
- Trace 2
- Trace 3

Remote Command	<pre>:CALCulate:<meas>:MTRace TRACe1 TRACe2 TRACe3 :CALCulate:<meas>:MTRace? <meas> is the identifier for the current measurement; any one of CHPower ACPower OBWidth SEMask SPURious PVTime</pre>
Example	<pre>Channel Power :CALC:CHP:MTR TRAC1 :CALC:CHP:MTR?</pre>
Dependencies	In the ACP measurement, this control is grayed-out when Meas Method is set to RBW or FAST , and only Trace 1 is enabled
Preset	TRACe1
State Saved	No
Range	Trace 1 Trace 2 Trace 3

3.6 Occupied BW Measurement

This measurement computes and displays the bandwidth occupied by a given percentage of the total mean power of a signal.

Measurement Commands

The general functionality of "CONFigure" on page 2551, "INITiate" on page 2552, "FETCh" on page 2552, "MEASure" on page 2554, and "READ" on page 2553 are described in the section **SCPI Operation and Results Query** in the topic **Programming the Instrument**.

Note that, in general, `:CONF : <Measurement>` resets the specified measurement settings to their defaults. X-Series permits the addition of the `NDEFault` node to the command, which prevents a measurement preset after a measurement switch.

The tables below list setup commands for this measurement and queries to retrieve results.

Command	Function
<code>:INITiate:OBwidth</code>	Initiates a trigger cycle for the OBW measurement, but does not return any data. You must then use <code>:FETC:OBW[n]?</code> to retrieve data
<code>:CONFigure?</code>	Does not change any measurement settings
<code>:CONFigure:OBwidth</code>	Returns the long form name of current measurement, in this case, OBwidth
<code>:CONFigure:OBwidth</code>	Selects OBW measurement with Meas Setup settings in preset state – same as Meas Preset
<code>:CONFigure:OBwidth:NDEFault</code>	Selects OBW measurement <i>without</i> affecting settings

The following queries are used to retrieve data. The type of data returned depends on the value of *n*, as detailed in "Remote Command Results" on page 934.

Command	Function
<code>:FETCh:OBwidth[n]?</code>	Retrieves the data defined by <i>n</i>
<code>:MEASure:OBwidth[n]?</code>	Switches to OBW measurement, restores default values, starts the measurement, then retrieves the data defined by <i>n</i>
<code>:READ:OBwidth[n]?</code>	Starts the measurement, then retrieves the data defined by <i>n</i>

Backwards Compatibility Queries

Command	Return Value
<code>:FETCh:OBwidth:OBwidth?</code>	Returns the Occupied Bandwidth (Hz)
<code>:MEASure:OBwidth:OBwidth?</code>	
<code>:READ:OBwidth:OBwidth?</code>	

Command	Return Value
:FETCh:OBWidth:FERRor?	Returns the Transmit Frequency Error (Hz)
:MEASure:OBWidth:FERRor?	
:READ:OBWidth:FERRor?	
:FETCh:OBWidth:XDB?	Returns the xdB Bandwidth (Hz)
:MEASure:OBWidth:XDB?	
:READ:OBWidth:XDB?	

Remote Command Results

The following table describes the results returned by the **FETCh**, **MEASure**, and **READ** queries listed above, according to the index value **n**.

n	Results Returned																								
1, or not specified	Returns scalar results, in the following order: <table border="1" data-bbox="381 882 1404 1281"> <thead> <tr> <th>#</th> <th>Item</th> <th>Unit</th> </tr> </thead> <tbody> <tr> <td>1</td> <td>Occupied Bandwidth</td> <td>Hz</td> </tr> <tr> <td>2</td> <td>Total Power or OBW Power Power reference type can be changed with "Power Ref" on page 1014 in Meas Setup</td> <td>dBm</td> </tr> <tr> <td>3</td> <td>Span</td> <td>Hz</td> </tr> <tr> <td>4</td> <td>Spectrum Trace Points</td> <td>points</td> </tr> <tr> <td>5</td> <td>Res BW</td> <td>Hz</td> </tr> <tr> <td>6</td> <td>Transmit Frequency Error</td> <td>Hz</td> </tr> <tr> <td>7</td> <td>7. x dB Bandwidth</td> <td>Hz</td> </tr> </tbody> </table>	#	Item	Unit	1	Occupied Bandwidth	Hz	2	Total Power or OBW Power Power reference type can be changed with "Power Ref" on page 1014 in Meas Setup	dBm	3	Span	Hz	4	Spectrum Trace Points	points	5	Res BW	Hz	6	Transmit Frequency Error	Hz	7	7. x dB Bandwidth	Hz
#	Item	Unit																							
1	Occupied Bandwidth	Hz																							
2	Total Power or OBW Power Power reference type can be changed with "Power Ref" on page 1014 in Meas Setup	dBm																							
3	Span	Hz																							
4	Spectrum Trace Points	points																							
5	Res BW	Hz																							
6	Transmit Frequency Error	Hz																							
7	7. x dB Bandwidth	Hz																							
2	Returns the frequency-domain spectrum trace (data array) for the entire frequency range being measured for Trace 1																								
3	Only available in LTEAFDD, LTEATDD, 5GNR Modes 1. Number of active carriers Returns number of active carriers within Span in Auto detected mode, otherwise the command is out of scope																								
4	Returns OBW Boundaries table results in the following order: <table border="1" data-bbox="381 1575 1404 1795"> <thead> <tr> <th>#</th> <th>Item</th> <th>Unit, if any</th> </tr> </thead> <tbody> <tr> <td>1</td> <td>Occupied bandwidth</td> <td>Hz</td> </tr> <tr> <td>2</td> <td>Total Power or OBW Power Power reference type can be changed with "Power Ref" on page 1014 in Meas Setup</td> <td>dBm</td> </tr> </tbody> </table>	#	Item	Unit, if any	1	Occupied bandwidth	Hz	2	Total Power or OBW Power Power reference type can be changed with "Power Ref" on page 1014 in Meas Setup	dBm															
#	Item	Unit, if any																							
1	Occupied bandwidth	Hz																							
2	Total Power or OBW Power Power reference type can be changed with "Power Ref" on page 1014 in Meas Setup	dBm																							

3 VMA Mode
3.6 Occupied BW Measurement

n Results Returned		
#	Item	Unit, if any
3	x dB Reference Power	dBm
4	x dB Reference Power Frequency - offset frequency	Hz
5	x dB Reference Power Frequency - absolute frequency	Hz
6	NaN (9.91E+37)	-
7	NaN (9.91E+37)	-
8	NaN (9.91E+37)	-
9	Lower OBW boundary - offset frequency	Hz
10	Lower OBW boundary - absolute frequency	Hz
11	Lower OBW boundary - absolute power	dBm
12	Lower OBW boundary - relative power	dBc
13	Upper OBW boundary - offset frequency	Hz
14	Upper OBW boundary - absolute frequency	Hz
15	Upper OBW boundary - absolute power	dBm
16	Upper OBW boundary - relative power	dBc
17	Lower x dB BW boundary - offset frequency	Hz
18	Lower x dB BW boundary - absolute frequency	Hz
19	Lower x dB BW boundary - absolute power	dBm
20	NaN (9.91E+37)	-
21	Upper x dB BW boundary - offset frequency	Hz
22	Upper x dB BW boundary - absolute frequency	Hz
23	Upper x dB BW boundary - absolute power	dBm
24	NaN (9.91E+37)	-
Results 6, 7, 8, 20 and 24 always return NaN (9.91E+37)		
5	Returns the frequency-domain spectrum trace (data array) for the entire frequency range being measured for Trace 2	
6	Returns the frequency-domain spectrum trace (data array) for the entire frequency range being measured for Trace 3	

3.6.1 Views

This measurement has three predefined views:

Name	SCPI Name	SCPI #
"OBW Results" on page 936	OBWResults	1

Name	SCPI Name	SCPI #
"OBW Boundaries" on page 937	BOUNDaries	2
"Gate" on page 937	See "Gate View On/Off" on page 2484	

These are multiple-window views. When in a multiple-window view, you select a window by touching it. The menu controls may sometimes change depending on which window is selected.

Whenever the **View** changes, the default menu is **Frequency**, unless otherwise specified in the **View** description.

The following SCPI commands can be used to select any view other than **Gate**.

View Selection by Name

Remote Command	<code>:DISPlay:OBwidth:VIEW[:SElect] OBWResults BOUNDaries</code> <code>:DISPlay:OBwidth:VIEW[:SElect]?</code>
Example	<code>:DISP:OBW:VIEW OBWR</code> <code>:DISP:OBW:VIEW?</code>
Preset	<code>OBWResults</code>
State Saved	Saved in instrument state
Range	<code>OBWResults BOUNDaries</code>

View Selection by Number

Remote Command	<code>:DISPlay:OBwidth:VIEW:NSElect <integer></code> <code>:DISPlay:OBwidth:VIEW:NSElect?</code>
Example	<code>:DISP:OBW:VIEW:NSEL 2</code> <code>:DISP:OBW:VIEW:NSEL?</code>
Preset	1
State Saved	Saved in instrument state
Min/Max	1/2

3.6.1.1 OBW Results

Windows: "Graph" on page 937, "Metrics - OBW Results" on page 938

The spectrum trace is displayed in the upper window. Measurement results such as Occupied Bandwidth or Power are displayed in the lower window.

Example	<code>:DISP:OBW:VIEW OBWR</code>
---------	----------------------------------

3.6.1.2 OBW Boundaries

Windows: "Graph" on page 937, "Metrics - OBW Boundaries" on page 940

The spectrum trace is displayed in the upper window. The lower window of OBW Results view is replaced by the OBW boundaries table in this view. Occupied bandwidth and X dB bandwidth for both lower and upper boundaries are displayed.

Example `:DISP:OBW:VIEW BOUN`

3.6.1.3 Gate

See "Gate View On/Off" on page 2484

3.6.2 Windows

There are four available window types. The **Gate** window is available only when "Gate View On/Off" on page 2484 is **ON** in the **Gate Settings** menu under **Trigger**.

View	#
"Graph" on page 937	1
"OBW Results" on page 936	2
"OBW Boundaries" on page 937	3
"Gate" on page 941	4

3.6.2.1 Graph

Window #1

Appears in two Views, as follows:

View	Size	Position
"OBW Results" on page 936	Three fifth, full width	Top
"OBW Boundaries" on page 937	Half, full width	Top

Spectrum View

For SA, WCDMA, WLAN mode:

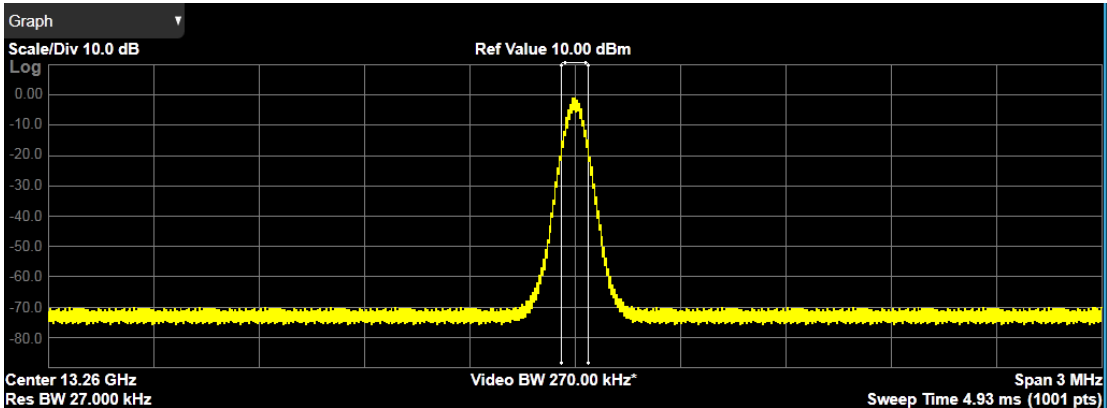

For LTE-Advanced FDD/TDD mode only

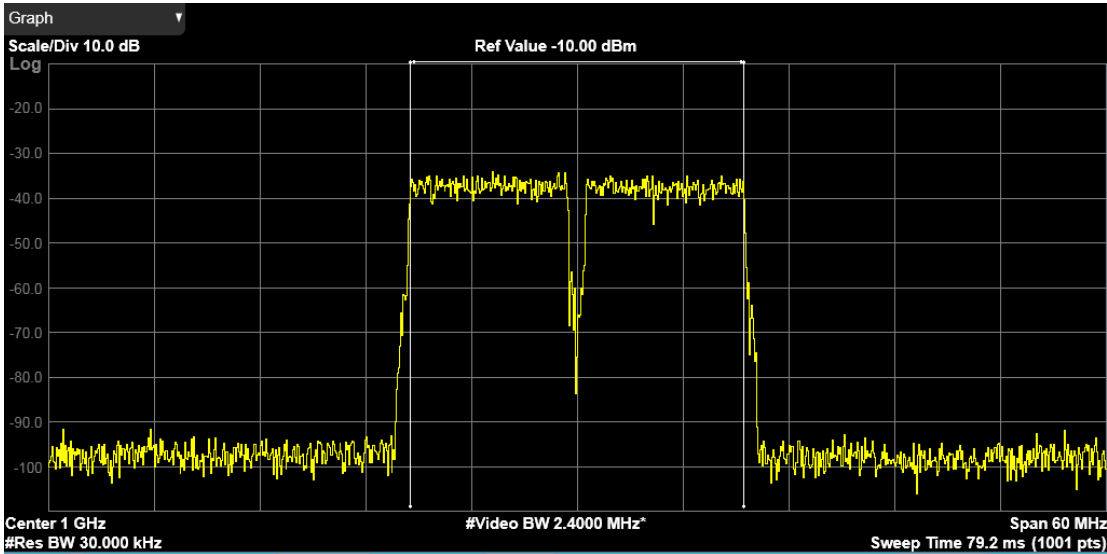

3.6.2.2 Metrics - OBW Results

Window #2

Displays the textual results of the Occupied BW measurement.

View	Size	Position
"OBW Results" on page 936	Two fifth, full width	Bottom
Gate	One third, full width	Bottom

3 VMA Mode

3.6 Occupied BW Measurement

Metrics	
Occupied Bandwidth	2.9730 MHz
Transmit Freq Error	0 Hz
x dB Bandwidth	3.000 MHz
Total Power	20.2 dBm
% of OBW Power	99.00 %
x dB	-26.00 dB

For the LTE-Advanced FDD/TDD and 5G NR modes, the metric result is shown as below:

Metrics	
Occupied Bandwidth	2.9730 MHz
Transmit Freq Error	0 Hz
x dB Bandwidth	3.000 MHz
Total Power	20.2 dBm
% of OBW Power	99.00 %
x dB	-26.00 dB

Occupied Bandwidth

The occupied bandwidth result is $f_2 - f_1$, where f_1 and f_2 are the lower and upper carrier boundary point. f_1 and f_2 are calculated with Occupied Bandwidth algorithms.

Total Power or OBW Power

The total power is the power integrated in the specified span setting. The OBW power is calculated from multiplying the total power by OBW percent power. The user can select the total power or the OBW power with the Power Ref control in Meas Setup.

Transmit Freq Error

The transmit freq error (transmit frequency error) result is calculated as the difference between $(f_2+f_1)/2$ and the tuned center frequency of the signal, where f_1 and f_2 are the lower and upper carrier boundary point.

x dB Bandwidth

The x dB result is a bandwidth measured between two points on the signal which are a certain number of dBs down from the highest signal point within the OBW Span. For example, If the 'x dB' parameter is set to -26 dB, and the 'Occupied BW Span' is set to 10 MHz, then the maximum signal power level is first determined from the 10 MHz wide trace sweep. Next, the two furthest frequencies below ($x_{db_f_1}$) and above ($x_{db_f_2}$) the frequency of the maximum level occurrence are found where the signal level is 26 dB below the peak level. This calculation also uses linear interpolation to find the lower and upper carrier boundary point within the width of a sweep point (the span divided by the number of sweep points).

The x dB bandwidth is calculated to be $x_{db_f_2} - x_{db_f_1}$.

% of OBW Power

This is the setting parameter. See "[% of OBW Power](#)" on page 1013

x dB

This is the setting parameter. See "[x dB](#)" on page 1014.

Active Carriers

In the LTE-Advanced FDD/TDD and 5G NR modes, the number of active carriers is displayed to show how many carriers are identified as active in auto detected mode of span, otherwise “-” is displayed to indicate that it is out of scope. When there is one active carrier, Transmit Freq Error is displayed. Otherwise, “---” is displayed.

Measure Trace

See "[Measure Trace](#)" on page 1755.

3.6.2.3 Metrics - OBW Boundaries

Window #3

Displays occupied bandwidth and X dB bandwidth for both lower and upper boundaries.

View	Size	Position
"OBW Boundaries" on page 937	Half, full width	Bottom
Gate	One third, full width	Bottom

Metrics		Occupied Bandwidth			x dB Reference		
		2.9730 MHz			x dB	-26.00 dB	
	Total Power	20.2 dBm			Power	0.00 dBm	
					Offset Frequency	-1.5000 MHz	
		Lower Boundary			Upper Boundary		
		Offset Freq	Abs Power	Rel Power	Offset Freq	Abs Power	Rel Power
	Occupied Bandwidth	-1.4865 MHz	0.00 dBm	-20.2 dBc	1.4865 MHz	0.00 dBm	-20.2 dBc
	x dB Bandwidth	-1.5000 MHz	-26.0 dBm		1.5000 MHz	-26.0 dBm	

Occupied Bandwidth

The occupied bandwidth result is $f_2 - f_1$, where f_1 and f_2 are the lower and upper carrier boundary point. f_1 and f_2 are calculated with Occupied Bandwidth algorithms.

Total Power or OBW Power

Total Power is the power integrated in the specified span setting. OBW Power is calculated from multiplying the total power by OBW percent power. The user can select the total power or the OBW power with the Power Ref control in Meas Setup.

x dB

This is the setting parameter. See "[x dB](#)" on page 1014.

x dB Ref Pwr

3 VMA Mode
3.6 Occupied BW Measurement

The x dB reference power result shows the power of the highest signal point within the OBW Span.

x dB At Freq

The x dB reference power frequency result shows the frequency of the highest signal point within the OBW Span. The frequency display type, either Offset or Absolute, can be selected with the Boundary Frequency control under Display.

OBW Boundary Results

Name	Unit	Corresponding Results
Lower OBW boundary - offset frequency	Hz	Offset frequency of the lower OBW boundary from center frequency
Lower OBW boundary - absolute power	dB	Absolute power on the point of lower OBW boundary
Lower OBW boundary - relative power	dBc	Relative power on the point of lower OBW boundary
Upper OBW boundary - offset frequency	Hz	Offset frequency of the upper OBW boundary from center frequency
Upper OBW boundary - absolute power	dB	Absolute power on the point of upper OBW boundary
Upper OBW boundary - relative power	dBc	Relative power on the point of upper OBW boundary
Lower x dB BW boundary - offset frequency	Hz	Offset frequency of the lower x dB BW boundary from center frequency
Lower x dB BW boundary - absolute power	dB	Absolute power on the point of lower x dB BW boundary
Upper x dB BW boundary - offset frequency	Hz	Offset frequency of the lower x dB BW boundary from center frequency
Upper x dB BW boundary - absolute power	dB	Absolute power on the point of lower x dB BW boundary

3.6.2.4 Gate

Window #4

Turning on **Gate** View shows the **Gate** Window, which lets you see your Gating signal at the same time as the measured data. See the description in "[Gate View On/Off](#)" on page 2484 under **Trigger, Gate Settings**.

Views in which this window appears:

View	Size	Position
Gate	One third, full width	Top

3.6.3 Amplitude

Activates the **Amplitude** menu and selects **Reference Level** or **Reference Value** as the active function, depending on the measurement.

Some features in this menu apply to multiple measurements. Some other features apply only to specific measurements and their controls are blanked or grayed-out in measurements that do not support the feature.

3.6.3.1 Y Scale

Contains controls that pertain to the Y axis parameters of the measurement. These parameters control how data on the vertical (Y) axis is displayed and control instrument settings that affect the vertical axis.

Ref Value

Sets the value for the absolute power reference. The reference line is at the top, center, or bottom of the graticule, depending on the value of the Ref Position function.

Remote Command	<code>:DISPlay:OBWidth:WINDow[1]:TRACe:Y[:SCALe]:RLEVel <real></code> <code>:DISPlay:OBWidth:WINDow[1]:TRACe:Y[:SCALe]:RLEVel?</code>
Example	<code>:DISP:OBW:WIND:TRAC:Y:RLEV 125</code> <code>:DISP:OBW:WIND:TRAC:Y:RLEV?</code>
Couplings	When " Auto Scaling " on page 945 is ON (default), this value is automatically determined by the measurement result. When you set a value manually, Auto Scaling changes to OFF " Attenuation " on page 1763 is not coupled to Ref Value
Preset	10.00 dBm
State Saved	Saved in instrument state
Min/Max	-250.00 dBm / 250.00 dBm
Annotation	Ref <value> top left of graph
Backwards Compatibility SCPI	<code>:DISPlay:OBWidth:VIEW[1]:WINDow[1]:TRACe:Y[:SCALe]:RLEVel</code>

Scale/Div

For measurements that support a logarithmic Y-Axis, **Scale/Div** sets the height of one division of the graticule in the current Y-Axis unit.

3 VMA Mode
3.6 Occupied BW Measurement

Scale/Div also determines the displayed amplitude range in the log plot graph. Since there are usually 10 vertical graticule division on the display, the total amplitude range of the graph is typically 10x this amount. For example, if Scale/Div is 10 dB, then the total range of the graph is 100 dB.

Remote Command	<code>:DISPlay:OBWidth:WINDow[1]:TRACe:Y[:SCALe]:PDIVision <rel_amp1></code> <code>:DISPlay:OBWidth:WINDow[1]:TRACe:Y[:SCALe]:PDIVision?</code>
Example	<code>:DISP:OBW:WIND:TRAC:Y:PDIV 5</code> <code>:DISP:OBW:WIND:TRAC:Y:PDIV?</code>
Couplings	Coupled to Scale Range as follows Scale/Div = Scale Range/10 (number of divisions) When the Auto Scaling is On, this value is automatically determined by the measurement result When you change a value, Auto Scaling automatically changes to Off
Preset	10.00 dB / Div
State Saved	Saved in instrument state
Min	0.10 dB
Max	20 dB
Annotation	<value> dB/ left upper of graph
Backwards Compatibility SCPI	<code>:DISPlay:OBWidth:VIEW[1]:WINDow[1]:TRACe:Y[:SCALe]:PDIVision</code>

Scale Range

Sets the Y-Axis scale range.

Remote Command	Replace <meas> with the identifier for the current measurement <code>:DISPlay:<meas>:WINDow[1]:TRACe:Y[:SCALe]:RANGe <rel_amp1></code> <code>:DISPlay:<meas>:WINDow[1]:TRACe:Y[:SCALe]:RANGe?</code>
Example	<code>:DISP:CHP:WIND:TRAC:Y:RANG 100</code> <code>:DISP:CHP:WIND:TRAC:Y:RANG?</code>
Couplings	Coupled to Scale/Div as follows Scale Range = Scale/Div * 10 (number of divisions) When you change this value, Auto Scaling automatically changes to OFF
Preset	100 dB
State Saved	Saved in instrument state
Min	1
Max	200

Ref Level Offset

Adds an offset value to the displayed reference level. The reference level is the absolute amplitude represented by the top graticule line on the display.

The on/off (**AUTO**) switch turns **Ref Level Offset** on or off. Setting a value for **Ref Level Offset** turns **AUTOOFF**.

Remote Command	<pre>:DISPlay:WINDow[1]:TRACe:Y[:SCALe]:RLEVel:OFFSet <rel_amp1> :DISPlay:WINDow[1]:TRACe:Y[:SCALe]:RLEVel:OFFSet? :DISPlay:WINDow[1]:TRACe:Y[:SCALe]:RLEVel:OFFSet:STATe OFF ON 0 1 :DISPlay:WINDow[1]:TRACe:Y[:SCALe]:RLEVel:OFFSet:STATe?</pre>
Example	<p>Set Ref Level Offset to 12.7 dB. The only valid suffix is dB. If no suffix is sent, dB is assumed:</p> <pre>:DISP:WIND:TRAC:Y:RLEV:OFFS 12.7 :DISP:WIND:TRAC:Y:RLEV:OFFS?</pre> <p>Turn Ref Level Offset AUTOON:</p> <pre>:DISP:WIND:TRAC:Y:RLEV:OFFS:STAT ON</pre>
Dependencies	Appears only in Spectrum Analyzer Mode
Preset	0 dBm OFF
State Saved	Saved in instrument state
Min	Variable. Limited to values that keep the reference level within the range of -327.6 dB to 327.6 dB
Max	327.6 dB
Annotation	The offset is displayed as “Ref Offset <value>” to the right of the reference level annotation if nonzero. When the offset is zero, no annotation is shown

Ref Position

Positions the reference level at the top, center, or bottom of the Y Scale display. Changing the reference position does not change the reference level value.

Remote Command	<pre>:DISPlay:OBWidth:WINDow[1]:TRACe:Y[:SCALe]:RPOSition TOP CENTer BOTTom :DISPlay:OBWidth:WINDow[1]:TRACe:Y[:SCALe]:RPOSition?</pre>
Example	<pre>:DISP:OBW:WIND:TRAC:Y:RPOS CENT :DISP:OBW:WIND:TRAC:Y:RPOS?</pre>
Preset	TOP
State Saved	Saved in instrument state
Range	TOP CENTer BOTTom
Annotation	The greater than (>) and less than (<) symbols are displayed on both sides of the graph to indicate the

	Reference Position
Backwards Compatibility SCPI	<code>:DISPlay:OBWidth:VIEW[1]:WINDow[1]:TRACe:Y[:SCALe]:RPOsition</code>

Auto Scaling

Toggles **Auto Scaling** On or Off.

Remote Command	<code>:DISPlay:OBWidth:WINDow[1]:TRACe:Y[:SCALe]:COUPlE 0 1 OFF ON</code> <code>:DISPlay:OBWidth:WINDow[1]:TRACe:Y[:SCALe]:COUPlE?</code>
Example	<code>:DISP:OBW:WIND:TRAC:Y:COUP OFF</code> <code>:DISP:OBW:WIND:TRAC:Y:COUP?</code>
Couplings	When Auto Scaling is ON , and the Restart front-panel key is pressed, this function automatically sets the scale per division to 10 dB and determines the reference values based on the measurement results When you change a value of "Scale/Div" on page 942 , "Ref Value" on page 942 , or "Scale Range" on page 1612 , Auto Scaling automatically changes to OFF
Preset	1
State Saved	Saved in instrument state
Range	OFF ON
Backwards Compatibility SCPI	<code>:DISPlay:OBWidth:VIEW[1]:WINDow[1]:TRACe:Y[:SCALe]:COUPlE</code>

3.6.3.2 Attenuation

Controls the attenuator functions and interactions between the attenuation system components.

There are two attenuator configurations in the X-Series. One is a Dual-Attenuator configuration consisting of a mechanical attenuator and an optional electronic attenuator. The other configuration uses a single attenuator with combined mechanical and electronic sections that controls all the attenuation functions. Different models in the X-Series come with different configurations.

- See **"Dual-Attenuator Configurations" on page 946**
- See **"Single-Attenuator Configuration" on page 946**

Most attenuation settings are the same for all measurements – they do not change as you change measurements. Settings like these are called “Meas Global” and are unaffected by **Meas Preset**.

Only available when the hardware set includes an input attenuator, which is typically only the case for Keysight’s benchtop instruments. For example, this tab does *not* appear in VXT models M9420A/10A/11A/15A/16A, M9410E/11E/15E/16E, nor in UXM. In UXM, all **Attenuation** and **Range** settings are disabled, as the expected input power level is handled by the Call Processing App that drives the DUT power control.

Dependencies In measurements that support the I/Q inputs, unavailable when I/Q is the selected input. Replaced by the **Range** tab in that case

Dual-Attenuator Configurations

Configuration 1: Mechanical attenuator + optional electronic attenuator

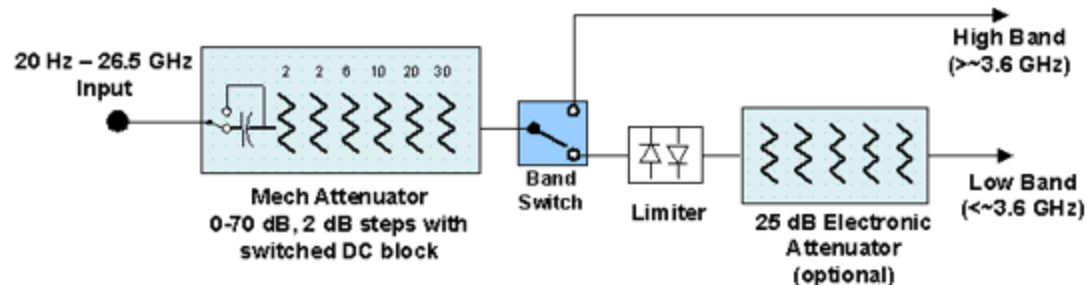

Configuration 2: Mechanical attenuator, no optional electronic attenuator

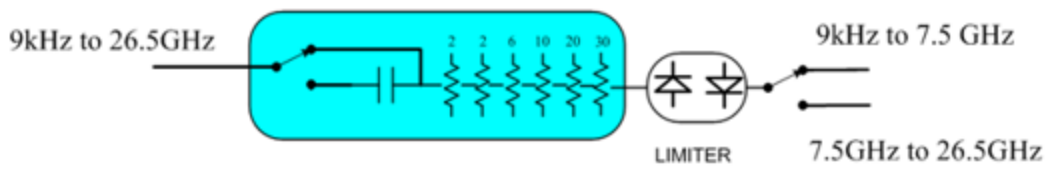

Note that Configuration 2 is not strictly speaking a dual-section attenuator, since there is no electronic section available. However, it behaves exactly like Configuration 1 without the Electronic Attenuator Option EA3, therefore for the sake of this document it is grouped into the “Dual-Attenuator” configuration.

Single-Attenuator Configuration

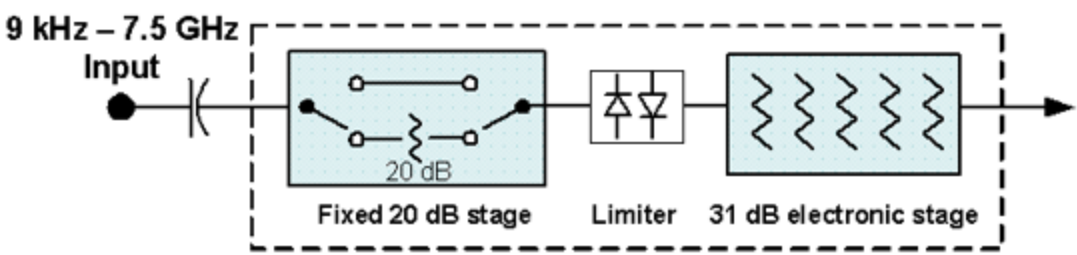

You can tell which attenuator configuration you have by pressing the Attenuation tab, which (in most Modes) opens the Attenuation menu. If the first control in the Attenuation menu says **Mech Atten** you have the Dual-Attenuator configuration. If the first control says **Atten** you have the Single-Attenuator configuration.



(Note that depending on the measurement, there may be no Auto/Man functionality on the Mech Atten control.)

In the Single-Attenuator configuration, you control the attenuation with a single control, as the fixed stage has only two states. In the Dual-Attenuator configuration, both stages have significant range, so you are given separate control of the mechanical and electronic attenuator stages.

When you have the Dual-Attenuator configuration, you may still have only a Single-Attenuator, because unless Option EA3 (the Electronic Attenuator option) is available, and you purchase it, you will have only the mechanical attenuator.

Full Range Atten

This control and **Attenuator Summary** only appear in N9041B, when the RF input is selected, the RF Input Port is set to RF Input 2, and the Full Range Attenuator is installed. The Full Range Attenuator adds a second input attenuator in front of RF Input 2, which enhances the protection and optimizes the performance of the extra internal mixers used by RF Input 2.

Remote Command	<code>[:SENSe]:POWer[:RF]:FRATten <rel_amp1></code> <code>[:SENSe]:POWer[:RF]:FRATten?</code>
Example	<code>:POW:FRAT 14</code> <code>:POW:FRAT?</code>
Notes	When you enter an amplitude value that falls between valid values, the value will be incremented to the next smallest valid value
Dependencies	Only appears if input RF is selected, RF Input Port 2 is selected, and the Full Range Attenuator exists
Couplings	This value is never changed by any coupling, but other couplings use this value. See Reference Level and " Mech Atten " on page 1766 command descriptions
Preset	20 dB

State Saved	Saved in instrument state
Min	0 dB
Max	Only valid values are 0, 6, 14, 20 dB
Annotation	<p>When the Input is RF, and the Input Port is RF Input 2, and the Full Range Attenuator is installed: On the Meas Bar, the field “Atten” displays as follows:</p> <ul style="list-style-type: none"> - If the sweep is entirely < 50 GHz, the value shown after “Atten:” is equal to Mech Atten + Elec Atten + Full Range Atten - If the sweep is entirely > 50 GHz, the value shown after “Atten:” is equal to Full Range Atten - If the sweep straddles 50 GHz, the value shown after “Atten:” is preceded by the symbol “>=” and is equal to Full Range Atten <p>In the Amplitude, "Y Scale" on page 1760 menu, and the Atten Meas Bar dropdown menu panel, a summary is displayed as follows: “Total Atten below 50 GHz” followed by the value of Full Range Atten + Mech Atten + Elec Atten “Total Atten above 50 GHz” followed by the value of Full Range Atten For example, if Mech Atten = 6 dB, Elec Atten = 4 dB, and Full Range Atten = 20 dB, the summary below is shown:</p> <ul style="list-style-type: none"> - Attenuator summary: - Total Atten below 50 GHz: 30 dB - Total Atten above 50 GHz: 20 dB

Mech Atten

Labeled **Mech Atten** in Dual-Attenuator models, and **Atten** in Single-Attenuator models. In the Dual-Attenuator configuration, this control only affects the mechanical attenuator.

Lets you modify the attenuation applied to the RF input signal path. This value is normally auto-coupled to **Ref Level**, **"Internal Preamp"** on page 1788 Gain, any External Gain that is entered, and **Max Mixer Level** (if available), as described in the table below.

See **"Attenuator Configurations and Auto/Man"** on page 950

Remote Command	<pre>[:SENSe]:POWer[:RF]:ATTenuation <rel_amp1> [:SENSe]:POWer[:RF]:ATTenuation?</pre>
Example	<pre>:POW:ATT 20</pre> <p>Dual-Attenuator configuration: sets the mechanical attenuator to 20 dB Single-Attenuator mode: sets the main attenuation to 20 dB (see below for definition of “main” attenuation)</p>

3 VMA Mode
3.6 Occupied BW Measurement

	In either case, if the attenuator was in Auto, it is set to Manual						
Dependencies	<p>Some measurements do not support Auto setting of Mech Atten. In these measurements, the Auto/Man selection is not available, and the Auto/Man toggle function is not available</p> <p>In Dual-Attenuator configurations, when the electronic attenuator is enabled, the mechanical attenuator has no auto setting, and the Auto/Man toggle function is not available. The state of Auto/Man is remembered and restored when the electronic attenuator is once again disabled. This is described in more detail in "Elec Atten" on page 1769</p> <p>See "Attenuator Configurations and Auto/Man" on page 950 for more information on the Auto/Man functionality</p>						
Couplings	<p>If the RF Input Port is the RF Input:</p> <ul style="list-style-type: none"> - If the USB Preamp is connected to USB, use 0 dB for Mech Atten - Otherwise compute the auto-selected value of Mech Atten based on Reference Level, Int Preamp, External Gain, Ref Level Offset, Max Mixer Level, μW Path Control and IF Gain settings. Limit this value to be no less than 6 dB (total attenuation below 6 dB can never be chosen by Auto) - In N9041B, if the RF Input Port is RF Input 2, use the formula above and subtract the value of "Full Range Atten" on page 1765 from the result to determine the Mech Atten. Limit the value so that it is never lower than 0 dB and so that total attenuation, including Full Range Atten, is never less than 6 dB (total attenuation, including Full Range Atten below 6 dB, can never be chosen by Auto) <p>In External Mixing and BBIQ, where the attenuator is not in the signal path, the attenuator setting changes as described above when Mech Atten is in Auto, but no changes are made to the actual attenuator hardware setting until the input is changed back to the RF Input</p> <p>For CXA-m with Option FSA (Fine-Step Attenuator or 2 dB steps), the FSA-like behavior is only available when the frequency setting is ≤ 7.5 GHz. So, when the frequency is changed from below 7.5 GHz to above 7.5 GHz, the attenuation setting changes to a multiple of 10 dB that is no smaller than the previous setting. For example, 4 dB attenuation changes to 10 dB</p>						
Preset	<p>Auto</p> <p>The Auto value is 10 dB</p>						
State Saved	Saved in instrument state						
Min	<p>0 dB</p> <p>The attenuation set by this control cannot be decreased below 6 dB with the knob or step keys. Values below 6 dB must be directly entered from the keypad or via SCPI. This protects against setting a dangerously small attenuation value, which can put the instrument at risk of damage to input circuitry. If the current mechanical attenuation is below 6 dB, it can be increased with the knob and step keys, but not decreased</p>						
Max	<table border="1"> <tr> <td>CXA Option 503 or 507</td> <td>50 dB</td> </tr> <tr> <td>EXA</td> <td>60 dB</td> </tr> <tr> <td>All other models</td> <td>70 dB</td> </tr> </table> <p>Note that in the Single-Attenuator configuration, the total of ATT and EATT cannot exceed 50 dB. So, if the EATT is set to 24 dB first, the main attenuation cannot be greater than 26 dB and will be reduced accordingly; if the main attenuator is set to 40 dB first, EATT cannot be greater than 10 dB</p>	CXA Option 503 or 507	50 dB	EXA	60 dB	All other models	70 dB
CXA Option 503 or 507	50 dB						
EXA	60 dB						
All other models	70 dB						

Annotation	<p>The current value for Total Atten is displayed in the Measurement Bar at the top of the display. A value appears for Electronic Attenuation only if the Electronic Attenuator is enabled. The annotation appears as:</p> <p><i>Atten: <total> dB (e<elec>)</i></p> <p>The e letter is in amber in Single-Attenuator configurations</p> <p>For example:</p> <p>Dual-Attenuator configuration:</p> <p><i>Atten: 24 dB (e14)</i></p> <p>Indicating the total attenuation is at 24 dB and the electronic attenuation is at 14 dB</p> <p>Single-Attenuator configuration:</p> <p><i>A: 24 dB (e14)</i></p> <p>Indicating the total attenuation is at 24 dB and the “soft” attenuation is at 14 dB (see below for definition of “soft” attenuation)</p> <p>When in Manual, a # sign appears in front of Atten in the annotation</p> <p>Auto Function</p>
------------	---

Remote Command	<code>[:SENSe]:POWer[:RF]:ATTenuation:AUTO OFF ON 0 1</code> <code>[:SENSe]:POWer[:RF]:ATTenuation:AUTO?</code>
Example	Turn Auto Mech Atten ON: <code>:POW:ATT:AUTO ON</code>
Dependencies	<code>:POW:ATT:AUTO</code> is only available in measurements that support Auto , such as Swept SA
Preset	<code>ON</code>

Attenuator Configurations and Auto/Man

As described under ["Attenuation" on page 1763](#), there are two distinct attenuator configurations available in the X-Series, the Single Attenuator and Dual-Attenuator configurations.

In Dual-Attenuator configurations, we have mechanical attenuation and electronic attenuation, and current total attenuation is the sum of electronic + mechanical attenuation.

In Single-Attenuator configurations, we refer to the attenuation set using ["Mech Atten" on page 948](#) (or `:POW:ATT`) as the “main” attenuation; and the attenuation that is set by `:POW:EATT` as the “soft” attenuation (`:POW:EATT` is honored even in the Single-Attenuator configuration, for compatibility purposes). Then current total attenuation is the sum of main + soft attenuation.

See ["Elec Atten" on page 1769](#) for more about “soft” attenuation.

NOTE

In some measurements, the **Mech Atten** control has an **Auto/Man** function. In these measurements, an **Auto/Man** switch is shown on the **Mech Atten** control:



Note that in configurations that include an Electronic Attenuator, this switch is only shown when the Electronic Attenuator is disabled.

In other measurements, **Mech Atten** has no **Auto/Man** function. In these measurements, no switch is shown on the **Mech Atten** control:



Mech Atten also appears with no switch, as above, in configurations that include an Electronic Attenuator but when the Electronic Attenuator is enabled.

Elec Atten

Controls the Electronic Attenuator in Dual-Attenuator configurations. Does not appear in Single-Attenuator configurations, because the control of both the mechanical and electronic stages of the Single-Attenuator is integrated into the single **Atten** control.

This control includes an **Enable/Disable** toggle switch; it is only possible to enter a value for the Electronic Attenuator when this switch is in the **Enable** position.

For more details of the Electronic Attenuator, see ["More Information" on page 953](#)

Remote Command	<code>[:SENSe]:POWer[:RF]:EATTenuation <rel_amp1></code> <code>[:SENSe]:POWer[:RF]:EATTenuation?</code>
Example	<code>:POW:EATT 10</code> <code>:POW:EATT?</code>
Notes	Electronic Attenuation's specification is defined only when Mech Atten is 6 dB
Dependencies	Only appears in Dual-Attenuator models with an Electronic Attenuator installed and licensed. Does not appear in models with the Single-Attenuator configuration, because in the Single-Attenuator configuration there is no "electronic attenuator"; there is only a single integrated attenuator (which has both a mechanical and electronic stage). However, in the Single-Attenuator configuration, EATT SCPI commands are accepted for compatibility with other X-series instruments, and set a "soft" attenuation. The "soft" attenuation is treated as an addition to the "main" attenuation value set by the Attenuation control or <code>:POW:ATT</code> , and affects the total attenuation displayed on the Attenuation

control and the Meas Bar

The electronic attenuator, and the “soft” attenuation function provided in Single-Attenuator configurations, are unavailable above the low band (0-3.6 GHz, 0-3.4 GHz, 0-3 GHz, depending on the model). If the low band range is from 0-3.6 GHz, and Stop Frequency of the instrument is > 3.6 GHz, then the **Enabled/Disabled** section of the **Elec Atten** control will be **OFF** and grayed-out

If "**Internal Preamp**" on page 1788 is **ON** (that is, set to Low Band or Full), the electronic attenuator (and the “soft” attenuation function provided in Single-Attenuator configurations) is unavailable. In this case the **Enabled/Disabled** section of the **Elec Atten** control will be **OFF** and grayed-out

If either of the above is true, and the SCPI command is sent, an error indicating that the electronic attenuator is unavailable is returned

If both the above are true, pressing the control generates error message -221, in other words, the frequency range lockout takes precedence

If the electronic/soft Attenuator is enabled, then the **Stop Freq** of the instrument is limited to 3.6 GHz and **Internal Preamp** is unavailable

If "**LNA**" on page 1790 is **ON**, the electronic attenuator (and the “soft” attenuation function provided in Single-Attenuator configurations) is unavailable. In this case the **Enabled/Disabled** section of the **Elec Atten** control will be **OFF** and grayed-out. This coupling works in the following modes/measurements:

- Channel Power, Occupied BW, ACP, SEM, Spurious Emissions, Power Stat CCDF measurements in all Modes
- Transmit On|Off Power measurement in 5GNR Mode
- Power vs. Time and Transmit Power measurement in GSM/EDGE Mode
- Burst Power measurement in Spectrum Analyzer Mode

The SCPI-only “soft” electronic attenuation for the single-attenuator configuration is not available in all measurements; in particular, it is not available in the Swept SA measurement

Couplings	Enabling and disabling the Electronic Attenuator affects the setting of the Mechanical Attenuator (in Dual-Attenuator configurations). This is described in more detail below and in " Mechanical Attenuator Transition Rules " on page 953
Preset	0 dB
State Saved	Saved in instrument state
Min	0 dB
Max	Dual-Attenuator configuration: 24 dB Single-Attenuator configuration: the total of ATT and EATT cannot exceed 50 dB. So, if the EATT is set to 24 dB first, the main attenuation cannot be greater than 26 dB and will be reduced accordingly; if the main attenuator is set to 40 dB first, EATT cannot be greater than 10 dB
Annotation	See Annotation under the Mech Atten control description

Auto Function

Remote Command	<code>[:SENSe] :POWer [:RF] :EATTenuation :STATE OFF ON 0 1</code> <code>[:SENSe] :POWer [:RF] :EATTenuation :STATE?</code>
Example	<code>:POW:EATT:STAT ON</code>

:POW:EATT:STAT?

Preset **OFF** (Disabled) for Swept SA measurement
 ON (Enabled) for all other measurements that support the electronic attenuator

NOTE

The maximum **Center Frequency** for Low Band can change based on the selected IFBW for measurements that support IFBW (for example, Waveform measurement across all Modes that support it). In certain models (such as N9042B & N9032B), IFBW values ≤ 40 MHz have a maximum Low Band frequency of 3.6 GHz, while $40 \text{ MHz} < \text{IFBW} \leq 1 \text{ GHz}$ have a maximum of 3.3 GHz, and $1 \text{ GHz} < \text{IFBW} \leq 1.5 \text{ GHz}$ have a maximum of 3.5 GHz. This frequency is reflected in the disabled message displayed for Electrical Attenuator. For N9032B and N9042B IFBW values $> 1.5 \text{ GHz}$ do not support a **Center Frequency** that can reach the Low Band maximum frequency. In these cases, the Electrical Attenuator will remain disabled no matter the Center Frequency.

More Information

The electronic attenuator offers finer steps than the mechanical attenuator, has no acoustical noise, is faster, and is less subject to wear. These advantages primarily aid in remote operation and are negligible for front panel use. See ["Using the Electronic Attenuator: Pros and Cons" on page 954](#) for a detailed discussion of the pros and cons of using the electronic attenuator.

For the Single-Attenuator configuration, for SCPI backwards compatibility, the "soft" attenuation feature replaces the Dual-Attenuator configuration's electronic attenuator. All the same couplings and limitations apply. See ["Attenuator Configurations and Auto/Man" on page 1768](#)

Mechanical Attenuator Transition Rules

When the Electronic Attenuator is enabled, the Mechanical Attenuator transitions to a state that has no Auto function. Below are the rules for transitioning the Mechanical Attenuator. Note that the information below *only* applies to the Dual-Attenuator configurations, and *only* when the Electronic Attenuator is installed:

When the Electronic Attenuation is enabled from a disabled state:

- The Mechanical Attenuator is initialized to 10 dB (this is its optimal performance setting). You can then set it as desired with SCPI, numeric keypad, step keys, or knob, and it behaves as it normally would in manual mode
- The Auto/Man state of (Mech) Atten is saved
- The Auto/Man toggle on the (Mech) Atten control disappears, and the auto rules are disabled

- The Electronic Attenuator is set to 10 dB less than the previous value of the Mechanical Attenuator, within the limitation that it must stay within the range of 0 to 24 dB of attenuation

Examples in the Dual-Attenuator configuration:

- Mech Atten at 20 dB. Elec Atten enabled, Mech Atten set to 10 dB, and Elec Atten set to 10 dB. New total attenuation equals the value before Elec Atten enabled
- Mech Atten at 0 dB. Elec Atten enabled, Mech Atten set to 10 dB, and Elec Atten set to 0 dB. New total attenuation does not equal the value before Elec Atten enabled
- Mech Atten at 40 dB. Elec Atten enabled, Mech Atten set to 10 dB, and Elec Atten set to 24 dB. New total attenuation does not equal the value before Elec Atten enabled

When the Electronic Attenuation is disabled from an enabled state:

- The Elec Atten control is grayed out
- The Auto/Man state of (Mech) Atten is restored
- If now in Auto, (Mech) Atten recouples
- If now in Man, (Mech) Atten is set to the value of total attenuation that existed before the Elec Atten was disabled. The resulting value is rounded up to the smallest value possible given the (Mech) Atten Step setting - (That is, 57 dB changes to 58 dB when (Mech) Atten Step is 2 dB)

Using the Electronic Attenuator: Pros and Cons

The electronic attenuator offers finer steps than the mechanical attenuator, has no acoustical noise, is faster, and is less subject to wear.

The “finer steps” advantage of the electronic attenuator is beneficial in optimizing the alignment of the instrument dynamic range to the signal power in the front panel as well as remote use. Thus, you can achieve improved relative signal measurement accuracy. Compared to a mechanical attenuator with 2 dB steps, the 1 dB resolution of the electronic attenuator only gives better resolution when the odd-decibel steps are used. Those odd-decibel steps are less accurately calibrated than the even-decibel steps, so one tradeoff for this superior relative accuracy is reduced absolute amplitude accuracy.

Another disadvantage of the electronic attenuator is that the spectrum analyzer loses its “Auto” setting, making operation less convenient.

Also, the relationship between the dynamic range specifications (TOI, SHI, compression, and noise) and instrument performance are less well-known with the

electrical attenuator. With the mechanical attenuator, TOI, SHI, and compression threshold levels increase dB-for-dB with increasing attenuation, and the noise floor does as well. With the electronic attenuator, there is an excess attenuation of about 1 to 3 dB between 0 and 3.6 GHz, making the effective TOI, SHI, and so forth, less well known. Excess attenuation is the actual attenuation relative to stated attenuation. Excess attenuation is accounted for in the instrument calibration.

Adjust Atten for Min Clipping

Sets the combination of mechanical and electronic attenuation and gain based on the current measured signal level so that clipping will be at a minimum.

This is an immediate action function, that is, it executes once, when the control is pressed.

The algorithms that are used for the adjustment are documented under ["Pre-Adjust for Min Clipping" on page 1773](#).

Remote Command	<code>[:SENSe]:POWer[:RF]:RANGe:OPTimize IMMEDIATE</code>
Example	<code>:POW:RANG:OPT IMM</code>
Notes	Executing Adjust Atten for Min Clipping initiates the measurement
Dependencies	Does not appear in the Swept SA, RTSA, Monitor Spectrum and Complex Spectrum measurements Appears in the Waveform measurement in BASIC and 5G NR Modes

Adjust Atten

Allows you to select;

- Electric attenuator only
- Combination of Electric attenuator and Mechanical attenuator

when `[:SENSe]:POWer[:RF]:RANGe:OPTimize IMMEDIATE` is executed.

Remote Command	<code>[:SENSe]:POWer[:RF]:RANGe:OPTimize:TYPE EONLY COMBined</code> <code>[:SENSe]:POWer[:RF]:RANGe:OPTimize:TYPE?</code>
Example	<code>:POW:RANG:OPT:TYPE EONL</code> <code>:POW:RANG:OPT:TYPE?</code>
Dependencies	Does not appear in the Swept SA, RTSA, Monitor Spectrum and Complex Spectrum measurements Appears in the Waveform measurement in BASIC and 5G NR Modes
Preset	<code>COMBined</code>
State Saved	Saved in instrument state

Pre-Adjust for Min Clipping

If this function is **ON**, it applies the adjustment described under "[Adjust Atten for Min Clipping](#)" on page 1772 each time a measurement restarts. Therefore, in Continuous measurement mode, it only executes before the first measurement.

In Dual-Attenuator models, you can set **Elec+Mech Atten**, in which case both attenuators participate in the autoranging, or **Elec Atten Only**, in which case the mechanical attenuator does not participate in the autoranging. This latter case results in less wear on the mechanical attenuator and is usually faster.

See "[Adjustment Algorithm](#)" on page 957

Selection	SCPI	Note
Off	OFF	This is the default setting
On	ON	Available in Single-Attenuator instruments. For compatibility with models that do not have an input attenuator, the ON parameter is supported and mapped to COMBined
Elec Atten Only	ELECTrical	Selects only the electric attenuator to participate in auto ranging. This offers less wear on the mechanical attenuator and is usually faster
Elec+Mech Atten	COMBined	In Dual-Attenuator models, this selects both attenuators to participate in the autoranging

Remote Command	<code>[:SENSe]:POWer[:RF]:RANGe:OPTimize:ATTenuation OFF ON ELECTrical COMBined</code> <code>[:SENSe]:POWer[:RF]:RANGe:OPTimize:ATTenuation?</code>
Example	<code>:POW:RANG:OPT:ATT OFF</code> <code>:POW:RANG:OPT:ATT?</code>
Notes	The parameter option ELECTrical sets this function to ON in Single-Attenuator models The parameter option COMBined is mapped to ELECTrical in Single-Attenuator models. If you send COMBined , it sets the function to ON and returns ELEC to a query For SCPI compatibility with models that do not have an input attenuator, the ON parameter is honored and mapped to COMBined
Dependencies	Only appears in Dual-Attenuator models with an Electronic Attenuator installed In instruments with Dual-Attenuator model, when " Elec Atten " on page 1769 is OFF or grayed-out, " Pre-Adjust for Min Clipping " on page 956 is grayed-out Does not appear in the Swept SA, RTSA, Monitor Spectrum and Complex Spectrum measurements Appears in the Waveform measurement in BASIC and 5G NR Modes
Preset	OFF when Elec Atten is Disabled at preset, otherwise ELEC
State Saved	Saved in instrument state

3 VMA Mode
 3.6 Occupied BW Measurement

Range	Dual-Attenuator models:	Off Elec Atten Only Mech + Elec Atten
	Single-Attenuator models:	Off On

Backwards Compatibility Command

Notes	ON aliases to "Elec Atten Only" (:POW:RANG:OPT:ATT ELEC) OFF aliases to "Off" (:POW:RANG:OPT:ATT OFF) :POW:RANG:AUTO? returns true if :POW:RANG:OPT:ATT is not OFF
Backwards Compatibility SCPI	[:SENSe]:POWer[:RF]:RANGe:AUTO ON OFF 1 0 [:SENSe]:POWer[:RF]:RANGe:AUTO?

Adjustment Algorithm

The algorithms for the adjustment are documented below:

Single-Attenuator Models

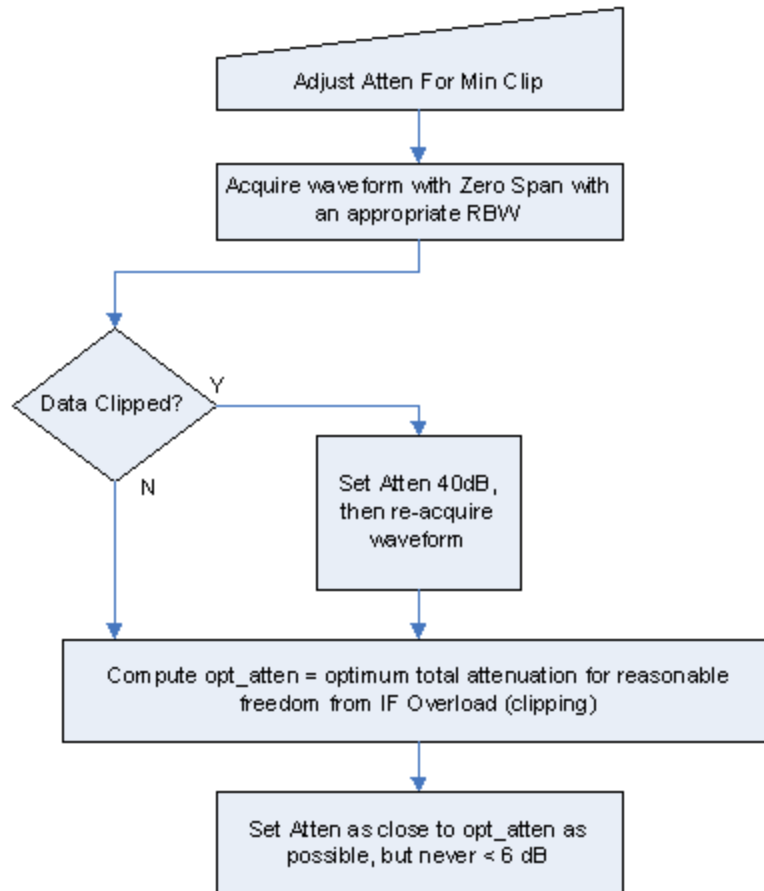

Dual-Attenuator models

"Adjust Atten for Min Clipping" on page 1772 or "Pre-Adjust for Min Clipping" on page 956 selection is Mech + Elec Atten:

3 VMA Mode
 3.6 Occupied BW Measurement

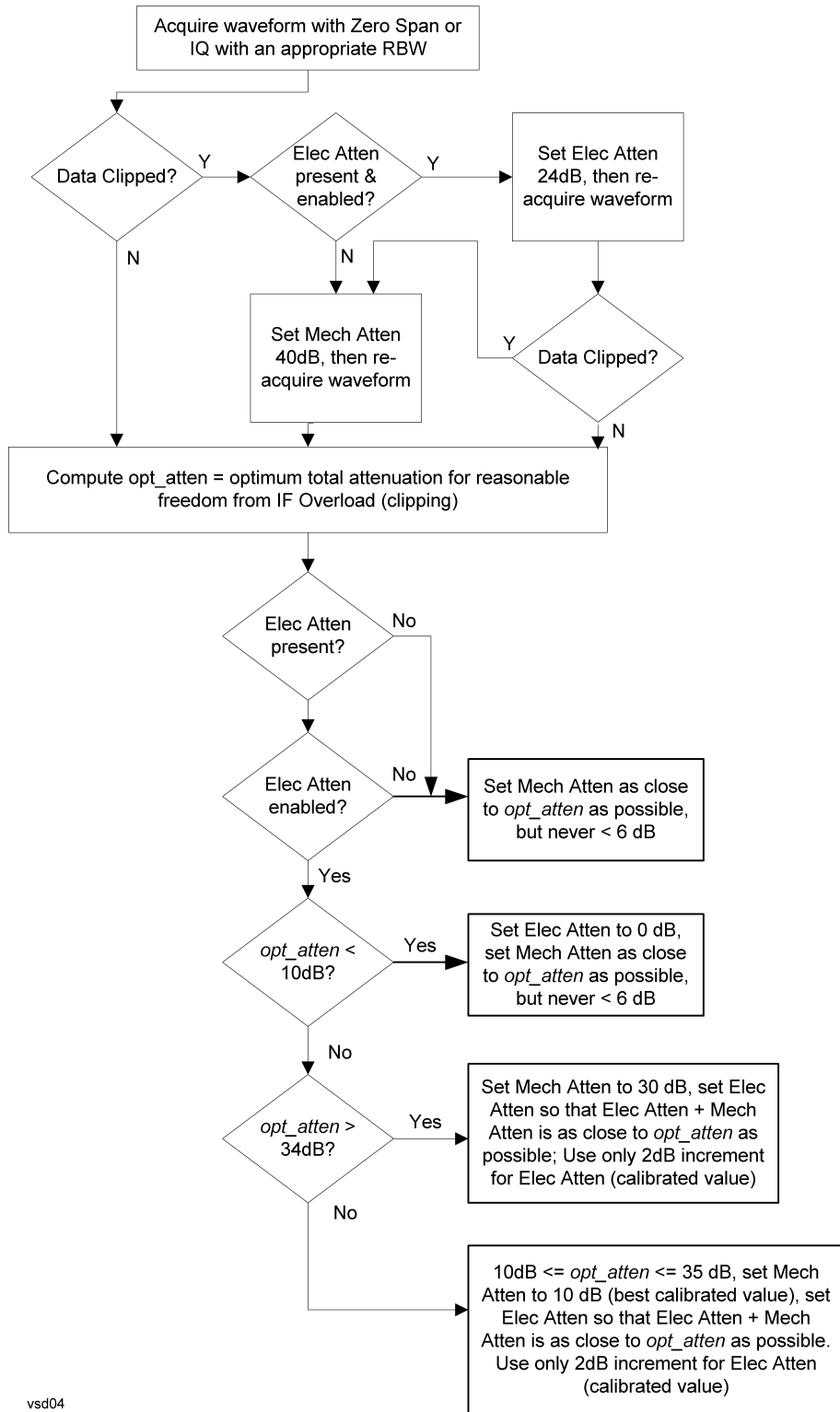

vsd04

"Pre-Adjust for Min Clipping" on page 956 selection is Elec Only.

Note that the **Mech Atten** value is not adjusted, and the value previously set is used. Therefore, there is a case that IF Overload is still observed depending on the input signal level and the Mech Atten setting.

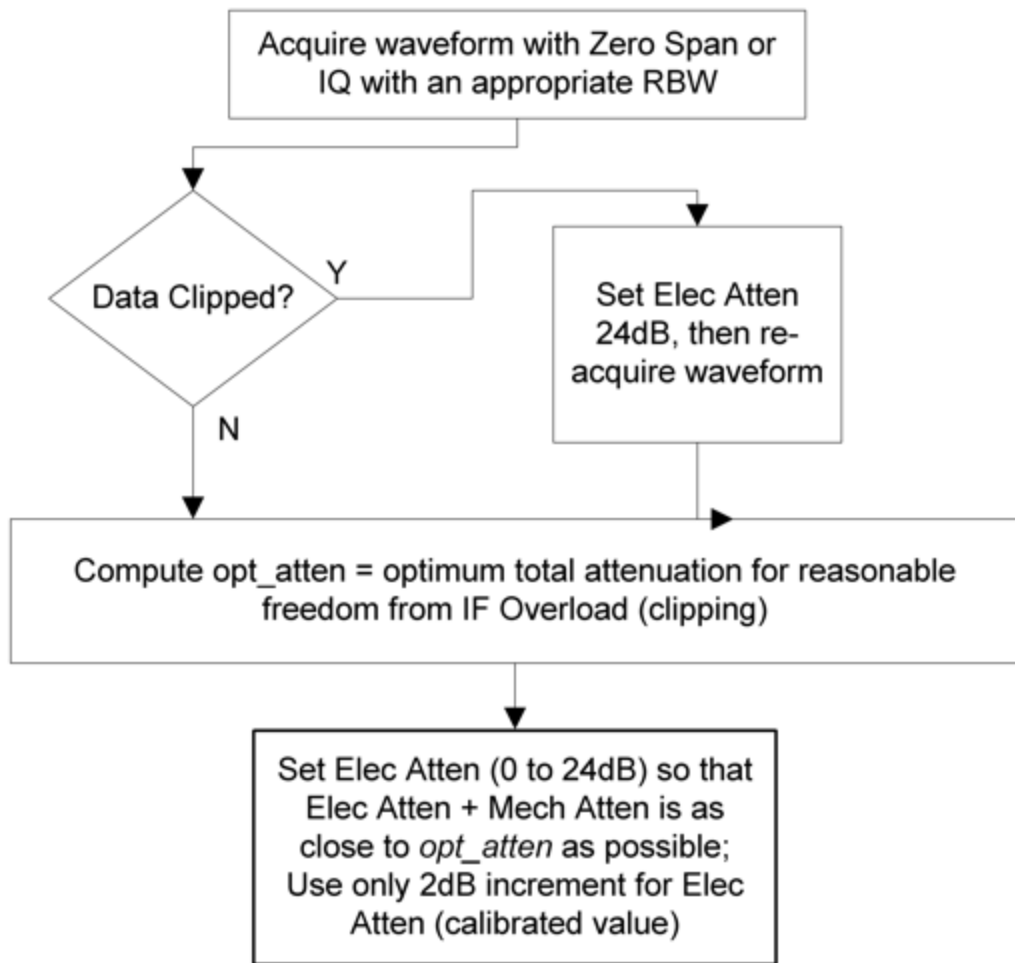

Mech Atten Step

Controls the step size used when making adjustments to the input attenuation.

Labeled **Mech Atten Step** in Dual-Attenuator models and **Atten Step** in Single-Attenuator models. In the Dual-Attenuator configuration, only affects the step size of the mechanical attenuator.

Remote Command `[:SENSe]:POWer[:RF]:ATTenuation:STEP[:INCRement] 10 dB | 2 dB`

3 VMA Mode
 3.6 Occupied BW Measurement

	<code>[:SENSe] :POWer [:RF] :ATTenuation :STEP [:INCRement] ?</code>
Example	<code>:POW:ATT:STEP 2</code> <code>:POW:ATT:STEP?</code>
Notes	Has a toggle control on the front panel, but takes a specific value (in dB) when used remotely. The only valid values are 2 and 10
Dependencies	Blanked in EXA, CXA and CXA-m if option FSA (2 dB steps) is not present. If blanked, attempts to set it via SCPI yield an error
Couplings	When the attenuation step size changes, the current mechanical attenuation value is adjusted (if necessary) to be quantized to the new step size. That is, if step is set to 10 dB, mech atten is increased if necessary so it is a multiple of 10 dB
Preset	EXA, CXA and CXA-m: 10 dB (2 dB with option FSA) All other models: 2 dB
State Saved	Saved in instrument state

3.6.3.3 Range (Non-attenuator models)

Only available for Keysight's modular signal analyzers and certain other Keysight products, such as VXT and M941xE.

State Saved	No
-------------	----

Range

Represents the amplitude of the largest sinusoidal signal that could be present within the IF without being clipped by the ADC. For signals with high peak-to-average ratios, the range may need to exceed the rms signal power by a significant amount to avoid clipping.

This is a measurement global setting.

Remote Command	<code>[:SENSe] :POWer [:RF] :RANGe <real></code> <code>[:SENSe] :POWer [:RF] :RANGe?</code>
Example	<code>:POW:RANG 10 dBm</code> <code>:POW:RANG?</code>
Notes	The MIN and MAX values are affected by the External Gain parameters, and by the Center Frequency The hardware compensates for frequency response and alters the Range setting
Preset	0 dBm
State Saved	Yes
Min/Max	-/+100
Annotation	Meas Bar

Adjust Range for Min Clipping

Sets the combination of attenuation and gain based on the current measured signal level so that clipping will be at a minimum.

This is an "immediate action" function, that is, it executes once, when the key is pressed.

This key does not appear in measurements that do not support this functionality.

Remote Command	<code>[:SENSe]:POWer[:RF]:RANGe:OPTimize IMMEDIATE</code>
Notes	Executing Adjust Range for Min Clipping initiates the measurement
Dependencies	Does not appear in the Swept SA and Monitor Spectrum measurements

Pre-Adjust for Min Clipping

If this function is **ON**, it applies the adjustment described under Adjust Range For Min Clipping each time a measurement restarts. Therefore, in Continuous measurement mode, it only executes before the first measurement.

Remote Command	<code>[:SENSe]:POWer[:RF]:RANGe:OPTimize:ATTenuation OFF ON ELECTrical COMBined</code> <code>[:SENSe]:POWer[:RF]:RANGe:OPTimize:ATTenuation?</code>
Notes	Because there is no attenuator control available in these models, the control displays only ON and OFF choices. However, for SCPI compatibility with other platforms, all three parameters (ELECTrical , COMBined , and ON) are honored and all are mapped to ELECTrical , so if any of these three parameters is sent, a subsequent query will return ELEC
Dependencies	Does not appear in the Swept SA and Monitor Spectrum measurements
Preset	OFF for Swept SA measurement; ON for all other measurements that support Pre-Adjust for Min Clipping
State Saved	Saved in instrument state

Adjustment Algorithm

The algorithm for the adjustment is documented below:

3 VMA Mode
3.6 Occupied BW Measurement

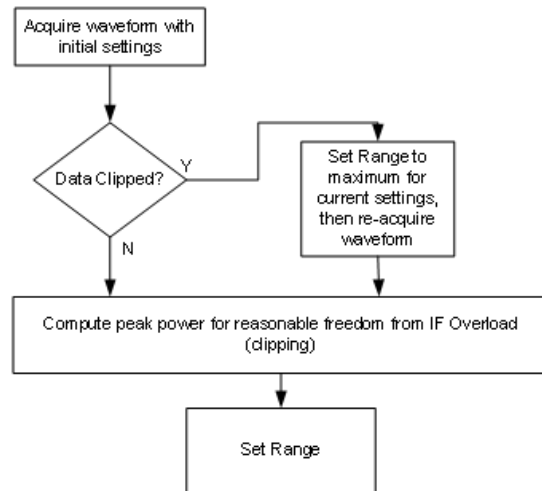

Peak-to-Average Ratio

Used with "[Range \(Non-attenuator models\)](#)" on page 1782 to optimize the level control in the instrument. The value is the ratio, in dB, of the peak power to the average power of the signal to be measured. A ratio of 0 should be used for sinusoidal signals; for 802.11g OFDM signals use 9 dB.

All Modes show the current value of Peak-to-Average ratio on the control. However, some Modes do not permit changing the value. In these situations, the control is grayed-out.

Remote Command	[:SENSe]:POWer[:RF]:RANGe:PARatio <real> [:SENSe]:POWer[:RF]:RANGe:PARatio?	
Example	:POW:RANG:PAR 12 dB	
Notes	In some Modes, this parameter is read-only; meaning the value will appear on the control and query via SCPI, but is not changeable. In such applications the control is grayed-out. Attempts to change the value via SCPI are ignored, but no error message is generated	
Dependencies	Does not appear in Spectrum Analyzer Mode	
Preset	VXT Models M9410A/11A	0 dB
	All Others	10 dB
State Saved	Saved in instrument state	
Min	0 dB	
Max	VXT Models M9410A/11A	50 dB
	All Others	20 dB

Mixer Lvl Offset

This is an advanced setting to adjust target Range at the input mixer, which in turn affects the signal level in the instrument's IF. This setting can be used when additional optimization is needed after setting "[Peak-to-Average Ratio](#)" on page 1784. Positive values of offset optimize noise performance over distortion, negative values optimize distortion performance over noise.

Remote Command	<code>[:SENSe]:POWer[:RF]:RANGe:MIXer:OFFSet <real></code> <code>[:SENSe]:POWer[:RF]:RANGe:MIXer:OFFSet?</code>	
Example	<code>:POW:RANG:MIX:OFFS -5 dB</code>	
Preset	0 dB	
State Saved	Saved in instrument state	
Min	VXT Models M9410A/11A	-34 dB
	All Others	-35 dB
Max	30 dB	

3.6.3.4 Signal Path

Contains controls that pertain to the routing of the signal through the frontend of the instrument.

In general, only appears in instruments whose hardware supports this signal routing. For example, this tab does not appear in many of the modular instrument products, including VXT Model M9420A, or UXM.

This tab *does* appear in VXT Models M9410A/11A/15A/16A and M9410E/11E/15E/16E, because "[Software Preselection](#)" on page 1801 is under this tab, and VXT Models M9410A/11A/15A/16A and M9410E/11E/15E/16E implement a version of Software Preselection.

Presel Center

Adjusts the centering of the preselector filter to optimize the amplitude accuracy at the frequency of the selected marker. If the selected marker is not on when **Presel Center** is pressed, the instrument turns on the selected marker, performs a peak search, and then performs centering on the marker's center frequency. If the selected marker is already on and between the start and stop frequencies of the instrument, the instrument performs the preselector calibration on that marker's frequency. If the selected marker is already on, but outside the frequency range

3 VMA Mode
3.6 Occupied BW Measurement

between **Start Freq** and **Stop Freq**, the instrument first performs a peak search, and then performs centering on the marker's center frequency.

The value displayed on "**Preselector Adjust**" on page 1787 changes to reflect the new preselector tuning.

Certain considerations should be observed to ensure proper operation, as detailed in "**Proper Preselector Operation**" on page 965.

Remote Command	<code>[:SENSe] :POWer [:RF] :PCENter</code>
Example	<code>:POW:PCEN</code>
Notes	The rules outlined above under the control description apply for the remote command as well as the key. The result of the command depends on marker position, etc. Any message generated by the control press is also generated in response to the remote command
Dependencies	Does not appear in CXA-m, nor in VXT Models M9410A/11A/15A/16A, M9410E/11E/15E/16E Grayed-out if the microwave preselector is off <ul style="list-style-type: none"> - If the selected marker's frequency is below Band 1, an advisory message is generated "Preselector not used in this frequency range" and no action is taken - Grayed-out if entirely in Band 0, that is, if Stop Freq is below about 3.6 GHz Grayed-out if entirely above 50 GHz, that is, if Start Freq is above 50 GHz - Blanked in models that do not include a preselector, such as Option 503. If the remote command is sent in these instruments, accepted without error, and the query always returns 0 - Grayed-out in the Spectrogram View
Couplings	The active marker position determines where the centering will be attempted If the instrument is in a measurement such as averaging when centering is initiated, the act of centering the preselector restarts averaging, but the first average trace will not be taken until the centering is completed The offset applied to do the centering appears in " Preselector Adjust " on page 1787
Status Bits/OPC dependencies	When centering the preselector, *OPC does not return true until the process is complete and a subsequent measurement has completed, nor are results returned in response to <code>:READ</code> or <code>:MEASure</code> queries The Measuring bit remains set (true) while this command is operating, and does not go false until the subsequent sweep/measurement has completed

Proper Preselector Operation

Certain considerations should be observed to ensure proper operation:

1. If the selected marker is **Off**, the instrument turns on a marker, performs a peak search, and adjusts the preselector using the selected marker's frequency. It uses the "highest peak" peak search method unqualified by threshold or excursion, so that there is no chance of a 'no peak found' error. It continues with that peak, even if it is the peak of just noise. Therefore, for this operation to work properly, there should be a signal on-screen in a preselected range for the peak

search to find

2. If the selected marker is already **On**, the instrument attempts the centering at that marker's frequency. There is no preselector for signals below about 3.6 GHz, so if the marker is on a signal below 3.6 GHz, no centering is attempted, and an advisory message is generated
3. In some models, the preselector can be bypassed. If it is bypassed, no centering is attempted in that range and a message is generated

Preselector Adjust

Lets you manually adjust the preselector filter frequency to optimize its response to the signal of interest. Only available when "**Presel Center**" on page 1786 is available.

For general purpose signal analysis, using **Presel Center** is recommended. Centering the filter minimizes the impact of long-term preselector drift. **Preselector Adjust** can be used instead to manually optimize the preselector. One application of manual optimization would be to peak the preselector response, which both optimizes the signal-to-noise ratio and minimizes amplitude variations due to small (short-term) preselector drifting.

When **Presel Center** is performed, the offset applied to do the centering becomes the new value of **Preselector Adjust**.

Remote Command	<code>[:SENSe]:POWer[:RF]:PADJust <freq></code> <code>[:SENSe]:POWer[:RF]:PADJust?</code>
Example	<code>:POW:PADJ 100KHz</code> <code>:POW:PADJ?</code>
Notes	The value on the control is displayed to 0.1 MHz resolution
Dependencies	<ul style="list-style-type: none"> - Does not appear in CXA-m - Does not appear in VXT Models M9410A/11A/15A/16A - Does not appear in M9410E/11E/15E/16E - Grayed-out if microwave preselector is off - Grayed-out if entirely in Band 0, that is, if Stop Freq is lower than about 3.6 GHz - Grayed-out if entirely above 50 GHz, that is, if Start Freq is higher than 50 GHz - Blank in models that do not include a preselector, such as Option 503. If the command is sent in these instruments, it is accepted without error, and the query always returns 0 - Grayed-out in the Spectrogram View
Preset	0 MHz

State Saved	The Preselector Adjust value set by " Presel Center " on page 1786, or by manually adjusting Preselector Adjust Not saved in instrument state, and does not survive a Preset or power cycle
Min/Max	-/+500 MHz
Backwards Compatibility SCPI	<code>[:SENSe] :POWer [:RF] :MW :PADJust</code> <code>[:SENSe] :POWer [:RF] :MMW :PADJust</code> Backwards Compatibility Command
Notes	The command has no effect, and the query always returns <code>MWAVE</code>
Backwards Compatibility SCPI	<code>[:SENSe] :POWer [:RF] :PADJust :PRESelector MWAVE MMWave EXternal</code> <code>[:SENSe] :POWer [:RF] :PADJust :PRESelector?</code>

Internal Preamp

Accesses a menu of controls for the internal preamps. Turning on the preamp gives a better noise figure, but a poorer inter-modulation distortion (TOI) to noise floor dynamic range. You can optimize this setting for your measurement.

The instrument takes the preamp gain into account as it sweeps. If you sweep outside of the range of the preamp, the instrument will also account for that. The displayed result always reflects the correct gain.

For some measurements, when the preamp is on and any part of the displayed frequency range is below the lowest frequency for which the preamp has specifications, a warning condition message appears in the status line. For example, for a preamp with a 9 kHz lowest specified frequency: "Preamp: Accy unspec'd below 9 kHz".

Selection	Example	Note
Off	<code>:POW:GAIN OFF</code>	
Low Band	<code>:POW:GAIN ON</code> <code>:POW:GAIN:BAND LOW</code>	Sets the internal preamp to use only the low band. The frequency range of the installed (optional) low-band preamp is displayed in square brackets on the Low Band selection in the dropdown
Full Range	<code>:POW:GAIN ON</code> <code>:POW:GAIN:BAND FULL</code>	Sets the internal preamp to use its full range. The low band (0-3.6 GHz, 0-3.4 GHz, 0-3 GHz, depending on the model) is supplied by the low band preamp and the frequencies above low band are supplied by the high band preamp The frequency range of the installed (optional) low-band preamp is displayed in square brackets on the Full Range selection in the dropdown. If the high band option is not installed the Full Range selection does not appear

NOTE

The maximum **Center Frequency for Low Band**, displayed in square brackets, can change based on the selected IFBW for measurements that support IFBW (for example, Waveform measurement across all Modes that support it). In certain models (such as N9042B & N9032B), IFBW values ≤ 40 MHz have a maximum **Low Band** frequency of 3.6 GHz, while $40 \text{ MHz} < \text{IFBW} \leq 1 \text{ GHz}$ have a maximum of 3.3 GHz, and $1 \text{ GHz} < \text{IFBW} \leq 1.5 \text{ GHz}$ have a maximum of 3.5 GHz. IFBW values $> 1.5 \text{ GHz}$ do not support a **Center Frequency** that can reach the **Low Band** maximum frequency. In these cases, **N/A** is displayed in the square brackets for **Low Band**.

Remote Command	<code>[:SENSe]:POWer[:RF]:GAIN:BAND LOW FULL</code> <code>[:SENSe]:POWer[:RF]:GAIN:BAND?</code>
Example	<code>:POW:GAIN:BAND LOW</code> <code>:POW:GAIN:BAND?</code>
Dependencies	Not available on all hardware platforms. If the preamp is not present or is unlicensed, this control is not shown Does not appear in VXT Models M9410A/11A/15A/16A nor in M9410E/11E/15E/16E If <code>:POW:GAIN:BAND FULL</code> is sent when a low band preamp is available, the preamp band parameter is set to <code>LOW</code> instead of <code>FULL</code> , and an "Option not installed" message is generated Not available when the electronic/soft attenuator is enabled
Preset	<code>LOW</code>
State Saved	Saved in instrument state
Annotation	When the USB Preamp is not connected to USB, the Preamp annotation in the Meas Bar says "Off" if the preamp is off and displays the frequency range of the low band or full range preamp depending on the setting. For example, if the Preamp is set to Low Band and the Low Band is 3.6 GHz the annotation says "3.6 GHz". If it is a 13.6 GHz preamp and it is set to Full Range the annotation says "13.6 GHz" When the USB Preamp is connected to USB, the Preamp annotation says "Preamp: USB" if the internal preamp is off or "Preamp: USB, Int" if the internal preamp is on (only for measurements that support the USB preamp)

Auto Function

Remote Command	<code>[:SENSe]:POWer[:RF]:GAIN[:STATe] OFF ON 0 1</code> <code>[:SENSe]:POWer[:RF]:GAIN[:STATe]?</code>
Example	<code>:POW:GAIN OFF</code> <code>:POW:GAIN?</code>
Preset	<code>OFF</code>

LNA

Lets you turn the Low Noise Amplifier (LNA) on or off.

3 VMA Mode
3.6 Occupied BW Measurement

LNA is an additional preamplifier that provides superior DANL and frequency range compared to "Internal Preamp" on page 1788. LNA provides lower system noise figure, especially at frequencies above 100 MHz, and can be operated up to the full range of 50 GHz instruments.

For best possible sensitivity, LNA can be turned on *together* with "Internal Preamp" on page 1788, although if you operate both preamps together, note that the TOI (distortion) specifications are impacted. The sensitivity improvement of this combination is substantial when operating in high band (frequencies above 3.6 GHz).

For more details about annotation, see "More Information" on page 969

Remote Command	<code>[:SENSe]:POWer[:RF]:GAIN:LNA[:STATe] OFF ON 0 1</code> <code>[:SENSe]:POWer[:RF]:GAIN:LNA[:STATe]?</code>
Example	<code>:POW:GAIN:LNA ON</code>
Dependencies	Requires Option LNA, except for VXT models M9415A/16A Does not appear in VXT models M9420A/10A/11A M9410E/11E/15E/16E support LNA May not appear in some measurements LNA is not available when the electronic/soft attenuator is enabled
Preset	OFF
State Saved	Saved in State

More Information

When LNA is installed, the preamp annotation changes to show the state of both LNA and Internal Preamp. Below is an example:

```
Atten: 8 dB
Pre: Int on, LNA on
µW Path: LNP, On
Source: Off
```

Note that when operating entirely in the low band (below about 3.6 GHz), if LNA is on, **Internal Preamp** is switched off (even if you have its switch set to ON). This is because the noise performance is actually degraded in low band if both preamps are on. In this case, the annotation reflects the actual state of the two preamps, but the **Internal Preamp** annotation displays in amber, to warn you that the actual state of **Internal Preamp** does not match its switch control display:

```
Atten: 8 dB
Pre: Int off, LNA on
µW Path: LNP, On
Source: Off
```

μW Path Control

Options for this control include **μW Preselector Bypass** (Option MPB), **Low Noise Path** (Option LNP) and **Full Bypass Enable** in the High Band path circuits.

When the μW Preselector is bypassed, flatness is improved, but will be subject to spurs from out of band interfering signals. When **Low Noise Path Enable** is selected, the instrument automatically bypasses certain circuitry in the high frequency bands that can contribute to noise, when it is appropriate based on other instrument settings.

For most applications, the preset state is **Standard Path**, which provides the best remote-control throughput, minimizes acoustic noise from switching and minimizes the risk of wear in the hardware switches, particularly in remote test scenarios where both low band and high band setups will follow in rapid succession. In this path, the bypass of the low band/high band switch and microwave preamp is never activated, which can cause some noise degradation but preserves the life of the bypass switch.

For applications that utilize the wideband IF paths, the preset state is **μW Preselector Bypass**, if option MPB is present. This is because, when using a wideband IF such as the 140 MHz IF, the μW Preselector's bandwidth can be narrower than the available IF bandwidth, causing degraded amplitude flatness and phase linearity, so it is desirable to bypass the preselector in the default case.

You may choose **Low Noise Path Enable** for a lower noise floor, especially in the 21–26.5 GHz region, though without improving many measures of dynamic range, and without giving the best possible noise floor. The preamp, if purchased and used, gives better noise floor than does **Low Noise Path Enable**, but the preamp's compression threshold and third-order intercept are much poorer than that of **Low Noise Path Enable**.

A fourth choice is **Full Bypass Enable**, which combines **μW Preselector Bypass** and **Low Noise Path Enable**. Because this can bypass most of the circuitry between the input and the first mixer, care should be taken when using this setting to avoid damaging the mixer. **Full Bypass Enable** is only available if both options LNP and MPB are present, as well as option FBP.

Path	Example	Note
Standard Path	:POW:MW:PATH STD	Normal setting for most measurements. μW Preselector in circuit, Low Noise Path disabled
Low Noise Path Enable	:POW:MW:PATH LNP	See " Low Noise Path Enable " on page 974
μW Preselector Bypass	:POW:MW:PATH MPB	See " μW Preselector Bypass " on page 976
Full Bypass Enable	:POW:MW:PATH FULL	See " Full Bypass Enable " on page 977

3 VMA Mode
 3.6 Occupied BW Measurement

Remote Command	<code>[:SENSe]:POWer[:RF]:MW:PATH STD LNPath MPBypass FULL</code> <code>[:SENSe]:POWer[:RF]:MW:PATH?</code>														
Example	<code>:POW:MW:PATH LNP</code> Enables the Low Noise path <code>:POW:MW:PATH?</code>														
Notes	<p>When "Presel Center" on page 1786 is performed, the instrument momentarily switches to the Standard Path, regardless of the setting of μW Path Control</p> <p>The DC Block will always be switched in when the low noise path is switched in, to protect succeeding circuitry from DC. Note that this does not mean "when the low noise path is enabled" but when, based on the Low Noise Path rules, the path is actually switched in. This can happen when the selection is Low Noise Path Enable or Full Bypass Enable. In the case where the DC Block is switched in, the instrument is now AC-coupled. However, if you selected DC coupling, the UI would still behave as though it were DC-coupled, including all annunciation, warnings, status bits, and responses to SCPI queries. This is because, based on other settings, the instrument could switch out the low noise path at any time and hence go back to being DC-coupled</p> <p>Alignment switching ignores the settings in this menu, and restores them when finished</p>														
Dependencies	<p>Does not appear in CXA-m, VXT Models M9410A/11A/15A/16A, nor in M9410E/11E/15E/16E, BBIQ and External Mixing</p> <ul style="list-style-type: none"> - The Low Noise Path Enable selection does not appear unless Option LNP is present and licensed - The μW Preselector Bypass selection does not appear unless Option MPB is present and licensed - The Full Bypass Enable selection does not appear unless options LNP and MPB are both present as well as option FBP <p>In any of these cases, if the required options are not present and the SCPI command is sent, error - 241, "Hardware missing; Option not installed" is generated</p> <p>Low Noise Path Enable and Full Bypass Enable are grayed-out if the current measurement does not support them</p> <p>Low Noise Path Enable and Full Bypass Enable are not supported in Avionics and MMR Modes (non-modulation measurements). In any of these cases (that is, the feature is not supported in either measurement or Mode), if the SCPI command is sent, the following error is generated: -221, "Setting Conflict; Feature not supported for this measurement"</p>														
Preset	<table border="1"> <thead> <tr> <th>Mode</th> <th>Value</th> </tr> </thead> <tbody> <tr> <td>IQ Analyzer</td> <td>MPB option present and licensed: MPB</td> </tr> <tr> <td>Pulse</td> <td>MPB option not present and licensed: STD</td> </tr> <tr> <td>RTSA</td> <td></td> </tr> <tr> <td>Avionics</td> <td></td> </tr> <tr> <td>All other Modes</td> <td>STD</td> </tr> <tr> <td>-</td> <td></td> </tr> </tbody> </table>	Mode	Value	IQ Analyzer	MPB option present and licensed: MPB	Pulse	MPB option not present and licensed: STD	RTSA		Avionics		All other Modes	STD	-	
Mode	Value														
IQ Analyzer	MPB option present and licensed: MPB														
Pulse	MPB option not present and licensed: STD														
RTSA															
Avionics															
All other Modes	STD														
-															
State Saved	Save in instrument state														
Range	Standard Path Low Noise Path Enable μW Presel Bypass Full Bypass Enable														

Annotation In the Meas Bar, if the Standard path is chosen:
 μ W Path: Standard
 If Low Noise Path is enabled but the LNP switch is not thrown:
 μ W Path: LNP,Off
 If the Low Noise Path is enabled and the LNP switch is thrown:
 μ W Path: LNP,On
 If the preselector is bypassed:
 μ W Path: Bypass
 If Full Bypass Enable is selected but the LNP switch is not thrown:
 μ W Path: FByp,Off
 If Full Bypass Enable is selected and the LNP switch is thrown:
 μ W Path: FByp,On

μ W Path Control Auto

In VMA, WLAN, 5G NR, CQM Modes, an **Auto/Man** switch is added to μ W Path Control:



This allows the function to automatically switch based on certain Auto Rules as shown below:

VMA Mode

Measurement	μ W Path Control Auto behavior
Digital Demod	Use Standard Path unless tuned frequency > 3.6 GHz and IFBW > 15 MHz, in which case choose Preselector Bypass
Monitor Spectrum	Always Presel Bypass
IQ Waveform	Use Standard Path unless tuned frequency > 3.6 GHz and IFBW > 15 MHz, in which case choose Preselector Bypass
Custom OFDM	Use Standard Path unless tuned frequency > 3.6 GHz and IFBW > 15 MHz, in which case choose Preselector Bypass
Channel Power	Always Presel Bypass
Occupied BW	Always Presel Bypass
CCDF	Use Standard Path unless tuned frequency > 3.6 GHz and IFBW > 15 MHz, in which case choose Preselector Bypass

3 VMA Mode
3.6 Occupied BW Measurement

Measurement	μ W Path Control Auto behavior
ACP	Always Presel Bypass
SEM	Always Presel Bypass
Spurious Emissions	Always Standard Path

WLAN Mode

Measurement	μ W Path Control Auto behavior
Modulation Analysis	Always Presel Bypass
Spectral Flatness	Always Presel Bypass
Power vs Time	Always Presel Bypass
Monitor Spectrum	Always Presel Bypass
IQ Waveform	Always Presel Bypass
Channel Power	Always Presel Bypass
Occupied BW	Always Presel Bypass
CCDF	Always Presel Bypass
SEM	For 11be 320M, when 'Enabled Wideband IF for FFT' is OFF or 'Sweep Type Rule' is Best Dynamic Range, auto μ W path is standard For other cases, auto μ W path is presel bypass if presel bypass is enabled, auto μ W path is standard if presel bypass is not enabled
Spurious Emissions	Always Standard Path

5G NR Mode

Measurement	μ W Path Control Auto behavior
Modulation Analysis	Use Standard Path unless tuned frequency > 3.6 GHz and IFBW > 15 MHz, in which case choose Full Bypass if conditions warrant(FBP Option is available and "Allow Full Bypass in Auto" is On), otherwise choose Preselector Bypass
Monitor Spectrum	Always Standard Path
IQ Waveform	Use Standard Path unless tuned frequency > 3.6 GHz and IFBW > 15 MHz, in which case choose Full Bypass if conditions warrant(FBP Option is available and "Allow Full Bypass in Auto" is On), otherwise choose Preselector Bypass
Channel Power	Always Standard Path
Occupied BW	Always Standard Path
CCDF	Use Standard Path unless tuned frequency > 3.6 GHz and IFBW > 15 MHz, in which case choose Preselector Bypass
ACP	Always Standard Path
SEM	Always Standard Path
Spurious	Always Standard Path

Measurement	μ W Path Control Auto behavior
Emissions	
Transmit On Off Power	Use Standard Path unless tuned frequency > 3.6 GHz and Info BW > 15 MHz, in which case choose Preselector Bypass
Channel Quality Mode	
Measurement	μ W Path Control Auto behavior
Group Delay	Use Standard Path unless tuned frequency > 3.6 GHz and IFBW > 15 MHz, in which case choose Full Bypass if conditions warrant(FBP Option is available and "Allow Full Bypass in Auto" is On), otherwise choose Preselector Bypass
Monitor Spectrum	Always Standard Path
IQ Waveform	Use Standard Path unless tuned frequency > 3.6 GHz and IFBW > 15 MHz, in which case choose Preselector Bypass
CCDF	Use Standard Path unless tuned frequency > 3.6 GHz and IFBW > 15 MHz, in which case choose Preselector Bypass

Remote Command	<code>[:SENSE]:POWER[:RF]:MW:PATH:AUTO ON OFF 1 0</code> <code>[:SENSE]:POWER[:RF]:MW:PATH:AUTO?</code>
Example	<code>:POW:MW:PATH:AUTO ON</code> <code>:POW:MW:PATH:AUTO?</code>
Dependencies	Only appears in VMA, WLAN, 5G NR and CQM Modes
Couplings	See " μW Path Control Auto " on page 972 above
Preset	ON
Range	ON OFF

Low Noise Path Enable

Low Noise Path Enable provides a lower noise floor under some circumstances, particularly when operating in the 21–26.5 GHz region. With the Low Noise Path enabled, the low band/high band switch and microwave preamp are bypassed whenever *all* the following are true:

- The instrument is not in the Low Band, meaning:
- the start frequency is above 3.5 GHz and
- the stop frequency is above 3.6 GHz
- The internal preamp is not installed, or if installed, is set to **Off** or **Low Band**

Note that this means that, when any part of a sweep is done in Low Band, the Low Noise Path is not used, whether or not the **Low Noise Path Enable** is selected in the user interface. Also, if the preamp is turned on, the Low Noise Path is not used,

3 VMA Mode

3.6 Occupied BW Measurement

whether or not the **Low Noise Path Enable** is selected in the user interface. The only time the Low Noise Path is used is when **Low Noise Path Enable** is selected, the sweep is completely in High Band (> 3.6 GHz) and no preamp is in use.

For measurements that use IQ acquisition, the low noise path is used when **Center Frequency** is in High Band (> 3.6 GHz) and no preamp is in use. In other words, the rules above are modified to use only the center frequency to qualify which path to switch in. This is not the case for FFTs in the Swept SA measurement; they use the same rules as swept measurements.

Note that the Low Noise Path, while giving improved DANL, has the disadvantage of decreased TOI performance and decreased gain compression performance relative to the standard path.

Note also that the bypass switch is a mechanical switch and has finite life, so if the **Low Noise Path Enable** is selected, it is possible to cause frequent cycling of this switch by frequently changing instrument settings such that the above conditions hold true only some of the time. A user making tests of this nature should consider opting for the **Standard Path**, which will never throw the bypass switch, at the expense of some degraded noise performance.

The low noise path is useful for situations where the signal level is so low that the instrument performance is dominated by noise even with 0 dB attenuation, but still high enough that the preamp option would have excessive third-order intermodulation or compression. The preamp, if purchased and used, gives better noise floor than does the “Low Noise Path.” However, its compression threshold and third-order intercept are much poorer than that of the non-preamp path.

There are some applications, typically for signals around –30 dBm, for which the third-order dynamic range of the standard path is good enough, but the noise floor is not low enough even with 0 dB input attenuation. When the third-order dynamic range of the preamp path is too little and the noise floor of the standard path is too high, the Low Noise Path can provide the best dynamic range

The graph below illustrates the concept. It shows, in red, the performance of an instrument at different attenuation settings, both with the preamp on and off, in a measurement that is affected by both instrument noise and instrument TOI. The green shows the best available dynamic range, offset by 0.5 dB for clarity. The blue shows how the best available dynamic range improves for moderate signal levels with the low noise path switched in. In this illustration, the preamp improves the noise floor by 15 dB while degrading the third-order intercept by 30 dB, and the low noise path reduces loss by 8 dB. The attenuator step size is 2 dB.

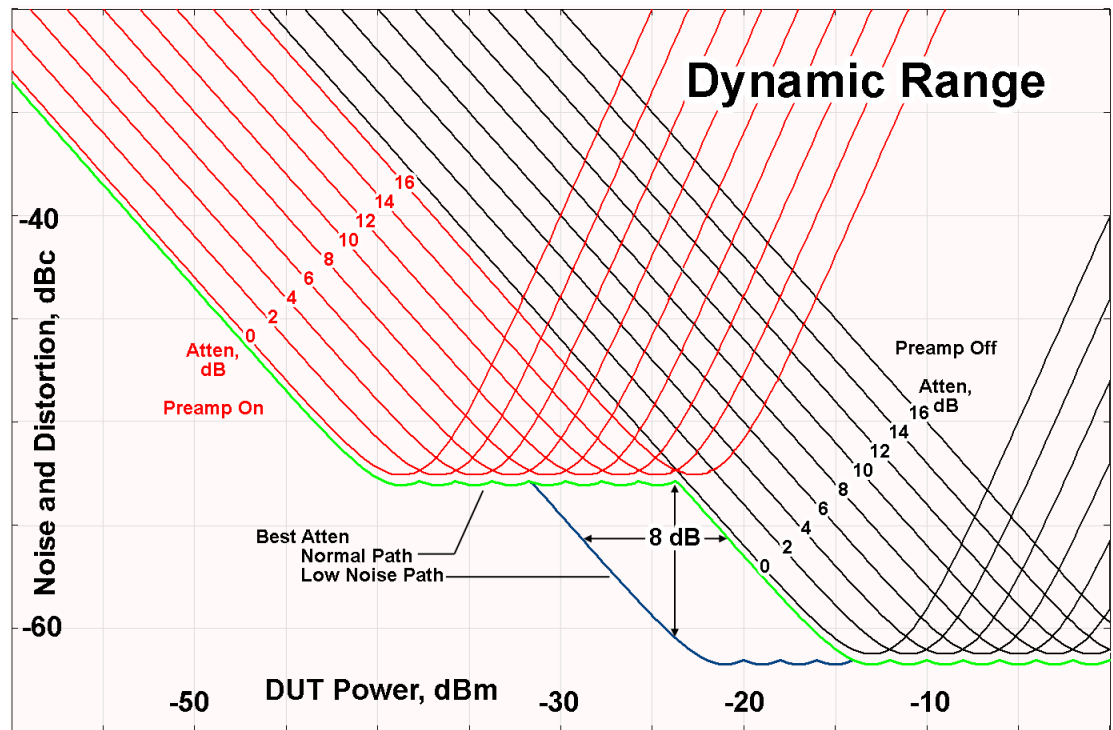

There are other times where selecting the low noise path improves performance, too. Compression-limited measurements such as finding the nulls in a pulsed-RF spectrum can profit from the low noise path in a way similar to the TOI-limited measurement illustrated. Accuracy can be improved when the low noise path allows the optimum attenuation to increase from a small amount like 0, 2 or 4 dB to a larger amount, giving better return loss at the instrument input. Harmonic measurements, such as second and third harmonic levels, are much improved using the low noise path because of the superiority of that path for harmonic (though not intermodulation) distortion performance.

μ W Preselector Bypass

Toggles the preselector bypass switch for band 1 and higher. When the microwave preselector is on, the signal path is preselected. When the microwave preselector is off, the signal path is not preselected. The preselected path is the normal path for the instrument.

The preselector is a tunable bandpass filter which prevents signals away from the frequency of interest from combining in the mixer to generate in-band spurious signals (images). The consequences of using a preselector filter are its limited bandwidth, the amplitude and phase ripple in its passband, and any amplitude and phase instability due to center frequency drift.

Option MPB or pre-selector bypass provides an unpreselected input mixer path for certain X-Series signal analyzers with frequency ranges above 3.6 GHz. This signal path allows a wider bandwidth and less amplitude variability, which is an advantage when doing modulation analysis and broadband signal analysis. The disadvantage is that, without the preselector, image signals will be displayed. Another disadvantage of bypassing the preselector is increased LO emission levels at the front panel input port.

Image responses are separated from the real signal by twice the 1st IF. For IF Paths of 10 MHz and 25 MHz, the 1st IF is 322.5 MHz, so the image response and the real signal will be separated by 645 MHz. The 1st IF will be different for other IF Path settings. When viewing a real signal and its corresponding image response in internal mixing, the image response will be to the left of the real signal.

Also, the image response and the real signal typically have the same amplitude and exhibit the same shape factor.

However, if Option FS1 (Fast Sweep Capability) is enabled, the image response in the Swept SA measurement appears lower in amplitude and has a much wider shape factor compared to the real signal.

Full Bypass Enable

With **Full Bypass Enable** selected, the microwave preselector is bypassed. In addition, the low band/high band switch and microwave preamp are bypassed whenever *all* the following are true:

- The instrument is not in the Low Band, meaning:
- the start frequency is above 3.5 GHz and
- the stop frequency is above 3.6 GHz.
- the internal preamp is not installed or if installed, is set to **Off** or **Low Band**

Note that this means that, when any part of a sweep is done in Low Band, the Low Noise Path is not used, whether or not the **Full Bypass Enable** is selected in the user interface. Also, if the preamp is turned on, the Low Noise Path is not used, whether or not the **Full Bypass Enable** is selected in the user interface. The only time the Low Noise Path is used is when **Full Bypass Enable** is selected, the sweep is completely in High Band (> 3.6 GHz) and no preamp is in use.

CAUTION

When **Full Bypass Enable** is selected, and "**Y Scale**" on page 1760 is set to 0 dB, there will be a direct AC connection between the input and the first converter when the Low Noise Path switches in (when Start Freq >3.6 GHz and the Preamp is either not licensed, set to Low Band, or Off). This puts the first converter at considerable risk to be damaged by high AC power. Consequently,

whenever **Full Bypass Enable** is selected, a warning message appears in the status bar:

“Full Bypass Enabled, maximum safe input power reduced”

Microwave Preselector Bypass Backwards Compatibility

Example	Bypass the microwave preselector: :POW:MW:PRES OFF
Notes	Included for Microwave Preselector Bypass backwards compatibility The ON parameter sets the STD path (:POW:MW:PATH STD) The OFF parameter sets path MPB (:POW:MW:PATH MPB)
Preset	ON
Backwards Compatibility SCPI	[:SENSe]:POWer[:RF]:MW:PRESelector[:STATe] ON OFF 0 1 [:SENSe]:POWer[:RF]:MW:PRESelector[:STATe]?

Frequency Extender Preselection Bypass

Only applies to the high frequency path of the Frequency Extender, and only if the Frequency Extender allows it. For example, the V3050A high frequency path is 50 – 110 GHz and *does* allow control of the preselector bypass.

When the Frequency Extender’s preselection is bypassed, flatness is improved, but will be subject to spurs from out-of-band interfering signals. For bandwidths greater than 2.5 [GHz], it is recommended that the signal bypass the Frequency Extender Preselector since the max bandwidth of the Preselector can be as narrow as 2.5 [GHz].

For most applications, the preset state is **OFF**, which gives the best remote-control throughput, minimizes acoustic noise from switching, minimizes out of band spurs, and minimizes the risk of wear in the hardware switches.

Preselector and Bandwidth Conflict

When the Frequency Extender Preselector is applied and the signal bandwidth is greater than 2.5 [GHz], then a settings alert message will show to warn the user that the signal may be distorted due to the limitation of the Frequency Extender Preselector bandwidth.

An example of the settings alert message is shown below.

Settings Alert message in the Status Bar at the bottom of the display.

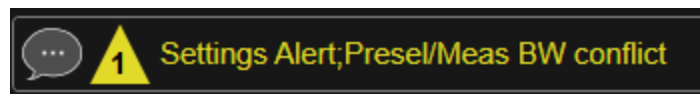

Settings Alert message in the error queue

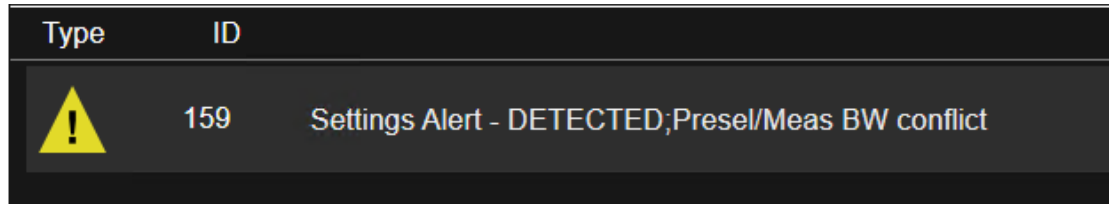

Allow Full Bypass in Auto

Enable or disable Full Bypass in μ W Path Auto rule. See " [\$\mu\$ W Path Control](#)" on page 1791.

When this function is **ON**, and " [\$\mu\$ W Path Control](#)" on page 1791 is in **AUTO**, it is possible for the auto rules to select the **FULL** Bypass state, which bypasses both the Preamp and the Microwave Preselector. Otherwise, the auto rules never select the **FULL** Bypass state. This is convenient when making wideband measurements, but it also adds some risk of damage to the first converter.

CAUTION

When **Full Bypass Enable** is selected, and "[Y Scale](#)" on page 1760 is set to 0 dB, there will be a direct AC connection between the input and the first converter when the Low Noise Path switches in (when Start Freq > 3.6 GHz and the Preamp is either not licensed, set to **Low Band** or **Off**). This puts the first converter at considerable risk to be damaged by high AC power. Consequently, whenever **Full Bypass Enable** is selected, a warning message appears in the status bar:

"Full Bypass Enabled, maximum safe input power reduced"

Remote Command	<code>[:SENSe]:POWer[:RF]:MW:PATH:AUTO:FULL ON OFF 1 0</code> <code>[:SENSe]:POWer[:RF]:MW:PATH:AUTO:FULL?</code>
Example	<code>:POW:MW:PATH:AUTO:FULL ON</code> <code>:POW:MW:PATH:AUTO:FULL?</code>
Dependencies	Only appears if Option FBP is installed, and in the following measurements <ul style="list-style-type: none"> - 5GNRMode: Modulation Analysis and IQ Waveform - WLAN Mode: IQ Waveform - Channel Quality Mode: Group Delay and Noise Power Ratio
Preset	OFF
State Saved	Saved in instrument state

Software Preselection

Provided in some instruments, either to compensate for issues with provided hardware preselection or to provide the preselection function when there is no hardware preselector.

N9041B

Software Preselection compensates for the frequency range limit of the microwave preselector. Since the microwave preselector only goes up to 50 GHz, software preselection must be used to suppress and separate images above 50 GHz. The specific algorithm used for software preselection is specified by the SW Preselection Type selection – Normal or Advanced.

In N9041B, **Software Preselection** only applies for frequencies above 50 GHz, therefore it is only used for RF Input 2. Even if turned on, it is not used for other inputs, and never for frequencies below 50 GHz. This is why the label of this control contains the parenthetical note “(>~50 GHz)”.

Note that in N9041B, in Swept SA measurement, **Software Preselection** works even if the measurement is using an FFT Sweep Type. In measurements other than Swept SA, Software Preselection is not used if the measurement is using an FFT sweep type.

N9042B+V3050A

Software Preselection compensates for the frequency range limit of the microwave preselector. Since the microwave preselector only goes up to 50 GHz, software preselection must be used to suppress and separate images above 50 GHz. The specific algorithm used for software preselection is specified by the SW Preselection Type selection – Normal or Advanced.

For N9042B+V3050A, Software Preselection only applies for frequencies above 50 GHz, therefore it is only used for External RF. Even if it is turned on, it will not be used for other inputs and never for frequencies below 50 GHz. This is why the label of this control contains the parenthetical note “(>~50 GHz)”.

Note that for N9042B+V3050A, in the Swept SA measurement, Software Preselection works even if the measurement is using an FFT Sweep Type. In measurements other than Swept SA, Software Preselection is not used if the measurement is using an FFT Sweep Type.

VXT models M9410A/11A/15A/16A

Software Preselection is used to provide the preselection function, as there is no hardware preselector in these models. Two background traces are taken and compared point by point, and the point with the lowest amplitude from the two

traces is used. This provides a method to reduce spurs that are internally generated within the VXT, but you should note the following when using Software Preselection:

- There is some speed cost due to the need to take multiple captures
- Taking the point with the lowest amplitude in each trace will make the average noise level lower at all points that do not have a spur. This can reduce the accuracy of the measurement of noise and noise-like signals

Because of the difficulty in identifying spurs manually, you are recommended to leave Software Preselection **ON** at all times in VXT models M9410A/11A. If you turn it off in order to speed up your measurement or improve noise accuracy, be aware of unwanted onscreen spurs.

Remote Command	<code>[:SENSe]:POWer[:RF]:SWPrese1:STATe 0 1 ON OFF</code> <code>[:SENSe]:POWer[:RF]:SWPrese1:STAT?</code>
Example	<code>:POW:SWPR:STAT 1</code> <code>:POW:SWPR:STAT?</code>
Dependencies	Only appears in N9041B, N9042B+V2050A, VXT models M9410A/11A and M9410E/11E. Does not appear in all measurements
Couplings	Affects Sweep Time Auto Tune supports Software Preselection , so Auto Tune should be performed after setting the Software Preselection state
Preset	N9041B OFF N9042B+V3050A ON M9410A/11A ON
State Saved	Saved in instrument state

SW Preselection Type

Specifies the algorithm used for software preselection.

Two hidden sweeps occur in succession. The second sweep is offset in LO frequency by $2 * IF / N$. For each point in each trace, the smaller amplitude from the two traces is taken and placed in that point in the selected trace. The Peak detector is auto-selected to improve the image suppression effectiveness. Responses of each trace that lie on top of one another will remain and are valid signals. Other signals are images, which are suppressed. The action of taking the smaller of the two traces will make the average noise level lower in all points that do not have an image, thus reducing the accuracy of the measurement of noise and noise-like signals.

- **NORMa1** - mathematically removes all image and multiple responses of signals present at the input
- **ADVanced** - any trace processing (such as “max hold” or trace averaging) is performed on the points of both candidate traces before the “select minimum” operation occurs. This form of processing works better for non-stationary signals, such as pulsed-RF signals

Remote Command	<code>[:SENSe]:POWer[:RF]:SWPResel NORMa1 ADVanced</code> <code>[:SENSe]:POWer[:RF]:SWPResel?</code>
Example	<code>:POW:SWPR NORM</code> <code>:POW:SWPR?</code>
Dependencies	Only appears in N9041B and N9042B+V3050A. Only appears in measurements that use the Swept method Grayed-out when "Software Preselection" on page 1801 is OFF. The grayout message is “Unavailable unless SW Presel enabled”
Preset	N9041B ADVanced N9042B+V3050A NORMa1
State Saved	Saved in instrument state

SW Preselection BW

Specifies the effective bandwidth to be used for Software Preselection.

The options are:

- **NORMa1** – when making Swept measurements, a software preselection algorithm is used which takes up to 4 background acquisitions, then post-processes the result. This algorithm can remove images from signals with an occupied bandwidth up to around 3 GHz. (Default/Preset setting). When making FFT measurements, this algorithm is not used, instead the same algorithm is used as for **NARRow** (below)
- **NARRow**– a software preselection algorithm is used which takes two background acquisitions, then post-processes the result to detect and remove images from wideband signals with occupied bandwidths up to 2 GHz. This increases the risk of images failing to be rejected, but improves the measurement speed

Remote Command	<code>[:SENSe]:POWer[:RF]:SWPResel:BW NORMa1 NARRow</code> <code>[:SENSe]:POWer[:RF]:SWPResel:BW?</code>
Example	<code>:POW:SWPR:BW NARR</code>
Dependencies	Only appears in N9041B and N9042B+V3050A. Only appears in measurements that use the Swept

3 VMA Mode
3.6 Occupied BW Measurement

	method	
	Grayed-out when " Software Preselection " on page 1801 is OFF . The grayout message is "Unavailable unless SW Presel enabled"	
	For N9042B+V3050A, the parameter is SCPI-only, and always set to NARRow when Software Preselection is enabled	
Preset	N9041B	NORMa1
	N9042B+V3050A	NARRow
State Saved	Saved in instrument state	

High Freq Prefilter

Lets you set the state of Prefilter for center frequencies above 1310 MHz.

In VXT Models M9410A/11A and M9410E/11E in bypass frequency range (1310MHz~5GHz), the Receiver RF path has a bank of filters that come after the RF Attenuator in the signal path. Since this bank of filters precedes the mixer they are known as the "Prefilter" bank. Their purpose is to eliminate unwanted in-band mixing products by filtering out all but the desired frequencies before the signals get to the mixer. There are 13 prefilter bands to cover the frequencies between 9 kHz and 6000 MHz. The Prefilter provides the necessary rejection of the unwanted signal.

Remote Command	<code>[:SENSE]:<measurement>:PFILter[:STATE] ON OFF 1 0</code> <code>[:SENSE]:<measurement>:PFILter[:STATE]?</code>
Example	Enable High Freq Prefilter for the Complex Spectrum Measurement in BASIC Mode: <code>:SPEC:PFIL ON</code> Enable High Freq Prefilter for the IQ Waveform Measurement, in multiple Modes: <code>:WAV:PFIL ON</code> Enable High Freq Prefilter for the Swept SA Measurement in SA Mode: <code>:SAN:PFIL ON</code>
Dependencies	Only appears in VXT models M9410A/11A with center frequency above 1310 MHz, and M9410E/11E in frequency range 1310MHz~5GHz
Preset	See " Prefilter Presets " on page 983 below
State Saved	Saved in instrument state

Prefilter Presets

Meas	Mode	Preset
SPEC	BASIC	OFF

Meas	Mode	Preset
WAV	BASIC, WCDMA, WLAN, LTEAFDD, LTEATDD, 5GNR, VMA	OFF
MON	WCDMA, WLAN, LTEAFDD, LTEATDD, 5GNR, VMA	OFF
RHO	WCDMA	OFF
CDP	WCDMA	OFF
PCON	WCDMA	OFF
EVMQ	WCDMA	OFF
CHP	WCDMA, WLAN, LTEAFDD, LTEATDD, 5GNR, VMA, SA	OFF
OBW	WCDMA, WLAN, LTEAFDD, LTEATDD, 5GNR, VMA, SA	OFF
ACP	WCDMA, LTEAFDD, LTEATDD, 5GNR, VMA, SA	OFF
SEM	WCDMA, WLAN, LTEAFDD, LTEATDD, 5GNR, VMA, SA	OFF
PST	WCDMA, WLAN, LTEAFDD, LTEATDD, 5GNR, VMA, SA	OFF
PVT	WLAN, LTEAFDD, LTEATDD, 5GNR	OFF
EVM	WLAN, LTEAFDD, LTEATDD, 5GNR	OFF
FLAT	WLAN	OFF
EVMM	WLAN	OFF
CEVM	LTEAFDD, LTEATDD	OFF
PAVT	5GNR, VMA	OFF
DDEM	VMA	OFF
OFDM	VMA	OFF
SAN	SA	ON
HARM	SA	ON

3.6.4 BW

Opens the Bandwidth (**BW**) menu, which contains controls for "[Res BW](#)" on page 985 and "[Video BW](#)" on page 986.

The **Resolution BW** functions control filter bandwidth and filter type. There are two filter types, Gaussian and Flattop. The Gaussian filters have a response curve that is parabolic on a log scale. The Flattop filter shape is a close approximation of a rectangular filter.

3.6.4.1 Settings

Contains the basic bandwidth functions. In this measurement, it is the only tab under **BW**.

Res BW

Activates the resolution bandwidth active function, which allows you to manually set the resolution bandwidth (RBW) of the instrument.

Normally, **Res BW** (Auto) selects automatic coupling of the **Res BW** to "**Span**" on [page 1003](#) using the ratio set by **Span:3 dB RBW** (some measurements do not have a **Span:3 dB RBW** control, in which case the measurement chooses the optimal ratio). To decouple the resolution bandwidth, press the **Auto/Man** toggle on the **Res BW** control, or simply enter a different value for **Res BW**.

When the **Res BW** is manually selected, it may be returned to the coupled state by pressing the **Auto/Man** toggle on the **Res BW** control. This may also be done by pressing "**Auto Couple**" on [page 1825](#) or by performing a **Preset**.

When **Res BW** is set to **Auto**, the bandwidth selected depends on "**RBW Filter Type**" on [page 987](#).

Only certain discrete resolution bandwidths are available. The available bandwidths are dependent on **Filter Type** or **EMC Standard**. If an unavailable bandwidth is entered with the numeric keypad, the closest available bandwidth is selected.

Remote Command	<pre>[:SENSe]:OBwidth:BANDwidth[:RESolution] <bandwidth> [:SENSe]:OBwidth:BANDwidth[:RESolution]? [:SENSe]:OBwidth:BANDwidth[:RESolution]:AUTO ON OFF 1 0 [:SENSe]:OBwidth:BANDwidth[:RESolution]:AUTO?</pre>
Example	<pre>:OBW:BAND 5 MHz :OBW:BAND? :OBW:BAND:AUTO ON :OBW:BAND:AUTO?</pre>
Notes	<p>For numeric entries, all RBW Types choose the nearest (arithmetically, on a linear scale, rounding up) available RBW to the value entered</p> <p>The setting and querying of values depend on the current bandwidth type</p>
Couplings	<p>Sweep time is coupled to RBW. As RBW changes, the sweep time (if set to Auto) is changed to maintain amplitude calibration</p> <p>"Video BW" on page 986 is coupled to RBW. As the resolution bandwidth changes, the video bandwidth (if set to Auto) changes to maintain the ratio of VBW/RBW (10:1)</p> <p>When Res BW is set to Auto, the resolution bandwidth is auto-coupled to the span. The ratio of Span/RBW is approximately 106:1 when auto coupled. When Res BW is set to Man, and the bandwidths are entered manually, these bandwidths are used regardless of other instrument settings</p>
Preset	<p>Auto, unless noted in "RBW Presets" on page 986 below</p> <p>See table below</p>
State Saved	<p>Saved in instrument state</p>

Min	1 Hz
Max	8 MHz is the max equivalent -3 dB RBW, which means that the named RBW (the one shown on the control etc.) can exceed 8 MHz if using a filter other than -3 dB Gaussian
Annotation	A “#” mark appears before “RBW” in the annotation when it is switched from Auto to Manual coupling
Backwards Compatibility Notes	For backwards compatibility, this command supports both BANDwidth and BwIDth forms For ESA, the maximum Res BW was 5 MHz; for X-Series it is 8 MHz

RBW Presets

Unless noted in the table below, the Preset value of RBW is **Auto**.

Mode	Preset Value
WCDMA	30 kHz
BT	10 kHz
WLAN	100 kHz
MSR	30 kHz
LTE, LTETDD, LTEAFDD, LTEATDD, 5G NR	30 kHz

Video BW

Lets you change the instrument post-detection filter (VBW or “video bandwidth”) from 1 Hz to 8 MHz, in approximately 10% steps. In addition, a wide-open video filter bandwidth may be chosen by selecting 50 MHz. The VBW is annotated at the bottom of the display, in the center.

Video BW (Auto) selects automatic coupling of **Video BW** to **"Res BW"** on page 985. To decouple the resolution bandwidth, press the **Auto/Man** toggle on the **Video BW** control, or simply enter a different value for **Video BW**.

When **Video BW** is manually selected, it may be returned to the coupled state by pressing the **Auto/Man** toggle on **Video BW**. This may also be done by pressing **"Auto Couple"** on page 1825 or by performing a **Preset**.

Remote Command	<pre>[:SENSe]:OBwidth:BANDwidth:VIDeo <bandwidth> [:SENSe]:OBwidth:BANDwidth:VIDeo? [:SENSe]:OBwidth:BANDwidth:VIDeo:AUTO ON OFF 1 0 [:SENSe]:OBwidth:BANDwidth:VIDeo:AUTO?</pre>
Example	<pre>:OBW:BAND:VID 2.4 MHz :OBW:BAND:VID? :OBW:BAND:VID:AUTO ON :OBW:BAND:VID:AUTO?</pre>

3 VMA Mode
3.6 Occupied BW Measurement

Notes	For numeric entries, the instrument chooses the nearest (arithmetically, on a linear scale, rounding up) available VBW to the value entered. The 50 MHz VBW is defined to mean “wide open” The values shown in this table reflect the conditions after a Mode Preset
Dependencies	Sometimes the displayed Video BW is not actually used to process the trace data: When the Average detector is selected, and Sweep Type is set to Swept , the video bandwidth filter cannot be used, because it uses the same hardware as the Average detector When the Quasi-Peak , EMI Average , or RMS Average detector is selected, Video BW is implemented by the digital IF as part of the detector In this case, Video BW still acts to change the Sweep Time, if Sweep Time is in Auto , and still affects the data on other traces for which this is not the case
Couplings	Normally coupled to Res BW . If Video BW is set to Auto , then video bandwidth is changed as Res BW changes, to maintain the preset ratio (normally 10:1)
Preset	Auto , unless noted in " Video BW Presets " on page 987 below ON
State Saved	Saved in instrument state
Min	1 Hz
Max	50 MHz
Annunciation	A “#” mark appears before “VBW” in the annotation when it is not coupled
Annotation	In the bottom center of the screen, “VBW <value> <units>” indicates the current video bandwidth value. Note that for some detectors this is not the value used for VBW (see above)
Backwards Compatibility Notes	For backwards compatibility, this command supports both BANDwidth and BWIDTH forms

Video BW Presets

Unless noted in the table below, the Preset value is **Auto**.

Mode ID	Preset Value
WCDMA	300 kHz
BT	30 kHz

RBW Filter Type

Selects the type for the resolution bandwidth filters. Historically, the **Res BW** filters in HP/Agilent/Keysight spectrum analyzers were Gaussian filters, specified using the –3 dB bandwidth of the filter. That is, a 10 MHz **Res BW** filter was a Gaussian shape with its –3 dB points 10 MHz apart. In X-Series, you can choose between a Gaussian and Flat Top filter shape, for varying measurement conditions.

	Filter Type	SCPI
	Gaussian	GAUSSian
	Flattop	FLATtop
Remote Command	[:SENSe]:OBwidth:BANDwidth:SHAPE GAUSSian FLATtop [:SENSe]:OBwidth:BANDwidth:SHAPE?	
Example	:OBW:BAND:SHAP GAUS :OBW:BAND:SHAP?	
Preset	"Auto Couple" on page 1825 selects the preset value	
State Saved	Saved in instrument state	
Annotation	The annotation under RBW in the bottom left of the screen shows the type of filter or bandwidth that is being used. The following examples illustrate this:	
	-3 dB (Normal) filter BW	Res BW 300 Hz
	-6 dB filter BW	Res BW (-6 dB) 422 Hz
	Noise filter BW	Res BW (Noise) 317 Hz
	Impulse filter BW	Res BW (Impulse) 444 Hz
	CISPR filter BW	Res BW (CISPR) 200 Hz
	MIL filter BW	Res BW (MIL) 1 kHz
	Flattop filter type	Res BW (Flattop) 300 Hz
Backwards Compatibility SCPI	[:SENSe]:OBwidth:BWIDth:SHAPE	

3.6.5 Display

Opens the **Display** menu, which lets you configure display items for the current Mode, Measurement View or Window.

3.6.5.1 Meas Display

Contains controls for setting the display for the current Measurement, View or Window.

x dB BW Boundaries On/Off

Turns the x dB BW Boundaries On or Off.

Remote Command	:DISPlay:OBwidth:WINDow[1]:XDB 0 1 OFF ON :DISPlay:OBwidth:WINDow[1]:XDB?
----------------	--

3 VMA Mode
3.6 Occupied BW Measurement

Example	<code>:DISP:OBW:WIND:XDB 1</code> <code>:DISP:OBW:WIND:XDB?</code>
Preset	0
State Saved	Saved in instrument state
Range	OFF ON
Backwards Compatibility SCPI	<code>:DISPlay:OBWidth:VIEW:WINDow[1]:XDB</code>

Boundary Frequency

Selects frequency display type:

- **OFFSet**: offsets from Center Freq to OBW boundary frequency are displayed
- **ABSolute**: absolute frequencies are displayed

Remote Command	<code>:DISPlay:OBWidth:WINDow2:BOUNDaries:FREQuency OFFSet ABSolute</code> <code>:DISPlay:OBWidth:WINDow2:BOUNDaries:FREQuency?</code>
Example	<code>:DISP:OBW:WIND2:BOUN:FREQ ABS</code> <code>:DISP:OBW:WIND2:BOUN:FREQ?</code>
Preset	OFFSet
State Saved	Saved in instrument state
Range	OFFSet ABSolute
Backwards Compatibility SCPI	<code>:DISPlay:OBWidth:VIEW2:WINDow2:BOUNDaries:FREQuency</code>

3.6.5.2 Annotation

Contains controls for setting up the annotation for the current Mode or Measurement.

Graticule

Turns the display graticule On or Off for all windows with graticules in all measurements in the current Mode. Also turns the graticule Y-Axis annotation on and off.

Remote Command	<code>:DISPlay:GRATicule[:STATe] OFF ON 0 1</code> <code>:DISPlay:GRATicule[:STATe]?</code>
Example	<code>:DISP:GRAT OFF</code>

Notes	The graticule is the set of horizontal and vertical lines that make up the grid/divisions for the X-Axis and Y-Axis
Preset	ON
State Saved	Saved in instrument state
Backwards Compatibility SCPI	<code>:DISPlay:WINDow[1]:TRACe:GRATicule:GRID[:STATe] OFF ON 0 1</code> <code>:DISPlay:WINDow[1]:TRACe:GRATicule:GRID[:STATe]?</code> This command is accepted for backwards compatibility with older instruments, but the WINDow , TRACe and GRID parameters are ignored

Screen Annotation

Controls the display of the annunciation and annotation around the graticule, including any annotation on lines (such as the display line, the threshold line, etc.) and the Y-Axis annotation, for all windows with screen annotation in all measurements in the current Mode.

This does *not* include marker annotation (or the N dB result). When **OFF**, the graticule expands to fill the entire graticule area, leaving only the 1.5% gap above the graticule, as described in the **Trace** section.

Remote Command	<code>:DISPlay:ANNotation:SCReen[:STATe] OFF ON 0 1</code> <code>:DISPlay:ANNotation:SCReen[:STATe]?</code>
Example	<code>:DISP:ANN:SCR OFF</code>
Dependencies	Grayed-out and forced to OFF when System Display Settings, Annotation is OFF
Preset	ON This remains OFF through a Preset when System Display Settings, Annotation is set to OFF
State Saved	Saved in instrument state

Trace Annotation

Turns on and off the labels on the traces, showing their detector (or their Math Mode) as described in the **Trace** section, for all windows in all measurements in the current Mode for which Trace Annotation on/off is supported.

If Trace Math is being performed on a trace, then the Trace Math annotation replaces the detector annotation.

For measurements that support limit lines, this key also turns on and off the labels on the Limit Lines. The label is the Limit number annotation and Limit Comment displayed on the graph. If the length of the comment is greater than 20 characters, the first 8 characters and the last 8 characters are displayed, joined with

Remote Command	<code>:DISPlay:ANNotation:TRACe[:STATe] ON OFF 1 0</code>
----------------	---

	<code>:DISPlay:ANNotation:TRACe[:STATe]?</code>
Example	<code>:DISP:ANN:TRAC OFF</code>
Preset	<code>OFF</code>
State Saved	Saved in instrument state

Control Annotation

Turns on and off the display of values on the Active Function controls for all measurements in the current Mode. This is a security feature.

Remote Command	<code>:DISPlay:ACTivefunc[:STATe] ON OFF 1 0</code> <code>:DISPlay:ACTivefunc[:STATe]?</code>
Example	<code>:DISP:ACT OFF</code>
Dependencies	Grayed out and forced to <code>OFF</code> when System Display Settings, Annotation is <code>OFF</code>
Preset	<code>ON</code> This remains <code>OFF</code> through a Preset when System Display Settings, Annotation is set to <code>OFF</code>
State Saved	Saved in instrument state

Meas Bar

Turns the Measurement Bar at the top of the screen on and off for all measurements in the current Mode. When `OFF`, the graticule area expands to fill the area formerly occupied by the Measurement Bar.

Remote Command	<code>:DISPlay:ANNotation:MBAR[:STATe] OFF ON 0 1</code> <code>:DISPlay:ANNotation:MBAR[:STATe]?</code>
Example	<code>:DISP:ANN:MBAR OFF</code>
Dependencies	Grayed out and forced to <code>OFF</code> when System Display Settings, Annotation is <code>OFF</code>
Preset	<code>ON</code> This remains <code>OFF</code> through a Preset when System Display Settings, Annotation is set to <code>OFF</code>
State Saved	Saved in instrument state

Display Enable (Remote Command Only)

Turns the display on/off, including the display drive circuitry. The backlight stays lit to confirm that the instrument is on. The display enable setting is mode global. There are three reasons for turning the display off:

1. To increase speed as much as possible by freeing the instrument from having to update the display
2. To reduce emissions from the display, drive circuitry
3. For security purposes

If you have turned off the display:

- and you are in local operation, the display can be turned back on by pressing any key or by sending `:SYSTem:DEFaults MISC` or `:DISPlay:ENABle ON` (neither `*RST` nor `:SYSTem:PRESet` enable the display)
- and you are in remote operation, the display can be turned back on by pressing the **Local** or **Esc** keys, or by sending `:SYSTem:DEFaults MISC` or `:DISPlay:ENABle ON` (neither `*RST` nor `:SYSTem:PRESet` enable the display)
- and you are using either the `:SYSTem:KLOCK` command or GPIB local lockout, then *no* front-panel key press will turn the display back on. You must turn it back on remotely.

If the display is **OFF**, many SCPI commands related to User Views and Multiscreen functionality do not work, and return the error messages “-221, Settings conflict; Screen SCPI cannot be used when Display is disabled” or “221, Settings conflict; View SCPI cannot be used while Display is disabled”. These commands include:

Name	Command
Select User View	<code>:DISPlay:VIEW:ADVanced:SElect</code>
Rename User View	<code>:DISPlay:VIEW:ADVanced:REName</code>
Delete User View	<code>:DISPlay:VIEW:ADVanced:DELeTe</code>
Create User View	<code>:DISPlay:VIEW:ADVanced:NAME</code>
Select Screen	<code>:INSTrument:SCReen:SElect</code>
Delete Screen	<code>:INSTrument:SCReen:DELeTe</code>
Delete All But This Screen	<code>:INSTrument:SCReen:DELeTe:ALL</code>
Add Screen	<code>:INSTrument:SCReen:CREate</code>
Rename Screen	<code>:INSTrument:SCReen:REName</code>
Sequencer On/Off	<code>:SYSTem:SEQuencer</code>

Remote Command	<code>:DISPlay:ENABle OFF ON 0 1</code>
Example	<code>:DISP:ENAB OFF</code>
Couplings	<code>:DISP:ENAB OFF</code> turns Backlight OFF and <code>:DISP:ENAB ON</code> turns Backlight ON , but changing Backlight settings does <i>not</i> change the state of <code>:DISP:ENAB</code>
Preset	ON

	Set by <code>:SYST:DEF MISC</code> , but not affected by <code>*RST</code> or <code>:SYSTem:PRESet</code>
State Saved	Not saved in instrument state
Backwards Compatibility Notes	<code>:SYST:PRES</code> no longer turns on <code>:DISPlay:ENABle</code> as it did in legacy analyzers

3.6.5.3 View

Contains controls for selecting the current **View**, and for editing User Views.

View

See "Views" on page 935

User View

Lets you choose a View from the saved User Views for the current measurement. This panel only appears if a User View exists for the current measurement.

Remote Command	<code>:DISPlay:VIEW:ADVanced:SElect <alphanumeric></code> <code>:DISPlay:VIEW:ADVanced:SElect?</code>
Example	Select Baseband as the current View <code>:DISP:VIEW:ADV:SEL "Baseband"</code>
Notes	<p>You must be in the measurement whose View you are trying to set to send the command. You can only set Views for the current measurement using this command</p> <p>For predefined views, the parameter is derived from the view name that is shown in the View list in the user interface. For example, if you are trying to select the Trace Zoom view in the Swept SA measurement, you send:</p> <pre><code>:DISP:VIEW:ADV:SEL "Trace Zoom"</code></pre> <p>because "Trace Zoom" is the name of the View as seen in the Mode/Meas dialog or in the Display, View menu</p> <p>You <i>cannot</i> use the legacy View parameter (which in this case would be <code>TZOom</code>) with</p> <pre><code>:DISP:VIEW:ADV:SEL</code></pre> <p><code><alphanumeric></code> is case insensitive; you can specify mixed case, however the name will be evaluated on a single case. Thus, both of the following forms work:</p> <pre><code>:DISP:VIEW:ADV:SEL "Trace Zoom"</code></pre> <pre><code>:DISP:VIEW:ADV:SEL "TRACE ZOOM"</code></pre> <p>If the specified view is not a valid View, the query returns the error message "-224, Illegal parameter value; View with the name <alphanumeric> does not exist"</p> <p>If the display is disabled (via <code>:DISP:ENAB OFF</code>) then the error message "-221, Settings conflict; View SCPI cannot be used while Display is disabled" is generated</p>

Backwards Compatibility SCPI	The legacy node <code>:DISPlay:VIEW[:SElect]</code> is retained for backwards compatibility, but it only supports predefined views
------------------------------	--

Restore Layout to Default

Restores the Layout to the default for Basic.

Modified Views are very temporary; if you exit the current measurement they are discarded, and they are not saved in State. To retain this View for later use, and to be able to return easily to your original Basic View, you can save your edited View as a “User View”.

Save Layout as New View

Saves your new View as a User View. An alpha keyboard appears, which lets you name your new View; the default is the old View name plus a number.

Remote Command	<code>:DISPlay:VIEW:ADVanced:NAME <alphanumeric></code>
Example	<code>:DISP:VIEW:ADV:NAME "Baseband"</code> Creates a new View named Baseband from the current View, and selects it as the current View
Notes	<code><alphanumeric></code> is case insensitive; you can specify mixed case, however the name will be evaluated on a single case If <code><alphanumeric></code> name already exists as a View, the error message “-224, Illegal parameter value; View <alphanumeric> already exists” is generated If the display is disabled (via <code>:DISP:ENAB OFF</code>) then the error message “-221, Settings conflict; User View SCPI cannot be used while Display is disabled” is generated

Re-Save User View

You can re-edit a User View; if you make changes, then an asterisk will appear next to the User View’s name. You can then tap **Re-Save User View** to save it back to its existing name, or **Save Layout as New View** to add another, new User View.

This is a front panel function only, there is no remote command available to perform this function. To do this remotely, you must first perform **Save Layout as New View**, then delete the old User View and rename the new one with the name of the View you just deleted.

Rename User View

You can rename the current View by giving it a new unique name. Only User Views can be renamed, if the current View is a Predefined View, an error occurs.

Remote Command	<code>:DISPlay:VIEW:ADVanced:REName <alphanumeric></code>
Example	<code>:DISP:VIEW:ADV:REN "Baseband"</code>
Notes	<p><code><alphanumeric></code> is case insensitive; you can specify mixed case, however the name will be evaluated on a single case</p> <p>If the <code><alphanumeric></code> specifying the new name is already present in the list of View names, the error message "-224, Illegal parameter value; View <alphanumeric> already exists" is generated</p> <p>If the current View is a Predefined View, the error message "-224, Illegal parameter value; Cannot rename a Predefined View" is generated</p> <p>If the display is disabled (via <code>:DISP:ENAB OFF</code>) then the error message "-221, Settings conflict; View SCPI cannot be used while Display is disabled" is generated</p>

Delete User View

You can delete the current View if it is a User View. The default view becomes the current view for the Measurement.

Remote Command	<code>:DISPlay:VIEW:ADVanced:DElete</code>
Example	<code>:DISP:VIEW:ADV:DEL</code>
Notes	<p><code><alphanumeric></code> is case insensitive; you can specify mixed case, however the name will be evaluated on a single case</p> <p>If the <code><alphanumeric></code> is not present in the list of View names, the error message "-224, Illegal parameter value; View <alphanumeric> does not exist" is generated</p> <p>If the current View is a Predefined View, the error message "-224, Illegal parameter value; Cannot delete a Predefined View" is generated</p> <p>If the display is disabled (via <code>:DISP:ENAB OFF</code>) then the error message "-221, Settings conflict; View SCPI cannot be used while Display is disabled" is generated</p>

Delete All User Views

Deletes all previously saved User Views. The default view becomes the current view for the Measurement if a User View was the current view when this command was executed.

Remote Command	<code>:DISPlay:VIEW:ADVanced:DElete:ALL</code>
----------------	--

Example	<code>:DISP:VIEW:ADV:DEL:ALL</code>
Notes	Disabled if there are no User Views

View Editor Remote Commands

The following remote commands help you manage Views and User Views. Note that the SCPI node for User Views handles both Predefined and User Views. The legacy nodes, `:DISPlay:VIEW[:SElect]` and `:DISPlay:VIEW:NSEL`, are retained for backwards compatibility, but they only support predefined views.

View Listing Query

Returns a string containing a comma-separated list of names for *all* the Views, including User Views, available for the current Measurement.

Remote Command	<code>:DISPlay:VIEW:ADVanced:CATalog?</code>
Example	<code>:DISP:VIEW:ADV:CAT?</code>
Notes	<p>Returns a quoted string of the available Views for the current measurement, separated by commas. The list includes names for <i>all</i> the Views, including User Views, available for the current Measurement</p> <p>Example: <code>"Normal,Trace Zoom,Spectrogram,Baseband,myView1,yourView1"</code></p> <p>No distinction is made between Predefined and User Views</p> <p>If you switch measurements with the display disabled (via <code>:DISP:ENAB OFF</code>), then query the list of available Views, the result is undefined</p>

User View Listing Query

Returns a string containing a comma-separated list of names for *only* the User Views available for the current Measurement.

Remote Command	<code>:DISPlay:VIEW:ADVanced:USER:CATalog?</code>
Example	<code>:DISP:VIEW:ADV:USER:CAT?</code>
Notes	<p>Returns a quoted string of the available User Views for the current measurement, separated by commas.</p> <p>Example: <code>"Baseband,myView1,yourView1"</code></p> <p>If you switch measurements with the display disabled (see "Display Enable (Remote Command Only)" on page 1812), then query the list of available Views, the result is undefined</p>

3.6.6 Frequency

Opens the **Frequency** menu, which contains controls that allow you to control the Frequency and Channel parameters of the instrument.

Some features in the **Frequency** menu are the same for all measurements in the current Mode – they do not change as you change measurements. Settings like these are called “Meas Global” and are unaffected by Meas Preset. For example, the Center Freq setting is the same for all measurements – it does not change as you change measurements.

3.6.6.1 Settings

Contains controls that pertain to the X-Axis parameters of the measurement. These parameters control how data on the vertical (X) axis is displayed and control instrument settings that affect the horizontal axis.

Center Frequency

Sets the frequency that corresponds to the horizontal center of the graticule (when frequency Scale Type is set to linear). While adjusting **Center Frequency**, **Span** is held constant, which means that both **Start Freq** and **Stop Freq** will change.

In measurements that also have **Start Freq** and **Stop Freq** controls, pressing **Center Frequency** sets the frequency entry mode to Center/Span. In Center/Span mode, the center frequency and span values are displayed below the graticule, and the default active function in the **Frequency** menu is **Center Frequency**. In the Start/Stop annotation mode, **Start Freq** and **Stop Freq** are displayed below the graticule instead of **Center Frequency** and **Span**.

Pressing **Center Frequency** also sets the frequency entry mode to Center/Span. In Center/Span mode, the center frequency and span values are displayed below the graticule, and the default active function in the **Frequency** menu is **Center Frequency**.

When **Display Scale Type** is set to **LOG**, pressing **Center Frequency** sets the frequency that corresponds to the arithmetic mean of the start frequency and stop frequency, which is not at the horizontal center of the graticule.

The center frequency setting is the same for all measurements within a Mode, that is, it is Meas Global. Some Modes are also able to share a Mode Global center frequency value. If this is the case, the Mode has a **Global** tab in its **Meas Setup** menu.

Center Frequency sets (and queries) the center frequency for the currently selected input. If your instrument has multiple inputs, and you select another input, **Center**

Frequency changes to the value for that input. SCPI commands are available to directly set **Center Frequency** for a specific input (see "**RF Center Frequency**" on page 1001 and "**Ext Mix Center Freq**" on page 1002).

Center Frequency is remembered as you go from input to input. Thus you can set a **Center Frequency** of 10 GHz with the RF Input selected, change to BBIQ and set a **Center Frequency** of 20 MHz, then switch to External Mixing and set a **Center Frequency** of 60 GHz. When you return to the RF Input, **Center Frequency** reverts to 10 GHz; back to BBIQ and it is 20 MHz; back to External Mixing and it is 60 GHz.

Remote Command	<code>[:SENSe] :FREQuency :CENTer <freq></code> <code>[:SENSe] :FREQuency :CENTer?</code>
Example	Set Center Frequency to 50 MHz: <code>:FREQ:CENT 50 MHz</code> Increment Center Frequency by the value of CF Step : <code>:FREQ:CENT UP</code> Return the current value of Center Frequency : <code>:FREQ:CENT?</code>
Notes	Sets the RF, External Mixing or I/Q Center Frequency depending on the selected input: <ul style="list-style-type: none"> - For RF input it is equivalent to <code>:FREQ:RF :CENT</code> - For I/Q input it is equivalent to <code>:FREQ:IQ :CENT</code> - For External Mixer it is equivalent to <code>:FREQ:EMIX :CENT</code> Preset and Max values depend on Hardware Options If no terminator (for example, MHz) is sent, the terminator Hz is used. If a terminator with unit other than frequency is used, an invalid suffix error message is generated
Dependencies	Center Frequency can be limited by Start Freq or Stop Freq limits, if Span is so large that start or stop reach their limits
Couplings	When operating in "swept span", any value of Center Frequency or Span that is within the frequency range of the instrument is allowed, <i>if</i> the value is being set through the front panel numeric key pad or the SCPI command. The other parameter is forced to a different value if needed, to keep Start and Stop Frequencies within the instrument's frequency range Coupling between center frequency and span: numeric (keypad) entries are treated differently than changing the value using the step keys (Up/Down Arrows) or the knob. Similarly, for remote operation, sending a numeric frequency value is treated differently than the UP DOWN keywords: <ul style="list-style-type: none"> - Numeric entries (keypad or remote): Any value of Center Frequency or Span (within the frequency range of the instrument) is allowed. The other parameter is changed, as necessary, to keep the Start Freq and Stop Freq within the instrument frequency range - Knob or Step keys (up/down arrows) or UP DOWN keywords: The value of the parameter being changed (Center Frequency or Span) is limited so the other parameter is not forced to a new value. Thus, if only the step keys and knob are used, you can return to the initial Center Frequency and Span by changing only the current parameter

3 VMA Mode
3.6 Occupied BW Measurement

	Note that, since out-of-range Start Freq and Stop Freq are never allowed, markers and trace math work correctly without requiring any special handling for out-of-range conditions
Preset	Depends on instrument maximum frequency, mode, measurement, and selected input See "Center Frequency Presets" on page 999 and "Ext Mix Center Freq" on page 1002
State Saved	Saved in instrument state
Min/Max	Depends on instrument maximum frequency, mode, measurement, and selected input See "Center Frequency Presets" on page 999 and "Ext Mix Center Freq" on page 1002
Annotation	Center <value> appears in the lower left corner of the display
Status Bits/OPC dependencies	Non-overlapped

Center Frequency Presets

The following table provides the Center Frequency Presets for the Spectrum Analyzer mode, and the Max Freq, for the various frequency options:

Freq Option	CF after Mode Preset	Stop Freq after Mode Preset	Max Freq (can't tune above)
503 (all but CXA)	1.805 GHz	3.6 GHz	3.7 GHz
503 (CXA)	1.505 GHz	3.0 GHz	3.08 GHz
507 (all but CXA)	3.505 GHz	7.0 GHz	7.1 GHz
507 (CXA)	3.755 GHz	7.5 GHz	7.58 GHz
508 (all but MXE)	1.805 GHz	3.6 GHz	8.5 GHz
508 (MXE)	4.205 GHz	8.4 GHz	8.5 GHz
513	6.805 GHz	13.6 GHz	13.8 GHz
526 (except CXA and MXE)	13.255 GHz	26.5 GHz	27.0 GHz*
526 (CXA)	13.255 GHz	26.5 GHz	26.55 GHz
526 (MXE)	1.805 GHz	3.6 GHz	27.0 GHz
532	16.005 GHz	32.0 GHz	32.5 GHz
540	20.005 GHz	40.0 GHz	40.5 GHz
543	21.505 GHz	43.0 GHz	43.0 GHz
544	22.005 GHz	44.0 GHz	45.0 GHz
550	25.005 GHz	50.0 GHz	52 GHz
F03 (CXA-m)	1.505 GHz	3.0 GHz	3.08 GHz
F07 (CXA-m)	3.755 GHz	7.5 GHz	7.575 GHz
F13 (CXA-m)	6.805 GHz	13.6 GHz	13.8 GHz
F26 (CXA-m)	13.255 GHz	26.5 GHz	26.55 GHz

Freq Option	CF after Mode Preset	Stop Freq after Mode Preset	Max Freq (can't tune above)
504 (M9421A, M8920A)	2.145 GHz	3.88GHz	3.88 GHz
506 (M9421A, M8920A)	3.245 GHz	6.08GHz	6.08 GHz
F06 (M9410A/11A)	1.0 GHz	6.08 GHz	6.08 GHz
F06 (M9415A)	1 GHz	1.08 GHz	6.6 GHz
F08 (M9415A)	1 GHz	1.08 GHz	8.6 GHz
F12 (M9415A)	1 GHz	1.08 GHz	12.9 GHz

*For option 526, the Max CF in RTSA is 26.999999995 GHz.

N9041B Center Freq Presets

Input	CF after Mode Preset	Stop Freq after Mode Preset	Max Freq (can't tune above)
Input 1, all models	25.005 GHz	50.0 GHz	52 GHz
Input 2, opt 585	42.505 GHz	85.0 GHz	86 GHz
Input 2, opt 590	45.005 GHz	90.0 GHz	92 GHz
Input 2, opt 5CX	55.005 GHz	110.0 GHz	110 GHz

Input 2, CXA and MXE

Model	CF after Mode Preset	Stop Freq after Mode Preset	Max Freq (can't tune above)
CXA opt C75	0.7505 GHz	1.5 GHz	1.58 GHz
MXE	505 MHz	1 GHz	1.000025 GHz

Tracking Generator Frequency Limits (CXA only)

Tracking Generator Option	Min Freq (clips to this freq when turn TG on and can't tune below while TG on)	If above this Freq, Stop Freq clipped to this Freq when TG turned on	Max Freq (can't tune above) while TG on
T03	9 kHz	3.0 GHz	3.08 GHz
T06	9 kHz	6.0 GHz	6.05 GHz

Tracking Generator Frequency Limits(CXA-m only)

Tracking Generator Option	Min Freq (clips to this freq when turn TG on and can't tune below while TG on)	If above this Freq, Stop Freq clipped to this Freq when TG turned on	Max Freq (can't tune above) while TG on
T03	2 MHz	3.08 GHz	3.08 GHz

3 VMA Mode
3.6 Occupied BW Measurement

Tracking Generator Option	Min Freq (clips to this freq when turn TG on and can't tune below while TG on)	If above this Freq, Stop Freq clipped to this Freq when TG turned on	Max Freq (can't tune above) while TG on
T07	2 MHz	7.575 GHz	7.575 GHz
T13	2 MHz	13.8 GHz	13.8 GHz
T26	2 MHz	26.55 GHz	26.55 GHz

RF Center Frequency

Specifies the RF Center Frequency. Sets the center frequency to use when the RF input is selected, even if the RF input is not the input that is selected at the time the command is sent. Note that **Center Frequency** in the **Frequency** menu on the front panel always applies to the currently selected input.

Remote Command	<code>[:SENSe] :FREQuency:RF:CENTer <freq></code> <code>[:SENSe] :FREQuency:RF:CENTer?</code>
Example	<code>:FREQ:RF:CENT 30 MHz</code> <code>:FREQ:RF:CENT?</code>
Notes	This command is the same in all Modes, but the parameter is Measurement Global. So, the value is independent in each Mode and common across all the measurements in the Mode
Dependencies	If the electronic/soft attenuator is enabled, any attempt to set Center Frequency such that the Stop Frequency would be >3.6 GHz fails and results in an advisory message. If the equivalent SCPI command is sent, this same message is generated as part of a “-221, Settings conflict” warning If Source Mode is set to Tracking, and the Max or Min Center Frequency is therefore limited by the limits of the source, a warning message is generated, “Data out of range; clipped to source max/min” if these limits are exceeded. Note that for an external source, these limits can be affected by the settings of Source Numerator, Source Denominator, and Power Sweep
Preset	See " Center Frequency Presets " on page 999
State Saved	Saved in instrument state

Min	Instrument Types	Value
	VXT model M9421A	55.000005 MHz
	VXT models M9410A/11A	6.505 kHz with Option LFE 330.000005 MHz without Option LFE 330.000005 MHz
	VXT model M9415A	330.000005 MHz
	M8920A	80.005 kHz
	All other instruments	-79.999995 MHz

	Instrument Types	Value
	<i>Unless Source Mode is set to Tracking, in which case it is limited by the minimum frequency of the Source</i>	
Max	See table above. Basically, instrument maximum frequency – 5 Hz. Note that, if the Source Mode is set to Tracking, the effective instrument maximum frequency may be limited by the source maximum frequency If the knob or step keys are being used, also depends on the value of the other three interdependent parameters: Span , Start Frequency and Stop Frequency	
	<p>Ext Mix Center Freq</p> <p>Specifies the External Mixer Center Frequency. Sets the center frequency to use when the External Mixer is selected, even if the External Mixer input is not the input which is selected at the time the command is sent. Note that the Center Frequency function in the Frequency menu on the front panel always applies to the currently selected input.</p>	
Remote Command	[:SENSe]:FREQUency:EMIXer:CENTer <freq> [:SENSe]:FREQUency:EMIXer:CENTer?	
Example	:FREQ:EMIX:CENT 60 GHz :FREQ:EMIX:CENT?	
Notes	This command is the same in all Modes, but the parameter is Measurement Global. So, the value is independent in each Mode and common across all the measurements in the Mode	
Couplings	When you return to External Mixing after using one of the other inputs (for example, RF), you return to the settings that you had when you left External Mixing. So, you return to the band you were in with the Center Frequency that you had. However, Span is <i>not</i> an input-dependent parameter, so it does not change. Therefore, the instrument comes back with the Span from the previous input, limited as necessary by the current mixer setup	
Preset	<p>When Mode Preset is performed while in External Mixing, the start frequency of the current Mode is set to the nominal Min frequency of the lowest harmonic range in the Harmonic Table for the current mixer setup. Similarly, the stop frequency of the current Mode is set to the nominal Max frequency of the highest harmonic range in the Harmonic Table. Center Frequency thus presets to the point arithmetically equidistant from these two frequencies</p> <p>Note that, if the current measurement has a limited Span available to it, and cannot achieve the span shown in the table (Span = Stop Freq – Start Freq), the instrument uses the maximum span that the measurement allows, and still sets Center Frequency to the midpoint of the Start Freq and Stop Freq values in the Harmonic Table</p> <p>When Restore Input/Output Defaults is performed, the mixer presets to the 11970A, whose Start and Stop frequencies are 26.5 and 40 GHz respectively. The center of these two frequencies is 33.25 GHz. Therefore, after Restore Input/Output Defaults, if you switch to External Mixing and do a Mode Preset while in the Spectrum Analyzer Mode, the resulting Center Frequency is 33.25 GHz</p>	

3 VMA Mode
3.6 Occupied BW Measurement

State Saved	Yes
Min	The minimum frequency in the currently selected mixer band + 5 Hz
Max	The maximum frequency in the currently selected mixer band - 5 Hz If the knob or step keys are being used, also depends on the value of the other three interdependent parameters Span , Start Freq and Stop Freq

Span

Set the frequency of the occupied bandwidth span for the current measurement.

Remote Command	<pre>[:SENSe]:OBWidth:FREQuency:SPAN <freq> [:SENSe]:OBWidth:FREQuency:SPAN? [:SENSe]:OBWidth:FREQuency:SPAN:AUTO ON OFF 0 1 [:SENSe]:OBWidth:FREQuency:SPAN:AUTO?</pre>																																	
Example	<pre>:OBW:FREQ:SPAN 2.4 MHz :OBW:FREQ:SPAN? :OBW:FREQ:SPAN:AUTO 0 :OBW:FREQ:SPAN:AUTO?</pre>																																	
Notes	Span Auto Detector ([:SENSe]:OBWidth:FREQuency:SPAN:AUTO) is only available in the MSR, LTEAFDD/LTEATDD and 5GNR modes																																	
Dependencies	The Auto Detect functionality is only available in the MSR, LTEAFDD/LTEATDD and 5GNR modes																																	
Preset	<table border="1"> <thead> <tr> <th>Mode</th> <th>Value</th> </tr> </thead> <tbody> <tr> <td>SA</td> <td>3 MHz</td> </tr> <tr> <td>WCDMA</td> <td>10 MHz</td> </tr> <tr> <td>LTEAFDD, LTEATDD</td> <td>10 MHz</td> </tr> <tr> <td>BT</td> <td>2 MHz</td> </tr> <tr> <td>5GNR</td> <td>Automatically calculated</td> </tr> <tr> <td>RTS</td> <td>27 kHz</td> </tr> <tr> <td>MSR</td> <td>10 MHz</td> </tr> <tr> <td>WLAN</td> <td> <table border="1"> <thead> <tr> <th>Radio Std</th> <th>Value</th> </tr> </thead> <tbody> <tr> <td>802.11b</td> <td>30MHz</td> </tr> <tr> <td>802.11a/g/n/ac/ax/be (20MHz)</td> <td>25 MHz</td> </tr> <tr> <td>802.11n/ac/ax/be (40MHz)</td> <td>50 MHz</td> </tr> <tr> <td>802.11n/ac/ax/be (80MHz)</td> <td>100 MHz</td> </tr> <tr> <td>802.11ac/ax/be (160MHz)</td> <td>200 MHz</td> </tr> <tr> <td>802.11be (320MHz)</td> <td>400 MHz</td> </tr> </tbody> </table> </td> </tr> </tbody> </table>		Mode	Value	SA	3 MHz	WCDMA	10 MHz	LTEAFDD, LTEATDD	10 MHz	BT	2 MHz	5GNR	Automatically calculated	RTS	27 kHz	MSR	10 MHz	WLAN	<table border="1"> <thead> <tr> <th>Radio Std</th> <th>Value</th> </tr> </thead> <tbody> <tr> <td>802.11b</td> <td>30MHz</td> </tr> <tr> <td>802.11a/g/n/ac/ax/be (20MHz)</td> <td>25 MHz</td> </tr> <tr> <td>802.11n/ac/ax/be (40MHz)</td> <td>50 MHz</td> </tr> <tr> <td>802.11n/ac/ax/be (80MHz)</td> <td>100 MHz</td> </tr> <tr> <td>802.11ac/ax/be (160MHz)</td> <td>200 MHz</td> </tr> <tr> <td>802.11be (320MHz)</td> <td>400 MHz</td> </tr> </tbody> </table>	Radio Std	Value	802.11b	30MHz	802.11a/g/n/ac/ax/be (20MHz)	25 MHz	802.11n/ac/ax/be (40MHz)	50 MHz	802.11n/ac/ax/be (80MHz)	100 MHz	802.11ac/ax/be (160MHz)	200 MHz	802.11be (320MHz)	400 MHz
Mode	Value																																	
SA	3 MHz																																	
WCDMA	10 MHz																																	
LTEAFDD, LTEATDD	10 MHz																																	
BT	2 MHz																																	
5GNR	Automatically calculated																																	
RTS	27 kHz																																	
MSR	10 MHz																																	
WLAN	<table border="1"> <thead> <tr> <th>Radio Std</th> <th>Value</th> </tr> </thead> <tbody> <tr> <td>802.11b</td> <td>30MHz</td> </tr> <tr> <td>802.11a/g/n/ac/ax/be (20MHz)</td> <td>25 MHz</td> </tr> <tr> <td>802.11n/ac/ax/be (40MHz)</td> <td>50 MHz</td> </tr> <tr> <td>802.11n/ac/ax/be (80MHz)</td> <td>100 MHz</td> </tr> <tr> <td>802.11ac/ax/be (160MHz)</td> <td>200 MHz</td> </tr> <tr> <td>802.11be (320MHz)</td> <td>400 MHz</td> </tr> </tbody> </table>	Radio Std	Value	802.11b	30MHz	802.11a/g/n/ac/ax/be (20MHz)	25 MHz	802.11n/ac/ax/be (40MHz)	50 MHz	802.11n/ac/ax/be (80MHz)	100 MHz	802.11ac/ax/be (160MHz)	200 MHz	802.11be (320MHz)	400 MHz																			
Radio Std	Value																																	
802.11b	30MHz																																	
802.11a/g/n/ac/ax/be (20MHz)	25 MHz																																	
802.11n/ac/ax/be (40MHz)	50 MHz																																	
802.11n/ac/ax/be (80MHz)	100 MHz																																	
802.11ac/ax/be (160MHz)	200 MHz																																	
802.11be (320MHz)	400 MHz																																	

Mode	Value
State Saved	Yes
Min	100 Hz
Max	Hardware Maximum Span
Backwards Compatibility SCPI	<code>[:SENSe] : EBWidth : FREQUENCY : SPAN</code>

CF Step

Changes the step size for the center frequency and start and stop frequency functions. Once a step size has been selected, and the center frequency function is active, the step keys (and the **UP** | **DOWN** parameters for **Center Frequency** from remote commands) change the center frequency by the step-size value. The step size function is useful for finding harmonics and sidebands beyond the current frequency span of the instrument.

Note that Start Frequency and Stop Frequency also step by the **CF Step** value.

Remote Command	<code>[:SENSe] : FREQUENCY : CENTER : STEP [: INCRement] <freq></code> <code>[:SENSe] : FREQUENCY : CENTER : STEP [: INCRement] ?</code> <code>[:SENSe] : FREQUENCY : CENTER : STEP : AUTO OFF ON 0 1</code> <code>[:SENSe] : FREQUENCY : CENTER : STEP : AUTO ?</code>
Example	Increase the current center frequency value by 500 MHz: <code>:FREQ:CENT:STEP 500 MHz</code> <code>:FREQ:CENT UP</code> <code>:FREQ:CENT:STEP:AUTO ON</code> <code>:FREQ:CENT:STEP:AUTO?</code>
Notes	Preset and Max values depend on Hardware Options
Dependencies	Span, RBW, Center frequency If the electronic/soft attenuator is enabled, any attempt to change the value of the center frequency >3.6 GHz by pressing the Up Arrow key, fails and results in an advisory message. If the equivalent SCPI command is sent, this same message is generated as part of a “-221, Settings conflict” warning
Couplings	When auto-coupled in a non-zero span, the center frequency step size is set to 10% of the span When auto-coupled in zero span, the center frequency step size is set to the equivalent -3 dB RBW value
Preset	Auto ON

State Saved	Saved in instrument state
Min	- /+(the maximum frequency of the instrument). That is, 27 GHz max freq instrument has a CF step range of +/- 27 GHz. Note that this is the maximum frequency given the current settings of the instrument, so in External Mixing, for example, it is the maximum frequency of the current mixer band
Status Bits/OPC dependencies	non-overlapped

Full Span (Remote Command Only)

Changes the Occupied Bandwidth Span to show the full frequency range of the instrument. It maximizes the span within a range but does not change **Center Frequency**. When using external mixing, it changes the displayed frequency span to the frequency range specified for the selected external mixing band.

Remote Command	<code>[:SENSe] :OBWidth :FREQuency :SPAN :FULL</code>
Example	<code>:OBW :FREQ :SPAN :FULL</code>
Couplings	Selecting full span changes the measurement span value

3.6.7 Marker

Accesses a menu that enables you to select, set up and control the markers for the current measurement. If there are no active markers, **Marker** selects marker 1, sets it to **Normal** mode (see "**Marker Mode**" on page 1007), and places it at the center of the display. If the selected marker is **Off**, it is set to **Normal** and placed at the center of the screen, on the trace determined by the Marker Trace rules.

3.6.7.1 Select Marker

Specifies the selected marker. The term "selected marker" is used throughout this document to specify which marker will be affected when you change marker settings, perform a **Peak Search**, etc.

This control appears above the menu panel, indicating that it applies to all controls in the **Marker** menu panels. **Select Marker** is blanked if you select a tab whose controls do *not* depend on the selected marker (for example, **Counter**).

For any menu that includes **Select Marker**, the first control is always **Marker Frequency | Time**.

Notes	The selected marker is remembered even when not in the Marker menu and is used if a search is done, or a Band Function is turned on, or for Signal Track or Continuous Peak
-------	--

Preset	Marker 1
State Saved	The number of the selected marker is saved in instrument state
Annunciation	Appears in the marker results block label for Normal and Delta markers

3.6.7.2 Settings

The controls on this tab include the Marker active function and a radio button selection for the marker control mode (**Normal/Position**, **Delta** or **Off**; see "**Marker Mode**" on page 1007) for the selected marker, as well as additional functions that help you use markers.

Marker Frequency

Sets the marker X-Axis value in the current marker X-Axis Scale unit. It has no effect if the control mode (see "**Marker Mode**" on page 1007) is **Off**, but is the SCPI equivalent of entering an X value if the control mode is **Normal** or **Delta**.

Remote Command	<code>:CALCulate:OBWidth:MARKer[1] 2 ... 12:X <freq></code> <code>:CALCulate:OBWidth:MARKer[1] 2 ... 12:X?</code>
Example	<code>:CALC:OBW:MARK3:X 0</code> <code>:CALC:OBW:MARK3:X?</code>
Notes	If no suffix is sent, uses the fundamental units for the current marker X Axis Scale. If a suffix is sent that does not match the current marker X Axis Scale unit, an error "Invalid suffix" is generated The query returns the marker's absolute X Axis value if the control mode is Normal , or the offset from the marker's reference marker if the control mode is Delta . The query is returned in the fundamental units for the current marker X Axis scale: Hz for Frequency and Inverse Time , seconds for Period and Time
Preset	After a preset, all markers are turned OFF , so Marker X Axis Value query returns Not a Number (NAN)
State Saved	Saved in instrument state
Min	-9.9E+37
Max	9.9E+37
Annotation	Mkr # <X value> and <Marker value> upper right on graph

Marker X Axis Position (Remote Command Only)

Sets the marker X-Axis Scale position in trace points. This setting has no effect if the control mode is **Off**, but is the SCPI equivalent of entering a value if the control mode is **Normal** or **Delta** - except in trace points rather than X-Axis Scale units. The entered value is immediately translated into the current X-Axis Scale units for setting the value of the marker.

Remote	<code>:CALCulate:OBWidth:MARKer[1] 2 ... 12:X:POSition <real></code>
--------	--

3 VMA Mode
3.6 Occupied BW Measurement

Command	:CALCulate:OBWidth:MARKer[1] 2 ... 12:X:POSition?
Example	:CALC:OBW:MARK10:X:POS 0 :CALC:OBW:MARK10:X:POS?
Notes	The query returns the marker's absolute X-Axis value in trace points if the control mode is Normal , or the offset from the marker's reference marker in trace points if the control mode is Delta . The value is returned as a real number, not an integer, corresponding to the translation from X-Axis Scale units to trace points . When a marker is turned on, it is placed center of the screen on the trace. Therefore, the default value depends on instrument condition If the marker is Off , the query response is Not A Number
Preset	After a preset, all markers are turned Off , so the query returns Not A Number (NAN)
State Saved	Saved in instrument state
Min	-9.9E+37
Max	9.9E+37

Marker Y Axis Value (Remote Query only)

Returns the marker Y-Axis value in the current marker Y-Axis unit.

Remote Command	:CALCulate:OBWidth:MARKer[1] 2 ... 12:Y?
Example	:CALC:OBW:MARK11:Y?
Notes	Returns the marker Y-Axis result, if the control mode is Normal or Delta If the marker is Off , the response is Not A Number
Preset	Result dependent on Markers setup and signal source
State Saved	No
Backwards Compatibility SCPI	:CALCulate:OBWidth:MARKer[1] 2 ... 12:FUNCTION:RESult?

Marker Mode

Sets the marker control mode to **Normal (POSition)**, **Delta**, or **Off**. All interactions and dependencies detailed under the control description are enforced when the remote command is sent. If the selected marker is **OFF**, pressing **Marker** sets it to **Normal** and places it at the center of the screen on the trace determined by the **Marker Trace** rules. At the same time, **Marker X Axis Value** appears on the Active Function area.

The default active function is the active function for the currently selected marker control mode. If the current control mode is **Off**, there is no active function, and the active function is turned off.

Remote Command	:CALCulate:OBWidth:MARKer[1] 2 ... 12:MODE POSition DELTa OFF
Example	:CALC:OBW:MARK:MODE POS :CALC:OBW:MARK:MODE?
Preset	OFF
State Saved	Saved in instrument state
Range	POSition DELTA OFF

Annotation Mkr # <X value> and <Marker value> upper right on graph
When Marker Trace is Polar in WCDMA mode:
Mkr # <Chip Value (RHO & QPSKEVM)/Symbol Value (CDP)>, <X value> and <Y value> upper right on graph

Backwards Compatibility SCPI Command

Sets or queries the state of a marker. Setting a marker that is **OFF** to **ON** (1), puts it in **Normal** mode, and places it at the center of the screen.

Example	:CALC:OBW:MARK3:STAT ON :CALC:OBW:MARK3:STAT?
Preset	OFF
State Saved	Saved in instrument state
Range	OFF ON
Backwards Compatibility SCPI	:CALCulate:OBWidth:MARKer[1] 2 ... 12:STATE OFF ON 0 1 :CALCulate:OBWidth:MARKer[1] 2 ... 12:STATE?

Delta Marker (Reset Delta)

Pressing this button has the same effect as pressing **Delta** in **Marker Mode**. The selected marker becomes a **Delta** marker. If the selected marker is already a **Delta** marker, the reference marker is moved to the current position of the selected marker, thus resetting the delta to zero.

Marker Settings Diagram

Lets you configure the **Marker** system using a visual utility.

All Markers Off

Turns off all markers.

Remote Command :CALCulate:OBWidth:MARKer:AOff

Example :CALC:OBW:MARK:AOff

3.6.7.3 Peak Search

The controls on this tab allow you to move the marker to selected peaks of the signal, giving you enormous analysis capabilities, particularly when combined with "[Marker Delta](#)" on page 1010.

NOTE

Pressing the **Peak Search** hardkey automatically moves you to the **Peak Search** page of the **Marker** menu *and* performs a peak search.

Pressing the **Peak Search** tab once you are already *in* the **Marker** menu does *not* perform a peak search.

Marker Frequency

This is the fundamental control that you use to move a marker around on the trace. It is the same as "[Marker Frequency](#)" on page 1006 on the **Settings** tab.

Peak Search

Moves the selected marker to the trace point which has the maximum y-axis value for that marker's trace.

NOTE

Pressing the **Peak Search** hardkey automatically moves you to the **Peak Search** page of the **Marker** menu *and* performs a peak search.

Remote Command :CALCulate:OBWidth:MARKer[1]|2|...|12:MAXimum

Example :CALC:OBW:MARK2:MAX
 :SYST:ERR?

can be used to query the errors to determine if a peak is found. The message "No peak found" (-200) will be returned after an unsuccessful search

Notes Sending this command selects the subopcoded marker
 In WCDMA Mode, this command does not work when the selected marker is located on the polar trace. In this case, the command is ignored

Marker Delta

Pressing this button has the same effect as pressing **Delta** in "**Marker Mode**" on [page 1007](#) on the **Settings** tab. The selected marker becomes a **Delta** marker. If the selected marker is already a **Delta** marker, the reference marker is moved to the current position of the selected marker, thus resetting the delta to zero.

The control is duplicated here to allow you to conveniently perform a peak search and change the marker's control mode to **Delta** without having to access two separate menus.

3.6.7.4 Properties

The controls on this tab are used to set certain properties of the selected marker.

Marker Frequency

This is the fundamental control that you use to move a marker around on the trace. It is the same as "**Marker Frequency**" on [page 1006](#) on the **Settings** tab.

Relative To

Selects the marker to which the selected marker is relative (its reference marker).

Every marker has another marker to which it is relative. This marker is referred to as the "reference marker" for that marker. This attribute is set by the **Marker, Properties, Relative To** key. The marker must be a **Delta** marker to make this attribute relevant. If it is a **Delta** marker, the reference marker determines how the marker is controlled and how its value is displayed. A marker cannot be relative to itself.

Remote Command	<code>:CALCulate:OBWidth:MARKer[1] 2 ... 12:REFerence <integer></code>
Example	<code>:CALC:OBW:MARK:REF 2</code> <code>:CALC:OBW:MARK:REF?</code>
Notes	Causes the marker specified with the subopcode to become selected Range (for SCPI command): 1 to 12. If the range is exceeded, the value is clipped A marker cannot be relative to itself so that choice is not available, and if sent from SCPI generates error -221: "Settings conflict; marker cannot be relative to itself" The query returns a single value (the specified marker number's relative marker)
Couplings	The act of specifying the selected marker's reference marker makes the selected marker a Delta marker

	If the reference marker is Off , it is turned on in Normal mode at the Delta marker location
Preset	The preset default "Relative To" marker (reference marker) is the next higher numbered marker (current marker +1). For example, if marker 2 is selected, then it's default reference marker is marker 3. The exception is marker 12, which has a default reference of marker 1 Set to the defaults by using Restore Mode Defaults . This is not reset by Marker Off , All Markers Off , or Preset
State Saved	Saved in instrument state. Not affected by Marker Off and hence not affected by Preset or power cycle
Min	1
Max	12
Annunciation	Appears in the marker label of a Delta marker

Marker Trace

Selects the trace on which you want your marker placed. A marker is associated with one and only one trace. This trace is used to determine the placement, result, and X-Axis Scale of the marker. All markers have an associated trace; it is from that trace that they determine their attributes and behaviors, and it is to that trace that they go when they become **Normal** or **Delta** markers (see "[Marker Mode](#)" on page 1007).

Specifying a **Marker Trace** manually or with this command associates the marker with the specified trace. If the marker is not **Off**, it moves from the trace it was on to the new trace. If the marker is **Off**, it stays off, but is now associated with the specified trace.

The query returns the number of the trace on which the marker is currently placed.

Remote Command	<code>:CALCulate:OBWidth:MARKer[1] 2 ... 12:TRACe 1 2 3</code> <code>:CALCulate:OBWidth:MARKer[1] 2 ... 12:TRACe?</code>
Example	<code>:CALC:OBW:MARK2:TRAC 2</code> <code>:CALC:OBW:MARK2:TRAC?</code>
Notes	A marker may be placed on a blanked and/or inactive trace, even though the trace is not visible and/or updating An application may register a trace name to be displayed on the control instead of a trace number
Couplings	The state of Marker Trace is not affected by " Auto Couple " on page 1825 Sending the remote command causes the addressed marker to become selected
Preset	1
State Saved	Saved in instrument state

Marker Settings Diagram

Lets you configure the **Marker** system using a visual utility. It is the same as "[Marker Settings Diagram](#)" on page 1008 on the **Settings** tab.

3.6.8 Meas Setup

Contains functions for setting up the measurement parameters and contains functions for setting up parameters global to all measurements in the mode.

3.6.8.1 Settings

Contains frequently used **Meas Setup** functions to which you will want the fastest access.

Avg/Hold Num

Specifies the number of measurement averages used when calculating the measurement result. The average is displayed at the end of each sweep.

Initiates an averaging routine that averages the sweep points in several successive sweeps, resulting in trace smoothing.

After the specified number of average counts, "[Average Mode](#)" on page 1013 (termination control) determines the average action.

Remote Command	<code>[:SENSe] :OBwidth:AVERage:COUNT <integer></code>
Example	<code>:OBW:AVER:COUN 1500</code> <code>:OBW:AVER:COUN?</code>
Preset	10
State Saved	Yes
Min/Max	1/10000
Annotation	The average count is displayed in the measurement bar on the front panel display. The annotation appears in the format n/N where n is the current average and N is the average count
Backwards Compatibility SCPI	<code>[:SENSe] :EBwidth:AVERage:COUNT</code>

Averaging On/Off

Turns averaging on or off.

NOTE

In this measurement, **Average Type** is always preset to the [Log-Pwr Avg \(Video\)](#) method. Other averaging methods are not available.

3 VMA Mode
3.6 Occupied BW Measurement

Remote Command	<code>[:SENSe]:OBWidth:AVERage[:STATe] ON OFF 1 0</code> <code>[:SENSe]:OBWidth:AVERage[:STATe]?</code>
Example	<code>:OBW:AVER ON</code> <code>:OBW:AVER?</code>
Couplings	Averaging state is coupled to " Max Hold (Remote Command Only) " on page 1018. If Max Hold is changed from OFF to ON , Averaging state is automatically set to ON
Preset	ON
State Saved	Yes
Range	ON OFF
Backwards Compatibility SCPI	<code>[:SENSe]:EBWidth:AVERage[:STATe]</code>

Average Mode

Lets you set the averaging mode.

EXponential	Measurement averaging continues using the specified number of averages to compute each averaged value. The average is displayed at the end of each sweep
REPeat	The measurement resets the average counter each time the specified number of averages is reached

Remote Command	<code>[:SENSe]:OBWidth:AVERage:TCONtrol EXponential REPeat</code> <code>[:SENSe]:OBWidth:AVERage:TCONtrol?</code>
Example	<code>:OBW:AVER:TCON REP</code> <code>:OBW:AVER:TCON?</code>
Preset	EXP
State Saved	Yes
Range	EXponential REPeat

% of OBW Power

Assigns the percentage of the total power that is measured within the Occupied Bandwidth for the current measurement. The resulting Occupied Bandwidth limits are displayed by markers placed on the frequencies of the specified percentage.

Remote Command	<code>[:SENSe]:OBWidth:PERCent <real></code> <code>[:SENSe]:OBWidth:PERCent?</code>
Example	<code>:OBW:PERC 75</code>

	<code>:OBW:PERC?</code>
Preset	99.00
State Saved	Yes
Min/Max	10/99.99

Power Ref

Lets you select Power Ref type:

Total Power	<code>TPOWer</code>	Total power in the current span is displayed
OBW Power	<code>OBWPower</code>	Occupied power is displayed

When **Power Ref** type is changed, the annotation in the lower window and Remote Command SCPI Results also change.

Remote Command	<code>[:SENSe]:OBWidth:PREFERENCE OBWPower</code> <code>[:SENSe]:OBWidth:PREFERENCE?</code>
Example	<code>:OBW:PREF TPOW</code> <code>:OBW:PREF?</code>
Preset	<code>TPOWer</code>
State Saved	Saved in instrument state
Range	<code>TPOWer OBWPower</code>

x dB

Sets the x dB value used for the "x dB bandwidth" result that measures the bandwidth between two points on the signal that is x dB down from the highest signal point within the OBW Span.

Remote Command	<code>[:SENSe]:OBWidth:XDB <rel_amp></code> <code>[:SENSe]:OBWidth:XDB?</code>
Example	<code>:OBW:XDB -20</code> <code>:OBW:XDB?</code>
Preset	BT Mode: -20.0 dB All other Modes: -26.0 dB
State Saved	Yes
Min/Max	-100.0 dB/-0.1 dB
Backwards Compatibility SCPI	<code>[:SENSe]:EBWidth:XDB</code>

Power Integration Method

Selects the power integration method:

Normal	NORMal	By integrating the linear power bucket values from the lower edge of the trace, and interpolating to find the point where the integrated power equals $(1 - [\text{Occ BW \% Pwr}]) / 2$ (0.5% if, for example, the 99% occupied bandwidth is to be found) of the total power, frequency f1 is obtained. This procedure is repeated from the upper trace edge to find frequency f2. This calculation uses linear interpolation to find the lower and upper carrier boundary point within the width of a sweep point (the span divided by the number of sweep points), f1 and f2
From Center	ICENter	Measures the power spectrum distribution within two times or more frequency range over the requirement for Occupied Bandwidth specification centering on the current carrier frequency

Remote Command	<code>[:SENSe]:OBwidth:INTEgration[:METHod] NORMal ICENter</code> <code>[:SENSe]:OBwidth:INTEgration[:METHod]?</code>
Example	<code>:OBW:INT NORM</code> <code>:OBW:INT?</code>
Preset	For 5GNR Mode, Uplink: ICENter All other Modes NORMal
State Saved	Yes
Range	NORMal ICENter

Spur Avoidance

Because VXT models M9410A/11A/15A/16A and M9410E/11E/15E/16E are direct-conversion (zero-IF) receivers, feedthrough leakage from the local oscillator appears as a spurious signal (spur) at the center frequency. The **Spur Avoidance** function is provided to eliminate this spur, at the expense of some measurement speed.

When **Spur Avoidance** is enabled (the default), the instrument uses a software algorithm to remove this spur from the displayed measurement data, but the algorithm only operates under certain conditions. Specifically, it only operates in the multiple capture case.

You can disable this function to speed up your measurement by setting **Spur Avoidance** to “Disabled.”

Note that when **Spur Avoidance** is not in effect, either because you have disabled it or because you are not in multiple capture, the following warning message will appear in the status bar:

Settings Alert;Spur Avoidance Off

This is to alert you that measurement accuracy might be impacted by the fact that **Spur Avoidance** is not in effect.

The spur avoidance function is not available for:

- M9410A/11A with EP6 option at frequency above 6 GHz
- M9415A/16A at frequency below 380 MHz and above 12.3 GHz
- M9410E/11E/15E/16E at frequency below 380 MHz and above 25.9 GHz

Remote Command	<code>[:SENSe]:OBWidth:SAVoid[:STATe] OFF ON 0 1</code> <code>[:SENSe]:OBWidth:SAVoid[:STATe]?</code>
Example	<code>:OBW:SAV ON</code> <code>:OBW:SAV?</code>
Dependencies	Only appears in VXT models M9410A/11A/15A/16A and M9410E/11E/15E/16E
Preset	<code>OFF</code>
State Saved	Saved in instrument state
Range	<code>OFF ON</code>

Meas Setup Summary Table

Lets you view and access many of the parameters in the **Meas Setup** menus on one screen.

Auto Couple

Immediately puts all **Auto/Man** functions into **Auto**. **Auto Couple** is confined to the current measurement only. It does not affect other measurements in the Mode.

In the **Auto** state, **Auto/Man** functions are said to be “coupled”, meaning their values change as you make changes to other values in the measurement. This helps ensure accurate measurements and optimum dynamic range. **Auto Couple** is an immediate action function, and when it is executed, all the **Auto/Man** controls for the current measurement are set to **Auto**, and all measurement settings coupled to the **Auto/Man** parameters are automatically set to their optimal values.

For further details of measurement-specific settings (if any), see "[Measurement-Specific Details](#)" on page 1017 below.

Remote Command	:COUPl ^e ALL
Example	:COUP ALL
Backwards Compatibility SCPI	:COUPLE ALL NONE
Backwards Compatibility Notes	:COUP:NONE puts all Auto/Man parameters in manual mode, decoupling all the coupled instrument parameters. It is retained for backwards compatibility and is <i>not</i> recommended for making measurements or new designs

All **Auto/Man** parameter couplings in the measurement are set to **Auto**. This includes couplings that may be unavailable or grayed-out due to the current state. For example, in the Swept SA measurement, there is no **Auto/Man** coupling for **RBW** while in Zero Span. Nonetheless, if **Auto Couple** were executed while in Zero Span, it would set **RBW** to Auto "behind the scenes" so that, on exit from Zero Span, it would be in **Auto**.

Any **Auto/Man** selection specific (local) to the other measurements in the current Mode are not affected by **Auto Couple**. Any functions that are *not* coupled with other instrument parameters, such as ranging or leveling variables, such as **AutoRange** or **AutoScale**, are not affected.

Executing **Auto Couple** generates the informational message, "All Auto/Man functions have been set to Auto".

Each parameter, upon being set to **Auto**, selects and sets the appropriate auto-coupled value based on that parameter's coupling rules. The Dependency Resolver orchestrates the couplings for parameters that depend on one or more other parameters. The coupling and dependency rules for each parameter are defined in the section describing that parameter.

Executing **Auto Couple** *does not* affect markers, marker functions, trace or display attributes, or any other instrument setting other than those specifically mentioned above.

Measurement-Specific Details

TOI (SA Mode only)

Parameters affected by **Auto Couple** are:

- Center Frequency Step
- Resolution Bandwidth
- Span/RBW Ratio

- Sweep Time
- Video BANDwidth VBW/RBW ratio
- Upper and Lower Tone (set to Sense)
- Zero span measurement Resolution Bandwidth
- Zero span measurement Dwell Time

Harmonics (SA Mode only)

Parameters affected by **Auto Couple** are:

- Resolution Bandwidth
- Fundamental Frequency
- Dwell Time
- Range Table Resolution Bandwidths
- Range Table Dwell Times

Meas Preset

Restores all measurement parameters to their default values.

Remote Command	<code>:CONFigure:OBwidth</code>
Example	<code>:CONF:OBW</code>

Max Hold (Remote Command Only)

When **ON**, **Max Hold** displays and holds the maximum responses of the current measurement. Turn **Max HoldOFF** to disable the maximum hold feature.

Remote Command	<code>[:SENSe]:OBwidth:MAXHold ON OFF 1 0</code> <code>[:SENSe]:OBwidth:MAXHold?</code>
Example	<code>:OBW:MAXH ON</code> <code>:OBW:MAXH?</code>
Couplings	Max Hold is coupled to " Averaging On/Off " on page 1012. Max Hold is activated only if Average state is ON . If Max Hold is changed to ON when Average state is OFF , Average state is automatically set to ON
Preset	OFF

State Saved	Yes
Range	OFF ON
Backwards Compatibility SCPI	[:SENSe]:EBWidth:MAXHold

3.6.8.2 Limits

Lets you set measurement limits and be alerted when they have been exceeded.

Limit

Enables you to turn on or off limit checking at the specified frequency. For results that fail the limit test, a red FAIL appears in the Meas Bar.

Remote Command	<pre>:CALCulate:OBWidth:LIMit:FBLimit <freq> :CALCulate:OBWidth:LIMit:FBLimit? :CALCulate:OBWidth:LIMit[:TEST] ON OFF 1 0 :CALCulate:OBWidth:LIMit[:TEST]?</pre>																											
Example	<pre>:CALC:OBW:LIM:FBL 50 kHz :CALC:OBW:LIM:FBL? :CALC:OBW:LIM OFF :CALC:OBW:LIM?</pre>																											
Dependencies	Appears in all Modes except MSR, LTE-A and 5G NR																											
Preset	<table border="1"> <thead> <tr> <th>Mode</th> <th>Value</th> </tr> </thead> <tbody> <tr> <td>SA</td> <td>5 MHz</td> </tr> <tr> <td>WCDMA</td> <td></td> </tr> <tr> <td>MSR</td> <td></td> </tr> <tr> <td>WLAN</td> <td> <table border="1"> <thead> <tr> <th>Radio Std</th> <th>Value</th> </tr> </thead> <tbody> <tr> <td>802.11a/g(OFDM/DSSS-OFDM)</td> <td>20 MHz</td> </tr> <tr> <td>802.11b</td> <td>25 MHz</td> </tr> <tr> <td>802.11n/ac/ax/be (20MHz)</td> <td>20 MHz</td> </tr> <tr> <td>802.11n/ac/ax/be (40MHz)</td> <td>40 MHz</td> </tr> <tr> <td>802.11n/ac/ax/be (80MHz)</td> <td>80 MHz</td> </tr> <tr> <td>802.11ac/ax/be (160MHz)</td> <td>160 MHz</td> </tr> <tr> <td>802.11be (320MHz)</td> <td>320 MHz</td> </tr> </tbody> </table> </td> </tr> </tbody> </table>		Mode	Value	SA	5 MHz	WCDMA		MSR		WLAN	<table border="1"> <thead> <tr> <th>Radio Std</th> <th>Value</th> </tr> </thead> <tbody> <tr> <td>802.11a/g(OFDM/DSSS-OFDM)</td> <td>20 MHz</td> </tr> <tr> <td>802.11b</td> <td>25 MHz</td> </tr> <tr> <td>802.11n/ac/ax/be (20MHz)</td> <td>20 MHz</td> </tr> <tr> <td>802.11n/ac/ax/be (40MHz)</td> <td>40 MHz</td> </tr> <tr> <td>802.11n/ac/ax/be (80MHz)</td> <td>80 MHz</td> </tr> <tr> <td>802.11ac/ax/be (160MHz)</td> <td>160 MHz</td> </tr> <tr> <td>802.11be (320MHz)</td> <td>320 MHz</td> </tr> </tbody> </table>	Radio Std	Value	802.11a/g(OFDM/DSSS-OFDM)	20 MHz	802.11b	25 MHz	802.11n/ac/ax/be (20MHz)	20 MHz	802.11n/ac/ax/be (40MHz)	40 MHz	802.11n/ac/ax/be (80MHz)	80 MHz	802.11ac/ax/be (160MHz)	160 MHz	802.11be (320MHz)	320 MHz
Mode	Value																											
SA	5 MHz																											
WCDMA																												
MSR																												
WLAN	<table border="1"> <thead> <tr> <th>Radio Std</th> <th>Value</th> </tr> </thead> <tbody> <tr> <td>802.11a/g(OFDM/DSSS-OFDM)</td> <td>20 MHz</td> </tr> <tr> <td>802.11b</td> <td>25 MHz</td> </tr> <tr> <td>802.11n/ac/ax/be (20MHz)</td> <td>20 MHz</td> </tr> <tr> <td>802.11n/ac/ax/be (40MHz)</td> <td>40 MHz</td> </tr> <tr> <td>802.11n/ac/ax/be (80MHz)</td> <td>80 MHz</td> </tr> <tr> <td>802.11ac/ax/be (160MHz)</td> <td>160 MHz</td> </tr> <tr> <td>802.11be (320MHz)</td> <td>320 MHz</td> </tr> </tbody> </table>	Radio Std	Value	802.11a/g(OFDM/DSSS-OFDM)	20 MHz	802.11b	25 MHz	802.11n/ac/ax/be (20MHz)	20 MHz	802.11n/ac/ax/be (40MHz)	40 MHz	802.11n/ac/ax/be (80MHz)	80 MHz	802.11ac/ax/be (160MHz)	160 MHz	802.11be (320MHz)	320 MHz											
Radio Std	Value																											
802.11a/g(OFDM/DSSS-OFDM)	20 MHz																											
802.11b	25 MHz																											
802.11n/ac/ax/be (20MHz)	20 MHz																											
802.11n/ac/ax/be (40MHz)	40 MHz																											
802.11n/ac/ax/be (80MHz)	80 MHz																											
802.11ac/ax/be (160MHz)	160 MHz																											
802.11be (320MHz)	320 MHz																											

Mode	Value
BT	1 MHz
RTS	25 kHz

Mode	Value
SA	OFF
All others	ON

State Saved	Yes
	Yes
Range	OFF ON
Min/Max	1 kHz/Depends on instrument maximum frequency

Limit Test

Toggles the limit test.

Remote Command	<code>:CALCulate:OBWidth:LIMit[:TEST] ON OFF 1 0</code> <code>:CALCulate:OBWidth:LIMit[:TEST]?</code>
Example	<code>:CALC:OBW:LIM 0</code> <code>:CALC:OBW:LIM?</code>
Dependencies	Only appears in LTEAFDD/LTEATDD and 5G NR Modes
Preset	ON
State Saved	Saved in instrument state
Range	ON OFF

Bandwidth

Sets the limit bandwidth for OBW measurement.

Remote Command	<code>:CALCulate:OBWidth:LIMit:FBLimit <freq></code> <code>:CALCulate:OBWidth:LIMit:FBLimit?</code>
Example	<code>:CALC:OBW:LIM:FBL 10</code> <code>:CALC:OBW:LIM:FBL?</code>
Dependencies	Only appears in LTEAFDD/LTEATDD and 5G NR Modes
Preset	Automatically calculated
State Saved	Saved in instrument state
Min/Max	1 kHz/Depends on instrument maximum frequency

3 VMA Mode
3.6 Occupied BW Measurement

Remote Command	<code>:CALCulate:OBwidth:LIMit:FBLimit:AUTO ON OFF 1 0</code> <code>:CALCulate:OBwidth:LIMit:FBLimit:AUTO?</code>
Example	<code>:CALC:OBW:LIM:FBL:AUTO OFF</code> <code>:CALC:OBW:LIM:FBL:AUTO?</code>
Dependencies	Only available in LTE-A and 5G NR Modes
Couplings	When the state of limit bandwidth is ON , the bandwidth value is automatically determined by multi-carrier configuration (system bandwidth and freq offset of each component carrier). Otherwise, the bandwidth value depends on user input When the bandwidth value is set manually, the state of limit bandwidth automatically changes to OFF
Preset	ON
State Saved	Yes
Range	Auto Man

3.6.8.3 Advanced

Contains controls for setting advanced functions of the instrument. This tab does not appear in EXM, nor in VXT models M9420A/10A/11A.

Noise Floor Extension

Lets you configure **Noise Floor Extension** (NFE). All Modes that support NFE let you set it on or off. Additionally, some Modes support two “on” states for NFE, **Full** and **Adaptive**, as described below.

Adaptive Option Support

At present (Release: X-Apps 2024), support for **Adaptive** NFE is as follows:

Mode	Measurements	Supports Adaptive NFE?
BT	ACP, IBEM, IBSP	No
CQM	MON	Yes
EDGE GSM	EORF, ETSP, MON	No
EMI	APD, DAN, FSC, MON, RTSC, SCH	Yes
LTEAFDD	PVT	No
LTEATDD	PVT	No
MSR	ACP, CHP, MON, OBW, SEM, SPUR	Yes
NR5G	PVT	No
PNOISE	LPL, MON, SFR	No

Mode	Measurements	Supports Adaptive NFE?
SA	SAN	Yes
SRCOMMS	ACP, CHP, MON, OBW, SEM, SPUR	Yes
VMA	ACP, CHP, OBW, SEM, SPUR	Yes
WCDMA	ACP, CHP, MON, OBW, SEM, SPUR	Yes
WLAN	CHP, MON, OBW, SEM, SPUR	Yes

The menus and command options are as follows:

NFE State	Modes with Adaptive NFE	Modes without Adaptive NFE	SCPI
Off	Off	Off	See "NFE On/Off Command" on page 1023
On	Full	On	
Adaptive	Adaptive	n/a	See "Adaptive NFE Command" on page 1024

As shown in the table above, the **On** state (in Modes that do not support **Adaptive NFE**) matches the **Full** state in Modes that *do* support **Adaptive NFE**.

To maintain SCPI backwards compatibility, the existing command to turn NFE on or off is retained, and a new command is added to set the state to turn **AdaptiveON** or **OFF**:

- `[[:SENSe]:CORRection:NOISe:FLOOr ON|OFF|1|0]` is retained, with the default changed to **ON** for Modes that support **Adaptive NFE**
- `[[:SENSe]:CORRection:NOISe:FLOOr:ADAPtive ON|OFF|1|0]` is added (for certain Modes), default = **ON**

When NFE is **On** or **Full**, the expected noise power of the instrument (derived from a factory calibration) is subtracted from the trace data. This will usually reduce the apparent noise level by about 10 dB in low band, and 8 dB in high band (>~3.6 GHz).

NFE works with any RBW, VBW, detector, any setting of **Average Type**, any amount of trace averaging, and any signal type. It is ineffective when the trace is not smoothed (smoothing processes include narrow VBWs, trace averaging, and long sweep times with the detector set to **Average** or **Peak**). It works best with extreme amounts of smoothing, and with the average detector, with the **Average Type** set to **Power**.

In those cases where the cancellation is ineffective, it nonetheless has no undesirable side-effects. There is no significant speed impact to having **Noise Floor Extension** on.

The best accuracy is achieved when substantial smoothing occurs in each point before trace averaging. Thus, when using the **Average** detector, results are better with long sweep times and fewer trace averages. When using the **Sample** detector,

the VBW filter should be set narrow with less trace averaging, instead of a wide VBW filter with more trace averaging.

NOTE

Noise Floor Extension has no effect unless the RF Input is selected, so when External Mixing is selected, it does nothing.

For more details, see ["Optimal Detector & Averaging Selections" on page 1024](#) and ["Recalibration of Noise Floor" on page 1026](#).

Pros & Cons of Adaptive NFE

Adaptive NFE provides an alternative to fully-on or fully-off NFE. Fully-on NFE can, notably in cases with little or no averaging of the spectrum, result in a display that is distractingly unfamiliar in the variability in response to low level signals. Fully-off NFE fails to achieve the potential improvement in dynamic range and associated accuracy of measurement of low-level signals. **Adaptive** NFE controls the degree of potential improvement in the noise floor to give more improvement for those instrument settings that can make good use of the potential improvement—those settings with high degrees of variance reduction through some variant of averaging. When the potential improvement is small, the display acts like the fully-off case, and when it is high, it acts like the fully-on case, and in-between, application is a compromise between attractiveness and effectiveness.

In **Adaptive** NFE, there is not the same dramatic visual impact on the noise floor as there is in **Full** NFE. **Adaptive** NFE controls the amount of correction that is applied based on other instrument settings like RBW, averaging and sweep time. **Adaptive** NFE controls the degree of potential improvement in the noise floor to give more improvement for those instrument settings that can make good use of the potential improvement, such as settings that provide more averaging. The result is that when not much averaging is being performed, the signal displays more like the fully-off case; and when lots of averaging is being performed, the signal displays more like the **Full** NFE case.

Adaptive NFE is recommended for general-purpose use. For fully-ATE (automatic test equipment) applications, where possible distraction of the instrument user is not a risk, **Full** NFE is recommended.

NFE On/Off Command

Remote Command	<code>[:SENSe]:CORRection:NOISe:FLOor ON OFF 1 0</code> <code>[:SENSe]:CORRection:NOISe:FLOor?</code>
Example	<code>:CORR:NOIS:FLO ON</code>
Dependencies	Only appears in instruments with the NFE or NF2 license installed. In all others, the control does not appear. In those cases, the SCPI command is accepted without error, but has no effect
Couplings	When NFE is enabled in any Mode manually, a prompt is displayed reminding you to perform the

	<p>Characterize Noise Floor operation if it is needed</p> <p>When NFE is enabled through SCPI, and a Characterize Noise Floor operation is needed, an error is entered in the system error queue</p>
Preset	<p>Unaffected by Mode Preset. Turned ON at startup and by Restore Mode Defaults in Modes that support Adaptive. Turned OFF at startup and by Restore Mode Defaults in Modes that do <i>not</i> support Adaptive</p> <p>In Modes that support Adaptive NFE, the default (preset) state of NFE is Adaptive. In Modes that do not support Adaptive NFE, the default state of NFE is Off</p>
State Saved	No

Adaptive NFE Command

Only effective in instruments with the NFE or NF2 license installed, and in Modes that support **Adaptive** NFE. For coverage, see "[Adaptive Option Support](#)" on page 1021 above.

For all other cases, the SCPI command below is accepted without error, but has no effect.

Remote Command	<pre>[:SENSe]:CORRection:NOISe:FLOOr:ADAPtive ON OFF 1 0 [:SENSe]:CORRection:NOISe:FLOOr:ADAPtive?</pre>
Example	<p>First turn NFE on, this is Full mode</p> <pre>:CORR:NOIS:FLO ON</pre> <p>Then set it to Adaptive</p> <pre>:CORR:NOIS:FLO:ADAP ON</pre>
Couplings	To maintain backwards compatibility, sending <code>:CORR:NOIS:FLO ON</code> turns NFE AdaptiveOFF . To turn Adaptive on, you must issue the commands in the proper order, as shown in the example above
Preset	Not affected by Mode Preset , but set to ON at startup and by Restore Mode Defaults
State Saved	No

Optimal Detector & Averaging Selections

Note that some measurements do not allow you to switch the **Detector** type (which is set by default to **Average**), so the discussion of detector types here is irrelevant for those measurements. Similarly, some measurements do not allow you to set **Average Type** (set by default to **LOG**), so that discussion here is irrelevant in those cases.

The instrument is characterized in the factory (or during a field calibration) with a model of the noise, referred to the input mixer, versus frequency in each band and path combination. Bands are 0 (low band) and 1 through 4 (high band) in a 26.5 GHz instrument, for example. Paths include normal paths, preamp paths, the electronic attenuator, etc.

3 VMA Mode

3.6 Occupied BW Measurement

In most band/path combinations, the noise can be well characterized based on just two parameters and the instrument frequency response before compensation for frequency-dependent losses.

After the noise density at the input mixer is estimated, the effects of the input attenuator, RBW, detector, etc. are computed to obtain the estimated input-port-referred noise level.

In the simplest case, the measured power (signal plus analyzer noise) in each display point (bucket) is compensated by subtracting the estimated noise power, leaving just the signal power. This is the operation when **Detector** is **Average** and **Average Type** is set to **Power (RMS)**.

For best operation, **AverageDetector** (default) and **Average Type. = Power** are recommended, as already stated. In other cases, operation is often not quite as good but still highly effective. Other **Detector** options, when available, behave as follows:

Positive Peak The noise floor is estimated based on the RBW and the duration of the bucket using the same equations used in the noise marker function. The voltage of the noise is subtracted from the voltage of the observed signal-plus-noise measurement to compute the estimated signal voltage

Positive Peak is one example of processing that varies with detector to give good estimates of the signal level without the analyzer noise

For pulsed-RF, **Positive Peak** can still give excellent effectiveness

FFT analysis does not work well, and does not perform NFE well, with pulsed-RF signals, so this combination is *not* recommended

Negative Peak Not very useful

Sample Works well, but never better than **Average**, because it does not smooth as well

Normal A combination of peak and negative peak behaviors, and works about as well as these

For best operation, extreme smoothing is desirable, as already stated. Using narrow VBWs works well, but using very long bucket durations and the average detector works best. Reducing the number of trace points makes the buckets longer.

For best operation, **Average Type = Power (RMS)** is optimal (when this option is available). When making CW measurements in the presence of noise without NFE, averaging on the decibel scale has the advantage of reducing the effect of noise. Using NFE with **Average Type = Log-Power (LOG)** is not synergistic, though; NFE with **Average Type = Power (RMS)** works a little better than NFE with **LOG**.

The results from NFE with internal preamp can often be lower than the theoretical noise in a signal source at room temperature, a noise density of -174 dBm/Hz. This is expected and useful behavior, because NFE is designed to report the amount of input signal that exceeds the thermal noise, not the amount that includes the thermal noise. This can be a useful behavior because thermal noise often interferes

with what you want to measure, instead of being part of what you want to measure. Note that NFE is not adequately accurate to always be able to read below kTB.

Recalibration of Noise Floor

In instruments with the NF2 license installed, the calibrated noise floor used by **Noise Floor Extension** should be refreshed periodically. Keysight recommends that the **Characterize Noise Floor** operation be performed after the first 500 hours of operation, *and* once every calendar year. To do this, use "**Characterize Noise Floor**" on page 1941, under **System, Alignments, Advanced**. If you have not done this yourself at the recommended interval, then when you turn on **Noise Floor Extension**, the instrument will prompt you to do so with a dialog stating:

This action will take several minutes to perform. Please disconnect all cables from the RF input and press Enter to proceed. Press ESC to cancel, or Postpone to postpone for a week

If you cancel, you will be prompted again the next time you turn NFE on. If you postpone, you will be prompted again after a week passes and you then turn NFE on.

IF Gain

Sets the **IF Gain** function to one of:

Setting	SCPI	Comments
Auto	AUTO = ON	Auto
Low	OFF	Low Gain
	AUTO = OFF	
High	ON	High Gain
	AUTO = OFF	

This setting affects sensitivity and IF overloads. It only applies to the RF input; not to the baseband I/Q input.

Remote Command [:SENSe]:OBWidth:IF:GAIN[:STATe] ON | OFF | 1 | 0
 [:SENSe]:OBWidth:IF:GAIN[:STATe]?
 [:SENSe]:OBWidth:IF:GAIN:AUTO[:STATe] ON | OFF | 1 | 0
 [:SENSe]:OBWidth:IF:GAIN:AUTO[:STATe]?

Example :OBW:IF:GAIN ON
 :OBW:IF:GAIN?
 :OBW:IF:GAIN:AUTO OFF
 :OBW:IF:GAIN:AUTO?

Dependencies	Has no effect when the U7227A USB Preamplifier is connected. This is not annotated or reflected on any control; there are no controls grayed-out nor any SCPI locked out. The instrument simply behaves as though both IF Gain is set to Low regardless of the setting on the control Not available in VXT models M9420A/10A/11A, EXM, or UXM
Couplings	Auto sets IF Gain to High (ON) under any of the following conditions: <ul style="list-style-type: none"> - The input attenuator is set to 0 dB, or - The preamp is turned on and the frequency range is under 3.6 GHz For other conditions, Auto sets IF Gain to Low (OFF)
Preset	OFF OFF
State Saved	Saved in instrument state
Range	Low Gain High Gain

3.6.8.4 Global

The controls in this menu apply to all Modes in the instrument.

Some controls (for example, "[Global Center Freq](#)" on page 1828) allow you to switch certain Meas Global parameters to a Mode Global state. These switches apply to all Modes that support global settings. For example, no matter what Mode you are in when you set **Global Center Freq** to **ON**, it applies to all Modes that support Global settings.

Other controls (for example, **Extend Low Band**) are actually set in this menu, but apply to all Modes.

Global Center Freq

The software maintains a Mode Global value called **Global Center Freq**.

When **Global Center Freq** is switched **ON**, the current Mode's center frequency is copied into the **Global Center Frequency**, and from then on all Modes that support global settings use the **Global Center Frequency**, so you can switch between any of these Modes and the **Center Frequency** remains unchanged.

Adjusting the **Center Frequency** of any Mode that supports Global Settings, while **Global Center Freq** is **ON**, modifies the **Global Center Freq**.

When **Global Center Freq** is switched **OFF**, the **Center Frequency** of the current Mode is unchanged, but now the **Center Frequency** of each Mode is once again independent.

When **Mode Preset** is pressed while **Global Center Freq** is **ON**, the **Global Center Freq** is preset to the preset **Center Frequency** of the current Mode.

This function resets to **OFF** when "Restore Defaults" on page 1829 is pressed, or when **System, Restore Defaults, All Modes** is pressed.

Remote Command	:INSTRUMENT:COUPLE:FREQUENCY:CENTER ALL NONE :INSTRUMENT:COUPLE:FREQUENCY:CENTER?
Example	:INST:COUP:FREQ:CENT ALL :INST:COUP:FREQ:CENT?
Preset	Set to OFF on Global Settings, Restore Defaults and System, Restore Defaults, All Modes
Range	ALL NONE
Preset	OFF
Backwards Compatibility SCPI	:GLOBAL:FREQUENCY:CENTER[:STATE] 1 0 ON OFF :GLOBAL:FREQUENCY:CENTER[:STATE]?

Global EMC Std

When this control is switched **ON**, the current Mode's EMC Std is copied into the **Global EMC Std**, and from then on all Modes that support global settings use the **Global EMC Std**, so you can switch between any of these Modes and the EMC Std remains unchanged.

Adjusting the EMC Std of any Mode that supports Global settings, while **Global EMC Std** is **ON** modifies the **Global EMC Std**.

When **Global EMC Std** is switched **OFF**, the EMC Std of the current Mode remains unchanged, but now the EMC Std of each Mode is once again independent. When **Mode Preset** is pressed while **Global EMC Std** is **ON**, **Global EMC Std** is preset to the preset EMC Std of the current Mode.

This function resets to **OFF** when "Restore Defaults" on page 1829 is pressed, or when **System, Restore Defaults, All Modes** is pressed.

Remote Command	:INSTRUMENT:COUPLE:EMC:STANDARD ALL NONE :INSTRUMENT:COUPLE:EMC:STANDARD?
Example	:INST:COUP:EMC:STAN ALL :INST:COUP:EMC:STAN?
Dependencies	Only available if Option EMC is installed
Preset	Set to OFF on Global Settings, Restore Defaults and System, Restore Defaults, All Modes
Range	ALL NONE

Restore Defaults

Resets all functions in the **Global** settings menu to **OFF**. Pressing **System, Restore Defaults, All Modes** has the same effect.

Remote Command	:INSTRument:COUPle:DEFault
Example	:INST:COUP:DEF
Backwards Compatibility SCPI	:GLOBal:DEFault

3.6.9 Sweep

Accesses controls to configure and control the acquisition of data, and the X-axis parameters of the instrument.

Depending on the selected mode and measurement, these controls might include: **Sweep Time**, **Continuous/Single**, **Pause/Resume**, **X Scale** and **Number of Points**.

3.6.9.1 Sweep/Control

Accesses controls that let you operate the sweep and control functions of the instrument, such as **Sweep Time** and **Continuous/Single**.

Sweep Time

Controls the time the instrument takes to sweep the current frequency span in swept measurements, displays the sweep time in swept measurements, and displays the equivalent Sweep Time in FFT measurements.

When **Sweep Time** is in Auto, the instrument computes a time that will give accurate measurements based on other settings, such as RBW and VBW.

You can select a shorter sweep time to improve the measurement throughput (with some potential unspecified accuracy reduction), but the **Meas Uncal** indicator will appear if the sweep time you set is less than the calculated Auto Sweep time.

You can also select a longer sweep time, which can be useful (for example) for obtaining accurate insertion loss measurements on very narrowband filters.

NOTE

Significantly faster sweep times are available with Option FS1.

NOTE

The **Meas Uncal** (measurement uncalibrated) warning is displayed in the Status Bar at the bottom of the screen when the manual Sweep time entered is faster than the time computed by the instrument's Sweep time equations, that is, the Auto Sweep Time. The instrument's computed Sweep time will provide accurate measurements; if you sweep faster than this your measurements may be inaccurate. A **Meas Uncal** condition may be corrected by returning the Sweep Time to Auto; by entering a longer Sweep Time; or by choosing a wider RBW

and/or VBW.

NOTE	On non-sweeping hardware, this control is grayed-out. The value shown on this control is an estimate. It is the measurement's turnaround time, which is the sum of signal acquisition time, FFT time, and other overhead time, to complete the entire span of the measurement. If you need to specify the same "Sweep Time" as you would for sweeping hardware, send <code>[:SENSe] :<meas> :SWEEp:TIME <time></code> . The measurement emulates the "Sweep Time" effect, but this emulation is not straightforward, and therefore the behavior is not specified. Instead, we recommend using Minimum Acquisition Time, which provides better control.
Remote Command	<code>[:SENSe] :<meas> :SWEEp:TIME <time></code> <code>[:SENSe] :<meas> :SWEEp:TIME?</code>
Example	Channel Power measurement: <code>:CHP:SWE:TIME 25ms</code> <code>:CHP:SWE:TIME?</code>
Notes	In the ACP measurement in WCDMA Mode, this parameter is preset by Meas Method selection. Preset values are as follows: <ul style="list-style-type: none"> - IBW: 29 ms - IBWR: 108 ms - FAST 7.5 ms
Dependencies	On non-sweeping hardware, this control is grayed out, and the Auto/Man toggle disappears. The read-only control shows estimated sweep time In those instruments, " Minimum Acquisition Time " on page 1357 is available
Couplings	Coupled to Span , RBW , VBW , and Sweep Time Rules when Sweep Time is set to Auto; Sweep Time changes when these parameters are changed When you manually set a value when in the Auto state, the state automatically changes to Man
Preset	Automatically Calculated unless noted below WCDMA Mode <ul style="list-style-type: none"> - Channel Power: 1.0 msOBW: 32.6 ms - ACP: 29 ms
State Saved	Saved in instrument state
Min	Other than non-sweeping hardware: Typically, 1 ms Non-sweeping hardware: N/A In the ACP measurement, when Meas Method is Fast Power , the minimum sweep time is span-dependent and automatically calculated
Max	Other than non-sweeping hardware: 4000 s

3 VMA Mode
3.6 Occupied BW Measurement

	Non-sweeping hardware: N/A
Annotation	The sweep time is displayed in the lower-right corner of the screen. The number of points is displayed parenthetically, as: Sweep 13.3 ms (1001 points) A “#” mark appears before “Sweep” in the annotation when it is switched from Auto to Manual coupling
Status Bits/OPC dependencies	Meas Uncal is Bit 0 in the register: <code>STATus:QUEStionable:INTEgrity:UNCalibrated</code>
	Auto Function
Remote Command	<code>[:SENSe]:<meas>:SWEep:TIME:AUTO OFF ON 0 1</code> <code>[:SENSe]:<meas>:SWEep:TIME:AUTO?</code>
Example	Channel Power measurement: <code>:CHP:SWE:TIME:AUTO OFF</code> <code>:CHP:SWE:TIME:AUTO?</code>
Preset	WCDMA Mode <code>OFF</code> All others <code>ON</code>

Minimum Acquisition Time

Available on non-sweeping hardware.

Specifies the minimum acquisition time for each “chunk” of the measurement result. The instrument automatically divides Span into multiple chunks if needed. Therefore, the total signal acquisition time for the entire Span is:

$\sim(\sim\text{Minimum Acquisition Time}) * (\text{The number of chunks})$

When in Auto, this parameter’s value is determined by other parameters, such as **Span**, **RBW** and **VBW**.

You can manually increase this parameter value from this Auto value.

If increased, the instrument acquires signal for the specified time duration for each chunk. It performs additional FFTs, and averages or peak-holds the FFT results for a chunk, depending on **Detector** settings.

Note that the actual acquisition time for each chunk may exceed the **Minimum Acquisition Time** value, in order to satisfy FFT time required by other parameters, and to perform an integer number of FFTs.

Remote Command	<code>[:SENSe]:<meas>:SWEep:ACQuisition:TIME <time></code> <code>[:SENSe]:<meas>:SWEep:ACQuisition:TIME?</code>
----------------	--

	<code><meas></code> is the identifier for the current measurement; any one of CHPower- ACPower OBWidth MONitor
Example	Channel Power measurement <code>:CHP:SWE:ACQ:TIME 500 ms</code> <code>:CHP:SWE:ACQ:TIME?</code>
Dependencies	Available only on non-sweeping hardware
Couplings	Coupled to Span , RBW , and VBW when in the Auto state When you manually set a value when in the Auto state, the state automatically changes to Man
Preset	Automatically calculated
State Saved	Saved in instrument state
Min	100 ns
Max	4.00 ks

Auto Function

Remote Command	<code>[:SENSe]:<meas>:SWEep:ACQquisition:TIME:AUTO OFF ON 0 1</code> <code>[:SENSe]:<meas>:SWEep:ACQquisition:TIME:AUTO?</code> <code><meas></code> is the identifier for the current measurement; any one of CHPower- ACPower OBWidth MONitor
Example	Channel Power measurement: <code>:CHP:SWE:ACQ:TIME:AUTO OFF</code>
Preset	ON

Sweep/Measure

Lets you toggle between **Continuous** and **Single** sweep or measurement operation. The single/continuous state is Meas Global, so the setting affects all measurements.

The front-panel key **Single/Cont** performs exactly the same function

See "[More Information](#)" on page 1033

Remote Command	<code>:INITiate:CONTinuous OFF ON 0 1</code> <code>:INITiate:CONTinuous?</code>
Example	Put instrument into Single measurement operation: <code>:INIT:CONT 0</code> <code>:INIT:CONT OFF</code> Put instrument into Continuous measurement operation: <code>:INIT:CONT 1</code> <code>:INIT:CONT ON</code>
Preset	ON

Note that **:SYST:PRES** sets **:INIT:CONT** to **ON**, but ***RST** sets **:INIT:CONT** to **OFF**

State Saved	Saved in instrument state
Annunciation	The Single/Continuous icon in the Meas Bar changes depending on the setting: <ul style="list-style-type: none"> - A line with an arrow is Single - A loop with an arrow is Continuous
Backwards Compatibility Notes	X-Series A-models had Single and Cont hardkeys in place of the SweepSingleCont softkey. In the X-Series A-models, if in single measurement, the Cont hardkey (and INIT:CONT ON) switched to continuous measurement, but never restarted a measurement and never reset a sweep X-Series B-models have a Cont/Single toggle control instead of Single and Cont hardkeys, but it is still true that, if in single measurement, the Cont/Single toggle control never restarts a measurement and never resets a sweep

More Information

Continuous Mode	<p>The instrument takes repetitive sweeps, averages, measurements, etc., when in continuous mode. If in average or Max/Min Hold, and the average/hold count reaches the Average/Hold Num, the count stops incrementing, but the instrument keeps sweeping</p> <p>See the Trace key description under Trace Average for the averaging formula used both before and after the Average/Hold Num is reached. The trigger condition must be met prior to each sweep</p> <p>The type of trace processing for multiple sweeps is set under the Trace key, with choices of Trace Average, Max Hold, or Min Hold</p>
Single Mode	<p>The instrument takes a single sweep when in Single mode, or if in average or Max/Min Hold, or if there is a Waterfall window displayed, it takes multiple sweeps until the average/hold count reaches the Average/Hold Num, then the count stops incrementing, and the instrument stops sweeping</p> <p>See the Trace key description under Trace Average for the averaging formula used. The trigger condition must be met prior to the sweep</p> <p>The type of trace processing for multiple sweeps is set under the Trace key, with choices of Trace Average, Max Hold, or Min Hold</p>

If the instrument is in **Single** measurement mode, pressing the **Cont/Single** toggle control does not zero the count and does not cause the sweep to be reset; the only action is to put the instrument into Continuous measurement operation.

If the instrument is already in **Continuous** sweep:

- **:INIT:CONT 1** has no effect
- **:INIT:CONT 0** places the instrument in Single Sweep but has no effect on the current sequence until $k = N$, at which point the current sequence will stop and the instrument will go to the idle state

See "**Restart**" on page 1832 for details of **:INIT:IMMEDIATE**.

If the instrument is already in **Single** sweep, **:INIT:CONT OFF** has no effect.

If the instrument is already in **Single** sweep, then pressing **Cont/Single** in the middle of a sweep does not restart the sweep or sequence. Similarly, pressing **Cont/Single** does not restart the sweep or sequence if the sweep is not in the idle state (for example, if you are taking a very slow sweep, or the instrument is waiting for a trigger). Even though pressing **Cont/Single** in the middle of a sweep does not restart the sweep, sending **:INIT:IMM** does reset it.

If the instrument is in **Single** sweep, and *not* Averaging/Holding, and you want to take one more sweep, press **Restart**.

If the instrument is in **Single** sweep, *and* Averaging/Holding, and you want to take one more sweep without resetting the Average trace or count, go to **Meas Setup** and increment the average count by 1 by pressing the **Step-Up** key while **Average/Hold Num** is the active function. You can also do this by sending **:CALC:AVER:TCON UP**.

Restart

Restarts the current sweep, or measurement, or set of averaged/hold sweeps or measurements. If you are Paused, pressing **Restart** performs a Resume.

The front-panel key **Restart** performs exactly the same function.

The **Restart** function is accessed in several ways:

- Pressing the **Restart** key
- Sending **:INIT:IMM**
- Sending **:INIT:REST**

See "[More Information](#)" on page 1035

Remote Command	:INITiate[:IMMediate] :INITiate:REStart
Example	:INIT:IMM :INIT:REST
Notes	:INIT:REST and :INIT:IMM perform exactly the same function
Couplings	Resets average/hold count k. For the first sweep overwrites all active (update = on) traces with new current data. For application modes, it resets other parameters as required by the measurement
Status Bits/OPC dependencies	This is an Overlapped command The STATus:OPERation register bits 0 through 8 are cleared , <i>except</i> bit 6 (Waiting for Periodic Sync). Initiating a measurement and Waiting for Periodic Sync could be asynchronous The STATus:QUEStionable register bit 9 (INTegrity sum) is cleared

	The Sweeping bit is set
	The Measuring bit is set
Backwards Compatibility Notes	For Spectrum Analysis Mode in ESA and PSA, the Restart hardkey and the :INIT:REST command restarted trace averages (displayed average count reset to 1) for a trace in Clear Write , but did not restart Max Hold and Min Hold In X-Series, the Restart hardkey and the :INIT:REST command restart not only Trace Average , but MaxHold and MinHold traces as well

More Information

The **Restart** function first aborts the current sweep or measurement as quickly as possible. It then resets the sweep and trigger systems, sets up the measurement and initiates a new data measurement sequence with a new data acquisition (sweep) taken once the trigger condition is met.

If the instrument is in the process of aligning when a **Restart** is executed, the alignment finishes before the restart function is performed.

Even when set for **Single** operation, multiple sweeps may be taken when **Restart** is pressed (for example, when averaging/holding is on). Thus, when we say that **Restart** "restarts a measurement", depending on the current settings, we may mean that it:

- Restarts the current sweep
- Restarts the current measurement
- Restarts the current set of sweeps if any trace is in Trace Average, Max Hold or Min Hold
- Restarts the current set of measurements if Averaging, or Max Hold, or Min Hold is on for the measurement

If there is no Average or Max/Min Hold function (no trace in Trace Average or Hold, or **Average/Hold Num** set to 1), and no **Waterfall** window is being displayed, a single sweep is equivalent to a single measurement. A single sweep is taken after the trigger condition is met; and the instrument stops sweeping once that sweep has completed. However, with **Average/Hold Num** >1, and at least one trace set to Trace Average, Max Hold, or Min Hold, or a **Waterfall** window being displayed, multiple sweeps/data acquisitions are taken for a single measurement. The trigger condition must be met prior to each sweep. The sweep is stopped when the average count k equals the number N set for **Average/Hold Num**.

Once the full set of sweeps has been taken, the instrument goes to the idle state. To take one more sweep without resetting the average count, increment the average count by 1, by pressing the **Step-Up** key while **Average/Hold Number** is the active function, or by sending the remote command **:CALC:AVER:TCON UP**.

Trace Update

The numeric results are not blanked at any time during the restart cycle.

For slow sweeps (see **Trace Update** section in **Trace/Detector**), the traces are updated real-time during the sweep. There may be a special circumstance in application mode measurements where an exception is made and the traces and/or results need to be blanked before displaying the new results.

To summarize, the following list shows what happens to the trace data on various events:

Event	Trace Effect
Clear/Write pressed (even if already in Clear/Write)	Set to mintracevalue
Max Hold pressed (even if already in Max Hold)	Set to mintracevalue
Min Hold pressed (even if already in Min Hold)	Set to maxtracevalue
Trace Average pressed (even if already in Trace Average)	Trace data unaffected but start new sweep/avg/hold
Restart pressed	Trace data unaffected but start new sweep/avg/hold
Parameter requiring restart changed (e.g., RBW)	Trace data unaffected but start new sweep/avg/hold

Sweep and Trigger Reset

Resetting the sweep system resets the average/hold count k to 0. It also resets the set point counter to 0. Resetting the trigger system resets the internal auto trig timer to the value set by the **Auto Trig** control.

Averaging

The weighting factor used for averaging is k . This k is also the average/hold count for how many valid sweeps (data acquisitions) have been done. This k is used for comparisons with N , as those comparisons always needs to be based on valid completed sweeps.

The displayed average/hold, K , shows the count for the sweep (data acquisition) in progress. $K = k + 1$, with a limit of N . The displayed value K changes from its previous value to 1 as soon as the trigger condition for the first data acquisition (sweep) is met.

Pause/Resume

Pauses a measurement after the current data acquisition is complete.

When paused, the label on the control changes to **Resume**. Pressing **Resume** un-pauses the measurement. When paused, pressing **Restart** performs a Resume.

Remote Command	<code>:INITiate:PAUSE</code> <code>:INITiate:RESume</code>
Example	<code>:INIT:PAUS</code> <code>:INIT:RES</code>
Dependencies	Not displayed in Modes that do not support pausing
Annotation	Only on control

Abort (Remote Command Only)

Stops the current measurement. Aborts the current measurement as quickly as possible, resets the sweep and trigger systems, and puts the measurement into an "idle" state. If the instrument is in the process of aligning when `:ABORt` is sent, the alignment finishes *before* the abort function is performed, so `:ABORt` does not abort an alignment.

If the instrument is set for **Continuous** measurement, it sets up the measurement and initiates a new data measurement sequence with a new data acquisition (sweep) taken once the trigger condition is met.

If the instrument is set for **Single** measurement, it remains in the "idle" state until an `:INIT:IMM` command is received.

Remote Command	<code>:ABORt</code>
Example	<code>:ABOR</code>
Notes	If <code>:INIT:CONT</code> is ON , then a new continuous measurement will start immediately, with sweep (data acquisition) occurring once the trigger condition has been met If <code>:INIT:CONT</code> is OFF , then <code>:INIT:IMM</code> is used to start a single measurement, with sweep (data acquisition) occurring once the trigger condition has been met
Dependencies	For continuous measurement, <code>:ABORt</code> is equivalent to the Restart key Not all measurements support this command
Status Bits/OPC dependencies	The <code>STATus:OPERation</code> register bits 0 through 8 are cleared, <i>except</i> bit 6 (Waiting for Periodic Sync). Initiating a measurement and Waiting for Periodic Sync could be asynchronous The <code>STATus:QUEStionable</code> register bit 9 (INTEGRity sum) is cleared Since all the bits that feed into OPC are cleared by <code>:ABORt</code> , the Abort command will cause the <code>*OPC</code> query to return true

Sweep Time Annotation (Remote Query Only)

Returns the **Sweep Time Annotation** value. Available only on non-sweeping hardware.

This value is also displayed in the result trace window.

The value returned is the estimated turnaround time of each measurement cycle, in seconds. The turnaround time is the sum of the signal acquisition time, FFT time, and other overhead time, to complete the entire span of each measurement cycle.

Remote Command	<code>[:SENSe] : <meas> : SWEep : ETIME?</code> <code><meas></code> is the identifier for the current measurement; any one of <code>CHPower-</code> <code> ACPower OBWidth MONitor</code>
Example	Channel Power measurement <code>:CHP:SWE:ETIME?</code>
Dependencies	Available only on non-sweeping hardware
Preset	Automatically calculated

3.6.9.2 Sweep Config

Accesses controls that let you configure the sweep and control functions of the instrument, such as "[Sweep Time Rules](#)" on page 1038.

Sweep Time Rules

Switches the instrument between normal and accuracy sweep states:

Accy	<code>ACCuracy</code>
Norm	<code>NORMal</code>

Setting **Auto Sweep Time** to **Accy** results in slower sweep times, usually about three times as long, but yields better amplitude accuracy for CW signals. The instrument amplitude accuracy specifications only apply when **Auto Sweep Time** is set to **Accy**.

Additional amplitude errors which occur when **Auto Sweep Time** is set to **Norm** are usually well under 0.1 dB, though this is not guaranteed. Because of the faster sweep times and still low errors, **Norm** is the preferred setting of **Auto Sweep Time**. **Auto Sweep Time** is set to **Norm** on a **Preset**. This means that in the Preset state, instrument amplitude accuracy specifications do not apply.

Remote Command	<code>[:SENSe] : OBWidth : SWEep : TIME : AUTO : RULEs NORMal ACCuracy</code> <code>[:SENSe] : OBWidth : SWEep : TIME : AUTO : RULEs?</code>
Example	<code>:OBW:SWE:TIME:AUTO:RUL NORM</code>

3 VMA Mode
3.6 Occupied BW Measurement

	<code>:OBW:SWE:TIME:AUTO:RUL?</code>
Dependencies	Does not appear in Spectrum Analyzer Mode in VXT model M9420A
Preset	<code>NORMa1</code>
State Saved	Saved in instrument state
Range	<code>NORMa1 ACCuracy</code>

Points

Sets the number of points taken per sweep, and displayed in the traces. The current value of points is displayed parenthetically, next to the sweep time in the lower-right corner of the display. Using more points provides greater resolution. Using fewer points compacts the data and decreases the time required to access a trace over the remote interface.

Increasing the number of points does not increase the sweep time. However, it can slightly impact the trace processing time and therefore the overall measurement speed. Decreasing the number of points does not decrease the sweep time, but it may speed up the measurement, depending on the other sweep settings (for example, in FFT sweeps). Fewer points will always speed up the I/O.

Due to minimum sweep rate limitations of the hardware, the minimum sweep time available to the user will increase above its normal value of 1 ms as the number of sweep points increases above 15001.

Changing the number of sweep points has several effects on the instrument. Since markers are read at the point location, the marker reading may change. The sweep time resolution will change. Trace data for all the traces will be cleared and, if **Sweep** is in **Cont**, a new trace taken. If any trace is in average or hold, the averaging starts over.

Due to sweep time quantization issues, the knob and up/down keys *cannot* be used to adjust the number of points.

When in a split-screen display, each window may have its own value for points.

When sweep **Points** is changed, an informational message "Sweep points changed, all traces cleared" is displayed, and in 5G NR Mode, **Auto Sweep Points** is set to **OFF** (0).

Remote Command	<code>[:SENSe] :OBWidth :SWEep :POINts <integer></code> <code>[:SENSe] :OBWidth :SWEep :POINts ?</code>
Example	<code>:OBW:SWE:POIN 501</code> <code>:OBW:SWE:POIN?</code>
Dependencies	Not available when Signal ID is set to On in External Mixing Neither the knob nor the step keys can be used to change this value. If it is tried, a warning is given

	Not displayed in Modes that do not support Swept								
Couplings	Whenever the number of sweep points change: <ul style="list-style-type: none"> - All trace data is erased - Any traces with Update Off will also go to Display Off - Sweep time is re-quantized - Any limit lines that are on will be updated - If averaging/hold is on, averaging/hold starts over - Auto Sweep Points is set to OFF (5G NR Mode only) <p>The resolution of setting the sweep time depends on the number of points selected</p>								
Preset	<table border="1"> <thead> <tr> <th>Mode</th> <th>Value</th> </tr> </thead> <tbody> <tr> <td>MSR, LTEAFDD, LTEATDD</td> <td>2001</td> </tr> <tr> <td>5GNR</td> <td>Automatically calculated</td> </tr> <tr> <td>All Others</td> <td>1001</td> </tr> </tbody> </table>	Mode	Value	MSR, LTEAFDD, LTEATDD	2001	5GNR	Automatically calculated	All Others	1001
Mode	Value								
MSR, LTEAFDD, LTEATDD	2001								
5GNR	Automatically calculated								
All Others	1001								
State Saved	Saved in instrument state								
Min	101								
Max	20001								
Annotation	On second line of annotations, in lower right corner in parenthesis behind the sweep annotation								

IF Dithering

Lets you turn IF Dithering on or off. This is a technique used in unpreselected instruments (such as Keysight's modular instruments) to enhance the rejection of images and internally-generated spurious signals.

Remote Command	<code>[:SENSe] :SWEep:IF:DITHer OFF ON 0 1</code> <code>[:SENSe] :SWEep:IF:DITHer?</code>
Dependencies	Only appears in Spectrum Analyzer Mode in VXT models
Preset	OFF
State Saved	Saved in instrument state

Image Protection

Lets you turn IF Protection on or off. This is a technique used in unpreselected instruments (such as Keysight's modular instruments) to detect and suppress images and spurs that may be present in non-preselected hardware.

3 VMA Mode
 3.6 Occupied BW Measurement

IF Protection takes two sweeps and by correlating the data between them, provides a single, correct power-versus-frequency trace.

Remote Command	<code>[:SENSe]:SWEep:IMAGeprot OFF ON 0 1</code> <code>[:SENSe]:SWEep:IMAGeprot?</code>
Dependencies	Only appears in Spectrum Analyzer Mode in VXT models
Preset	ON
State Saved	Saved in instrument state

3.6.10 Trace

Lets you control the acquisition, display, storage, detection and manipulation of trace data for the available traces.

The "Trace Control" on page 1736 tab of this menu contains radio-button selections for the trace type (**Clear/Write**, **Trace Average**, **Max Hold**, **Min Hold**) and **View/Blank** setting for the selected trace.

A trace is a series of data points, each having an x and a y value. The x value is frequency (or time, in zero span) and the y value is amplitude. Each data point is referred to as a *trace point*. In any given trace, trace point 0 is the first point, and trace point (*sweep_points - 1*) is the last. For example, in a 1001 point trace, the first point is 0 and the last is 1000. Another term sometimes used to describe traces is *bucket*. A bucket is the frequency span of a trace point, equal to the point spacing. For swept analysis, the y value in each bucket is measured while the instrument is sweeping across the bucket. The selected detector determines how it is measured.

When in **Single** Mode, Measurements and their Views save the trace data from the last acquisition. This is true on multiple screens. The marker and trace data will be present whenever the measurement is brought back into focus. The measurement switches for these measurements do not clear the traces, so the data will be present until the next acquisition is completed.

Invalid Data Indicator

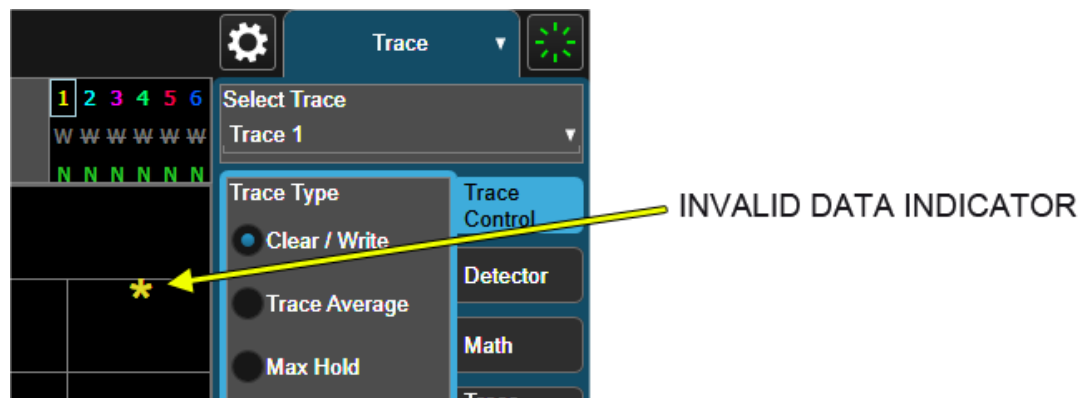

The Invalid Data Indicator is displayed whenever the data on the display does not match the settings of the instrument. The most common example of this is when instrument settings have changed in the time since the data in the traces on the display was taken. This means that the screen annotation cannot be guaranteed to match the trace data. For example, if you change **Center Frequency**, the Invalid Data Indicator will display until the trace has been retaken.

If any Trace is in View mode (displaying but not updating) and instrument settings are changed, the Invalid Data Indicator will display as long as that trace remains in View. Traces that are blanked do not turn on the Invalid Data Indicator.

Not all instrument settings require display of the invalid data indicator when they change; only changes that require a new acquisition will cause it to display. For example, changing the Y-Axis scale of the instrument does not cause the invalid data indicator to display, unless the attenuation changes.

The Invalid Data Indicator is also turned on:

- When the counter is turned on, until the completion of the first count
- When a trace is imported from mass storage and the trace's parameters do not match the current instrument settings
- When a trace is sent to the instrument from a remote interface (since there is no way to know if its settings match)

NOTE

The Invalid Data Indicator has an associated status bit that can be checked at any time to determine whether the indicator is on.

Trace right-click menu

If you right-click on a trace (or touch and hold a trace and wait for the circle to close) you will see the Trace Right-Click Menu:

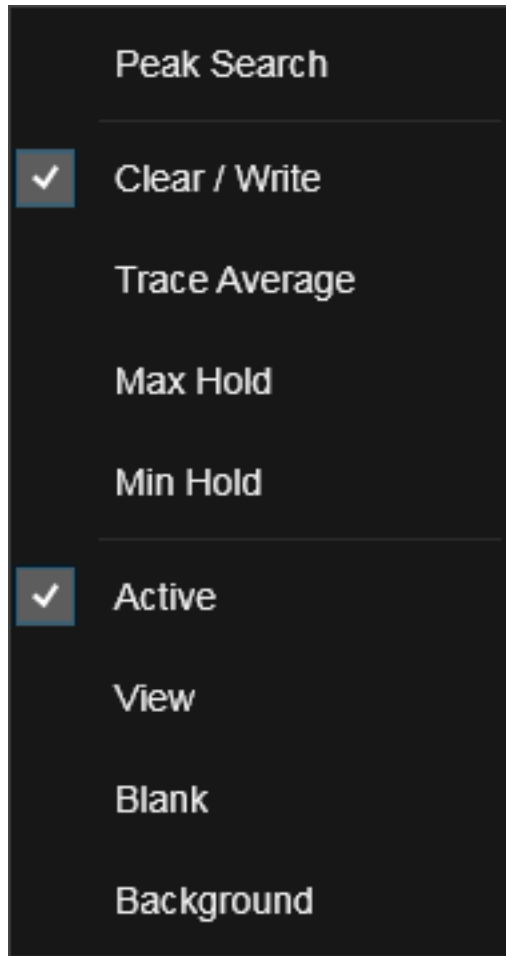

If you now tap or click on one of the items in this menu, the instrument will perform the corresponding function. **Peak Search** finds the highest peak on the selected Trace. **Clear/Write**, **Trace Average**, **Max Hold** and **Min Hold** set the "Trace Type" on [page 1737](#). **Active**, **View**, **Blank**, and **Background** set the "View/Blank" on [page 1742](#) type.

Waterfall Window

If you right-click on the trace (or touch and hold the trace and wait for the circle to close) in the **Waterfall** window (for example, in the Spectrogram View) you will see the Waterfall Trace Right-Click Menu:

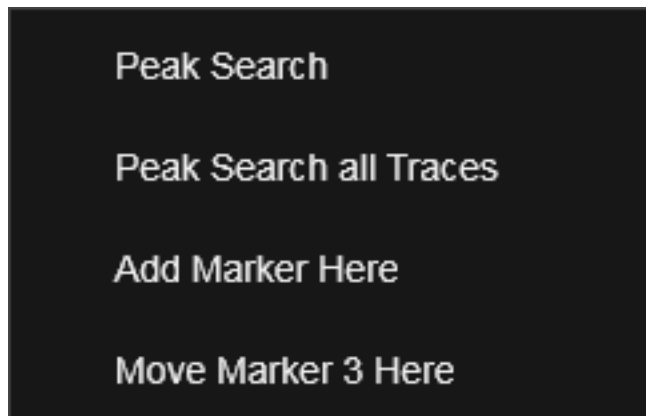

In this menu, **Peak Search** works as above. **Peak Search all Traces** finds the highest peak in the Waterfall window. **Add Marker Here** takes the lowest numbered Marker that is currently Off and turns it On as a **Normal** marker in the Waterfall window at the point where you right-clicked (or touched-and-held). **Move Marker n Here** moves the currently selected Marker to the point in the Waterfall window where you right-clicked (or touched-and-held).

Trace Update Indicator

Trace updates can take one of two forms:

1. The trace is updated in a single operation that affects all of the points in the trace at once. This happens, for example, in the case of very fast (< 200 ms) sweeps, single-chunk FFT's, and the initial math operation after a math function is set for a trace
2. The trace is updated in a series of discrete steps, with measurement data being gathered between each step. This will be the case for slow sweeps, multi-chunk FFTs, gated sweeps, etc.

In the first case, no update indicator is required. In the second case, however, a visual indicator exists on the trace where the new data is being written. The indicator is a green caret (^), which moves across the bottom of the graticule showing the current trace point.

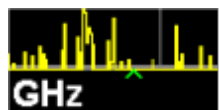

Trace Annunciator Panel

This panel appears on the right hand side of the Meas Bar. Here is an explanation of the fields in this panel, as shown below:

3 VMA Mode

3.6 Occupied BW Measurement

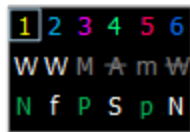

Top Line

On the top line, each trace number is shown, in the trace color. A box is drawn around the currently selected trace.

Middle Line

Below each trace number, is a letter signifying the trace type for that trace number, where

W	Clear/Write
A	Trace Average
M	Max Hold
m	Min Hold

If the letter is white, it means the trace is being updated (**Update = ON**); if the letter is dimmed, it means the trace is not being updated (**Update = OFF**). A strikethrough indicates that the trace is blanked (**Display = OFF**). Note that it is possible for a trace to be updating *and* blanked, which is useful if the trace is a trace math component.

Bottom Line

The third line shows the detector type for each trace, or, if trace math is on for that trace, it shows “f” (for “math function”). It is not always possible to have a unique detector for each trace, but the instrument hardware provides the maximum flexibility of detector selection in order to maintain the highest accuracy. The letters used for this readout are

N	Normal
A	Average
P	peak
p	negative peak
S	Sample
Q	Quasi Peak
E	EMI Average
R	RMS Average
f	math function

If the letter is green, the detector is in Auto. If white, the detector has been manually selected.

In the example above, the panel is indicating the following:

- Trace 1: Visible, being updated, in Clear/Write, with Normal detector auto selected
- Trace 2: Visible, being updated, in Clear/Write, being written to with a math function
- Trace 3: Visible, not updating, data was taken in Max Hold, with the peak detector auto selected
- Trace 4: Blanked, not updating, data was taken with Averaging turned on, Sample detector manually selected
- Trace 5: Visible, not updating, data was taken in Min Hold with Negative Peak detector auto selected
- Trace 6: Blanked, not updating, in Clear/Write, with Normal detector manually selected

Trace Annotation

When **Trace Annotation** (see **Display**) is **ON**, each non-blanked trace is labeled on the trace with the detector used to take it, unless a Trace Math function is on for that trace, in which case it is labeled with the **"Math Function"** on page 1745.

The detector labels are:

NORM	Normal
PEAK	Peak
SAMP	Sample
NPEAK	Negative Peak
RMS	Average detector with Power Average (RMS)
LG AVG	Average detector with Log-Pwr Average
VAVG	Average detector with Voltage Average
QPEAK	Quasi Peak
EMI AVG	EMI Average
RMS AVG	RMS Average

The trace math labels are:

PDIF	Power Difference
PSUM	Power Sum
LOFF	Log Offset
LDIF	Log Difference

3.6.10.1 Select Trace

Specifies the *selected trace*, which is the trace that will be affected when you change trace settings.

Select Trace appears above the menu panel, indicating that it applies to *all* controls in the menu panel. **Select Trace** is blanked if you select a tab whose controls do *not* depend on the selected trace (for example, **Trace Function**).

Notes	The selected trace is remembered even when not in the Trace menu
Dependencies	For the Swept SA measurement: <ul style="list-style-type: none">- In Image Suppress mode, when you select a trace it becomes the active trace, and the formerly active trace goes into View- When you turn on Image Suppress, Update turns off for all traces except the selected trace For the ACP measurement, when Meas Method is RBW , FAST or FPOwer , Select Trace is disabled
Preset	Trace 1
State Saved	Yes

3.6.10.2 Trace Control

The controls on this tab allow you to set the "**Trace Type**" on page 1737 and its update mode.

There are four Trace Types:

- **Clear/Write**
- **Trace Average**
- **Max Hold**
- **Min Hold**

Each type handles data in a different way.

Each trace also has two values that determine whether it is being written or not, and whether it is being displayed or not. These values, **Update** and **Display**, are described fully in the "**View/Blank**" on page 1742 control description. Essentially, when **Update** is **ON**, a trace is updating, and when **Update** is **OFF** it is not. When **Display** is **ON**, it is visible and when **Display** is **OFF** it is not. These terms are used throughout the descriptions in this section.

Trace Type

There are four trace Types:

Option	Parameter	SCPI Example	Details
Clear/Write	WRITe	:TRAC2:TYPE WRIT	See: "Clear/Write" on page 1051
Trace Average	AVERAge	:TRAC2:TYPE AVER	See: "Trace Average" on page 1051
Maximum Hold	MAXHold	:TRAC3:TYPE MAXH	See: "Max Hold" on page 1052
Minimum Hold	MINHold	:TRAC5:TYPE MINH	See: "Min Hold" on page 1052

Full descriptions of each type are provided below. You may select one of these types for each trace. Re-selecting the current **Trace Type** initiates the same action that selecting it the first time did, even though it is already selected. For example, selecting **Clear/Write** while **Clear/Write** is already selected will nonetheless clear the trace and begin rewriting it.

Besides the **Trace Type**, the "**View/Blank**" on page 1742 state must be set to **Active** (**Update: ON**, **Display: ON**) for a trace to be updating and visible. Selecting any **Trace Type** automatically makes the trace **Active**.

See also: "**Trace Mode Backwards Compatibility Commands**" on page 1049

Remote Command	<p>For Swept SA Measurement (in SA Mode):</p> <pre>:TRACe[1] 2 ... 6:TYPE WRITe AVERAge MAXHold MINHold</pre> <pre>:TRACe[1] 2 ... 6:TYPE?</pre> <p>For all other measurements:</p> <pre>:TRACe[1] 2 3:<meas>:TYPE WRITe AVERAge MAXHold MINHold</pre> <pre>:TRACe[1] 2 3:<meas>:TYPE?</pre> <p>where <meas> is the identifier for the current measurement</p>
Example	<pre>:TRAC:TYPE WRIT</pre> <pre>:TRAC:TYPE?</pre>
Couplings	<p>Selecting a Trace Type (by pressing any of the Trace Type selections or sending <code>:TRAC:TYPE</code>) sets the Trace to Active (Update: ON, Display: OFF), even if the same trace type was already selected</p> <p>When Detector setting is "Auto" (<code>[:SENSe]: <meas>:DETector:AUTO?</code>), Detector (<code>[:SENSe]: <meas>:DETector[:FUNCTion]?</code>) switches aligning with the switch of this parameter: "NORMAL" with WRITe (Clear Write), "AVERAge" with AVERAge, "POSitive (peak)" with MAXHold, and "NEGative (peak)" with MINHold</p>
Preset	<p>Swept SA and Monitor Spectrum: WRITe</p> <p>All other measurements: AVERAge</p> <p>Following Preset, all traces are cleared (all trace points set to mintracevalue)</p>
State Saved	The type of each trace is saved in instrument state
Annunciation	The type for each trace is indicated in the Trace annunciator panel on the Measurement Bar

Trace Mode Backwards Compatibility Commands

In earlier instruments, the “Trace Modes” were: Clear/Write, Max Hold, Min Hold, View and Blank. Averaging was global to all traces and was controlled under the **BW/Avg** menu.

In X-Series, trace averaging can be done on a per-trace basis. The Trace Modes (now called Trace Types) are Clear/Write, Trace Average, Max Hold and Min Hold. View and Blank are set separately under "[View/Blank](#)" on page 1742.

While this provides more flexibility, it also gives rise to potential backwards compatibility problems. To mitigate these, the old Trace Mode command has been retained and a new Trace Type command has been added. The `:TRACe:MODE` command is retained for backwards compatibility, and the `:TRACe:TYPE`, `:TRACe:UPDate` and `:TRACe:DISPlay` commands introduced for ongoing use. The old Trace Modes are selected using `:TRAC:MODE`, whose parameters are mapped into calls to `:TRACe:TYPE`, `:TRACe:UPDate` and `:TRACe:DISPlay`, and the old global Averaging command `[:SENSe]:AVERage[:STATe]` is provided for backwards compatibility. See the individual command descriptions for details.

When **Average/Hold** in the **Meas Setup, Legacy Compatibility** menu is **ON**, the following is true for traces in Max Hold and Min Hold:

- They ignore the **Average/Hold** number; **Single** for Max Hold causes one sweep only, so switching to **Single** stops after the current sweep, and switching to **Cont** starts again without clearing the accumulated result
- Max Hold is not cleared on a **Restart**, **Single** or `:INIT:IMM`, but changing a measurement parameter, like frequency or bandwidth etc., still restarts the Max Hold

Preset	<code>WRITE</code>
State Saved	The trace mode is an alias only
Backwards Compatibility SCPI	<code>:TRACe[1] 2 ... 6:MODE WRITE MAXHold MINHold VIEW BLANK</code> <code>:TRACe[1] 2 ... 6:MODE?</code>
Backwards Compatibility Notes	<p>The legacy <code>:TRACe:MODE</code> command is retained for backwards compatibility. In conjunction with the legacy <code>:AVERage</code> command, it works as follows:</p> <ul style="list-style-type: none"> – <code>:AVERage ON OFF</code> sets/clears a variable that we will call average for the sake of this discussion. This variable is maintained by the instrument solely for backwards compatibility. See the <code>[:SENSe]:AVERage[:STATe]</code> command description below – <code>:TRACe:MODE WRITE</code> sets <code>:TRACe:TYPE WRITE</code> (Clear/Write) unless average is true, in which case it sets it to <code>:TRACe:TYPE AVERage</code>. It also sets <code>:TRACe:UPDate ON</code>, <code>:TRACe:DISPlay ON</code>, for the selected trace – <code>:TRACe:MODE MAXHold</code> sets <code>:TRACe:TYPE MAXHold</code> (Max Hold). It also sets <code>:TRACe:UPDate ON</code>, <code>:TRACe:DISPlay ON</code>, for the selected trace

- `:TRACe:MODE MINHold` sets `:TRACe:TYPE MINHold` (Min Hold). It also sets `:TRACe:UPDate ON`, `:TRACe:DISPlay ON`, for the selected trace
- `:TRACe:MODE VIEW` sets `:TRACe:UPDate OFF`, `:TRACe:DISPlay ON`, for the selected trace
- `:TRACe:MODE BLANK` sets `:TRACe:UPDate OFF`, `:TRACe:DISPlay OFF`, for the selected trace

The query returns the same value as `:TRACe:TYPE?`, meaning that if you set `:TRACe:MODE:VIEW` or `:TRACe:MODE:BLANK`, the query response will not be what you sent

`:TRACe[n]:MODE` was formerly used to set the type or “writing mode” of the trace. At that time, View and Blank were writing modes. The new `:TRACe:TYPE` command should be used in the future, but `:TRACe:MODE` is retained to provide backwards compatibility

In X-Series, unlike earlier instruments, Max Hold and Min Hold now obey the Average Number and counts up to a terminal value as Average always has

As the **Average/Hold Number** now affects **Min Hold** and **Max Hold**, the operations that restart Averaging (for example, the **Restart** key) now also restart **Min Hold** and **Max Hold**

As a result of these changes, legacy code that restarts averaging while retaining a running Max Hold will need to be rewritten, because the Max Hold will now restart when the Average does

Also, previous to X-Series:

- Pressing **Max Hold** while already in **Max Hold** (or doing so remotely) had no effect. Now it will clear the trace and restart the sweep and the Max Hold sequence
- Changing the vertical scale (Log/Lin or dB/div) of the display restarted **Max Hold** and **Min Hold**. This is no longer the case

Preset	<code>OFF</code>
State Saved	The state of Average is saved in Instrument State for ghosting purposes
Backwards Compatibility SCPI	<code>[:SENSe]:AVERage[:STATe] ON OFF 1 0</code> <code>[:SENSe]:AVERage[:STATe]?</code>
Backwards Compatibility Notes	<p>Previous to X-Series, Averaging (also sometimes known as trace averaging) was global to all traces, that is, it was either on or off for all active traces. The legacy command <code>[:SENSe]:AVERage[:STATe] ON OFF 1 0</code> was used to turn Averaging on or off</p> <p>In X-Series, Averaging is turned on or off on a per-trace basis, so it can be on for one trace and off for another</p> <p>For backwards compatibility, the old global Average State variable is retained solely as a legacy variable, turned on and off and queried by the legacy command <code>[:SENSe]:AVERage[:STATe] OFF ON 0 1</code>. When Average is turned on, any trace in Clear/Write will get put into Average. While Average is on, any trace put into Clear/Write by the old <code>:TRAC:MODE</code> command will instead get put into Average. When Average is turned off, any trace in Average will get put into Clear/Write</p>

Trace Type Details

Clear/Write

Each trace update replaces the old data in the trace with new data.

Pressing **Clear/Write** for the selected trace, or sending `:TRAC:TYPE WRIT` for the specified trace, sets the trace type to **Clear/Write** and clears the trace, even if you are already in **Clear/Write**. Then a new sweep is initiated. Trigger conditions must be met before the sweep actually starts, and if in **Single** the sweep won't start until **Restart** is pressed.

Pressing **Clear/Write** stops the current sweep and initiates a new one, so **Trace Average**, **Max Hold** and **Min Hold** data may be interrupted in mid-sweep when **Clear/Write** is pressed, and therefore may not accurately reflect the displayed count. Therefore, when **Clear/Write** is pressed for one trace, **Trace Average**, **Max Hold** and **Min Hold** must restart for all traces.

When in **Clear/Write**, if a measurement-related instrument setting is changed (that is, one which requires new data to be taken, like **Center Frequency** or **Attenuation**), a new sweep is initiated but the trace is not cleared.

Trace Average

The instrument maintains and displays an average trace, which represents the cumulative average on a point-by-point basis of the new trace data and previous averaged trace data.

Pressing **Trace Average** (for the selected trace), or sending `:TRAC:TYPE AVER` (for the specified trace), sets the trace type to **Trace Average**, clears the trace, initiates a new sweep, and restarts the Average sequence.

Details of the count limiting behavior and the averaging calculations may be found under **Avg|Hold Number** and **Average Type** under **Meas Setup**.

When in **Trace Average**, if a measurement-related instrument setting is changed (that is, one which requires new data to be taken, like **Center Frequency** or **Attenuation**), the average restarts and a new sweep is initiated but the trace is not cleared.

Restarting the average means:

- The average/hold count k is set to 1, so that the next time the average trace is displayed it simply represents one trace of new data
- A new sweep is initiated

- Once the new sweep starts, the trace is overwritten with current trace data as the first trace of the new average

Remember that restarting averaging also restarts **Max Hold** and **Min Hold**, as there is only one count for Trace Average and Hold.

Max Hold

The instrument maintains and displays a max hold trace, which represents the maximum data value on a point-by-point basis of the new trace data and previous trace data. Details of the count limiting behavior may be found under **Avg|Hold Number** under **Meas Setup**.

Pressing **Max Hold** for the selected trace, or sending `:TRAC:TYPE MAXH` for the specified trace, sets the Trace Type to **Max Hold**, clears the trace, initiates a new sweep, and restarts the hold sequence, even if you are already in **Max Hold**.

When in **Max Hold**, if a measurement-related instrument setting is changed (that is, one which requires new data to be taken, like **Center Frequency** or **Attenuation**), the **Max Hold** sequence restarts and a new sweep is initiated but the trace is not cleared.

Restarting the **Max Hold** sequence means:

- The average/hold count k is set to 1, so that the next time the max hold trace is displayed it simply represents one trace of new data
- A new sweep is initiated.

Remember that restarting **Max Hold** also restarts averaging and **Min Hold**, as there is only one count for Trace Average and Hold.

Min Hold

The instrument maintains and displays a min hold trace, which represents the minimum data value on a point-by-point basis of the new trace data and previous trace data. Details of the count limiting behavior may be found under **Avg|Hold Number** under the **Meas Setup** functions.

Pressing **Min Hold** for the selected trace, or sending `:TRAC:TYPE MINH` for the specified trace, sets the Trace Type to **Min Hold**, clears the trace, initiates a new sweep, and restarts the hold sequence, even if you are already in **Min Hold**.

When in **Min Hold**, if a measurement-related instrument setting is changed (that is, one which requires new data to be taken, like **Center Frequency** or **Attenuation**), the **Min Hold** sequence restarts and a new sweep is initiated but the trace is not cleared.

Restarting the **Min Hold** sequence means:

3 VMA Mode
3.6 Occupied BW Measurement

- The average/hold count k is set to 1, so that the next time the min hold trace is displayed it simply represents one trace of new data
- A new sweep is initiated

Remember that restarting **Min Hold** also restarts **Max Hold** and averaging, because there is only one count for Trace Average and Hold.

Clear and Write | Restart Averaging | Restart Max/Min Hold

Starts the trace writing, as though the "Trace Type" on page 1737 had just been selected. The effect is exactly the same as reselecting the current **Trace Type** again

- the control is provided because it may not be obvious that reselecting the same selection from a radio button menu will take any action.

This control displays different labels, depending on the selected Trace Type:

- **Clear/Write**: Clear and Write
- **Trace Average**: Restart Averaging
- **Max Hold**: Restart Max Hold
- **Min Hold**: Restart Min Hold

View/Blank

Lets you set the state of the two trace variables: **Update** and **Display**. The choices available in this dropdown menu are:

Active	Update and Display both ON
View	Update OFF ; Display ON
Blank	Update OFF ; Display OFF
Background	Update ON , Display OFF Allows a trace to be blanked <i>and</i> continue to update "in the background", which was not possible in the past

In the Swept SA measurement, a trace with **DisplayOFF** is indicated by a strikethrough of the type letter in the trace annotation panel in the Measurement Bar. A trace with **UpdateOFF** is indicated by dimming the type letter in the trace annotation panel in the Measurement Bar. In the example below, Traces 3, 4, 5 and 6 have **UpdateOFF**, and Traces 4 and 6 have **DisplayOFF**.

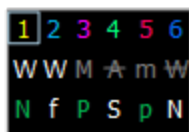

See: "[More Information](#)" on page 1055

Notes	For the commands to control the two variables, Update and Display, see " Trace Update State On/Off " on page 1054 and " Trace Display State On/Off " on page 1054 below
Dependencies	When Signal ID is on, this key is grayed-out
Couplings	<p>Selecting a Trace Type for a trace (pressing the key or sending the equivalent command) puts the trace in Active (Update ON and Display ON), even if that trace type was already selected</p> <p>Selecting a detector for a trace (pressing the key or sending [:SENS] :DET :TRAC) puts the trace in Active (UpdateON and DisplayON), even if that detector was already selected</p> <p>Selecting a "Math Function" on page 1745 other than OFF for a trace (pressing the key or sending the equivalent command) puts the trace in Active (UpdateON and DisplayON), even if that Math Mode was already selected</p> <p>Loading a trace from a file puts that trace in View regardless of the state it was in when it was saved; as does being the target of a Copy or a participant in an Exchange</p>

Trace Update State On/Off

Remote Command	<p>For Swept SA Measurement (in SA Mode):</p> <pre>:TRACe[1] 2 ... 6:UPDate[:STATe] ON OFF 1 0</pre> <pre>:TRACe[1] 2 ... 6:UPDate[:STATe]?</pre> <p>For all other measurements:</p> <pre>:TRACe[1] 2 3:<meas>:UPDate[:STATe] ON OFF 1 0</pre> <pre>:TRACe[1] 2 3:<meas>:UPDate[:STATe]?</pre> <p>where <meas> is the identifier for the current measurement</p>
Example	<p>Make trace 2 inactive (stop updating):</p> <pre>:TRAC2:UPD 0</pre>
Couplings	Whenever you set Update to ON for any trace, the Display is set to ON for that trace
Preset	<p>For Swept SA Measurement (in SA Mode):</p> <pre>1 0 0 0 0 0</pre> <p>ON for Trace 1; OFF for 2–6</p> <p>For all other measurements:</p> <pre>1 0 0</pre> <p>ON for Trace 1; OFF for 2 & 3</p>
State Saved	Saved in instrument state

Trace Display State On/Off

Remote Command	<p>For Swept SA Measurement (in SA Mode):</p> <pre>:TRACe[1] 2 ... 6:DISPly[:STATe] ON OFF 1 0</pre> <pre>:TRACe[1] 2 ... 6:DISPly[:STATe]?</pre> <p>For all other measurements:</p>
----------------	--

	<pre>:TRACe[1] 2 3:<meas>:DISPlay[:STATe] ON OFF 1 0</pre> <pre>:TRACe[1] 2 3:<meas>:DISPlay[:STATe]?</pre> <p>where <meas> is the identifier for the current measurement</p>
Example	<p>Make trace 1 visible:</p> <pre>:TRAC2:DISP 1</pre> <p>Blank trace 3:</p> <pre>:TRAC3:DISP 3</pre>
Couplings	Whenever you set Update to ON for any trace, the Display is set to ON for that trace
Preset	<p>For Swept SA Measurement (in SA Mode):</p> <pre>1 0 0 0 0 0</pre> <p>ON for Trace 1; OFF for 2–6</p> <p>For all other measurements:</p> <pre>1 0 0</pre> <p>ON for Trace 1; OFF for 2 & 3</p>
State Saved	Saved in instrument state

More Information

When a trace becomes inactive, any update from the **:SENSe** system (detectors) immediately stops, without waiting for the end of the sweep. The trace data remains unchanged, but stops updating. If the trace is blanked, this still does not affect the data in the trace. Traces that are blanked (**Display=OFF**) do not display nor appear on printouts, but their data stays intact, they may be queried, and markers may be placed on them

In most cases, inactive traces are static and unchanging; however, there are cases when an inactive trace will update, specifically:

- if data is written to that trace from remote
- if trace data is loaded from mass storage
- if the trace is the target of a **Copy** or participant in an **Exchange**
- if the trace is cleared using **Clear Trace**

Inactive traces that are also being displayed (traces in **View**) are displayed at half intensity. Traces in **View** display across the entire X-Axis of the instrument. Their horizontal placement does not change, even if X-Axis settings subsequently are changed, although Y-Axis settings do affect the vertical placement of data.

When a trace becomes active (**Update=ON**), the trace is cleared, the average count is reset, and a new sweep is initiated.

Note that putting a trace into **Display=OFF** and/or **Update=OFF** does *not* restart the sweep and does *not* restart Averaging or Hold functions for any traces.

3.6.10.3 Math

Lets you turn on and configure Trace Math functions.

Math Function

Trace Math functions perform mathematical operations between traces and, in some cases, user-specified offsets. When in a Trace Math function, the indicated function is performed during the sweep with the math function used in place of a detector. The trace operands for the math function are set using the "[Operand 1 / Operand 2](#)" on [page 1751](#) controls.

- See "[How trace math is processed](#)" on [page 1060](#)

Remote Command For option details, see "[Trace Math Options](#)" on [page 1058](#)
For Swept SA Measurement (in SA Mode):
:CALCulate:MATH <trace_num>, PDIFference | PSUM | LOFFset | LDIFference | OFF, <trace_num>, <trace_num>, <real>,<real>
:CALCulate:MATH? <trace_num>
where <trace_num> is any one of:
TRACE1|...|TRACE6
For all other measurements:
:CALCulate:<meas>:MATH <trace_num>, PDIFference | PSUM | LOFFset | LDIFference | OFF, <trace_num>, <trace_num>, <real>,<real>
:CALCulate[:<meas>]:MATH? <trace_num>
where:
<meas> is the identifier for the current measurement, and
<trace_num> is any one of:
TRACe1|TRACe2|TRACe3
Note that the format of the TRACe<n> parameter differs from that for the Swept SA Measurement

Example :CALC:MATH TRACE3,PDIF,TRACE1,TRACE2,0,0
Sets Trace 3 to Power Diff trace math function, and sets the First Trace operand (for Trace 3) to Trace 1 and the Second Trace operand (for Trace 3) to Trace 2
:CALC:MATH TRACE3,PSUM,TRACE1,TRACE2,0,0
Sets Trace 3 to Power Sum trace math function and sets the First Trace operand (for Trace 3) to Trace 1 and the Second Trace operand (for Trace 3) to Trace 2
:CALC:MATH TRACE3,LOFF,TRACE1,TRACE2,-6.00,0

3 VMA Mode
3.6 Occupied BW Measurement

	<p>Sets Trace 3 to Log Offset trace math function, sets the First Trace operand (for Trace 3) to Trace 1, leaves the Second Trace operand (for Trace 3) unchanged (it is irrelevant for this function) and sets the Log Offset (for Trace 3) to -6 dB</p> <p><code>:CALC:MATH TRACE3,LDIF,TRACE1,TRACE2,0,-6.00</code></p> <p>Sets Trace 3 to Log Diff trace math function, sets the First Trace operand (for Trace 3) to Trace 1, sets the Second Trace operand (for Trace 3) to Trace 2, and sets the Log Difference reference (for Trace 3) to -6 dBm</p> <p><code>:CALC:MATH TRACE1,OFF,TRACE2,TRACE3,0,0</code></p> <p>Turns off trace math for trace 1</p>
Notes	<p>The Trace Math Function command has 6 main set of parameters:</p> <ul style="list-style-type: none"> - Set 1 defines the “result trace”: <code>TRACE1 ... TRACE6</code> -Set 2 defines the “function”: <code>PDIFference PSUM LOFFset LDIFference OFF</code> - Set 3 is a “trace operand” (1): <code>TRACE1 ... TRACE6</code> - Set 4 is a “trace operand” (2): <code>TRACE1 ... TRACE6</code> - Set 5 defines the “Log Offset” (in dB) - Set 6 defines the “Log Difference Reference” (in dBm) <p>Note that the trace math mode is an enumeration; that is, when a math function is set for a trace, it turns off any math function that is on for that trace, then sets the new math function</p> <p>The parameters sent in the command are reflected in the values in the control menu. There is no default for any parameter; all 6 parameters must be sent to satisfy the parser. Failure to specify a parameter will result in a missing parameter message</p> <p>The query returns the math mode, the operand traces, the offset and the reference for the specified trace, all separated by commas</p>
Dependencies	<p>Trace Math is not available if Normalize is on</p> <p>Trace Math is not available if Signal ID is on</p> <p>None of the trace operands can be the destination trace. If any of the three trace math commands is sent with a destination trace number matching one of the operands, a warning is generated and the function does not turn on</p>
Couplings	When a math function is changed for a trace, that trace is set to Display = ON ; and Update = ON
Preset	<p>For Swept SA Measurement (in SA Mode):</p> <p><code>OFF,TRACE5,TRACE6,0,0 OFF,TRACE6,TRACE1,0,0 OFF,TRACE1,TRACE2,0,0 </code> <code>OFF,TRACE2,TRACE3,0,0 OFF,TRACE3,TRACE4,0,0 OFF,TRACE4,TRACE5,0,0</code></p> <p>For all other measurements:</p> <p><code>OFF,TRACE2,TRACE3,0,0 OFF,TRACE3,TRACE1,0,0 OFF,TRACE1,TRACE2,0,0</code></p>
State Saved	The trace math function for each trace is saved in instrument state
Annunciation	An “f” is shown on the trace annunciation panel in the Measurement Bar when a math function is on;

	and the function is annotated on the trace if Trace Annotation is on
Status Bits/OPC dependencies	*OPC can be used to detect the completion of a sweep, which will also correspond to the completion of the math operation, since all math takes place during the sweep

Trace Math Options

IMPORTANT

To generate a trace math result, *you must take a sweep*. The trace math engine, described below, operates in concert with the sweep engine in the instrument. Until a sweep has been taken, even if the constituent traces are not in Update mode, no result is generated.

Note that certain events can affect the trace in ways that affects all points at once. This can happen in any number of ways, including:

- A trace clear taking place
- A trace being loaded from the file system
- Trace data being sent in from the remote interface
- A copy or exchange of trace data

You should try to avoid these occurrences during a sweep, as they will tend to invalidate the math result being accumulated.

The Trace Math functions are:

Power Diff (Op1 - Op2)

Calculates a power difference between the **First Trace** operand and the **Second Trace** operand and puts the result in the destination trace.

During the sweep, the following formula is executed for each point in the trace operands, and the corresponding point is generated for the destination trace:

$$\text{DestinationTrace} = 10 \log_{10}(1/10)(\text{FirstTrace}) - 10(1/10)(\text{SecondTrace})$$

The values of the trace points are assumed to be in a decibel scale, as they are internally stored.

If a point in **FirstTrace** is equal to **maxtracevalue**, the resultant point is also **maxtracevalue**.

Otherwise, if the result of the subtraction is less than or equal to 0, the resultant point is **mintracevalue**.

Power Sum (Op1 + Op2)

Calculates a power sum between the **First Trace** operand and the **Second Trace** operand and puts the result in the destination trace.

During the sweep, the following formula is executed for each point in the trace operands, and the corresponding point is generated for the destination trace.

$$\text{DestinationTrace} = 10 \log(10(1/10)(\text{FirstTrace}) + 10(1/10)(\text{SecondTrace}))$$

The values of the trace points are assumed to be in a decibel scale, as they are internally stored.

If a point in either trace operand is equal to **maxtracevalue**, the resultant point is also **maxtracevalue**.

Log Offset (Op1 + Offset)

Calculates a log offset from the **First Trace** operand and puts the result in the destination trace. This is like the B-DL function in some older instruments. The offset is entered on the **Offset** control, which only appears when this math function is in force for the selected trace. Each destination trace has its own offset.

During the sweep, the following formula is executed for each point in the trace operand, and the corresponding point is generated for the destination trace.

$$\text{DestinationTrace} = \text{FirstTrace} + \text{Offset}$$

The values of the trace points are assumed to be in dBm (as they are internally stored) and the offset is in dB.

If a point in the trace operand is equal to **maxtracevalue**, the resultant point is also **maxtracevalue**.

If a point in the trace operand is equal to **mintracevalue**, the resultant point is also **mintracevalue**.

Example: If offset is 25 dB, then our destination trace will be higher than the operand trace by 25 dB.

Note that the **Second Trace** operand is not used for this function.

Log Diff (Op1 - Op2 + Ref)

Offsets the difference between the **First Trace** operand and the **Second Trace** operand by a reference and puts the result in the destination trace. This is like the A-B+DL function in some older instruments. The Reference is entered on the **Reference** control, which only appears when this math function is in force for the selected trace. Each destination trace has its own reference.

Offsets the difference between the **First Trace** operand and the **Second Trace** operand by a reference and puts the result in the destination trace. This is like the A-

B+DL function in some older instruments. The Reference is entered on the **Reference** control, which only appears when this math function is in force for the selected trace. Each destination trace has its own reference.

During the sweep, the following formula is executed for each point in the trace operands, and the corresponding point is generated for the destination trace.

$$\text{DestinationTrace} = (\text{FirstTrace} - \text{SecondTrace}) + \text{Reference}$$

The values of the operand trace points are assumed to be in decibel units (as they are internally stored) and the reference is in dBm so the result is in dBm.

Example: If the first operand trace 1 is at 5 dBm, the second operand trace 2 is at -5 dBm, and the reference is -25 dBm, then the destination trace will be -15 dBm.

Example: If the first operand trace 1 is at 60 dBuV, the second operand trace 2 is at 50 dBuV, and the reference is 35 dBuV, then the destination trace will be 45 dBuV.

If a point in **FirstTrace** is equal to **maxtracevalue**, the resultant point is also **maxtracevalue**.

If a point in **FirstTrace** is equal to **mintracevalue**, the resultant point is also **mintracevalue**.

If neither of the above is true for a given point, then:

- If that point in **SecondTrace** is equal to **maxtracevalue**, the resultant point is **mintracevalue**.
- If that point in **SecondTrace** is equal to **mintracevalue**, the resultant point is **maxtracevalue**.

How trace math is processed

Whenever a trace math function is turned on, or the parameters and/or operands of an existing trace math function are changed, the destination trace is cleared. After the trace is cleared, all x-axis values in the trace, and the domain of the trace, are set to match the X-Axis settings of the first trace operand. When this is complete, a new sweep is initiated.

The process of acquiring data, processing it using the math and Average/Hold functions, and presenting it as trace data, consists of several functional blocks, as shown below:

3 VMA Mode
 3.6 Occupied BW Measurement

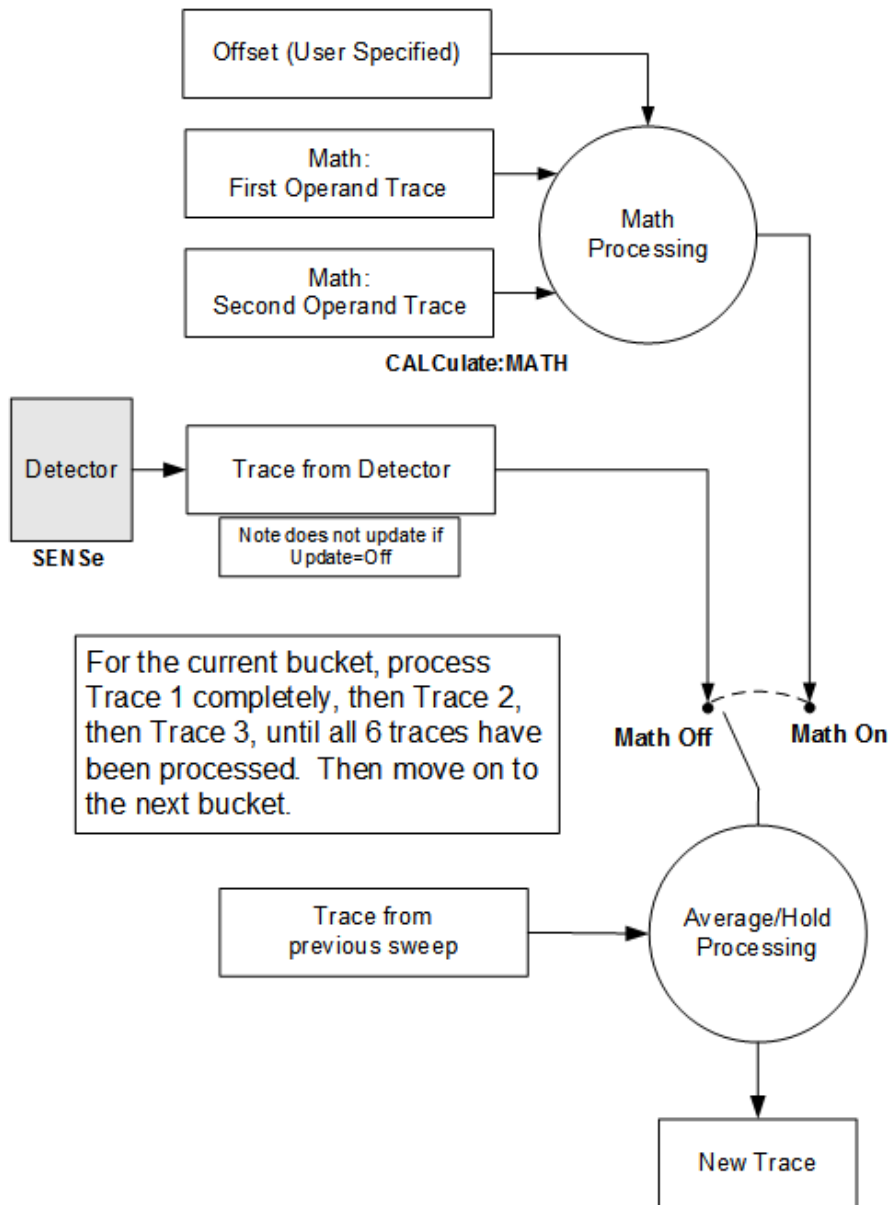

NOTE ABOUT OFFSETS: When either External Gain or Ref Level Offset is on, an offset is applied to the trace operands, and when Trace Math is on this offset is applied before any math processing is performed. Since the operands have already been offset the result trace should NOT be offset. Therefore when any Trace Math operation is performed, the sum of (External Gain - Ref Level Offset) is added to the result before it is stored in the result trace.

For each active trace, the current trace point is processed for **Trace 1**, then **Trace 2**, then **Trace 3**, etc. Trace data is taken from either the detector for that trace, or

from the mathematical result of up to two other traces and an offset, depending on whether trace math is on or not. The resultant data is then fed to the Average/Hold processing block, where (if the trace type is **Average**, **Max Hold**, or **Min Hold**) it is processed with previous trace data. The new trace data resulting from this process is then available for display, storage or remote output.

When the processing is complete for **Trace 1**, **Trace 2** is processed, and so on until all six traces have been processed. This allows a downstream trace to use as one of its math components a fully processed upstream trace. In other words, if math is **ON** for **Trace 4**, and its operand traces are **Trace 2** and **Trace 3**, then all detector, math, average and hold processing for Traces 2 and 3 is completed before the math is performed for **Trace 4**. When the current trace point is completed for all traces, the instrument moves on to the next trace point.

This allows very flexible and powerful math functions to be configured. For example, **Trace 1** can be an average trace, which can be fed with an offset to **Trace 2**, which can also be in **Max Hold**, allowing you to obtain the **Max Hold** of an Average trace.

Note that none of this processing is performed on inactive traces.

Note also that for any active trace with math **ON**, the Operand traces should have *lower* numbers than the trace (for example, using **Trace 4** as an operand for **Trace 1** will cause the data coming from **Trace 4** to be delayed by one sweep).

Operand 1 / Operand 2

These two controls select the first and second trace operands to be used for the trace math functions for the destination trace. The operands are common to all math functions for a given trace. The most recently sent **:CALCulate:MATH** command for a given trace sets the operands for that trace. Those settings are displayed on the trace operand controls for that trace.

Example	<p>The following examples are for the Swept SA measurement</p> <p>Set Trace 3 to Power Diff trace math function. Set the First Trace operand (for Trace 3) to Trace 1 and the Second Trace operand (for Trace 3) to Trace 2:</p> <pre>:CALC:MATH TRACE3,PDIF,TRACE1,TRACE2,0,0</pre> <p>Set Trace 3 to Log Offset trace math function. Set the First Trace operand (for Trace 3) to Trace 1, leave the Second Trace operand (for Trace 3) unchanged (it is irrelevant for this function) and set the Log Offset (for Trace 3) to -6 dB:</p> <pre>:CALC:MATH TRACE3,LOFF,TRACE1,TRACE2,-6.00,0</pre>
Notes	See " Math Function " on page 1745 for how to specify Operands 1 and 2 using :CALCulate:MATH
Dependencies	The destination trace cannot be an operand. The destination trace number is grayed-out on the dropdown
Preset	Operand 1: Trace number minus 2 (wraps at 1). For example, for Trace 1, Operand 1 presets to Trace

	5; for Trace 6, it presets to Trace 4 Operand 2: Trace number minus 1 (wraps at 1). For example, for Trace 1, Operand 2 presets to Trace 6; for Trace 6, it presets to Trace 5
State Saved	Operands 1 and 2 for each trace are stored in instrument state

Offset

Used by the Log Offset math function.

Example	The following example is for the Swept SA measurement Set Trace 3 to Log Offset trace math function, set the First Trace operand (for Trace 3) to Trace 1, leave the Second Trace operand (for Trace 3) unchanged (it is irrelevant for this function) and set the Log Offset (for Trace 3) to -6 dB: <code>:CALC:MATH TRACE3,LOFF,TRACE1,TRACE2,-6.00,0</code>
State Saved	The Log Offset value for each trace is saved in Instrument State
Min	-100 dB
Max	100 dB

Reference

Used by the Log Diff math function.

Example	The following example is for the Swept SA measurement Set Trace 3 to Log Diff trace math function, set the First Trace operand (for Trace 3) to Trace 1, set the Second Trace operand (for Trace 3) to Trace 2, and set the Log Difference reference (for Trace 3) to -6 dBm: <code>:CALC:MATH TRACE3,LDIF,TRACE1,TRACE2,0,-6.00</code>
State Saved	The Log Difference reference value for each trace is saved in instrument state
Min/Max	Same as reference level

3.6.10.4 Detector

Lets you select and configure detectors for the specified trace.

Detector

Selects a detector to be used by the instrument for the current measurement. The following selections are available:

Option	Behavior
<code>AUTO</code>	The detector selected depends on marker functions, trace functions, average type,

Option	Behavior
	and the trace averaging function For details, see " Detector Select Auto/Man " on page 1065
NORMal	The detector determines the peak of the CW-like signals, and it yields alternating maximums and minimums of noise-like signals. This is also referred to as Rosenfell detection
AVERage	The detector determines the average of the signal within the sweep points, using RMS averaging
POSitive Peak	The detector determines the maximum of the signal within the sweep points
SAMPle	The detector indicates the instantaneous level of the signal at the center of the sweep points represented by each display point
NEGative Peak	The detector determines the minimum of the signal within the sweep points
RMS	Equivalent to AVERage

Because they may not find a spectral component's true peak, neither **AVERage** nor **SAMPle** detectors measure amplitudes of CW signals as accurately as **POSitivePeak** or **NORMal**, but they do measure noise without the biases of peak detection.

Remote Command `[:SENSe]:OBWidth:DETECTOR[:FUNCTION] NORMal | AVERage | POSitive | SAMPle | NEGative | RMS`
`[:SENSe]:OBWidth:DETECTOR[:FUNCTION]?`

Example `:OBW:DET NORM`
`:OBW:DET?`

Set the detector to **Average**. **Average** uses RMS averaging, so this is equivalent to selecting an **RMS** detector:
`:OBW:DET RMS`

Notes The query returns a name that corresponds to the detector type, as follows
The **RMS** selection sets the detector type to **AVERage**, with RMS averaging. Therefore, if **RMS** had been selected, the query returns **AVER**

String Returned	Definition
NORM	Normal
AVER	Average (RMS)
POS	Peak
SAMP	Sample
NEG	Negative Peak

Couplings When "[Detector Select Auto/Man](#)" on page 1065 is **ON**, the values returned by the query depend on the setting of "[Trace Type](#)" on page 1737 as follows:

	Trace Type	Query Returns:
	WRITE	NORMAL
	AVERAGE	AVERAGE
	MAXHOLD	POSITIVE
	MINHOLD	NEGATIVE
Preset	AVERAGE	
State Saved	Saved in instrument state	
Range	NORMAL AVERAGE POSITIVE SAMPLE NEGATIVE RMS	

Detector Select Auto/Man

Sets the Detector mode to **Auto (ON)** or **Man (OFF)**. In **Auto**, the proper detector is chosen based on rules that take into account the measurement settings and other instrument settings.

When you select any "Detector" on page 1063 manually, this setting reverts automatically to **Man** (manual).

Remote Command	[:SENSe]:OBWidth:DETECTOR:AUTO ON OFF 1 0 [:SENSe]:OBWidth:DETECTOR:AUTO?	
Example	:OBW:DET:AUTO ON :OBW:DET:AUTO?	
Couplings	When ON , the query "Detector" on page 1063 returns values that depend on the setting of "Trace Type" on page 1737 as follows:	
	Trace Type	Query Returns:
	WRITE	NORMAL
	AVERAGE	AVERAGE
	MAXHOLD	POSITIVE
	MINHOLD	NEGATIVE
Preset	ON	
State Saved	Yes	

3.6.10.5 Trace Function

Contains controls to:

- Copy and Exchange traces
- Preset or Clear all traces

From Trace

Selects the trace to be copied to or exchanged with the "To Trace" on page 1753 when a "Copy" on page 1753 or "Exchange" on page 1754 is performed

Preset 1

To Trace

Selects the trace to be copied from or exchanged with the "From Trace" on page 1753 when a "Copy" on page 1753 or "Exchange" on page 1754 is performed

Preset 2

Copy

Executes a Trace Copy based on the "From Trace" on page 1753 and "To Trace" on page 1753 parameters. The copy operation is from the **From Trace** to the **To Trace**. The action is performed once.

The X-Axis settings and domain of a trace are also copied.

Remote Command For Swept SA Measurement (in SA Mode):
`:TRACe:COPIY TRACE1 | ... | TRACE6, TRACE1 | ... | TRACE6`
 For all other measurements:
`:TRACe:<meas>:COPIY TRACe1 | TRACe2 | TRACe3, TRACe1 | TRACe2 | TRACe3`
 where <meas> is the identifier for the current measurement
 Note that the format of the `TRACe<n>` parameter differs from that for the Swept SA Measurement

Example Copy Trace 1 to Trace 3 and put Trace 3 in Update=Off, Display=On
`:TRAC:COPIY TRACE1, TRACE3`

Notes The command is of the form:
`:TRACe:COPIY <source_trace>, <dest_trace>`

Dependencies When Signal ID is on, this key is grayed-out

Couplings The destination trace is put in **View** (Update = Off, Display = On) after the copy

Preset For Swept SA Measurement (in SA Mode):
`TRACE1, TRACE2`
 For all other measurements:
`TRACe1, TRACe2`

Exchange

Executes a Trace Exchange based on the "From Trace" on page 1753 and "To Trace" on page 1753 parameters. The **From Trace** and **To Trace** values are exchanged with each other. The action is performed once.

The X-Axis settings and domain of a trace are also copied when it is exchanged with another trace.

Remote Command	<p>For Swept SA Measurement (in SA Mode): <code>:TRACe:EXCHange TRACE1 ... TRACE6, TRACE1 ... TRACE6</code></p> <p>For all other measurements: <code>:TRACe:<meas>:EXCHange TRACe1 TRACe2 TRACe3, TRACe1 TRACe2 TRACe3</code></p> <p>where <code><meas></code> is the identifier for the current measurement</p> <p>Note that the format of the <code>:TRACe<n></code> parameter differs from that for the Swept SA Measurement</p>
Example	<p>Exchange Trace 1 and Trace 2 and put both traces in Update=OFF, Display=ON: <code>:TRAC:EXCH TRACE1, TRACE2</code></p>
Notes	<p>The command is of the form: <code>:TRACe:EXCHange <trace_1>, <trace_2></code></p>
Couplings	Both traces are put in View (Update=Off, Display=On) after the exchange

Preset All Traces

Turns on Trace 1 and blanks all other traces. This is useful when you have many traces on and you want to return to having only Trace 1 on the display. Does not affect the trace type, detector or any other aspect of the trace system.

Remote Command	<code>:TRACe[:<meas>]:PRESet:ALL</code>
Example	<code>:TRAC:PRE:ALL</code>
Dependencies	When Signal ID is on, this key is grayed-out

Clear All Traces

Clears all traces. Does not affect the state of any function or variable in the instrument. Loads `mintracevalue` into all of the points for all traces, except traces in **Min Hold**, in which case it loads `maxtracevalue`, even if **Update = OFF**.

Remote Command	<code>:TRACe[:<meas>]:CLEAr:ALL</code>
Example	<code>:TRAC:CLE:ALL</code>
Dependencies	When Signal ID is on, this key is grayed-out

3.6.10.6 Advanced

Contains controls for setting advanced trace functions of the instrument.

Measure Trace

Specifies which trace's scalar results are displayed in the **Metrics** window, and retrieved by sending a **:READ** or **:FETCH** query:

- Trace 1
- Trace 2
- Trace 3

Remote Command	<pre>:CALCulate:<meas>:MTRace TRACe1 TRACe2 TRACe3 :CALCulate:<meas>:MTRace? <meas> is the identifier for the current measurement; any one of CHPower ACPower OBWidth SEMask SPURious PVTime</pre>
Example	<pre>Channel Power :CALC:CHP:MTR TRAC1 :CALC:CHP:MTR?</pre>
Dependencies	In the ACP measurement, this control is grayed-out when Meas Method is set to RBW or FAST , and only Trace 1 is enabled
Preset	TRACe1
State Saved	No
Range	Trace 1 Trace 2 Trace 3

3.7 Power Stat CCDF Measurement

Many modern digitally-modulated signals look noise-like in the time and frequency domain, requiring statistical measurement of these signals for meaningful characterization and differentiation. The **Power Statistics Complementary Cumulative Distribution Function (CCDF)** measurement displays curves to characterize the higher-level power statistics of digitally modulated signals. The curves can be useful in determining design parameters for digital communications systems.

The Power Statistics CCDF measurement displays probability on the Y-Axis and amplitude on the X-axis, for a display of the statistical amplitude distribution of a signal. This distribution can be affected by many factors. For example, modulation filtering, modulation format, combining the multiple signals at different frequencies, number of active codes, and correlation between symbols on different codes with spread spectrum systems will all affect measurement results. These factors are all related to modulation and signal parameters. External factors such as signal compression and expansion by nonlinear components, group delay distortion from filtering, and power control within the observation interval also affect the measurement.

The power measured in power statistics CCDF curves is actually instantaneous envelope power defined by the equation:

$$P = (I^2 + Q^2) / Z_0$$

where I & Q are the quadrature voltage components of the waveform, and Z_0 is the characteristic impedance.

A CCDF curve is defined by how much time the waveform spends at or above a given power level. The percent of time the signal spends at or above the level defines the probability for that particular power level. For capturing a lower probability down to 0.0001%, this measurement is made in the single mode by pressing Single. To make the power statistics CCDF measurement, the instrument uses digital signal processing (DSP) to sample the input signal in the channel bandwidth. The Gaussian distribution line as the band-limited Gaussian noise CCDF reference line, the user-definable reference trace, and the currently measured trace can be displayed on a semi-log graph. If the currently measured trace is above the user reference trace, it means that the higher peak power levels against the average power are included in the input signal.

Power Stat CCDF Measurement Commands

The general functionality of ["CONFigure" on page 2551](#), ["INITiate" on page 2552](#), ["FETCh" on page 2552](#), ["MEASure" on page 2554](#), and ["READ" on page 2553](#) are described in the section **SCPI Operation and Results Query** in the topic

Programming the Instrument.

The following measurement commands and queries are used to configure the measurement:

<code>:INITiate:PSTatistic</code>	Initiates a trigger cycle for the PST measurement, but does not return any data. You must then use <code>:FETC:PST[n]?</code> to retrieve data
<code>:CONFigure?</code>	Does not change any measurement settings Returns the long form name of current measurement, in this case, PSTatistic
<code>:CONFigure:PSTatistic</code>	Selects PST measurement with Meas Setup settings in preset state – same as "Meas Preset" on page 1143
<code>:CONFigure:PSTatistic:NDEFault</code>	Selects PST measurement <i>without</i> affecting settings

The following queries are used to retrieve the results:

<code>:FETCh:PSTatistic?</code>	Retrieves the data specified by n
<code>:MEASure:PSTatistic [n]?</code>	Switches to PST measurement, restores default values, starts the measurement, then retrieves the data specified by n
<code>:READ:PSTatistic[n]?</code>	Starts the measurement, then retrieves the data specified by n

Measurement Results for Power Stat CCDF

The following table describes the results returned by the `:FETCh`, `:MEASure`, and `:READ` queries listed above, according to the index value **n**.

n	Results Returned																								
0	Returns unprocessed I/Q trace data, as a series of trace point values, in volts. The I values are listed first in each pair, using the 0 through even-indexed values. The Q values are the odd-indexed values																								
1, or not specified	Returns 11 scalar results: <table border="1" data-bbox="360 1402 1406 1757"> <thead> <tr> <th>#</th> <th>Item</th> <th>Unit, if any</th> </tr> </thead> <tbody> <tr> <td>1</td> <td>Average input power</td> <td>dBm</td> </tr> <tr> <td>2</td> <td>Probability at the average input power level</td> <td>%</td> </tr> <tr> <td>3</td> <td>Power level that has 10 % of the power</td> <td></td> </tr> <tr> <td>4</td> <td>Power level that has 1 % of the power</td> <td></td> </tr> <tr> <td>5</td> <td>Power level that has 0.1 % of the power</td> <td></td> </tr> <tr> <td>6</td> <td>Power level that has 0.01 % of the power</td> <td></td> </tr> <tr> <td>7</td> <td>Power level that has 0.001 % of the power</td> <td></td> </tr> </tbody> </table>	#	Item	Unit, if any	1	Average input power	dBm	2	Probability at the average input power level	%	3	Power level that has 10 % of the power		4	Power level that has 1 % of the power		5	Power level that has 0.1 % of the power		6	Power level that has 0.01 % of the power		7	Power level that has 0.001 % of the power	
#	Item	Unit, if any																							
1	Average input power	dBm																							
2	Probability at the average input power level	%																							
3	Power level that has 10 % of the power																								
4	Power level that has 1 % of the power																								
5	Power level that has 0.1 % of the power																								
6	Power level that has 0.01 % of the power																								
7	Power level that has 0.001 % of the power																								

3 VMA Mode
 3.7 Power Stat CCDF Measurement

n Results Returned			
#	Item	Unit, if any	
8	Power level that has 0.0001 % of the power		
9	Peak power	dB	
10	Count		
11	Power level that has 0.00001% of the power if "Minimum Probability" on page 1075 is PP7 (0.00001 %) This value is returned only when PP7 is selected		
2	Returns a series of 5001 floating point numbers (in percent) that represent the current measured power stat trace. This is the probability at particular power levels (average power), in the following order: 1. Probability at 0.0 dB power 2. Probability at 0.01 dB power 3. Probability at 0.02 dB power ... 5000. Probability at 49.9 dB power 5001. Probability at 50.0 dB power		
3	Returns a series of 5001 floating point numbers (in percent) that represent the Gaussian trace. This is the probability at particular power levels (average power), in the following order: 1. Probability at 0.0 dB power 2. Probability at 0.01 dB power 3. Probability at 0.02 dB power ... 5000. Probability at 49.9 dB power 5001. Probability at 50.0 dB power		
4	Returns a series of 5001 floating point numbers (in percent) that represent the user-definable reference trace. This is the probability at particular power levels (average power), in the following order: 1. Probability at 0.0 dB power 2. Probability at 0.01 dB power 3. Probability at 0.02 dB power ... 5000. Probability at 49.9 dB power 5001. Probability at 50.0 dB power		

3.7.1 Views

In the **LTEATDD** and **5GNR** Modes, this measurement has two views: "Normal" on page 1072 and **Slot**. In all other Modes, there is only a single view (**Normal**).

These are multiple-window Views. When in a multiple-window View, you select a window by touching it. The menu controls may sometimes change depending on which window is selected.

3.7.1.1 Normal

Windows: ["Metrics" on page 1073](#), ["Graph" on page 1072](#)

The Power Stat CCDF measurement provides CCDF curves and power statistics metrics. This is common for both Uplink (MS) and Downlink (BTS).

Example `:PST:SLTV OFF`

3.7.2 Windows

Three window types are defined:

1. ["Graph" on page 1072](#)
2. Slot
3. ["Metrics" on page 1073](#)

Slot only appears in LTEATDD and 5GNR Modes.

3.7.2.1 Graph

Displays Amplitude versus probability

3 VMA Mode
3.7 Power Stat CCDF Measurement

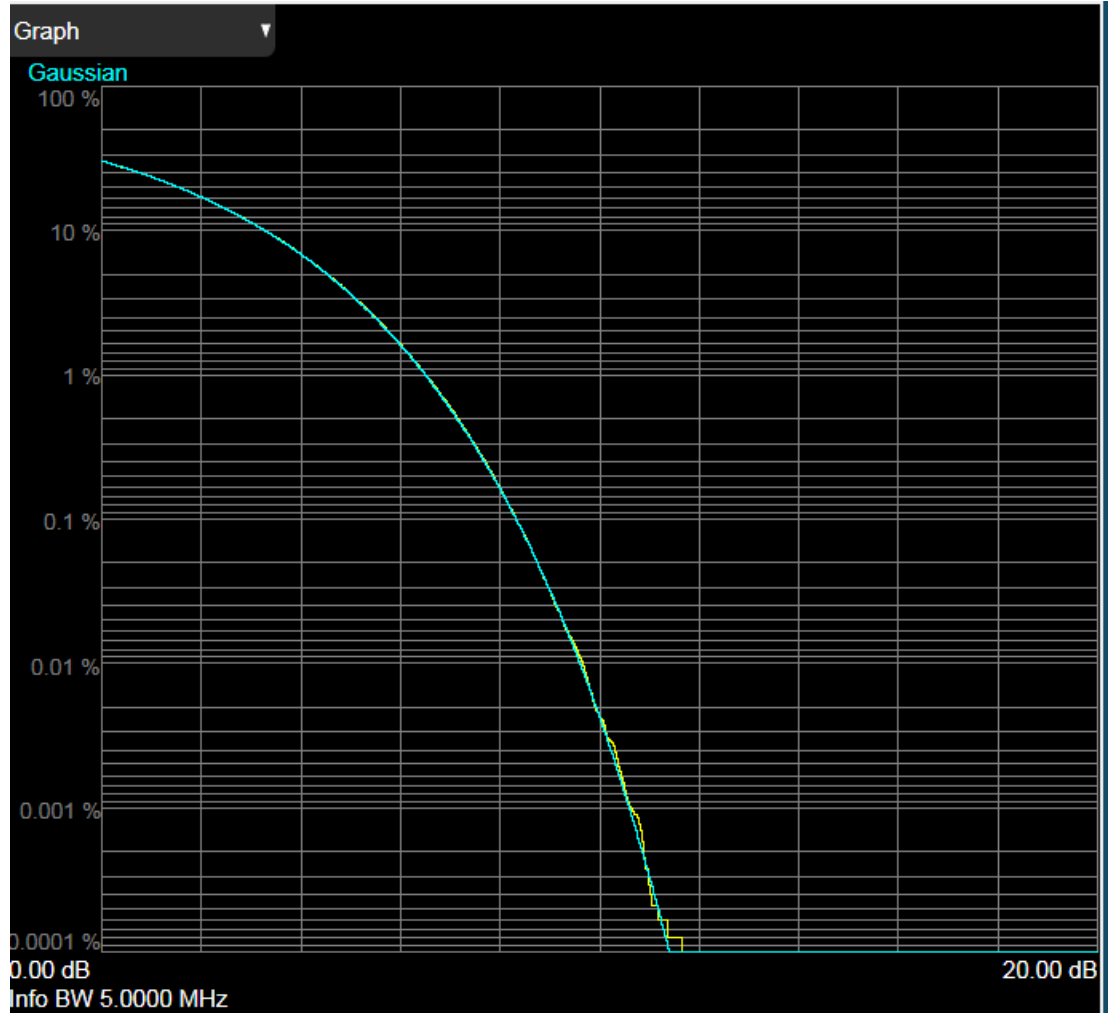

3.7.2.2 Metrics

Displays the textual results of the Power Stat CCDF measurement.

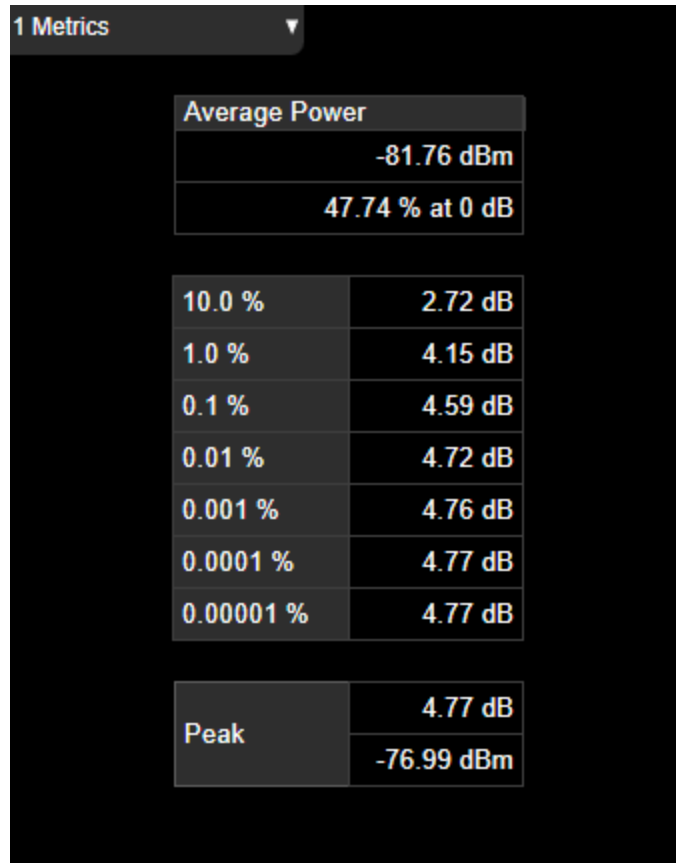

For the list of $n = 1$ measurement results, see "Measurement Results for Power Stat CCDF" on page 1070 above.

Name	Unit	Corresponding Results	Results Item for $n = 1$	Explanation
Average Power	dBm	Average input power	1	99.99 dBm
Average Power	%	Probability at the average input power level	2	99.99 %
10.0%	dB	Power level that has 10 % of the power	3	99.99 dB
1.0%	dB	Power level that has 1 % of the power	4	99.99 dB
0.1%	dB	Power level that has 0.1 % of the power	5	99.99 dB
0.01%	dB	Power level that has 0.01 % of the power	6	99.99 dB
0.001%	dB	Power level that has 0.001 % of the power	7	99.99 dB

3 VMA Mode
 3.7 Power Stat CCDF Measurement

Name	Unit	Corresponding Results	Results Item for n = 1	Explanation
0.0001%	dB	Power level that has 0.0001 % of the power	8	99.99 dB
0.00001%	dB	Power level that has 0.00001% of the power if " Minimum Probability " on page 1075 is PP7 (0.00001 %)	11	99.99 dB
Peak	dB	Peak power	9	99.99 dB
Peak	dBm	Not available via remote commands	n/a	99.99 dBm

3.7.3 Amplitude

Activates the **Amplitude** menu and selects **Reference Level** or **Reference Value** as the active function, depending on the measurement.

Some features in this menu apply to multiple measurements. Some other features apply only to specific measurements and their controls are blanked or grayed-out in measurements that do not support the feature.

3.7.3.1 Y Scale

Contains controls that pertain to the Y axis parameters of the measurement. These parameters control how data on the vertical (Y) axis is displayed and control instrument settings that affect the vertical axis.

Minimum Probability

Sets the minimum probability range.

Remote Command	<code>:CALCulate:PStatistic:RANGe[:PROBability]:MINimum PP2 ... PP7</code> For parameter values, see " Parameter Options " on page 1076 below <code>:CALCulate:PStatistic:RANGe[:PROBability]:MINimum?</code>
Example	<code>:CALC:PST:RANG:MIN PP6</code> <code>:CALC:PST:RANG:MIN?</code>
Preset	PP6
State Saved	Yes
Range	1 % 0.1 % 0.01 % 0.001 % 0.0001 % 0.00001 %

Parameter Options

Option	Value
PP2	1.0e-2 (1 %)
PP3	1.0e-3 (0.1 %)
PP4	1.0e-4 (0.01 %)
PP5	1.0e-5 (0.001 %)
PP6	1.0e-6 (0.0001 %)
PP7	1.0e-7 (0.00001 %)

3.7.3.2 Attenuation

Controls the attenuator functions and interactions between the attenuation system components.

There are two attenuator configurations in the X-Series. One is a Dual-Attenuator configuration consisting of a mechanical attenuator and an optional electronic attenuator. The other configuration uses a single attenuator with combined mechanical and electronic sections that controls all the attenuation functions. Different models in the X-Series come with different configurations.

- See ["Dual-Attenuator Configurations" on page 1076](#)
- See ["Single-Attenuator Configuration" on page 1077](#)

Most attenuation settings are the same for all measurements – they do not change as you change measurements. Settings like these are called “Meas Global” and are unaffected by **Meas Preset**.

Only available when the hardware set includes an input attenuator, which is typically only the case for Keysight’s benchtop instruments. For example, this tab does *not* appear in VXT models M9420A/10A/11A/15A/16A, M9410E/11E/15E/16E, nor in UXM. In UXM, all **Attenuation** and **Range** settings are disabled, as the expected input power level is handled by the Call Processing App that drives the DUT power control.

Dependencies	In measurements that support the I/Q inputs, unavailable when I/Q is the selected input. Replaced by the Range tab in that case
--------------	--

Dual-Attenuator Configurations

Configuration 1: Mechanical attenuator + optional electronic attenuator

3 VMA Mode
 3.7 Power Stat CCDF Measurement

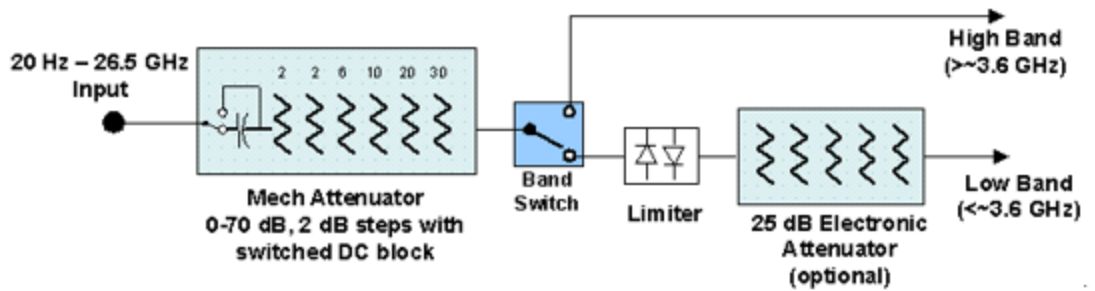

Configuration 2: Mechanical attenuator, no optional electronic attenuator

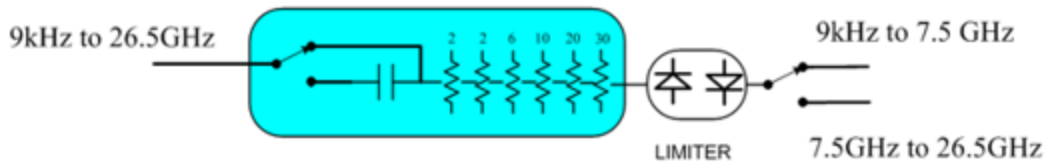

Note that Configuration 2 is not strictly speaking a dual-section attenuator, since there is no electronic section available. However, it behaves exactly like Configuration 1 without the Electronic Attenuator Option EA3, therefore for the sake of this document it is grouped into the “Dual-Attenuator” configuration.

Single-Attenuator Configuration

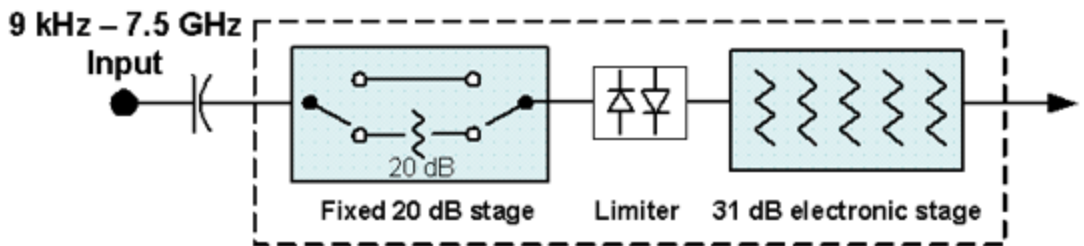

You can tell which attenuator configuration you have by pressing the Attenuation tab, which (in most Modes) opens the Attenuation menu. If the first control in the Attenuation menu says **Mech Atten** you have the Dual-Attenuator configuration. If the first control says **Atten** you have the Single-Attenuator configuration.

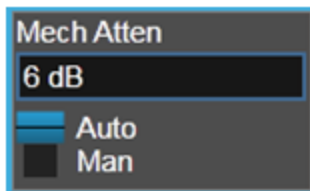

Dual Attenuator



Single Attenuator

(Note that depending on the measurement, there may be no Auto/Man functionality on the Mech Atten control.)

In the Single-Attenuator configuration, you control the attenuation with a single control, as the fixed stage has only two states. In the Dual-Attenuator configuration, both stages have significant range, so you are given separate control of the mechanical and electronic attenuator stages.

When you have the Dual-Attenuator configuration, you may still have only a Single-Attenuator, because unless Option EA3 (the Electronic Attenuator option) is available, and you purchase it, you will have only the mechanical attenuator.

Full Range Atten

This control and **Attenuator Summary** only appear in N9041B, when the RF input is selected, the RF Input Port is set to RF Input 2, and the Full Range Attenuator is installed. The Full Range Attenuator adds a second input attenuator in front of RF Input 2, which enhances the protection and optimizes the performance of the extra internal mixers used by RF Input 2.

Remote Command	<code>[:SENSe]:POWer[:RF]:FRATten <rel_amp1></code> <code>[:SENSe]:POWer[:RF]:FRATten?</code>
Example	<code>:POW:FRAT 14</code> <code>:POW:FRAT?</code>
Notes	When you enter an amplitude value that falls between valid values, the value will be incremented to the next smallest valid value
Dependencies	Only appears if input RF is selected, RF Input Port 2 is selected, and the Full Range Attenuator exists
Couplings	This value is never changed by any coupling, but other couplings use this value. See Reference Level and " Mech Atten " on page 1766 command descriptions
Preset	20 dB
State Saved	Saved in instrument state
Min	0 dB
Max	Only valid values are 0, 6, 14, 20 dB
Annotation	When the Input is RF , and the Input Port is RF Input 2 , and the Full Range Attenuator is installed: On the Meas Bar, the field "Atten" displays as follows: <ul style="list-style-type: none"> - If the sweep is entirely < 50 GHz, the value shown after "Atten:" is equal to Mech Atten + Elec Atten + Full Range Atten - If the sweep is entirely > 50 GHz, the value shown after "Atten:" is equal to Full Range Atten - If the sweep straddles 50 GHz, the value shown after "Atten:" is preceded by the symbol ">=" and is equal to Full Range Atten

In the **Amplitude**, "**Y Scale**" on page 1760 menu, and the Atten **Meas Bar** dropdown menu panel, a summary is displayed as follows:

"Total Atten below 50 GHz" followed by the value of Full Range Atten + Mech Atten + Elec Atten

"Total Atten above 50 GHz" followed by the value of Full Range Atten

For example, if Mech Atten = 6 dB, Elec Atten = 4 dB, and Full Range Atten = 20 dB, the summary below is shown:

- Attenuator summary:
- Total Atten below 50 GHz: 30 dB
- Total Atten above 50 GHz: 20 dB

Mech Atten

Labeled **Mech Atten** in Dual-Attenuator models, and **Atten** in Single-Attenuator models. In the Dual-Attenuator configuration, this control only affects the mechanical attenuator.

Lets you modify the attenuation applied to the RF input signal path. This value is normally auto-coupled to **Ref Level**, "**Internal Preamp**" on page 1788 Gain, any External Gain that is entered, and **Max Mixer Level** (if available), as described in the table below.

See "**Attenuator Configurations and Auto/Man**" on page 1081

Remote Command	<code>[:SENSe]:POWer[:RF]:ATTenuation <rel_aml></code> <code>[:SENSe]:POWer[:RF]:ATTenuation?</code>
Example	<code>:POW:ATT 20</code> Dual-Attenuator configuration: sets the mechanical attenuator to 20 dB Single-Attenuator mode: sets the main attenuation to 20 dB (see below for definition of "main" attenuation) In either case, if the attenuator was in Auto, it is set to Manual
Dependencies	Some measurements do not support Auto setting of Mech Atten . In these measurements, the Auto/Man selection is not available, and the Auto/Man toggle function is not available In Dual-Attenuator configurations, when the electronic attenuator is enabled, the mechanical attenuator has no auto setting, and the Auto/Man toggle function is not available. The state of Auto/Man is remembered and restored when the electronic attenuator is once again disabled. This is described in more detail in " Elec Atten " on page 1769 See " Attenuator Configurations and Auto/Man " on page 1081 for more information on the Auto/Man functionality
Couplings	If the RF Input Port is the RF Input: - If the USB Preamp is connected to USB, use 0 dB for Mech Atten - Otherwise compute the auto-selected value of Mech Atten based on Reference Level , Int Preamp ,

External Gain, Ref Level Offset, Max Mixer Level, μ W Path Control and IF Gain settings. Limit this value to be no less than 6 dB (total attenuation below 6 dB can never be chosen by Auto)

- In N9041B, if the RF Input Port is RF Input 2, use the formula above and subtract the value of "**Full Range Atten**" on page 1765 from the result to determine the **Mech Atten**. Limit the value so that it is never lower than 0 dB and so that total attenuation, including **Full Range Atten**, is never less than 6 dB (total attenuation, including **Full Range Atten** below 6 dB, can never be chosen by Auto)

In External Mixing and BBIQ, where the attenuator is not in the signal path, the attenuator setting changes as described above when **Mech Atten** is in **Auto**, but no changes are made to the actual attenuator hardware setting until the input is changed back to the RF Input

For CXA-m with Option FSA (Fine-Step Attenuator or 2 dB steps), the FSA-like behavior is only available when the frequency setting is ≤ 7.5 GHz. So, when the frequency is changed from below 7.5 GHz to above 7.5 GHz, the attenuation setting changes to a multiple of 10 dB that is no smaller than the previous setting. For example, 4 dB attenuation changes to 10 dB

Preset	Auto The Auto value is 10 dB						
State Saved	Saved in instrument state						
Min	0 dB The attenuation set by this control cannot be decreased below 6 dB with the knob or step keys. Values below 6 dB must be directly entered from the keypad or via SCPI. This protects against setting a dangerously small attenuation value, which can put the instrument at risk of damage to input circuitry. If the current mechanical attenuation is below 6 dB, it can be increased with the knob and step keys, but not decreased						
Max	<table border="1"> <tr> <td>CXA Option 503 or 507</td> <td>50 dB</td> </tr> <tr> <td>EXA</td> <td>60 dB</td> </tr> <tr> <td>All other models</td> <td>70 dB</td> </tr> </table> <p>Note that in the Single-Attenuator configuration, the total of ATT and EATT cannot exceed 50 dB. So, if the EATT is set to 24 dB first, the main attenuation cannot be greater than 26 dB and will be reduced accordingly; if the main attenuator is set to 40 dB first, EATT cannot be greater than 10 dB</p>	CXA Option 503 or 507	50 dB	EXA	60 dB	All other models	70 dB
CXA Option 503 or 507	50 dB						
EXA	60 dB						
All other models	70 dB						
Annotation	<p>The current value for Total Atten is displayed in the Measurement Bar at the top of the display. A value appears for Electronic Attenuation only if the Electronic Attenuator is enabled. The annotation appears as:</p> <p><i>Atten: <total> dB (e<elec>)</i></p> <p>The e letter is in amber in Single-Attenuator configurations</p> <p>For example:</p> <p>Dual-Attenuator configuration: <i>Atten: 24 dB (e14)</i></p> <p>Indicating the total attenuation is at 24 dB and the electronic attenuation is at 14 dB</p> <p>Single-Attenuator configuration: <i>A: 24 dB (e14)</i></p> <p>Indicating the total attenuation is at 24 dB and the "soft" attenuation is at 14 dB (see below for definition of "soft" attenuation)</p>						

When in Manual, a # sign appears in front of Atten in the annotation

Auto Function

Remote Command	<code>[:SENSe]:POWer[:RF]:ATTenuation:AUTO OFF ON 0 1</code> <code>[:SENSe]:POWer[:RF]:ATTenuation:AUTO?</code>
Example	Turn Auto Mech Atten ON: <code>:POW:ATT:AUTO ON</code>
Dependencies	<code>:POW:ATT:AUTO</code> is only available in measurements that support Auto , such as Swept SA
Preset	ON

Attenuator Configurations and Auto/Man

As described under "[Attenuation](#)" on page 1763, there are two distinct attenuator configurations available in the X-Series, the Single Attenuator and Dual-Attenuator configurations.

In Dual-Attenuator configurations, we have mechanical attenuation and electronic attenuation, and current total attenuation is the sum of electronic + mechanical attenuation.

In Single-Attenuator configurations, we refer to the attenuation set using "[Mech Atten](#)" on page 1079 (or `:POW:ATT`) as the "main" attenuation; and the attenuation that is set by `:POW:EATT` as the "soft" attenuation (`:POW:EATT` is honored even in the Single-Attenuator configuration, for compatibility purposes). Then current total attenuation is the sum of main + soft attenuation.

See "[Elec Atten](#)" on page 1769 for more about "soft" attenuation.

NOTE

In some measurements, the **Mech Atten** control has an **Auto/Man** function. In these measurements, an **Auto/Man** switch is shown on the **Mech Atten** control:

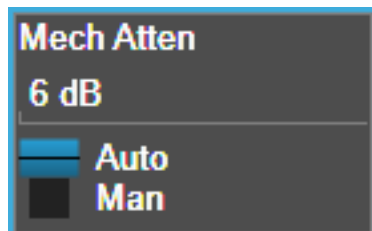

Note that in configurations that include an Electronic Attenuator, this switch is only shown when the Electronic Attenuator is disabled.

In other measurements, **Mech Atten** has no **Auto/Man** function. In these measurements, no switch is shown on the **Mech Atten** control:



Mech Atten also appears with no switch, as above, in configurations that include an Electronic Attenuator but when the Electronic Attenuator is enabled.

Elec Atten

Controls the Electronic Attenuator in Dual-Attenuator configurations. Does not appear in Single-Attenuator configurations, because the control of both the mechanical and electronic stages of the Single-Attenuator is integrated into the single **Atten** control.

This control includes an **Enable/Disable** toggle switch; it is only possible to enter a value for the Electronic Attenuator when this switch is in the **Enable** position.

For more details of the Electronic Attenuator, see ["More Information" on page 1084](#)

Remote Command	<code>[:SENSe]:POWer[:RF]:EATTenuation <rel_amp1></code> <code>[:SENSe]:POWer[:RF]:EATTenuation?</code>
Example	<code>:POW:EATT 10</code> <code>:POW:EATT?</code>
Notes	Electronic Attenuation's specification is defined only when Mech Atten is 6 dB
Dependencies	<p>Only appears in Dual-Attenuator models with an Electronic Attenuator installed and licensed. Does not appear in models with the Single-Attenuator configuration, because in the Single-Attenuator configuration there is no "electronic attenuator"; there is only a single integrated attenuator (which has both a mechanical and electronic stage). However, in the Single-Attenuator configuration, EATT SCPI commands are accepted for compatibility with other X-series instruments, and set a "soft" attenuation. The "soft" attenuation is treated as an addition to the "main" attenuation value set by the Attenuation control or <code>:POW:ATT</code>, and affects the total attenuation displayed on the Attenuation control and the Meas Bar</p> <p>The electronic attenuator, and the "soft" attenuation function provided in Single-Attenuator configurations, are unavailable above the low band (0-3.6 GHz, 0-3.4 GHz, 0-3 GHz, depending on the model). If the low band range is from 0-3.6 GHz, and Stop Frequency of the instrument is > 3.6 GHz, then the Enabled/Disabled section of the Elec Atten control will be OFF and grayed-out</p> <p>If "Internal Preamp" on page 1788 is ON (that is, set to Low Band or Full), the electronic attenuator (and the "soft" attenuation function provided in Single-Attenuator configurations) is unavailable. In this case the Enabled/Disabled section of the Elec Atten control will be OFF and grayed-out</p> <p>If either of the above is true, and the SCPI command is sent, an error indicating that the electronic attenuator is unavailable is returned</p> <p>If both the above are true, pressing the control generates error message -221, in other words, the</p>

3 VMA Mode
 3.7 Power Stat CCDF Measurement

frequency range lockout takes precedence

If the electronic/soft Attenuator is enabled, then the **Stop Freq** of the instrument is limited to 3.6 GHz and **Internal Preamp** is unavailable

If "LNA" on page 1790 is **ON**, the electronic attenuator (and the "soft" attenuation function provided in Single-Attenuator configurations) is unavailable. In this case the **Enabled/Disabled** section of the **Elec Atten** control will be **OFF** and grayed-out. This coupling works in the following modes/measurements:

- Channel Power, Occupied BW, ACP, SEM, Spurious Emissions, Power Stat CCDF measurements in all Modes
- Transmit On|Off Power measurement in 5GNR Mode
- Power vs. Time and Transmit Power measurement in GSM/EDGE Mode
- Burst Power measurement in Spectrum Analyzer Mode

The SCPI-only "soft" electronic attenuation for the single-attenuator configuration is not available in all measurements; in particular, it is not available in the Swept SA measurement

Couplings	Enabling and disabling the Electronic Attenuator affects the setting of the Mechanical Attenuator (in Dual-Attenuator configurations). This is described in more detail below and in " Mechanical Attenuator Transition Rules " on page 1084
Preset	0 dB
State Saved	Saved in instrument state
Min	0 dB
Max	Dual-Attenuator configuration: 24 dB Single-Attenuator configuration: the total of ATT and EATT cannot exceed 50 dB. So, if the EATT is set to 24 dB first, the main attenuation cannot be greater than 26 dB and will be reduced accordingly; if the main attenuator is set to 40 dB first, EATT cannot be greater than 10 dB
Annotation	See Annotation under the Mech Atten control description

Auto Function

Remote Command	<code>[:SENSe]:POWer[:RF]:EATTenuation:STATe OFF ON 0 1</code> <code>[:SENSe]:POWer[:RF]:EATTenuation:STATe?</code>
Example	<code>:POW:EATT:STAT ON</code> <code>:POW:EATT:STAT?</code>
Preset	OFF (Disabled) for Swept SA measurement ON (Enabled) for all other measurements that support the electronic attenuator

NOTE

The maximum **Center Frequency** for Low Band can change based on the selected **IFBW** for measurements that support IFBW (for example, Waveform measurement across all Modes that support it). In certain models (such as N9042B & N9032B), IFBW values ≤ 40 MHz have a maximum Low Band frequency of 3.6 GHz, while $40 \text{ MHz} < \text{IFBW} \leq 1 \text{ GHz}$ have a maximum of

3.3 GHz, and $1 \text{ GHz} < \text{IFBW} \leq 1.5 \text{ GHz}$ have a maximum of 3.5 GHz. This frequency is reflected in the disabled message displayed for Electrical Attenuator. For N9032B and N9042B IFBW values $> 1.5 \text{ GHz}$ do not support a **Center Frequency** that can reach the Low Band maximum frequency. In these cases, the Electrical Attenuator will remain disabled no matter the Center Frequency.

More Information

The electronic attenuator offers finer steps than the mechanical attenuator, has no acoustical noise, is faster, and is less subject to wear. These advantages primarily aid in remote operation and are negligible for front panel use. See ["Using the Electronic Attenuator: Pros and Cons" on page 1085](#) for a detailed discussion of the pros and cons of using the electronic attenuator.

For the Single-Attenuator configuration, for SCPI backwards compatibility, the "soft" attenuation feature replaces the Dual-Attenuator configuration's electronic attenuator. All the same couplings and limitations apply. See ["Attenuator Configurations and Auto/Man" on page 1768](#)

Mechanical Attenuator Transition Rules

When the Electronic Attenuator is enabled, the Mechanical Attenuator transitions to a state that has no Auto function. Below are the rules for transitioning the Mechanical Attenuator. Note that the information below *only* applies to the Dual-Attenuator configurations, and *only* when the Electronic Attenuator is installed:

When the Electronic Attenuation is enabled from a disabled state:

- The Mechanical Attenuator is initialized to 10 dB (this is its optimal performance setting). You can then set it as desired with SCPI, numeric keypad, step keys, or knob, and it behaves as it normally would in manual mode
- The Auto/Man state of (Mech) Atten is saved
- The Auto/Man toggle on the (Mech) Atten control disappears, and the auto rules are disabled
- The Electronic Attenuator is set to 10 dB less than the previous value of the Mechanical Attenuator, within the limitation that it must stay within the range of 0 to 24 dB of attenuation

Examples in the Dual-Attenuator configuration:

- Mech Atten at 20 dB. Elec Atten enabled, Mech Atten set to 10 dB, and Elec Atten set to 10 dB. New total attenuation equals the value before Elec Atten enabled

3 VMA Mode

3.7 Power Stat CCDF Measurement

- Mech Atten at 0 dB. Elec Atten enabled, Mech Atten set to 10 dB, and Elec Atten set to 0 dB. New total attenuation does not equal the value before Elec Atten enabled
- Mech Atten at 40 dB. Elec Atten enabled, Mech Atten set to 10 dB, and Elec Atten set to 24 dB. New total attenuation does not equal the value before Elec Atten enabled

When the Electronic Attenuation is disabled from an enabled state:

- The Elec Atten control is grayed out
- The Auto/Man state of (Mech) Atten is restored
- If now in Auto, (Mech) Atten recouples
- If now in Man, (Mech) Atten is set to the value of total attenuation that existed before the Elec Atten was disabled. The resulting value is rounded up to the smallest value possible given the (Mech) Atten Step setting - (That is, 57 dB changes to 58 dB when (Mech) Atten Step is 2 dB)

Using the Electronic Attenuator: Pros and Cons

The electronic attenuator offers finer steps than the mechanical attenuator, has no acoustical noise, is faster, and is less subject to wear.

The “finer steps” advantage of the electronic attenuator is beneficial in optimizing the alignment of the instrument dynamic range to the signal power in the front panel as well as remote use. Thus, you can achieve improved relative signal measurement accuracy. Compared to a mechanical attenuator with 2 dB steps, the 1 dB resolution of the electronic attenuator only gives better resolution when the odd-decibel steps are used. Those odd-decibel steps are less accurately calibrated than the even-decibel steps, so one tradeoff for this superior relative accuracy is reduced absolute amplitude accuracy.

Another disadvantage of the electronic attenuator is that the spectrum analyzer loses its “Auto” setting, making operation less convenient.

Also, the relationship between the dynamic range specifications (TOI, SHI, compression, and noise) and instrument performance are less well-known with the electrical attenuator. With the mechanical attenuator, TOI, SHI, and compression threshold levels increase dB-for-dB with increasing attenuation, and the noise floor does as well. With the electronic attenuator, there is an excess attenuation of about 1 to 3 dB between 0 and 3.6 GHz, making the effective TOI, SHI, and so forth, less well known. Excess attenuation is the actual attenuation relative to stated attenuation. Excess attenuation is accounted for in the instrument calibration.

Adjust Atten for Min Clipping

Sets the combination of mechanical and electronic attenuation and gain based on the current measured signal level so that clipping will be at a minimum.

This is an immediate action function, that is, it executes once, when the control is pressed.

The algorithms that are used for the adjustment are documented under "[Pre-Adjust for Min Clipping](#)" on page 1773.

Remote Command	<code>[:SENSe]:POWer[:RF]:RANGe:OPTimize IMMEDIATE</code>
Example	<code>:POW:RANG:OPT IMM</code>
Notes	Executing Adjust Atten for Min Clipping initiates the measurement
Dependencies	Does not appear in the Swept SA, RTSA, Monitor Spectrum and Complex Spectrum measurements Appears in the Waveform measurement in BASIC and 5G NR Modes

Adjust Atten

Allows you to select;

- Electric attenuator only
- Combination of Electric attenuator and Mechanical attenuator

when `[:SENSe]:POWer[:RF]:RANGe:OPTimize IMMEDIATE` is executed.

Remote Command	<code>[:SENSe]:POWer[:RF]:RANGe:OPTimize:TYPE EONLY COMBined</code> <code>[:SENSe]:POWer[:RF]:RANGe:OPTimize:TYPE?</code>
Example	<code>:POW:RANG:OPT:TYPE EONL</code> <code>:POW:RANG:OPT:TYPE?</code>
Dependencies	Does not appear in the Swept SA, RTSA, Monitor Spectrum and Complex Spectrum measurements Appears in the Waveform measurement in BASIC and 5G NR Modes
Preset	<code>COMBined</code>
State Saved	Saved in instrument state

Pre-Adjust for Min Clipping

If this function is **ON**, it applies the adjustment described under "[Adjust Atten for Min Clipping](#)" on page 1772 each time a measurement restarts. Therefore, in Continuous measurement mode, it only executes before the first measurement.

3 VMA Mode
 3.7 Power Stat CCDF Measurement

In Dual-Attenuator models, you can set **Elec+Mech Atten**, in which case both attenuators participate in the autoranging, or **Elec Atten Only**, in which case the mechanical attenuator does not participate in the autoranging. This latter case results in less wear on the mechanical attenuator and is usually faster.

See ["Adjustment Algorithm" on page 1088](#)

Selection	SCPI	Note
Off	OFF	This is the default setting
On	ON	Available in Single-Attenuator instruments. For compatibility with models that do not have an input attenuator, the ON parameter is supported and mapped to COMBined
Elec Atten Only	ELECtrical	Selects only the electric attenuator to participate in auto ranging. This offers less wear on the mechanical attenuator and is usually faster
Elec+Mech Atten	COMBined	In Dual-Attenuator models, this selects both attenuators to participate in the autoranging

Remote Command	[:SENSe]:POWer[:RF]:RANGe:OPTimize:ATTenuation OFF ON ELECtrical COMBined [:SENSe]:POWer[:RF]:RANGe:OPTimize:ATTenuation?	
Example	:POW:RANG:OPT:ATT OFF :POW:RANG:OPT:ATT?	
Notes	The parameter option ELECtrical sets this function to ON in Single-Attenuator models The parameter option COMBined is mapped to ELECtrical in Single-Attenuator models. If you send COMBined , it sets the function to ON and returns ELEC to a query For SCPI compatibility with models that do not have an input attenuator, the ON parameter is honored and mapped to COMBined	
Dependencies	Only appears in Dual-Attenuator models with an Electronic Attenuator installed In instruments with Dual-Attenuator model, when "Elec Atten" on page 1769 is OFF or grayed-out, "Pre-Adjust for Min Clipping" on page 1086 is grayed-out Does not appear in the Swept SA, RTSA, Monitor Spectrum and Complex Spectrum measurements Appears in the Waveform measurement in BASIC and 5G NR Modes	
Preset	OFF when Elec Atten is Disabled at preset, otherwise ELEC	
State Saved	Saved in instrument state	
Range	Dual-Attenuator models:	Off Elec Atten Only Mech + Elec Atten
	Single-Attenuator models:	Off On

Backwards Compatibility Command

Notes	ON aliases to "Elec Atten Only" (:POW:RANG:OPT:ATT ELEC) OFF aliases to "Off" (:POW:RANG:OPT:ATT OFF)
-------	--

	<code>:POW:RANG:AUTO?</code> returns true if <code>:POW:RANG:OPT:ATT</code> is not <code>OFF</code>
Backwards	<code>[:SENSe]:POWer[:RF]:RANGe:AUTO ON OFF 1 0</code>
Compatibility	<code>[:SENSe]:POWer[:RF]:RANGe:AUTO?</code>
SCPI	

Adjustment Algorithm

The algorithms for the adjustment are documented below:

Single-Attenuator Models

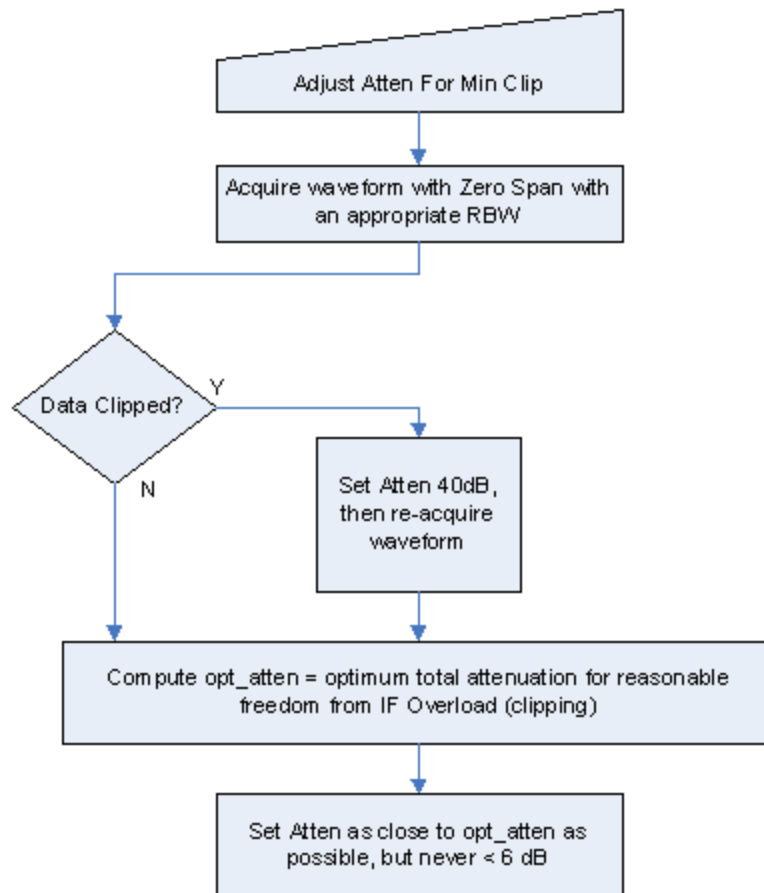

Dual-Attenuator models

"Adjust Atten for Min Clipping" on page 1772 or "Pre-Adjust for Min Clipping" on page 1086 selection is Mech + Elec Atten:

3 VMA Mode
 3.7 Power Stat CCDF Measurement

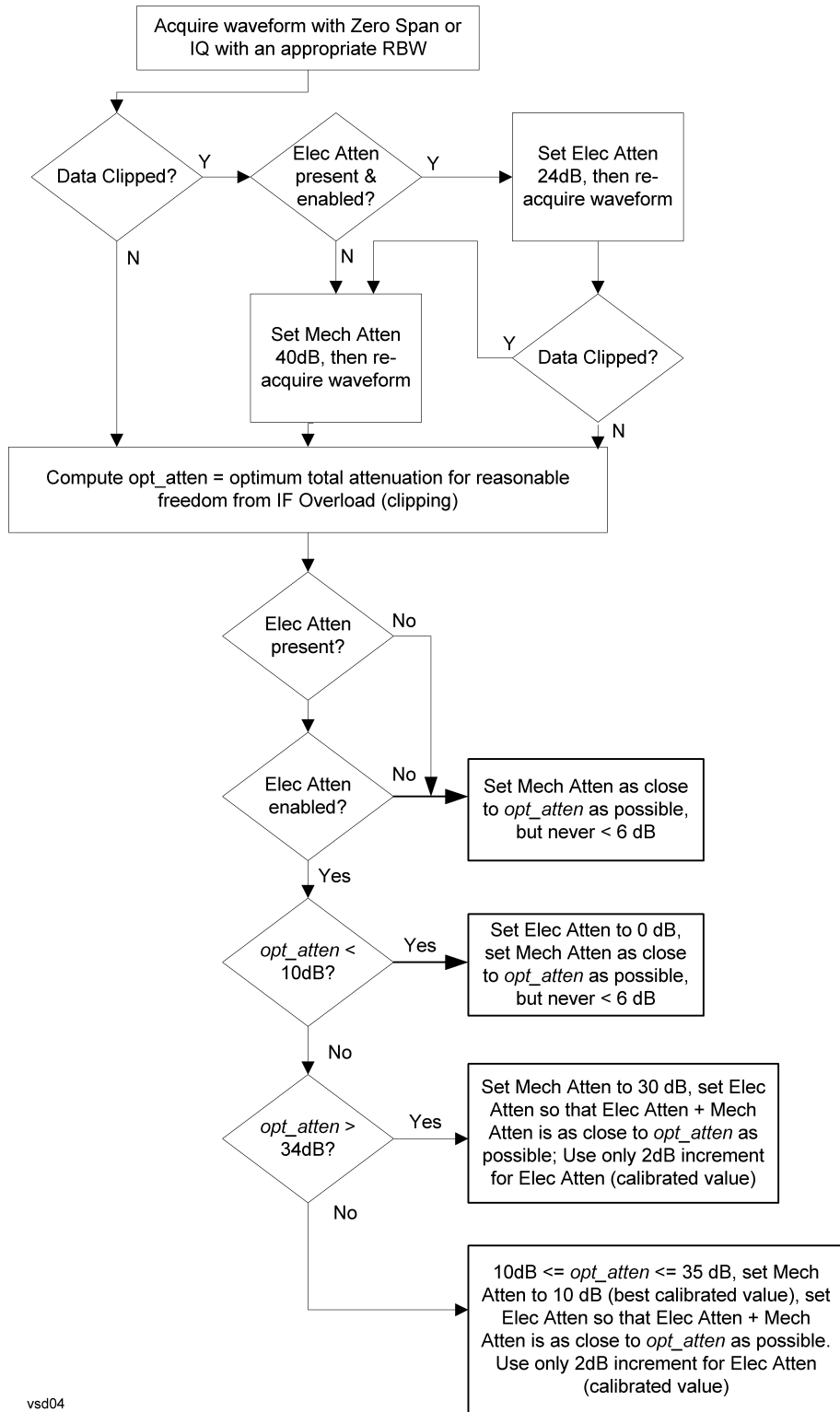

vsd04

"Pre-Adjust for Min Clipping" on page 1086 selection is Elec Only.

Note that the **Mech Atten** value is not adjusted, and the value previously set is used. Therefore, there is a case that IF Overload is still observed depending on the input signal level and the Mech Atten setting.

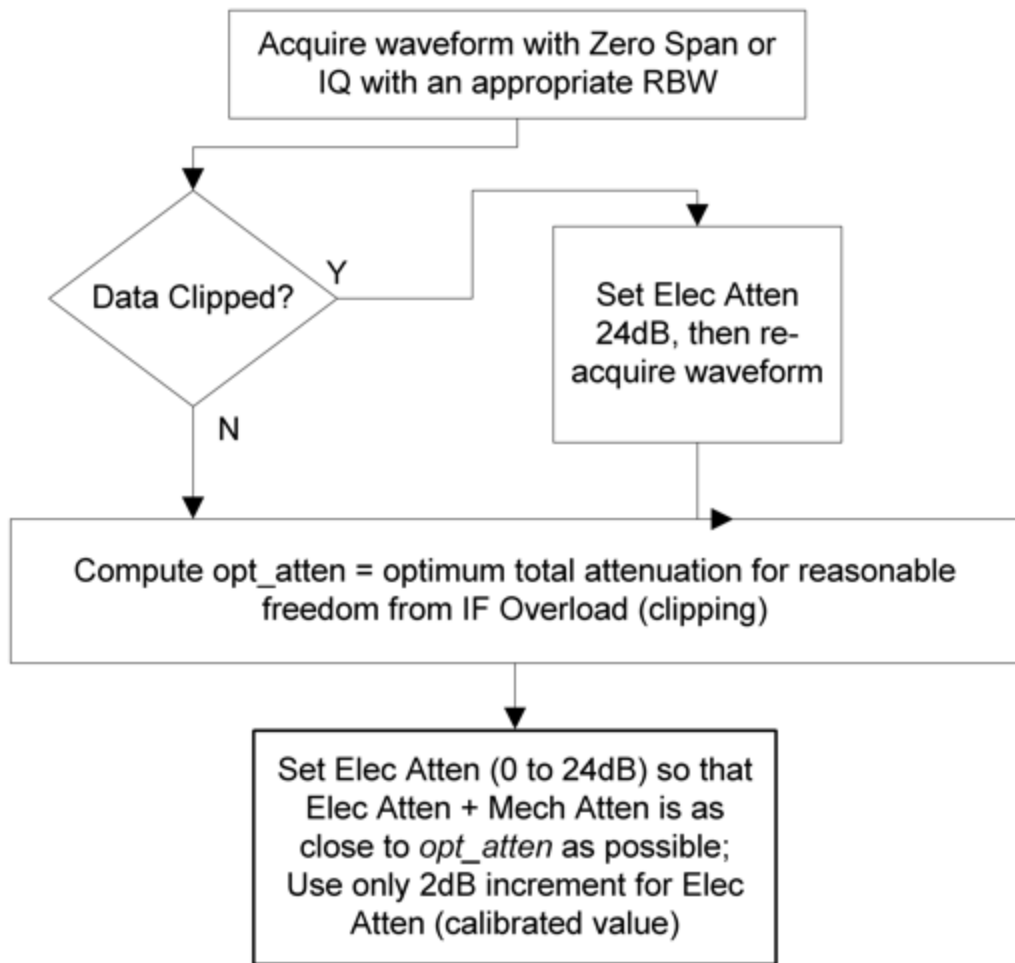

Mech Atten Step

Controls the step size used when making adjustments to the input attenuation.

Labeled **Mech Atten Step** in Dual-Attenuator models and **Atten Step** in Single-Attenuator models. In the Dual-Attenuator configuration, only affects the step size of the mechanical attenuator.

Remote Command `[:SENSe]:POWer[:RF]:ATTenuation:STEP[:INCRement] 10 dB | 2 dB`

3 VMA Mode
 3.7 Power Stat CCDF Measurement

	<code>[:SENSe]:POWer[:RF]:ATTenuation:STEP[:INCRement]?</code>
Example	<code>:POW:ATT:STEP 2</code> <code>:POW:ATT:STEP?</code>
Notes	Has a toggle control on the front panel, but takes a specific value (in dB) when used remotely. The only valid values are 2 and 10
Dependencies	Blanked in EXA, CXA and CXA-m if option FSA (2 dB steps) is not present. If blanked, attempts to set it via SCPI yield an error
Couplings	When the attenuation step size changes, the current mechanical attenuation value is adjusted (if necessary) to be quantized to the new step size. That is, if step is set to 10 dB, mech atten is increased if necessary so it is a multiple of 10 dB
Preset	EXA, CXA and CXA-m: 10 dB (2 dB with option FSA) All other models: 2 dB
State Saved	Saved in instrument state

3.7.3.3 Range (Baseband Input models)

Only available when Option BBA is present (I/Q Baseband Inputs), the current measurement supports option BBA, and I/Q is the selected input. In these cases, replaces the **Attenuation** tab.

Each input channel (I and Q) has four internal gain ranges. The maximum allowed voltage in each gain range is slightly more than the nominal value, so the break point between ranges is a few millivolts higher than the nominal (setting a peak voltage of 0.502 mV will still map to the 0.5 V Peak range).

Gain Setting	Volts RMS	Volts Peak	Volts Peak - Peak	dBm (50Ω)	Break Point
0 dB	0.7071	1.0	2.0	10	n/a
6 dB	0.3536	0.5	1.0	4	0.502 V Peak
12 dB	0.1768	0.25	0.5	-2	0.252 V Peak
18 dB	0.0884	0.125	0.25	-8	0.127 V Peak

Dependencies	Available only when the selected input is I/Q. If the current measurement does not support baseband inputs, an error will be displayed: "No result; Meas invalid with I/Q inputs"
State Saved	No

Range Auto/Man

The **Auto** setting for **Range** causes the range to be set based on the Y Scale settings. When **Range** is **Auto**, the I & Q Range are set based on the top of the Y Scale when the Y scale is in dB units (for example, power), or to the max(abs(top), abs(bottom)) when the Y scale reference is not at the top of the screen.

Not all measurements support **Range Auto/Man**. If **Auto** is not supported in the current measurement, this control is grayed-out, displaying **Man**, and **MAN** is returned to a SCPI query, but this does *not* change the Auto/Man setting for **Range**. When you switch to a measurement that supports **Auto**, it goes back to **Auto** if it was previously in **Auto** mode.

Remote Command	<code>[:SENSe]:VOLTage:IQ:RANGe:AUTO OFF ON 0 1</code> <code>[:SENSe]:VOLTage:IQ:RANGe:AUTO?</code>
Example	Put the I Range and Q Range in manual <code>:VOLT:IQ:RANG:AUTO OFF</code> <code>:VOLT:IQ:RANG:AUTO?</code>
Dependencies	If Auto is not supported, sending the SCPI command generates an error
Couplings	When in Auto , both I Range and Q Range are set to the same value, computed as follows: Maximum absolute value is computed for the Y Scale. The top and bottom of the graph are computed based on Ref Value, Scale/Div, and Ref Position. Formula: $Y_{Max} = \max(\text{abs}(\text{top}), \text{abs}(\text{bottom}))$ The I Range and Q Range are then set to YMax
Preset	ON
State Saved	Saved in instrument state
Annotation	When in Man, the Range annotation is preceded by "#" This is an alternate form of the command to match the POWer form of the I Range and Q Range SCPI.
Remote Command	<code>[:SENSe]:POWer:IQ:RANGe:AUTO OFF ON 0 1</code> <code>[:SENSe]:POWer:IQ:RANGe:AUTO?</code>
Example	Put the I Range and Q Range in manual <code>:POW:IQ:RANG:AUTO OFF</code> <code>:POW:IQ:RANG:AUTO?</code>
Notes	<code>:POW:IQ:RANG:AUTO</code> is an alternate form of <code>:VOLT:IQ:RANG:AUTO</code> , to maintain consistency with I Range and Q Range, which support both the POWer and VOLTage forms of the command
Preset	ON
Range	Auto Man

I Range

The internal gain range for the I channel when the Input Path is I Only or I and I/Q. Used for both the I and Q channels when the Input Path is I+jQ.

Remote Command	<code>[:SENSe]:VOLTage:IQ[:I]:RANGe[:UPPer] <voltage></code> <code>[:SENSe]:VOLTage:IQ[:I]:RANGe[:UPPer]?</code>
Example	Set the I Range to 0.5 V Peak <code>:VOLT:IQ:RANG 0.5 V</code>

3 VMA Mode
3.7 Power Stat CCDF Measurement

	<code>:VOLT:IQ:RANG?</code>
Notes	The numeric entries are mapped to the smallest gain range whose break point is greater than or equal to the value, or 1 V Peak if the value is greater than 1 V
Couplings	When " Q Same as I " on page 1782 is On, the I Range value will be copied to " Q Range " on page 1781 Changing the value also sets Range = Man
Preset	Complex SPECTrum Measurement: 0.5 V Peak All others: 1 V Peak
State Saved	Saved in instrument state
Range	1 V Peak (10 dBm @ 50 Ω) 0.5 V Peak (4 dBm @ 50Ω) 0.25 V Peak (-2 dBm @ 50Ω) 0.125 V Peak (-8 dBm @ 50Ω)
Min	0.125 V
Max	1 V
Annotation	The Range annotation replaces the RF Input context's "Atten" annotation "Rng: <I Range>". When Range = Man the annotation is preceded by "#" The I Range is not annotated in Input Path Q Only. When I Range and Q Range are the same, the annotation is "Rng: <Range>". When I Range and Q Range are different and the Input Path is Ind I/Q, the annotation is "Rng: <I Range>, <Q Range>" and "Peak" is removed from the text. Examples: "Rng: 1 V Peak" the I Range is 1 V Peak "Rng: 1 V, 0.5 V " the I Range is 1 V Peak and the Q Range is 0.5 V Peak This is an alternate form of the command to allow entry as a power.
Remote Command	<code>[:SENSe]:POWer:IQ[:I]:RANGe[:UPPer] <amp;pl></code> <code>[:SENSe]:POWer:IQ[:I]:RANGe[:UPPer]?</code>
Example	Set the I Range to 0.5 V Peak when Reference Z is 50 Ω, and to 1.0 V Peak when Reference Z is 75 Ω <code>:POW:IQ:RANG 4 dBm</code> <code>:POW:IQ:RANG?</code>
Notes	The POWer form of the command is provided for convenience. It maps to the same underlying gain range parameter as the VOLTage form The Reference Z (not the I channel Input Z) is used to convert the power to peak voltage, which is then used to set the I Range as with the VOLTage form of the command. The power values of the 4 range states (1V Peak, 0.5V Peak, 0.25V Peak, and 0.125V Peak) will vary with Reference Z. Here are some examples: 50 Ω: 10, 4, -2, -8 75 Ω: 8.2, 2.2, -3.8, -9.8 600 Ω: -0.8, -6.8, -12.8, -18.9
Preset	10.0 dBm
Range	-20 dBm to 10 dBm
Min	-20 dBm
Max	10 dBm

Q Range

The internal gain range for the Q channel. **Q Range** only applies to Input Path Q Only and Ind I/Q. For input I+jQ "[I Range](#)" on page 1779 determines both I and Q channel range settings.

Remote Command	<code>[:SENSe]:VOLTage:IQ:Q:RANGe[:UPPer] <voltage></code> <code>[:SENSe]:VOLTage:IQ:Q:RANGe[:UPPer]?</code>
Example	Set the Q Range to 0.5 V Peak: <code>:VOLT:IQ:Q:RANG 0.5 V</code> <code>:VOLT:IQ:Q:RANG?</code>
Notes	The numeric entries are mapped to the smallest gain range whose break point is greater than or equal to the value, or 1 V Peak if the value is greater than 1 V Q Range is only used for Input Path Q Only and Ind I/Q. For input I+jQ, " I Range " on page 1779 determines both I and Q channel range settings
Couplings	When " Q Same as I " on page 1782 is On, the " I Range " on page 1779 value is copied to Q Range and the range value keys are disabled Changing the value also sets Range = Man
Preset	1 V Peak
State Saved	Saved in instrument state
Range	1 V Peak (10 dBm @ 50Ω) 0.5 V Peak (4 dBm @ 50Ω) 0.25 V Peak (-2 dBm @ 50Ω) 0.125 V Peak (-8 dBm @ 50Ω)
Min	0.125 V
Max	1 V
Annotation	The Range annotation replaces the RF Input context's "Atten" annotation "Rng: <Q Range>". When Range = Man the annotation is preceded by "#" The Q Range is not annotated in Input Path I Only or I+jQ. When I Range and Q Range are the same, the annotation is "Rng: <Range>". When I Range and Q Range are different and the Input Path is Ind I/Q, the annotation is "Rng: <I Range>, <Q Range>" and "Peak" is removed from the text. Examples: "Rng: 1 V Peak" the Q Range is 1 V Peak "Rng: 1 V, 0.5 V" the I Range is 1 V Peak and the Q Range is 0.5 V Peak This is an alternate form of the command to allow entry as a power.
Remote Command	<code>[:SENSe]:POWer:IQ:Q:RANGe[:UPPer] <amp;gt;</code> <code>[:SENSe]:POWer:IQ:Q:RANGe[:UPPer]?</code>
Example	Sets the Q Range to 0.5 V Peak when Reference Z is 50 Ω, and to 1.0 V Peak when Reference Z is 75 Ω: <code>:POW:IQ:Q:RANG 4 dBm</code> <code>:POW:IQ:Q:RANG?</code>
Notes	The POWer form of the command is provided for convenience. It maps to the same underlying gain

3 VMA Mode
3.7 Power Stat CCDF Measurement

range parameter as the **VOLTage** form of the command

The Reference Z (not the Q channel Input Z) is used to convert the power to peak voltage, which is then used to set the Q Range as with the **VOLTage** form of the command. The power values of the 4 range states (1V Peak, 0.5V Peak, 0.25V Peak, and 0.125V Peak) will vary with Reference Z. Here are some examples:

50 Ω: 10, 4, -2, -8

75 Ω: 8.2, 2.2, -3.8, -9.8

600 Ω: -0.8, -6.8, -12.8, -18.9

Preset	10.0 dBm
Range	-20 dBm to 10 dBm
Min	-20 dBm
Max	10 dBm

Q Same as I

Many, but not all, usages require the I and Q channels to have an identical setup. To simplify channel setup, **Q Same as I** causes the Q channel range to be mirrored from the I channel. That way, you only need to set up one channel (the I channel). The I channel values are copied to the Q channel, so at the time **Q Same as I** is Off, the I and Q channel setups will be identical.

Remote Command	<code>[:SENSe] :VOLTage POWer:IQ:MIRROred OFF ON 0 1</code> <code>[:SENSe] :VOLTage POWer:IQ:MIRROred?</code>
Example	Turn off the mirroring of I Range to Q Range <code>:VOLT:IQ:MIRR OFF</code> <code>:POW:IQ:MIRR OFF</code>
Couplings	When ON , the " I Range " on page 1779 value is mirrored (copied) to the " Q Range " on page 1781
Preset	ON
State Saved	Saved in instrument state
Range	OFF ON

3.7.3.4 Range (Non-attenuator models)

Only available for Keysight's modular signal analyzers and certain other Keysight products, such as VXT and M941xE.

State Saved	No
-------------	----

Range

Represents the amplitude of the largest sinusoidal signal that could be present within the IF without being clipped by the ADC. For signals with high peak-to-average ratios, the range may need to exceed the rms signal power by a significant amount to avoid clipping.

This is a measurement global setting.

Remote Command	<code>[:SENSe]:POWer[:RF]:RANGe <real></code> <code>[:SENSe]:POWer[:RF]:RANGe?</code>
Example	<code>:POW:RANG 10 dBm</code> <code>:POW:RANG?</code>
Notes	The MIN and MAX values are affected by the External Gain parameters, and by the Center Frequency . The hardware compensates for frequency response and alters the Range setting.
Preset	0 dBm
State Saved	Yes
Min/Max	-/+100
Annotation	Meas Bar

Adjust Range for Min Clipping

Sets the combination of attenuation and gain based on the current measured signal level so that clipping will be at a minimum.

This is an "immediate action" function, that is, it executes once, when the key is pressed.

This key does not appear in measurements that do not support this functionality.

Remote Command	<code>[:SENSe]:POWer[:RF]:RANGe:OPTimize IMMEDIATE</code>
Notes	Executing Adjust Range for Min Clipping initiates the measurement.
Dependencies	Does not appear in the Swept SA and Monitor Spectrum measurements.

Pre-Adjust for Min Clipping

If this function is **ON**, it applies the adjustment described under Adjust Range For Min Clipping each time a measurement restarts. Therefore, in Continuous measurement mode, it only executes before the first measurement.

Remote Command	<code>[:SENSe]:POWer[:RF]:RANGe:OPTimize:ATTenuation OFF ON ELECTRICAL COMBined</code>
----------------	---

	<code>[:SENSe]:POWer[:RF]:RANGe:OPTimize:ATTenuation?</code>
Notes	Because there is no attenuator control available in these models, the control displays only ON and OFF choices. However, for SCPI compatibility with other platforms, all three parameters (ELECTrical , COMBined , and ON) are honored and all are mapped to ELECTrical , so if any of these three parameters is sent, a subsequent query will return ELEC
Dependencies	Does not appear in the Swept SA and Monitor Spectrum measurements
Preset	OFF for Swept SA measurement; ON for all other measurements that support Pre-Adjust for Min Clipping
State Saved	Saved in instrument state

Adjustment Algorithm

The algorithm for the adjustment is documented below:

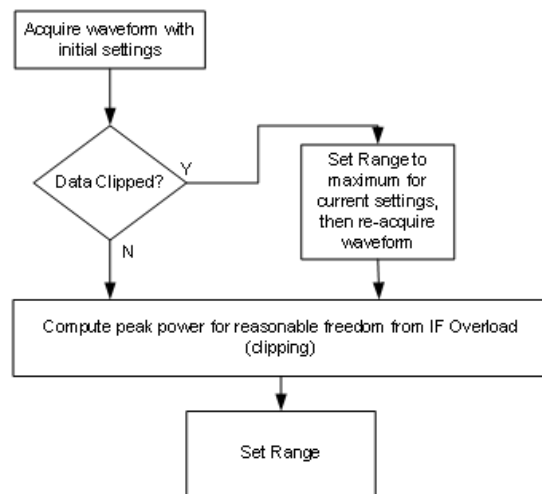

Peak-to-Average Ratio

Used with "[Range \(Non-attenuator models\)](#)" on page 1782 to optimize the level control in the instrument. The value is the ratio, in dB, of the peak power to the average power of the signal to be measured. A ratio of 0 should be used for sinusoidal signals; for 802.11g OFDM signals use 9 dB.

All Modes show the current value of Peak-to-Average ratio on the control. However, some Modes do not permit changing the value. In these situations, the control is grayed-out.

Remote Command	<code>[:SENSe]:POWer[:RF]:RANGe:PARatio <real></code> <code>[:SENSe]:POWer[:RF]:RANGe:PARatio?</code>
Example	<code>:POW:RANG:PAR 12 dB</code>
Notes	In some Modes, this parameter is read-only; meaning the value will appear on the control and query

	via SCPI, but is not changeable. In such applications the control is grayed-out. Attempts to change the value via SCPI are ignored, but no error message is generated	
Dependencies	Does not appear in Spectrum Analyzer Mode	
Preset	VXT Models M9410A/11A	0 dB
	All Others	10 dB
State Saved	Saved in instrument state	
Min	0 dB	
Max	VXT Models M9410A/11A	50 dB
	All Others	20 dB

Mixer Lvl Offset

This is an advanced setting to adjust target Range at the input mixer, which in turn affects the signal level in the instrument's IF. This setting can be used when additional optimization is needed after setting "[Peak-to-Average Ratio](#)" on page 1784. Positive values of offset optimize noise performance over distortion, negative values optimize distortion performance over noise.

Remote Command	<code>[:SENSe]:POWer[:RF]:RANGe:MIXer:OFFSet <real></code> <code>[:SENSe]:POWer[:RF]:RANGe:MIXer:OFFSet?</code>	
Example	<code>:POW:RANG:MIX:OFFS -5 dB</code>	
Preset	0 dB	
State Saved	Saved in instrument state	
Min	VXT Models M9410A/11A	-34 dB
	All Others	-35 dB
Max	30 dB	

3.7.3.5 Signal Path

Contains controls that pertain to the routing of the signal through the frontend of the instrument.

In general, only appears in instruments whose hardware supports this signal routing. For example, this tab does not appear in many of the modular instrument products, including VXT Model M9420A, or UXM.

This tab *does* appear in VXT Models M9410A/11A/15A/16A and M9410E/11E/15E/16E, because ["Software Preselection" on page 1801](#) is under this tab, and VXT Models M9410A/11A/15A/16A and M9410E/11E/15E/16E implement a version of Software Preselection.

Presel Center

Adjusts the centering of the preselector filter to optimize the amplitude accuracy at the frequency of the selected marker. If the selected marker is not on when **Presel Center** is pressed, the instrument turns on the selected marker, performs a peak search, and then performs centering on the marker's center frequency. If the selected marker is already on and between the start and stop frequencies of the instrument, the instrument performs the preselector calibration on that marker's frequency. If the selected marker is already on, but outside the frequency range between **Start Freq** and **Stop Freq**, the instrument first performs a peak search, and then performs centering on the marker's center frequency.

The value displayed on ["Preselector Adjust" on page 1787](#) changes to reflect the new preselector tuning.

Certain considerations should be observed to ensure proper operation, as detailed in ["Proper Preselector Operation" on page 1100](#).

Remote Command	<code>[:SENSe] :POWer [:RF] :PCENter</code>
Example	<code>:POW:PCEN</code>
Notes	The rules outlined above under the control description apply for the remote command as well as the key. The result of the command depends on marker position, etc. Any message generated by the control press is also generated in response to the remote command
Dependencies	Does not appear in CXA-m, nor in VXT Models M9410A/11A/15A/16A, M9410E/11E/15E/16E Grayed-out if the microwave preselector is off <ul style="list-style-type: none"> - If the selected marker's frequency is below Band 1, an advisory message is generated "Preselector not used in this frequency range" and no action is taken - Grayed-out if entirely in Band 0, that is, if Stop Freq is below about 3.6 GHz Grayed-out if entirely above 50 GHz, that is, if Start Freq is above 50 GHz - Blanked in models that do not include a preselector, such as Option 503. If the remote command is sent in these instruments, accepted without error, and the query always returns 0 - Grayed-out in the Spectrogram View
Couplings	The active marker position determines where the centering will be attempted If the instrument is in a measurement such as averaging when centering is initiated, the act of centering the preselector restarts averaging, but the first average trace will not be taken until the centering is completed The offset applied to do the centering appears in "Preselector Adjust" on page 1787
Status Bits/OPC	When centering the preselector, *OPC does not return true until the process is complete and a

dependencies subsequent measurement has completed, nor are results returned in response to `:READ` or `:MEASure` queries
The **Measuring** bit remains set (true) while this command is operating, and does not go false until the subsequent sweep/measurement has completed

Proper Preselector Operation

Certain considerations should be observed to ensure proper operation:

1. If the selected marker is **Off**, the instrument turns on a marker, performs a peak search, and adjusts the preselector using the selected marker's frequency. It uses the "highest peak" peak search method unqualified by threshold or excursion, so that there is no chance of a 'no peak found' error. It continues with that peak, even if it is the peak of just noise. Therefore, for this operation to work properly, there should be a signal on-screen in a preselected range for the peak search to find
2. If the selected marker is already **On**, the instrument attempts the centering at that marker's frequency. There is no preselector for signals below about 3.6 GHz, so if the marker is on a signal below 3.6 GHz, no centering is attempted, and an advisory message is generated
3. In some models, the preselector can be bypassed. If it is bypassed, no centering is attempted in that range and a message is generated

Preselector Adjust

Lets you manually adjust the preselector filter frequency to optimize its response to the signal of interest. Only available when **"Presel Center"** on page 1786 is available.

For general purpose signal analysis, using **Presel Center** is recommended. Centering the filter minimizes the impact of long-term preselector drift. **Preselector Adjust** can be used instead to manually optimize the preselector. One application of manual optimization would be to peak the preselector response, which both optimizes the signal-to-noise ratio and minimizes amplitude variations due to small (short-term) preselector drifting.

When **Presel Center** is performed, the offset applied to do the centering becomes the new value of **Preselector Adjust**.

Remote Command	<code>[:SENSe] :POWer [:RF] :PADJust <freq></code> <code>[:SENSe] :POWer [:RF] :PADJust?</code>
Example	<code>:POW:PADJ 100KHz</code> <code>:POW:PADJ?</code>
Notes	The value on the control is displayed to 0.1 MHz resolution
Dependencies	- Does not appear in CXA-m

3 VMA Mode
 3.7 Power Stat CCDF Measurement

- Does not appear in VXT Models M9410A/11A/15A/16A
- Does not appear in M9410E/11E/15E/16E
- Grayed-out if microwave preselector is off
- Grayed-out if entirely in Band 0, that is, if Stop Freq is lower than about 3.6 GHz
- Grayed-out if entirely above 50 GHz, that is, if Start Freq is higher than 50 GHz
- Blank in models that do not include a preselector, such as Option 503. If the command is sent in these instruments, it is accepted without error, and the query always returns 0
- Grayed-out in the **Spectrogram View**

Preset	0 MHz
State Saved	The Preselector Adjust value set by " Presel Center " on page 1786, or by manually adjusting Preselector Adjust Not saved in instrument state, and does not survive a Preset or power cycle
Min/Max	-/+500 MHz
Backwards Compatibility SCPI	<code>[:SENSe]:POWer[:RF]:MW:PADJust</code> <code>[:SENSe]:POWer[:RF]:MMW:PADJust</code> Backwards Compatibility Command
Notes	The command has no effect, and the query always returns MWAVE
Backwards Compatibility SCPI	<code>[:SENSe]:POWer[:RF]:PADJust:PRESelector MWAVE MMWave EXTERNAL</code> <code>[:SENSe]:POWer[:RF]:PADJust:PRESelector?</code>

Internal Preamp

Accesses a menu of controls for the internal preamps. Turning on the preamp gives a better noise figure, but a poorer inter-modulation distortion (TOI) to noise floor dynamic range. You can optimize this setting for your measurement.

The instrument takes the preamp gain into account as it sweeps. If you sweep outside of the range of the preamp, the instrument will also account for that. The displayed result always reflects the correct gain.

For some measurements, when the preamp is on and any part of the displayed frequency range is below the lowest frequency for which the preamp has specifications, a warning condition message appears in the status line. For example, for a preamp with a 9 kHz lowest specified frequency: "Preamp: Accy unspec'd below 9 kHz".

Selection	Example	Note
Off	:POW:GAIN OFF	
Low Band	:POW:GAIN ON :POW:GAIN:BAND LOW	Sets the internal preamp to use only the low band. The frequency range of the installed (optional) low-band preamp is displayed in square brackets on the Low Band selection in the dropdown
Full Range	:POW:GAIN ON :POW:GAIN:BAND FULL	Sets the internal preamp to use its full range. The low band (0-3.6 GHz, 0-3.4 GHz, 0-3 GHz, depending on the model) is supplied by the low band preamp and the frequencies above low band are supplied by the high band preamp The frequency range of the installed (optional) low-band preamp is displayed in square brackets on the Full Range selection in the dropdown. If the high band option is not installed the Full Range selection does not appear

NOTE

The maximum **Center Frequency for Low Band**, displayed in square brackets, can change based on the selected IFBW for measurements that support IFBW (for example, Waveform measurement across all Modes that support it). In certain models (such as N9042B & N9032B), IFBW values ≤ 40 MHz have a maximum **Low Band** frequency of 3.6 GHz, while $40 \text{ MHz} < \text{IFBW} \leq 1 \text{ GHz}$ have a maximum of 3.3 GHz, and $1 \text{ GHz} < \text{IFBW} \leq 1.5 \text{ GHz}$ have a maximum of 3.5 GHz. IFBW values $> 1.5 \text{ GHz}$ do not support a **Center Frequency** that can reach the **Low Band** maximum frequency. In these cases, **N/A** is displayed in the square brackets for **Low Band**.

Remote Command	<code>[:SENSe]:POWer[:RF]:GAIN:BAND LOW FULL</code> <code>[:SENSe]:POWer[:RF]:GAIN:BAND?</code>
Example	<code>:POW:GAIN:BAND LOW</code> <code>:POW:GAIN:BAND?</code>
Dependencies	Not available on all hardware platforms. If the preamp is not present or is unlicensed, this control is not shown Does not appear in VXT Models M9410A/11A/15A/16A nor in M9410E/11E/15E/16E If <code>:POW:GAIN:BAND FULL</code> is sent when a low band preamp is available, the preamp band parameter is set to <code>LOW</code> instead of <code>FULL</code> , and an "Option not installed" message is generated Not available when the electronic/soft attenuator is enabled
Preset	<code>LOW</code>
State Saved	Saved in instrument state
Annotation	When the USB Preamp is not connected to USB, the Preamp annotation in the Meas Bar says "Off" if the preamp is off and displays the frequency range of the low band or full range preamp depending on the setting. For example, if the Preamp is set to Low Band and the Low Band is 3.6 GHz the annotation says "3.6 GHz". If it is a 13.6 GHz preamp and it is set to Full Range the annotation says "13.6 GHz"

3 VMA Mode
3.7 Power Stat CCDF Measurement

When the USB Preamp is connected to USB, the Preamp annotation says "Preamp: USB" if the internal preamp is off or "Preamp: USB, Int" if the internal preamp is on (only for measurements that support the USB preamp)

Auto Function

Remote Command	<code>[:SENSe]:POWer[:RF]:GAIN[:STATe] OFF ON 0 1</code> <code>[:SENSe]:POWer[:RF]:GAIN[:STATe]?</code>
Example	<code>:POW:GAIN OFF</code> <code>:POW:GAIN?</code>
Preset	<code>OFF</code>

LNA

Lets you turn the Low Noise Amplifier (**LNA**) on or off.

LNA is an additional preamplifier that provides superior DANL and frequency range compared to "[Internal Preamp](#)" on page 1788. LNA provides lower system noise figure, especially at frequencies above 100 MHz, and can be operated up to the full range of 50 GHz instruments.

For best possible sensitivity, **LNA** can be turned on *together* with "[Internal Preamp](#)" on page 1788, although if you operate both preamps together, note that the TOI (distortion) specifications are impacted. The sensitivity improvement of this combination is substantial when operating in high band (frequencies above 3.6 GHz).

For more details about annotation, see "[More Information](#)" on page 1104

Remote Command	<code>[:SENSe]:POWer[:RF]:GAIN:LNA[:STATe] OFF ON 0 1</code> <code>[:SENSe]:POWer[:RF]:GAIN:LNA[:STATe]?</code>
Example	<code>:POW:GAIN:LNA ON</code>
Dependencies	Requires Option LNA, except for VXT models M9415A/16A Does not appear in VXT models M9420A/10A/11A M9410E/11E/15E/16E support LNA May not appear in some measurements LNA is not available when the electronic/soft attenuator is enabled
Preset	<code>OFF</code>
State Saved	Saved in State

More Information

When **LNA** is installed, the preamp annotation changes to show the state of both **LNA** and **Internal Preamp**. Below is an example:

```
Atten: 8 dB
Pre: Int on, LNA on
μW Path: LNP, On
Source: Off
```

Note that when operating entirely in the low band (below about 3.6 GHz), if **LNA** is on, **Internal Preamp** is switched off (even if you have its switch set to **ON**). This is because the noise performance is actually degraded in low band if both preamps are on. In this case, the annotation reflects the actual state of the two preamps, but the **Internal Preamp** annotation displays in amber, to warn you that the actual state of **Internal Preamp** does not match its switch control display:

```
Atten: 8 dB
Pre: Int off, LNA on
μW Path: LNP, On
Source: Off
```

μW Path Control

Options for this control include **μW Preselector Bypass** (Option MPB), **Low Noise Path** (Option LNP) and **Full Bypass Enable** in the High Band path circuits.

When the μW Preselector is bypassed, flatness is improved, but will be subject to spurs from out of band interfering signals. When **Low Noise Path Enable** is selected, the instrument automatically bypasses certain circuitry in the high frequency bands that can contribute to noise, when it is appropriate based on other instrument settings.

For most applications, the preset state is **Standard Path**, which provides the best remote-control throughput, minimizes acoustic noise from switching and minimizes the risk of wear in the hardware switches, particularly in remote test scenarios where both low band and high band setups will follow in rapid succession. In this path, the bypass of the low band/high band switch and microwave preamp is never activated, which can cause some noise degradation but preserves the life of the bypass switch.

For applications that utilize the wideband IF paths, the preset state is **μW Preselector Bypass**, if option MPB is present. This is because, when using a wideband IF such as the 140 MHz IF, the μW Preselector's bandwidth can be narrower than the available IF bandwidth, causing degraded amplitude flatness and phase linearity, so it is desirable to bypass the preselector in the default case.

You may choose **Low Noise Path Enable** for a lower noise floor, especially in the 21-26.5 GHz region, though without improving many measures of dynamic range, and

3 VMA Mode
 3.7 Power Stat CCDF Measurement

without giving the best possible noise floor. The preamp, if purchased and used, gives better noise floor than does **Low Noise Path Enable**, but the preamp's compression threshold and third-order intercept are much poorer than that of **Low Noise Path Enable**.

A fourth choice is **Full Bypass Enable**, which combines **μW Preselector Bypass** and **Low Noise Path Enable**. Because this can bypass most of the circuitry between the input and the first mixer, care should be taken when using this setting to avoid damaging the mixer. **Full Bypass Enable** is only available if both options LNP and MPB are present, as well as option FBP.

Path	Example	Note
Standard Path	:POW:MW:PATH STD	Normal setting for most measurements. μW Preselector in circuit, Low Noise Path disabled
Low Noise Path Enable	:POW:MW:PATH LNP	See " Low Noise Path Enable " on page 1109
μW Preselector Bypass	:POW:MW:PATH MPB	See " μW Preselector Bypass " on page 1111
Full Bypass Enable	:POW:MW:PATH FULL	See " Full Bypass Enable " on page 1111

Remote Command	<code>[:SENSe]:POWer[:RF]:MW:PATH STD LNPath MPBypass FULL</code> <code>[:SENSe]:POWer[:RF]:MW:PATH?</code>
Example	<code>:POW:MW:PATH LNP</code> Enables the Low Noise path <code>:POW:MW:PATH?</code>
Notes	When " Presel Center " on page 1786 is performed, the instrument momentarily switches to the Standard Path, regardless of the setting of μW Path Control The DC Block will always be switched in when the low noise path is switched in, to protect succeeding circuitry from DC. Note that this does not mean "when the low noise path is enabled" but when, based on the Low Noise Path rules, the path is actually switched in. This can happen when the selection is Low Noise Path Enable or Full Bypass Enable . In the case where the DC Block is switched in, the instrument is now AC-coupled. However, if you selected DC coupling, the UI would still behave as though it were DC-coupled, including all annunciation, warnings, status bits, and responses to SCPI queries. This is because, based on other settings, the instrument could switch out the low noise path at any time and hence go back to being DC-coupled Alignment switching ignores the settings in this menu, and restores them when finished
Dependencies	Does not appear in CXA-m, VXT Models M9410A/11A/15A/16A, nor in M9410E/11E/15E/16E, BBIQ and External Mixing <ul style="list-style-type: none"> - The Low Noise Path Enable selection does not appear unless Option LNP is present and licensed - The μW Preselector Bypass selection does not appear unless Option MPB is present and licensed - The Full Bypass Enable selection does not appear unless options LNP and MPB are both present as well as option FBP

In any of these cases, if the required options are not present and the SCPI command is sent, error - 241, "Hardware missing; Option not installed" is generated

Low Noise Path Enable and **Full Bypass Enable** are grayed-out if the current measurement does not support them

Low Noise Path Enable and **Full Bypass Enable** are not supported in Avionics and MMR Modes (non-modulation measurements). In any of these cases (that is, the feature is not supported in either measurement or Mode), if the SCPI command is sent, the following error is generated: -221, "Setting Conflict; Feature not supported for this measurement"

Preset	Mode	Value
	IQ Analyzer	MPB option present and licensed: MPB
	Pulse	MPB option not present and licensed: STD
	RTSA	
	Avionics	
	All other Modes	STD
	-	

State Saved Save in instrument state

Range Standard Path | Low Noise Path Enable | μ W Presel Bypass | Full Bypass Enable

Annotation In the Meas Bar, if the Standard path is chosen:
 μ W Path: Standard
 If Low Noise Path is enabled but the LNP switch is not thrown:
 μ W Path: LNP,Off
 If the Low Noise Path is enabled and the LNP switch is thrown:
 μ W Path: LNP,On
 If the preselector is bypassed:
 μ W Path: Bypass
 If Full Bypass Enable is selected but the LNP switch is not thrown:
 μ W Path: FByp,Off
 If Full Bypass Enable is selected and the LNP switch is thrown:
 μ W Path: FByp,On

μ W Path Control Auto

In VMA, WLAN, 5G NR, CQM Modes, an **Auto/Man** switch is added to μ W Path Control:



3 VMA Mode
 3.7 Power Stat CCDF Measurement

This allows the function to automatically switch based on certain Auto Rules as shown below:

VMA Mode

Measurement	μ W Path Control Auto behavior
Digital Demod	Use Standard Path unless tuned frequency > 3.6 GHz and IFBW > 15 MHz, in which case choose Preselector Bypass
Monitor Spectrum	Always Presel Bypass
IQ Waveform	Use Standard Path unless tuned frequency > 3.6 GHz and IFBW > 15 MHz, in which case choose Preselector Bypass
Custom OFDM	Use Standard Path unless tuned frequency > 3.6 GHz and IFBW > 15 MHz, in which case choose Preselector Bypass
Channel Power	Always Presel Bypass
Occupied BW	Always Presel Bypass
CCDF	Use Standard Path unless tuned frequency > 3.6 GHz and IFBW > 15 MHz, in which case choose Preselector Bypass
ACP	Always Presel Bypass
SEM	Always Presel Bypass
Spurious Emissions	Always Standard Path

WLAN Mode

Measurement	μ W Path Control Auto behavior
Modulation Analysis	Always Presel Bypass
Spectral Flatness	Always Presel Bypass
Power vs Time	Always Presel Bypass
Monitor Spectrum	Always Presel Bypass
IQ Waveform	Always Presel Bypass
Channel Power	Always Presel Bypass
Occupied BW	Always Presel Bypass
CCDF	Always Presel Bypass
SEM	For 11be 320M, when 'Enabled Wideband IF for FFT' is OFF or 'Sweep Type Rule' is Best Dynamic Range, auto μ W path is standard For other cases, auto μ W path is presel bypass if presel bypass is enabled, auto μ W path is standard if presel bypass is not enabled
Spurious Emissions	Always Standard Path

5G NR Mode

Measurement	μ W Path Control Auto behavior
Modulation Analysis	Use Standard Path unless tuned frequency > 3.6 GHz and IFBW > 15 MHz, in which case choose Full Bypass if conditions warrant(FBP Option is available and "Allow Full Bypass in Auto" is On), otherwise choose Preselector Bypass
Monitor Spectrum	Always Standard Path
IQ Waveform	Use Standard Path unless tuned frequency > 3.6 GHz and IFBW > 15 MHz, in which case choose Full Bypass if conditions warrant(FBP Option is available and "Allow Full Bypass in Auto" is On), otherwise choose Preselector Bypass
Channel Power	Always Standard Path
Occupied BW	Always Standard Path
CCDF	Use Standard Path unless tuned frequency > 3.6 GHz and IFBW > 15 MHz, in which case choose Preselector Bypass
ACP	Always Standard Path
SEM	Always Standard Path
Spurious Emissions	Always Standard Path
Transmit On Off Power	Use Standard Path unless tuned frequency > 3.6 GHz and Info BW > 15 MHz, in which case choose Preselector Bypass

Channel Quality Mode

Measurement	μ W Path Control Auto behavior
Group Delay	Use Standard Path unless tuned frequency > 3.6 GHz and IFBW > 15 MHz, in which case choose Full Bypass if conditions warrant(FBP Option is available and "Allow Full Bypass in Auto" is On), otherwise choose Preselector Bypass
Monitor Spectrum	Always Standard Path
IQ Waveform	Use Standard Path unless tuned frequency > 3.6 GHz and IFBW > 15 MHz, in which case choose Preselector Bypass
CCDF	Use Standard Path unless tuned frequency > 3.6 GHz and IFBW > 15 MHz, in which case choose Preselector Bypass

Remote Command	<code>[:SENSe]:POWer[:RF]:MW:PATH:AUTO ON OFF 1 0</code> <code>[:SENSe]:POWer[:RF]:MW:PATH:AUTO?</code>
Example	<code>:POW:MW:PATH:AUTO ON</code> <code>:POW:MW:PATH:AUTO?</code>
Dependencies	Only appears in VMA, WLAN, 5G NR and CQM Modes
Couplings	See " μW Path Control Auto " on page 1106 above
Preset	ON
Range	ON OFF

Low Noise Path Enable

Low Noise Path Enable provides a lower noise floor under some circumstances, particularly when operating in the 21–26.5 GHz region. With the Low Noise Path enabled, the low band/high band switch and microwave preamp are bypassed whenever *all* the following are true:

- The instrument is not in the Low Band, meaning:
- the start frequency is above 3.5 GHz and
- the stop frequency is above 3.6 GHz
- The internal preamp is not installed, or if installed, is set to **Off** or **Low Band**

Note that this means that, when any part of a sweep is done in Low Band, the Low Noise Path is not used, whether or not the **Low Noise Path Enable** is selected in the user interface. Also, if the preamp is turned on, the Low Noise Path is not used, whether or not the **Low Noise Path Enable** is selected in the user interface. The only time the Low Noise Path is used is when **Low Noise Path Enable** is selected, the sweep is completely in High Band (> 3.6 GHz) and no preamp is in use.

For measurements that use IQ acquisition, the low noise path is used when **Center Frequency** is in High Band (> 3.6 GHz) and no preamp is in use. In other words, the rules above are modified to use only the center frequency to qualify which path to switch in. This is not the case for FFTs in the Swept SA measurement; they use the same rules as swept measurements.

Note that the Low Noise Path, while giving improved DANL, has the disadvantage of decreased TOI performance and decreased gain compression performance relative to the standard path.

Note also that the bypass switch is a mechanical switch and has finite life, so if the **Low Noise Path Enable** is selected, it is possible to cause frequent cycling of this switch by frequently changing instrument settings such that the above conditions hold true only some of the time. A user making tests of this nature should consider opting for the **Standard Path**, which will never throw the bypass switch, at the expense of some degraded noise performance.

The low noise path is useful for situations where the signal level is so low that the instrument performance is dominated by noise even with 0 dB attenuation, but still high enough that the preamp option would have excessive third-order intermodulation or compression. The preamp, if purchased and used, gives better noise floor than does the “Low Noise Path.” However, its compression threshold and third-order intercept are much poorer than that of the non-preamp path.

There are some applications, typically for signals around –30 dBm, for which the third-order dynamic range of the standard path is good enough, but the noise floor is not low enough even with 0 dB input attenuation. When the third-order dynamic

range of the preamp path is too little and the noise floor of the standard path is too high, the Low Noise Path can provide the best dynamic range

The graph below illustrates the concept. It shows, in red, the performance of an instrument at different attenuation settings, both with the preamp on and off, in a measurement that is affected by both instrument noise and instrument TOI. The green shows the best available dynamic range, offset by 0.5 dB for clarity. The blue shows how the best available dynamic range improves for moderate signal levels with the low noise path switched in. In this illustration, the preamp improves the noise floor by 15 dB while degrading the third-order intercept by 30 dB, and the low noise path reduces loss by 8 dB. The attenuator step size is 2 dB.

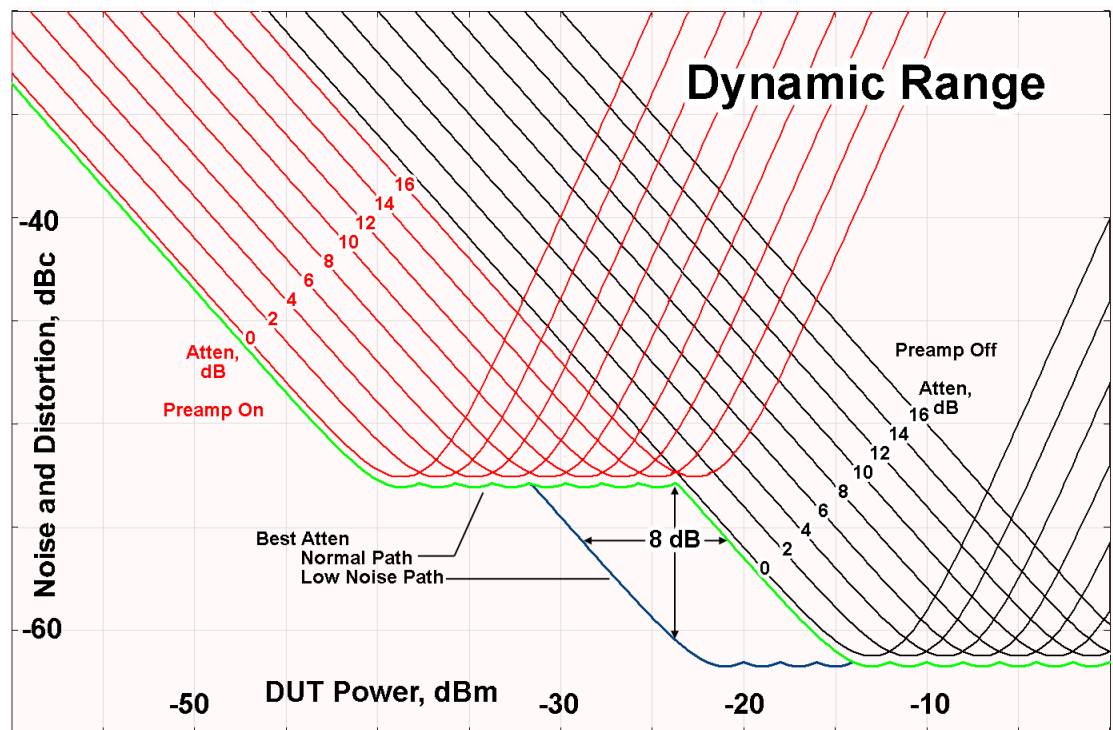

There are other times where selecting the low noise path improves performance, too. Compression-limited measurements such as finding the nulls in a pulsed-RF spectrum can profit from the low noise path in a way similar to the TOI-limited measurement illustrated. Accuracy can be improved when the low noise path allows the optimum attenuation to increase from a small amount like 0, 2 or 4 dB to a larger amount, giving better return loss at the instrument input. Harmonic measurements, such as second and third harmonic levels, are much improved using the low noise path because of the superiority of that path for harmonic (though not intermodulation) distortion performance.

μW Preselector Bypass

Toggles the preselector bypass switch for band 1 and higher. When the microwave preselector is on, the signal path is preselected. When the microwave preselector is off, the signal path is not preselected. The preselected path is the normal path for the instrument.

The preselector is a tunable bandpass filter which prevents signals away from the frequency of interest from combining in the mixer to generate in-band spurious signals (images). The consequences of using a preselector filter are its limited bandwidth, the amplitude and phase ripple in its passband, and any amplitude and phase instability due to center frequency drift.

Option MPB or pre-selector bypass provides an unpreselected input mixer path for certain X-Series signal analyzers with frequency ranges above 3.6 GHz. This signal path allows a wider bandwidth and less amplitude variability, which is an advantage when doing modulation analysis and broadband signal analysis. The disadvantage is that, without the preselector, image signals will be displayed. Another disadvantage of bypassing the preselector is increased LO emission levels at the front panel input port.

Image responses are separated from the real signal by twice the 1st IF. For IF Paths of 10 MHz and 25 MHz, the 1st IF is 322.5 MHz, so the image response and the real signal will be separated by 645 MHz. The 1st IF will be different for other IF Path settings. When viewing a real signal and its corresponding image response in internal mixing, the image response will be to the left of the real signal.

Also, the image response and the real signal typically have the same amplitude and exhibit the same shape factor.

However, if Option FS1 (Fast Sweep Capability) is enabled, the image response in the Swept SA measurement appears lower in amplitude and has a much wider shape factor compared to the real signal.

Full Bypass Enable

With **Full Bypass Enable** selected, the microwave preselector is bypassed. In addition, the low band/high band switch and microwave preamp are bypassed whenever *all* the following are true:

- The instrument is not in the Low Band, meaning:
- the start frequency is above 3.5 GHz and
- the stop frequency is above 3.6 GHz.
- the internal preamp is not installed or if installed, is set to **Off** or **Low Band**

Note that this means that, when any part of a sweep is done in Low Band, the Low Noise Path is not used, whether or not the **Full Bypass Enable** is selected in the user

interface. Also, if the preamp is turned on, the Low Noise Path is not used, whether or not the **Full Bypass Enable** is selected in the user interface. The only time the Low Noise Path is used is when **Full Bypass Enable** is selected, the sweep is completely in High Band (> 3.6 GHz) and no preamp is in use.

CAUTION

When **Full Bypass Enable** is selected, and "**Y Scale**" on page 1760 is set to 0 dB, there will be a direct AC connection between the input and the first converter when the Low Noise Path switches in (when Start Freq >3.6 GHz and the Preamp is either not licensed, set to Low Band, or Off). This puts the first converter at considerable risk to be damaged by high AC power. Consequently, whenever **Full Bypass Enable** is selected, a warning message appears in the status bar:

"Full Bypass Enabled, maximum safe input power reduced"

Microwave Preselector Bypass Backwards Compatibility

Example	Bypass the microwave preselector: <code>:POW:MW:PRES OFF</code>
Notes	Included for Microwave Preselector Bypass backwards compatibility The ON parameter sets the STD path (<code>:POW:MW:PATH STD</code>) The OFF parameter sets path MPB (<code>:POW:MW:PATH MPB</code>)
Preset	ON
Backwards Compatibility SCPI	<code>[:SENSe]:POWer[:RF]:MW:PRESelector[:STATe] ON OFF 0 1</code> <code>[:SENSe]:POWer[:RF]:MW:PRESelector[:STATe]?</code>

Frequency Extender Preselection Bypass

Only applies to the high frequency path of the Frequency Extender, and only if the Frequency Extender allows it. For example, the V3050A high frequency path is 50 – 110 GHz and *does* allow control of the preselector bypass.

When the Frequency Extender's preselection is bypassed, flatness is improved, but will be subject to spurs from out-of-band interfering signals. For bandwidths greater than 2.5 [GHz], it is recommended that the signal bypass the Frequency Extender Preselector since the max bandwidth of the Preselector can be as narrow as 2.5 [GHz].

For most applications, the preset state is **OFF**, which gives the best remote-control throughput, minimizes acoustic noise from switching, minimizes out of band spurs, and minimizes the risk of wear in the hardware switches.

Preselector and Bandwidth Conflict

When the Frequency Extender Preselector is applied and the signal bandwidth is greater than 2.5 [GHz], then a settings alert message will show to warn the user that the signal may be distorted due to the limitation of the Frequency Extender Preselector bandwidth.

An example of the settings alert message is shown below.

Settings Alert message in the Status Bar at the bottom of the display.



Settings Alert message in the error queue

Type	ID	
	159	Settings Alert - DETECTED; Presel/Meas BW conflict

Allow Full Bypass in Auto

Enable or disable Full Bypass in μ W Path Auto rule. See " [\$\mu\$ W Path Control](#)" on page 1791.

When this function is **ON**, and " [\$\mu\$ W Path Control](#)" on page 1791 is in **AUTO**, it is possible for the auto rules to select the **FULL** Bypass state, which bypasses both the Preamp and the Microwave Preselector. Otherwise, the auto rules never select the **FULL** Bypass state. This is convenient when making wideband measurements, but it also adds some risk of damage to the first converter.

CAUTION

When **Full Bypass Enable** is selected, and "[Y Scale](#)" on page 1760 is set to 0 dB, there will be a direct AC connection between the input and the first converter when the Low Noise Path switches in (when Start Freq > 3.6 GHz and the Preamp is either not licensed, set to **Low Band** or **Off**). This puts the first converter at considerable risk to be damaged by high AC power. Consequently, whenever **Full Bypass Enable** is selected, a warning message appears in the status bar:

"Full Bypass Enabled, maximum safe input power reduced"

Remote Command [:SENSe]:POWer[:RF]:MW:PATH:AUTO:FULL ON | OFF | 1 | 0
[:SENSe]:POWer[:RF]:MW:PATH:AUTO:FULL?

Example	<code>:POW:MW:PATH:AUTO:FULL ON</code> <code>:POW:MW:PATH:AUTO:FULL?</code>
Dependencies	Only appears if Option FBP is installed, and in the following measurements <ul style="list-style-type: none"> - 5GNRMode: Modulation Analysis and IQ Waveform - WLAN Mode: IQ Waveform - Channel Quality Mode: Group Delay and Noise Power Ratio
Preset	<code>OFF</code>
State Saved	Saved in instrument state

Software Preselection

Provided in some instruments, either to compensate for issues with provided hardware preselection or to provide the preselection function when there is no hardware preselector.

N9041B

Software Preselection compensates for the frequency range limit of the microwave preselector. Since the microwave preselector only goes up to 50 GHz, software preselection must be used to suppress and separate images above 50 GHz. The specific algorithm used for software preselection is specified by the SW Preselection Type selection – Normal or Advanced.

In N9041B, **Software Preselection** only applies for frequencies above 50 GHz, therefore it is only used for RF Input 2. Even if turned on, it is not used for other inputs, and never for frequencies below 50 GHz. This is why the label of this control contains the parenthetical note “(>~50 GHz)”.

Note that in N9041B, in Swept SA measurement, **Software Preselection** works even if the measurement is using an FFT Sweep Type. In measurements other than Swept SA, Software Preselection is not used if the measurement is using an FFT sweep type.

N9042B+V3050A

Software Preselection compensates for the frequency range limit of the microwave preselector. Since the microwave preselector only goes up to 50 GHz, software preselection must be used to suppress and separate images above 50 GHz. The specific algorithm used for software preselection is specified by the SW Preselection Type selection – Normal or Advanced.

For N9042B+V3050A, Software Preselection only applies for frequencies above 50 GHz, therefore it is only used for External RF. Even if it is turned on, it will not be

3 VMA Mode
 3.7 Power Stat CCDF Measurement

used for other inputs and never for frequencies below 50 GHz. This is why the label of this control contains the parenthetical note “(>~50 GHz)”.

Note that for N9042B+V3050A, in the Swept SA measurement, Software Preselection works even if the measurement is using an FFT Sweep Type. In measurements other than Swept SA, Software Preselection is not used if the measurement is using an FFT Sweep Type.

VXT models M9410A/11A/15A/16A

Software Preselection is used to provide the preselection function, as there is no hardware preselector in these models. Two background traces are taken and compared point by point, and the point with the lowest amplitude from the two traces is used. This provides a method to reduce spurs that are internally generated within the VXT, but you should note the following when using Software Preselection:

- There is some speed cost due to the need to take multiple captures
- Taking the point with the lowest amplitude in each trace will make the average noise level lower at all points that do not have a spur. This can reduce the accuracy of the measurement of noise and noise-like signals

Because of the difficulty in identifying spurs manually, you are recommended to leave Software Preselection **ON** at all times in VXT models M9410A/11A. If you turn it off in order to speed up your measurement or improve noise accuracy, be aware of unwanted onscreen spurs.

Remote Command	<code>[:SENSe]:POWer[:RF]:SWPResel:STATe 0 1 ON OFF</code> <code>[:SENSe]:POWer[:RF]:SWPResel:STAT?</code>
Example	<code>:POW:SWPR:STAT 1</code> <code>:POW:SWPR:STAT?</code>
Dependencies	Only appears in N9041B, N9042B+V2050A, VXT models M9410A/11A and M9410E/11E. Does not appear in all measurements
Couplings	Affects Sweep Time Auto Tune supports Software Preselection , so Auto Tune should be performed after setting the Software Preselection state
Preset	N9041B OFF N9042B+V3050A ON M9410A/11A ON
State Saved	Saved in instrument state

SW Preselection Type

Specifies the algorithm used for software preselection.

Two hidden sweeps occur in succession. The second sweep is offset in LO frequency by $2 * IF / N$. For each point in each trace, the smaller amplitude from the two traces is taken and placed in that point in the selected trace. The Peak detector is auto-selected to improve the image suppression effectiveness. Responses of each trace that lie on top of one another will remain and are valid signals. Other signals are images, which are suppressed. The action of taking the smaller of the two traces will make the average noise level lower in all points that do not have an image, thus reducing the accuracy of the measurement of noise and noise-like signals.

- **NORMa1** - mathematically removes all image and multiple responses of signals present at the input
- **ADVanced** - any trace processing (such as “max hold” or trace averaging) is performed on the points of both candidate traces before the “select minimum” operation occurs. This form of processing works better for non-stationary signals, such as pulsed-RF signals

Remote Command	<code>[:SENSe]:POWer[:RF]:SWPreSel NORMa1 ADVanced</code> <code>[:SENSe]:POWer[:RF]:SWPreSel?</code>
Example	<code>:POW:SWPR NORM</code> <code>:POW:SWPR?</code>
Dependencies	Only appears in N9041B and N9042B+V3050A. Only appears in measurements that use the Swept method Grayed-out when "Software Preselection" on page 1801 is OFF. The grayout message is “Unavailable unless SW Presel enabled”
Preset	N9041B ADVanced N9042B+V3050A NORMa1
State Saved	Saved in instrument state

SW Preselection BW

Specifies the effective bandwidth to be used for Software Preselection.

The options are:

- **NORMa1** – when making Swept measurements, a software preselection algorithm is used which takes up to 4 background acquisitions, then post-processes the result. This algorithm can remove images from signals with an occupied

3 VMA Mode
 3.7 Power Stat CCDF Measurement

bandwidth up to around 3 GHz. (Default/Preset setting). When making FFT measurements, this algorithm is not used, instead the same algorithm is used as for **NARRow** (below)

- **NARRow**– a software preselection algorithm is used which takes two background acquisitions, then post-processes the result to detect and remove images from wideband signals with occupied bandwidths up to 2 GHz. This increases the risk of images failing to be rejected, but improves the measurement speed

Remote Command	<code>[:SENSe]:POWer[:RF]:SWPreSel:BW NORMa1 NARRow</code> <code>[:SENSe]:POWer[:RF]:SWPreSel:BW?</code>
Example	<code>:POW:SWPR:BW NARR</code>
Dependencies	Only appears in N9041B and N9042B+V3050A. Only appears in measurements that use the Swept method Grayed-out when " Software Preselection " on page 1801 is OFF . The grayout message is "Unavailable unless SW Presel enabled" For N9042B+V3050A, the parameter is SCPI-only, and always set to NARRow when Software Preselection is enabled
Preset	N9041B NORMa1 N9042B+V3050A NARRow
State Saved	Saved in instrument state

High Freq Prefilter

Lets you set the state of Prefilter for center frequencies above 1310 MHz.

In VXT Models M9410A/11A and M9410E/11E in bypass frequency range (1310MHz~5GHz), the Receiver RF path has a bank of filters that come after the RF Attenuator in the signal path. Since this bank of filters precedes the mixer they are known as the "Prefilter" bank. Their purpose is to eliminate unwanted in-band mixing products by filtering out all but the desired frequencies before the signals get to the mixer. There are 13 prefilter bands to cover the frequencies between 9 kHz and 6000 MHz. The Prefilter provides the necessary rejection of the unwanted signal.

Remote Command	<code>[:SENSe]:<measurement>:PFILter[:STATe] ON OFF 1 0</code> <code>[:SENSe]:<measurement>:PFILter[:STATe]?</code>
Example	Enable High Freq Prefilter for the Complex Spectrum Measurement in BASIC Mode: <code>:SPEC:PFIL ON</code> Enable High Freq Prefilter for the IQ Waveform Measurement, in multiple Modes: <code>:WAV:PFIL ON</code>

	Enable High Freq Prefilter for the Swept SA Measurement in SA Mode: :SAN:PFIL ON
Dependencies	Only appears in VXT models M9410A/11A with center frequency above 1310 MHz, and M9410E/11E in frequency range 1310MHz~5GHz
Preset	See " Prefilter Presets " on page 1118 below
State Saved	Saved in instrument state

Prefilter Presets

Meas	Mode	Preset
SPEC	BASIC	OFF
WAV	BASIC, WCDMA, WLAN, LTEAFDD, LTEATDD, 5GNR, VMA	OFF
MON	WCDMA, WLAN, LTEAFDD, LTEATDD, 5GNR, VMA	OFF
RHO	WCDMA	OFF
CDP	WCDMA	OFF
PCON	WCDMA	OFF
EVMQ	WCDMA	OFF
CHP	WCDMA, WLAN, LTEAFDD, LTEATDD, 5GNR, VMA, SA	OFF
OBW	WCDMA, WLAN, LTEAFDD, LTEATDD, 5GNR, VMA, SA	OFF
ACP	WCDMA, LTEAFDD, LTEATDD, 5GNR, VMA, SA	OFF
SEM	WCDMA, WLAN, LTEAFDD, LTEATDD, 5GNR, VMA, SA	OFF
PST	WCDMA, WLAN, LTEAFDD, LTEATDD, 5GNR, VMA, SA	OFF
PVT	WLAN, LTEAFDD, LTEATDD, 5GNR	OFF
EVM	WLAN, LTEAFDD, LTEATDD, 5GNR	OFF
FLAT	WLAN	OFF
EVMM	WLAN	OFF
CEVM	LTEAFDD, LTEATDD	OFF
PAVT	5GNR, VMA	OFF
DDEM	VMA	OFF
OFDM	VMA	OFF
SAN	SA	ON
HARM	SA	ON

3.7.4 BW

Opens the Bandwidth (**BW**) menu, which contains the Info BW control.

3.7.4.1 Settings

Contains basic bandwidth functions. It is the only tab under **BW**.

Info BW

Allows you to enter a frequency value to set the channel bandwidth that will be used for data acquisition. When in **Auto**, it is set to the value that covers carriers set by carrier configuration.

Remote Command	<code>[:SENSe]:PStatistic:BAWdwidth <freq></code> <code>[:SENSe]:PStatistic:BAWdwidth?</code>				
Example	<code>:PST:BAWd 8 MHz</code> <code>:PST:BAWd?</code>				
Notes	Auto/Man is available only for 5G NR, LTE, LTE-TDD, LTE-AFDD, LTE-A TDD				
Preset	Depends on Mode and installed Options. See " Preset Values " on page 1119 below				
State Saved	Saved in instrument state				
Min	10 kHz				
Max	Hardware-dependent: <table border="0" style="width: 100%; border-collapse: collapse;"> <tr> <td style="border-top: 1px solid black; border-bottom: 1px solid black; padding: 2px;">RF Input</td> <td style="border-top: 1px solid black; border-bottom: 1px solid black; padding: 2px;">- No Option = 10 MHz - WB (25 MHz or wider) = Hardware Option Limit</td> </tr> <tr> <td style="border-bottom: 1px solid black; padding: 2px;">I/Q Input (for I+jQ)</td> <td style="border-bottom: 1px solid black; padding: 2px;">- No Option = 20 MHz - Option B25 = 50 MHz</td> </tr> </table>	RF Input	- No Option = 10 MHz - WB (25 MHz or wider) = Hardware Option Limit	I/Q Input (for I+jQ)	- No Option = 20 MHz - Option B25 = 50 MHz
RF Input	- No Option = 10 MHz - WB (25 MHz or wider) = Hardware Option Limit				
I/Q Input (for I+jQ)	- No Option = 20 MHz - Option B25 = 50 MHz				
Backwards Compatibility SCPI	<code>[:SENSe]:PStatistic:BWIDth</code>				

Auto Function

Remote Command	<code>[:SENSe]:PStatistic:BAWdwidth:AUTO ON OFF 1 0</code> <code>[:SENSe]:PStatistic:BAWdwidth:AUTO</code>
Example	<code>:PST:BAWd:AUTO 0</code> <code>:PST:BAWd:AUTO?</code>
Preset	ON

Preset Values

Modes	Option	Preset Values
SA, WCDMA	All	5 MHz
CQM	All	10 MHz
LTE-TDD, LTE-AFDD, 5G NR	All	Automatically calculated

Modes	Option	Preset Values	
MSR	All	Same as max value	
WLAN	None	10 MHz	
	B25	25 MHz	
	B40	Radio Std	Preset
		802.11 a/b/g/n/ac/ax/be (20 MHz)	25 MHz
		802.11n/ac/ax/be (40 MHz)	40 MHz
		802.11ac/ax/be (80 MHz)	80 MHz
		802.11ac/ax/be (160 MHz)	160 MHz
	802.11be (320 MHz)	320 MHz	
	B1X	Radio Std	Preset
		802.11ac(80 MHz)	80 MHz
B1Y	Radio Std	Preset	
	802.11ac(160 MHz)	160 MHz	

3.7.5 Display

Lets you configure display items for the current Mode, Measurement View or Window.

3.7.5.1 View

Contains controls for selecting the current **View**, and for editing User Views.

View

See "[Views](#)" on page 1071.

User View

Lets you choose a View from the saved User Views for the current measurement. This panel only appears if a User View exists for the current measurement.

3 VMA Mode
3.7 Power Stat CCDF Measurement

Remote Command	<code>:DISPlay:VIEW:ADVanced:SElect <alphanumeric></code> <code>:DISPlay:VIEW:ADVanced:SElect?</code>
Example	Select Baseband as the current View <code>:DISP:VIEW:ADV:SEL "Baseband"</code>
Notes	<p>You must be in the measurement whose View you are trying to set to send the command. You can only set Views for the current measurement using this command</p> <p>For predefined views, the parameter is derived from the view name that is shown in the View list in the user interface. For example, if you are trying to select the Trace Zoom view in the Swept SA measurement, you send:</p> <pre>:DISP:VIEW:ADV:SEL "Trace Zoom"</pre> <p>because "Trace Zoom" is the name of the View as seen in the Mode/Meas dialog or in the Display, View menu</p> <p>You <i>cannot</i> use the legacy View parameter (which in this case would be <code>TZOOM</code>) with</p> <pre>:DISP:VIEW:ADV:SEL</pre> <p><code><alphanumeric></code> is case insensitive; you can specify mixed case, however the name will be evaluated on a single case. Thus, both of the following forms work:</p> <pre>:DISP:VIEW:ADV:SEL "Trace Zoom"</pre> <pre>:DISP:VIEW:ADV:SEL "TRACE ZOOM"</pre> <p>If the specified view is not a valid View, the query returns the error message "-224, Illegal parameter value; View with the name <alphanumeric> does not exist"</p> <p>If the display is disabled (via <code>:DISP:ENAB OFF</code>) then the error message "-221, Settings conflict; View SCPI cannot be used while Display is disabled" is generated</p>
Backwards Compatibility SCPI	<p>The legacy node</p> <pre>:DISPlay:VIEW[:SElect]</pre> <p>is retained for backwards compatibility, but it only supports predefined views</p>

Restore Layout to Default

Restores the Layout to the default for Basic.

Modified Views are very temporary; if you exit the current measurement they are discarded, and they are not saved in State. To retain this View for later use, and to be able to return easily to your original Basic View, you can save your edited View as a "User View".

Save Layout as New View

Saves your new View as a User View. An alpha keyboard appears, which lets you name your new View; the default is the old View name plus a number.

Remote Command	<code>:DISPlay:VIEW:ADVanced:NAME <alphanumeric></code>
----------------	---

Example	<code>:DISP:VIEW:ADV:NAME "Baseband"</code> Creates a new View named Baseband from the current View, and selects it as the current View
Notes	<p><code><alphanumeric></code> is case insensitive; you can specify mixed case, however the name will be evaluated on a single case</p> <p>If <code><alphanumeric></code> name already exists as a View, the error message “-224, Illegal parameter value; View <alphanumeric> already exists” is generated</p> <p>If the display is disabled (via <code>:DISP:ENAB OFF</code>) then the error message “-221, Settings conflict; User View SCPI cannot be used while Display is disabled” is generated</p>

Re-Save User View

You can re-edit a User View; if you make changes, then an asterisk will appear next to the User View’s name. You can then tap **Re-Save User View** to save it back to its existing name, or **Save Layout as New View** to add another, new User View.

This is a front panel function only, there is no remote command available to perform this function. To do this remotely, you must first perform **Save Layout as New View**, then delete the old User View and rename the new one with the name of the View you just deleted.

Rename User View

You can rename the current View by giving it a new unique name. Only User Views can be renamed, if the current View is a Predefined View, an error occurs.

Remote Command	<code>:DISPlay:VIEW:ADVanced:REName <alphanumeric></code>
Example	<code>:DISP:VIEW:ADV:REN "Baseband"</code>
Notes	<p><code><alphanumeric></code> is case insensitive; you can specify mixed case, however the name will be evaluated on a single case</p> <p>If the <code><alphanumeric></code> specifying the new name is already present in the list of View names, the error message “-224, Illegal parameter value; View <alphanumeric> already exists” is generated</p> <p>If the current View is a Predefined View, the error message “-224, Illegal parameter value; Cannot rename a Predefined View” is generated</p> <p>If the display is disabled (via <code>:DISP:ENAB OFF</code>) then the error message “-221, Settings conflict; View SCPI cannot be used while Display is disabled” is generated</p>

Delete User View

You can delete the current View if it is a User View. The default view becomes the current view for the Measurement.

Remote Command	<code>:DISPlay:VIEW:ADVanced:DELeTe</code>
Example	<code>:DISP:VIEW:ADV:DEL</code>
Notes	<p><code><alphanumeric></code> is case insensitive; you can specify mixed case, however the name will be evaluated on a single case</p> <p>If the <code><alphanumeric></code> is not present in the list of View names, the error message “-224, Illegal parameter value; View <code><alphanumeric></code> does not exist” is generated</p> <p>If the current View is a Predefined View, the error message “-224, Illegal parameter value; Cannot delete a Predefined View” is generated</p> <p>If the display is disabled (via <code>:DISP:ENAB OFF</code>) then the error message “-221, Settings conflict; View SCPI cannot be used while Display is disabled” is generated</p>

Delete All User Views

Deletes all previously saved User Views. The default view becomes the current view for the Measurement if a User View was the current view when this command was executed.

Remote Command	<code>:DISPlay:VIEW:ADVanced:DELeTe:ALL</code>
Example	<code>:DISP:VIEW:ADV:DEL:ALL</code>
Notes	Disabled if there are no User Views

View Editor Remote Commands

The following remote commands help you manage Views and User Views. Note that the SCPI node for User Views handles both Predefined and User Views. The legacy nodes, `:DISPlay:VIEW[:SElect]` and `:DISPlay:VIEW:NSEL`, are retained for backwards compatibility, but they only support predefined views.

View Listing Query

Returns a string containing a comma-separated list of names for *all* the Views, including User Views, available for the current Measurement.

Remote Command	<code>:DISPlay:VIEW:ADVanced:CATalog?</code>
Example	<code>:DISP:VIEW:ADV:CAT?</code>
Notes	<p>Returns a quoted string of the available Views for the current measurement, separated by commas. The list includes names for <i>all</i> the Views, including User Views, available for the current Measurement</p> <p>Example:</p> <p><code>"Normal,Trace Zoom,Spectrogram,Baseband,myView1,yourView1"</code></p>

No distinction is made between Predefined and User Views
If you switch measurements with the display disabled (via `:DISP:ENAB OFF`), then query the list of available Views, the result is undefined

User View Listing Query

Returns a string containing a comma-separated list of names for *only* the User Views available for the current Measurement.

Remote Command	<code>:DISPlay:VIEW:ADVanced:USER:CATalog?</code>
Example	<code>:DISP:VIEW:ADV:USER:CAT?</code>
Notes	Returns a quoted string of the available User Views for the current measurement, separated by commas. Example: <code>"Baseband,myView1,yourView1"</code> If you switch measurements with the display disabled (see "Display Enable (Remote Command Only)" on page 1812), then query the list of available Views, the result is undefined

3.7.5.2 Annotation

Contains controls for setting up the annotation for the current Mode or Measurement.

Graticule

Turns the display graticule On or Off for all windows with graticules in all measurements in the current Mode. Also turns the graticule Y-Axis annotation on and off.

Remote Command	<code>:DISPlay:GRATicule[:STATe] OFF ON 0 1</code> <code>:DISPlay:GRATicule[:STATe]?</code>
Example	<code>:DISP:GRAT OFF</code>
Notes	The graticule is the set of horizontal and vertical lines that make up the grid/divisions for the X-Axis and Y-Axis
Preset	<code>ON</code>
State Saved	Saved in instrument state
Backwards Compatibility SCPI	<code>:DISPlay:WINDow[1]:TRACe:GRATicule:GRID[:STATe] OFF ON 0 1</code> <code>:DISPlay:WINDow[1]:TRACe:GRATicule:GRID[:STATe]?</code> This command is accepted for backwards compatibility with older instruments, but the <code>WINDow</code> , <code>TRACe</code> and <code>GRID</code> parameters are ignored

Screen Annotation

Controls the display of the annunciation and annotation around the graticule, including any annotation on lines (such as the display line, the threshold line, etc.) and the Y-Axis annotation, for all windows with screen annotation in all measurements in the current Mode.

This does *not* include marker annotation (or the N dB result). When **OFF**, the graticule expands to fill the entire graticule area, leaving only the 1.5% gap above the graticule, as described in the **Trace** section.

Remote Command	<code>:DISPlay:ANNotation:SCReen[:STATe] OFF ON 0 1</code> <code>:DISPlay:ANNotation:SCReen[:STATe]?</code>
Example	<code>:DISP:ANN:SCR OFF</code>
Dependencies	Grayed-out and forced to OFF when System Display Settings, Annotation is OFF
Preset	ON This remains OFF through a Preset when System Display Settings, Annotation is set to OFF
State Saved	Saved in instrument state

Trace Annotation

Turns on and off the labels on the traces, showing their detector (or their Math Mode) as described in the **Trace** section, for all windows in all measurements in the current Mode for which Trace Annotation on/off is supported.

If Trace Math is being performed on a trace, then the Trace Math annotation replaces the detector annotation.

For measurements that support limit lines, this key also turns on and off the labels on the Limit Lines. The label is the Limit number annotation and Limit Comment displayed on the graph. If the length of the comment is greater than 20 characters, the first 8 characters and the last 8 characters are displayed, joined with

Remote Command	<code>:DISPlay:ANNotation:TRACe[:STATe] ON OFF 1 0</code> <code>:DISPlay:ANNotation:TRACe[:STATe]?</code>
Example	<code>:DISP:ANN:TRAC OFF</code>
Preset	OFF
State Saved	Saved in instrument state

Control Annotation

Turns on and off the display of values on the Active Function controls for all measurements in the current Mode. This is a security feature.

Remote Command	<code>:DISPlay:ACTivefunc[:STATe] ON OFF 1 0</code> <code>:DISPlay:ACTivefunc[:STATe]?</code>
Example	<code>:DISP:ACT OFF</code>
Dependencies	Grayed out and forced to OFF when System Display Settings, Annotation is OFF
Preset	ON This remains OFF through a Preset when System Display Settings, Annotation is set to OFF
State Saved	Saved in instrument state

Meas Bar

Turns the Measurement Bar at the top of the screen on and off for all measurements in the current Mode. When **OFF**, the graticule area expands to fill the area formerly occupied by the Measurement Bar.

Remote Command	<code>:DISPlay:ANNotation:MBAR[:STATe] OFF ON 0 1</code> <code>:DISPlay:ANNotation:MBAR[:STATe]?</code>
Example	<code>:DISP:ANN:MBAR OFF</code>
Dependencies	Grayed out and forced to OFF when System Display Settings, Annotation is OFF
Preset	ON This remains OFF through a Preset when System Display Settings, Annotation is set to OFF
State Saved	Saved in instrument state

Display Enable (Remote Command Only)

Turns the display on/off, including the display drive circuitry. The backlight stays lit to confirm that the instrument is on. The display enable setting is mode global. There are three reasons for turning the display off:

1. To increase speed as much as possible by freeing the instrument from having to update the display
2. To reduce emissions from the display, drive circuitry
3. For security purposes

If you have turned off the display:

3 VMA Mode
 3.7 Power Stat CCDF Measurement

- and you are in local operation, the display can be turned back on by pressing any key or by sending `:SYSTem:DEFaults MISC` or `:DISPlay:ENABle ON` (neither `*RST` nor `:SYSTem:PRESet` enable the display)
- and you are in remote operation, the display can be turned back on by pressing the **Local** or **Esc** keys, or by sending `:SYSTem:DEFaults MISC` or `:DISPlay:ENABle ON` (neither `*RST` nor `:SYSTem:PRESet` enable the display)
- and you are using either the `:SYSTem:KLOCK` command or GPIB local lockout, then *no* front-panel key press will turn the display back on. You must turn it back on remotely.

If the display is **OFF**, many SCPI commands related to User Views and Multiscreen functionality do not work, and return the error messages “-221, Settings conflict; Screen SCPI cannot be used when Display is disabled” or “221, Settings conflict; View SCPI cannot be used while Display is disabled”. These commands include:

Name	Command
Select User View	<code>:DISPlay:VIEW:ADVanced:SElect</code>
Rename User View	<code>:DISPlay:VIEW:ADVanced:REName</code>
Delete User View	<code>:DISPlay:VIEW:ADVanced:DElete</code>
Create User View	<code>:DISPlay:VIEW:ADVanced:NAME</code>
Select Screen	<code>:INSTrument:SCReen:SElect</code>
Delete Screen	<code>:INSTrument:SCReen:DElete</code>
Delete All But This Screen	<code>:INSTrument:SCReen:DElete:ALL</code>
Add Screen	<code>:INSTrument:SCReen:CREate</code>
Rename Screen	<code>:INSTrument:SCReen:REName</code>
Sequencer On/Off	<code>:SYSTem:SEQuencer</code>

Remote Command	<code>:DISPlay:ENABle OFF ON 0 1</code>
Example	<code>:DISP:ENAB OFF</code>
Couplings	<code>:DISP:ENAB OFF</code> turns Backlight OFF and <code>:DISP:ENAB ON</code> turns Backlight ON , but changing Backlight settings does <i>not</i> change the state of <code>:DISP:ENAB</code>
Preset	ON Set by <code>:SYST:DEF MISC</code> , but not affected by <code>*RST</code> or <code>:SYSTem:PRESet</code>
State Saved	Not saved in instrument state
Backwards Compatibility Notes	<code>:SYST:PRES</code> no longer turns on <code>:DISPlay:ENABle</code> as it did in legacy analyzers

3.7.6 Frequency

Opens the **Frequency** menu, which contains controls that allow you to control the frequency and channel parameters of the instrument.

Some features in this menu are the same for all measurements in the current Mode – they do not change as you change measurements. Settings like these are called “Meas Global” and are unaffected by Meas Preset. For example, **Center Frequency** is the same for all measurements – it does not change as you change measurements.

3.7.6.1 Settings

Contains controls that pertain to the X-Axis parameters of the measurement. These parameters control how data on the vertical (X) axis is displayed and control instrument settings that affect the horizontal axis.

Center Frequency

Sets the frequency that corresponds to the horizontal center of the graticule. While adjusting **Center Frequency**, **Span** is held constant.

The **Center Frequency** setting is the same for all measurements within a mode, that is, it is Meas Global. Some Modes are also able to share a Mode Global center frequency value. If this is the case, the Mode will have a **Global** tab in its **Meas Setup** menu.

Center Frequency sets (and queries) the center frequency for the currently selected input. If your instrument has multiple inputs, and you select another input, **Center Frequency** changes to the value for that input. SCPI commands are available to directly set the center frequency for a specific input.

Center Frequency is remembered as you go from input to input. Thus, you can set a **Center Frequency** of 10 GHz with the RF Input selected, change to BBIQ and set a **Center Frequency** of 20 MHz, then switch to External Mixing and set a Center Freq of 60 GHz, and when you go back to the RF Input, **Center Frequency** will go back to 10 GHz; back to BBIQ and it is 20 MHz; back to External Mixing and it is 60 GHz.

See:

- ["Center Frequency Presets" on page 1130](#)
- ["VXT Models with Radio Heads/CIU Frequency Range" on page 1132](#)
- ["RF Center Freq" on page 1132](#)

3 VMA Mode
 3.7 Power Stat CCDF Measurement

- ["Ext Mix Center Freq" on page 1133](#)
- ["I/Q Center Freq" on page 1133](#)

Remote Command	<code>[:SENSE] :FREQuency:CENTer <freq></code> <code>[:SENSE] :FREQuency:CENTer?</code>
Example	Set Center Frequency to 50 MHz: <code>:FREQ:CENT 50 MHz</code> Increment Center Frequency by the value of CF Step : <code>:FREQ:CENT UP</code> Return the current value of Center Frequency: <code>:FREQ:CENT?</code>
Notes	Sets the RF, External Mixing or I/Q Center Frequency depending on the selected input: <ul style="list-style-type: none"> – For RF input it is equivalent to <code>:FREQ:RF:CENT</code> – For I/Q input it is equivalent to <code>:FREQ:IQ:CENT</code> – For External Mixer it is equivalent to <code>:FREQ:EMIX:CENT</code> Preset and Max values are dependent on Hardware Options If no terminator (for example, MHz) is sent, the terminator Hz is used. If a terminator with unit other than Frequency is used, an invalid suffix error message is generated
Preset	Depends on instrument maximum frequency, mode, measurement, and selected input See "Center Frequency Presets" on page 1130 , "RF Center Freq" on page 1132 , "Ext Mix Center Freq" on page 1133 , "I/Q Center Freq" on page 1133 , and "VXT Models with Radio Heads/CIU Frequency Range" on page 1132
State Saved	Saved in instrument state
Min/Max	Depends on instrument maximum frequency, mode, measurement, and selected input See "Center Frequency Presets" on page 1130 , "RF Center Freq" on page 1132 , "I/Q Center Freq" on page 1133 , and "VXT Models with Radio Heads/CIU Frequency Range" on page 1132
Status Bits/OPC dependencies	Non-overlapped The following command and parameters apply only to MSR, LTE-Advanced FDD/TDD and 5G NR Modes.
Remote Command	<code>[:SENSe] :FREQuency:CENTer:AUTO ON OFF 1 0</code> <code>[:SENSe] :FREQuency:CENTer:AUTO?</code>
Example	<code>:FREQ:CENT:AUTO OFF</code> <code>:FREQ:CENT:AUTO?</code>
Dependencies	Only available for the Monitor Spectrum, Power Stat CCDF and IQ waveform measurements in MSR, LTE-Advanced FDD/TDD and 5G NR Modes
Couplings	When Center Frequency changes, state automatically changes to Manual (OFF)

Center Frequency, Center Frequency Offset and Carrier Reference Frequency are coupled. When Carrier Reference Frequency changes:

Center Frequency	Relationship
Auto	Center Frequency = Carrier Reference Frequency + Center Frequency Offset (fixed)
Man	Center Frequency (fixed) = Carrier Reference Frequency + Center Frequency Offset

Preset	ON
State Saved	Saved in instrument state
Range	Auto Man

Center Frequency Presets

The following table provides the Center Frequency Presets for the Spectrum Analyzer mode, and the Max Freq, for the various frequency options:

Freq Option	CF after Mode Preset	Stop Freq after Mode Preset	Max Freq (can't tune above)
503 (all but CXA)	1.805 GHz	3.6 GHz	3.7 GHz
503 (CXA)	1.505 GHz	3.0 GHz	3.08 GHz
507 (all but CXA)	3.505 GHz	7.0 GHz	7.1 GHz
507 (CXA)	3.755 GHz	7.5 GHz	7.58 GHz
508 (all but MXE)	1.805 GHz	3.6 GHz	8.5 GHz
508 (MXE)	4.205 GHz	8.4 GHz	8.5 GHz
513	6.805 GHz	13.6 GHz	13.8 GHz
526 (except CXA and MXE)	13.255 GHz	26.5 GHz	27.0 GHz*
526 (CXA)	13.255 GHz	26.5 GHz	26.55 GHz
526 (MXE)	1.805 GHz	3.6 GHz	27.0 GHz
532	16.005 GHz	32.0 GHz	32.5 GHz
540	20.005 GHz	40.0 GHz	40.5 GHz
543	21.505 GHz	43.0 GHz	43.0 GHz
544	22.005 GHz	44.0 GHz	45.0 GHz
550	25.005 GHz	50.0 GHz	52 GHz
F03 (CXA-m)	1.505 GHz	3.0 GHz	3.08 GHz
F07 (CXA-m)	3.755 GHz	7.5 GHz	7.575 GHz
F13 (CXA-m)	6.805 GHz	13.6 GHz	13.8 GHz

3 VMA Mode
 3.7 Power Stat CCDF Measurement

Freq Option	CF after Mode Preset	Stop Freq after Mode Preset	Max Freq (can't tune above)
F26 (CXA-m)	13.255 GHz	26.5 GHz	26.55 GHz
504 (M9421A, M8920A)	2.145 GHz	3.88GHz	3.88 GHz
506 (M9421A, M8920A)	3.245 GHz	6.08GHz	6.08 GHz
F06 (M9410A/11A)	1.0 GHz	6.08 GHz	6.08 GHz
F06 (M9415A)	1 GHz	1.08 GHz	6.6 GHz
F08 (M9415A)	1 GHz	1.08 GHz	8.6 GHz
F12 (M9415A)	1 GHz	1.08 GHz	12.9 GHz

*For option 526, the Max CF in RTSA is 26.999999995 GHz.

N9041B Center Freq Presets

Input	CF after Mode Preset	Stop Freq after Mode Preset	Max Freq (can't tune above)
Input 1, all models	25.005 GHz	50.0 GHz	52 GHz
Input 2, opt 585	42.505 GHz	85.0 GHz	86 GHz
Input 2, opt 590	45.005 GHz	90.0 GHz	92 GHz
Input 2, opt 5CX	55.005 GHz	110.0 GHz	110 GHz

Input 2, CXA and MXE

Model	CF after Mode Preset	Stop Freq after Mode Preset	Max Freq (can't tune above)
CXA opt C75	0.7505 GHz	1.5 GHz	1.58 GHz
MXE	505 MHz	1 GHz	1.000025 GHz

Tracking Generator Frequency Limits (CXA only)

Tracking Generator Option	Min Freq (clips to this freq when turn TG on and can't tune below while TG on)	If above this Freq, Stop Freq clipped to this Freq when TG turned on	Max Freq (can't tune above) while TG on
T03	9 kHz	3.0 GHz	3.08 GHz
T06	9 kHz	6.0 GHz	6.05 GHz

Tracking Generator Frequency Limits(CXA-m only)

Tracking Generator Option	Min Freq (clips to this freq when turn TG on and can't tune below while TG on)	If above this Freq, Stop Freq clipped to this Freq when TG turned on	Max Freq (can't tune above) while TG on
T03	2 MHz	3.08 GHz	3.08 GHz
T07	2 MHz	7.575 GHz	7.575 GHz
T13	2 MHz	13.8 GHz	13.8 GHz
T26	2 MHz	26.55 GHz	26.55 GHz

VXT Models with Radio Heads/CIU Frequency Range

The following table shows the Center Frequency Presets and Range for VXT modes with Radio Heads/CIU.

Products with Radio Heads/CIU	Preset	Start frequency	Stop frequency
M9421A + CIU	6 GHz	5.9 GHz	12 GHz
M9410A + CIU	6 GHz	5.9 GHz	12 GHz
M9410A + CIU + RRH	25 GHz	24.25 GHz	43.5 GHz

RF Center Freq

Lets you specify the RF Center Frequency. Sets the Center Frequency to use when the RF input is selected, even if the RF input is not selected at the time the command is sent. Note that **Center Frequency** in the **Frequency** menu on the front panel always applies to the currently selected input.

Remote Command	<code>[:SENSe] :FREQuency:RF:CENTer <freq></code> <code>[:SENSe] :FREQuency:RF:CENTer?</code>
Example	<code>:FREQ:RF:CENT 30 MHz</code> <code>:FREQ:RF:CENT?</code>
Notes	This command is the same in all Modes, but the parameter is Measurement Global, so the value is independent in each mode and common across all the measurements in the mode
Dependencies	If the electronic/soft attenuator is enabled, any attempt to set Center Frequency such that the Stop Frequency would be > 3.6 GHz fails and results in an advisory message If the equivalent SCPI command is sent, this same message is generated as part of a "-221, Settings conflict" warning
Preset	See " Center Frequency Presets " on page 1130
State Saved	Saved in instrument state
Min	-79.999995 MHz
Max	See " Center Frequency Presets " on page 1130. Basically, instrument maximum frequency - 5 Hz

Ext Mix Center Freq

Specifies the External Mixer Center Frequency. Sets the Center Frequency to use when the External Mixer is selected, even if the External Mixer input is not the input that is selected at the time the command is sent. Note that **Center Frequency** in the **Frequency** menu on the front panel always applies to the currently selected input.

Remote Command	<code>[:SENSe] :FREQuency:EMIXer:CENTer <freq></code> <code>[:SENSe] :FREQuency:EMIXer:CENTer?</code>
Example	<code>:FREQ:EMIX:CENT 60 GHz</code> <code>:FREQ:EMIX:CENT?</code>
Notes	This command is the same in all Modes, but the parameter is Measurement Global, so the value is independent in each Mode and common across all the measurements in the Mode
Couplings	When returning to External Mixing after having switched to one of the other inputs (for example, RF), you will come back into the settings that you had when you left External Mixing. So, you will come back to the band you were in with the Center Frequency that you had. However, Span is not an input-dependent parameter, therefore you will bring the span over from the other input. Therefore, the instrument comes back with the span from the previous input, limited as necessary by the current mixer setup
Preset	When a Mode Preset is performed while in External Mixing, the Start frequency of the current Mode is set to the nominal Min Freq of the lowest harmonic range in the Harmonic Table for the current mixer setup. Similarly, the Stop frequency of the current Mode is set to the nominal Max Freq of the highest harmonic range in the Harmonic Table. The Center Freq thus presets to the point arithmetically equidistant from these two frequencies Note that, if the current measurement has a limited Span available to it, and cannot achieve the Span shown in the table (Span=Stop Freq – Start Freq), the instrument uses the maximum Span the measurement allows, and still sets the Center Freq to the midpoint of the Start and Stop Freq values in the Harmonic Table When Restore Input/Output Defaults is performed, the mixer presets to the 11970A, whose Start and Stop frequencies are 26.5 and 40 GHz respectively. The center of these two frequencies is 33.25 GHz Therefore, after Restore Input/Output Defaults , if you go to External Mixing and do a Mode Preset while in Spectrum Analyzer Mode, the resulting Center Freq is 33.25 GHz
State Saved	Yes
Min	The minimum frequency in the currently selected mixer band + 5 Hz
Max	The maximum frequency in the currently selected mixer band - 5 Hz

I/Q Center Freq

Specifies the I/Q Center Frequency. Sets the Center Frequency to be used when the I/Q input is selected, even if the I/Q input is not the input that is selected at the time the command is sent. Note that **Center Frequency** in the **Frequency** menu on the front panel always applies to the currently selected input.

Remote Command	<code>[:SENSe] :FREQuency:IQ:CENTer <freq></code>
----------------	---

	<code>[:SENSe] :FREQuency :IQ :CENTer?</code>
Example	<code>:FREQ:IQ:CENT 30 MHz</code>
Notes	This command is the same in all Modes, but the parameter is Measurement Global, so the value is independent in each Mode and common across all the measurements in the Mode
Preset	0 Hz
State Saved	Saved in instrument state
Min/Max	-/+40.049995 MHz

CF Step

Changes the step size for the "Center Frequency" on page 1128 and start and stop frequency functions. Once a step size has been selected and the center frequency function is active, the step keys (and the **UP | DOWN** parameters for **Center Frequency** from remote commands) change the center frequency by the step-size value. The step size function is useful for finding harmonics and sidebands beyond the current frequency span of the instrument.

Note that the start and stop frequencies also step by the **CF Step** value.

Remote Command	<code>[:SENSe] :FREQuency :CENTer :STEP [:INCRement] <freq></code> <code>[:SENSe] :FREQuency :CENTer :STEP [:INCRement]?</code>
Example	Increase the current center frequency value by 500 MHz: <code>:FREQ:CENT:STEP 500 MHz</code> <code>:FREQ:CENT UP</code> <code>:FREQ:CENT:STEP?</code>
Notes	Preset and Max values are depending on Hardware Options
Dependencies	<i>Not</i> available in the MSR, LTEAFDD, LTEATDD, 5GNR, and Channel Quality Modes If the electronic/soft attenuator is enabled, any attempt to change the value of the center frequency >3.6 GHz by pressing the Up-Arrow key, fails and results in an advisory message. If the equivalent SCPI command is sent, this same message is generated as part of a "-221, Settings conflict" warning
Couplings	When auto-coupled, the center frequency step size is set to 10% of the span
Preset	Auto
State Saved	Saved in instrument state
Min/Max	-/+ (the maximum frequency of the instrument). That is, 27 GHz max freq instrument has a CF step range of +/- 27 GHz. Note that this is the maximum frequency given the current settings of the instrument, so in External Mixing, for example, it is the maximum frequency of the current mixer band
Status Bits/OPC dependencies	non-overlapped

Auto Function

Remote Command	<code>[:SENSe]:FREQuency:CENTer:STEP:AUTO OFF ON 0 1</code>
Example	<code>:FREQ:CENT:STEP:AUTO ON</code> <code>:FREQ:CENT:STEP:AUTO?</code>
Preset	ON

Adjust Center Frequency to Carrier Config

This immediate action control adjusts "Center Frequency" on page 1128 to cover all the configured carriers when "Info BW" on page 1119 is Auto.

Remote Command	<code>[:SENSe]:PStatistic:FREQuency:CENTer:ADJust</code>
Example	<code>:PST:FREQ:CENT:ADJ</code>
Couplings	When "Info BW" on page 1119 is Man , pressing this control automatically changes it to Auto

3.7.7 Marker

Accesses a menu that enables you to select, set up and control the markers for the current measurement. If there are no active markers, **Marker** selects marker 1, sets it to **Normal** and places it at the center of the display. If the selected marker is **Off**, it is set to **Normal** and placed at the center of the screen on the trace determined by the Marker Trace rules.

3.7.7.1 Select Marker

Specifies the selected marker. The term "selected marker" is used throughout this document to specify which marker will be affected when you change marker settings, perform a Peak Search, etc.

The **Select Marker** control appears above the menu panel, indicating that it applies to all controls in the **Marker** menu panels. **Select Marker** is blanked if you select a tab whose controls do *not* depend on the selected marker (for example, Counter).

For any menu that includes **Select Marker**, the first control is always **Marker Frequency | Time**.

Notes	The selected marker is remembered even when not in the Marker menu, and is used if a search is done, or a Band Function is turned on, or for Signal Track or Continuous Peak
Preset	Marker 1
State Saved	The number of the selected marker is saved in instrument state
Annunciation	Appears in the marker results block label for Normal and Delta markers

3.7.7.2 Settings

The controls on this tab include the Marker active function and a radio button selection of the marker control mode (**Position/Normal**, **Delta** or **Off**) for the selected marker, as well as additional functions that help you use markers.

Marker X-Axis Value

Sets the marker X-Axis value in the current marker X-Axis Scale unit. This function has no effect if the control mode is **Off**, but is the remote command equivalent of entering an X value if the control mode is **Normal** or **Delta**.

Remote Command	<code>:CALCulate:PStatistic:MARKer[1] 2 ... 12:X <rel_amp></code> <code>:CALCulate:PStatistic:MARKer[1] 2 ... 12:X?</code>
Example	<code>:CALC:PST:MARK3:X 0</code> <code>:CALC:PST:MARK3:X?</code>
Notes	If no suffix is sent, uses the fundamental units for the current marker X-Axis Scale. If a suffix is sent that does not match the current marker X-Axis Scale unit, an error "Invalid suffix" is generated The query returns the marker's absolute X Axis value if the control mode is Normal , or the offset from the marker's reference marker if the control mode is Delta . The query is returned in the fundamental units for the current marker X-Axis scale: Hz for Frequency and Inverse Time , seconds for Period and Time . If the marker is Off the response is Not A Number
Preset	After a preset, all Markers are turned OFF , so Marker X-Axis Value query returns Not a Number (NAN)
State Saved	No
Min/Max	-/+9.9E+37
Annotation	Mkr # <X value> and <Marker value> upper right on graph

Marker Y Axis Value (Remote Command Only)

Queries the marker Y-Axis value in the current marker Y-Axis unit.

Remote Command	<code>:CALCulate:PStatistic:MARKer[1] 2 ... 12:Y?</code>
Example	<code>:CALC:PST:MARK11:Y?</code>
Notes	Returns the marker Y-Axis result, if the control mode is Normal , or Delta . If the marker is Off , the response is <i>Not a Number</i>
Preset	0
State Saved	No
Backwards Compatibility SCPI	<code>:CALCulate:PStatistic:MARKer[1] 2 ... 12:FUNCtion:RESult?</code>

Marker Mode

Sets the marker control mode to **Normal (POSiTion)**, **Delta**, or **Off**. All interactions and dependencies detailed under the control description are enforced when the remote command is sent. If the selected marker is **Off**, pressing **Marker** sets it to **Normal** and places it at the center of the screen on the trace determined by the **Marker Trace** rules. At the same time, **Marker X Axis Value** appears on the Active Function area.

The default active function is the active function for the currently selected marker control mode. If the current control mode is **OFF**, there is no active function, and the active function is turned off.

Remote Command	<code>:CALCulate:PStatistic:MARKer[1] 2 ... 12:MODE POSiTiOn DELTa OFF</code> <code>:CALCulate:PStatistic:MARKer[1] 2 ... 12:MODE?</code>
Example	<code>:CALC:PST:MARK:MODE POS</code> <code>:CALC:PST:MARK:MODE?</code>
Preset	<code>OFF</code>
State Saved	Saved in instrument state
Range	<code>POSiTiOn DELTa OFF</code>
Annotation	Mkr # <X value> and <Marker value> upper right on graph When Marker Trace is Polar in WCDMA mode: Mkr # <Chip Value (RHO & QPSKEVM)/Symbol Value (CDP)>, <X value> and <Y value> upper right on graph

Backwards Compatibility SCPI Commands

Sets or queries the state of a marker. Setting a marker that is **OFF** to **ON** (1) puts it into **Normal** mode and places it at the center of the screen.

Example	<code>:CALC:PST:MARK3:STAT 1</code> <code>:CALC:PST:MARK3:STAT?</code>
Preset	<code>OFF</code>
State Saved	Saved in instrument state
Range	<code>OFF ON</code>
Backwards Compatibility SCPI	<code>:CALCulate:PStatistic:MARKer[1] 2 ... 12:STATe OFF ON 0 1</code> <code>:CALCulate:PStatistic:MARKer[1] 2 ... 12:STATe?</code>

Delta Marker (Reset Delta)

Pressing this button has exactly the same effect as pressing **Delta** in "**Marker Mode**" on page 1137. The selected marker becomes a **Delta** marker. If the selected marker is already a **Delta** marker, the reference marker is moved to the current position of the selected marker, thus resetting the Delta to zero.

Marker Settings Diagram

Lets you configure the Marker system using a visual utility.

All Markers Off

Turns off all markers.

Remote Command	:CALCulate:PStatistic:MARKer:AOff
Example	:CALC:PST:MARK:AOff

Couple Markers

When this function is **ON**, moving any marker causes an equal X-Axis movement of every other marker that is not **Off**. By "equal X-Axis movement" we mean that we preserve the difference between each marker's X-Axis value (in the fundamental x-axis units of the trace that marker is on), and the X-Axis value of the marker being moved (in the same fundamental x-axis units).

This may result in markers going off screen.

Remote Command	:CALCulate:PStatistic:MARKer:COUple[:STATe] ON OFF 1 0
Example	:CALC:PST:MARK:COUP ON :CALC:PST:MARK:COUP?
Preset	OFF Presets on Mode Preset and All Markers Off
State Saved	Saved in instrument state

3.7.7.3 Properties

The controls on this tab are used to set certain properties of the selected marker.

Marker X-Axis Value

This is the fundamental control that you use to move a marker around on the trace. This is the same as "[Marker X-Axis Value](#)" on page 1136 in **Settings**.

Relative To

Selects the marker to which the selected marker is relative (its reference marker).

Every marker has another marker to which it is relative. This marker is referred to as the "reference marker" for that marker. This attribute is set by the **Marker, Properties, Relative To** key. The marker must be a **Delta** marker to make this attribute relevant. If it is a **Delta** marker, the reference marker determines how the marker is controlled and how its value is displayed. A marker cannot be relative to itself.

Remote Command	<code>:CALCulate:PStatistic:MARKer[1] 2 ... 12:REFerence <integer></code> <code>:CALCulate:PStatistic:MARKer[1] 2 ... 12:REFerence?</code>
Example	<code>:CALC:PST:MARK:REF 3</code> <code>:CALC:PST:MARK:REF?</code>
Notes	Causes the marker specified with the subopcode to become selected Range (for SCPI command): 1 to 12. If the range is exceeded the value is clipped A marker cannot be relative to itself so that choice is not available, and if sent from SCPI generates error -221: "Settings conflict; marker cannot be relative to itself" When queried, a single value is returned (the specified marker numbers relative marker)
Couplings	The act of specifying the selected marker's reference marker makes the selected marker a Delta marker If the reference marker is off it is turned on in Fixed or Normal mode at the delta marker location
Preset	The preset default "Relative To" marker (reference marker) is the next higher numbered marker (current marker +1). For example, if marker 2 is selected, then it's default reference marker is marker 3. The exception is marker 12, which has a default reference of marker 1 Set to the defaults by using Restore Mode Defaults . This is not reset by Marker Off, All Markers Off, or Preset
State Saved	Saved in instrument state. Not affected by Marker Off and hence not affected by Preset or power cycle
Min	1
Max	12
Annunciation	Appears in the marker label of a Delta marker

Marker Trace

Assigns the specified marker to the designated trace. The trace choices are:

- MEASured
- GAUSSian
- REFerence

Remote Command	:CALCulate:PSTatistic:MARKer[1] 2 ... 12:TRACe MEASured GAUSSian REFerence :CALCulate:PSTatistic:MARKer[1] 2 ... 12:TRACe?
Example	:CALC:PST:MARK3:TRAC MEAS :CALC:PST:MARK:TRACE?
Preset	MEASured
State Saved	Yes
Range	MEASured GAUSSian REFerence

Marker Settings Diagram

Lets you configure the Marker system using a visual utility. This is the same as "[Marker Settings Diagram](#)" on page 1138 in **Settings**.

3.7.8 Meas Setup

Contains functions for setting up the measurement parameters and also contains functions for setting up parameters global to all measurements in the mode.

3.7.8.1 Settings

Contains frequently used functions to which you will want the fastest access.

Counts

Sets the accumulated number of sampling points for data acquisition. The range is 1.000 kpt (k point) to 2.00000 Gpt (G point) with 1 kpt resolution.

Remote Command	[:SENSe]:PSTatistic:COUNts <integer> [:SENSe]:PSTatistic:COUNts?
Example	:PST:COUN 5001 :PST:COUN?
Couplings	Coupled to " Meas Cycles " on page 1141, by: Counts = Meas Cycles * SamplingFrequency * "Meas Interval" on page 1141
Preset	10000000

State Saved	Saved in instrument state
Min/Max	1000/2000000000

Meas Cycles

Set the number of measurement cycles to calculate power statistic data. This number is coupled to "Counts" on page 1140, by:

$$\text{Meas Cycles} = \text{Counts} / (\text{Sampling Frequency} * \text{Meas Interval})$$

When the **Counts** value cannot be divided by (**Sampling Frequency** * "**Meas Interval**" on page 1141), this value is displayed as a decimal fraction.

Remote Command	<code>[:SENSe]:PStatistic:SWEEP:CYCLes <real></code> <code>[:SENSe]:PStatistic:SWEEP:CYCLes?</code>
Example	<code>:PST:SWE:CYCL 1001</code> <code>:PST:SWE:CYCL?</code>
Preset	Depends on the sampling frequency
Min	0.001
Max	Depends on the sampling frequency

Meas Interval

Sets the number of data points to be used as the measurement interval. This value couples to "Counts" on page 1140, as:

$$\text{Meas Interval} = \text{Counts} / (\text{"Meas Cycles" on page 1141} * \text{Sampling Frequency})$$

Remote Command	<code>[:SENSe]:PStatistic:SWEEP:TIME <time></code> <code>[:SENSe]:PStatistic:SWEEP:TIME?</code>
Example	<code>:PST:SWE:TIME 2 ms</code> <code>:PST:SWE:TIME?</code>
Preset	1.0 ms !unless noted below LTEATDD, 5G NR: 500 us
Min/Max	50.0 us/10.0 ms !unless noted below LTEATDD, 5G NR: 1 us/10.0 ms

Meas Setup Summary Table

Lets you view and access many of the parameters in the **Meas Setup** menus on one screen.

Auto Couple

Immediately puts all **Auto/Man** functions into **Auto**. **Auto Couple** is confined to the current measurement only. It does not affect other measurements in the Mode.

In the **Auto** state, **Auto/Man** functions are said to be “coupled”, meaning their values change as you make changes to other values in the measurement. This helps ensure accurate measurements and optimum dynamic range. **Auto Couple** is an immediate action function, and when it is executed, all the **Auto/Man** controls for the current measurement are set to **Auto**, and all measurement settings coupled to the **Auto/Man** parameters are automatically set to their optimal values.

For further details of measurement-specific settings (if any), see "[Measurement-Specific Details](#)" on page 1143 below.

Remote Command	:COUPle ALL
Example	:COUP ALL
Backwards Compatibility SCPI	:COUPLE ALL NONE
Backwards Compatibility Notes	:COUP:NONE puts all Auto/Man parameters in manual mode, decoupling all the coupled instrument parameters. It is retained for backwards compatibility and is <i>not</i> recommended for making measurements or new designs

All **Auto/Man** parameter couplings in the measurement are set to **Auto**. This includes couplings that may be unavailable or grayed-out due to the current state. For example, in the Swept SA measurement, there is no **Auto/Man** coupling for **RBW** while in Zero Span. Nonetheless, if **Auto Couple** were executed while in Zero Span, it would set **RBW** to Auto "behind the scenes" so that, on exit from Zero Span, it would be in **Auto**.

Any **Auto/Man** selection specific (local) to the other measurements in the current Mode are not affected by **Auto Couple**. Any functions that are *not* coupled with other instrument parameters, such as ranging or leveling variables, such as **AutoRange** or **AutoScale**, are not affected.

Executing **Auto Couple** generates the informational message, "All Auto/Man functions have been set to Auto".

Each parameter, upon being set to **Auto**, selects and sets the appropriate auto-coupled value based on that parameter's coupling rules. The Dependency Resolver orchestrates the couplings for parameters that depend on one or more other parameters. The coupling and dependency rules for each parameter are defined in the section describing that parameter.

Executing **Auto Couple** does not affect markers, marker functions, trace or display attributes, or any other instrument setting other than those specifically mentioned above.

Measurement-Specific Details

TOI (SA Mode only)

Parameters affected by **Auto Couple** are:

- Center Frequency Step
- Resolution Bandwidth
- Span/RBW Ratio
- Sweep Time
- Video BANDwidth VBW/RBW ratio
- Upper and Lower Tone (set to Sense)
- Zero span measurement Resolution Bandwidth
- Zero span measurement Dwell Time

Harmonics (SA Mode only)

Parameters affected by **Auto Couple** are:

- Resolution Bandwidth
- Fundamental Frequency
- Dwell Time
- Range Table Resolution Bandwidths
- Range Table Dwell Times

Meas Preset

Restores all the measurement parameters to their default values.

Remote Command [:CONFigure:PStatistic](#)

Example	<code>:CONF:PST</code>
Couplings	Selecting Meas Preset restores all measurement parameters to their default values

3.7.8.2 Advanced

Contains controls for setting advanced functions of the instrument.

IF Gain

Used to set the IF Gain function to: Auto, Low Gain or High Gain. These settings affect sensitivity and IF overloads.

Only applies to the RF input. Does not apply to baseband I/Q input.

Remote Command	<code>[:SENSe]:PStatistic:IF:GAIN[:STATe] ON OFF 1 0</code> <code>[:SENSe]:PStatistic:IF:GAIN[:STATe]?</code>
Example	<code>:PST:IF:GAIN ON</code> <code>:PST:IF:GAIN?</code>
Notes	ON = high gain OFF = low gain
Dependencies	Not available when IQ Input is selected Has no effect when the U7227A USB Preamplifier is connected. This is not annotated or reflected on any control; there are no controls grayed out nor any SCPI locked out. The instrument simply behaves as though both IF Gain is set to Low regardless of the setting on the control Not available in VXT, EXM, or UXM
Couplings	Sending this command forces IF Gain Auto to OFF (Man)
Preset	OFF
State Saved	Saved in instrument state
Range	Low Gain High Gain Auto Function
Remote Command	<code>[:SENSe]:PStatistic:IF:GAIN:AUTO[:STATe] ON OFF 1 0</code> <code>[:SENSe]:PStatistic:IF:GAIN:AUTO[:STATe]?</code>
Example	<code>:PST:IF:GAIN:AUTO ON</code> <code>:PST:IF:GAIN:AUTO?</code>
Couplings	Auto sets IF Gain to High Gain if the input attenuator is set to 0 dB, or the preamp is turned on, or the Max Mixer Level is -20 dBm or lower For other conditions, Auto sets IF Gain to Low Gain
Preset	OFF

IF Upsampling Ratio

Allows you to select the upsampling ratio after data is captured for a measurement. Using this method, mitigation of peak detection error can be expected when upsampling ratio is set to $> x1$.

Remote Command	<code>[:SENSe]:PStatistic:URATio X1 X2 X4 X8 X16 X32</code> <code>[:SENSe]:PStatistic:URATio?</code>
Example	<code>:PST:URAT X8</code> <code>:PST:URAT?</code>
Notes	X1 is for backwards compatibility
Preset	X1
State Saved	Yes, Saved in instrument state
Range	X1 X2 X4 X8 X16 X32

3.7.8.3 Global

The controls in this menu apply to all Modes in the instrument.

Some controls (for example, "[Global Center Freq](#)" on page 1828) allow you to switch certain Meas Global parameters to a Mode Global state. These switches apply to all Modes that support global settings. For example, no matter what Mode you are in when you set **Global Center Freq** to **ON**, it applies to all Modes that support Global settings.

Other controls (for example, **Extend Low Band**) are actually set in this menu, but apply to all Modes.

Global Center Freq

The software maintains a Mode Global value called **Global Center Freq**.

When **Global Center Freq** is switched **ON**, the current Mode's center frequency is copied into the **Global Center Frequency**, and from then on all Modes that support global settings use the **Global Center Frequency**, so you can switch between any of these Modes and the **Center Frequency** remains unchanged.

Adjusting the **Center Frequency** of any Mode that supports Global Settings, while **Global Center Freq** is **ON**, modifies the **Global Center Freq**.

When **Global Center Freq** is switched **OFF**, the **Center Frequency** of the current Mode is unchanged, but now the **Center Frequency** of each Mode is once again independent.

When **Mode Preset** is pressed while **Global Center Freq** is **ON**, the **Global Center Freq** is preset to the preset **Center Frequency** of the current Mode.

This function resets to **OFF** when "**Restore Defaults**" on page 1829 is pressed, or when **System, Restore Defaults, All Modes** is pressed.

Remote Command	<code>:INSTRument:COUPlE:FREQuency:CENTer ALL NONE</code> <code>:INSTRument:COUPlE:FREQuency:CENTer?</code>
Example	<code>:INST:COUP:FREQ:CENT ALL</code> <code>:INST:COUP:FREQ:CENT?</code>
Preset	Set to OFF on Global Settings, Restore Defaults and System, Restore Defaults, All Modes
Range	ALL NONE
Preset	OFF
Backwards Compatibility SCPI	<code>:GLOBal:FREQuency:CENTer[:STATE] 1 0 ON OFF</code> <code>:GLOBal:FREQuency:CENTer[:STATE]?</code>

Global EMC Std

When this control is switched **ON**, the current Mode's EMC Std is copied into the **Global EMC Std**, and from then on all Modes that support global settings use the **Global EMC Std**, so you can switch between any of these Modes and the EMC Std remains unchanged.

Adjusting the EMC Std of any Mode that supports Global settings, while **Global EMC Std** is **ON** modifies the **Global EMC Std**.

When **Global EMC Std** is switched **OFF**, the EMC Std of the current Mode remains unchanged, but now the EMC Std of each Mode is once again independent. When **Mode Preset** is pressed while **Global EMC Std** is **ON**, **Global EMC Std** is preset to the preset EMC Std of the current Mode.

This function resets to **OFF** when "**Restore Defaults**" on page 1829 is pressed, or when **System, Restore Defaults, All Modes** is pressed.

Remote Command	<code>:INSTRument:COUPlE:EMC:STANdard ALL NONE</code> <code>:INSTRument:COUPlE:EMC:STANdard?</code>
Example	<code>:INST:COUP:EMC:STAN ALL</code> <code>:INST:COUP:EMC:STAN?</code>
Dependencies	Only available if Option EMC is installed
Preset	Set to OFF on Global Settings, Restore Defaults and System, Restore Defaults, All Modes
Range	ALL NONE

Restore Defaults

Resets all functions in the **Global** settings menu to **OFF**. Pressing **System, Restore Defaults, All Modes** has the same effect.

Remote Command	:INSTrument:COUPle:DEFault
Example	:INST:COUP:DEF
Backwards Compatibility SCPI	:GLOBal:DEFault

3.7.9 Sweep

Accesses controls to configure and control the acquisition of data, and the X-axis parameters of the instrument.

Depending on the selected mode and measurement, these controls might include: **Sweep Time, Continuous/Single, Pause/Resume, X Scale** and **Number of Points**.

3.7.9.1 Sweep/Control

Accesses controls that let you operate the sweep and control functions of the instrument, such as **Sweep Time** and **Continuous/Single**.

Sweep/Measure

Lets you toggle between **Continuous** and **Single** sweep or measurement operation. The single/continuous state is Meas Global, so the setting affects all measurements.

The front-panel key **Single/Cont** performs exactly the same function

See "[More Information](#)" on page 1148

Remote Command	:INITiate:CONTinuous OFF ON 0 1 :INITiate:CONTinuous?
Example	Put instrument into Single measurement operation: :INIT:CONT 0 :INIT:CONT OFF Put instrument into Continuous measurement operation: :INIT:CONT 1 :INIT:CONT ON
Preset	ON

Note that **:SYST:PRES** sets **:INIT:CONT** to **ON**, but ***RST** sets **:INIT:CONT** to **OFF**

State Saved	Saved in instrument state
Annunciation	<p>The Single/Continuous icon in the Meas Bar changes depending on the setting:</p> <ul style="list-style-type: none"> - A line with an arrow is Single - A loop with an arrow is Continuous
Backwards Compatibility Notes	<p>X-Series A-models had Single and Cont hardkeys in place of the SweepSingleCont softkey. In the X-Series A-models, if in single measurement, the Cont hardkey (and INIT:CONT ON) switched to continuous measurement, but never restarted a measurement and never reset a sweep</p> <p>X-Series B-models have a Cont/Single toggle control instead of Single and Cont hardkeys, but it is still true that, if in single measurement, the Cont/Single toggle control never restarts a measurement and never resets a sweep</p>

More Information

Continuous Mode	<p>The instrument takes repetitive sweeps, averages, measurements, etc., when in continuous mode. If in average or Max/Min Hold, and the average/hold count reaches the Average/Hold Num, the count stops incrementing, but the instrument keeps sweeping</p> <p>See the Trace key description under Trace Average for the averaging formula used both before and after the Average/Hold Num is reached. The trigger condition must be met prior to each sweep</p> <p>The type of trace processing for multiple sweeps is set under the Trace key, with choices of Trace Average, Max Hold, or Min Hold</p>
Single Mode	<p>The instrument takes a single sweep when in Single mode, or if in average or Max/Min Hold, or if there is a Waterfall window displayed, it takes multiple sweeps until the average/hold count reaches the Average/Hold Num, then the count stops incrementing, and the instrument stops sweeping</p> <p>See the Trace key description under Trace Average for the averaging formula used. The trigger condition must be met prior to the sweep</p> <p>The type of trace processing for multiple sweeps is set under the Trace key, with choices of Trace Average, Max Hold, or Min Hold</p>

If the instrument is in **Single** measurement mode, pressing the **Cont/Single** toggle control does not zero the count and does not cause the sweep to be reset; the only action is to put the instrument into Continuous measurement operation.

If the instrument is already in **Continuous** sweep:

- **:INIT:CONT 1** has no effect
- **:INIT:CONT 0** places the instrument in Single Sweep but has no effect on the current sequence until $k = N$, at which point the current sequence will stop and the instrument will go to the idle state

See "**Restart**" on page 1832 for details of **:INIT:IMMEDIATE**.

If the instrument is already in **Single** sweep, `:INIT:CONT OFF` has no effect.

If the instrument is already in **Single** sweep, then pressing **Cont/Single** in the middle of a sweep does not restart the sweep or sequence. Similarly, pressing **Cont/Single** does not restart the sweep or sequence if the sweep is not in the idle state (for example, if you are taking a very slow sweep, or the instrument is waiting for a trigger). Even though pressing **Cont/Single** in the middle of a sweep does not restart the sweep, sending `:INIT:IMM` does reset it.

If the instrument is in **Single** sweep, and *not* Averaging/Holding, and you want to take one more sweep, press **Restart**.

If the instrument is in **Single** sweep, *and* Averaging/Holding, and you want to take one more sweep without resetting the Average trace or count, go to **Meas Setup** and increment the average count by 1 by pressing the **Step-Up** key while **Average/Hold Num** is the active function. You can also do this by sending `:CALC:AVER:TCON UP`.

Restart

Restarts the current sweep, or measurement, or set of averaged/held sweeps or measurements. If you are Paused, pressing **Restart** performs a Resume.

The front-panel key **Restart** performs exactly the same function.

The **Restart** function is accessed in several ways:

- Pressing the **Restart** key
- Sending `:INIT:IMM`
- Sending `:INIT:REST`

See "[More Information](#)" on page 1150

Remote Command	<code>:INITiate[:IMMEDIATE]</code> <code>:INITiate:REStart</code>
Example	<code>:INIT:IMM</code> <code>:INIT:REST</code>
Notes	<code>:INIT:REST</code> and <code>:INIT:IMM</code> perform exactly the same function
Couplings	Resets average/hold count k. For the first sweep overwrites all active (update = on) traces with new current data. For application modes, it resets other parameters as required by the measurement
Status Bits/OPC dependencies	This is an Overlapped command The <code>STATus:OPERation</code> register bits 0 through 8 are cleared , <i>except</i> bit 6 (Waiting for Periodic Sync). Initiating a measurement and Waiting for Periodic Sync could be asynchronous The <code>STATus:QUESTionable</code> register bit 9 (<code>INTEGRity</code> sum) is cleared The <code>SWEEPING</code> bit is set

	The MEASURING bit is set
Backwards Compatibility Notes	For Spectrum Analysis Mode in ESA and PSA, the Restart hardkey and the :INIT:REST command restarted trace averages (displayed average count reset to 1) for a trace in Clear Write , but did not restart Max Hold and Min Hold In X-Series, the Restart hardkey and the :INIT:REST command restart not only Trace Average , but MaxHold and MinHold traces as well

More Information

The **Restart** function first aborts the current sweep or measurement as quickly as possible. It then resets the sweep and trigger systems, sets up the measurement and initiates a new data measurement sequence with a new data acquisition (sweep) taken once the trigger condition is met.

If the instrument is in the process of aligning when a **Restart** is executed, the alignment finishes before the restart function is performed.

Even when set for **Single** operation, multiple sweeps may be taken when **Restart** is pressed (for example, when averaging/holding is on). Thus, when we say that **Restart** "restarts a measurement", depending on the current settings, we may mean that it:

- Restarts the current sweep
- Restarts the current measurement
- Restarts the current set of sweeps if any trace is in Trace Average, Max Hold or Min Hold
- Restarts the current set of measurements if Averaging, or Max Hold, or Min Hold is on for the measurement

If there is no Average or Max/Min Hold function (no trace in Trace Average or Hold, or **Average/Hold Num** set to 1), and no **Waterfall** window is being displayed, a single sweep is equivalent to a single measurement. A single sweep is taken after the trigger condition is met; and the instrument stops sweeping once that sweep has completed. However, with **Average/Hold Num** > 1, and at least one trace set to Trace Average, Max Hold, or Min Hold, or a **Waterfall** window being displayed, multiple sweeps/data acquisitions are taken for a single measurement. The trigger condition must be met prior to each sweep. The sweep is stopped when the average count k equals the number N set for **Average/Hold Num**.

Once the full set of sweeps has been taken, the instrument goes to the idle state. To take one more sweep without resetting the average count, increment the average count by 1, by pressing the **Step-Up** key while **Average/Hold Number** is the active function, or by sending the remote command **:CALC:AVER:TCN UP**.

Trace Update

The numeric results are not blanked at any time during the restart cycle.

For slow sweeps (see **Trace Update** section in **Trace/Detector**), the traces are updated real-time during the sweep. There may be a special circumstance in application mode measurements where an exception is made and the traces and/or results need to be blanked before displaying the new results.

To summarize, the following list shows what happens to the trace data on various events:

Event	Trace Effect
Clear/Write pressed (even if already in Clear/Write)	Set to mintracevalue
Max Hold pressed (even if already in Max Hold)	Set to mintracevalue
Min Hold pressed (even if already in Min Hold)	Set to maxtracevalue
Trace Average pressed (even if already in Trace Average)	Trace data unaffected but start new sweep/avg/hold
Restart pressed	Trace data unaffected but start new sweep/avg/hold
Parameter requiring restart changed (e.g., RBW)	Trace data unaffected but start new sweep/avg/hold

Sweep and Trigger Reset

Resetting the sweep system resets the average/hold count k to 0. It also resets the set point counter to 0. Resetting the trigger system resets the internal auto trig timer to the value set by the **Auto Trig** control.

Averaging

The weighting factor used for averaging is k . This k is also the average/hold count for how many valid sweeps (data acquisitions) have been done. This k is used for comparisons with N , as those comparisons always needs to be based on valid completed sweeps.

The displayed average/hold, K , shows the count for the sweep (data acquisition) in progress. $K = k + 1$, with a limit of N . The displayed value K changes from its previous value to 1 as soon as the trigger condition for the first data acquisition (sweep) is met.

Pause/Resume

Pauses a measurement after the current data acquisition is complete.

When paused, the label on the control changes to **Resume**. Pressing **Resume** unpauses the measurement. When paused, pressing **Restart** performs a Resume.

Remote Command	<code>:INITiate:PAUSe</code> <code>:INITiate:RESume</code>
Example	<code>:INIT:PAUS</code> <code>:INIT:RES</code>
Dependencies	Not displayed in Modes that do not support pausing
Annotation	Only on control

Abort (Remote Command Only)

Stops the current measurement. Aborts the current measurement as quickly as possible, resets the sweep and trigger systems, and puts the measurement into an "idle" state. If the instrument is in the process of aligning when `:ABORt` is sent, the alignment finishes *before* the abort function is performed, so `:ABORt` does not abort an alignment.

If the instrument is set for **Continuous** measurement, it sets up the measurement and initiates a new data measurement sequence with a new data acquisition (sweep) taken once the trigger condition is met.

If the instrument is set for **Single** measurement, it remains in the "idle" state until an `:INIT:IMM` command is received.

Remote Command	<code>:ABORt</code>
Example	<code>:ABOR</code>
Notes	If <code>:INIT:CONT</code> is ON , then a new continuous measurement will start immediately, with sweep (data acquisition) occurring once the trigger condition has been met If <code>:INIT:CONT</code> is OFF , then <code>:INIT:IMM</code> is used to start a single measurement, with sweep (data acquisition) occurring once the trigger condition has been met
Dependencies	For continuous measurement, <code>:ABORt</code> is equivalent to the Restart key Not all measurements support this command
Status Bits/OPC dependencies	The <code>STATus:OPERation</code> register bits 0 through 8 are cleared, <i>except</i> bit 6 (Waiting for Periodic Sync). Initiating a measurement and Waiting for Periodic Sync could be asynchronous The <code>STATus:QUESTionable</code> register bit 9 (INTEGRity sum) is cleared Since all the bits that feed into OPC are cleared by <code>:ABORt</code> , the Abort command will cause the <code>*OPC</code> query to return true

3.7.9.2 X Scale

Accesses controls that enable you to set the horizontal scale parameters.

Scale/Div

Enables you to enter a time value to change the horizontal scale.

Remote Command	<code>:DISPlay:PStatistic:VIEW[1]:WINDow2:TRACe:X[:SCALe]:PDIVision <rel_ampl></code>
Example	<code>:DISP:PST:VIEW:WIND2:TRAC:X:PDIV 10</code> <code>:DISP:PST:VIEW:WIND2:TRAC:X:PDIV?</code>
Notes	The CCDF measurement has the trace display only in Window 2, because values other than "2" are <i>not</i> available as the sub-op code
Preset	2.00
State Saved	Saved in instrument state
Min	0.1
Max	20
Backwards Compatibility SCPI	<code>:DISPlay:PStatistic:XScale</code>

3.7.10 Trace

Lets you control the display and storage of trace data for the available traces.

3.7.10.1 Trace Control

The controls on this tab allow you to select display of the Reference Trace and the Gaussian Line, and store the Reference Trace.

Store Ref Trace

Copies the currently measured curve as the user-definable reference trace. The captured data remains until the other mode is chosen. Pressing this key also refreshes the reference trace.

No query is available.

Remote Command	<code>:CALCulate:PStatistic:STORe:REFerence</code>
----------------	--

Example	<code>:CALC:PST:STOR:REF</code>
Backwards Compatibility SCPI	<code>[:SENSe]:PStatistic:SRRace</code>

Ref Trace

Toggles the reference trace display On or Off.

Remote Command	<code>:DISPlay:PStatistic:RTRace[:STATe] OFF ON 0 1</code> <code>:DISPlay:PStatistic:RTRace[:STATe]?</code>
Example	<code>:DISP:PST:RTR OFF</code> <code>:DISP:PST:RTR?</code>
Preset	<code>OFF</code>
State Saved	Saved in instrument state
Range	<code>OFF ON</code>
Backwards Compatibility SCPI	<code>[:SENSe]:PStatistic:RTRace[:STATe]</code>

Gaussian Line

Toggles the Gaussian trace display On or Off.

Remote Command	<code>:DISPlay:PStatistic:GAUSSian[:STATe] OFF ON 0 1</code> <code>:DISPlay:PStatistic:GAUSSian[:STATe]?</code>
Example	<code>:DISP:PST:GAUS OFF</code> <code>:DISP:PST:GAUS?</code>
Preset	<code>ON</code>
State Saved	Saved in instrument state
Range	<code>OFF ON</code>
Backwards Compatibility SCPI	<code>[:SENSe]:PStatistic:GAUSSian[:STATe]</code>

3.8 ACP Measurement

ACP is a measurement of the amount of interference, or power, in an adjacent frequency channel. The results are displayed as a bar graph or as spectrum data, with measurement data at specified offsets.

Measurement Commands

The general functionality of ["CONFigure" on page 2551](#), ["INITiate" on page 2552](#), ["FETCh" on page 2552](#), ["MEASure" on page 2554](#), and ["READ" on page 2553](#) are described in the section **SCPI Operation and Results Query** in the topic **Programming the Instrument**.

The following measurement commands and queries are used to configure the measurement:

<code>:INITiate:ACPower</code>	Initiates a trigger cycle for the ACPower measurement, but does not return any data. You must then use <code>:FETC:ACP[n]?</code> to retrieve data
<code>:CONFigure?</code>	Does not change any measurement settings Returns the long form name of current measurement, in this case, ACPower
<code>:CONFigure:ACPower</code>	Selects ACP measurement with Meas Setup settings in preset state – same as "Meas Preset" on page 1288
<code>:CONFigure:ACPower:NDEFault</code>	Selects ACP measurement <i>without</i> affecting settings

The following queries are used to retrieve the results:

<code>:FETCh:ACPower?</code>	Retrieves the data specified by n
<code>:MEASure:ACPower[n]?</code>	Switches to ACP measurement, restores default values, starts the measurement, then retrieves the data specified by n
<code>:READ:ACPower[n]?</code>	Starts the measurement, then retrieves the data specified by n

Remote Command Results

The following table describes the results returned by the `:FETCh`, `:MEASure`, and `:READ` queries listed above, according to the index value **n**.

n	Results Returned
1, or not specified	Dependent on Mode , "Meas Method" on page 1246 , "Power Ref" on page 1331 , and "Measurement Type" on page 1330 See "Measurement Results for n = 1, or no Index Specified" on page 1158
2	Dependent on "Measurement Type" on page 1330 . See "Measurement Results for n = 2" on page 1161
3	Dependent on Mode and "Measurement Type" on page 1330 . See "Measurement Results for n = 3" on page 1161

n Results Returned

1162

- 4 Returns <Num Pts> comma-separated scalar values representing the Y values in Trace 1
- 5 Returns <Num Pts> comma-separated scalar values representing the Y values in Trace 2
- 6 Returns <Num Pts> comma-separated scalar values representing the Y values in Trace 3
- 7 Dependent on **Mode** and "Measurement Type" on page 1330. See "Measurement Results for n = 7" on page 1163
- 8 Only available in LTEAFDD, LTEATDD, 5GNR, MSR Modes
Dependent on "Measurement Type" on page 1330, "PSD Unit" on page 1338, and "Power Ref" on page 1331. See "Measurement Results for n = 8" on page 1164
- 9 Only available in LTEAFDD, LTEATDD, 5GNR, MSR Modes
Returns scalar pass/fail values (0 = passed, or 1 = failed) for the trace specified by "Measure Trace" on page 1755, determined by comparing the relative to the reference carrier and by testing the absolute power limit of the offset frequencies

#	Item
1	Inner Lower offset A - relative limit result
2	Inner Lower offset A - absolute limit result
3	Inner Upper offset A - relative limit result
4	Inner Upper offset A - absolute limit result
5	Inner Lower offset B - relative limit result
6	Inner Lower offset B - absolute limit result
7	Inner Upper offset B - relative limit result
8	Inner Upper offset B - absolute limit result
...	...

When "Max Num of Offsets" on page 1285 is 6, returns 24 results (Offset A-F: 24 = 4*6) and when set to 12, returns 48 results (Offset A-L: 48 = 4 * 12)

- 10 Only available in LTEAFDD, LTEATDD, 5GNR, MSR Modes
Returns scalar values of offset results for the trace specified by "Measure Trace" on page 1755
Numbers returned in this trace are 10 x the actual measured offsets. Note that upper and lower sides of an offset are returned separately. For example, when only outer offset A is measured with offset side both, 10 x 2 = 20 values are returned
In the table below, f is the Number of Offsets. See "Max Num of Offsets" on page 1285

#	Measurement Type	Item	Unit, if any
1		Inner = 1 or Outer = 2	
2		Offset A~L. (A = 1, B = 2, ... L = 12)	
3		Offset Side. Lower = 1 or Upper = 2	

3 VMA Mode
3.8 ACP Measurement

n Results Returned			
#	Measurement Type	Item	Unit, if any
4	TPRef	Relative power or	dBc
	PSDRef	Relative PSD	dB
5	TPRef	Absolute power	dBm
	PSDRef	Absolute PSD	dBm/Hz, dBm/MHz*
6	TPRef	Reference power	dBm
	PSDRef	Reference PSD	dBm/Hz, dBm/MHz*
7		Reference Index 1	
8		Reference Index 2	
9		0 (Reserved)	
10		0 (Reserved)	
...			
10(f - 1) + 1		Inner = 1 or Outer = 2	
10(f - 1) + 2		Offset A~L. (A = 1, B = 2, ... L = 12)	
10(f - 1) + 3		Offset Side. Lower = 1 or Upper = 2	
10(f - 1) + 4	TPRef	Relative power	dBc
	PSDRef	Relative PSD	dB
10(f - 1) + 5	TPRef	Absolute power	dBm
	PSDRef	Absolute PSD	dBm/Hz, dBm/MHz*
10(f - 1) + 6	TPRef	Reference power	dBm
	PSDRef	Reference PSD	dBm/Hz, dBm/MHz*
10(f - 1) + 7		Reference Index 1	
10(f - 1) + 8		Reference Index 2	
10(f - 1) + 9		0 (Reserved)	
10(f - 1) + 10		0 (Reserved)	

"Measurement Type" on page 1330 determines which type of power result is returned: Total Pwr Ref (TPRef) or PSD Ref (PSDRef)

*For PSD results, the unit is determined by "PSD Unit" on page 1338: DBMHZ or DBMMHZ

If any result is not available, 9.91E+37 (NaN) is returned

11 Returns Marker Table data as a series of comma separated values in the following form:

<Marker Number>,<Marker Trace>,<X>,<Y>,<Reserved>,<Reserved>

Only markers that are enabled are included. <Reserved> are returned as NaN ("Not a Number", 9.91e+37). The data is returned in the current sort order as displayed in the Marker Table

3.8.1 Measurement Results for n = 1, or no Index Specified

Mode = SA, Radio Std = None, Number of carriers = 1, Only Offset A is On

Returns 3 comma-separated values that correspond to:

#	Item	Unit, if any
1	Reference carrier power	
2	Lower-adjacent channel power of the trace specified by "Measure Trace" on page 1755	dBc
3	Upper-adjacent channel power of the trace specified by "Measure Trace" on page 1755	dBc

The values are in the current Y Axis Unit of the instrument

Meas Method = FAST

See also "Meas Method" on page 1246

For the trace specified by "Measure Trace" on page 1755, returns 5 comma-separated scalar results in the following order:

#	Item	Result	Unit, if any
1	Reference carrier	Absolute power	dBm
2	Lower offset A	Absolute power	dBm
3	Upper offset A	Absolute power	dBm
4	Lower offset B	Absolute power	dBm
5	Upper offset B	Absolute power	dBm

Measurement Type = Total Power Reference

Conditions	Results															
Mode: LTEAFDD, LTEATDD, 5GNR, MSR "Power Ref" on page 1331: LRCarriers LRSubblocks MPCSubblock MINSubblock	For the trace specified by "Measure Trace" on page 1755, returns comma-separated scalar results in the following order: <table border="1"> <thead> <tr> <th>#</th> <th>Item</th> <th>Unit, if any</th> </tr> </thead> <tbody> <tr> <td>1</td> <td>0.0</td> <td></td> </tr> <tr> <td>2</td> <td>Total carrier power</td> <td>dBm</td> </tr> <tr> <td>3</td> <td>Left Reference power</td> <td>dBm</td> </tr> <tr> <td>4</td> <td>Right Reference power</td> <td>dBm</td> </tr> </tbody> </table>	#	Item	Unit, if any	1	0.0		2	Total carrier power	dBm	3	Left Reference power	dBm	4	Right Reference power	dBm
#	Item	Unit, if any														
1	0.0															
2	Total carrier power	dBm														
3	Left Reference power	dBm														
4	Right Reference power	dBm														
For all other Power Ref settings, see All other Modes row below																

3 VMA Mode
3.8 ACP Measurement

Conditions	Results
------------	---------

#	Item	Unit, if any
5	Lower offset A - relative power	dB
6	Lower offset A - absolute power	dBm
7	Upper offset A - relative power	dB
8	Upper offset A - absolute power	dBm
9	Lower offset B - relative power	dB
10	Lower offset B - absolute power	dBm
11	Upper offset B - relative power	dB
12	Upper offset B - absolute power	dBm
...	...	

When "Max Num of Offsets" on page 1285 is 6, returns 28 results (Offset A-F: $28 = 4 + 4*6$) and when set to 12, returns 52 results (Offset A-L: $52 = 4 + 4 * 12$)

If any result is not available, -999.0 is returned

This trace includes only outer offset results and their reference value(s)

All other Modes and Power Ref settings

For the trace specified by "Measure Trace" on page 1755, returns comma-separated scalar results in the following order:

#	Item	Unit, if any
1	0.0	
2	Total carrier power	dBm
3	0.0	
4	Reference power	dBm
5	Lower offset A - relative power	dB
6	Lower offset A - absolute power	dBm
7	Upper offset A - relative power	dB
8	Upper offset A - absolute power	dBm
9	Lower offset B - relative power	dB
10	Lower offset B - absolute power	dBm
11	Upper offset B - relative power	dB
12	Upper offset B - absolute power	dBm
...	...	

When "Max Num of Offsets" on page 1285 is 6, returns 28 results (Offset A-F: $28 = 4 + 4*6$) and when set to 12, returns 52 results (Offset A-L: $52 = 4 + 4 * 12$)

If any result is not available, -999.0 is returned

For SA Mode, the values are in the current Y Axis Unit of the instrument

Measurement Type = Power Spectral Density Reference

Conditions	Results																																							
Mode: LTEAFDD, LTEATDD, 5GNR, MSR "Power Ref" on page 1331: LRCarriers LRSubblocks MPCSubblock MINSubblock	<p>For the trace specified by "Measure Trace" on page 1755, returns comma-separated scalar results in the following order:</p> <table border="1"> <thead> <tr> <th>#</th> <th>Item</th> <th>Unit, if any</th> </tr> </thead> <tbody> <tr><td>1</td><td>0.0</td><td></td></tr> <tr><td>2</td><td>Total carrier power</td><td>dBm/Hz or dBm/MHz*</td></tr> <tr><td>3</td><td>Left reference power</td><td>dBm/Hz or dBm/MHz*</td></tr> <tr><td>4</td><td>Right reference power</td><td>dBm/Hz or dBm/MHz*</td></tr> <tr><td>5</td><td>Lower offset A - relative power</td><td>dB</td></tr> <tr><td>6</td><td>Lower offset A - absolute power</td><td>dBm/Hz or dBm/MHz*</td></tr> <tr><td>7</td><td>Upper offset A - relative power</td><td>dB</td></tr> <tr><td>8</td><td>Upper offset A - absolute power</td><td>dBm/Hz or dBm/MHz*</td></tr> <tr><td>9</td><td>Lower offset B - relative power</td><td>dB</td></tr> <tr><td>10</td><td>Lower offset B - absolute power</td><td>dBm/Hz or dBm/MHz*</td></tr> <tr><td>11</td><td>Upper offset B - relative power</td><td>dB</td></tr> <tr><td>12</td><td>Upper offset B - absolute power</td><td>dBm/Hz or dBm/MHz*</td></tr> </tbody> </table> <p>When "Max Num of Offsets" on page 1285 is 6, returns 28 results (Offset A-F: 28 = 4 + 4*6) and when set to 12, returns 52 results (Offset A-L: 52 = 4 + 4 * 12)</p> <p>*The unit is determined by "PSD Unit" on page 1338: DBMHZ or DBMMHZ</p> <p>If any result is not available, -999.0 is returned</p> <p>This trace includes only outer offset results and their reference value(s)</p>	#	Item	Unit, if any	1	0.0		2	Total carrier power	dBm/Hz or dBm/MHz*	3	Left reference power	dBm/Hz or dBm/MHz*	4	Right reference power	dBm/Hz or dBm/MHz*	5	Lower offset A - relative power	dB	6	Lower offset A - absolute power	dBm/Hz or dBm/MHz*	7	Upper offset A - relative power	dB	8	Upper offset A - absolute power	dBm/Hz or dBm/MHz*	9	Lower offset B - relative power	dB	10	Lower offset B - absolute power	dBm/Hz or dBm/MHz*	11	Upper offset B - relative power	dB	12	Upper offset B - absolute power	dBm/Hz or dBm/MHz*
#	Item	Unit, if any																																						
1	0.0																																							
2	Total carrier power	dBm/Hz or dBm/MHz*																																						
3	Left reference power	dBm/Hz or dBm/MHz*																																						
4	Right reference power	dBm/Hz or dBm/MHz*																																						
5	Lower offset A - relative power	dB																																						
6	Lower offset A - absolute power	dBm/Hz or dBm/MHz*																																						
7	Upper offset A - relative power	dB																																						
8	Upper offset A - absolute power	dBm/Hz or dBm/MHz*																																						
9	Lower offset B - relative power	dB																																						
10	Lower offset B - absolute power	dBm/Hz or dBm/MHz*																																						
11	Upper offset B - relative power	dB																																						
12	Upper offset B - absolute power	dBm/Hz or dBm/MHz*																																						
All other Modes and Power Ref settings	<p>For the trace specified by "Measure Trace" on page 1755, returns comma-separated scalar results in the following order:</p> <table border="1"> <thead> <tr> <th>#</th> <th>Item</th> <th>Unit, if any</th> </tr> </thead> <tbody> <tr><td>1</td><td>0.0</td><td></td></tr> <tr><td>2</td><td>Total carrier power</td><td>dBm/Hz or dBm/MHz*</td></tr> <tr><td>3</td><td>0.0</td><td></td></tr> <tr><td>4</td><td>Reference power</td><td>dBm/Hz or dBm/MHz*</td></tr> <tr><td>5</td><td>Lower offset A - relative power</td><td>dB</td></tr> <tr><td>6</td><td>Lower offset A - absolute power</td><td>dBm/Hz or dBm/MHz*</td></tr> <tr><td>7</td><td>Upper offset A - relative power</td><td>dB</td></tr> <tr><td>8</td><td>Upper offset A - absolute power</td><td>dBm/Hz or dBm/MHz*</td></tr> <tr><td>9</td><td>Lower offset B - relative power</td><td>dB</td></tr> <tr><td>10</td><td>Lower offset B - absolute power</td><td>dBm/Hz or dBm/MHz*</td></tr> </tbody> </table>	#	Item	Unit, if any	1	0.0		2	Total carrier power	dBm/Hz or dBm/MHz*	3	0.0		4	Reference power	dBm/Hz or dBm/MHz*	5	Lower offset A - relative power	dB	6	Lower offset A - absolute power	dBm/Hz or dBm/MHz*	7	Upper offset A - relative power	dB	8	Upper offset A - absolute power	dBm/Hz or dBm/MHz*	9	Lower offset B - relative power	dB	10	Lower offset B - absolute power	dBm/Hz or dBm/MHz*						
#	Item	Unit, if any																																						
1	0.0																																							
2	Total carrier power	dBm/Hz or dBm/MHz*																																						
3	0.0																																							
4	Reference power	dBm/Hz or dBm/MHz*																																						
5	Lower offset A - relative power	dB																																						
6	Lower offset A - absolute power	dBm/Hz or dBm/MHz*																																						
7	Upper offset A - relative power	dB																																						
8	Upper offset A - absolute power	dBm/Hz or dBm/MHz*																																						
9	Lower offset B - relative power	dB																																						
10	Lower offset B - absolute power	dBm/Hz or dBm/MHz*																																						

Conditions	Results												
	<table border="1"> <thead> <tr> <th>#</th> <th>Item</th> <th>Unit, if any</th> </tr> </thead> <tbody> <tr> <td>11</td> <td>Upper offset B - relative power</td> <td>dB</td> </tr> <tr> <td>12</td> <td>Upper offset B - absolute power</td> <td>dBm/Hz or dBm/MHz*</td> </tr> <tr> <td>...</td> <td>...</td> <td>...</td> </tr> </tbody> </table>	#	Item	Unit, if any	11	Upper offset B - relative power	dB	12	Upper offset B - absolute power	dBm/Hz or dBm/MHz*
#	Item	Unit, if any											
11	Upper offset B - relative power	dB											
12	Upper offset B - absolute power	dBm/Hz or dBm/MHz*											
...											
	<p>When "Max Num of Offsets" on page 1285 is 6, returns 28 results (Offset A-F: $28 = 4 + 4*6$) and when set to 12, returns 52 results (Offset A-L: $52 = 4 + 4 * 12$)</p> <p>*The unit is determined by "PSD Unit" on page 1338: DBMHZ or DBMMHZ</p> <p>If any result is not available, -999.0 is returned</p> <p>For SA Mode, the values are in the current Y Axis Unit of the instrument</p>												

3.8.2 Measurement Results for n = 2

- For SA Mode, the values are in the current Y Axis Unit of the instrument
- For MSR, LTE Advanced FDD/TDD, and 5G NR Modes, this trace includes only outer offset results and their reference value(s)

Measurement Type = Total power reference

For the trace specified by "Measure Trace" on page 1755, returns comma-separated scalar results in the following order:

#	Item	Result	Unit, if any
1	Channel (1)	Relative power	dB
2	Channel (1)	Absolute power	dBm
3	Channel (2)	Relative power	dB
4	Channel (2)	Absolute power	dBm
...
23	Channel (12)	Relative power	dB
24	Channel (12)	Absolute power	dBm
25	Lower offset A	Relative power	dB
26	Lower offset A	Absolute power	dBm
27	Upper offset A	Relative power	dB
28	Upper offset A	Absolute power	dBm
29	Lower offset B	Relative power	dB
30	Lower offset B	Absolute power	dBm
31	Upper offset B	Relative power	dB

#	Item	Result	Unit, if any
32	Upper offset B	Absolute power	dBm
...	

When "Max Num of Offsets" on page 1285 is 6, returns 48 results (Offset A-F: $48 = 24 + 4*6$) and when set to 12, returns 72 results (Offset A-L: $72 = 24 + 4 * 12$)

If any result is not available, -999.0 is returned

Measurement Type = Power spectral density reference

For the trace specified by "Measure Trace" on page 1755, returns comma-separated scalar results in the following order:

#	Channel	Item	Unit, if any
1	Channel (1)	Relative power	dB
2	Channel (1)	Absolute power	dBm/Hz or dBm/MHz*
3	Channel (2)	Relative power	dB
4	Channel (2)	Absolute power	dBm/Hz or dBm/MHz*
...	
23	Channel (12)	Relative power	dB
24	Channel (12)	Absolute power	dBm/Hz or dBm/MHz*
25	Lower offset A	Relative power	dB
26	Lower offset A	Absolute power	dBm/Hz or dBm/MHz*
27	Upper offset A	Relative power	dB
28	Upper offset A	Absolute power	dBm/Hz or dBm/MHz*
29	Lower offset B	Relative power	dB
30	Lower offset B	Absolute power	dBm/Hz or dBm/MHz*
31	Upper offset B	Relative power	dB
32	Upper offset B	Absolute power	dBm/Hz or dBm/MHz*
...	

When "Max Num of Offsets" on page 1285 is 6, returns 48 results (Offset A-F: $48 = 24 + 4*6$) and when set to 12, returns 72 results (Offset A-L: $72 = 24 + 4 * 12$)

*The unit is determined by "PSD Unit" on page 1338: **DBMHZ** or **DBMMHZ**

If any result is not available, -999.0 is returned

3.8.3 Measurement Results for n = 3

For the trace specified by "Measure Trace" on page 1755, returns scalar pass/fail values (0 = passed, or 1 = failed) determined by comparing the relative to the

3 VMA Mode
 3.8 ACP Measurement

reference carrier and by testing the absolute power limit of the offset frequencies (measured as total power in dB if "Measurement Type" on page 1330 is Total Pwr Ref, or as power spectral density in dB if Measurement Type is PSD Ref).

When "Max Num of Offsets" on page 1285 is 6, returns 24 results (Offset A-F: 24 = 4*6). When set to 12, returns 48 results (Offset A-L: 48 = 4 * 12).

For MSR, LTE-Advanced FDD/TDD, and 5G NR Modes, this trace includes only outer offset results.

#	Item
1	Lower offset A - relative limit result
2	Lower offset A - absolute limit result
3	Upper offset A - relative limit result
4	Upper offset A - absolute limit result
5	Lower offset B - relative limit result
6	Lower offset B - absolute limit result
7	Upper offset B - relative limit result
8	Upper offset B - absolute limit result
...	...

If any result is not available, 1 is returned.

3.8.4 Measurement Results for n = 7

In all cases below:

- for SA Mode, the values are in the current Y Axis Unit of the instrument
- if any result is not available, 9.91E+37 (NaN) is returned

Mode	Max Number of Carriers
MSR	100
LTEAFDD, LTEATDD	5
5G NR	16
All Others	18

Measurement Type = Total power reference

For the trace specified by "Measure Trace" on page 1755, returns (2 * Number of Carriers) comma-separated scalar results in the following order:

#	Channel	Result	Unit, if any
1	Channel (1)	Relative power	dB
2	Channel (1)	Absolute power	dBm

#	Channel	Result	Unit, if any
3	Channel (2)	Relative power	dB
4	Channel (2)	Absolute power	dBm
...	...		
2 * Number of Carriers - 1	Channel (Number of Carriers)	Relative power	dB
2 * Number of Carriers	Channel (Number of Carriers)	Absolute power	dBm

Measurement Type = Power spectral density reference

For the trace specified by "Measure Trace" on page 1755, returns (2 * Number of Carriers) comma-separated scalar results in the following order:

#	Channel	Result	Unit, if any
1	Channel (1)	Relative power	dB
2	Channel (1)	Absolute power	dBm/Hz or dBm/MHz*
3	Channel (2)	Relative power	dB
4	Channel (2)	Absolute power	dBm/Hz or dBm/MHz*
...	...		
2 * Number of Carriers - 1	Channel (Number of Carriers)	Relative power	dB
2 * Number of Carriers	Channel (Number of Carriers)	Absolute power	dBm/Hz or dBm/MHz*

*The unit is determined by "PSD Unit" on page 1338: **DBMHZ** or **DBMMHZ**

3.8.5 Measurement Results for n = 8

Only available in LTEAFDD, LTEATDD, 5GNR, MSR Modes

For the trace specified by "Measure Trace" on page 1755, returns scalar results in the following order:

#	Item	Unit, if any
1	0.0	
2	Total carrier power	dBm
3	Reference Power #1 (See "Reference Power Result Details" on page 1165)	
4	Reference Power #2 (See "Reference Power Result Details" on page 1165)	
5	Inner Lower offset A - relative power	dB
6	Inner Lower offset A - absolute power	dBm, dBm/Hz or dBm/MHz*
7	Inner Upper offset A - relative power	dB

3 VMA Mode
3.8 ACP Measurement

#	Item	Unit, if any
8	Inner Upper offset A - absolute power	dBm, dBm/Hz or dBm/MHz*
9	Inner Lower offset B - relative power	dB
10	Inner Lower offset B - absolute power	dBm, dBm/Hz or dBm/MHz*
11	Inner Upper offset B - relative power	dB
12	Inner Upper offset B - absolute power	dBm, dBm/Hz or dBm/MHz*
...	...	

This trace includes only inner offset results

When "Max Num of Offsets" on page 1285 is 6, returns 28 results (Offset A-F: 24 = 4 + 4*6) and when set to 12, returns 52 results (Offset A-L: 52 = 4 + 4 * 12)

Absolute Power Units

*For Absolute power results, the units depend on the "Measurement Type" on page 1330 and "PSD Unit" on page 1338 settings as follows:

Measurement Type	PSD Unit	Unit
Total Pwr Ref	All	dBm
PSD Reference	dBm/Hz, DBMHZ	dBm/Hz
	dBm/MHz, DBMMHZ	dBm/MHz

Reference Power Result Details

The values returned as Reference Power #1 and Reference Power #2 depend on "Power Ref" on page 1331:

Power Ref Setting	Option	Reference Power #1	Reference Power #2
Left & Right Carriers	LRCarriers	Left or Max Power Carrier in the lower sub-block	Right or Max Power Carrier in the upper sub-block
Max Power Carriers in Sub-block	MPCSubblock	dBm, dBm/Hz or dBm/MHz*	dBm, dBm/Hz or dBm/MHz*
Left & Right Sub-blocks	LRSubblocks	Integrated Power of the lower sub-block	Integrated Power of the upper sub-block
		dBm, dBm/Hz or dBm/MHz*	dBm, dBm/Hz or dBm/MHz*
Others		0.0	Reference carrier power
			dBm, dBm/Hz or dBm/MHz*

*For PSD results, the unit is determined by "PSD Unit" on page 1338. See "Absolute Power Units" on page 1165 above

If any result is not available, 9.91E+37 (NaN) is returned

3.8.6 Views

This measurement has two predefined views:

View	Enumerated Parameter	SCPI Number
"Normal" on page 1167	PRESult	1
"Carrier Info" on page 1167	CINformation	2

These are multiple-window views. When in a multiple-window view, you select a window by touching it. The menu controls may sometimes change depending on which window is selected.

Whenever the view changes, the default menu is **Frequency**, unless otherwise specified in the view description.

NOTE

Y Scale/Div, Y Ref Position, Y Auto Scale, Y Ref Value and Bar Graph affect both views. For example, power bars on the traces in both views appear or disappear when Bar Graph is toggled.

View Selection by Name

Selects the results view. The following command allows you to select the desired measurement view by enumerated parameter.

Remote Command	<code>:DISPlay:ACPower:VIEW[:SElect] PRESult CINformation</code> For view names, see table above <code>:DISPlay:ACPower:VIEW[:SElect]?</code>
Example	<code>:DISP:ACP:VIEW PRES</code> <code>:DISP:ACP:VIEW?</code>
Preset	<code>PRESult</code>
State Saved	Saved in instrument state
Range	<code>PRESult CINformation</code>

View Selection by Number (Remote Command Only)

Selects the results view. The following command allows you to select the desired measurement view numerically.

3 VMA Mode
3.8 ACP Measurement

Remote Command	<code>:DISPlay:ACPower:VIEW:NSElect <integer></code> For view numbers, see table above <code>:DISPlay:ACPower:VIEW:NSElect?</code>
Example	<code>:DISP:ACP:VIEW:NSEL 1</code> <code>:DISP:ACP:VIEW:NSEL?</code>
Dependencies	Available only for LTEAFDD, LTEATDD and 5G NR Modes
Preset	1
State Saved	Saved in instrument state
Min/Max	1 / 2

3.8.6.1 Normal

Windows: "Graph" on page 1167, "Metrics" on page 1168,
Dual window view of the graph and the metrics.

Example `:DISP:ACP:VIEW PRES`

3.8.6.2 Carrier Info

Windows: "Graph" on page 1167, "Metrics" on page 1168,
Dual window view of the graph and the metrics.

Example `:DISP:ACP:VIEW CINF`

3.8.7 Windows

This section describes the windows that are available in this measurement.

3.8.7.1 Graph

Window #1

Used to display the spectrum being measured by the ACP measurement.

The results of the measurement can be displayed as a single spectrum trace view or displayed with a Bar Graph trace on the spectrum trace.

The Graph window appears in several Views, as follows:

View	Size	Position
Normal	Half, full width	Top
Carrier Info	Half, full width	Top
Gate View	One third, full width	Middle

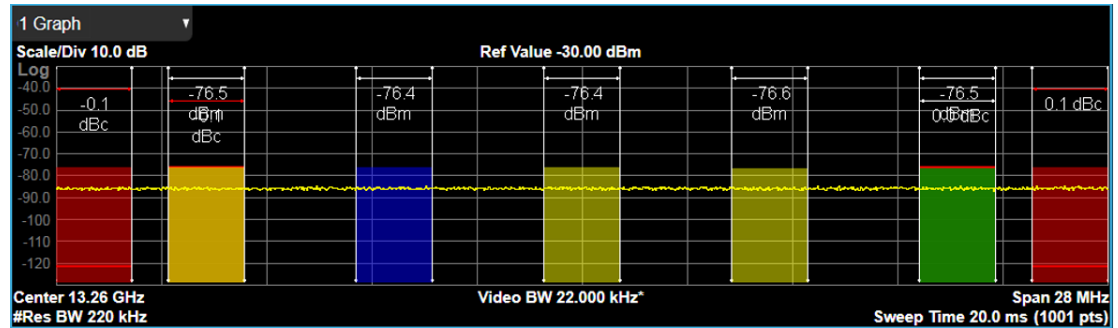

When the Bar Graph is **ON** and Limit Test is **ON**, the color of each bar graph reflects the limit test result. When the limit test fails, the bar color is red, and when limit test passes, the bar color is green.

When RBW is selected as the measurement method, the spectrum trace is not displayed, only the bar graph is displayed. In addition, the Bar Graph control (under the Display front-panel key) is set to **ON** and is grayed-out.

3.8.7.2 Metrics

Window # 2 & 3

Displays the textual results of the ACP measurement.

Views in which the Metrics window appears:

View	Size	Position
Normal	Half, full width	Bottom
Carrier Info	Half, full width	Bottom
Gate View	One Third, full width	Bottom

Metrics Window in Normal view:

3 VMA Mode
3.8 ACP Measurement

2 Metrics		Total Car Pwr		36.66 dBm/491.400 MHz		Measure Trace		Trace 1		
Total PSD		---				Trace Type		Trace Average (Active)		
		Lower				Upper				
Offs Freq	Integ BW	ACP		Reference		ACP		Reference		
		dBc	dBm	dBm	Car #	dBc	dBm	dBm	Car #	Filter
A	100.000 MHz	98.280 MHz	-47.03	-75.67	-28.64	1	-53.80	-82.43	-28.64	1 -3 dB
B	200.000 MHz	98.280 MHz	-45.32	-73.96	-28.64	1	-55.30	-83.94	-28.64	1 -3 dB
C	0.0 Hz	98.280 MHz	0.0	-28.64	-28.64	1	0.0	-28.64	-28.64	1 -3 dB
D	0.0 Hz	98.280 MHz	0.0	-28.64	-28.64	1	0.0	-28.64	-28.64	1 -3 dB
E	0.0 Hz	98.280 MHz	0.0	-28.64	-28.64	1	0.0	-28.64	-28.64	1 -3 dB

Metrics Window in Carrier Info view:

3 Carrier Info		Total Car Pwr		-66.97 dBm/22.58 MHz		Ref Pwr		-28.87 dBm/98.280 MHz	
Total PSD		---				Ref PSD		---	
RF-BW		5.000 MHz				Reference		Carrier#6: Sub-block Left Carrier#---: Sub-block Right	
Carrier Power	Carrier PSD	Integ BW	Filter	Offset Freq	Measure				
CC0	-28.50 dBm	---	98.280 MHz -3 dB	0.0 Hz	On				
CC1	-28.50 dBm	---	98.280 MHz -3 dB	0.0 Hz	On				
CC2	-28.50 dBm	---	98.280 MHz -3 dB	0.0 Hz	On				
CC3	-28.50 dBm	---	98.280 MHz -3 dB	0.0 Hz	On				
CC4	-28.50 dBm	---	98.280 MHz -3 dB	0.0 Hz	On				
CC5	-28.50 dBm	---	98.280 MHz -3 dB	0.0 Hz	On				

The text window displays the following results:

Total Carrier Power

This is the total power of all the carriers with carrier power present set to yes. The power is calculated by integrating across the bandwidth declared by the Carrier Integ BW parameter for each carrier and then totaling the sums. The total integration bandwidth is shown as part of the result. This will be the total of the Carrier Integ Bw of the carriers used in calculating the total carrier power. If the RRC Filter is on, then the integration bandwidth used is $(1 + \alpha)/T$ where $T = 1/(\text{Carrier Integ BW})$ multiplied by the number of carriers with carrier power present set to yes.

Ref Power

This is the power of the reference. The power is calculated by integrating across the bandwidth defined by the Reference Type. The integration bandwidth is shown as a part of the result. For some Power Reference Type, this is the value of the Carrier Integ BW for that carrier unless the RRC Filter is on, then the integration bandwidth used is the displayed value, which is $(1 + \alpha)/T$ where $T = 1/(\text{Carrier Integ BW})$.

Reference

In multi-carrier applications, this row displays what is used as a reference power.

Carrier Power

This is the power in all the currently defined carriers. If the carrier has carrier power present, the power will be absolute. If the carrier is defined as not having power

present, the power will be relative to the reference carrier. The power is calculated by integrating across the bandwidth declared by the Carrier Integ BW parameter. The integration bandwidth is shown as part of the result. This is the value of the Carrier Integ BW for the carrier unless the RRC Filter is on, then the integration bandwidth used is the displayed value, which is $(1 + \alpha)/T$ where $T = 1/(\text{Carrier Integ BW})$.

Offset Relative Power

This is the power in the offsets relative to the reference carrier. The power is calculated by integrating across the bandwidth declared by the Offset Integ BW parameter. The offset integration bandwidth is shown as part of the result. This is the value on the Offset Integ BW menu unless the RRC Filter is on, then the integration bandwidth used is the displayed value, which is $(1 + \alpha)/T$ where $T = 1/(\text{Offset Integ BW})$.

Offset Absolute Power

This is the absolute power in the offsets. The power is calculated by integrating across the bandwidth declared by the Offset Integ BW parameter. The offset integration bandwidth is shown as part of the result. This is the value on the Offset Integ BW menu unless the RRC Filter is on, then the integration bandwidth used is the displayed value, which is $(1 + \alpha)/T$ where $T = 1/(\text{Offset Integ BW})$.

RF-BW

Displays the total bandwidth from the lowest carrier to the highest carrier whatever their measurement states are on or off.

Integration Bandwidth

Displays the noise bandwidth of each carrier to be measured in the ACP measurement

Measure Trace

See "[Measure Trace](#)" on page 1755.

Trace Type

This is the trace type (and view/blank parameter) of a trace specified by Measure Trace.

Measure Trace and Trace Type are displayed only when Meas Method is set to "Integration BW", "Filtered IBW", or "Fast Power"

Filter

Indicates whether RRC filter is used for ACP measurement or not.

Offset Frequency

Shows the offset frequency from the carrier reference frequency in multi-carrier measurements. The carrier frequency display type determines whether the relative frequency or absolute frequency will be displayed.

Sub-block

For intra-band non-contiguous spectrum operation, the sub-block concept is introduced, which refers to one contiguous allocated block of spectrum for transmission and reception in the intra-band non-contiguous aggregation mode. So far we support the two sub-blocks. It displays which sub-block the carrier belongs to in the intra-band non-contiguous aggregation mode. The column will be displayed when the carrier allocation mode is non-contiguous.

Measure

Shows whether the carrier power presents or not.

3.8.7.3 Gate

Window # 4

Turning on Gate View displays the Gate Window, which allows you to see your gating signal at the same time as the measured data. See the description under **Gate View** in the **Trigger, Gate Settings** section.

View	Size	Position
Gate View	One third, full width	Top

3.8.7.4 Marker Table

Window# 5

Displays a table containing detailed information about all the markers in the current measurement. It can be selected from the Data control on the Window Title. There is no specific view in which the **Marker Table** window turns on, it is on by demand.

3.8.8 Amplitude

Activates the **Amplitude** menu and selects **Reference Level** or **Reference Value** as the active function, depending on the measurement.

Some features in this menu apply to multiple measurements. Some other features apply only to specific measurements and their controls are blanked or grayed-out in measurements that do not support the feature.

3.8.8.1 Y Scale

Contains controls that pertain to the Y axis parameters of the measurement. These parameters control how data on the vertical (Y) axis is displayed and control instrument settings that affect the vertical axis.

Ref Value

Sets the value for the absolute power reference. The reference line is at the top, center, or bottom of the graticule, depending on the value of the **Ref Position** function.

Remote Command	<code>:DISPlay:ACPower:WINDow[1]:TRACe:Y[:SCALE]:RLEVel <real></code>
Example	<code>:DISP:ACP:WIND:TRAC:Y:RLEV 100</code> <code>:DISP:ACP:WIND:TRAC:Y:RLEV?</code>
Couplings	When "Auto Scaling" on page 1174 is ON (default), this value is automatically determined by the measurement result. When you set a value manually, Auto Scaling changes to OFF "Attenuation" on page 1763 is not coupled to Ref Value
Preset	10.00 dBm
State Saved	Saved in instrument state
Min/Max	-250.00 dBm / 250.00 dBm
Annotation	Ref <value> top left of graph
Backwards Compatibility SCPI	<code>:DISPlay:ACPower:VIEW[1]:WINDow[1]:TRACe:Y[:SCALE]:RLEVel</code>

Scale/Div

For measurements that support a logarithmic Y-Axis, **Scale/Div** sets the height of one division of the graticule in the current Y-Axis unit.

Scale/Div also determines the displayed amplitude range in the log plot graph. Since there are usually 10 vertical graticule division on the display, the total amplitude range of the graph is typically 10x this amount. For example, if Scale/Div is 10 dB, then the total range of the graph is 100 dB.

Remote Command	<code>:DISPlay:ACPower:WINDow[1]:TRACe:Y[:SCALE]:PDIVision <rel_amp></code>
Example	<code>:DISP:ACP:WIND:TRAC:Y:PDIV 5</code> <code>:DISP:ACP:WIND:TRAC:Y:PDIV?</code>

Couplings	Coupled to "Scale Range" on page 1612 as follows: Scale/Div = Scale Range/10 (number of divisions) When "Auto Scaling" on page 1174 is ON , this value is automatically determined by the measurement result When you change a value, Auto Scaling automatically changes to Off
Preset	10.00 dB / Div
State Saved	Saved in instrument state
Min	0.10 dB
Max	20 dB
Annotation	<value> dB/ left upper of graph
Backwards Compatibility SCPI	<code>:DISPlay:ACPower:VIEW[1]:WINDow[1]:TRACe:Y[:SCALe]:PDIVision</code>

Scale Range

Sets the Y-Axis scale range.

Remote Command	Replace <meas> with the identifier for the current measurement <code>:DISPlay:<meas>:WINDow[1]:TRACe:Y[:SCALe]:RANGe <rel_amp1></code> <code>:DISPlay:<meas>:WINDow[1]:TRACe:Y[:SCALe]:RANGe?</code>
Example	<code>:DISP:CHP:WIND:TRAC:Y:RANG 100</code> <code>:DISP:CHP:WIND:TRAC:Y:RANG?</code>
Couplings	Coupled to Scale/Div as follows Scale Range = Scale/Div * 10 (number of divisions) When you change this value, Auto Scaling automatically changes to OFF
Preset	100 dB
State Saved	Saved in instrument state
Min	1
Max	200

Ref Position

Positions the reference level at the top, center, or bottom of the Y Scale display. Changing the reference position does not change the reference level value.

Remote Command	<code>:DISPlay:ACPower:WINDow[1]:TRACe:Y[:SCALe]:RPOSition TOP CENTER BOTTom</code> <code>:DISPlay:ACPower:WINDow[1]:TRACe:Y[:SCALe]:RPOSition?</code>
Example	<code>:DISP:ACP:WIND:TRAC:Y:RPOS CENT</code>

	<code>:DISP:ACP:WIND:TRAC:Y:RPOS?</code>
Preset	TOP
State Saved	Saved in instrument state
Range	TOP CENTer BOTTom
Annotation	The greater than (>) and less than (<) symbols are displayed on both sides of the graph to indicate the Reference Position
Backwards Compatibility SCPI	<code>:DISPlay:ACPower:VIEW[1]:WINDow[1]:TRACe:Y[:SCALe]:RPOSition</code>

Auto Scaling

Toggles **Auto Scaling** On or Off.

Remote Command	<code>:DISPlay:ACPower:WINDow[1]:TRACe:Y[:SCALe]:COUPle 0 1 OFF ON</code>
Example	<code>:DISP:ACP:WIND:TRAC:Y:COUP OFF</code> <code>:DISP:ACP:WIND:TRAC:Y:COUP?</code>
Couplings	When Auto Scaling is ON , and the Restart front-panel key is pressed, this function automatically sets the scale per division to 10 dB and determines the reference values based on the measurement results When you change the value of " Scale/Div " on page 1172, " Ref Value " on page 1172, or " Scale Range " on page 1612, Auto Scaling automatically changes to OFF
Preset	1
State Saved	Saved in instrument state
Range	OFF ON
Backwards Compatibility SCPI	<code>:DISPlay:ACPower:VIEW[1]:WINDow[1]:TRACe:Y[:SCALe]:COUPle</code>

3.8.8.2 Attenuation

Controls the attenuator functions and interactions between the attenuation system components.

There are two attenuator configurations in the X-Series. One is a Dual-Attenuator configuration consisting of a mechanical attenuator and an optional electronic attenuator. The other configuration uses a single attenuator with combined mechanical and electronic sections that controls all the attenuation functions. Different models in the X-Series come with different configurations.

- See "Dual-Attenuator Configurations" on page 1175
- See "Single-Attenuator Configuration" on page 1176

Most attenuation settings are the same for all measurements – they do not change as you change measurements. Settings like these are called “Meas Global” and are unaffected by **Meas Preset**.

Only available when the hardware set includes an input attenuator, which is typically only the case for Keysight’s benchtop instruments. For example, this tab does *not* appear in VXT models M9420A/10A/11A/15A/16A, M9410E/11E/15E/16E, nor in UXM. In UXM, all **Attenuation** and **Range** settings are disabled, as the expected input power level is handled by the Call Processing App that drives the DUT power control.

Dependencies In measurements that support the I/Q inputs, unavailable when I/Q is the selected input. Replaced by the **Range** tab in that case

Dual-Attenuator Configurations

Configuration 1: Mechanical attenuator + optional electronic attenuator

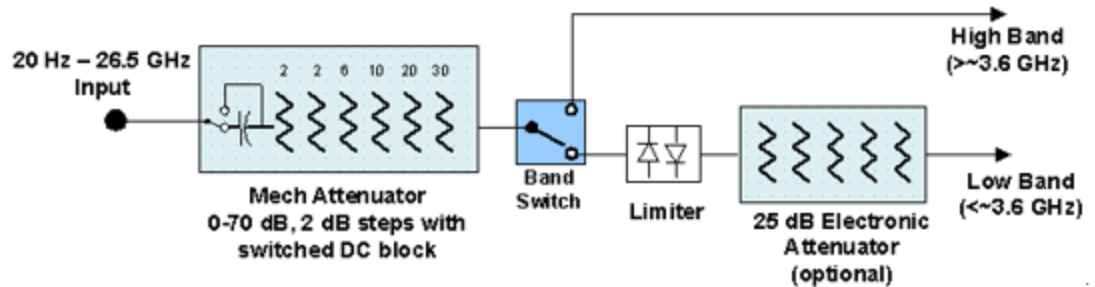

Configuration 2: Mechanical attenuator, no optional electronic attenuator

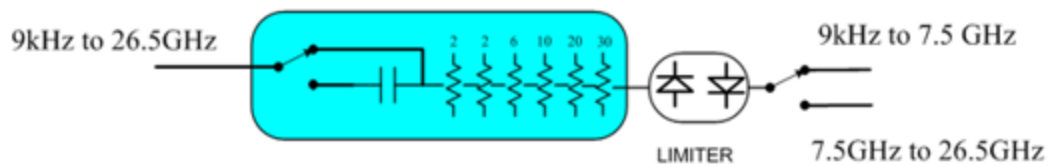

Note that Configuration 2 is not strictly speaking a dual-section attenuator, since there is no electronic section available. However, it behaves exactly like Configuration 1 without the Electronic Attenuator Option EA3, therefore for the sake of this document it is grouped into the “Dual-Attenuator” configuration.

Single-Attenuator Configuration

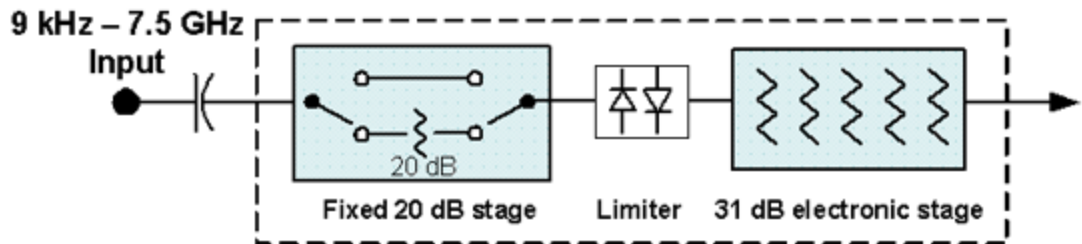

You can tell which attenuator configuration you have by pressing the Attenuation tab, which (in most Modes) opens the Attenuation menu. If the first control in the Attenuation menu says **Mech Atten** you have the Dual-Attenuator configuration. If the first control says **Atten** you have the Single-Attenuator configuration.

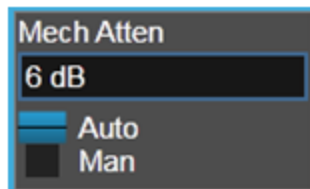

Dual Attenuator

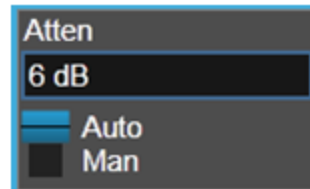

Single Attenuator

(Note that depending on the measurement, there may be no Auto/Man functionality on the Mech Atten control.)

In the Single-Attenuator configuration, you control the attenuation with a single control, as the fixed stage has only two states. In the Dual-Attenuator configuration, both stages have significant range, so you are given separate control of the mechanical and electronic attenuator stages.

When you have the Dual-Attenuator configuration, you may still have only a Single-Attenuator, because unless Option EA3 (the Electronic Attenuator option) is available, and you purchase it, you will have only the mechanical attenuator.

Full Range Atten

This control and **Attenuator Summary** only appear in N9041B, when the RF input is selected, the RF Input Port is set to RF Input 2, and the Full Range Attenuator is installed. The Full Range Attenuator adds a second input attenuator in front of RF Input 2, which enhances the protection and optimizes the performance of the extra internal mixers used by RF Input 2.

Remote Command `[:SENSe]:POWer[:RF]:FRATten <rel_amp1>`
 `[:SENSe]:POWer[:RF]:FRATten?`

Example `:POW:FRAT 14`

:POW:FRAT?	
Notes	When you enter an amplitude value that falls between valid values, the value will be incremented to the next smallest valid value
Dependencies	Only appears if input RF is selected, RF Input Port 2 is selected, and the Full Range Attenuator exists
Couplings	This value is never changed by any coupling, but other couplings use this value. See Reference Level and " Mech Atten " on page 1766 command descriptions
Preset	20 dB
State Saved	Saved in instrument state
Min	0 dB
Max	Only valid values are 0, 6, 14, 20 dB
Annotation	<p>When the Input is RF, and the Input Port is RF Input 2, and the Full Range Attenuator is installed: On the Meas Bar, the field "Atten" displays as follows:</p> <ul style="list-style-type: none"> - If the sweep is entirely < 50 GHz, the value shown after "Atten:" is equal to Mech Atten + Elec Atten + Full Range Atten - If the sweep is entirely > 50 GHz, the value shown after "Atten:" is equal to Full Range Atten - If the sweep straddles 50 GHz, the value shown after "Atten:" is preceded by the symbol ">=" and is equal to Full Range Atten <p>In the Amplitude, "Y Scale" on page 1760 menu, and the Atten Meas Bar dropdown menu panel, a summary is displayed as follows: "Total Atten below 50 GHz" followed by the value of Full Range Atten + Mech Atten + Elec Atten "Total Atten above 50 GHz" followed by the value of Full Range Atten For example, if Mech Atten = 6 dB, Elec Atten = 4 dB, and Full Range Atten = 20 dB, the summary below is shown:</p> <ul style="list-style-type: none"> - Attenuator summary: - Total Atten below 50 GHz: 30 dB - Total Atten above 50 GHz: 20 dB

Mech Atten

Labeled **Mech Atten** in Dual-Attenuator models, and **Atten** in Single-Attenuator models. In the Dual-Attenuator configuration, this control only affects the mechanical attenuator.

Lets you modify the attenuation applied to the RF input signal path. This value is normally auto-coupled to **Ref Level**, "**Internal Preamplifier**" on page 1788 Gain, any External Gain that is entered, and **Max Mixer Level** (if available), as described in the table below.

See "**Attenuator Configurations and Auto/Man**" on page 1179

Remote Command	<code>[:SENSe]:POWer[:RF]:ATTenuation <rel_ampl></code> <code>[:SENSe]:POWer[:RF]:ATTenuation?</code>
Example	<code>:POW:ATT 20</code> Dual-Attenuator configuration: sets the mechanical attenuator to 20 dB Single-Attenuator mode: sets the main attenuation to 20 dB (see below for definition of “main” attenuation) In either case, if the attenuator was in Auto, it is set to Manual
Dependencies	Some measurements do not support Auto setting of Mech Atten . In these measurements, the Auto/Man selection is not available, and the Auto/Man toggle function is not available In Dual-Attenuator configurations, when the electronic attenuator is enabled, the mechanical attenuator has no auto setting, and the Auto/Man toggle function is not available. The state of Auto/Man is remembered and restored when the electronic attenuator is once again disabled. This is described in more detail in "Elec Atten" on page 1769 See "Attenuator Configurations and Auto/Man" on page 1179 for more information on the Auto/Man functionality
Couplings	If the RF Input Port is the RF Input: <ul style="list-style-type: none"> - If the USB Preamp is connected to USB, use 0 dB for Mech Atten - Otherwise compute the auto-selected value of Mech Atten based on Reference Level, Int Preamp, External Gain, Ref Level Offset, Max Mixer Level, μW Path Control and IF Gain settings. Limit this value to be no less than 6 dB (total attenuation below 6 dB can never be chosen by Auto) - In N9041B, if the RF Input Port is RF Input 2, use the formula above and subtract the value of "Full Range Atten" on page 1765 from the result to determine the Mech Atten. Limit the value so that it is never lower than 0 dB and so that total attenuation, including Full Range Atten, is never less than 6 dB (total attenuation, including Full Range Atten below 6 dB, can never be chosen by Auto) <p>In External Mixing and BBIQ, where the attenuator is not in the signal path, the attenuator setting changes as described above when Mech Atten is in Auto, but no changes are made to the actual attenuator hardware setting until the input is changed back to the RF Input</p> <p>For CXA-m with Option FSA (Fine-Step Attenuator or 2 dB steps), the FSA-like behavior is only available when the frequency setting is <= 7.5 GHz. So, when the frequency is changed from below 7.5 GHz to above 7.5 GHz, the attenuation setting changes to a multiple of 10 dB that is no smaller than the previous setting. For example, 4 dB attenuation changes to 10 dB</p>
Preset	Auto The Auto value is 10 dB
State Saved	Saved in instrument state
Min	0 dB The attenuation set by this control cannot be decreased below 6 dB with the knob or step keys. Values below 6 dB must be directly entered from the keypad or via SCPI. This protects against setting a dangerously small attenuation value, which can put the instrument at risk of damage to input circuitry. If the current mechanical attenuation is below 6 dB, it can be increased with the knob and step keys, but not decreased

3 VMA Mode
3.8 ACP Measurement

Max	CXA Option 503 or 507 EXA All other models	50 dB 60 dB 70 dB
Annotation	<p>Note that in the Single-Attenuator configuration, the total of ATT and EATT cannot exceed 50 dB. So, if the EATT is set to 24 dB first, the main attenuation cannot be greater than 26 dB and will be reduced accordingly; if the main attenuator is set to 40 dB first, EATT cannot be greater than 10 dB</p> <p>The current value for Total Atten is displayed in the Measurement Bar at the top of the display. A value appears for Electronic Attenuation only if the Electronic Attenuator is enabled. The annotation appears as:</p> <p><i>Atten: <total> dB (e<elec>)</i></p> <p>The e letter is in amber in Single-Attenuator configurations</p> <p>For example:</p> <p>Dual-Attenuator configuration:</p> <p><i>Atten: 24 dB (e14)</i></p> <p>Indicating the total attenuation is at 24 dB and the electronic attenuation is at 14 dB</p> <p>Single-Attenuator configuration:</p> <p><i>A: 24 dB (e14)</i></p> <p>Indicating the total attenuation is at 24 dB and the “soft” attenuation is at 14 dB (see below for definition of “soft” attenuation)</p> <p>When in Manual, a # sign appears in front of Atten in the annotation</p> <p>Auto Function</p>	
Remote Command	<pre>[:SENSe]:POWer[:RF]:ATTenuation:AUTO OFF ON 0 1 [:SENSe]:POWer[:RF]:ATTenuation:AUTO?</pre>	
Example	<p>Turn Auto Mech AttenON:</p> <pre>:POW:ATT:AUTO ON</pre>	
Dependencies	<pre>:POW:ATT:AUTO</pre> <p>is only available in measurements that support Auto, such as Swept SA</p>	
Preset	<pre>ON</pre>	

Attenuator Configurations and Auto/Man

As described under ["Attenuation" on page 1763](#), there are two distinct attenuator configurations available in the X-Series, the Single Attenuator and Dual-Attenuator configurations.

In Dual-Attenuator configurations, we have mechanical attenuation and electronic attenuation, and current total attenuation is the sum of electronic + mechanical attenuation.

In Single-Attenuator configurations, we refer to the attenuation set using ["Mech Atten" on page 1177](#) (or `:POW:ATT`) as the “main” attenuation; and the attenuation that is set by `:POW:EATT` as the “soft” attenuation (`:POW:EATT` is honored even in

the Single-Attenuator configuration, for compatibility purposes). Then current total attenuation is the sum of main + soft attenuation.

See "[Elec Atten](#)" on page 1769 for more about "soft" attenuation.

NOTE

In some measurements, the **Mech Atten** control has an **Auto/Man** function. In these measurements, an **Auto/Man** switch is shown on the **Mech Atten** control:



Note that in configurations that include an Electronic Attenuator, this switch is only shown when the Electronic Attenuator is disabled.

In other measurements, **Mech Atten** has no **Auto/Man** function. In these measurements, no switch is shown on the **Mech Atten** control:



Mech Atten also appears with no switch, as above, in configurations that include an Electronic Attenuator but when the Electronic Attenuator is enabled.

Elec Atten

Controls the Electronic Attenuator in Dual-Attenuator configurations. Does not appear in Single-Attenuator configurations, because the control of both the mechanical and electronic stages of the Single-Attenuator is integrated into the single **Atten** control.

This control includes an **Enable/Disable** toggle switch; it is only possible to enter a value for the Electronic Attenuator when this switch is in the **Enable** position.

For more details of the Electronic Attenuator, see "[More Information](#)" on page 1182

Remote Command	<code>[:SENSe]:POWer[:RF]:EATTenuation <rel_amp></code> <code>[:SENSe]:POWer[:RF]:EATTenuation?</code>
Example	<code>:POW:EATT 10</code> <code>:POW:EATT?</code>
Notes	Electronic Attenuation's specification is defined only when Mech Atten is 6 dB

3 VMA Mode
3.8 ACP Measurement

Dependencies	<p>Only appears in Dual-Attenuator models with an Electronic Attenuator installed and licensed. Does not appear in models with the Single-Attenuator configuration, because in the Single-Attenuator configuration there is no “electronic attenuator”; there is only a single integrated attenuator (which has both a mechanical and electronic stage). However, in the Single-Attenuator configuration, EATT SCPI commands are accepted for compatibility with other X-series instruments, and set a “soft” attenuation. The “soft” attenuation is treated as an addition to the “main” attenuation value set by the Attenuation control or :POW:ATT, and affects the total attenuation displayed on the Attenuation control and the Meas Bar</p> <p>The electronic attenuator, and the “soft” attenuation function provided in Single-Attenuator configurations, are unavailable above the low band (0-3.6 GHz, 0-3.4 GHz, 0-3 GHz, depending on the model). If the low band range is from 0-3.6 GHz, and Stop Frequency of the instrument is > 3.6 GHz, then the Enabled/Disabled section of the Elec Atten control will be OFF and grayed-out</p> <p>If "Internal Preamp" on page 1788 is ON (that is, set to Low Band or Full), the electronic attenuator (and the “soft” attenuation function provided in Single-Attenuator configurations) is unavailable. In this case the Enabled/Disabled section of the Elec Atten control will be OFF and grayed-out</p> <p>If either of the above is true, and the SCPI command is sent, an error indicating that the electronic attenuator is unavailable is returned</p> <p>If both the above are true, pressing the control generates error message -221, in other words, the frequency range lockout takes precedence</p> <p>If the electronic/soft Attenuator is enabled, then the Stop Freq of the instrument is limited to 3.6 GHz and Internal Preamp is unavailable</p> <p>If "LNA" on page 1790 is ON, the electronic attenuator (and the “soft” attenuation function provided in Single-Attenuator configurations) is unavailable. In this case the Enabled/Disabled section of the Elec Atten control will be OFF and grayed-out. This coupling works in the following modes/measurements:</p> <ul style="list-style-type: none"> - Channel Power, Occupied BW, ACP, SEM, Spurious Emissions, Power Stat CCDF measurements in all Modes - Transmit On Off Power measurement in 5GNR Mode - Power vs. Time and Transmit Power measurement in GSM/EDGE Mode - Burst Power measurement in Spectrum Analyzer Mode <p>The SCPI-only “soft” electronic attenuation for the single-attenuator configuration is not available in all measurements; in particular, it is not available in the Swept SA measurement</p>
Couplings	Enabling and disabling the Electronic Attenuator affects the setting of the Mechanical Attenuator (in Dual-Attenuator configurations). This is described in more detail below and in "Mechanical Attenuator Transition Rules" on page 1182
Preset	0 dB
State Saved	Saved in instrument state
Min	0 dB
Max	<p>Dual-Attenuator configuration: 24 dB</p> <p>Single-Attenuator configuration: the total of ATT and EATT cannot exceed 50 dB. So, if the EATT is set to 24 dB first, the main attenuation cannot be greater than 26 dB and will be reduced accordingly; if the main attenuator is set to 40 dB first, EATT cannot be greater than 10 dB</p>
Annotation	See Annotation under the Mech Atten control description

Auto Function

Remote Command	<code>[:SENSe]:POWer[:RF]:EATTenuation:STATe OFF ON 0 1</code> <code>[:SENSe]:POWer[:RF]:EATTenuation:STATe?</code>
Example	<code>:POW:EATT:STAT ON</code> <code>:POW:EATT:STAT?</code>
Preset	<code>OFF</code> (Disabled) for Swept SA measurement <code>ON</code> (Enabled) for all other measurements that support the electronic attenuator

NOTE

The maximum **Center Frequency** for Low Band can change based on the selected IFBW for measurements that support IFBW (for example, Waveform measurement across all Modes that support it). In certain models (such as N9042B & N9032B), IFBW values ≤ 40 MHz have a maximum Low Band frequency of 3.6 GHz, while $40 \text{ MHz} < \text{IFBW} \leq 1 \text{ GHz}$ have a maximum of 3.3 GHz, and $1 \text{ GHz} < \text{IFBW} \leq 1.5 \text{ GHz}$ have a maximum of 3.5 GHz. This frequency is reflected in the disabled message displayed for Electrical Attenuator. For N9032B and N9042B IFBW values $> 1.5 \text{ GHz}$ do not support a **Center Frequency** that can reach the Low Band maximum frequency. In these cases, the Electrical Attenuator will remain disabled no matter the Center Frequency.

More Information

The electronic attenuator offers finer steps than the mechanical attenuator, has no acoustical noise, is faster, and is less subject to wear. These advantages primarily aid in remote operation and are negligible for front panel use. See ["Using the Electronic Attenuator: Pros and Cons" on page 1183](#) for a detailed discussion of the pros and cons of using the electronic attenuator.

For the Single-Attenuator configuration, for SCPI backwards compatibility, the "soft" attenuation feature replaces the Dual-Attenuator configuration's electronic attenuator. All the same couplings and limitations apply. See ["Attenuator Configurations and Auto/Man" on page 1768](#)

Mechanical Attenuator Transition Rules

When the Electronic Attenuator is enabled, the Mechanical Attenuator transitions to a state that has no Auto function. Below are the rules for transitioning the Mechanical Attenuator. Note that the information below *only* applies to the Dual-Attenuator configurations, and *only* when the Electronic Attenuator is installed:

When the Electronic Attenuation is enabled from a disabled state:

- The Mechanical Attenuator is initialized to 10 dB (this is its optimal performance setting). You can then set it as desired with SCPI, numeric keypad, step keys, or

3 VMA Mode

3.8 ACP Measurement

knob, and it behaves as it normally would in manual mode

- The Auto/Man state of (Mech) Atten is saved
- The Auto/Man toggle on the (Mech) Atten control disappears, and the auto rules are disabled
- The Electronic Attenuator is set to 10 dB less than the previous value of the Mechanical Attenuator, within the limitation that it must stay within the range of 0 to 24 dB of attenuation

Examples in the Dual-Attenuator configuration:

- Mech Atten at 20 dB. Elec Atten enabled, Mech Atten set to 10 dB, and Elec Atten set to 10 dB. New total attenuation equals the value before Elec Atten enabled
- Mech Atten at 0 dB. Elec Atten enabled, Mech Atten set to 10 dB, and Elec Atten set to 0 dB. New total attenuation does not equal the value before Elec Atten enabled
- Mech Atten at 40 dB. Elec Atten enabled, Mech Atten set to 10 dB, and Elec Atten set to 24 dB. New total attenuation does not equal the value before Elec Atten enabled

When the Electronic Attenuation is disabled from an enabled state:

- The Elec Atten control is grayed out
- The Auto/Man state of (Mech) Atten is restored
- If now in Auto, (Mech) Atten recouples
- If now in Man, (Mech) Atten is set to the value of total attenuation that existed before the Elec Atten was disabled. The resulting value is rounded up to the smallest value possible given the (Mech) Atten Step setting - (That is, 57 dB changes to 58 dB when (Mech) Atten Step is 2 dB)

Using the Electronic Attenuator: Pros and Cons

The electronic attenuator offers finer steps than the mechanical attenuator, has no acoustical noise, is faster, and is less subject to wear.

The “finer steps” advantage of the electronic attenuator is beneficial in optimizing the alignment of the instrument dynamic range to the signal power in the front panel as well as remote use. Thus, you can achieve improved relative signal measurement accuracy. Compared to a mechanical attenuator with 2 dB steps, the 1 dB resolution of the electronic attenuator only gives better resolution when the odd-decibel steps are used. Those odd-decibel steps are less accurately calibrated than the even-

decibel steps, so one tradeoff for this superior relative accuracy is reduced absolute amplitude accuracy.

Another disadvantage of the electronic attenuator is that the spectrum analyzer loses its "Auto" setting, making operation less convenient.

Also, the relationship between the dynamic range specifications (TOI, SHI, compression, and noise) and instrument performance are less well-known with the electrical attenuator. With the mechanical attenuator, TOI, SHI, and compression threshold levels increase dB-for-dB with increasing attenuation, and the noise floor does as well. With the electronic attenuator, there is an excess attenuation of about 1 to 3 dB between 0 and 3.6 GHz, making the effective TOI, SHI, and so forth, less well known. Excess attenuation is the actual attenuation relative to stated attenuation. Excess attenuation is accounted for in the instrument calibration.

Adjust Atten for Min Clipping

Sets the combination of mechanical and electronic attenuation and gain based on the current measured signal level so that clipping will be at a minimum.

This is an immediate action function, that is, it executes once, when the control is pressed.

The algorithms that are used for the adjustment are documented under "[Pre-Adjust for Min Clipping](#)" on page 1773.

Remote Command	<code>[:SENSe]:POWer[:RF]:RANGe:OPTimize IMMEDIATE</code>
Example	<code>:POW:RANG:OPT IMM</code>
Notes	Executing Adjust Atten for Min Clipping initiates the measurement
Dependencies	Does not appear in the Swept SA, RTSA, Monitor Spectrum and Complex Spectrum measurements Appears in the Waveform measurement in BASIC and 5G NR Modes

Adjust Atten

Allows you to select;

- Electric attenuator only
- Combination of Electric attenuator and Mechanical attenuator

when `[:SENSe]:POWer[:RF]:RANGe:OPTimize IMMEDIATE` is executed.

Remote Command	<code>[:SENSe]:POWer[:RF]:RANGe:OPTimize:TYPE EONLY COMBined</code> <code>[:SENSe]:POWer[:RF]:RANGe:OPTimize:TYPE?</code>
Example	<code>:POW:RANG:OPT:TYPE EONL</code>

	<code>:POW:RANG:OPT:TYPE?</code>
Dependencies	Does not appear in the Swept SA, RTSA, Monitor Spectrum and Complex Spectrum measurements Appears in the Waveform measurement in BASIC and 5G NR Modes
Preset	<code>COMBined</code>
State Saved	Saved in instrument state

Pre-Adjust for Min Clipping

If this function is **ON**, it applies the adjustment described under "[Adjust Atten for Min Clipping](#)" on page 1772 each time a measurement restarts. Therefore, in Continuous measurement mode, it only executes before the first measurement.

In Dual-Attenuator models, you can set **Elec+Mech Atten**, in which case both attenuators participate in the autoranging, or **Elec Atten Only**, in which case the mechanical attenuator does not participate in the autoranging. This latter case results in less wear on the mechanical attenuator and is usually faster.

See "[Adjustment Algorithm](#)" on page 1186

Selection	SCPI	Note
Off	<code>OFF</code>	This is the default setting
On	<code>ON</code>	Available in Single-Attenuator instruments. For compatibility with models that do not have an input attenuator, the ON parameter is supported and mapped to <code>COMBined</code>
Elec Atten Only	<code>ELECTrical</code>	Selects only the electric attenuator to participate in auto ranging. This offers less wear on the mechanical attenuator and is usually faster
Elec+Mech Atten	<code>COMBined</code>	In Dual-Attenuator models, this selects both attenuators to participate in the autoranging

Remote Command	<code>[:SENSe]:POWer[:RF]:RANGe:OPTimize:ATTenuation OFF ON ELECTrical COMBined</code> <code>[:SENSe]:POWer[:RF]:RANGe:OPTimize:ATTenuation?</code>
Example	<code>:POW:RANG:OPT:ATT OFF</code> <code>:POW:RANG:OPT:ATT?</code>
Notes	The parameter option <code>ELECTrical</code> sets this function to ON in Single-Attenuator models The parameter option <code>COMBined</code> is mapped to <code>ELECTrical</code> in Single-Attenuator models. If you send <code>COMBined</code> , it sets the function to ON and returns <code>ELEC</code> to a query For SCPI compatibility with models that do not have an input attenuator, the ON parameter is honored and mapped to <code>COMBined</code>
Dependencies	Only appears in Dual-Attenuator models with an Electronic Attenuator installed In instruments with Dual-Attenuator model, when " Elec Atten " on page 1769 is OFF or grayed-out, " Pre-Adjust for Min Clipping " on page 1185 is grayed-out

	Does not appear in the Swept SA, RTSA, Monitor Spectrum and Complex Spectrum measurements Appears in the Waveform measurement in BASIC and 5G NR Modes	
Preset	OFF when Elec Atten is Disabled at preset, otherwise ELEC	
State Saved	Saved in instrument state	
Range	Dual-Attenuator models:	Off Elec Atten Only Mech + Elec Atten
	Single-Attenuator models:	Off On

Backwards Compatibility Command

Notes	ON aliases to "Elec Atten Only" (:POW:RANG:OPT:ATT ELEC) OFF aliases to "Off" (:POW:RANG:OPT:ATT OFF) :POW:RANG:AUTO? returns true if :POW:RANG:OPT:ATT is not OFF	
Backwards Compatibility SCPI	[:SENSe]:POWer[:RF]:RANGe:AUTO ON OFF 1 0 [:SENSe]:POWer[:RF]:RANGe:AUTO?	

Adjustment Algorithm

The algorithms for the adjustment are documented below:

Single-Attenuator Models

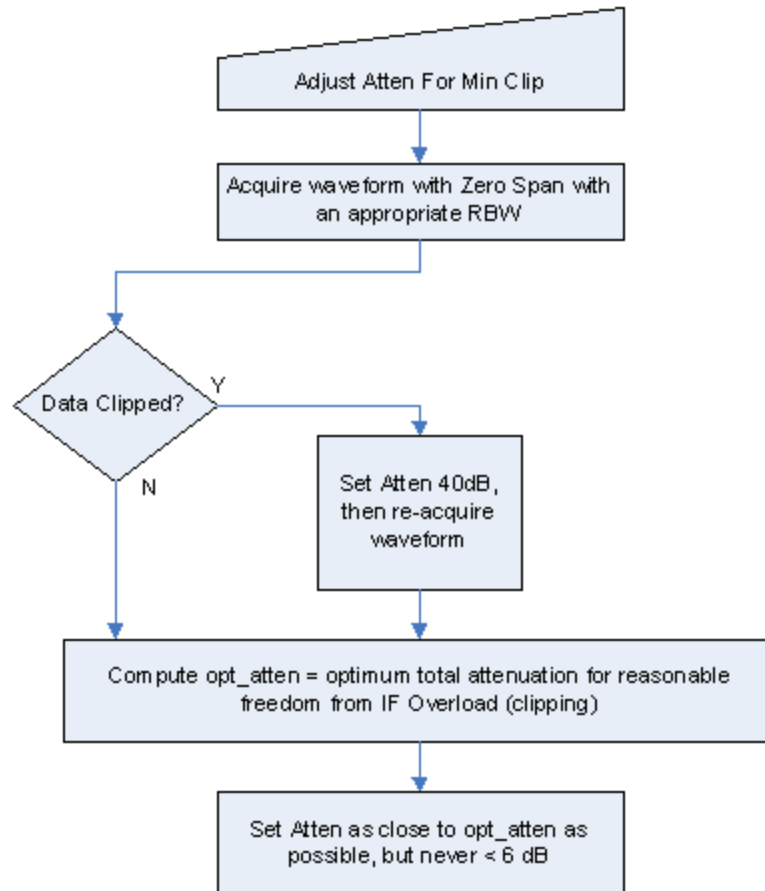

Dual-Attenuator models

"Adjust Atten for Min Clipping" on page 1772 or "Pre-Adjust for Min Clipping" on page 1185 selection is Mech + Elec Atten:

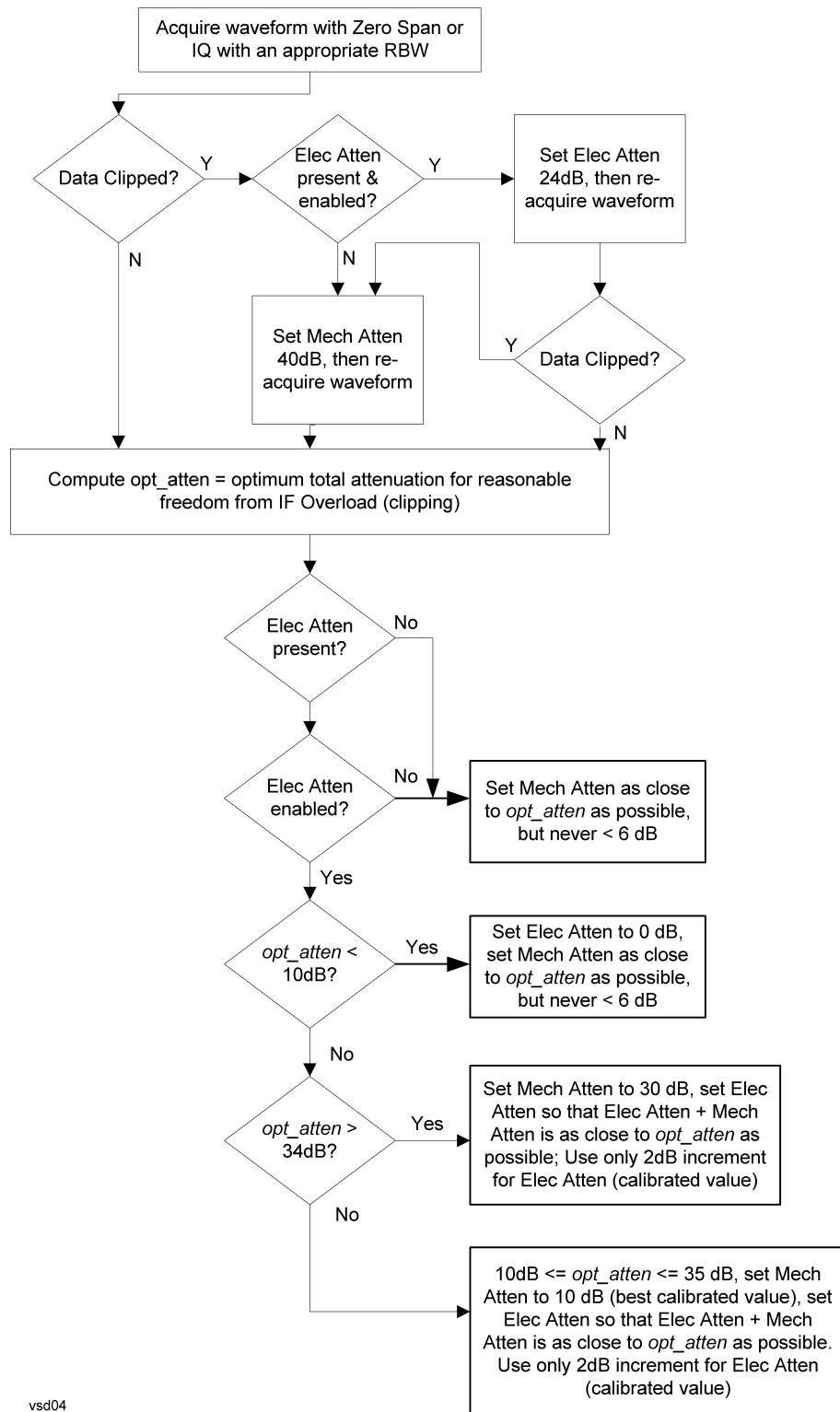

vsd04

"Pre-Adjust for Min Clipping" on page 1185 selection is Elec Only.

Note that the **Mech Atten** value is not adjusted, and the value previously set is used. Therefore, there is a case that IF Overload is still observed depending on the input signal level and the Mech Atten setting.

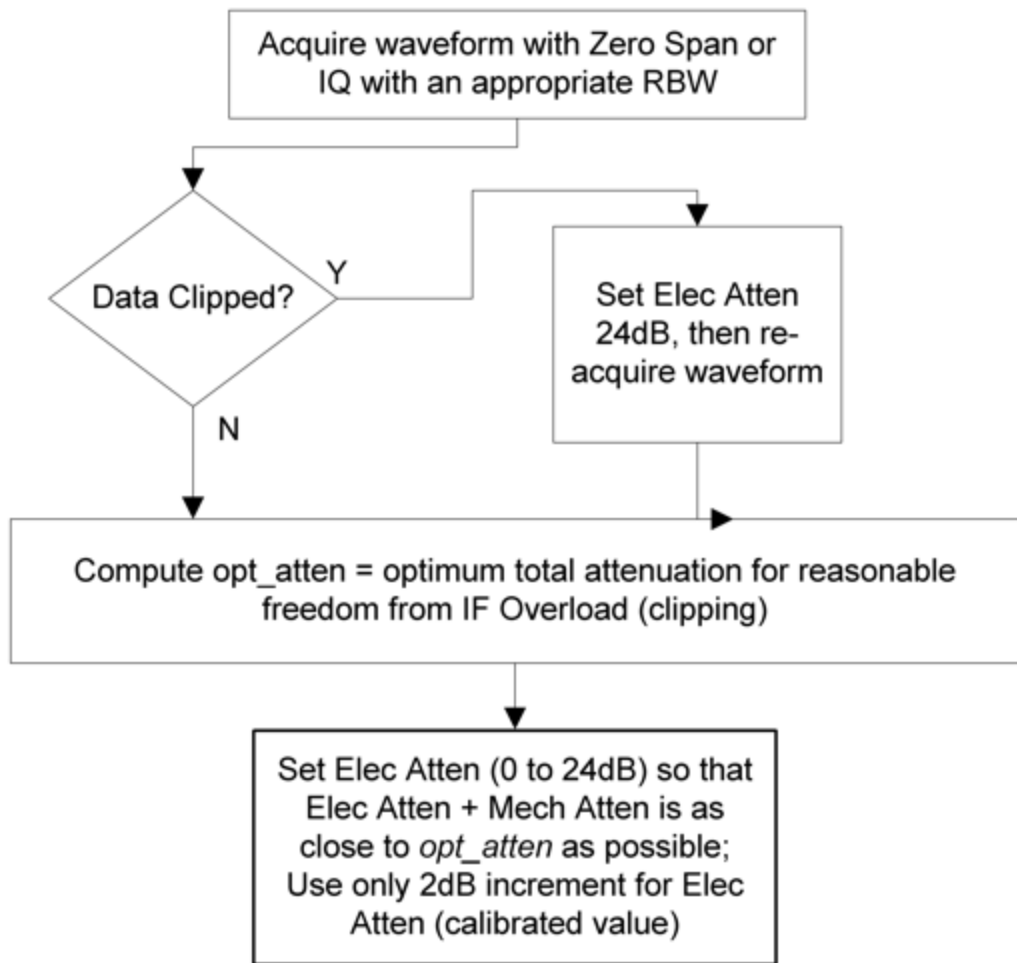

Mech Atten Step

Controls the step size used when making adjustments to the input attenuation.

Labeled **Mech Atten Step** in Dual-Attenuator models and **Atten Step** in Single-Attenuator models. In the Dual-Attenuator configuration, only affects the step size of the mechanical attenuator.

Remote Command `[:SENSe]:POWer[:RF]:ATTenuation:STEP[:INCRement] 10 dB | 2 dB`

	<code>[:SENSe]:POWer[:RF]:ATTenuation:STEP[:INCRement]?</code>
Example	<code>:POW:ATT:STEP 2</code> <code>:POW:ATT:STEP?</code>
Notes	Has a toggle control on the front panel, but takes a specific value (in dB) when used remotely. The only valid values are 2 and 10
Dependencies	Blanked in EXA, CXA and CXA-m if option FSA (2 dB steps) is not present. If blanked, attempts to set it via SCPI yield an error
Couplings	When the attenuation step size changes, the current mechanical attenuation value is adjusted (if necessary) to be quantized to the new step size. That is, if step is set to 10 dB, mech atten is increased if necessary so it is a multiple of 10 dB
Preset	EXA, CXA and CXA-m: 10 dB (2 dB with option FSA) All other models: 2 dB
State Saved	Saved in instrument state

3.8.8.3 Range (Non-attenuator models)

Only available for Keysight's modular signal analyzers and certain other Keysight products, such as VXT and M941xE.

State Saved	No
-------------	----

Range

Represents the amplitude of the largest sinusoidal signal that could be present within the IF without being clipped by the ADC. For signals with high peak-to-average ratios, the range may need to exceed the rms signal power by a significant amount to avoid clipping.

This is a measurement global setting.

Remote Command	<code>[:SENSe]:POWer[:RF]:RANGe <real></code> <code>[:SENSe]:POWer[:RF]:RANGe?</code>
Example	<code>:POW:RANG 10 dBm</code> <code>:POW:RANG?</code>
Notes	The MIN and MAX values are affected by the External Gain parameters, and by the Center Frequency . The hardware compensates for frequency response and alters the Range setting
Preset	0 dBm
State Saved	Yes
Min/Max	-/+100
Annotation	Meas Bar

Adjust Range for Min Clipping

Sets the combination of attenuation and gain based on the current measured signal level so that clipping will be at a minimum.

This is an "immediate action" function, that is, it executes once, when the key is pressed.

This key does not appear in measurements that do not support this functionality.

Remote Command	<code>[:SENSe]:POWer[:RF]:RANGe:OPTimize IMMEDIATE</code>
Notes	Executing Adjust Range for Min Clipping initiates the measurement
Dependencies	Does not appear in the Swept SA and Monitor Spectrum measurements

Pre-Adjust for Min Clipping

If this function is **ON**, it applies the adjustment described under Adjust Range For Min Clipping each time a measurement restarts. Therefore, in Continuous measurement mode, it only executes before the first measurement.

Remote Command	<code>[:SENSe]:POWer[:RF]:RANGe:OPTimize:ATTenuation OFF ON ELECTrical COMBined</code> <code>[:SENSe]:POWer[:RF]:RANGe:OPTimize:ATTenuation?</code>
Notes	Because there is no attenuator control available in these models, the control displays only ON and OFF choices. However, for SCPI compatibility with other platforms, all three parameters (ELECTrical , COMBined , and ON) are honored and all are mapped to ELECTrical , so if any of these three parameters is sent, a subsequent query will return ELEC
Dependencies	Does not appear in the Swept SA and Monitor Spectrum measurements
Preset	OFF for Swept SA measurement; ON for all other measurements that support Pre-Adjust for Min Clipping
State Saved	Saved in instrument state

Adjustment Algorithm

The algorithm for the adjustment is documented below:

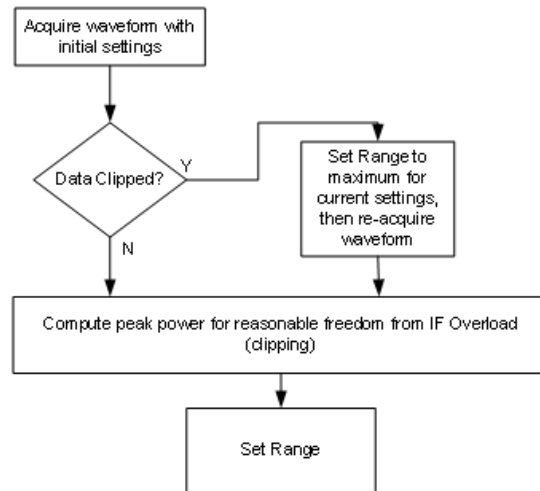

Peak-to-Average Ratio

Used with "[Range \(Non-attenuator models\)](#)" on page 1782 to optimize the level control in the instrument. The value is the ratio, in dB, of the peak power to the average power of the signal to be measured. A ratio of 0 should be used for sinusoidal signals; for 802.11g OFDM signals use 9 dB.

All Modes show the current value of Peak-to-Average ratio on the control. However, some Modes do not permit changing the value. In these situations, the control is grayed-out.

Remote Command	<code>[:SENSe]:POWer[:RF]:RANGe:PARatio <real></code> <code>[:SENSe]:POWer[:RF]:RANGe:PARatio?</code>	
Example	<code>:POW:RANG:PAR 12 dB</code>	
Notes	In some Modes, this parameter is read-only; meaning the value will appear on the control and query via SCPI, but is not changeable. In such applications the control is grayed-out. Attempts to change the value via SCPI are ignored, but no error message is generated	
Dependencies	Does not appear in Spectrum Analyzer Mode	
Preset	VXT Models M9410A/11A	0 dB
	All Others	10 dB
State Saved	Saved in instrument state	
Min	0 dB	
Max	VXT Models M9410A/11A	50 dB
	All Others	20 dB

Mixer Lvl Offset

This is an advanced setting to adjust target Range at the input mixer, which in turn affects the signal level in the instrument's IF. This setting can be used when additional optimization is needed after setting "[Peak-to-Average Ratio](#)" on page 1784. Positive values of offset optimize noise performance over distortion, negative values optimize distortion performance over noise.

Remote Command	<code>[:SENSe]:POWer[:RF]:RANGe:MIXer:OFFSet <real></code> <code>[:SENSe]:POWer[:RF]:RANGe:MIXer:OFFSet?</code>	
Example	<code>:POW:RANG:MIX:OFFS -5 dB</code>	
Preset	0 dB	
State Saved	Saved in instrument state	
Min	VXT Models M9410A/11A	-34 dB
	All Others	-35 dB
Max	30 dB	

3.8.8.4 Signal Path

Contains controls that pertain to the routing of the signal through the frontend of the instrument.

In general, only appears in instruments whose hardware supports this signal routing. For example, this tab does not appear in many of the modular instrument products, including VXT Model M9420A, or UXM.

This tab *does* appear in VXT Models M9410A/11A/15A/16A and M9410E/11E/15E/16E, because "[Software Preselection](#)" on page 1801 is under this tab, and VXT Models M9410A/11A/15A/16A and M9410E/11E/15E/16E implement a version of Software Preselection.

Presel Center

Adjusts the centering of the preselector filter to optimize the amplitude accuracy at the frequency of the selected marker. If the selected marker is not on when **Presel Center** is pressed, the instrument turns on the selected marker, performs a peak search, and then performs centering on the marker's center frequency. If the selected marker is already on and between the start and stop frequencies of the instrument, the instrument performs the preselector calibration on that marker's frequency. If the selected marker is already on, but outside the frequency range

between **Start Freq** and **Stop Freq**, the instrument first performs a peak search, and then performs centering on the marker's center frequency.

The value displayed on "[Preselector Adjust](#)" on page 1787 changes to reflect the new preselector tuning.

Certain considerations should be observed to ensure proper operation, as detailed in "[Proper Preselector Operation](#)" on page 1194.

Remote Command	<code>[:SENSe] :POWer [:RF] :PCENter</code>
Example	<code>:POW:PCEN</code>
Notes	The rules outlined above under the control description apply for the remote command as well as the key. The result of the command depends on marker position, etc. Any message generated by the control press is also generated in response to the remote command
Dependencies	Does not appear in CXA-m, nor in VXT Models M9410A/11A/15A/16A, M9410E/11E/15E/16E Grayed-out if the microwave preselector is off <ul style="list-style-type: none"> - If the selected marker's frequency is below Band 1, an advisory message is generated "Preselector not used in this frequency range" and no action is taken - Grayed-out if entirely in Band 0, that is, if Stop Freq is below about 3.6 GHz Grayed-out if entirely above 50 GHz, that is, if Start Freq is above 50 GHz - Blanked in models that do not include a preselector, such as Option 503. If the remote command is sent in these instruments, accepted without error, and the query always returns 0 - Grayed-out in the Spectrogram View
Couplings	The active marker position determines where the centering will be attempted If the instrument is in a measurement such as averaging when centering is initiated, the act of centering the preselector restarts averaging, but the first average trace will not be taken until the centering is completed The offset applied to do the centering appears in " Preselector Adjust " on page 1787
Status Bits/OPC dependencies	When centering the preselector, *OPC does not return true until the process is complete and a subsequent measurement has completed, nor are results returned in response to <code>:READ</code> or <code>:MEASure</code> queries The Measuring bit remains set (true) while this command is operating, and does not go false until the subsequent sweep/measurement has completed

Proper Preselector Operation

Certain considerations should be observed to ensure proper operation:

1. If the selected marker is **Off**, the instrument turns on a marker, performs a peak search, and adjusts the preselector using the selected marker's frequency. It uses the "highest peak" peak search method unqualified by threshold or excursion, so that there is no chance of a 'no peak found' error. It continues with that peak, even if it is the peak of just noise. Therefore, for this operation to work properly, there should be a signal on-screen in a preselected range for the peak

search to find

2. If the selected marker is already **On**, the instrument attempts the centering at that marker's frequency. There is no preselector for signals below about 3.6 GHz, so if the marker is on a signal below 3.6 GHz, no centering is attempted, and an advisory message is generated
3. In some models, the preselector can be bypassed. If it is bypassed, no centering is attempted in that range and a message is generated

Preselector Adjust

Lets you manually adjust the preselector filter frequency to optimize its response to the signal of interest. Only available when "[Presel Center](#)" on page 1786 is available.

For general purpose signal analysis, using **Presel Center** is recommended. Centering the filter minimizes the impact of long-term preselector drift. **Preselector Adjust** can be used instead to manually optimize the preselector. One application of manual optimization would be to peak the preselector response, which both optimizes the signal-to-noise ratio and minimizes amplitude variations due to small (short-term) preselector drifting.

When **Presel Center** is performed, the offset applied to do the centering becomes the new value of **Preselector Adjust**.

Remote Command	<code>[:SENSe]:POWer[:RF]:PADJust <freq></code> <code>[:SENSe]:POWer[:RF]:PADJust?</code>
Example	<code>:POW:PADJ 100KHz</code> <code>:POW:PADJ?</code>
Notes	The value on the control is displayed to 0.1 MHz resolution
Dependencies	<ul style="list-style-type: none"> - Does not appear in CXA-m - Does not appear in VXT Models M9410A/11A/15A/16A - Does not appear in M9410E/11E/15E/16E - Grayed-out if microwave preselector is off - Grayed-out if entirely in Band 0, that is, if Stop Freq is lower than about 3.6 GHz - Grayed-out if entirely above 50 GHz, that is, if Start Freq is higher than 50 GHz - Blank in models that do not include a preselector, such as Option 503. If the command is sent in these instruments, it is accepted without error, and the query always returns 0 - Grayed-out in the Spectrogram View
Preset	0 MHz

State Saved	The Preselector Adjust value set by " Presel Center " on page 1786, or by manually adjusting Preselector Adjust Not saved in instrument state, and does not survive a Preset or power cycle
Min/Max	-/+500 MHz
Backwards Compatibility SCPI	<code>[:SENSe]:POWer[:RF]:MW:PADJust</code> <code>[:SENSe]:POWer[:RF]:MMW:PADJust</code> Backwards Compatibility Command
Notes	The command has no effect, and the query always returns MWAVE
Backwards Compatibility SCPI	<code>[:SENSe]:POWer[:RF]:PADJust:PRESelector MWAVE MMWave EXTERNAL</code> <code>[:SENSe]:POWer[:RF]:PADJust:PRESelector?</code>

Internal Preamp

Accesses a menu of controls for the internal preamps. Turning on the preamp gives a better noise figure, but a poorer inter-modulation distortion (TOI) to noise floor dynamic range. You can optimize this setting for your measurement.

The instrument takes the preamp gain into account as it sweeps. If you sweep outside of the range of the preamp, the instrument will also account for that. The displayed result always reflects the correct gain.

For some measurements, when the preamp is on and any part of the displayed frequency range is below the lowest frequency for which the preamp has specifications, a warning condition message appears in the status line. For example, for a preamp with a 9 kHz lowest specified frequency: "Preamp: Accy unspec'd below 9 kHz".

Selection	Example	Note
Off	<code>:POW:GAIN OFF</code>	
Low Band	<code>:POW:GAIN ON</code> <code>:POW:GAIN:BAND LOW</code>	Sets the internal preamp to use only the low band. The frequency range of the installed (optional) low-band preamp is displayed in square brackets on the Low Band selection in the dropdown
Full Range	<code>:POW:GAIN ON</code> <code>:POW:GAIN:BAND FULL</code>	Sets the internal preamp to use its full range. The low band (0-3.6 GHz, 0-3.4 GHz, 0-3 GHz, depending on the model) is supplied by the low band preamp and the frequencies above low band are supplied by the high band preamp The frequency range of the installed (optional) low-band preamp is displayed in square brackets on the Full Range selection in the dropdown. If the high band option is not installed the Full Range selection does not appear

NOTE

The maximum **Center Frequency for Low Band**, displayed in square brackets, can change based on the selected IFBW for measurements that support IFBW (for example, Waveform measurement across all Modes that support it). In certain models (such as N9042B & N9032B), IFBW values ≤ 40 MHz have a maximum **Low Band** frequency of 3.6 GHz, while $40 \text{ MHz} < \text{IFBW} \leq 1 \text{ GHz}$ have a maximum of 3.3 GHz, and $1 \text{ GHz} < \text{IFBW} \leq 1.5 \text{ GHz}$ have a maximum of 3.5 GHz. IFBW values $> 1.5 \text{ GHz}$ do not support a **Center Frequency** that can reach the **Low Band** maximum frequency. In these cases, **N/A** is displayed in the square brackets for **Low Band**.

Remote Command	<code>[:SENSe]:POWer[:RF]:GAIN:BAND LOW FULL</code> <code>[:SENSe]:POWer[:RF]:GAIN:BAND?</code>
Example	<code>:POW:GAIN:BAND LOW</code> <code>:POW:GAIN:BAND?</code>
Dependencies	Not available on all hardware platforms. If the preamp is not present or is unlicensed, this control is not shown Does not appear in VXT Models M9410A/11A/15A/16A nor in M9410E/11E/15E/16E If <code>:POW:GAIN:BAND FULL</code> is sent when a low band preamp is available, the preamp band parameter is set to LOW instead of FULL , and an "Option not installed" message is generated Not available when the electronic/soft attenuator is enabled
Preset	LOW
State Saved	Saved in instrument state
Annotation	When the USB Preamp is not connected to USB, the Preamp annotation in the Meas Bar says "Off" if the preamp is off and displays the frequency range of the low band or full range preamp depending on the setting. For example, if the Preamp is set to Low Band and the Low Band is 3.6 GHz the annotation says "3.6 GHz". If it is a 13.6 GHz preamp and it is set to Full Range the annotation says "13.6 GHz" When the USB Preamp is connected to USB, the Preamp annotation says "Preamp: USB" if the internal preamp is off or "Preamp: USB, Int" if the internal preamp is on (only for measurements that support the USB preamp)

Auto Function

Remote Command	<code>[:SENSe]:POWer[:RF]:GAIN[:STATe] OFF ON 0 1</code> <code>[:SENSe]:POWer[:RF]:GAIN[:STATe]?</code>
Example	<code>:POW:GAIN OFF</code> <code>:POW:GAIN?</code>
Preset	OFF

LNA

Lets you turn the Low Noise Amplifier (**LNA**) on or off.

LNA is an additional preamplifier that provides superior DANL and frequency range compared to ["Internal Preamp" on page 1788](#). LNA provides lower system noise figure, especially at frequencies above 100 MHz, and can be operated up to the full range of 50 GHz instruments.

For best possible sensitivity, LNA can be turned on *together* with ["Internal Preamp" on page 1788](#), although if you operate both preamps together, note that the TOI (distortion) specifications are impacted. The sensitivity improvement of this combination is substantial when operating in high band (frequencies above 3.6 GHz).

For more details about annotation, see ["More Information" on page 1198](#)

Remote Command	<code>[:SENSe]:POWer[:RF]:GAIN:LNA[:STATe] OFF ON 0 1</code> <code>[:SENSe]:POWer[:RF]:GAIN:LNA[:STATe]?</code>
Example	<code>:POW:GAIN:LNA ON</code>
Dependencies	Requires Option LNA, except for VXT models M9415A/16A Does not appear in VXT models M9420A/10A/11A M9410E/11E/15E/16E support LNA May not appear in some measurements LNA is not available when the electronic/soft attenuator is enabled
Preset	OFF
State Saved	Saved in State

More Information

When LNA is installed, the preamp annotation changes to show the state of both LNA and Internal Preamp. Below is an example:

```
Atten: 8 dB
Pre: Int on, LNA on
µW Path: LNP, On
Source: Off
```

Note that when operating entirely in the low band (below about 3.6 GHz), if LNA is on, Internal Preamp is switched off (even if you have its switch set to ON). This is because the noise performance is actually degraded in low band if both preamps are on. In this case, the annotation reflects the actual state of the two preamps, but the Internal Preamp annotation displays in amber, to warn you that the actual state of Internal Preamp does not match its switch control display:

```
Atten: 8 dB
Pre: Int off, LNA on
µW Path: LNP, On
Source: Off
```

μW Path Control

Options for this control include **μW Preselector Bypass** (Option MPB), **Low Noise Path** (Option LNP) and **Full Bypass Enable** in the High Band path circuits.

When the μW Preselector is bypassed, flatness is improved, but will be subject to spurs from out of band interfering signals. When **Low Noise Path Enable** is selected, the instrument automatically bypasses certain circuitry in the high frequency bands that can contribute to noise, when it is appropriate based on other instrument settings.

For most applications, the preset state is **Standard Path**, which provides the best remote-control throughput, minimizes acoustic noise from switching and minimizes the risk of wear in the hardware switches, particularly in remote test scenarios where both low band and high band setups will follow in rapid succession. In this path, the bypass of the low band/high band switch and microwave preamp is never activated, which can cause some noise degradation but preserves the life of the bypass switch.

For applications that utilize the wideband IF paths, the preset state is **μW Preselector Bypass**, if option MPB is present. This is because, when using a wideband IF such as the 140 MHz IF, the μW Preselector's bandwidth can be narrower than the available IF bandwidth, causing degraded amplitude flatness and phase linearity, so it is desirable to bypass the preselector in the default case.

You may choose **Low Noise Path Enable** for a lower noise floor, especially in the 21–26.5 GHz region, though without improving many measures of dynamic range, and without giving the best possible noise floor. The preamp, if purchased and used, gives better noise floor than does **Low Noise Path Enable**, but the preamp's compression threshold and third-order intercept are much poorer than that of **Low Noise Path Enable**.

A fourth choice is **Full Bypass Enable**, which combines **μW Preselector Bypass** and **Low Noise Path Enable**. Because this can bypass most of the circuitry between the input and the first mixer, care should be taken when using this setting to avoid damaging the mixer. **Full Bypass Enable** is only available if both options LNP and MPB are present, as well as option FBP.

Path	Example	Note
Standard Path	:POW:MW:PATH STD	Normal setting for most measurements. μW Preselector in circuit, Low Noise Path disabled
Low Noise Path Enable	:POW:MW:PATH LNP	See " Low Noise Path Enable " on page 1203
μW Preselector Bypass	:POW:MW:PATH MPB	See " μW Preselector Bypass " on page 1205
Full Bypass Enable	:POW:MW:PATH FULL	See " Full Bypass Enable " on page 1206

Remote Command	<code>[:SENSe]:POWer[:RF]:MW:PATH STD LNPath MPBypass FULL</code> <code>[:SENSe]:POWer[:RF]:MW:PATH?</code>														
Example	<code>:POW:MW:PATH LNP</code> Enables the Low Noise path <code>:POW:MW:PATH?</code>														
Notes	<p>When "Presel Center" on page 1786 is performed, the instrument momentarily switches to the Standard Path, regardless of the setting of μW Path Control</p> <p>The DC Block will always be switched in when the low noise path is switched in, to protect succeeding circuitry from DC. Note that this does not mean “when the low noise path is enabled” but when, based on the Low Noise Path rules, the path is actually switched in. This can happen when the selection is Low Noise Path Enable or Full Bypass Enable. In the case where the DC Block is switched in, the instrument is now AC-coupled. However, if you selected DC coupling, the UI would still behave as though it were DC-coupled, including all annunciation, warnings, status bits, and responses to SCPI queries. This is because, based on other settings, the instrument could switch out the low noise path at any time and hence go back to being DC-coupled</p> <p>Alignment switching ignores the settings in this menu, and restores them when finished</p>														
Dependencies	<p>Does not appear in CXA-m, VXT Models M9410A/11A/15A/16A, nor in M9410E/11E/15E/16E, BBIQ and External Mixing</p> <ul style="list-style-type: none"> - The Low Noise Path Enable selection does not appear unless Option LNP is present and licensed - The μW Preselector Bypass selection does not appear unless Option MPB is present and licensed - The Full Bypass Enable selection does not appear unless options LNP and MPB are both present as well as option FBP <p>In any of these cases, if the required options are not present and the SCPI command is sent, error - 241, "Hardware missing; Option not installed" is generated</p> <p>Low Noise Path Enable and Full Bypass Enable are grayed-out if the current measurement does not support them</p> <p>Low Noise Path Enable and Full Bypass Enable are not supported in Avionics and MMR Modes (non-modulation measurements). In any of these cases (that is, the feature is not supported in either measurement or Mode), if the SCPI command is sent, the following error is generated: -221, “Setting Conflict; Feature not supported for this measurement”</p>														
Preset	<table border="1"> <thead> <tr> <th>Mode</th> <th>Value</th> </tr> </thead> <tbody> <tr> <td>IQ Analyzer</td> <td>MPB option present and licensed: MPB</td> </tr> <tr> <td>Pulse</td> <td>MPB option not present and licensed: STD</td> </tr> <tr> <td>RTSA</td> <td></td> </tr> <tr> <td>Avionics</td> <td></td> </tr> <tr> <td>All other Modes</td> <td>STD</td> </tr> <tr> <td>-</td> <td></td> </tr> </tbody> </table>	Mode	Value	IQ Analyzer	MPB option present and licensed: MPB	Pulse	MPB option not present and licensed: STD	RTSA		Avionics		All other Modes	STD	-	
Mode	Value														
IQ Analyzer	MPB option present and licensed: MPB														
Pulse	MPB option not present and licensed: STD														
RTSA															
Avionics															
All other Modes	STD														
-															
State Saved	Save in instrument state														
Range	Standard Path Low Noise Path Enable μW Presel Bypass Full Bypass Enable														

Annotation In the Meas Bar, if the Standard path is chosen:
 μ W Path: Standard
 If Low Noise Path is enabled but the LNP switch is not thrown:
 μ W Path: LNP,Off
 If the Low Noise Path is enabled and the LNP switch is thrown:
 μ W Path: LNP,On
 If the preselector is bypassed:
 μ W Path: Bypass
 If Full Bypass Enable is selected but the LNP switch is not thrown:
 μ W Path: FByp,Off
 If Full Bypass Enable is selected and the LNP switch is thrown:
 μ W Path: FByp,On

μ W Path Control Auto

In VMA, WLAN, 5G NR, CQM Modes, an **Auto/Man** switch is added to μ W Path Control:



This allows the function to automatically switch based on certain Auto Rules as shown below:

VMA Mode

Measurement	μ W Path Control Auto behavior
Digital Demod	Use Standard Path unless tuned frequency > 3.6 GHz and IFBW > 15 MHz, in which case choose Preselector Bypass
Monitor Spectrum	Always Presel Bypass
IQ Waveform	Use Standard Path unless tuned frequency > 3.6 GHz and IFBW > 15 MHz, in which case choose Preselector Bypass
Custom OFDM	Use Standard Path unless tuned frequency > 3.6 GHz and IFBW > 15 MHz, in which case choose Preselector Bypass
Channel Power	Always Presel Bypass
Occupied BW	Always Presel Bypass
CCDF	Use Standard Path unless tuned frequency > 3.6 GHz and IFBW > 15 MHz, in which case choose Preselector Bypass

Measurement	μ W Path Control Auto behavior
ACP	Always Presel Bypass
SEM	Always Presel Bypass
Spurious Emissions	Always Standard Path

WLAN Mode

Measurement	μ W Path Control Auto behavior
Modulation Analysis	Always Presel Bypass
Spectral Flatness	Always Presel Bypass
Power vs Time	Always Presel Bypass
Monitor Spectrum	Always Presel Bypass
IQ Waveform	Always Presel Bypass
Channel Power	Always Presel Bypass
Occupied BW	Always Presel Bypass
CCDF	Always Presel Bypass
SEM	For 11be 320M, when 'Enabled Wideband IF for FFT' is OFF or 'Sweep Type Rule' is Best Dynamic Range, auto μ W path is standard For other cases, auto μ W path is presel bypass if presel bypass is enabled, auto μ W path is standard if presel bypass is not enabled
Spurious Emissions	Always Standard Path

5G NR Mode

Measurement	μ W Path Control Auto behavior
Modulation Analysis	Use Standard Path unless tuned frequency > 3.6 GHz and IFBW > 15 MHz, in which case choose Full Bypass if conditions warrant(FBP Option is available and "Allow Full Bypass in Auto" is On), otherwise choose Preselector Bypass
Monitor Spectrum	Always Standard Path
IQ Waveform	Use Standard Path unless tuned frequency > 3.6 GHz and IFBW > 15 MHz, in which case choose Full Bypass if conditions warrant(FBP Option is available and "Allow Full Bypass in Auto" is On), otherwise choose Preselector Bypass
Channel Power	Always Standard Path
Occupied BW	Always Standard Path
CCDF	Use Standard Path unless tuned frequency > 3.6 GHz and IFBW > 15 MHz, in which case choose Preselector Bypass
ACP	Always Standard Path
SEM	Always Standard Path
Spurious	Always Standard Path

3 VMA Mode
3.8 ACP Measurement

Measurement	μ W Path Control Auto behavior
Emissions	
Transmit On Off Power	Use Standard Path unless tuned frequency > 3.6 GHz and Info BW > 15 MHz, in which case choose Preselector Bypass
Channel Quality Mode	
Measurement	μ W Path Control Auto behavior
Group Delay	Use Standard Path unless tuned frequency > 3.6 GHz and IFBW > 15 MHz, in which case choose Full Bypass if conditions warrant(FBP Option is available and "Allow Full Bypass in Auto" is On), otherwise choose Preselector Bypass
Monitor Spectrum	Always Standard Path
IQ Waveform	Use Standard Path unless tuned frequency > 3.6 GHz and IFBW > 15 MHz, in which case choose Preselector Bypass
CCDF	Use Standard Path unless tuned frequency > 3.6 GHz and IFBW > 15 MHz, in which case choose Preselector Bypass

Remote Command	<code>[:SENSe]:POWer[:RF]:MW:PATH:AUTO ON OFF 1 0</code> <code>[:SENSe]:POWer[:RF]:MW:PATH:AUTO?</code>
Example	<code>:POW:MW:PATH:AUTO ON</code> <code>:POW:MW:PATH:AUTO?</code>
Dependencies	Only appears in VMA, WLAN, 5G NR and CQM Modes
Couplings	See " μW Path Control Auto " on page 1201 above
Preset	ON
Range	ON OFF

Low Noise Path Enable

Low Noise Path Enable provides a lower noise floor under some circumstances, particularly when operating in the 21–26.5 GHz region. With the Low Noise Path enabled, the low band/high band switch and microwave preamp are bypassed whenever *all* the following are true:

- The instrument is not in the Low Band, meaning:
- the start frequency is above 3.5 GHz and
- the stop frequency is above 3.6 GHz
- The internal preamp is not installed, or if installed, is set to **Off** or **Low Band**

Note that this means that, when any part of a sweep is done in Low Band, the Low Noise Path is not used, whether or not the **Low Noise Path Enable** is selected in the user interface. Also, if the preamp is turned on, the Low Noise Path is not used,

whether or not the **Low Noise Path Enable** is selected in the user interface. The only time the Low Noise Path is used is when **Low Noise Path Enable** is selected, the sweep is completely in High Band (> 3.6 GHz) and no preamp is in use.

For measurements that use IQ acquisition, the low noise path is used when **Center Frequency** is in High Band (> 3.6 GHz) and no preamp is in use. In other words, the rules above are modified to use only the center frequency to qualify which path to switch in. This is not the case for FFTs in the Swept SA measurement; they use the same rules as swept measurements.

Note that the Low Noise Path, while giving improved DANL, has the disadvantage of decreased TOI performance and decreased gain compression performance relative to the standard path.

Note also that the bypass switch is a mechanical switch and has finite life, so if the **Low Noise Path Enable** is selected, it is possible to cause frequent cycling of this switch by frequently changing instrument settings such that the above conditions hold true only some of the time. A user making tests of this nature should consider opting for the **Standard Path**, which will never throw the bypass switch, at the expense of some degraded noise performance.

The low noise path is useful for situations where the signal level is so low that the instrument performance is dominated by noise even with 0 dB attenuation, but still high enough that the preamp option would have excessive third-order intermodulation or compression. The preamp, if purchased and used, gives better noise floor than does the “Low Noise Path.” However, its compression threshold and third-order intercept are much poorer than that of the non-preamp path.

There are some applications, typically for signals around –30 dBm, for which the third-order dynamic range of the standard path is good enough, but the noise floor is not low enough even with 0 dB input attenuation. When the third-order dynamic range of the preamp path is too little and the noise floor of the standard path is too high, the Low Noise Path can provide the best dynamic range

The graph below illustrates the concept. It shows, in red, the performance of an instrument at different attenuation settings, both with the preamp on and off, in a measurement that is affected by both instrument noise and instrument TOI. The green shows the best available dynamic range, offset by 0.5 dB for clarity. The blue shows how the best available dynamic range improves for moderate signal levels with the low noise path switched in. In this illustration, the preamp improves the noise floor by 15 dB while degrading the third-order intercept by 30 dB, and the low noise path reduces loss by 8 dB. The attenuator step size is 2 dB.

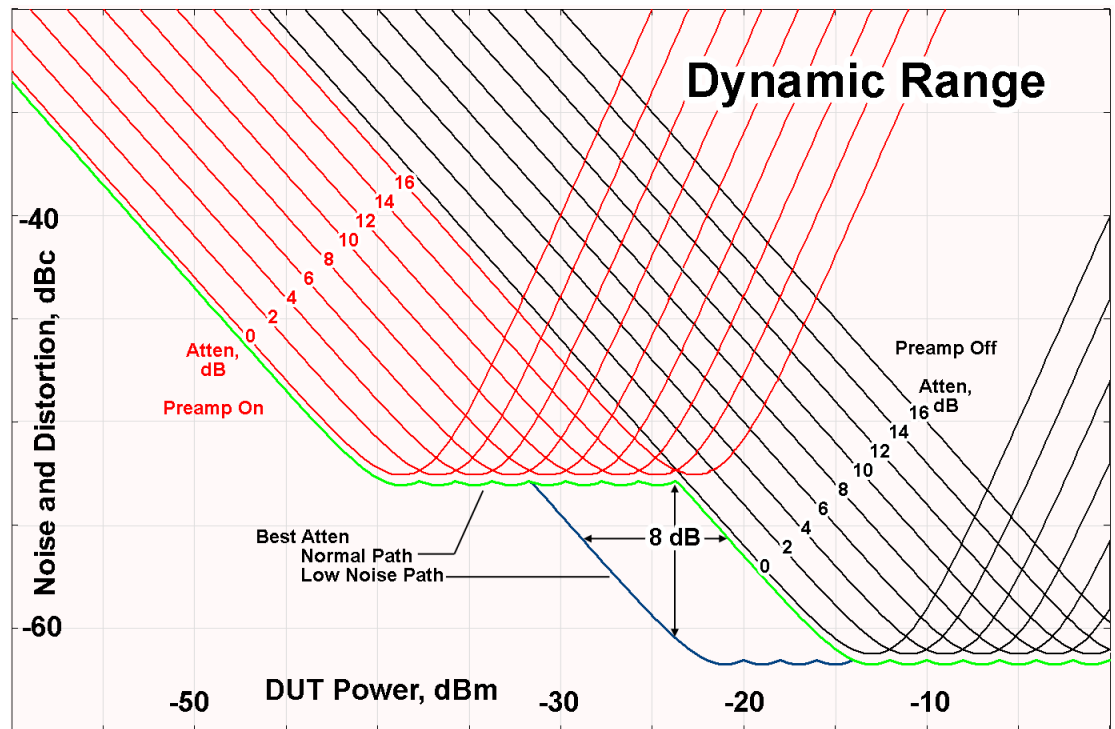

There are other times where selecting the low noise path improves performance, too. Compression-limited measurements such as finding the nulls in a pulsed-RF spectrum can profit from the low noise path in a way similar to the TOI-limited measurement illustrated. Accuracy can be improved when the low noise path allows the optimum attenuation to increase from a small amount like 0, 2 or 4 dB to a larger amount, giving better return loss at the instrument input. Harmonic measurements, such as second and third harmonic levels, are much improved using the low noise path because of the superiority of that path for harmonic (though not intermodulation) distortion performance.

μW Preselector Bypass

Toggles the preselector bypass switch for band 1 and higher. When the microwave preselector is on, the signal path is preselected. When the microwave preselector is off, the signal path is not preselected. The preselected path is the normal path for the instrument.

The preselector is a tunable bandpass filter which prevents signals away from the frequency of interest from combining in the mixer to generate in-band spurious signals (images). The consequences of using a preselector filter are its limited bandwidth, the amplitude and phase ripple in its passband, and any amplitude and phase instability due to center frequency drift.

Option MPB or pre-selector bypass provides an unpreselected input mixer path for certain X-Series signal analyzers with frequency ranges above 3.6 GHz. This signal path allows a wider bandwidth and less amplitude variability, which is an advantage when doing modulation analysis and broadband signal analysis. The disadvantage is that, without the preselector, image signals will be displayed. Another disadvantage of bypassing the preselector is increased LO emission levels at the front panel input port.

Image responses are separated from the real signal by twice the 1st IF. For IF Paths of 10 MHz and 25 MHz, the 1st IF is 322.5 MHz, so the image response and the real signal will be separated by 645 MHz. The 1st IF will be different for other IF Path settings. When viewing a real signal and its corresponding image response in internal mixing, the image response will be to the left of the real signal.

Also, the image response and the real signal typically have the same amplitude and exhibit the same shape factor.

However, if Option FS1 (Fast Sweep Capability) is enabled, the image response in the Swept SA measurement appears lower in amplitude and has a much wider shape factor compared to the real signal.

Full Bypass Enable

With **Full Bypass Enable** selected, the microwave preselector is bypassed. In addition, the low band/high band switch and microwave preamp are bypassed whenever *all* the following are true:

- The instrument is not in the Low Band, meaning:
- the start frequency is above 3.5 GHz and
- the stop frequency is above 3.6 GHz.
- the internal preamp is not installed or if installed, is set to **Off** or **Low Band**

Note that this means that, when any part of a sweep is done in Low Band, the Low Noise Path is not used, whether or not the **Full Bypass Enable** is selected in the user interface. Also, if the preamp is turned on, the Low Noise Path is not used, whether or not the **Full Bypass Enable** is selected in the user interface. The only time the Low Noise Path is used is when **Full Bypass Enable** is selected, the sweep is completely in High Band (> 3.6 GHz) and no preamp is in use.

CAUTION

When **Full Bypass Enable** is selected, and "**Y Scale**" on page 1760 is set to 0 dB, there will be a direct AC connection between the input and the first converter when the Low Noise Path switches in (when Start Freq >3.6 GHz and the Preamp is either not licensed, set to Low Band, or Off). This puts the first converter at considerable risk to be damaged by high AC power. Consequently,

whenever **Full Bypass Enable** is selected, a warning message appears in the status bar:

“Full Bypass Enabled, maximum safe input power reduced”

Microwave Preselector Bypass Backwards Compatibility

Example	Bypass the microwave preselector: <code>:POW:MW:PRES OFF</code>
Notes	Included for Microwave Preselector Bypass backwards compatibility The ON parameter sets the STD path (<code>:POW:MW:PATH STD</code>) The OFF parameter sets path MPB (<code>:POW:MW:PATH MPB</code>)
Preset	ON
Backwards Compatibility SCPI	<code>[:SENSe]:POWer[:RF]:MW:PRESelector[:STATe] ON OFF 0 1</code> <code>[:SENSe]:POWer[:RF]:MW:PRESelector[:STATe]?</code>

Frequency Extender Preselection Bypass

Only applies to the high frequency path of the Frequency Extender, and only if the Frequency Extender allows it. For example, the V3050A high frequency path is 50 – 110 GHz and *does* allow control of the preselector bypass.

When the Frequency Extender’s preselection is bypassed, flatness is improved, but will be subject to spurs from out-of-band interfering signals. For bandwidths greater than 2.5 [GHz], it is recommended that the signal bypass the Frequency Extender Preselector since the max bandwidth of the Preselector can be as narrow as 2.5 [GHz].

For most applications, the preset state is **OFF**, which gives the best remote-control throughput, minimizes acoustic noise from switching, minimizes out of band spurs, and minimizes the risk of wear in the hardware switches.

Preselector and Bandwidth Conflict

When the Frequency Extender Preselector is applied and the signal bandwidth is greater than 2.5 [GHz], then a settings alert message will show to warn the user that the signal may be distorted due to the limitation of the Frequency Extender Preselector bandwidth.

An example of the settings alert message is shown below.

Settings Alert message in the Status Bar at the bottom of the display.



Settings Alert message in the error queue

Type	ID	
	159	Settings Alert - DETECTED;Presel/Meas BW conflict

Allow Full Bypass in Auto

Enable or disable Full Bypass in μ W Path Auto rule. See " [\$\mu\$ W Path Control](#)" on page 1791.

When this function is **ON**, and " [\$\mu\$ W Path Control](#)" on page 1791 is in **AUTO**, it is possible for the auto rules to select the **FULL** Bypass state, which bypasses both the Preamp and the Microwave Preselector. Otherwise, the auto rules never select the **FULL** Bypass state. This is convenient when making wideband measurements, but it also adds some risk of damage to the first converter.

CAUTION

When **Full Bypass Enable** is selected, and "[Y Scale](#)" on page 1760 is set to 0 dB, there will be a direct AC connection between the input and the first converter when the Low Noise Path switches in (when Start Freq > 3.6 GHz and the Preamp is either not licensed, set to **Low Band** or **Off**). This puts the first converter at considerable risk to be damaged by high AC power. Consequently, whenever **Full Bypass Enable** is selected, a warning message appears in the status bar:

"Full Bypass Enabled, maximum safe input power reduced"

Remote Command `[:SENSe] :POWer [:RF] :MW :PATH :AUTO :FULL ON | OFF | 1 | 0`
`[:SENSe] :POWer [:RF] :MW :PATH :AUTO :FULL ?`

Example `:POW :MW :PATH :AUTO :FULL ON`
`:POW :MW :PATH :AUTO :FULL ?`

Dependencies Only appears if Option FBP is installed, and in the following measurements

- 5GNRMode: Modulation Analysis and IQ Waveform
- WLAN Mode: IQ Waveform
- Channel Quality Mode: Group Delay and Noise Power Ratio

Preset **OFF**

State Saved Saved in instrument state

Software Preselection

Provided in some instruments, either to compensate for issues with provided hardware preselection or to provide the preselection function when there is no hardware preselector.

N9041B

Software Preselection compensates for the frequency range limit of the microwave preselector. Since the microwave preselector only goes up to 50 GHz, software preselection must be used to suppress and separate images above 50 GHz. The specific algorithm used for software preselection is specified by the SW Preselection Type selection – Normal or Advanced.

In N9041B, **Software Preselection** only applies for frequencies above 50 GHz, therefore it is only used for RF Input 2. Even if turned on, it is not used for other inputs, and never for frequencies below 50 GHz. This is why the label of this control contains the parenthetical note “(>~50 GHz)”.

Note that in N9041B, in Swept SA measurement, **Software Preselection** works even if the measurement is using an FFT Sweep Type. In measurements other than Swept SA, Software Preselection is not used if the measurement is using an FFT sweep type.

N9042B+V3050A

Software Preselection compensates for the frequency range limit of the microwave preselector. Since the microwave preselector only goes up to 50 GHz, software preselection must be used to suppress and separate images above 50 GHz. The specific algorithm used for software preselection is specified by the SW Preselection Type selection – Normal or Advanced.

For N9042B+V3050A, Software Preselection only applies for frequencies above 50 GHz, therefore it is only used for External RF. Even if it is turned on, it will not be used for other inputs and never for frequencies below 50 GHz. This is why the label of this control contains the parenthetical note “(>~50 GHz)”.

Note that for N9042B+V3050A, in the Swept SA measurement, Software Preselection works even if the measurement is using an FFT Sweep Type. In measurements other than Swept SA, Software Preselection is not used if the measurement is using an FFT Sweep Type.

VXT models M9410A/11A/15A/16A

Software Preselection is used to provide the preselection function, as there is no hardware preselector in these models. Two background traces are taken and compared point by point, and the point with the lowest amplitude from the two

traces is used. This provides a method to reduce spurs that are internally generated within the VXT, but you should note the following when using Software Preselection:

- There is some speed cost due to the need to take multiple captures
- Taking the point with the lowest amplitude in each trace will make the average noise level lower at all points that do not have a spur. This can reduce the accuracy of the measurement of noise and noise-like signals

Because of the difficulty in identifying spurs manually, you are recommended to leave Software Preselection **ON** at all times in VXT models M9410A/11A. If you turn it off in order to speed up your measurement or improve noise accuracy, be aware of unwanted onscreen spurs.

Remote Command	<code>[:SENSe]:POWer[:RF]:SWPrese1:STATe 0 1 ON OFF</code> <code>[:SENSe]:POWer[:RF]:SWPrese1:STAT?</code>
Example	<code>:POW:SWPR:STAT 1</code> <code>:POW:SWPR:STAT?</code>
Dependencies	Only appears in N9041B, N9042B+V2050A, VXT models M9410A/11A and M9410E/11E. Does not appear in all measurements
Couplings	Affects Sweep Time Auto Tune supports Software Preselection , so Auto Tune should be performed after setting the Software Preselection state
Preset	N9041B OFF N9042B+V3050A ON M9410A/11A ON
State Saved	Saved in instrument state

SW Preselection Type

Specifies the algorithm used for software preselection.

Two hidden sweeps occur in succession. The second sweep is offset in LO frequency by $2 * IF / N$. For each point in each trace, the smaller amplitude from the two traces is taken and placed in that point in the selected trace. The Peak detector is auto-selected to improve the image suppression effectiveness. Responses of each trace that lie on top of one another will remain and are valid signals. Other signals are images, which are suppressed. The action of taking the smaller of the two traces will make the average noise level lower in all points that do not have an image, thus reducing the accuracy of the measurement of noise and noise-like signals.

3 VMA Mode
3.8 ACP Measurement

- **NORMa1** - mathematically removes all image and multiple responses of signals present at the input
- **ADVanced** - any trace processing (such as “max hold” or trace averaging) is performed on the points of both candidate traces before the “select minimum” operation occurs. This form of processing works better for non-stationary signals, such as pulsed-RF signals

Remote Command	<code>[:SENSe]:POWer[:RF]:SWPResel NORMa1 ADVanced</code> <code>[:SENSe]:POWer[:RF]:SWPResel?</code>
Example	<code>:POW:SWPR NORM</code> <code>:POW:SWPR?</code>
Dependencies	Only appears in N9041B and N9042B+V3050A. Only appears in measurements that use the Swept method Grayed-out when " Software Preselection " on page 1801 is OFF . The grayout message is “Unavailable unless SW Presel enabled”
Preset	N9041B ADVanced N9042B+V3050A NORMa1
State Saved	Saved in instrument state

SW Preselection BW

Specifies the effective bandwidth to be used for Software Preselection.

The options are:

- **NORMa1** – when making Swept measurements, a software preselection algorithm is used which takes up to 4 background acquisitions, then post-processes the result. This algorithm can remove images from signals with an occupied bandwidth up to around 3 GHz. (Default/Preset setting). When making FFT measurements, this algorithm is not used, instead the same algorithm is used as for **NARRow** (below)
- **NARRow**– a software preselection algorithm is used which takes two background acquisitions, then post-processes the result to detect and remove images from wideband signals with occupied bandwidths up to 2 GHz. This increases the risk of images failing to be rejected, but improves the measurement speed

Remote Command	<code>[:SENSe]:POWer[:RF]:SWPResel:BW NORMa1 NARRow</code> <code>[:SENSe]:POWer[:RF]:SWPResel:BW?</code>
Example	<code>:POW:SWPR:BW NARR</code>
Dependencies	Only appears in N9041B and N9042B+V3050A. Only appears in measurements that use the Swept

	method	
	Grayed-out when " Software Preselection " on page 1801 is OFF . The grayout message is "Unavailable unless SW Presel enabled"	
	For N9042B+V3050A, the parameter is SCPI-only, and always set to NARRow when Software Preselection is enabled	
Preset	N9041B	NORMa1
	N9042B+V3050A	NARRow
State Saved	Saved in instrument state	

High Freq Prefilter

Lets you set the state of Prefilter for center frequencies above 1310 MHz.

In VXT Models M9410A/11A and M9410E/11E in bypass frequency range (1310MHz~5GHz), the Receiver RF path has a bank of filters that come after the RF Attenuator in the signal path. Since this bank of filters precedes the mixer they are known as the "Prefilter" bank. Their purpose is to eliminate unwanted in-band mixing products by filtering out all but the desired frequencies before the signals get to the mixer. There are 13 prefilter bands to cover the frequencies between 9 kHz and 6000 MHz. The Prefilter provides the necessary rejection of the unwanted signal.

Remote Command	<code>[:SENSe]:<measurement>:PFILter[:STATe] ON OFF 1 0</code> <code>[:SENSe]:<measurement>:PFILter[:STATe]?</code>
Example	Enable High Freq Prefilter for the Complex Spectrum Measurement in BASIC Mode: <code>:SPEC:PFIL ON</code> Enable High Freq Prefilter for the IQ Waveform Measurement, in multiple Modes: <code>:WAV:PFIL ON</code> Enable High Freq Prefilter for the Swept SA Measurement in SA Mode: <code>:SAN:PFIL ON</code>
Dependencies	Only appears in VXT models M9410A/11A with center frequency above 1310 MHz, and M9410E/11E in frequency range 1310MHz~5GHz
Preset	See " Prefilter Presets " on page 1212 below
State Saved	Saved in instrument state

Prefilter Presets

Meas	Mode	Preset
SPEC	BASIC	OFF

3 VMA Mode
 3.8 ACP Measurement

Meas	Mode	Preset
WAV	BASIC, WCDMA, WLAN, LTEAFDD, LTEATDD, 5GNR, VMA	OFF
MON	WCDMA, WLAN, LTEAFDD, LTEATDD, 5GNR, VMA	OFF
RHO	WCDMA	OFF
CDP	WCDMA	OFF
PCON	WCDMA	OFF
EVMQ	WCDMA	OFF
CHP	WCDMA, WLAN, LTEAFDD, LTEATDD, 5GNR, VMA, SA	OFF
OBW	WCDMA, WLAN, LTEAFDD, LTEATDD, 5GNR, VMA, SA	OFF
ACP	WCDMA, LTEAFDD, LTEATDD, 5GNR, VMA, SA	OFF
SEM	WCDMA, WLAN, LTEAFDD, LTEATDD, 5GNR, VMA, SA	OFF
PST	WCDMA, WLAN, LTEAFDD, LTEATDD, 5GNR, VMA, SA	OFF
PVT	WLAN, LTEAFDD, LTEATDD, 5GNR	OFF
EVM	WLAN, LTEAFDD, LTEATDD, 5GNR	OFF
FLAT	WLAN	OFF
EVMM	WLAN	OFF
CEVM	LTEAFDD, LTEATDD	OFF
PAVT	5GNR, VMA	OFF
DDEM	VMA	OFF
OFDM	VMA	OFF
SAN	SA	ON
HARM	SA	ON

3.8.9 BW

Opens the **BW** menu, which contains controls for the Resolution Bandwidth and Video Bandwidth functions of the instrument.

The Resolution BW functions control filter bandwidth and filter type. There are two filter types, Gaussian and Flattop. The Gaussian filters have a response curve that is parabolic on a log scale. The Flattop filter shape is a close approximation of a rectangular filter.

3.8.9.1 Settings

Contains the basic Bandwidth functions. In most measurements it is the only tab under Bandwidth.

Res BW

Activates the resolution bandwidth active function, which allows you to manually set the resolution bandwidth (RBW) of the instrument.

Normally, **Res BW (Auto)** selects automatic coupling of **Res BW** to "[Span](#)" on page 1232. To decouple the resolution bandwidth, press the **Auto/Man** toggle on the **Res BW** control, or simply enter a different value for **Res BW**.

When **Res BW** is manually selected, it may be returned to the coupled state by pressing the **Auto/Man** toggle on the **Res BW** control. This may also be done by pressing "[Auto Couple](#)" on page 1825 or by performing a **Preset**.

For more Mode-specific details, see: "[More Information](#)" on page 1215

Remote Command	<code>[:SENSe]:ACPower:BANDwidth[:RESolution] <bandwidth></code> <code>[:SENSe]:ACPower:BANDwidth[:RESolution]?</code>												
Example	<code>:ACP:BAND 5 MHz</code> <code>:ACP:BAND?</code>												
Notes	<p>For numeric entries, all Res BW Types choose the nearest (arithmetically, on a linear scale, rounding up) available Res BW to the value entered</p> <p>The setting and querying of values depend on the current bandwidth type</p> <p>This parameter is preset by "Meas Method" on page 1246. Preset values are:</p> <table border="1"> <thead> <tr> <th>Modes</th> <th>Values</th> </tr> </thead> <tbody> <tr> <td rowspan="2">5GNR, LTEAFDD/TDD, MSR, VMA, SRCOMM</td> <td>IBW 100 kHz</td> </tr> <tr> <td>IBWR 30 kHz</td> </tr> <tr> <td rowspan="2">SA</td> <td>IBW 220 kHz</td> </tr> <tr> <td>IBWR 30 kHz</td> </tr> <tr> <td rowspan="3">WCDMA</td> <td>IBW 100 kHz</td> </tr> <tr> <td>IBWR 27 kHz</td> </tr> <tr> <td>FAST 390 kHz</td> </tr> </tbody> </table> <p>When Meas Method is FPOwer and Fast Power RBW mode is "Best Speed," RBW is calculated as follows: $RBW = \text{Span} \times 2.442 \times 10^{-3}$</p>	Modes	Values	5GNR, LTEAFDD/TDD, MSR, VMA, SRCOMM	IBW 100 kHz	IBWR 30 kHz	SA	IBW 220 kHz	IBWR 30 kHz	WCDMA	IBW 100 kHz	IBWR 27 kHz	FAST 390 kHz
Modes	Values												
5GNR, LTEAFDD/TDD, MSR, VMA, SRCOMM	IBW 100 kHz												
	IBWR 30 kHz												
SA	IBW 220 kHz												
	IBWR 30 kHz												
WCDMA	IBW 100 kHz												
	IBWR 27 kHz												
	FAST 390 kHz												
Dependencies	Disabled when Meas Method is RBW , FAST , or FPOwer , and Fast Power RBW mode is Best Speed If pressed, an advisory message is generated. If the equivalent SCPI command is sent, a "Setting conflict" warning is generated												
Couplings	Sweep time is coupled to RBW. As RBW changes, the sweep time (if set to Auto) is changed to maintain amplitude calibration " Video BW " on page 1216 is coupled to Res BW . As the resolution bandwidth changes, the video bandwidth (if set to Auto) changes to maintain the ratio of VBW/RBW (10:1)												

	When Res BW is set to Auto , the resolution bandwidth is auto-coupled to the span. The ratio of Span/RBW is approximately 106:1 when auto coupled. When Res BW is set to Man , and the bandwidths are entered manually, these bandwidths are used regardless of other instrument settings
Preset	Auto, unless noted in "RBW Presets" on page 1215
State Saved	Saved in instrument state
Min	1 Hz
Max	8 MHz is the max equivalent -3 dB RBW, which means that the named RBW (the one shown on the control etc.) can actually exceed 8 MHz if using a filter other than -3 dB Gaussian
Annotation	A "#" mark appears before "RBW" in the annotation when it is switched from Auto to Manual coupling
Backwards Compatibility Notes	For backwards compatibility, this command accepts both the BANDwidth and BWIDth forms For ESA, the maximum Res BW was 5 MHz; for X-Series it is 8 MHz The following command is supported [:SENSe]:ACP:SWEp:BANDwidth BWIDth[:RESolution]
	Auto Function
Remote Command	<code>[:SENSe]:ACPower:BANDwidth[:RESolution]:AUTO ON OFF 1 0</code> <code>[:SENSe]:ACPower:BANDwidth[:RESolution]:AUTO?</code>
Example	<code>:ACP:BAND:AUTO ON</code> <code>:ACP:BAND:AUTO?</code>
Preset	See "RBW Presets" on page 1215

RBW Presets

Unless noted in the table below, the Preset value of **Res BW** is **Auto**.

Mode	Preset Value
WCDMA	100 kHz
MSR	100 kHz
SA	220 kHz
5G NR	100 kHz

More Information

When **Res BW** is set to **Auto**, the bandwidth selected depends on ["RBW Filter Type" on page 1217](#).

Only certain discrete resolution bandwidths are available. The available bandwidths are dependent on the **RBW Filter Type** or the **EMC Standard**. If an unavailable bandwidth is entered with the numeric keypad, the closest available bandwidth is selected.

In some PowerSuite measurements, in the LTE-Advanced (both FDD and TDD) Modes, when **Res BW** is **Auto**, the resolution bandwidth is predefined based on the

corresponding bandwidth of the single LTE carrier, as shown in the table below. In the Multi-carrier case, the narrowest **Res BW** among the active carriers is used.

LTEAFDD, LTEATDD Modes

Carrier BW	Auto Res BW, kHz
1.4 MHz	51
3 MHz	51
5 MHz	100
10 MHz	100
15 MHz	100
20 MHz	100
200 kHz (NB-IoT in FDD)	10

5G NR Mode

100 kHz for all carrier bandwidths.

Video BW

Lets you change the instrument post-detection filter (VBW or “video bandwidth”) from 1 Hz to 8 MHz in approximately 10% steps. In addition, a wide-open video filter bandwidth may be chosen by selecting 50 MHz. The VBW is annotated at the bottom of the display, in the center.

Normally, **Video BW (Auto)** selects automatic coupling of the Video BW to **"Res BW"** on page 1214. To decouple the resolution bandwidth, press the **Auto/Man** toggle on the **Video BW** control, or simply enter a different value for **Video BW**.

When the **Video BW** is manually selected, it may be returned to the coupled state by pressing the **Auto/Man** toggle on the **Video BW** control. This may also be done by pressing **"Auto Couple"** on page 1825 or by performing a **Preset**.

For more information, see **"VBW Presets"** on page 1217

Remote Command	<code>[:SENSe]:ACPower:BANDwidth:VIDeo <bandwidth></code> <code>[:SENSe]:ACPower:BANDwidth:VIDeo?</code>
Example	<code>:ACP:BAND:VID 2.4 MHz</code> <code>:ACP:BAND:VID?</code>
Notes	For numeric entries, the instrument chooses the nearest (arithmetically, on a linear scale, rounding up) available VBW to the value entered. The 50 MHz VBW is defined to mean “wide open” The values shown in this table reflect the conditions after Mode Preset
Dependencies	Sometimes the displayed Video BW is not actually used to process the trace data: <ul style="list-style-type: none"> When the Average Detector is selected and Sweep Type is set to Swept, the video bandwidth filter

cannot be used, because it uses the same hardware as the Average Detector

- When the Quasi-Peak, EMI Average or RMS Average detector is selected the VBW is implemented by the digital IF as part of the detector

When this is the case, the VBW still acts to change the sweep time, if **Sweep Time** is in **Auto**, and still affects the data on other traces for which this is not the case

Disabled when "**Meas Method**" on page 1246 is **RBW**, **FAST**, **FPOWer**

If pressed, an advisory message is generated. If the equivalent command is sent, a "Setting conflict" warning is generated

Couplings	Video bandwidth (VBW) is normally coupled to RBW. If VBW is set to Auto , then the VBW is changed as the RBW changes, to maintain the ratio (usually 10:1)
Preset	See " VBW Presets " on page 1217 below
State Saved	Saved in instrument state
Min	1 Hz
Max	50 MHz
Annunciation	A "#" mark appears before "VBW" in the annotation when it is not coupled
Annotation	In the bottom center of the screen, "VBW <value> <units>" indicates the current video bandwidth value. Note that for some detectors this is not the value actually used for VBW (see above)
Backwards Compatibility Notes	For backwards compatibility this command accepts both the BANDwidth and BWIDth forms

Auto Function

Remote Command	<code>[:SENSe] :ACPower :BANDwidth :VIDeo :AUTO ON OFF 1 0</code>
Example	<code>:ACP :BAND :VID :AUTO ON</code>

VBW Presets

Unless noted in the table below, the Preset value of **Video BW** is **Auto**.

Mode	Preset Value
WCDMA	1 MHz

RBW Filter Type

Selects the type for the resolution bandwidth filters. Historically, the Res BW filters in HP/Agilent/Keysight spectrum analyzers were Gaussian filters, specified using the -3 dB bandwidth of the filter. That is, a 10 MHz Res BW filter was a Gaussian shape with its -3 dB points 10 MHz apart. In X-Series, the **RBW Filter BW** menu lets you choose between a Gaussian and Flat Top filter shape, for varying measurement conditions.

	Filter Type	SCPI Example
	Gaussian	:BAND:SHAP GAUS
	Flattop	:BAND:SHAP FLAT
Remote Command	[:SENSe]:ACPower:BANDwidth:SHAPE GAUSSian FLATtop [:SENSe]:ACPower:BANDwidth:SHAPE?	
Example	:ACP:BAND:SHAP GAUS :ACP:BAND:SHAP?	
Notes	GAUSSian= Gaussian FLATtop = Flattop	
Dependencies	Disabled when "Meas Method" on page 1246 is FAST or FPOWER If pressed, an advisory message is generated. If the equivalent command is sent, a "Setting conflict" warning is generated	
Preset	"Auto Couple" on page 1825 selects the preset value	
State Saved	Saved in instrument state	
Annotation	The annotation under RBW in the bottom left of the screen shows the type of filter or bandwidth that is being used	
Backwards Compatibility SCPI	[:SENSe]:ACPower:BWIDth:SHAPE	

RBW Filter BW

Selects a Gaussian filter based on its –3 dB (Normal) bandwidth or its –6 dB bandwidth.

Remote Command	[:SENSe]:ACPower:BANDwidth:TYPE DB3 DB6 [:SENSe]:ACPower:BANDwidth:TYPE?	
Example	:ACP:BAND:TYPE DB3 :ACP:BAND:TYPE?	
Dependencies	Disabled when "RBW Filter Type" on page 1217 is FLATtop or "Meas Method" on page 1246 is RBW, FAST, or Fast Power If pressed, an advisory message is generated. If the equivalent command is sent, a "Setting conflict" warning is generated	
Preset	DB3	
State Saved	Saved in instrument state	
Range	–3 dB (Normal) –6 dB	
Backwards Compatibility SCPI	[:SENSe]:ACPower:BWIDth:TYPE	

3.8.10 Display

Lets you configure display items for the current Mode, Measurement, View, or Window.

3.8.10.1 Meas Display

Contains controls for setting up the display for the current Measurement, View or Window.

Bar Graph On/Off

Turns the Bar Graph On or Off.

Remote Command	<code>:DISPlay:ACPower:WINDow[1]:BGRaph OFF ON 0 1</code> <code>:DISPlay:ACPower:WINDow[1]:BGRaph?</code>
Example	<code>:DISP:ACP:WIND:BGR OFF</code> <code>:DISP:ACP:WIND:BGR?</code>
Dependencies	Always set to ON and grayed-out when the method is RBW
Preset	ON
State Saved	Saved in instrument state
Range	OFF ON
Backwards Compatibility SCPI	<code>:DISPlay:ACPower:VIEW[1]:WINDow[1]:BGRaph</code>

3.8.10.2 Annotation

Contains controls for setting up the annotation for the current Mode or Measurement.

Graticule

Turns the display graticule On or Off for all windows with graticules in all measurements in the current Mode. Also turns the graticule Y-Axis annotation on and off.

Remote Command	<code>:DISPlay:GRATicule[:STATe] OFF ON 0 1</code> <code>:DISPlay:GRATicule[:STATe]?</code>
Example	<code>:DISP:GRAT OFF</code>

Notes	The graticule is the set of horizontal and vertical lines that make up the grid/divisions for the X-Axis and Y-Axis
Preset	ON
State Saved	Saved in instrument state
Backwards Compatibility SCPI	<code>:DISPlay:WINDow[1]:TRACe:GRATicule:GRID[:STATe] OFF ON 0 1</code> <code>:DISPlay:WINDow[1]:TRACe:GRATicule:GRID[:STATe]?</code> This command is accepted for backwards compatibility with older instruments, but the WINDow , TRACe and GRID parameters are ignored

Screen Annotation

Controls the display of the annunciation and annotation around the graticule, including any annotation on lines (such as the display line, the threshold line, etc.) and the Y-Axis annotation, for all windows with screen annotation in all measurements in the current Mode.

This does *not* include marker annotation (or the N dB result). When **OFF**, the graticule expands to fill the entire graticule area, leaving only the 1.5% gap above the graticule, as described in the **Trace** section.

Remote Command	<code>:DISPlay:ANNotation:SCReen[:STATe] OFF ON 0 1</code> <code>:DISPlay:ANNotation:SCReen[:STATe]?</code>
Example	<code>:DISP:ANN:SCR OFF</code>
Dependencies	Grayed-out and forced to OFF when System Display Settings, Annotation is OFF
Preset	ON This remains OFF through a Preset when System Display Settings, Annotation is set to OFF
State Saved	Saved in instrument state

Trace Annotation

Turns on and off the labels on the traces, showing their detector (or their Math Mode) as described in the **Trace** section, for all windows in all measurements in the current Mode for which Trace Annotation on/off is supported.

If Trace Math is being performed on a trace, then the Trace Math annotation replaces the detector annotation.

For measurements that support limit lines, this key also turns on and off the labels on the Limit Lines. The label is the Limit number annotation and Limit Comment displayed on the graph. If the length of the comment is greater than 20 characters, the first 8 characters and the last 8 characters are displayed, joined with

Remote Command	<code>:DISPlay:ANNotation:TRACe[:STATe] ON OFF 1 0</code>
----------------	---

	<code>:DISPlay:ANNotation:TRACe[:STATe]?</code>
Example	<code>:DISP:ANN:TRAC OFF</code>
Preset	<code>OFF</code>
State Saved	Saved in instrument state

Control Annotation

Turns on and off the display of values on the Active Function controls for all measurements in the current Mode. This is a security feature.

Remote Command	<code>:DISPlay:ACTivefunc[:STATe] ON OFF 1 0</code> <code>:DISPlay:ACTivefunc[:STATe]?</code>
Example	<code>:DISP:ACT OFF</code>
Dependencies	Grayed out and forced to <code>OFF</code> when System Display Settings, Annotation is <code>OFF</code>
Preset	<code>ON</code> This remains <code>OFF</code> through a Preset when System Display Settings, Annotation is set to <code>OFF</code>
State Saved	Saved in instrument state

Meas Bar

Turns the Measurement Bar at the top of the screen on and off for all measurements in the current Mode. When `OFF`, the graticule area expands to fill the area formerly occupied by the Measurement Bar.

Remote Command	<code>:DISPlay:ANNotation:MBAR[:STATe] OFF ON 0 1</code> <code>:DISPlay:ANNotation:MBAR[:STATe]?</code>
Example	<code>:DISP:ANN:MBAR OFF</code>
Dependencies	Grayed out and forced to <code>OFF</code> when System Display Settings, Annotation is <code>OFF</code>
Preset	<code>ON</code> This remains <code>OFF</code> through a Preset when System Display Settings, Annotation is set to <code>OFF</code>
State Saved	Saved in instrument state

Display Enable (Remote Command Only)

Turns the display on/off, including the display drive circuitry. The backlight stays lit to confirm that the instrument is on. The display enable setting is mode global. There are three reasons for turning the display off:

1. To increase speed as much as possible by freeing the instrument from having to update the display
2. To reduce emissions from the display, drive circuitry
3. For security purposes

If you have turned off the display:

- and you are in local operation, the display can be turned back on by pressing any key or by sending `:SYSTem:DEFaults MISC` or `:DISPlay:ENABle ON` (neither `*RST` nor `:SYSTem:PRESet` enable the display)
- and you are in remote operation, the display can be turned back on by pressing the **Local** or **Esc** keys, or by sending `:SYSTem:DEFaults MISC` or `:DISPlay:ENABle ON` (neither `*RST` nor `:SYSTem:PRESet` enable the display)
- and you are using either the `:SYSTem:KLOCK` command or GPIB local lockout, then *no* front-panel key press will turn the display back on. You must turn it back on remotely.

If the display is **OFF**, many SCPI commands related to User Views and Multiscreen functionality do not work, and return the error messages “-221, Settings conflict; Screen SCPI cannot be used when Display is disabled” or “221, Settings conflict; View SCPI cannot be used while Display is disabled”. These commands include:

Name	Command
Select User View	<code>:DISPlay:VIEW:ADVanced:SElect</code>
Rename User View	<code>:DISPlay:VIEW:ADVanced:REName</code>
Delete User View	<code>:DISPlay:VIEW:ADVanced:DELeTe</code>
Create User View	<code>:DISPlay:VIEW:ADVanced:NAME</code>
Select Screen	<code>:INSTrument:SCReen:SElect</code>
Delete Screen	<code>:INSTrument:SCReen:DELeTe</code>
Delete All But This Screen	<code>:INSTrument:SCReen:DELeTe:ALL</code>
Add Screen	<code>:INSTrument:SCReen:CREate</code>
Rename Screen	<code>:INSTrument:SCReen:REName</code>
Sequencer On/Off	<code>:SYSTem:SEQuencer</code>

Remote Command	<code>:DISPlay:ENABle OFF ON 0 1</code>
Example	<code>:DISP:ENAB OFF</code>
Couplings	<code>:DISP:ENAB OFF</code> turns Backlight OFF and <code>:DISP:ENAB ON</code> turns Backlight ON , but changing Backlight settings does <i>not</i> change the state of <code>:DISP:ENAB</code>
Preset	ON

	Set by <code>:SYST:DEF MISC</code> , but not affected by <code>*RST</code> or <code>:SYSTem:PRESet</code>
State Saved	Not saved in instrument state
Backwards Compatibility Notes	<code>:SYST:PRES</code> no longer turns on <code>:DISPlay:ENABle</code> as it did in legacy analyzers

3.8.10.3 View

Contains controls for selecting the current **View**, and for editing User Views.

View

See "Views" on page 1166.

User View

Lets you choose a View from the saved User Views for the current measurement. This panel only appears if a User View exists for the current measurement.

Remote Command	<code>:DISPlay:VIEW:ADVanced:SElect <alphanumeric></code> <code>:DISPlay:VIEW:ADVanced:SElect?</code>
Example	Select Baseband as the current View <code>:DISP:VIEW:ADV:SEL "Baseband"</code>
Notes	<p>You must be in the measurement whose View you are trying to set to send the command. You can only set Views for the current measurement using this command</p> <p>For predefined views, the parameter is derived from the view name that is shown in the View list in the user interface. For example, if you are trying to select the Trace Zoom view in the Swept SA measurement, you send:</p> <pre><code>:DISP:VIEW:ADV:SEL "Trace Zoom"</code></pre> <p>because "Trace Zoom" is the name of the View as seen in the Mode/Meas dialog or in the Display, View menu</p> <p>You <i>cannot</i> use the legacy View parameter (which in this case would be <code>TZOom</code>) with</p> <pre><code>:DISP:VIEW:ADV:SEL</code></pre> <p><code><alphanumeric></code> is case insensitive; you can specify mixed case, however the name will be evaluated on a single case. Thus, both of the following forms work:</p> <pre><code>:DISP:VIEW:ADV:SEL "Trace Zoom"</code></pre> <pre><code>:DISP:VIEW:ADV:SEL "TRACE ZOOM"</code></pre> <p>If the specified view is not a valid View, the query returns the error message "-224, Illegal parameter value; View with the name <alphanumeric> does not exist"</p> <p>If the display is disabled (via <code>:DISP:ENAB OFF</code>) then the error message "-221, Settings conflict; View SCPI cannot be used while Display is disabled" is generated</p>

Backwards Compatibility SCPI	The legacy node <code>:DISPlay:VIEW[:SElect]</code> is retained for backwards compatibility, but it only supports predefined views
------------------------------	--

Restore Layout to Default

Restores the Layout to the default for Basic.

Modified Views are very temporary; if you exit the current measurement they are discarded, and they are not saved in State. To retain this View for later use, and to be able to return easily to your original Basic View, you can save your edited View as a “User View”.

Save Layout as New View

Saves your new View as a User View. An alpha keyboard appears, which lets you name your new View; the default is the old View name plus a number.

Remote Command	<code>:DISPlay:VIEW:ADVanced:NAME <alphanumeric></code>
Example	<code>:DISP:VIEW:ADV:NAME "Baseband"</code> Creates a new View named Baseband from the current View, and selects it as the current View
Notes	<code><alphanumeric></code> is case insensitive; you can specify mixed case, however the name will be evaluated on a single case If <code><alphanumeric></code> name already exists as a View, the error message “-224, Illegal parameter value; View <alphanumeric> already exists” is generated If the display is disabled (via <code>:DISP:ENAB OFF</code>) then the error message “-221, Settings conflict; User View SCPI cannot be used while Display is disabled” is generated

Re-Save User View

You can re-edit a User View; if you make changes, then an asterisk will appear next to the User View’s name. You can then tap **Re-Save User View** to save it back to its existing name, or **Save Layout as New View** to add another, new User View.

This is a front panel function only, there is no remote command available to perform this function. To do this remotely, you must first perform **Save Layout as New View**, then delete the old User View and rename the new one with the name of the View you just deleted.

Rename User View

You can rename the current View by giving it a new unique name. Only User Views can be renamed, if the current View is a Predefined View, an error occurs.

Remote Command	<code>:DISPlay:VIEW:ADVanced:REName <alphanumeric></code>
Example	<code>:DISP:VIEW:ADV:REN "Baseband"</code>
Notes	<p><code><alphanumeric></code> is case insensitive; you can specify mixed case, however the name will be evaluated on a single case</p> <p>If the <code><alphanumeric></code> specifying the new name is already present in the list of View names, the error message "-224, Illegal parameter value; View <alphanumeric> already exists" is generated</p> <p>If the current View is a Predefined View, the error message "-224, Illegal parameter value; Cannot rename a Predefined View" is generated</p> <p>If the display is disabled (via <code>:DISP:ENAB OFF</code>) then the error message "-221, Settings conflict; View SCPI cannot be used while Display is disabled" is generated</p>

Delete User View

You can delete the current View if it is a User View. The default view becomes the current view for the Measurement.

Remote Command	<code>:DISPlay:VIEW:ADVanced:DElete</code>
Example	<code>:DISP:VIEW:ADV:DEL</code>
Notes	<p><code><alphanumeric></code> is case insensitive; you can specify mixed case, however the name will be evaluated on a single case</p> <p>If the <code><alphanumeric></code> is not present in the list of View names, the error message "-224, Illegal parameter value; View <alphanumeric> does not exist" is generated</p> <p>If the current View is a Predefined View, the error message "-224, Illegal parameter value; Cannot delete a Predefined View" is generated</p> <p>If the display is disabled (via <code>:DISP:ENAB OFF</code>) then the error message "-221, Settings conflict; View SCPI cannot be used while Display is disabled" is generated</p>

Delete All User Views

Deletes all previously saved User Views. The default view becomes the current view for the Measurement if a User View was the current view when this command was executed.

Remote Command	<code>:DISPlay:VIEW:ADVanced:DElete:ALL</code>
----------------	--

Example	<code>:DISP:VIEW:ADV:DEL:ALL</code>
Notes	Disabled if there are no User Views

View Editor Remote Commands

The following remote commands help you manage Views and User Views. Note that the SCPI node for User Views handles both Predefined and User Views. The legacy nodes, `:DISPlay:VIEW[:SElect]` and `:DISPlay:VIEW:NSEL`, are retained for backwards compatibility, but they only support predefined views.

View Listing Query

Returns a string containing a comma-separated list of names for *all* the Views, including User Views, available for the current Measurement.

Remote Command	<code>:DISPlay:VIEW:ADVanced:CATalog?</code>
Example	<code>:DISP:VIEW:ADV:CAT?</code>
Notes	Returns a quoted string of the available Views for the current measurement, separated by commas. The list includes names for <i>all</i> the Views, including User Views, available for the current Measurement Example: <code>"Normal,Trace Zoom,Spectrogram,Baseband,myView1,yourView1"</code> No distinction is made between Predefined and User Views If you switch measurements with the display disabled (via <code>:DISP:ENAB OFF</code>), then query the list of available Views, the result is undefined

User View Listing Query

Returns a string containing a comma-separated list of names for *only* the User Views available for the current Measurement.

Remote Command	<code>:DISPlay:VIEW:ADVanced:USER:CATalog?</code>
Example	<code>:DISP:VIEW:ADV:USER:CAT?</code>
Notes	Returns a quoted string of the available User Views for the current measurement, separated by commas. Example: <code>"Baseband,myView1,yourView1"</code> If you switch measurements with the display disabled (see "Display Enable (Remote Command Only)" on page 1812), then query the list of available Views, the result is undefined

3.8.11 Frequency

Contains controls that allow you to control the Frequency and Channel parameters of the instrument.

Some features in the **Frequency** menu are the same for all measurements in the current Mode – they do not change as you change measurements. Settings like these are called “Meas Global” and are unaffected by Meas Preset. For example, the **Center Frequency** setting is the same for all measurements – it does not change as you change measurements.

3.8.11.1 Settings

Contains controls that pertain to the X-Axis parameters of the measurement. These parameters control how data on the vertical (Y) axis is displayed and control instrument settings that affect the horizontal axis.

Center Frequency

Sets the frequency that corresponds to the horizontal center of the graticule. While adjusting the Center Frequency the Span is held constant.

The **Center Frequency** setting is the same for all measurements within a mode, that is, it is Meas Global. Some Modes are also able to share a Mode Global center frequency value. If this is the case, the Mode has a **Global** tab in its **Meas Setup** menu.

Center Frequency sets (and queries) the center frequency for the currently selected input. If your instrument has multiple inputs, and you select another input, **Center Frequency** changes to the value for that input. SCPI commands are available to directly set **Center Frequency** for a specific input.

Center Frequency is remembered as you go from input to input. Thus, you can set a **Center Frequency** of 10 GHz with the RF Input selected, change to BBIQ and set a **Center Frequency** of 20 MHz, then switch to External Mixing and set a **Center Frequency** of 60 GHz. When you go back to the RF Input, **Center Frequency** returns to 10 GHz; back to BBIQ and it is 20 MHz; back to External Mixing and it is 60 GHz.

See:

- ["RF Center Freq" on page 1230](#)
- ["Ext Mix Center Freq" on page 1231](#)
- ["I/Q Center Freq" on page 1232](#)

Remote Command	<code>[:SENSe] :FREQuency :CENTer <freq></code> <code>[:SENSe] :FREQuency :CENTer?</code>
Example	Set Center Frequency to 50 MHz: <code>:FREQ:CENT 50 MHz</code> Increment the Center Frequency by the value of CF Step: <code>:FREQ:CENT UP</code> Return the current value of Center Frequency: <code>:FREQ:CENT?</code>
Notes	Sets the RF, External Mixing or I/Q Center Frequency depending on the selected input <ul style="list-style-type: none"> - For RF input it is equivalent to <code>:FREQ:RF :CENT</code> - For I/Q input it is equivalent to <code>:FREQ:IQ :CENT</code> - For External Mixer it is equivalent to <code>:FREQ:EMIX :CENT</code> Preset and Max values depend on Hardware Options If no terminator (for example, MHz) is sent, the terminator Hz is used. If a terminator with unit other than Frequency is used, an invalid suffix error message is generated
Dependencies	Not available in the MSR, LTEAFDD, LTEATDD and 5G NR Modes
Preset	Depends on instrument maximum frequency, mode, measurement, and selected input See "Center Frequency Presets" on page 1228, "RF Center Freq" on page 1230, "Ext Mix Center Freq" on page 1231, "I/Q Center Freq" on page 1232 and "VXT Models with Radio Heads/CIU Frequency Range" on page 1230
State Saved	Saved in instrument state
Min/Max	Depends on instrument maximum frequency, mode, measurement, and selected input See "Center Frequency Presets" on page 1228, "RF Center Freq" on page 1230, "I/Q Center Freq" on page 1232 and "VXT Models with Radio Heads/CIU Frequency Range" on page 1230
Annotation	Center <value> appears in the lower left corner of the display
Status Bits/OPC dependencies	Non-overlapped

Center Frequency Presets

The following table provides the Center Frequency Presets for the Spectrum Analyzer mode, and the Max Freq, for the various frequency options:

Freq Option	CF after Mode Preset	Stop Freq after Mode Preset	Max Freq (can't tune above)
503 (all but CXA)	1.805 GHz	3.6 GHz	3.7 GHz
503 (CXA)	1.505 GHz	3.0 GHz	3.08 GHz
507 (all but CXA)	3.505 GHz	7.0 GHz	7.1 GHz

3 VMA Mode
3.8 ACP Measurement

Freq Option	CF after Mode Preset	Stop Freq after Mode Preset	Max Freq (can't tune above)
507 (CXA)	3.755 GHz	7.5 GHz	7.58 GHz
508 (all but MXE)	1.805 GHz	3.6 GHz	8.5 GHz
508 (MXE)	4.205 GHz	8.4 GHz	8.5 GHz
513	6.805 GHz	13.6 GHz	13.8 GHz
526 (except CXA and MXE)	13.255 GHz	26.5 GHz	27.0 GHz*
526 (CXA)	13.255 GHz	26.5 GHz	26.55 GHz
526 (MXE)	1.805 GHz	3.6 GHz	27.0 GHz
532	16.005 GHz	32.0 GHz	32.5 GHz
540	20.005 GHz	40.0 GHz	40.5 GHz
543	21.505 GHz	43.0 GHz	43.0 GHz
544	22.005 GHz	44.0 GHz	45.0 GHz
550	25.005 GHz	50.0 GHz	52 GHz
F03 (CXA-m)	1.505 GHz	3.0 GHz	3.08 GHz
F07 (CXA-m)	3.755 GHz	7.5 GHz	7.575 GHz
F13 (CXA-m)	6.805 GHz	13.6 GHz	13.8 GHz
F26 (CXA-m)	13.255 GHz	26.5 GHz	26.55 GHz
504 (M9421A, M8920A)	2.145 GHz	3.88GHz	3.88 GHz
506 (M9421A, M8920A)	3.245 GHz	6.08GHz	6.08 GHz
F06 (M9410A/11A)	1.0 GHz	6.08 GHz	6.08 GHz
F06 (M9415A)	1 GHz	1.08 GHz	6.6 GHz
F08 (M9415A)	1 GHz	1.08 GHz	8.6 GHz
F12 (M9415A)	1 GHz	1.08 GHz	12.9 GHz

*For option 526, the Max CF in RTSA is 26.999999995 GHz.

N9041B Center Freq Presets

Input	CF after Mode Preset	Stop Freq after Mode Preset	Max Freq (can't tune above)
Input 1, all models	25.005 GHz	50.0 GHz	52 GHz
Input 2, opt 585	42.505 GHz	85.0 GHz	86 GHz
Input 2, opt 590	45.005 GHz	90.0 GHz	92 GHz
Input 2, opt 5CX	55.005 GHz	110.0 GHz	110 GHz

Input 2, CXA and MXE

Model	CF after Mode Preset	Stop Freq after Mode Preset	Max Freq (can't tune above)
CXA opt C75	0.7505 GHz	1.5 GHz	1.58 GHz
MXE	505 MHz	1 GHz	1.000025 GHz

Tracking Generator Frequency Limits (CXA only)

Tracking Generator Option	Min Freq (clips to this freq when turn TG on and can't tune below while TG on)	If above this Freq, Stop Freq clipped to this Freq when TG turned on	Max Freq (can't tune above) while TG on
T03	9 kHz	3.0 GHz	3.08 GHz
T06	9 kHz	6.0 GHz	6.05 GHz

Tracking Generator Frequency Limits(CXA-m only)

Tracking Generator Option	Min Freq (clips to this freq when turn TG on and can't tune below while TG on)	If above this Freq, Stop Freq clipped to this Freq when TG turned on	Max Freq (can't tune above) while TG on
T03	2 MHz	3.08 GHz	3.08 GHz
T07	2 MHz	7.575 GHz	7.575 GHz
T13	2 MHz	13.8 GHz	13.8 GHz
T26	2 MHz	26.55 GHz	26.55 GHz

VXT Models with Radio Heads/CIU Frequency Range

The following table shows the Center Frequency Presets and Range for VXT modes with Radio Heads/CIU.

Products with Radio Heads/CIU	Preset	Start frequency	Stop frequency
M9421A + CIU	6 GHz	5.9 GHz	12 GHz
M9410A + CIU	6 GHz	5.9 GHz	12 GHz
M9410A + CIU + RRH	25 GHz	24.25 GHz	43.5 GHz

RF Center Freq

Specifies the RF Center Frequency. Sets the center frequency to use when the RF input is selected, even if the RF input is not the input that is selected at the time the command is sent. Note that the **Center Frequency** function in the **Frequency** menu on the front panel always applies to the currently selected input.

Remote Command `[:SENSe] :FREQuency:RF:CENTer <freq>`
 `[:SENSe] :FREQuency:RF:CENTer?`

3 VMA Mode
3.8 ACP Measurement

Example	<code>:FREQ:RF:CENT 30 MHz</code> <code>:FREQ:RF:CENT?</code>
Notes	This command is the same in all Modes, but the parameter is Measurement Global. So, the value is independent in each Mode and common across all the measurements in the Mode
Dependencies	If the electronic/soft attenuator is enabled, any attempt to set Center Frequency such that the Stop Frequency would be >3.6 GHz fails and results in an advisory message. If the equivalent SCPI command is sent, this same message is generated as part of a “-221, Settings conflict” warning
Preset	See table above
State Saved	Saved in instrument state
Min	-79.999995 MHz
Max	See " Center Frequency Presets " on page 1228 above. Basically, instrument maximum frequency - 5 Hz If the knob or step keys are being used, also depends on the value of Span

Ext Mix Center Freq

Specifies the External Mixer Center Frequency. Sets the center frequency to use when the External Mixer is selected, even if the External Mixer input is not the input which is selected at the time the command is sent. Note that the **Center Frequency** function in the **Frequency** menu on the front panel always applies to the currently selected input.

Remote Command	<code>[:SENSe] :FREQuency:EMIXer:CENTer <freq></code> <code>[:SENSe] :FREQuency:EMIXer:CENTer?</code>
Example	<code>:FREQ:EMIX:CENT 60 GHz</code> <code>:FREQ:EMIX:CENT?</code>
Notes	This command is the same in all Modes, but the parameter is Measurement Global. So, the value is independent in each Mode and common across all the measurements in the Mode
Couplings	When returning to External Mixing after having switched to one of the other inputs (for example, RF), you return to the settings that you had when you left External Mixing. So, you return to the band you were in with the Center Frequency that you had. However, Span is not an input-dependent parameter, so the instrument retains the span from the previous input, limited as necessary by the current mixer setup
Preset	When a Mode Preset is performed while in External Mixing, the start frequency of the current Mode is set to the nominal Min Freq of the lowest harmonic range in the Harmonic Table for the current mixer setup. Similarly, the stop frequency of the current Mode is set to the nominal Max Freq of the highest harmonic range in the Harmonic Table. Center Frequency thus presets to the point arithmetically equidistant from these two frequencies Note that, if the current measurement has a limited Span available to it, and cannot achieve the span shown in the table (Span = Stop Freq – Start Freq), then the instrument uses the maximum Span the measurement allows, and still sets Center Frequency to the midpoint of the start and stop freq values in the Harmonic Table

When **Restore Input/Output Defaults** is performed, the mixer presets to the 11970A, whose Start and Stop frequencies are 26.5 and 40 GHz respectively. The center of these two frequencies is 33.25 GHz. Therefore, after **Restore Input/Output Defaults**, if you go to External Mixing and do a **Mode Preset** while in Spectrum Analyzer Mode, the resulting **Center Frequency** is 33.25 GHz

State Saved	Yes
Min	The minimum frequency in the currently selected mixer band + 5 Hz If the knob or step keys are being used, also depends on Span
Max	The maximum frequency in the currently selected mixer band – 5 Hz If the knob or step keys are being used, also depends on Span

I/Q Center Freq

Specifies the I/Q Center Frequency. Sets the center frequency to use when the I/Q input is selected, even if the I/Q input is not the input which is selected at the time the command is sent. Note that the **Center Frequency** function in the **Frequency** menu on the front panel always applies to the currently selected input.

Remote Command	<code>[:SENSe] :FREQUency :IQ :CENTer <freq></code> <code>[:SENSe] :FREQUency :IQ :CENTer?</code>
Example	<code>:FREQ:IQ:CENT 30 MHz</code>
Notes	This command is the same in all Modes, but the parameter is Measurement Global. So, the value is independent in each Mode and common across all the measurements in the Mode
Preset	0 Hz
State Saved	Saved in instrument state
Min/Max	-/+40.049995 MHz

Span

Changes the displayed frequency range symmetrically about **Center Frequency**. While adjusting **Span**, **Center Frequency** is held constant, which means that both start and stop frequencies will change.

If **Span** is set to a value greater than the maximum allowable span of the instrument, an error message is generated indicating the data is out of range and was clipped to upper limit.

The default (and minimum) **Span** is calculated using the number of carriers and the carrier width where;

$$\text{Span} = (\text{Upper Carrier Freq} + (\text{max offset IBW} * (1 + \alpha)) / 2) - (\text{Lower Carrier Freq} - (\text{max offset IBW} * (1 + \alpha)) / 2)$$

Span is increased by a factor of 1 + Filter Alpha if the RRC Filter is on.

3 VMA Mode
3.8 ACP Measurement

Remote Command	<code>[:SENSe]:ACPower:FREQuency:SPAN <freq></code> <code>[:SENSe]:ACPower:FREQuency:SPAN?</code>
Example	<code>:ACP:FREQ:SPAN 10 MHz</code> <code>:ACP:FREQ:SPAN?</code>
Notes	In Bluetooth Mode, the value of Span has to be an odd MHz
Dependencies	If the electrical attenuator is enabled, any attempt to set Span such that the Stop Frequency would be >3.6 GHz results in an error In instruments with an RF Preselector, such as MXE, you cannot sweep across the band break at 3.6 GHz while the RF Preselector is on in Continuous sweep, as there is a mechanical switch that bypasses the RF Preselector above 3.6 GHz
Couplings	Span affects RBW, sweep time, FFT & Sweep choice (including FFT Width, Phase Noise Optimization and ADC Dither auto couplings) <ul style="list-style-type: none"> - Any value of Center Frequency or Span that is within the frequency range of the instrument is allowed <i>when</i> the value is being set through the front panel numeric keypad or the SCPI command. The other parameter is forced to a different value if needed, to keep the start and stop frequencies within the instrument's frequency range - When using the knob or the step up/down keys or the UP DOWN keywords in SCPI, the value that is being changed, that is, Center Frequency or Span, is limited so that the other parameter is not forced to a new value - In Bluetooth Mode, if Meas Method is FFT, the max value of Span is coupled to the MAX IFBW of the platform <p>The Span value is clipped when the carrier settings and/or the offset settings are changed. The value is changed to satisfy following formula: Span = (Upper Carrier Freq + (max offset IBW * (1 + alpha)) / 2) - (Lower Carrier Freq - (max offset IBW * (1 + alpha)) / 2)</p> <p>This parameter is unavailable when Meas Method is Fast Power. In that case, the span is fixed by the formula above</p>
Preset	Depends on instrument maximum frequency, mode, measurement, and selected input See " Span Presets " on page 1233
State Saved	Saved in instrument state
Min/Max	Depends on instrument maximum frequency, mode, measurement, and selected input. See " Span Presets " on page 1233
Annotation	Span <value> appears on the first line of the annotation in the lower right corner of display

Span Presets

The following table provides the Max Span, for the various frequency options:

Freq Option	Max Span (can't set higher than this)
503 (all but CXA)	3.7 GHz

Freq Option	Max Span (can't set higher than this)
503, F03 (CXA, CXA-m)	3.08 GHz
507 (all but CXA)	7.1 GHz
507 (CXA, CXA-m)	7.575 GHz
508 (all but MXE)	8.5 GHz
508 (MXE)	8.5 GHz
513, F13	13.8 GHz
526 (all but CXA and MXE)	27.0 GHz
526 (MXE)	27.0 GHz
526, F26 (CXA, CXA-m)	26.55 GHz
544	44.5 GHz
550	52 GHz
F06 & EP6 (VXT models M9410A/11A)	6.27 GHz
F06 & LFE & EP6 (VXT models M9411A)	6.5999935 GHz
M9415A-F06	6.27 GHz
M9415A-F08	8.27 GHz
M9415A-F12	12.57 GHz

Input 2:

Model	Max Span (can't set higher than this)
CXA opt C75	1.58 GHz
MXE	1.000025 GHz

Note that if you are in External Mixing, the maximum Span will be equal to the Maximum Stop Frequency – Minimum Start Frequency for the currently selected mixer.

Span Presets by Mode

Mode	Preset Value
SA	8 MHz
WCDMA	24.6848 MHz
LTE, LTETDD, LTEAFDD, LTEATDD, MSR	25 MHz
5G NR	500 MHz
Radio Test	175 kHz

CF Step

Changes the step size for the center frequency and start and stop frequency functions. Once a step size has been selected and the center frequency function is active, the step keys (and the **UP | DOWN** parameters for **Center Frequency** from remote commands) change the center frequency by the step-size value. The step size function is useful for finding harmonics and sidebands beyond the current frequency span of the instrument.

Note that the start and stop frequencies also step by the **CF Step** value.

Remote Command	<code>[:SENSe]:FREQuency:CENTer:STEP[:INCRement] <freq></code> <code>[:SENSe]:FREQuency:CENTer:STEP[:INCRement]?</code>
Example	Increase the current center frequency value by 500 MHz: <code>:FREQ:CENT:STEP 500 MHz</code> <code>:FREQ:CENT UP</code>
Notes	Preset and Max values depend on Hardware Options
Dependencies	If the electronic/soft attenuator is enabled, any attempt to change the value of the center frequency >3.6 GHz by pressing the Up-arrow key, fails and results in an advisory message. If the equivalent SCPI command is sent, this same message is generated as part of a “-221, Settings conflict” warning Not available in MSR, LTEAFDD, LTEATDD and 5G NR Modes
Couplings	When auto-coupled, the center frequency step size is set to 10% of the span
Preset	Auto
State Saved	Saved in instrument state
Min/Max	- /+(the maximum frequency of the instrument). That is, 27 GHz max freq instrument has a CF step range of +/- 27 GHz. Note that this is the maximum frequency given the current settings of the instrument, so in External Mixing, for example, it is the maximum frequency of the current mixer band
Status Bits/OPC dependencies	non-overlapped

Auto Function

Remote Command	<code>[:SENSe]:FREQuency:CENTer:STEP:AUTO OFF ON 0 1</code> <code>[:SENSe]:FREQuency:CENTer:STEP:AUTO?</code>
Example	<code>:FREQ:CENT:STEP:AUTO ON</code> <code>:FREQ:CENT:STEP:AUTO?</code>
Preset	ON

3.8.12 Marker

Accesses a menu that enables you to select, set up and control the markers for the current measurement. If there are no active markers, **Marker** selects marker 1, sets it to **POSition** (Normal) and places it at the center of the display. If the selected marker is **OFF**, it is set to **POSition** and placed at the center of the screen on the trace determined by the **Marker Trace** rules.

Note that this hard key and all sub keys are unavailable when "Meas Method" on page 1246 is RBW.

3.8.12.1 Select Marker

Specifies the selected marker. The term "selected marker" is used throughout this document to specify which marker will be affected when you change marker settings, perform a Peak Search, etc.

The **Select Marker** control appears above the menu panel, indicating that it applies to all controls in the **Marker** menu panels. **Select Marker** is blanked if you select a tab whose controls do *not* depend on the selected marker (for example, **Counter**).

On any menu tab in which **Select Marker** appears, the first control is always **Marker Frequency | Time**.

Notes	The selected marker is remembered even when not in the Marker menu and is used if a Search is done or a Band Function is turned on or for Signal Track or Continuous Peak
Preset	Marker 1
State Saved	The number of the selected marker is saved in instrument state
Annunciation	Appears in the marker results block label for Normal , Delta and Fixed markers

3.8.12.2 Settings

The controls on this tab include the **Marker** active function and a radio button selection of the marker control mode (**POSition**, **DELTA**, or **OFF**) for the selected marker, as well as additional functions that help you use markers.

Marker Frequency

Sets the marker X-Axis value in the current marker X-Axis Scale unit. Has no effect if the control mode is **OFF**, but is the SCPI equivalent of entering an X value if the control mode is **POSition** or **DELTA**.

Remote Command `:CALCulate:ACPower:MARKer[1]|2|...|12:X <freq>`

	<code>:CALCulate:ACPower:MARKer[1] 2 ... 12:X?</code>
Example	<code>:CALC:ACP:MARK3:X 0</code> <code>:CALC:ACP:MARK3:X?</code>
Notes	If no suffix is sent, uses the fundamental units for the current marker X-Axis Scale. If a suffix is sent that does not match the current marker X-Axis Scale unit, an error "Invalid suffix" is generated The query returns the marker's absolute X Axis value if the control mode is POSition , or the offset from the marker's reference marker if the control mode is DELTA . The query is returned in the fundamental units for the current marker X-Axis scale: Hz for Frequency and Inverse Time , seconds for Period and Time
Dependencies	Unavailable when " Meas Method " on page 1246 is RBW
Preset	After a preset, all markers are turned OFF , so the query returns Not A Number (NAN)
State Saved	Saved in instrument state
Min/Max	-/+9.9E+37
Annotation	Mkr # <X value> and <Marker value> upper right on graph

Marker X Axis Position (Remote Command Only)

Sets the marker X-Axis Scale position in trace points. This setting has no effect if the control mode is **OFF**, but is the SCPI equivalent of entering a value if the control mode is **POSition** or **DELTA**, except in trace points rather than X-Axis Scale units. The entered value is immediately translated into the current X-Axis Scale units for setting the value of the marker.

Remote Command	<code>:CALCulate:ACPower:MARKer[1] 2 ... 12:X:POSition <real></code> <code>:CALCulate:ACPower:MARKer[1] 2 ... 12:X:POSition?</code>
Example	<code>:CALC:ACP:MARK10:X:POS 0</code> <code>:CALC:ACP:MARK10:X:POS?</code>
Notes	The query returns the marker's absolute X-Axis value in trace points if the control mode is POSition , or the offset from the marker's reference marker in trace points if the control mode is DELTA . The value is returned as a real number, not an integer, corresponding to the translation from X-Axis Scale units to trace points. When a Marker is turned on, it is placed center of the screen on the trace. Therefore, the default value depends on instrument condition. If the marker is OFF , the response is Not A Number
Dependencies	Unavailable when Meas Method is RBW
Preset	After a preset, all markers are turned OFF , so the query returns Not A Number (NAN)
State Saved	Saved in instrument state
Min	-9.9E+37
Max	9.9E+37

Marker Y Axis Value (Remote Query only)

Returns the marker Y-Axis value in the current marker Y-Axis unit.

Remote Command	<code>:CALCulate:ACPower:MARKer[1] 2 ... 12:Y?</code>
Example	<code>:CALC:ACP:MARK11:Y?</code>
Notes	Returns the marker Y-axis result, if the control mode is POSition or DELTA . If the marker is OFF , the response is Not A Number
Dependencies	Unavailable when " Meas Method " on page 1246 is RBW
Preset	Depends on Markers setup and signal source
State Saved	No
Backwards Compatibility SCPI	<code>:CALCulate:ACPower:MARKer[1] 2 ... 12:FUNCTION:RESult?</code>

Marker Mode

Sets the marker control mode to **POSition** (Normal), **DELTA**, or **OFF**. All interactions and dependencies detailed under the control description are enforced when the remote command is sent. If the selected marker is **OFF**, pressing **Marker** sets it to **POSition**, and places it at the center of the screen on the trace determined by the **Marker Trace** rules. At the same time, **Marker X Axis Value** appears on the Active Function area.

The default active function is the active function for the currently selected marker control mode. If the current control mode is **OFF**, there is no active function, and the active function is turned off.

Remote Command	<code>:CALCulate:ACPower:MARKer[1] 2 ... 12:MODE POSition DELTA OFF</code> <code>:CALCulate:ACPower:MARKer[1] 2 ... 12:MODE?</code>
Example	<code>:CALC:ACP:MARK3:MODE POS</code> <code>:CALC:ACP:MARK3:MODE?</code>
Dependencies	Unavailable when Meas Method is RBW
Preset	OFF
State Saved	Saved in instrument state
Range	POSition DELTA OFF
Annotation	Mkr # <X value> and <Marker value> upper right on graph

Backwards Compatibility SCPI Commands

Sets or queries the state of a marker. Setting a marker that is **OFF** to **ON** (1) puts it in **POSition** mode and places it at the center of the screen.

Example	<code>:CALC:ACP:MARK2:STAT ON</code> <code>:CALC:ACP:MARK2:STAT?</code>
---------	--

Preset	OFF
State Saved	Saved in instrument state
Range	OFF ON
Backwards Compatibility SCPI	:CALCulate:ACPower:MARKer[1] 2 ... 12:STATE OFF ON 0 1 :CALCulate:ACPower:MARKer[1] 2 ... 12:STATE?

Delta Marker (Reset Delta)

Pressing this button has exactly the same effect as pressing **DELTA** in **Marker Mode**. The selected marker becomes a **Delta** marker. If the selected marker is already a **Delta** marker, the reference marker is moved to the current position of the selected marker, thus resetting the delta to zero.

Marker Settings Diagram

Lets you configure the **Marker** system using a visual utility.

All Markers Off

Turns off all markers.

Remote Command	:CALCulate:ACPower:MARKer:AOFF
Example	:CALC:ACP:MARK:AOFF
Dependencies	Unavailable when " Meas Method " on page 1246 is RBW

Couple Markers

When this function is **ON**, moving any marker causes an equal X-Axis movement of every other marker that is not **OFF**. By “equal X-Axis movement” we mean that we preserve the difference between each marker’s X-Axis value (in the fundamental X-Axis units of the trace that marker is on), and the X-Axis value of the marker being moved (in the same fundamental X-Axis units).

This may result in markers going off screen.

Remote Command	:CALCulate:ACPower:MARKer:COUPle[:STATE] ON OFF 1 0 :CALCulate:ACPower:MARKer:COUPle[:STATE]?
Example	:CALC:ACP:MARK:COUP ON :CALC:ACP:MARK:COUP?
Dependencies	Unavailable when " Meas Method " on page 1246 is RBW

Preset	OFF Presets on Mode Preset and All Markers Off
State Saved	Saved in instrument state

3.8.12.3 Peak Search

The controls on this tab allow you to move the marker to selected peaks of the signal, giving you enormous analysis capabilities, particularly when combined with the Delta Marker function.

NOTE

Pressing the **Peak Search** hardkey automatically moves you to the **Peak Search** page of the **Marker** menu *and* performs a **Peak Search**.
Pressing the **Peak Search** tab once you are already *in* the **Marker** menu does *not* perform a **Peak Search**.

Marker Frequency

This is the fundamental control that you use to move a marker around on the trace. It is the same as "**Marker Frequency**" on page 1236 on the **Settings** tab.

Peak Search

Pressing the **Peak Search** control moves the selected marker to the trace point which has the maximum Y-Axis value for that marker's trace.

NOTE

Pressing the **Peak Search** hardkey automatically moves you to the **Peak Search** page of the **Marker** menu *and* performs a peak search.

Remote Command	:CALCulate:ACPower:MARKer[1] 2 ... 12:MAXimum
Example	:CALC:ACP:MARK2:MAX :SYST:ERR? can be used to query the errors to determine if a peak is found. The message "No peak found" will be returned after an unsuccessful search
Notes	Sending this command selects the subopcoded marker

Next Peak

Moves the selected marker to the peak that is next lower in amplitude than the current marker value.

If the selected marker was **OFF**, then it is turned on as a normal marker and a peak search is performed.

Remote Command	:CALCulate:ACPower:MARKer[1] 2 ... 12:MAXimum:NEXT
Example	:CALC:ACP:MARK2:MAX:NEXT
Notes	Sending this command selects the subopcoded marker
State Saved	Not part of saved state

Next Pk Right

Moves the selected marker to the nearest peak right of the current marker.

If the selected marker was **OFF**, then it is turned on as a normal marker and a peak search is performed.

Remote Command	:CALCulate:ACPower:MARKer[1] 2 ... 12:MAXimum:RIGHT
Example	:CALC:ACP:MARK2:MAX:RIGH
Notes	Sending this command selects the subopcoded marker
State Saved	Not part of saved state

Next Pk Left

Moves the selected marker to the nearest peak left of the current marker.

If the selected marker was **OFF**, then it is turned on as a normal marker and a peak search is performed.

Remote Command	:CALCulate:ACPower:MARKer[1] 2 ... 12:MAXimum:LEFT
Example	:CALC:ACP:MARK2:MAX:LEFT
State Saved	Not part of saved state

Minimum Peak

Moves the selected marker to the minimum Y-Axis value on the current trace.

If the selected marker is **OFF**, it is turned on before the minimum search is performed.

Remote Command	:CALCulate:ACPower:MARKer[1] 2 ... 12:MINimum
Example	:CALC:ACP:MARK:MIN
Notes	Sending this command selects the subopcoded marker
State Saved	Not part of saved state

Pk-Pk Search

Finds and displays the amplitude and frequency (or time, if in zero span) differences between the highest and lowest Y-Axis value. It places the selected marker on the minimum value on its selected trace, and places that marker's reference marker on the peak of its selected trace.

This function turns on the reference marker and sets its mode to **POSition** if it is not already on. (These markers may be on two different traces.)

If the selected marker is **OFF**, a delta type marker is turned on and the peak-to-peak search is done. If the selected marker is on, but it is not a delta marker, then it is changed to delta, which turns on the reference marker if needed, and then it performs the peak-to-peak function.

Remote Command	:CALCulate:ACPower:MARKer[1] 2 ... 12:PTPeak
Example	:CALC:ACP:MARK:PTP
Notes	Turns on the Marker D active function Sending this command selects the subopcoded marker
Dependencies	Pk-Pk Search is not available when Coupled Markers is on
Couplings	The selected marker becomes a delta marker if not already in delta mode
State Saved	Not part of saved state

Marker Delta

Pressing this button has exactly the same effect as pressing **DELTA** in **Marker Mode** on the **Settings** tab. The selected marker becomes a **Delta** marker. If the selected marker is already a **Delta** marker, the reference marker is moved to the current position of the selected marker, thus resetting the delta to zero.

The control is duplicated here to allow you to conveniently perform a peak search and change the marker's control mode to **Delta** without having to access two separate menus.

3.8.12.4 Properties

The controls on this tab are used to set certain properties of the selected marker.

Marker Frequency

This is the fundamental control that you use to move a marker around on the trace. It is the same as ["Marker Frequency" on page 1236](#) on the **Settings** tab.

Relative To

Selects the marker to which the selected marker is relative (its reference marker).

Every marker has another marker to which it is relative. This marker is referred to as the “reference marker” for that marker. This attribute is set by the **Marker, Properties, Relative To** key. The marker must be a **Delta** marker to make this attribute relevant. If it is a **Delta** marker, the reference marker determines how the marker is controlled and how its value is displayed. A marker cannot be relative to itself.

Remote Command	<code>:CALCulate:ACPower:MARKer[1] 2 ... 12:REference <integer></code> <code>:CALCulate:ACPower:MARKer[1] 2 ... 12:REference?</code>
Example	<code>:CALC:ACP:MARK2:REF 6</code> <code>:CALC:ACP:MARK2:REF?</code>
Notes	Causes the marker specified with the subopcode to become selected Range (for SCPI command): 1 to 12. If the range is exceeded the value is clipped A marker cannot be relative to itself so that choice is not available, and if sent from SCPI generates error -221: “Settings conflict; marker cannot be relative to itself” When queried a single value is returned (the specified marker numbers relative marker)
Dependencies	Unavailable when "Meas Method" on page 1246 is RBW
Couplings	If the reference marker is OFF , it is turned on in POSition mode at the delta marker location
Preset	The preset default “Relative To” marker (reference marker) is the next higher numbered marker (current marker +1). For example, if marker 2 is selected, then its default reference marker is marker 3. The exception is marker 12, which has a default reference of marker 1 Set to the defaults by using Restore Mode Defaults . This is not reset by Marker Off , All Markers Off , or Preset
State Saved	Saved in instrument state. Not affected by Marker Off and hence not affected by Preset or power cycle
Min	1
Max	12
Annunciation	Appears in the marker label of a Delta marker

Marker Trace

Selects the trace on which you want your marker placed. A marker is associated with one and only one trace. This trace is used to determine the placement, result, and X-

Axis Scale of the marker. All markers have an associated trace; it is from that trace that they determine their attributes and behaviors, and it is to that trace that they go when they become Normal markers.

Specifying a **Marker Trace** manually or with this command associates the marker with the specified trace. If the marker is not **OFF**, it moves the marker from the trace it was on to the new trace. If the marker is **OFF**, it stays off but is now associated with the specified trace.

The query returns the number of the trace on which the marker is currently placed.

Remote Command	<code>:CALCulate:ACPower:MARKer[1] 2 ... 12:TRACe 1 2 3</code> <code>:CALCulate:ACPower:MARKer[1] 2 ... 12:TRACe?</code>
Example	<code>:CALC:ACP:MARK2:TRAC 2</code> <code>:CALC:ACP:MARK2:TRAC?</code>
Notes	A marker may be placed on a blanked and/or inactive trace, even though the trace is not visible and/or updating An application may register a trace name to be displayed on the control instead of a trace number
Couplings	The state of Marker Trace is not affected by " Auto Couple " on page 1825 Sending the remote command causes the addressed marker to become selected
Preset	1
State Saved	Saved in instrument state
Min	1
Max	3

Marker Settings Diagram

Lets you configure the **Marker** system using a visual utility. It is the same as "[Marker Settings Diagram](#)" on page 1239 on the **Settings** tab.

3.8.13 Meas Setup

Contains functions for setting up the measurement parameters, and for setting up parameters global to all measurements in the Mode.

3.8.13.1 Settings

Contains frequently-used functions to which you will want the fastest access.

Avg | Hold Number

Specifies the number of measurement averages used to calculate the measurement result. The average will be displayed at the end of each sweep. After the specified number of average counts, the average mode (termination control) setting determines the average action.

Remote Command	<code>[:SENSe] :ACPower :AVERage :COUNT <integer></code> <code>[:SENSe] :ACPower :AVERage :COUNT?</code>
Example	<code>:ACP :AVER :COUN 250</code> <code>:ACP :AVER :COUN?</code>
Notes	The BAF backwards Compatibility SCPI command, <code>[:SENSe] :ACPR :AVERage [:STATe]</code> , is provided to support same functionality as <code>[:SENSe] :ACPr :AVERage [:STATe]</code> (PSA W-CDMA, PSA cdma2000 and PSA 1xEVDO) due to ACPr node conflicts with ACPower node
Preset	10
State Saved	Saved in instrument state
Min/Max	1/1000
Annotation	Avg Number is displayed in the Measurement Bar
Backwards Compatibility SCPI	<code>[:SENSe] :ACPR :AVERage :COUNT</code> <code>[:SENSe] :MCPower :AVERage :COUNT</code> Power Suite, W-CDMA

Averaging On/Off

Turns averaging on or off.

NOTE

In this measurement, the **Average Type** is preset to the **Log-Pwr Avg (Video)** method. Other averaging methods are not available.

Remote Command	<code>[:SENSe] :ACPower :AVERage [:STATe] OFF ON 0 1</code> <code>[:SENSe] :ACPower :AVERage [:STATe]?</code>
Example	<code>:ACP :AVER OFF</code> <code>:ACP :AVER?</code>
Preset	ON
State Saved	Yes
Range	OFF ON
Backwards Compatibility SCPI	<code>[:SENSe] :ACPR :AVERage [:STATe]</code> <code>[:SENSe] :MCPower :AVERage [:STATe]</code> Power Suite, W-CDMA

Avg Mode

Sets the Averaging Mode. This determines the averaging action after the specified number of data acquisitions (average count) is reached.

- When set to **EXponential**, the measurement averaging continues using the specified number of averages to compute each averaged value. The average will be displayed at the end of each sweep
- When set to **REPeat**, the measurement resets the average counter each time the specified number of averages is reached

Remote Command	<code>[:SENSe]:ACPower:AVERage:TCONtrol EXPonential REPeat</code> <code>[:SENSe]:ACPower:AVERage:TCONtrol?</code>
Example	<code>:ACP:AVER:TCON EXP</code> <code>:ACP:AVER:TCON?</code>
Notes	The backwards-compatibility SCPI command, <code>[:SENSe]:ACPR:AVERage:TCONtrol</code> , is provided to support same functionality as <code>[:SENSe]:ACPr:AVERage:TCONtrol</code> (PSA W-CDMA, PSA cdma2000 and PSA 1xEVDO) due to <code>ACPr</code> node conflicts with <code>ACPower</code> node
Preset	EXponential
State Saved	Saved in instrument state
Range	EXponential REPeat
Backwards Compatibility SCPI	<code>[:SENSe]:ACPR:AVERage:TCONtrol</code> Power Suite, W-CDMA: <code>[:SENSe]:MCPower:AVERage:TCONtrol</code>

Meas Method

Sets the desired method to measure ACP. The options are:

Integration BW IBW	One sweep of the trace is taken, and the band power for each offset is computed. Depending on " Measurement Type " on page 1330 (Total Power Reference or PSD Reference), results are displayed relative to the total power or the power spectral density. The display reflects either the current trace or a bar graph view
Filtered IBW IBWRange (max dynamic range)	The ACP Path is used to compute ACP when an ACP path is available. This method increases dynamic range, but increases measurement time as it limits the resolution bandwidth. This method is useful for improving dynamic range on a W-CDMA signal because a sharp cutoff bandpass filter is used. The accuracy of the adjacent channel power ratio is not degraded by this method, but the absolute accuracy of both adjacent channel power and carrier power are degraded by up to about 0.5 dB
RBW RBW	The algorithm uses zero-span and an appropriate RBW setting to capture all of the power in the carrier channel and the offsets. The zero-span algorithm (RBW method) is slower than the IBW method, but greatly improves repeatability
Fast	WCDMA Mode or SA Mode with 3GPP WCDMA radio standard selected:

3 VMA Mode
3.8 ACP Measurement

FAST Provides the same method as the Integration BW method, but is optimized for speed to measure a W-CDMA signal

SA Mode with CDMA2K radio standard selected:

Provides faster measurement using the FFT method with a limited parameter flexibility. When this is selected, CDMA2K preset offsets are given and control of the following are unavailable:

- BW menu
- Sweep/Control menu except Pause/Resume
- Trace/Detector menu
- Carrier Setup, Offset Limit, RRC Weighting, Filter Alpha, and Noise Correction in Meas Setup menu

Fast Power
FPOWer

(Option FP2 required)

This provides faster measurement using the Hardware accelerated FFT method with a limited parameter flexibility. When this is selected, the following parameters are not available:

- Points and Auto Sweep Points under Sweep
 - When changing Meas Method to Fast Power, Auto Sweep Points is turned on and grayed-out (Sweep Points will change according to the Fast Power setting)
 - When returning Meas Method to any setting other than Fast Power, Auto Sweep Points stays on and becomes available (Sweep Points will change according to the auto sweep points calculation algorithm)
- Trace Type, Restart Averaging and View/Blank under Trace when Select Trace is Trace 2 or Trace3
- Span under Frequency
- Res BW, Video BW, Filter Type and Filter BW of Offset > Advanced dialog of Carr/Offset/Limits Config control under Meas Setup
- For Trigger, only Free Run, External 1 and External 2 are supported

When in microwave frequency and measurement span is > 40MHz, RF preselector must be turned off

Remote Command	<code>[:SENSe] :ACPower :METHod IBW IBWRange FAST RBW FPOWer</code> <code>[:SENSe] :ACPower :METHod ?</code>
Example	<code>:ACP :METH IBW</code> <code>:ACP :METH ?</code>
Notes	FAST mode is only supported for WCDMA and C2K signals. You must be in WCDMA or SA Modes, with 3GPP WCDMA or CDMA2K radio standard. Otherwise, a setting conflict error message is reported MSR, LTEAFDD, LTEATDD and 5G NR Modes support only Integration BW, Filtered IBW and Fast Power methods
Dependencies	When RBW , FAST or FPOWer is selected, Gate function is not available. If you try to turn GateON while Meas Method is RBW , FAST or FPOWer , an error is generated When Gate function is ON , RBW , FAST and FPOWer are not available. If you try to change Meas Method to RBW , FAST or FPOWer , an error is generated VXT Models M9420A/10A/11A support only the Integration BW method

Couplings	IBW (Range) restricts the Res BW available for making this measurement to 30 kHz. When selected, Res BW is clipped to this value if required and an error number displayed
Preset	IBW
State Saved	Saved in instrument state
Range	IBW IBWRange FAST RBW FPOwer
Backwards	[:SENSe]:ACPR:SWEEp:TYPE
Compatibility SCPI	(Power Suite, WCDMA) [:SENSe]:MCPower:METHOD

Carrier/Offset/Limits Config

Opens a dialog that lets you set Carriers, Offset, and Limits parameters.

Carrier

Lets you configure your carriers, carrier spacing, noise bandwidth and measurement method.

Dependencies	Appears in all Modes except MSR, LTEAFDD, LTEATDD and 5G NR
--------------	---

Number of Carriers

This is the same as "[Number of Carriers](#)" on page 1289 under Reference.

Couple to #1

Couples carrier settings to carrier #1. The coupled parameters are:

- "[Carrier Pwr Present](#)" on page 1291
- "[Carrier Spacing](#)" on page 1292
- "[Measurement Noise Bandwidth](#)" on page 1292
- "[Method for Carrier](#)" on page 1293
- "[Filter Alpha for Carrier](#)" on page 1294

Remote Command	[:SENSe]:ACPower:CARRier[1] 2:LIST:COUPle OFF ON 0 1, ... [:SENSe]:ACPower:CARRier[1] 2:LIST:COUPle? Subopcode: 1 = BTS/Downlink (Default), 2 = MS/Uplink
Example	:ACP:CARR:LIST:COUP OFF

:ACP:CARR:LIST:COUP?	
Notes	Some modes do not support Carrier subopcode 2. In those cases, commands with subopcode 2 are accepted without error but ignored For LTEAFDD or LTEATDD Modes, this control is not shown. In order to maintain backwards compatibility with legacy LTE FDD/TDD, the SCPI command is supported in LTE & LTE-A converged applications
Couplings	When ON , the carrier settings are coupled to carrier #1. Coupled parameters are: Carrier Power Present, Carrier Spacing, Measurement Noise Bandwidth, Method and Filter Alpha When a setting is changed, coupling is switched off automatically Carrier #1 is always set to ON and cannot be changed
Preset	ON
State Saved	Saved in instrument state

Carrier Pwr Present

Configures the carriers for this measurement. Allows spaces to be inserted between carriers. Carriers with the power present parameter set to **YES** are carriers, and those with the power present parameter set to **NO** are spaces. Each carrier power present is set to **YES** or **NO**. The individual carrier can be set by selecting the desired carrier.

The query returns the current values for all of the carriers. If a carrier is defined as having no power present, the power displayed is relative to the reference carrier, otherwise the absolute power is displayed.

If you change the carrier power present to **NO**, and that carrier is currently configured as the reference carrier, the next carrier to the left (or the right if there are no carriers to the left) is assigned as the reference carrier. This also applies to the scenario where there are only two carriers configured as having power present, and you configure only one carrier to have no power present.

Remote Command	[:SENSe]:ACPower:CARRier[1] 2:LIST:PPresent YES NO, ... [:SENSe]:ACPower:CARRier[1] 2:LIST:PPresent? Subopcode: 1 = BTS/Downlink (Default), 2 = MS/Uplink
Example	:ACP:CARR2:LIST:PPR YES :ACP:CARR2:LIST:PPR?
Notes	Some Modes do not support Carrier subopcode 2. In those cases, commands with subopcode 2 are accepted without error but ignored When setting these values remotely, the position in the list sent corresponds to the carrier. Missing values are not permitted, so if you want to change values 2 and 6, you must send all values up to 6. Subsequent values remain unchanged, unless the number of values sent is greater than the number of carriers, then subsequent values are ignored For LTEAFDD or LTEATDD Modes, this control is not shown. To maintain backwards compatibility with

	legacy LTE FDD/TDD Modes, the SCPI command is supported in the LTE & LTE-A converged applications
Couplings	Coupled to number of carriers. When the SCPI command is sent, the number of carriers is set to the number of entries in the parameter list
Preset	YES
State Saved	Saved in instrument state
Backwards Compatibility SCPI	<code>[:SENSe] :MCPower :CARRier [1] 2 :LIST :PPResent</code>

Carrier Spacing

Sets the width of the carrier spacing. This is the value applied to all the current slots, whether they are carriers or spaces.

Enter each carrier spacing value individually by selecting the desired carrier, and then enter the carrier width.

Remote Command	<code>[:SENSe] :ACPpower :CARRier [1] 2 :LIST :WIDTh <freq>, ...</code> <code>[:SENSe] :ACPpower :CARRier [1] 2 :LIST :WIDTh?</code> Subopcode: 1 = BTS/Downlink (Default), 2 = MS/Uplink
Example	<code>:ACP :CARR2 :LIST :WIDTh 25kHz</code> <code>:ACP :CARR2 :LIST :WIDTh?</code>
Notes	Some Modes do not support Carrier subopcode 2. In those cases, commands with subopcode 2 are accepted without error but ignored When setting these values remotely, the position in the list sent corresponds to the carrier. Missing values are not permitted, so if you want to change values 2 and 6, you must send all values up to 6. Subsequent values remain unchanged, unless the number of values sent is greater than the number of carriers, then subsequent values are ignored For LTEAFDD or LTEATDD Modes, this control is not shown. To maintain backwards compatibility with legacy LTE FDD/TDD Modes, the SCPI command is supported in the LTE & LTE-A converged applications
Couplings	Coupled to number of carriers. When the SCPI command is sent, the number of carriers is set to the number of entries in the parameter list Changing Carrier Spacing might affect "Span" on page 1232
Preset	SA, WCDMA, LTE, LTE-TDD Modes 5 MHz Radio Test Mode 25 kHz
State Saved	Saved in instrument state
Min/Max	0 Hz/Depends on instrument maximum frequency. Same as the Max Span of Swept SA Measurement

Backwards Compatibility SCPI `[:SENSe]:MCPower:CARRier[1] | 2:LIST:WIDTH`

Measurement Noise Bandwidth

Specifies the **Measurement Noise Bandwidth** used to calculate the power in the carriers.

Each **Measurement Noise Bandwidth** value is entered individually by selecting the desired carrier. Enter the measurement noise bandwidth on the **Carrier** page of the **Carr/Offset/Limits Config** dialog.

Remote Command `[:SENSe]:ACPpower:CARRier[1] | 2:LIST:BANDwidth[:INTEgration] <freq>, ...`
`[:SENSe]:ACPpower:CARRier[1] | 2:LIST:BANDwidth[:INTEgration]?`
 Subopcode: 1 = BTS/Downlink (Default), 2 = MS/Uplink

Example `:ACP:CARR2:LIST:BAND 25kHz`
`:ACP:CARR2:LIST:BAND?`

Notes
 In WCDMA Mode, the preset/default value is defined as 3.84 MHz, but internally, 4.6848 MHz is used as the default value
 Some Modes do not support Carrier subopcode 2. In those cases, commands with subopcode 2 are accepted without error but ignored
 When setting these values remotely, the position in the list sent corresponds to the carrier. Missing values are not permitted, so if you want to change values 2 and 6, you must send all values up to 6. Subsequent values remain unchanged, unless the number of values sent is greater than the number of carriers, then subsequent values are ignored
 For LTEAFDD or LTEATDD Modes, this control is not shown. In order to maintain backwards compatibility with legacy LTE FDD/TDD Modes, the SCPI command is supported in the LTE & LTE-A converged applications

Couplings Coupled to number of carriers. When the SCPI command is sent, the number of carriers is set to the number of entries in the parameter list

Preset	Modes	Value
	SA	2 MHz
	WCDMA	3.84 MHz
	LTE, LTE-TDD	4.515 MHz 4.5 MHz
	Radio Test	25 kHz

State Saved Saved in instrument state

Min/Max 10 Hz/Depends on instrument maximum frequency. Same as Max Span of the Swept SA Measurement

Backwards Compatibility `[:SENSe]:ACPpower:BANDwidth:INTEgration`
`[:SENSe]:ACPpower:BWIDth:INTEgration`

SCPI `[:SENSe]:ACPower:CARRier[1]|2:LIST:BWIDth[:INTEgration]`
`[:SENSe]:MCPower:CARRier[1]|2:LIST:BANDwidth[:INTEgration]`
`[:SENSe]:MCPower:CARRier[1]|2:LIST:BWIDth[:INTEgration]`

Method for Carrier

Accesses the carrier configuration method settings.

Remote Command `[:SENSe]:ACPower:CARRier[1]|2:LIST:FILTer[:RRC][:STATe] ON | OFF | 1 | 0, ...`
`[:SENSe]:ACPower:CARRier[1]|2:LIST:FILTer[:RRC][:STATe]?`

Subopcode: 1 = BTS/Downlink (Default), 2 = MS/Uplink

Example `:ACP:CARR:LIST:FILT 0,0,0,0`
`:ACP:CARR:LIST:FILT?`

Notes The binary values translate as follows:

<code>1 ON</code>	RRC Weighted
<code>0 OFF</code>	Integ BW

Maximum of Array length depends on the number of carriers

Some Modes do not support Carrier subopcode 2. In those cases, commands with subopcode 2 are accepted without error but ignored

For LTEAFDD or LTEATDD Modes, this control is not shown. In order to maintain backwards compatibility with legacy LTE FDD/TDD Modes, the SCPI command is supported in the LTE & LTE-A converged applications

Presets	Modes	Value
	SA, LTE, LTE-TDD	OFF
	WCDMA	ON
	Radio Test	OFF

State Saved Saved in instrument state

Range Integration BW | RRC Weighted

Filter Alpha for Carrier

Inputs the alpha value for the filter used in the current carrier configuration.

Remote Command `[:SENSe]:ACPower:CARRier[1]|2:LIST:FILTer:ALPHA <real>, ...`
`[:SENSe]:ACPower:CARRier[1]|2:LIST:FILTer:ALPHA?`

Subopcode: 1 = BTS/Downlink (Default), 2 = MS/Uplink

Example	<code>:ACP:CARR2:LIST:FILT:ALPH 0.5</code> <code>:ACP:CARR2:LIST:FILT:ALPH?</code>
Notes	Some Modes do not support Carrier subopcode 2. In those cases, commands with subopcode 2 are accepted without error but ignored For LTEAFDD or LTEATDD Modes, this control is not shown. In order to maintain backwards compatibility with legacy LTE FDD/TDD Modes, the SCPI command is supported in the LTE & LTE-A converged applications
Preset	0.22
State Saved	Saved in instrument state
Min/Max	0.01/1.0

Offset

Lets you configure the spacing of the offset regions.

Offset Frequency Define

Lets you select offset frequency definition. Each standard defines each offset frequency from Carrier.

For example, 3GPP2 requires the “From Carrier Center to Integ BW Closer Edge” definition. LTE conformance test requires “From Carrier Edge to Integ BW Center” and/or “From Carrier Edge to Integ BW Closer Edge” definition.

CTOCenter	From the lowermost carrier center frequency (for lower offset), the uppermost carrier center frequency (for upper offset) to the center frequency of each Offset Integ BW
CTOEdge	From the lowermost carrier center frequency (for lower offset), the uppermost carrier center frequency (for upper offset) to the closest edge frequency of each Offset Integ BW
ETOCenter	From the lowermost carrier center frequency - spacing of this carrier /2 (for lower offset), the uppermost carrier center frequency + spacing of this carrier /2 (for upper offset) to the center frequency of each Offset Integ BW
ETOEdge	From the lowermost carrier center frequency - spacing of this carrier /2 (for lower offset), the uppermost carrier center frequency + spacing of this carrier /2 (for upper offset) to the closest edge of each Offset Integ BW
RTOCenter 5G NR Mode only	From either the lower or upper RF BW** edge frequency to the center frequency of each Offset Integ BW
RTOEdge 5G NR Mode only	From either the lower or upper RF BW** edge frequency to the closest edge frequency of each Offset Integ BW
RCTOCenter 5G NR Mode only	From the center frequency of RF BW** to the center frequency of each Offset Integ BW
SCTOCenter 5G NR Mode only	From the center frequency of sub-block** to the center frequency of each Offset Integ BW

** RF BW = $BW_{channel,CA}$ which is defined in each 3GPP standard, regardless of “Measure Carrier” for the uppermost and the lowermost carriers being Enabled or Disabled. When the Number of Component Carrier = 1, RF BW = $BW_{channel} = 2 \times F_{offset,RAT}$

** sub-block (bandwidth) = $BW_{channel,block}$ which is defined in each 3GPP standard, regardless of “Measure Carrier” for the uppermost and the lowermost carriers being Enabled or Disabled. When the Number of Component Carrier within each sub-block = 1, sub-block (bandwidth) = $BW_{channel} = 2 \times F_{offset,RAT}$.

See "Diagrams for Offset Freq Define" on page 1255.

Modes other than MSR, LTEAFDD, LTEATDD, 5G NR

Remote Command	<code>[:SENSe]:ACPower:OFFSet[1] 2[:OUTer]:TYPE CTOCenter CTOEdge ETOCenter ETOEdge</code> <code>[:SENSe]:ACPower:OFFSet[1] 2[:OUTer]:TYPE?</code> Subopcode: 1 = BTS/Downlink (Default), 2 = MS/Uplink
Example	<code>:ACP:OFFS:TYPE ETOC</code> <code>:ACP:OFFS:TYPE?</code>
Notes	Some Modes do not support Offset subopcode 2. In those cases, commands with subopcode 2 are accepted without error but ignored
Preset	<code>CTOCenter</code>
State Saved	Saved in instrument state
Range	<code>CTOCenter CTOEdge ETOCenter ETOEdge</code>

Mode: MSR, LTEAFDD, LTEATDD

Remote Command	<code>[:SENSe]:ACPower:OFFSet[1] 2[:OUTer]:TYPE CTOCenter CTOEdge ETOCenter ETOEdge</code> <code>[:SENSe]:ACPower:OFFSet[1] 2[:OUTer]:TYPE?</code> Subopcode: 1 = BTS/Downlink (Default), 2 = MS/Uplink
Example	<code>:ACP:OFFS:TYPE ETOC</code> <code>:ACP:OFFS:TYPE?</code>
Preset	<code>CTOCenter</code>
State Saved	Saved in instrument state
Range	<code>CTOCenter CTOEdge ETOCenter ETOEdge</code>

Mode: 5G NR

Remote Command	[:SENSe]:ACPower:OFFSet[1] 2[:OUTer]:TYPE CTOCenter CTOEdge ETOCenter ETOEdge RTOCenter RTOEdge RCTOCenter SCTOCenter [:SENSe]:ACPower:OFFSet[1] 2[:OUTer]:TYPE? Subopcode: 1 = BTS/Downlink (Default), 2 = MS/Uplink
Example	:ACP:OFFS:TYPE ETOC :ACP:OFFS:TYPE?
Preset	CTOCenter
State Saved	Saved in instrument state
Range	CTOCenter CTOEdge ETOCenter ETOEdge RTOCenter RTOEdge RCTOCenter SCTOCenter

Diagrams for Offset Freq Define

Details depend on the selected mode.

Diagram for Modes other than MSR, LTEAFDD, LTEATDD, 5G NR

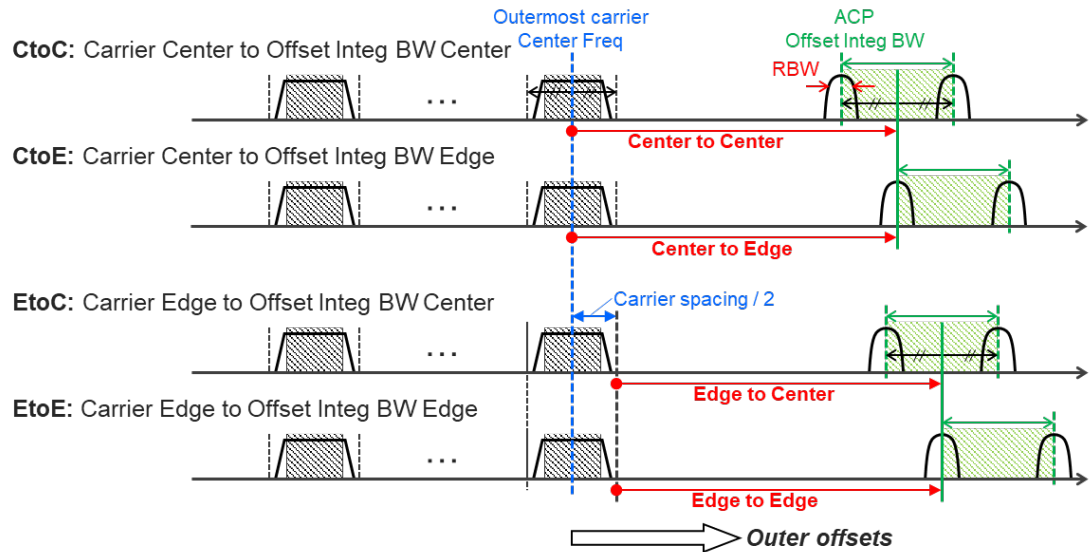
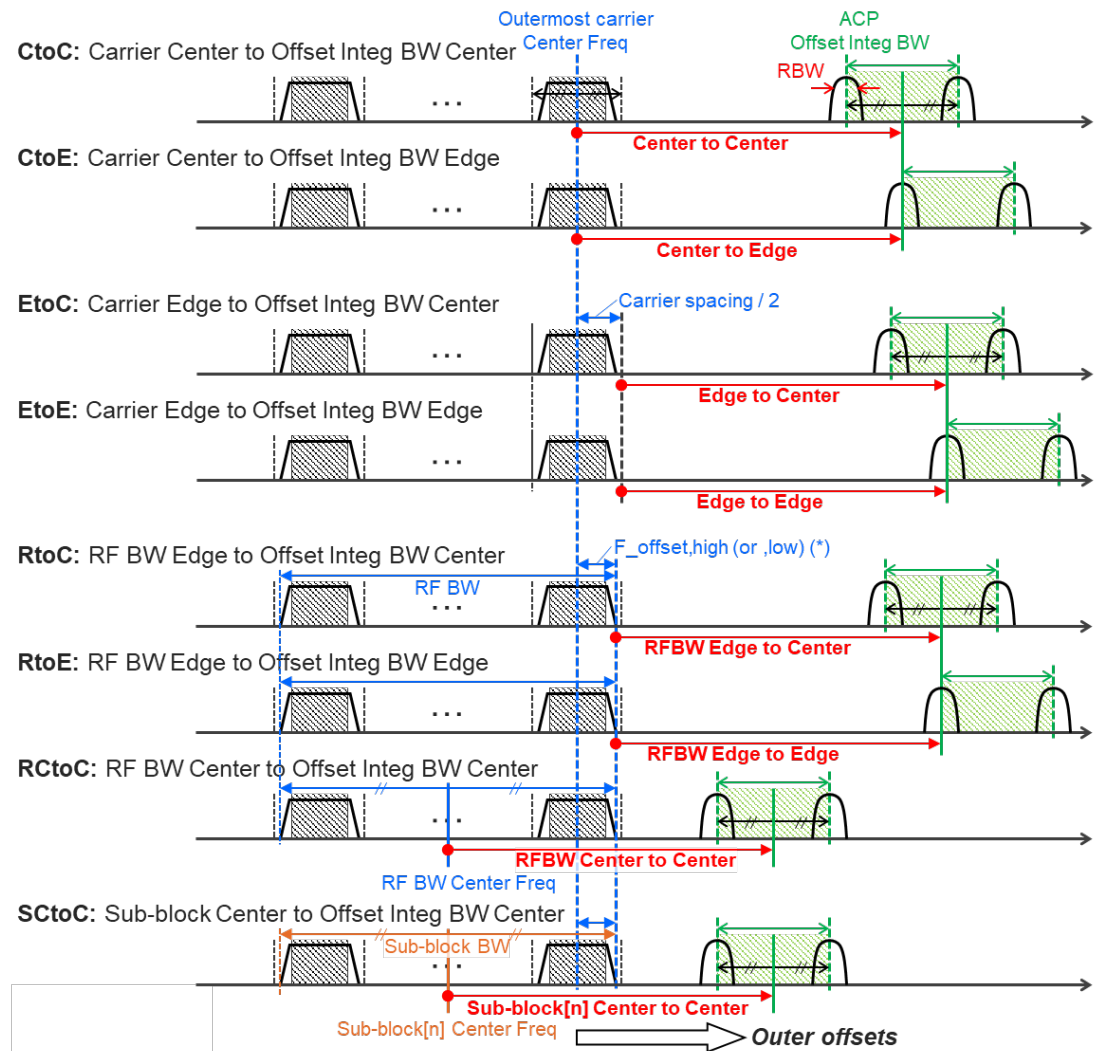

Diagram for MSR, LTEAFDD, LTEATDD, 5G NR



Note:

RF BW Edge and Outermost Carrier Edge are not always the same.
e.g.) 5G NR (3GPP) defines BW_channel, CA which calculates $F_{\text{offset,high}}$ and $F_{\text{offset,low}}$ asymmetrically with SCS shift.

(*) For MSR, $F_{\text{offset,high (or ,low)}} = F_{\text{offset,RAT,high (or ,low)}}$

Offset Freq

Determines the frequency difference between the center of the main channel and the center of the carrier.

Each **Offset Freq** state value is entered individually by selecting the desired carrier.

3 VMA Mode
3.8 ACP Measurement

The list contains up to six (6) entries, depending on the mode selected, for offset frequencies. Each offset frequency in the list corresponds to a reference bandwidth in the bandwidth list.

An offset frequency of zero turns the display of the measurement for that offset off, but the measurement is still made and reported. You can turn off (not use) specific offsets with `[:SENSe]:ACPower:OFFSet[1]|2[:OUTer]:LIST[:FREQuency]`.

Turning the offset off has the same effect as setting the frequency of the offset to 0 Hz, and causes it to be removed from the results screen.

Remote Command	<code>[:SENSe]:ACPower:OFFSet[1] 2[:OUTer]:LIST[:FREQuency] <freq>,...</code> <code>[:SENSe]:ACPower:OFFSet[1] 2[:OUTer]:LIST[:FREQuency]?</code> Subopcode: 1 = BTS/Downlink (Default), 2 = MS/Uplink												
Example	<code>:ACP:OFFS1:LIST 0,0,0,0,0,0</code> <code>:ACP:OFFS1:LIST?</code>												
Notes	Some Modes do not support Offset subopcode 2. In those cases, commands with subopcode 2 are accepted without error but ignored When setting these values remotely, the position in the list sent corresponds to the offset. Missing values are not permitted, unless the number of values sent is greater than the number of carriers, in which case subsequent values are ignored												
Couplings	Changing Offset Frequency might affect "Span" on page 1232												
Preset	When "Max Num of Offsets" on page 1285 is set to 12, the preset value of Offset G ~ L is the same as the Offset F value												
	<table border="1"> <thead> <tr> <th>Modes</th> <th>Values</th> </tr> </thead> <tbody> <tr> <td>SA</td> <td>3 MHz, 0 Hz, 0 Hz, 0 Hz, 0 Hz, 0 Hz 3 MHz, 0 Hz, 0 Hz, 0 Hz, 0 Hz, 0 Hz</td> </tr> <tr> <td>WCDMA</td> <td>5.0 MHz, 10.0 MHz, 0 Hz, 0 Hz, 0 Hz, 0 Hz 5.0 MHz, 10.0 MHz, 0 Hz, 0 Hz, 0 Hz, 0 Hz</td> </tr> <tr> <td>LTEAFDD, LTEATDD, MSR</td> <td>5.0 MHz, 10.0 MHz, 0 Hz, 0 Hz, 0 Hz, 0 Hz 5.0 MHz, 10.0 MHz, 0 Hz, 0 Hz, 0 Hz, 0 Hz</td> </tr> <tr> <td>5G NR</td> <td>100 MHz, 200 MHz, 0 Hz, 0 Hz, 0 Hz, 0 Hz 100 MHz, 200 MHz, 0 Hz, 0 Hz, 0 Hz, 0 Hz</td> </tr> <tr> <td>Radio Test</td> <td>25 kHz, 50 kHz, 75 kHz, 0 Hz, 0 Hz, 0 Hz</td> </tr> </tbody> </table>	Modes	Values	SA	3 MHz, 0 Hz, 0 Hz, 0 Hz, 0 Hz, 0 Hz 3 MHz, 0 Hz, 0 Hz, 0 Hz, 0 Hz, 0 Hz	WCDMA	5.0 MHz, 10.0 MHz, 0 Hz, 0 Hz, 0 Hz, 0 Hz 5.0 MHz, 10.0 MHz, 0 Hz, 0 Hz, 0 Hz, 0 Hz	LTEAFDD, LTEATDD, MSR	5.0 MHz, 10.0 MHz, 0 Hz, 0 Hz, 0 Hz, 0 Hz 5.0 MHz, 10.0 MHz, 0 Hz, 0 Hz, 0 Hz, 0 Hz	5G NR	100 MHz, 200 MHz, 0 Hz, 0 Hz, 0 Hz, 0 Hz 100 MHz, 200 MHz, 0 Hz, 0 Hz, 0 Hz, 0 Hz	Radio Test	25 kHz, 50 kHz, 75 kHz, 0 Hz, 0 Hz, 0 Hz
Modes	Values												
SA	3 MHz, 0 Hz, 0 Hz, 0 Hz, 0 Hz, 0 Hz 3 MHz, 0 Hz, 0 Hz, 0 Hz, 0 Hz, 0 Hz												
WCDMA	5.0 MHz, 10.0 MHz, 0 Hz, 0 Hz, 0 Hz, 0 Hz 5.0 MHz, 10.0 MHz, 0 Hz, 0 Hz, 0 Hz, 0 Hz												
LTEAFDD, LTEATDD, MSR	5.0 MHz, 10.0 MHz, 0 Hz, 0 Hz, 0 Hz, 0 Hz 5.0 MHz, 10.0 MHz, 0 Hz, 0 Hz, 0 Hz, 0 Hz												
5G NR	100 MHz, 200 MHz, 0 Hz, 0 Hz, 0 Hz, 0 Hz 100 MHz, 200 MHz, 0 Hz, 0 Hz, 0 Hz, 0 Hz												
Radio Test	25 kHz, 50 kHz, 75 kHz, 0 Hz, 0 Hz, 0 Hz												
State Saved	Saved in instrument state												
Min/Max	0 Hz/Depends on instrument maximum frequency. Same as Max Span of the Swept SA Measurement												
Backwards Compatibility SCPI	<code>[:SENSe]:MCPower:OFFSet[1] 2:LIST[:FREQuency]</code> Auto Function												
Remote Command	<code>[:SENSe]:ACPower:OFFSet[1] 2[:OUTer]:LIST:STATe OFF ON 0 1,...</code> <code>[:SENSe]:ACPower:OFFSet[1] 2[:OUTer]:LIST:STATe?</code>												

	Subopcode: 1 = BTS/Downlink (Default), 2 = MS/Uplink												
Example	<code>:ACP:OFFS2:LIST:STAT 1,1,0,0,0,0</code> <code>:ACP:OFFS2:LIST:STAT?</code>												
Preset	When "Max Num of Offsets" on page 1285 is 12, the preset value of Offset G ~ L is the same as the Offset F value												
	<table border="1"> <thead> <tr> <th>Modes</th> <th>Values</th> </tr> </thead> <tbody> <tr> <td>SA</td> <td>ON, OFF, OFF, OFF, OFF, OFF ON, OFF, OFF, OFF, OFF, OFF</td> </tr> <tr> <td>WCDMA</td> <td>ON, ON, OFF, OFF, OFF, OFF ON, ON, OFF, OFF, OFF, OFF</td> </tr> <tr> <td>LTEAFDD, LTEATDD, MSR</td> <td>ON, ON, OFF, OFF, OFF, OFF ON, OFF, OFF, OFF, OFF, OFF</td> </tr> <tr> <td>5G NR</td> <td>ON, ON, OFF, OFF, OFF, OFF ON, OFF, OFF, OFF, OFF, OFF</td> </tr> <tr> <td>Radio Test</td> <td>ON, ON, ON, OFF, OFF, OFF</td> </tr> </tbody> </table>	Modes	Values	SA	ON, OFF, OFF, OFF, OFF, OFF ON, OFF, OFF, OFF, OFF, OFF	WCDMA	ON, ON, OFF, OFF, OFF, OFF ON, ON, OFF, OFF, OFF, OFF	LTEAFDD, LTEATDD, MSR	ON, ON, OFF, OFF, OFF, OFF ON, OFF, OFF, OFF, OFF, OFF	5G NR	ON, ON, OFF, OFF, OFF, OFF ON, OFF, OFF, OFF, OFF, OFF	Radio Test	ON, ON, ON, OFF, OFF, OFF
Modes	Values												
SA	ON, OFF, OFF, OFF, OFF, OFF ON, OFF, OFF, OFF, OFF, OFF												
WCDMA	ON, ON, OFF, OFF, OFF, OFF ON, ON, OFF, OFF, OFF, OFF												
LTEAFDD, LTEATDD, MSR	ON, ON, OFF, OFF, OFF, OFF ON, OFF, OFF, OFF, OFF, OFF												
5G NR	ON, ON, OFF, OFF, OFF, OFF ON, OFF, OFF, OFF, OFF, OFF												
Radio Test	ON, ON, ON, OFF, OFF, OFF												
State Saved	Yes												
Range	OFF ON												

Integ BW

Sets the Integration Bandwidth for the offsets. Each resolution bandwidth in the list corresponds to an offset frequency in the list defined by `[:SENSe]:ACP:OFFSet[n] [:OUTer]:LIST[:FREQuency]`.

Enter each value individually by selecting the desired offset, then enter the Offset Integration Bandwidth.

You can turn off (not use) specific offsets with `[:SENSe]:ACP:OFFSet[n] [:OUTer]:LIST:STATe`.

Remote Command	<code>[:SENSe]:ACPower:OFFSet[1] 2[:OUTer]:LIST:BANDwidth[:INTEgration] <freq>,...</code> <code>[:SENSe]:ACPower:OFFSet[1] 2[:OUTer]:LIST:BANDwidth[:INTEgration]?</code>
	Subopcode: 1 = BTS/Downlink (Default), 2 = MS/Uplink
Example	<code>:ACP:OFFS2:LIST:BAND 2MHz,2MHz,2MHz,2MHz,2MHz,2MHz</code> <code>:ACP:OFFS2:LIST:BAND?</code>
Notes	Some Modes do not support Offset subopcode 2. In those cases, commands with subopcode 2 are accepted without error but ignored When setting these values remotely, the position in the list sent corresponds to the offset. Missing values are not permitted, so, if you want to change the second value, you must send all values up to that. Subsequent values remain unchanged, unless the number of values sent is greater than the number of carriers, then subsequent values is ignored
Couplings	Changing Integ BW might affect "Span" on page 1232

3 VMA Mode
3.8 ACP Measurement

Preset When "Max Num of Offsets" on page 1285 is set to 12, the preset value of Offset G ~ L is the same as the Offset F value

Modes	Values
SA	2 MHz, 2 MHz, 2 MHz, 2 MHz, 2 MHz, 2 MHz 2 MHz, 2 MHz, 2 MHz, 2 MHz, 2 MHz, 2 MHz
WCDMA	3.84 MHz, 3.84 MHz, 3.84 MHz, 3.84 MHz, 3.84 MHz, 3.84 MHz 3.84 MHz, 3.84 MHz, 3.84 MHz, 3.84 MHz, 3.84 MHz, 3.84 MHz
LTEAFDD, LTEATDD, MSR	4.515 MHz, 4.515 MHz, 4.515 MHz, 4.515 MHz, 4.515 MHz, 4.515 MHz 4.5 MHz, 4.5 MHz, 4.5 MHz, 4.5 MHz, 4.5 MHz, 4.5 MHz
5G NR	98.28 MHz, 98.28 MHz, 98.28 MHz, 98.28 MHz, 98.28 MHz, 98.28 MHz 98.31 MHz, 98.31 MHz, 98.31 MHz, 98.31 MHz, 98.31 MHz, 98.31 MHz
Radio Test	25 kHz, 25 kHz, 25 kHz, 25 kHz, 25 kHz, 25 kHz

State Saved Saved in instrument state

Min/Max 10 Hz/Depends on instrument maximum frequency. Same as Max Span of the Swept SA Measurement

Backwards Compatibility SCPI
[\[:SENSe\]:ACPower:OFFSet\[1\]|2:LIST:BWIDth\[:INTEgration\]](#)
[\[:SENSe\]:ACPR:OFFSet\[1\]|2:LIST:BANDwidth](#)
[\[:SENSe\]:ACPR:OFFSet\[1\]|2:LIST:BWIDth](#)
[\[:SENSe\]:MCPower:OFFSet\[1\]|2:LIST:BANDwidth\[:INTEgration\]](#)
[\[:SENSe\]:MCPower:OFFSet\[1\]|2:LIST:BWIDth\[:INTEgration\]](#)

Offset Side

Specifies which offset side to measure.

You can turn off (not use) specific offsets with [\[:SENSe\]:ACPower:OFFSet\[1\]|2\[:OUTer\]:LIST:SIDE](#).

NEGative Negative (lower) sideband only
BOTH Both of the negative (lower) and positive (upper) sidebands
POSitive Positive (upper) sideband only

The figure below shows the relation between the negative/positive offset side setups and the upper/lower results in MSR, LTEAFDD and LTEATDD Modes.

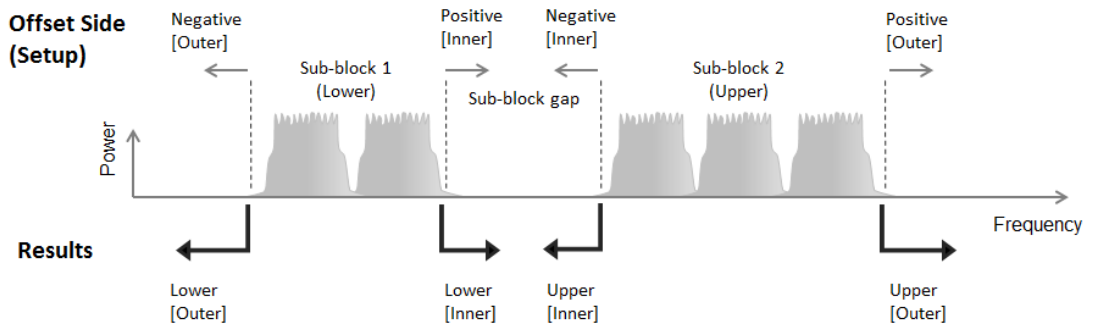

Remote Command	<code>[:SENSe]:ACPower:OFFSet[1] 2[:OUTer]:LIST:SIDE NEGative BOTH POSitive, ...</code> <code>[:SENSe]:ACPower:OFFSet[1] 2[:OUTer]:LIST:SIDE?</code> Subopcode: 1 = BTS/Downlink (Default), 2 = MS/Uplink
Example	<code>:ACP:OFFS:LIST:SIDE BOTH</code> <code>:ACP:OFFS:LIST:SIDE?</code>
Notes	Some Modes do not support Offset subopcode 2. In those cases, commands with subopcode 2 are accepted without error but ignored If you set POS or NEG in an offset, result of the inactive side returns -999
Preset	When " Max Num of Offsets " on page 1285 is 12, the preset value of Offset G ~ L is BOTH BOTH, BOTH, BOTH, BOTH, BOTH, BOTH BOTH, BOTH, BOTH, BOTH, BOTH, BOTH
State Saved	Saved in instrument state
Range	NEGative BOTH POSitive

Method

Allows you to turn RRC filtering of each offset on or off. The value (roll off) for the filter will be set to the value of the **Filter Alpha** parameter.

Remote Command	<code>[:SENSe]:ACPower:OFFSet[1] 2[:OUTer]:LIST:FILTer[:RRC][:STATE] ON OFF 1 0, ...</code> <code>[:SENSe]:ACPower:OFFSet[1] 2[:OUTer]:LIST:FILTer[:RRC][:STATE]?</code> Subopcode: 1 = BTS/Downlink (Default), 2 = MS/Uplink
Example	<code>:ACP:OFFS:LIST:FILT 1,0,0</code> <code>:ACP:OFFS:LIST:FILT?</code>
Notes	1 ON = RRC Weighted, 0 OFF = Integ BW Some Modes do not support Offset subopcode 2. In those cases, commands with subopcode 2 are accepted without error but ignored
Preset	When " Max Num of Offsets " on page 1285 is 12, the preset value of Offset G ~ L is the same as the Offset F value

3 VMA Mode
3.8 ACP Measurement

	Mode	Values
	SA	0, 0, 0, 0, 0, 0 0, 0, 0, 0, 0, 0
	WCDMA	1, 1, 1, 1, 1, 1 1, 1, 1, 1, 1, 1
	LTEAFDD, LTEATDD, 5G NR, MSR	0, 0, 0, 0, 0, 0 0, 0, 0, 0, 0, 0
	Radio Test	0, 0, 0, 0, 0, 0
State Saved	Saved in instrument state	
Range	Integ BW RRC Weighted	

Filter Alpha

Sets the alpha value for the RRC Filter for each offset.

Remote Command	[:SENSe]:ACPower:OFFSet[1] 2[:OUTer]:LIST:FILTer:ALPHA <real>, ... [:SENSe]:ACPower:OFFSet[1] 2[:OUTer]:LIST:FILTer:ALPHA?	
	Subopcode: 1 = BTS/Downlink (Default), 2 = MS/Uplink	
Example	:ACP:OFFS:LIST:FILT:ALPH 0.5,0.5,0.5,0.5,0.5,0.5 :ACP:OFFS:LIST:FILT:ALPH?	
Notes	Some Modes do not support Offset subopcode 2. In those cases, commands with subopcode 2 are accepted without error but ignored	
Preset	When "Max Num of Offsets" on page 1285 is 12, the preset value of Offset G ~ L is the same as the Offset F value	
	SA	0.22,0.22,0.22,0.22,0.22,0.22 0.22,0.22,0.22,0.22,0.22,0.22
	WCDMA	0.22,0.22,0.22,0.22,0.22,0.22 0.22,0.22,0.22,0.22,0.22,0.22
	LTEAFDD, LTEATDD, 5G NR, MSR	0.22,0.22,0.22,0.22,0.22,0.22 0.22,0.22,0.22,0.22,0.22,0.22
State Saved	Saved in instrument state	
Min/Max	0.01/1.00	

Advanced (Offset)

Opens a further menu page, which lets you set advanced properties of the Inner Offset, such as Res BW, Video BW, and Filter parameters.

Offset Freq

This column is the same as "Offset Freq" on page 1298 in the main **Offset** menu.

Res BW

Sets the resolution bandwidth. If an unavailable bandwidth is entered with the numeric keypad, the closest available bandwidth is selected.

Remote Command	<code>[:SENSe]:ACPower:OFFSet[1] 2[:OUTer]:LIST:BANDwidth:RESolution <freq>,...</code> <code>[:SENSe]:ACPower:OFFSet[1] 2[:OUTer]:LIST:BANDwidth:RESolution?</code> Subopcode: 1 = BTS/Downlink (Default), 2 = MS/Uplink
Example	<code>:ACP:OFFS2:LIST:BAND:RES 220kHz,220kHz,220kHz,220kHz,220kHz,220kHz</code> <code>:ACP:OFFS2:LIST:BAND:RES?</code>
Notes	Some Modes do not support Offset subopcode 2. In those cases, commands with subopcode 2 are accepted without error but ignored
Dependencies	When " Meas Method " on page 1246 is RBW, FAST or Fast Power, this cell is grayed-out and disabled. If the cell is pressed, an advisory message is generated. If the equivalent SCPI remote command is sent, a "Setting conflict" warning is generated
Couplings	When Res BW Mode is Auto , this value is exactly same as Res BW . When you change this value, Res BW Mode also changes to Man
Preset	When " Max Num of Offsets " on page 1285 is 12, the preset value of Offset G ~ L is the same as the Offset F value
	SA 220 kHz, 220 kHz, 220 kHz, 220 kHz, 220 kHz, 220 kHz
	WCDMA 100 kHz, 100 kHz, 100 kHz, 100 kHz, 100 kHz, 100 kHz
	LTEAFDD, LTEATDD, 5G NR, MSR 100 kHz, 100 kHz, 100 kHz, 100 kHz, 100 kHz, 100 kHz 100 kHz, 100 kHz, 100 kHz, 100 kHz, 100 kHz, 100 kHz
State Saved	Saved in instrument state
Min/Max	1 Hz/8 MHz
Backwards Compatibility SCPI	<code>[:SENSe]:ACPower:OFFSet[1] 2:LIST:BWIDth:RESolution</code>
	Auto Function
Remote Command	<code>[:SENSe]:ACPower:OFFSet[1] 2[:OUTer]:LIST:BANDwidth:RESolution:AUTO ON OFF 1 0,...</code> <code>[:SENSe]:ACPower:OFFSet[1] 2[:OUTer]:LIST:BANDwidth:RESolution:AUTO?</code> Subopcode: 1 = BTS/Downlink (Default), 2 = MS/Uplink
Example	<code>:ACP:OFFS2:LIST:BAND:RES:AUTO 1,1,1,1,1,1</code> <code>:ACP:OFFS2:LIST:BAND:RES:AUTO?</code>
Preset	When " Max Num of Offsets " on page 1285 is 12, the preset value of Offset G ~ L is 1, 1, 1, 1, 1, 1
State Saved	Yes

Backwards Compatibility SCPI `[:SENSe]:ACPower:OFFSet[1]|2[:LIST:BWIDth:RESolution:AUTO`

Video BW

Enables you to change the instrument post-detection filter (VBW).

Remote Command	<code>[:SENSe]:ACPower:OFFSet[1] 2[:OUTer]:LIST:BANDwidth:VIDeo <freq>,...</code> <code>[:SENSe]:ACPower:OFFSet[1] 2[:OUTer]:LIST:BANDwidth:VIDeo?</code> Subopcode: 1 = BTS/Downlink (Default), 2 = MS/Uplink								
Example	<code>:ACP:OFFS2:LIST:BAND:VID 5MHz, 5MHz, 5MHz, 5MHz, 5MHz, 5MHz</code> <code>:ACP:OFFS2:LIST:BAND:VID?</code>								
Notes	The values shown in this table reflect the conditions after Mode Preset Some Modes do not support Offset subopcode 2. In those cases, commands with subopcode 2 are accepted without error but ignored								
Dependencies	When " Meas Method " on page 1246 is RBW, FAST or Fast Power, this cell is grayed-out and disabled. If the cell is pressed, an advisory message is generated. If the equivalent remote command is sent, a "Setting conflict" warning is generated								
Preset	When " Max Num of Offsets " on page 1285 is 12, the preset value of Offset G ~ L is the same as the Offset F value								
	<table border="1"> <thead> <tr> <th>Modes</th> <th>Values</th> </tr> </thead> <tbody> <tr> <td>SA</td> <td>22 kHz, 22 kHz, 22 kHz, 22 kHz, 22 kHz, 22 kHz</td> </tr> <tr> <td>WCDMA</td> <td>1 MHz, 1 MHz, 1 MHz, 1 MHz, 1 MHz, 1 MHz</td> </tr> <tr> <td>LTEAFDD, LTEATDD, 5G NR, MSR</td> <td>1 MHz, 1 MHz, 1 MHz, 1 MHz, 1 MHz, 1 MHz</td> </tr> </tbody> </table>	Modes	Values	SA	22 kHz, 22 kHz, 22 kHz, 22 kHz, 22 kHz, 22 kHz	WCDMA	1 MHz, 1 MHz, 1 MHz, 1 MHz, 1 MHz, 1 MHz	LTEAFDD, LTEATDD, 5G NR, MSR	1 MHz, 1 MHz, 1 MHz, 1 MHz, 1 MHz, 1 MHz
Modes	Values								
SA	22 kHz, 22 kHz, 22 kHz, 22 kHz, 22 kHz, 22 kHz								
WCDMA	1 MHz, 1 MHz, 1 MHz, 1 MHz, 1 MHz, 1 MHz								
LTEAFDD, LTEATDD, 5G NR, MSR	1 MHz, 1 MHz, 1 MHz, 1 MHz, 1 MHz, 1 MHz								
State Saved	Saved in instrument state								
Min/Max	1 Hz/50 MHz								
Backwards Compatibility SCPI	<code>[:SENSe]:ACPower:OFFSet[1] 2[:LIST:BWIDth:VIDeo</code>								

Auto Function

Remote Command	<code>[:SENSe]:ACPower:OFFSet[1] 2[:OUTer]:LIST:BANDwidth:VIDeo:AUTO OFF ON 0 1,...</code> <code>[:SENSe]:ACPower:OFFSet[1] 2[:OUTer]:LIST:BANDwidth:VIDeo:AUTO?</code> Subopcode: 1 = BTS/Downlink (Default), 2 = MS/Uplink
Example	<code>:ACP:OFFS2:LIST:BAND:VID:AUTO 0, 0, 0, 0, 1, 1</code> <code>:ACP:OFFS2:LIST:BAND:VID:AUTO?</code>
Preset	When " Max Num of Offsets " on page 1285 is 12, the preset value of Offset G ~ L is ON <code>ON, ON, ON, ON, ON, ON</code>

State Saved	Yes
Backwards Compatibility SCPI	<code>[:SENSe]:ACPower:OFFSet[1] 2[:OUTer]:LIST:BWIDth:VIDeo:AUTO</code>

Filter Type

Selects the type of bandwidth filter that is used.

Remote Command	<code>[:SENSe]:ACPower:OFFSet[1] 2[:OUTer]:LIST:Bandwidth:SHAPE GAUSSian FLATtop,...</code> <code>[:SENSe]:ACPower:OFFSet[1] 2[:OUTer]:LIST:Bandwidth:SHAPE?</code> Subopcode: 1 = BTS/Downlink (Default), 2 = MS/Uplink
Example	<code>:ACP:OFFS2:LIST:BAND:SHAP FLAT,GAUS,GAUS,GAUS,GAUS,GAUS</code> <code>:ACP:OFFS2:LIST:BAND:SHAP?</code>
Notes	Some Modes do not support Offset subopcode 2. In those cases, commands with subopcode 2 are accepted without error but ignored
Dependencies	When " Res BW " on page 1214 Mode for the offset is Auto , this cell is grayed out and disabled. Since Res BW Mode for the offset is preset to Auto on changing " Meas Method " on page 1246 to RBW, FAST or Fast Power, this cell is grayed-out and disabled too. If the cell is pressed, an advisory message is generated. If the equivalent remote command is sent, a "Setting conflict" warning is generated
Preset	When " Max Num of Offsets " on page 1285 is 12, the preset value of Offset G ~ L is GAUSSian GAUSSian, GAUSSian, GAUSSian, GAUSSian, GAUSSian, GAUSSian
State Saved	Saved in instrument state
Range	GAUSSian FLATtop
Backwards Compatibility SCPI	<code>[:SENSe]:ACPower:OFFSet[1] 2[:LIST:BWIDth:SHAPE</code>

Filter BW

Selects a Gaussian filter based on its –3 dB (Normal) bandwidth or its –6 dB bandwidth.

Remote Command	<code>[:SENSe]:ACPower:OFFSet[1] 2[:OUTer]:LIST:Bandwidth:TYPE DB3 DB6,...</code> <code>[:SENSe]:ACPower:OFFSet[1] 2[:OUTer]:LIST:Bandwidth:TYPE?</code> Subopcode: 1 = BTS/Downlink (Default), 2 = MS/Uplink
Example	<code>:ACP:OFFS2:LIST:BAND:TYPE DB3,DB3,DB3,DB3,DB3</code> <code>:ACP:OFFS2:LIST:BAND:TYPE?</code>
Notes	Some Modes do not support Offset subopcode 2. In those cases, commands with subopcode 2 are accepted without error but ignored

Dependencies	When " RBW Filter Type " on page 1217 is Flattop, or " Res BW " on page 1214 Mode for the offset is Auto , this cell is grayed-out and disabled. Since Res BW Mode for the offset is preset to Auto on changing " Meas Method " on page 1246 to RBW, FAST or Fast Power, this cell is grayed-out and disabled too. If the cell is pressed, an advisory message is generated. If the equivalent remote command is sent, a "Setting conflict" warning is generated
Preset	When " Max Num of Offsets " on page 1285 is 12, the preset value of Offset G ~ L is DB3 DB3, DB3, DB3, DB3, DB3, DB3
State Saved	Saved in instrument state
Range	-3 dB (Normal) -6 dB
Backwards Compatibility SCPI	<code>[:SENSe]:ACPower:OFFSet[1] 2:LIST:BWIDth:TYPE</code>

Limits

Lets you configure the limits that are used to determine whether the offset regions **PASS** or **FAIL** the limit test.

Limit Test

This checkbox is the same as "[Limit Test](#)" on page 1265 in the **Meas Setup, Settings** tab.

Offset Freq

This column is the same as "[Offset Freq](#)" on page 1298 in the **Offset** index tab.

Abs Limit

Specifies an absolute limit value, which sets the absolute amplitude levels to test against for each of the custom offsets. The list must contain 6 entries. If there is more than one offset, the offset closest to the carrier channel is the first one in the list. `[:SENSe]:ACP:OFFSet[n][:OUTer]:LIST:TEST` selects the type of testing to be done at each offset.

You can turn off (not use) specific offsets with the `[:SENSe]:ACP:OFFSet[n][:OUTer]:LIST:STATE` command.

The query returns the six (6) sets of real numbers that are the current absolute amplitude test limits.

Remote Command	<code>[:SENSe]:ACPower:OFFSet[1] 2[:OUTer]:LIST:ABSolute < real>,...</code> <code>[:SENSe]:ACPower:OFFSet[1] 2[:OUTer]:LIST:ABSolute?</code>
----------------	---

	Subopcode: 1 = BTS/Downlink (Default), 2 = MS/Uplink										
Example	<code>:ACP:OFFS2:LIST:ABS -10, -10, -10, -10, -10</code> <code>:ACP:OFFS2:LIST:ABS?</code>										
Notes	Some Modes do not support Offset subopcode 2. In those cases, commands with subopcode 2 are accepted without error but ignored										
Preset	When "Max Num of Offsets" on page 1285 is 12, the preset value of Offset G ~ L is the same as the Offset F value										
	<table border="1"> <thead> <tr> <th>Modes</th> <th>Values</th> </tr> </thead> <tbody> <tr> <td>SA</td> <td>0dBm, 0 dBm, 0 dBm, 0 dBm, 0 dBm, 0 dBm 0dBm, 0 dBm, 0 dBm, 0 dBm, 0 dBm, 0 dBm</td> </tr> <tr> <td>WCDMA</td> <td>50 dBm, 50 dBm, 50 dBm, 50 dBm, 50 dBm, 50 dBm 50 dBm, 50 dBm, 50 dBm, 50 dBm, 50 dBm, 50 dBm</td> </tr> <tr> <td>LTEAFDD, LTEATDD, MSR</td> <td>-8.45, -8.45, -8.45, -8.45, -8.45, -8.45 -50.0, -50.0, -50.0, -50.0, -50.0, -50.0</td> </tr> <tr> <td>5G NR</td> <td>4.92, 4.92, 4.92, 4.92, 4.92, 4.92 -50.0, -50.0, -50.0, -50.0, -50.0, -50.0</td> </tr> </tbody> </table>	Modes	Values	SA	0dBm, 0 dBm, 0 dBm, 0 dBm, 0 dBm, 0 dBm 0dBm, 0 dBm, 0 dBm, 0 dBm, 0 dBm, 0 dBm	WCDMA	50 dBm, 50 dBm, 50 dBm, 50 dBm, 50 dBm, 50 dBm 50 dBm, 50 dBm, 50 dBm, 50 dBm, 50 dBm, 50 dBm	LTEAFDD, LTEATDD, MSR	-8.45, -8.45, -8.45, -8.45, -8.45, -8.45 -50.0, -50.0, -50.0, -50.0, -50.0, -50.0	5G NR	4.92, 4.92, 4.92, 4.92, 4.92, 4.92 -50.0, -50.0, -50.0, -50.0, -50.0, -50.0
Modes	Values										
SA	0dBm, 0 dBm, 0 dBm, 0 dBm, 0 dBm, 0 dBm 0dBm, 0 dBm, 0 dBm, 0 dBm, 0 dBm, 0 dBm										
WCDMA	50 dBm, 50 dBm, 50 dBm, 50 dBm, 50 dBm, 50 dBm 50 dBm, 50 dBm, 50 dBm, 50 dBm, 50 dBm, 50 dBm										
LTEAFDD, LTEATDD, MSR	-8.45, -8.45, -8.45, -8.45, -8.45, -8.45 -50.0, -50.0, -50.0, -50.0, -50.0, -50.0										
5G NR	4.92, 4.92, 4.92, 4.92, 4.92, 4.92 -50.0, -50.0, -50.0, -50.0, -50.0, -50.0										
State Saved	Saved in instrument state										
Min/Max	-200.0 dBm/50.0 dBm										
Backwards Compatibility SCPI	<code>[:SENSe] :ACPR:OFFSet[1] 2:LIST:ABSolute</code> SA, W-CDMA <code>[:SENSe] :MCPower:OFFSet[1] 2:LIST:ABSolute</code> SA, W-CDMA										

Rel Limit (Car)

Enters a relative limit value for the carrier level. This sets the amplitude levels to test against for the specified offsets.

The amplitude level is relative to the carrier amplitude. If multiple offsets are available, the list contains 6 entries. The offset closest to the carrier channel is the first one in the list.

`[:SENSe] :ACP:OFFSet[n] [:OUTer] :LIST:TEST` selects the type of testing to be done at each offset.

You can turn off (not use) specific offsets with `[:SENSe] :ACP:OFFSet[n] [:OUTer] :LIST:STATE`.

The query returns the 6 sets of real numbers that are the current amplitude test limits, relative to the carrier, for each offset.

Offset[n] n = 1 is base station and n = 2 is mobiles. The default is base station (1).

Remote	<code>[:SENSe] :ACP:OFFSet[1] 2 [:OUTer] :LIST:RCARrier <real>,...</code>
--------	---

3 VMA Mode
3.8 ACP Measurement

Command	<code>[:SENSe]:ACPower:OFFSet[1] 2[:OUTer]:LIST:RCARrier?</code> Subopcode: 1 = BTS/Downlink (Default), 2 = MS/Uplink												
Example	<code>:ACP:OFFS2:LIST:RCAR 0,0,0,0,0,0</code> <code>:ACP:OFFS2:LIST:RCAR?</code>												
Notes	Some Modes do not support Offset subopcode 2. In those cases, commands with subopcode 2 are accepted without error but ignored												
Preset	When " Max Num of Offsets " on page 1285 is 12, the preset value of Offset G ~ L is the same as the Offset F value												
	<table border="1"> <thead> <tr> <th>Modes</th> <th>Values</th> </tr> </thead> <tbody> <tr> <td>SA</td> <td>-45, -60, 0, 0, 0, 0 -45, -60, 0, 0, 0, 0</td> </tr> <tr> <td>WCDMA</td> <td>-44.2, -49.2, -49.2, -49.2, -49.2, -49.2 -32.2, -42.2, -42.2, -42.2, -42.2, -42.2</td> </tr> <tr> <td>LTEAFDD, LTEATDD, MSR</td> <td>-44.2, -44.2, -44.2, -44.2, -44.2, -44.2 -29.2, -29.2, -29.2, -29.2, -29.2, -29.2</td> </tr> <tr> <td>5G NR</td> <td>-43.8, -43.8, -43.8, -43.8, -43.8, -43.8 -29.2, -29.2, -29.2, -29.2, -29.2, -29.2</td> </tr> <tr> <td>Radio Test</td> <td>-60, -60, -60, 0, 0, 0</td> </tr> </tbody> </table>	Modes	Values	SA	-45, -60, 0, 0, 0, 0 -45, -60, 0, 0, 0, 0	WCDMA	-44.2, -49.2, -49.2, -49.2, -49.2, -49.2 -32.2, -42.2, -42.2, -42.2, -42.2, -42.2	LTEAFDD, LTEATDD, MSR	-44.2, -44.2, -44.2, -44.2, -44.2, -44.2 -29.2, -29.2, -29.2, -29.2, -29.2, -29.2	5G NR	-43.8, -43.8, -43.8, -43.8, -43.8, -43.8 -29.2, -29.2, -29.2, -29.2, -29.2, -29.2	Radio Test	-60, -60, -60, 0, 0, 0
Modes	Values												
SA	-45, -60, 0, 0, 0, 0 -45, -60, 0, 0, 0, 0												
WCDMA	-44.2, -49.2, -49.2, -49.2, -49.2, -49.2 -32.2, -42.2, -42.2, -42.2, -42.2, -42.2												
LTEAFDD, LTEATDD, MSR	-44.2, -44.2, -44.2, -44.2, -44.2, -44.2 -29.2, -29.2, -29.2, -29.2, -29.2, -29.2												
5G NR	-43.8, -43.8, -43.8, -43.8, -43.8, -43.8 -29.2, -29.2, -29.2, -29.2, -29.2, -29.2												
Radio Test	-60, -60, -60, 0, 0, 0												
State Saved	Saved in instrument state												
Min/Max	-150/50.0												
Backwards Compatibility SCPI	<code>[:SENSe]:MCPower:OFFSet[1] 2[:LIST:RCARrier</code>												

Positive Offset Limit (Remote Command only)

Enables you to set the upper limit for the upper segment of the specified offset pair.

Remote Command	<code>:CALCulate:ACPower:OFFSet[1] 2[:OUTer]:LIST:LIMit:POSitive[:UPPer]:DATA <real>,...</code> <code>:CALCulate:ACPower:OFFSet[1] 2[:OUTer]:LIST:LIMit:POSitive[:UPPer]:DATA?</code> Subopcode: 1 = BTS/Downlink (Default), 2 = MS/Uplink
Example	<code>:CALC:ACP:OFFS:LIST:LIM:POS:DATA 0,0,0,0,0,0</code> <code>:CALC:ACP:OFFS:LIST:LIM:POS:DATA?</code>
Notes	Some Modes do not support Offset subopcode 2. In those cases, commands with subopcode 2 are accepted without error but ignored
Preset	When " Max Num of Offsets " on page 1285 is 12, the preset value of Offset G ~ L is the same as the Offset F value

Modes	Values
SA	-45, -60, 0, 0, 0, 0 -45, -60, 0, 0, 0, 0
WCDMA	-44.2, -49.2, -49.2, -49.2, -49.2, -49.2 -32.2, -42.2, -42.2, -42.2, -42.2, -42.2
LTEAFDD, LTEATDD, MSR	-44.2, -44.2, -44.2, -44.2, -44.2, -44.2 -29.2, -29.2, -29.2, -29.2, -29.2, -29.2
5G NR	-43.8, -43.8, -43.8, -43.8, -43.8, -43.8 -29.2, -29.2, -29.2, -29.2, -29.2, -29.2
Radio Test	-60, -60, -60, 0, 0, 0
State Saved	Saved in instrument state
Min/Max	-150.0/50.0
Backwards Compatibility SCPI	:CALCulate:MCPower:OFFSet:LIST:LIMit:POSitive[:UPPer]:DATA (Power Suite)

Negative Offset Limit(Remote Command only)

Enables you to set the upper limit for the lower segment of the specified offset pair.

Remote Command	:CALCulate:ACPower:OFFSet[1] 2[:OUTer]:LIST:LIMit:NEGative[:UPPer]:DATA <real>, ... :CALCulate:ACPower:OFFSet[1] 2[:OUTer]:LIST:LIMit:NEGative[:UPPer]:DATA? Subopcode: 1 = BTS/Downlink (Default), 2 = MS/Uplink
Example	:CALC:ACP:OFFS:LIST:LIM:NEG:DATA 0,0,0,0,0,0 :CALC:ACP:OFFS:LIST:LIM:NEG:DATA?
Notes	Some Modes do not support Offset subopcode 2. In those cases, commands with subopcode 2 are accepted without error but ignored
Preset	When "Max Num of Offsets" on page 1285 is 12, the preset value of Offset G ~ L is the same as the Offset F value

Modes	Values
SA	-45, -60, 0, 0, 0, 0 -45, -60, 0, 0, 0, 0
WCDMA	-44.2, -49.2, -49.2, -49.2, -49.2, -49.2 -32.2, -42.2, -42.2, -42.2, -42.2, -42.2
LTEAFDD, LTEATDD, MSR	-44.2, -44.2, -44.2, -44.2, -44.2, -44.2 -29.2, -29.2, -29.2, -29.2, -29.2, -29.2
5G NR	-43.8, -43.8, -43.8, -43.8, -43.8, -43.8 -29.2, -29.2, -29.2, -29.2, -29.2, -29.2
Radio Test	-60, -60, -60, 0, 0, 0

State Saved	Saved in instrument state
Min/Max	-150.0/50.0
Backwards Compatibility SCPI	<code>:CALCulate:MCPower:OFFSet:LIST:LIMit:NEGative[:UPPer]:DATA</code> (Power Suite, WCDMA)

Rel Limit (PSD)

Enters a relative limit value for the level of the power spectral density. This sets the amplitude levels to test against for any custom offsets. The amplitude level is relative to the power spectral density. If multiple offsets are available, the list contains 6 entries. The offset closest to the carrier channel is the first one in the list.

`[:SENSe]:ACP:OFFSet[n][:OUTer]:LIST:TEST` selects the type of testing to be done at each offset.

You can turn off (not use) specific offsets with `[:SENSe]:ACP:OFFSet[n][:OUTer]:LIST:STATE`.

The query returns the 6 sets of real numbers that are the current amplitude test limits, relative to the power spectral density, for each offset.

Offset[n] n = 1 is base station and n = 2 is mobiles. The default is base station (1).

Remote Command	<code>[:SENSe]:ACP:Power:OFFSet[1] 2[:OUTer]:LIST:RPSDensity <rel_amp>,...</code> <code>[:SENSe]:ACP:Power:OFFSet[1] 2[:OUTer]:LIST:RPSDensity?</code> Subopcode: 1 = BTS/Downlink (Default), 2 = MS/Uplink
Example	<code>:ACP:OFFS2:LIST:RPSD 10,10,10,10,10,10</code> <code>:ACP:OFFS2:LIST:RPSD?</code>
Notes	Some Modes do not support Offset subopcode 2. In those cases, commands with subopcode 2 are accepted without error but ignored
Preset	When "Max Num of Offsets" on page 1285 is 12, the preset value of Offset G ~ L is the same as the Offset F value

Modes	Values
SA	-28.87 dB, -43.87 dB, 0 dB, 0 dB, 0 dB, 0 dB -28.87 dB, -43.87 dB, 0 dB, 0 dB, 0 dB, 0 dB
WCDMA	-44.2 dB, -49.2 dB, -49.2 dB, -49.2 dB, -49.2 dB, -49.2 dB -32.2 dB, -42.2 dB, -42.2 dB, -42.2 dB, -42.2 dB
LTEAFDD, LTEATDD, 5G NR, MSR	0, 0, 0, 0, 0, 0 0, 0, 0, 0, 0, 0
Radio Test	-60, -60, -60, 0, 0, 0

State Saved	Saved in instrument state
Min/Max	-150.0 dB/50.0 dB

Fail Mask

Accesses a menu that lets you select one of the logics for the fail conditions between the measurement results and the test limits. The setting defines the type of testing to be done at any custom offset frequencies. The measured powers are tested against the absolute values defined with `[:SENSe]:ACP:OFFSet[n] [:OUTer]:LIST:ABSolute`, or the relative values defined with `[:SENSe]:ACP:OFFSet[n]:OUTer]:LIST:RPSDensity` and `[:SENSe]:ACP:OFFSet[n] [:OUTer]:LIST:RCARrier`.

You can turn off (not use) specific offsets with `[:SENSe]:ACP:OFFSet[n] [:OUTer]:LIST:STATE`.

Absolute	ABSolute	Fail is shown if one of the absolute ACP measurement results is larger than the limit for Abs Limit
Relative	RELative	Fail is shown if one of the relative ACP measurement results is larger than the limit for Rel Lim (Car) or Rel Lim (PSD)
Abs AND Rel	AND	Fail is shown if one of the absolute ACP measurement results is larger than the limit for Abs Limit and one of the relative ACP measurement results is larger than the limit for Rel Lim (Car) or Rel Lim (PSD)
Abs OR Rel	OR	Fail is shown if one of the absolute ACP measurement results is larger than the limit for Abs Limit or one of the relative ACP measurement results is larger than the limit for Rel Lim (Car) or Rel Lim (PSD)

Remote Command	<code>[:SENSe]:ACP:Power:OFFSet[1] 2 [:OUTer]:LIST:TEST ABSolute AND OR RELative,...</code> <code>[:SENSe]:ACP:Power:OFFSet[1] 2 [:OUTer]:LIST:TEST?</code> Subopcode: 1 = BTS/Downlink (Default), 2 = MS/Uplink
----------------	--

Example	<code>:ACP:OFFS2:LIST:TEST ABS,ABS,ABS,ABS,ABS,ABS</code> <code>:ACP:OFFS2:LIST:TEST?</code>
---------	---

Notes	Some Modes do not support Offset subopcode 2. In those cases, commands with subopcode 2 are accepted without error but ignored
-------	--

Preset	When "Max Num of Offsets" on page 1285 is 12, the preset value of Offset G ~ L is the same as the Offset F value
--------	--

Modes	Values
SA, WCDMA	<code>REL, REL, REL, REL, REL, REL REL, REL, REL, REL, REL, REL</code>
LTEAFDD, LTEATDD, 5G NR, MSR	<code>AND, AND, AND, AND, AND, AND AND, AND, AND, AND, AND, AND</code>

	Modes	Values
	Radio Test	REL, REL, REL, REL, REL, REL
State Saved	Saved in instrument state	
Range	ABSolute AND OR RELative	
Backwards Compatibility SCPI	[:SENSe]:MCPower:OFFSet[1] 2:LIST:TEST	

Offset Frequency Define

Allows you to select “Offset” definition:

CTOCenter	From the lowermost carrier center frequency (for lower offset), the uppermost carrier center frequency (for upper offset) to the center frequency of each Offset Integ BW
CTOEdge	From the lowermost carrier center frequency (for lower offset), the uppermost carrier center frequency (for upper offset) to the closest edge frequency of each Offset Integ BW
ETOCenter	From the lowermost carrier center frequency - spacing of this carrier /2 (for lower offset), the uppermost carrier center frequency + spacing of this carrier /2 (for upper offset) to the center frequency of each Offset Integ BW
ETOEdge	From the lowermost carrier center frequency - spacing of this carrier /2 (for lower offset), the uppermost carrier center frequency + spacing of this carrier /2 (for upper offset) to the closest edge frequency of each Offset Integ BW
STOCenter	From either the lower or upper sub-block edge frequency to the center frequency of each Offset Integ BW
STOEdge	From either the lower or upper sub-block edge frequency to the closest edge frequency of each Offset Integ BW
SCTOCenter	From the center frequency of sub-block** to the center frequency of each Offset Integ BW

5G NR Mode only

** sub-block (bandwidth) = $BW_{\text{channel,block}}$ which is defined in each 3GPP standard, regardless of “Measure Carrier” for the uppermost and the lowermost carriers being Enabled or Disabled. When the Number of Component Carrier within each sub-block = 1, sub-block (bandwidth) = $BW_{\text{channel}} = 2 \times F_{\text{offset,RAT}}$.

See "Diagram for Offset Freq Define" on page 1273

Mode: MSR, LTEAFDD, LTEATDD

Remote Command	[:SENSe]:ACPPower:OFFSet[1] 2:INNER:TYPE CTOCenter CTOEdge ETOCenter ETOEdge STOCenter STOEdge
	[:SENSe]:ACPPower:OFFSet[1] 2:INNER:TYPE?
	Subopcode: 1 = BTS/Downlink (Default), 2 = MS/Uplink

Example	<code>:ACP:OFFS:INN:TYPE ETOC</code> <code>:ACP:OFFS:INN:TYPE?</code>
Preset	<code>STOCenter</code>
State Saved	Saved in instrument state
Range	<code>CTOCenter CTOEdge ETOCenter ETOEdge STOCenter STOEdge</code>

Mode: 5G NR

Remote Command	<code>[[:SENSe]:ACPower:OFFSet[1] 2:INNER:TYPE CTOCenter CTOEdge ETOCenter ETOEdge STOCenter STOEdge SCTOCenter</code> <code>[[:SENSe]:ACPower:OFFSet[1] 2:INNER:TYPE?</code> Subopcode: 1 = BTS/Downlink (Default), 2 = MS/Uplink
Example	<code>:ACP:OFFS:INN:TYPE ETOC</code> <code>:ACP:OFFS:INN:TYPE?</code>
Preset	<code>STOCenter CTOCenter</code>
State Saved	Saved in instrument state
Range	<code>CTOCenter CTOEdge ETOCenter ETOEdge STOCenter STOEdge SCTOCenter</code>

Diagram for Offset Freq Define

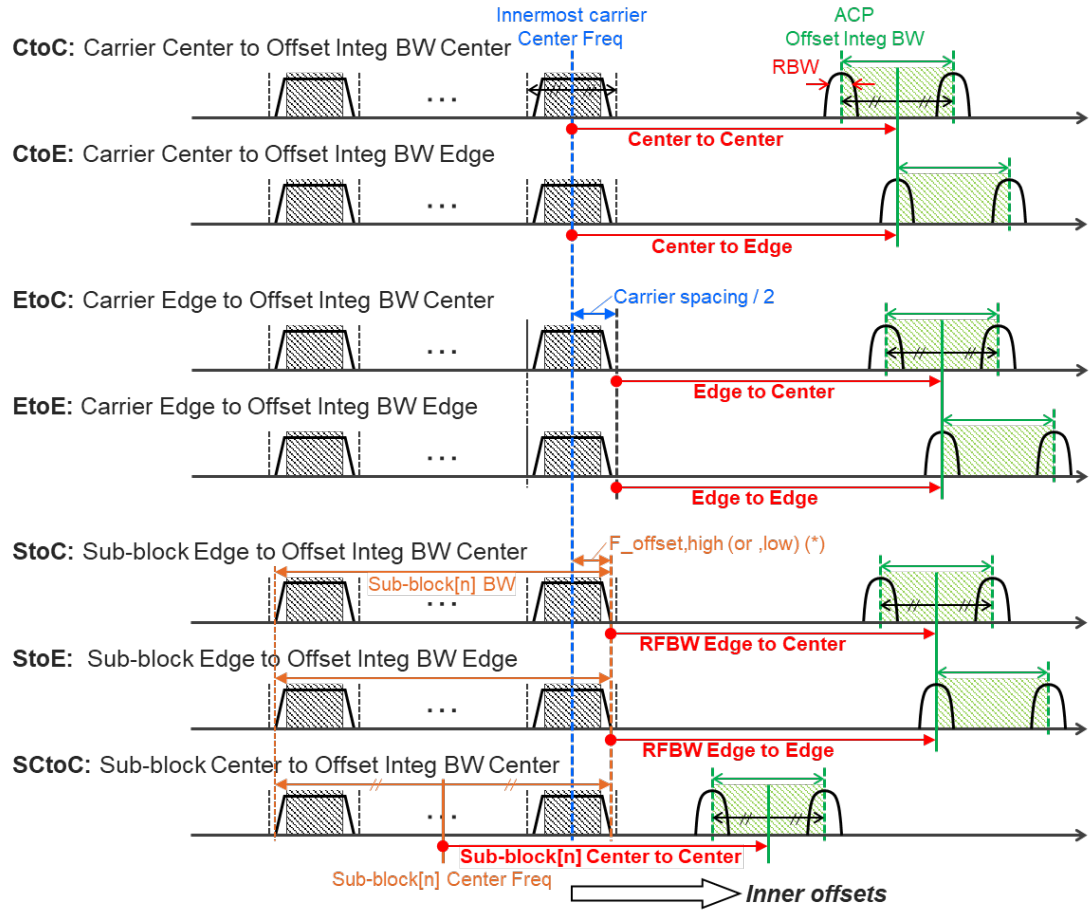

Note:

RF BW Edge and Outermost Carrier Edge are not always same.
e.g.) 5G NR (3GPP) defines BW_channel,CA which calculates $F_{\text{offset,high}}$ and $F_{\text{offset,low}}$ asymmetrically with SCS shift

(*) For MSR, $F_{\text{offset,high}}$ (or ,low) = $F_{\text{offset,RAT,high}}$ (or ,low)

Offset Freq

Determines the frequency difference between the center of the main channel and the center of the carrier. When set to Offset to Edge, this parameter determines the frequency difference between the center of the main channel and the near edge of the offset.

Each **Offset Freq** state value is entered individually by selecting the desired carrier. Use the **Enabled** checkbox to turn the **Offset Freq** State on or off.

The list contains up to 6 entries, depending on the mode selected, for offset frequencies. Each offset frequency in the list corresponds to a reference bandwidth in the bandwidth list.

An offset frequency of zero turns the display of the measurement for that offset off, but the measurement is still made and reported. You can turn off (not use) specific offsets with `[:SENSe]:ACPower:OFFSet[n]:INNeR:LIST:STATE`.

Turning the offset off has the same effect as setting the frequency of the offset to 0 Hz, and causes it to be removed from the results screen.

Remote Command	<code>[:SENSe]:ACPower:OFFSet[1] 2:INNeR:LIST[:FREQuency] <freq>,...</code> <code>[:SENSe]:ACPower:OFFSet[1] 2:INNeR:LIST[:FREQuency]?</code> Subopcode: 1 = BTS/Downlink (Default), 2 = MS/Uplink						
Example	<code>:ACP:OFFS1:INN:LIST 0,0,0,0,0,0</code> <code>:ACP:OFFS1:INN:LIST?</code>						
Notes	When setting these values remotely, the position in the list sent corresponds to the offset. Missing values are not permitted, unless the number of values sent is greater than the number of carriers, then subsequent values are ignored						
Couplings	Changing Offset Frequency might affect "Span" on page 1232						
Preset	When "Max Num of Offsets" on page 1285 is 12, the preset value of Offset G ~ L is the same as the Offset F value						
	<table border="1"> <thead> <tr> <th>Modes</th> <th>Values</th> </tr> </thead> <tbody> <tr> <td>5G NR</td> <td>10 MHz, 30 MHz, 0 Hz, 0 Hz, 0 Hz, 0 Hz 100 MHz, 200 MHz, 0 Hz, 0 Hz, 0 Hz, 0 Hz</td> </tr> <tr> <td>All Others</td> <td>2.5MHz,7.5MHz,0,0,0,0 2.5MHz,7.5MHz,0,0,0,0</td> </tr> </tbody> </table>	Modes	Values	5G NR	10 MHz, 30 MHz, 0 Hz, 0 Hz, 0 Hz, 0 Hz 100 MHz, 200 MHz, 0 Hz, 0 Hz, 0 Hz, 0 Hz	All Others	2.5MHz,7.5MHz,0,0,0,0 2.5MHz,7.5MHz,0,0,0,0
Modes	Values						
5G NR	10 MHz, 30 MHz, 0 Hz, 0 Hz, 0 Hz, 0 Hz 100 MHz, 200 MHz, 0 Hz, 0 Hz, 0 Hz, 0 Hz						
All Others	2.5MHz,7.5MHz,0,0,0,0 2.5MHz,7.5MHz,0,0,0,0						
State Saved	Saved in instrument state						
Min/Max	0 Hz/Depends on instrument maximum frequency. Same as Max Span of the Swept SA Measurement Auto Function						
Remote Command	<code>[:SENSe]:ACPower:OFFSet[1] 2:INNeR:LIST:STATe OFF ON 0 1,...</code> <code>[:SENSe]:ACPower:OFFSet[1] 2:INNeR:LIST:STATe?</code> Subopcode: 1 = BTS/Downlink (Default), 2 = MS/Uplink						
Example	<code>:ACP:OFFS2:INN:LIST:STAT 1,1,0,0,0,0</code> <code>:ACP:OFFS2:INN:LIST:STAT?</code>						
Preset	When "Max Num of Offsets" on page 1285 is 12, the preset value of Offset G ~ L is the same as the Offset F value <code>ON, ON, OFF, OFF, OFF, OFF ON, OFF, OFF, OFF, OFF, OFF</code>						
State Saved	Yes						

Integ BW

Sets the Integration Bandwidth for the offsets. Each resolution bandwidth in the list corresponds to an offset frequency in the list defined by `[:SENSe]:ACPower:OFFSet [n]:INNeR:LIST[:FREQUENCY]`.

Enter each value individually by selecting the desired offset on the **Offset** menu key using the up down arrows, the knob, or the numeric keypad, then enter the Offset Integration Bandwidth using the **Offset Integration Bandwidth** menu key.

You can turn off (not use) specific offsets with `[:SENSe]:ACPower:OFFSet [n]:INNeR:LIST:STATE`.

Remote Command	<code>[:SENSe]:ACPower:OFFSet[1] 2:INNeR:LIST:BANDwidth[:INTEgration] <freq>,...</code> <code>[:SENSe]:ACPower:OFFSet[1] 2:INNeR:LIST:BANDwidth[:INTEgration]?</code> Subopcode: 1 = BTS/Downlink (Default), 2 = MS/Uplink								
Example	<code>:ACP:OFFS2:INN:LIST:BAND 2MHz,2MHz,2MHz,2MHz,2MHz,2MHz</code> <code>:ACP:OFFS2:INN:LIST:BAND?</code>								
Notes	When setting these values remotely, the position in the list sent corresponds to the offset. Missing values are not permitted, so, if you want to change the second value you must send all values up to it. Subsequent values remain unchanged								
Couplings	Changing Integ BW might affect " Span " on page 1232								
Preset	When " Max Num of Offsets " on page 1285 is 12, the preset value of Offset G ~ L is the same as the Offset F value								
	<table border="1"> <thead> <tr> <th>Modes</th> <th>Values</th> </tr> </thead> <tbody> <tr> <td>LTEAFDD</td> <td>3.84MHz, 3.84MHz, 3.84MHz, 3.84MHz, 3.84MHz, 3.84MHz 3.84MHz, 3.84MHz, 3.84MHz, 3.84MHz, 3.84MHz</td> </tr> <tr> <td>MSR, LTEATDD</td> <td>4.515MHz, 4.515MHz, 4.515MHz, 4.515MHz, 4.515MHz, 4.515MHz 4.5MHz, 4.5MHz, 4.5MHz, 4.5MHz, 4.5MHz</td> </tr> <tr> <td>5G NR</td> <td>19.08 MHz, 19.08 MHz, 19.08 MHz, 19.08 MHz, 19.08 MHz, 19.08 MHz 98.31 MHz, 98.31 MHz, 98.31 MHz, 98.31 MHz, 98.31 MHz</td> </tr> </tbody> </table>	Modes	Values	LTEAFDD	3.84MHz, 3.84MHz, 3.84MHz, 3.84MHz, 3.84MHz, 3.84MHz 3.84MHz, 3.84MHz, 3.84MHz, 3.84MHz, 3.84MHz	MSR, LTEATDD	4.515MHz, 4.515MHz, 4.515MHz, 4.515MHz, 4.515MHz, 4.515MHz 4.5MHz, 4.5MHz, 4.5MHz, 4.5MHz, 4.5MHz	5G NR	19.08 MHz, 19.08 MHz, 19.08 MHz, 19.08 MHz, 19.08 MHz, 19.08 MHz 98.31 MHz, 98.31 MHz, 98.31 MHz, 98.31 MHz, 98.31 MHz
Modes	Values								
LTEAFDD	3.84MHz, 3.84MHz, 3.84MHz, 3.84MHz, 3.84MHz, 3.84MHz 3.84MHz, 3.84MHz, 3.84MHz, 3.84MHz, 3.84MHz								
MSR, LTEATDD	4.515MHz, 4.515MHz, 4.515MHz, 4.515MHz, 4.515MHz, 4.515MHz 4.5MHz, 4.5MHz, 4.5MHz, 4.5MHz, 4.5MHz								
5G NR	19.08 MHz, 19.08 MHz, 19.08 MHz, 19.08 MHz, 19.08 MHz, 19.08 MHz 98.31 MHz, 98.31 MHz, 98.31 MHz, 98.31 MHz, 98.31 MHz								
State Saved	Saved in instrument state								
Min/Max	10 Hz/Depends on instrument maximum frequency. Same as Max Span of the Swept SA Measurement								

Offset Side

Lets you turn off (not use) specific offsets with `[:SENSe]:ACPower:OFFSet [1]|2:INNeR:LIST:SIDE`.

- **NEGative** - The upper side in the sub-block gap only (that is, negative sideband of the upper sub-block) is enabled

- **BOTH** - Both sides in the sub-block gap are enabled
- **POSitive** - The lower side in the sub-block gap only (that is, positive sideband of the lower sub-block) is enabled

The diagram below shows the relation between the negative/positive offset side setups and the upper/lower results in the MSR, LTEAFDD and LTEATDD Modes.

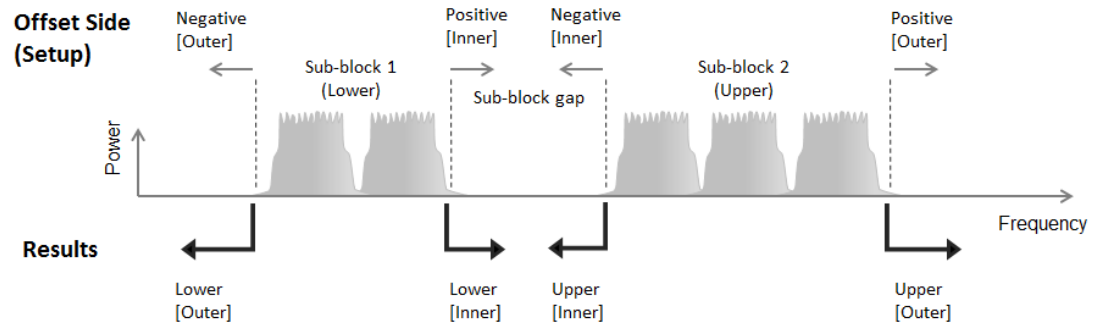

Remote Command	<code>[:SENSe]:ACPower:OFFSet[1] 2:INNeR:LIST:SIDE NEGative BOTH POSitive, ...</code> <code>[:SENSe]:ACPower:OFFSet[1] 2:INNeR:LIST:SIDE?</code> Subopcode: 1 = BTS/Downlink (Default), 2 = MS/Uplink
Example	<code>:ACP:OFFS:INN:LIST:SIDE BOTH</code> <code>:ACP:OFFS:INN:LIST:SIDE?</code>
Notes	If you set POS or NEG in an offset, result of the inactive side returns -999
Preset	When " Max Num of Offsets " on page 1285 is 12, the preset value of Offset G ~ L is BOTH BOTH, BOTH, BOTH, BOTH, BOTH, BOTH BOTH, BOTH, BOTH, BOTH, BOTH, BOTH
State Saved	Saved in instrument state
Range	NEGative BOTH POSitive

Method

Lets you turn RRC filtering of each offset on or off. The value (roll off) for the filter is set to the value of the Filter Alpha parameter.

Remote Command	<code>[:SENSe]:ACPower:OFFSet[1] 2:INNeR:LIST:FILTer[:RRC][:STATe] ON OFF 1 0, ...</code> <code>[:SENSe]:ACPower:OFFSet[1] 2:INNeR:LIST:FILTer[:RRC][:STATe]?</code> Subopcode: 1 = BTS/Downlink (Default), 2 = MS/Uplink
Example	<code>:ACP:OFFS:INN:LIST:FILT 1,0,0</code> <code>:ACP:OFFS:INN:LIST:FILT?</code>
Notes	1 ON = RRC Weighted, 0 OFF = Integ BW

Preset	When " Max Num of Offsets " on page 1285 is 12, the preset value of Offset G ~ L is the same as the Offset F value						
	<table border="1"> <thead> <tr> <th>Modes</th> <th>Values</th> </tr> </thead> <tbody> <tr> <td>LTEAFDD</td> <td>1,1,1,1,1,1 1,1,1,1,1,1</td> </tr> <tr> <td>MSR, LTEATDD, 5G NR</td> <td>0,0,0,0,0,0 0,0,0,0,0,0</td> </tr> </tbody> </table>	Modes	Values	LTEAFDD	1,1,1,1,1,1 1,1,1,1,1,1	MSR, LTEATDD, 5G NR	0,0,0,0,0,0 0,0,0,0,0,0
Modes	Values						
LTEAFDD	1,1,1,1,1,1 1,1,1,1,1,1						
MSR, LTEATDD, 5G NR	0,0,0,0,0,0 0,0,0,0,0,0						
State Saved	Saved in instrument state						
Range	Integ BW RRC Weighted						

Filter Alpha

Sets the alpha value for the RRC Filter for each offset.

Remote Command	<pre>[:SENSe]:ACPower:OFFSet[1] 2:INNeR:LIST:FILTer:ALPHa <real>,...</pre> <pre>[:SENSe]:ACPower:OFFSet[1] 2:INNeR:LIST:FILTer:ALPHa?</pre> <p>Subopcode: 1 = BTS/Downlink (Default), 2 = MS/Uplink</p>
Example	<pre>:ACP:OFFS:INN:LIST:FILT:ALPH 0.5,0.5,0.5,0.5,0.5,0.5</pre> <pre>:ACP:OFFS:INN:LIST:FILT:ALPH?</pre>
Preset	When " Max Num of Offsets " on page 1285 is 12, the preset value of Offset G ~ L is 0.22 0.22,0.22,0.22,0.22,0.22,0.22 0.22,0.22,0.22,0.22,0.22,0.22
State Saved	Saved in instrument state
Min/Max	0.01/1.00

Offset Freq

The same as "[Offset Freq](#)" on page 1315 in the main **Inner Offset** menu.

Res BW

Sets the Resolution Bandwidth. If an unavailable bandwidth is entered with the numeric keypad, the closest available bandwidth is selected.

Remote Command	<pre>[:SENSe]:ACPower:OFFSet[1] 2:INNeR:LIST:BANDwidth:RESolution <freq>,...</pre> <pre>[:SENSe]:ACPower:OFFSet[1] 2:INNeR:LIST:BANDwidth:RESolution?</pre> <p>Subopcode: 1 = BTS/Downlink (Default), 2 = MS/Uplink</p>
Example	<pre>:ACP:OFFS2:INN:LIST:BAND:RES 220kHz,220kHz,220kHz,220kHz,220kHz,220kHz</pre> <pre>:ACP:OFFS2:INN:LIST:BAND:RES?</pre>
Dependencies	When " Meas Method " on page 1246 is RBW, FAST or Fast Power, this control is grayed-out and disabled. If the cell is pressed, an advisory message is generated. If the equivalent SCPI remote

	command is sent, a "Setting conflict" warning is generated
Couplings	When " Res BW " on page 1214 Mode is Auto , this value is exactly the same as Res BW . When you change this value, Res BW Mode also changes to Man
Preset	When " Max Num of Offsets " on page 1285 is 12, the preset value of Offset G ~ L is 100 kHz 100 kHz, 100 kHz, 100k Hz, 100 kHz 100 kHz, 100 kHz, 100 kHz, 100 kHz, 100 kHz, 100 kHz
State Saved	Saved in instrument state
Min/Max	1 Hz/8 MHz

Auto Function

Remote Command	<code>[:SENSe]:ACPower:OFFSet[1] 2:INNeR:LIST:BANDwidth:RESolution:AUTO ON OFF 1 0,...</code> <code>[:SENSe]:ACPower:OFFSet[1] 2:INNeR:LIST:BANDwidth:RESolution:AUTO?</code> Subopcode: 1 = BTS/Downlink (Default), 2 = MS/Uplink
Example	<code>:ACP:OFFS2:INN:LIST:BAND:RES:AUTO 1,1,1,1,1,1</code> <code>:ACP:OFFS2:INN:LIST:BAND:RES:AUTO?</code>
Preset	When " Max Num of Offsets " on page 1285 is 12, the preset value of Offset G ~ L is 1 1, 1, 1, 1, 1, 1
State Saved	Yes

Video BW

Lets you change the instrument post-detection filter (VBW).

Remote Command	<code>[:SENSe]:ACPower:OFFSet[1] 2:INNeR:LIST:BANDwidth:VIDeo <freq>,...</code> <code>[:SENSe]:ACPower:OFFSet[1] 2:INNeR:LIST:BANDwidth:VIDeo?</code> Subopcode: 1 = BTS/Downlink (Default), 2 = MS/Uplink
Example	<code>:ACP:OFFS2:INN:LIST:BAND:VID 5MHz,5MHz,5MHz,5MHz,5MHz,5MHz</code> <code>:ACP:OFFS2:INN:LIST:BAND:VID?</code>
Notes	The values shown in this table reflect the conditions after Mode Preset
Dependencies	When " Meas Method " on page 1246 is RBW, FAST or Fast Power, this cell is grayed-out and disabled. If the cell is pressed, an advisory message is generated. If the equivalent remote command is sent, a "Setting conflict" warning is generated
Preset	When " Max Num of Offsets " on page 1285 is 12, the preset value of Offset G ~ L is 1 MHz 1 MHz, 1 MHz, 1 MHz, 1 MHz, 1 MHz, 1 MHz
State Saved	Yes
Min/Max	1 Hz/50 MHz

Auto Function

3 VMA Mode
3.8 ACP Measurement

Remote Command	<code>[:SENSe]:ACPower:OFFSet[1] 2:INNER:LIST:BANDwidth:VIDeo:AUTO OFF ON 0 1,...</code> <code>[:SENSe]:ACPower:OFFSet[1] 2:INNER:LIST:BANDwidth:VIDeo:AUTO?</code> Subopcode: 1 = BTS/Downlink (Default), 2 = MS/Uplink
Example	<code>:ACP:OFFS2:INN:LIST:BAND:VID:AUTO 0,0,0,0,1,1</code> <code>:ACP:OFFS2:INN:LIST:BAND:VID:AUTO?</code>
Preset	When "Max Num of Offsets" on page 1285 is 12, the preset value of Offset G ~ L is ON, ON, ON, ON, ON, ON
State Saved	Yes

Filter Type

Selects the type of bandwidth filter that is used.

Remote Command	<code>[:SENSe]:ACPower:OFFSet[1] 2:INNER:LIST:BANDwidth:SHAPE GAUSSian FLATtop,...</code> <code>[:SENSe]:ACPower:OFFSet[1] 2:INNER:LIST:BANDwidth:SHAPE?</code> Subopcode: 1 = BTS/Downlink (Default), 2 = MS/Uplink
Example	<code>:ACP:OFFS2:INN:LIST:BAND:SHAP FLAT, GAUS, GAUS, GAUS, GAUS, GAUS</code> <code>:ACP:OFFS2:INN:LIST:BAND:SHAP?</code>
Dependencies	When "Res BW" on page 1214 Mode for the offset is Auto , this cell is grayed-out and disabled. Since Res BW Mode for the offset is preset to Auto on changing "Meas Method" on page 1246 to RBW, FAST or Fast Power, this cell is grayed-out and disabled. If the cell is pressed, an advisory message is generated. If the equivalent remote command is sent, a "Setting conflict" warning is generated
Preset	When "Max Num of Offsets" on page 1285 is 12, the preset value of Offset G ~ L is GAUSSian, GAUSSian, GAUSSian, GAUSSian, GAUSSian, GAUSSian
State Saved	Saved in instrument state
Range	GAUSSian FLATtop

Filter BW

Selects a Gaussian filter based on its -3 dB (Normal) bandwidth or its -6 dB bandwidth.

Remote Command	<code>[:SENSe]:ACPower:OFFSet[1] 2:INNER:LIST:BANDwidth:TYPE DB3 DB6,...</code> <code>[:SENSe]:ACPower:OFFSet[1] 2:INNER:LIST:BANDwidth:TYPE?</code> Subopcode: 1 = BTS/Downlink (Default), 2 = MS/Uplink
Example	<code>:ACP:OFFS2:INN:LIST:BAND:TYPE DB3,DB3,DB3,DB3,DB3,DB3</code> <code>:ACP:OFFS2:INN:LIST:BAND:TYPE?</code>
Dependencies	When "RBW Filter Type" on page 1217 is FLATtop or "Res BW" on page 1214 Mode for the offset is

	Auto , this cell is grayed-out and disabled. Since Res BW Mode for the offset is preset to Auto on changing " Meas Method " on page 1246 to RBW, FAST or Fast Power, this cell is also grayed-out and disabled. If the cell is pressed, an advisory message is generated. If the equivalent remote command is sent, a "Setting conflict" warning is generated
Preset	When " Max Num of Offsets " on page 1285 is 12, the preset value of Offset G ~ L is DB3 DB3, DB3, DB3, DB3, DB3, DB3
State Saved	Saved in instrument state
Range	-3 dB (Normal) -6 dB

Power Ref Type

Lets you set reference types of inner offsets.

CUMulative Cumulated power of the upper and lower sub-block carriers is the reference level. This selection is effective only when one of the following "**Power Ref**" on page 1331 values is selected:

Left & Right Carriers	LRCarriers
Max Power Carrier in Sub-block	MPCSubblock
Min Power Carrier in Sub-block	MINSubblock
Left & Right Sub-blocks	LRSubblocks
Manual	MANual

When one of the other **Power Ref** values is selected, carrier powers are not cumulated, and the reference level is equivalent to Normal

NORMal Power of specified carrier or the manual reference level is the reference level

Remote Command	<code>[:SENSe]:ACPower:OFFSet[1] 2:INNeR:LIST:PREFeRence CUMulative NORMal, ...</code> <code>[:SENSe]:ACPower:OFFSet[1] 2:INNeR:LIST:PREFeRence?</code> Subopcode: 1 = BTS/Downlink (Default), 2 = MS/Uplink
Example	<code>:ACP:OFFS:INN:LIST:PREF CUM,CUM,NORM,NORM,NORM,NORM</code> <code>:ACP:OFFS:INN:LIST:PREF?</code>
Preset	When " Max Num of Offsets " on page 1285 is 12, the preset value of Offset G ~ L is NORMal NORMal, NORMal, NORMal, NORMal, NORMal, NORMal
State Saved	Saved in instrument state
Range	CUMulative NORMal

Auto Function

Remote Command	<code>[:SENSe]:ACPower:OFFSet[1] 2:INNeR:LIST:PREFeRence:AUTO OFF ON 0 1, ...</code> <code>[:SENSe]:ACPower:OFFSet[1] 2:INNeR:LIST:PREFeRence:AUTO?</code> Subopcode: 1 = BTS/Downlink (Default), 2 = MS/Uplink
Example	<code>:ACP:OFFS:INN:LIST:PREF:AUTO OFF,OFF,OFF,OFF,OFF,OFF</code>

3 VMA Mode
3.8 ACP Measurement

:ACP:OFFS:INN:LIST:PREF:AUTO?

Dependencies	Available only in LTEAFDD, LTEATDD and 5G NR Modes																												
Couplings	<p>When in the LTEAFDD, LTEATDD Modes, the inner power ref type is set automatically when the power ref type state is auto according to the scopes of the sub-block gap in the following table</p> <table border="1"> <thead> <tr> <th>Sub-block Gap</th> <th>Inner ACP offset</th> <th>Power Ref Type</th> </tr> </thead> <tbody> <tr> <td rowspan="2">Wgap <5MHz</td> <td>1st (2.5MHz)</td> <td>Normal</td> </tr> <tr> <td>2nd (7.5MHz)</td> <td>Normal</td> </tr> <tr> <td rowspan="2">5MHz ≤ Wgap <10MHz</td> <td>1st (2.5MHz)</td> <td>Cumulative</td> </tr> <tr> <td>2nd (7.5MHz)</td> <td>Normal</td> </tr> <tr> <td rowspan="2">10MHz ≤ Wgap <15MHz</td> <td>1st (2.5MHz)</td> <td>Cumulative</td> </tr> <tr> <td>2nd (7.5MHz)</td> <td>Cumulative</td> </tr> <tr> <td rowspan="2">15MHz ≤ Wgap <20MHz</td> <td>1st (2.5MHz)</td> <td>Normal</td> </tr> <tr> <td>2nd (7.5MHz)</td> <td>Cumulative</td> </tr> <tr> <td rowspan="2">20MHz ≤ Wgap</td> <td>1st (2.5MHz)</td> <td>Normal</td> </tr> <tr> <td>2nd (7.5MHz)</td> <td>Normal</td> </tr> </tbody> </table> <p>When in 5G NR Mode, Power Ref Type “Auto” sets the power reference type of inner-ACLR offset automatically</p> <p>Downlink: “Cumulative” or “Normal” is selected accordingly when the inner-offsets are configured to meet the test requirements as follows:</p> <p>FR1, 3GPP TS 38.141-1 v16.5.0 (2020-09) Section 6.6.3.5.3 BS type 1-C:</p> <ul style="list-style-type: none"> - Table 6.6.3.5.2-3: Base Station ACLR limit in non-contiguous spectrum or multiple bands - Table 6.6.3.5.2-4: Base station CAACLR limit <p>FR2, 3GPP TS 38.141-2 v16.5.0 (2020-09) Section 6.7.3.5.3 BS type 2-O:</p> <ul style="list-style-type: none"> - Table 6.7.3.5.2-3: BS type 2-O ACLR limit in non-contiguous spectrum - Table 6.7.3.5.2-4: BS type 2-O CAACLR limit in non-contiguous spectrum <p>Uplink: “Normal” is always selected</p>	Sub-block Gap	Inner ACP offset	Power Ref Type	Wgap <5MHz	1st (2.5MHz)	Normal	2nd (7.5MHz)	Normal	5MHz ≤ Wgap <10MHz	1st (2.5MHz)	Cumulative	2nd (7.5MHz)	Normal	10MHz ≤ Wgap <15MHz	1st (2.5MHz)	Cumulative	2nd (7.5MHz)	Cumulative	15MHz ≤ Wgap <20MHz	1st (2.5MHz)	Normal	2nd (7.5MHz)	Cumulative	20MHz ≤ Wgap	1st (2.5MHz)	Normal	2nd (7.5MHz)	Normal
Sub-block Gap	Inner ACP offset	Power Ref Type																											
Wgap <5MHz	1st (2.5MHz)	Normal																											
	2nd (7.5MHz)	Normal																											
5MHz ≤ Wgap <10MHz	1st (2.5MHz)	Cumulative																											
	2nd (7.5MHz)	Normal																											
10MHz ≤ Wgap <15MHz	1st (2.5MHz)	Cumulative																											
	2nd (7.5MHz)	Cumulative																											
15MHz ≤ Wgap <20MHz	1st (2.5MHz)	Normal																											
	2nd (7.5MHz)	Cumulative																											
20MHz ≤ Wgap	1st (2.5MHz)	Normal																											
	2nd (7.5MHz)	Normal																											
Preset	<p>When "Max Num of Offsets" on page 1285 is 12, the preset value of Offset G ~ L is the same as the Offset F value</p> <p>ON, ON, ON, ON, ON, ON OFF, OFF, OFF, OFF, OFF, OFF</p>																												
State Saved	Saved in instrument state																												
Range	Auto Man																												

Limit Test

This checkbox is the same as "**Limit Test**" on page 1307 in the **Settings** tab.

Offset Freq

This column is the same as "Offset Freq" on page 1315 in the **Offset** tab.

Abs Limit

Specifies an absolute limit value, which sets the absolute amplitude levels to test against for each of the custom offsets. The list must contain 6 entries. If there is more than one offset, the offset closest to the carrier channel is the first one in the list. `[:SENSe]:ACP:OFFSet[n]:INNER:LIST:TEST` selects the type of testing to be done at each offset.

You can turn off (not use) specific offsets with `[:SENSe]:ACP:OFFSet[n]:INNER:LIST:STATE`.

The query returns the 6 sets of real numbers that are the current absolute amplitude test limits.

Remote Command	<code>[:SENSe]:ACPower:OFFSet[1] 2:INNER:LIST:ABSolute < real>,...</code> <code>[:SENSe]:ACPower:OFFSet[1] 2:INNER:LIST:ABSolute?</code>						
Example	Subopcode: 1 = BTS/Downlink (Default), 2 = MS/Uplink <code>:ACP:OFFS2:INN:LIST:ABS -10,-10,-10,-10,-10,-10</code> <code>:ACP:OFFS2:INN:LIST:ABS?</code>						
Preset	When "Max Num of Offsets" on page 1285 is 12, the preset value of Offset G ~ L is the same as the Offset F value						
	<table border="1"> <thead> <tr> <th>Modes</th> <th>Values</th> </tr> </thead> <tbody> <tr> <td>5G NR</td> <td>-2.2, -2.2, -2.2, -2.2, -2.2, -2.2 -50.0,-50.0,-50.0,-50.0,-50.0,-50.0</td> </tr> <tr> <td>All Others</td> <td>-8.45,-8.45,-8.45,-8.45,-8.45,-8.45 -50.0,-50.0,-50.0,-50.0,-50.0,-50.0</td> </tr> </tbody> </table>	Modes	Values	5G NR	-2.2, -2.2, -2.2, -2.2, -2.2, -2.2 -50.0,-50.0,-50.0,-50.0,-50.0,-50.0	All Others	-8.45,-8.45,-8.45,-8.45,-8.45,-8.45 -50.0,-50.0,-50.0,-50.0,-50.0,-50.0
Modes	Values						
5G NR	-2.2, -2.2, -2.2, -2.2, -2.2, -2.2 -50.0,-50.0,-50.0,-50.0,-50.0,-50.0						
All Others	-8.45,-8.45,-8.45,-8.45,-8.45,-8.45 -50.0,-50.0,-50.0,-50.0,-50.0,-50.0						
State Saved	Saved in instrument state						
Min/Max	-200.0 dBm/50.0 dBm						

Rel Limit (Car)

Specifies a relative limit value for the carrier level. This sets the amplitude levels to test against for the specified offsets.

The amplitude level is relative to the carrier amplitude. If multiple offsets are available, the list contains 6 entries. The offset closest to the carrier channel is the first one in the list. `[:SENSe]:ACP:OFFSet[n]:INNER:LIST:TEST` selects the type of testing to be done at each offset.

3 VMA Mode
3.8 ACP Measurement

You can turn off (not use) specific offsets with `[:SENSe]:ACP:OFFSet [n]:INNeR:LIST:STATe`.

The query returns the 6 sets of real numbers that are the current amplitude test limits, relative to the carrier, for each offset.

Offset[n] n = 1 is base station and n = 2 is mobiles. The default is base station (1).

Remote Command	<code>[:SENSe]:ACP:OFFSet[1] 2:INNeR:LIST:RCARrier <real>,...</code> <code>[:SENSe]:ACP:OFFSet[1] 2:INNeR:LIST:RCARrier?</code> Subopcode: 1 = BTS/Downlink (Default), 2 = MS/Uplink						
Example	<code>:ACP:OFFS2:INN:LIST:RCAR 0,0,0,0,0,0</code> <code>:ACP:OFFS2:INN:LIST:RCAR?</code>						
Preset	When "Max Num of Offsets" on page 1285 is 12, the preset value of Offset G ~ L is the same as the Offset F value						
	<table border="1"> <thead> <tr> <th>Modes</th> <th>Values</th> </tr> </thead> <tbody> <tr> <td>5G NR</td> <td>-43.8, -43.8, 43.8, -43.8, -43.8, -43.8 -29.2, -29.2, -29.2, -29.2, -29.2, -29.2</td> </tr> <tr> <td>All Others</td> <td>-44.2, -44.2, -44.2, -44.2, -44.2, -44.2 -29.2, -29.2, -29.2, -29.2, -29.2, -29.2</td> </tr> </tbody> </table>	Modes	Values	5G NR	-43.8, -43.8, 43.8, -43.8, -43.8, -43.8 -29.2, -29.2, -29.2, -29.2, -29.2, -29.2	All Others	-44.2, -44.2, -44.2, -44.2, -44.2, -44.2 -29.2, -29.2, -29.2, -29.2, -29.2, -29.2
Modes	Values						
5G NR	-43.8, -43.8, 43.8, -43.8, -43.8, -43.8 -29.2, -29.2, -29.2, -29.2, -29.2, -29.2						
All Others	-44.2, -44.2, -44.2, -44.2, -44.2, -44.2 -29.2, -29.2, -29.2, -29.2, -29.2, -29.2						
State Saved	Saved in instrument state						
Min/Max	-150/50.0						

Rel Limit (PSD)

Specifies a relative limit value for the level of the power spectral density. This sets the amplitude levels to test against for any custom offsets. The amplitude level is relative to the power spectral density. If multiple offsets are available, the list contains 6 entries. The offset closest to the carrier channel is the first one in the list.

`[:SENSe]:ACP:OFFSet [n]:INNeR:LIST:TEST` selects the type of testing to be done at each offset.

You can turn off (not use) specific offsets with `[:SENSe]:ACP:OFFSet [n]:INNeR:LIST:STATe`.

The query returns the 6 sets of real numbers that are the current amplitude test limits, relative to the power spectral density, for each offset.

Offset[n] n = 1 is base station and n = 2 is mobiles. The default is base station (1).

Remote Command	<code>[:SENSe]:ACP:OFFSet[1] 2:INNeR:LIST:RPSDensity <rel_amp>,...</code> <code>[:SENSe]:ACP:OFFSet[1] 2:INNeR:LIST:RPSDensity?</code> Subopcode: 1 = BTS/Downlink (Default), 2 = MS/Uplink
Example	<code>:ACP:OFFS2:INN:LIST:RPSD 10,10,10,10,10,10</code> <code>:ACP:OFFS2:INN:LIST:RPSD?</code>

Preset	When "Max Num of Offsets" on page 1285 is 12, the preset value of Offset G ~ L is 0 0, 0, 0, 0, 0, 0 0, 0, 0, 0, 0, 0
State Saved	Saved in instrument state
Min/Max	-150.0 dB/50.0 dB

Fail Mask

Accesses a menu that enables you to select one of the logics for the fail conditions between the measurement results and the test limits. The setting defines the type of testing to be done at any custom offset frequencies. The measured powers are tested against the absolute values defined with `[:SENSe]:ACP:OFFSet [n]:INNeR:LIST:ABSolute`, or the relative values defined with `[:SENSe]:ACP:OFFSet [n]:INNeR:LIST:RPSDeNsity` and `[:SENSe]:ACP:OFFSet [n]:INNeR:LIST:RCARrier`.

You can turn off (not use) specific offsets with `[:SENSe]:ACP:OFFSet [n]:INNeR:LIST:STATe`.

Option	SCPI	Description
Absolute	<code>ABSolute</code>	Fail is shown if one of the absolute ACP measurement results is larger than the limit for Abs Limit
Relative	<code>RELative</code>	Fail is shown if one of the relative ACP measurement results is larger than the limit for Rel Lim (Car) or Rel Lim (PSD)
Abs AND Rel	<code>AND</code>	Fail is shown if one of the absolute ACP measurement results is larger than the limit for Abs Limit <i>and</i> one of the relative ACP measurement results is larger than the limit for Rel Lim (Car) or Rel Lim (PSD)
Abs OR Rel	<code>OR</code>	Fail is shown if one of the absolute ACP measurement results is larger than the limit for Abs Limit <i>or</i> one of the relative ACP measurement results is larger than the limit for Rel Lim (Car) or Rel Lim (PSD)

Remote Command	<code>[:SENSe]:ACP:Power:OFFSet [1] 2:INNeR:LIST:TEST ABSolute AND OR RELative,...</code> <code>[:SENSe]:ACP:Power:OFFSet [1] 2:INNeR:LIST:TEST?</code> Subopcode: 1 = BTS/Downlink (Default), 2 = MS/Uplink
Example	<code>:ACP:OFFS2:INN:LIST:TEST ABS,ABS,ABS,ABS,ABS,ABS</code> <code>:ACP:OFFS2:INN:LIST:TEST?</code>
Preset	When "Max Num of Offsets" on page 1285 is 12, the preset value of Offset G ~ L is <code>AND</code> <code>AND, AND, AND, AND, AND, AND AND, AND, AND, AND, AND, AND</code>
State Saved	Saved in instrument state
Range	<code>ABSolute AND OR RELative</code>

Max Num of Offsets

Sets the max number of offsets: either 6 or 12.

This setting applies only to SCPI operations. To specify the same behavior as that of the previous version, selecting 6 offsets is recommended. If you select 12 offsets, the results returned by the **:READ** | **:FETCH** queries increase accordingly.

Example:

When you select 6 offsets, querying the offset state returns 6 values, as below.

```
-> :SENSe:ACPower:OFFSet:LIST:STATe?
<- 1,0,0,0,0,0
```

When you select 12 offsets, sending the same query returns 12 values, as below.

```
-> :SENSe:ACPower:OFFSet:LIST:STATe?
<- 1,0,0,0,0,0,0,0,0,0,0,0
```

If your program depends on the number of returned values, you should select 6 offsets, or else change your program.

Remote Command	<code>[:SENSe]:ACPower:OFFSet:MAXNumber NUM6 NUM12</code> <code>[:SENSe]:ACPower:OFFSet:MAXNumber?</code>
Example	<code>:ACP:OFFS:MAXN NUM12</code> <code>:ACP:OFFS:MAXN?</code>
Preset	<code>NUM6</code>
State Saved	Saved in instrument state
Range	6 12

Limit Test

Turns limit checking for each offset On or Off. The limits may be specified in the **Offset** menu, for each offset, both sides of the carrier. For results that fail the limit, a red F is appended. In the **Combined** view, the bar turns red.

Remote Command	<code>:CALCulate:ACPower:LIMit:STATe OFF ON 0 1</code> <code>:CALCulate:ACPower:LIMit:STATe?</code>
Example	<code>:CALC:ACP:LIM:STAT OFF</code> <code>:CALC:ACP:LIM:STAT?</code>
Preset	SA OFF WCDMA, LTEAFDD, LTEATDD, 5G NR, MSR ON

State Saved	Saved in instrument state
Range	ON OFF
Backwards Compatibility SCPI	[:SENSe] :MCPower :LIMit [:STATe] [:SENSe] :ACPower :LIMit [:STATe]

Spur Avoidance

Because VXT models M9410A/11A/15A are direct-conversion (zero-IF) receivers, feedthrough leakage from the local oscillator appears as a spurious signal (spur) at the center frequency. The **Spur Avoidance** function is provided to eliminate this spur, at the expense of some measurement speed.

When **Spur Avoidance** is enabled (the default), the instrument uses a software algorithm to remove this spur from the displayed measurement data, but the algorithm only operates under certain conditions. Specifically, it only operates in multiple capture case.

You can disable this function to speed up your measurement by setting **Spur Avoidance** to **Disabled**.

Note that when **Spur Avoidance** is not in effect, either because you have disabled it or because you are not in multiple capture, the following warning message appears in the status bar:

Settings Alert;Spur Avoidance Off

This is to alert you that measurement accuracy might be impacted by the fact that **Spur Avoidance** is not in effect.

Remote Command	[:SENSe] :ACPower :SAVoid [:STATe] ON OFF 0 1 [:SENSe] :ACPower :SAVoid [:STATe] ?
Example	:ACP :SAVoid ON :ACP :SAVoid ?
Dependencies	Only appears in VXT models M9410A/11A/15A
Preset	OFF
State Saved	Saved in instrument state
Range	ON OFF

Meas Setup Summary Table

Lets you view and access many of the parameters in the **Meas Setup** menus on one screen.

Auto Couple

Immediately puts all **Auto/Man** functions into **Auto**. **Auto Couple** is confined to the current measurement only. It does not affect other measurements in the Mode.

In the **Auto** state, **Auto/Man** functions are said to be “coupled”, meaning their values change as you make changes to other values in the measurement. This helps ensure accurate measurements and optimum dynamic range. **Auto Couple** is an immediate action function, and when it is executed, all the **Auto/Man** controls for the current measurement are set to **Auto**, and all measurement settings coupled to the **Auto/Man** parameters are automatically set to their optimal values.

For further details of measurement-specific settings (if any), see "[Measurement-Specific Details](#)" on page 1288 below.

Remote Command	:COUPle ALL
Example	:COUP ALL
Backwards Compatibility SCPI	:COUPLE ALL NONE
Backwards Compatibility Notes	: COUP :NONE puts all Auto/Man parameters in manual mode, decoupling all the coupled instrument parameters. It is retained for backwards compatibility and is <i>not</i> recommended for making measurements or new designs

All **Auto/Man** parameter couplings in the measurement are set to **Auto**. This includes couplings that may be unavailable or grayed-out due to the current state. For example, in the Swept SA measurement, there is no **Auto/Man** coupling for **RBW** while in Zero Span. Nonetheless, if **Auto Couple** were executed while in Zero Span, it would set **RBW** to Auto "behind the scenes" so that, on exit from Zero Span, it would be in **Auto**.

Any **Auto/Man** selection specific (local) to the other measurements in the current Mode are not affected by **Auto Couple**. Any functions that are *not* coupled with other instrument parameters, such as ranging or leveling variables, such as **AutoRange** or **AutoScale**, are not affected.

Executing **Auto Couple** generates the informational message, "All Auto/Man functions have been set to Auto".

Each parameter, upon being set to **Auto**, selects and sets the appropriate auto-coupled value based on that parameter's coupling rules. The Dependency Resolver orchestrates the couplings for parameters that depend on one or more other parameters. The coupling and dependency rules for each parameter are defined in the section describing that parameter.

Executing **Auto Couple** does not affect markers, marker functions, trace or display attributes, or any other instrument setting other than those specifically mentioned above.

Measurement-Specific Details

TOI (SA Mode only)

Parameters affected by **Auto Couple** are:

- Center Frequency Step
- Resolution Bandwidth
- Span/RBW Ratio
- Sweep Time
- Video BANDwidth VBW/RBW ratio
- Upper and Lower Tone (set to Sense)
- Zero span measurement Resolution Bandwidth
- Zero span measurement Dwell Time

Harmonics (SA Mode only)

Parameters affected by **Auto Couple** are:

- Resolution Bandwidth
- Fundamental Frequency
- Dwell Time
- Range Table Resolution Bandwidths
- Range Table Dwell Times

Meas Preset

Restores all measurement parameters to their default values.

Remote Command `:CONFigure:ACPower`

Example	<code>:CONF:ACP</code>
Couplings	Selecting Meas Preset restores all measurement parameters to their default values

3.8.13.2 Reference

All ACP measurements are taken relative to a specific carrier frequency, relative to whose power the offset channel power is measured.

The controls on this tab let you specify the reference carrier frequency and other parameters relevant to the reference carrier.

Number of Carriers

Specifies the number of carriers to be measured.

Remote Command	<code>[:SENSe]:ACPower:CARRier[1] 2:COUNT <integer></code> <code>[:SENSe]:ACPower:CARRier[1] 2:COUNT?</code> Subopcode: 1 = BTS/Downlink (Default), 2 = MS/Uplink
Example	<code>:ACP:CARR:COUN 1</code> <code>:ACP:CARR:COUN?</code>
Notes	Note that Carrier subopcode 2 is not supported in some Modes. In those cases, Carrier subopcode 1 is used for both BTS and MS and commands with subopcode 2 are accepted without error but ignored
Dependencies	When Number of Carriers is 1, Ref Carrier is grayed out Does not appear in MSR, LTEAFDD, LTEATDD and 5G NR Modes. In order to maintain backwards compatibility with legacy LTE FDD/TDD Modes, the SCPI command is supported in the LTE-A converged applications
Couplings	Changing this parameter might affect "Span" on page 1232
Preset	1
State Saved	Saved in instrument state
Min/Max	1/18
Backwards Compatibility SCPI	<code>[:SENSe]:MCPower:CARRier[1] 2:COUNT</code> (Power Suite)

Carrier/Offset/Limits Config

This is the same dialog as ["Carrier/Offset/Limits Config" on page 1248](#) in the **Settings** menu.

Carrier

Lets you configure your carriers, carrier spacing, noise bandwidth and measurement method.

Dependencies Appears in all Modes except MSR, LTEAFDD, LTEATDD and 5G NR

Number of Carriers

This is the same as "[Number of Carriers](#)" on page 1289 under Reference.

Couple to #1

Couples carrier settings to carrier #1. The coupled parameters are:

- "[Carrier Pwr Present](#)" on page 1291
- "[Carrier Spacing](#)" on page 1292
- "[Measurement Noise Bandwidth](#)" on page 1292
- "[Method for Carrier](#)" on page 1293
- "[Filter Alpha for Carrier](#)" on page 1294

Remote Command	<code>[:SENSe]:ACPower:CARRier[1] 2:LIST:COUple OFF ON 0 1, ...</code> <code>[:SENSe]:ACPower:CARRier[1] 2:LIST:COUple?</code> Subopcode: 1 = BTS/Downlink (Default), 2 = MS/Uplink
Example	<code>:ACP:CARR:LIST:COUP OFF</code> <code>:ACP:CARR:LIST:COUP?</code>
Notes	Some modes do not support Carrier subopcode 2. In those cases, commands with subopcode 2 are accepted without error but ignored For LTEAFDD or LTEATDD Modes, this control is not shown. In order to maintain backwards compatibility with legacy LTE FDD/TDD, the SCPI command is supported in LTE & LTE-A converged applications
Couplings	When ON , the carrier settings are coupled to carrier #1. Coupled parameters are: Carrier Power Present, Carrier Spacing, Measurement Noise Bandwidth, Method and Filter Alpha When a setting is changed, coupling is switched off automatically Carrier #1 is always set to ON and cannot be changed
Preset	ON
State Saved	Saved in instrument state

Carrier Pwr Present

Configures the carriers for this measurement. Allows spaces to be inserted between carriers. Carriers with the power present parameter set to **YES** are carriers, and those with the power present parameter set to **NO** are spaces. Each carrier power present is set to **YES** or **NO**. The individual carrier can be set by selecting the desired carrier.

The query returns the current values for all of the carriers. If a carrier is defined as having no power present, the power displayed is relative to the reference carrier, otherwise the absolute power is displayed.

If you change the carrier power present to **NO**, and that carrier is currently configured as the reference carrier, the next carrier to the left (or the right if there are no carriers to the left) is assigned as the reference carrier. This also applies to the scenario where there are only two carriers configured as having power present, and you configure only one carrier to have no power present.

Remote Command	<pre>[:SENSe]:ACPower:CARRier[1] 2:LIST:PPresent YES NO, ... [:SENSe]:ACPower:CARRier[1] 2:LIST:PPresent?</pre> <p>Subopcode: 1 = BTS/Downlink (Default), 2 = MS/Uplink</p>
Example	<pre>:ACP:CARR2:LIST:PPR YES :ACP:CARR2:LIST:PPR?</pre>
Notes	<p>Some Modes do not support Carrier subopcode 2. In those cases, commands with subopcode 2 are accepted without error but ignored</p> <p>When setting these values remotely, the position in the list sent corresponds to the carrier. Missing values are not permitted, so if you want to change values 2 and 6, you must send all values up to 6. Subsequent values remain unchanged, unless the number of values sent is greater than the number of carriers, then subsequent values are ignored</p> <p>For LTEAFDD or LTEATDD Modes, this control is not shown. To maintain backwards compatibility with legacy LTE FDD/TDD Modes, the SCPI command is supported in the LTE & LTE-A converged applications</p>
Couplings	Coupled to number of carriers. When the SCPI command is sent, the number of carriers is set to the number of entries in the parameter list
Preset	YES
State Saved	Saved in instrument state
Backwards Compatibility SCPI	<pre>[:SENSe]:MCPower:CARRier[1] 2:LIST:PPresent</pre>

Carrier Spacing

Sets the width of the carrier spacing. This is the value applied to all the current slots, whether they are carriers or spaces.

Enter each carrier spacing value individually by selecting the desired carrier, and then enter the carrier width.

Remote Command	[:SENSe]:ACPpower:CARRier[1] 2:LIST:WIDTH <freq>, ... [:SENSe]:ACPpower:CARRier[1] 2:LIST:WIDTH?	
	Subopcode: 1 = BTS/Downlink (Default), 2 = MS/Uplink	
Example	:ACP:CARR2:LIST:WIDT 25kHz :ACP:CARR2:LIST:WIDT?	
Notes	<p>Some Modes do not support Carrier subopcode 2. In those cases, commands with subopcode 2 are accepted without error but ignored</p> <p>When setting these values remotely, the position in the list sent corresponds to the carrier. Missing values are not permitted, so if you want to change values 2 and 6, you must send all values up to 6. Subsequent values remain unchanged, unless the number of values sent is greater than the number of carriers, then subsequent values are ignored</p> <p>For LTEAFDD or LTEATDD Modes, this control is not shown. To maintain backwards compatibility with legacy LTE FDD/TDD Modes, the SCPI command is supported in the LTE & LTE-A converged applications</p>	
Couplings	<p>Coupled to number of carriers. When the SCPI command is sent, the number of carriers is set to the number of entries in the parameter list</p> <p>Changing Carrier Spacing might affect "Span" on page 1232</p>	
Preset	SA, WCDMA, LTE, LTE-TDD Modes	5 MHz
	Radio Test Mode	25 kHz
State Saved	Saved in instrument state	
Min/Max	0 Hz/Depends on instrument maximum frequency. Same as the Max Span of Swept SA Measurement	
Backwards Compatibility SCPI	[:SENSe]:MCPower:CARRier[1] 2:LIST:WIDTH	

Measurement Noise Bandwidth

Specifies the **Measurement Noise Bandwidth** used to calculate the power in the carriers.

Each **Measurement Noise Bandwidth** value is entered individually by selecting the desired carrier. Enter the measurement noise bandwidth on the **Carrier** page of the **Carr/Offset/Limits Config** dialog.

Remote Command	<code>[:SENSe]:ACPower:CARRier[1] 2:LIST:BANDwidth[:INTEgration] <freq>, ...</code> <code>[:SENSe]:ACPower:CARRier[1] 2:LIST:BANDwidth[:INTEgration]?</code> Subopcode: 1 = BTS/Downlink (Default), 2 = MS/Uplink										
Example	<code>:ACP:CARR2:LIST:BAND 25kHz</code> <code>:ACP:CARR2:LIST:BAND?</code>										
Notes	In WCDMA Mode, the preset/default value is defined as 3.84 MHz, but internally, 4.6848 MHz is used as the default value Some Modes do not support Carrier subopcode 2. In those cases, commands with subopcode 2 are accepted without error but ignored When setting these values remotely, the position in the list sent corresponds to the carrier. Missing values are not permitted, so if you want to change values 2 and 6, you must send all values up to 6. Subsequent values remain unchanged, unless the number of values sent is greater than the number of carriers, then subsequent values are ignored For LTEAFDD or LTEATDD Modes, this control is not shown. In order to maintain backwards compatibility with legacy LTE FDD/TDD Modes, the SCPI command is supported in the LTE & LTE-A converged applications										
Couplings	Coupled to number of carriers. When the SCPI command is sent, the number of carriers is set to the number of entries in the parameter list										
Preset	<table border="1"> <thead> <tr> <th>Modes</th> <th>Value</th> </tr> </thead> <tbody> <tr> <td>SA</td> <td>2 MHz</td> </tr> <tr> <td>WCDMA</td> <td>3.84 MHz</td> </tr> <tr> <td>LTE, LTE-TDD</td> <td>4.515 MHz 4.5 MHz</td> </tr> <tr> <td>Radio Test</td> <td>25 kHz</td> </tr> </tbody> </table>	Modes	Value	SA	2 MHz	WCDMA	3.84 MHz	LTE, LTE-TDD	4.515 MHz 4.5 MHz	Radio Test	25 kHz
Modes	Value										
SA	2 MHz										
WCDMA	3.84 MHz										
LTE, LTE-TDD	4.515 MHz 4.5 MHz										
Radio Test	25 kHz										
State Saved	Saved in instrument state										
Min/Max	10 Hz/Depends on instrument maximum frequency. Same as Max Span of the Swept SA Measurement										
Backwards Compatibility SCPI	<code>[:SENSe]:ACPower:BANDwidth:INTEgration</code> <code>[:SENSe]:ACPower:BWIDth:INTEgration</code> <code>[:SENSe]:ACPower:CARRier[1] 2:LIST:BWIDth[:INTEgration]</code> <code>[:SENSe]:MCPower:CARRier[1] 2:LIST:BANDwidth[:INTEgration]</code> <code>[:SENSe]:MCPower:CARRier[1] 2:LIST:BWIDth[:INTEgration]</code>										

Method for Carrier

Accesses the carrier configuration method settings.

Remote Command	<code>[:SENSe]:ACPower:CARRier[1] 2:LIST:FILTer[:RRC][:STATe] ON OFF 1 0, ...</code> <code>[:SENSe]:ACPower:CARRier[1] 2:LIST:FILTer[:RRC][:STATe]?</code> Subopcode: 1 = BTS/Downlink (Default), 2 = MS/Uplink								
Example	<code>:ACP:CARR:LIST:FILT 0,0,0,0</code> <code>:ACP:CARR:LIST:FILT?</code>								
Notes	The binary values translate as follows: <table border="1" data-bbox="391 558 1406 642"> <tr> <td>1 ON</td> <td>RRC Weighted</td> </tr> <tr> <td>0 OFF</td> <td>Integ BW</td> </tr> </table> Maximum of Array length depends on the number of carriers Some Modes do not support Carrier subopcode 2. In those cases, commands with subopcode 2 are accepted without error but ignored For LTEAFDD or LTEATDD Modes, this control is not shown. In order to maintain backwards compatibility with legacy LTE FDD/TDD Modes, the SCPI command is supported in the LTE & LTE-A converged applications	1 ON	RRC Weighted	0 OFF	Integ BW				
1 ON	RRC Weighted								
0 OFF	Integ BW								
Preset	<table border="1" data-bbox="391 884 1406 1052"> <thead> <tr> <th>Modes</th> <th>Value</th> </tr> </thead> <tbody> <tr> <td>SA, LTE, LTETDD</td> <td>OFF</td> </tr> <tr> <td>WCDMA</td> <td>ON</td> </tr> <tr> <td>Radio Test</td> <td>OFF</td> </tr> </tbody> </table>	Modes	Value	SA, LTE, LTETDD	OFF	WCDMA	ON	Radio Test	OFF
Modes	Value								
SA, LTE, LTETDD	OFF								
WCDMA	ON								
Radio Test	OFF								
State Saved	Saved in instrument state								
Range	Integration BW RRC Weighted								

Filter Alpha for Carrier

Inputs the alpha value for the filter used in the current carrier configuration.

Remote Command	<code>[:SENSe]:ACPower:CARRier[1] 2:LIST:FILTer:ALPHa <real>, ...</code> <code>[:SENSe]:ACPower:CARRier[1] 2:LIST:FILTer:ALPHa?</code> Subopcode: 1 = BTS/Downlink (Default), 2 = MS/Uplink
Example	<code>:ACP:CARR2:LIST:FILT:ALPH 0.5</code> <code>:ACP:CARR2:LIST:FILT:ALPH?</code>
Notes	Some Modes do not support Carrier subopcode 2. In those cases, commands with subopcode 2 are accepted without error but ignored For LTEAFDD or LTEATDD Modes, this control is not shown. In order to maintain backwards compatibility with legacy LTE FDD/TDD Modes, the SCPI command is supported in the LTE & LTE-A converged applications
Preset	0.22

State Saved	Saved in instrument state
Min/Max	0.01/1.0

Offset

Lets you configure the spacing of the offset regions.

Offset Frequency Define

Lets you select offset frequency definition. Each standard defines each offset frequency from Carrier.

For example, 3GPP2 requires the “From Carrier Center to Integ BW Closer Edge” definition. LTE conformance test requires “From Carrier Edge to Integ BW Center” and/or “From Carrier Edge to Integ BW Closer Edge” definition.

CTOCenter	From the lowermost carrier center frequency (for lower offset), the uppermost carrier center frequency (for upper offset) to the center frequency of each Offset Integ BW
CTOEdge	From the lowermost carrier center frequency (for lower offset), the uppermost carrier center frequency (for upper offset) to the closest edge frequency of each Offset Integ BW
ETOCenter	From the lowermost carrier center frequency - spacing of this carrier /2 (for lower offset), the uppermost carrier center frequency + spacing of this carrier /2 (for upper offset) to the center frequency of each Offset Integ BW
ETOEdge	From the lowermost carrier center frequency - spacing of this carrier /2 (for lower offset), the uppermost carrier center frequency + spacing of this carrier /2 (for upper offset) to the closest edge of each Offset Integ BW
RTOCenter 5G NR Mode only	From either the lower or upper RF BW** edge frequency to the center frequency of each Offset Integ BW
RTOEdge 5G NR Mode only	From either the lower or upper RF BW** edge frequency to the closest edge frequency of each Offset Integ BW
RCTOCenter 5G NR Mode only	From the center frequency of RF BW** to the center frequency of each Offset Integ BW
SCTOCenter 5G NR Mode only	From the center frequency of sub-block** to the center frequency of each Offset Integ BW

** RF BW = $BW_{channel,CA}$ which is defined in each 3GPP standard, regardless of “Measure Carrier” for the uppermost and the lowermost carriers being Enabled or Disabled. When the Number of Component Carrier = 1, RF BW = $BW_{channel} = 2 \times F_{offset,RAT}$

** sub-block (bandwidth) = $BW_{channel,block}$ which is defined in each 3GPP standard, regardless of “Measure Carrier” for the uppermost and the lowermost carriers being

Enabled or Disabled. When the Number of Component Carrier within each sub-block = 1, sub-block (bandwidth) = $BW_{\text{channel}} = 2 \times F_{\text{offset,RAT}}$.

See "Diagrams for Offset Freq Define" on page 1297.

Modes other than MSR, LTEAFDD, LTEATDD, 5G NR

Remote Command	<code>[:SENSe]:ACPower:OFFSet[1] 2[:OUTer]:TYPE CTOCenter CTOEdge ETOCenter ETOEdge</code> <code>[:SENSe]:ACPower:OFFSet[1] 2[:OUTer]:TYPE?</code> Subopcode: 1 = BTS/Downlink (Default), 2 = MS/Uplink
Example	<code>:ACP:OFFS:TYPE ETOC</code> <code>:ACP:OFFS:TYPE?</code>
Notes	Some Modes do not support Offset subopcode 2. In those cases, commands with subopcode 2 are accepted without error but ignored
Preset	<code>CTOCenter</code>
State Saved	Saved in instrument state
Range	<code>CTOCenter CTOEdge ETOCenter ETOEdge</code>

Mode: MSR, LTEAFDD, LTEATDD

Remote Command	<code>[:SENSe]:ACPower:OFFSet[1] 2[:OUTer]:TYPE CTOCenter CTOEdge ETOCenter ETOEdge</code> <code>[:SENSe]:ACPower:OFFSet[1] 2[:OUTer]:TYPE?</code> Subopcode: 1 = BTS/Downlink (Default), 2 = MS/Uplink
Example	<code>:ACP:OFFS:TYPE ETOC</code> <code>:ACP:OFFS:TYPE?</code>
Preset	<code>CTOCenter</code>
State Saved	Saved in instrument state
Range	<code>CTOCenter CTOEdge ETOCenter ETOEdge</code>

Mode: 5G NR

Remote Command	<code>[:SENSe]:ACPower:OFFSet[1] 2[:OUTer]:TYPE CTOCenter CTOEdge ETOCenter ETOEdge RTOCenter RTOEdge RCTOCenter SCTOCenter</code> <code>[:SENSe]:ACPower:OFFSet[1] 2[:OUTer]:TYPE?</code> Subopcode: 1 = BTS/Downlink (Default), 2 = MS/Uplink
Example	<code>:ACP:OFFS:TYPE ETOC</code>

	:ACP:OFFS:TYPE?
Preset	CTOCenter
State Saved	Saved in instrument state
Range	CTOCenter CTOEdge ETOCenter ETOEdge RTOCenter RTOEdge RCTOCenter SCTOCenter

Diagrams for Offset Freq Define

Details depend on the selected mode.

Diagram for Modes other than MSR, LTEAFDD, LTEATDD, 5G NR

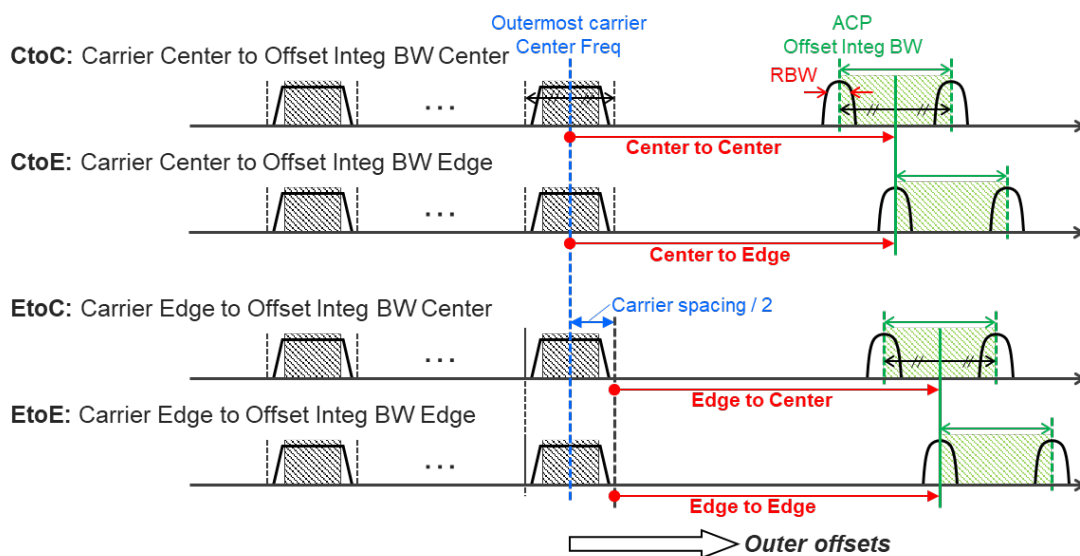
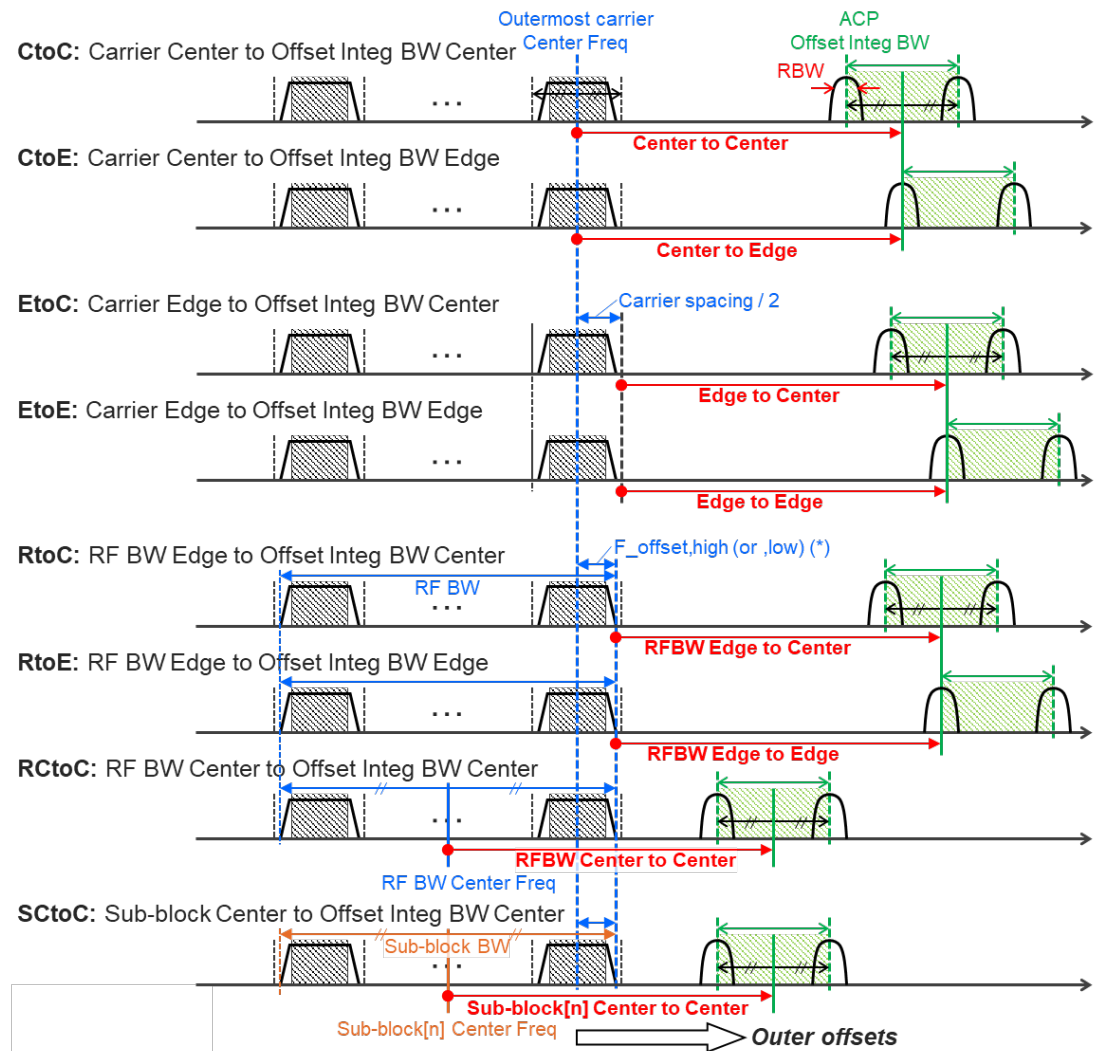

Diagram for MSR, LTEAFDD, LTEATDD, 5G NR



Note:

RF BW Edge and Outermost Carrier Edge are not always the same.
e.g.) 5G NR (3GPP) defines BW_channel, CA which calculates $F_{\text{offset,high}}$ and $F_{\text{offset,low}}$ asymmetrically with SCS shift.

(*) For MSR, $F_{\text{offset,high (or ,low)}} = F_{\text{offset,RAT,high (or ,low)}}$

Offset Freq

Determines the frequency difference between the center of the main channel and the center of the carrier.

Each **Offset Freq** state value is entered individually by selecting the desired carrier.

3 VMA Mode
3.8 ACP Measurement

The list contains up to six (6) entries, depending on the mode selected, for offset frequencies. Each offset frequency in the list corresponds to a reference bandwidth in the bandwidth list.

An offset frequency of zero turns the display of the measurement for that offset off, but the measurement is still made and reported. You can turn off (not use) specific offsets with `[:SENSe]:ACPower:OFFSet[1]|2[:OUTer]:LIST[:FREQuency] <freq>,...`

Turning the offset off has the same effect as setting the frequency of the offset to 0 Hz, and causes it to be removed from the results screen.

Remote Command	<code>[:SENSe]:ACPower:OFFSet[1] 2[:OUTer]:LIST[:FREQuency] <freq>,...</code> <code>[:SENSe]:ACPower:OFFSet[1] 2[:OUTer]:LIST[:FREQuency]?</code> Subopcode: 1 = BTS/Downlink (Default), 2 = MS/Uplink												
Example	<code>:ACP:OFFS1:LIST 0,0,0,0,0,0</code> <code>:ACP:OFFS1:LIST?</code>												
Notes	Some Modes do not support Offset subopcode 2. In those cases, commands with subopcode 2 are accepted without error but ignored When setting these values remotely, the position in the list sent corresponds to the offset. Missing values are not permitted, unless the number of values sent is greater than the number of carriers, in which case subsequent values are ignored												
Couplings	Changing Offset Frequency might affect "Span" on page 1232												
Preset	When "Max Num of Offsets" on page 1285 is set to 12, the preset value of Offset G ~ L is the same as the Offset F value												
	<table border="1"> <thead> <tr> <th>Modes</th> <th>Values</th> </tr> </thead> <tbody> <tr> <td>SA</td> <td>3 MHz, 0 Hz, 0 Hz, 0 Hz, 0 Hz, 0 Hz 3 MHz, 0 Hz, 0 Hz, 0 Hz, 0 Hz, 0 Hz</td> </tr> <tr> <td>WCDMA</td> <td>5.0 MHz, 10.0 MHz, 0 Hz, 0 Hz, 0 Hz, 0 Hz 5.0 MHz, 10.0 MHz, 0 Hz, 0 Hz, 0 Hz, 0 Hz</td> </tr> <tr> <td>LTEAFDD, LTEATDD, MSR</td> <td>5.0 MHz, 10.0 MHz, 0 Hz, 0 Hz, 0 Hz, 0 Hz 5.0 MHz, 10.0 MHz, 0 Hz, 0 Hz, 0 Hz, 0 Hz</td> </tr> <tr> <td>5G NR</td> <td>100 MHz, 200 MHz, 0 Hz, 0 Hz, 0 Hz, 0 Hz 100 MHz, 200 MHz, 0 Hz, 0 Hz, 0 Hz, 0 Hz</td> </tr> <tr> <td>Radio Test</td> <td>25 kHz, 50 kHz, 75 kHz, 0 Hz, 0 Hz, 0 Hz</td> </tr> </tbody> </table>	Modes	Values	SA	3 MHz, 0 Hz, 0 Hz, 0 Hz, 0 Hz, 0 Hz 3 MHz, 0 Hz, 0 Hz, 0 Hz, 0 Hz, 0 Hz	WCDMA	5.0 MHz, 10.0 MHz, 0 Hz, 0 Hz, 0 Hz, 0 Hz 5.0 MHz, 10.0 MHz, 0 Hz, 0 Hz, 0 Hz, 0 Hz	LTEAFDD, LTEATDD, MSR	5.0 MHz, 10.0 MHz, 0 Hz, 0 Hz, 0 Hz, 0 Hz 5.0 MHz, 10.0 MHz, 0 Hz, 0 Hz, 0 Hz, 0 Hz	5G NR	100 MHz, 200 MHz, 0 Hz, 0 Hz, 0 Hz, 0 Hz 100 MHz, 200 MHz, 0 Hz, 0 Hz, 0 Hz, 0 Hz	Radio Test	25 kHz, 50 kHz, 75 kHz, 0 Hz, 0 Hz, 0 Hz
Modes	Values												
SA	3 MHz, 0 Hz, 0 Hz, 0 Hz, 0 Hz, 0 Hz 3 MHz, 0 Hz, 0 Hz, 0 Hz, 0 Hz, 0 Hz												
WCDMA	5.0 MHz, 10.0 MHz, 0 Hz, 0 Hz, 0 Hz, 0 Hz 5.0 MHz, 10.0 MHz, 0 Hz, 0 Hz, 0 Hz, 0 Hz												
LTEAFDD, LTEATDD, MSR	5.0 MHz, 10.0 MHz, 0 Hz, 0 Hz, 0 Hz, 0 Hz 5.0 MHz, 10.0 MHz, 0 Hz, 0 Hz, 0 Hz, 0 Hz												
5G NR	100 MHz, 200 MHz, 0 Hz, 0 Hz, 0 Hz, 0 Hz 100 MHz, 200 MHz, 0 Hz, 0 Hz, 0 Hz, 0 Hz												
Radio Test	25 kHz, 50 kHz, 75 kHz, 0 Hz, 0 Hz, 0 Hz												
State Saved	Saved in instrument state												
Min/Max	0 Hz/Depends on instrument maximum frequency. Same as Max Span of the Swept SA Measurement												
Backwards Compatibility SCPI	<code>[:SENSe]:MCPower:OFFSet[1] 2:LIST[:FREQuency]</code> Auto Function												
Remote Command	<code>[:SENSe]:ACPower:OFFSet[1] 2[:OUTer]:LIST:STATe OFF ON 0 1,...</code> <code>[:SENSe]:ACPower:OFFSet[1] 2[:OUTer]:LIST:STATe?</code>												

	Subopcode: 1 = BTS/Downlink (Default), 2 = MS/Uplink												
Example	<code>:ACP:OFFS2:LIST:STAT 1,1,0,0,0,0</code> <code>:ACP:OFFS2:LIST:STAT?</code>												
Preset	When "Max Num of Offsets" on page 1285 is 12, the preset value of Offset G ~ L is the same as the Offset F value												
	<table border="1"> <thead> <tr> <th>Modes</th> <th>Values</th> </tr> </thead> <tbody> <tr> <td>SA</td> <td>ON, OFF, OFF, OFF, OFF, OFF ON, OFF, OFF, OFF, OFF, OFF</td> </tr> <tr> <td>WCDMA</td> <td>ON, ON, OFF, OFF, OFF, OFF ON, ON, OFF, OFF, OFF, OFF</td> </tr> <tr> <td>LTEAFDD, LTEATDD, MSR</td> <td>ON, ON, OFF, OFF, OFF, OFF ON, OFF, OFF, OFF, OFF, OFF</td> </tr> <tr> <td>5G NR</td> <td>ON, ON, OFF, OFF, OFF, OFF ON, OFF, OFF, OFF, OFF, OFF</td> </tr> <tr> <td>Radio Test</td> <td>ON, ON, ON, OFF, OFF, OFF</td> </tr> </tbody> </table>	Modes	Values	SA	ON, OFF, OFF, OFF, OFF, OFF ON, OFF, OFF, OFF, OFF, OFF	WCDMA	ON, ON, OFF, OFF, OFF, OFF ON, ON, OFF, OFF, OFF, OFF	LTEAFDD, LTEATDD, MSR	ON, ON, OFF, OFF, OFF, OFF ON, OFF, OFF, OFF, OFF, OFF	5G NR	ON, ON, OFF, OFF, OFF, OFF ON, OFF, OFF, OFF, OFF, OFF	Radio Test	ON, ON, ON, OFF, OFF, OFF
Modes	Values												
SA	ON, OFF, OFF, OFF, OFF, OFF ON, OFF, OFF, OFF, OFF, OFF												
WCDMA	ON, ON, OFF, OFF, OFF, OFF ON, ON, OFF, OFF, OFF, OFF												
LTEAFDD, LTEATDD, MSR	ON, ON, OFF, OFF, OFF, OFF ON, OFF, OFF, OFF, OFF, OFF												
5G NR	ON, ON, OFF, OFF, OFF, OFF ON, OFF, OFF, OFF, OFF, OFF												
Radio Test	ON, ON, ON, OFF, OFF, OFF												
State Saved	Yes												
Range	OFF ON												

Integ BW

Sets the Integration Bandwidth for the offsets. Each resolution bandwidth in the list corresponds to an offset frequency in the list defined by `[:SENSe]:ACP:OFFSet[n] [:OUTer]:LIST[:FREquency]`.

Enter each value individually by selecting the desired offset, then enter the Offset Integration Bandwidth.

You can turn off (not use) specific offsets with `[:SENSe]:ACP:OFFSet[n] [:OUTer]:LIST:STATe`.

Remote Command	<code>[:SENSe]:ACPower:OFFSet[1] 2[:OUTer]:LIST:BANDwidth[:INTEgration] <freq>,...</code> <code>[:SENSe]:ACPower:OFFSet[1] 2[:OUTer]:LIST:BANDwidth[:INTEgration]?</code> Subopcode: 1 = BTS/Downlink (Default), 2 = MS/Uplink
Example	<code>:ACP:OFFS2:LIST:BAND 2MHz,2MHz,2MHz,2MHz,2MHz,2MHz</code> <code>:ACP:OFFS2:LIST:BAND?</code>
Notes	Some Modes do not support Offset subopcode 2. In those cases, commands with subopcode 2 are accepted without error but ignored When setting these values remotely, the position in the list sent corresponds to the offset. Missing values are not permitted, so, if you want to change the second value, you must send all values up to that. Subsequent values remain unchanged, unless the number of values sent is greater than the number of carriers, then subsequent values is ignored
Couplings	Changing Integ BW might affect "Span" on page 1232

3 VMA Mode
3.8 ACP Measurement

Preset	When "Max Num of Offsets" on page 1285 is set to 12, the preset value of Offset G ~ L is the same as the Offset F value												
	<table border="1"> <thead> <tr> <th>Modes</th> <th>Values</th> </tr> </thead> <tbody> <tr> <td>SA</td> <td>2 MHz, 2 MHz, 2 MHz, 2 MHz, 2 MHz, 2 MHz 2 MHz, 2 MHz, 2 MHz, 2 MHz, 2 MHz, 2 MHz</td> </tr> <tr> <td>WCDMA</td> <td>3.84 MHz, 3.84 MHz, 3.84 MHz, 3.84 MHz, 3.84 MHz, 3.84 MHz 3.84 MHz, 3.84 MHz, 3.84 MHz, 3.84 MHz, 3.84 MHz, 3.84 MHz</td> </tr> <tr> <td>LTEAFDD, LTEATDD, MSR</td> <td>4.515 MHz, 4.515 MHz, 4.515 MHz, 4.515 MHz, 4.515 MHz, 4.515 MHz 4.5 MHz, 4.5 MHz, 4.5 MHz, 4.5 MHz, 4.5 MHz, 4.5 MHz</td> </tr> <tr> <td>5G NR</td> <td>98.28 MHz, 98.28 MHz, 98.28 MHz, 98.28 MHz, 98.28 MHz, 98.28 MHz 98.31 MHz, 98.31 MHz, 98.31 MHz, 98.31 MHz, 98.31 MHz, 98.31 MHz</td> </tr> <tr> <td>Radio Test</td> <td>25 kHz, 25 kHz, 25 kHz, 25 kHz, 25 kHz, 25 kHz</td> </tr> </tbody> </table>	Modes	Values	SA	2 MHz, 2 MHz, 2 MHz, 2 MHz, 2 MHz, 2 MHz 2 MHz, 2 MHz, 2 MHz, 2 MHz, 2 MHz, 2 MHz	WCDMA	3.84 MHz, 3.84 MHz, 3.84 MHz, 3.84 MHz, 3.84 MHz, 3.84 MHz 3.84 MHz, 3.84 MHz, 3.84 MHz, 3.84 MHz, 3.84 MHz, 3.84 MHz	LTEAFDD, LTEATDD, MSR	4.515 MHz, 4.515 MHz, 4.515 MHz, 4.515 MHz, 4.515 MHz, 4.515 MHz 4.5 MHz, 4.5 MHz, 4.5 MHz, 4.5 MHz, 4.5 MHz, 4.5 MHz	5G NR	98.28 MHz, 98.28 MHz, 98.28 MHz, 98.28 MHz, 98.28 MHz, 98.28 MHz 98.31 MHz, 98.31 MHz, 98.31 MHz, 98.31 MHz, 98.31 MHz, 98.31 MHz	Radio Test	25 kHz, 25 kHz, 25 kHz, 25 kHz, 25 kHz, 25 kHz
Modes	Values												
SA	2 MHz, 2 MHz, 2 MHz, 2 MHz, 2 MHz, 2 MHz 2 MHz, 2 MHz, 2 MHz, 2 MHz, 2 MHz, 2 MHz												
WCDMA	3.84 MHz, 3.84 MHz, 3.84 MHz, 3.84 MHz, 3.84 MHz, 3.84 MHz 3.84 MHz, 3.84 MHz, 3.84 MHz, 3.84 MHz, 3.84 MHz, 3.84 MHz												
LTEAFDD, LTEATDD, MSR	4.515 MHz, 4.515 MHz, 4.515 MHz, 4.515 MHz, 4.515 MHz, 4.515 MHz 4.5 MHz, 4.5 MHz, 4.5 MHz, 4.5 MHz, 4.5 MHz, 4.5 MHz												
5G NR	98.28 MHz, 98.28 MHz, 98.28 MHz, 98.28 MHz, 98.28 MHz, 98.28 MHz 98.31 MHz, 98.31 MHz, 98.31 MHz, 98.31 MHz, 98.31 MHz, 98.31 MHz												
Radio Test	25 kHz, 25 kHz, 25 kHz, 25 kHz, 25 kHz, 25 kHz												
State Saved	Saved in instrument state												
Min/Max	10 Hz/Depends on instrument maximum frequency. Same as Max Span of the Swept SA Measurement												
Backwards Compatibility SCPI	<pre>[:SENSe]:ACPower:OFFSet[1] 2:LIST:BWIDth[:INTEgration] [:SENSe]:ACPR:OFFSet[1] 2:LIST:BANDwidth [:SENSe]:ACPR:OFFSet[1] 2:LIST:BWIDth [:SENSe]:MCPower:OFFSet[1] 2:LIST:BANDwidth[:INTEgration] [:SENSe]:MCPower:OFFSet[1] 2:LIST:BWIDth[:INTEgration]</pre>												

Offset Side

Specifies which offset side to measure.

You can turn off (not use) specific offsets with `[:SENSe]:ACPower:OFFSet[1] | 2[:OUTer]:LIST:SIDE`.

NEGative	Negative (lower) sideband only
BOTH	Both of the negative (lower) and positive (upper) sidebands
POSitive	Positive (upper) sideband only

The figure below shows the relation between the negative/positive offset side setups and the upper/lower results in MSR, LTEAFDD and LTEATDD Modes.

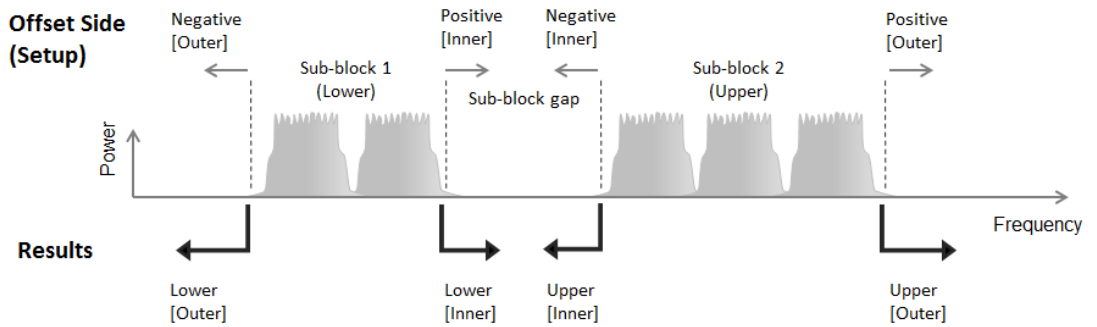

Remote Command	<code>[:SENSe]:ACPower:OFFSet[1] 2[:OUTer]:LIST:SIDE NEGative BOTH POSitive, ...</code> <code>[:SENSe]:ACPower:OFFSet[1] 2[:OUTer]:LIST:SIDE?</code> Subopcode: 1 = BTS/Downlink (Default), 2 = MS/Uplink
Example	<code>:ACP:OFFS:LIST:SIDE BOTH</code> <code>:ACP:OFFS:LIST:SIDE?</code>
Notes	Some Modes do not support Offset subopcode 2. In those cases, commands with subopcode 2 are accepted without error but ignored If you set POS or NEG in an offset, result of the inactive side returns -999
Preset	When " Max Num of Offsets " on page 1285 is 12, the preset value of Offset G ~ L is BOTH BOTH, BOTH, BOTH, BOTH, BOTH, BOTH BOTH, BOTH, BOTH, BOTH, BOTH, BOTH
State Saved	Saved in instrument state
Range	NEGative BOTH POSitive

Method

Allows you to turn RRC filtering of each offset on or off. The value (roll off) for the filter will be set to the value of the **Filter Alpha** parameter.

Remote Command	<code>[:SENSe]:ACPower:OFFSet[1] 2[:OUTer]:LIST:FILTer[:RRC][:STATE] ON OFF 1 0, ...</code> <code>[:SENSe]:ACPower:OFFSet[1] 2[:OUTer]:LIST:FILTer[:RRC][:STATE]?</code> Subopcode: 1 = BTS/Downlink (Default), 2 = MS/Uplink
Example	<code>:ACP:OFFS:LIST:FILT 1,0,0</code> <code>:ACP:OFFS:LIST:FILT?</code>
Notes	1 ON = RRC Weighted, 0 OFF = Integ BW Some Modes do not support Offset subopcode 2. In those cases, commands with subopcode 2 are accepted without error but ignored
Preset	When " Max Num of Offsets " on page 1285 is 12, the preset value of Offset G ~ L is the same as the Offset F value

3 VMA Mode
3.8 ACP Measurement

	Mode	Values
	SA	0, 0, 0, 0, 0, 0 0, 0, 0, 0, 0, 0
	WCDMA	1, 1, 1, 1, 1, 1 1, 1, 1, 1, 1, 1
	LTEAFDD, LTEATDD, 5G NR, MSR	0, 0, 0, 0, 0, 0 0, 0, 0, 0, 0, 0
	Radio Test	0, 0, 0, 0, 0, 0
State Saved	Saved in instrument state	
Range	Integ BW RRC Weighted	

Filter Alpha

Sets the alpha value for the RRC Filter for each offset.

Remote Command	[:SENSe]:ACPower:OFFSet[1] 2[:OUTer]:LIST:FILTer:ALPHA <real>, ... [:SENSe]:ACPower:OFFSet[1] 2[:OUTer]:LIST:FILTer:ALPHA?	
	Subopcode: 1 = BTS/Downlink (Default), 2 = MS/Uplink	
Example	:ACP:OFFS:LIST:FILT:ALPH 0.5,0.5,0.5,0.5,0.5,0.5 :ACP:OFFS:LIST:FILT:ALPH?	
Notes	Some Modes do not support Offset subopcode 2. In those cases, commands with subopcode 2 are accepted without error but ignored	
Preset	When " Max Num of Offsets " on page 1285 is 12, the preset value of Offset G ~ L is the same as the Offset F value	
	SA	0.22,0.22,0.22,0.22,0.22,0.22 0.22,0.22,0.22,0.22,0.22,0.22
	WCDMA	0.22,0.22,0.22,0.22,0.22,0.22 0.22,0.22,0.22,0.22,0.22,0.22
	LTEAFDD, LTEATDD, 5G NR, MSR	0.22,0.22,0.22,0.22,0.22,0.22 0.22,0.22,0.22,0.22,0.22,0.22
State Saved	Saved in instrument state	
Min/Max	0.01/1.00	

Advanced (Offset)

Opens a further menu page, which lets you set advanced properties of the Inner Offset, such as Res BW, Video BW, and Filter parameters.

Offset Freq

This column is the same as "[Offset Freq](#)" on page 1298 in the main **Offset** menu.

Res BW

Sets the resolution bandwidth. If an unavailable bandwidth is entered with the numeric keypad, the closest available bandwidth is selected.

Remote Command	<code>[:SENSe]:ACPower:OFFSet[1] 2[:OUTer]:LIST:BANDwidth:RESolution <freq>,...</code> <code>[:SENSe]:ACPower:OFFSet[1] 2[:OUTer]:LIST:BANDwidth:RESolution?</code> Subopcode: 1 = BTS/Downlink (Default), 2 = MS/Uplink
Example	<code>:ACP:OFFS2:LIST:BAND:RES 220kHz,220kHz,220kHz,220kHz,220kHz,220kHz</code> <code>:ACP:OFFS2:LIST:BAND:RES?</code>
Notes	Some Modes do not support Offset subopcode 2. In those cases, commands with subopcode 2 are accepted without error but ignored
Dependencies	When " Meas Method " on page 1246 is RBW, FAST or Fast Power, this cell is grayed-out and disabled. If the cell is pressed, an advisory message is generated. If the equivalent SCPI remote command is sent, a "Setting conflict" warning is generated
Couplings	When Res BW Mode is Auto , this value is exactly same as Res BW . When you change this value, Res BW Mode also changes to Man
Preset	When " Max Num of Offsets " on page 1285 is 12, the preset value of Offset G ~ L is the same as the Offset F value
	SA 220 kHz, 220 kHz, 220 kHz, 220 kHz, 220 kHz, 220 kHz
	WCDMA 100 kHz, 100 kHz, 100 kHz, 100 kHz, 100 kHz, 100 kHz
	LTEAFDD, LTEATDD, 5G NR, MSR 100 kHz, 100 kHz, 100 kHz, 100 kHz, 100 kHz, 100 kHz 100 kHz, 100 kHz, 100 kHz, 100 kHz, 100 kHz, 100 kHz
State Saved	Saved in instrument state
Min/Max	1 Hz/8 MHz
Backwards Compatibility SCPI	<code>[:SENSe]:ACPower:OFFSet[1] 2:LIST:BWIDth:RESolution</code>
	Auto Function
Remote Command	<code>[:SENSe]:ACPower:OFFSet[1] 2[:OUTer]:LIST:BANDwidth:RESolution:AUTO ON OFF 1 0,...</code> <code>[:SENSe]:ACPower:OFFSet[1] 2[:OUTer]:LIST:BANDwidth:RESolution:AUTO?</code> Subopcode: 1 = BTS/Downlink (Default), 2 = MS/Uplink
Example	<code>:ACP:OFFS2:LIST:BAND:RES:AUTO 1,1,1,1,1,1</code> <code>:ACP:OFFS2:LIST:BAND:RES:AUTO?</code>
Preset	When " Max Num of Offsets " on page 1285 is 12, the preset value of Offset G ~ L is 1, 1, 1, 1, 1, 1
State Saved	Yes

Backwards Compatibility SCPI `[:SENSe]:ACPower:OFFSet[1]|2[:LIST:BWIDth:RESolution:AUTO`

Video BW

Enables you to change the instrument post-detection filter (VBW).

Remote Command	<code>[:SENSe]:ACPower:OFFSet[1] 2[:OUTer]:LIST:BANDwidth:VIDeo <freq>,...</code> <code>[:SENSe]:ACPower:OFFSet[1] 2[:OUTer]:LIST:BANDwidth:VIDeo?</code> Subopcode: 1 = BTS/Downlink (Default), 2 = MS/Uplink								
Example	<code>:ACP:OFFS2:LIST:BAND:VID 5MHz,5MHz,5MHz,5MHz,5MHz,5MHz</code> <code>:ACP:OFFS2:LIST:BAND:VID?</code>								
Notes	The values shown in this table reflect the conditions after Mode Preset Some Modes do not support Offset subopcode 2. In those cases, commands with subopcode 2 are accepted without error but ignored								
Dependencies	When " Meas Method " on page 1246 is RBW, FAST or Fast Power, this cell is grayed-out and disabled. If the cell is pressed, an advisory message is generated. If the equivalent remote command is sent, a "Setting conflict" warning is generated								
Preset	When " Max Num of Offsets " on page 1285 is 12, the preset value of Offset G ~ L is the same as the Offset F value								
	<table border="1"> <thead> <tr> <th>Modes</th> <th>Values</th> </tr> </thead> <tbody> <tr> <td>SA</td> <td>22 kHz, 22 kHz, 22 kHz, 22 kHz, 22 kHz, 22 kHz</td> </tr> <tr> <td>WCDMA</td> <td>1 MHz, 1 MHz, 1 MHz, 1 MHz, 1 MHz, 1 MHz</td> </tr> <tr> <td>LTEAFDD, LTEATDD, 5G NR, MSR</td> <td>1 MHz, 1 MHz, 1 MHz, 1 MHz, 1 MHz, 1 MHz</td> </tr> </tbody> </table>	Modes	Values	SA	22 kHz, 22 kHz, 22 kHz, 22 kHz, 22 kHz, 22 kHz	WCDMA	1 MHz, 1 MHz, 1 MHz, 1 MHz, 1 MHz, 1 MHz	LTEAFDD, LTEATDD, 5G NR, MSR	1 MHz, 1 MHz, 1 MHz, 1 MHz, 1 MHz, 1 MHz
Modes	Values								
SA	22 kHz, 22 kHz, 22 kHz, 22 kHz, 22 kHz, 22 kHz								
WCDMA	1 MHz, 1 MHz, 1 MHz, 1 MHz, 1 MHz, 1 MHz								
LTEAFDD, LTEATDD, 5G NR, MSR	1 MHz, 1 MHz, 1 MHz, 1 MHz, 1 MHz, 1 MHz								
State Saved	Saved in instrument state								
Min/Max	1 Hz/50 MHz								
Backwards Compatibility SCPI	<code>[:SENSe]:ACPower:OFFSet[1] 2[:LIST:BWIDth:VIDeo</code>								

Auto Function

Remote Command	<code>[:SENSe]:ACPower:OFFSet[1] 2[:OUTer]:LIST:BANDwidth:VIDeo:AUTO OFF ON 0 1,...</code> <code>[:SENSe]:ACPower:OFFSet[1] 2[:OUTer]:LIST:BANDwidth:VIDeo:AUTO?</code> Subopcode: 1 = BTS/Downlink (Default), 2 = MS/Uplink
Example	<code>:ACP:OFFS2:LIST:BAND:VID:AUTO 0,0,0,0,1,1</code> <code>:ACP:OFFS2:LIST:BAND:VID:AUTO?</code>
Preset	When " Max Num of Offsets " on page 1285 is 12, the preset value of Offset G ~ L is ON <code>ON, ON, ON, ON, ON, ON</code>

State Saved	Yes
Backwards Compatibility SCPI	<code>[:SENSe]:ACPower:OFFSet[1] 2[:OUTer]:LIST:BWIDth:VIDeo:AUTO</code>

Filter Type

Selects the type of bandwidth filter that is used.

Remote Command	<code>[:SENSe]:ACPower:OFFSet[1] 2[:OUTer]:LIST:BAWdwidth:SHAPE GAUSSian FLATtop,...</code> <code>[:SENSe]:ACPower:OFFSet[1] 2[:OUTer]:LIST:BAWdwidth:SHAPE?</code> Subopcode: 1 = BTS/Downlink (Default), 2 = MS/Uplink
Example	<code>:ACP:OFFS2:LIST:BAND:SHAP FLAT,GAUS,GAUS,GAUS,GAUS,GAUS</code> <code>:ACP:OFFS2:LIST:BAND:SHAP?</code>
Notes	Some Modes do not support Offset subopcode 2. In those cases, commands with subopcode 2 are accepted without error but ignored
Dependencies	When " Res BW " on page 1214 Mode for the offset is Auto , this cell is grayed out and disabled. Since Res BW Mode for the offset is preset to Auto on changing " Meas Method " on page 1246 to RBW, FAST or Fast Power, this cell is grayed-out and disabled too. If the cell is pressed, an advisory message is generated. If the equivalent remote command is sent, a "Setting conflict" warning is generated
Preset	When " Max Num of Offsets " on page 1285 is 12, the preset value of Offset G ~ L is GAUSSian GAUSSian, GAUSSian, GAUSSian, GAUSSian, GAUSSian, GAUSSian
State Saved	Saved in instrument state
Range	GAUSSian FLATtop
Backwards Compatibility SCPI	<code>[:SENSe]:ACPower:OFFSet[1] 2[:LIST:BWIDth:SHAPE</code>

Filter BW

Selects a Gaussian filter based on its –3 dB (Normal) bandwidth or its –6 dB bandwidth.

Remote Command	<code>[:SENSe]:ACPower:OFFSet[1] 2[:OUTer]:LIST:BAWdwidth:TYPE DB3 DB6,...</code> <code>[:SENSe]:ACPower:OFFSet[1] 2[:OUTer]:LIST:BAWdwidth:TYPE?</code> Subopcode: 1 = BTS/Downlink (Default), 2 = MS/Uplink
Example	<code>:ACP:OFFS2:LIST:BAND:TYPE DB3,DB3,DB3,DB3,DB3</code> <code>:ACP:OFFS2:LIST:BAND:TYPE?</code>
Notes	Some Modes do not support Offset subopcode 2. In those cases, commands with subopcode 2 are accepted without error but ignored

Dependencies	When " RBW Filter Type " on page 1217 is Flattop, or " Res BW " on page 1214 Mode for the offset is Auto , this cell is grayed-out and disabled. Since Res BW Mode for the offset is preset to Auto on changing " Meas Method " on page 1246 to RBW, FAST or Fast Power, this cell is grayed-out and disabled too. If the cell is pressed, an advisory message is generated. If the equivalent remote command is sent, a "Setting conflict" warning is generated
Preset	When " Max Num of Offsets " on page 1285 is 12, the preset value of Offset G ~ L is DB3 DB3, DB3, DB3, DB3, DB3, DB3
State Saved	Saved in instrument state
Range	-3 dB (Normal) -6 dB
Backwards Compatibility SCPI	<code>[:SENSe] :ACPower:OFFSet[1] 2 :LIST:BWIDth:TYPE</code>

Limits

Lets you configure the limits that are used to determine whether the offset regions **PASS** or **FAIL** the limit test.

Limit Test

This checkbox is the same as "[Limit Test](#)" on page 1307 in the **Meas Setup, Settings** tab.

Offset Freq

This column is the same as "[Offset Freq](#)" on page 1298 in the **Offset** index tab.

Abs Limit

Specifies an absolute limit value, which sets the absolute amplitude levels to test against for each of the custom offsets. The list must contain 6 entries. If there is more than one offset, the offset closest to the carrier channel is the first one in the list. `[:SENSe] :ACP:OFFSet[n] [:OUTer] :LIST:TEST` selects the type of testing to be done at each offset.

You can turn off (not use) specific offsets with the `[:SENSe] :ACP:OFFSet[n] [:OUTer] :LIST:STATE` command.

The query returns the six (6) sets of real numbers that are the current absolute amplitude test limits.

Remote Command	<code>[:SENSe] :ACPower:OFFSet[1] 2 [:OUTer] :LIST:ABSolute < real>, ...</code> <code>[:SENSe] :ACPower:OFFSet[1] 2 [:OUTer] :LIST:ABSolute?</code>
-------------------	--

	Subopcode: 1 = BTS/Downlink (Default), 2 = MS/Uplink										
Example	<code>:ACP:OFFS2:LIST:ABS -10, -10, -10, -10, -10</code> <code>:ACP:OFFS2:LIST:ABS?</code>										
Notes	Some Modes do not support Offset subopcode 2. In those cases, commands with subopcode 2 are accepted without error but ignored										
Preset	When " Max Num of Offsets " on page 1285 is 12, the preset value of Offset G ~ L is the same as the Offset F value										
	<table border="1"> <thead> <tr> <th>Modes</th> <th>Values</th> </tr> </thead> <tbody> <tr> <td>SA</td> <td>0dBm, 0 dBm, 0 dBm, 0 dBm, 0 dBm, 0 dBm 0dBm, 0 dBm, 0 dBm, 0 dBm, 0 dBm, 0 dBm</td> </tr> <tr> <td>WCDMA</td> <td>50 dBm, 50 dBm, 50 dBm, 50 dBm, 50 dBm, 50 dBm 50 dBm, 50 dBm, 50 dBm, 50 dBm, 50 dBm, 50 dBm</td> </tr> <tr> <td>LTEAFDD, LTEATDD, MSR</td> <td>-8.45, -8.45, -8.45, -8.45, -8.45, -8.45 -50.0, -50.0, -50.0, -50.0, -50.0, -50.0</td> </tr> <tr> <td>5G NR</td> <td>4.92, 4.92, 4.92, 4.92, 4.92, 4.92 -50.0, -50.0, -50.0, -50.0, -50.0, -50.0</td> </tr> </tbody> </table>	Modes	Values	SA	0dBm, 0 dBm, 0 dBm, 0 dBm, 0 dBm, 0 dBm 0dBm, 0 dBm, 0 dBm, 0 dBm, 0 dBm, 0 dBm	WCDMA	50 dBm, 50 dBm, 50 dBm, 50 dBm, 50 dBm, 50 dBm 50 dBm, 50 dBm, 50 dBm, 50 dBm, 50 dBm, 50 dBm	LTEAFDD, LTEATDD, MSR	-8.45, -8.45, -8.45, -8.45, -8.45, -8.45 -50.0, -50.0, -50.0, -50.0, -50.0, -50.0	5G NR	4.92, 4.92, 4.92, 4.92, 4.92, 4.92 -50.0, -50.0, -50.0, -50.0, -50.0, -50.0
Modes	Values										
SA	0dBm, 0 dBm, 0 dBm, 0 dBm, 0 dBm, 0 dBm 0dBm, 0 dBm, 0 dBm, 0 dBm, 0 dBm, 0 dBm										
WCDMA	50 dBm, 50 dBm, 50 dBm, 50 dBm, 50 dBm, 50 dBm 50 dBm, 50 dBm, 50 dBm, 50 dBm, 50 dBm, 50 dBm										
LTEAFDD, LTEATDD, MSR	-8.45, -8.45, -8.45, -8.45, -8.45, -8.45 -50.0, -50.0, -50.0, -50.0, -50.0, -50.0										
5G NR	4.92, 4.92, 4.92, 4.92, 4.92, 4.92 -50.0, -50.0, -50.0, -50.0, -50.0, -50.0										
State Saved	Saved in instrument state										
Min/Max	-200.0 dBm/50.0 dBm										
Backwards Compatibility SCPI	<code>[:SENSe]:ACPR:OFFSet[1] 2:LIST:ABSolute</code> SA, W-CDMA <code>[:SENSe]:MCPower:OFFSet[1] 2:LIST:ABSolute</code> SA, W-CDMA										

Rel Limit (Car)

Enters a relative limit value for the carrier level. This sets the amplitude levels to test against for the specified offsets.

The amplitude level is relative to the carrier amplitude. If multiple offsets are available, the list contains 6 entries. The offset closest to the carrier channel is the first one in the list.

`[:SENSe]:ACP:OFFSet[n][:OUTer]:LIST:TEST` selects the type of testing to be done at each offset.

You can turn off (not use) specific offsets with `[:SENSe]:ACP:OFFSet[n][:OUTer]:LIST:STATE`.

The query returns the 6 sets of real numbers that are the current amplitude test limits, relative to the carrier, for each offset.

Offset[n] n = 1 is base station and n = 2 is mobiles. The default is base station (1).

Remote	<code>[:SENSe]:ACP:OFFSet[1] 2[:OUTer]:LIST:RCARrier <real>,...</code>
--------	---

3 VMA Mode
3.8 ACP Measurement

Command	<code>[:SENSe]:ACPower:OFFSet[1] 2[:OUTer]:LIST:RCARrier?</code> Subopcode: 1 = BTS/Downlink (Default), 2 = MS/Uplink												
Example	<code>:ACP:OFFS2:LIST:RCAR 0,0,0,0,0,0</code> <code>:ACP:OFFS2:LIST:RCAR?</code>												
Notes	Some Modes do not support Offset subopcode 2. In those cases, commands with subopcode 2 are accepted without error but ignored												
Preset	When "Max Num of Offsets" on page 1285 is 12, the preset value of Offset G ~ L is the same as the Offset F value												
	<table border="1"> <thead> <tr> <th>Modes</th> <th>Values</th> </tr> </thead> <tbody> <tr> <td>SA</td> <td>-45, -60, 0, 0, 0, 0 -45, -60, 0, 0, 0, 0</td> </tr> <tr> <td>WCDMA</td> <td>-44.2, -49.2, -49.2, -49.2, -49.2, -49.2 -32.2, -42.2, -42.2, -42.2, -42.2, -42.2</td> </tr> <tr> <td>LTEAFDD, LTEATDD, MSR</td> <td>-44.2, -44.2, -44.2, -44.2, -44.2, -44.2 -29.2, -29.2, -29.2, -29.2, -29.2, -29.2</td> </tr> <tr> <td>5G NR</td> <td>-43.8, -43.8, -43.8, -43.8, -43.8, -43.8 -29.2, -29.2, -29.2, -29.2, -29.2, -29.2</td> </tr> <tr> <td>Radio Test</td> <td>-60, -60, -60, 0, 0, 0</td> </tr> </tbody> </table>	Modes	Values	SA	-45, -60, 0, 0, 0, 0 -45, -60, 0, 0, 0, 0	WCDMA	-44.2, -49.2, -49.2, -49.2, -49.2, -49.2 -32.2, -42.2, -42.2, -42.2, -42.2, -42.2	LTEAFDD, LTEATDD, MSR	-44.2, -44.2, -44.2, -44.2, -44.2, -44.2 -29.2, -29.2, -29.2, -29.2, -29.2, -29.2	5G NR	-43.8, -43.8, -43.8, -43.8, -43.8, -43.8 -29.2, -29.2, -29.2, -29.2, -29.2, -29.2	Radio Test	-60, -60, -60, 0, 0, 0
Modes	Values												
SA	-45, -60, 0, 0, 0, 0 -45, -60, 0, 0, 0, 0												
WCDMA	-44.2, -49.2, -49.2, -49.2, -49.2, -49.2 -32.2, -42.2, -42.2, -42.2, -42.2, -42.2												
LTEAFDD, LTEATDD, MSR	-44.2, -44.2, -44.2, -44.2, -44.2, -44.2 -29.2, -29.2, -29.2, -29.2, -29.2, -29.2												
5G NR	-43.8, -43.8, -43.8, -43.8, -43.8, -43.8 -29.2, -29.2, -29.2, -29.2, -29.2, -29.2												
Radio Test	-60, -60, -60, 0, 0, 0												
State Saved	Saved in instrument state												
Min/Max	-150/50.0												
Backwards Compatibility SCPI	<code>[:SENSe]:MCPower:OFFSet[1] 2[:LIST:RCARrier</code>												

Positive Offset Limit (Remote Command only)

Enables you to set the upper limit for the upper segment of the specified offset pair.

Remote Command	<code>:CALCulate:ACPower:OFFSet[1] 2[:OUTer]:LIST:LIMit:POSitive[:UPPer]:DATA <real>,...</code> <code>:CALCulate:ACPower:OFFSet[1] 2[:OUTer]:LIST:LIMit:POSitive[:UPPer]:DATA?</code> Subopcode: 1 = BTS/Downlink (Default), 2 = MS/Uplink
Example	<code>:CALC:ACP:OFFS:LIST:LIM:POS:DATA 0,0,0,0,0,0</code> <code>:CALC:ACP:OFFS:LIST:LIM:POS:DATA?</code>
Notes	Some Modes do not support Offset subopcode 2. In those cases, commands with subopcode 2 are accepted without error but ignored
Preset	When "Max Num of Offsets" on page 1285 is 12, the preset value of Offset G ~ L is the same as the Offset F value

Modes	Values
SA	-45, -60, 0, 0, 0, 0 -45, -60, 0, 0, 0, 0
WCDMA	-44.2, -49.2, -49.2, -49.2, -49.2, -49.2 -32.2, -42.2, -42.2, -42.2, -42.2, -42.2
LTEAFDD, LTEATDD, MSR	-44.2, -44.2, -44.2, -44.2, -44.2, -44.2 -29.2, -29.2, -29.2, -29.2, -29.2, -29.2
5G NR	-43.8, -43.8, -43.8, -43.8, -43.8, -43.8 -29.2, -29.2, -29.2, -29.2, -29.2, -29.2
Radio Test	-60, -60, -60, 0, 0, 0
State Saved	Saved in instrument state
Min/Max	-150.0/50.0
Backwards Compatibility SCPI	:CALCulate:MCPower:OFFSet:LIST:LIMit:POSitive[:UPPer]:DATA (Power Suite)

Negative Offset Limit(Remote Command only)

Enables you to set the upper limit for the lower segment of the specified offset pair.

Remote Command	:CALCulate:ACPower:OFFSet[1] 2[:OUTer]:LIST:LIMit:NEGative[:UPPer]:DATA <real>, ... :CALCulate:ACPower:OFFSet[1] 2[:OUTer]:LIST:LIMit:NEGative[:UPPer]:DATA? Subopcode: 1 = BTS/Downlink (Default), 2 = MS/Uplink
Example	:CALC:ACP:OFFS:LIST:LIM:NEG:DATA 0,0,0,0,0,0 :CALC:ACP:OFFS:LIST:LIM:NEG:DATA?
Notes	Some Modes do not support Offset subopcode 2. In those cases, commands with subopcode 2 are accepted without error but ignored
Preset	When "Max Num of Offsets" on page 1285 is 12, the preset value of Offset G ~ L is the same as the Offset F value

Modes	Values
SA	-45, -60, 0, 0, 0, 0 -45, -60, 0, 0, 0, 0
WCDMA	-44.2, -49.2, -49.2, -49.2, -49.2, -49.2 -32.2, -42.2, -42.2, -42.2, -42.2, -42.2
LTEAFDD, LTEATDD, MSR	-44.2, -44.2, -44.2, -44.2, -44.2, -44.2 -29.2, -29.2, -29.2, -29.2, -29.2, -29.2
5G NR	-43.8, -43.8, -43.8, -43.8, -43.8, -43.8 -29.2, -29.2, -29.2, -29.2, -29.2, -29.2
Radio Test	-60, -60, -60, 0, 0, 0

State Saved	Saved in instrument state
Min/Max	-150.0/50.0
Backwards Compatibility SCPI	<code>:CALCulate:MCPower:OFFSet:LIST:LIMit:NEGative[:UPPer]:DATA</code> (Power Suite, WCDMA)

Rel Limit (PSD)

Enters a relative limit value for the level of the power spectral density. This sets the amplitude levels to test against for any custom offsets. The amplitude level is relative to the power spectral density. If multiple offsets are available, the list contains 6 entries. The offset closest to the carrier channel is the first one in the list.

`[:SENSe]:ACP:OFFSet[n][:OUTer]:LIST:TEST` selects the type of testing to be done at each offset.

You can turn off (not use) specific offsets with `[:SENSe]:ACP:OFFSet[n][:OUTer]:LIST:STATE`.

The query returns the 6 sets of real numbers that are the current amplitude test limits, relative to the power spectral density, for each offset.

Offset[n] n = 1 is base station and n = 2 is mobiles. The default is base station (1).

Remote Command	<code>[:SENSe]:ACP:Power:OFFSet[1] 2[:OUTer]:LIST:RPSDensity <rel_amp>,...</code> <code>[:SENSe]:ACP:Power:OFFSet[1] 2[:OUTer]:LIST:RPSDensity?</code> Subopcode: 1 = BTS/Downlink (Default), 2 = MS/Uplink
Example	<code>:ACP:OFFS2:LIST:RPSD 10,10,10,10,10,10</code> <code>:ACP:OFFS2:LIST:RPSD?</code>
Notes	Some Modes do not support Offset subopcode 2. In those cases, commands with subopcode 2 are accepted without error but ignored
Preset	When "Max Num of Offsets" on page 1285 is 12, the preset value of Offset G ~ L is the same as the Offset F value

Modes	Values
SA	-28.87 dB, -43.87 dB, 0 dB, 0 dB, 0 dB, 0 dB -28.87 dB, -43.87 dB, 0 dB, 0 dB, 0 dB, 0 dB
WCDMA	-44.2 dB, -49.2 dB, -49.2 dB, -49.2 dB, -49.2 dB, -49.2 dB -32.2 dB, -42.2 dB, -42.2 dB, -42.2 dB, -42.2 dB
LTEAFDD, LTEATDD, 5G NR, MSR	0, 0, 0, 0, 0, 0 0, 0, 0, 0, 0, 0
Radio Test	-60, -60, -60, 0, 0, 0

State Saved	Saved in instrument state
Min/Max	-150.0 dB/50.0 dB

Fail Mask

Accesses a menu that lets you select one of the logics for the fail conditions between the measurement results and the test limits. The setting defines the type of testing to be done at any custom offset frequencies. The measured powers are tested against the absolute values defined with `[:SENSe]:ACP:OFFSet[n] [:OUTer]:LIST:ABSolute`, or the relative values defined with `[:SENSe]:ACP:OFFSet[n]:OUTer]:LIST:RPSDensity` and `[:SENSe]:ACP:OFFSet[n] [:OUTer]:LIST:RCARrier`.

You can turn off (not use) specific offsets with `[:SENSe]:ACP:OFFSet[n] [:OUTer]:LIST:STATE`.

Absolute	ABSolute	Fail is shown if one of the absolute ACP measurement results is larger than the limit for Abs Limit
Relative	RELative	Fail is shown if one of the relative ACP measurement results is larger than the limit for Rel Lim (Car) or Rel Lim (PSD)
Abs AND Rel	AND	Fail is shown if one of the absolute ACP measurement results is larger than the limit for Abs Limit and one of the relative ACP measurement results is larger than the limit for Rel Lim (Car) or Rel Lim (PSD)
Abs OR Rel	OR	Fail is shown if one of the absolute ACP measurement results is larger than the limit for Abs Limit or one of the relative ACP measurement results is larger than the limit for Rel Lim (Car) or Rel Lim (PSD)

Remote Command	<code>[:SENSe]:ACP:Power:OFFSet[1] 2 [:OUTer]:LIST:TEST ABSolute AND OR RELative,...</code> <code>[:SENSe]:ACP:Power:OFFSet[1] 2 [:OUTer]:LIST:TEST?</code> Subopcode: 1 = BTS/Downlink (Default), 2 = MS/Uplink
----------------	--

Example	<code>:ACP:OFFS2:LIST:TEST ABS,ABS,ABS,ABS,ABS,ABS</code> <code>:ACP:OFFS2:LIST:TEST?</code>
---------	---

Notes	Some Modes do not support Offset subopcode 2. In those cases, commands with subopcode 2 are accepted without error but ignored
-------	--

Preset	When "Max Num of Offsets" on page 1285 is 12, the preset value of Offset G ~ L is the same as the Offset F value
--------	--

Modes	Values
SA, WCDMA	<code>REL, REL, REL, REL, REL, REL REL, REL, REL, REL, REL, REL</code>
LTEAFDD, LTEATDD, 5G NR, MSR	<code>AND, AND, AND, AND, AND, AND AND, AND, AND, AND, AND, AND</code>

	Modes	Values
	Radio Test	REL, REL, REL, REL, REL, REL
State Saved	Saved in instrument state	
Range	ABSolute AND OR RELative	
Backwards Compatibility SCPI	[:SENSe]:MCPower:OFFSet[1] 2:LIST:TEST	

Offset Frequency Define

Allows you to select “Offset” definition:

CTOCenter	From the lowermost carrier center frequency (for lower offset), the uppermost carrier center frequency (for upper offset) to the center frequency of each Offset Integ BW
CTOEdge	From the lowermost carrier center frequency (for lower offset), the uppermost carrier center frequency (for upper offset) to the closest edge frequency of each Offset Integ BW
ETOCenter	From the lowermost carrier center frequency - spacing of this carrier /2 (for lower offset), the uppermost carrier center frequency + spacing of this carrier /2 (for upper offset) to the center frequency of each Offset Integ BW
ETOEdge	From the lowermost carrier center frequency - spacing of this carrier /2 (for lower offset), the uppermost carrier center frequency + spacing of this carrier /2 (for upper offset) to the closest edge frequency of each Offset Integ BW
STOCenter	From either the lower or upper sub-block edge frequency to the center frequency of each Offset Integ BW
STOEdge	From either the lower or upper sub-block edge frequency to the closest edge frequency of each Offset Integ BW
SCTOCenter	From the center frequency of sub-block** to the center frequency of each Offset Integ BW

5G NR Mode only

** sub-block (bandwidth) = $BW_{\text{channel,block}}$ which is defined in each 3GPP standard, regardless of “Measure Carrier” for the uppermost and the lowermost carriers being Enabled or Disabled. When the Number of Component Carrier within each sub-block = 1, sub-block (bandwidth) = $BW_{\text{channel}} = 2 \times F_{\text{offset,RAT}}$.

See "Diagram for Offset Freq Define" on page 1315

Mode: MSR, LTEAFDD, LTEATDD

Remote Command	[:SENSe]:ACPPower:OFFSet[1] 2:INNER:TYPE CTOCenter CTOEdge ETOCenter ETOEdge STOCenter STOEdge [:SENSe]:ACPPower:OFFSet[1] 2:INNER:TYPE? Subopcode: 1 = BTS/Downlink (Default), 2 = MS/Uplink
----------------	---

Example	<code>:ACP:OFFS:INN:TYPE ETOC</code> <code>:ACP:OFFS:INN:TYPE?</code>
Preset	<code>STOCenter</code>
State Saved	Saved in instrument state
Range	<code>CTOCenter CTOEdge ETOCenter ETOEdge STOCenter STOEdge</code>

Mode: 5G NR

Remote Command	<code>[[:SENSE]:ACPower:OFFSet[1] 2:INNER:TYPE CTOCenter CTOEdge ETOCenter ETOEdge STOCenter STOEdge SCTOCenter</code> <code>[[:SENSe]:ACPower:OFFSet[1] 2:INNER:TYPE?</code> Subopcode: 1 = BTS/Downlink (Default), 2 = MS/Uplink
Example	<code>:ACP:OFFS:INN:TYPE ETOC</code> <code>:ACP:OFFS:INN:TYPE?</code>
Preset	<code>STOCenter CTOCenter</code>
State Saved	Saved in instrument state
Range	<code>CTOCenter CTOEdge ETOCenter ETOEdge STOCenter STOEdge SCTOCenter</code>

Diagram for Offset Freq Define

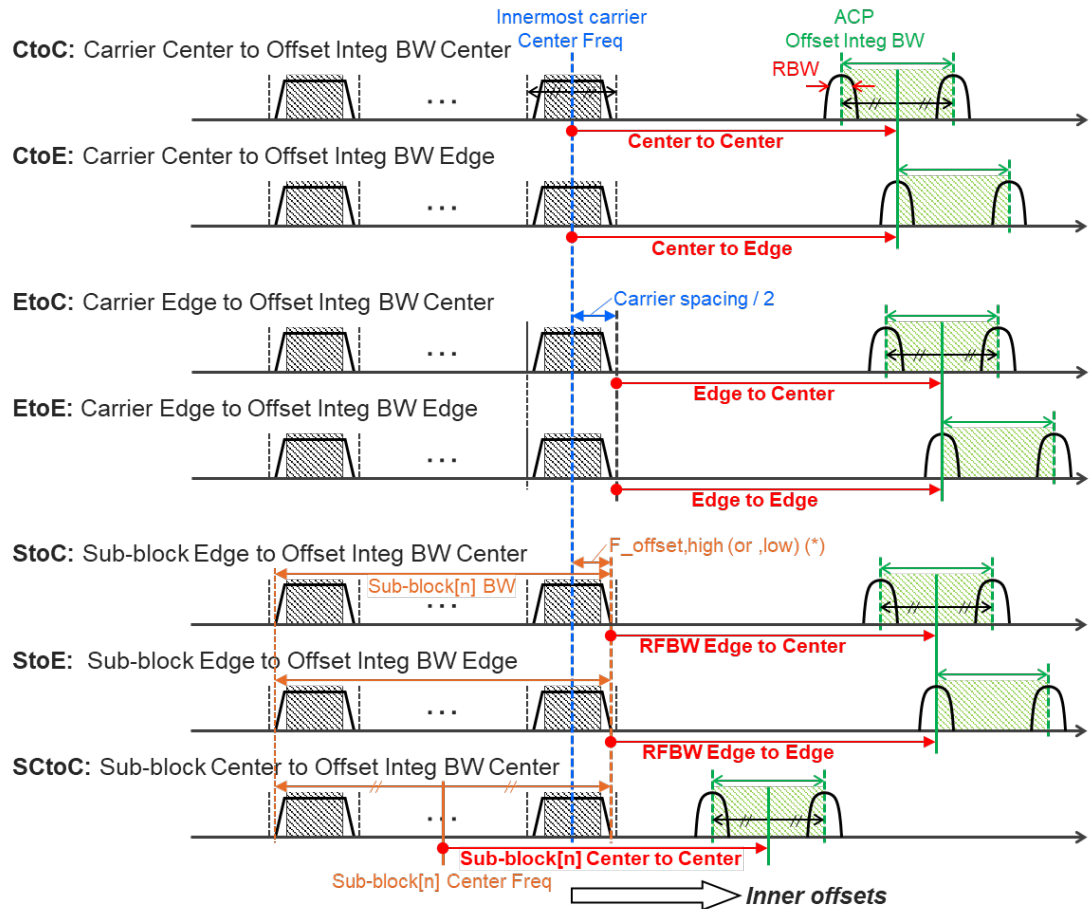

Note:

RF BW Edge and Outermost Carrier Edge are not always same.
 e.g.) 5G NR (3GPP) defines BW_channel,CA which calculates $F_{\text{offset,high}}$ and $F_{\text{offset,low}}$ asymmetrically with SCS shift

(*) For MSR, $F_{\text{offset,high}}$ (or ,low) = $F_{\text{offset,RAT,high}}$ (or ,low)

Offset Freq

Determines the frequency difference between the center of the main channel and the center of the carrier. When set to Offset to Edge, this parameter determines the frequency difference between the center of the main channel and the near edge of the offset.

Each **Offset Freq** state value is entered individually by selecting the desired carrier. Use the **Enabled** checkbox to turn the **Offset Freq** State on or off.

The list contains up to 6 entries, depending on the mode selected, for offset frequencies. Each offset frequency in the list corresponds to a reference bandwidth in the bandwidth list.

An offset frequency of zero turns the display of the measurement for that offset off, but the measurement is still made and reported. You can turn off (not use) specific offsets with `[:SENSe] :ACPower:OFFSet[n] :INNeR:LIST:STATE`.

Turning the offset off has the same effect as setting the frequency of the offset to 0 Hz, and causes it to be removed from the results screen.

Remote Command	<code>[:SENSe] :ACPower:OFFSet[1] 2:INNeR:LIST[:FREQuency] <freq>,...</code> <code>[:SENSe] :ACPower:OFFSet[1] 2:INNeR:LIST[:FREQuency]?</code> Subopcode: 1 = BTS/Downlink (Default), 2 = MS/Uplink						
Example	<code>:ACP:OFFS1:INN:LIST 0,0,0,0,0,0</code> <code>:ACP:OFFS1:INN:LIST?</code>						
Notes	When setting these values remotely, the position in the list sent corresponds to the offset. Missing values are not permitted, unless the number of values sent is greater than the number of carriers, then subsequent values are ignored						
Couplings	Changing Offset Frequency might affect "Span" on page 1232						
Preset	When "Max Num of Offsets" on page 1285 is 12, the preset value of Offset G ~ L is the same as the Offset F value						
	<table border="1"> <thead> <tr> <th>Modes</th> <th>Values</th> </tr> </thead> <tbody> <tr> <td>5G NR</td> <td>10 MHz, 30 MHz, 0 Hz, 0 Hz, 0 Hz, 0 Hz 100 MHz, 200 MHz, 0 Hz, 0 Hz, 0 Hz, 0 Hz</td> </tr> <tr> <td>All Others</td> <td>2.5MHz,7.5MHz,0,0,0,0 2.5MHz,7.5MHz,0,0,0,0</td> </tr> </tbody> </table>	Modes	Values	5G NR	10 MHz, 30 MHz, 0 Hz, 0 Hz, 0 Hz, 0 Hz 100 MHz, 200 MHz, 0 Hz, 0 Hz, 0 Hz, 0 Hz	All Others	2.5MHz,7.5MHz,0,0,0,0 2.5MHz,7.5MHz,0,0,0,0
Modes	Values						
5G NR	10 MHz, 30 MHz, 0 Hz, 0 Hz, 0 Hz, 0 Hz 100 MHz, 200 MHz, 0 Hz, 0 Hz, 0 Hz, 0 Hz						
All Others	2.5MHz,7.5MHz,0,0,0,0 2.5MHz,7.5MHz,0,0,0,0						
State Saved	Saved in instrument state						
Min/Max	0 Hz/Depends on instrument maximum frequency. Same as Max Span of the Swept SA Measurement Auto Function						
Remote Command	<code>[:SENSe] :ACPower:OFFSet[1] 2:INNeR:LIST:STATe OFF ON 0 1,...</code> <code>[:SENSe] :ACPower:OFFSet[1] 2:INNeR:LIST:STATe?</code> Subopcode: 1 = BTS/Downlink (Default), 2 = MS/Uplink						
Example	<code>:ACP:OFFS2:INN:LIST:STAT 1,1,0,0,0,0</code> <code>:ACP:OFFS2:INN:LIST:STAT?</code>						
Preset	When "Max Num of Offsets" on page 1285 is 12, the preset value of Offset G ~ L is the same as the Offset F value <code>ON, ON, OFF, OFF, OFF, OFF ON, OFF, OFF, OFF, OFF, OFF</code>						
State Saved	Yes						

Integ BW

Sets the Integration Bandwidth for the offsets. Each resolution bandwidth in the list corresponds to an offset frequency in the list defined by `[:SENSe]:ACPower:OFFSet [n]:INNER:LIST[:FREQUENCY]`.

Enter each value individually by selecting the desired offset on the **Offset** menu key using the up down arrows, the knob, or the numeric keypad, then enter the Offset Integration Bandwidth using the **Offset Integration Bandwidth** menu key.

You can turn off (not use) specific offsets with `[:SENSe]:ACPower:OFFSet [n]:INNER:LIST:STATE`.

Remote Command	<code>[:SENSe]:ACPower:OFFSet[1] 2:INNER:LIST:BANDwidth[:INTEgration] <freq>,...</code> <code>[:SENSe]:ACPower:OFFSet[1] 2:INNER:LIST:BANDwidth[:INTEgration]?</code> Subopcode: 1 = BTS/Downlink (Default), 2 = MS/Uplink								
Example	<code>:ACP:OFFS2:INN:LIST:BAND 2MHz,2MHz,2MHz,2MHz,2MHz,2MHz</code> <code>:ACP:OFFS2:INN:LIST:BAND?</code>								
Notes	When setting these values remotely, the position in the list sent corresponds to the offset. Missing values are not permitted, so, if you want to change the second value you must send all values up to it. Subsequent values remain unchanged								
Couplings	Changing Integ BW might affect " Span " on page 1232								
Preset	When " Max Num of Offsets " on page 1285 is 12, the preset value of Offset G ~ L is the same as the Offset F value								
	<table border="1"> <thead> <tr> <th>Modes</th> <th>Values</th> </tr> </thead> <tbody> <tr> <td>LTEAFDD</td> <td>3.84MHz, 3.84MHz, 3.84MHz, 3.84MHz, 3.84MHz, 3.84MHz 3.84MHz, 3.84MHz, 3.84MHz, 3.84MHz, 3.84MHz</td> </tr> <tr> <td>MSR, LTEATDD</td> <td>4.515MHz, 4.515MHz, 4.515MHz, 4.515MHz, 4.515MHz, 4.515MHz 4.5MHz, 4.5MHz, 4.5MHz, 4.5MHz, 4.5MHz</td> </tr> <tr> <td>5G NR</td> <td>19.08 MHz, 19.08 MHz, 19.08 MHz, 19.08 MHz, 19.08 MHz, 19.08 MHz 98.31 MHz, 98.31 MHz, 98.31 MHz, 98.31 MHz, 98.31 MHz</td> </tr> </tbody> </table>	Modes	Values	LTEAFDD	3.84MHz, 3.84MHz, 3.84MHz, 3.84MHz, 3.84MHz, 3.84MHz 3.84MHz, 3.84MHz, 3.84MHz, 3.84MHz, 3.84MHz	MSR, LTEATDD	4.515MHz, 4.515MHz, 4.515MHz, 4.515MHz, 4.515MHz, 4.515MHz 4.5MHz, 4.5MHz, 4.5MHz, 4.5MHz, 4.5MHz	5G NR	19.08 MHz, 19.08 MHz, 19.08 MHz, 19.08 MHz, 19.08 MHz, 19.08 MHz 98.31 MHz, 98.31 MHz, 98.31 MHz, 98.31 MHz, 98.31 MHz
Modes	Values								
LTEAFDD	3.84MHz, 3.84MHz, 3.84MHz, 3.84MHz, 3.84MHz, 3.84MHz 3.84MHz, 3.84MHz, 3.84MHz, 3.84MHz, 3.84MHz								
MSR, LTEATDD	4.515MHz, 4.515MHz, 4.515MHz, 4.515MHz, 4.515MHz, 4.515MHz 4.5MHz, 4.5MHz, 4.5MHz, 4.5MHz, 4.5MHz								
5G NR	19.08 MHz, 19.08 MHz, 19.08 MHz, 19.08 MHz, 19.08 MHz, 19.08 MHz 98.31 MHz, 98.31 MHz, 98.31 MHz, 98.31 MHz, 98.31 MHz								
State Saved	Saved in instrument state								
Min/Max	10 Hz/Depends on instrument maximum frequency. Same as Max Span of the Swept SA Measurement								

Offset Side

Lets you turn off (not use) specific offsets with `[:SENSe]:ACPower:OFFSet [1]|2:INNER:LIST:SIDE`.

- **NEGative** - The upper side in the sub-block gap only (that is, negative sideband of the upper sub-block) is enabled

- **BOTH** - Both sides in the sub-block gap are enabled
- **POSitive** - The lower side in the sub-block gap only (that is, positive sideband of the lower sub-block) is enabled

The diagram below shows the relation between the negative/positive offset side setups and the upper/lower results in the MSR, LTEAFDD and LTEATDD Modes.

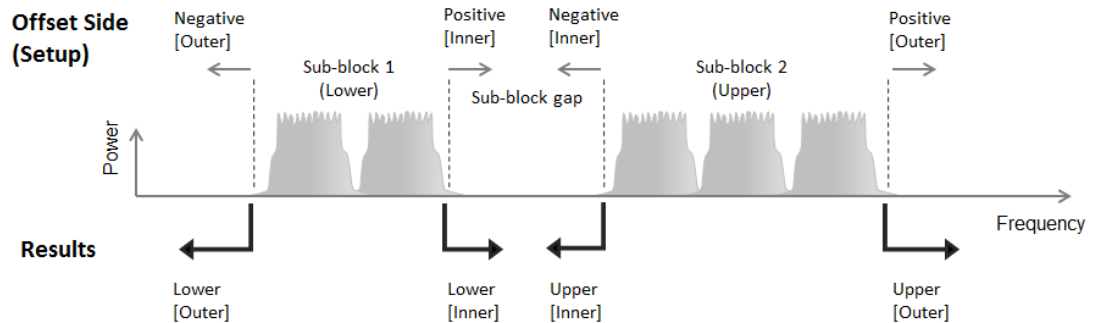

Remote Command	<code>[:SENSe]:ACPower:OFFSet[1] 2:INNeR:LIST:SIDE NEGative BOTH POSitive, ...</code> <code>[:SENSe]:ACPower:OFFSet[1] 2:INNeR:LIST:SIDE?</code> Subopcode: 1 = BTS/Downlink (Default), 2 = MS/Uplink
Example	<code>:ACP:OFFS:INN:LIST:SIDE BOTH</code> <code>:ACP:OFFS:INN:LIST:SIDE?</code>
Notes	If you set POS or NEG in an offset, result of the inactive side returns -999
Preset	When " Max Num of Offsets " on page 1285 is 12, the preset value of Offset G ~ L is BOTH BOTH, BOTH, BOTH, BOTH, BOTH, BOTH BOTH, BOTH, BOTH, BOTH, BOTH, BOTH
State Saved	Saved in instrument state
Range	NEGative BOTH POSitive

Method

Lets you turn RRC filtering of each offset on or off. The value (roll off) for the filter is set to the value of the Filter Alpha parameter.

Remote Command	<code>[:SENSe]:ACPower:OFFSet[1] 2:INNeR:LIST:FILTer[:RRC][:STATe] ON OFF 1 0, ...</code> <code>[:SENSe]:ACPower:OFFSet[1] 2:INNeR:LIST:FILTer[:RRC][:STATe]?</code> Subopcode: 1 = BTS/Downlink (Default), 2 = MS/Uplink
Example	<code>:ACP:OFFS:INN:LIST:FILT 1,0,0</code> <code>:ACP:OFFS:INN:LIST:FILT?</code>
Notes	1 ON = RRC Weighted, 0 OFF = Integ BW

Preset When "[Max Num of Offsets](#)" on page 1285 is 12, the preset value of Offset G ~ L is the same as the Offset F value

Modes	Values
LTEAFDD	1,1,1,1,1,1 1,1,1,1,1,1
MSR, LTEATDD, 5G NR	0,0,0,0,0,0 0,0,0,0,0,0

State Saved Saved in instrument state

Range Integ BW | RRC Weighted

Filter Alpha

Sets the alpha value for the RRC Filter for each offset.

Remote Command `[:SENSe]:ACPower:OFFSet[1]|2:INNeR:LIST:FILTer:ALPHa <real>,...`
`[:SENSe]:ACPower:OFFSet[1]|2:INNeR:LIST:FILTer:ALPHa?`

Subopcode: 1 = BTS/Downlink (Default), 2 = MS/Uplink

Example `:ACP:OFFS:INN:LIST:FILT:ALPH 0.5,0.5,0.5,0.5,0.5,0.5`

`:ACP:OFFS:INN:LIST:FILT:ALPH?`

Preset When "[Max Num of Offsets](#)" on page 1285 is 12, the preset value of Offset G ~ L is 0.22
0.22,0.22,0.22,0.22,0.22,0.22|0.22,0.22,0.22,0.22,0.22,0.22

State Saved Saved in instrument state

Min/Max 0.01/1.00

Offset Freq

The same as "[Offset Freq](#)" on page 1315 in the main **Inner Offset** menu.

Res BW

Sets the Resolution Bandwidth. If an unavailable bandwidth is entered with the numeric keypad, the closest available bandwidth is selected.

Remote Command `[:SENSe]:ACPower:OFFSet[1]|2:INNeR:LIST:BANDwidth:RESolution <freq>,...`
`[:SENSe]:ACPower:OFFSet[1]|2:INNeR:LIST:BANDwidth:RESolution?`

Subopcode: 1 = BTS/Downlink (Default), 2 = MS/Uplink

Example `:ACP:OFFS2:INN:LIST:BAND:RES 220kHz,220kHz,220kHz,220kHz,220kHz,220kHz`

`:ACP:OFFS2:INN:LIST:BAND:RES?`

Dependencies When "[Meas Method](#)" on page 1246 is RBW, FAST or Fast Power, this control is grayed-out and disabled. If the cell is pressed, an advisory message is generated. If the equivalent SCPI remote

	command is sent, a "Setting conflict" warning is generated
Couplings	When " Res BW " on page 1214 Mode is Auto , this value is exactly the same as Res BW . When you change this value, Res BW Mode also changes to Man
Preset	When " Max Num of Offsets " on page 1285 is 12, the preset value of Offset G ~ L is 100 kHz 100 kHz, 100 kHz, 100k Hz, 100 kHz 100 kHz, 100 kHz, 100 kHz, 100 kHz, 100 kHz, 100 kHz
State Saved	Saved in instrument state
Min/Max	1 Hz/8 MHz

Auto Function

Remote Command	<code>[:SENSe]:ACPower:OFFSet[1] 2:INNER:LIST:BANDwidth:RESolution:AUTO ON OFF 1 0,...</code> <code>[:SENSe]:ACPower:OFFSet[1] 2:INNER:LIST:BANDwidth:RESolution:AUTO?</code> Subopcode: 1 = BTS/Downlink (Default), 2 = MS/Uplink
Example	<code>:ACP:OFFS2:INN:LIST:BAND:RES:AUTO 1,1,1,1,1,1</code> <code>:ACP:OFFS2:INN:LIST:BAND:RES:AUTO?</code>
Preset	When " Max Num of Offsets " on page 1285 is 12, the preset value of Offset G ~ L is 1 1, 1, 1, 1, 1, 1
State Saved	Yes

Video BW

Lets you change the instrument post-detection filter (VBW).

Remote Command	<code>[:SENSe]:ACPower:OFFSet[1] 2:INNER:LIST:BANDwidth:VIDeo <freq>,...</code> <code>[:SENSe]:ACPower:OFFSet[1] 2:INNER:LIST:BANDwidth:VIDeo?</code> Subopcode: 1 = BTS/Downlink (Default), 2 = MS/Uplink
Example	<code>:ACP:OFFS2:INN:LIST:BAND:VID 5MHz,5MHz,5MHz,5MHz,5MHz,5MHz</code> <code>:ACP:OFFS2:INN:LIST:BAND:VID?</code>
Notes	The values shown in this table reflect the conditions after Mode Preset
Dependencies	When " Meas Method " on page 1246 is RBW, FAST or Fast Power, this cell is grayed-out and disabled. If the cell is pressed, an advisory message is generated. If the equivalent remote command is sent, a "Setting conflict" warning is generated
Preset	When " Max Num of Offsets " on page 1285 is 12, the preset value of Offset G ~ L is 1 MHz 1 MHz, 1 MHz, 1 MHz, 1 MHz, 1 MHz, 1 MHz
State Saved	Yes
Min/Max	1 Hz/50 MHz

Auto Function

3 VMA Mode
3.8 ACP Measurement

Remote Command	<code>[:SENSe]:ACPower:OFFSet[1] 2:INNER:LIST:BANDwidth:VIDeo:AUTO OFF ON 0 1,...</code> <code>[:SENSe]:ACPower:OFFSet[1] 2:INNER:LIST:BANDwidth:VIDeo:AUTO?</code> Subopcode: 1 = BTS/Downlink (Default), 2 = MS/Uplink
Example	<code>:ACP:OFFS2:INN:LIST:BAND:VID:AUTO 0,0,0,0,1,1</code> <code>:ACP:OFFS2:INN:LIST:BAND:VID:AUTO?</code>
Preset	When " Max Num of Offsets " on page 1285 is 12, the preset value of Offset G ~ L is ON , ON , ON , ON , ON , ON
State Saved	Yes

Filter Type

Selects the type of bandwidth filter that is used.

Remote Command	<code>[:SENSe]:ACPower:OFFSet[1] 2:INNER:LIST:BANDwidth:SHAPE GAUSSian FLATtop,...</code> <code>[:SENSe]:ACPower:OFFSet[1] 2:INNER:LIST:BANDwidth:SHAPE?</code> Subopcode: 1 = BTS/Downlink (Default), 2 = MS/Uplink
Example	<code>:ACP:OFFS2:INN:LIST:BAND:SHAP FLAT,GAUS,GAUS,GAUS,GAUS,GAUS</code> <code>:ACP:OFFS2:INN:LIST:BAND:SHAP?</code>
Dependencies	When " Res BW " on page 1214 Mode for the offset is Auto , this cell is grayed-out and disabled. Since Res BW Mode for the offset is preset to Auto on changing " Meas Method " on page 1246 to RBW, FAST or Fast Power, this cell is grayed-out and disabled. If the cell is pressed, an advisory message is generated. If the equivalent remote command is sent, a "Setting conflict" warning is generated
Preset	When " Max Num of Offsets " on page 1285 is 12, the preset value of Offset G ~ L is GAUSSian , GAUSSian , GAUSSian , GAUSSian , GAUSSian , GAUSSian
State Saved	Saved in instrument state
Range	GAUSSian FLATtop

Filter BW

Selects a Gaussian filter based on its -3 dB (Normal) bandwidth or its -6 dB bandwidth.

Remote Command	<code>[:SENSe]:ACPower:OFFSet[1] 2:INNER:LIST:BANDwidth:TYPE DB3 DB6,...</code> <code>[:SENSe]:ACPower:OFFSet[1] 2:INNER:LIST:BANDwidth:TYPE?</code> Subopcode: 1 = BTS/Downlink (Default), 2 = MS/Uplink
Example	<code>:ACP:OFFS2:INN:LIST:BAND:TYPE DB3,DB3,DB3,DB3,DB3,DB3</code> <code>:ACP:OFFS2:INN:LIST:BAND:TYPE?</code>
Dependencies	When " RBW Filter Type " on page 1217 is FLATtop or " Res BW " on page 1214 Mode for the offset is

	Auto , this cell is grayed-out and disabled. Since Res BW Mode for the offset is preset to Auto on changing " Meas Method " on page 1246 to RBW, FAST or Fast Power, this cell is also grayed-out and disabled. If the cell is pressed, an advisory message is generated. If the equivalent remote command is sent, a "Setting conflict" warning is generated
Preset	When " Max Num of Offsets " on page 1285 is 12, the preset value of Offset G ~ L is DB3 DB3, DB3, DB3, DB3, DB3, DB3
State Saved	Saved in instrument state
Range	-3 dB (Normal) -6 dB

Power Ref Type

Lets you set reference types of inner offsets.

CUMulative Cumulated power of the upper and lower sub-block carriers is the reference level. This selection is effective only when one of the following "**Power Ref**" on page 1331 values is selected:

Left & Right Carriers	LRCarriers
Max Power Carrier in Sub-block	MPCSubblock
Min Power Carrier in Sub-block	MINSubblock
Left & Right Sub-blocks	LRSubblocks
Manual	MANual

When one of the other **Power Ref** values is selected, carrier powers are not cumulated, and the reference level is equivalent to Normal

NORMal Power of specified carrier or the manual reference level is the reference level

Remote Command	<code>[:SENSe]:ACPower:OFFSet[1] 2:INNeR:LIST:PREFeRence CUMulative NORMal, ...</code> <code>[:SENSe]:ACPower:OFFSet[1] 2:INNeR:LIST:PREFeRence?</code> Subopcode: 1 = BTS/Downlink (Default), 2 = MS/Uplink
Example	<code>:ACP:OFFS:INN:LIST:PREF CUM,CUM,NORM,NORM,NORM,NORM</code> <code>:ACP:OFFS:INN:LIST:PREF?</code>
Preset	When " Max Num of Offsets " on page 1285 is 12, the preset value of Offset G ~ L is NORMal NORMal, NORMal, NORMal, NORMal, NORMal, NORMal
State Saved	Saved in instrument state
Range	CUMulative NORMal

Auto Function

Remote Command	<code>[:SENSe]:ACPower:OFFSet[1] 2:INNeR:LIST:PREFeRence:AUTO OFF ON 0 1, ...</code> <code>[:SENSe]:ACPower:OFFSet[1] 2:INNeR:LIST:PREFeRence:AUTO?</code> Subopcode: 1 = BTS/Downlink (Default), 2 = MS/Uplink
Example	<code>:ACP:OFFS:INN:LIST:PREF:AUTO OFF,OFF,OFF,OFF,OFF,OFF</code>

3 VMA Mode
3.8 ACP Measurement

:ACP:OFFS:INN:LIST:PREF:AUTO?

Dependencies	Available only in LTEAFDD, LTEATDD and 5G NR Modes																												
Couplings	<p>When in the LTEAFDD, LTEATDD Modes, the inner power ref type is set automatically when the power ref type state is auto according to the scopes of the sub-block gap in the following table</p> <table border="1"> <thead> <tr> <th>Sub-block Gap</th> <th>Inner ACP offset</th> <th>Power Ref Type</th> </tr> </thead> <tbody> <tr> <td rowspan="2">Wgap <5MHz</td> <td>1st (2.5MHz)</td> <td>Normal</td> </tr> <tr> <td>2nd (7.5MHz)</td> <td>Normal</td> </tr> <tr> <td rowspan="2">5MHz ≤ Wgap <10MHz</td> <td>1st (2.5MHz)</td> <td>Cumulative</td> </tr> <tr> <td>2nd (7.5MHz)</td> <td>Normal</td> </tr> <tr> <td rowspan="2">10MHz ≤ Wgap <15MHz</td> <td>1st (2.5MHz)</td> <td>Cumulative</td> </tr> <tr> <td>2nd (7.5MHz)</td> <td>Cumulative</td> </tr> <tr> <td rowspan="2">15MHz ≤ Wgap <20MHz</td> <td>1st (2.5MHz)</td> <td>Normal</td> </tr> <tr> <td>2nd (7.5MHz)</td> <td>Cumulative</td> </tr> <tr> <td rowspan="2">20MHz ≤ Wgap</td> <td>1st (2.5MHz)</td> <td>Normal</td> </tr> <tr> <td>2nd (7.5MHz)</td> <td>Normal</td> </tr> </tbody> </table> <p>When in 5G NR Mode, Power Ref Type “Auto” sets the power reference type of inner-ACLR offset automatically</p> <p>Downlink: “Cumulative” or “Normal” is selected accordingly when the inner-offsets are configured to meet the test requirements as follows:</p> <p>FR1, 3GPP TS 38.141-1 v16.5.0 (2020-09) Section 6.6.3.5.3 BS type 1-C:</p> <ul style="list-style-type: none"> - Table 6.6.3.5.2-3: Base Station ACLR limit in non-contiguous spectrum or multiple bands - Table 6.6.3.5.2-4: Base station CAACLR limit <p>FR2, 3GPP TS 38.141-2 v16.5.0 (2020-09) Section 6.7.3.5.3 BS type 2-O:</p> <ul style="list-style-type: none"> - Table 6.7.3.5.2-3: BS type 2-O ACLR limit in non-contiguous spectrum - Table 6.7.3.5.2-4: BS type 2-O CAACLR limit in non-contiguous spectrum <p>Uplink: “Normal” is always selected</p>	Sub-block Gap	Inner ACP offset	Power Ref Type	Wgap <5MHz	1st (2.5MHz)	Normal	2nd (7.5MHz)	Normal	5MHz ≤ Wgap <10MHz	1st (2.5MHz)	Cumulative	2nd (7.5MHz)	Normal	10MHz ≤ Wgap <15MHz	1st (2.5MHz)	Cumulative	2nd (7.5MHz)	Cumulative	15MHz ≤ Wgap <20MHz	1st (2.5MHz)	Normal	2nd (7.5MHz)	Cumulative	20MHz ≤ Wgap	1st (2.5MHz)	Normal	2nd (7.5MHz)	Normal
Sub-block Gap	Inner ACP offset	Power Ref Type																											
Wgap <5MHz	1st (2.5MHz)	Normal																											
	2nd (7.5MHz)	Normal																											
5MHz ≤ Wgap <10MHz	1st (2.5MHz)	Cumulative																											
	2nd (7.5MHz)	Normal																											
10MHz ≤ Wgap <15MHz	1st (2.5MHz)	Cumulative																											
	2nd (7.5MHz)	Cumulative																											
15MHz ≤ Wgap <20MHz	1st (2.5MHz)	Normal																											
	2nd (7.5MHz)	Cumulative																											
20MHz ≤ Wgap	1st (2.5MHz)	Normal																											
	2nd (7.5MHz)	Normal																											
Preset	<p>When "Max Num of Offsets" on page 1285 is 12, the preset value of Offset G ~ L is the same as the Offset F value</p> <p>ON, ON, ON, ON, ON, ON OFF, OFF, OFF, OFF, OFF, OFF</p>																												
State Saved	Saved in instrument state																												
Range	Auto Man																												

Limit Test

This checkbox is the same as "**Limit Test**" on page 1307 in the **Settings** tab.

Offset Freq

This column is the same as "Offset Freq" on page 1315 in the **Offset** tab.

Abs Limit

Specifies an absolute limit value, which sets the absolute amplitude levels to test against for each of the custom offsets. The list must contain 6 entries. If there is more than one offset, the offset closest to the carrier channel is the first one in the list. `[:SENSe]:ACP:OFFSet[n]:INNER:LIST:TEST` selects the type of testing to be done at each offset.

You can turn off (not use) specific offsets with `[:SENSe]:ACP:OFFSet[n]:INNER:LIST:STATE`.

The query returns the 6 sets of real numbers that are the current absolute amplitude test limits.

Remote Command	<code>[:SENSe]:ACPower:OFFSet[1] 2:INNER:LIST:ABSolute < real>,...</code> <code>[:SENSe]:ACPower:OFFSet[1] 2:INNER:LIST:ABSolute?</code>						
Example	Subopcode: 1 = BTS/Downlink (Default), 2 = MS/Uplink <code>:ACP:OFFS2:INN:LIST:ABS -10,-10,-10,-10,-10,-10</code> <code>:ACP:OFFS2:INN:LIST:ABS?</code>						
Preset	When "Max Num of Offsets" on page 1285 is 12, the preset value of Offset G ~ L is the same as the Offset F value						
	<table border="1"> <thead> <tr> <th>Modes</th> <th>Values</th> </tr> </thead> <tbody> <tr> <td>5G NR</td> <td>-2.2, -2.2, -2.2, -2.2, -2.2, -2.2 -50.0, -50.0, -50.0, -50.0, -50.0, -50.0</td> </tr> <tr> <td>All Others</td> <td>-8.45, -8.45, -8.45, -8.45, -8.45, -8.45 -50.0, -50.0, -50.0, -50.0, -50.0, -50.0</td> </tr> </tbody> </table>	Modes	Values	5G NR	-2.2, -2.2, -2.2, -2.2, -2.2, -2.2 -50.0, -50.0, -50.0, -50.0, -50.0, -50.0	All Others	-8.45, -8.45, -8.45, -8.45, -8.45, -8.45 -50.0, -50.0, -50.0, -50.0, -50.0, -50.0
Modes	Values						
5G NR	-2.2, -2.2, -2.2, -2.2, -2.2, -2.2 -50.0, -50.0, -50.0, -50.0, -50.0, -50.0						
All Others	-8.45, -8.45, -8.45, -8.45, -8.45, -8.45 -50.0, -50.0, -50.0, -50.0, -50.0, -50.0						
State Saved	Saved in instrument state						
Min/Max	-200.0 dBm/50.0 dBm						

Rel Limit (Car)

Specifies a relative limit value for the carrier level. This sets the amplitude levels to test against for the specified offsets.

The amplitude level is relative to the carrier amplitude. If multiple offsets are available, the list contains 6 entries. The offset closest to the carrier channel is the first one in the list. `[:SENSe]:ACP:OFFSet[n]:INNER:LIST:TEST` selects the type of testing to be done at each offset.

3 VMA Mode
3.8 ACP Measurement

You can turn off (not use) specific offsets with `[:SENSe]:ACP:OFFSet [n]:INNeR:LIST:STATe`.

The query returns the 6 sets of real numbers that are the current amplitude test limits, relative to the carrier, for each offset.

Offset[n] n = 1 is base station and n = 2 is mobiles. The default is base station (1).

Remote Command	<code>[:SENSe]:ACP:OFFSet[1] 2:INNeR:LIST:RCARrier <real>,...</code> <code>[:SENSe]:ACP:OFFSet[1] 2:INNeR:LIST:RCARrier?</code> Subopcode: 1 = BTS/Downlink (Default), 2 = MS/Uplink						
Example	<code>:ACP:OFFS2:INN:LIST:RCAR 0,0,0,0,0,0</code> <code>:ACP:OFFS2:INN:LIST:RCAR?</code>						
Preset	When "Max Num of Offsets" on page 1285 is 12, the preset value of Offset G ~ L is the same as the Offset F value						
	<table border="1"> <thead> <tr> <th>Modes</th> <th>Values</th> </tr> </thead> <tbody> <tr> <td>5G NR</td> <td>-43.8, -43.8, 43.8, -43.8, -43.8, -43.8 -29.2, -29.2, -29.2, -29.2, -29.2, -29.2</td> </tr> <tr> <td>All Others</td> <td>-44.2, -44.2, -44.2, -44.2, -44.2, -44.2 -29.2, -29.2, -29.2, -29.2, -29.2, -29.2</td> </tr> </tbody> </table>	Modes	Values	5G NR	-43.8, -43.8, 43.8, -43.8, -43.8, -43.8 -29.2, -29.2, -29.2, -29.2, -29.2, -29.2	All Others	-44.2, -44.2, -44.2, -44.2, -44.2, -44.2 -29.2, -29.2, -29.2, -29.2, -29.2, -29.2
Modes	Values						
5G NR	-43.8, -43.8, 43.8, -43.8, -43.8, -43.8 -29.2, -29.2, -29.2, -29.2, -29.2, -29.2						
All Others	-44.2, -44.2, -44.2, -44.2, -44.2, -44.2 -29.2, -29.2, -29.2, -29.2, -29.2, -29.2						
State Saved	Saved in instrument state						
Min/Max	-150/50.0						

Rel Limit (PSD)

Specifies a relative limit value for the level of the power spectral density. This sets the amplitude levels to test against for any custom offsets. The amplitude level is relative to the power spectral density. If multiple offsets are available, the list contains 6 entries. The offset closest to the carrier channel is the first one in the list.

`[:SENSe]:ACP:OFFSet[n]:INNeR:LIST:TEST` selects the type of testing to be done at each offset.

You can turn off (not use) specific offsets with `[:SENSe]:ACP:OFFSet [n]:INNeR:LIST:STATe`.

The query returns the 6 sets of real numbers that are the current amplitude test limits, relative to the power spectral density, for each offset.

Offset[n] n = 1 is base station and n = 2 is mobiles. The default is base station (1).

Remote Command	<code>[:SENSe]:ACP:OFFSet[1] 2:INNeR:LIST:RPSDensity <rel_ampl>,...</code> <code>[:SENSe]:ACP:OFFSet[1] 2:INNeR:LIST:RPSDensity?</code> Subopcode: 1 = BTS/Downlink (Default), 2 = MS/Uplink
Example	<code>:ACP:OFFS2:INN:LIST:RPSD 10,10,10,10,10,10</code> <code>:ACP:OFFS2:INN:LIST:RPSD?</code>

Preset	When "Max Num of Offsets" on page 1285 is 12, the preset value of Offset G ~ L is 0 0, 0, 0, 0, 0, 0 0, 0, 0, 0, 0, 0
State Saved	Saved in instrument state
Min/Max	-150.0 dB/50.0 dB

Fail Mask

Accesses a menu that enables you to select one of the logics for the fail conditions between the measurement results and the test limits. The setting defines the type of testing to be done at any custom offset frequencies. The measured powers are tested against the absolute values defined with `[:SENSe]:ACP:OFFSet [n]:INNeR:LIST:ABSolute`, or the relative values defined with `[:SENSe]:ACP:OFFSet [n]:INNeR:LIST:RPSDeNsity` and `[:SENSe]:ACP:OFFSet [n]:INNeR:LIST:RCARrier`.

You can turn off (not use) specific offsets with `[:SENSe]:ACP:OFFSet [n]:INNeR:LIST:StAtE`.

Option	SCPI	Description
Absolute	<code>ABSolute</code>	Fail is shown if one of the absolute ACP measurement results is larger than the limit for Abs Limit
Relative	<code>RELative</code>	Fail is shown if one of the relative ACP measurement results is larger than the limit for Rel Lim (Car) or Rel Lim (PSD)
Abs AND Rel	<code>AND</code>	Fail is shown if one of the absolute ACP measurement results is larger than the limit for Abs Limit <i>and</i> one of the relative ACP measurement results is larger than the limit for Rel Lim (Car) or Rel Lim (PSD)
Abs OR Rel	<code>OR</code>	Fail is shown if one of the absolute ACP measurement results is larger than the limit for Abs Limit <i>or</i> one of the relative ACP measurement results is larger than the limit for Rel Lim (Car) or Rel Lim (PSD)

Remote Command	<code>[:SENSe]:ACP:OFFSet [1] 2:INNeR:LIST:TEST ABSolute AND OR RELative,...</code> <code>[:SENSe]:ACP:OFFSet [1] 2:INNeR:LIST:TEST?</code> Subopcode: 1 = BTS/Downlink (Default), 2 = MS/Uplink
Example	<code>:ACP:OFFS2:INN:LIST:TEST ABS,ABS,ABS,ABS,ABS,ABS</code> <code>:ACP:OFFS2:INN:LIST:TEST?</code>
Preset	When "Max Num of Offsets" on page 1285 is 12, the preset value of Offset G ~ L is <code>AND</code> <code>AND, AND, AND, AND, AND, AND AND, AND, AND, AND, AND, AND</code>
State Saved	Saved in instrument state
Range	<code>ABSolute AND OR RELative</code>

Reference Carrier (Carrier Index)

Sets the reference carrier. Relative power measurements are made from the reference carrier.

If set to **Auto**, the measurement selects the carrier with the highest power as the reference carrier and the Ref Carrier parameter is updated. If a value is entered when Ref Carrier Mode is set to **Auto**, the mode changes to **Man**.

If set to **Man**, the value that you enter for the Ref Carrier is used as the reference carrier.

In MSR, LTEAFDD, LTEATDD and 5G NR Modes, this control is called **Carrier Index** and has a different SCPI command. In these Modes, it sets the carrier index of the reference power. The power of the carrier selected by this index becomes reference power when "[Power Ref](#)" on page 1331 is **Carrier Index**. Any value up to the MAX can be set, though the measurement only deals with number of carriers specified by Carrier. If the index is larger than Carrier, reference power in this measurement becomes **NaN** and therefore all relative power results are **NaN**.

For more information, see "[Carrier Index \(Modes: MSR, LTEAFDD, LTEATDD, and 5G NR\)](#)" on page 1328.

Remote Command	<code>[:SENSe]:ACPower:CARRier[1] 2:RCARrier <integer></code> <code>[:SENSe]:ACPower:CARRier[1] 2:RCARrier?</code> Subopcode: 1 = BTS/Downlink (Default), 2 = MS/Uplink
Example	<code>:ACP:CARR:RCAR 1</code> <code>:ACP:CARR:RCAR?</code>
Notes	Note that Carrier subopcode 2 is not supported in some Modes. In those cases, Carrier subopcode 1 is used for both BTS and MS and commands with subopcode 2 are accepted without error but ignored For LTEAFDD and LTEATDD Modes, this control is not shown. In order to maintain backwards compatibility with legacy LTE FDD/TDD Modes, the SCPI command is supported in the LTE & LTE-A converged applications
Dependencies	Grayed-out if there is only one carrier Does not appear in MSR, LTEAFDD, LTEATDD and 5G NR Modes
Couplings	If you enter a carrier value that is currently configured as having no power present, that carrier changes to having power present
Preset	Auto determined
State Saved	Saved in instrument state
Min/Max	1/Number of available carriers
Backwards Compatibility SCPI	<code>[:SENSe]:MCPower:RCARrier[1] 2</code>

Auto Function

Remote Command	<code>[:SENSe]:ACPower:CARRier[1] 2:RCARrier:AUTO OFF ON 0 1</code> <code>[:SENSe]:ACPower:CARRier[1] 2:RCARrier:AUTO?</code> Subopcode: 1 = BTS/Downlink (Default), 2 = MS/Uplink
Example	<code>:ACP:CARR:RCAR:AUTO OFF</code> <code>:ACP:CARR:RCAR:AUTO?</code>
Couplings	If you enter a ref carrier this parameter will be set to manual
Preset	1
State Saved	Yes
Range	Auto Man
Backwards Compatibility SCPI	<code>[:SENSe]:MCPower:RCARrier[1] 2:AUTO</code> (Power Suite)

Carrier Index (Modes: MSR, LTEAFDD, LTEATDD, and 5G NR)

Remote Command	<code>[:SENSe]:ACPower:CARRier[1] 2:INDex <integer></code> <code>[:SENSe]:ACPower:CARRier[1] 2:INDex?</code> Subopcode: 1 = BTS/Downlink (Default), 2 = MS/Uplink
Example	<code>:ACP:CARR:IND 1</code> <code>:ACP:CARR:IND?</code>
Notes	Note that Carrier subopcode 2 is not supported in some Modes. In those cases, Carrier subopcode 1 is used for both BTS and MS and commands with subopcode 2 are accepted without error but ignored
Dependencies	Only appears in MSR, LTEAFDD, LTEATDD and 5G NR Modes
Preset	1
State Saved	Saved in instrument state
Min/Max	LTEAFDD, LTEATDD: 1/Dependent on Num Component Carriers 5G NR: 1/Dependent on Num Component Carriers MSR: 1/100

Carrier Index Zero Base (Remote Command Only)

Remote Command	<code>[:SENSe]:ACPower:CARRier[1] 2:RCARrier:ZBAsE <integer></code> <code>[:SENSe]:ACPower:CARRier[1] 2:RCARrier:ZBAsE?</code> Subopcode: 1 = BTS/Downlink (Default), 2 = MS/Uplink
Example	<code>:ACP:CARR:RCAR:ZBAS 1</code> <code>:ACP:CARR:RCAR:ZBAS?</code>

3 VMA Mode
3.8 ACP Measurement

Notes	Note that Carrier subopcode 2 is not supported in some Modes. In those cases, Carrier subopcode 1 is used for both BTS and MS and commands with subopcode 2 are accepted without error but ignored
Dependencies	Not available in multicarrier applications (MSR, 5GNR, LTE Modes)
Couplings	Coupled with: <code>[:SENSe]:ACPower:CARRier[1] 2:RCARrier <integer></code>
Preset	0
State Saved	Saved in instrument state
Min	0
Max	9

Ref Carrier Freq

Sets the reference carrier frequency.

Remote Command	<code>[:SENSe]:ACPower:CARRier[1] 2:RCFRrequency <freq></code> <code>[:SENSe]:ACPower:CARRier[1] 2:RCFRrequency?</code> Subopcode: 1 = BTS/Downlink (Default), 2 = MS/Uplink
Example	<code>:ACP:CARR:RCFR 250 MHz</code> <code>:ACP:CARR:RCFR?</code>
Notes	Note that Carrier subopcode 2 is not supported in some Modes. In those cases, Carrier subopcode 1 is used for both BTS and MS and commands with subopcode 2 are accepted without error but ignored For LTEAFDD and LTEATDD Modes, this control is not shown. In order to maintain backwards compatibility with legacy LTE FDD/TDD Modes, the SCPI command is supported in the LTE & LTE-A converged applications
Dependencies	Does not appear in MSR, LTEAFDD, LTEATDD and 5G NR Modes
Couplings	LTEAFDD and LTEATDD Modes do not support the following couplings Coupled to Center Frequency If the center frequency changes, Ref Carrier Freq is calculated using the following three steps; <ol style="list-style-type: none"> 1. Ref Freq1 = Ctr Freq - (Total of all Carrier Widths / 2) 2. Ref Freq2 = Ref Freq1 + (Total of all Carrier Widths up to Ref Carrier) 3. Ref Freq = Ref Freq2 + (0.5 * Carrier Width of Ref Carrier) <p>If Ref Carrier Freq changes, Center Frequency is calculated using the following three steps;</p> <ol style="list-style-type: none"> 1. Ctr Freq1 = Ref Freq - (0.5 * Carrier Width of Ref Carrier) 2. Ctr Freq2 = Ctr Freq1 - (Total of all Carrier Widths up to Ref Carrier) 3. Ctr Freq = Ctr Freq2 + (Total of all Carrier Widths / 2) <p>This ensures that the carriers are always centered on the screen</p>

	If there is only one carrier present, Ref Carrier Freq is the same as Center Frequency
Preset	Calculated based on the current Center Frequency
State Saved	Saved in instrument state
Min/Max	-79.999995 MHz/Hardware Dependent
Backwards Compatibility SCPI	<code>[:SENSe]:MCPower:RCFRequency[1] 2 (Power Suite)</code>
Auto Function	
Remote Command	<code>[:SENSe]:ACPPower:CARRier[1] 2:RCFRequency:AUTO OFF ON 0 1</code> <code>[:SENSe]:ACPPower:CARRier[1] 2:RCFRequency:AUTO?</code> Subopcode: 1 = BTS/Downlink (Default), 2 = MS/Uplink
Example	<code>:ACP:CARR:RCFR:AUTO OFF</code> <code>:ACP:CARR:RCFR:AUTO?</code>
Preset	ON
State Saved	Yes
Range	Auto Man
Backwards Compatibility SCPI	<code>[:SENSe]:MCPower:RCFRequency[1] 2:AUTO</code>

Measurement Type

Changes the reference used for the measurement. This allows you to make absolute and relative power measurements of either total power or the power normalized to the measurement bandwidth.

- Total Pwr Ref (**TPRef**) sets the reference to the total carrier power
- PSD Ref (**PSDRef**) sets the reference to the power spectral density of the carrier

Remote Command	<code>[:SENSe]:ACPPower:TYPE TPRef PSDRef</code> <code>[:SENSe]:ACPPower:TYPE?</code>
Example	<code>:ACP:TYPE PSDR</code> <code>:ACP:TYPE?</code>
Preset	TPRef
State Saved	Saved in instrument state
Range	Total Power Ref PSD Ref

Power Ref

Selects the power reference type. This control has two different forms, depending on the currently-selected Mode:

- "Power Ref (Modes: SA, WCDMA, VMA, SRComms)" on page 1331
- "Power Ref (Modes: LTEAFDD, LTEATDD, 5G NR, MSR)" on page 1331

Power Ref (Modes: SA, WCDMA, VMA, SRComms)

Type	Option	Description
Ref Carrier	<code>RCARrier</code>	Power of the specified carrier is the reference of measurement. Use the Reference Carrier control to select Carrier Index
Manual Power	<code>MANual</code>	Power or PSD specified by the user is the reference of measurement
Total Multicarriers	<code>TMCarrriers</code>	Total Power of multi carriers is the power reference of measurement. Each carrier power is calculated with its own carrier configuration settings
Remote Command	<code>[:SENSe]:ACP:Power:CARRier[1] 2:PREF:ence:TYPE RCARrier MANual TMCarrriers</code> <code>[:SENSe]:ACP:Power:CARRier[1] 2:PREF:ence:TYPE?</code>	Subopcode: 1 = BTS/Downlink (Default), 2 = MS/Uplink
Example	<code>:ACP:CARR:REF:TYPE RCARrier</code> <code>:ACP:CARR:REF:TYPE?</code>	
Notes		Available only in SA, WCDMA, VMA and Short-Range Comms Modes Note that Carrier subopcode 2 is not supported in some Modes. In those cases, Carrier subopcode 1 is used for both BTS and MS and commands with subopcode 2 are accepted without error but ignored
Preset	<code>RCARrier</code>	
State Saved		Saved in instrument state
Range	<code>RCARrier MANual TMCarrriers</code>	

Power Ref (Modes: LTEAFDD, LTEATDD, 5G NR, MSR)

Selects the power reference type:

Type	Option	Description
Left & Right Carriers	<code>LRCarriers</code>	Powers of leftmost and rightmost carriers with Measure Carrier On in a sub-block are the references of left and right sides respectively. Left and right carriers are determined based on the carrier center frequencies. If Measure Carriers of all the carriers in a sub-block are off, the reference power in a sub-block and all the relative power results are NaN. Relative limits are not

Type	Option	Description
		evaluated
Max Power Carrier	MPCarrier	Maximum carrier power among the carriers of Measure Carrier On is the reference of measurement. If Measure Carriers of all the carriers are off, the reference power and all the relative power results are NAN . Relative limits are not evaluated
Min Power Carrier 5G NR only	MINPcarrier	Minimum carrier power among the carriers of Measure Carrier On is the reference of measurement. If Measure Carriers of all the carriers are off, the reference power and all the relative power results are NAN . Relative limits are not evaluated
Carrier Index	CINdex	Power of the specified carrier is the reference of measurement. If Measure Carriers of this carrier index is off, the reference power and all the relative power results are NAN . Relative limits are not evaluated
Manual	MANual	Power or PSD specified by the user is the reference of measurement
Aggregated Chan BW LTEAFDD, LTEATDD, 5G NR only	ACBandwidth	The assigned aggregated channel bandwidth power which is measured with a rectangular filter with measurement bandwidth specified as aggregated channel bandwidth based on the definition of each 3GPP standard. Calculated from the carrier configuration including SCS (Power Meas), the smallest SCS among the enabled SCSs of the selected component carrier. If Measure Carriers of all the carriers are off, the reference power and all the relative power results are NAN . Relative limits are not evaluated
Max Power Carrier in Sub-block	MPCSubblock	Maximum carrier power among the sub-block carriers of Measure Carrier On is the reference of measurement. If Measure Carriers of all the carriers in a sub-block are off, the reference power of the sub-block and all the relative power results referring to this sub-block are NAN , and these relative limits are not evaluated
Total Multicarriers MSR only	TMCarrriers	Total power of multi carriers is the power reference of measurement. Each carrier power is calculated with its own carrier configuration settings
Min Power Carrier in Sub-block 5G NR only	MINSubbloc	Minimum carrier power among the sub-block carriers of Measure Carrier On is the reference of measurement. If Measure Carriers of all the carriers in a sub-block are off, the reference power of the sub-block and all the relative power results referring to this sub-block are NAN , and these relative limits are not evaluated
Left & Right Sub-blocks 5G NR only	LRSubblocks	The reference depends on the number of Component Carriers (CC) and Carrier Allocation as follows: <ul style="list-style-type: none"> - Num of CC is 1: the carrier power is the reference - Num of CC is 2 or more & Carrier Allocation is Contiguous: Aggregated Channel power is the reference - Num of CC is 2 or more & Carrier Allocation is Non-Contiguous: Aggregated powers of left and right sub-blocks are the references. Left and right sub-blocks are determined by component carrier configuration

3 VMA Mode
 3.8 ACP Measurement

The powers of carriers are not included in the reference power when their Measure Carriers are Off. When Measure Carriers of all the carriers in a sub-block are Off, the reference power and all the relative power results are NaN. Therefore, relative limits are not evaluated.

Measurement Type = Total Power Ref

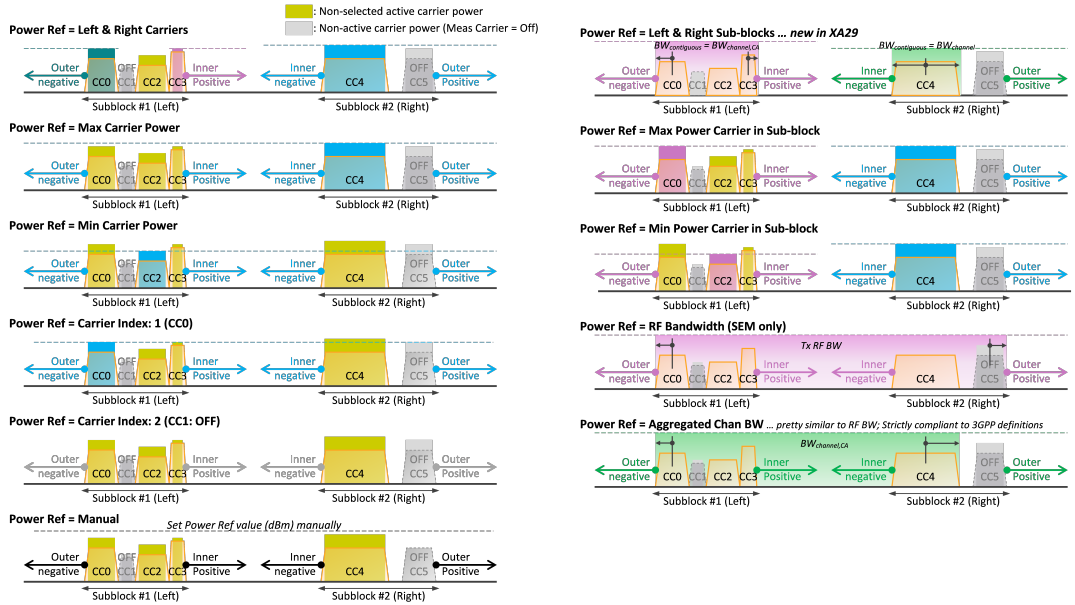

Measurement Type = PSD Ref

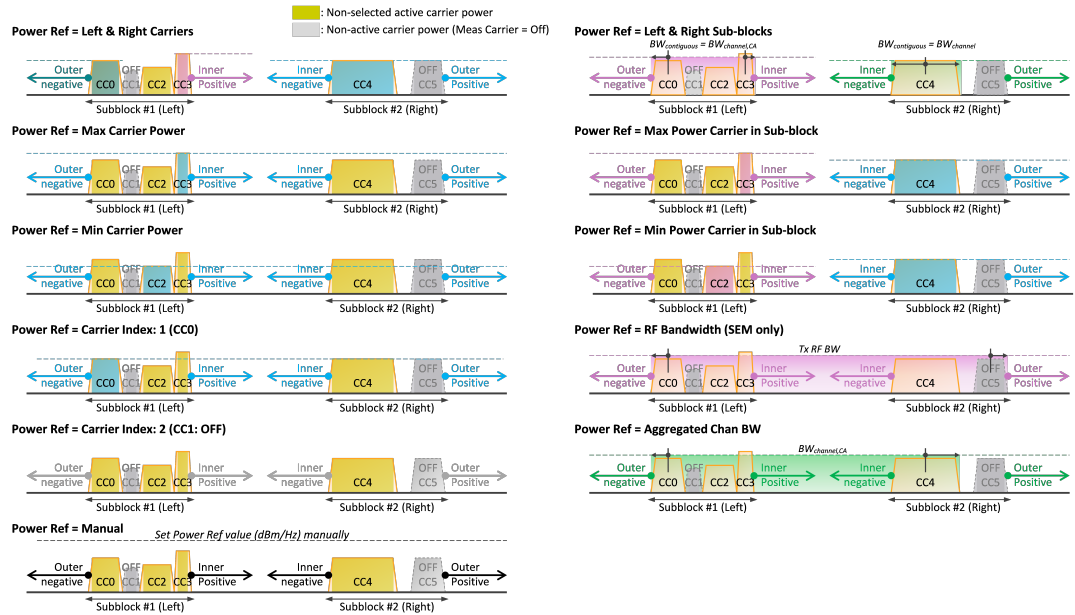

Remote Command	<pre>[:SENSE]:ACPower:CARRIER[1] 2:PREference:TYPE LRCarriers MPCarrier CINDEX MANual MPCSubblock ACBandwidth TMCarrriers MINPcarrier MINSubblock LRSubblocks [:SENSE]:ACPower:CARRIER[1] 2:PREference:TYPE?</pre>
Example	<pre>:ACP:CARR:PREF:TYPE CIND :ACP:CARR:PREF:TYPE?</pre>
Notes	<p>Available only in MSR, LTEAFDD, LTEATDD and 5G NR Modes</p> <p>ACBandwidth is available only in LTEAFDD, LTEATDD and 5G NR Modes</p> <p>TMCarrriers is available only in MSR Mode</p> <p>MINPcarrier, MINSubblock, and LRSubblocks are available only in 5G NR Mode</p> <p>Note that Carrier subopcode 2 is not supported in some Modes. In those cases, Carrier subopcode 1 is used for both BTS and MS and commands with subopcode 2 are accepted without error but ignored</p>
Preset	MPCarrier
State Saved	Saved in instrument state

Power Ref State (Remote Command Only)

Remote Command	<pre>[:SENSE]:ACPower:CARRIER[1] 2:AUTO[:STATE] OFF ON 0 1</pre>
----------------	---

	<code>[:SENSe] :ACPpower :CARRier [1] 2 :AUTO [:STATe] ?</code>
	Subopcode: 1 = BTS/Downlink (Default), 2 = MS/Uplink
Example	<code>:ACP:CARR:AUTO OFF</code> <code>:ACP:CARR:AUTO?</code>
Preset	ON
State Saved	Saved in instrument state
Range	Auto Man
Backwards Compatibility SCPI	<code>[:SENSe] :MCPower :CARRier [1] 2 :AUTO [:STATe]</code>

Total Power Ref

Sets manual total power reference.

This control has two different forms, depending on the currently-selected Mode:

- ["Total Power Ref \(Modes: SA, WCDMA, VMA, SRComms\)" on page 1335](#)
- ["Total Power Ref \(Modes: LTEAFDD, LTEATDD, 5G NR, MSR\)" on page 1336](#)

Total Power Ref (Modes: SA, WCDMA, VMA, SRComms)

This is used when Power Ref is Manual and ["Measurement Type" on page 1330](#) is Total Power.

Remote Command	<code>[:SENSe] :ACPpower :CARRier [1] 2 [:POWer] <real></code> <code>[:SENSe] :ACPpower :CARRier [1] 2 [:POWer] ?</code>
	Subopcode: 1 = BTS/Downlink (Default), 2 = MS/Uplink
Example	<code>:ACP:CARR 10</code> <code>:ACP:CARR?</code>
Notes	Although the default value is defined, the value is recalculated by the measurement result just after measurement Note that Carrier subopcode 2 is not supported in some Modes. In those cases, Carrier subopcode 1 is used for both BTS and MS and commands with subopcode 2 are accepted without error but ignored The Unit Terminators differ depending on whether or not the mode supports Y Axis Unit and also which Y Axis Unit is selected
Dependencies	Available only when Measurement Type is TPRef , otherwise grayed-out
Preset	0.0
State Saved	Saved in instrument state

Min/Max	-200 dBm/200 dBm
Backwards Compatibility SCPI	<code>[:SENSe]:MCPower:CARRier[1] 2[:POWer]</code>

Total Power Ref (Modes: LTEAFDD, LTEATDD, 5G NR, MSR)

Sets the multi-carrier power reference. This is used when Power Ref is Manual and "Measurement Type" on page 1330 is Total Power.

When set to **Auto**, the carrier power result reflects the measured power value in the selected reference carrier.

When set to **Man**, the result is referenced to the last measured value, or you may specify the reference for the multi-carrier power measurement. Relative values are displayed, referenced to the "Power Reference" value.

Remote Command	<code>[:SENSe]:ACPPower:CARRier[1] 2[:POWer] <real></code> <code>[:SENSe]:ACPPower:CARRier[1] 2[:POWer]?</code> Subopcode: 1 = BTS/Downlink (Default), 2 = MS/Uplink
Example	<code>:ACP:CARR 10</code> <code>:ACP:CARR?</code>
Notes	Although the default value is defined, the value is recalculated by the measurement result just after measurement Note that Carrier subopcode 2 is not supported in some Modes. In those cases, Carrier subopcode 1 is used for both BTS and MS and commands with subopcode 2 are accepted without error but ignored The Unit Terminators differ depending on whether or not the mode supports Y Axis Unit and also which Y Axis Unit is selected
Dependencies	Enabled when "Measurement Type" on page 1330 is Total Power and "Power Ref" on page 1331 is Manual
Preset	0.0
State Saved	Saved in instrument state
Min/Max	-200 dBm/200 dBm
Backwards Compatibility SCPI	<code>[:SENSe]:MCPower:CARRier[1] 2[:POWer]</code>

PSD Ref

Sets manual PSD reference.

This control has two different forms, depending on the currently-selected Mode:

- "PSD Ref (Modes: SA, WCDMA, VMA, SRComms)" on page 1337
- "PSD Ref (Modes: LTEAFDD, LTEATDD, 5G NR, MSR)" on page 1338

PSD Ref (Modes: SA, WCDMA, VMA, SRComms)

This is used when "Power Ref" on page 1331 is Manual and "Measurement Type" on page 1330 is PSD.

Sets the power spectral density in the carrier (main channel) that is used to compute the relative power spectral density values for the offsets when **Measurement Type** is PSD Ref.

Remote Command	<code>[:SENSe]:ACPower:CARRier[1] 2:CPSD <real></code> <code>[:SENSe]:ACPower:CARRier[1] 2:CPSD?</code> Subopcode: 1 = BTS/Downlink (Default), 2 = MS/Uplink
Example	<code>:ACP:CARR:CPSD 25</code> <code>:ACP:CARR:CPSD?</code>
Notes	Although the default value is defined, the value is recalculated by the measurement result just after measurement Note that Carrier subopcode 2 is not supported in some Modes. In those cases, Carrier subopcode 1 is used for both BTS and MS and commands with subopcode 2 are accepted without error but ignored
Dependencies	Available only when Measurement Type is PSDRef , otherwise grayed-out
Couplings	The value of PSD Ref is automatically converted when PSD Unit is changed
Preset	0.0
State Saved	Saved in instrument state
Min/Max	-999/999

Power Ref State (Backwards Compatibility SCPI)

Sets the Power Reference State to auto or manual.

Example	<code>:ACP:CARR:AUTO OFF</code> <code>:ACP:CARR:AUTO?</code> <code>:MCP:CARR:AUTO ON</code> <code>:MCP:CARR:AUTO?</code>
Notes	For backwards compatibility with legacy SA and WCDMA, this command is supported When ON , corresponds to the Ref Carrier of the "Power Ref" on page 1331 selection When OFF , corresponds to the Manual of the Power Ref selection

Preset	ON
State Saved	Saved in instrument state
Range	Auto Man
Backwards Compatibility SCPI	[:SENSe]:ACPower:CARRier[1] 2:AUTO[:STATe] OFF ON 0 1 [:SENSe]:ACPower:CARRier[1] 2:AUTO[:STATe]? [:SENSe]:MCPower:CARRier[1] 2:AUTO[:STATe] OFF ON 0 1 [:SENSe]:MCPower:CARRier[1] 2:AUTO[:STATe]?

PSD Ref (Modes: LTEAFDD, LTEATDD, 5G NR, MSR)

Sets manual PSD reference. This is used when "Power Ref" on page 1331 is **Manual** and "Measurement Type" on page 1330 is **PSD**.

Sets the power spectral density in the carrier (main channel) that is used to compute the relative power spectral density values for the offsets when **Measurement Type** is set to **PSD Ref**. When the **PSD Ref** state is set to **Auto**, this will be set to the measured carrier power spectral density.

Remote Command	[:SENSe]:ACPower:CARRier[1] 2:CPSD <real> [:SENSe]:ACPower:CARRier[1] 2:CPSD? Subopcode: 1 = BTS/Downlink (Default), 2 = MS/Uplink
Example	:ACP:CARR:CPSD 25 :ACP:CARR:CPSD?
Notes	Although the default value is defined, the value is recalculated by the measurement result just after measurement Note that Carrier subopcode 2 is not supported in some Modes. In those cases, Carrier subopcode 1 is used for both BTS and MS and commands with subopcode 2 are accepted without error but ignored
Dependencies	Enabled when "Measurement Type" on page 1330 is PSD Reference and Power Ref is Manual
Couplings	The value of PSD is automatically converted when PSD Unit is changed
Preset	0.0
State Saved	Saved in instrument state
Min/Max	-/+999

PSD Unit

Sets the unit bandwidth for Power Spectral Density. The available units are dBm/Hz (**DBMHZ**) and dBm/MHz (**DBMMHZ**).

Remote Command	:UNIT:ACPower:POWer:PSD DBMHZ DBMMHZ :UNIT:ACPower:POWer:PSD?
----------------	--

3 VMA Mode
3.8 ACP Measurement

Example	<code>:UNIT:ACP:POW:PSD DBMMHZ</code> <code>:UNIT:ACP:POW:PSD?</code>
Dependencies	Enabled when " Measurement Type " on page 1330 is PSD Reference
Couplings	When the PSD unit is changed, the PSD reference result of <code>:MEAS READ FETCH:ACP[n]?</code> is also changed by the PSD unit basis (in either dBm/Hz or dBm/MHz)
Preset	<code>DBMHZ</code>
State Saved	Saved in instrument state
Range	dBm/Hz dBm/MHz

3.8.13.3 Advanced

Contains controls for setting advanced functions of the instrument.

This tab does *not* appear in the following instruments:

- EXM
- VXT model M9420A

Phase Noise Opt

Selects the LO (local oscillator) phase noise behavior for various operating conditions.

Remote Command	<code>[:SENSe]:ACPower:FREQuency:SYNThesis[:STATe] 1 ... 5</code> For the meaning of each numeric option value, see " Parameter Options, Installed Options, Auto Rules & Ranges " on page 1340 below <code>[:SENSe]:ACPower:FREQuency:SYNThesis[:STATe]?</code>
Example	<code>:ACP:FREQ:SYNT 1</code> <code>:ACP:FREQ:SYNT?</code>
Dependencies	Does not appear in all models. For models that do not display this control, the SCPI command is accepted for compatibility (although no action is taken) Not available in VXT models M9410A/11A/15A
Preset	Because this function is in Auto after preset, the state of this function after Preset will be automatically calculated
State Saved	Saved in instrument state
Range	See " Ranges " on page 1344 below
Auto Function	
Remote Command	<code>[:SENSe]:ACPower:FREQuency:SYNThesis:AUTO[:STATe] OFF ON 0 1</code> <code>[:SENSe]:ACPower:FREQuency:SYNThesis:AUTO[:STATe]?</code>

Example :ACP:FREQ:SYNT:AUTO 1
 :ACP:FREQ:SYNT:AUTO?

Preset ON

Parameter Options, Installed Options, Auto Rules & Ranges

The Phase Noise Optimization control lets you optimize the setup and behavior of the Local Oscillator (LO) depending on your specific measurement conditions. You may wish to trade off noise and speed, for example, to make a measurement faster without regard to noise or with optimum noise characteristics without regard to speed.

Parameter Values Summary

Option	#	Description
"Balanced" on page 1341	1	<ul style="list-style-type: none"> - In instruments with EPO, balances close-in phase noise with spur avoidance - In instruments without EPO optimizes phase noise for small frequency offsets from the carrier
"Best Wide-offset" on page 1341	2	Optimizes phase noise for wide frequency offsets from the carrier
"Fast Tuning" on page 1342	3	Optimizes LO for tuning speed
"Best Close-in" on page 1341	4 or 1*	<ul style="list-style-type: none"> - In instruments with EPO, emphasizes close-in phase noise performance without regard to spur avoidance - In instruments without EPO, this setting is accepted but no action is taken
"Best Spurs" on page 1341	5	<ul style="list-style-type: none"> - In instruments with EPO, emphasizes spur avoidance over close-in phase noise performance - In instruments without EPO, this setting is accepted but no action taken
Auto	-	Automatically selects LO (local oscillator) phase noise behavior to optimize dynamic range and speed for various instrument operating conditions

*Dependent on Option EPO installation. See "Best Close-in" on page 1341 below.

The actual behavior varies somewhat depending on model number and option; for example, you always get Fast Tuning by choosing Option #3, but in some models, "Fast Tuning" on page 1342 is identical in effect to "Best Close-in" on page 1341.

Best Close-in

Without option EPO

`:FREQ:SYNT 1`

The LO phase noise is optimized for smaller offsets from the carrier, at the expense of phase noise farther out.

The actual frequency offset within which noise is optimized is shown with in square brackets, as this can vary depending on the hardware set in use. For example, in some instruments this annotation appears as [offset <20 kHz]

With option EPO

`:FREQ:SYNT 4`

In instruments with Option EPO, the LO is configured for the best possible close-in phase noise (offsets up to 600 kHz from the carrier), regardless of spurious products that occur with some center frequencies. Because this is generally less desirable for close-in measurements than the "Balanced" on page 1341 setting, parameter 1 selects "Balanced" on page 1341 in EPO instruments, in the interests of optimizing code compatibility across the family. Parameter 4 selects "Best Close-in" on page 1341, which is usually not as good a choice as "Balanced" on page 1341.

Balanced

`:FREQ:SYNT 1`

In instruments with EPO, the LO is configured for the best possible phase noise at offsets up to 600 kHz from the carrier whenever there are no significant spurs within the span observed with an on-screen carrier. When there will be such a spur, the LO is reconfigured in a way that allows the phase noise to increase by 7 dB mostly within ± 1 octave around 400 kHz offset. The spurs will always be below -70 dBc.

Best Spurs

`:FREQ:SYNT 5`

In instruments with EPO, the LO is configured for better phase noise than the "Best Wide-offset" on page 1341 case close to the carrier, but the configuration has 11 dB worse phase noise than the "Best Close-in" on page 1341 case mostly within ± 1 octave around 300 kHz offset. Spurs are even lower than in the "Balanced" on page 1341 case at better than -90 dBc, whether or not the carrier is on-screen.

This setting is never selected when Phase Noise Optimization is in Auto, you must select it manually.

Best Wide-offset

`:FREQ:SYNT 2`

The LO phase noise is optimized for wider offsets from the carrier. Optimization is especially improved for offsets from 70 kHz to 300 kHz. Closer offsets are compromised and the throughput of measurements (especially remote measurements where the center frequency is changing rapidly), is reduced.

The actual frequency offset beyond which noise is optimized is shown with in square brackets, as this can vary depending on the hardware set in use. For example, in some instruments this annotation appears as [offset >30 kHz]

In instruments with Option EPO, the LO is configured for the best possible phase noise at offsets up to 600 kHz from the carrier whenever there are no significant spurs within the span observed with an on-screen carrier. When there will be such a spur, the LO is reconfigured in a way that allows the phase noise to increase by 7 dB mostly within ± 1 octave around 400 kHz offset. The spurs will always be below -70 dBc.

Fast Tuning

`:FREQ:SYNT 3`

In this mode, the LO behavior compromises phase noise at many offsets from the carrier in order to allow rapid measurement throughput when changing the center frequency or span. The term "[Fast Tuning](#)" on page 1342 refers to the time it takes to move the local oscillator to the start frequency and begin a sweep; this setting does not impact the actual sweep time in any way.

In instruments with EP1, the LO behavior compromises phase noise at offsets below 4 MHz in order to improve measurement throughput. The throughput is especially affected when moving the LO more than 2.5 MHz and up to 10 MHz from the stop frequency to the next start frequency.

In instruments with Option EPO, this is the same configuration as "[Best Spurs](#)" on page 1341. It is available with the "[Fast Tuning](#)" on page 1342 label for convenience, and to make the user interface more consistent with other X-Series instrument family members.

(In models whose hardware does not provide for a "[Fast Tuning](#)" on page 1342 option, the settings for "[Best Close-in](#)" on page 1341 are used if "[Fast Tuning](#)" on page 1342 is selected. This gives the fastest possible tuning for that hardware set.)

Auto

`:FREQ:SYNT:AUTO ON`

Selects the LO (local oscillator) phase noise behavior to optimize dynamic range and speed for various instrument operating conditions. The selection rules are as follows.

Auto Optimization Rules

X-Series instruments have several grades of LO, offering different configurations when in the Auto Mode. The rules for Auto selection are as follows:

Models with Option	Conditions	Selection
EPO Models with option EPO have a two stage local oscillator, which switches to a single loop for fast tuning (available in UXA)	Center frequency is < 699.9 kHz Span > 114.1 MHz, <i>or</i> RBW > 800 kHz RBW > 290 kHz, <i>or</i> Span > 4.2 MHz Other conditions	"Balanced" on page 1341 "Fast Tuning" on page 1342 "Best Wide-offset" on page 1341 "Balanced" on page 1341
EP1 Models with option EP1 have a two-loop local oscillator, which switches to a single loop for fast tuning (available in PXA)	Span > 44.44 MHz, <i>or</i> RBW > 1.9 MHz, <i>or</i> Source Mode is set to "Tracking" Center frequency is < 195 kHz, <i>or</i> CF >= 1 MHz and Span <= 1.3 MHz and RBW <= 75 kHz All other conditions	"Fast Tuning" on page 1342 "Best Close-in" on page 1341 "Best Wide-offset" on page 1341
EP2 Models with option EP2 use a different loop bandwidth for the fast-tuning choice, which is a compromise between tuning speed and phase noise, giving good tuning speed at all offsets. Although not as good as for "Best Close-in" on page 1341; this is useful when you have to look across a wide range of spans (available, for example, in MXA for excellent phase noise)	CF < 130 kHz, <i>or</i> CF > 12 MHz and Span < 495 kHz and RBW < 40 kHz Span > 22 MHz, <i>or</i> RBW > 400 kHz, <i>or</i> CF ≤ 12 MHz and Span < 495 kHz and RBW < 23 kHz All other conditions	"Best Close-in" on page 1341 "Fast Tuning" on page 1342 "Best Wide-offset" on page 1341
EP4 (available in CXA for improved phase noise)	Span > 101 MHz <i>or</i> RBW > 1.15 MHz <i>or</i> Source Mode is set to "Tracking" CF is < 109 kHz <i>or</i> CF >= 4.95 MHz and Span <= 666 kHz and RBW < 28 kHz	"Fast Tuning" on page 1342 "Best Close-in" on page 1341

Models with Option	Conditions	Selection
	All other conditions	"Best Wide-offset" on page 1341
All Other Models Note that in these models, the hardware does not actually provide for an extra-fast tuning option, so the settings for "Fast Tuning" on page 1342 are actually the same as "Best Close-in" on page 1341, but the rules are implemented this way so that the user who doesn't care about phase noise but does care about tuning speed doesn't have to remember which of the other two settings gives faster tuning	Span > 12.34 MHz, or RBW > 250 kHz, or Source Mode is set to "Tracking"	"Fast Tuning" on page 1342
	Center frequency is < 25 kHz, or CF >= 1 MHz and Span <= 141.4 kHz and RBW <= 5 kHz	"Best Close-in" on page 1341
	All other conditions	"Best Wide-offset" on page 1341

In all the above cases:

- The RBW to be used in the calculations is the equivalent -3 dB bandwidth of the current RBW filter
- The rules apply whether in swept spans, zero span, or FFT spans

Ranges

Option	Option #	Phase Noise Option	Range
No EPx Option	1	Best Close-in	[offset < 20 kHz]
	2	Best Wide-offset	[offset > 30 kHz]
	3	Fast Tuning	[same as Best Close-In]
EPO	4	Best Close-in	[offset < 600 kHz]
	1	Balanced	[offset < 600 kHz]
	5	Best Spurs	[offset < 600 kHz]
	2	Best Wide-offset	[offset > 800 kHz]
	3	Fast Tuning	[same as Best Close-In]
EP1	1	Best Close-in	[offset < 140 kHz]
	2	Best Wide-offset	[offset > 160 kHz]
	3	Fast Tuning	[single loop]

Option	Option #	Phase Noise Option	Range
EP2, EP3, EP5	1	Best Close-in	[offset < 70 kHz]
	2	Best Wide-offset	[offset > 100 kHz]
	3	Fast Tuning	[medium loop bw]
EP4	1	Best Close-in	[offset < 90 kHz]
	2	Best Wide-offset	[offset > 130 kHz]
	3	Fast Tuning	[same as Best Close-In]

Noise Correction

Sets the measurement noise floor correction function to On or Off. On enables measurement noise correction when the measured power in the reference channel or any offset is close to the noise floor of the instrument. Off turns these corrections off.

In instruments with the noise floor extensions option (option NFE) enabled, there are two ways to compensate for the analyzer noise floor: through the NFE and through this noise corrections control. The techniques and results are similar but not identical. NFE uses a model of the analyzer noise floor, adapted to the current conditions such as center frequency, RBW and ambient temperature. The parameters of this model are measured in the factory or field calibration in a highly averaged measurement. So, they are consistent. However, because the model is imperfect, the corrections are imperfect. Using NFE is very convenient; the user need not wait for the ACP noise corrections calibration to occur. The ACP NC calibration, though, has advantages of being measured very recently, at the current ambient, and the exact center frequency, with no requirement that the model be perfect. So, it will often (but not always) have slightly better dynamic range. If both ACP NC is turned on and NFE is turned on, the instrument uses only the ACP NC. When ACP NC is turned off, but NFE is on, NFE is used, and performance should still be excellent.

When **Meas Method** is Fast Power, HW supported noise correction works when either or both of Noise Correction and NFE is on.

Remote Command	<code>[:SENSe]:ACPower:CORRection:NOISe[:AUTO] OFF ON 0 1</code> <code>[:SENSe]:ACPower:CORRection:NOISe[:AUTO]?</code>
Example	<code>:ACP:CORR:NOIS OFF</code> <code>:ACP:CORR:NOIS?</code>
Dependencies	Not available when " Meas Method " on page 1246 is RBW or Fast
Preset	0
State Saved	Saved in instrument state
Range	<code>OFF ON</code>

Noise Floor Extension

Lets you configure **Noise Floor Extension** (NFE). All Modes that support NFE let you set it on or off. Additionally, some Modes support two “on” states for NFE, **Full** and **Adaptive**, as described below.

Adaptive Option Support

At present (Release: X-Apps 2024), support for **Adaptive** NFE is as follows:

Mode	Measurements	Supports Adaptive NFE?
BT	ACP, IBEM, IBSP	No
CQM	MON	Yes
EDGE GSM	EORF, ETSP, MON	No
EMI	APD, DAN, FSC, MON, RTSC, SCH	Yes
LTEAFDD	PVT	No
LTEATDD	PVT	No
MSR	ACP, CHP, MON, OBW, SEM, SPUR	Yes
NR5G	PVT	No
PNOISE	LPL, MON, SFR	No
SA	SAN	Yes
SRCOMMS	ACP, CHP, MON, OBW, SEM, SPUR	Yes
VMA	ACP, CHP, OBW, SEM, SPUR	Yes
WCDMA	ACP, CHP, MON, OBW, SEM, SPUR	Yes
WLAN	CHP, MON, OBW, SEM, SPUR	Yes

The menus and command options are as follows:

NFE State	Modes with Adaptive NFE	Modes without Adaptive NFE	SCPI
Off	Off	Off	See "NFE On/Off Command" on page 1348
On	Full	On	
Adaptive	Adaptive	n/a	See "Adaptive NFE Command" on page 1348

As shown in the table above, the **On** state (in Modes that do not support **Adaptive** NFE) matches the **Full** state in Modes that *do* support **Adaptive** NFE.

To maintain SCPI backwards compatibility, the existing command to turn NFE on or off is retained, and a new command is added to set the state to turn **AdaptiveON** or **OFF**:

- [:SENSe]:CORRection:NOISe:FLOor ON|OFF|1|0 is retained, with the default changed to **ON** for Modes that support **Adaptive** NFE
- [:SENSe]:CORRection:NOISe:FLOor:ADAPtive ON|OFF|1|0 is added (for certain Modes), default = **ON**

When NFE is **On** or **Full**, the expected noise power of the instrument (derived from a factory calibration) is subtracted from the trace data. This will usually reduce the apparent noise level by about 10 dB in low band, and 8 dB in high band (>~3.6 GHz).

NFE works with any RBW, VBW, detector, any setting of **Average Type**, any amount of trace averaging, and any signal type. It is ineffective when the trace is not smoothed (smoothing processes include narrow VBWs, trace averaging, and long sweep times with the detector set to **Average** or **Peak**). It works best with extreme amounts of smoothing, and with the average detector, with the **Average Type** set to **Power**.

In those cases where the cancellation is ineffective, it nonetheless has no undesirable side-effects. There is no significant speed impact to having **Noise Floor Extension** on.

The best accuracy is achieved when substantial smoothing occurs in each point before trace averaging. Thus, when using the **Average** detector, results are better with long sweep times and fewer trace averages. When using the **Sample** detector, the VBW filter should be set narrow with less trace averaging, instead of a wide VBW filter with more trace averaging.

NOTE

Noise Floor Extension has no effect unless the RF Input is selected, so when External Mixing is selected, it does nothing.

For more details, see "[Optimal Detector & Averaging Selections](#)" on page 1349 and "[Recalibration of Noise Floor](#)" on page 1350.

Pros & Cons of Adaptive NFE

Adaptive NFE provides an alternative to fully-on or fully-off NFE. Fully-on NFE can, notably in cases with little or no averaging of the spectrum, result in a display that is distractingly unfamiliar in the variability in response to low level signals. Fully-off NFE fails to achieve the potential improvement in dynamic range and associated accuracy of measurement of low-level signals. **Adaptive** NFE controls the degree of potential improvement in the noise floor to give more improvement for those instrument settings that can make good use of the potential improvement—those settings with high degrees of variance reduction through some variant of averaging. When the potential improvement is small, the display acts like the fully-off case, and when it is high, it acts like the fully-on case, and in-between, application is a compromise between attractiveness and effectiveness.

In **Adaptive** NFE, there is not the same dramatic visual impact on the noise floor as there is in **Full** NFE. **Adaptive** NFE controls the amount of correction that is applied based on other instrument settings like RBW, averaging and sweep time. **Adaptive** NFE controls the degree of potential improvement in the noise floor to give more improvement for those instrument settings that can make good use of the potential improvement, such as settings that provide more averaging. The result is that when not much averaging is being performed, the signal displays more like the fully-off case; and when lots of averaging is being performed, the signal displays more like the **Full** NFE case.

Adaptive NFE is recommended for general-purpose use. For fully-ATE (automatic test equipment) applications, where possible distraction of the instrument user is not a risk, **Full** NFE is recommended.

NFE On/Off Command

Remote Command	<code>[:SENSe]:CORRection:NOISe:FLOor ON OFF 1 0</code> <code>[:SENSe]:CORRection:NOISe:FLOor?</code>
Example	<code>:CORR:NOIS:FLO ON</code>
Dependencies	Only appears in instruments with the NFE or NF2 license installed. In all others, the control does not appear. In those cases, the SCPI command is accepted without error, but has no effect
Couplings	When NFE is enabled in any Mode manually, a prompt is displayed reminding you to perform the Characterize Noise Floor operation if it is needed When NFE is enabled through SCPI, and a Characterize Noise Floor operation is needed, an error is entered in the system error queue
Preset	Unaffected by Mode Preset . Turned ON at startup and by Restore Mode Defaults in Modes that support Adaptive . Turned OFF at startup and by Restore Mode Defaults in Modes that do <i>not</i> support Adaptive In Modes that support Adaptive NFE, the default (preset) state of NFE is Adaptive . In Modes that do not support Adaptive NFE, the default state of NFE is Off
State Saved	No

Adaptive NFE Command

Only effective in instruments with the NFE or NF2 license installed, and in Modes that support **Adaptive** NFE. For coverage, see "[Adaptive Option Support](#)" on page 1346 above.

For all other cases, the SCPI command below is accepted without error, but has no effect.

Remote	<code>[:SENSe]:CORRection:NOISe:FLOor:ADaptive ON OFF 1 0</code>
--------	---

Command	<code>[:SENSe] :CORRection:NOISe:FLOor:ADApTive?</code>
Example	First turn NFE on, this is Full mode <code>:CORR:NOIS:FLO ON</code> Then set it to Adaptive <code>:CORR:NOIS:FLO:ADAP ON</code>
Couplings	To maintain backwards compatibility, sending <code>:CORR:NOIS:FLO ON</code> turns NFE AdaptiveOFF . To turn Adaptive on, you must issue the commands in the proper order, as shown in the example above
Preset	Not affected by Mode Preset , but set to ON at startup and by Restore Mode Defaults
State Saved	No

Optimal Detector & Averaging Selections

Note that some measurements do not allow you to switch the **Detector** type (which is set by default to **Average**), so the discussion of detector types here is irrelevant for those measurements. Similarly, some measurements do not allow you to set **Average Type** (set by default to **LOG**), so that discussion here is irrelevant in those cases.

The instrument is characterized in the factory (or during a field calibration) with a model of the noise, referred to the input mixer, versus frequency in each band and path combination. Bands are 0 (low band) and 1 through 4 (high band) in a 26.5 GHz instrument, for example. Paths include normal paths, preamp paths, the electronic attenuator, etc.

In most band/path combinations, the noise can be well characterized based on just two parameters and the instrument frequency response before compensation for frequency-dependent losses.

After the noise density at the input mixer is estimated, the effects of the input attenuator, RBW, detector, etc. are computed to obtain the estimated input-port-referred noise level.

In the simplest case, the measured power (signal plus analyzer noise) in each display point (bucket) is compensated by subtracting the estimated noise power, leaving just the signal power. This is the operation when **Detector** is **Average** and **Average Type** is set to **Power (RMS)**.

For best operation, **AverageDetector** (default) and **Average Type. = Power** are recommended, as already stated. In other cases, operation is often not quite as good but still highly effective. Other **Detector** options, when available, behave as follows:

Positive Peak The noise floor is estimated based on the RBW and the duration of the bucket using the same equations used in the noise marker function. The voltage of the noise is subtracted from the voltage of the observed signal-plus-noise measurement to compute the estimated signal voltage

Positive Peak is one example of processing that varies with detector to give good

	estimates of the signal level without the analyzer noise
	For pulsed-RF, Positive Peak can still give excellent effectiveness
	FFT analysis does not work well, and does not perform NFE well, with pulsed-RF signals, so this combination is <i>not</i> recommended
Negative Peak	Not very useful
Sample	Works well, but never better than Average , because it does not smooth as well
Normal	A combination of peak and negative peak behaviors, and works about as well as these

For best operation, extreme smoothing is desirable, as already stated. Using narrow VBWs works well, but using very long bucket durations and the average detector works best. Reducing the number of trace points makes the buckets longer.

For best operation, **Average Type = Power (RMS)** is optimal (when this option is available). When making CW measurements in the presence of noise without NFE, averaging on the decibel scale has the advantage of reducing the effect of noise. Using NFE with **Average Type = Log-Power (LOG)** is not synergistic, though; NFE with **Average Type = Power (RMS)** works a little better than NFE with **LOG**.

The results from NFE with internal preamp can often be lower than the theoretical noise in a signal source at room temperature, a noise density of -174 dBm/Hz. This is expected and useful behavior, because NFE is designed to report the amount of input signal that exceeds the thermal noise, not the amount that includes the thermal noise. This can be a useful behavior because thermal noise often interferes with what you want to measure, instead of being part of what you want to measure. Note that NFE is not adequately accurate to always be able to read below kTB.

Recalibration of Noise Floor

In instruments with the NF2 license installed, the calibrated noise floor used by **Noise Floor Extension** should be refreshed periodically. Keysight recommends that the **Characterize Noise Floor** operation be performed after the first 500 hours of operation, *and* once every calendar year. To do this, use "**Characterize Noise Floor**" on page 1941, under **System, Alignments, Advanced**. If you have not done this yourself at the recommended interval, then when you turn on **Noise Floor Extension**, the instrument will prompt you to do so with a dialog stating:

This action will take several minutes to perform. Please disconnect all cables from the RF input and press Enter to proceed. Press ESC to cancel, or Postpone to postpone for a week

If you cancel, you will be prompted again the next time you turn NFE on. If you postpone, you will be prompted again after a week passes and you then turn NFE on.

Fast Power RBW Mode

Specifies RBW behavior of Fast Power under **Meas Method**.

Option	SCPI	Description
Best Speed	<code>SPEed</code>	The acquisition RBW is set to be configured for best speed. The RBW is automatically calculated, and is not configurable
Explicit	<code>EXPLicit</code>	You can configure RBW manually

Remote Command	<code>[:SENSe]:ACPower:BANDwidth[:RESolution]:FPOWer:MODE SPEed EXPLicit</code> <code>[:SENSe]:ACPower:BANDwidth[:RESolution]:FPOWer:MODE?</code>	
Example	<code>:ACP:BAND:FPOW:MODE EXPL</code> <code>:ACP:BAND:FPOW:MODE?</code>	
Dependencies	Grayed-out when " Meas Method " on page 1246 is not Fast Power Not available in VXT models M9410A/11A/15A	
Couplings	If <code>EXPLicit</code> is selected, " Res BW " on page 1214 is configurable. If not, Res BW is grayed-out	
Preset	<code>SPEed</code>	
State Saved	Saved in instrument state	

Fast Power IF Gain Offset

Lets you optimize for dynamic range versus input signal level.

Remote Command	<code>[:SENSe]:ACPower:IF:GAIN:FPOWer <integer></code> <code>[:SENSe]:ACPower:IF:GAIN:FPOWer?</code>	
Example	<code>:ACP:IF:GAIN:FPOW 10</code> <code>:ACP:IF:GAIN:FPOW?</code>	
Dependencies	Grayed-out when " Meas Method " on page 1246 is not Fast Power Not available in VXT models M9410A/11A/15A	
Preset	0	
State Saved	Saved in instrument state	
Min/Max	-20/20	

Integration BW

Selects an Integration BW passband from either -3 dB (**DB3**) or -6 dB (**DB6**).

Remote Command	<code>[:SENSe]:ACPower:FILTer:BANDwidth[:INTEgration] DB3 DB6</code> <code>[:SENSe]:ACPower:FILTer:BANDwidth[:INTEgration]?</code>	
----------------	---	--

Example	<code>:ACP:FILT:BAND DB3</code> <code>:ACP:FILT:BAND?</code>
Dependencies	Applicable for carriers and offsets whose filter method is not RRC, and when " Meas Method " on page 1246 is other than RBW
Preset	<code>DB3</code>
State Saved	Saved in instrument state
Range	-3 dB -6 dB

3.8.13.4 Global

The controls in this menu apply to all Modes in the instrument.

Some controls (for example, "[Global Center Freq](#)" on page [1828](#)) allow you to switch certain Meas Global parameters to a Mode Global state. These switches apply to all Modes that support global settings. For example, no matter what Mode you are in when you set **Global Center Freq** to **ON**, it applies to all Modes that support Global settings.

Other controls (for example, **Extend Low Band**) are actually set in this menu, but apply to all Modes.

Global Center Freq

The software maintains a Mode Global value called **Global Center Freq**.

When **Global Center Freq** is switched **ON**, the current Mode's center frequency is copied into the **Global Center Frequency**, and from then on all Modes that support global settings use the **Global Center Frequency**, so you can switch between any of these Modes and the **Center Frequency** remains unchanged.

Adjusting the **Center Frequency** of any Mode that supports Global Settings, while **Global Center Freq** is **ON**, modifies the **Global Center Freq**.

When **Global Center Freq** is switched **OFF**, the **Center Frequency** of the current Mode is unchanged, but now the **Center Frequency** of each Mode is once again independent.

When **Mode Preset** is pressed while **Global Center Freq** is **ON**, the **Global Center Freq** is preset to the preset **Center Frequency** of the current Mode.

This function resets to **OFF** when "[Restore Defaults](#)" on page [1829](#) is pressed, or when **System, Restore Defaults, All Modes** is pressed.

Remote Command	<code>:INSTrument:COUPle:FREQuency:CENTer ALL NONE</code> <code>:INSTrument:COUPle:FREQuency:CENTer?</code>
Example	<code>:INST:COUP:FREQ:CENT ALL</code>

	<code>:INST:COUP:FREQ:CENT?</code>
Preset	Set to OFF on Global Settings, Restore Defaults and System, Restore Defaults, All Modes
Range	ALL NONE
Preset	OFF
Backwards Compatibility SCPI	<code>:GLOBal:FREQuency:CENTer[:STATe] 1 0 ON OFF</code> <code>:GLOBal:FREQuency:CENTer[:STATe]?</code>

Global EMC Std

When this control is switched **ON**, the current Mode's EMC Std is copied into the **Global EMC Std**, and from then on all Modes that support global settings use the **Global EMC Std**, so you can switch between any of these Modes and the EMC Std remains unchanged.

Adjusting the EMC Std of any Mode that supports Global settings, while **Global EMC Std** is **ON** modifies the **Global EMC Std**.

When **Global EMC Std** is switched **OFF**, the EMC Std of the current Mode remains unchanged, but now the EMC Std of each Mode is once again independent. When **Mode Preset** is pressed while **Global EMC Std** is **ON**, **Global EMC Std** is preset to the preset EMC Std of the current Mode.

This function resets to **OFF** when "**Restore Defaults**" on page 1829 is pressed, or when **System, Restore Defaults, All Modes** is pressed.

Remote Command	<code>:INSTrument:COUPle:EMC:STANdard ALL NONE</code> <code>:INSTrument:COUPle:EMC:STANdard?</code>
Example	<code>:INST:COUP:EMC:STAN ALL</code> <code>:INST:COUP:EMC:STAN?</code>
Dependencies	Only available if Option EMC is installed
Preset	Set to OFF on Global Settings, Restore Defaults and System, Restore Defaults, All Modes
Range	ALL NONE

Restore Defaults

Resets all functions in the **Global** settings menu to **OFF**. Pressing **System, Restore Defaults, All Modes** has the same effect.

Remote Command	<code>:INSTrument:COUPle:DEFault</code>
Example	<code>:INST:COUP:DEF</code>
Backwards Compatibility SCPI	<code>:GLOBal:DEFault</code>

3.8.13.5 Offset RRC Weighting (Backwards Compatibility SCPI)

Example	<code>:ACP:FILT OFF</code> <code>:ACP:FILT?</code>
Couplings	This command is an alias of: <code>[:SENSe]:ACPower:OFFSet[1] 2:LIST:FILTer[:RRC][:STATe]</code> Sending the command sets values of all offsets for BS and MS, but the query always returns a value of BS Offset A
Preset	SA, LTEAFDD, LTEATDD, MSR OFF WCDMA ON
State Saved	Yes
Backwards Compatibility SCPI	<code>[:SENSe]:ACPower:FILTer[:RRC][:STATe] OFF ON 0 1</code> <code>[:SENSe]:ACPower:FILTer[:RRC][:STATe]?</code> <code>[:SENSe]:ACPR:FILTer[:RRC][:STATe]</code> <code>[:SENSe]:MCPower:FILTer[:RRC][:STATe]</code>

3.8.13.6 Offset Filter Alpha (Backward Compatibility SCPI)

Example	<code>:ACP:FILT:ALPH 0.5</code> <code>:ACP:FILT:ALPH?</code>
Couplings	This command is an alias of: <code>[:SENSe]:ACPower:OFFSet[1] 2:LIST:FILTer:ALPHa</code> Sending the command sets values of all offsets for BS and MS, but the query always returns a value of BS Offset A
Preset	0.22
State Saved	Saved in instrument state
Min/Max	0.01/1.00
Backwards Compatibility SCPI	<code>[:SENSe]:ACPower:FILTer[:RRC]:ALPHa <real></code> <code>[:SENSe]:ACPower:FILTer[:RRC]:ALPHa?</code> <code>[:SENSe]:ACPR:FILTer[:RRC]:ALPHa</code> <code>[:SENSe]:MCPower:FILTer[:RRC]:ALPHa</code>

3.8.13.7 Method for Carrier (Backward Compatibility SCPI)

Example	<code>:ACP:CARR2:LIST:METH RRC</code>
---------	---------------------------------------

<code>:ACP:CARR2:LIST:METH?</code>									
Notes	Maximum of Array length depends on the number of carriers								
Couplings	This command is an alias of: <code>[:SENSe]:ACPower:CARRier[1] 2:LIST:FILTER[:RRC][:STATE]</code> The enum value translates as follows: <ul style="list-style-type: none"> - RRC Weighted = <code>1 ON</code> - Integ BW = <code>0 OFF</code> Maximum of Array length depends on the number of carriers								
Preset	<table border="1"> <thead> <tr> <th>Modes</th> <th>Value</th> </tr> </thead> <tbody> <tr> <td>SA</td> <td>IBW</td> </tr> <tr> <td>WCDMA</td> <td>RRC</td> </tr> <tr> <td>LTEAFDD, LTEATDD, MSR</td> <td>IBW</td> </tr> </tbody> </table>	Modes	Value	SA	IBW	WCDMA	RRC	LTEAFDD, LTEATDD, MSR	IBW
Modes	Value								
SA	IBW								
WCDMA	RRC								
LTEAFDD, LTEATDD, MSR	IBW								
State Saved	Saved in instrument state								
Backwards Compatibility SCPI	<code>[:SENSe]:ACPower:CARRier[1] 2:LIST:METHod IBW RRC, ...</code> <code>[:SENSe]:ACPower:CARRier[1] 2:LIST:METHod?</code>								

3.8.14 Sweep

Accesses controls to configure and control the acquisition of data, and the X-axis parameters of the instrument.

Depending on the selected mode and measurement, these controls might include: **Sweep Time**, **Continuous/Single**, **Pause/Resume**, **X Scale** and **Number of Points**.

3.8.14.1 Sweep/Control

Accesses controls that let you operate the sweep and control functions of the instrument, such as **Sweep Time** and **Continuous/Single**.

Sweep Time

Controls the time the instrument takes to sweep the current frequency span in swept measurements, displays the sweep time in swept measurements, and displays the equivalent Sweep Time in FFT measurements.

When **Sweep Time** is in Auto, the instrument computes a time that will give accurate measurements based on other settings, such as RBW and VBW.

You can select a shorter sweep time to improve the measurement throughput (with some potential unspecified accuracy reduction), but the **Meas Uncal** indicator will appear if the sweep time you set is less than the calculated Auto Sweep time.

You can also select a longer sweep time, which can be useful (for example) for obtaining accurate insertion loss measurements on very narrowband filters.

NOTE

Significantly faster sweep times are available with Option FS1.

NOTE

The **Meas Uncal** (measurement uncalibrated) warning is displayed in the Status Bar at the bottom of the screen when the manual Sweep time entered is faster than the time computed by the instrument's Sweep time equations, that is, the Auto Sweep Time. The instrument's computed Sweep time will provide accurate measurements; if you sweep faster than this your measurements may be inaccurate. A **Meas Uncal** condition may be corrected by returning the Sweep Time to Auto; by entering a longer Sweep Time; or by choosing a wider RBW and/or VBW.

NOTE

On non-sweeping hardware, this control is grayed-out. The value shown on this control is an estimate. It is the measurement's turnaround time, which is the sum of signal acquisition time, FFT time, and other overhead time, to complete the entire span of the measurement. If you need to specify the same "Sweep Time" as you would for sweeping hardware, send `[:SENSe] :<meas> :SWEep:TIME <time>`. The measurement emulates the "Sweep Time" effect, but this emulation is not straightforward, and therefore the behavior is not specified. Instead, we recommend using Minimum Acquisition Time, which provides better control.

Remote Command `[:SENSe] :<meas> :SWEep:TIME <time>`
`[:SENSe] :<meas> :SWEep:TIME?`

Example Channel Power measurement:
`:CHP:SWE:TIME 25ms`
`:CHP:SWE:TIME?`

Notes In the ACP measurement in WCDMA Mode, this parameter is preset by **Meas Method** selection. Preset values are as follows:

- IBW: 29 ms
- IBWR: 108 ms
- FAST 7.5 ms

Dependencies On non-sweeping hardware, this control is grayed out, and the Auto/Man toggle disappears. The read-only control shows estimated sweep time
In those instruments, "[Minimum Acquisition Time](#)" on page 1357 is available

Couplings Coupled to **Span**, **RBW**, **VBW**, and **Sweep Time Rules** when **Sweep Time** is set to Auto; **Sweep Time**

3 VMA Mode
3.8 ACP Measurement

	changes when these parameters are changed When you manually set a value when in the Auto state, the state automatically changes to Man
Preset	Automatically Calculated unless noted below WCDMA Mode <ul style="list-style-type: none"> - Channel Power: 1.0 msOBW: 32.6 ms - ACP: 29 ms
State Saved	Saved in instrument state
Min	Other than non-sweeping hardware: Typically, 1 ms Non-sweeping hardware: N/A In the ACP measurement, when Meas Method is Fast Power , the minimum sweep time is span-dependent and automatically calculated
Max	Other than non-sweeping hardware: 4000 s Non-sweeping hardware: N/A
Annotation	The sweep time is displayed in the lower-right corner of the screen. The number of points is displayed parenthetically, as: Sweep 13.3 ms (1001 points) A “#” mark appears before “Sweep” in the annotation when it is switched from Auto to Manual coupling
Status Bits/OPC dependencies	Meas Uncal is Bit 0 in the register: STATus:QUESTionable:INTEgrity:UNCalibrated
Auto Function	
Remote Command	[:SENSe]:<meas>:SWEep:TIME:AUTO OFF ON 0 1 [:SENSe]:<meas>:SWEep:TIME:AUTO?
Example	Channel Power measurement: :CHP:SWE:TIME:AUTO OFF :CHP:SWE:TIME:AUTO?
Preset	WCDMA Mode OFF All others ON

Minimum Acquisition Time

Available on non-sweeping hardware.

Specifies the minimum acquisition time for each “chunk” of the measurement result. The instrument automatically divides Span into multiple chunks if needed. Therefore, the total signal acquisition time for the entire Span is:

$$\sim(\sim\text{Minimum Acquisition Time}) * (\text{The number of chunks})$$

When in Auto, this parameter's value is determined by other parameters, such as **Span**, **RBW** and **VBW**.

You can manually increase this parameter value from this Auto value.

If increased, the instrument acquires signal for the specified time duration for each chunk. It performs additional FFTs, and averages or peak-holds the FFT results for a chunk, depending on **Detector** settings.

Note that the actual acquisition time for each chunk may exceed the **Minimum Acquisition Time** value, in order to satisfy FFT time required by other parameters, and to perform an integer number of FFTs.

Remote Command	<pre>[:SENSe]:<meas>:SWEep:ACQuisition:TIME <time> [:SENSe]:<meas>:SWEep:ACQuisition:TIME? <meas> is the identifier for the current measurement; any one of CHPower- ACPower OBWidth MONitor</pre>
Example	<pre>Channel Power measurement :CHP:SWE:ACQ:TIME 500 ms :CHP:SWE:ACQ:TIME?</pre>
Dependencies	Available only on non-sweeping hardware
Couplings	Coupled to Span , RBW , and VBW when in the Auto state When you manually set a value when in the Auto state, the state automatically changes to Man
Preset	Automatically calculated
State Saved	Saved in instrument state
Min	100 ns
Max	4.00 ks
Auto Function	
Remote Command	<pre>[:SENSe]:<meas>:SWEep:ACQuisition:TIME:AUTO OFF ON 0 1 [:SENSe]:<meas>:SWEep:ACQuisition:TIME:AUTO? <meas> is the identifier for the current measurement; any one of CHPower- ACPower OBWidth MONitor</pre>
Example	<pre>Channel Power measurement: :CHP:SWE:ACQ:TIME:AUTO OFF</pre>
Preset	ON

Sweep/Measure

Lets you toggle between **Continuous** and **Single** sweep or measurement operation. The single/continuous state is Meas Global, so the setting affects all measurements.

The front-panel key **Single/Cont** performs exactly the same function

See ["More Information" on page 1359](#)

Remote Command	<code>:INITiate:CONTinuous OFF ON 0 1</code> <code>:INITiate:CONTinuous?</code>
Example	Put instrument into Single measurement operation: <code>:INIT:CONT 0</code> <code>:INIT:CONT OFF</code> Put instrument into Continuous measurement operation: <code>:INIT:CONT 1</code> <code>:INIT:CONT ON</code>
Preset	ON Note that <code>:SYST:PRES</code> sets <code>:INIT:CONT</code> to ON , but <code>*RST</code> sets <code>:INIT:CONT</code> to OFF
State Saved	Saved in instrument state
Annunciation	The Single/Continuous icon in the Meas Bar changes depending on the setting: <ul style="list-style-type: none"> - A line with an arrow is Single - A loop with an arrow is Continuous
Backwards Compatibility Notes	X-Series A-models had Single and Cont hardkeys in place of the SweepSingleCont softkey. In the X-Series A-models, if in single measurement, the Cont hardkey (and <code>INIT:CONT ON</code>) switched to continuous measurement, but never restarted a measurement and never reset a sweep X-Series B-models have a Cont/Single toggle control instead of Single and Cont hardkeys, but it is still true that, if in single measurement, the Cont/Single toggle control never restarts a measurement and never resets a sweep

More Information

Continuous Mode	The instrument takes repetitive sweeps, averages, measurements, etc., when in continuous mode. If in average or Max/Min Hold, and the average/hold count reaches the Average/Hold Num , the count stops incrementing, but the instrument keeps sweeping See the Trace key description under Trace Average for the averaging formula used both before and after the Average/Hold Num is reached. The trigger condition must be met prior to each sweep The type of trace processing for multiple sweeps is set under the Trace key, with choices of Trace Average , Max Hold , or Min Hold
Single Mode	The instrument takes a single sweep when in Single mode, or if in average or Max/Min Hold, or if there is a Waterfall window displayed, it takes multiple sweeps until the average/hold count reaches the Average/Hold Num , then the count stops incrementing, and the instrument stops sweeping See the Trace key description under Trace Average for the averaging formula used. The trigger condition must be met prior to the sweep The type of trace processing for multiple sweeps is set under the Trace key, with choices of Trace Average , Max Hold , or Min Hold

If the instrument is in **Single** measurement mode, pressing the **Cont/Single** toggle control does not zero the count and does not cause the sweep to be reset; the only action is to put the instrument into Continuous measurement operation.

If the instrument is already in **Continuous** sweep:

- `:INIT:CONT 1` has no effect
- `:INIT:CONT 0` places the instrument in Single Sweep but has no effect on the current sequence until $k = N$, at which point the current sequence will stop and the instrument will go to the idle state

See "[Restart](#)" on page 1832 for details of `:INIT:IMMEDIATE`.

If the instrument is already in **Single** sweep, `:INIT:CONT OFF` has no effect.

If the instrument is already in **Single** sweep, then pressing **Cont/Single** in the middle of a sweep does not restart the sweep or sequence. Similarly, pressing **Cont/Single** does not restart the sweep or sequence if the sweep is not in the idle state (for example, if you are taking a very slow sweep, or the instrument is waiting for a trigger). Even though pressing **Cont/Single** in the middle of a sweep does not restart the sweep, sending `:INIT:IMM` does reset it.

If the instrument is in **Single** sweep, and *not* Averaging/Holding, and you want to take one more sweep, press **Restart**.

If the instrument is in **Single** sweep, *and* Averaging/Holding, and you want to take one more sweep without resetting the Average trace or count, go to **Meas Setup** and increment the average count by 1 by pressing the **Step-Up** key while **Average/Hold Num** is the active function. You can also do this by sending `:CALC:AVER:TCON UP`.

Restart

Restarts the current sweep, or measurement, or set of averaged/held sweeps or measurements. If you are Paused, pressing **Restart** performs a Resume.

The front-panel key **Restart** performs exactly the same function.

The **Restart** function is accessed in several ways:

- Pressing the **Restart** key
- Sending `:INIT:IMM`
- Sending `:INIT:REST`

See "[More Information](#)" on page 1361

3 VMA Mode
3.8 ACP Measurement

Remote Command	:INITiate[:IMMEDIATE]
Example	:INIT:IMM :INIT:REST
Notes	:INIT:REST and :INIT:IMM perform exactly the same function
Couplings	Resets average/hold count k. For the first sweep overwrites all active (update = on) traces with new current data. For application modes, it resets other parameters as required by the measurement
Status Bits/OPC dependencies	This is an Overlapped command The STATUS:OPERation register bits 0 through 8 are cleared , except bit 6 (Waiting for Periodic Sync). Initiating a measurement and Waiting for Periodic Sync could be asynchronous The STATUS:QUESTionable register bit 9 (INTEGRity sum) is cleared The SWEEPING bit is set The MEASURING bit is set
Backwards Compatibility Notes	For Spectrum Analysis Mode in ESA and PSA, the Restart hardkey and the :INIT:REST command restarted trace averages (displayed average count reset to 1) for a trace in Clear Write, but did not restart Max Hold and Min Hold In X-Series, the Restart hardkey and the :INIT:REST command restart not only Trace Average, but MaxHold and MinHold traces as well

More Information

The **Restart** function first aborts the current sweep or measurement as quickly as possible. It then resets the sweep and trigger systems, sets up the measurement and initiates a new data measurement sequence with a new data acquisition (sweep) taken once the trigger condition is met.

If the instrument is in the process of aligning when a **Restart** is executed, the alignment finishes before the restart function is performed.

Even when set for **Single** operation, multiple sweeps may be taken when **Restart** is pressed (for example, when averaging/holding is on). Thus, when we say that **Restart** "restarts a measurement", depending on the current settings, we may mean that it:

- Restarts the current sweep
- Restarts the current measurement
- Restarts the current set of sweeps if any trace is in Trace Average, Max Hold or Min Hold
- Restarts the current set of measurements if Averaging, or Max Hold, or Min Hold is on for the measurement

If there is no Average or Max/Min Hold function (no trace in Trace Average or Hold, or **Average/Hold Num** set to 1), and no **Waterfall** window is being displayed, a single sweep is equivalent to a single measurement. A single sweep is taken after the trigger condition is met; and the instrument stops sweeping once that sweep has completed. However, with **Average/Hold Num** >1, and at least one trace set to Trace Average, Max Hold, or Min Hold, or a **Waterfall** window being displayed, multiple sweeps/data acquisitions are taken for a single measurement. The trigger condition must be met prior to each sweep. The sweep is stopped when the average count k equals the number N set for **Average/Hold Num**.

Once the full set of sweeps has been taken, the instrument goes to the idle state. To take one more sweep without resetting the average count, increment the average count by 1, by pressing the **Step-Up** key while **Average/Hold Number** is the active function, or by sending the remote command **:CALC: AVER: TCON UP**.

Trace Update

The numeric results are not blanked at any time during the restart cycle.

For slow sweeps (see **Trace Update** section in **Trace/Detector**), the traces are updated real-time during the sweep. There may be a special circumstance in application mode measurements where an exception is made and the traces and/or results need to be blanked before displaying the new results.

To summarize, the following list shows what happens to the trace data on various events:

Event	Trace Effect
Clear/Write pressed (even if already in Clear/Write)	Set to mintracevalue
Max Hold pressed (even if already in Max Hold)	Set to mintracevalue
Min Hold pressed (even if already in Min Hold)	Set to maxtracevalue
Trace Average pressed (even if already in Trace Average)	Trace data unaffected but start new sweep/avg/hold
Restart pressed	Trace data unaffected but start new sweep/avg/hold
Parameter requiring restart changed (e.g., RBW)	Trace data unaffected but start new sweep/avg/hold

Sweep and Trigger Reset

Resetting the sweep system resets the average/hold count k to 0. It also resets the set point counter to 0. Resetting the trigger system resets the internal auto trig timer to the value set by the **Auto Trig** control.

Averaging

The weighting factor used for averaging is k . This k is also the average/hold count for how many valid sweeps (data acquisitions) have been done. This k is used for comparisons with N , as those comparisons always needs to be based on valid completed sweeps.

The displayed average/hold, K , shows the count for the sweep (data acquisition) in progress. $K = k + 1$, with a limit of N . The displayed value K changes from its previous value to 1 as soon as the trigger condition for the first data acquisition (sweep) is met.

Pause/Resume

Pauses a measurement after the current data acquisition is complete.

When paused, the label on the control changes to **Resume**. Pressing **Resume** unpauses the measurement. When paused, pressing **Restart** performs a Resume.

Remote Command	<code>:INITiate:PAUSE</code> <code>:INITiate:RESume</code>
Example	<code>:INIT:PAUS</code> <code>:INIT:RES</code>
Dependencies	Not displayed in Modes that do not support pausing
Annotation	Only on control

Abort (Remote Command Only)

Stops the current measurement. Aborts the current measurement as quickly as possible, resets the sweep and trigger systems, and puts the measurement into an "idle" state. If the instrument is in the process of aligning when `:ABORt` is sent, the alignment finishes *before* the abort function is performed, so `:ABORt` does not abort an alignment.

If the instrument is set for **Continuous** measurement, it sets up the measurement and initiates a new data measurement sequence with a new data acquisition (sweep) taken once the trigger condition is met.

If the instrument is set for **Single** measurement, it remains in the "idle" state until an `:INIT:IMM` command is received.

Remote Command	<code>:ABORt</code>
Example	<code>:ABOR</code>

Notes	<p>If :INIT:CONT is ON, then a new continuous measurement will start immediately, with sweep (data acquisition) occurring once the trigger condition has been met</p> <p>If :INIT:CONT is OFF, then :INIT:IMM is used to start a single measurement, with sweep (data acquisition) occurring once the trigger condition has been met</p>
Dependencies	<p>For continuous measurement, :ABORT is equivalent to the Restart key</p> <p>Not all measurements support this command</p>
Status Bits/OPC dependencies	<p>The STATus:OPERation register bits 0 through 8 are cleared, <i>except</i> bit 6 (Waiting for Periodic Sync). Initiating a measurement and Waiting for Periodic Sync could be asynchronous</p> <p>The STATus:QUEStionable register bit 9 (INTEgrity sum) is cleared</p> <p>Since all the bits that feed into OPC are cleared by :ABORT, the Abort command will cause the *OPC query to return true</p>

Sweep Time Annotation (Remote Query Only)

Returns the **Sweep Time Annotation** value. Available only on non-sweeping hardware.

This value is also displayed in the result trace window.

The value returned is the estimated turnaround time of each measurement cycle, in seconds. The turnaround time is the sum of the signal acquisition time, FFT time, and other overhead time, to complete the entire span of each measurement cycle.

Remote Command	<p>[:SENSe] : <meas> : SWEep : ETIME?</p> <p><meas> is the identifier for the current measurement; any one of CHPower- ACPower OBWidth MONitor</p>
Example	<p>Channel Power measurement</p> <p>:CHP:SWE:ETIME?</p>
Dependencies	Available only on non-sweeping hardware
Preset	Automatically calculated

3.8.14.2 Sweep Config

Accesses controls that enable you to configure the Sweep and Control functions of the instrument.

Sweep Time Rules

Switches the instrument between **NORMal** and **ACCuracy** sweep states.

Setting **Auto Sweep Time** to **ACCuracy** results in slower sweep times, usually about three times as long, but yields better amplitude accuracy for CW signals. The

3 VMA Mode
3.8 ACP Measurement

instrument amplitude accuracy specifications only apply when **Auto Sweep Time** is set to **ACCuracy**.

Additional amplitude errors that occur when **Auto Sweep Time** is set to **NORMa1** are usually well under 0.1 dB, though this is not guaranteed. Because of the faster sweep times and still low errors, **NORMa1** is the preferred setting of **Auto Sweep Time**. **Auto Sweep Time** is set to **NORMa1** on a **Preset**. This means that in the Preset state, instrument amplitude accuracy specifications do not apply.

Remote Command	<code>[:SENSe]:ACPower:SWEEp:TIME:AUTO:RULes NORMa1 ACCuracy</code> <code>[:SENSe]:ACPower:SWEEp:TIME:AUTO:RULes?</code>								
Example	<code>:ACP:SWE:TIME:AUTO:RUL NORM</code> <code>:ACP:SWE:TIME:AUTO:RUL?</code>								
Dependencies	Does not appear in Spectrum Analyzer Mode in VXT model M9420A								
Preset	<table border="1"> <thead> <tr> <th>Modes, Instruments</th> <th>Value</th> </tr> </thead> <tbody> <tr> <td>SA, WCDMA, LTEAFDD, LTEATDD, MSR</td> <td>ACCuracy</td> </tr> <tr> <td>5G NR</td> <td>NORMa1</td> </tr> <tr> <td>5G NR in VXT models M9410A/11A/15A</td> <td>ACCuracy</td> </tr> </tbody> </table>	Modes, Instruments	Value	SA, WCDMA, LTEAFDD, LTEATDD, MSR	ACCuracy	5G NR	NORMa1	5G NR in VXT models M9410A/11A/15A	ACCuracy
Modes, Instruments	Value								
SA, WCDMA, LTEAFDD, LTEATDD, MSR	ACCuracy								
5G NR	NORMa1								
5G NR in VXT models M9410A/11A/15A	ACCuracy								
State Saved	Saved in instrument state								
Range	NORMa1 ACCuracy								

Points

Sets the number of points taken per sweep, and displayed in the traces. The current value of points is displayed parenthetically, next to the sweep time in the lower-right corner of the display. Using more points provides greater resolution. Using fewer points compacts the data and decreases the time required to access a trace over the remote interface.

Increasing the number of points does not increase the sweep time. However, it can slightly impact the trace processing time and therefore the overall measurement speed. Decreasing the number of points does not decrease the sweep time, but it may speed up the measurement, depending on the other sweep settings (for example, in FFT sweeps). Fewer points will always speed up the I/O.

Due to minimum sweep rate limitations of the hardware, the minimum sweep time available will increase above its normal value of 1 ms as the number of sweep points increases above 15001.

Changing the number of sweep points has several effects on the instrument. Since markers are read at the point location, the marker reading may change. The sweep time resolution changes. Trace data for all the traces is cleared and, if **Sweep** is in

Cont, a new trace is taken. If any trace is in average or hold, the averaging starts over.

Because of sweep time quantization issues, the knob and up/down keys cannot be used to adjust the number of points.

When in a split screen display each window may have its own value for points.

When sweep points is changed, an informational message "Sweep points changed, all traces cleared" is displayed and in 5G NR Mode, **Auto Sweep Points** is set to **OFF** (0).

Remote Command	[:SENSe]:ACPower:SWEp:POINts <integer> [:SENSe]:ACPower:SWEp:POINts?	
Example	:ACP:SWE:POIN 500 :ACP:SWE:POIN?	
Dependencies	Not available when Signal ID is On in External Mixing Neither the knob nor the step keys can be used to change this value. If it is tried, a warning is given Not displayed in Modes that do not support Swept This parameter is automatically calculated and not configurable when Meas Method is set to Fast Power	
Couplings	Whenever the number of sweep points change: <ul style="list-style-type: none"> - All trace data is erased - Any traces with Update Off will also go to Display OffSweep time is re-quantized - Any limit lines that are on will be updated - If averaging/hold is on, averaging/hold starts over - Auto Sweep Points is set to OFF (5G NR Mode only) The resolution of setting the sweep time depends on the number of points selected	
Preset	5G NR Mode, in all models except M9410A/11A/15A	5001
	All others	1001
State Saved	Saved in instrument state	
Min	1	
Max	20001	
Annotation	On second line of annotations, in lower right corner in parenthesis behind the sweep annotation	

3.8.14.3 X Scale

Accesses controls that enable you to set the horizontal scale parameters.

Auto Scaling

Toggles the scale coupling function On or Off.

Remote Command	<code>:DISPlay:ACPower:VIEW[1]:WINDow[1]:TRACe:X[:SCALe]:COUPLe 0 1 OFF ON</code>
Example	<code>:DISP:ACP:WIND:TRAC:X:COUP ON</code> <code>:DISP:ACP:WIND:TRAC:X:COUP?</code>
Couplings	When Auto Scaling is ON and the "Restart" on page 1832 front-panel key is pressed, this function automatically determines the scale per division and reference values based on the measurement results When you set a value to either Scale/Div or Ref Value manually, Auto Scaling automatically changes to OFF
Preset	OFF
State Saved	Saved in instrument state
Range	OFF ON
Backwards Compatibility SCPI	<code>:DISPlay:ACPower:VIEW[1]:WINDow[1]:TRACe:X[:SCALe]:COUPLe</code>

3.8.15 Trace

Lets you control the acquisition, display, storage, detection and manipulation of trace data for the available traces. The Trace Control tab of this menu contains radio-button selections for the trace type (**Clear/Write**, **Trace Average**, **Max Hold**, **Min Hold**) and **View/Blank** setting for the selected trace.

For the Spectrum Analyzer Mode, when in **Single** Mode, Measurements and their Views save the trace data from the last acquisition. This is true for multiple screens. The marker and trace data will be present whenever the measurement is brought back into focus. The measurement switches for these measurements do not clear the traces, so the data will be present until the next acquisition is completed.

3.8.15.1 Select Trace

Specifies the *selected trace*, which is the trace that will be affected when you change trace settings.

Select Trace appears above the menu panel, indicating that it applies to *all* controls in the menu panel. **Select Trace** is blanked if you select a tab whose controls do *not* depend on the selected trace (for example, **Trace Function**).

Notes	The selected trace is remembered even when not in the Trace menu
Dependencies	For the Swept SA measurement: <ul style="list-style-type: none"> - In Image Suppress mode, when you select a trace it becomes the active trace, and the formerly active trace goes into View - When you turn on Image Suppress, Update turns off for all traces except the selected trace For the ACP measurement, when Meas Method is RBW , FAST or FPOwer , Select Trace is disabled
Preset	Trace 1
State Saved	Yes

3.8.15.2 Trace Control

The controls on this tab allow you to set the "Trace Type" on page 1737 and its update mode.

There are four Trace Types:

- Clear/Write
- Trace Average
- Max Hold
- Min Hold

Each type handles data in a different way.

Each trace also has two values that determine whether it is being written or not, and whether it is being displayed or not. These values, **Update** and **Display**, are described fully in the "View/Blank" on page 1742 control description. Essentially, when **Update** is **ON**, a trace is updating, and when **Update** is **OFF** it is not. When **Display** is **ON**, it is visible and when **Display** is **OFF** it is not. These terms are used throughout the descriptions in this section.

Trace Type

There are four trace Types:

Option	Parameter	SCPI Example	Details
Clear/Write	WRITe	:TRAC2:TYPE WRIT	See: "Clear/Write" on page 1371
Trace Average	AVERage	:TRAC2:TYPE AVER	See: "Trace Average" on page 1372
Maximum Hold	MAXHold	:TRAC3:TYPE MAXH	See: "Max Hold" on page 1372
Minimum Hold	MINHold	:TRAC5:TYPE MINH	See: "Min Hold" on page 1373

Full descriptions of each type are provided below. You may select one of these types for each trace. Re-selecting the current **Trace Type** initiates the same action that selecting it the first time did, even though it is already selected. For example, selecting **Clear/Write** while **Clear/Write** is already selected will nonetheless clear the trace and begin rewriting it.

Besides the **Trace Type**, the "**View/Blank**" on page 1742 state must be set to **Active** (**Update: ON, Display: ON**) for a trace to be updating and visible. Selecting any **Trace Type** automatically makes the trace **Active**.

See also: "**Trace Mode Backwards Compatibility Commands**" on page 1369

Remote Command	<p>For Swept SA Measurement (in SA Mode):</p> <pre>:TRACe[1] 2 ... 6:TYPE WRITe AVERAge MAXHold MINHold</pre> <pre>:TRACe[1] 2 ... 6:TYPE?</pre> <p>For all other measurements:</p> <pre>:TRACe[1] 2 3:<meas>:TYPE WRITe AVERAge MAXHold MINHold</pre> <pre>:TRACe[1] 2 3:<meas>:TYPE?</pre> <p>where <meas> is the identifier for the current measurement</p>
Example	<pre>:TRAC:TYPE WRIT</pre> <pre>:TRAC:TYPE?</pre>
Couplings	<p>Selecting a Trace Type (by pressing any of the Trace Type selections or sending :TRAC:TYPE) sets the Trace to Active (Update: ON, Display: OFF), even if the same trace type was already selected</p> <p>When Detector setting is "Auto" ([:SENSe]:<meas>:DETECTOR:AUTO?), Detector ([:SENSe]:<meas>:DETECTOR[:FUNCTION]?) switches aligning with the switch of this parameter: "NORMAL" with WRITe (Clear Write), "AVERAge" with AVERAge, "POSitive (peak)" with MAXHold, and "NEGative (peak)" with MINHold</p>
Preset	<p>Swept SA and Monitor Spectrum: WRITe</p> <p>All other measurements: AVERAge</p> <p>Following Preset, all traces are cleared (all trace points set to mintracevalue)</p>
State Saved	The type of each trace is saved in instrument state
Annunciation	The type for each trace is indicated in the Trace annunciator panel on the Measurement Bar

Trace Mode Backwards Compatibility Commands

In earlier instruments, the "Trace Modes" were: Clear/Write, Max Hold, Min Hold, View and Blank. Averaging was global to all traces and was controlled under the **BW/Avg** menu.

In X-Series, trace averaging can be done on a per-trace basis. The Trace Modes (now called Trace Types) are Clear/Write, Trace Average, Max Hold and Min Hold. View and Blank are set separately under "**View/Blank**" on page 1742.

While this provides more flexibility, it also gives rise to potential backwards compatibility problems. To mitigate these, the old Trace Mode command has been

retained and a new Trace Type command has been added. The `:TRACe:MODE` command is retained for backwards compatibility, and the `:TRACe:TYPE`, `:TRACe:UPDate` and `:TRACe:DISPlay` commands introduced for ongoing use. The old Trace Modes are selected using `:TRAC:MODE`, whose parameters are mapped into calls to `:TRACe:TYPE`, `:TRACe:UPDate` and `:TRACe:DISPlay`, and the old global Averaging command `[:SENSe]:AVERage[:STATe]` is provided for backwards compatibility. See the individual command descriptions for details.

When **Average/Hold** in the **Meas Setup, Legacy Compatibility** menu is **ON**, the following is true for traces in Max Hold and Min Hold:

- They ignore the **Average/Hold** number; **Single** for Max Hold causes one sweep only, so switching to **Single** stops after the current sweep, and switching to **Cont** starts again without clearing the accumulated result
- Max Hold is not cleared on a **Restart, Single** or `:INIT:IMM`, but changing a measurement parameter, like frequency or bandwidth etc., still restarts the Max Hold

Preset	<code>WRITE</code>
State Saved	The trace mode is an alias only
Backwards Compatibility SCPI	<code>:TRACe[1] 2 ... 6:MODE WRITE MAXHold MINHold VIEW BLANK</code> <code>:TRACe[1] 2 ... 6:MODE?</code>
Backwards Compatibility Notes	<p>The legacy <code>:TRACe:MODE</code> command is retained for backwards compatibility. In conjunction with the legacy <code>:AVERage</code> command, it works as follows:</p> <ul style="list-style-type: none"> – <code>:AVERage ON OFF</code> sets/clears a variable that we will call average for the sake of this discussion. This variable is maintained by the instrument solely for backwards compatibility. See the <code>[:SENSe]:AVERage[:STATe]</code> command description below – <code>:TRACe:MODE WRITE</code> sets <code>:TRACe:TYPE WRITE</code> (Clear/Write) unless average is true, in which case it sets it to <code>:TRACe:TYPE AVERage</code>. It also sets <code>:TRACe:UPDate ON</code>, <code>:TRACe:DISPlay ON</code>, for the selected trace – <code>:TRACe:MODE MAXHold</code> sets <code>:TRACe:TYPE MAXHold</code> (Max Hold). It also sets <code>:TRACe:UPDate ON</code>, <code>:TRACe:DISPlay ON</code>, for the selected trace – <code>:TRACe:MODE MINHold</code> sets <code>:TRACe:TYPE MINHold</code> (Min Hold). It also sets <code>:TRACe:UPDate ON</code>, <code>:TRACe:DISPlay ON</code>, for the selected trace – <code>:TRACe:MODE VIEW</code> sets <code>:TRACe:UPDate OFF</code>, <code>:TRACe:DISPlay ON</code>, for the selected trace – <code>:TRACe:MODE BLANK</code> sets <code>:TRACe:UPDate OFF</code>, <code>:TRACe:DISPlay OFF</code>, for the selected trace <p>The query returns the same value as <code>:TRACe:TYPE?</code>, meaning that if you set <code>:TRACe:MODE:VIEW</code> or <code>:TRACe:MODE:BLANK</code>, the query response will not be what you sent</p>

`:TRACe[n]:MODE` was formerly used to set the type or “writing mode” of the trace. At that time, View and Blank were writing modes. The new `:TRACe:TYPE` command should be used in the future, but `:TRACe:MODE` is retained to provide backwards compatibility

In X-Series, unlike earlier instruments, Max Hold and Min Hold now obey the Average Number and counts up to a terminal value as Average always has

As the **Average/Hold Number** now affects **Min Hold** and **Max Hold**, the operations that restart Averaging (for example, the **Restart** key) now also restart **Min Hold** and **Max Hold**

As a result of these changes, legacy code that restarts averaging while retaining a running Max Hold will need to be rewritten, because the Max Hold will now restart when the Average does

Also, previous to X-Series:

- Pressing **Max Hold** while already in **Max Hold** (or doing so remotely) had no effect. Now it will clear the trace and restart the sweep and the Max Hold sequence
- Changing the vertical scale (Log/Lin or dB/div) of the display restarted **Max Hold** and **Min Hold**. This is no longer the case

Preset	<code>OFF</code>
State Saved	The state of Average is saved in Instrument State for ghosting purposes
Backwards Compatibility SCPI	<code>[:SENSe]:AVERage[:STATe] ON OFF 1 0</code> <code>[:SENSe]:AVERage[:STATe]?</code>
Backwards Compatibility Notes	<p>Previous to X-Series, Averaging (also sometimes known as trace averaging) was global to all traces, that is, it was either on or off for all active traces. The legacy command <code>[:SENSe]:AVERage[:STATe] ON OFF 1 0</code> was used to turn Averaging on or off</p> <p>In X-Series, Averaging is turned on or off on a per-trace basis, so it can be on for one trace and off for another</p> <p>For backwards compatibility, the old global Average State variable is retained solely as a legacy variable, turned on and off and queried by the legacy command <code>[:SENSe]:AVERage[:STATe] OFF ON 0 1</code>. When Average is turned on, any trace in Clear/Write will get put into Average. While Average is on, any trace put into Clear/Write by the old <code>:TRAC:MODE</code> command will instead get put into Average. When Average is turned off, any trace in Average will get put into Clear/Write</p>

Trace Type Details

Clear/Write

Each trace update replaces the old data in the trace with new data.

Pressing **Clear/Write** for the selected trace, or sending `:TRAC:TYPE WRIT` for the specified trace, sets the trace type to **Clear/Write** and clears the trace, even if you are already in **Clear/Write**. Then a new sweep is initiated. Trigger conditions must be met before the sweep actually starts, and if in **Single** the sweep won't start until **Restart** is pressed.

Pressing **Clear/Write** stops the current sweep and initiates a new one, so **Trace Average**, **Max Hold** and **Min Hold** data may be interrupted in mid-sweep when **Clear/Write** is pressed, and therefore may not accurately reflect the displayed count. Therefore, when **Clear/Write** is pressed for one trace, **Trace Average**, **Max Hold** and **Min Hold** must restart for all traces.

When in **Clear/Write**, if a measurement-related instrument setting is changed (that is, one which requires new data to be taken, like **Center Frequency** or **Attenuation**), a new sweep is initiated but the trace is not cleared.

Trace Average

The instrument maintains and displays an average trace, which represents the cumulative average on a point-by-point basis of the new trace data and previous averaged trace data.

Pressing **Trace Average** (for the selected trace), or sending **:TRAC:TYPE AVER** (for the specified trace), sets the trace type to **Trace Average**, clears the trace, initiates a new sweep, and restarts the Average sequence.

Details of the count limiting behavior and the averaging calculations may be found under **Avg|Hold Number** and **Average Type** under **Meas Setup**.

When in **Trace Average**, if a measurement-related instrument setting is changed (that is, one which requires new data to be taken, like **Center Frequency** or **Attenuation**), the average restarts and a new sweep is initiated but the trace is not cleared.

Restarting the average means:

- The average/hold count *k* is set to 1, so that the next time the average trace is displayed it simply represents one trace of new data
- A new sweep is initiated
- Once the new sweep starts, the trace is overwritten with current trace data as the first trace of the new average

Remember that restarting averaging also restarts **Max Hold** and **Min Hold**, as there is only one count for Trace Average and Hold.

Max Hold

The instrument maintains and displays a max hold trace, which represents the maximum data value on a point-by-point basis of the new trace data and previous trace data. Details of the count limiting behavior may be found under **Avg|Hold Number** under **Meas Setup**.

Pressing **Max Hold** for the selected trace, or sending `:TRAC:TYPE MAXH` for the specified trace, sets the Trace Type to **Max Hold**, clears the trace, initiates a new sweep, and restarts the hold sequence, even if you are already in **Max Hold**.

When in **Max Hold**, if a measurement-related instrument setting is changed (that is, one which requires new data to be taken, like **Center Frequency** or **Attenuation**), the **Max Hold** sequence restarts and a new sweep is initiated but the trace is not cleared.

Restarting the **Max Hold** sequence means:

- The average/hold count k is set to 1, so that the next time the max hold trace is displayed it simply represents one trace of new data
- A new sweep is initiated.

Remember that restarting **Max Hold** also restarts averaging and **Min Hold**, as there is only one count for Trace Average and Hold.

Min Hold

The instrument maintains and displays a min hold trace, which represents the minimum data value on a point-point basis of the new trace data and previous trace data. Details of the count limiting behavior may be found under **Avg|Hold Number** under the **Meas Setup** functions.

Pressing **Min Hold** for the selected trace, or sending `:TRAC:TYPE MINH` for the specified trace, sets the Trace Type to **Min Hold**, clears the trace, initiates a new sweep, and restarts the hold sequence, even if you are already in **Min Hold**.

When in **Min Hold**, if a measurement-related instrument setting is changed (that is, one which requires new data to be taken, like **Center Frequency** or **Attenuation**), the **Min Hold** sequence restarts and a new sweep is initiated but the trace is not cleared.

Restarting the **Min Hold** sequence means:

- The average/hold count k is set to 1, so that the next time the min hold trace is displayed it simply represents one trace of new data
- A new sweep is initiated

Remember that restarting **Min Hold** also restarts **Max Hold** and averaging, because there is only one count for Trace Average and Hold.

Clear and Write | Restart Averaging | Restart Max/Min Hold

Starts the trace writing, as though the "Trace Type" on page 1737 had just been selected. The effect is exactly the same as reselecting the current **Trace Type** again

– the control is provided because it may not be obvious that reselecting the same selection from a radio button menu will take any action.

This control displays different labels, depending on the selected Trace Type:

- **Clear/Write**: Clear and Write
- **Trace Average**: Restart Averaging
- **Max Hold**: Restart Max Hold
- **Min Hold**: Restart Min Hold

View/Blank

Lets you set the state of the two trace variables: **Update** and **Display**. The choices available in this dropdown menu are:

Active	Update and Display both ON
View	Update OFF ; Display ON
Blank	Update OFF ; Display OFF
Background	Update ON , Display OFF Allows a trace to be blanked <i>and</i> continue to update “in the background”, which was not possible in the past

In the Swept SA measurement, a trace with **DisplayOFF** is indicated by a strikethrough of the type letter in the trace annotation panel in the Measurement Bar. A trace with **UpdateOFF** is indicated by dimming the type letter in the trace annotation panel in the Measurement Bar. In the example below, Traces 3, 4, 5 and 6 have **UpdateOFF**, and Traces 4 and 6 have **DisplayOFF**.

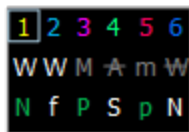

See: "[More Information](#)" on page 1376

Notes	For the commands to control the two variables, Update and Display, see " Trace Update State On/Off " on page 1375 and " Trace Display State On/Off " on page 1375 below
Dependencies	When Signal ID is on, this key is grayed-out
Couplings	<p>Selecting a Trace Type for a trace (pressing the key or sending the equivalent command) puts the trace in Active (Update ON and Display ON), even if that trace type was already selected</p> <p>Selecting a detector for a trace (pressing the key or sending [:SENS] :DET :TRAC) puts the trace in Active (UpdateON and DisplayON), even if that detector was already selected</p> <p>Selecting a "Math Function" on page 1745 other than OFF for a trace (pressing the key or sending the equivalent command) puts the trace in Active (UpdateON and DisplayON), even if that Math Mode was</p>

already selected

Loading a trace from a file puts that trace in **View** regardless of the state it was in when it was saved; as does being the target of a **Copy** or a participant in an **Exchange**

Trace Update State On/Off

Remote Command	<p>For Swept SA Measurement (in SA Mode):</p> <pre>:TRACe[1] 2 ... 6:UPDate[:STATe] ON OFF 1 0</pre> <pre>:TRACe[1] 2 ... 6:UPDate[:STATe]?</pre> <p>For all other measurements:</p> <pre>:TRACe[1] 2 3:<meas>:UPDate[:STATe] ON OFF 1 0</pre> <pre>:TRACe[1] 2 3:<meas>:UPDate[:STATe]?</pre> <p>where <meas> is the identifier for the current measurement</p>
Example	<p>Make trace 2 inactive (stop updating):</p> <pre>:TRAC2:UPD 0</pre>
Couplings	Whenever you set Update to ON for any trace, the Display is set to ON for that trace
Preset	<p>For Swept SA Measurement (in SA Mode):</p> <pre>1 0 0 0 0 0</pre> <p>ON for Trace 1; OFF for 2–6</p> <p>For all other measurements:</p> <pre>1 0 0</pre> <p>ON for Trace 1; OFF for 2 & 3</p>
State Saved	Saved in instrument state

Trace Display State On/Off

Remote Command	<p>For Swept SA Measurement (in SA Mode):</p> <pre>:TRACe[1] 2 ... 6:DISPlay[:STATe] ON OFF 1 0</pre> <pre>:TRACe[1] 2 ... 6:DISPlay[:STATe]?</pre> <p>For all other measurements:</p> <pre>:TRACe[1] 2 3:<meas>:DISPlay[:STATe] ON OFF 1 0</pre> <pre>:TRACe[1] 2 3:<meas>:DISPlay[:STATe]?</pre> <p>where <meas> is the identifier for the current measurement</p>
Example	<p>Make trace 1 visible:</p> <pre>:TRAC2:DISP 1</pre> <p>Blank trace 3:</p> <pre>:TRAC3:DISP 3</pre>
Couplings	Whenever you set Update to ON for any trace, the Display is set to ON for that trace

Preset	<p>For Swept SA Measurement (in SA Mode): 1 0 0 0 0 0</p> <p>ON for Trace 1; OFF for 2–6</p> <p>For all other measurements: 1 0 0</p> <p>ON for Trace 1; OFF for 2 & 3</p>
State Saved	Saved in instrument state

More Information

When a trace becomes inactive, any update from the **:SENSE** system (detectors) immediately stops, without waiting for the end of the sweep. The trace data remains unchanged, but stops updating. If the trace is blanked, this still does not affect the data in the trace. Traces that are blanked (**Display=OFF**) do not display nor appear on printouts, but their data stays intact, they may be queried, and markers may be placed on them

In most cases, inactive traces are static and unchanging; however, there are cases when an inactive trace will update, specifically:

- if data is written to that trace from remote
- if trace data is loaded from mass storage
- if the trace is the target of a **Copy** or participant in an **Exchange**
- if the trace is cleared using **Clear Trace**

Inactive traces that are also being displayed (traces in **View**) are displayed at half intensity. Traces in **View** display across the entire X-Axis of the instrument. Their horizontal placement does not change, even if X-Axis settings subsequently are changed, although Y-Axis settings do affect the vertical placement of data.

When a trace becomes active (**Update=ON**), the trace is cleared, the average count is reset, and a new sweep is initiated.

Note that putting a trace into **Display=OFF** and/or **Update=OFF** does *not* restart the sweep and does *not* restart Averaging or Hold functions for any traces.

3.8.15.3 Math

Lets you turn on and configure Trace Math functions.

Math Function

Trace Math functions perform mathematical operations between traces and, in some cases, user-specified offsets. When in a Trace Math function, the indicated function is performed during the sweep with the math function used in place of a detector. The trace operands for the math function are set using the "[Operand 1 / Operand 2](#)" on page 1751 controls.

- See "[How trace math is processed](#)" on page 1381

Remote Command For option details, see "[Trace Math Options](#)" on page 1379

For Swept SA Measurement (in SA Mode):

```
:CALCulate:MATH <trace_num>, PDIFference | PSUM | LOFFset | LDIFference | OFF, <trace_num>, <trace_num>, <real>,<real>
```

```
:CALCulate:MATH? <trace_num>
```

where <trace_num> is any one of:

```
TRACE1|...|TRACE6
```

For all other measurements:

```
:CALCulate:<meas>:MATH <trace_num>, PDIFference | PSUM | LOFFset | LDIFference | OFF, <trace_num>, <trace_num>, <real>,<real>
```

```
:CALCulate[:<meas>]:MATH? <trace_num>
```

where:

<meas> is the identifier for the current measurement, and

<trace_num> is any one of:

```
TRACe1|TRACe2|TRACe3
```

Note that the format of the **TRACe<n>** parameter differs from that for the Swept SA Measurement

Example

```
:CALC:MATH TRACE3,PDIF,TRACE1,TRACE2,0,0
```

Sets Trace 3 to Power Diff trace math function, and sets the First Trace operand (for Trace 3) to Trace 1 and the Second Trace operand (for Trace 3) to Trace 2

```
:CALC:MATH TRACE3,PSUM,TRACE1,TRACE2,0,0
```

Sets Trace 3 to Power Sum trace math function and sets the First Trace operand (for Trace 3) to Trace 1 and the Second Trace operand (for Trace 3) to Trace 2

```
:CALC:MATH TRACE3,LOFF,TRACE1,TRACE2,-6.00,0
```

Sets Trace 3 to Log Offset trace math function, sets the First Trace operand (for Trace 3) to Trace 1, leaves the Second Trace operand (for Trace 3) unchanged (it is irrelevant for this function) and sets the Log Offset (for Trace 3) to -6 dB

```
:CALC:MATH TRACE3,LDIF,TRACE1,TRACE2,0,-6.00
```

Sets Trace 3 to Log Diff trace math function, sets the First Trace operand (for Trace 3) to Trace 1, sets the Second Trace operand (for Trace 3) to Trace 2, and sets the Log Difference reference (for Trace 3) to -6 dBm

```
:CALC:MATH TRACE1,OFF,TRACE2,TRACE3,0,0
```

	Turns off trace math for trace 1
Notes	<p>The Trace Math Function command has 6 main set of parameters:</p> <ul style="list-style-type: none"> - Set 1 defines the “result trace”: <code>TRACE1 ... TRACE6</code> -Set 2 defines the “function”: <code>PDIFference PSUM LOFFset LDIFference OFF</code> - Set 3 is a “trace operand” (1): <code>TRACE1 ... TRACE6</code> - Set 4 is a “trace operand” (2): <code>TRACE1 ... TRACE6</code> - Set 5 defines the “Log Offset” (in dB) - Set 6 defines the “Log Difference Reference” (in dBm) <p>Note that the trace math mode is an enumeration; that is, when a math function is set for a trace, it turns off any math function that is on for that trace, then sets the new math function</p> <p>The parameters sent in the command are reflected in the values in the control menu. There is no default for any parameter; all 6 parameters must be sent to satisfy the parser. Failure to specify a parameter will result in a missing parameter message</p> <p>The query returns the math mode, the operand traces, the offset and the reference for the specified trace, all separated by commas</p>
Dependencies	<p>Trace Math is not available if Normalize is on</p> <p>Trace Math is not available if Signal ID is on</p> <p>None of the trace operands can be the destination trace. If any of the three trace math commands is sent with a destination trace number matching one of the operands, a warning is generated and the function does not turn on</p>
Couplings	When a math function is changed for a trace, that trace is set to Display = ON ; and Update = ON
Preset	<p>For Swept SA Measurement (in SA Mode):</p> <p><code>OFF, TRACE5, TRACE6, 0, 0 OFF, TRACE6, TRACE1, 0, 0 OFF, TRACE1, TRACE2, 0, 0 </code> <code>OFF, TRACE2, TRACE3, 0, 0 OFF, TRACE3, TRACE4, 0, 0 OFF, TRACE4, TRACE5, 0, 0</code></p> <p>For all other measurements:</p> <p><code>OFF, TRACE2, TRACE3, 0, 0 OFF, TRACE3, TRACE1, 0, 0 OFF, TRACE1, TRACE2, 0, 0</code></p>
State Saved	The trace math function for each trace is saved in instrument state
Annunciation	An “f” is shown on the trace annunciation panel in the Measurement Bar when a math function is on; and the function is annotated on the trace if Trace Annotation is on
Status Bits/OPC dependencies	*OPC can be used to detect the completion of a sweep, which will also correspond to the completion of the math operation, since all math takes place during the sweep

Trace Math Options

IMPORTANT

To generate a trace math result, *you must take a sweep*. The trace math engine, described below, operates in concert with the sweep engine in the instrument. Until a sweep has been taken, even if the constituent traces are not in Update mode, no result is generated.

Note that certain events can affect the trace in ways that affects all points at once. This can happen in any number of ways, including:

- A trace clear taking place
- A trace being loaded from the file system
- Trace data being sent in from the remote interface
- A copy or exchange of trace data

You should try to avoid these occurrences during a sweep, as they will tend to invalidate the math result being accumulated.

The Trace Math functions are:

Power Diff (Op1 - Op2)

Calculates a power difference between the **First Trace** operand and the **Second Trace** operand and puts the result in the destination trace.

During the sweep, the following formula is executed for each point in the trace operands, and the corresponding point is generated for the destination trace:

$$\text{DestinationTrace} = 10 \log_{10}(1/10)(\text{FirstTrace}) - 10(1/10)(\text{SecondTrace})$$

The values of the trace points are assumed to be in a decibel scale, as they are internally stored.

If a point in **FirstTrace** is equal to **maxtracevalue**, the resultant point is also **maxtracevalue**.

Otherwise, if the result of the subtraction is less than or equal to 0, the resultant point is **mintracevalue**.

Power Sum (Op1 + Op2)

Calculates a power sum between the **First Trace** operand and the **Second Trace** operand and puts the result in the destination trace.

During the sweep, the following formula is executed for each point in the trace operands, and the corresponding point is generated for the destination trace.

$$\text{DestinationTrace} = 10 \log(10(1/10)(\text{FirstTrace}) + 10(1/10)(\text{SecondTrace}))$$

The values of the trace points are assumed to be in a decibel scale, as they are internally stored.

If a point in either trace operand is equal to **maxtracevalue**, the resultant point is also **maxtracevalue**.

Log Offset (Op1 + Offset)

Calculates a log offset from the **First Trace** operand and puts the result in the destination trace. This is like the B-DL function in some older instruments. The offset is entered on the **Offset** control, which only appears when this math function is in force for the selected trace. Each destination trace has its own offset.

During the sweep, the following formula is executed for each point in the trace operand, and the corresponding point is generated for the destination trace.

$$\text{DestinationTrace} = \text{FirstTrace} + \text{Offset}$$

The values of the trace points are assumed to be in dBm (as they are internally stored) and the offset is in dB.

If a point in the trace operand is equal to **maxtracevalue**, the resultant point is also **maxtracevalue**.

If a point in the trace operand is equal to **mintracevalue**, the resultant point is also **mintracevalue**.

Example: If offset is 25 dB, then our destination trace will be higher than the operand trace by 25 dB.

Note that the **Second Trace** operand is not used for this function.

Log Diff (Op1 - Op2 + Ref)

Offsets the difference between the **First Trace** operand and the **Second Trace** operand by a reference and puts the result in the destination trace. This is like the A-B+DL function in some older instruments. The Reference is entered on the **Reference** control, which only appears when this math function is in force for the selected trace. Each destination trace has its own reference.

Offsets the difference between the **First Trace** operand and the **Second Trace** operand by a reference and puts the result in the destination trace. This is like the A-B+DL function in some older instruments. The Reference is entered on the **Reference** control, which only appears when this math function is in force for the selected trace. Each destination trace has its own reference.

During the sweep, the following formula is executed for each point in the trace operands, and the corresponding point is generated for the destination trace.

$$\text{DestinationTrace} = (\text{FirstTrace} - \text{SecondTrace}) + \text{Reference}$$

The values of the operand trace points are assumed to be in decibel units (as they are internally stored) and the reference is in dBm so the result is in dBm.

Example: If the first operand trace 1 is at 5 dBm, the second operand trace 2 is at -5 dBm, and the reference is -25 dBm, then the destination trace will be -15 dBm.

Example: If the first operand trace 1 is at 60 dBuV, the second operand trace 2 is at 50 dBuV, and the reference is 35 dBuV, then the destination trace will be 45 dBuV.

If a point in **FirstTrace** is equal to **maxtracevalue**, the resultant point is also **maxtracevalue**.

If a point in **FirstTrace** is equal to **mintracevalue**, the resultant point is also **mintracevalue**.

If neither of the above is true for a given point, then:

- If that point in **SecondTrace** is equal to **maxtracevalue**, the resultant point is **mintracevalue**.
- If that point in **SecondTrace** is equal to **mintracevalue**, the resultant point is **maxtracevalue**.

How trace math is processed

Whenever a trace math function is turned on, or the parameters and/or operands of an existing trace math function are changed, the destination trace is cleared. After the trace is cleared, all x-axis values in the trace, and the domain of the trace, are set to match the X-Axis settings of the first trace operand. When this is complete, a new sweep is initiated.

The process of acquiring data, processing it using the math and Average/Hold functions, and presenting it as trace data, consists of several functional blocks, as shown below:

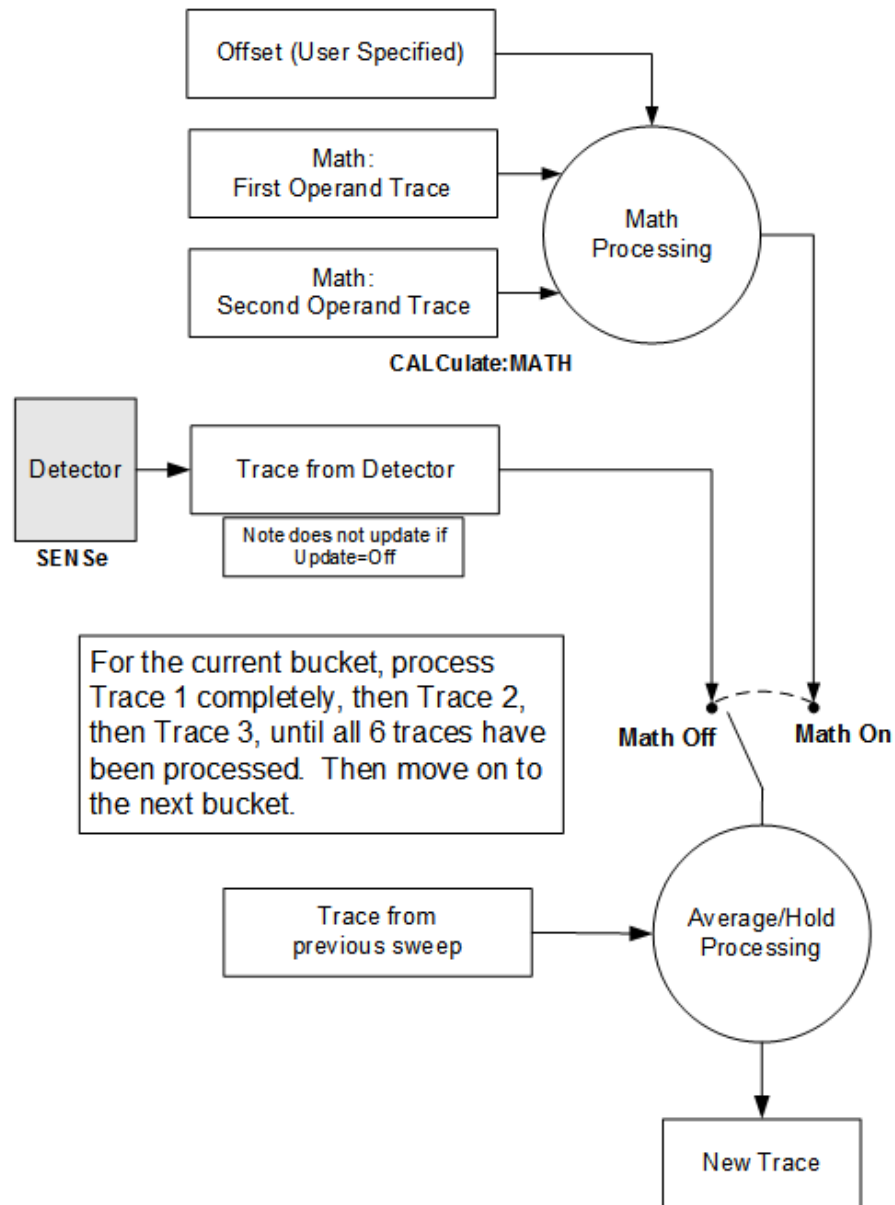

NOTE ABOUT OFFSETS: When either External Gain or Ref Level Offset is on, an offset is applied to the trace operands, and when Trace Math is on this offset is applied before any math processing is performed. Since the operands have already been offset the result trace should NOT be offset. Therefore when any Trace Math operation is performed, the sum of (External Gain - Ref Level Offset) is added to the result before it is stored in the result trace.

For each active trace, the current trace point is processed for **Trace 1**, then **Trace 2**, then **Trace 3**, etc. Trace data is taken from either the detector for that trace, or

from the mathematical result of up to two other traces and an offset, depending on whether trace math is on or not. The resultant data is then fed to the Average/Hold processing block, where (if the trace type is **Average**, **Max Hold**, or **Min Hold**) it is processed with previous trace data. The new trace data resulting from this process is then available for display, storage or remote output.

When the processing is complete for **Trace 1**, **Trace 2** is processed, and so on until all six traces have been processed. This allows a downstream trace to use as one of its math components a fully processed upstream trace. In other words, if math is **ON** for **Trace 4**, and its operand traces are **Trace 2** and **Trace 3**, then all detector, math, average and hold processing for Traces 2 and 3 is completed before the math is performed for **Trace 4**. When the current trace point is completed for all traces, the instrument moves on to the next trace point.

This allows very flexible and powerful math functions to be configured. For example, **Trace 1** can be an average trace, which can be fed with an offset to **Trace 2**, which can also be in **Max Hold**, allowing you to obtain the **Max Hold** of an Average trace.

Note that none of this processing is performed on inactive traces.

Note also that for any active trace with math **ON**, the Operand traces should have *lower* numbers than the trace (for example, using **Trace 4** as an operand for **Trace 1** will cause the data coming from **Trace 4** to be delayed by one sweep).

Operand 1 / Operand 2

These two controls select the first and second trace operands to be used for the trace math functions for the destination trace. The operands are common to all math functions for a given trace. The most recently sent **:CALCulate:MATH** command for a given trace sets the operands for that trace. Those settings are displayed on the trace operand controls for that trace.

Example	<p>The following examples are for the Swept SA measurement</p> <p>Set Trace 3 to Power Diff trace math function. Set the First Trace operand (for Trace 3) to Trace 1 and the Second Trace operand (for Trace 3) to Trace 2:</p> <pre>:CALC:MATH TRACE3,PDIF,TRACE1,TRACE2,0,0</pre> <p>Set Trace 3 to Log Offset trace math function. Set the First Trace operand (for Trace 3) to Trace 1, leave the Second Trace operand (for Trace 3) unchanged (it is irrelevant for this function) and set the Log Offset (for Trace 3) to -6 dB:</p> <pre>:CALC:MATH TRACE3,LOFF,TRACE1,TRACE2,-6.00,0</pre>
Notes	See " Math Function " on page 1745 for how to specify Operands 1 and 2 using :CALCulate:MATH
Dependencies	The destination trace cannot be an operand. The destination trace number is grayed-out on the dropdown
Preset	Operand 1: Trace number minus 2 (wraps at 1). For example, for Trace 1, Operand 1 presets to Trace

	5; for Trace 6, it presets to Trace 4 Operand 2: Trace number minus 1 (wraps at 1). For example, for Trace 1, Operand 2 presets to Trace 6; for Trace 6, it presets to Trace 5
State Saved	Operands 1 and 2 for each trace are stored in instrument state

Offset

Used by the Log Offset math function.

Example	The following example is for the Swept SA measurement Set Trace 3 to Log Offset trace math function, set the First Trace operand (for Trace 3) to Trace 1, leave the Second Trace operand (for Trace 3) unchanged (it is irrelevant for this function) and set the Log Offset (for Trace 3) to -6 dB: <code>:CALC:MATH TRACE3,LOFF,TRACE1,TRACE2,-6.00,0</code>
State Saved	The Log Offset value for each trace is saved in Instrument State
Min	-100 dB
Max	100 dB

Reference

Used by the Log Diff math function.

Example	The following example is for the Swept SA measurement Set Trace 3 to Log Diff trace math function, set the First Trace operand (for Trace 3) to Trace 1, set the Second Trace operand (for Trace 3) to Trace 2, and set the Log Difference reference (for Trace 3) to -6 dBm: <code>:CALC:MATH TRACE3,LDIF,TRACE1,TRACE2,0,-6.00</code>
State Saved	The Log Difference reference value for each trace is saved in instrument state
Min/Max	Same as reference level

3.8.15.4 Detector

Lets you choose and configure detectors for the selected trace.

Detector

Selects a detector to be used by the instrument for the current measurement. Allows up to three (3) traces, but each use the same detector type choice. The following choices are available:

3 VMA Mode
3.8 ACP Measurement

Option	Parameters	Description
Auto	See "Detector Select Auto/Man" on page 1386	Detector selected depends on marker functions, trace functions, average type, and the trace averaging function When in AUTO , the detector selected is set to AVERage , unless the Radio Standard defaults state otherwise, for example, it is set to POS for Radio Standard = PDC when Device = both MS and BTS, and when Radio Standard = NADC and Device = MS
Normal	NORMal	Detector determines the peak of the CW-like signals, and yields alternating maximums and minimums of noise-like signals. This is also referred to as Rosenfell detection
Average	AVERage RMS	Detector determines the average of the signal within the sweep points, using RMS averaging
Peak (Positive)	POSitive	Detector determines the maximum of the signal within the sweep points
Sample	SAMPle	Detector indicates the instantaneous level of the signal at the center of the sweep points represented by each display point
Negative Peak	NEGative	Detector determines the minimum of the signal within the sweep points

Because they may not find a spectral component's true peak, neither Average nor Sample detectors measure amplitudes of CW signals as accurately as Peak or Normal, but they do measure noise without the biases of peak detection.

When **Meas Method** is Fast Power, Auto, Peak and Average are selectable.

Remote Command	<code>[:SENSe]:ACPoweR:DETEctor[:FUNction] NORMal AVERage POSitive SAMPle NEGative RMS</code> <code>[:SENSe]:ACPoweR:DETEctor[:FUNction]?</code>
Example	<code>:ACP:DET NORM</code> <code>:ACP:DET?</code> <code>:ACP:DET RMS</code> Sets the detector to AVERage . In ACP, AVERage uses RMS averaging, so this is equivalent to selecting an RMS detector

Notes
The query returns a name that corresponds to the detector type, as shown below
The **RMS** selection sets the detector type to **AVERage** with RMS averaging. Therefore, if **RMS** has been selected, the query returns **AVER**

String Returned	Definition
NORM	Normal
AVER	Average (RMS)
POS	Peak
SAMP	Sample
NEG	Negative Peak

Couplings	<p>When "Detector Select Auto/Man" on page 1386 is Auto, Detector switches aligning with the switch of this parameter: NORMal with Clear Write, AVERage with AVERage, POSitive (Peak) with MAXHold, and NEGative (Peak) with MINHold</p> <p>When Detector Select Auto/Man is Auto, Detector is set to what the Radio Standard defaults states for all conditions of Trace Type and for all traces</p> <p>When Detector Select Auto/Man is set to Manual, all Traces use the same detector type</p> <p>When Average State = Off then Trace Types AVERage, MaxHold and MinHold do not function, since Averaging must be 'on' for them to operate. Only one Detector type for all 3 traces is allowed</p> <p>When "Meas Method" on page 1246 is RBW or FAST, Detector is disabled</p>
Preset	AVERage
State Saved	Saved in instrument state
Range	NORMal AVERage POSitive SAMPle NEGative RMS
Annotation	The four-letter mnemonic for the detector appears in the trace window next to the referenced trace
Backwards Compatibility SCPI	[:SENSe] :ACP:SWEEp:DETEctor [:FUNction]

Detector Select Auto/Man

Sets the Detector mode to Auto (**ON** | **1**) or Manual (**OFF** | **0**). In Auto, the proper detector is chosen based on rules that take into account the measurement settings and other instrument settings.

When you manually select any detector, this toggle is automatically set to Manual (**OFF**).

Remote Command	[:SENSe] :ACP:Power:DETEctor:AUTO ON OFF 1 0 [:SENSe] :ACP:Power:DETEctor:AUTO?
Example	:ACP:DET:AUTO 1 :ACP:DET?
Notes	When "Meas Method" on page 1246 is Fast Power, Peak and Average are selectable
Couplings	<p>When Detector Select Auto/Man is Auto, "Detector" on page 1384 switches aligning with the switch of this parameter: NORMal with Clear Write, AVERage with AVERage, POSitive with MAXHold, and NEGative with MINHold</p> <p>When Detector Select Auto/Man is Auto, Detector is set to what the Radio Standard defaults states for all conditions of Trace Type and for all traces</p> <p>When Detector Select Auto/Man is set to Manual, all Traces use the same detector type</p> <p>When Average State = Off then Trace Types AVERage, MaxHold and MinHold do not function, since Averaging must be ON for them to operate</p>
Preset	ON
State Saved	Yes

3.8.15.5 Trace Function

Contains controls to:

- Copy and Exchange traces
- Preset or Clear all traces

From Trace

Selects the trace to be copied to or exchanged with the **"To Trace" on page 1753** when a **"Copy" on page 1753** or **"Exchange" on page 1754** is performed

Preset	1
--------	---

To Trace

Selects the trace to be copied from or exchanged with the **"From Trace" on page 1753** when a **"Copy" on page 1753** or **"Exchange" on page 1754** is performed

Preset	2
--------	---

Copy

Executes a Trace Copy based on the **"From Trace" on page 1753** and **"To Trace" on page 1753** parameters. The copy operation is from the **From Trace** to the **To Trace**. The action is performed once.

The X-Axis settings and domain of a trace are also copied.

Remote Command	<p>For Swept SA Measurement (in SA Mode):</p> <pre style="margin: 0;">:TRACe:COPIY TRACE1 ... TRACE6, TRACE1 ... TRACE6</pre> <p>For all other measurements:</p> <pre style="margin: 0;">:TRACe:<meas>:COPIY TRACe1 TRACe2 TRACe3, TRACe1 TRACe2 TRACe3</pre> <p>where <meas> is the identifier for the current measurement</p> <p>Note that the format of the TRACe<n> parameter differs from that for the Swept SA Measurement</p>
Example	<p>Copy Trace 1 to Trace 3 and put Trace 3 in Update=Off, Display=On</p> <pre style="margin: 0;">:TRAC:COPIY TRACE1,TRACE3</pre>
Notes	<p>The command is of the form:</p> <pre style="margin: 0;">:TRACe:COPIY <source_trace>,<dest_trace></pre>
Dependencies	<p>When Signal ID is on, this key is grayed-out</p>

Couplings	The destination trace is put in View (Update = Off, Display = On) after the copy
Preset	For Swept SA Measurement (in SA Mode): <code>TRACE1, TRACE2</code> For all other measurements: <code>TRACe1, TRACe2</code>

Exchange

Executes a Trace Exchange based on the "From Trace" on page 1753 and "To Trace" on page 1753 parameters. The **From Trace** and **To Trace** values are exchanged with each other. The action is performed once.

The X-Axis settings and domain of a trace are also copied when it is exchanged with another trace.

Remote Command	For Swept SA Measurement (in SA Mode): <code>:TRACe:EXCHange TRACE1 ... TRACE6, TRACE1 ... TRACE6</code> For all other measurements: <code>:TRACe:<meas>:EXCHange TRACe1 TRACe2 TRACe3, TRACe1 TRACe2 TRACe3</code> where <code><meas></code> is the identifier for the current measurement Note that the format of the <code>:TRACe<n></code> parameter differs from that for the Swept SA Measurement
Example	Exchange Trace 1 and Trace 2 and put both traces in Update= OFF , Display= ON : <code>:TRAC:EXCH TRACE1,TRACE2</code>
Notes	The command is of the form: <code>:TRACe:EXCHange <trace_1>,<trace_2></code>
Couplings	Both traces are put in View (Update=Off, Display=On) after the exchange

Preset All Traces

Turns on Trace 1 and blanks all other traces. This is useful when you have many traces on and you want to return to having only Trace 1 on the display. Does not affect the trace type, detector or any other aspect of the trace system.

Remote Command	<code>:TRACe[:<meas>]:PRESet:ALL</code>
Example	<code>:TRAC:PREs:ALL</code>
Dependencies	When Signal ID is on, this key is grayed-out

Clear All Traces

Clears all traces. Does not affect the state of any function or variable in the instrument. Loads `mintracevalue` into all of the points for all traces, except traces

in **Min Hold**, in which case it loads **maxtracevalue**, even if **Update = OFF**.

Remote Command	:TRACe[<meas>]:CLEAr:ALL
Example	:TRAC:CLE:ALL
Dependencies	When Signal ID is on, this key is grayed-out

3.8.15.6 Advanced

Contains controls for setting advanced trace functions of the instrument.

Measure Trace

Specifies which trace's scalar results are displayed in the **Metrics** window, and retrieved by sending a **:READ** or **:FETCh** query:

- Trace 1
- Trace 2
- Trace 3

Remote Command	:CALCulate:<meas>:MTRace TRACe1 TRACe2 TRACe3 :CALCulate:<meas>:MTRace? <meas> is the identifier for the current measurement; any one of CHPower ACPower OBWidth SEMask SPURious PVTime
Example	Channel Power :CALC:CHP:MTR TRAC1 :CALC:CHP:MTR?
Dependencies	In the ACP measurement, this control is grayed-out when Meas Method is set to RBW or FAST , and only Trace 1 is enabled
Preset	TRACe1
State Saved	No
Range	Trace 1 Trace 2 Trace 3

3.9 SEM Measurement

The Spectrum Emission Mask measurement analyzes spurious signal levels in up to six pairs of offset frequencies and relates them to the carrier power.

SEM Measurement Commands

The following commands and queries can be used to configure the measurement, then retrieve measurement results:

The general functionality of ["CONFigure" on page 2551](#), ["INITiate" on page 2552](#), ["FETCh" on page 2552](#), ["MEASure" on page 2554](#), and ["READ" on page 2553](#) are described in the section **SCPI Operation and Results Query** in the topic **Programming the Instrument**.

Note that, in general, `:CONF : <measurement>` resets the specified measurement settings to their defaults. X-Series permits the addition of the `NDEFault` node to the command, which prevents a measurement preset after a measurement switch.

```
:CONFigure:SEMask
:CONFigure:SEMask:NDEFault
:INITiate:SEMask
:FETCh:SEMask[n]?
:MEASure:SEMask[n]?
:READ:SEMask[n]?
```

Remote Command Results Overview

The following table provides an overview of the results returned by the `:FETCh`, `:MEASure`, and `:READ` queries listed above, according to the index value `n`. For Mode-specific details, click on the appropriate link for each `n` value.

Offsets that are turned off (inactive) return -999.0 or `NAN` when their results are queried via SCPI. The value of `NAN` is 9.91E+37.

n	Results
1	Result summary (Offsets A - F) Note that n = 1 returns results of 6 offsets (Offset A to F) See "Results for n = 1" on page 1392
2	Displayed frequency domain spectrum trace data for Trace 1 See "Results for n = 2-4" on page 1393
3	Displayed frequency domain absolute limit trace data See "Results for n = 2-4" on page 1393
4	Displayed frequency domain relative limit trace data

n	Results
	See "Results for n = 2-4" on page 1393
5	Offset abs power, Offset abs PSD, Offset abs peak power depending on "Measurement Type" on page 1559 (Offset A- L) See "Results for n = 5" on page 1393
6	Offset rel power, Offset rel PSD, Offset rel peak power depending on "Measurement Type" on page 1559 (Offset A- L) See "Results for n = 6" on page 1394
7, 8	Offset pass/fail (Offset A- L) See "Results for n = 7-11" on page 1395
9	Offset peak power freq (Offset A- L) See "Results for n = 7-11" on page 1395
10	Offset abs peak power (Offset A- L) See "Results for n = 7-11" on page 1395
11	Offset rel peak power (Offset A- L) See "Results for n = 7-11" on page 1395
12	Peak power of the signal in the ref channel when "Measurement Type" on page 1559 is Spectrum Peak Reference See "Results for n = 12" on page 1397
13	Ref channel summary Available only in LTEAFDD, LTEATDD, MSR and 5GNR Modes
14	Offset result summary (Offset A- L) See "Results for n = 14" on page 1397
15	Offset limit margins (Offset A- L)
16	Carrier powers Available only in LTEAFDD, LTEATDD, MSR, 5GNR, and WLAN Modes
17	Displayed frequency domain combined limit trace data Available only in LTEAFDD, LTEATDD, MSR and 5GNR Modes
18	Displayed frequency domain spectrum trace data for Trace 2 See "Results for n = 18-20" on page 1399
19	Displayed frequency domain spectrum trace data for Trace 3 See "Results for n = 18-20" on page 1399
20	Displayed frequency domain absolute 2 limit trace data See "Results for n = 18-20" on page 1399
21	Result Summary (Offset A - L, Outer and Inner) Available only in LTEAFDD, LTEATDD, and 5GNR Modes
22	Offset pass/fail (Offset A- L) Available only in LTEAFDD, LTEATDD, and 5GNR Modes

3.9.1 Results for n = 1

For WLAN Mode, these results apply to all standards *except* 802.11ac/ax (80+80MHz).

Returns 82 comma-separated scalar results, in the following order:

k is an index for each offset: k = 0 for offset A; k = 1 for offset B; k = 2 for offset C, etc. The number of offsets is 6 (A-F).

#	Item	Unit, if any
1	Reserved for future use, returns -999.0	
2	Power ^(*1) at the center frequency (reference) area	When "Measurement Type" on page 1559 is PSD Ref: dBm/Hz Others: dBm
3~4	Reserved for future use, returns -999.0	
5	Peak frequency in the center frequency (reference) area	Hz
6~10	Reserved for future use, returns -999.0	
11	Relative integrated power on the negative offset A	When "Measurement Type" on page 1559 is PSD Ref: dB
10k + 11, k = 0	Returns -999.0 when "Measurement Type" on page 1559 is Spectrum Peak Ref	When Total Power Ref: dBc
12	Absolute integrated power on the negative offset A	When "Measurement Type" on page 1559 is PSD Ref: dBm/Hz
10k + 12, k = 0	Returns -999.0 when "Measurement Type" on page 1559 is Spectrum Peak Ref	When Total Power Ref: dBm
13	Relative peak power on the negative offset A	When "Measurement Type" on page 1559 is Total Power Ref: dBc
10k + 13, k = 0		Others: dB
14	Absolute peak power on the negative offset A	When "Measurement Type" on page 1559 is PSD Ref: dBm/Hz
10k + 14, k = 0		Others: dBm
15	Peak power offset frequency from the center or carrier edge frequency in the negative offset A	Hz
10k + 15, k = 0	Depends on the setting of "Offset Freq Define" on page 1500	
16	Relative integrated power on the positive offset A	When "Measurement Type" on page 1559 is PSD Ref: dB
10k + 16, k = 0	Returns -999.0 when "Measurement Type" on page 1559 is Spectrum Peak Ref	Others: dBc
17	Absolute integrated power on the positive offset A	When "Measurement Type" on page 1559 is PSD Ref: dBm/Hz
10k + 17, k = 0	Returns -999.0 when "Measurement Type" on page 1559 is Spectrum Peak Ref	Others: dBm
18	Relative peak power on the positive offset A	When "Measurement Type" on page 1559 is Total Power Ref: dBc
10k + 18, k = 0		Others: dB

3 VMA Mode
3.9 SEM Measurement

#	Item	Unit, if any
19 10k + 19, k = 0	Absolute peak power on the positive offset A	When "Measurement Type" on page 1559 is PSD Ref: dBm/Hz Others: dBm
20 10k + 20, k = 0	Peak power offset frequency from the center or carrier edge frequency in the positive offset A Depends on the setting of "Offset Freq Define" on page 1500	Hz

70 10k + 20, k = 5	Peak power offset frequency from the center or carrier edge frequency in the positive offset F Depends on the setting of "Offset Freq Define" on page 1500	Hz
71 2k + 71, k = 0	Minimum margin from limit line on the negative offset A	dB
72 2k + 72, k = 0	Minimum margin from limit line on the positive offset A	dB

82 2k + 72, k = 5	Minimum margin from limit line on the positive offset F	dB

*1: Absolute power when "Measurement Type" on page 1559 is Total Power Ref or PSD Ref; Peak power when "Measurement Type" on page 1559 is Spectrum Peak Ref

3.9.2 Results for n = 2-4

n	Data
2	Returns the displayed frequency domain spectrum trace data for Trace 1 separated by commas
3	Returns the displayed frequency domain absolute limit trace data separated by commas
4	Returns the displayed frequency domain relative limit trace data separated by commas

3.9.3 Results for n = 5

Returns comma-separated scalar values of the absolute integrated power when "Measurement Type" on page 1559 is Total Power Ref or PSD Ref and the absolute peak power when "Measurement Type" on page 1559 is Spectrum Peak Ref of the segment frequencies

The length of the result depends on the number of available offset (See ["Number of Offsets" on page 1399](#))

k is an index for each offset: k = 0 for offset A; k = 1 for offset B; k = 2 for offset C, etc. The number of offsets is 12 (A-L).

#	Item
1	Depends on "Measurement Type" on page 1559 : <ul style="list-style-type: none"> - Total power reference (dBm) - Power spectral density reference (dBm/Hz) - Spectrum peak power reference (dBm)
2	Reserved for future use, returns -999.0
3	Power ^(*1) at negative offset A
2k + 3, k = 0	
4	Power ^(*1) at positive offset A
2k + 4, k = 0	

26	Power ^(*1) at positive offset L
2k + 4, k = 11	

*1: Absolute integrated power when ["Measurement Type" on page 1559](#) is Total Power Ref or PSD Ref; Absolute peak power when ["Measurement Type" on page 1559](#) is Spectrum Peak Ref

3.9.4 Results for n = 6

When ["Measurement Type" on page 1559](#) is Total Power Ref or PSD Ref, returns comma-separated scalar values (in dBc or dBc/Hz) of the integrated power relative to the carrier at the segment frequencies

When ["Measurement Type" on page 1559](#) is Spectrum Peak Ref, returns comma-separated scalar values (in dB) of the peak power relative to the carrier at the segment frequencies

The length of the result depends on the number of available offset (See ["Number of Offsets" on page 1399](#))

For MSR, 5G NR, LTEAFDD, and LTEATDD Modes, returns outer offset results when ["Non-Contiguous Meas Region" on page 1478](#) is set to **Outer** or **Outer & Inner** (5GNR, LTEAFDD, LTEATDD only), and returns inner offset results when it is set to **Inner**

The results are in the following order:

3 VMA Mode
3.9 SEM Measurement

k is an index for each offset: k = 0 for offset A; k = 1 for offset B; k = 2 for offset C, etc. The number of offsets is 12 (A-L).

#	Item
1	Reserved for future use, returns -999.0
2	Reserved for future use, returns -999.0
3	Power ^(*1) at negative offset A
2k + 3, k = 0	
4	Power ^(*1) at positive offset A
2k + 4, k = 0	

26	Power ^(*1) at positive offset L
2k + 4, k = 11	

*1: Relative integrated power when "Measurement Type" on page 1559 is Total Power Ref or PSD Ref; Relative peak power when "Measurement Type" on page 1559 is Spectrum Peak Ref

3.9.5 Results for n = 7-11

n	Data																				
7, 8	<p>Returns comma-separated pass/fail test results (0 = passed, or 1 = failed) determined by testing the minimum margin point from the limit line that is determined each offset's Limits setting. The length of the result depends on the number of available offset (See "Number of Offsets" on page 1399)</p> <p>For MSR, 5G NR, LTEAFDD, and LTEATDD Modes, returns outer offset results when "Non-Contiguous Meas Region" on page 1478 is set to Outer or Outer & Inner (5G NR, LTEAFDD, LTEATDD only), and returns inner offset results when it is set to Inner</p> <p>The results are in the following order:</p> <table border="1"> <thead> <tr> <th>#</th> <th>Item</th> </tr> </thead> <tbody> <tr> <td>1</td> <td>Reserved for future use, returns -999.0</td> </tr> <tr> <td>2</td> <td>Reserved for future use, returns -999.0</td> </tr> <tr> <td>3</td> <td>At negative offset A</td> </tr> <tr> <td>2k + 3, k = 0</td> <td></td> </tr> <tr> <td>4</td> <td>At positive offset A</td> </tr> <tr> <td>2k + 4, k = 0</td> <td></td> </tr> <tr> <td>---</td> <td></td> </tr> <tr> <td>26</td> <td>At positive offset L</td> </tr> <tr> <td>2k + 4, k = 11</td> <td></td> </tr> </tbody> </table>	#	Item	1	Reserved for future use, returns -999.0	2	Reserved for future use, returns -999.0	3	At negative offset A	2k + 3, k = 0		4	At positive offset A	2k + 4, k = 0		---		26	At positive offset L	2k + 4, k = 11	
#	Item																				
1	Reserved for future use, returns -999.0																				
2	Reserved for future use, returns -999.0																				
3	At negative offset A																				
2k + 3, k = 0																					
4	At positive offset A																				
2k + 4, k = 0																					

26	At positive offset L																				
2k + 4, k = 11																					
9	<p>Returns comma-separated scalar values of frequency (in Hz) that have peak power from center or carrier edge frequency in each offset, depending on the setting of "Offset Freq Define" on page 1500. The length of the result depends on the number of available offset (See "Number of Offsets" on page 1399)</p>																				

n Data

For MSR, 5G NR, LTEAFDD, and LTEATDD Modes, returns outer offset results when "Non-Contiguous Meas Region" on page 1478 is set to **Outer** or **Outer & Inner** (5G NR, LTEAFDD, LTEATDD only), and returns inner offset results when it is set to **Inner**

The results are in the following order:

#	Item
1	Reserved for future use, returns -999.0
2	Reserved for future use, returns -999.0
3	Negative offset A
$2k + 3, k = 0$	
4	Positive offset A
$2k + 4, k = 0$	
---	---
26	Positive offset L
$2k + 4, k = 11$	

10 Returns comma-separated scalar values (in dBm) of the absolute peak power of the segment frequencies. The length of the result depends on the number of available offset (See "Number of Offsets" on page 1399)

For MSR, 5G NR, LTEAFDD, and LTEATDD Modes, returns outer offset results when "Non-Contiguous Meas Region" on page 1478 is set to **Outer** or **Outer & Inner** (5G NR, LTEAFDD, LTEATDD only), and returns inner offset results when it is set to **Inner**

The results are in the following order:

#	Item
1	Reserved for future use, returns -999.0
2	Reserved for future use, returns -999.0
3	At negative offset A
$2k + 3, k = 0$	
4	At positive offset A
$2k + 4, k = 0$	

26	At positive offset L
$2k + 4, k = 11$	

11 Returns comma-separated scalar values in dBc (dB if **MeasType** = PSD) of the peak power relative to the carrier at the segment frequencies. The length of the result depends on the number of available offset (See "Number of Offsets" on page 1399)

For MSR, 5G NR, LTEAFDD, and LTEATDD Modes, returns outer offset results when "Non-Contiguous Meas Region" on page 1478 is set to **Outer** or **Outer & Inner** (5G NR, LTEAFDD, LTEATDD only), and returns inner offset results when it is set to **Inner**

The results are in the following order:

n	Data																				
	<table border="1"> <thead> <tr> <th>#</th> <th>Item</th> </tr> </thead> <tbody> <tr> <td>1</td> <td>Reserved for future use, returns -999.0</td> </tr> <tr> <td>2</td> <td>Reserved for future use, returns -999.0</td> </tr> <tr> <td>3</td> <td>At negative offset A</td> </tr> <tr> <td>2k + 3, k = 0</td> <td></td> </tr> <tr> <td>4</td> <td>At positive offset A</td> </tr> <tr> <td>2k + 4, k = 0</td> <td></td> </tr> <tr> <td>---</td> <td></td> </tr> <tr> <td>26</td> <td>At positive offset L</td> </tr> <tr> <td>2k + 4, k = 11</td> <td></td> </tr> </tbody> </table>	#	Item	1	Reserved for future use, returns -999.0	2	Reserved for future use, returns -999.0	3	At negative offset A	2k + 3, k = 0		4	At positive offset A	2k + 4, k = 0		---		26	At positive offset L	2k + 4, k = 11	
#	Item																				
1	Reserved for future use, returns -999.0																				
2	Reserved for future use, returns -999.0																				
3	At negative offset A																				
2k + 3, k = 0																					
4	At positive offset A																				
2k + 4, k = 0																					

26	At positive offset L																				
2k + 4, k = 11																					

3.9.6 Results for n = 12

When "Measurement Type" on page 1559 is Spectrum Peak reference, returns the peak power of the signal in the ref channel

Otherwise, the value returned is -999.0

3.9.7 Results for n = 14

Returns comma-separated scalar results

For MSR, 5G NR, LTEAFDD, and LTEATDD Modes, returns outer offset results when "Non-Contiguous Meas Region" on page 1478 is set to **Outer** or **Outer & Inner** (5G NR, LTEAFDD, LTEATDD only), and returns inner offset results when it is set to **Inner**

The results are in the following order:

k is an index for each offset: k = 0 for offset A; k = 1 for offset B; k = 2 for offset C, etc. The number of offsets is 12 (A-L)

#	Item	Unit
1	Relative integrated power on the negative offset A	When "Measurement Type" on page 1559 is Total Power Ref: dBc
10k + 1, k = 0	Returns NaN when "Measurement Type" on page 1559 is Spectrum Peak Ref	When PSD: dB
2	Absolute integrated power on the negative offset A	When "Measurement Type" on page 1559 is Total Power Ref: dBm
10k + 2, k = 0	Returns NaN when "Measurement Type" on page 1559 is Spectrum Peak Ref	When PSD: dBm/Hz
3	Relative peak power on the negative offset A	When "Measurement Type" on page 1559 is Total Power Ref PSD: dBc
10k + 3, k		

#	Item	Unit
=0		Others: dB
4	Absolute peak power on the negative offset A	When "Measurement Type" on page 1559 is PSD Ref: dBm/Hz
10k + 4, k = 0		Others: dBm
5	Peak power offset frequency from the center or carrier edge frequency in the negative offset A	Hz
10k + 5, k = 0	Depends on the setting of "Offset Freq Define" on page 1500	
6	Relative integrated power on the positive offset A	When "Measurement Type" on page 1559 is Total Power Ref: dBc
10k + 6, k = 0	Returns NaN when "Measurement Type" on page 1559 is Spectrum Peak Ref	When PSD: dB
7	Absolute integrated power on the positive offset A	When "Measurement Type" on page 1559 is Total Power Ref: dBm
10k + 7, k = 0	Returns NaN when "Measurement Type" on page 1559 is Spectrum Peak Ref	When PSD: dBm/Hz
8	Relative peak power on the positive offset A	When "Measurement Type" on page 1559 is Total Power Ref: dBc
10k + 8, k = 0		Others: dB
9	Absolute peak power on the positive offset A	When "Measurement Type" on page 1559 is PSD Ref: dBm/Hz
10k + 9, k = 0		Others: dBm
10	Peak power offset frequency from the center or carrier edge frequency in the positive offset A	Hz
10k + 10, k = 0	Depends on the setting of "Offset Freq Define" on page 1500	

120	Peak power offset frequency from the center or carrier edge frequency in the positive offset L	Hz
10k + 10, k = 11	Depends on the setting of "Offset Freq Define" on page 1500	

If the result is not available, NaN (9.91E+37) is returned

3.9.8 Results for n = 15

Results available only when "Measurement Type" on page 1559 is Total Power Reference.

Returns comma-separated scalar results

For MSR, 5G NR, LTEAFDD, and LTEATDD Modes, returns outer offset results when "Non-Contiguous Meas Region" on page 1478 is set to **Outer** or **Outer & Inner** (5G NR, LTEAFDD, LTEATDD only), and returns inner offset results when it is set to **Inner**

The results are in the following order:

3 VMA Mode
3.9 SEM Measurement

k is an index for each offset: k = 0 for offset A; k = 1 for offset B; k = 2 for offset C, etc. The number of offsets is 12 (A-L).

#	Item	Unit
1	Minimum margin from limit line on the negative offset A	dB
2k + 1, k = 0		
2	Minimum margin from limit line on the positive offset A	dB
2k + 2, k = 0		
3	Minimum margin from limit line on the negative offset B	dB
2k + 1, k = 1		
4	Minimum margin from limit line on the positive offset B	dB
2k + 2, k = 1		

24	Minimum margin from limit line on the positive offset L	dB
2k + 2, k = 11		

3.9.9 Results for n = 18-20

n	Return Value
18	Returns the displayed frequency domain spectrum trace data for Trace 2 separated by commas
19	Returns the displayed frequency domain spectrum trace data for Trace 3 separated by commas
20	Returns the displayed frequency domain absolute 2 limit trace data, separated by commas

3.9.10 Number of Offsets

The number of available offsets varies depending on the mode and option as below.

Mode	Number of available offsets
MSR LTEAFDD, LTEATDD, 5G NR	12 (Offset A to L)
WLAN	14 (Offset A to N)
Other Modes with option: N9060A-7FP, N9060B-2FP, N9060C-2FP, N9060EM1D, N9060EM1E, or N90EMPSMB	12 (Offset A to L)
Other Modes without option N9060A-7FP, N9060B-2FP, N9060C-2FP, N9060EM1D, N9060EM1E, or N90EMPSMB	6 (Offset A to F)

3.9.11 Views

All Modes provide three predefined views. In MSR, LTE-Advanced FDD/TDD and 5G NR Modes, there is also a fourth predefined view. The views are listed in the table

below.

In the following table:

- The Enumerated ID is used with `:DISP:SEM:VIEW`
- The Numeric ID is used with `:DISP:SEM:VIEW:NSEL`

View Name	Enumerated ID	Numeric ID	Details
"Abs Pwr Freq" on page 1401	APFReq	1	Displays the absolute power levels in dBm and the corresponding frequencies in the text window
"Rel Pwr Freq" on page 1401	RPFReq	2	Displays the relative power levels in dBc and the corresponding frequencies in the text window
"Integrated Power" on page 1401	IPOwer	3	Displays the absolute and relative power levels integrated throughout the bandwidths between the start and stop frequencies in the text window

View Selection by Name

Remote Command	<code>:DISPlay:SEMask:VIEW[:SElect] APFReq RPFReq IPOwer CINformation</code> <code>:DISPlay:SEMask:VIEW[:SElect]?</code>
Example	<code>:DISP:SEM:VIEW IPOW</code> <code>:DISP:SEM:VIEW?</code>
Dependencies	In SA Mode, when Radio Standard is set to WLAN, IPOwer is not available CINformation is available only in MSR, LTE-Advanced FDD/TDD and 5G NR Modes
Preset	APFReq unless noted below RPFReq WLAN
State Saved	Saved in instrument state
Range	Abs Pwr Freq Rel Pwr Freq Integrated Power Carrier Info

Views Selection by Number

Remote Command	<code>:DISPlay:SEMask:VIEW:NSElect <integer></code> <code>:DISPlay:SEMask:VIEW:NSElect?</code>
Example	<code>:DISP:SEM:VIEW:NSEL 2</code> <code>:DISP:SEM:VIEW:NSEL?</code>
Dependencies	In SA Mode, when Radio Standard is set to WLAN, Option 3 is not available Option 4 is available only in MSR, LTE-Advanced FDD/TDD and 5G NR Modes

Preset	1 unless noted below: 2 WLAN
State Saved	Saved in instrument state
Min/Max	MSR, LTEAFDD, LTEATDD, 5G NR Modes 1/4 All other Modes 1/3

3.9.11.1 Abs Pwr Freq

Displays the absolute power levels in dBm and the corresponding frequencies in the text window.

Windows: "Graph" on page 1402, "Table" on page 1407

Example `:DISP:SEM:VIEW APFR`

3.9.11.2 Rel Pwr Freq

Displays the relative power levels in dBc and the corresponding frequencies in the text window.

Windows: "Graph" on page 1402, "Table" on page 1407

Example `:DISP:SEM:VIEW RPFR`

3.9.11.3 Integrated Power

Displays the absolute and relative power levels integrated throughout the bandwidths between the start and stop frequencies in the text window.

Windows: "Graph" on page 1402, "Table" on page 1407

Example `:DISP:SEM:VIEW IPOW`

3.9.12 Windows

There are four available window types:

- In all Modes, the "Graph" on page 1402 and "Table" on page 1407 windows are available
- When **Gate View** is on, the "Gate" on page 1417 window is available

This section describes the windows.

3.9.12.1 Graph

Used to display the spectrum being measured by the SEM measurement.

This window appears in several Views, as follows:

View	Size	Position
Abs Pwr Freq	Three fifth, full width	Top
Rel Pwr Freq	Three fifth, full width	Top
Integrated Power	Three fifth, full width	Top
Gate View	One third, full width	Middle

The Graph differs depending on which View you are in. The views differ depending on the setting of the measurement type ("[Measurement Type](#)" on page 1559) under the **Meas Setup** menu

Graph Window in Abs Pwr Freq View

Corresponding Trace yellow - Combined trace from carrier and each offset

Abs Peak Pwr & Freq (Total Pwr Ref)

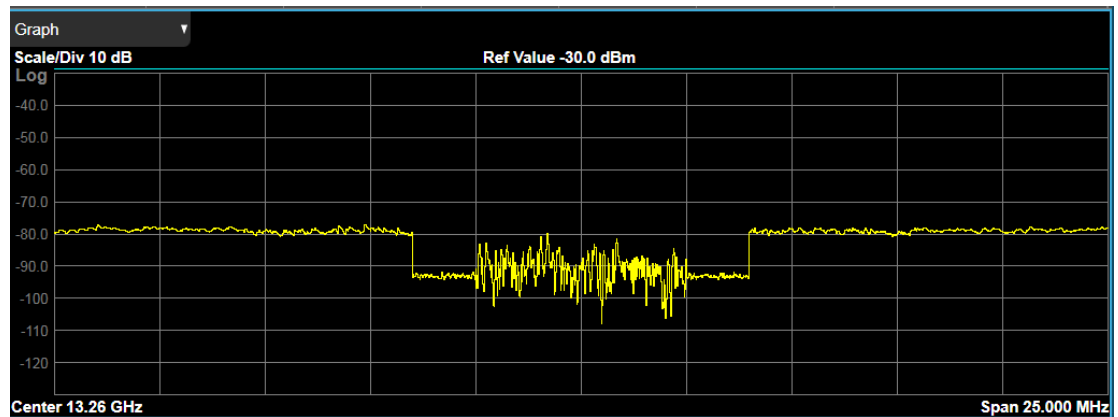

Abs Peak Pwr & Freq (PSD Ref)

3 VMA Mode
3.9 SEM Measurement

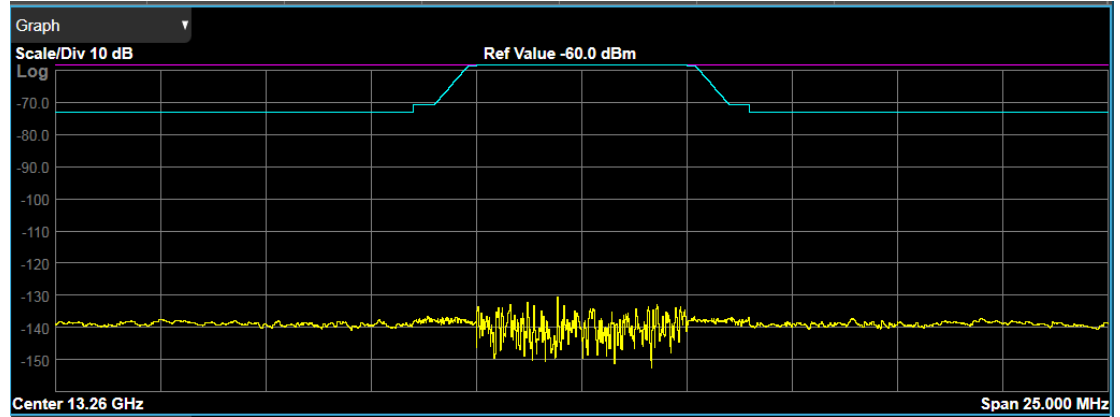

Abs Peak Pwr & Freq (Spectrum Pk Ref)

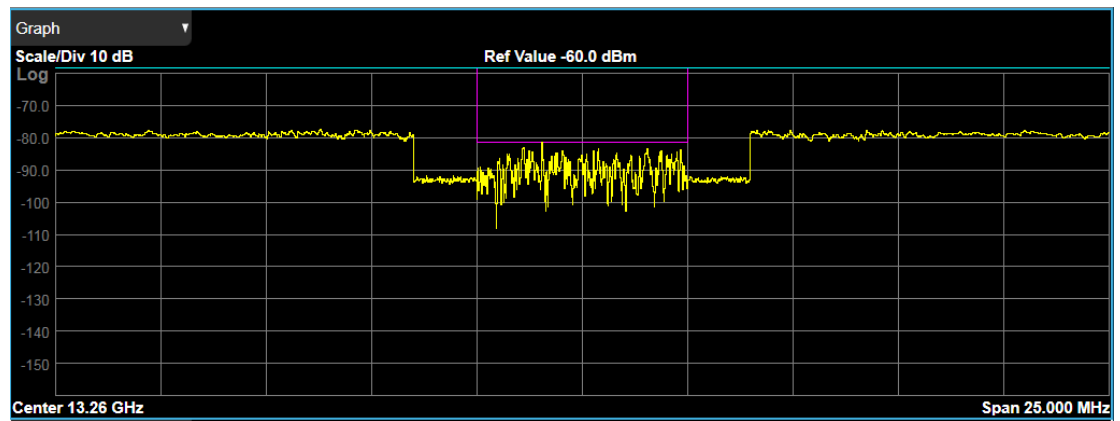

Graph Window in Rel Pwr Freq View

Corresponding Trace yellow - Combined trace from carrier and each offset

Rel Peak Pwr & Freq (Total Pwr Ref)

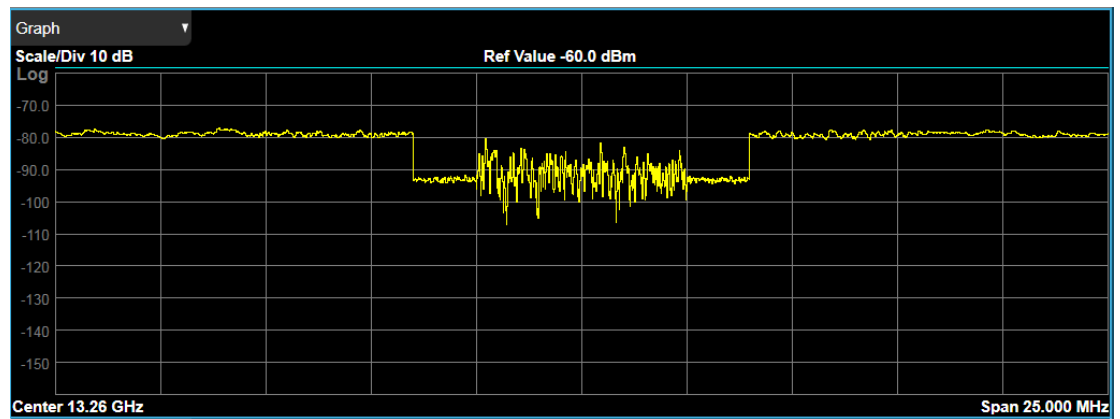

Rel Peak Pwr & Freq (PSD Ref)

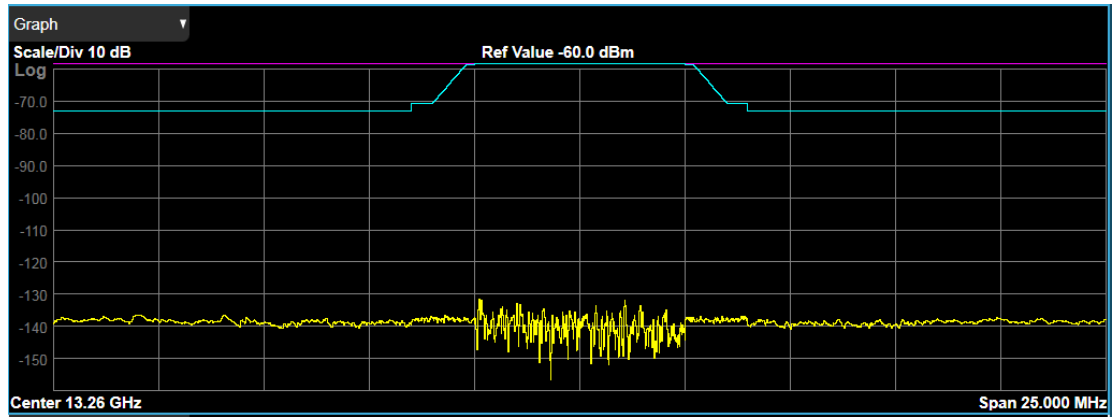

Rel Peak Pwr & Freq (Spectrum Pk Ref)

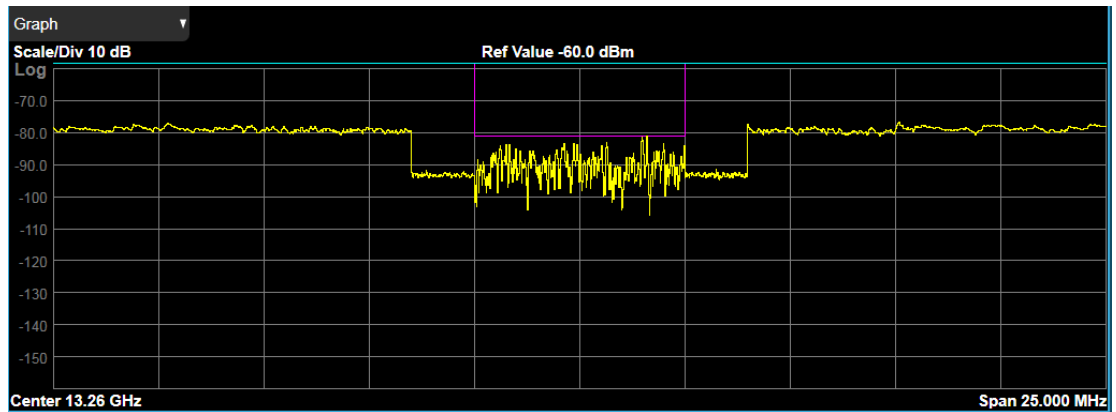

Graph Window in Integrated Power View

Corresponding Trace yellow - Combined trace from carrier and each offset

Integrated Power (Total Pwr Ref)

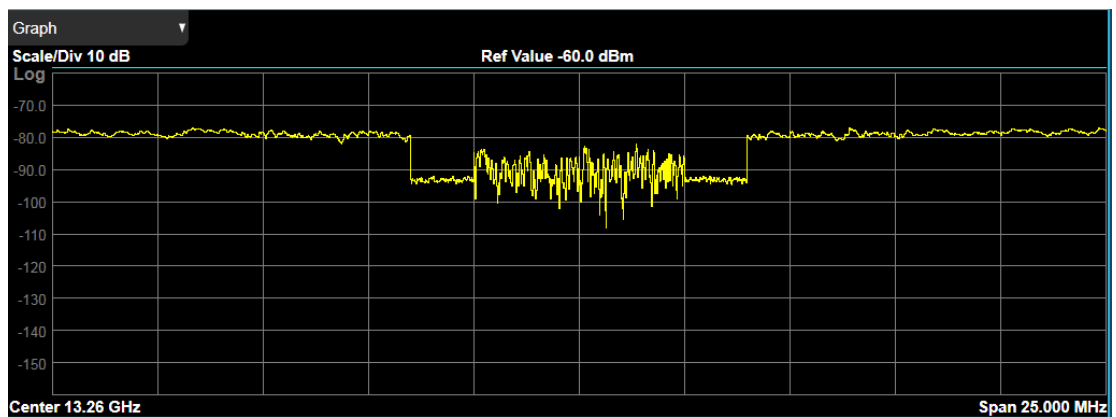

3 VMA Mode
3.9 SEM Measurement

Integrated Power (PSD Ref)

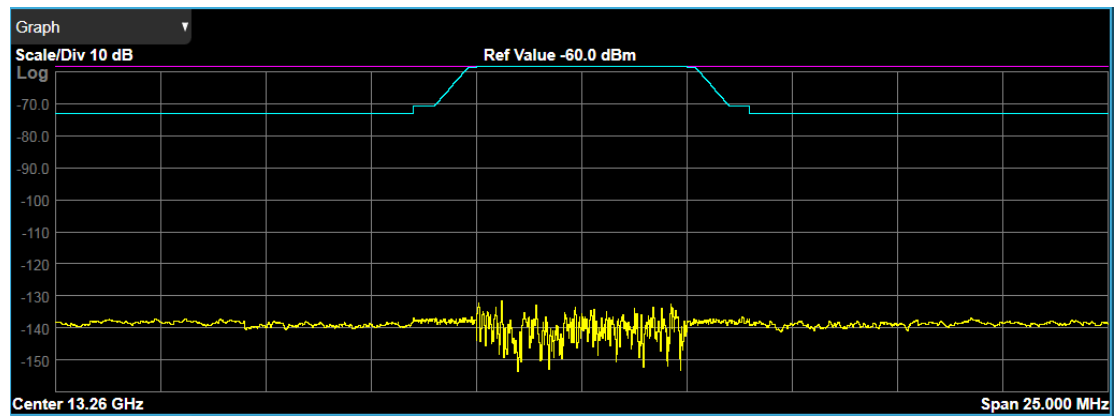

Integrated Power (Spectrum Pk Ref)

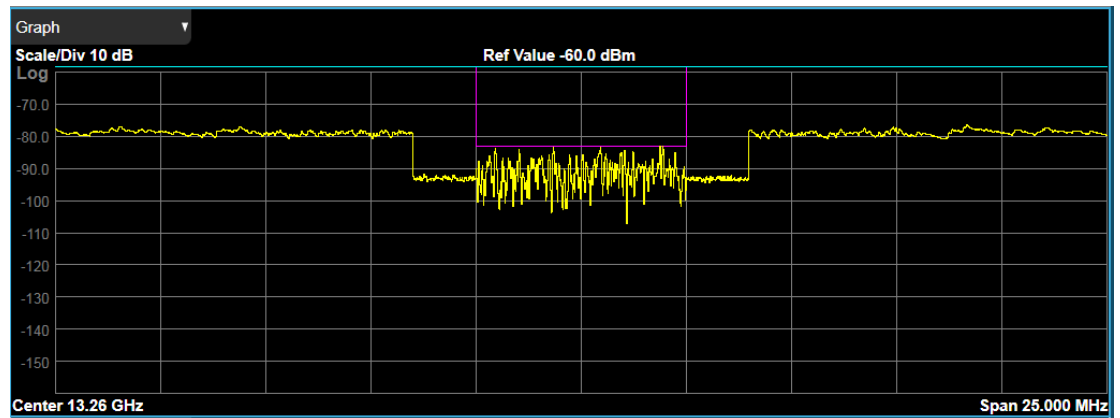

Graph Window in Carrier Info View

Sets the display to the carrier info view. The views differ depending on the setting of "Measurement Type" on page 1559.

Spectrum trace (Total Pwr Ref)

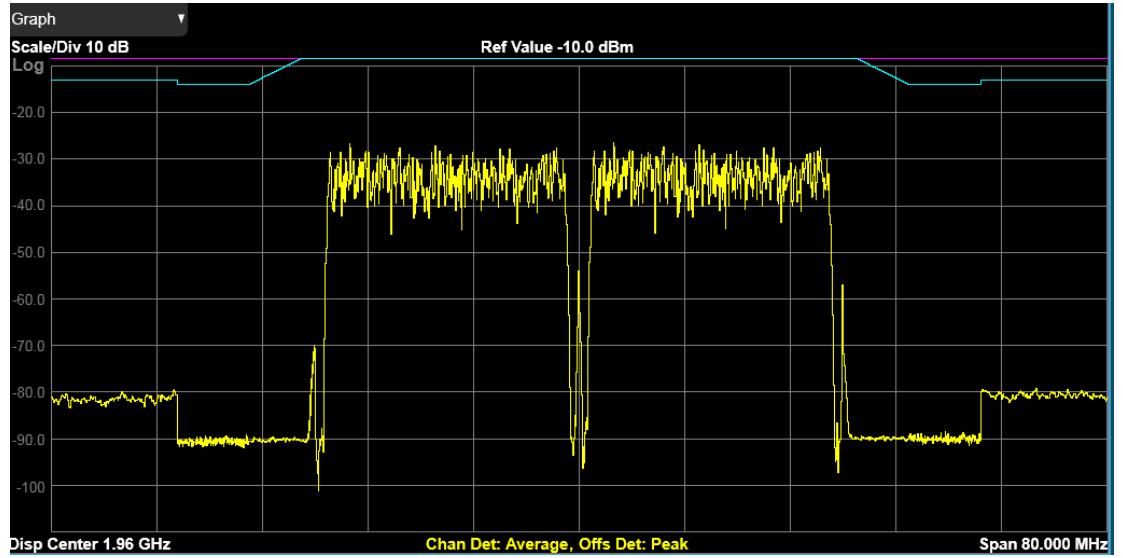

Spectrum trace (PSD Ref)

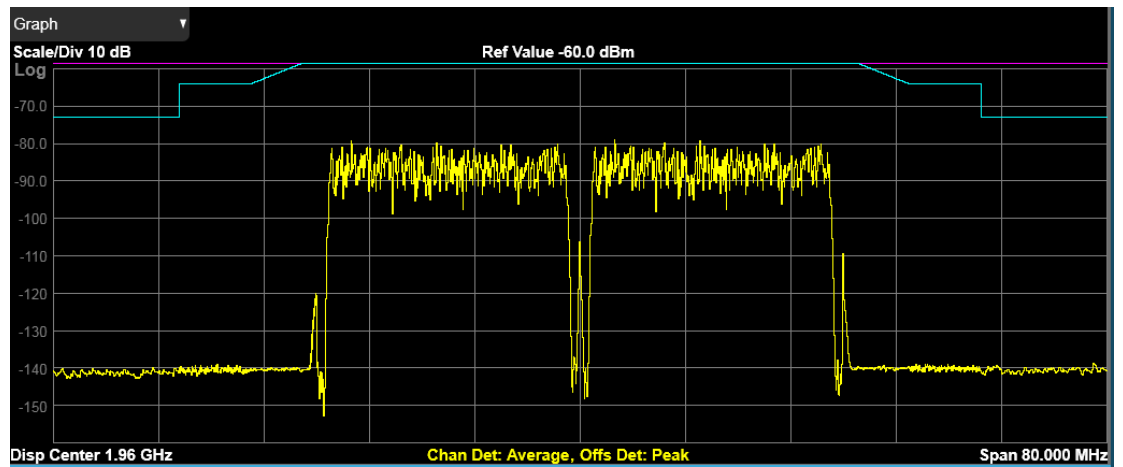

Spectrum trace (Spectrum Pk Ref)

3 VMA Mode
3.9 SEM Measurement

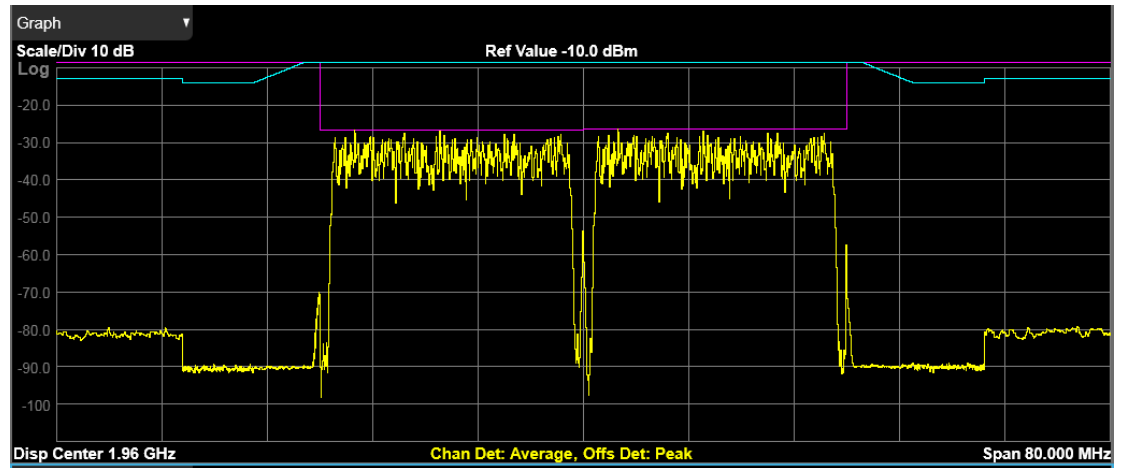

3.9.12.2 Table

Displays textual results for the measurement. The Table differs depending on which View you are in.

The views differ depending on the setting of "Measurement Type" on page 1559.

View	Size	Position
Abs Pwr Freq	Two fifth, full width	Bottom
Rel Pwr Freq	Two fifth, full width	Bottom
Integrated Power	Two fifth, full width	Bottom
Gate View	One third, full width	Bottom

Table Window in Abs Pwr Freq View

Name (Measurement Type)	Unit, if any	Corresponding Results
Power		n = 1 2nd element Absolute power at the reference area
Reference		In multi-carrier applications, this column displays which carrier is reference carrier
PSD Ref (PSD Ref)		n = 5 1st element Power spectral density reference at the reference area
Spectrum Peak ref (Spectrum Pk Ref)		n = 5 1st element Spectrum peak power reference at the reference area

Name (Measurement Type)	Unit, if any	Corresponding Results
Measure Trace		See "Measure Trace" on page 1755
Start Freq	Hz	Start frequency for offset
Stop Freq	Hz	Stop frequency for offset
Integ BW	Hz	Measurement bandwidth for offset
Lower Peak (Total Power Ref, Spectrum Pk Ref)	dBm	Absolute peak power on minimum margin point of the negative offset
Lower (PSD Ref)	dBm/Hz	Absolute power spectrum density of the negative offset
Lower Δ lim	dB	Minimum margin from limit line which is decided by Fail Mask setting on the negative offset
Lower Freq	Hz	Frequency on minimum margin point of the negative offset
Upper Peak (Total Power Ref, Spectrum Pk Ref)	dBm	Absolute peak power on minimum margin point of the positive offset
Upper (PSD Ref)	dBm/Hz	Absolute power spectrum density of the positive offset
Upper Δ lim	dB	Minimum margin from limit line which is decided by Fail Mask setting on the positive offset
Upper Freq	Hz	Frequency on minimum margin point of the positive offset

When Measurement Type is Total Power Ref

Modes other than MSR, LTE-Advanced FDD/TDD and 5G NR

2 Table		Power						Measure Trace	
		-75.08 dBm / 3.84 MHz						Trace 1	
Start Freq	Stop Freq	Integ BW	Lower			Upper			
			dBm	Δ Limit(dB)	Freq (Hz)	dBm	Δ Limit(dB)	Freq (Hz)	
2.515 MHz	2.715 MHz	30.00 kHz	-97.53	(-83.53)	-2.650 M	-97.85	(-83.85)	2.680 M	
2.715 MHz	3.515 MHz	30.00 kHz	-99.02	(-73.17)	-3.505 M	-96.22	(-70.37)	3.505 M	
3.515 MHz	4.000 MHz	30.00 kHz	-98.01	(-72.01)	-3.595 M	-97.50	(-71.50)	3.963 M	
4.000 MHz	8.000 MHz	1.000 MHz	-84.11	(-71.11)	-6.488 M	-82.54	(-69.54)	5.450 M	
8.000 MHz	12.50 MHz	1.000 MHz	-82.36	(-69.36)	-9.300 M	-83.15	(-70.15)	11.23 M	
12.50 MHz	15.00 MHz	1.000 MHz	---	(--)	---	---	(--)	---	
12.50 MHz	15.00 MHz	1.000 MHz	---	(--)	---	---	(--)	---	

MSR, LTE-Advanced FDD/TDD and 5G NR

3 VMA Mode
3.9 SEM Measurement

2 Table		Reference	Power		Measure Trace			
		Sub-block Left	-60.63 dBm / 99.97 MHz		Trace 1			
		Sub-block Right	-60.63 dBm / 99.97 MHz					
Start Freq	Stop Freq	Integ BW	Lower			Upper		
			dBm	ΔLimit(dB)	Freq (Hz)	dBm	ΔLimit(dB)	Freq (Hz)
50.00 kHz	5.050 MHz	102.0 kHz	-89.50	(-77.23)	-4.884 M	-89.58	(-77.08)	5.050 M
5.050 MHz	10.05 MHz	100.0 kHz	-87.86	(-75.36)	-6.725 M	-87.98	(-75.48)	7.675 M
10.50 MHz	40.00 MHz	1.000 MHz	-20.42	(-5.42)	-14.80 M	-78.24	(-63.24)	35.65 M
40.00 MHz	100.0 MHz	1.000 MHz	-77.73	(-62.73)	-57.55 M	-77.94	(-62.94)	59.95 M
100.0 MHz	500.0 MHz	1.000 MHz	---	(---)	---	---	(---)	---
100.0 MHz	500.0 MHz	1.000 MHz	---	(---)	---	---	(---)	---
100.0 MHz	500.0 MHz	1.000 MHz	---	(---)	---	---	(---)	---

When Measurement Type is PSD Ref:

Modes other than MSR, LTE-Advanced FDD/TDD and 5G NR

2 Table		Power		PSD Ref		Measure Trace		
		-75.55 dBm / 3.84 MHz		-141.39 dBm/Hz		Trace 1		
Start Freq	Stop Freq	Integ BW	Lower			Upper		
			dBm/Hz	ΔLimit(dB)	Freq (Hz)	dBm/Hz	ΔLimit(dB)	Freq (Hz)
2.515 MHz	2.715 MHz	30.00 kHz	-145.39	(-84.46)	-2.553 M	-144.42	(-82.94)	2.658 M
2.715 MHz	3.515 MHz	30.00 kHz	-144.96	(-73.59)	-3.515 M	-144.86	(-72.24)	3.513 M
3.515 MHz	4.000 MHz	30.00 kHz	-144.92	(-70.74)	-3.843 M	-145.04	(-71.79)	3.558 M
4.000 MHz	8.000 MHz	1.000 MHz	-146.73	(-71.41)	-5.950 M	-146.24	(-70.80)	7.525 M
8.000 MHz	12.50 MHz	1.000 MHz	-145.26	(-69.37)	-11.89 M	-145.49	(-69.12)	8.388 M
12.50 MHz	15.00 MHz	1.000 MHz	---	(---)	---	---	(---)	---
12.50 MHz	15.00 MHz	1.000 MHz	---	(---)	---	---	(---)	---

MSR, LTE-Advanced FDD/TDD and 5G NR

2 Table		Reference	Power		PSD Ref		Measure Trace	
		Sub-block Left	-60.39 dBm / 99.97 MHz		-140.39 dBm/Hz		Trace 1	
		Sub-block Right	-60.39 dBm / 99.97 MHz		-140.39 dBm/Hz			
Start Freq	Stop Freq	Integ BW	Lower			Upper		
			dBm/Hz	ΔLimit(dB)	Freq (Hz)	dBm/Hz	ΔLimit(dB)	Freq (Hz)
50.00 kHz	5.050 MHz	102.0 kHz	-139.82	(-77.24)	-5.050 M	-139.86	(-77.14)	5.050 M
5.050 MHz	10.05 MHz	100.0 kHz	-139.53	(-75.14)	-6.375 M	-139.45	(-75.05)	8.900 M
10.50 MHz	40.00 MHz	1.000 MHz	-94.24	(-5.41)	-14.80 M	-139.59	(-62.92)	34.00 M
40.00 MHz	100.0 MHz	1.000 MHz	-139.81	(-62.31)	-69.55 M	-139.88	(-62.73)	54.70 M
100.0 MHz	500.0 MHz	1.000 MHz	---	(---)	---	---	(---)	---
100.0 MHz	500.0 MHz	1.000 MHz	---	(---)	---	---	(---)	---

When Measurement Type is Spectrum Pk Ref:

Modes other than MSR, LTE-Advanced FDD/TDD and 5G NR

2 Table		Power		Spectrum Peak Ref		Measure Trace		
		-74.79 dBm / 3.84 MHz		-82.60 dBm		Trace 1		
Start Freq	Stop Freq	Integ BW	dBm	Lower ΔLimit(dB)	Freq (Hz)	Upper dBm	ΔLimit(dB)	Freq (Hz)
2.515 MHz	2.715 MHz	30.00 kHz	-99.47	(-85.47)	-2.545 M	-98.13	(-84.13)	2.538 M
2.715 MHz	3.515 MHz	30.00 kHz	-98.92	(-73.18)	-3.498 M	-97.29	(-71.55)	3.498 M
3.515 MHz	4.000 MHz	30.00 kHz	-98.39	(-72.39)	-3.835 M	-97.40	(-71.40)	3.723 M
4.000 MHz	8.000 MHz	1.000 MHz	-84.06	(-71.06)	-5.250 M	-83.22	(-70.22)	6.663 M
8.000 MHz	12.50 MHz	1.000 MHz	-82.52	(-69.52)	-9.313 M	-82.16	(-69.16)	12.26 M
12.50 MHz	15.00 MHz	1.000 MHz	---	(--)	---	---	(--)	---
12.50 MHz	15.00 MHz	1.000 MHz	---	(--)	---	---	(--)	---

MSR, LTE-Advanced FDD/TDD and 5G NR

2 Table		Reference		Power		Spectrum Peak Ref		Measure Trace	
		Sub-block Left		-60.60 dBm / 99.97 MHz		-74.10 dBm		Trace 1	
		Sub-block Right		-60.60 dBm / 99.97 MHz		-74.10 dBm			
Start Freq	Stop Freq	Integ BW	dBm	Lower ΔLimit(dB)	Freq (Hz)	Upper dBm	ΔLimit(dB)	Freq (Hz)	
50.00 kHz	5.050 MHz	102.0 kHz	-89.75	(-77.34)	-4.986 M	-89.69	(-77.19)	5.050 M	
5.050 MHz	10.05 MHz	100.0 kHz	-87.79	(-75.29)	-8.875 M	-87.91	(-75.41)	8.975 M	
10.50 MHz	40.00 MHz	1.000 MHz	-20.42	(-5.42)	-14.80 M	-77.91	(-62.91)	31.00 M	
40.00 MHz	100.0 MHz	1.000 MHz	-77.44	(-62.44)	-47.80 M	-78.05	(-63.05)	41.35 M	
100.0 MHz	500.0 MHz	1.000 MHz	---	(--)	---	---	(--)	---	
100.0 MHz	500.0 MHz	1.000 MHz	---	(--)	---	---	(--)	---	
100.0 MHz	500.0 MHz	1.000 MHz	---	(--)	---	---	(--)	---	

Table Window in Rel Pwr Freq View

Name (Measurement Type)	Unit, if any	Corresponding Results
Power		n = 1 2nd element Absolute power at the reference area
Reference		In multi-carrier applications, this column displays which carrier is reference carrier
PSD Ref		n=5 1st element Power spectral density reference at the reference area
Spectrum Peak Ref		n = 5 1st element Spectrum peak power reference at the reference area
Measure Trace		See " Measure Trace " on page 1755
Start Freq	Hz	Start frequency for offset
Stop Freq	Hz	Stop frequency for offset
Integ BW	Hz	Measurement bandwidth for offset
Lower Peak (Total Pwr Ref, Spectrum Pk Ref)	dBc (Total Pwr Ref) dB (Spectrum Pk Ref)	Relative peak power on minimum margin point of the negative offset

3 VMA Mode
3.9 SEM Measurement

Name (Measurement Type)	Unit, if any	Corresponding Results
Lower (PSD Ref)	dB	Relative power spectrum density of the negative offset
Lower Δ Lim	dB	Minimum margin from limit line which is decided by Fail Mask setting on the negative offset
Lower Freq	Hz	Frequency on minimum margin point of the negative offset
Upper Peak (Total Pwr Ref, Spectrum Pk Ref)	dBc (Total Pwr Ref) dB (Spectrum Pk Ref)	Relative peak power on minimum margin point of the positive offset
Upper (PSD Ref)	dB	Relative power spectrum density of the positive offset
Upper Δ Lim	dB	Minimum margin from limit line which is decided by Fail Mask setting on the positive offset
Upper Freq	Hz	Frequency on minimum margin point of the positive offset

When Measurement Type is Total Power Ref:

Modes other than MSR, LTE-Advanced FDD/TDD and 5G NR

2 Table		Power		Measure Trace				
		-75.54 dBm / 3.84 MHz		Trace 1				
Start Freq	Stop Freq	Integ BW	dBc	Δ Limit(dB)	Freq (Hz)	dBc	Δ Limit(dB)	Freq (Hz)
2.515 MHz	2.715 MHz	30.00 kHz	-23.32	(-84.86)	-2.515 M	-22.02	(-83.56)	2.703 M
2.715 MHz	3.515 MHz	30.00 kHz	-21.35	(-71.38)	-3.483 M	-21.76	(-71.57)	3.498 M
3.515 MHz	4.000 MHz	30.00 kHz	-21.68	(-71.22)	-3.633 M	-22.23	(-71.77)	3.790 M
4.000 MHz	8.000 MHz	1.000 MHz	-8.29	(-70.83)	-6.488 M	-5.96	(-68.50)	5.900 M
8.000 MHz	12.50 MHz	1.000 MHz	-6.02	(-68.56)	-8.100 M	-6.17	(-68.71)	8.775 M
12.50 MHz	15.00 MHz	1.000 MHz	---	(---)	---	---	(---)	---
12.50 MHz	15.00 MHz	1.000 MHz	---	(---)	---	---	(---)	---

MSR, LTE-Advanced FDD/TDD and 5G NR

2 Table		Reference	Power		Measure Trace			
		Sub-block Left	-60.67 dBm / 99.97 MHz		Trace 1			
		Sub-block Right	-60.67 dBm / 99.97 MHz					
Start Freq	Stop Freq	Integ BW	dBc	Δ Limit(dB)	Freq (Hz)	dBc	Δ Limit(dB)	Freq (Hz)
50.00 kHz	5.050 MHz	102.0 kHz	-28.81	(-76.98)	-5.050 M	-28.69	(-76.99)	4.961 M
5.050 MHz	10.05 MHz	100.0 kHz	-27.13	(-75.30)	-9.275 M	-27.07	(-75.25)	6.200 M
10.50 MHz	40.00 MHz	1.000 MHz	40.24	(-5.43)	-14.80 M	-17.50	(-63.17)	16.30 M
40.00 MHz	100.0 MHz	1.000 MHz	-17.42	(-63.09)	-71.65 M	-17.24	(-62.91)	81.10 M
100.0 MHz	500.0 MHz	1.000 MHz	---	(---)	---	---	(---)	---
100.0 MHz	500.0 MHz	1.000 MHz	---	(---)	---	---	(---)	---

When Measurement Type is PSD Ref:

Modes other than MSR, LTE-Advanced FDD/TDD and 5G NR

2 Table		Power		PSD Ref		Measure Trace		
		-75.32 dBm / 3.84 MHz		-141.16 dBm/Hz		Trace 1		
Start Freq	Stop Freq	Integ BW	dB	Lower ΔLimit(dB)	Freq (Hz)	Upper dB	ΔLimit(dB)	Freq (Hz)
2.515 MHz	2.715 MHz	30.00 kHz	-3.38	(-82.66)	-2.553 M	-4.49	(-85.02)	2.680 M
2.715 MHz	3.515 MHz	30.00 kHz	-3.71	(-73.61)	-3.490 M	-3.79	(-73.81)	3.515 M
3.515 MHz	4.000 MHz	30.00 kHz	-3.79	(-71.26)	-3.588 M	-3.48	(-70.88)	3.865 M
4.000 MHz	8.000 MHz	1.000 MHz	-5.66	(-69.72)	-4.300 M	-5.37	(-71.05)	8.000 M
8.000 MHz	12.50 MHz	1.000 MHz	-4.17	(-69.03)	-11.44 M	-4.36	(-68.82)	12.50 M
12.50 MHz	15.00 MHz	1.000 MHz	---	(---)	---	---	(---)	---
12.50 MHz	15.00 MHz	1.000 MHz	---	(---)	---	---	(---)	---

MSR, LTE-Advanced FDD/TDD and 5G NR

2 Table		Reference		Power		PSD Ref		Measure Trace	
		Sub-block Left		-60.58 dBm / 99.97 MHz		-140.58 dBm/Hz		Trace 1	
		Sub-block Right		-60.58 dBm / 99.97 MHz		-140.58 dBm/Hz			
Start Freq	Stop Freq	Integ BW	dB	Lower ΔLimit(dB)	Freq (Hz)	Upper dB	ΔLimit(dB)	Freq (Hz)	
50.00 kHz	5.050 MHz	102.0 kHz	0.72	(-77.17)	-5.050 M	0.72	(-77.34)	4.859 M	
5.050 MHz	10.05 MHz	100.0 kHz	1.02	(-75.25)	-6.025 M	1.00	(-75.39)	6.450 M	
10.50 MHz	40.00 MHz	1.000 MHz	46.32	(-5.39)	-14.80 M	0.90	(-62.81)	26.50 M	
40.00 MHz	100.0 MHz	1.000 MHz	0.70	(-62.71)	-72.55 M	0.60	(-63.26)	67.00 M	
100.0 MHz	500.0 MHz	1.000 MHz	---	(---)	---	---	(---)	---	
100.0 MHz	500.0 MHz	1.000 MHz	---	(---)	---	---	(---)	---	

When Measurement Type is Spectrum Pk Ref:

Modes other than MSR, LTE-Advanced FDD/TDD and 5G NR

2 Table		Power		Spectrum Peak Ref		Measure Trace		
		-75.00 dBm / 3.84 MHz		-82.77 dBm		Trace 1		
Start Freq	Stop Freq	Integ BW	dB	Lower ΔLimit(dB)	Freq (Hz)	Upper dB	ΔLimit(dB)	Freq (Hz)
2.515 MHz	2.715 MHz	30.00 kHz	-14.59	(-83.37)	-2.530 M	-15.11	(-83.88)	2.575 M
2.715 MHz	3.515 MHz	30.00 kHz	-15.41	(-72.22)	-3.513 M	-14.67	(-71.45)	3.515 M
3.515 MHz	4.000 MHz	30.00 kHz	-14.73	(-71.51)	-3.528 M	-12.62	(-69.39)	3.700 M
4.000 MHz	8.000 MHz	1.000 MHz	0.62	(-69.16)	-6.450 M	-0.56	(-70.33)	7.813 M
8.000 MHz	12.50 MHz	1.000 MHz	-0.34	(-70.12)	-11.18 M	0.72	(-69.05)	11.44 M
12.50 MHz	15.00 MHz	1.000 MHz	---	(---)	---	---	(---)	---

MSR, LTE-Advanced FDD/TDD and 5G NR

3 VMA Mode
3.9 SEM Measurement

2 Table			Reference		Power		Spectrum Peak Ref		Measure Trace
			Sub-block Left		-60.58 dBm / 99.97 MHz		-74.09 dBm		Trace 1
			Sub-block Right		-60.58 dBm / 99.97 MHz		-74.09 dBm		
			Lower				Upper		
Start Freq	Stop Freq	Integ BW	dB	Δ Limit(dB)	Freq (Hz)	dB	Δ Limit(dB)	Freq (Hz)	
50.00 kHz	5.050 MHz	102.0 kHz	-15.34	(-77.14)	-4.897 M	-15.66	(-77.27)	5.037 M	
5.050 MHz	10.05 MHz	100.0 kHz	-13.91	(-75.50)	-5.475 M	-13.91	(-75.50)	7.775 M	
10.50 MHz	40.00 MHz	1.000 MHz	53.62	(-5.47)	-14.80 M	-3.87	(-62.96)	18.85 M	
40.00 MHz	100.0 MHz	1.000 MHz	-3.51	(-62.60)	-99.25 M	-3.65	(-62.74)	96.70 M	
100.0 MHz	500.0 MHz	1.000 MHz	---	(---)	---	---	(---)	---	
100.0 MHz	500.0 MHz	1.000 MHz	---	(---)	---	---	(---)	---	

Table Window in Integrated Power View

Name (Measurement Type)	Unit, if any	Corresponding Results
Power		n = 1 2nd element Absolute power at the reference area
Reference		In multi-carrier applications, this column displays which carrier is reference carrier
PSD Ref		n = 5 1st element Power spectral density reference at the reference area
Spectrum Peak Ref		n = 5 1st element Peak power at the reference area
Measure Trace		See " Measure Trace " on page 1755
Start Freq	Hz	Start frequency for offset
Stop Freq	Hz	Stop frequency for offset
Integ BW	Hz	Measurement bandwidth for offset
Lower Integ (Total Power Ref)	dBc	Relative integrated power on the negative offset
Lower (PSD Ref)	dB	Relative power spectrum density of the negative offset
Lower Peak (Spectrum Pk Ref)	dB	Relative peak power on minimum margin point of the negative offset
Lower Δ Lim	dB	Minimum margin from limit line which is decided by Fail Mask setting on the negative offset
Lower Integ (Total Power Ref)	dBm	Absolute integrated power on the negative offset
Lower (PSD Ref)	dBm/Hz	Absolute power spectrum density of the negative offset
Lower Peak (Spectrum Pk Ref)	dBm	Absolute peak power on minimum margin point of the negative offset
Upper Integ (Total Power Ref)	dBc	Relative integrated power on the positive offset

Name (Measurement Type)	Unit, if any	Corresponding Results
Upper (PSD Ref)	dB	Relative power spectrum density of the positive offset
Upper Peak (Spectrum Pk Ref)	dB	Relative peak power on minimum margin point of the positive offset
Upper Δ Lim	dB	Minimum margin from limit line which is decided by Fail Mask setting on the positive offset
Upper Integ (Total Power Ref)	dBm	Absolute integrated power on the positive offset
Upper (PSD Ref)	dBm/Hz	Absolute power spectrum density of the positive offset
Upper Peak (Spectrum Pk Ref)	dBm	Absolute peak power on minimum margin point of the positive offset

When Measurement Type is Total Power Ref:

Modes other than MSR, LTE-Advanced FDD/TDD and 5G NR

2 Table		Power		Measure Trace					
		-74.97 dBm / 3.84 MHz		Trace 1					
Start Freq	Stop Freq	Integ BW	dBc	ΔLimit(dB)	dBm	dBc	ΔLimit(dB)	dBm	
2.515 MHz	2.715 MHz	30.00 kHz	-17.16	(-84.04)	-92.13	-17.07	(-83.72)	-92.04	
2.715 MHz	3.515 MHz	30.00 kHz	-11.02	(-73.04)	-85.99	-10.76	(-70.18)	-85.73	
3.515 MHz	4.000 MHz	30.00 kHz	-12.97	(-71.13)	-87.94	-13.10	(-70.37)	-88.07	
4.000 MHz	8.000 MHz	1.000 MHz	-5.58	(-67.90)	-80.55	-5.64	(-69.89)	-80.61	
8.000 MHz	12.50 MHz	1.000 MHz	-4.10	(-68.15)	-79.07	-4.15	(-69.25)	-79.12	
12.50 MHz	15.00 MHz	1.000 MHz	---	(---)	---	---	(---)	---	

MSR, LTE-Advanced FDD/TDD and 5G NR

2 Table		Reference	Power		Measure Trace					
		Sub-block Left	-60.67 dBm / 99.97 MHz		Trace 1					
		Sub-block Right	-60.67 dBm / 99.97 MHz							
Start Freq	Stop Freq	Integ BW	dBc	ΔLimit(dB)	dBm	dBc	ΔLimit(dB)	dBm		
50.00 kHz	5.050 MHz	102.0 kHz	-12.20	(-77.41)	-72.87	-12.22	(-77.51)	-72.89		
5.050 MHz	10.05 MHz	100.0 kHz	-11.85	(-75.50)	-72.51	-11.79	(-74.79)	-72.45		
10.50 MHz	40.00 MHz	1.000 MHz	40.90	(-5.49)	-19.77	-4.24	(-62.77)	-64.90		
40.00 MHz	100.0 MHz	1.000 MHz	-1.43	(-63.23)	-62.09	-1.48	(-63.24)	-62.14		
100.0 MHz	500.0 MHz	1.000 MHz	---	(---)	---	---	(---)	---		

When Measurement Type is PSD Ref:

Modes other than MSR, LTE-Advanced FDD/TDD and 5G NR

3 VMA Mode
3.9 SEM Measurement

2 Table		Power		PSD Ref		Measure Trace		
		-75.62 dBm / 3.84 MHz		-141.47 dBm/Hz		Trace 1		
Start Freq	Stop Freq	Integ BW	dB	Lower ΔLimit(dB)	dBm/Hz	Upper dB	ΔLimit(dB)	dBm/Hz
2.515 MHz	2.715 MHz	30.00 kHz	-3.69	(-82.69)	-145.16	-3.85	(-83.76)	-145.32
2.715 MHz	3.515 MHz	30.00 kHz	-3.46	(-73.42)	-144.92	-3.53	(-71.41)	-145.00
3.515 MHz	4.000 MHz	30.00 kHz	-3.62	(-71.73)	-145.09	-3.32	(-70.57)	-144.79
4.000 MHz	8.000 MHz	1.000 MHz	-5.13	(-69.13)	-146.59	-5.20	(-69.79)	-146.66
8.000 MHz	12.50 MHz	1.000 MHz	-4.73	(-70.43)	-146.19	-4.20	(-69.28)	-145.67
12.50 MHz	15.00 MHz	1.000 MHz	---	(---)	---	---	(---)	---

MSR, LTE-Advanced FDD/TDD and 5G NR

2 Table		Reference		Power		PSD Ref		Measure Trace	
		Sub-block Left		-60.69 dBm / 99.97 MHz		-140.69 dBm/Hz		Trace 1	
		Sub-block Right		-60.69 dBm / 99.97 MHz		-140.69 dBm/Hz			
Start Freq	Stop Freq	Integ BW	dB	Lower ΔLimit(dB)	dBm/Hz	Upper dB	ΔLimit(dB)	dBm/Hz	
50.00 kHz	5.050 MHz	102.0 kHz	0.86	(-76.90)	-139.83	0.89	(-77.15)	-139.80	
5.050 MHz	10.05 MHz	100.0 kHz	1.08	(-75.27)	-139.61	1.07	(-75.63)	-139.62	
10.50 MHz	40.00 MHz	1.000 MHz	46.46	(-5.39)	-94.23	0.92	(-63.00)	-139.77	
40.00 MHz	100.0 MHz	1.000 MHz	0.80	(-63.20)	-139.89	0.77	(-62.95)	-139.92	
100.0 MHz	500.0 MHz	1.000 MHz	---	(---)	---	---	(---)	---	

When Measurement Type is Spectrum Pk Ref:

Modes other than MSR, LTE-Advanced FDD/TDD and 5G NR

2 Table		Power		Spectrum Peak Ref		Measure Trace		
		-75.44 dBm / 3.84 MHz		-84.03 dBm		Trace 1		
Start Freq	Stop Freq	Integ BW	dB	Lower ΔLimit(dB)	dBm	Upper dB	ΔLimit(dB)	dBm
2.515 MHz	2.715 MHz	30.00 kHz	-12.79	(-82.82)	-96.82	-13.07	(-83.10)	-97.10
2.715 MHz	3.515 MHz	30.00 kHz	-14.32	(-72.50)	-98.35	-15.22	(-73.62)	-99.25
3.515 MHz	4.000 MHz	30.00 kHz	-12.82	(-70.85)	-96.85	-12.95	(-70.98)	-96.98
4.000 MHz	8.000 MHz	1.000 MHz	0.61	(-70.42)	-83.42	0.58	(-70.45)	-83.45
8.000 MHz	12.50 MHz	1.000 MHz	2.05	(-68.98)	-81.98	-0.18	(-71.21)	-84.21
12.50 MHz	15.00 MHz	1.000 MHz	---	(---)	---	---	(---)	---
12.50 MHz	15.00 MHz	1.000 MHz	---	(---)	---	---	(---)	---

MSR, LTE-Advanced FDD/TDD and 5G NR

2 Table		Reference		Power		Spectrum Peak Ref		Measure Trace	
		Sub-block Left		-60.52 dBm / 99.97 MHz		-73.53 dBm		Trace 1	
		Sub-block Right		-60.52 dBm / 99.97 MHz		-73.53 dBm			
Start Freq	Stop Freq	Integ BW	dB	Lower ΔLimit(dB)	dBm	Upper dB	ΔLimit(dB)	dBm	
50.00 kHz	5.050 MHz	102.0 kHz	-16.13	(-77.17)	-89.67	-15.70	(-76.91)	-89.23	
5.050 MHz	10.05 MHz	100.0 kHz	-14.00	(-75.03)	-87.53	-14.14	(-75.17)	-87.67	
10.50 MHz	40.00 MHz	1.000 MHz	53.13	(-5.40)	-20.40	-4.35	(-62.88)	-77.88	
40.00 MHz	100.0 MHz	1.000 MHz	-4.44	(-62.97)	-77.97	-4.43	(-62.96)	-77.96	
100.0 MHz	500.0 MHz	1.000 MHz	---	(---)	---	---	(---)	---	
100.0 MHz	500.0 MHz	1.000 MHz	---	(---)	---	---	(---)	---	

Table Window in Carrier Info View

Only available in MSR, LTE-Advanced FDD/TDD and 5G NR Modes. Carrier center frequency can be displayed in either offset or absolute frequency depending on Carrier Freq.

LTE-Advanced FDD/TDD has a different carrier info table from that in MSR in this view, which displays with measured component carrier powers and its power spectral density in the order of component carrier index in one of the view windows.

Name	Unit, if any	Corresponding Results
Total Carrier Power		The total power of all the carriers with carrier measure state set to yes. The power is calculated by integrating across the bandwidth declared by the Carrier Integ Bw parameter for each carrier and then totaling the sums. The total integration bandwidth is shown as part of the result. This will be the total of the Carrier Integ Bw of the carriers used in calculating the total carrier power. If the RRC Filter is on, then the integration bandwidth used is $(1 + \alpha)/T$ where $T = 1/(\text{Carrier Integ Bw})$ multiplied by the number of carriers with carrier measure state set to yes
RF-BW		Displays the total bandwidth from the lowest carrier to uppermost carrier
Carrier Power	dBm	The power in all the currently defined carriers with measure state is on. The power is calculated by integrating across the bandwidth declared by the Carrier Integ Bw parameter. The integration bandwidth is shown as part of the result. This is the value of the Carrier Integ Bw for the carrier unless the RRC Filter is on, then the integration bandwidth used is the displayed value, which is $(1 + \alpha)/T$ where $T = 1/(\text{Carrier Integ Bw})$
Integration Bandwidth	Hz	Shows carrier transmission bandwidth
Filter		Displays whether RRC filter is used or not
Offset Frequency	Hz	Shows the offset frequency from the carrier reference frequency in multi-carrier measurements. The carrier frequency display type determines whether the relative frequency or absolute frequency will be displayed
Sub-block		Displays which sub-block the carrier belongs to in the intra-band non-contiguous aggregation mode. The column will be displayed when Carrier Allocation is Non-contiguous
Measure		Indicates whether the carrier power is present or not

3 VMA Mode
3.9 SEM Measurement

MSR

2 Carrier Info						
Total Car Pwr	-66.71 dBm / 22.575 MHz					
Total PSD	---					
RF-BW	5.000 MHz					
			Reference		Ref Carrier Power	
			Carrier #1: Left		-73.70 dBm / 4.515 MHz	
			Carrier #--: Right		--- dBm / ---	
	Carrier Power	Integ BW	Filter	Offset Freq	Measure	Parameter Set
1	-73.70 dBm	4.515 MHz	OFF	0.0000 Hz	On	
2	-73.70 dBm	4.515 MHz	OFF	0.0000 Hz	On	
3	-73.70 dBm	4.515 MHz	OFF	0.0000 Hz	On	
4	-73.70 dBm	4.515 MHz	OFF	0.0000 Hz	On	
5	-73.70 dBm	4.515 MHz	OFF	0.0000 Hz	On	

LTE-Advanced FDD/TDD and 5G NR

2 Carrier Info						
Total Car Pwr	-49.83 dBm / 1.199280 GHz					
Total PSD	---					
RF-BW	99.970 MHz					
			Reference		Ref Power	
			Sub-block Left		-60.62 dBm / 99.97 MHz	
			Sub-block Right		-60.62 dBm / 99.97 MHz	
	Carrier Power	Integ BW	Filter	Offset Freq	Sub-block	Measure
CC0	-60.62 dBm	100.000 MHz	OFF	0.0 Hz	1	On
CC1	-60.62 dBm	100.000 MHz	OFF	0.0 Hz	1	On
CC2	-60.62 dBm	100.000 MHz	OFF	0.0 Hz	1	On
CC3	-60.62 dBm	100.000 MHz	OFF	0.0 Hz	1	On
CC4	-60.62 dBm	100.000 MHz	OFF	0.0 Hz	1	On
CC5	-60.62 dBm	100.000 MHz	OFF	0.0 Hz	1	On

3.9.12.3 Gate

Allows you to see your Gating signal at the same time as the measured data. See the description under "[Gate View On/Off](#)" on page 2484 in **Trigger, Gate Settings**.

Views in which the **Gate** window appears:

View	Size	Position
Gate View	One third, full width	Top

3.9.13 Amplitude

Activates the **Amplitude** menu and selects **Reference Level** or **Reference Value** as the active function, depending on the measurement.

Some features in this menu apply to multiple measurements. Some other features apply only to specific measurements and their controls are blanked or grayed-out in measurements that do not support the feature.

3.9.13.1 Y Scale

Contains controls that pertain to the Y axis parameters of the measurement. These parameters control how data on the vertical (Y) axis is displayed and control instrument settings that affect the vertical axis.

Ref Value

Sets the value for the absolute power reference. The reference line is at the top, center, or bottom of the graticule, depending on the value of "Ref Position" on page 1419.

Remote Command	<code>:DISPlay:SEMask:WINDow[1]:TRACe:Y[:SCALE]:RLEVel <real></code> <code>:DISPlay:SEMask:WINDow[1]:TRACe:Y[:SCALE]:RLEVel?</code>
Example	<code>:DISP:SEM:WIND:TRAC:Y:RLEV 100</code> <code>:DISP:SEM:WIND:TRAC:Y:RLEV?</code>
Couplings	When "Auto Scaling" on page 1420 is ON (default), this value is automatically determined by the measurement result. If you set a value manually, Auto Scaling changes to OFF Attenuation is not coupled to Ref Value
Preset	0.00 dBm
State Saved	Saved in instrument state
Min/Max	-250.00 dBm / 250.00 dBm
Annotation	Ref <value> top left of graph
Backwards Compatibility SCPI	<code>:DISPlay:SEMask:VIEW[1]:WINDow[1]:TRACe:Y[:SCALE]:RLEVel</code>

Scale/Div

For measurements that support a logarithmic Y-Axis, **Scale/Div** sets the height of one division of the graticule in the current Y-Axis unit.

Scale/Div also determines the displayed amplitude range in the log plot graph. Since there are usually 10 vertical graticule division on the display, the total amplitude range of the graph is typically 10x this amount. For example, if **Scale/Div** is 10 dB, then the total range of the graph is 100 dB.

Remote Command	<code>:DISPlay:SEMask:WINDow[1]:TRACe:Y[:SCALE]:PDIVision <rel_ampl></code> <code>:DISPlay:SEMask:WINDow[1]:TRACe:Y[:SCALE]:PDIVision?</code>
Example	<code>:DISP:SEM:WIND:TRAC:Y:PDIV 15dB</code> <code>:DISP:SEM:WIND:TRAC:Y:PDIV?</code>

Couplings	When "Auto Scaling" on page 1420 is ON, this value is automatically determined by the measurement result. If you set a value manually, "Auto Scaling" on page 1420 automatically changes to OFF
Preset	10.00 dB / Div
State Saved	Saved in instrument state
Min	0.10 dB
Max	20 dB
Annotation	<value> dB/ left upper of graph
Backwards Compatibility SCPI	:DISPlay:SEMask:VIEW[1]:WINDow[1]:TRACe:Y[:SCALE]:PDIVision

Scale Range

Sets the Y-Axis scale range.

Remote Command	Replace <meas> with the identifier for the current measurement :DISPlay:<meas>:WINDow[1]:TRACe:Y[:SCALE]:RANGe <rel_ampl> :DISPlay:<meas>:WINDow[1]:TRACe:Y[:SCALE]:RANGe?
Example	:DISP:CHP:WIND:TRAC:Y:RANG 100 :DISP:CHP:WIND:TRAC:Y:RANG?
Couplings	Coupled to Scale/Div as follows Scale Range = Scale/Div * 10 (number of divisions) When you change this value, Auto Scaling automatically changes to OFF
Preset	100 dB
State Saved	Saved in instrument state
Min	1
Max	200

Ref Position

Positions the reference level at the top, center, or bottom of the Y Scale display. Changing the reference position does not change "Ref Value" on page 1418.

Remote Command	:DISPlay:SEMask:WINDow[1]:TRACe:Y[:SCALE]:RPOsition TOP CENTer BOTTom :DISPlay:SEMask:WINDow[1]:TRACe:Y[:SCALE]:RPOsition?
Example	:DISP:SEM:WIND:TRAC:Y:RPOS CENT :DISP:SEM:WIND:TRAC:Y:RPOS?
Preset	TOP

State Saved	Saved in instrument state
Range	TOP CENTer BOTTom
Annotation	The greater than (>) and less than (<) symbols are displayed on both sides of the graph to indicate the Reference Position
Backwards Compatibility SCPI	:DISPlay:SEMask:VIEW[1]:WINDow[1]:TRACe:Y[:SCALE]:RPOSition

Auto Scaling

Toggles **Auto Scaling** On or Off.

Remote Command	:DISPlay:SEMask:WINDow[1]:TRACe:Y[:SCALE]:COUPle 0 1 OFF ON :DISPlay:SEMask:WINDow[1]:TRACe:Y[:SCALE]:COUPle?
Example	:DISP:SEM:WIND:TRAC:Y:COUP OFF :DISP:SEM:WIND:TRAC:Y:COUP?
Couplings	When Auto Scaling is ON , and the Restart front-panel key is pressed, this function automatically sets the scale per division to 10 dB and determines the reference values based on the measurement results When you set the value of either Scale/Div , Ref Value , or Scale Range manually, Auto Scaling automatically changes to OFF
Preset	1
State Saved	Saved in instrument state
Range	OFF ON
Backwards Compatibility SCPI	:DISPlay:SEMask:VIEW[1]:WINDow[1]:TRACe:Y[:SCALE]:COUPle

3.9.13.2 Attenuation

Controls the attenuator functions and interactions between the attenuation system components.

There are two attenuator configurations in the X-Series. One is a Dual-Attenuator configuration consisting of a mechanical attenuator and an optional electronic attenuator. The other configuration uses a single attenuator with combined mechanical and electronic sections that controls all the attenuation functions. Different models in the X-Series come with different configurations.

- See ["Dual-Attenuator Configurations"](#) on page 1421
- See ["Single-Attenuator Configuration"](#) on page 1422

Most attenuation settings are the same for all measurements – they do not change as you change measurements. Settings like these are called “Meas Global” and are unaffected by **Meas Preset**.

Only available when the hardware set includes an input attenuator, which is typically only the case for Keysight’s benchtop instruments. For example, this tab does *not* appear in VXT models M9420A/10A/11A/15A/16A, M9410E/11E/15E/16E, nor in UXM. In UXM, all **Attenuation** and **Range** settings are disabled, as the expected input power level is handled by the Call Processing App that drives the DUT power control.

Dependencies In measurements that support the I/Q inputs, unavailable when I/Q is the selected input. Replaced by the **Range** tab in that case

Dual-Attenuator Configurations

Configuration 1: Mechanical attenuator + optional electronic attenuator

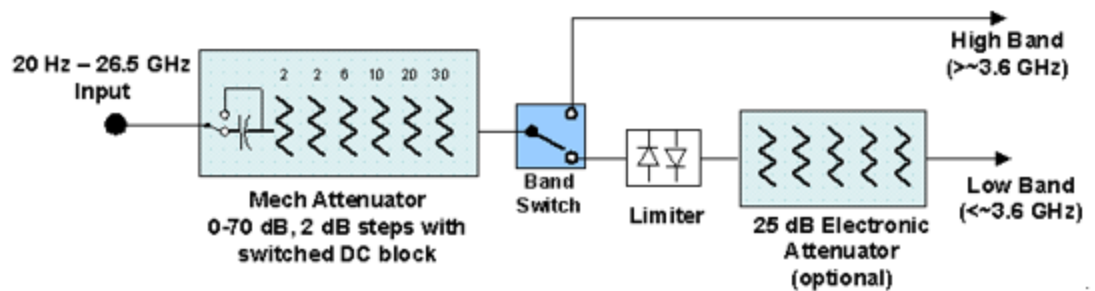

Configuration 2: Mechanical attenuator, no optional electronic attenuator

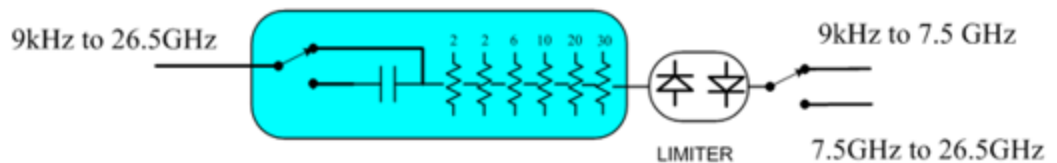

Note that Configuration 2 is not strictly speaking a dual-section attenuator, since there is no electronic section available. However, it behaves exactly like Configuration 1 without the Electronic Attenuator Option EA3, therefore for the sake of this document it is grouped into the “Dual-Attenuator” configuration.

Single-Attenuator Configuration

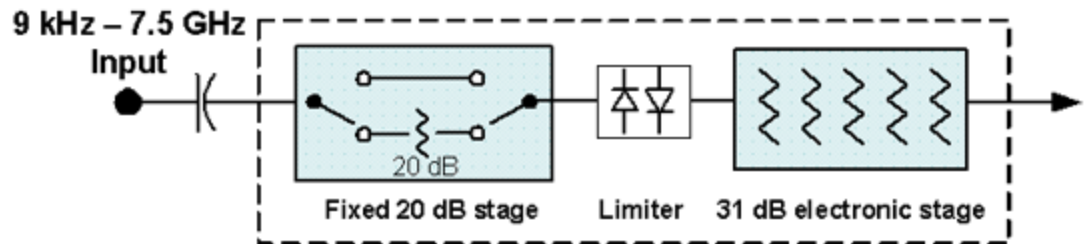

You can tell which attenuator configuration you have by pressing the Attenuation tab, which (in most Modes) opens the Attenuation menu. If the first control in the Attenuation menu says **Mech Atten** you have the Dual-Attenuator configuration. If the first control says **Atten** you have the Single-Attenuator configuration.

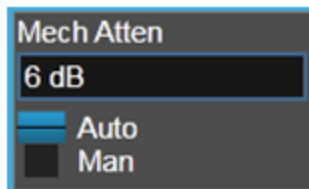

Dual Attenuator

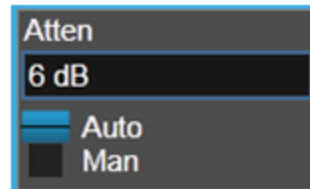

Single Attenuator

(Note that depending on the measurement, there may be no Auto/Man functionality on the Mech Atten control.)

In the Single-Attenuator configuration, you control the attenuation with a single control, as the fixed stage has only two states. In the Dual-Attenuator configuration, both stages have significant range, so you are given separate control of the mechanical and electronic attenuator stages.

When you have the Dual-Attenuator configuration, you may still have only a Single-Attenuator, because unless Option EA3 (the Electronic Attenuator option) is available, and you purchase it, you will have only the mechanical attenuator.

Full Range Atten

This control and **Attenuator Summary** only appear in N9041B, when the RF input is selected, the RF Input Port is set to RF Input 2, and the Full Range Attenuator is installed. The Full Range Attenuator adds a second input attenuator in front of RF Input 2, which enhances the protection and optimizes the performance of the extra internal mixers used by RF Input 2.

Remote Command `[:SENSe]:POWer[:RF]:FRATten <rel_amp1>`
 `[:SENSe]:POWer[:RF]:FRATten?`

Example `:POW:FRAT 14`

:POW:FRAT?	
Notes	When you enter an amplitude value that falls between valid values, the value will be incremented to the next smallest valid value
Dependencies	Only appears if input RF is selected, RF Input Port 2 is selected, and the Full Range Attenuator exists
Couplings	This value is never changed by any coupling, but other couplings use this value. See Reference Level and " Mech Atten " on page 1766 command descriptions
Preset	20 dB
State Saved	Saved in instrument state
Min	0 dB
Max	Only valid values are 0, 6, 14, 20 dB
Annotation	<p>When the Input is RF, and the Input Port is RF Input 2, and the Full Range Attenuator is installed: On the Meas Bar, the field "Atten" displays as follows:</p> <ul style="list-style-type: none"> - If the sweep is entirely < 50 GHz, the value shown after "Atten:" is equal to Mech Atten + Elec Atten + Full Range Atten - If the sweep is entirely > 50 GHz, the value shown after "Atten:" is equal to Full Range Atten - If the sweep straddles 50 GHz, the value shown after "Atten:" is preceded by the symbol ">=" and is equal to Full Range Atten <p>In the Amplitude, "Y Scale" on page 1760 menu, and the Atten Meas Bar dropdown menu panel, a summary is displayed as follows: "Total Atten below 50 GHz" followed by the value of Full Range Atten + Mech Atten + Elec Atten "Total Atten above 50 GHz" followed by the value of Full Range Atten For example, if Mech Atten = 6 dB, Elec Atten = 4 dB, and Full Range Atten = 20 dB, the summary below is shown:</p> <ul style="list-style-type: none"> - Attenuator summary: - Total Atten below 50 GHz: 30 dB - Total Atten above 50 GHz: 20 dB

Mech Atten

Labeled **Mech Atten** in Dual-Attenuator models, and **Atten** in Single-Attenuator models. In the Dual-Attenuator configuration, this control only affects the mechanical attenuator.

Lets you modify the attenuation applied to the RF input signal path. This value is normally auto-coupled to **Ref Level**, "**Internal Preamplifier**" on page 1788 Gain, any External Gain that is entered, and **Max Mixer Level** (if available), as described in the table below.

See "**Attenuator Configurations and Auto/Man**" on page 1425

Remote Command	<code>[:SENSe]:POWer[:RF]:ATTenuation <rel_ampl></code> <code>[:SENSe]:POWer[:RF]:ATTenuation?</code>
Example	<code>:POW:ATT 20</code> Dual-Attenuator configuration: sets the mechanical attenuator to 20 dB Single-Attenuator mode: sets the main attenuation to 20 dB (see below for definition of “main” attenuation) In either case, if the attenuator was in Auto, it is set to Manual
Dependencies	Some measurements do not support Auto setting of Mech Atten . In these measurements, the Auto/Man selection is not available, and the Auto/Man toggle function is not available In Dual-Attenuator configurations, when the electronic attenuator is enabled, the mechanical attenuator has no auto setting, and the Auto/Man toggle function is not available. The state of Auto/Man is remembered and restored when the electronic attenuator is once again disabled. This is described in more detail in "Elec Atten" on page 1769 See "Attenuator Configurations and Auto/Man" on page 1425 for more information on the Auto/Man functionality
Couplings	If the RF Input Port is the RF Input: <ul style="list-style-type: none"> - If the USB Preamp is connected to USB, use 0 dB for Mech Atten - Otherwise compute the auto-selected value of Mech Atten based on Reference Level, Int Preamp, External Gain, Ref Level Offset, Max Mixer Level, μW Path Control and IF Gain settings. Limit this value to be no less than 6 dB (total attenuation below 6 dB can never be chosen by Auto) - In N9041B, if the RF Input Port is RF Input 2, use the formula above and subtract the value of "Full Range Atten" on page 1765 from the result to determine the Mech Atten. Limit the value so that it is never lower than 0 dB and so that total attenuation, including Full Range Atten, is never less than 6 dB (total attenuation, including Full Range Atten below 6 dB, can never be chosen by Auto) <p>In External Mixing and BBIQ, where the attenuator is not in the signal path, the attenuator setting changes as described above when Mech Atten is in Auto, but no changes are made to the actual attenuator hardware setting until the input is changed back to the RF Input</p> <p>For CXA-m with Option FSA (Fine-Step Attenuator or 2 dB steps), the FSA-like behavior is only available when the frequency setting is <= 7.5 GHz. So, when the frequency is changed from below 7.5 GHz to above 7.5 GHz, the attenuation setting changes to a multiple of 10 dB that is no smaller than the previous setting. For example, 4 dB attenuation changes to 10 dB</p>
Preset	Auto The Auto value is 10 dB
State Saved	Saved in instrument state
Min	0 dB The attenuation set by this control cannot be decreased below 6 dB with the knob or step keys. Values below 6 dB must be directly entered from the keypad or via SCPI. This protects against setting a dangerously small attenuation value, which can put the instrument at risk of damage to input circuitry. If the current mechanical attenuation is below 6 dB, it can be increased with the knob and step keys, but not decreased

3 VMA Mode
3.9 SEM Measurement

Max	CXA Option 503 or 507	50 dB
	EXA	60 dB
	All other models	70 dB
<p>Note that in the Single-Attenuator configuration, the total of ATT and EATT cannot exceed 50 dB. So, if the EATT is set to 24 dB first, the main attenuation cannot be greater than 26 dB and will be reduced accordingly; if the main attenuator is set to 40 dB first, EATT cannot be greater than 10 dB</p>		
Annotation	<p>The current value for Total Atten is displayed in the Measurement Bar at the top of the display. A value appears for Electronic Attenuation only if the Electronic Attenuator is enabled. The annotation appears as:</p> <p><i>Atten: <total> dB (e<elec>)</i></p> <p>The e letter is in amber in Single-Attenuator configurations</p> <p>For example:</p> <p>Dual-Attenuator configuration:</p> <p><i>Atten: 24 dB (e14)</i></p> <p>Indicating the total attenuation is at 24 dB and the electronic attenuation is at 14 dB</p> <p>Single-Attenuator configuration:</p> <p><i>A: 24 dB (e14)</i></p> <p>Indicating the total attenuation is at 24 dB and the “soft” attenuation is at 14 dB (see below for definition of “soft” attenuation)</p> <p>When in Manual, a # sign appears in front of Atten in the annotation</p>	
<p>Auto Function</p>		
Remote Command	<pre>[:SENSe]:POWer[:RF]:ATTenuation:AUTO OFF ON 0 1 [:SENSe]:POWer[:RF]:ATTenuation:AUTO?</pre>	
Example	<p>Turn Auto Mech AttenON:</p> <pre>:POW:ATT:AUTO ON</pre>	
Dependencies	<p>:POW:ATT:AUTO is only available in measurements that support Auto, such as Swept SA</p>	
Preset	<p>ON</p>	

Attenuator Configurations and Auto/Man

As described under ["Attenuation" on page 1763](#), there are two distinct attenuator configurations available in the X-Series, the Single Attenuator and Dual-Attenuator configurations.

In Dual-Attenuator configurations, we have mechanical attenuation and electronic attenuation, and current total attenuation is the sum of electronic + mechanical attenuation.

In Single-Attenuator configurations, we refer to the attenuation set using ["Mech Atten" on page 1423](#) (or **:POW:ATT**) as the “main” attenuation; and the attenuation that is set by **:POW:EATT** as the “soft” attenuation (**:POW:EATT** is honored even in

the Single-Attenuator configuration, for compatibility purposes). Then current total attenuation is the sum of main + soft attenuation.

See "[Elec Atten](#)" on page 1769 for more about “soft” attenuation.

NOTE

In some measurements, the **Mech Atten** control has an **Auto/Man** function. In these measurements, an **Auto/Man** switch is shown on the **Mech Atten** control:



Note that in configurations that include an Electronic Attenuator, this switch is only shown when the Electronic Attenuator is disabled.

In other measurements, **Mech Atten** has no **Auto/Man** function. In these measurements, no switch is shown on the **Mech Atten** control:



Mech Atten also appears with no switch, as above, in configurations that include an Electronic Attenuator but when the Electronic Attenuator is enabled.

Elec Atten

Controls the Electronic Attenuator in Dual-Attenuator configurations. Does not appear in Single-Attenuator configurations, because the control of both the mechanical and electronic stages of the Single-Attenuator is integrated into the single **Atten** control.

This control includes an **Enable/Disable** toggle switch; it is only possible to enter a value for the Electronic Attenuator when this switch is in the **Enable** position.

For more details of the Electronic Attenuator, see "[More Information](#)" on page 1428

Remote Command	<code>[:SENSe]:POWer[:RF]:EATTenuation <rel_amp1></code> <code>[:SENSe]:POWer[:RF]:EATTenuation?</code>
Example	<code>:POW:EATT 10</code> <code>:POW:EATT?</code>
Notes	Electronic Attenuation's specification is defined only when Mech Atten is 6 dB

3 VMA Mode
 3.9 SEM Measurement

Dependencies	<p>Only appears in Dual-Attenuator models with an Electronic Attenuator installed and licensed. Does not appear in models with the Single-Attenuator configuration, because in the Single-Attenuator configuration there is no “electronic attenuator”; there is only a single integrated attenuator (which has both a mechanical and electronic stage). However, in the Single-Attenuator configuration, EATT SCPI commands are accepted for compatibility with other X-series instruments, and set a “soft” attenuation. The “soft” attenuation is treated as an addition to the “main” attenuation value set by the Attenuation control or :POW:ATT, and affects the total attenuation displayed on the Attenuation control and the Meas Bar</p> <p>The electronic attenuator, and the “soft” attenuation function provided in Single-Attenuator configurations, are unavailable above the low band (0-3.6 GHz, 0-3.4 GHz, 0-3 GHz, depending on the model). If the low band range is from 0-3.6 GHz, and Stop Frequency of the instrument is > 3.6 GHz, then the Enabled/Disabled section of the Elec Atten control will be OFF and grayed-out</p> <p>If "Internal Preamp" on page 1788 is ON (that is, set to Low Band or Full), the electronic attenuator (and the “soft” attenuation function provided in Single-Attenuator configurations) is unavailable. In this case the Enabled/Disabled section of the Elec Atten control will be OFF and grayed-out</p> <p>If either of the above is true, and the SCPI command is sent, an error indicating that the electronic attenuator is unavailable is returned</p> <p>If both the above are true, pressing the control generates error message -221, in other words, the frequency range lockout takes precedence</p> <p>If the electronic/soft Attenuator is enabled, then the Stop Freq of the instrument is limited to 3.6 GHz and Internal Preamp is unavailable</p> <p>If "LNA" on page 1790 is ON, the electronic attenuator (and the “soft” attenuation function provided in Single-Attenuator configurations) is unavailable. In this case the Enabled/Disabled section of the Elec Atten control will be OFF and grayed-out. This coupling works in the following modes/measurements:</p> <ul style="list-style-type: none"> - Channel Power, Occupied BW, ACP, SEM, Spurious Emissions, Power Stat CCDF measurements in all Modes - Transmit On Off Power measurement in 5GNR Mode - Power vs. Time and Transmit Power measurement in GSM/EDGE Mode - Burst Power measurement in Spectrum Analyzer Mode <p>The SCPI-only “soft” electronic attenuation for the single-attenuator configuration is not available in all measurements; in particular, it is not available in the Swept SA measurement</p>
Couplings	Enabling and disabling the Electronic Attenuator affects the setting of the Mechanical Attenuator (in Dual-Attenuator configurations). This is described in more detail below and in " Mechanical Attenuator Transition Rules " on page 1428
Preset	0 dB
State Saved	Saved in instrument state
Min	0 dB
Max	<p>Dual-Attenuator configuration: 24 dB</p> <p>Single-Attenuator configuration: the total of ATT and EATT cannot exceed 50 dB. So, if the EATT is set to 24 dB first, the main attenuation cannot be greater than 26 dB and will be reduced accordingly; if the main attenuator is set to 40 dB first, EATT cannot be greater than 10 dB</p>
Annotation	See Annotation under the Mech Atten control description

Auto Function

Remote Command	<code>[:SENSe]:POWer[:RF]:EATTenuation:STATe OFF ON 0 1</code> <code>[:SENSe]:POWer[:RF]:EATTenuation:STATe?</code>
Example	<code>:POW:EATT:STAT ON</code> <code>:POW:EATT:STAT?</code>
Preset	<code>OFF</code> (Disabled) for Swept SA measurement <code>ON</code> (Enabled) for all other measurements that support the electronic attenuator

NOTE

The maximum **Center Frequency** for Low Band can change based on the selected IFBW for measurements that support IFBW (for example, Waveform measurement across all Modes that support it). In certain models (such as N9042B & N9032B), IFBW values ≤ 40 MHz have a maximum Low Band frequency of 3.6 GHz, while $40 \text{ MHz} < \text{IFBW} \leq 1 \text{ GHz}$ have a maximum of 3.3 GHz, and $1 \text{ GHz} < \text{IFBW} \leq 1.5 \text{ GHz}$ have a maximum of 3.5 GHz. This frequency is reflected in the disabled message displayed for Electrical Attenuator. For N9032B and N9042B IFBW values $> 1.5 \text{ GHz}$ do not support a **Center Frequency** that can reach the Low Band maximum frequency. In these cases, the Electrical Attenuator will remain disabled no matter the Center Frequency.

More Information

The electronic attenuator offers finer steps than the mechanical attenuator, has no acoustical noise, is faster, and is less subject to wear. These advantages primarily aid in remote operation and are negligible for front panel use. See ["Using the Electronic Attenuator: Pros and Cons" on page 1429](#) for a detailed discussion of the pros and cons of using the electronic attenuator.

For the Single-Attenuator configuration, for SCPI backwards compatibility, the "soft" attenuation feature replaces the Dual-Attenuator configuration's electronic attenuator. All the same couplings and limitations apply. See ["Attenuator Configurations and Auto/Man" on page 1768](#)

Mechanical Attenuator Transition Rules

When the Electronic Attenuator is enabled, the Mechanical Attenuator transitions to a state that has no Auto function. Below are the rules for transitioning the Mechanical Attenuator. Note that the information below *only* applies to the Dual-Attenuator configurations, and *only* when the Electronic Attenuator is installed:

When the Electronic Attenuation is enabled from a disabled state:

- The Mechanical Attenuator is initialized to 10 dB (this is its optimal performance setting). You can then set it as desired with SCPI, numeric keypad, step keys, or

knob, and it behaves as it normally would in manual mode

- The Auto/Man state of (Mech) Atten is saved
- The Auto/Man toggle on the (Mech) Atten control disappears, and the auto rules are disabled
- The Electronic Attenuator is set to 10 dB less than the previous value of the Mechanical Attenuator, within the limitation that it must stay within the range of 0 to 24 dB of attenuation

Examples in the Dual-Attenuator configuration:

- Mech Atten at 20 dB. Elec Atten enabled, Mech Atten set to 10 dB, and Elec Atten set to 10 dB. New total attenuation equals the value before Elec Atten enabled
- Mech Atten at 0 dB. Elec Atten enabled, Mech Atten set to 10 dB, and Elec Atten set to 0 dB. New total attenuation does not equal the value before Elec Atten enabled
- Mech Atten at 40 dB. Elec Atten enabled, Mech Atten set to 10 dB, and Elec Atten set to 24 dB. New total attenuation does not equal the value before Elec Atten enabled

When the Electronic Attenuation is disabled from an enabled state:

- The Elec Atten control is grayed out
- The Auto/Man state of (Mech) Atten is restored
- If now in Auto, (Mech) Atten recouples
- If now in Man, (Mech) Atten is set to the value of total attenuation that existed before the Elec Atten was disabled. The resulting value is rounded up to the smallest value possible given the (Mech) Atten Step setting - (That is, 57 dB changes to 58 dB when (Mech) Atten Step is 2 dB)

Using the Electronic Attenuator: Pros and Cons

The electronic attenuator offers finer steps than the mechanical attenuator, has no acoustical noise, is faster, and is less subject to wear.

The “finer steps” advantage of the electronic attenuator is beneficial in optimizing the alignment of the instrument dynamic range to the signal power in the front panel as well as remote use. Thus, you can achieve improved relative signal measurement accuracy. Compared to a mechanical attenuator with 2 dB steps, the 1 dB resolution of the electronic attenuator only gives better resolution when the odd-decibel steps are used. Those odd-decibel steps are less accurately calibrated than the even-

decibel steps, so one tradeoff for this superior relative accuracy is reduced absolute amplitude accuracy.

Another disadvantage of the electronic attenuator is that the spectrum analyzer loses its “Auto” setting, making operation less convenient.

Also, the relationship between the dynamic range specifications (TOI, SHI, compression, and noise) and instrument performance are less well-known with the electrical attenuator. With the mechanical attenuator, TOI, SHI, and compression threshold levels increase dB-for-dB with increasing attenuation, and the noise floor does as well. With the electronic attenuator, there is an excess attenuation of about 1 to 3 dB between 0 and 3.6 GHz, making the effective TOI, SHI, and so forth, less well known. Excess attenuation is the actual attenuation relative to stated attenuation. Excess attenuation is accounted for in the instrument calibration.

Adjust Atten for Min Clipping

Sets the combination of mechanical and electronic attenuation and gain based on the current measured signal level so that clipping will be at a minimum.

This is an immediate action function, that is, it executes once, when the control is pressed.

The algorithms that are used for the adjustment are documented under "[Pre-Adjust for Min Clipping](#)" on page 1773.

Remote Command	<code>[:SENSe]:POWer[:RF]:RANGe:OPTimize IMMEDIATE</code>
Example	<code>:POW:RANG:OPT IMM</code>
Notes	Executing Adjust Atten for Min Clipping initiates the measurement
Dependencies	Does not appear in the Swept SA, RTSA, Monitor Spectrum and Complex Spectrum measurements Appears in the Waveform measurement in BASIC and 5G NR Modes

Adjust Atten

Allows you to select;

- Electric attenuator only
- Combination of Electric attenuator and Mechanical attenuator

when `[:SENSe]:POWer[:RF]:RANGe:OPTimize IMMEDIATE` is executed.

Remote Command	<code>[:SENSe]:POWer[:RF]:RANGe:OPTimize:TYPE EONLY COMBined</code> <code>[:SENSe]:POWer[:RF]:RANGe:OPTimize:TYPE?</code>
Example	<code>:POW:RANG:OPT:TYPE EONL</code>

	<code>:POW:RANG:OPT:TYPE?</code>
Dependencies	Does not appear in the Swept SA, RTSA, Monitor Spectrum and Complex Spectrum measurements Appears in the Waveform measurement in BASIC and 5G NR Modes
Preset	<code>COMBined</code>
State Saved	Saved in instrument state

Pre-Adjust for Min Clipping

If this function is **ON**, it applies the adjustment described under "[Adjust Atten for Min Clipping](#)" on page 1772 each time a measurement restarts. Therefore, in Continuous measurement mode, it only executes before the first measurement.

In Dual-Attenuator models, you can set **Elec+Mech Atten**, in which case both attenuators participate in the autoranging, or **Elec Atten Only**, in which case the mechanical attenuator does not participate in the autoranging. This latter case results in less wear on the mechanical attenuator and is usually faster.

See "[Adjustment Algorithm](#)" on page 1432

Selection	SCPI	Note
Off	<code>OFF</code>	This is the default setting
On	<code>ON</code>	Available in Single-Attenuator instruments. For compatibility with models that do not have an input attenuator, the ON parameter is supported and mapped to <code>COMBined</code>
Elec Atten Only	<code>ELECTrical</code>	Selects only the electric attenuator to participate in auto ranging. This offers less wear on the mechanical attenuator and is usually faster
Elec+Mech Atten	<code>COMBined</code>	In Dual-Attenuator models, this selects both attenuators to participate in the autoranging

Remote Command	<code>[:SENSe]:POWer[:RF]:RANGe:OPTimize:ATTenuation OFF ON ELECTrical COMBined</code> <code>[:SENSe]:POWer[:RF]:RANGe:OPTimize:ATTenuation?</code>
Example	<code>:POW:RANG:OPT:ATT OFF</code> <code>:POW:RANG:OPT:ATT?</code>
Notes	The parameter option <code>ELECTrical</code> sets this function to ON in Single-Attenuator models The parameter option <code>COMBined</code> is mapped to <code>ELECTrical</code> in Single-Attenuator models. If you send <code>COMBined</code> , it sets the function to ON and returns <code>ELEC</code> to a query For SCPI compatibility with models that do not have an input attenuator, the ON parameter is honored and mapped to <code>COMBined</code>
Dependencies	Only appears in Dual-Attenuator models with an Electronic Attenuator installed In instruments with Dual-Attenuator model, when " Elec Atten " on page 1769 is OFF or grayed-out, " Pre-Adjust for Min Clipping " on page 1431 is grayed-out

	Does not appear in the Swept SA, RTSA, Monitor Spectrum and Complex Spectrum measurements Appears in the Waveform measurement in BASIC and 5G NR Modes	
Preset	OFF when Elec Atten is Disabled at preset, otherwise ELEC	
State Saved	Saved in instrument state	
Range	Dual-Attenuator models:	Off Elec Atten Only Mech + Elec Atten
	Single-Attenuator models:	Off On

Backwards Compatibility Command

Notes	ON aliases to "Elec Atten Only" (:POW:RANG:OPT:ATT ELEC) OFF aliases to "Off" (:POW:RANG:OPT:ATT OFF) :POW:RANG:AUTO? returns true if :POW:RANG:OPT:ATT is not OFF	
Backwards Compatibility SCPI	[:SENSe]:POWer[:RF]:RANGe:AUTO ON OFF 1 0 [:SENSe]:POWer[:RF]:RANGe:AUTO?	

Adjustment Algorithm

The algorithms for the adjustment are documented below:

Single-Attenuator Models

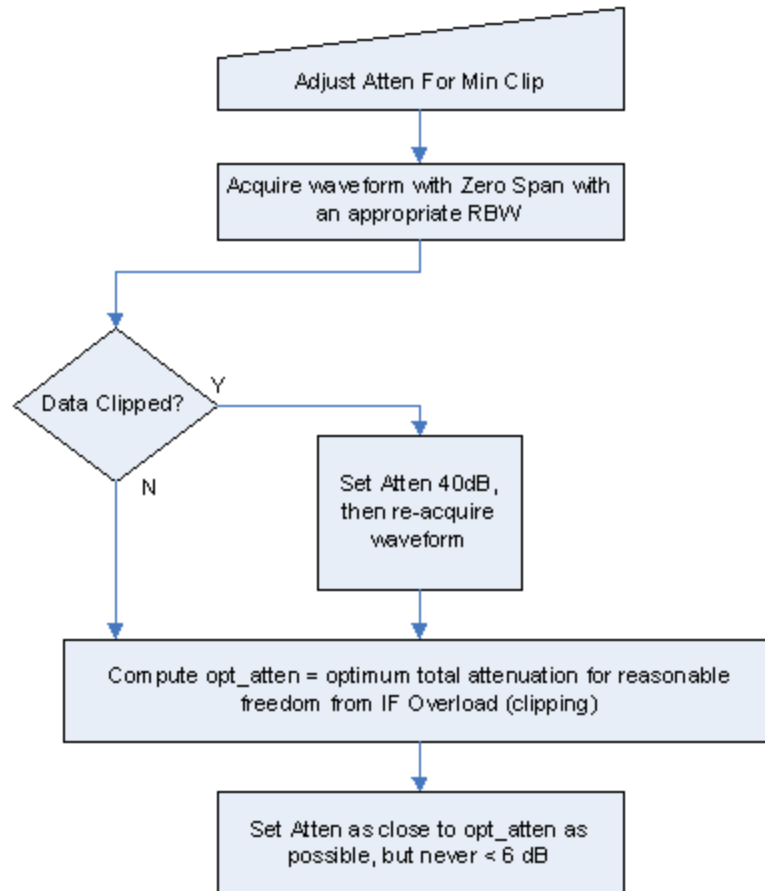

Dual-Attenuator models

"Adjust Atten for Min Clipping" on page 1772 or "Pre-Adjust for Min Clipping" on page 1431 selection is Mech + Elec Atten:

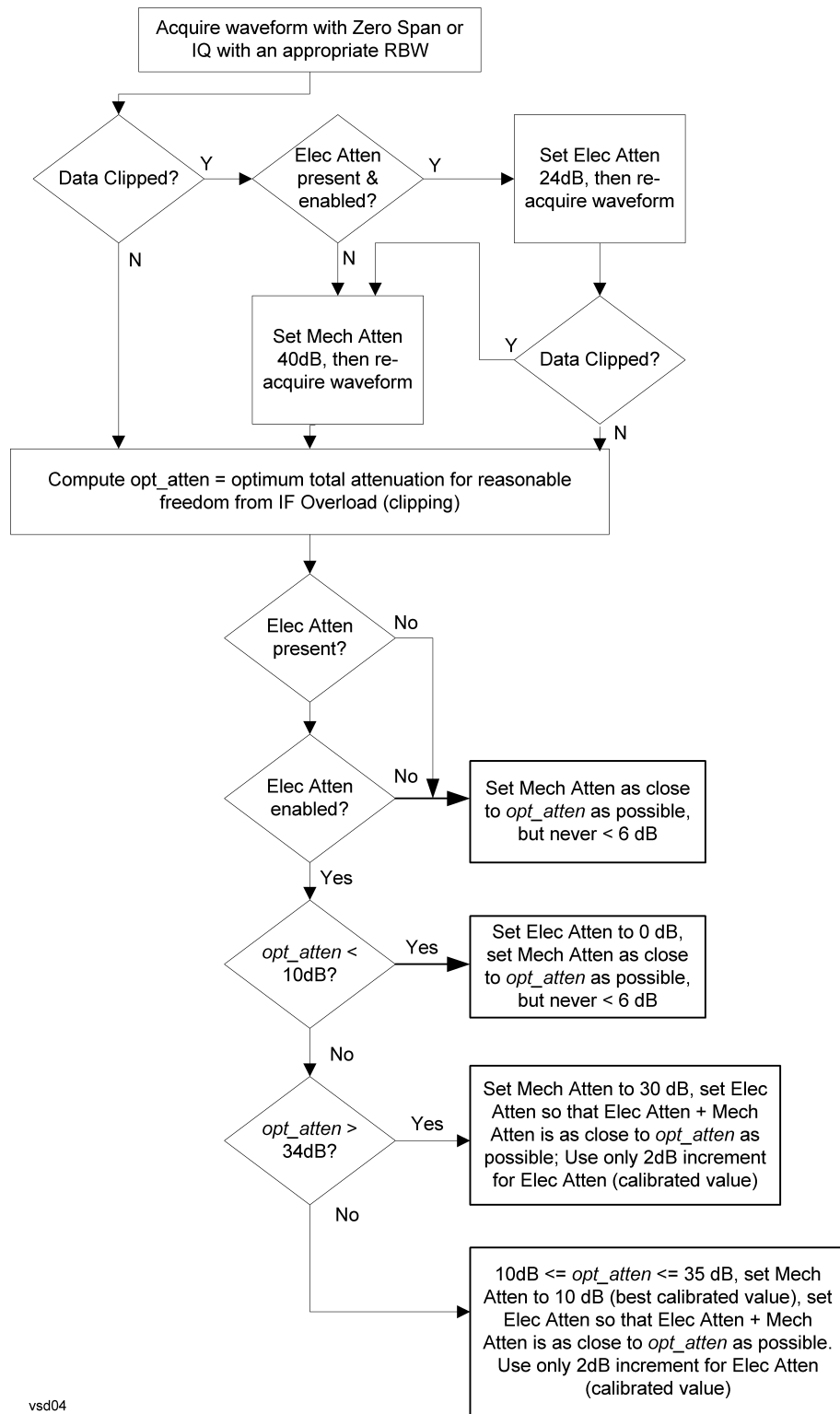

vsd04

"Pre-Adjust for Min Clipping" on page 1431 selection is Elec Only.

Note that the **Mech Atten** value is not adjusted, and the value previously set is used. Therefore, there is a case that IF Overload is still observed depending on the input signal level and the Mech Atten setting.

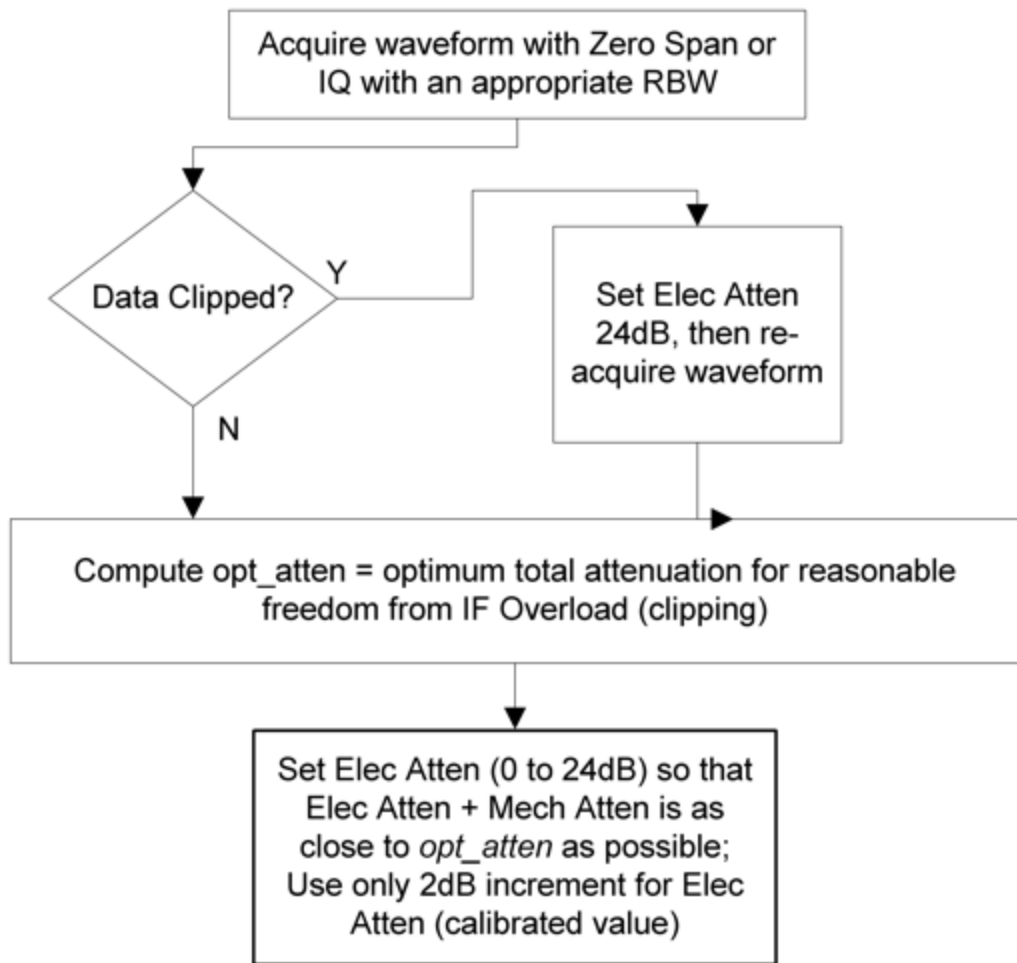

Mech Atten Step

Controls the step size used when making adjustments to the input attenuation.

Labeled **Mech Atten Step** in Dual-Attenuator models and **Atten Step** in Single-Attenuator models. In the Dual-Attenuator configuration, only affects the step size of the mechanical attenuator.

Remote Command `[:SENSe]:POWer[:RF]:ATTenuation:STEP[:INCRement] 10 dB | 2 dB`

	<code>[:SENSe]:POWer[:RF]:ATTenuation:STEP[:INCRement]?</code>
Example	<code>:POW:ATT:STEP 2</code> <code>:POW:ATT:STEP?</code>
Notes	Has a toggle control on the front panel, but takes a specific value (in dB) when used remotely. The only valid values are 2 and 10
Dependencies	Blanked in EXA, CXA and CXA-m if option FSA (2 dB steps) is not present. If blanked, attempts to set it via SCPI yield an error
Couplings	When the attenuation step size changes, the current mechanical attenuation value is adjusted (if necessary) to be quantized to the new step size. That is, if step is set to 10 dB, mech atten is increased if necessary so it is a multiple of 10 dB
Preset	EXA, CXA and CXA-m: 10 dB (2 dB with option FSA) All other models: 2 dB
State Saved	Saved in instrument state

3.9.13.3 Range (Non-attenuator models)

Only available for Keysight's modular signal analyzers and certain other Keysight products, such as VXT and M941xE.

State Saved	No
-------------	----

Range

Represents the amplitude of the largest sinusoidal signal that could be present within the IF without being clipped by the ADC. For signals with high peak-to-average ratios, the range may need to exceed the rms signal power by a significant amount to avoid clipping.

This is a measurement global setting.

Remote Command	<code>[:SENSe]:POWer[:RF]:RANGe <real></code> <code>[:SENSe]:POWer[:RF]:RANGe?</code>
Example	<code>:POW:RANG 10 dBm</code> <code>:POW:RANG?</code>
Notes	The MIN and MAX values are affected by the External Gain parameters, and by the Center Frequency . The hardware compensates for frequency response and alters the Range setting
Preset	0 dBm
State Saved	Yes
Min/Max	-/+100
Annotation	Meas Bar

Adjust Range for Min Clipping

Sets the combination of attenuation and gain based on the current measured signal level so that clipping will be at a minimum.

This is an "immediate action" function, that is, it executes once, when the key is pressed.

This key does not appear in measurements that do not support this functionality.

Remote Command	<code>[:SENSe]:POWer[:RF]:RANGe:OPTimize IMMEDIATE</code>
Notes	Executing Adjust Range for Min Clipping initiates the measurement
Dependencies	Does not appear in the Swept SA and Monitor Spectrum measurements

Pre-Adjust for Min Clipping

If this function is **ON**, it applies the adjustment described under Adjust Range For Min Clipping each time a measurement restarts. Therefore, in Continuous measurement mode, it only executes before the first measurement.

Remote Command	<code>[:SENSe]:POWer[:RF]:RANGe:OPTimize:ATTenuation OFF ON ELECTrical COMBined</code> <code>[:SENSe]:POWer[:RF]:RANGe:OPTimize:ATTenuation?</code>
Notes	Because there is no attenuator control available in these models, the control displays only ON and OFF choices. However, for SCPI compatibility with other platforms, all three parameters (ELECTrical , COMBined , and ON) are honored and all are mapped to ELECTrical , so if any of these three parameters is sent, a subsequent query will return ELEC
Dependencies	Does not appear in the Swept SA and Monitor Spectrum measurements
Preset	OFF for Swept SA measurement; ON for all other measurements that support Pre-Adjust for Min Clipping
State Saved	Saved in instrument state

Adjustment Algorithm

The algorithm for the adjustment is documented below:

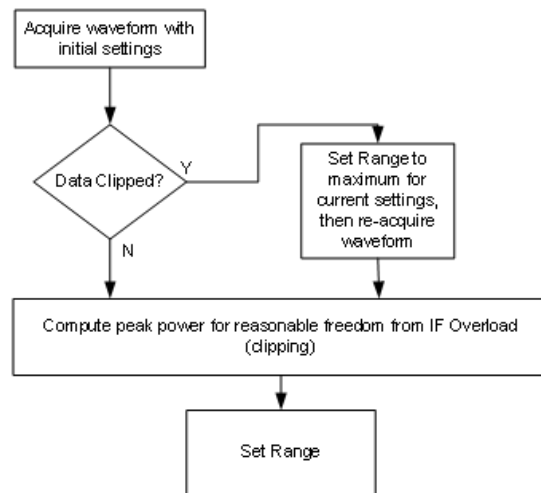

Peak-to-Average Ratio

Used with "[Range \(Non-attenuator models\)](#)" on page 1782 to optimize the level control in the instrument. The value is the ratio, in dB, of the peak power to the average power of the signal to be measured. A ratio of 0 should be used for sinusoidal signals; for 802.11g OFDM signals use 9 dB.

All Modes show the current value of Peak-to-Average ratio on the control. However, some Modes do not permit changing the value. In these situations, the control is grayed-out.

Remote Command	<code>[:SENSe]:POWer[:RF]:RANGe:PARatio <real></code> <code>[:SENSe]:POWer[:RF]:RANGe:PARatio?</code>	
Example	<code>:POW:RANG:PAR 12 dB</code>	
Notes	In some Modes, this parameter is read-only; meaning the value will appear on the control and query via SCPI, but is not changeable. In such applications the control is grayed-out. Attempts to change the value via SCPI are ignored, but no error message is generated	
Dependencies	Does not appear in Spectrum Analyzer Mode	
Preset	VXT Models M9410A/11A	0 dB
	All Others	10 dB
State Saved	Saved in instrument state	
Min	0 dB	
Max	VXT Models M9410A/11A	50 dB
	All Others	20 dB

Mixer Lvl Offset

This is an advanced setting to adjust target Range at the input mixer, which in turn affects the signal level in the instrument's IF. This setting can be used when additional optimization is needed after setting "[Peak-to-Average Ratio](#)" on page 1784. Positive values of offset optimize noise performance over distortion, negative values optimize distortion performance over noise.

Remote Command	<code>[:SENSe]:POWer[:RF]:RANGe:MIXer:OFFSet <real></code> <code>[:SENSe]:POWer[:RF]:RANGe:MIXer:OFFSet?</code>	
Example	<code>:POW:RANG:MIX:OFFS -5 dB</code>	
Preset	0 dB	
State Saved	Saved in instrument state	
Min	VXT Models M9410A/11A	-34 dB
	All Others	-35 dB
Max	30 dB	

3.9.13.4 Signal Path

Contains controls that pertain to the routing of the signal through the frontend of the instrument.

In general, only appears in instruments whose hardware supports this signal routing. For example, this tab does not appear in many of the modular instrument products, including VXT Model M9420A, or UXM.

This tab *does* appear in VXT Models M9410A/11A/15A/16A and M9410E/11E/15E/16E, because "[Software Preselection](#)" on page 1801 is under this tab, and VXT Models M9410A/11A/15A/16A and M9410E/11E/15E/16E implement a version of Software Preselection.

Presel Center

Adjusts the centering of the preselector filter to optimize the amplitude accuracy at the frequency of the selected marker. If the selected marker is not on when **Presel Center** is pressed, the instrument turns on the selected marker, performs a peak search, and then performs centering on the marker's center frequency. If the selected marker is already on and between the start and stop frequencies of the instrument, the instrument performs the preselector calibration on that marker's frequency. If the selected marker is already on, but outside the frequency range

between **Start Freq** and **Stop Freq**, the instrument first performs a peak search, and then performs centering on the marker's center frequency.

The value displayed on "[Preselector Adjust](#)" on page 1787 changes to reflect the new preselector tuning.

Certain considerations should be observed to ensure proper operation, as detailed in "[Proper Preselector Operation](#)" on page 1440.

Remote Command	<code>[:SENSe] :POWer [:RF] :PCENter</code>
Example	<code>:POW:PCEN</code>
Notes	The rules outlined above under the control description apply for the remote command as well as the key. The result of the command depends on marker position, etc. Any message generated by the control press is also generated in response to the remote command
Dependencies	Does not appear in CXA-m, nor in VXT Models M9410A/11A/15A/16A, M9410E/11E/15E/16E Grayed-out if the microwave preselector is off <ul style="list-style-type: none"> - If the selected marker's frequency is below Band 1, an advisory message is generated "Preselector not used in this frequency range" and no action is taken - Grayed-out if entirely in Band 0, that is, if Stop Freq is below about 3.6 GHz Grayed-out if entirely above 50 GHz, that is, if Start Freq is above 50 GHz - Blanked in models that do not include a preselector, such as Option 503. If the remote command is sent in these instruments, accepted without error, and the query always returns 0 - Grayed-out in the Spectrogram View
Couplings	The active marker position determines where the centering will be attempted If the instrument is in a measurement such as averaging when centering is initiated, the act of centering the preselector restarts averaging, but the first average trace will not be taken until the centering is completed The offset applied to do the centering appears in " Preselector Adjust " on page 1787
Status Bits/OPC dependencies	When centering the preselector, *OPC does not return true until the process is complete and a subsequent measurement has completed, nor are results returned in response to <code>:READ</code> or <code>:MEASure</code> queries The Measuring bit remains set (true) while this command is operating, and does not go false until the subsequent sweep/measurement has completed

Proper Preselector Operation

Certain considerations should be observed to ensure proper operation:

1. If the selected marker is **Off**, the instrument turns on a marker, performs a peak search, and adjusts the preselector using the selected marker's frequency. It uses the "highest peak" peak search method unqualified by threshold or excursion, so that there is no chance of a 'no peak found' error. It continues with that peak, even if it is the peak of just noise. Therefore, for this operation to work properly, there should be a signal on-screen in a preselected range for the peak

search to find

2. If the selected marker is already **On**, the instrument attempts the centering at that marker's frequency. There is no preselector for signals below about 3.6 GHz, so if the marker is on a signal below 3.6 GHz, no centering is attempted, and an advisory message is generated
3. In some models, the preselector can be bypassed. If it is bypassed, no centering is attempted in that range and a message is generated

Preselector Adjust

Lets you manually adjust the preselector filter frequency to optimize its response to the signal of interest. Only available when "[Presel Center](#)" on page 1786 is available.

For general purpose signal analysis, using **Presel Center** is recommended. Centering the filter minimizes the impact of long-term preselector drift. **Preselector Adjust** can be used instead to manually optimize the preselector. One application of manual optimization would be to peak the preselector response, which both optimizes the signal-to-noise ratio and minimizes amplitude variations due to small (short-term) preselector drifting.

When **Presel Center** is performed, the offset applied to do the centering becomes the new value of **Preselector Adjust**.

Remote Command	<code>[:SENSe]:POWer[:RF]:PADJust <freq></code> <code>[:SENSe]:POWer[:RF]:PADJust?</code>
Example	<code>:POW:PADJ 100KHz</code> <code>:POW:PADJ?</code>
Notes	The value on the control is displayed to 0.1 MHz resolution
Dependencies	<ul style="list-style-type: none"> - Does not appear in CXA-m - Does not appear in VXT Models M9410A/11A/15A/16A - Does not appear in M9410E/11E/15E/16E - Grayed-out if microwave preselector is off - Grayed-out if entirely in Band 0, that is, if Stop Freq is lower than about 3.6 GHz - Grayed-out if entirely above 50 GHz, that is, if Start Freq is higher than 50 GHz - Blank in models that do not include a preselector, such as Option 503. If the command is sent in these instruments, it is accepted without error, and the query always returns 0 - Grayed-out in the Spectrogram View
Preset	0 MHz

State Saved	The Preselector Adjust value set by " Presel Center " on page 1786, or by manually adjusting Preselector Adjust Not saved in instrument state, and does not survive a Preset or power cycle
Min/Max	-/+500 MHz
Backwards Compatibility SCPI	<code>[:SENSe]:POWer[:RF]:MW:PADJust</code> <code>[:SENSe]:POWer[:RF]:MMW:PADJust</code> Backwards Compatibility Command
Notes	The command has no effect, and the query always returns MWAVE
Backwards Compatibility SCPI	<code>[:SENSe]:POWer[:RF]:PADJust:PRESelector MWAVE MMWave EXTERNAL</code> <code>[:SENSe]:POWer[:RF]:PADJust:PRESelector?</code>

Internal Preamp

Accesses a menu of controls for the internal preamps. Turning on the preamp gives a better noise figure, but a poorer inter-modulation distortion (TOI) to noise floor dynamic range. You can optimize this setting for your measurement.

The instrument takes the preamp gain into account as it sweeps. If you sweep outside of the range of the preamp, the instrument will also account for that. The displayed result always reflects the correct gain.

For some measurements, when the preamp is on and any part of the displayed frequency range is below the lowest frequency for which the preamp has specifications, a warning condition message appears in the status line. For example, for a preamp with a 9 kHz lowest specified frequency: "Preamp: Accy unspec'd below 9 kHz".

Selection	Example	Note
Off	<code>:POW:GAIN OFF</code>	
Low Band	<code>:POW:GAIN ON</code> <code>:POW:GAIN:BAND LOW</code>	Sets the internal preamp to use only the low band. The frequency range of the installed (optional) low-band preamp is displayed in square brackets on the Low Band selection in the dropdown
Full Range	<code>:POW:GAIN ON</code> <code>:POW:GAIN:BAND FULL</code>	Sets the internal preamp to use its full range. The low band (0-3.6 GHz, 0-3.4 GHz, 0-3 GHz, depending on the model) is supplied by the low band preamp and the frequencies above low band are supplied by the high band preamp The frequency range of the installed (optional) low-band preamp is displayed in square brackets on the Full Range selection in the dropdown. If the high band option is not installed the Full Range selection does not appear

NOTE

The maximum **Center Frequency for Low Band**, displayed in square brackets, can change based on the selected IFBW for measurements that support IFBW (for example, Waveform measurement across all Modes that support it). In certain models (such as N9042B & N9032B), IFBW values ≤ 40 MHz have a maximum **Low Band** frequency of 3.6 GHz, while $40 \text{ MHz} < \text{IFBW} \leq 1 \text{ GHz}$ have a maximum of 3.3 GHz, and $1 \text{ GHz} < \text{IFBW} \leq 1.5 \text{ GHz}$ have a maximum of 3.5 GHz. IFBW values $> 1.5 \text{ GHz}$ do not support a **Center Frequency** that can reach the **Low Band** maximum frequency. In these cases, **N/A** is displayed in the square brackets for **Low Band**.

Remote Command	<code>[:SENSe]:POWer[:RF]:GAIN:BAND LOW FULL</code> <code>[:SENSe]:POWer[:RF]:GAIN:BAND?</code>
Example	<code>:POW:GAIN:BAND LOW</code> <code>:POW:GAIN:BAND?</code>
Dependencies	Not available on all hardware platforms. If the preamp is not present or is unlicensed, this control is not shown Does not appear in VXT Models M9410A/11A/15A/16A nor in M9410E/11E/15E/16E If <code>:POW:GAIN:BAND FULL</code> is sent when a low band preamp is available, the preamp band parameter is set to LOW instead of FULL , and an "Option not installed" message is generated Not available when the electronic/soft attenuator is enabled
Preset	LOW
State Saved	Saved in instrument state
Annotation	When the USB Preamp is not connected to USB, the Preamp annotation in the Meas Bar says "Off" if the preamp is off and displays the frequency range of the low band or full range preamp depending on the setting. For example, if the Preamp is set to Low Band and the Low Band is 3.6 GHz the annotation says "3.6 GHz". If it is a 13.6 GHz preamp and it is set to Full Range the annotation says "13.6 GHz" When the USB Preamp is connected to USB, the Preamp annotation says "Preamp: USB" if the internal preamp is off or "Preamp: USB, Int" if the internal preamp is on (only for measurements that support the USB preamp)

Auto Function

Remote Command	<code>[:SENSe]:POWer[:RF]:GAIN[:STATe] OFF ON 0 1</code> <code>[:SENSe]:POWer[:RF]:GAIN[:STATe]?</code>
Example	<code>:POW:GAIN OFF</code> <code>:POW:GAIN?</code>
Preset	OFF

LNA

Lets you turn the Low Noise Amplifier (**LNA**) on or off.

LNA is an additional preamplifier that provides superior DANL and frequency range compared to "Internal Preamp" on page 1788. LNA provides lower system noise figure, especially at frequencies above 100 MHz, and can be operated up to the full range of 50 GHz instruments.

For best possible sensitivity, LNA can be turned on *together* with "Internal Preamp" on page 1788, although if you operate both preamps together, note that the TOI (distortion) specifications are impacted. The sensitivity improvement of this combination is substantial when operating in high band (frequencies above 3.6 GHz).

For more details about annotation, see "More Information" on page 1444

Remote Command	<code>[:SENSe]:POWer[:RF]:GAIN:LNA[:STATe] OFF ON 0 1</code> <code>[:SENSe]:POWer[:RF]:GAIN:LNA[:STATe]?</code>
Example	<code>:POW:GAIN:LNA ON</code>
Dependencies	Requires Option LNA, except for VXT models M9415A/16A Does not appear in VXT models M9420A/10A/11A M9410E/11E/15E/16E support LNA May not appear in some measurements LNA is not available when the electronic/soft attenuator is enabled
Preset	OFF
State Saved	Saved in State

More Information

When LNA is installed, the preamp annotation changes to show the state of both LNA and Internal Preamp. Below is an example:

```
Atten: 8 dB
Pre: Int on, LNA on
µW Path: LNP, On
Source: Off
```

Note that when operating entirely in the low band (below about 3.6 GHz), if LNA is on, Internal Preamp is switched off (even if you have its switch set to ON). This is because the noise performance is actually degraded in low band if both preamps are on. In this case, the annotation reflects the actual state of the two preamps, but the Internal Preamp annotation displays in amber, to warn you that the actual state of Internal Preamp does not match its switch control display:

```
Atten: 8 dB
Pre: Int off, LNA on
µW Path: LNP, On
Source: Off
```

μW Path Control

Options for this control include **μW Preselector Bypass** (Option MPB), **Low Noise Path** (Option LNP) and **Full Bypass Enable** in the High Band path circuits.

When the μW Preselector is bypassed, flatness is improved, but will be subject to spurs from out of band interfering signals. When **Low Noise Path Enable** is selected, the instrument automatically bypasses certain circuitry in the high frequency bands that can contribute to noise, when it is appropriate based on other instrument settings.

For most applications, the preset state is **Standard Path**, which provides the best remote-control throughput, minimizes acoustic noise from switching and minimizes the risk of wear in the hardware switches, particularly in remote test scenarios where both low band and high band setups will follow in rapid succession. In this path, the bypass of the low band/high band switch and microwave preamp is never activated, which can cause some noise degradation but preserves the life of the bypass switch.

For applications that utilize the wideband IF paths, the preset state is **μW Preselector Bypass**, if option MPB is present. This is because, when using a wideband IF such as the 140 MHz IF, the μW Preselector's bandwidth can be narrower than the available IF bandwidth, causing degraded amplitude flatness and phase linearity, so it is desirable to bypass the preselector in the default case.

You may choose **Low Noise Path Enable** for a lower noise floor, especially in the 21–26.5 GHz region, though without improving many measures of dynamic range, and without giving the best possible noise floor. The preamp, if purchased and used, gives better noise floor than does **Low Noise Path Enable**, but the preamp's compression threshold and third-order intercept are much poorer than that of **Low Noise Path Enable**.

A fourth choice is **Full Bypass Enable**, which combines **μW Preselector Bypass** and **Low Noise Path Enable**. Because this can bypass most of the circuitry between the input and the first mixer, care should be taken when using this setting to avoid damaging the mixer. **Full Bypass Enable** is only available if both options LNP and MPB are present, as well as option FBP.

Path	Example	Note
Standard Path	:POW:MW:PATH STD	Normal setting for most measurements. μW Preselector in circuit, Low Noise Path disabled
Low Noise Path Enable	:POW:MW:PATH LNP	See " Low Noise Path Enable " on page 1449
μW Preselector Bypass	:POW:MW:PATH MPB	See " μW Preselector Bypass " on page 1451
Full Bypass Enable	:POW:MW:PATH FULL	See " Full Bypass Enable " on page 1452

Remote Command	<code>[:SENSe]:POWer[:RF]:MW:PATH STD LNPath MPBypass FULL</code> <code>[:SENSe]:POWer[:RF]:MW:PATH?</code>														
Example	<code>:POW:MW:PATH LNP</code> Enables the Low Noise path <code>:POW:MW:PATH?</code>														
Notes	<p>When "Presel Center" on page 1786 is performed, the instrument momentarily switches to the Standard Path, regardless of the setting of μW Path Control</p> <p>The DC Block will always be switched in when the low noise path is switched in, to protect succeeding circuitry from DC. Note that this does not mean “when the low noise path is enabled” but when, based on the Low Noise Path rules, the path is actually switched in. This can happen when the selection is Low Noise Path Enable or Full Bypass Enable. In the case where the DC Block is switched in, the instrument is now AC-coupled. However, if you selected DC coupling, the UI would still behave as though it were DC-coupled, including all annunciation, warnings, status bits, and responses to SCPI queries. This is because, based on other settings, the instrument could switch out the low noise path at any time and hence go back to being DC-coupled</p> <p>Alignment switching ignores the settings in this menu, and restores them when finished</p>														
Dependencies	<p>Does not appear in CXA-m, VXT Models M9410A/11A/15A/16A, nor in M9410E/11E/15E/16E, BBIQ and External Mixing</p> <ul style="list-style-type: none"> - The Low Noise Path Enable selection does not appear unless Option LNP is present and licensed - The μW Preselector Bypass selection does not appear unless Option MPB is present and licensed - The Full Bypass Enable selection does not appear unless options LNP and MPB are both present as well as option FBP <p>In any of these cases, if the required options are not present and the SCPI command is sent, error - 241, "Hardware missing; Option not installed" is generated</p> <p>Low Noise Path Enable and Full Bypass Enable are grayed-out if the current measurement does not support them</p> <p>Low Noise Path Enable and Full Bypass Enable are not supported in Avionics and MMR Modes (non-modulation measurements). In any of these cases (that is, the feature is not supported in either measurement or Mode), if the SCPI command is sent, the following error is generated: -221, “Setting Conflict; Feature not supported for this measurement”</p>														
Preset	<table border="1"> <thead> <tr> <th>Mode</th> <th>Value</th> </tr> </thead> <tbody> <tr> <td>IQ Analyzer</td> <td>MPB option present and licensed: MPB</td> </tr> <tr> <td>Pulse</td> <td>MPB option not present and licensed: STD</td> </tr> <tr> <td>RTSA</td> <td></td> </tr> <tr> <td>Avionics</td> <td></td> </tr> <tr> <td>All other Modes</td> <td>STD</td> </tr> <tr> <td>-</td> <td></td> </tr> </tbody> </table>	Mode	Value	IQ Analyzer	MPB option present and licensed: MPB	Pulse	MPB option not present and licensed: STD	RTSA		Avionics		All other Modes	STD	-	
Mode	Value														
IQ Analyzer	MPB option present and licensed: MPB														
Pulse	MPB option not present and licensed: STD														
RTSA															
Avionics															
All other Modes	STD														
-															
State Saved	Save in instrument state														
Range	Standard Path Low Noise Path Enable μW Presel Bypass Full Bypass Enable														

Annotation In the Meas Bar, if the Standard path is chosen:
 μ W Path: Standard
 If Low Noise Path is enabled but the LNP switch is not thrown:
 μ W Path: LNP,Off
 If the Low Noise Path is enabled and the LNP switch is thrown:
 μ W Path: LNP,On
 If the preselector is bypassed:
 μ W Path: Bypass
 If Full Bypass Enable is selected but the LNP switch is not thrown:
 μ W Path: FByp,Off
 If Full Bypass Enable is selected and the LNP switch is thrown:
 μ W Path: FByp,On

μ W Path Control Auto

In VMA, WLAN, 5G NR, CQM Modes, an **Auto/Man** switch is added to **μ W Path Control**:



This allows the function to automatically switch based on certain Auto Rules as shown below:

VMA Mode

Measurement	μ W Path Control Auto behavior
Digital Demod	Use Standard Path unless tuned frequency > 3.6 GHz and IFBW > 15 MHz, in which case choose Preselector Bypass
Monitor Spectrum	Always Presel Bypass
IQ Waveform	Use Standard Path unless tuned frequency > 3.6 GHz and IFBW > 15 MHz, in which case choose Preselector Bypass
Custom OFDM	Use Standard Path unless tuned frequency > 3.6 GHz and IFBW > 15 MHz, in which case choose Preselector Bypass
Channel Power	Always Presel Bypass
Occupied BW	Always Presel Bypass
CCDF	Use Standard Path unless tuned frequency > 3.6 GHz and IFBW > 15 MHz, in which case choose Preselector Bypass

Measurement	μ W Path Control Auto behavior
ACP	Always Presel Bypass
SEM	Always Presel Bypass
Spurious Emissions	Always Standard Path

WLAN Mode

Measurement	μ W Path Control Auto behavior
Modulation Analysis	Always Presel Bypass
Spectral Flatness	Always Presel Bypass
Power vs Time	Always Presel Bypass
Monitor Spectrum	Always Presel Bypass
IQ Waveform	Always Presel Bypass
Channel Power	Always Presel Bypass
Occupied BW	Always Presel Bypass
CCDF	Always Presel Bypass
SEM	For 11be 320M, when 'Enabled Wideband IF for FFT' is OFF or 'Sweep Type Rule' is Best Dynamic Range, auto μ W path is standard For other cases, auto μ W path is presel bypass if presel bypass is enabled, auto μ W path is standard if presel bypass is not enabled
Spurious Emissions	Always Standard Path

5G NR Mode

Measurement	μ W Path Control Auto behavior
Modulation Analysis	Use Standard Path unless tuned frequency > 3.6 GHz and IFBW > 15 MHz, in which case choose Full Bypass if conditions warrant(FBP Option is available and "Allow Full Bypass in Auto" is On), otherwise choose Preselector Bypass
Monitor Spectrum	Always Standard Path
IQ Waveform	Use Standard Path unless tuned frequency > 3.6 GHz and IFBW > 15 MHz, in which case choose Full Bypass if conditions warrant(FBP Option is available and "Allow Full Bypass in Auto" is On), otherwise choose Preselector Bypass
Channel Power	Always Standard Path
Occupied BW	Always Standard Path
CCDF	Use Standard Path unless tuned frequency > 3.6 GHz and IFBW > 15 MHz, in which case choose Preselector Bypass
ACP	Always Standard Path
SEM	Always Standard Path
Spurious	Always Standard Path

Measurement	μ W Path Control Auto behavior
Emissions	
Transmit On Off Power	Use Standard Path unless tuned frequency > 3.6 GHz and Info BW > 15 MHz, in which case choose Preselector Bypass
Channel Quality Mode	
Measurement	μ W Path Control Auto behavior
Group Delay	Use Standard Path unless tuned frequency > 3.6 GHz and IFBW > 15 MHz, in which case choose Full Bypass if conditions warrant(FBP Option is available and "Allow Full Bypass in Auto" is On), otherwise choose Preselector Bypass
Monitor Spectrum	Always Standard Path
IQ Waveform	Use Standard Path unless tuned frequency > 3.6 GHz and IFBW > 15 MHz, in which case choose Preselector Bypass
CCDF	Use Standard Path unless tuned frequency > 3.6 GHz and IFBW > 15 MHz, in which case choose Preselector Bypass

Remote Command	<code>[:SENSe]:POWer[:RF]:MW:PATH:AUTO ON OFF 1 0</code> <code>[:SENSe]:POWer[:RF]:MW:PATH:AUTO?</code>
Example	<code>:POW:MW:PATH:AUTO ON</code> <code>:POW:MW:PATH:AUTO?</code>
Dependencies	Only appears in VMA, WLAN, 5G NR and CQM Modes
Couplings	See " μW Path Control Auto " on page 1447 above
Preset	ON
Range	ON OFF

Low Noise Path Enable

Low Noise Path Enable provides a lower noise floor under some circumstances, particularly when operating in the 21–26.5 GHz region. With the Low Noise Path enabled, the low band/high band switch and microwave preamp are bypassed whenever *all* the following are true:

- The instrument is not in the Low Band, meaning:
- the start frequency is above 3.5 GHz and
- the stop frequency is above 3.6 GHz
- The internal preamp is not installed, or if installed, is set to **Off** or **Low Band**

Note that this means that, when any part of a sweep is done in Low Band, the Low Noise Path is not used, whether or not the **Low Noise Path Enable** is selected in the user interface. Also, if the preamp is turned on, the Low Noise Path is not used,

whether or not the **Low Noise Path Enable** is selected in the user interface. The only time the Low Noise Path is used is when **Low Noise Path Enable** is selected, the sweep is completely in High Band (> 3.6 GHz) and no preamp is in use.

For measurements that use IQ acquisition, the low noise path is used when **Center Frequency** is in High Band (> 3.6 GHz) and no preamp is in use. In other words, the rules above are modified to use only the center frequency to qualify which path to switch in. This is not the case for FFTs in the Swept SA measurement; they use the same rules as swept measurements.

Note that the Low Noise Path, while giving improved DANL, has the disadvantage of decreased TOI performance and decreased gain compression performance relative to the standard path.

Note also that the bypass switch is a mechanical switch and has finite life, so if the **Low Noise Path Enable** is selected, it is possible to cause frequent cycling of this switch by frequently changing instrument settings such that the above conditions hold true only some of the time. A user making tests of this nature should consider opting for the **Standard Path**, which will never throw the bypass switch, at the expense of some degraded noise performance.

The low noise path is useful for situations where the signal level is so low that the instrument performance is dominated by noise even with 0 dB attenuation, but still high enough that the preamp option would have excessive third-order intermodulation or compression. The preamp, if purchased and used, gives better noise floor than does the “Low Noise Path.” However, its compression threshold and third-order intercept are much poorer than that of the non-preamp path.

There are some applications, typically for signals around –30 dBm, for which the third-order dynamic range of the standard path is good enough, but the noise floor is not low enough even with 0 dB input attenuation. When the third-order dynamic range of the preamp path is too little and the noise floor of the standard path is too high, the Low Noise Path can provide the best dynamic range

The graph below illustrates the concept. It shows, in red, the performance of an instrument at different attenuation settings, both with the preamp on and off, in a measurement that is affected by both instrument noise and instrument TOI. The green shows the best available dynamic range, offset by 0.5 dB for clarity. The blue shows how the best available dynamic range improves for moderate signal levels with the low noise path switched in. In this illustration, the preamp improves the noise floor by 15 dB while degrading the third-order intercept by 30 dB, and the low noise path reduces loss by 8 dB. The attenuator step size is 2 dB.

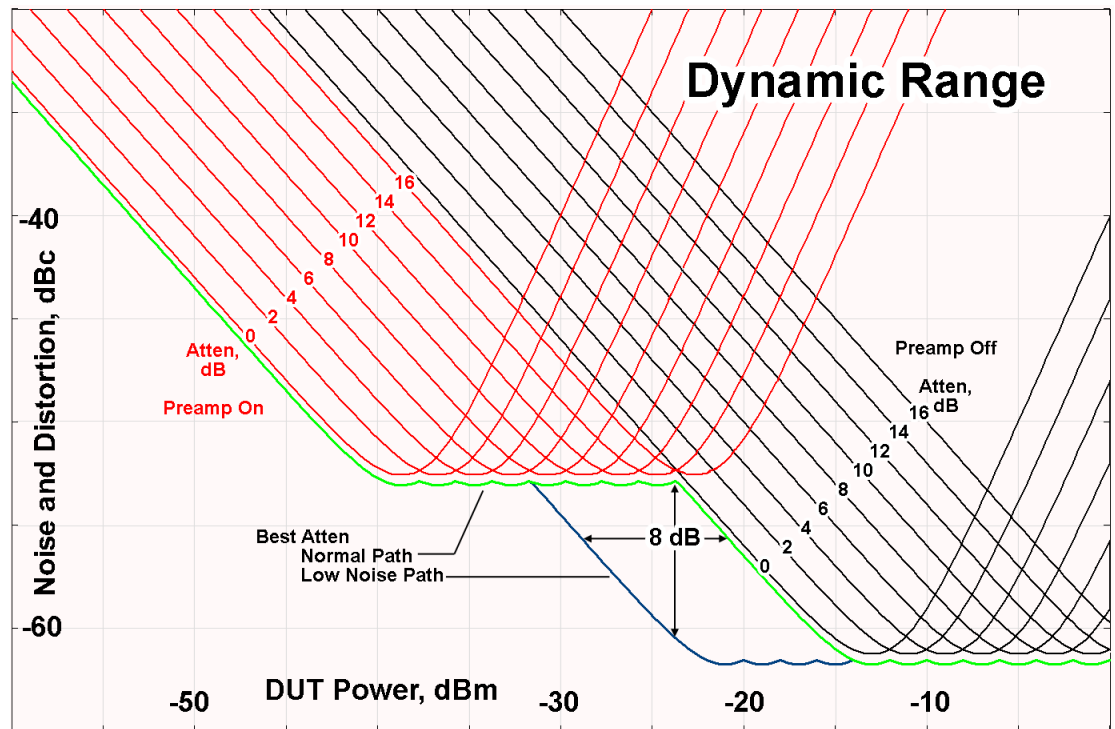

There are other times where selecting the low noise path improves performance, too. Compression-limited measurements such as finding the nulls in a pulsed-RF spectrum can profit from the low noise path in a way similar to the TOI-limited measurement illustrated. Accuracy can be improved when the low noise path allows the optimum attenuation to increase from a small amount like 0, 2 or 4 dB to a larger amount, giving better return loss at the instrument input. Harmonic measurements, such as second and third harmonic levels, are much improved using the low noise path because of the superiority of that path for harmonic (though not intermodulation) distortion performance.

μW Preselector Bypass

Toggles the preselector bypass switch for band 1 and higher. When the microwave preselector is on, the signal path is preselected. When the microwave preselector is off, the signal path is not preselected. The preselected path is the normal path for the instrument.

The preselector is a tunable bandpass filter which prevents signals away from the frequency of interest from combining in the mixer to generate in-band spurious signals (images). The consequences of using a preselector filter are its limited bandwidth, the amplitude and phase ripple in its passband, and any amplitude and phase instability due to center frequency drift.

Option MPB or pre-selector bypass provides an unpreselected input mixer path for certain X-Series signal analyzers with frequency ranges above 3.6 GHz. This signal path allows a wider bandwidth and less amplitude variability, which is an advantage when doing modulation analysis and broadband signal analysis. The disadvantage is that, without the preselector, image signals will be displayed. Another disadvantage of bypassing the preselector is increased LO emission levels at the front panel input port.

Image responses are separated from the real signal by twice the 1st IF. For IF Paths of 10 MHz and 25 MHz, the 1st IF is 322.5 MHz, so the image response and the real signal will be separated by 645 MHz. The 1st IF will be different for other IF Path settings. When viewing a real signal and its corresponding image response in internal mixing, the image response will be to the left of the real signal.

Also, the image response and the real signal typically have the same amplitude and exhibit the same shape factor.

However, if Option FS1 (Fast Sweep Capability) is enabled, the image response in the Swept SA measurement appears lower in amplitude and has a much wider shape factor compared to the real signal.

Full Bypass Enable

With **Full Bypass Enable** selected, the microwave preselector is bypassed. In addition, the low band/high band switch and microwave preamp are bypassed whenever *all* the following are true:

- The instrument is not in the Low Band, meaning:
- the start frequency is above 3.5 GHz and
- the stop frequency is above 3.6 GHz.
- the internal preamp is not installed or if installed, is set to **Off** or **Low Band**

Note that this means that, when any part of a sweep is done in Low Band, the Low Noise Path is not used, whether or not the **Full Bypass Enable** is selected in the user interface. Also, if the preamp is turned on, the Low Noise Path is not used, whether or not the **Full Bypass Enable** is selected in the user interface. The only time the Low Noise Path is used is when **Full Bypass Enable** is selected, the sweep is completely in High Band (> 3.6 GHz) and no preamp is in use.

CAUTION

When **Full Bypass Enable** is selected, and **"Y Scale"** on page 1760 is set to 0 dB, there will be a direct AC connection between the input and the first converter when the Low Noise Path switches in (when Start Freq >3.6 GHz and the Preamp is either not licensed, set to Low Band, or Off). This puts the first converter at considerable risk to be damaged by high AC power. Consequently,

whenever **Full Bypass Enable** is selected, a warning message appears in the status bar:

“Full Bypass Enabled, maximum safe input power reduced”

Microwave Preselector Bypass Backwards Compatibility

Example	Bypass the microwave preselector: <code>:POW:MW:PRES OFF</code>
Notes	Included for Microwave Preselector Bypass backwards compatibility The ON parameter sets the STD path (<code>:POW:MW:PATH STD</code>) The OFF parameter sets path MPB (<code>:POW:MW:PATH MPB</code>)
Preset	ON
Backwards Compatibility SCPI	<code>[:SENSe]:POWer[:RF]:MW:PRESelector[:STATe] ON OFF 0 1</code> <code>[:SENSe]:POWer[:RF]:MW:PRESelector[:STATe]?</code>

Frequency Extender Preselection Bypass

Only applies to the high frequency path of the Frequency Extender, and only if the Frequency Extender allows it. For example, the V3050A high frequency path is 50 – 110 GHz and *does* allow control of the preselector bypass.

When the Frequency Extender’s preselection is bypassed, flatness is improved, but will be subject to spurs from out-of-band interfering signals. For bandwidths greater than 2.5 [GHz], it is recommended that the signal bypass the Frequency Extender Preselector since the max bandwidth of the Preselector can be as narrow as 2.5 [GHz].

For most applications, the preset state is **OFF**, which gives the best remote-control throughput, minimizes acoustic noise from switching, minimizes out of band spurs, and minimizes the risk of wear in the hardware switches.

Preselector and Bandwidth Conflict

When the Frequency Extender Preselector is applied and the signal bandwidth is greater than 2.5 [GHz], then a settings alert message will show to warn the user that the signal may be distorted due to the limitation of the Frequency Extender Preselector bandwidth.

An example of the settings alert message is shown below.

Settings Alert message in the Status Bar at the bottom of the display.



Settings Alert message in the error queue

Type	ID	
	159	Settings Alert - DETECTED;Presel/Meas BW conflict

Allow Full Bypass in Auto

Enable or disable Full Bypass in μ W Path Auto rule. See " [\$\mu\$ W Path Control](#)" on page 1791.

When this function is **ON**, and " [\$\mu\$ W Path Control](#)" on page 1791 is in **AUTO**, it is possible for the auto rules to select the **FULL** Bypass state, which bypasses both the Preamp and the Microwave Preselector. Otherwise, the auto rules never select the **FULL** Bypass state. This is convenient when making wideband measurements, but it also adds some risk of damage to the first converter.

CAUTION

When **Full Bypass Enable** is selected, and "[Y Scale](#)" on page 1760 is set to 0 dB, there will be a direct AC connection between the input and the first converter when the Low Noise Path switches in (when Start Freq > 3.6 GHz and the Preamp is either not licensed, set to **Low Band** or **Off**). This puts the first converter at considerable risk to be damaged by high AC power. Consequently, whenever **Full Bypass Enable** is selected, a warning message appears in the status bar:

"Full Bypass Enabled, maximum safe input power reduced"

Remote Command `[:SENSe]:POWer[:RF]:MW:PATH:AUTO:FULL ON | OFF | 1 | 0`
`[:SENSe]:POWer[:RF]:MW:PATH:AUTO:FULL?`

Example `:POW:MW:PATH:AUTO:FULL ON`
`:POW:MW:PATH:AUTO:FULL?`

Dependencies Only appears if Option FBP is installed, and in the following measurements

- 5GNRMode: Modulation Analysis and IQ Waveform
- WLAN Mode: IQ Waveform
- Channel Quality Mode: Group Delay and Noise Power Ratio

Preset **OFF**

State Saved Saved in instrument state

Software Preselection

Provided in some instruments, either to compensate for issues with provided hardware preselection or to provide the preselection function when there is no hardware preselector.

N9041B

Software Preselection compensates for the frequency range limit of the microwave preselector. Since the microwave preselector only goes up to 50 GHz, software preselection must be used to suppress and separate images above 50 GHz. The specific algorithm used for software preselection is specified by the SW Preselection Type selection – Normal or Advanced.

In N9041B, **Software Preselection** only applies for frequencies above 50 GHz, therefore it is only used for RF Input 2. Even if turned on, it is not used for other inputs, and never for frequencies below 50 GHz. This is why the label of this control contains the parenthetical note “(>~50 GHz)”.

Note that in N9041B, in Swept SA measurement, **Software Preselection** works even if the measurement is using an FFT Sweep Type. In measurements other than Swept SA, Software Preselection is not used if the measurement is using an FFT sweep type.

N9042B+V3050A

Software Preselection compensates for the frequency range limit of the microwave preselector. Since the microwave preselector only goes up to 50 GHz, software preselection must be used to suppress and separate images above 50 GHz. The specific algorithm used for software preselection is specified by the SW Preselection Type selection – Normal or Advanced.

For N9042B+V3050A, Software Preselection only applies for frequencies above 50 GHz, therefore it is only used for External RF. Even if it is turned on, it will not be used for other inputs and never for frequencies below 50 GHz. This is why the label of this control contains the parenthetical note “(>~50 GHz)”.

Note that for N9042B+V3050A, in the Swept SA measurement, Software Preselection works even if the measurement is using an FFT Sweep Type. In measurements other than Swept SA, Software Preselection is not used if the measurement is using an FFT Sweep Type.

VXT models M9410A/11A/15A/16A

Software Preselection is used to provide the preselection function, as there is no hardware preselector in these models. Two background traces are taken and compared point by point, and the point with the lowest amplitude from the two

traces is used. This provides a method to reduce spurs that are internally generated within the VXT, but you should note the following when using Software Preselection:

- There is some speed cost due to the need to take multiple captures
- Taking the point with the lowest amplitude in each trace will make the average noise level lower at all points that do not have a spur. This can reduce the accuracy of the measurement of noise and noise-like signals

Because of the difficulty in identifying spurs manually, you are recommended to leave Software Preselection **ON** at all times in VXT models M9410A/11A. If you turn it off in order to speed up your measurement or improve noise accuracy, be aware of unwanted onscreen spurs.

Remote Command	<code>[:SENSe]:POWer[:RF]:SWPrese1:STATe 0 1 ON OFF</code> <code>[:SENSe]:POWer[:RF]:SWPrese1:STAT?</code>
Example	<code>:POW:SWPR:STAT 1</code> <code>:POW:SWPR:STAT?</code>
Dependencies	Only appears in N9041B, N9042B+V2050A, VXT models M9410A/11A and M9410E/11E. Does not appear in all measurements
Couplings	Affects Sweep Time Auto Tune supports Software Preselection , so Auto Tune should be performed after setting the Software Preselection state
Preset	N9041B OFF N9042B+V3050A ON M9410A/11A ON
State Saved	Saved in instrument state

SW Preselection Type

Specifies the algorithm used for software preselection.

Two hidden sweeps occur in succession. The second sweep is offset in LO frequency by $2 * IF / N$. For each point in each trace, the smaller amplitude from the two traces is taken and placed in that point in the selected trace. The Peak detector is auto-selected to improve the image suppression effectiveness. Responses of each trace that lie on top of one another will remain and are valid signals. Other signals are images, which are suppressed. The action of taking the smaller of the two traces will make the average noise level lower in all points that do not have an image, thus reducing the accuracy of the measurement of noise and noise-like signals.

3 VMA Mode
3.9 SEM Measurement

- **NORMa1** - mathematically removes all image and multiple responses of signals present at the input
- **ADVanced** - any trace processing (such as “max hold” or trace averaging) is performed on the points of both candidate traces before the “select minimum” operation occurs. This form of processing works better for non-stationary signals, such as pulsed-RF signals

Remote Command	<code>[:SENSe]:POWer[:RF]:SWPResel NORMa1 ADVanced</code> <code>[:SENSe]:POWer[:RF]:SWPResel?</code>
Example	<code>:POW:SWPR NORM</code> <code>:POW:SWPR?</code>
Dependencies	Only appears in N9041B and N9042B+V3050A. Only appears in measurements that use the Swept method Grayed-out when "Software Preselection" on page 1801 is OFF. The grayout message is “Unavailable unless SW Presel enabled”
Preset	N9041B ADVanced N9042B+V3050A NORMa1
State Saved	Saved in instrument state

SW Preselection BW

Specifies the effective bandwidth to be used for Software Preselection.

The options are:

- **NORMa1** – when making Swept measurements, a software preselection algorithm is used which takes up to 4 background acquisitions, then post-processes the result. This algorithm can remove images from signals with an occupied bandwidth up to around 3 GHz. (Default/Preset setting). When making FFT measurements, this algorithm is not used, instead the same algorithm is used as for **NARRow** (below)
- **NARRow**– a software preselection algorithm is used which takes two background acquisitions, then post-processes the result to detect and remove images from wideband signals with occupied bandwidths up to 2 GHz. This increases the risk of images failing to be rejected, but improves the measurement speed

Remote Command	<code>[:SENSe]:POWer[:RF]:SWPResel:BW NORMa1 NARRow</code> <code>[:SENSe]:POWer[:RF]:SWPResel:BW?</code>
Example	<code>:POW:SWPR:BW NARR</code>
Dependencies	Only appears in N9041B and N9042B+V3050A. Only appears in measurements that use the Swept

	method	
	Grayed-out when " Software Preselection " on page 1801 is OFF . The grayout message is "Unavailable unless SW Presel enabled"	
	For N9042B+V3050A, the parameter is SCPI-only, and always set to NARRow when Software Preselection is enabled	
Preset	N9041B	NORMa1
	N9042B+V3050A	NARRow
State Saved	Saved in instrument state	

High Freq Prefilter

Lets you set the state of Prefilter for center frequencies above 1310 MHz.

In VXT Models M9410A/11A and M9410E/11E in bypass frequency range (1310MHz~5GHz), the Receiver RF path has a bank of filters that come after the RF Attenuator in the signal path. Since this bank of filters precedes the mixer they are known as the "Prefilter" bank. Their purpose is to eliminate unwanted in-band mixing products by filtering out all but the desired frequencies before the signals get to the mixer. There are 13 prefilter bands to cover the frequencies between 9 kHz and 6000 MHz. The Prefilter provides the necessary rejection of the unwanted signal.

Remote Command	<code>[:SENSe]:<measurement>:PFILter[:STATe] ON OFF 1 0</code> <code>[:SENSe]:<measurement>:PFILter[:STATe]?</code>
Example	Enable High Freq Prefilter for the Complex Spectrum Measurement in BASIC Mode: <code>:SPEC:PFIL ON</code> Enable High Freq Prefilter for the IQ Waveform Measurement, in multiple Modes: <code>:WAV:PFIL ON</code> Enable High Freq Prefilter for the Swept SA Measurement in SA Mode: <code>:SAN:PFIL ON</code>
Dependencies	Only appears in VXT models M9410A/11A with center frequency above 1310 MHz, and M9410E/11E in frequency range 1310MHz~5GHz
Preset	See " Prefilter Presets " on page 1458 below
State Saved	Saved in instrument state

Prefilter Presets

Meas	Mode	Preset
SPEC	BASIC	OFF

3 VMA Mode
3.9 SEM Measurement

Meas	Mode	Preset
WAV	BASIC, WCDMA, WLAN, LTEAFDD, LTEATDD, 5GNR, VMA	OFF
MON	WCDMA, WLAN, LTEAFDD, LTEATDD, 5GNR, VMA	OFF
RHO	WCDMA	OFF
CDP	WCDMA	OFF
PCON	WCDMA	OFF
EVMQ	WCDMA	OFF
CHP	WCDMA, WLAN, LTEAFDD, LTEATDD, 5GNR, VMA, SA	OFF
OBW	WCDMA, WLAN, LTEAFDD, LTEATDD, 5GNR, VMA, SA	OFF
ACP	WCDMA, LTEAFDD, LTEATDD, 5GNR, VMA, SA	OFF
SEM	WCDMA, WLAN, LTEAFDD, LTEATDD, 5GNR, VMA, SA	OFF
PST	WCDMA, WLAN, LTEAFDD, LTEATDD, 5GNR, VMA, SA	OFF
PVT	WLAN, LTEAFDD, LTEATDD, 5GNR	OFF
EVM	WLAN, LTEAFDD, LTEATDD, 5GNR	OFF
FLAT	WLAN	OFF
EVMM	WLAN	OFF
CEVM	LTEAFDD, LTEATDD	OFF
PAVT	5GNR, VMA	OFF
DDEM	VMA	OFF
OFDM	VMA	OFF
SAN	SA	ON
HARM	SA	ON

3.9.14 BW

Opens the Bandwidth (**BW**) menu, which contains controls for the Resolution Bandwidth functions of the instrument.

The Resolution BW functions control filter type. There are two filter types, Gaussian and Flattop. The Gaussian filters have a response curve that is parabolic on a log scale. The Flattop filter shape is a close approximation of a rectangular filter.

3.9.14.1 Settings

Contains basic Bandwidth functions. The only tab under **BW**.

RBW Filter Type

Selects the type of bandwidth filter that is used in Carriers and Offsets:

Option	SCPI	Behavior
Gaussian	GAUSSian	The selected filter is applied to carriers and all offsets
Flattop	FLATtop	
Auto Sense	ASENSE	<p>The filter type is automatically selected for each carrier and offset in a way such that measurement speed and accuracy are optimized</p> <p>Filter Auto Sense Rules:</p> <ul style="list-style-type: none"> - Flattop is selected when "Enable Wideband IF for FFT" on page 1572 is ON - Flattop is selected for offsets close to the reference carrier - For all other cases, Gaussian is selected
Remote Command	[:SENSe]:SEMAsk:BANDwidth:SHAPE ASENSe GAUSSian FLATtop [:SENSe]:SEMAsk:BANDwidth:SHAPE?	
Example	:SEM:BAND:SHAP GAUS :SEM:BAND:SHAP?	
Preset	ASENSE	
State Saved	Saved in instrument state	
Range	Auto Sense (each offset and carrier) Gaussian (all offsets and carriers) Flattop (all offsets and carriers)	

3.9.15 Display

Lets you configure display items for the current Mode, Measurement View or Window.

3.9.15.1 Meas Display

Contains controls for setting up the display for the current Measurement, View or Window.

Limit Lines

Toggles Limit Lines display for this measurement On or Off.

Remote Command	:CALCulate:SEMAsk:LLINe:STATe ON OFF 1 0 :CALCulate:SEMAsk:LLINe:STATe?
Example	:CALC:SEM:LLIN:STAT OFF :CALC:SEM:LLIN:STAT?

Preset	ON
State Saved	Saved in instrument state
Range	ON OFF

3.9.15.2 Annotation

Contains controls for setting up the annotation for the current Mode or Measurement.

Graticule

Turns the display graticule On or Off for all windows with graticules in all measurements in the current Mode. Also turns the graticule Y-Axis annotation on and off.

Remote Command	:DISPlay:GRATicule[:STATe] OFF ON 0 1 :DISPlay:GRATicule[:STATe]?
Example	:DISP:GRAT OFF
Notes	The graticule is the set of horizontal and vertical lines that make up the grid/divisions for the X-Axis and Y-Axis
Preset	ON
State Saved	Saved in instrument state
Backwards Compatibility SCPI	:DISPlay:WINDow[1]:TRACe:GRATicule:GRID[:STATe] OFF ON 0 1 :DISPlay:WINDow[1]:TRACe:GRATicule:GRID[:STATe]?
	This command is accepted for backwards compatibility with older instruments, but the WINDow , TRACe and GRID parameters are ignored

Screen Annotation

Controls the display of the annunciation and annotation around the graticule, including any annotation on lines (such as the display line, the threshold line, etc.) and the Y-Axis annotation, for all windows with screen annotation in all measurements in the current Mode.

This does *not* include marker annotation (or the N dB result). When **OFF**, the graticule expands to fill the entire graticule area, leaving only the 1.5% gap above the graticule, as described in the **Trace** section.

Remote Command	:DISPlay:ANNotation:SCReen[:STATe] OFF ON 0 1 :DISPlay:ANNotation:SCReen[:STATe]?
----------------	--

Example	<code>:DISP:ANN:SCR OFF</code>
Dependencies	Grayed-out and forced to OFF when System Display Settings, Annotation is OFF
Preset	ON This remains OFF through a Preset when System Display Settings, Annotation is set to OFF
State Saved	Saved in instrument state

Trace Annotation

Turns on and off the labels on the traces, showing their detector (or their Math Mode) as described in the **Trace** section, for all windows in all measurements in the current Mode for which Trace Annotation on/off is supported.

If Trace Math is being performed on a trace, then the Trace Math annotation replaces the detector annotation.

For measurements that support limit lines, this key also turns on and off the labels on the Limit Lines. The label is the Limit number annotation and Limit Comment displayed on the graph. If the length of the comment is greater than 20 characters, the first 8 characters and the last 8 characters are displayed, joined with

Remote Command	<code>:DISPlay:ANNotation:TRACe[:STATe] ON OFF 1 0</code> <code>:DISPlay:ANNotation:TRACe[:STATe]?</code>
Example	<code>:DISP:ANN:TRAC OFF</code>
Preset	OFF
State Saved	Saved in instrument state

Control Annotation

Turns on and off the display of values on the Active Function controls for all measurements in the current Mode. This is a security feature.

Remote Command	<code>:DISPlay:ACTivefunc[:STATe] ON OFF 1 0</code> <code>:DISPlay:ACTivefunc[:STATe]?</code>
Example	<code>:DISP:ACT OFF</code>
Dependencies	Grayed out and forced to OFF when System Display Settings, Annotation is OFF
Preset	ON This remains OFF through a Preset when System Display Settings, Annotation is set to OFF
State Saved	Saved in instrument state

Meas Bar

Turns the Measurement Bar at the top of the screen on and off for all measurements in the current Mode. When **OFF**, the graticule area expands to fill the area formerly occupied by the Measurement Bar.

Remote Command	<code>:DISPlay:ANNotation:MBAR[:STATe] OFF ON 0 1</code> <code>:DISPlay:ANNotation:MBAR[:STATe]?</code>
Example	<code>:DISP:ANN:MBAR OFF</code>
Dependencies	Grayed out and forced to OFF when System Display Settings, Annotation is OFF
Preset	ON This remains OFF through a Preset when System Display Settings, Annotation is set to OFF
State Saved	Saved in instrument state

Display Enable (Remote Command Only)

Turns the display on/off, including the display drive circuitry. The backlight stays lit to confirm that the instrument is on. The display enable setting is mode global. There are three reasons for turning the display off:

1. To increase speed as much as possible by freeing the instrument from having to update the display
2. To reduce emissions from the display, drive circuitry
3. For security purposes

If you have turned off the display:

- and you are in local operation, the display can be turned back on by pressing any key or by sending `:SYSTem:DEFaults MISC` or `:DISPlay:ENABle ON` (neither `*RST` nor `:SYSTem:PRESet` enable the display)
- and you are in remote operation, the display can be turned back on by pressing the **Local** or **Esc** keys, or by sending `:SYSTem:DEFaults MISC` or `:DISPlay:ENABle ON` (neither `*RST` nor `:SYSTem:PRESet` enable the display)
- and you are using either the `:SYSTem:KLOCK` command or GPIB local lockout, then *no* front-panel key press will turn the display back on. You must turn it back on remotely.

If the display is **OFF**, many SCPI commands related to User Views and Multiscreen functionality do not work, and return the error messages “-221, Settings conflict; Screen SCPI cannot be used when Display is disabled” or “221, Settings conflict; View SCPI cannot be used while Display is disabled”. These commands include:

Name	Command
Select User View	:DISPlay:VIEW:ADVanced:SElect
Rename User View	:DISPlay:VIEW:ADVanced:REName
Delete User View	:DISPlay:VIEW:ADVanced:DElete
Create User View	:DISPlay:VIEW:ADVanced:NAME
Select Screen	:INSTrument:SCReen:SElect
Delete Screen	:INSTrument:SCReen:DElete
Delete All But This Screen	:INSTrument:SCReen:DElete:ALL
Add Screen	:INSTrument:SCReen:CREate
Rename Screen	:INSTrument:SCReen:REName
Sequencer On/Off	:SYSTem:SEQuencer

Remote Command	:DISPlay:ENABle OFF ON 0 1
Example	:DISP:ENAB OFF
Couplings	:DISP:ENAB OFF turns Backlight OFF and :DISP:ENAB ON turns Backlight ON, but changing Backlight settings does <i>not</i> change the state of :DISP:ENAB
Preset	ON Set by :SYST:DEF MISC, but not affected by *RST or :SYSTem:PRESet
State Saved	Not saved in instrument state
Backwards Compatibility Notes	:SYST:PRES no longer turns on :DISPlay:ENABle as it did in legacy analyzers

3.9.15.3 View

See "[Views](#)" on page 1399

3.9.16 Frequency

Opens the **Frequency** menu, which contains controls that allow you to control the Frequency and Channel parameters of the instrument.

Some features in the **Frequency** menu are the same for all measurements in the current Mode – they do not change as you change measurements. Settings like these are called “Meas Global” and are unaffected by Meas Preset. For example, the **Center Freq** setting is the same for all measurements – it does not change as you change measurements.

3.9.16.1 Settings

Contains controls that pertain to the X axis parameters of the measurement. These parameters control how data on the vertical (X) axis is displayed, and control instrument settings that affect the horizontal axis.

Center Frequency

Sets the frequency that corresponds to the horizontal center of the graticule. While adjusting **Center Frequency**, **Span** is held constant.

This setting is the same for all measurements within a Mode, that is, it is Meas Global. Some Modes are also able to share a Mode Global Center Frequency value. If this is the case, the Mode has a **Global** tab in its **Meas Setup** menu.

Center Frequency sets (and queries) the center frequency for the currently selected input. If your instrument has multiple inputs, and you select another input, **Center Frequency** changes to the value for that input. SCPI commands are available to directly set **Center Frequency** for a specific input.

Center Frequency is remembered as you go from input to input. Thus you can set a **Center Frequency** of 10 GHz with the RF Input selected, change to BBIQ and set a **Center Frequency** of 20 MHz, then switch to External Mixing and set a **Center Frequency** of 60 GHz. When you go back to the RF Input, **Center Frequency** returns to 10 GHz; back to BBIQ and it is 20 MHz; back to External Mixing and it is 60 GHz.

See also:

- ["Center Frequency Presets" on page 1466](#)
- ["VXT Models with Radio Heads/CIU Frequency Range" on page 1468](#)
- ["RF Center Freq" on page 1468](#)
- ["Ext Mix Center Freq" on page 1469](#)
- ["I/Q Center Freq" on page 1470](#)

Remote Command	<code>[:SENSe]:FREQuency:CENTer <freq></code> <code>[:SENSe]:FREQuency:CENTer?</code>
----------------	--

Example	Set Center Frequency to 50 MHz: <code>:FREQ:CENT 50 MHz</code> Increment Center Frequency by the value of "CF Step" on page 1470 : <code>:FREQ:CENT UP</code> Return the current value of Center Frequency :
---------	---

:FREQ:CENT?	
Notes	<p>Sets the RF, External Mixing or I/Q Center Frequency depending on the selected input:</p> <ul style="list-style-type: none"> - For RF input, equivalent to :FREQ:RF:CENT - For I/Q input, equivalent to :FREQ:IQ:CENT - For External Mixer, equivalent to :FREQ:EMIX:CENT <p>Preset and Max values are dependent on Hardware Options If no terminator (for example. MHz) is sent, the terminator Hz is used. If a terminator with unit other than frequency is used, an invalid suffix error message is generated</p>
Dependencies	Not available in the MSR, LTE-Advanced FDD/TDD and 5G NR Modes
Preset	<p>Depends on instrument maximum frequency, Mode, measurement, and selected input</p> <p>See "Center Frequency Presets" on page 1466, and "RF Center Freq" on page 1468, "Ext Mix Center Freq" on page 1469, "I/Q Center Freq" on page 1470 and "VXT Models with Radio Heads/CIU Frequency Range" on page 1468</p>
State Saved	Saved in instrument state
Min/Max	<p>Depends on instrument maximum frequency, Mode, measurement, and selected input</p> <p>See "Center Frequency Presets" on page 1466, "RF Center Freq" on page 1468, "I/Q Center Freq" on page 1470 and "VXT Models with Radio Heads/CIU Frequency Range" on page 1468</p>
Annotation	Center <value> appears in the lower left corner of the display
Status Bits/OPC dependencies	Non-overlapped

Center Frequency Presets

The following table provides the Center Frequency Presets for the Spectrum Analyzer mode, and the Max Freq, for the various frequency options:

Freq Option	CF after Mode Preset	Stop Freq after Mode Preset	Max Freq (can't tune above)
503 (all but CXA)	1.805 GHz	3.6 GHz	3.7 GHz
503 (CXA)	1.505 GHz	3.0 GHz	3.08 GHz
507 (all but CXA)	3.505 GHz	7.0 GHz	7.1 GHz
507 (CXA)	3.755 GHz	7.5 GHz	7.58 GHz
508 (all but MXE)	1.805 GHz	3.6 GHz	8.5 GHz
508 (MXE)	4.205 GHz	8.4 GHz	8.5 GHz
513	6.805 GHz	13.6 GHz	13.8 GHz
526 (except CXA and MXE)	13.255 GHz	26.5 GHz	27.0 GHz*
526 (CXA)	13.255 GHz	26.5 GHz	26.55 GHz
526 (MXE)	1.805 GHz	3.6 GHz	27.0 GHz

3 VMA Mode
3.9 SEM Measurement

Freq Option	CF after Mode Preset	Stop Freq after Mode Preset	Max Freq (can't tune above)
532	16.005 GHz	32.0 GHz	32.5 GHz
540	20.005 GHz	40.0 GHz	40.5 GHz
543	21.505 GHz	43.0 GHz	43.0 GHz
544	22.005 GHz	44.0 GHz	45.0 GHz
550	25.005 GHz	50.0 GHz	52 GHz
F03 (CXA-m)	1.505 GHz	3.0 GHz	3.08 GHz
F07 (CXA-m)	3.755 GHz	7.5 GHz	7.575 GHz
F13 (CXA-m)	6.805 GHz	13.6 GHz	13.8 GHz
F26 (CXA-m)	13.255 GHz	26.5 GHz	26.55 GHz
504 (M9421A, M8920A)	2.145 GHz	3.88GHz	3.88 GHz
506 (M9421A, M8920A)	3.245 GHz	6.08GHz	6.08 GHz
F06 (M9410A/11A)	1.0 GHz	6.08 GHz	6.08 GHz
F06 (M9415A)	1 GHz	1.08 GHz	6.6 GHz
F08 (M9415A)	1 GHz	1.08 GHz	8.6 GHz
F12 (M9415A)	1 GHz	1.08 GHz	12.9 GHz

*For option 526, the Max CF in RTSA is 26.999999995 GHz.

N9041B Center Freq Presets

Input	CF after Mode Preset	Stop Freq after Mode Preset	Max Freq (can't tune above)
Input 1, all models	25.005 GHz	50.0 GHz	52 GHz
Input 2, opt 585	42.505 GHz	85.0 GHz	86 GHz
Input 2, opt 590	45.005 GHz	90.0 GHz	92 GHz
Input 2, opt 5CX	55.005 GHz	110.0 GHz	110 GHz

Input 2, CXA and MXE

Model	CF after Mode Preset	Stop Freq after Mode Preset	Max Freq (can't tune above)
CXA opt C75	0.7505 GHz	1.5 GHz	1.58 GHz
MXE	505 MHz	1 GHz	1.000025 GHz

Tracking Generator Frequency Limits (CXA only)

Tracking Generator Option	Min Freq (clips to this freq when turn TG on and can't tune below while TG on)	If above this Freq, Stop Freq clipped to this Freq when TG turned on	Max Freq (can't tune above) while TG on
T03	9 kHz	3.0 GHz	3.08 GHz
T06	9 kHz	6.0 GHz	6.05 GHz

Tracking Generator Frequency Limits(CXA-m only)

Tracking Generator Option	Min Freq (clips to this freq when turn TG on and can't tune below while TG on)	If above this Freq, Stop Freq clipped to this Freq when TG turned on	Max Freq (can't tune above) while TG on
T03	2 MHz	3.08 GHz	3.08 GHz
T07	2 MHz	7.575 GHz	7.575 GHz
T13	2 MHz	13.8 GHz	13.8 GHz
T26	2 MHz	26.55 GHz	26.55 GHz

VXT Models with Radio Heads/CIU Frequency Range

The following table shows the Center Frequency Presets and Range for VXT modes with Radio Heads/CIU.

Products with Radio Heads/CIU	Preset	Start frequency	Stop frequency
M9421A + CIU	6 GHz	5.9 GHz	12 GHz
M9410A + CIU	6 GHz	5.9 GHz	12 GHz
M9410A + CIU + RRH	25 GHz	24.25 GHz	43.5 GHz

RF Center Freq

Specifies the RF Center Frequency. Sets the center frequency to use when the RF input is selected, even if the RF input is not the selected input at the time the command is sent. Note that **Center Frequency** in the **Frequency** menu on the front panel always applies to the currently-selected input.

Remote Command	<code>[:SENSe] :FREQuency:RF:CENTer <freq></code> <code>[:SENSe] :FREQuency:RF:CENTer?</code>
Example	<code>:FREQ:RF:CENT 30 MHz</code> <code>:FREQ:RF:CENT?</code>
Notes	This command is the same in all Modes, but the parameter is Measurement Global, so the value is independent in each Mode and common across all the measurements in the Mode
Dependencies	If the electronic/soft attenuator is enabled, any attempt to set Center Frequency such that the Stop Frequency would be >3.6 GHz fails and results in an advisory message. If the equivalent SCPI command is sent, this same message is generated as part of a "-221, Settings conflict" warning

Preset	See "Center Frequency Presets" on page 1466 above
State Saved	Saved in instrument state
Min	-79.999995 MHz
Max	See "Center Frequency Presets" on page 1466 above. Basically, instrument maximum frequency - 5 Hz If the knob or step keys are being used, also depends on Span

Ext Mix Center Freq

Sets the center frequency to use when the External Mixer is selected, even if the External Mixer input is not the selected input at the time the command is sent. Note that **Center Frequency** in the **Frequency** menu on the front panel always applies to the currently selected input.

Remote Command	<code>[:SENSe] :FREQuency:EMIXer:CENTer <freq></code> <code>[:SENSe] :FREQuency:EMIXer:CENTer?</code>
Example	<code>:FREQ:EMIX:CENT 60 GHz</code> <code>:FREQ:EMIX:CENT?</code>
Notes	This command is the same in all Modes, but the parameter is Measurement Global, so the value is independent in each Mode and common across all the measurements in the Mode
Couplings	When returning to External Mixing after having been switched to one of the other inputs (for example, RF), you will return to the settings that you had when you left External Mixing, so you will return to the band you were in with the Center Frequency that you had. However, Span is not an input-dependent parameter, so the Span setting from the other input will be retained. Therefore, the instrument retains the Span from the previous input, limited as necessary by the current mixer setup
Preset	When a Mode Preset is performed while in External Mixing, the Start frequency of the current Mode is set to the nominal Min Freq of the lowest harmonic range in the Harmonic Table for the current mixer setup. Similarly, the Stop frequency of the current Mode is set to the nominal Max Freq of the highest harmonic range in the Harmonic Table. Center Frequency thus presets to the point arithmetically equidistant from these two frequencies Note that, if the current measurement has a limited Span available to it, and cannot achieve the Span shown in the table ($\text{Span} = \text{Stop Freq} - \text{Start Freq}$), the instrument uses the maximum Span the measurement allows, and still sets Center Frequency to the midpoint of the Start and Stop Freq values in the Harmonic Table When Restore Input/Output Defaults is performed, the mixer presets to the 11970A, whose Start and Stop frequencies are 26.5 and 40 GHz respectively. The center of these two frequencies is 33.25 GHz Therefore, after Restore Input/Output Defaults , if you switch to External Mixing and do a Mode Preset while in Spectrum Analyzer Mode, the resulting Center Frequency is 33.25 GHz
State Saved	Yes
Min	The minimum frequency in the currently selected mixer band + 5 Hz If the knob or step keys are being used, also depends on Span
Max	The maximum frequency in the currently selected mixer band - 5 Hz If the knob or step keys are being used, also depends on Span

I/Q Center Freq

Sets the center frequency to use when the I/Q input is selected, even if the I/Q input is not the selected input at the time the command is sent. Note that **Center Frequency** in the **Frequency** menu on the front panel always applies to the currently selected input.

Remote Command	<code>[:SENSe] :FREQuency :IQ :CENTer <freq></code> <code>[:SENSe] :FREQuency :IQ :CENTer ?</code>
Example	<code>:FREQ :IQ :CENT 30 MHz</code>
Notes	This command is the same in all Modes, but the parameter is Measurement Global, so the value is independent in each Mode and common across all the measurements in the Mode
Preset	0 Hz
State Saved	Saved in instrument state
Min	-40.049995 MHz
Max	40.049995 MHz

CF Step

Changes the step size for "**Center Frequency**" on page 1465, and start and stop frequency functions. Once a step size has been selected and the **Center Frequency** function is active, the step keys (and the **UP | DOWN** parameters for **Center Frequency** from remote commands) change the center frequency by the step-size value. The step size function is useful for finding harmonics and sidebands beyond the current frequency span of the instrument.

Note that the start and stop frequencies also step by the **CF Step** value.

Remote Command	<code>[:SENSe] :FREQuency :CENTer :STEP [:INCRe ment] <freq></code> <code>[:SENSe] :FREQuency :CENTer :STEP [:INCRe ment] ?</code> <code>[:SENSe] :FREQuency :CENTer :STEP :AUTO OFF ON 0 1</code> <code>[:SENSe] :FREQuency :CENTer :STEP :AUTO ?</code>
Example	<code>:FREQ :CENT :STEP 500 MHz</code> increases the current center frequency value by 500 MHz <code>:FREQ :CENT UP</code> <code>:FREQ :CENT :STEP ?</code> <code>:FREQ :CENT :STEP :AUTO ON</code> <code>:FREQ :CENT :STEP :AUTO ?</code>
Notes	Preset and Max values depend on Hardware Options
Dependencies	Not available in the MSR, LTE-A FDD/TDD and 5G NR Modes If the electronic/soft attenuator is enabled, any attempt to change the value of the Center Frequency

	>3.6 GHz by pressing the Up -arrow key, fails and results in an advisory message. If the equivalent SCPI command is sent, this same message is generated as part of a “-221, Settings conflict” warning
Couplings	When auto-coupled, the center frequency step size is set to 10% of the span
Preset	Auto ON
State Saved	Saved in instrument state
Min/Max	-/+ (The maximum frequency of the instrument) That is, 27 GHz max freq instrument has a CF step range of +/- 27 GHz. Note that this is the maximum frequency given the current settings of the instrument, so in External Mixing, for example, it is the maximum frequency of the current mixer band
Status Bits/OPC dependencies	non-overlapped

3.9.17 Marker

Enables you to select, set up and control the markers for the current measurement. If there are no active markers, **Marker** selects Marker 1, sets it to **Normal (POSITION)** and places it at the center of the display. If the selected marker is **OFF**, it is set to **Normal** and placed at the center of the screen, on the trace determined by the **Marker Trace** rules.

3.9.17.1 Select Marker

Specifies the selected marker. The term “selected marker” is used throughout this document to specify which marker will be affected when you change marker settings, perform a Peak Search, etc.

This control appears above the menu panel, indicating that it applies to all controls in the **Marker** menu panels. **Select Marker** is blanked if you select a tab whose controls do *not* depend on the selected marker (for example, **Counter**).

In any menu that includes **Select Marker**, the first control is always **Marker Frequency|Time**.

Notes	The selected marker is remembered even when not in the Marker menu and is used if a search is done, or a Band Function is turned on, or for Signal Track or Continuous Peak
Preset	Marker 1
State Saved	The number of the selected marker is saved in instrument state
Annunciation	Appears in the marker results block label for Normal marker

3.9.17.2 Settings

The controls on this tab include the Marker active function and a radio button selection of the marker control mode (**Normal**, **Delta** or **Off**) for the selected marker, as well as additional functions that help you use markers.

Marker Frequency

Sets the marker X-Axis value in the current marker X-Axis Scale unit. Has no effect if the control mode is **Off**, but is the SCPI equivalent of entering an X value if the control mode is **Normal**.

Remote Command	<code>:CALCulate:SEMask:MARKer[1] 2 ... 12:X <freq></code> <code>:CALCulate:SEMask:MARKer[1] 2 ... 12:X?</code>
Example	<code>:CALC:SEM:MARK3:X 1.0 GHz</code> <code>:CALC:SEM:MARK3:X?</code>
Notes	If no suffix is sent, uses the fundamental units for the current marker X-Axis Scale. If a suffix is sent that does not match the current marker X-Axis Scale unit, an error "Invalid suffix" is generated The query returns the marker's absolute X-Axis value if the control mode is Normal , or the offset from the marker's reference marker if the control mode is Delta . The query is returned in the fundamental units for the current marker X-Axis scale: Hz for Frequency and Inverse Time , seconds for Period and Time
Preset	After a preset, all markers are turned OFF , so the query returns Not A Number (NAN)
State Saved	Saved in instrument state
Min	-9.9E+37
Max	9.9E+37
Annotation	Mkr # <X value> and <Marker value> upper right on graph

Marker X Axis Position (Remote Command Only)

Sets the marker X-Axis Scale position in trace points. This setting has no effect if the control mode is **Off**, but is the SCPI equivalent of entering a value if the control mode is **Normal** or **Delta** - except in trace points rather than X-Axis Scale units. The entered value is immediately translated into the current X-Axis Scale units for setting the value of the marker.

Remote Command	<code>:CALCulate:SEMask:MARKer[1] 2 ... 12:X:POStion <real></code> <code>:CALCulate:SEMask:MARKer[1] 2 ... 12:X:POStion?</code>
Example	<code>:CALC:SEM:MARK10:X:POS 1001</code> <code>:CALC:SEM:MARK10:X:POS?</code>
Notes	The query returns the marker's absolute X Axis value in trace points if the control mode is Normal , or

	the offset from the marker's reference marker in trace points if the control mode is Delta . The value is returned as a real number, not an integer, corresponding to the translation from X-Axis Scale units to trace points . When a Marker is turned on, it is placed center of the screen on the trace. Therefore, the default value depends on instrument condition. If the marker is Off , the response is Not A Number
Preset	After a preset, all markers are turned OFF , so the query returns Not A Number (NAN)
State Saved	Saved in instrument state
Min	-9.9E+37
Max	9.9E+37

Marker Y Axis Value (Remote Command only)

Returns the marker Y-Axis value in the current marker Y Axis unit.

Remote Command	<code>:CALCulate:SEMask:MARKer[1] 2 ... 12:Y?</code>
Example	<code>:CALC:SEM:MARK11:Y?</code>
Notes	The query returns the marker Y-Axis result, if the control mode is Normal . If the marker is Off , the response is Not A Number
Preset	Result depends on Markers setup and signal source
State Saved	No
Backwards Compatibility SCPI	<code>:CALCulate:SEMask:MARKer[1] 2 ... 12:FUNCTION:RESult?</code>

Marker Mode

Sets the marker control mode to **POSITION** (**Normal**) or **OFF**.

If the selected marker is **OFF**, pressing **Marker** sets it to **POSITION** and places it at the center of the screen, on the trace determined by the **Marker Trace** rules. At the same time, **Marker X Axis Value** appears on the Active Function area. If the current control mode for the measurement is **OFF**, there is no active function, and the active function is turned off.

Remote Command	<code>:CALCulate:SEMask:MARKer[1] 2 ... 12:MODE POSITION OFF</code> <code>:CALCulate:SEMask:MARKer[1] 2 ... 12:MODE?</code>
Example	<code>:CALC:SEM:MARK:MODE POS</code> <code>:CALC:SEM:MARK:MODE?</code>
Notes	Default Active Function: the active function for the selected marker's current control mode. If the current control mode is OFF , there is no active function, and the active function is turned off
Preset	<code>OFF OFF OFF OFF OFF OFF OFF OFF OFF OFF OFF OFF</code>

State Saved	Saved in instrument state
Range	POSITION OFF
Annotation	Mkr# <X value> and <Marker value> upper right of graph

All Markers Off

Turns off all markers.

Remote Command	:CALCulate:SEMAsk:MARKer:AOff
Example	:CALC:SEM:MARK:AOff

Couple Markers

When this function is **ON**, moving any marker causes an equal X-Axis movement of every other marker that is not **OFF**. By “equal X-Axis movement” we mean that we preserve the difference between each marker’s X-Axis value (in the fundamental X-Axis units of the trace that marker is on) and the X-Axis value of the marker being moved (in the same fundamental X-Axis units).

This may result in markers going off screen.

Remote Command	:CALCulate:SEMAsk:MARKer:COUple[:STATe] ON OFF 1 0 :CALCulate:SEMAsk:MARKer:COUple[:STATe]?
Example	:CALC:SEM:MARK:COUP ON :CALC:SEM:MARK:COUP?
Preset	OFF Preset by Mode Preset and All Markers Off
State Saved	Saved in instrument state

3.9.17.3 Properties

The controls on this tab are used to set certain properties of the selected marker.

Marker Frequency

This is the fundamental control that you use to move a marker around on the trace. This is the same as **"Marker Frequency" on page 1472** in the **Settings** tab.

Marker Trace

Selects the trace on which you want your marker placed. A marker is associated with one and only one trace. This trace is used to determine the placement, result, and X-Axis Scale of the marker. All markers have an associated trace; it is from that trace that they determine their attributes and behaviors, and it is to that trace that they go when they become Normal markers.

Specifying a Marker Trace manually or with this command associates the marker with the specified trace. If the marker is not **OFF**, it moves the marker from the trace it was on to the new trace. If the marker is **OFF** it stays off but is now associated with the specified trace.

The query returns the number of the trace on which the marker is currently placed.

Remote Command	<code>:CALCulate:SEMask:MARKer[1] 2 ... 12:TRACe 1 2 3</code> <code>:CALCulate:SEMask:MARKer[1] 2 ... 12:TRACe?</code>
Example	<code>:CALC:SEM:MARK2:TRAC 2</code> <code>:CALC:SEM:MARK2:TRAC?</code>
Notes	A marker may be placed on a blanked and/or inactive trace, even though the trace is not visible and/or updating An application may register a trace name to be displayed on the control instead of a trace number
Couplings	The state of Marker Trace is not affected by " Auto Couple " on page 1825 Sending the remote command causes the addressed marker to become selected
Preset	1
State Saved	Saved in instrument state

3.9.18 Meas Setup

Contains functions for setting up the measurement parameters and also contains functions for setting up parameters global to all measurements in the Mode.

3.9.18.1 Settings

Contains frequently used **Meas Setup** functions to which you will want the fastest access.

Avg/Hold Num

Toggles averaging On or Off, in addition to enabling you to set the number of measurement averages used to calculate the measurement result. The average is

displayed at the end of each sweep. After the specified number of average counts, the average mode (termination control) setting determines the average action.

In the remote mode, use "[Averaging On/Off](#)" on page 1477 to turn Averaging on or off.

Remote Command	<code>[:SENSe] :SEMAsk :AVERage :COUNT <integer></code> <code>[:SENSe] :SEMAsk :AVERage :COUNT?</code>
Example	<code>:SEM:AVER:COUN 100</code> <code>:SEM:AVER:COUN?</code>
Preset	10
State Saved	Saved in instrument state
Min/Max	1/10000

Continue Averaging

Designed for acquiring the trace averaging multiple sets of DUT conditions, in order to meet requirements such as OTA measurement.

NOTE

You must be in **Single** sweep/measurement to use **Continue Averaging**. Go to **Single** and press **Restart** to get your first set of averages, then **Continue Averaging** will be available.

Use `:FETCh:<meas>?` to retrieve the data as it waits for completion of **Continue Averaging**. `*OPC?` Does *not* wait for completion and returns true immediately.

Pressing this control adds a number of Averages that matches the "[Avg/Hold Num](#)" on page 1475 to the already averaged trace or measurement. Every time you press it, the terminal count increases to 2N, 3N and so on. You can change the DUT position or antenna when each set of average count is reached to the terminal count and the measurement is complete.

Since the measurement results are valid for each completed set of average conditions, there is no need to predetermine the number of sets of DUT conditions.

Remote Command	<code>[:SENSe] :SEMAsk :AVERage :CONTinue</code>
Example	<code>:SEM:AVER:CONT</code>
Dependencies	Enabled when you change the Sweep mode to Single , and the Average Count reaches the Average Number. Otherwise, grayed-out

SEM Terminal Count (Remote Query Only)

Returns the terminal count that shows the target average number after **Continue Averaging** is pressed. Every time you press **Continue Averaging**, the terminal count

3 VMA Mode
3.9 SEM Measurement

increases to 2N, 3N and so on. The value is the same as "Avg/Hold Num" on page 1475 unless **Continue Averaging** is pressed, and it is reset to match the Avg|Hold Number when **Restart** is pressed.

Remote Command	<code>[:SENSe]:SEMAsk:AVERage:COUNT:TERMinal?</code>
Example	<code>:SEM:AVER:COUN:TERM?</code>

Averaging On/Off

Turns Averaging on or off.

NOTE

In this measurement, **Average Type** is preset to the [Log-Pwr Avg \(Video\)](#) method. Other averaging methods are not available.

Remote Command	<code>[:SENSe]:SEMAsk:AVERage[:STATe] ON OFF 1 0</code> <code>[:SENSe]:SEMAsk:AVERage[:STATe]?</code>
Example	<code>:SEM:AVER ON</code> <code>:SEM:AVER?</code>
Preset	OFF
State Saved	Saved in instrument state
Range	ON OFF

Meas Method

Sets the measurement method:

Method	Option	Description
Integration BW	0 OFF	Enables you to set the channel integration bandwidth
RRC Weighted	1 ON	Selects Root Raised Cosine (RRC) filtering of the carriers. The a value (rolloff) for the filter is set to the value of the Filter Alpha parameter

Remote Command	<code>[:SENSe]:SEMAsk:FILTer[:RRC][:STATe] OFF ON 0 1</code> <code>[:SENSe]:SEMAsk:FILTer[:RRC][:STATe]?</code>
Example	<code>:SEM:FILT ON</code> <code>:SEM:FILT?</code>
Dependencies	WLAN: RRC Weight is not supported when the radio standard is WLAN 802.11ac (80+80MHz)
Preset	SA, LTEAFDD, LTEATDD, 5G NR, WLAN, MSR Modes OFF WCDMA Mode ON

State Saved	Saved in instrument state
Range	Integration BW RRC Weighted

RRC Filter Alpha

Sets the alpha value for the RRC Filter.

Remote Command	<code>[:SENSe]:SEMAsk:FILTer[:RRC]:ALPHa <real></code> <code>[:SENSe]:SEMAsk:FILTer[:RRC]:ALPHa?</code>
Example	<code>:SEM:FILT:ALPH 0.3</code> <code>:SEM:FILT:ALPH?</code>
Preset	0.22
State Saved	Saved in instrument state
Min/Max	0.01/1.0

Non-Contiguous Meas Region

Selects the region to measure for the non-contiguous frequency allocation.

Option	SCPI	Comments
Outer	<code>OUTer</code>	
Inner	<code>INNER</code>	
Outer & Inner	<code>OINNER</code>	Available only in 5G NR and LTE-Advanced FDD/TDD Modes

Remote Command	<code>[:SENSe]:SEMAsk:NCONtiguous:REGion INNER OUTER OINNER</code> <code>[:SENSe]:SEMAsk:NCONtiguous:REGion?</code>
Example	<code>:SEM:NCON:REG INN</code> <code>:SEM:NCON:REG?</code>
Dependencies	Available only in MSR, 5G NR and LTE-Advanced FDD/TDD Modes <code>OINNER</code> is available only in 5G NR and LTE-Advanced FDD/TDD Modes
Preset	<code>INNER</code>
State Saved	Yes
Range	Inner Outer Outer & Inner

Sweep Type Rules

Selects which set of rules will be used for automatic selection of "Sweep Type" on [page 1504](#) when Sweep Type mode is Auto.

Rule	Option	Description
Best Dynamic Range	DRANge	The instrument selects either swept or FFT analysis with the primary goal of dynamic range optimization. If the dynamic range of swept and FFT is very close, then it chooses the faster one. In determining the Swept or FFT setting, the auto rules use the following approach: <ul style="list-style-type: none"> - If the RBW > 210 Hz, use swept; for the RBW <= 210 Hz, use FFT - If Sweep Time Mode is Man, the Sweep Type is always Swept for backwards compatibility
Best Speed	SPEed	The instrument selects either FFT or swept analysis based on the fastest instrument speed
Remote Command	[:SENSe]:SEMAsk:SWEEp:TYPE:AUTO:RULEs SPEed DRANge [:SENSe]:SEMAsk:SWEEp:TYPE:AUTO:RULEs?	
Dependencies	In modular products such as VXT, the value is always set to Best Dynamic Range and this control does not appear	
Preset	DRANge	
State Saved	Saved in instrument state	

Mask State

Only appears in WLAN Mode.

The mask lines can be drawn in two different ways, according to the WLAN standard when the control's value is **Standard (STD)**; or by the user-defined specifications listed in the **Offset/Limits** menu.

Remote Command	[:SENSe]:SEMAsk:MASK[:STATE] STD MAN [:SENSe]:SEMAsk:MASK[:STATE]?	
Example	:SEM:MASK:STATE STD :SEM:MASK:STATE?	
Couplings	<p>When the value is STD, the parameters displayed on the Offset/Limits menu are automatically changed according to WLAN standard</p> <p>If you manually modify any parameter in the Offset/Limits menu, then Limit State will be coupled to Manual (MAN)</p> <p>If you recall a mask file or state file, Limit State will be coupled to MAN</p> <p>If WLAN radio standard is changed, Limit State will be preset to STD</p> <p>When the value of Limit State is STD, and Radio Standard is 11ac 80+80 MHz, the channel span will be set to the value satisfying the equation below if its previous value is less than the value calculated through the equation</p> <p>Chan Span = spacing between the two carriers + Chan IntegBW</p>	

Preset	STD
State Saved	Saved in instrument state
Range	STD MAN
Backwards Compatibility SCPI	[:SENSe]:SEMAsk:LIMits STD MAN
Notes	ON aliases to STD OFF aliases to MAN
Range	Auto Man
Backwards Compatibility SCPI	[:SENSe]:SEMAsk:T80Mask:AUTO ON OFF 1 0 [:SENSe]:SEMAsk:T80Mask:AUTO?

Mask Standard

Allows you to select various masks according to region-specific standards. Only appears in WLAN Mode.

Mask Selected	Example	Mask used as auto standard mask
IEEE	:SEM:LIM:STAN IEEE	Mask defined in IEEE 802.11-2012 standard
FCC Class A	:SEM:LIM:STAN FCA	Mask defined in FCC 11p standard for STA transmit power class A
FCC Class B	:SEM:LIM:STAN FCB	Mask defined in FCC 11p standard for STA transmit power class B
FCC Class C	:SEM:LIM:STAN FCC	Mask defined in FCC 11p standard for STA transmit power class C
FCC Class D	:SEM:LIM:STAN FCD	Mask defined in FCC 11p standard for STA transmit power class D
ETSI CCH SCH1/5/6	:SEM:LIM:STAN ESCH1	Mask defined in ETSI 11p standard for G5-CCH, G5-SCH1, G5-SCH5 and G5-SCH6 channels
ETSI SCH2/3	:SEM:LIM:STAN ESCH2	Mask defined in ETSI 11p standard for G5-SCH2 and G5-SCH3 channels
ETSI SCH4	:SEM:LIM:STAN ESCH4	Mask defined in ETSI 11p standard for G5-SCH4 channel

Remote Command	[:SENSe]:SEMAsk:LIMits:STANdard IEEE FCA FCB FCC FCD ESCH1 ESCH2 ESCH4 [:SENSe]:SEMAsk:LIMits:STANdard?
Example	:SEM:LIM:STAN IEEE
Dependencies	Only available in WLAN Mode

	Grayed-out if Radio Standard is <i>not</i> 802.11a/g/j/p 20MHz, 802.11j/p 10MHz, 802.11p 5MHz The ETSI masks are grayed-out if Radio Standard is <i>not</i> 802.11j/p 10M
Preset	IEEE
State Saved	Saved in instrument state

Spur Avoidance

Because VXT models M9410A/11A/15A are direct-conversion (zero-IF) receivers, feedthrough leakage from the local oscillator appears as a spurious signal (spur) at the Center Frequency. The **Spur Avoidance** function is provided to eliminate this spur, at the expense of some measurement speed. For Spur Avoidance, the instrument uses a software algorithm to remove this spur from the displayed measurement data.

Some measurements allow you to turn off **Spur Avoidance**, but in this measurement it is always enabled. Therefore, the **Spur Avoidance** switch is unavailable (grayed-out) and set to **ON**.

If you press the grayed-out switch, a popup message appears stating:

Always enabled in this measurement. See manual for details

Remote Command	[:SENSe]:SEMAsk:SAVoid[:STATe]?
Example	:SEM:SAV? Always returns ON
Dependencies	Only appears in VXT models M9410A/11A/15A
Preset	ON
State Saved	Saved in instrument state
Range	ON

Offset/Limits Config Table

Enables you to set up the measurement parameters for offset pairs and to set the power limits for start and stop frequencies of the selected offsets. For example, you can assign the start and stop frequencies, select the resolution bandwidth, and set the sweep time.

Before UE, the LTE-Advanced FDD/TDD standards gave the test specification requirements for BS intra-band contiguous aggregation and intra-band non-contiguous aggregation modes. However, for UE, only the requirements of intra-band contiguous aggregation modes are defined. So, the standards don't support making the measurement in UE intra-band non-contiguous aggregation mode for LTE-Advanced FDD/TDD. As a result, the preset values of Inner Offset/Limits are temporarily set as those of Outer Offset/Limits for UE.

Limits for Inner Offsets

Since inner offsets are defined from the sub-block edges to the gap, limits from two sub-blocks overlap each other. Therefore, the limit used for inner offsets are the cumulative sum of limits from both sub-blocks. Offsets can have different RBWs, which must be compensated when accumulated.

For example, when offset A and D overlap, the limit of offset A is calculated as follows.

$$\text{Cumulated Limit of Offset A} = 10^{\frac{[\text{Offset A Limit in dBm}]}{10}} + \frac{\text{Offset A RBW}}{\text{Offset D RBW}} 10^{\frac{[\text{Offset D Limit in dBm}]}{10}}$$

The diagram below depicts what inner offset limits look like.

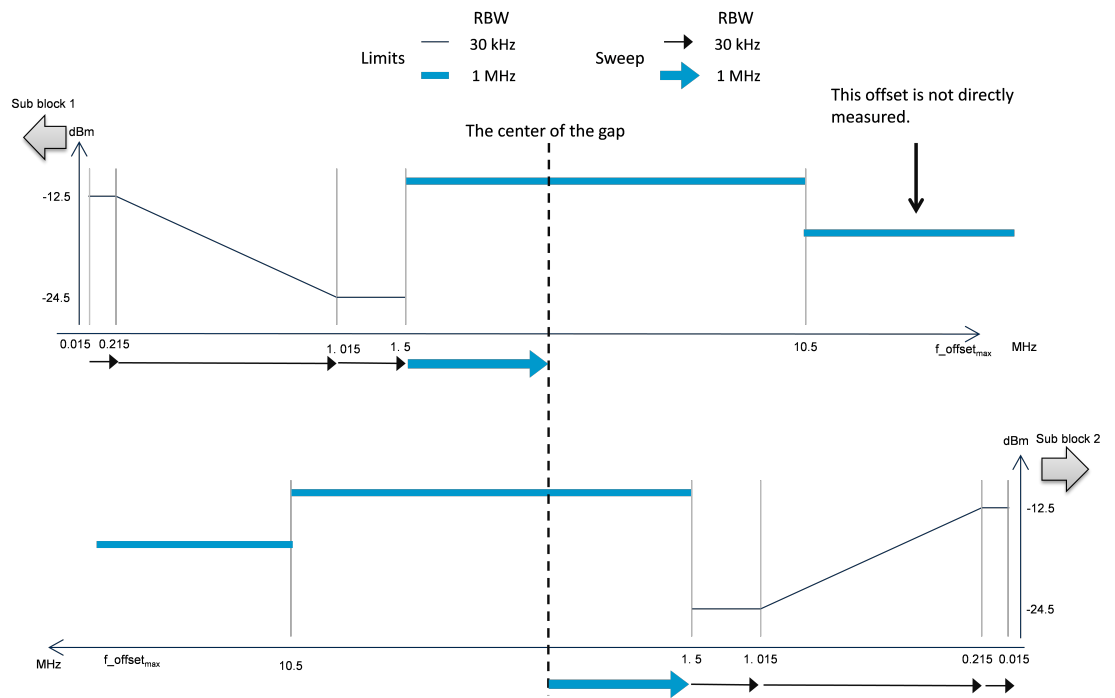

Offset (Bandwidth)

Enables you to set up the bandwidth measurement parameters for offset pairs. For example, you can assign the start and stop frequencies, and select the resolution bandwidth.

Offset Freq Define

Enables you to select offset frequency definition. Each standard defines each offset frequency from Carrier.

For example, 3GPP2 requires the “Carrier Center to Meas BW Edge” definition. LTE conformance test requires “Carrier Edge to Meas BW Center” and/or “Carrier Edge to Meas BW Edge” definition. The MSR standard requires “RF BW Edge to Meas BW Center” and/or “RF BW Edge to Meas Edge” definition.

“Meas BW Edge” means the edge frequency of resolution bandwidth closer to the carrier that is represented by Meas BW and Res BW settings. Actual center frequency of Meas BW and the limit line have $\frac{1}{2}$ Meas BW offset when the Meas BW Edge is selected.

Note that the outermost (lowermost, uppermost) carrier at each side is determined by which carrier edge frequency is located outermost within the RF BW or each sub-block bandwidth, instead of which carrier center frequency is located outermost.

See also "[Diagrams for Offset Freq Define](#)" on page 1485.

Modes other than MSR, LTE-A, 5G NR

Options:

CTOCenter	From carrier center to the center of offset measuring filter*
CTOEdge	From carrier center to the nominal -3 dB point of the offset measuring filter* closer to the carrier
ETOCenter	From Center Frequency - Span of Ref Channel / 2 (for lower offset), Center Frequency + Span of Ref Channel / 2 (for upper offset) of the carrier closest to each offset to the center of offset measuring filter *
ETOEdge	From Center Frequency - Span of Ref Channel / 2 (for lower offset), Center Frequency + Span of Ref Channel / 2 (for upper offset) of the carrier closest to each offset to the nominal -3 dB point of the offset measuring filter * closer to the carrier

*Measuring filter = Meas BW (N) x Res BW

** RF BW = $BW_{\text{channel,CA}}$ which is defined in each 3GPP standard, regardless of “Measure Carrier” for the uppermost and the lowermost carriers being Enabled or Disabled. When **Number of Component Carriers** = 1, RF BW = $BW_{\text{channel}} = 2 \times F_{\text{offset,RAT}}$

Remote Command	<code>[:SENSe]:SEMAsk:OFFSet[1] 2:TYPE CTOCenter CTOEdge ETOCenter ETOEdge</code>
Example	<code>:SEM:OFFS:TYPE ETOC</code>

	:SEM:OFFS:TYPE?
Notes	OFFSet1 is for BTS, 2 for MS. Default is BTS Note that Offset sub op code 2 is supported only in non-SA Modes. In SA Mode, Offset sub op code 1 is used for both BTS and MS
Preset	CTOCenter
State Saved	Saved in instrument state
Range	Carrier Center to Meas BW Center Carrier Center to Meas BW Edge Carrier Edge to Meas BW Center Carrier Edge to Meas BW Edge

Mode: MSR, LTEAFDD, LTEATDD

Options:

CTOCenter	From the lowermost carrier center frequency (for lower offset), the uppermost carrier center frequency (for upper offset) to the center of offset measuring filter*
CTOEdge	From the lowermost carrier center frequency (for lower offset), the uppermost carrier center frequency (for upper offset) to the nominal -3 dB point of the offset measuring filter* closer to the carrier
ETOCenter	From the lowermost carrier center frequency - spacing of this carrier /2 (for lower offset), the uppermost carrier center frequency + spacing of this carrier /2 (for upper offset) to the center frequency of offset measuring filter*
ETOEdge	From the lowermost carrier center frequency - spacing of this carrier /2 (for lower offset), the uppermost carrier center frequency + spacing of this carrier /2 (for upper offset) to the nominal -3 dB point of the offset measuring filter* closer to the carrier
RTOCenter	From either the lower or upper RF BW** edge frequency to the center frequency of offset measuring filter*
RTOEdge	From either the lower or upper RF BW** edge frequency to the nominal -3 dB point of the offset measuring filter* closer to the carrier
RCTOCenter 5G NR Mode only	From the center frequency of RF BW to the center frequency of offset measuring filter*

*Measuring filter = Meas BW (N) x Res BW

** RF BW = $BW_{channel,CA}$ which is defined in each 3GPP standard, regardless of "Measure Carrier" for the uppermost and the lowermost carriers being Enabled or Disabled. When **Number of Component Carriers** = 1, RF BW = $BW_{channel} = 2 \times F_{offset,RAT}$

Remote Command	[:SENSe]:SEMAsk:OFFSet[1] 2[:OUTer]:TYPE CTOCenter CTOEdge ETOCenter ETOEdge RTOCenter RTOEdge [:SENSe]:SEMAsk:OFFSet[1] 2[:OUTer]:TYPE?
----------------	---

3 VMA Mode
3.9 SEM Measurement

Example	<code>:SEM:OFFS:TYPE ETOC</code> <code>:SEM:OFFS:TYPE?</code>
Notes	OFFSet1 is for BTS, 2 for MS. Default is BTS
Preset	MSR: RTOCenter LTEAFDD, LTEATDD: ETOCenter
State Saved	Saved in instrument state
Range	Carrier Center to Meas BW Center Carrier Center to Meas BW Edge Carrier Edge to Meas BW Center- Carrier Edge to Meas BW Edge RF BW Edge to Meas BW Center RF BW Edge to Meas BW Edge

Mode: 5G NR

Options: see "[Mode: MSR, LTEAFDD, LTEATDD](#)" on page 1484 above.

Remote Command	<code>[:SENSe] :SEMAsk:OFFSet[1] 2 [:OUTer] :TYPE CTOCenter CTOEdge ETOCenter ETOEdge RTOCenter RTOEdge RCTOCenter</code> <code>[:SENSe] :SEMAsk:OFFSet[1] 2 [:OUTer] :TYPE?</code>
Example	<code>:SEM:OFFS:TYPE ETOC</code> <code>:SEM:OFFS:TYPE?</code>
Notes	OFFSet1 is for BTS, 2 for MS. Default is BTS
Preset	ETOCenter
State Saved	Saved in instrument state
Range	Carrier Center to Meas BW Center Carrier Center to Meas BW Edge Carrier Edge to Meas BW Center- Carrier Edge to Meas BW Edge RF BW Edge to Meas BW Center RF BW Edge to Meas BW Edge RF BW Center to Meas BW Center

Diagrams for Offset Freq Define

Details depend on the selected mode.

Diagrams for Modes other than MSR, LTEAFDD/LTEATDD, 5G NR

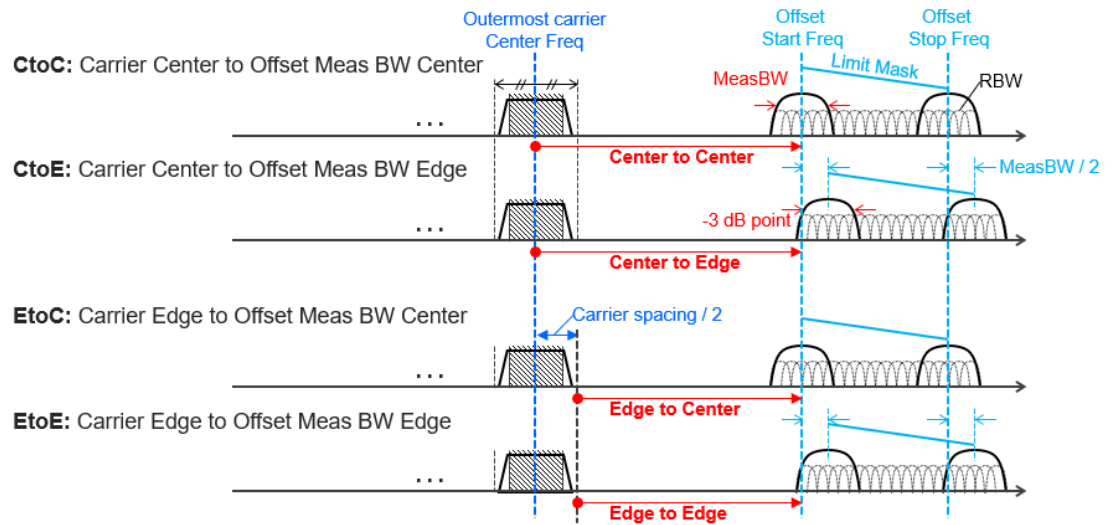

Note:
• $MeasBW = N \times RBW$

Diagrams for MSR, LTEAFDD/LTEATDD, 5G NR

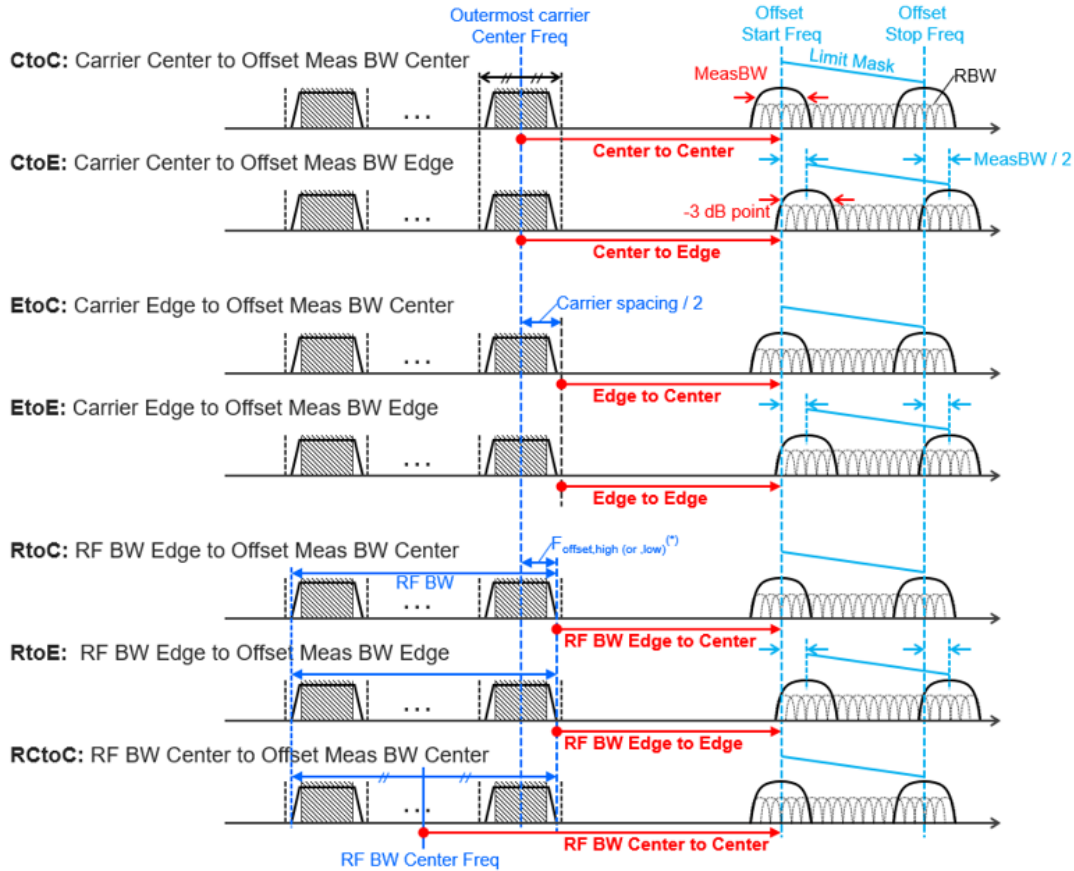

Notes:

- $MeasBW = N \times RBW$
- RF BW Edge and Outermost Carrier Edge are not always same. e.g.) 5G NR (3GPP) defines $BW_{channel, CA}$ which calculates $F_{offset, high}$ and $F_{offset, low}$ asymmetrically with SCS shift. (*) For MSR, $F_{offset, high (or, low)} = F_{offset, RAT, high (or, low)}$

Offset Detector

Enables you to control the detector for offsets. The following choices are available:

- AUTO** The detector selected depends on marker functions, trace functions, average type, and the trace averaging function
- NORMa1** The detector determines the peak of the CW-like signals, and it yields alternating maximums and minimums of noise-like signals. This is also referred to as Rosenfell detection
- AVERage** The detector determines the average of the signal within the sweep points. The

	averaging method depends upon the Average Type selection (voltage, power or log scales)
POSitive Peak	The detector determines the maximum of the signal within the sweep points
SAMPle	The detector indicates the instantaneous level of the signal at the center of the sweep points represented by each display point
NEGative Peak	The detector determines the minimum of the signal within the sweep points

Remote Command	<code>[:SENSe]:SEMAsk:DETEctor:OFFSet[:FUNction] AVERage NEGative NORMal POSitive SAMPle</code> <code>[:SENSe]:SEMAsk:DETEctor:OFFSet[:FUNction]?</code> <code>[:SENSe]:SEMAsk:DETEctor:OFFSet:AUTO ON OFF 1 0</code> <code>[:SENSe]:SEMAsk:DETEctor:OFFSet:AUTO?</code>
Example	<code>:SEM:DET:OFFS AVER</code> <code>:SEM:DET:OFFS?</code> <code>:SEM:DET:OFFS:AUTO OFF</code> <code>:SEM:DET:OFFS:AUTO?</code>
Notes	When you manually select a detector (instead of selecting Auto), that detector is used regardless of other instrument settings Note that this detector setting affects all offsets; there is no per-trace detector
Couplings	See Couplings in "Trace Type" on page 1737
Preset	<code>POSitive</code> <code>ON</code>
State Saved	Saved in instrument state
Range	<code>AVERage NEGative NORMal POSitive SAMPle</code>

Offset Average Type (Remote Command Only)

Select trace average type for the offsets.

Remote Command	<code>[:SENSe]:SEMAsk:AVERage:OFFSet:TYPE RMS LOG</code> <code>[:SENSe]:SEMAsk:AVERage:OFFSet:TYPE?</code>
Example	<code>:SEM:AVER:OFFS:TYPE LOG</code> <code>:SEM:AVER:OFFS:TYPE?</code>
Preset	<code>RMS</code>
State Saved	Saved in instrument state

Start Freq

Specifies the start frequency for the currently selected offset. Also enables you to toggle that offset between On and Off.

When sending the remote command, missing values are not permitted; that is, if you want to change values 2 and 6, you must send all values up to 6. Subsequent values will remain unchanged. The query for this parameter returns 14 values for WLAN mode, 12 values for other modes.

Remote Command	<pre>[:SENSe]:SEMAsk:OFFSet[1] 2[:OUTer]:LIST:FREQuency:STARt <freq>, ... [:SENSe]:SEMAsk:OFFSet[1] 2[:OUTer]:LIST:FREQuency:STARt? [:SENSe]:SEMAsk:OFFSet[1] 2[:OUTer]:LIST:STATe ON OFF 1 0, ... [:SENSe]:SEMAsk:OFFSet[1] 2[:OUTer]:LIST:STATe?</pre>												
Example	<pre>:SEM:OFFS2:LIST:FREQ:STAR 2.515 MHz, 2.715 MHz, 3.515 MHz, 4.00 MHz, 8.00 MHz, 12.50 MHz :SEM:OFFS2:LIST:FREQ:STAR? :SEM:OFFS:LIST:STAT ON, ON, ON, OFF, OFF, OFF :SEM:OFFS:LIST:STAT?</pre>												
Notes	<p>Comma-separated list of values OFFSet1 is for BTS, 2 for MS. Default is BTS Note that Offset sub op code 2 is supported only in non-SA Modes. In SA Mode, Offset sub op code 1 is used for both BTS and MS If the offset is outside of the frequency range, the result spectrum will be invalid</p>												
Couplings	Coupled to Stop Freq. When the start freq goes above the stop freq, the stop freq is automatically adjusted to the start freq plus 100 Hz												
Preset	<p>When the max number of offsets is 6:</p> <table border="1"> <thead> <tr> <th>Mode</th> <th>Values</th> </tr> </thead> <tbody> <tr> <td>SA</td> <td>2.515 MHz, 2.715 MHz, 3.515 MHz, 4.00 MHz, 8.00 MHz, 12.50 MHz</td> </tr> <tr> <td>WCDMA</td> <td>2.515 MHz, 2.715 MHz, 3.515 MHz, 4.000 MHz, 8.000 MHz, 12.50 MHz 2.515MHz, 4.000 MHz, 7.500 MHz, 8.500 MHz, 12.5 MHz, 15 MHz</td> </tr> </tbody> </table> <p>When the max number of offsets is 12 in these modes, the preset value of Offset G ~ L is the same as the Offset F value</p> <table border="1"> <thead> <tr> <th>Mode</th> <th>Values</th> </tr> </thead> <tbody> <tr> <td>MSR</td> <td>15 kHz, 215kHz, 1.015MHz, 1.5MHz, 10.5MHz, 15.00MHz, 30MHz, 30MHz, 30MHz, 30MHz, 30MHz 15kHz, 215kHz, 1.015MHz, 1.5MHz, 10.5MHz, 15.00MHz, 30MHz, 30MHz, 30MHz, 30MHz, 30MHz, 30MHz</td> </tr> <tr> <td>LTEAFDD,</td> <td>50 kHz, 5.05 MHz, 10.5 MHz, 15.00 MHz, 30 MHz, 40 MHz, 40 MHz, 40 MHz, 40</td> </tr> </tbody> </table>	Mode	Values	SA	2.515 MHz, 2.715 MHz, 3.515 MHz, 4.00 MHz, 8.00 MHz, 12.50 MHz	WCDMA	2.515 MHz, 2.715 MHz, 3.515 MHz, 4.000 MHz, 8.000 MHz, 12.50 MHz 2.515MHz, 4.000 MHz, 7.500 MHz, 8.500 MHz, 12.5 MHz, 15 MHz	Mode	Values	MSR	15 kHz, 215kHz, 1.015MHz, 1.5MHz, 10.5MHz, 15.00MHz, 30MHz, 30MHz, 30MHz, 30MHz, 30MHz 15kHz, 215kHz, 1.015MHz, 1.5MHz, 10.5MHz, 15.00MHz, 30MHz, 30MHz, 30MHz, 30MHz, 30MHz, 30MHz	LTEAFDD,	50 kHz, 5.05 MHz, 10.5 MHz, 15.00 MHz, 30 MHz, 40 MHz, 40 MHz, 40 MHz, 40
Mode	Values												
SA	2.515 MHz, 2.715 MHz, 3.515 MHz, 4.00 MHz, 8.00 MHz, 12.50 MHz												
WCDMA	2.515 MHz, 2.715 MHz, 3.515 MHz, 4.000 MHz, 8.000 MHz, 12.50 MHz 2.515MHz, 4.000 MHz, 7.500 MHz, 8.500 MHz, 12.5 MHz, 15 MHz												
Mode	Values												
MSR	15 kHz, 215kHz, 1.015MHz, 1.5MHz, 10.5MHz, 15.00MHz, 30MHz, 30MHz, 30MHz, 30MHz, 30MHz 15kHz, 215kHz, 1.015MHz, 1.5MHz, 10.5MHz, 15.00MHz, 30MHz, 30MHz, 30MHz, 30MHz, 30MHz, 30MHz												
LTEAFDD,	50 kHz, 5.05 MHz, 10.5 MHz, 15.00 MHz, 30 MHz, 40 MHz, 40 MHz, 40 MHz, 40												

Mode	Values
LTEATDD	MHz,40 MHz, 40 MHz, 40 MHz 15.00 kHz,1.5 MHz, 5.5 MHz, 6.5 MHz, 10 MHz, 20MHz, 20MHz, 20MHz, 20MHz, 20MHz, 20MHz, 20MHz
5G NR	50 kHz, 5.05 MHz, 10.5 MHz, 40.00 MHz, 100 MHz, 100 MHz, 100 MHz, 100 MHz, 100 MHz, 100 MHz, 100 MHz 15.00 kHz, 1.5 MHz, 5.5 MHz, 100.50 MHz, 105.00 MHz, 100 MHz, 100 MHz, 100 MHz, 100 MHz, 100 MHz, 100 MHz, 100 MHz

When the max number of offsets is 14 in these modes, the preset value of Offset G ~ N is the same as the Offset F value

WLAN Mode: See the table of "WLAN Mode Presets" on page 1490 below

When the max number of offsets is 6:

Mode	Values
SA	ON, ON, ON, ON, ON, OFF
WCDMA	ON, ON, ON, ON, ON, OFF ON, ON, ON, ON, OFF, OFF

When the max number of offsets is 12 in these modes, the preset value of Offset G ~ L is the same as the Offset F value

MSR	ON, ON, ON, ON, ON, OFF, OFF, OFF, OFF, OFF, OFF, OFF, OFF ON, ON, ON, ON, OFF, OFF, OFF, OFF, OFF, OFF, OFF
LTEAFDD, LTEATDD	ON, ON, ON, OFF, OFF, OFF, OFF, OFF, OFF, OFF, OFF, OFF, OFF ON, ON, ON, ON, OFF, OFF, OFF, OFF, OFF, OFF, OFF
5G NR	ON, ON, ON, ON, OFF, OFF, OFF, OFF, OFF, OFF, OFF, OFF, OFF ON, ON, ON, ON, OFF, OFF, OFF, OFF, OFF, OFF, OFF

When the max number of offsets is 14 in these modes, the preset value of Offset G ~ N is the same as the Offset F value

Mode	Values
WLAN	See the table of "WLAN Mode Auto Function Presets" on page 1492 below

State Saved	Saved in instrument state Saved in instrument state
Min/Max	0 Hz/Depends on instrument maximum frequency Always Offset Stop Freq - 100 Hz

WLAN Mode Presets

Radio Std	Presets
802.11a/g (OFDM/DSSS-OFDM)/802.11n (20MHz)	9 MHz, 11 MHz, 20 MHz, 30 MHz, 40 MHz, 216 MHz, 216 MHz, 216 MHz, 216 MHz, 216 MHz, 216 MHz, 216 MHz, 216 MHz

3 VMA Mode
3.9 SEM Measurement

Radio Std	Presets
802.11b/g (DSSS/CCK/PBCC)	11 MHz, 22 MHz, 50 MHz, 70 MHz, 90 MHz, 100 MHz, 100 MHz, 100 MHz, 100 MHz, 100 MHz, 100 MHz, 100 MHz, 100 MHz
802.11n(20MHz)	9 MHz, 11 MHz, 20 MHz, 30 MHz, 40 MHz, 100 MHz, 100 MHz, 100 MHz, 100 MHz, 100 MHz, 100 MHz, 100 MHz
802.11n(40MHz)	19 MHz, 21 MHz, 40 MHz, 60 MHz, 70 MHz, 100 MHz, 200 MHz, 200 MHz, 200 MHz, 200 MHz, 200 MHz, 200 MHz, 200 MHz
802.11ac(20MHz)	9 MHz, 11 MHz, 20 MHz, 30 MHz, 40 MHz, 40 MHz, 40 MHz, 40 MHz, 40 MHz, 40 MHz, 40 MHz, 40 MHz, 40 MHz
802.11ac(40MHz)	19 MHz, 21 MHz, 40 MHz, 60 MHz, 70 MHz, 70 MHz, 70 MHz, 70 MHz, 70 MHz, 70 MHz, 70 MHz, 70 MHz, 70 MHz
802.11ac(80MHz)	39 MHz, 41 MHz, 80 MHz, 120 MHz, 125 MHz, 125 MHz, 125 MHz, 125 MHz, 125 MHz, 125 MHz, 125 MHz, 125 MHz, 125 MHz
802.11ac(160MHz)	79 MHz, 81 MHz, 160 MHz, 240 MHz, 250 MHz, 250 MHz, 250 MHz, 250 MHz, 250 MHz, 250 MHz, 250 MHz, 250 MHz, 250 MHz
802.11ac(80 MHz + 80MHz)	0MHz, 0 MHz, 40 MHz, 79 MHz, 159 MHz, 161 MHz, 200 MHz, 240 MHz, 240 MHz, 240 MHz, 240 MHz, 240 MHz, 240 MHz
802.11ah(1MHz)	0.45 MHz, 0.6 MHz, 1 MHz, 1.5 MHz, 1.5 MHz, 1.5 MHz, 1.5 MHz, 1.5 MHz, 1.5 MHz, 1.5 MHz, 1.5 MHz, 1.5 MHz, 1.5 MHz
802.11ah(2MHz)	0.9 MHz, 1.1 MHz, 2 MHz, 3 MHz, 3 MHz, 3 MHz, 3 MHz, 3 MHz, 3 MHz, 3 MHz, 3 MHz, 3 MHz, 3 MHz
802.11ah(4MHz)	1.9 MHz, 2.1 MHz, 4 MHz, 6 MHz, 6 MHz, 6 MHz, 6 MHz, 6 MHz, 6 MHz, 6 MHz, 6 MHz, 6 MHz, 6 MHz
802.11ah(8MHz)	3.9 MHz, 4.1 MHz, 8 MHz, 12 MHz, 12 MHz, 12 MHz, 12 MHz, 12 MHz, 12 MHz, 12 MHz, 12 MHz, 12 MHz, 12 MHz
802.11ah(16MHz)	7.9 MHz, 8.1 MHz, 16 MHz, 24 MHz, 24 MHz, 24 MHz, 24 MHz, 24 MHz, 24 MHz, 24 MHz, 24 MHz, 24 MHz, 24 MHz
802.11j/p(10MHz)	4.5 MHz, 5MHz, 5.5 MHz, 10 MHz, 15 MHz, 216 MHz, 216MHz, 216 MHz, 216MHz, 216MHz, 216MHz, 216MHz, 216MHz
802.11p(5MHz)	2.25 MHz, 2.5MHz, 2.75 MHz, 5 MHz, 7.5 MHz, 216 MHz, 216MHz, 216 MHz, 216MHz, 216MHz, 216MHz, 216MHz, 216MHz
802.11ax/be(20MHz)	9.75 MHz, 10.5 MHz, 20 MHz, 30 MHz, 40 MHz, 40 MHz, 40 MHz, 40 MHz, 40 MHz, 40 MHz, 40 MHz, 40 MHz, 40 MHz
802.11ax/be(40MHz)	19.5 MHz, 20.5 MHz, 40 MHz, 60 MHz, 70 MHz, 70 MHz, 70 MHz, 70 MHz, 70 MHz, 70 MHz, 70 MHz, 70 MHz, 70 MHz
802.11ax/be(80MHz)	39.5 MHz, 40.5 MHz, 80 MHz, 120 MHz, 125 MHz, 125 MHz, 125 MHz, 125 MHz, 125 MHz, 125 MHz, 125 MHz, 125 MHz, 125 MHz
802.11ax/be(160MHz):	79.5 MHz, 80.5 MHz, 160 MHz, 240 MHz, 250 MHz, 250 MHz, 250 MHz, 250 MHz, 250 MHz, 250 MHz, 250 MHz, 250 MHz, 250 MHz
802.11ax(80 MHz + 80MHz)	0MHz, 0 MHz, 40 MHz, 79 MHz, 159 MHz, 161 MHz, 200 MHz, 240 MHz, 240 MHz, 240 MHz, 240 MHz, 240 MHz, 240 MHz
802.11af(6MHz)	2.85 MHz, 3.15 MHz, 6 MHz, 9 MHz, 9 MHz, 9 MHz, 9 MHz, 9 MHz, 9 MHz, 9 MHz, 9 MHz, 9 MHz, 9 MHz

Radio Std	Presets
	9 MHz, 9 MHz, 9 MHz, 9 MHz, 9 MHz
802.11af(7MHz)	3.325 MHz, 3.675 MHz, 7 MHz, 10.5 MHz, 10.5 MHz, 10.5 MHz, 10.5 MHz, 10.5 MHz, 10.5 MHz, 10.5 MHz, 10.5 MHz, 10.5 MHz, 10.5 MHz
802.11af(8MHz)	3.8 MHz, 4.2 MHz, 8 MHz, 12 MHz, 12 MHz, 12 MHz, 12 MHz, 12 MHz, 12 MHz, 12 MHz, 12 MHz, 12 MHz, 12 MHz, 12 MHz
802.11be (320MHz)	159.5 MHz, 160.5 MHz, 320 MHz, 480 MHz, 490 MHz, 490 MHz, 490 MHz, 490 MHz, 490 MHz, 490MHz, 490 MHz, 490 MHz, 490 MHz, 490 MHz, 490 MHz

WLAN Mode Auto Function Presets

For X Series:

Radio Std	Presets
802.11b/g(DSSS/CCK/PBCC)	ON, ON, OFF, OFF, OFF, OFF, OFF, OFF, OFF, OFF, OFF, OFF, OFF, OFF
802.11a/g/j/p 20MHz (OFDM/DSSS-OFDM)	ON, ON, ON, ON, OFF, OFF, OFF, OFF, OFF, OFF, OFF, OFF, OFF, OFF
802.11j/p 10MHz	
802.11p 5MHz/802.11n (20MHz/40MHz)	
802.11ac/ax/be (20 MHz/ 40 MHz/ 80 MHz/ 160 MHz)	ON, ON, ON, ON, OFF, OFF, OFF, OFF, OFF, OFF, OFF, OFF, OFF, OFF
802.11be (320 MHz)	ON, ON, ON, ON, OFF, OFF, OFF, OFF, OFF, OFF, OFF, OFF, OFF, OFF
802.11ac/ax (80 MHz + 80 MHz)	OFF, ON, ON, ON, ON, ON, ON, ON, OFF, OFF, OFF, OFF, OFF, OFF
802.ah (1MHz/ 2MHz/ 4MHz/ 8MHz/ 16MHz)	ON, ON, ON, ON, OFF, OFF, OFF, OFF, OFF, OFF, OFF, OFF, OFF, OFF
802.11af (6 MHz/ 7 MHz/ 8 MHz)	ON, ON, ON, ON, OFF, OFF, OFF, OFF, OFF, OFF, OFF, OFF, OFF, OFF

For E6630A, E6640A, and M90XA:

Radio Std	Presets
802.11a/g(OFDM/DSSS-OFDM)	ON, ON, ON, OFF, OFF, OFF, OFF, OFF, OFF, OFF, OFF, OFF, OFF, OFF
802.11n(20MHz/40MHz)	
802.11ac/ax/be (20 MHz/ 40 MHz/ 80 MHz/ 160 MHz)	ON, ON, ON, OFF, OFF, OFF, OFF, OFF, OFF, OFF, OFF, OFF, OFF, OFF
802.11be (320 MHz)	ON, ON, ON, OFF, OFF, OFF, OFF, OFF, OFF, OFF, OFF, OFF, OFF, OFF
802.11ac/ax (80 MHz + 80 MHz)	ON, ON, ON, OFF, ON, ON, ON, OFF, OFF, OFF, OFF, OFF, OFF, OFF
802.11af (6 MHz/ 7 MHz/ 8 MHz)	ON, ON, ON, ON, OFF, OFF, OFF, OFF, OFF, OFF, OFF, OFF, OFF, OFF

Stop Freq

Specifies the stop frequency for the currently selected offset.

When sending the remote command, missing values are not permitted; that is, if you want to change values 2 and 6, you must send all values up to 6. Subsequent values will remain unchanged. The query for this parameter returns 14 values for WLAN mode, 12 values for other modes.

Remote Command	<code>[:SENSE]:SEMAsk:OFFSet[1] 2[:OUTer]:LIST:FREQuency:STOP <freq>, ...</code> <code>[:SENSE]:SEMAsk:OFFSet[1] 2[:OUTer]:LIST:FREQuency:STOP?</code>
Example	<code>:SEM:OFFS:LIST:FREQ:STOP 2.715 MHz, 3.515 MHz, 4.00 MHz, 8.00 MHz, 12.50 MHz, 15.0 MHz</code> <code>:SEM:OFFS:LIST:FREQ:STOP?</code>
Notes	Comma separated list of values OFFSet1 is for BTS, 2 for MS. Default is BTS Note that Offset sub op code 2 is supported only in non-SA Modes. In SA Mode, Offset sub op code 1 is used for both BTS and MS If the offset is outside of the frequency range, the result spectrum will be invalid
Couplings	Coupled to Start Freq. When Stop Freq goes below Start Freq, Start Freq is automatically adjusted to Stop Freq minus 100 Hz
Preset	When the max number of offsets is 6:

Mode	Values
SA	2.715 MHz, 3.515 MHz, 4.00 MHz, 8.00 MHz, 12.50 MHz, 15.0 MHz
WCDMA	2.715 MHz, 3.515 MHz, 4.000 MHz, 8.000 MHz, 12.50 MHz, 15.0 MHz 3.485 MHz, 7.500 MHz, 8.500 MHz, 12.00 MHz, 15.00 MHz, 18.0 MHz

When the max number of offsets is 12 in these modes, the preset value of Offset G ~ L is the same as the Offset F value

Mode	Values
MSR	215 kHz, 1.015 MHz, 1.5 MHz, 10.5 MHz, 50 MHz, 50 MHz, 50 MHz, 50 MHz, 50 MHz, 50 MHz, 50 MHz 215 kHz, 1.015 MHz, 1.5 MHz, 10.5 MHz, 50 MHz, 50 MHz, 50 MHz, 50 MHz, 50 MHz, 50 MHz, 50 MHz, 50 MHz
LTEAFDD, LTEATDD	5.05 MHz, 10.05 MHz, 15 MHz, 30 MHz, 40 MHz, 50 MHz, 50 MHz, 50 MHz, 50 MHz, 50 MHz, 50 MHz 985.0 kHz, 4.50 MHz, 5.5001 MHz, 9.50 MHz, 20 MHz, 40 MHz, 40 MHz, 40 MHz, 40 MHz, 40 MHz, 40 MHz, 40 MHz, 40 MHz
5G NR	5.05 MHz, 10.05 MHz, 40 MHz, 100 MHz, 500 MHz, 500 MHz, 500 MHz, 500 MHz, 500 MHz, 500 MHz, 500 MHz, 500 MHz, 500 MHz, 500 MHz 985.0 kHz, 4.50 MHz, 99.500 MHz, 104.5 MHz, 500 MHz, 500 MHz, 500 MHz, 500 MHz, 500 MHz, 500 MHz, 500 MHz, 500 MHz

When the max number of offsets is 14 in these modes, the preset value of Offset G ~ N is the same as

	the Offset F value
	WLAN Mode: See table of " WLAN Mode Presets " on page 1494 below
State Saved	Saved in instrument state
Min/Max	100 Hz/Depends on instrument maximum frequency. Same as the Max Span in Swept SA Measurement

WLAN Mode Presets

Radio Std	Presets
802.11a/g (OFDM/DSSS-OFDM)	11 MHz, 20 MHz, 30 MHz, 40 MHz, 100 MHz, 250 MHz, 250 MHz, 250 MHz, 250 MHz, 250 MHz, 250 MHz, 250 MHz, 250 MHz
802.11n (20MHz)	
802.11b/g (DSSS/CCK/PBCC)	22 MHz, 50 MHz, 70 MHz, 90 MHz, 100 MHz, 120 MHz, 120 MHz, 120 MHz, 120 MHz, 120 MHz, 120 MHz, 120 MHz, 120 MHz
802.11n (20MHz)	11 MHz, 20 MHz, 30 MHz, 40 MHz, 100 MHz, 200 MHz, 200 MHz, 200 MHz, 200 MHz, 200 MHz, 200 MHz, 200 MHz, 200 MHz
802.11n (40MHz)	21 MHz, 40 MHz, 60 MHz, 70 MHz, 100 MHz, 200 MHz, 300 MHz, 300 MHz, 300 MHz, 300 MHz, 300 MHz, 300 MHz, 300 MHz
802.11ac (20MHz)	11 MHz, 20 MHz, 30 MHz, 40 MHz, 50 MHz, 50 MHz, 50 MHz, 50 MHz, 50 MHz, 50 MHz, 50 MHz, 50 MHz, 50 MHz
802.11ac (40MHz)	21 MHz, 40 MHz, 60 MHz, 70 MHz, 100 MHz, 100 MHz, 100 MHz, 100 MHz, 100 MHz, 100 MHz, 100 MHz, 100 MHz, 100 MHz
802.11ac (80MHz)	41 MHz, 80 MHz, 120 MHz, 125 MHz, 200 MHz, 200 MHz, 200 MHz, 200 MHz, 200 MHz, 200 MHz, 200 MHz, 200 MHz, 200 MHz
802.11ac (160MHz)	81 MHz, 160 MHz, 240 MHz, 250 MHz, 400 MHz, 400 MHz, 400 MHz, 400 MHz, 400 MHz, 400 MHz, 400 MHz, 400 MHz, 400 MHz
802.11ac (80 MHz + 80MHz)	100Hz, 40 MHz, 79 MHz, 81 MHz, 161 MHz, 200 MHz, 240 MHz, 250 MHz, 250 MHz, 250 MHz, 250 MHz, 250 MHz, 250 MHz
802.11ah (1MHz)	0.6MHz, 1 MHz, 1.5 MHz, 2.5MHz, 2.5 MHz, 2.5 MHz, 2.5 MHz, 2.5 MHz, 2.5 MHz, 2.5 MHz, 2.5 MHz, 2.5 MHz, 2.5 MHz
802.11ah (2MHz)	1.1 MHz, 2 MHz, 3 MHz, 5MHz, 5 MHz, 5 MHz, 5 MHz, 5 MHz, 5 MHz, 5 MHz, 5 MHz, 5 MHz, 5 MHz
802.11ah (4MHz)	2.1 MHz, 4 MHz, 6 MHz, 10 MHz, 10 MHz, 10 MHz, 10 MHz, 10 MHz, 10 MHz, 10 MHz, 10 MHz, 10 MHz, 10 MHz
802.11ah (8MHz)	4.1 MHz, 8 MHz, 12 MHz, 20 MHz, 20 MHz, 20 MHz, 20 MHz, 20 MHz, 20 MHz, 20 MHz, 20 MHz, 20 MHz, 20 MHz
802.11ah (16MHz)	8.1 MHz, 16 MHz, 24 MHz, 40 MHz, 40 MHz, 40 MHz, 40 MHz, 40 MHz, 40 MHz, 40 MHz, 40 MHz, 40 MHz, 40 MHz
802.11j/p (20MHz)	10MHz, 11 MHz, 20 MHz, 30 MHz, 50MHz, 50 MHz, 50 MHz, 50 MHz, 50 MHz, 50 MHz, 50 MHz, 50 MHz, 50 MHz
802.11j/p (10MHz)	5MHz, 5.5 MHz, 10 MHz, 15 MHz, 25MHz, 250MHz, 250MHz, 250MHz, 250 MHz, 250MHz, 250MHz, 250MHz, 250MHz

3 VMA Mode
3.9 SEM Measurement

Radio Std	Presets
802.11p (5MHz)	2.5MHz, 2.75MHz, 5 MHz, 7.5 MHz, 12.5MHz, 250MHz, 250MHz, 250MHz, 250 MHz, 250MHz, 250MHz, 250MHz, 250MHz
802.11ax/be (20MHz)	10.5 MHz, 20 MHz, 30 MHz, 40 MHz, 50 MHz, 50 MHz, 50 MHz, 50 MHz, 50 MHz, 50 MHz, 50 MHz, 50 MHz, 50 MHz
802.11ax/be (40MHz)	20.5 MHz, 40 MHz, 60 MHz, 70 MHz, 100 MHz, 100 MHz, 100 MHz, 100 MHz, 100 MHz, 100 MHz, 100 MHz, 100 MHz, 100 MHz
802.11ax/be (80MHz)	40.5 MHz, 80 MHz, 120 MHz, 125 MHz, 200 MHz, 200 MHz, 200 MHz, 200 MHz, 200 MHz, 200 MHz, 200 MHz, 200 MHz, 200 MHz
802.11ax/be (160MHz)	80.5 MHz, 160 MHz, 240 MHz, 250 MHz, 400 MHz, 400 MHz, 400 MHz, 400 MHz, 400 MHz, 400 MHz, 400 MHz, 400 MHz, 400 MHz
802.11ax (80 MHz + 80MHz)	100Hz, 40 MHz, 79 MHz, 81 MHz, 161 MHz, 200 MHz, 240 MHz, 250 MHz, 250 MHz, 250 MHz, 250 MHz, 250 MHz, 250 MHz
802.11af (6MHz)	3.15MHz, 6 MHz, 9 MHz, 15MHz, 15 MHz, 15 MHz, 15 MHz, 15 MHz, 15 MHz, 15 MHz, 15 MHz, 15 MHz, 15 MHz
802.11af (7MHz)	3.675 MHz, 7 MHz, 10.5 MHz, 17.5MHz, 17.5 MHz, 17.5 MHz, 17.5 MHz, 17.5 MHz, 17.5 MHz, 17.5 MHz, 17.5 MHz, 17.5 MHz, 17.5 MHz
802.11af (8MHz)	4.2 MHz, 8 MHz, 12 MHz, 20 MHz, 20 MHz, 20 MHz, 20 MHz, 20 MHz, 20 MHz, 20 MHz, 20 MHz, 20 MHz, 20 MHz
802.11be (320MHz)	160.5 MHz, 320 MHz, 480 MHz, 490 MHz, 800 MHz, 800 MHz, 800 MHz, 800 MHz, 800 MHz, 800 MHz, 800 MHz, 800 MHz, 800 MHz

Res BW

Specifies which Resolution BW filter to use when measuring the currently selected offset.

Offset Res BW Mode allows the instrument to determine the optimum Resolution BW filter to use when measuring the currently selected offset.. When changing the Meas BW parameter, if the Res BW needs to be changed to adhere to the rule:

$$(N \times \text{Res BW}) \leq (\text{Stop freq of the offset} - \text{Start freq of the offset}),$$

where N is the multiplier, this setting will automatically be changed to manual.

When sending the remote command, missing values are not permitted; that is, if you want to change values 2 and 6, you must send all values up to 6. Subsequent values will remain unchanged. The query for this parameter returns 14 values for WLAN mode, 12 values for other modes.

Remote Command	<code>[:SENSe]:SEMAsk:OFFSet[1] 2[:OUTer]:LIST:BANDwidth[:RESolution] <bandwidth>, ...</code>
	<code>[:SENSe]:SEMAsk:OFFSet[1] 2[:OUTer]:LIST:BANDwidth[:RESolution]?</code>
	<code>[:SENSe]:SEMAsk:OFFSet[1] 2[:OUTer]:LIST:BANDwidth[:RESolution]:AUTO OFF ON 1 0, ...</code>

Example	<pre>[:SENSe]:SEMAsk:OFFSet[1] 2[:OUTer]:LIST:BANDwidth[:RESolution]:AUTO? :SEM:OFFS2:LIST:BAND 30.0 kHz, 30.0 kHz, 30.0 kHz, 1.00 MHz,1.00 MHz, 1.00 MHz :SEM:OFFS2:LIST:BAND? :SEM:OFFS:LIST:BAND:AUTO 1,1,1,1,1,1 :SEM:OFFS:LIST:BAND:AUTO?</pre>																
Notes	<p>Comma separated list of values OFFSet1 is for BTS, 2 for MS. Default is BTS Note that Offset sub op code 2 is supported only in non-SA modes. In the SA mode, Offset sub op code 1 is used for both BTS and MS</p>																
Couplings	<p>Coupled to Start and Stop offset and Meas BW multiplier. This parameter must adhere to the rule (N x Res BW) <= (Stop freq of the offset - Start freq of the offset), where N is the multiplier. If the multiplier is changed, the Res BW will change to ensure this. When set manually, Res BW Coupling is set to manual The resolution bandwidth is coupled to the offset width determined by the start frequency and stop frequency</p>																
Preset	<p>When the max number of offsets is 6:</p> <table border="1" data-bbox="399 947 1403 1108"> <thead> <tr> <th>Mode</th> <th>Values</th> </tr> </thead> <tbody> <tr> <td>SA</td> <td>30.0 kHz, 30.0 kHz, 30.0 kHz, 1.00 MHz,1.00 MHz, 1.00 MHz</td> </tr> <tr> <td>WCDMA</td> <td>30.00 kHz, 30.00 kHz, 30.00 kHz, 100.00 kHz, 1.000 MHz, 1.00 MHz 30.00 kHz, 1.000 MHz, 1.000 MHz, 1.000 MHz, 1.000 MHz, 1.00 MHz</td> </tr> </tbody> </table> <p>When the max number of offsets is 12 in these modes, the preset value of Offset G ~ L is the same as the Offset F value</p> <table border="1" data-bbox="399 1213 1403 1465"> <thead> <tr> <th>Mode</th> <th>Values</th> </tr> </thead> <tbody> <tr> <td>LTEAFDD, LTEATDD, 5G NR</td> <td>51 kHz, 100 kHz, 1.0 MHz, 1.0 MHz, 1.0 MHz, 1.0 MHz, 1.0 MHz, 1.0 MHz, 1.0 MHz, 1.0 MHz 15.0 kHz, 510 kHz, 1.0 MHz, 1.0 MHz, 1.0 MHz, 1.0 MHz, 1.0 MHz, 1.0 MHz</td> </tr> <tr> <td>MSR</td> <td>30kHz, 30kHz, 30kHz, 1.0MHz,1.0MHz, 1.0MHz, 1.0MHz, 1.0MHz, 1.0MHz, 1.0MHz, 1.0MHz 30kHz, 30kHz, 30kHz, 1.0MHz,1.0MHz, 1.0MHz, 1.0MHz, 1.0MHz, 1.0MHz, 1.0MHz, 1.0MHz</td> </tr> </tbody> </table> <p>When the max number of offsets is 14 in these modes, the preset value of Offset G ~ N is the same as the Offset F value</p> <table border="1" data-bbox="399 1570 1403 1682"> <thead> <tr> <th>Mode</th> <th>Values</th> </tr> </thead> <tbody> <tr> <td>WLAN</td> <td>100 kHz, 100 kHz, 100 kHz, 100 kHz, 100 kHz, 100 kHz, 100 kHz, 100 kHz, 100 kHz, 100 kHz, 100 kHz, 100 kHz, 100 kHz, 100 kHz</td> </tr> </tbody> </table> <p>When the max number of offsets is 6: OFF, OFF, OFF, OFF, OFF, OFF OFF, OFF, OFF, OFF, OFF, OFF</p> <p>When the max number of offsets is 12: OFF, OFF, OFF, OFF, OFF, OFF, OFF, OFF, OFF, OFF, OFF, OFF OFF, OFF, OFF,</p>	Mode	Values	SA	30.0 kHz, 30.0 kHz, 30.0 kHz, 1.00 MHz,1.00 MHz, 1.00 MHz	WCDMA	30.00 kHz, 30.00 kHz, 30.00 kHz, 100.00 kHz, 1.000 MHz, 1.00 MHz 30.00 kHz, 1.000 MHz, 1.000 MHz, 1.000 MHz, 1.000 MHz, 1.00 MHz	Mode	Values	LTEAFDD, LTEATDD, 5G NR	51 kHz, 100 kHz, 1.0 MHz, 1.0 MHz, 1.0 MHz, 1.0 MHz, 1.0 MHz, 1.0 MHz, 1.0 MHz, 1.0 MHz 15.0 kHz, 510 kHz, 1.0 MHz, 1.0 MHz, 1.0 MHz, 1.0 MHz, 1.0 MHz, 1.0 MHz	MSR	30kHz, 30kHz, 30kHz, 1.0MHz,1.0MHz, 1.0MHz, 1.0MHz, 1.0MHz, 1.0MHz, 1.0MHz, 1.0MHz 30kHz, 30kHz, 30kHz, 1.0MHz,1.0MHz, 1.0MHz, 1.0MHz, 1.0MHz, 1.0MHz, 1.0MHz, 1.0MHz	Mode	Values	WLAN	100 kHz, 100 kHz, 100 kHz, 100 kHz, 100 kHz, 100 kHz, 100 kHz, 100 kHz, 100 kHz, 100 kHz, 100 kHz, 100 kHz, 100 kHz, 100 kHz
Mode	Values																
SA	30.0 kHz, 30.0 kHz, 30.0 kHz, 1.00 MHz,1.00 MHz, 1.00 MHz																
WCDMA	30.00 kHz, 30.00 kHz, 30.00 kHz, 100.00 kHz, 1.000 MHz, 1.00 MHz 30.00 kHz, 1.000 MHz, 1.000 MHz, 1.000 MHz, 1.000 MHz, 1.00 MHz																
Mode	Values																
LTEAFDD, LTEATDD, 5G NR	51 kHz, 100 kHz, 1.0 MHz, 1.0 MHz, 1.0 MHz, 1.0 MHz, 1.0 MHz, 1.0 MHz, 1.0 MHz, 1.0 MHz 15.0 kHz, 510 kHz, 1.0 MHz, 1.0 MHz, 1.0 MHz, 1.0 MHz, 1.0 MHz, 1.0 MHz																
MSR	30kHz, 30kHz, 30kHz, 1.0MHz,1.0MHz, 1.0MHz, 1.0MHz, 1.0MHz, 1.0MHz, 1.0MHz, 1.0MHz 30kHz, 30kHz, 30kHz, 1.0MHz,1.0MHz, 1.0MHz, 1.0MHz, 1.0MHz, 1.0MHz, 1.0MHz, 1.0MHz																
Mode	Values																
WLAN	100 kHz, 100 kHz, 100 kHz, 100 kHz, 100 kHz, 100 kHz, 100 kHz, 100 kHz, 100 kHz, 100 kHz, 100 kHz, 100 kHz, 100 kHz, 100 kHz																

3 VMA Mode
3.9 SEM Measurement

	<p>OFF, OFF, OFF, OFF, OFF, OFF, OFF, OFF, OFF, OFF</p> <p>When the max number of offsets is 14:</p> <p>OFF, OFF, OFF, OFF, OFF, OFF, OFF, OFF, OFF, OFF, OFF, OFF, OFF, OFF OFF, OFF, OFF, OFF, OFF, OFF, OFF, OFF, OFF, OFF, OFF, OFF</p>
State Saved	<p>Saved in instrument state</p> <p>Saved in instrument state</p>
Range	Auto Man
Min	1 Hz
Max	<p>Option FS1 or FS2 is installed: 10 MHz</p> <p>Otherwise: 8 MHz</p>
Backwards Compatibility SCPI	<p>[:SENSe]:SEMAsk:OFFSet[1] 2:LIST:BWIDth[:RESolution]</p> <p>[:SENSe]:SEMAsk:OFFSet[1] 2:LIST:BWIDth[:RESolution]:AUTO</p>

Meas BW

Allows you to specify a multiplier of Res BW for the measurement integration bandwidth.

Meas BW is multiplier integer number. It shows a ratio between Integration BW and Resolution BW of the measurement result.

$$\text{Integ BW} = \text{Meas BW} * \text{Resolution BW}$$

Integration BW is desired resolution bandwidth and Resolution BW is actual bandwidth for sweep. Measurement sweeps with Resolution BW and Meas BW compensates sweep resolution bandwidth to Integration BW.

If you set this value greater than 1, you can set Resolution BW narrower to avoid carrier power leakage effect to the offset power integration.

When sending the remote command, missing values are not permitted; that is, if you want to change values 2 and 6, you must send all values up to 6. Subsequent values will remain unchanged. The query for this parameter returns 14 values for WLAN mode, 12 values for other modes.

Remote Command	<p>[:SENSe]:SEMAsk:OFFSet[1] 2[:OUTer]:LIST:BANDwidth:IMULTi <integer>, ...</p> <p>[:SENSe]:SEMAsk:OFFSet[1] 2[:OUTer]:LIST:BANDwidth:IMULTi?</p>
Example	<p>:SEM:OFFS2:LIST:BAND:IMUL 1,1,1,1,1,1</p> <p>:SEM:OFFS2:LIST:BAND:IMUL?</p>
Notes	<p>Comma separated list of values</p> <p>OFFSet1 is for BTS, 2 for MS. Default is BTS</p> <p>Note that Offset sub op code 2 is supported only in non-SA modes. In the SA mode, Offset sub op code 1 is used for both BTS and MS</p>

Preset	When the max number of offsets is 6:						
	<table border="1"> <thead> <tr> <th>Mode</th> <th>Values</th> </tr> </thead> <tbody> <tr> <td>SA</td> <td>1, 1, 1, 1, 1, 1</td> </tr> <tr> <td>WCDMA</td> <td>1, 1, 1, 10, 1, 1 1, 1, 1, 1, 1, 1</td> </tr> </tbody> </table>	Mode	Values	SA	1, 1, 1, 1, 1, 1	WCDMA	1, 1, 1, 10, 1, 1 1, 1, 1, 1, 1, 1
Mode	Values						
SA	1, 1, 1, 1, 1, 1						
WCDMA	1, 1, 1, 10, 1, 1 1, 1, 1, 1, 1, 1						
	When the max number of offsets is 12 in these modes, the preset value of Offset G ~ L is the same as the Offset F value						
	<table border="1"> <thead> <tr> <th>Mode</th> <th>Values</th> </tr> </thead> <tbody> <tr> <td>MSR</td> <td>1, 1, 1, 1, 1, 1, 1, 1, 1, 1, 1, 1 1, 1, 1, 1, 1, 1, 1, 1, 1, 1, 1, 1</td> </tr> <tr> <td>LTEAFDD, LTEATDD, 5G NR</td> <td>2, 1, 1, 1, 1, 1, 1, 1, 1, 1, 1, 1 2, 2, 1, 1, 1, 1, 1, 1, 1, 1, 1, 1</td> </tr> </tbody> </table>	Mode	Values	MSR	1, 1, 1, 1, 1, 1, 1, 1, 1, 1, 1, 1 1, 1, 1, 1, 1, 1, 1, 1, 1, 1, 1, 1	LTEAFDD, LTEATDD, 5G NR	2, 1, 1, 1, 1, 1, 1, 1, 1, 1, 1, 1 2, 2, 1, 1, 1, 1, 1, 1, 1, 1, 1, 1
Mode	Values						
MSR	1, 1, 1, 1, 1, 1, 1, 1, 1, 1, 1, 1 1, 1, 1, 1, 1, 1, 1, 1, 1, 1, 1, 1						
LTEAFDD, LTEATDD, 5G NR	2, 1, 1, 1, 1, 1, 1, 1, 1, 1, 1, 1 2, 2, 1, 1, 1, 1, 1, 1, 1, 1, 1, 1						
	When the max number of offsets is 14 in these modes, the preset value of Offset G ~ N is the same as the Offset F value						
	<table border="1"> <thead> <tr> <th>Mode</th> <th>Values</th> </tr> </thead> <tbody> <tr> <td>WLAN</td> <td>1, 1, 1, 1, 1, 1, 1, 1, 1, 1, 1, 1, 1, 1, 1, 1</td> </tr> </tbody> </table>	Mode	Values	WLAN	1, 1, 1, 1, 1, 1, 1, 1, 1, 1, 1, 1, 1, 1, 1, 1		
Mode	Values						
WLAN	1, 1, 1, 1, 1, 1, 1, 1, 1, 1, 1, 1, 1, 1, 1, 1						
State Saved	Yes						
Min/Max	1/1000						
Backwards Compatibility SCPI	<code>[:SENSe]:SEMAsk:OFFSet[1] 2:LIST:BWIDth:IMULti</code>						

Video BW

Changes the instrument post-detection filter.

When sending the remote command, missing values are not permitted; that is, if you want to change values 2 and 6, you must send all values up to 6. Subsequent values will remain unchanged. The query for this parameter returns 14 values for WLAN mode, 12 values for other modes.

Remote Command	<pre>[:SENSe]:SEMAsk:OFFSet[1] 2[:OUTer]:LIST:BANDwidth:VIDeo <freq>, ... [:SENSe]:SEMAsk:OFFSet[1] 2[:OUTer]:LIST:BANDwidth:VIDeo? [:SENSe]:SEMAsk:OFFSet[1] 2[:OUTer]:LIST:BANDwidth:VIDeo:AUTO OFF ON 0 1, ... [:SENSe]:SEMAsk:OFFSet[1] 2[:OUTer]:LIST:BANDwidth:VIDeo:AUTO?</pre>
Example	<pre>:SEM:OFFS2:LIST:BAND:VID 3.00 kHz, 3.00 kHz, 3.00 kHz, 100.0 kHz,100.0 kHz, 100.0 kHz :SEM:OFFS2:LIST:BAND:VID? :SEM:OFFS2:LIST:BAND:VID:AUTO ON, ON, ON, ON, ON, ON :SEM:OFFS2:LIST:BAND:VID:AUTO?</pre>

3 VMA Mode
3.9 SEM Measurement

Notes	Comma separated list of values OFFSet1 is for BTS, 2 for MS. Default is BTS Note that Offset sub op code 2 is supported only in non-SA modes. In the SA mode, Offset sub op code 1 is used for both BTS and MS
Preset	Automatically Calculated When the max number of offsets is 6: ON, ON, ON, ON, ON, ON ON, ON, ON, ON, ON, ON When the max number of offsets is 12: ON, ON, ON, ON, ON, ON, ON, ON, ON, ON, ON, ON ON, ON, ON, ON, ON, ON, ON, ON, ON, ON, ON, ON When the max number of offsets is 14: ON, ON, ON, ON, ON, ON, ON, ON, ON, ON, ON, ON, ON, ON, ON, ON
State Saved	Saved in instrument state Saved in instrument state
Range	Auto Man
Min/Max	1 Hz/50 MHz
Backwards Compatibility SCPI	[:SENSe] :SEMAsk :OFFSet [1] 2 :LIST :BWIDth :VIDeo [:SENSe] :SEMAsk :OFFSet [1] 2 :LIST :BWIDth :VIDeo :AUTO

VBW/RBW

Selects the ratio between the video and resolution bandwidths.

When sending the remote command, missing values are not permitted; that is, if you want to change values 2 and 6, you must send all values up to 6. Subsequent values will remain unchanged. The query for this parameter returns 14 values for WLAN mode, 12 values for other modes.

Remote Command	[:SENSe] :SEMAsk :OFFSet [1] 2 [:OUTer] :LIST :BANDwidth :VIDeo :RATio <real>, ... [:SENSe] :SEMAsk :OFFSet [1] 2 [:OUTer] :LIST :BANDwidth :VIDeo :RATio? [:SENSe] :SEMAsk :OFFSet [1] 2 [:OUTer] :LIST :BANDwidth :VIDeo :RATio :AUTO OFF ON 0 1, ... [:SENSe] :SEMAsk :OFFSet [1] 2 [:OUTer] :LIST :BANDwidth :VIDeo :RATio :AUTO?
Example	:SEM:OFFS2:LIST:BAND:VID:RAT 0.1, 0.1, 0.1, 0.1, 0.1, 0.1 :SEM:OFFS2:LIST:BAND:VID:RAT? :SEM:OFFS2:LIST:BAND:VID:RAT:AUTO ON, ON, ON, ON, ON, ON :SEM:OFFS2:LIST:BAND:VID:RAT:AUTO?
Notes	Comma separated list of values OFFSet1 is for BTS, 2 for MS. Default is BTS

	Note that Offset sub op code 2 is supported only in non-SA modes. In the SA mode, Offset sub op code 1 is used for both BTS and MS
Preset	<p>Modes other than LTEAFDD, LTEATDD, 5G NR, MSR, WLAN:</p> <p>When the max number of offsets is 6: 0.01, 0.01, 0.01, 0.01, 0.01, 0.01 0.01, 0.01, 0.01, 0.01, 0.01, 0.01</p> <p>When the max number of offsets is 12, the preset value of Offset G ~ L is the same as the Offset F value</p> <p>LTEAFDD, LTEATDD, 5G NR, MSR Modes:</p> <p>0.01, 0.01, 0.01, 0.01, 0.01, 0.01, 0.01, 0.01, 0.01, 0.01, 0.01, 0.01 0.01, 0.01, 0.01, 0.01, 0.01, 0.01, 0.01, 0.01, 0.01, 0.01, 0.01, 0.01</p> <p>When the max number of offsets is 14 in these modes, the preset value of Offset G ~ N is the same as the Offset F value</p> <p>WLAN Mode:</p> <p>802.11 ax/be: 0.075, 0.075, 0.075, 0.075, 0.075, 0.075, 0.075, 0.075, 0.075, 0.075, 0.075, 0.075, 0.075, 0.075, 0.075, 0.075</p> <p>All other formats: 0.3, 0.3, 0.3, 0.3, 0.3, 0.3, 0.3, 0.3, 0.3, 0.3, 0.3, 0.3, 0.3, 0.3, 0.3, 0.3</p> <p>Modes other than WLAN</p> <p>When the max number of offsets is 6: OFF, OFF, OFF, OFF, OFF, OFF OFF, OFF, OFF, OFF, OFF, OFF</p> <p>When the max number of offsets is 12: OFF, OFF, OFF, OFF, OFF, OFF, OFF, OFF, OFF, OFF, OFF, OFF OFF, OFF, OFF, OFF, OFF, OFF, OFF, OFF, OFF, OFF, OFF, OFF</p> <p>WLAN Mode: OFF, OFF, OFF, OFF, OFF, OFF, OFF, OFF, OFF, OFF, OFF, OFF, OFF, OFF, OFF OFF, OFF, OFF, OFF, OFF, OFF, OFF, OFF, OFF, OFF, OFF, OFF, OFF, OFF, OFF, OFF</p>
State Saved	<p>Saved in instrument state</p> <p>Saved in instrument state</p>
Range	Auto Man
Min/Max	0.00001/3000000
Backwards Compatibility SCPI	<p>[:SENSe] :SEMAsk :OFFSet [1] 2 :LIST :BWIDth :VIDeo :RATio</p> <p>[:SENSe] :SEMAsk :OFFSet [1] 2 :LIST :BWIDth :VIDeo :RATio :AUTO</p>

Offset (Sweep)

Accesses a menu that enables you to set up the sweep measurement parameters for offset pairs.

Offset Freq Define

Same as "[Offset Freq Define](#)" on page 1483 under Offset (Bandwidth).

Offset Detector

Same as "Offset Detector" on page 1487 under Offset (Bandwidth).

Start Freq

Same as "Start Freq" on page 1489 under Offset (Bandwidth).

Stop Freq

Same as "Stop Freq" on page 1493 under Offset (Bandwidth).

Sweep Time

Specifies the **Sweep Time** for the currently selected offset and enables you to toggle the Sweep Time mode between Auto and Man.

When sending the remote command, missing values are not permitted; that is, if you want to change values 2 and 6, you must send all values up to 6. Subsequent values will remain unchanged. The query for this parameter returns 14 values for WLAN mode, 12 values for other modes.

NOTE

On non-sweeping hardware, this column is grayed out. The value shown on this column is an estimate. It is the turnaround time to complete the measurement of the entire offset span, which is the sum of signal acquisition time, FFT time, and other overhead time. If you need to specify the same "Sweep Time" as you would for sweeping hardware, send `[:SENSe]:SEMAsk:OFFSet[1]|2[:OUTer]:LIST:SWEp:TIME <time>`. The measurement emulates the "Sweep Time" effect, but this emulation is not straightforward, and therefore the behavior is not specified. Instead, we recommend using **Minimum Acquisition Time**, which provides better control.

Remote Command	<code>[:SENSe]:SEMAsk:OFFSet[1] 2[:OUTer]:LIST:SWEp:TIME <time>, ...</code> <code>[:SENSe]:SEMAsk:OFFSet[1] 2[:OUTer]:LIST:SWEp:TIME?</code> <code>[:SENSe]:SEMAsk:OFFSet[1] 2[:OUTer]:LIST:SWEp:TIME:AUTO ON OFF 1 0, ...</code> <code>[:SENSe]:SEMAsk:OFFSet[1] 2[:OUTer]:LIST:SWEp:TIME:AUTO?</code>
Example	<code>:SEM:OFFS2:LIST:SWE:TIME 1.0 ms, 3.4 ms, 2.08 ms, 1.0 ms, 1.0 ms, 1.0 ms</code> <code>:SEM:OFFS2:LIST:SWE:TIME?</code> <code>:SEM:OFFS2:LIST:SWE:TIME:AUTO ON, ON, ON, ON, OFF, OFF</code> <code>:SEM:OFFS2:LIST:SWE:TIME:AUTO?</code>

Notes	<p>Comma separated list of values</p> <p>OFFSet1 is for BTS, 2 for MS. Default is BTS</p> <p>Note that Offset sub op code 2 is supported only in non-SA modes. In the SA mode, Offset sub op code 1 is used for both BTS and MS</p>
Dependencies	<p>On non-sweeping hardware, this column is grayed out and the Auto/Man checkbox is invisible. The read-only value shows the estimated sweep time</p> <p>In those instruments, "Minimum Acquisition Time" on page 1502 is available</p>
Couplings	When you manually set a value when in the Auto state, the state automatically changes to Man
Preset	<p>Automatically calculated</p> <p>Modes other than LTEAFDD, LTEATDD, 5G NR, MSR, WLAN:</p> <p>When the max number of offsets is 6: ON, ON, ON, ON, ON, ON</p> <p>When the max number of offsets is 12: ON, ON, ON, ON, ON, ON, ON, ON, ON, ON, ON, ON, ON, ON</p> <p>Modes LTEAFDD, LTEATDD, 5G NR, MSR: ON, ON, ON, ON, ON, ON, ON, ON, ON, ON, ON, ON, ON, ON ON, ON, ON, ON, ON, ON, ON, ON, ON, ON, ON, ON, ON, ON</p> <p>When the max number of offsets is 14: Mode WLAN: ON, ON, ON, ON, ON, ON, ON, ON, ON, ON, ON, ON, ON, ON, ON, ON</p>
State Saved	<p>Saved in instrument state</p> <p>Saved in instrument state</p>
Range	Auto Man
Min	<p>Other than non-sweeping hardware</p> <p>Depends on Sweep Type:</p> <ul style="list-style-type: none"> - Sweep Type "Swept": 1 ms - Sweep Type "FFT": 100 ns <p>Non-sweeping hardware: N/A</p>
Max	<p>Other than non-sweeping hardware: 4000 s</p> <p>Non-sweeping hardware: N/A</p>
Backwards Compatibility SCPI	<p>[:SENSe] :SEMAsk :OFFSet [1] 2 :LIST :SWEep [:TIME]</p> <p>[:SENSe] :SEMAsk :OFFSet [1] 2 :LIST :SWEep [:TIME] :AUTO</p>

Minimum Acquisition Time

Available on non-sweeping hardware.

Specifies the minimum acquisition time for each "chunk" of the measurement result. The instrument automatically divides Span into multiple chunks if needed.

3 VMA Mode
3.9 SEM Measurement

Therefore, the total signal acquisition time for the entire offset span is $\sim(\sim\text{Minimum Acquisition Time}) * (\text{The number of chunks})$.

When in Auto, this parameter's value is determined by other parameters, such as Offset Start, Offset Stop, RBW and VBW.

You can manually increase this parameter value from this Auto value.

If increased, the instrument acquires signal for the specified time duration for each chunk. It performs additional FFTs, and averages or peak-holds the FFT results for a chunk, depending on Detector settings.

Note that the actual acquisition time for each chunk may exceed the Minimum Acquisition Time value, in order to satisfy FFT time required by other parameters, and to perform an integer number of FFTs.

Remote Command	<pre>[:SENSe]:SEMAsk:OFFSet[1] 2[:OUTer]:LIST:SWEep:ACQuisition:TIME <time>, ... [:SENSe]:SEMAsk:OFFSet[1] 2[:OUTer]:LIST:SWEep:ACQuisition:TIME? [:SENSe]:SEMAsk:OFFSet[1] 2[:OUTer]:LIST:SWEep:ACQuisition:TIME:AUTO ON OFF 1 0, ... [:SENSe]:SEMAsk:OFFSet[1] 2[:OUTer]:LIST:SWEep:ACQuisition:TIME:AUTO?</pre>
Example	<pre>:SEM:OFFS2:LIST:SWE:ACQ:TIME 1.0 ms, 3.4 ms, 2.08 ms, 1.0 ms, 1.0 ms, 1.0 ms :SEM:OFFS2:LIST:SWE:ACQ:TIME? :SEM:OFFS2:LIST:SWE:ACQ:TIME:AUTO ON, ON, ON, ON, OFF, OFF :SEM:OFFS2:LIST:SWE:ACQ:TIME:AUTO?</pre>
Dependencies	Available only on non-sweeping hardware
Couplings	Coupled to Offset Start Freq, Offset Stop Freq, RBW, and VBW when in the Auto state When you manually set a value when in the Auto state, the state automatically changes to Man
Preset	Automatically calculated ON
State Saved	Saved in instrument state
Min	100 ns
Max	4000 s

Sweep Time Annotation (Remote Query Only)

Returns the Sweep Time Annotation value. Available only on non-sweeping hardware.

The value returned is the estimated turnaround time of each acquisition, in seconds. The turnaround time is the sum of the signal acquisition time, FFT time, and other overhead time, to complete the entire offset span of each measurement cycle.

Remote Command	<pre>[:SENSe]:SEMAsk:OFFSet[1] 2[:OUTer]:LIST:SWEep:ETIME?</pre>
----------------	--

Example	<code>:SEM:OFFS2:LIST:SWE:ETIM?</code>
Dependencies	Available only on non-sweeping hardware
Preset	Automatically calculated

Sweep Type

Specifies the **Sweep Type** for the currently selected offset, and enables you to toggle the **Sweep Type** mode between **Auto** and **Man**.

When sending the remote command, missing values are not permitted; that is, if you want to change values 2 and 6, you must send all values up to 6. Subsequent values will remain unchanged. The query for this parameter returns 14 values for WLAN mode, 12 values for other modes.

How to define Sweep Time and Sweep Type:

Sweep Type mode	Behavior
Auto	Sweep Type is automatically selected according to "Sweep Type Rules" on page 1478 Sweep Time is automatically calculated according to the selected Sweep Type
Man	Sweep Type is user-selected
–	

Remote Command	<code>[:SENSe]:SEMAsk:OFFSet[1] 2[:OUTer]:LIST:SWEep:TYPE SWEep FFT, ...</code> <code>[:SENSe]:SEMAsk:OFFSet[1] 2[:OUTer]:LIST:SWEep:TYPE?</code> <code>[:SENSe]:SEMAsk:OFFSet[1] 2[:OUTer]:LIST:SWEep:TYPE:AUTO ON OFF 1 0, ...</code> <code>[:SENSe]:SEMAsk:OFFSet[1] 2[:OUTer]:LIST:SWEep:TYPE:AUTO?</code>
Example	<code>:SEM:OFFS2:LIST:SWE:TYPE FFT,FFT,SWE</code> <code>:SEM:OFFS2:LIST:SWE:TYPE?</code> <code>:SEM:OFFS2:LIST:SWE:TYPE:AUTO ON, ON, ON, ON, OFF, OFF</code> <code>:SEM:OFFS2:LIST:SWE:TYPE:AUTO?</code>
Notes	Comma-separated list of values OFFSet1 is for BTS, 2 for MS. Default is BTS Note that Offset sub op code 2 is supported only in non-SA Modes In SA Mode, Offset sub op code 1 is used for both BTS and MS
Dependencies	Not available in modular products, such as VXT
Couplings	When Sweep Type is set manually, Sweep Type mode is set to OFF (Manual) When Sweep Type mode is Auto , Sweep Type is automatically selected according to Sweep Type Rules

3 VMA Mode
 3.9 SEM Measurement

Preset	Automatically calculated LTEAFDD, LTEATDD, 5G NR, MSR Modes: <code>ON, ON, ON, ON, ON, ON, ON, ON, ON, ON, ON, ON, ON, ON </code> <code>ON, ON, ON, ON, ON, ON, ON, ON, ON, ON, ON, ON, ON, ON</code> When the max number of offsets is 14: WLAN Mode: <code>ON, ON, ON, ON, ON, ON, ON, ON, ON, ON, ON, ON, ON, ON, ON</code> All Other Modes: When the max number of offsets is 6: <code>ON, ON, ON, ON, ON, ON</code> When the max number of offsets is 12: <code>ON, ON, ON, ON, ON, ON, ON, ON, ON, ON, ON, ON, ON, ON</code>
State Saved	Saved in instrument state
Range	Auto Man

Offset Side

Specifies which offset side to measure.

You can turn off (not use) specific offsets with `[:SENSe] :SEMAsk :OFFSet [n] [:OUTer] :LIST :STATE`.

- `BOTH` Both of the negative (lower) and positive (upper) sidebands
- `NEGative` Negative (lower) sideband only
- `POSitive` Positive (upper) sideband only

When sending the remote command, missing values are not permitted; that is, if you want to change values 2 and 6, you must send all values up to 6. Subsequent values remain unchanged. The query returns 14 values for WLAN Mode, and 12 values for other Modes.

The figure below shows the relation between the negative/positive offset side setups and the upper/lower results in the MSR, LTE-Advanced FDD/TDD and 5G NR Modes.

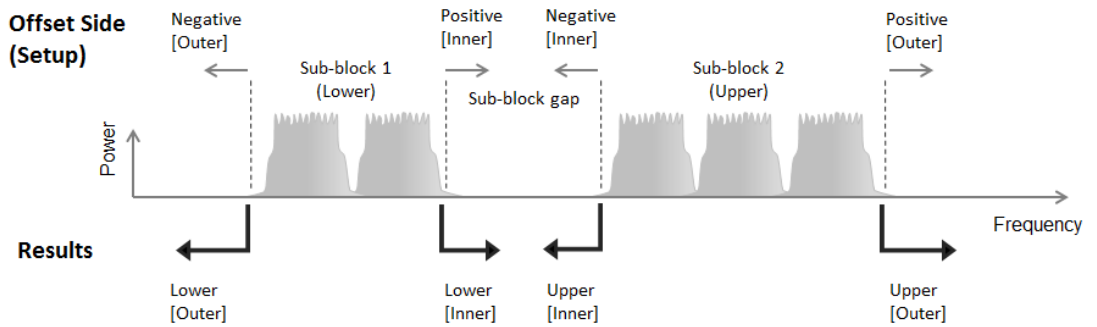

Remote Command	<code>[:SENSE]:SEMask:OFFSet[1] 2[:OUTer]:LIST:SIDE BOTH NEGative POSitive, ...</code> <code>[:SENSE]:SEMask:OFFSet[1] 2[:OUTer]:LIST:SIDE?</code>
Example	<code>:SEM:OFFS:LIST:SIDE BOTH, NEG, NEG, POS, POS, POS</code> <code>:SEM:OFFS:LIST:SIDE?</code>
Notes	Comma-separated list of values OFFSet1 is for BTS, 2 for MS. Default is BTS Note that Offset sub op code 2 is supported only in Modes other than SA. In SA Mode, Offset sub op code 1 is used for both BTS and MS
Preset	Modes LTEAFDD,LTEATDD, 5G NR, MSR: <code>BOTH, BOTH, BOTH, BOTH, BOTH, BOTH, BOTH, BOTH, BOTH, BOTH, BOTH, BOTH, BOTH BOTH, BOTH, BOTH, BOTH, BOTH, BOTH, BOTH, BOTH, BOTH, BOTH, BOTH, BOTH, BOTH</code> When the max number of offsets is 14: Mode WLAN: <code>BOTH, BOTH, BOTH, BOTH, BOTH, BOTH, BOTH, BOTH, BOTH, BOTH, BOTH, BOTH, BOTH, BOTH, BOTH</code> All Other Modes: When the max number of offsets is 6: <code>BOTH, BOTH, BOTH, BOTH, BOTH, BOTH</code> When the max number of offsets is 12: <code>BOTH, BOTH, BOTH, BOTH, BOTH, BOTH, BOTH, BOTH, BOTH, BOTH, BOTH, BOTH, BOTH</code>
State Saved	Saved in instrument state
Range	<code>BOTH NEGative POSitive</code>

Limits

Enables you to set the power limits for start and stop frequencies of the selected offsets.

Start Freq

Same as "Start Freq" on page 1489 under Offset (Bandwidth).

Stop Freq

Same as "Stop Freq" on page 1493 under **Offset (Bandwidth)**.

Abs Start

Sets the absolute power level limit at the start frequency for the selected offset. The absolute power level limit ranges from -200 to +50 dBm.

The fail condition for each offset channel is set remotely by
`[:SENSe]:SEMAsk:OFFSet[n][:OUTer]:LIST:TEST`.

You can turn off (not use) specific offset channels remotely with
`[:SENSe]:SEMAsk:OFFSet[n][:OUTer]:LIST:STATe`.

The query returns values currently set to the absolute power test limits.

When sending the remote command, missing values are not permitted; that is, if you want to change values 2 and 6, you must send all values up to 6. Subsequent values remain unchanged. The query returns 14 values for WLAN Mode, or 12 values for other Modes.

Remote Command	<code>[:SENSe]:SEMAsk:OFFSet[1] 2[:OUTer]:LIST:START:ABSolute <real>, ...</code> <code>[:SENSe]:SEMAsk:OFFSet[1] 2[:OUTer]:LIST:START:ABSolute?</code>								
Example	<code>:SEM:OFFS2:LIST:STAR:ABS -12.50 dBm, -12.50 dBm, -24.50 dBm, -11.50 dBm, -11.50 dBm, -11.50 dBm</code> <code>:SEM:OFFS2:LIST:STAR:ABS?</code>								
Notes	Comma-separated list of values OFFSet1 is for BTS, 2 for MS. Default is BTS Note that Offset sub op code 2 is supported only in non-SA modes. In SA Mode, Offset sub op code 1 is used for both BTS and MS								
Preset	When the max number of offsets is 6: <table border="1"> <thead> <tr> <th>Mode</th> <th>Values</th> </tr> </thead> <tbody> <tr> <td>SA</td> <td>-14.00 dBm, -14.00 dBm, -26.00 dBm, -13.00 dBm, -13.00 dBm, -13.00 dBm</td> </tr> <tr> <td>WCDMA</td> <td>-12.50 dBm, -12.50 dBm, -24.50 dBm, -11.50 dBm, -11.50 dBm, -11.50 dBm -69.6 dBm, -54.3 dBm, -54.3 dBm, -54.3 dBm, -54.3 dBm, -54.3 dBm</td> </tr> <tr> <td>LTE, LTETDD</td> <td>-5.5 dBm, -12.5 dBm, -15.0 dBm, -15.0 dBm, -15.0 dBm, -15.0 dBm -13.5 dBm, -8.5 dBm, -11.5 dBm, -23.5 dBm, -23.5 dBm, -23.5 dBm</td> </tr> </tbody> </table> <p>When the max number of offsets is 12 in these modes, the preset value of Offset G ~ L is the same as the Offset F value</p>	Mode	Values	SA	-14.00 dBm, -14.00 dBm, -26.00 dBm, -13.00 dBm, -13.00 dBm, -13.00 dBm	WCDMA	-12.50 dBm, -12.50 dBm, -24.50 dBm, -11.50 dBm, -11.50 dBm, -11.50 dBm -69.6 dBm, -54.3 dBm, -54.3 dBm, -54.3 dBm, -54.3 dBm, -54.3 dBm	LTE, LTETDD	-5.5 dBm, -12.5 dBm, -15.0 dBm, -15.0 dBm, -15.0 dBm, -15.0 dBm -13.5 dBm, -8.5 dBm, -11.5 dBm, -23.5 dBm, -23.5 dBm, -23.5 dBm
Mode	Values								
SA	-14.00 dBm, -14.00 dBm, -26.00 dBm, -13.00 dBm, -13.00 dBm, -13.00 dBm								
WCDMA	-12.50 dBm, -12.50 dBm, -24.50 dBm, -11.50 dBm, -11.50 dBm, -11.50 dBm -69.6 dBm, -54.3 dBm, -54.3 dBm, -54.3 dBm, -54.3 dBm, -54.3 dBm								
LTE, LTETDD	-5.5 dBm, -12.5 dBm, -15.0 dBm, -15.0 dBm, -15.0 dBm, -15.0 dBm -13.5 dBm, -8.5 dBm, -11.5 dBm, -23.5 dBm, -23.5 dBm, -23.5 dBm								

Mode	Values
LTEAFDD, LTEATDD	-5.5 dBm, -12.5 dBm, -15.0 dBm, -15.0 dBm, -15.0 dBm, -15.0 dBm, -15.0 dBm, -15.0 dBm, -15.0 dBm, -15.0 dBm, -13.5 dBm, -8.5 dBm, -11.5 dBm, -23.5 dBm, -23.5 dBm, -23.5 dBm, -23.5 dBm, -23.5 dBm, -23.5 dBm, -23.5 dBm, -23.5 dBm, -23.5 dBm
5G NR	-5.5 dBm, -12.5 dBm, -15.0 dBm, -15.0 dBm, -15.0 dBm, -15.0 dBm, -15.0 dBm, -15.0 dBm, -15.0 dBm, -15.0 dBm, -22.5 dBm, -8.5 dBm, -11.5 dBm, -23.5 dBm, -23.5 dBm, -23.5 dBm, -23.5 dBm, -23.5 dBm, -23.5 dBm, -23.5 dBm, -23.5 dBm, -23.5 dBm
MSR	-12.5 dBm, -12.5 dBm, -24.5 dBm, -11.5 dBm, -15.0 dBm, -15.0 dBm, -15.0 dBm, -15.0 dBm, -15.0 dBm, -15.0 dBm, -12.5 dBm, -12.5 dBm, -24.5 dBm, -11.5 dBm, -15.0 dBm, -15.0 dBm, -15.0 dBm, -15.0 dBm, -15.0 dBm, -15.0 dBm, -15.0 dBm, -15.0 dBm

When the max number of offsets is 14 in these Modes, the preset value of Offset G ~ N is the same as the Offset F value

WLAN Mode: See the table of "[WLAN Mode Presets](#)" on page 1508 below

State Saved	Saved in instrument state
Min/Max	-200 dBm/50 dBm

WLAN Mode Presets

Radio Std	Presets
802.11b/g(DSSS/CCK/PBCC)	-10 dBm, -30 dBm, -30 dBm, -30 dBm, -30 dBm, -30 dBm, -30 dBm, -30 dBm, -30 dBm, -30 dBm, -30 dBm, -30 dBm, -30 dBm, -30 dBm, -30 dBm, -30 dBm
802.11a/g(OFDM/DSSS-OFDM)	-63.00 dBm, -63.00 dBm, -63.00 dBm, -63.00 dBm, -63.00 dBm, -63.00 dBm, -63.00 dBm, -63.00 dBm, -63.00 dBm, -63.00 dBm, -63.00 dBm, -63.00 dBm, -63.00 dBm, -63.00 dBm
802.11n/ac/ax/be (20MHz)	-63.00 dBm, -63.00 dBm, -63.00 dBm, -63.00 dBm, -63.00 dBm, -63.00 dBm, -63.00 dBm, -63.00 dBm
802.11n/ac/ax/be (40MHz)	-66.00 dBm, -66.00 dBm, -66.00 dBm, -66.00 dBm, -66.00 dBm, -66.00 dBm, -66.00 dBm, -66.00 dBm, -66.00 dBm, -66.00 dBm, -66.00 dBm, -66.00 dBm, -66.00 dBm, -66.00 dBm, -66.00 dBm, -66.00 dBm, -66.00 dBm
802.11ac/ax(80MHz/160MHz)	-69.00 dBm, -69.00 dBm, -69.00 dBm, -69.00 dBm, -69.00 dBm, -69.00 dBm, -69.00 dBm, -69.00 dBm, -69.00 dBm, -69.00 dBm, -69.00 dBm, -69.00 dBm, -69.00 dBm, -69.00 dBm, -69.00 dBm, -69.00 dBm, -69.00 dBm
802.11be (80MHz/160MHz/320MHz)	-49.00 dBm, -49.00 dBm, -49.00 dBm, -49.00 dBm, -49.00 dBm, -49.00 dBm, -49.00 dBm, -49.00 dBm, -49.00 dBm, -49.00 dBm, -49.00 dBm, -49.00 dBm, -49.00 dBm, -49.00 dBm, -49.00 dBm, -49.00 dBm, -49.00 dBm
802.11ac/ax (80 MHz + 80 MHz)	-69.00 dBm, -69.00 dBm, -69.00 dBm, -69.00 dBm, -69.00 dBm, -69.00 dBm, -69.00 dBm, -69.00 dBm, -69.00 dBm, -69.00 dBm, -69.00 dBm, -69.00 dBm, -69.00 dBm, -69.00 dBm, -69.00 dBm, -69.00 dBm, -69.00 dBm
802.11ah (1MHz)	16.00 dBm, -4.00 dBm, -12.00 dBm, -60.00 dBm, -60.00 dBm, -60.00 dBm, -60.00 dBm, -60.00 dBm, -60.00 dBm, -60.00 dBm, -60.00 dBm, -60.00 dBm, -60.00 dBm, -60.00 dBm, -60.00 dBm, -60.00 dBm, -60.00 dBm

Radio Std	Presets
	60.00 dBm, -60.00 dBm, -60.00 dBm, -60.00 dBm
802.11ah (2MHz)	16.00 dBm, -4.00 dBm, -12.00 dBm, -63.00 dBm, -63.00 dBm, -63.00 dBm, -63.00 dBm, -63.00 dBm, -63.00 dBm, -63.00 dBm, -63.00 dBm, -63.00 dBm
802.11ah (4MHz)	16.00 dBm, -4.00 dBm, -12.00 dBm, -66.00 dBm, -66.00 dBm, -66.00 dBm, -66.00 dBm, -66.00 dBm, -66.00 dBm, -66.00 dBm, -66.00 dBm, -66.00 dBm
802.11ah (8MHz/16MHz)	16.00 dBm, -4.00 dBm, -12.00 dBm, -69.00 dBm, -69.00 dBm, -69.00 dBm, -69.00 dBm, -69.00 dBm, -69.00 dBm, -69.00 dBm, -69.00 dBm, -69.00 dBm
802.11j/p (20MHz)	16.00 dBm, -4.00 dBm, -12.00 dBm, -63.00 dBm, -63.00 dBm, -63.00 dBm, -63.00 dBm, -63.00 dBm, -63.00 dBm, -63.00 dBm, -63.00 dBm, -63.00 dBm
802.11j/p (10MHz)	16.00 dBm, -4.00 dBm, -12.00 dBm, -60.00 dBm, -60.00 dBm, -60.00 dBm, -60.00 dBm, -60.00 dBm, -60.00 dBm, -60.00 dBm, -60.00 dBm, -60.00 dBm
802.11p (5MHz)	16.00 dBm, -4.00 dBm, -12.00 dBm, -57.00 dBm, -57.00 dBm, -57.00 dBm, -57.00 dBm, -57.00 dBm, -57.00 dBm, -57.00 dBm, -57.00 dBm, -57.00 dBm
802.11af (6MHz)	16.00 dBm, -4.00 dBm, -12.00 dBm, -66.00 dBm, -66.00 dBm, -66.00 dBm, -66.00 dBm, -66.00 dBm, -66.00 dBm, -66.00 dBm, -66.00 dBm, -66.00 dBm
802.11af (7MHz)	16.00 dBm, -4.00 dBm, -12.00 dBm, -66.00 dBm, -66.00 dBm, -66.00 dBm, -66.00 dBm, -66.00 dBm, -66.00 dBm, -66.00 dBm, -66.00 dBm, -66.00 dBm
802.11af (8MHz)	16.00 dBm, -4.00 dBm, -12.00 dBm, -66.00 dBm, -66.00 dBm, -66.00 dBm, -66.00 dBm, -66.00 dBm, -66.00 dBm, -66.00 dBm, -66.00 dBm, -66.00 dBm

Abs Stop

Sets the absolute power level limit at the stop frequency for the selected offset. The absolute power level limit ranges from -200 to +50 dBm. You can also toggle this function between **Couple** (**COUPle = ON**) and **Manual** (**COUPle = OFF**). If set to **Couple**, the **Abs Stop** power level limit is coupled to **Abs Start** to result in a flat limit line. If set to **Man**, Abs Start and Abs Stop take different values, resulting in a sloped limit line.

The query returns values currently set to the offset stop absolute power limits.

When sending the remote command, missing values are not permitted; that is, if you want to change values 2 and 6, you must send all values up to 6. Subsequent values remain unchanged. The query returns 14 values for WLAN Mode, or 12 values for other Modes.

Remote Command	<pre>[:SENSe]:SEMask:OFFSet[1] 2[:OUTer]:LIST:STOP:ABSolute <real>, ... [:SENSe]:SEMask:OFFSet[1] 2[:OUTer]:LIST:STOP:ABSolute? [:SENSe]:SEMask:OFFSet[1] 2[:OUTer]:LIST:STOP:ABSolute:COUPle ON OFF 1 0, ... [:SENSe]:SEMask:OFFSet[1] 2[:OUTer]:LIST:STOP:ABSolute:COUPle?</pre>
Example	<pre>:SEM:OFFS:LIST:STOP:ABS -12.50 dBm, -24.50 dBm, -24.50 dBm, -11.50 dBm, -11.50 dBm, -11.50 dBm :SEM:OFFS1:LIST:STOP:ABS? :SEM:OFFS:LIST:STOP:ABS:COUP ON, OFF, ON, ON, ON, ON :SEM:OFFS:LIST:STOP:ABS:COUP?</pre>
Notes	<p>Comma-separated list of values</p> <p>OFFSet 1 is for BTS, 2 for MS. Default is BTS</p> <p>Note that Offset sub op code 2 is supported only in Modes other than SA. In SA Mode, Offset sub op code 1 is used for both BTS and MS</p>
Couplings	Coupled to Abs Start if Auto is selected, that is, the Stop value is equal to the Start value
Preset	When the max number of offsets is 6:

Mode	Values
SA	-14.00 dBm, -26.00 dBm, -26.00 dBm, -13.00 dBm, -13.00 dBm, -13.00 dBm
WCDMA	-12.50 dBm, -24.50 dBm, -24.50 dBm, -11.50 dBm, -11.50 dBm, -11.50 dBm -69.6 dBm, -54.3 dBm, -54.3 dBm, -54.3 dBm, -54.3 dBm, -54.3 dBm
LTE, LTETDD	-12.5 dBm, -12.5 dBm, -15.0 dBm, -15.0 dBm, -15.0 dBm, -15.0 dBm -13.5 dBm, -8.5 dBm, -11.5 dBm, -23.5 dBm, -23.5 dBm, -23.5 dBm

When the max number of offsets is 12 in these modes, the preset value of Offset G ~ L is the same as the Offset F value

Mode	Values
LTEAFDD, LTEATDD	-12.5 dBm, -12.5 dBm, -15.0 dBm, -15.0 dBm, -15.0 dBm, -15.0 dBm, -15.0 dBm, -15.0 dBm, -15.0 dBm, -15.0 dBm, -15.0 dBm, -15.0 dBm -13.5 dBm, -8.5 dBm, -11.5 dBm, -23.5 dBm, -23.5 dBm, -23.5 dBm -23.5 dBm, -23.5 dBm, -23.5 dBm, -23.5 dBm, -23.5 dBm
5G NR	-12.5 dBm, -12.5 dBm, -15.0 dBm, -15.0 dBm, -15.0 dBm, -15.0 dBm, -15.0 dBm, -15.0 dBm, -15.0 dBm, -15.0 dBm, -15.0 dBm, -15.0 dBm -22.5 dBm, -8.5 dBm, -11.5 dBm, -23.5 dBm, -23.5 dBm, -23.5 dBm, -23.5 dBm, -23.5 dBm, -23.5 dBm, -23.5 dBm, -23.5 dBm, -23.5 dBm
MSR	-12.5 dBm, -24.5 dBm, -11.5 dBm, -15.0 dBm, -15.0 dBm, -15.0 dBm, -15.0 dBm, -15.0 dBm, -15.0 dBm, -15.0 dBm, -15.0 dBm, -15.0 dBm -12.5 dBm, -24.5 dBm, -11.5 dBm, -15.0 dBm, -15.0 dBm, -15.0 dBm, -15.0 dBm, -15.0 dBm, -15.0 dBm, -15.0 dBm, -15.0 dBm, -15.0 dBm

When the max number of offsets is 14 in these modes, the preset value of Offset G ~ N is the same as the Offset F value

WLAN Mode: See the table of "[WLAN Mode Presets](#)" on page 1511 below

When the max number of offsets is 6:

Mode	Values
SA	ON, OFF, ON, ON, ON, ON
WCDMA	ON, OFF, ON, ON, ON, ON ON, ON, ON, ON, ON, ON
LTE, LTETDD	OFF, ON, ON, ON, ON, ON ON, ON, ON, ON, ON, ON

When the max number of offsets is 12 in these modes, the preset value of Offset G ~ L is the same as the Offset F value

Mode	Values
LTEAFDD, LTEATDD, 5G NR	OFF, ON, ON, ON, ON, ON, ON, ON, ON, ON, ON, ON ON, ON, ON, ON, ON, ON, ON, ON, ON, ON, ON, ON
MSR	ON, OFF, OFF, OFF, ON, OFF, OFF, OFF, OFF, OFF, OFF, OFF ON, OFF, OFF, OFF, ON, OFF, OFF, OFF, OFF, OFF, OFF, OFF

When the max number of offsets is 14 in these modes, the preset value of Offset G ~ N is the same as the Offset F value

WLAN Mode: See the table of "[WLAN Mode Auto Function Presets](#)" on page 1512 below

State Saved	Saved in instrument state Saved in instrument state
Range	Auto Man
Min/Max	-200 dBm/50 dBm

WLAN Mode Presets

Radio Std	Presets
802.11b/g (DSSS/CCK/PBCC)	-4.00 dBm, -12.00 dBm, -24.00 dBm, -24.00 dBm, -24.00 dBm, -24.00 dBm, -24.00 dBm, -24.00 dBm, -24.00 dBm, -24.00 dBm, -24.00 dBm, -24.00 dBm, -24.00 dBm, -24.00 dBm, -24.00 dBm
802.11a/g (OFDM/DSSS-OFDM)	-10 dBm, -30 dBm, -30 dBm, -30 dBm, -30 dBm, -30 dBm, -30 dBm, -30 dBm, -30 dBm, -30 dBm, -30 dBm, -30 dBm, -30 dBm, -30 dBm, -30 dBm
802.11n/ac/ax/be (20MHz)	-4.00 dBm, -12.00 dBm, -24.00 dBm, -63.00 dBm, -63.00 dBm, -63.00 dBm, -63.00 dBm, -63.00 dBm, -63.00 dBm, -63.00 dBm, -63.00 dBm, -63.00 dBm, -63.00 dBm, -63.00 dBm, -63.00 dBm
802.11n/ac/ax/be (40MHz)	-4.00 dBm, -12.00 dBm, -24.00 dBm, -66.00 dBm, -66.00 dBm, -66.00 dBm, -66.00 dBm, -66.00 dBm, -66.00 dBm, -66.00 dBm, -66.00 dBm, -66.00 dBm, -66.00 dBm, -66.00 dBm, -66.00 dBm
802.11ac/ax (80MHz/160MHz)	-69.00 dBm, -69.00 dBm, -69.00 dBm, -69.00 dBm, -69.00 dBm, -69.00 dBm, -69.00 dBm, -69.00 dBm, -69.00 dBm, -69.00 dBm, -69.00 dBm, -69.00 dBm, -69.00 dBm, -69.00 dBm, -69.00 dBm

Radio Std	Presets
	69.00 dBm, -69.00 dBm, -69.00 dBm, -69.00 dBm
802.11be (80MHz/160MHz/320MHz)	-49.00 dBm, -49.00 dBm, -49.00 dBm, -49.00 dBm, -49.00 dBm, -49.00 dBm, -49.00 dBm, -49.00 dBm, -49.00 dBm, -49.00 dBm, -49.00 dBm, -49.00 dBm, -49.00 dBm, -49.00 dBm
802.11ac/ax (80 + 80 MHz)	-69.00 dBm, -69.00 dBm, -69.00 dBm, -69.00 dBm, -69.00 dBm, -69.00 dBm, -69.00 dBm, -69.00 dBm, -69.00 dBm, -69.00 dBm, -69.00 dBm, -69.00 dBm, -69.00 dBm, -69.00 dBm
802.11ah (1MHz)	-4.00 dBm, -12.00 dBm, -24.00 dBm, -60.00 dBm, -60.00 dBm, - 60.00 dBm, -60.00 dBm, -60.00 dBm, -60.00 dBm, -60.00 dBm, - 60.00 dBm, -60.00 dBm, -60.00 dBm, -60.00 dBm
802.11ah (2MHz)	-4.00 dBm, -12.00 dBm, -24.00 dBm, -63.00 dBm, -63.00 dBm, - 63.00 dBm, -63.00 dBm, -63.00 dBm, -63.00 dBm, -63.00 dBm, - 63.00 dBm, -63.00 dBm, -63.00 dBm, -63.00 dBm
802.11ah (4MHz)	-4.00 dBm, -12.00 dBm, -24.00 dBm, -66.00 dBm, -66.00 dBm, - 66.00 dBm, -66.00 dBm, -66.00 dBm, -66.00 dBm, -66.00 dBm, - 66.00 dBm, -66.00 dBm, -66.00 dBm, -66.00 dBm
802.11ah (8MHz/16MHz)	-4.00 dBm, -12.00 dBm, -24.00 dBm, -69.00 dBm, -69.00 dBm, - 69.00 dBm, -69.00 dBm, -69.00 dBm, -69.00 dBm, -69.00 dBm, - 69.00 dBm, -69.00 dBm, -69.00 dBm, -69.00 dBm
802.11j/p (10MHz)	-4.00 dBm, -12.00 dBm, -24.00 dBm, -60.00 dBm, -60.00 dBm, - 60.00 dBm, -60.00 dBm, -60.00 dBm, -60.00 dBm, -60.00 dBm, - 60.00 dBm, -60.00 dBm, -60.00 dBm, -60.00 dBm
802.11j/p (5MHz)	-4.00 dBm, -12.00 dBm, -24.00 dBm, -57.00 dBm, -57.00 dBm, - 57.00 dBm, -57.00 dBm, -57.00 dBm, -57.00 dBm, -57.00 dBm, - 57.00 dBm, -57.00 dBm, -57.00 dBm, -57.00 dBm
802.11af (6MHz)	-4.00 dBm, -12.00 dBm, -24.00 dBm, -66.00 dBm, -66.00 dBm, - 66.00 dBm, -66.00 dBm, -66.00 dBm, -66.00 dBm, -66.00 dBm, - 66.00 dBm, -66.00 dBm, -66.00 dBm, -66.00 dBm
802.11af (7MHz)	-4.00 dBm, -12.00 dBm, -24.00 dBm, -66.00 dBm, -66.00 dBm, - 66.00 dBm, -66.00 dBm, -66.00 dBm, -66.00 dBm, -66.00 dBm, - 66.00 dBm, -66.00 dBm, -66.00 dBm, -66.00 dBm
802.11af (8MHz)	-4.00 dBm, -12.00 dBm, -24.00 dBm, -66.00 dBm, -66.00 dBm, - 66.00 dBm, -66.00 dBm, -66.00 dBm, -66.00 dBm, -66.00 dBm, - 66.00 dBm, -66.00 dBm, -66.00 dBm, -66.00 dBm

WLAN Mode Auto Function Presets

Radio Std	Presets
802.11a/g (OFDM/DSSS-OFDM)	OFF, OFF, OFF, ON, ON, ON, ON, ON, ON, ON,
802.11n (20MHz/40MHz)	ON, ON, ON, ON
802.11 ac/ax/be (20MHz/40MHz/80MHz/160MHz)	

Radio Std	Presets
802.11 be (320MHz)	
802.11ah (1MHz/2MHz/4MHz/8MHz/16MHz)	
802.11af (6MHz/7MHz/8MHz)	
802.11 ac/ax (80+80 MHz)	ON, ON, ON, ON, ON, ON, ON, ON, ON, ON, ON, ON, ON, ON, ON
802.11b/g (DSSS/CCK/PBCC)	ON, ON, ON, ON, ON, ON, ON, ON, ON, ON, ON, ON, ON, ON, ON
802.11j/p 20M, j/p 10M, p5M	OFF, OFF, OFF, ON, ON, ON, ON, ON, ON, ON, ON, ON, ON, ON, ON, ON

Rel Start

Sets a relative power level limit at the start frequency for the selected offset. The relative power level limit ranges from -200 to +50 dBc.

The fail condition is set remotely by `[:SENSe] :SEMAsk:OFFSet[n] [:OUTer] :LIST:TEST` for each offset channel test.

You can turn off (not use) specific offset channels remotely with `[:SENSe] :SEMAsk:OFFSet[n] [:OUTer] :LIST:STATe`.

The query returns values currently set to the relative power test limits.

When sending the remote command, missing values are not permitted; that is, if you want to change values 2 and 6, you must send all values up to 6. Subsequent values remain unchanged. The query returns 14 values for WLAN Mode, or 12 values for other Modes.

Remote Command	<code>[:SENSe] :SEMAsk:OFFSet[1] 2 [:OUTer] :LIST:START:RCARrier <rel_amp1>, ...</code> <code>[:SENSe] :SEMAsk:OFFSet[1] 2 [:OUTer] :LIST:START:RCARrier?</code>						
Example	<code>:SEM:OFFS:LIST:STAR:RCAR -30, -30, -30, -30, -30, -30</code> <code>:SEM:OFFS:LIST:STAR:RCAR?</code>						
Notes	Comma-separated list of values OFFSet 1 is for BTS, 2 for MS. Default is BTS Note that Offset sub op code 2 is supported only in Modes other than SA. In SA mode, Offset sub op code 1 is used for both BTS and MS						
Preset	When the max number of offsets is 6:						
	<table border="1"> <thead> <tr> <th>Mode</th> <th>Values</th> </tr> </thead> <tbody> <tr> <td>SA</td> <td>-30.00 dB, -30.00 dB, -30.00 dB, -30.00 dB, -30.00 dB, -30.00 dB</td> </tr> <tr> <td>WCDMA</td> <td>-30.00 dB, -30.00 dB, -30.00 dB, -30.00 dB, -30.00 dB, -30.00 dB -33.73 dB, -34.00 dB, -37.50 dB, -47.50 dB, -47.50 dB, -47.50 dB</td> </tr> </tbody> </table>	Mode	Values	SA	-30.00 dB, -30.00 dB, -30.00 dB, -30.00 dB, -30.00 dB, -30.00 dB	WCDMA	-30.00 dB, -30.00 dB, -30.00 dB, -30.00 dB, -30.00 dB, -30.00 dB -33.73 dB, -34.00 dB, -37.50 dB, -47.50 dB, -47.50 dB, -47.50 dB
Mode	Values						
SA	-30.00 dB, -30.00 dB, -30.00 dB, -30.00 dB, -30.00 dB, -30.00 dB						
WCDMA	-30.00 dB, -30.00 dB, -30.00 dB, -30.00 dB, -30.00 dB, -30.00 dB -33.73 dB, -34.00 dB, -37.50 dB, -47.50 dB, -47.50 dB, -47.50 dB						

Rel Stop

Sets a relative power level limit at the stop frequency for the selected offset. The relative power level limit ranges from -200 to +50 dBc.

The fail condition is set remotely by `[:SENSe]:SEMAsk:OFFSet[n] [:OUTer]:LIST:TEST` for each offset channel.

You can turn off (not use) specific offset channels remotely with `[:SENSe]:SEMAsk:OFFSet[n][:OUTer]:LIST:STATE`.

The query returns values currently set to the offset stop relative power limits.

When sending the remote command, missing values are not permitted; that is, if you want to change values 2 and 6, you must send all values up to 6. Subsequent values remain unchanged. The query returns 14 values for WLAN Mode, or 12 values for other Modes.

Remote Command	<pre>[:SENSe]:SEMAsk:OFFSet[1] 2[:OUTer]:LIST:STOP:RCARrier <rel_ampl>, ... [:SENSe]:SEMAsk:OFFSet[1] 2[:OUTer]:LIST:STOP:RCARrier? [:SENSe]:SEMAsk:OFFSet[1] 2[:OUTer]:LIST:STOP:RCARrier:COUPle ON OFF 1 0, ... [:SENSe]:SEMAsk:OFFSet[1] 2[:OUTer]:LIST:STOP:RCARrier:COUPle?</pre>						
Example	<pre>:SEM:OFFS:LIST:STOP:RCAR -30, -30, -30, -30, -30, -30 :SEM:OFFS:LIST:STOP:RCAR? :SEM:OFFS:LIST:STOP:RCAR:COUP ON, ON, ON, ON, ON, ON :SEM:OFFS:LIST:STOP:RCAR:COUP?</pre>						
Notes	<p>Comma-separated list of values</p> <p>OFFSet 1 is for BTS, 2 for MS. Default is BTS</p> <p>Note that Offset sub op code 2 is supported only in Modes other than SA. In SA mode, Offset sub op code 1 is used for both BTS and MS</p>						
Couplings	Coupled to Rel Start if "Auto" is selected, that is, Start is made the same as Stop						
Preset	<p>When the max number of offsets is 6:</p> <table border="1"> <thead> <tr> <th>Mode</th> <th>Values</th> </tr> </thead> <tbody> <tr> <td>SA</td> <td>-30.00 dB, -30.00 dB, -30.00 dB, -30.00 dB, -30.00 dB, -30.00 dB</td> </tr> <tr> <td>WCDMA</td> <td>-30.00 dB, -30.00 dB, -30.00 dB, -30.00 dB, -30.00 dB, -30.00 dB -48.28 dB, -37.50 dB, -47.50 dB, -47.50 dB, -47.50 dB, -47.50 dB</td> </tr> </tbody> </table> <p>When the max number of offsets is 12 in these modes, the preset value of Offset G ~ L is the same as the Offset F value</p>	Mode	Values	SA	-30.00 dB, -30.00 dB, -30.00 dB, -30.00 dB, -30.00 dB, -30.00 dB	WCDMA	-30.00 dB, -30.00 dB, -30.00 dB, -30.00 dB, -30.00 dB, -30.00 dB -48.28 dB, -37.50 dB, -47.50 dB, -47.50 dB, -47.50 dB, -47.50 dB
Mode	Values						
SA	-30.00 dB, -30.00 dB, -30.00 dB, -30.00 dB, -30.00 dB, -30.00 dB						
WCDMA	-30.00 dB, -30.00 dB, -30.00 dB, -30.00 dB, -30.00 dB, -30.00 dB -48.28 dB, -37.50 dB, -47.50 dB, -47.50 dB, -47.50 dB, -47.50 dB						

Mode	Values
LTEAFDD, LTEATDD, 5G NR, MSR	0 dB, 0 dB, 0 dB, 0 dB, 0 dB, 0 dB, 0 dB, 0 dB, 0 dB, 0 dB, 0 dB, 0 dB 0 dB, 0 dB, 0 dB, 0 dB, 0 dB, 0 dB, 0 dB, 0 dB, 0 dB, 0 dB

When the max number of offsets is 14 in these modes, the preset value of Offset G ~ N is the same as the Offset F value

WLAN Mode: See table of "[WLAN Mode Presets](#)" on page 1516 below

When the max number of offsets is 6:

Mode	Values
SA	ON, ON, ON, ON, ON, ON
WCDMA	ON, ON, ON, ON, ON, ON OFF, OFF, OFF, ON, ON, ON

When the max number of offsets is 12 in these modes, the preset value of Offset G ~ L is the same as the Offset F value

Mode	Values
LTEAFDD, LTEATDD, 5G NR, MSR	ON, ON, ON, ON, ON, ON, ON, ON, ON, ON, ON, ON ON, ON, ON, ON, ON, ON, ON, ON, ON, ON, ON, ON

When the max number of offsets is 14 in these modes, the preset value of Offset G ~ N is the same as the Offset F value

WLAN Mode: See table of "[WLAN Mode Auto Function Presets](#)" on page 1517 below

State Saved	Saved in instrument state Saved in instrument state
Range	Auto Man
Min/Max	-200 dB/50 dB

WLAN Mode Presets

Radio Std	Presets
802.11a/g (OFDM/DSSS-OFDM)	-20.00 dB, -28.00 dB, -40.00 dB, -40.00 dB, -47.00 dB, -47.00 dB, -47.00 dB, -47.00 dB, -47.00 dB, -47.00 dB, -47.00 dB, -47.00 dB, -47.00 dB, -47.00 dB
802.11b/g (DSSS/CCK/PBCC)	-30 dB, -50 dB, -50 dB, -50 dB, -50 dB, -50 dB, -50 dB, -50 dB, -50 dB, -50 dB, -50 dB, -50 dB, -50 dB, -50 dB
802.11n (20MHz/40MHz)	-20.00 dB, -28.00 dB, -45.00 dB, -45.00 dB, -45.00 dB, -45.00 dB, -45.00 dB, -45.00 dB, -45.00 dB, -45.00 dB, -45.00 dB, -45.00 dB, -45.00 dB, -45.00 dB
802.11ac/ax/be (20 MHz/ 40 MHz/ 80 MHz/)	-20.00 dB, -28.00 dB, -40.00 dB, -40.00 dB, -40.00 dB, -40.00 dB, -40.00 dB, -40.00 dB, -40.00 dB, -40.00 dB, -40.00 dB, -40.00 dB, -40.00 dB, -40.00 dB

3 VMA Mode
3.9 SEM Measurement

Radio Std	Presets
160 MHz)	dB, -40.00 dB
802.11be (320 MHz)	-20.00 dB, -28.00 dB, -40.00 dB, -40.00 dB, -40.00 dB, -40.00 dB, -40.00 dB, -40.00 dB, -40.00 dB, -40.00 dB, -40.00 dB, -40.00 dB, -40.00 dB, -40.00 dB
802.11ac/ax (80 MHz + 80MHz)	-40dB, -28.00 dB, -20.00 dB, 0 dB, -20.00 dB, -28.00 dB, -40.00 dB, -40.00 dB, -40.00 dB, -40.00 dB, -40.00 dB, -40.00 dB, -40.00 dB, -40.00 dB
802.11ah (1MHz/ 2 MHz/ 4 MHz/ 8 MHz/ 16 MHz)	-20.00 dB, -28.00 dB, -40.00 dB, -40.00 dB, -40.00 dB, -40.00 dB, -40.00 dB, -40.00 dB, -40.00 dB, -40.00 dB, -40.00 dB, -40.00 dB, -40.00 dB, -40.00 dB
802.11 j/p 10M, p5M	-20.00 dB, -28.00 dB, -40.00 dB, -40.00 dB, -40.00 dB, -47.00 dB, -47.00 dB, -47.00 dB, -47.00 dB, -47.00 dB, -47.00 dB, -47.00 dB, -40.00 dB, -40.00 dB
802.11af (6MHz/ 7MHz/ 8MHz)	-20.00 dB, -28.00 dB, -40.00 dB, -40.00 dB, -40.00 dB, -40.00 dB, -40.00 dB, -40.00 dB, -40.00 dB, -40.00 dB, -40.00 dB, -40.00 dB, -40.00 dB, -40.00 dB

WLAN Mode Auto Function Presets

Radio Std	Presets
802.11a/g (OFDM/DSSS-OFDM)	OFF, OFF, OFF, ON, ON, ON, ON, ON, ON, ON, ON, ON, ON, ON, ON, ON, ON, ON
802.11n (20MHz/ 40MHz)	ON, ON, ON
802.11b/g (DSSS/CCK/PBCC)	ON, ON, ON, ON, ON, ON, ON, ON, ON, ON, ON, ON, ON, ON, ON, ON, ON, ON
802.11ac/ax/be (20 MHz/ 40 MHz/ 80 MHz/ 160 MHz)	OFF, OFF, OFF, ON, ON, ON, ON, ON, ON, ON, ON, ON, ON, ON, ON, ON, ON, ON
802.11be (320 MHz)	OFF, OFF, OFF, ON, ON, ON, ON, ON, ON, ON, ON, ON, ON, ON, ON, ON, ON, ON
802.11ac/ax (80 MHz + 80MHz)	OFF, OFF, OFF, OFF, OFF, OFF, OFF, OFF, OFF, OFF, OFF, OFF, OFF, OFF, OFF, OFF, OFF, OFF
802.11ah (1MHz/2 MHz/ 4 MHz/ 8 MHz/ 16 MHz)	OFF, OFF, OFF, ON, ON, ON, ON, ON, ON, ON, ON, ON, ON, ON, ON, ON, ON, ON
802.11j/p (20M/ 10M) /11p(5M)	OFF, OFF, OFF, ON, ON, ON, ON, ON, ON, ON, ON, ON, ON, ON, ON, ON, ON, ON
802.11af (6 MHz/ 7 MHz/ 8 MHz)	OFF, OFF, OFF, ON, ON, ON, ON, ON, ON, ON, ON, ON, ON, ON, ON, ON, ON, ON

Fail Mask

Selects one of the logics for fail conditions between the measurement results and the test limits:

- **ABSolute** and **RELative** both check the results against the respective limit
- **OR** checks against both limits, failing if either of the limits is broken
- **AND** only displays a fail if both of the limits are broken

The absolute or relative power limit value for each offset channel can be set remotely with `[:SENSe]:SEMAsk:OFFSet[n][:OUTer]:LIST:ABSolute` or `[:SENSe]:SEMAsk:OFFSet[n][:OUTer]:LIST:RCARrier`.

You can turn off (not use) specific offset channels remotely with `[:SENSe]:SEMAsk:OFFSet[n][:OUTer]:LIST:STATE`.

When sending the remote command, missing values are not permitted; that is, if you want to change values 2 and 6, you must send all values up to 6. Subsequent values remain unchanged. The query returns 14 values for WLAN Mode, or 12 values for other Modes.

Remote Command	<code>[:SENSe]:SEMAsk:OFFSet[1] 2[:OUTer]:LIST:TEST ABSolute AND OR RELative, ...</code> <code>[:SENSe]:SEMAsk:OFFSet[1] 2[:OUTer]:LIST:TEST?</code>												
Example	<code>:SEM:OFFS:LIST:TEST ABS, ABS, ABS, ABS, ABS, ABS</code> <code>:SEM:OFFS:LIST:TEST?</code>												
Notes	Comma-separated list of values Note that Offset sub op code 2 is supported only in Modes other than SA. In SA Mode, Offset sub op code 1 is used for both BTS and MS												
Preset	When the max number of offsets is 6: <table border="1" data-bbox="389 1207 1404 1375"> <thead> <tr> <th>Mode</th> <th>Values</th> </tr> </thead> <tbody> <tr> <td>SA</td> <td>ABS, ABS, ABS, ABS, ABS, ABS</td> </tr> <tr> <td>WCDMA</td> <td>ABS, ABS, ABS, ABS, ABS, ABS AND, AND, AND, AND, AND, AND</td> </tr> <tr> <td>LTE, LTETDD</td> <td>ABS, ABS, ABS, ABS, ABS, ABS</td> </tr> </tbody> </table> <p>When the max number of offsets is 12 in these modes, the preset value of Offset G ~ L is the same as the Offset F value</p> <table border="1" data-bbox="389 1480 1404 1627"> <thead> <tr> <th>Mode</th> <th>Values</th> </tr> </thead> <tbody> <tr> <td>LTEAFDD, LTEATDD, 5G NR, MSR</td> <td>ABS, ABS, ABS, ABS, ABS, ABS, ABS, ABS, ABS, ABS, ABS, ABS ABS, ABS, ABS, ABS, ABS, ABS, ABS, ABS, ABS, ABS, ABS, ABS</td> </tr> </tbody> </table> <p>When the max number of offsets is 14 in these modes, the preset value of Offset G ~ N is the same as the Offset F value</p> <p>WLAN Mode: See the table of "WLAN Mode Presets" on page 1519 below</p>	Mode	Values	SA	ABS, ABS, ABS, ABS, ABS, ABS	WCDMA	ABS, ABS, ABS, ABS, ABS, ABS AND, AND, AND, AND, AND, AND	LTE, LTETDD	ABS, ABS, ABS, ABS, ABS, ABS	Mode	Values	LTEAFDD, LTEATDD, 5G NR, MSR	ABS, ABS, ABS, ABS, ABS, ABS, ABS, ABS, ABS, ABS, ABS, ABS ABS, ABS, ABS, ABS, ABS, ABS, ABS, ABS, ABS, ABS, ABS, ABS
Mode	Values												
SA	ABS, ABS, ABS, ABS, ABS, ABS												
WCDMA	ABS, ABS, ABS, ABS, ABS, ABS AND, AND, AND, AND, AND, AND												
LTE, LTETDD	ABS, ABS, ABS, ABS, ABS, ABS												
Mode	Values												
LTEAFDD, LTEATDD, 5G NR, MSR	ABS, ABS, ABS, ABS, ABS, ABS, ABS, ABS, ABS, ABS, ABS, ABS ABS, ABS, ABS, ABS, ABS, ABS, ABS, ABS, ABS, ABS, ABS, ABS												
State Saved	Saved in instrument state												
Range	Absolute Relative Abs AND Rel Abs OR Rel												

WLAN Mode Presets

Radio Std	Presets
802.11b/g (DSSS/CCK/PBCC)	REL, REL, REL, REL, REL, REL, REL, REL, REL, REL, REL, REL, REL, REL
802.11a/g (OFDM/DSSS-OFDM)	REL, REL, REL, AND, AND, AND, AND, AND, AND, AND, AND, AND, AND, AND
802.11n/ac/ax/be (20 MHz/ 40 MHz/ 80 MHz/80 MHz + 80MHz / 160 MHz/320MHz)	AND, AND, AND, AND, AND, AND, AND, AND, AND, AND, AND, AND, AND, AND
802.11ah (1MHz/ 2 MHz/ 4 MHz/ 8 MHz/ 16 MHz)	REL, REL, REL, AND, AND, AND, AND, AND, AND, AND, AND, AND, AND, AND
802.11j/p 10M, p5M	REL, REL, REL, AND, AND, AND, AND, AND, AND, AND, AND, AND, AND, AND
802.11af (6 MHz/ 7 MHz/ 8 MHz)	REL, REL, REL, AND, AND, AND, AND, AND, AND, AND, AND, AND, AND, AND

Show Abs2 Limit

Shows or hides Abs2 limit parameters.

Remote Command	<code>:DISPlay:SEMask:OFFSet:SABSolute ON OFF 1 0</code> <code>:DISPlay:SEMask:OFFSet:SABSolute?</code>
Example	<code>:DISP:SEM:OFFS:SABS 1</code> <code>:DISP:SEM:OFFS:SABS?</code>
Preset	0
State Saved	Yes
Range	ON OFF

Abs2 Start

Sets the 2nd absolute power level limit at the start frequency for the selected offset, ranging from -200 to +50 dBm.

The fail condition for each offset channel is set remotely using:

`[:SENSe] :SEMask:OFFSet[n] [:OUTer] :LIST:TEST:SABSolute`

You can turn off (not use) specific offset channels remotely using:

`[:SENSe] :SEMask:OFFSet[n] [:OUTer] :LIST:STATe`

The query returns values currently set to the 2nd absolute power test limits.

When sending the command, missing values are not permitted; that is, if you want to change values 2 and 6, you must send all values up to 6. Subsequent values remain unchanged. The query returns 14 values for WLAN Mode, or 12 values for other Modes.

Remote Command	<code>[:SENSe]:SEMAsk:OFFSet[1] 2[:OUTer]:LIST:STARt:SABSolute <real>, ...</code> <code>[:SENSe]:SEMAsk:OFFSet[1] 2[:OUTer]:LIST:STARt:SABSolute?</code>
Example	<code>:SEM:OFFS:LIST:STAR:SABS -12.50 dBm, -12.50 dBm, -24.50 dBm, -11.50 dBm, -11.50 dBm, -11.50 dBm</code> <code>:SEM:OFFS:LIST:STAR:SABS?</code>
Notes	Comma-separated list of values OFFSet1 is for BTS, 2 for MS. Default is BTS
Preset	For WLAN Mode: 0 dBm, 0 dBm, 0 dBm, 0 dBm, 0 dBm, 0 dBm, 0 dBm, 0 dBm, 0 dBm, 0 dBm, 0 dBm, 0 dBm, 0 dBm, 0 dBm, 0 dBm, 0 dBm For other Modes: 0 dBm, 0 dBm, 0 dBm, 0 dBm, 0 dBm, 0 dBm, 0 dBm, 0 dBm, 0 dBm, 0 dBm, 0 dBm, 0 dBm, 0 dBm 0 dBm, 0 dBm, 0 dBm, 0 dBm, 0 dBm, 0 dBm, 0 dBm, 0 dBm, 0 dBm, 0 dBm, 0 dBm, 0 dBm
State Saved	Saved in instrument state
Min	-200 dBm
Max	50 dBm

Abs2 Stop

Sets the 2nd absolute power level limit at the stop frequency for the selected offset, ranging from -200 to +50 dBm. You can also toggle this function between **Couple** and **Manual**. If **Couple = ON**, the **Abs2 Stop** power level limit is coupled to "**Abs2 Start**" on page 1519, resulting in a flat limit line. If set to **Man (Couple = OFF)**, **Abs2 Start** and **Abs2 Stop** take different values, resulting in a sloped limit line.

The query returns values currently set to the offset stop absolute2 power limits.

When sending the command, missing values are not permitted; that is, if you want to change values 2 and 6, you must send all values up to 6. Subsequent values remain unchanged. The query returns 14 values for WLAN Mode, or 12 values for other Modes.

Remote Command	<code>[:SENSe]:SEMAsk:OFFSet[1] 2[:OUTer]:LIST:STOP:SABSolute <real>, ...</code> <code>[:SENSe]:SEMAsk:OFFSet[1] 2[:OUTer]:LIST:STOP:SABSolute?</code> <code>[:SENSe]:SEMAsk:OFFSet[1] 2[:OUTer]:LIST:STOP:SABSolute:COUPlE ON OFF 1 0, ...</code> <code>[:SENSe]:SEMAsk:OFFSet[1] 2[:OUTer]:LIST:STOP:SABSolute:COUPlE?</code>
Example	<code>:SEM:OFFS:LIST:STOP:SABS -12.50 dBm, -24.50 dBm, -24.50 dBm, -11.50 dBm, -11.50 dBm, -11.50 dBm</code>

3 VMA Mode
3.9 SEM Measurement

	<pre> :SEM:OFFS:LIST:STOP:SABS? :SEM:OFFS:LIST:STOP:SABS:COUP ON, ON, ON, ON, ON, ON :SEM:OFFS:LIST:STOP:SABS:COUP? </pre>
Notes	Comma separated list of values OFFSet 1 is for BTS, 2 for MS. Default is BTS
Couplings	Coupled to Abs2 Start if Auto is selected, that is, the Stop value is equal to the Start value
Preset	For WLAN Mode: 0 dBm, 0 dBm, 0 dBm, 0 dBm, 0 dBm, 0 dBm, 0 dBm, 0 dBm, 0 dBm, 0 dBm, 0 dBm, 0 dBm, 0 dBm, 0 dBm, 0 dBm For other Modes: 0 dBm, 0 dBm, 0 dBm, 0 dBm, 0 dBm, 0 dBm, 0 dBm, 0 dBm, 0 dBm, 0 dBm, 0 dBm, 0 dBm 0 dBm, 0 dBm, 0 dBm, 0 dBm, 0 dBm, 0 dBm, 0 dBm, 0 dBm, 0 dBm, 0 dBm, 0 dBm, 0 dBm For WLAN Mode: ON, ON, ON, ON, ON, ON, ON, ON, ON, ON, ON, ON, ON, ON, ON, ON For other Modes: ON, ON, ON, ON, ON, ON, ON, ON, ON, ON, ON, ON ON, ON, ON, ON, ON, ON, ON, ON, ON, ON, ON, ON, ON, ON, ON, ON
State Saved	Saved in instrument state Saved in instrument state
Range	Auto Man
Min	-200 dBm
Max	50 dBm

Fail Mask2

Selects the logic operation for fail conditions between the measurement results and the test limits:

(Primary Fail Mask selection) OR Abs2	OR	Checks against both Primary and Abs2 limits. The test fails if either of the limits is broken
(Primary Fail Mask selection) AND Abs2	AND	Checks against both Primary and Abs2 limits. The test fails if both of the limits are broken
Abs2 Disabled	OFF	Fail Mask2 is disabled

Note that the Primary Fail Mask selection is set by **"Fail Mask"** on page 1517.

Examples:

- when Fail Mask is Abs **AND** Rel and Fail Mask2 is **OR** Abs2, “(Abs AND Rel) OR Abs2” is displayed in the column
- when Fail Mask is Absolute and Fail Mask2 is And Abs2, “(Absolute) AND Abs2” is displayed in the column

You can turn off (not use) specific offset channels remotely using:

`[:SENSe]:SEMAsk:OFFSet[n][:OUTer]:LIST:STATE`

When sending the command, missing values are not permitted; that is, if you want to change values 2 and 6, you must send all values up to 6. Subsequent values remain unchanged. The query returns 14 values for WLAN Mode, or 12 values for other Modes.

Remote Command	<code>[:SENSe]:SEMAsk:OFFSet[1] 2[:OUTer]:LIST:TEST:SABSolute AND OR OFF, ...</code> <code>[:SENSe]:SEMAsk:OFFSet[1] 2[:OUTer]:LIST:TEST:SABSolute?</code>
Example	<code>:SEM:OFFS:LIST:TEST:SABS AND, AND, OR, OFF, OFF, OFF</code> <code>:SEM:OFFS:LIST:TEST:SABS?</code>
Notes	Comma-separated list of values
Preset	For WLAN: <code>OFF, OFF, OFF, OFF, OFF, OFF, OFF, OFF, OFF, OFF, OFF, OFF, OFF, OFF</code> For other Modes: <code>OFF, OFF, OFF, OFF, OFF, OFF, OFF, OFF, OFF, OFF, OFF, OFF OFF, OFF, OFF, OFF, OFF, OFF, OFF, OFF, OFF, OFF</code>
State Saved	Saved in instrument state
Range	OR Abs2 AND Abs2 Abs2 Disabled

Inner Offset (BW)

Accesses a menu that enables you to set up the bandwidth measurement parameters for inner offset pairs.

Offset Freq Define

Enables you to select offset frequency definition. Each standard defines each offset frequency from Carrier.

For example, 3GPP2 requires the “Carrier Center to Meas BW Edge” definition, and LTE conformance test requires “Carrier Edge to Meas BW Center” and/or “Carrier Edge to Meas BW Edge” definition. MSR standard requires “RF BW Edge to Meas BW Center” and/or “RF BW Edge to Meas Edge” definition.

“Meas BW Edge” means the edge frequency of resolution bandwidth closer to the carrier that is represented by Meas BW and Res BW settings. Actual center frequency of Meas BW and the limit line have ½ Meas BW offset when the Meas BW Edge is selected.

Option	SCPI	Definition
Carrier Center to	<code>CTOCenter</code>	From the lowermost carrier center frequency (for lower offset), the uppermost carrier center frequency (for upper offset) to the

3 VMA Mode
3.9 SEM Measurement

Option	SCPI	Definition
Meas BW Center		center of offset measuring filter*
Carrier Center to Meas BW Edge	CTOEdge	From the lowermost carrier center frequency (for lower offset), the uppermost carrier center frequency (for upper offset) to the nominal -3 dB point of the offset measuring filter* closer to the carrier
Carrier Edge to Meas BW Center	ETOCenter	From the lowermost carrier center frequency - spacing of this carrier /2 (for lower offset), the uppermost carrier center frequency + spacing of this carrier /2 (for upper offset) to the center frequency of offset measuring filter*
Carrier Edge to Meas BW Edge	ETOEdge	From the lowermost carrier center frequency - spacing of this carrier /2 (for lower offset), the uppermost carrier center frequency + spacing of this carrier /2 (for upper offset) to the nominal -3 dB point of the offset measuring filter* closer to the carrier
Sub-block Edge to Meas BW Center	STOCenter	From either the lower or upper sub-block edge frequency to the center frequency of offset measuring filter*
Sub-block Edge to Meas BW Edge	STOEdge	From either the lower or upper sub-block edge frequency to the nominal -3 dB point of the offset measuring filter* closer to the carrier
Sub-block Center to Meas BW Center	SCTOCenter	From the center frequency of sub-block to the center frequency of offset measuring filter*

5G NR
Mode only

*Measuring filter = Meas BW (N) x Res BW

** sub-block (bandwidth) = $BW_{\text{channel,block}}$ which is defined in each 3GPP standard, regardless of "Measure Carrier" for the uppermost and the lowermost carriers being Enabled or Disabled. When the **Number of Component Carriers** within each sub-block = 1, sub-block (bandwidth) = $BW_{\text{channel}} = 2 \times F_{\text{offset,RAT}}$.

See "[Diagrams for Offset Freq Define](#)" on page 1525.

Mode: MSR, LTEAFDD, LTEATDD

Remote Command `[:SENSe] :SEMAsk:OFFSet[1] | 2:INNeR:TYPE CTOCenter | CTOEdge | ETOCenter | ETOEdge | STOCenter | STOEdge`
`[:SENSe] :SEMAsk:OFFSet[1] | 2:INNeR:TYPE?`

Example	<code>:SEM:OFFS:INN:TYPE ETOC</code> <code>:SEM:OFFS:INN:TYPE?</code>
Preset	<code>STOCenter</code>
State Saved	Saved in instrument state
Range	Carrier Center to Meas BW Center Carrier Center to Meas BW Edge Carrier Edge to Meas BW Center Carrier Edge to Meas BW Edge Sub-block Edge to Meas BW Center Sub-block Edge to Meas BW Edge

Mode: 5G NR

Remote Command	<code>[[:SENSe]:SEMAsk:OFFSet[1] 2:INNeR:TYPE CTOCenter CTOEdge ETOCenter ETOEdge STOCenter STOEdge SCTOCenter</code> <code>[[:SENSe]:SEMAsk:OFFSet[1] 2:INNeR:TYPE?</code>
Example	<code>:SEM:OFFS:INN:TYPE ETOC</code> <code>:SEM:OFFS:INN:TYPE?</code>
Preset	<code>STOCenter</code>
State Saved	Saved in instrument state
Range	Carrier Center to Meas BW Center Carrier Center to Meas BW Edge Carrier Edge to Meas BW Center Carrier Edge to Meas BW Edge Sub-block Edge to Meas BW Center Sub-block Edge to Meas BW Edge Sub-block Center to Meas BW Center

Diagrams for Offset Freq Define

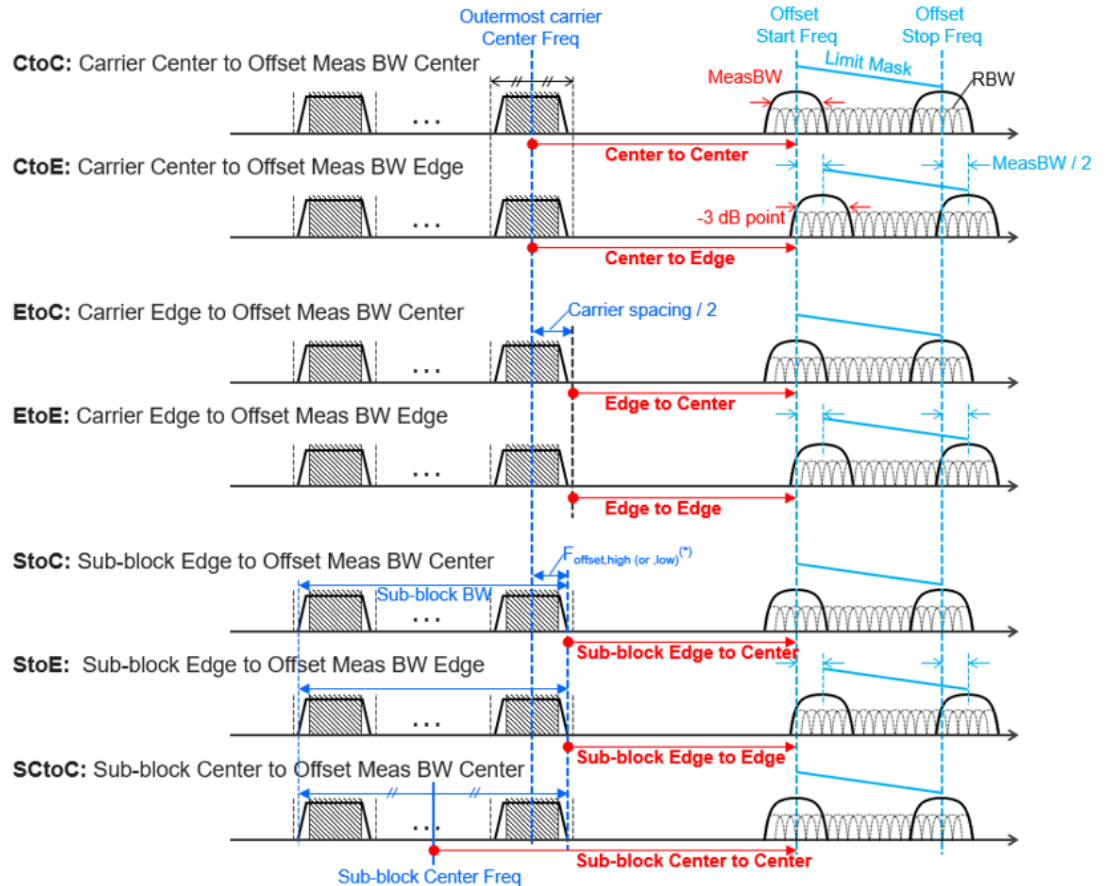

Notes:

- $MeasBW = N \times RBW$
- Sub-block Edge and Outermost Carrier Edge in the Sub-block are not always same. e.g.) 5G NR (3GPP) defines $BW_{channel,block}$ which calculates $F_{offset,high}$ and $F_{offset,low}$ asymmetrically with SCS shift.
(* For MSR, $F_{offset,high (or,low)} = F_{offset,RAT,high (or,low)}$)

Offset Detector

See "Offset Detector" on page 1487.

Cumulate Mask

Selects whether inner offset limit masks are cumulated or not.

Remote Command	<code>[:SENSe]:SEMAsk:OFFSet[1] 2:INNeR:CMASK[:STATe] ON OFF 0 1</code> <code>[:SENSe]:SEMAsk:OFFSet[1] 2:INNeR:CMASK[:STATe]?</code>
Example	<code>:SEM:OFFS:INN:CMAS 0</code> <code>:SEM:OFFS:INN:CMAS?</code>
Notes	OFFSet 1 is for BTS, 2 for MS. Default is BTS
Preset	1 0
State Saved	Yes
Range	ON OFF

Cumulate Mask Stop Frequency

Specifies stop frequency of summing limit masks. For outside of the stop frequency, the limit masks are not cumulated.

Remote Command	<code>[:SENSe]:SEMAsk:OFFSet[1] 2:INNeR:CMASK:FREQuency:STOP <freq></code> <code>[:SENSe]:SEMAsk:OFFSet[1] 2:INNeR:CMASK:FREQuency:STOP?</code>
Example	<code>:SEM:OFFS:INN:CMAS:FREQ:STOP 500E6</code> <code>:SEM:OFFS:INN:CMAS:FREQ:STOP?</code>
Notes	OFFSet 1 is for BTS, 2 for MS. Default is BTS
Dependencies	Valid only when " Cumulate Mask " on page 1525 is ON
Preset	10.5 MHz
State Saved	Yes
Min/Max	0 Hz/10 GHz

Start Freq

Specifies the start frequency for the currently selected offset. Also, enables you to toggle that offset between On and Off. When sending the remote command, missing values are not permitted; that is, if you want to change values 2 and 6, you must send all values up to 6. Subsequent values remain unchanged. The query for this parameter always returns 12 values.

Remote Command	<code>[:SENSe]:SEMAsk:OFFSet[1] 2:INNeR:LIST:FREQuency:STARt <freq>, ...</code> <code>[:SENSe]:SEMAsk:OFFSet[1] 2:INNeR:LIST:FREQuency:STARt?</code> <code>[:SENSe]:SEMAsk:OFFSet[1] 2:INNeR:LIST:STATe ON OFF 1 0, ...</code> <code>[:SENSe]:SEMAsk:OFFSet[1] 2:INNeR:LIST:STATe?</code>
Example	<code>:SEM:OFFS2:INN:LIST:FREQ:STAR 2.515 MHz, 2.715 MHz, 3.515 MHz, 4.00 MHz, 8.00 MHz, 12.50 MHz</code> <code>:SEM:OFFS2:INN:LIST:FREQ:STAR?</code>

	<code>:SEM:OFFS:INN:LIST:STAT ON, ON, ON, OFF, OFF, OFF</code> <code>:SEM:OFFS:INN:LIST:STAT?</code>																
Notes	Comma-separated list of values OFFSet 1 is for BTS, 2 for MS. Default is BTS If the offset is outside the frequency range, the result spectrum will be invalid																
Couplings	Coupled to "Stop Freq" on page 1527 . If Start Freq exceeds Stop Freq , Stop Freq is automatically adjusted to (Start Freq + 100 Hz)																
Preset	<table border="1"> <thead> <tr> <th>Mode</th> <th>Values</th> </tr> </thead> <tbody> <tr> <td>MSR</td> <td>15 kHz, 215 kHz, 1.015 MHz, 1.5 MHz, 10.5 MHz, 15.00 MHz, 30 MHz, 30 MHz, 30 MHz, 30 MHz, 30 MHz 15 kHz, 215 kHz, 1.015 MHz, 1.5 MHz, 10.5 MHz, 15.00 MHz, 30 MHz, 30 MHz, 30 MHz, 30 MHz, 30 MHz</td> </tr> <tr> <td>5G NR</td> <td>50 kHz, 5.05 MHz, 10.5 MHz, 40.00 MHz, 100 MHz, 100 MHz, 100 MHz, 100 MHz, 100 MHz, 100 MHz, 100 MHz 15.00 kHz, 1.5 MHz, 5.5 MHz, 100.50 MHz, 105.00 MHz, 100 MHz, 100 MHz, 100 MHz, 100 MHz, 100 MHz, 100 MHz</td> </tr> <tr> <td>LTEAFDD, LTEATDD</td> <td>50 kHz, 5.05 MHz, 10.5 MHz, 15.00 MHz, 30 MHz, 40 MHz, 40 MHz, 40 MHz, 40 MHz, 40 MHz, 40 MHz 15.00 kHz, 1.5 MHz, 5.5 MHz, 6.5 MHz, 10 MHz, 20MHz, 20MHz, 20MHz, 20MHz, 20MHz, 20MHz, 20MHz</td> </tr> <tr> <th>Mode</th> <th>Values</th> </tr> <tr> <td>MSR</td> <td>ON, ON, ON, ON, ON, OFF, OFF, OFF, OFF, OFF, OFF, OFF ON, ON, ON, ON, OFF, OFF, OFF, OFF, OFF, OFF, OFF</td> </tr> <tr> <td>5GNR</td> <td>ON, ON, ON, ON, OFF, OFF, OFF, OFF, OFF, OFF, OFF, OFF ON, ON, ON, ON, OFF, OFF, OFF, OFF, OFF, OFF, OFF</td> </tr> <tr> <td>LTEAFDD, LTEATDD</td> <td>ON, ON, ON, OFF, OFF, OFF, OFF, OFF, OFF, OFF, OFF, OFF ON, ON, ON, OFF, OFF, OFF, OFF, OFF, OFF, OFF, OFF</td> </tr> </tbody> </table>	Mode	Values	MSR	15 kHz, 215 kHz, 1.015 MHz, 1.5 MHz, 10.5 MHz, 15.00 MHz, 30 MHz, 30 MHz, 30 MHz, 30 MHz, 30 MHz 15 kHz, 215 kHz, 1.015 MHz, 1.5 MHz, 10.5 MHz, 15.00 MHz, 30 MHz, 30 MHz, 30 MHz, 30 MHz, 30 MHz	5G NR	50 kHz, 5.05 MHz, 10.5 MHz, 40.00 MHz, 100 MHz, 100 MHz, 100 MHz, 100 MHz, 100 MHz, 100 MHz, 100 MHz 15.00 kHz, 1.5 MHz, 5.5 MHz, 100.50 MHz, 105.00 MHz, 100 MHz, 100 MHz, 100 MHz, 100 MHz, 100 MHz, 100 MHz	LTEAFDD, LTEATDD	50 kHz, 5.05 MHz, 10.5 MHz, 15.00 MHz, 30 MHz, 40 MHz, 40 MHz, 40 MHz, 40 MHz, 40 MHz, 40 MHz 15.00 kHz, 1.5 MHz, 5.5 MHz, 6.5 MHz, 10 MHz, 20MHz, 20MHz, 20MHz, 20MHz, 20MHz, 20MHz, 20MHz	Mode	Values	MSR	ON, ON, ON, ON, ON, OFF, OFF, OFF, OFF, OFF, OFF, OFF ON, ON, ON, ON, OFF, OFF, OFF, OFF, OFF, OFF, OFF	5GNR	ON, ON, ON, ON, OFF, OFF, OFF, OFF, OFF, OFF, OFF, OFF ON, ON, ON, ON, OFF, OFF, OFF, OFF, OFF, OFF, OFF	LTEAFDD, LTEATDD	ON, ON, ON, OFF, OFF, OFF, OFF, OFF, OFF, OFF, OFF, OFF ON, ON, ON, OFF, OFF, OFF, OFF, OFF, OFF, OFF, OFF
Mode	Values																
MSR	15 kHz, 215 kHz, 1.015 MHz, 1.5 MHz, 10.5 MHz, 15.00 MHz, 30 MHz, 30 MHz, 30 MHz, 30 MHz, 30 MHz 15 kHz, 215 kHz, 1.015 MHz, 1.5 MHz, 10.5 MHz, 15.00 MHz, 30 MHz, 30 MHz, 30 MHz, 30 MHz, 30 MHz																
5G NR	50 kHz, 5.05 MHz, 10.5 MHz, 40.00 MHz, 100 MHz, 100 MHz, 100 MHz, 100 MHz, 100 MHz, 100 MHz, 100 MHz 15.00 kHz, 1.5 MHz, 5.5 MHz, 100.50 MHz, 105.00 MHz, 100 MHz, 100 MHz, 100 MHz, 100 MHz, 100 MHz, 100 MHz																
LTEAFDD, LTEATDD	50 kHz, 5.05 MHz, 10.5 MHz, 15.00 MHz, 30 MHz, 40 MHz, 40 MHz, 40 MHz, 40 MHz, 40 MHz, 40 MHz 15.00 kHz, 1.5 MHz, 5.5 MHz, 6.5 MHz, 10 MHz, 20MHz, 20MHz, 20MHz, 20MHz, 20MHz, 20MHz, 20MHz																
Mode	Values																
MSR	ON, ON, ON, ON, ON, OFF, OFF, OFF, OFF, OFF, OFF, OFF ON, ON, ON, ON, OFF, OFF, OFF, OFF, OFF, OFF, OFF																
5GNR	ON, ON, ON, ON, OFF, OFF, OFF, OFF, OFF, OFF, OFF, OFF ON, ON, ON, ON, OFF, OFF, OFF, OFF, OFF, OFF, OFF																
LTEAFDD, LTEATDD	ON, ON, ON, OFF, OFF, OFF, OFF, OFF, OFF, OFF, OFF, OFF ON, ON, ON, OFF, OFF, OFF, OFF, OFF, OFF, OFF, OFF																
State Saved	Saved in instrument state Saved in instrument state																
Range	<code>ON OFF</code>																
Min/Max	0 Hz/Depends on instrument maximum frequency. It's always Offset Stop Freq -100 Hz																

Stop Freq

Specifies the stop frequency for the currently selected offset.

When sending the remote command, missing values are not permitted; that is, if you want to change values 2 and 6 you must send all values up to 6. Subsequent values remain unchanged. The query for this parameter always returns 12 values.

Remote Command	<code>[:SENSe]:SEMAsk:OFFSet[1] 2:INNer:LIST:FREQuency:STOP <freq>, ...</code>
----------------	---

	<code>[:SENSe] :SEMAsk :OFFSet [1] 2 :INNer :LIST :FREQuency :STOP ?</code>								
Example	<code>:SEM :OFFS :INN :LIST :FREQ :STOP 2.715 MHz, 3.515 MHz, 4.00 MHz, 8.00 MHz, 12.50 MHz, 15.0 MHz</code> <code>:SEM :OFFS :INN :LIST :FREQ :STOP ?</code>								
Notes	Comma-separated list of values OFFSet 1 is for BTS, 2 for MS. Default is BTS If the offset is outside the frequency range, the result spectrum will be invalid								
Couplings	Coupled to " Start Freq " on page 1526. If Stop Freq is lower than Start Freq , Start Freq is automatically adjusted to (Stop Freq - 100 Hz)								
Preset	<table border="1"> <thead> <tr> <th>Mode</th> <th>Values</th> </tr> </thead> <tbody> <tr> <td>MSR</td> <td>215 kHz, 1.015 MHz, 1.5 MHz, 10.5 MHz, 50 MHz, 50 MHz, 50 MHz, 50 MHz, 50 MHz, 50 MHz, 50 MHz, 50 MHz</td> </tr> <tr> <td>5G NR</td> <td>5.05 MHz, 10.05 MHz, 40 MHz, 100 MHz, 500 MHz, 500 MHz, 500 MHz, 500 MHz, 500 MHz, 500 MHz, 500 MHz 985.0 kHz, 4.50 MHz, 99.500 MHz, 104.5 MHz, 500 MHz, 500 MHz, 500 MHz, 500 MHz, 500 MHz, 500 MHz, 500 MHz, 500 MHz</td> </tr> <tr> <td>LTEAFDD, LTEATDD</td> <td>5.05 MHz, 10.05 MHz, 15 MHz, 30 MHz, 40 MHz, 50 MHz, 50 MHz, 50 MHz, 50 MHz, 50 MHz, 50 MHz 985.0 kHz, 4.50 MHz, 5.5001 MHz, 9.50 MHz, 20 MHz, 40 MHz, 40 MHz, 40 MHz, 40 MHz, 40 MHz, 40 MHz, 40 MHz, 40 MHz</td> </tr> </tbody> </table>	Mode	Values	MSR	215 kHz, 1.015 MHz, 1.5 MHz, 10.5 MHz, 50 MHz, 50 MHz, 50 MHz, 50 MHz, 50 MHz, 50 MHz, 50 MHz, 50 MHz	5G NR	5.05 MHz, 10.05 MHz, 40 MHz, 100 MHz, 500 MHz, 500 MHz, 500 MHz, 500 MHz, 500 MHz, 500 MHz, 500 MHz 985.0 kHz, 4.50 MHz, 99.500 MHz, 104.5 MHz, 500 MHz, 500 MHz, 500 MHz, 500 MHz, 500 MHz, 500 MHz, 500 MHz, 500 MHz	LTEAFDD, LTEATDD	5.05 MHz, 10.05 MHz, 15 MHz, 30 MHz, 40 MHz, 50 MHz, 50 MHz, 50 MHz, 50 MHz, 50 MHz, 50 MHz 985.0 kHz, 4.50 MHz, 5.5001 MHz, 9.50 MHz, 20 MHz, 40 MHz, 40 MHz, 40 MHz, 40 MHz, 40 MHz, 40 MHz, 40 MHz, 40 MHz
Mode	Values								
MSR	215 kHz, 1.015 MHz, 1.5 MHz, 10.5 MHz, 50 MHz, 50 MHz, 50 MHz, 50 MHz, 50 MHz, 50 MHz, 50 MHz, 50 MHz								
5G NR	5.05 MHz, 10.05 MHz, 40 MHz, 100 MHz, 500 MHz, 500 MHz, 500 MHz, 500 MHz, 500 MHz, 500 MHz, 500 MHz 985.0 kHz, 4.50 MHz, 99.500 MHz, 104.5 MHz, 500 MHz, 500 MHz, 500 MHz, 500 MHz, 500 MHz, 500 MHz, 500 MHz, 500 MHz								
LTEAFDD, LTEATDD	5.05 MHz, 10.05 MHz, 15 MHz, 30 MHz, 40 MHz, 50 MHz, 50 MHz, 50 MHz, 50 MHz, 50 MHz, 50 MHz 985.0 kHz, 4.50 MHz, 5.5001 MHz, 9.50 MHz, 20 MHz, 40 MHz, 40 MHz, 40 MHz, 40 MHz, 40 MHz, 40 MHz, 40 MHz, 40 MHz								
State Saved	Saved in instrument state								
Min/Max	100 Hz/Depends on instrument maximum frequency. Same as the Max Span on Swept SA Measurement								

Res BW

Specifies which Resolution BW filter to use when measuring the currently selected offset.

Offset Res BW Mode allows the instrument to determine the optimum Resolution BW filter to use when measuring the currently selected offset. using front panel and all the offsets using SCPI. When changing the Meas BW parameter, if the Res BW needs to be changed to adhere to the rule:

$$(N \times \text{Res BW}) \leq (\text{Stop freq of the offset} - \text{Start freq of the offset}),$$

where N is the multiplier, this setting will automatically be changed to manual.

When sending the remote command, missing values are not permitted; that is, if you want to change values 2 and 6, you must send all values up to 6. Subsequent values remain unchanged. The query for this parameter always returns 12 values.

Remote Command	<code>[:SENSe] :SEMAsk :OFFSet [1] 2 :INNer :LIST :BANDwidth [:RESolution] <bandwidth>, ...</code>
----------------	--

3 VMA Mode
3.9 SEM Measurement

	<pre>[:SENSe]:SEMask:OFFSet[1] 2:INNeR:LIST:BANDwidth[:RESolution]? [:SENSe]:SEMask:OFFSet[1] 2:INNeR:LIST:BANDwidth[:RESolution]:AUTO OFF ON 1 0, ... [:SENSe]:SEMask:OFFSet[1] 2:INNeR:LIST:BANDwidth[:RESolution]:AUTO?</pre>								
Example	<pre>:SEM:OFFS2:INN:LIST:BAND 30.0 kHz, 30.0 kHz, 30.0 kHz, 1.00 MHz,1.00 MHz, 1.00 MHz :SEM:OFFS2:INN:LIST:BAND? :SEM:OFFS:INN:LIST:BAND:AUTO 1,1,1,1,1,1 :SEM:OFFS:INN:LIST:BAND:AUTO?</pre>								
Notes	<p>Comma-separated list of values OFFSet 1 is for BTS, 2 for MS. Default is BTS</p>								
Couplings	<p>Coupled to Start and Stop offset and "Meas BW" on page 1529 multiplier. This parameter must adhere to the rule: $(N \times \text{Res BW}) \leq (\text{Stop freq of the offset} - \text{Start freq of the offset})$, where N is the multiplier If the multiplier is changed, the Res BW changes to ensure conformance to the rule. When set manually, Res BW Coupling is set to manual The resolution bandwidth is coupled to the offset width, determined by "Start Freq" on page 1526 and "Stop Freq" on page 1527</p>								
Preset	<table border="1"> <thead> <tr> <th>Mode</th> <th>Values</th> </tr> </thead> <tbody> <tr> <td>MSR</td> <td>30 kHz, 30 kHz, 30 kHz, 1.0 MHz,1.0 MHz, 1.0 MHz, 1.0 MHz, 1.0 MHz, 1.0 MHz, 1.0 MHz, 1.0 MHz 30 kHz, 30 kHz, 30 kHz, 1.0 MHz,1.0 MHz, 1.0 MHz, 1.0 MHz, 1.0 MHz, 1.0 MHz, 1.0 MHz,1.0 MHz</td> </tr> <tr> <td>LTEAFDD, LTEATDD, 5G NR</td> <td>51 kHz, 100 kHz, 1.0 MHz, 1.0 MHz,1.0 MHz, 1.0 MHz,1.0 MHz, 1.0 MHz,1.0 MHz,1.0 MHz 15.0 kHz, 510 kHz,1.0 MHz,1.0 MHz, 1.0 MHz, 1.0 MHz, 1.0 MHz, 1.0 MHz,1.0 MHz, 1.0 MHz, 1.0 MHz</td> </tr> <tr> <td></td> <td>OFF, OFF, OFF, OFF, OFF, OFF, OFF, OFF, OFF, OFF, OFF, OFF OFF, OFF, OFF, OFF, OFF, OFF, OFF, OFF, OFF, OFF, OFF, OFF</td> </tr> </tbody> </table>	Mode	Values	MSR	30 kHz, 30 kHz, 30 kHz, 1.0 MHz,1.0 MHz, 1.0 MHz, 1.0 MHz, 1.0 MHz, 1.0 MHz, 1.0 MHz, 1.0 MHz 30 kHz, 30 kHz, 30 kHz, 1.0 MHz,1.0 MHz, 1.0 MHz, 1.0 MHz, 1.0 MHz, 1.0 MHz, 1.0 MHz,1.0 MHz	LTEAFDD, LTEATDD, 5G NR	51 kHz, 100 kHz, 1.0 MHz, 1.0 MHz,1.0 MHz, 1.0 MHz,1.0 MHz, 1.0 MHz,1.0 MHz,1.0 MHz 15.0 kHz, 510 kHz,1.0 MHz,1.0 MHz, 1.0 MHz, 1.0 MHz, 1.0 MHz, 1.0 MHz,1.0 MHz, 1.0 MHz, 1.0 MHz		OFF, OFF, OFF, OFF, OFF, OFF, OFF, OFF, OFF, OFF, OFF, OFF OFF, OFF, OFF, OFF, OFF, OFF, OFF, OFF, OFF, OFF, OFF, OFF
Mode	Values								
MSR	30 kHz, 30 kHz, 30 kHz, 1.0 MHz,1.0 MHz, 1.0 MHz, 1.0 MHz, 1.0 MHz, 1.0 MHz, 1.0 MHz, 1.0 MHz 30 kHz, 30 kHz, 30 kHz, 1.0 MHz,1.0 MHz, 1.0 MHz, 1.0 MHz, 1.0 MHz, 1.0 MHz, 1.0 MHz,1.0 MHz								
LTEAFDD, LTEATDD, 5G NR	51 kHz, 100 kHz, 1.0 MHz, 1.0 MHz,1.0 MHz, 1.0 MHz,1.0 MHz, 1.0 MHz,1.0 MHz,1.0 MHz 15.0 kHz, 510 kHz,1.0 MHz,1.0 MHz, 1.0 MHz, 1.0 MHz, 1.0 MHz, 1.0 MHz,1.0 MHz, 1.0 MHz, 1.0 MHz								
	OFF, OFF, OFF, OFF, OFF, OFF, OFF, OFF, OFF, OFF, OFF, OFF OFF, OFF, OFF, OFF, OFF, OFF, OFF, OFF, OFF, OFF, OFF, OFF								
State Saved	<p>Saved in instrument state Saved in instrument state</p>								
Range	Auto Man								
Min	1 Hz								
Max	<p>When Option FS1 or FS2 is installed:10 MHz Otherwise: 8 MHz</p>								

Meas BW

Allows you to specify a multiplier of Res BW for the measurement integration bandwidth.

Meas BW is multiplier integer, which defines a ratio between Integration BW and **Res BW** of the measurement result:

Integration BW = Meas BW * "Res BW" on page 1528

Integration BW is the desired resolution bandwidth, and **Res BW** is the actual bandwidth for sweep. Measurement sweeps with **Res BW**, and **Meas BW** compensates sweep resolution bandwidth to Integration BW.

If you set this parameter greater than 1, you can set **Res BW** narrower to avoid carrier power leakage effect to the offset power integration.

When sending the remote command, missing values are not permitted; that is, if you want to change values 2 and 6, you must send all values up to 6. Subsequent values remain unchanged. The query for this parameter always returns 12 values.

Remote Command	<code>[:SENSe]:SEMAsk:OFFSet[1] 2:INNer:LIST:BANDwidth:IMULti <integer>, ...</code> <code>[:SENSe]:SEMAsk:OFFSet[1] 2:INNer:LIST:BANDwidth:IMULti?</code>						
Example	<code>:SEM:OFFS2:INN:LIST:BAND:IMUL 1,1,1,1,1,1</code> <code>:SEM:OFFS2:INN:LIST:BAND:IMUL?</code>						
Notes	Comma-separated list of values OFFSet 1 is for BTS, 2 for MS. Default is BTS						
Couplings	This parameter must adhere to the rule: (N x Res BW) <= (Stop freq of the offset - Start freq of the offset), where N is the multiplier If Res BW is changed, the multiplier changes to conform to the rule						
Preset	<table border="1"> <thead> <tr> <th>Mode</th> <th>Values</th> </tr> </thead> <tbody> <tr> <td>MSR</td> <td>1, 1, 1, 1, 1, 1, 1, 1, 1, 1, 1, 1 1, 1, 1, 1, 1, 1, 1, 1, 1, 1, 1, 1</td> </tr> <tr> <td>LTEAFDD, LTEATDD, 5G NR</td> <td>2, 1, 1, 1, 1, 1, 1, 1, 1, 1, 1, 1 2, 2, 1, 1, 1, 1, 1, 1, 1, 1, 1, 1</td> </tr> </tbody> </table>	Mode	Values	MSR	1, 1, 1, 1, 1, 1, 1, 1, 1, 1, 1, 1 1, 1, 1, 1, 1, 1, 1, 1, 1, 1, 1, 1	LTEAFDD, LTEATDD, 5G NR	2, 1, 1, 1, 1, 1, 1, 1, 1, 1, 1, 1 2, 2, 1, 1, 1, 1, 1, 1, 1, 1, 1, 1
Mode	Values						
MSR	1, 1, 1, 1, 1, 1, 1, 1, 1, 1, 1, 1 1, 1, 1, 1, 1, 1, 1, 1, 1, 1, 1, 1						
LTEAFDD, LTEATDD, 5G NR	2, 1, 1, 1, 1, 1, 1, 1, 1, 1, 1, 1 2, 2, 1, 1, 1, 1, 1, 1, 1, 1, 1, 1						
State Saved	Yes						
Min/Max	1/1000						

Video BW

Changes the instrument post-detection filter.

When sending the remote command, missing values are not permitted; that is, if you want to change values 2 and 6, you must send all values up to 6. Subsequent values remain unchanged. The query for this parameter always returns 12 values.

Remote Command	<code>[:SENSe]:SEMAsk:OFFSet[1] 2:INNer:LIST:BANDwidth:VIDeo <freq>, ...</code> <code>[:SENSe]:SEMAsk:OFFSet[1] 2:INNer:LIST:BANDwidth:VIDeo?</code> <code>[:SENSe]:SEMAsk:OFFSet[1] 2:INNer:LIST:BANDwidth:VIDeo:AUTO OFF ON 0 1, ...</code> <code>[:SENSe]:SEMAsk:OFFSet[1] 2:INNer:LIST:BANDwidth:VIDeo:AUTO?</code>
Example	<code>:SEM:OFFS2:INN:LIST:BAND:VID 3.00 kHz, 3.00 kHz, 3.00 kHz, 100.0 kHz,100.0</code>

3 VMA Mode
3.9 SEM Measurement

	<p>kHz, 100.0 kHz</p> <p>:SEM:OFFS2:INN:LIST:BAND:VID?</p> <p>:SEM:OFFS2:INN:LIST:BAND:VID:AUTO ON, ON, ON, ON, ON, ON</p> <p>:SEM:OFFS2:INN:LIST:BAND:VID:AUTO?</p>
Notes	<p>Comma-separated list of values</p> <p>OFFSet 1 is for BTS, 2 for MS. Default is BTS</p>
Couplings	<p>When the Auto state is ON, Video BW is basically coupled with other parameters</p>
Preset	<p>Automatically Calculated</p> <p>ON, ON, ON, ON, ON, ON, ON, ON, ON, ON, ON, ON, ON ON, ON, ON, ON, ON, ON, ON, ON, ON, ON, ON, ON</p>
State Saved	<p>Saved in instrument state</p> <p>Saved in instrument state</p>
Range	<p>Auto Man</p>
Min/Max	<p>1 Hz/50 MHz</p>

VBW/RBW

Selects the ratio between the video and resolution bandwidths.

When sending the remote command, missing values are not permitted; that is, if you want to change values 2 and 6, you must send all values up to 6. Subsequent values remain unchanged. The query for this parameter always returns 12 values.

Remote Command	<p>[:SENSe] :SEMAsk:OFFSet[1] 2:INNer:LIST:BANDwidth:VIDeo:RATio <real>, ...</p> <p>[:SENSe] :SEMAsk:OFFSet[1] 2:INNer:LIST:BANDwidth:VIDeo:RATio?</p> <p>[:SENSe] :SEMAsk:OFFSet[1] 2:INNer:LIST:BANDwidth:VIDeo:RATio:AUTO OFF ON 0 1, ...</p> <p>[:SENSe] :SEMAsk:OFFSet[1] 2:INNer:LIST:BANDwidth:VIDeo:RATio:AUTO?</p>
Example	<p>:SEM:OFFS2:INN:LIST:BAND:VID:RAT 0.1, 0.1, 0.1, 0.1, 0.1, 0.1</p> <p>:SEM:OFFS2:INN:LIST:BAND:VID:RAT?</p> <p>:SEM:OFFS:INN:LIST:BAND:VID:RAT:AUTO ON, ON, ON, ON, ON, ON</p> <p>:SEM:OFFS:INN:LIST:BAND:VID:RAT:AUTO?</p>
Notes	<p>Comma-separated list of values</p> <p>OFFSet1 is for BTS, 2 for MS. Default is BTS</p>
Couplings	<p>When Auto state is ON, the VBW/RBW is basically coupled with other parameters</p>
Preset	<p>0.01, 0.01, 0.01, 0.01, 0.01, 0.01, 0.01, 0.01, 0.01, 0.01, 0.01, 0.01 0.01, 0.01, 0.01, 0.01, 0.01, 0.01, 0.01, 0.01, 0.01, 0.01, 0.01, 0.01</p> <p>OFF, OFF, OFF, OFF, OFF, OFF, OFF, OFF, OFF, OFF, OFF, OFF OFF, OFF, OFF, OFF, OFF, OFF, OFF, OFF, OFF, OFF, OFF, OFF</p>
State Saved	<p>Saved in instrument state</p>

	Saved in instrument state
Range	Auto Man
Min/Max	0.00001/3000000

Inner Offset (Sweep)

Accesses a menu that enables you to set up the sweep measurement parameters for inner offset pairs.

Offset Freq Define

Same as ["Offset Freq Define" on page 1522](#) under Inner Offset (BW)

Offset Detector

Same as ["Offset Detector" on page 1487](#) under Inner Offset (BW)

Cumulate Mask

Same as ["Cumulate Mask " on page 1525](#) under Inner Offset (BW)

Cumulate Mask Stop Frequency

Same as ["Cumulate Mask Stop Frequency" on page 1526](#), under Inner Offset (BW)

Start Freq

Same as ["Start Freq" on page 1526](#), under Inner Offset (BW)

Stop Freq

Same as ["Stop Freq" on page 1527](#), under Inner Offset (BW)

Sweep Time

Specifies the sweep time for the currently selected offset and enables you to toggle the **Sweep Time** mode between **Auto** and **Man**.

3 VMA Mode
3.9 SEM Measurement

When sending the remote command, missing values are not permitted; that is, if you want to change values 2 and 6, you must send all values up to 6. Subsequent values remain unchanged. The query for this parameter always returns 12 values.

NOTE

On non-sweeping hardware, this column is grayed-out. The value shown on this column is an estimate of the turnaround time to complete the measurement of the entire offset span, which is the sum of signal acquisition time, FFT time, and other overhead time. If you need to specify the same **Sweep Time** as you would for sweeping hardware, send `[:SENSe]:SEMask:OFFSet [1]|2:INNeR:LIST:SWEEp:TIME <time>`. The measurement emulates the **Sweep Time** effect, but this emulation is not straightforward, and therefore the behavior is not specified. Instead, we recommend using "**Minimum Acquisition Time**" on page 1534, which provides better control.

Remote Command	<code>[:SENSe]:SEMask:OFFSet [1] 2:INNeR:LIST:SWEEp:TIME <time>, ...</code> <code>[:SENSe]:SEMask:OFFSet [1] 2:INNeR:LIST:SWEEp:TIME?</code> <code>[:SENSe]:SEMask:OFFSet [1] 2:INNeR:LIST:SWEEp:TIME:AUTO ON OFF 1 0, ...</code> <code>[:SENSe]:SEMask:OFFSet [1] 2:INNeR:LIST:SWEEp:TIME:AUTO?</code>						
Example	<code>:SEM:OFFS2:INN:LIST:SWE:TIME 1.0 ms, 3.4 ms, 2.08 ms, 1.0 ms, 1.0 ms, 1.0 ms</code> <code>:SEM:OFFS2:INN:LIST:SWE:TIME?</code> <code>:SEM:OFFS2:INN:LIST:SWE:TIME:AUTO ON, ON, ON, ON, OFF, OFF</code> <code>:SEM:OFFS2:INN:LIST:SWE:TIME:AUTO?</code>						
Notes	OFFSet 1 is for BTS, 2 for MS. Default is BTS						
Dependencies	On non-sweeping hardware, this column is grayed-out and the Auto/Man checkbox is invisible. The read-only column shows estimated sweep time In those instruments, " Minimum Acquisition Time " on page 1534 is available						
Couplings	When you manually set a value while in Auto , the state automatically changes to Man						
Preset	Automatically calculated						
	<table border="1"> <thead> <tr> <th>Mode</th> <th>Values</th> </tr> </thead> <tbody> <tr> <td>MSR</td> <td>ON, ON, ON, ON, ON, ON, ON, ON, ON, ON, ON, ON</td> </tr> <tr> <td>LTEAFDD, LTEATDD, 5G NR</td> <td>ON, ON, ON, ON, ON, ON, ON, ON, ON, ON, ON, ON ON, ON, ON, ON, ON, ON, ON, ON, ON, ON, ON, ON</td> </tr> </tbody> </table>	Mode	Values	MSR	ON, ON, ON, ON, ON, ON, ON, ON, ON, ON, ON, ON	LTEAFDD, LTEATDD, 5G NR	ON, ON, ON, ON, ON, ON, ON, ON, ON, ON, ON, ON ON, ON, ON, ON, ON, ON, ON, ON, ON, ON, ON, ON
Mode	Values						
MSR	ON, ON, ON, ON, ON, ON, ON, ON, ON, ON, ON, ON						
LTEAFDD, LTEATDD, 5G NR	ON, ON, ON, ON, ON, ON, ON, ON, ON, ON, ON, ON ON, ON, ON, ON, ON, ON, ON, ON, ON, ON, ON, ON						
State Saved	Saved in instrument state Saved in instrument state						
Min	Other than non-sweeping hardware Depends on Sweep Type: <ul style="list-style-type: none"> - Sweep Type "Swept": 1 ms - Sweep Type "FFT": 100 ns Non-sweeping hardware: N/A						

Max	Sweeping hardware: 10 s Non-sweeping hardware: N/A						
Min/Max	Depends on "Sweep Type" on page 1504:						
	<table border="1"> <thead> <tr> <th>Sweep Type</th> <th>Min/Max</th> </tr> </thead> <tbody> <tr> <td>Swept</td> <td>1ms/10 s</td> </tr> <tr> <td>FFT</td> <td>100ns/10 s</td> </tr> </tbody> </table>	Sweep Type	Min/Max	Swept	1ms/10 s	FFT	100ns/10 s
Sweep Type	Min/Max						
Swept	1ms/10 s						
FFT	100ns/10 s						

Minimum Acquisition Time

Available on non-sweeping hardware.

Specifies the minimum acquisition time for each “chunk” of the measurement result. The instrument automatically divides **Span** into multiple chunks if needed.

Therefore, the total signal acquisition time for the entire offset span is:

$\sim(\sim\text{Minimum Acquisition Time}) * (\text{The number of chunks})$.

When in **Auto**, this parameter’s value is determined by other parameters, such as **Offset Start**, **Offset Stop**, **RBW** and **VBW**.

You can manually increase this parameter value from this **Auto** value.

If increased, the instrument acquires signal for the specified time duration for each chunk. It performs additional FFTs, and averages or peak-holds the FFT results for a chunk, depending on **Detector** settings.

Note that the actual acquisition time for each chunk may exceed the **Minimum Acquisition Time** value, in order to satisfy FFT time required by other parameters, and to perform an integer number of FFTs.

Remote Command	<pre>[:SENSe]:SEMAsk:OFFSet[1] 2:INNeR:LIST:SWEep:ACQuisition:TIME <time>, ... [:SENSe]:SEMAsk:OFFSet[1] 2:INNeR:LIST:SWEep:ACQuisition:TIME? [:SENSe]:SEMAsk:OFFSet[1] 2:INNeR:LIST:SWEep:ACQuisition:TIME:AUTO ON OFF 1 0, ... [:SENSe]:SEMAsk:OFFSet[1] 2:INNeR:LIST:SWEep:ACQuisition:TIME:AUTO?</pre>
Example	<pre>:SEM:OFFS2:INN:LIST:SWE:ACQ:TIME 1.0 ms, 3.4 ms, 2.08 ms, 1.0 ms, 1.0 ms, 1.0 ms :SEM:OFFS2:INN:LIST:SWE:ACQ:TIME? :SEM:OFFS2:INN:LIST:SWE:ACQ:TIME:AUTO ON, ON, ON, OFF, OFF :SEM:OFFS2:INN:LIST:SWE:ACQ:TIME:AUTO?</pre>
Dependencies	Available only on non-sweeping hardware
Couplings	Coupled to Offset Start Freq , Offset Stop Freq , RBW , and VBW when in the Auto state When you manually set a value while in Auto , the state automatically changes to Man

Preset	Automatically calculated ON
State Saved	Saved in instrument state
Min	100 ns
Max	4000 s

Sweep Time Annotation (Remote Query Only)

Returns the **Sweep Time Annotation** value. Available only on non-sweeping hardware.

The value returned is the estimated turnaround time of each acquisition, in seconds. The turnaround time is the sum of the signal acquisition time, FFT time, and other overhead time, to complete the entire offset span of each measurement cycle.

Remote Command	<code>[:SENSe] :SEMAsk:OFFSet[1] 2:INNeR:LIST:SWEEp:ETIMe?</code>
Example	<code>:SEM:OFFS2:INN:LIST:SWE:ETIM?</code>
Dependencies	Available only on non-sweeping hardware
Preset	Automatically calculated

Sweep Type

Specifies the **Sweep Type** for the currently selected offset and enables you to toggle **Sweep Type** mode between **Auto** and **Man**.

When sending the remote command, missing values are not permitted; that is, if you want to change values 2 and 6, you must send all values up to 6. Subsequent values remain unchanged. The query for this parameter always returns 12 values.

How to define Sweep Time and Sweep Type

Sweep Type Mode	Behavior
Auto	Sweep Type is automatically selected depending on Rules Sweep Time is automatically calculated, according to the selected Sweep Type
Man	Sweep Type is user-selected
–	

Remote Command	<code>[:SENSe] :SEMAsk:OFFSet[1] 2:INNeR:LIST:SWEEp:TYPE SWEEp FFT, ...</code> <code>[:SENSe] :SEMAsk:OFFSet[1] 2:INNeR:LIST:SWEEp:TYPE?</code> <code>[:SENSe] :SEMAsk:OFFSet[1] 2:INNeR:LIST:SWEEp:TYPE:AUTO ON OFF 1 0, ...</code> <code>[:SENSe] :SEMAsk:OFFSet[1] 2:INNeR:LIST:SWEEp:TYPE:AUTO?</code>
----------------	---

Example	<pre>:SEM:OFFS2:INN:LIST:SWE:TYPE FFT,FFT,SWE :SEM:OFFS2:INN:LIST:SWE:TYPE? :SEM:OFFS2:INN:LIST:SWE:TYPE:AUTO ON, ON, ON, ON, OFF, OFF :SEM:OFFS2:INN:LIST:SWE:TYPE:AUTO?</pre>
Notes	Comma-separated list of values OFFSet 1 is for BTS, 2 for MS. Default is BTS
Dependencies	Not available in modular products, such as VXT
Couplings	When Sweep Type is set manually, Sweep Type Mode is set to MANua1 When Sweep Type Mode is Auto , Sweep Type is automatically selected according to " Sweep Type Rules " on page 1478
Preset	Automatically calculated ON,ON,ON,ON,ON,ON,ON,ON,ON,ON,ON,ON,ON
State Saved	Saved in instrument state
Range	Auto Man

Offset Side

Specifies which offset side to measure.

You can turn off (not use) specific offsets with `[:SENSe] :SEMAsk:OFFSet [n] :INNer:LIST:STATe`.

BOTH	Both sides in the sub-block gap are enabled.
NEGative	The upper side in the sub-block gap only (i.e., negative sideband of the upper sub-block) is enabled
POSitive	The lower side in the sub-block gap only (i.e., positive sideband of the lower sub-block) is enabled.

When sending the remote command, missing values are not permitted; that is, if you want to change values 2 and 6, you must send all values up to 6. Subsequent values remain unchanged. The query for this parameter always returns 12 values.

The figure below shows the relation between the negative/positive offset side setups and the upper/lower results in the MSR and LTE-Advanced FDD/TDD Modes.

3 VMA Mode
3.9 SEM Measurement

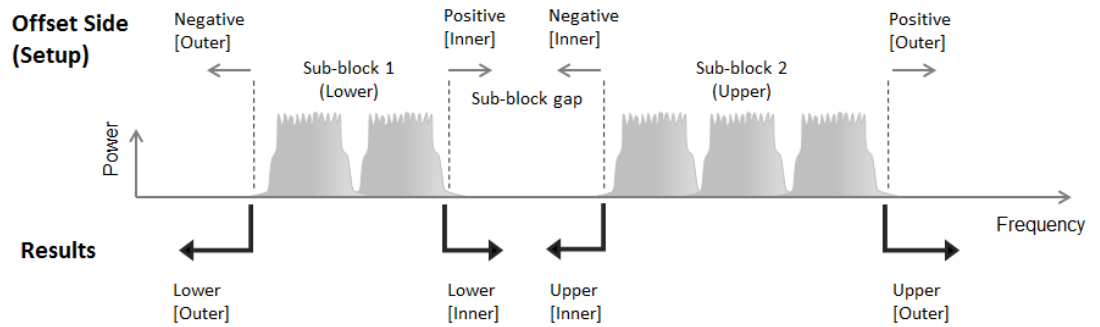

Remote Command	<code>[:SENSe]:SEMask:OFFSet[1] 2:INNeR:LIST:SIDE BOTH NEGative POSitive, ...</code> <code>[:SENSe]:SEMask:OFFSet[1] 2:INNeR:LIST:SIDE?</code>						
Example	<code>:SEM:OFFS:INN:LIST:SIDE BOTH, NEG, NEG, POS, POS, POS</code> <code>:SEM:OFFS:INN:LIST:SIDE?</code>						
Notes	Comma-separated list of values OFFSet1 is for BTS, 2 for MS. Default is BTS						
Preset	<table border="1"> <thead> <tr> <th>Mode</th> <th>Values</th> </tr> </thead> <tbody> <tr> <td>MSR</td> <td>BOTH, BOTH, BOTH, BOTH, BOTH, BOTH, BOTH, BOTH, BOTH, BOTH, BOTH, BOTH</td> </tr> <tr> <td>LTEAFDD, LTEATDD, SGNR</td> <td>BOTH, BOTH, BOTH, BOTH, BOTH, BOTH, BOTH, BOTH, BOTH, BOTH, BOTH, BOTH, BOTH, BOTH BOTH, BOTH, BOTH, BOTH, BOTH, BOTH, BOTH, BOTH, BOTH, BOTH, BOTH, BOTH</td> </tr> </tbody> </table>	Mode	Values	MSR	BOTH, BOTH, BOTH, BOTH, BOTH, BOTH, BOTH, BOTH, BOTH, BOTH, BOTH, BOTH	LTEAFDD, LTEATDD, SGNR	BOTH, BOTH, BOTH, BOTH, BOTH, BOTH, BOTH, BOTH, BOTH, BOTH, BOTH, BOTH, BOTH, BOTH BOTH, BOTH, BOTH, BOTH, BOTH, BOTH, BOTH, BOTH, BOTH, BOTH, BOTH, BOTH
Mode	Values						
MSR	BOTH, BOTH, BOTH, BOTH, BOTH, BOTH, BOTH, BOTH, BOTH, BOTH, BOTH, BOTH						
LTEAFDD, LTEATDD, SGNR	BOTH, BOTH, BOTH, BOTH, BOTH, BOTH, BOTH, BOTH, BOTH, BOTH, BOTH, BOTH, BOTH, BOTH BOTH, BOTH, BOTH, BOTH, BOTH, BOTH, BOTH, BOTH, BOTH, BOTH, BOTH, BOTH						
State Saved	Saved in instrument state						
Range	<code>BOTH NEGative POSitive</code>						

Inner Offset (Limits)

Accesses a menu that enables you to set the power limits for start and stop frequencies of the selected inner offsets.

Start Freq

Same as "Start Freq" on page 1526 under Inner Offset (BW)

Stop Freq

Same as "Stop Freq" on page 1527 under Inner Offset (BW)

Abs Start

Sets the absolute power level limit at the start frequency for the selected inner offset, ranging from -200 to +50 dBm.

The fail condition for each inner offset channel is set remotely by
[:SENSe]:SEMask:OFFSet[n]:INNER:LIST:TEST.

You can turn off (not use) specific inner offset channels remotely with
[:SENSe]:SEMask:OFFSet[n]:INNER:LIST:STATE.

The query returns values currently set to the absolute power test limits.

When sending the remote command, missing values are not permitted; that is, if you want to change values 2 and 6, you must send all values up to 6. Subsequent values remain unchanged. The query for this parameter always returns 12 values.

Remote Command	[:SENSe]:SEMask:OFFSet[1] 2:INNER:LIST:START:ABSolute <real>, ... [:SENSe]:SEMask:OFFSet[1] 2:INNER:LIST:START:ABSolute?	
Example	:SEM:OFFS2:INN:LIST:STAR:ABS -12.50 dBm, -12.50 dBm, -24.50 dBm, -11.50 dBm, -11.50 dBm, -11.50 dBm :SEM:OFFS2:INN:LIST:STAR:ABS?	
Notes	Comma-separated list of values OFFSet 1 is for BTS, 2 for MS. Default is BTS	
Preset	Mode	Values
	MSR	-12.5 dBm, -12.5 dBm, -24.5 dBm, -11.5 dBm, -15.0 dBm, -15.0 dBm, -15.0 dBm, -15.0 dBm, -15.0 dBm, -15.0 dBm, -15.0 dBm, -15.0 dBm -12.5 dBm, -12.5 dBm, -24.5 dBm, -11.5 dBm, -15.0 dBm, -15.0 dBm, -15.0 dBm, -15.0 dBm
	5G NR	-5.5 dBm, -12.5 dBm, -15.0 dBm, -15.0 dBm, -15.0 dBm, -15.0 dBm, -15.0 dBm, -15.0 dBm, -15.0 dBm -22.5 dBm, -8.5 dBm, -11.5 dBm, -23.5 dBm, -23.5 dBm, -23.5 dBm, -23.5 dBm, -23.5 dBm, -23.5 dBm, -23.5 dBm, -23.5 dBm, -23.5 dBm
	LTEAFDD, LTEATDD	-5.5 dBm, -12.5 dBm, -15.0 dBm, -15.0 dBm, -15.0 dBm, -15.0 dBm, -15.0 dBm, -15.0 dBm, -15.0 dBm -13.5 dBm, -8.5 dBm, -11.5 dBm, -23.5 dBm, -23.5 dBm, -23.5 dBm, -23.5 dBm, -23.5 dBm, -23.5 dBm, -23.5 dBm, -23.5 dBm
State Saved	Saved in instrument state	
Min/Max	-200 dBm/50 dBm	

Abs Stop

Sets the absolute power level limit at the stop frequency for the selected inner offset, ranging from -200 to +50 dBm. You can also toggle this function between **Couple** (**COUPle** = **ON**) and **Manual** (**COUPle** = **OFF**). If set to **Couple**, the Abs Stop power level limit is coupled to Abs Start to result in a flat limit line. If set to **Man**, Abs Start and Abs Stop take different values to result in a sloped limit line.

The query returns values currently set to the inner offset stop absolute power limits.

When sending the remote command, missing values are not permitted; that is, if you want to change values 2 and 6, you must send all values up to 6. Subsequent values remain unchanged. The query for this parameter always returns 12 values.

Remote Command	<pre>[:SENSe]:SEMask:OFFSet[1] 2:INNeR:LIST:STOP:ABSolute <real>, ... [:SENSe]:SEMask:OFFSet[1] 2:INNeR:LIST:STOP:ABSolute? [:SENSe]:SEMask:OFFSet[1] 2:INNeR:LIST:STOP:ABSolute:COUPle ON OFF 1 0, ... [:SENSe]:SEMask:OFFSet[1] 2:INNeR:LIST:STOP:ABSolute:COUPle?</pre>								
Example	<pre>:SEM:OFFS:INN:LIST:STOP:ABS -12.50 dBm, -24.50 dBm, -24.50 dBm, -11.50 dBm, -11.50 dBm, -11.50 dBm :SEM:OFFS1:INN:LIST:STOP:ABS? :SEM:OFFS:INN:LIST:STOP:ABS:COUP ON, OFF, ON, ON, ON, ON :SEM:OFFS:INN:LIST:STOP:ABS:COUP?</pre>								
Notes	<p>Comma-separated list of values OFFSet 1 is for BTS, 2 for MS. Default is BTS</p>								
Couplings	Coupled to Abs Start if Auto is selected, that is, the Stop value is equal to the Start value								
Preset	<table border="1"> <thead> <tr> <th>Mode</th> <th>Values</th> </tr> </thead> <tbody> <tr> <td>MSR</td> <td>-12.5 dBm, -24.5 dBm, -11.5 dBm, -15.0 dBm, -15.0 dBm, -15.0 dBm, -15.0 dBm, -15.0 dBm, -15.0 dBm, -15.0 dBm, -15.0 dBm, -15.0 dBm -12.5 dBm, -24.5 dBm, -11.5 dBm, -15.0 dBm, -15.0 dBm, -15.0 dBm, -15.0 dBm, -15.0 dBm, -15.0 dBm, -15.0 dBm, -15.0 dBm, -15.0 dBm</td> </tr> <tr> <td>5G NR</td> <td>-12.5 dBm, -12.5 dBm, -15.0 dBm, -15.0 dBm, -15.0 dBm, -15.0 dBm, -15.0 dBm, -15.0 dBm, -15.0 dBm, -15.0 dBm, -15.0 dBm -22.5 dBm, -8.5 dBm, -11.5 dBm, -23.5 dBm, -23.5 dBm, -23.5 dBm, -23.5 dBm, -23.5 dBm, -23.5 dBm, -23.5 dBm, -23.5 dBm, -23.5 dBm, -23.5 dBm</td> </tr> <tr> <td>LTEAFDD, LTEATDD</td> <td>-12.5 dBm, -12.5 dBm, -15.0 dBm, -15.0 dBm, -15.0 dBm, -15.0 dBm, -15.0 dBm, -15.0 dBm, -15.0 dBm, -15.0 dBm, -15.0 dBm -13.5 dBm, -8.5 dBm, -11.5 dBm, -23.5 dBm, -23.5 dBm, -23.5 dBm -23.5 dBm, -23.5 dBm, -23.5 dBm, -23.5 dBm, -23.5 dBm, -23.5 dBm</td> </tr> </tbody> </table>	Mode	Values	MSR	-12.5 dBm, -24.5 dBm, -11.5 dBm, -15.0 dBm, -15.0 dBm, -15.0 dBm, -15.0 dBm, -15.0 dBm, -15.0 dBm, -15.0 dBm, -15.0 dBm, -15.0 dBm -12.5 dBm, -24.5 dBm, -11.5 dBm, -15.0 dBm, -15.0 dBm, -15.0 dBm, -15.0 dBm, -15.0 dBm, -15.0 dBm, -15.0 dBm, -15.0 dBm, -15.0 dBm	5G NR	-12.5 dBm, -12.5 dBm, -15.0 dBm, -15.0 dBm, -15.0 dBm, -15.0 dBm, -15.0 dBm, -15.0 dBm, -15.0 dBm, -15.0 dBm, -15.0 dBm -22.5 dBm, -8.5 dBm, -11.5 dBm, -23.5 dBm, -23.5 dBm, -23.5 dBm, -23.5 dBm, -23.5 dBm, -23.5 dBm, -23.5 dBm, -23.5 dBm, -23.5 dBm, -23.5 dBm	LTEAFDD, LTEATDD	-12.5 dBm, -12.5 dBm, -15.0 dBm, -15.0 dBm, -15.0 dBm, -15.0 dBm, -15.0 dBm, -15.0 dBm, -15.0 dBm, -15.0 dBm, -15.0 dBm -13.5 dBm, -8.5 dBm, -11.5 dBm, -23.5 dBm, -23.5 dBm, -23.5 dBm -23.5 dBm, -23.5 dBm, -23.5 dBm, -23.5 dBm, -23.5 dBm, -23.5 dBm
Mode	Values								
MSR	-12.5 dBm, -24.5 dBm, -11.5 dBm, -15.0 dBm, -15.0 dBm, -15.0 dBm, -15.0 dBm, -15.0 dBm, -15.0 dBm, -15.0 dBm, -15.0 dBm, -15.0 dBm -12.5 dBm, -24.5 dBm, -11.5 dBm, -15.0 dBm, -15.0 dBm, -15.0 dBm, -15.0 dBm, -15.0 dBm, -15.0 dBm, -15.0 dBm, -15.0 dBm, -15.0 dBm								
5G NR	-12.5 dBm, -12.5 dBm, -15.0 dBm, -15.0 dBm, -15.0 dBm, -15.0 dBm, -15.0 dBm, -15.0 dBm, -15.0 dBm, -15.0 dBm, -15.0 dBm -22.5 dBm, -8.5 dBm, -11.5 dBm, -23.5 dBm, -23.5 dBm, -23.5 dBm, -23.5 dBm, -23.5 dBm, -23.5 dBm, -23.5 dBm, -23.5 dBm, -23.5 dBm, -23.5 dBm								
LTEAFDD, LTEATDD	-12.5 dBm, -12.5 dBm, -15.0 dBm, -15.0 dBm, -15.0 dBm, -15.0 dBm, -15.0 dBm, -15.0 dBm, -15.0 dBm, -15.0 dBm, -15.0 dBm -13.5 dBm, -8.5 dBm, -11.5 dBm, -23.5 dBm, -23.5 dBm, -23.5 dBm -23.5 dBm, -23.5 dBm, -23.5 dBm, -23.5 dBm, -23.5 dBm, -23.5 dBm								

Mode	Values
MSR	ON, OFF, OFF, OFF, ON, OFF, OFF, OFF, OFF, OFF, OFF, OFF ON, OFF, OFF, OFF, ON, OFF, OFF, OFF, OFF, OFF, OFF, OFF
LTEAFDD, LTEATDD, 5G NR	OFF, ON, ON, ON, ON, ON, ON, ON, ON, ON, ON, ON ON, ON, ON, ON, ON, ON, ON, ON, ON, ON, ON, ON
State Saved	Saved in instrument state Saved in instrument state
Range	Auto Man
Min/Max	-200 dBm/50 dBm

Rel Start

Sets a relative power level limit at the start frequency for the selected inner offset, ranging from -200 to +50 dBc.

The fail condition is set remotely by `[:SENSe]:SEMAsk:OFFSet [n]:INNer:LIST:TEST` for each inner offset channel test.

You can turn off (not use) specific inner offset channels remotely with `[:SENSe]:SEMAsk:OFFSet[n]:INNer:LIST:STAtE`.

The query returns values currently set to the relative power test limits.

When sending the remote command, missing values are not permitted; that is, if you want to change values 2 and 6, you must send all values up to 6. Subsequent values remain unchanged. The query for this parameter always returns 12 values.

Remote Command	<code>[:SENSe]:SEMAsk:OFFSet[1] 2:INNer:LIST:STARt:RCARrier <rel_ampl>, ...</code> <code>[:SENSe]:SEMAsk:OFFSet[1] 2:INNer:LIST:STARt:RCARrier?</code>
Example	<code>:SEM:OFFS:INN:LIST:STAR:RCAR -30, -30, -30, -30, -30, -30</code> <code>:SEM:OFFS:INN:LIST:STAR:RCAR?</code>
Notes	Comma-separated list of values OFFSet 1 is for BTS, 2 for MS. Default is BTS
Preset	0 dB, 0 dB, 0 dB, 0 dB, 0 dB, 0 dB, 0 dB, 0 dB, 0 dB, 0 dB, 0 dB, 0 dB 0 dB, 0 dB, 0 dB, 0 dB, 0 dB, 0 dB, 0 dB, 0 dB, 0 dB, 0 dB, 0 dB, 0 dB
State Saved	Saved in instrument state
Min/Max	-200 dB/50 dB

Rel Stop

Sets a relative power level limit at the stop frequency for the selected inner offset, ranging from -200 to +50 dBc.

The fail condition is set remotely by `[:SENSe]:SEMAsk:OFFSet [n]:INNer:LIST:TEST` for each inner offset channel.

You can turn off (not use) specific inner offset channels remotely with `[:SENSe]:SEMAsk:OFFSet[n]:INNer:LIST:STATe`.

The query returns values currently set to the inner offset stop relative power limits.

When sending the remote command, missing values are not permitted; that is, if you want to change values 2 and 6, you must send all values up to 6. Subsequent values remain unchanged. The query for this parameter always returns 12 values.

Remote Command	<pre>[:SENSe]:SEMAsk:OFFSet[1] 2:INNer:LIST:STOP:RCARrier <rel_ampl>, ... [:SENSe]:SEMAsk:OFFSet[1] 2:INNer:LIST:STOP:RCARrier? [:SENSe]:SEMAsk:OFFSet[1] 2:INNer:LIST:STOP:RCARrier:COUple ON OFF 1 0, ... [:SENSe]:SEMAsk:OFFSet[1] 2:INNer:LIST:STOP:RCARrier:COUple?</pre>
Example	<pre>:SEM:OFFS:INN:LIST:STOP:RCAR -30, -30, -30, -30, -30, -30 :SEM:OFFS:INN:LIST:STOP:RCAR? :SEM:OFFS:INN:LIST:STOP:RCAR:COUP ON, ON, ON, ON, ON, ON :SEM:OFFS:INN:LIST:STOP:RCAR:COUP?</pre>
Notes	<p>Comma-separated list of values OFFSet 1 is for BTS, 2 for MS. Default is BTS</p>
Couplings	Coupled to Rel Start if "Auto" is selected, that is, Start is made the same as Stop
Preset	<pre>0 dB, 0 dB, 0 dB, 0 dB, 0 dB, 0 dB, 0 dB, 0 dB, 0 dB, 0 dB, 0 dB, 0 dB 0 dB, 0 dB, 0 dB, 0 dB, 0 dB, 0 dB, 0 dB, 0 dB, 0 dB, 0 dB, 0 dB, 0 dB ON, ON, ON, ON, ON, ON, ON, ON, ON, ON, ON, ON ON, ON, ON, ON, ON, ON, ON, ON, ON, ON, ON, ON</pre>
State Saved	<p>Saved in instrument state Saved in instrument state</p>
Range	Auto Man
Min/Max	-200 dB/50 dB

Fail Mask

Selects one of the logics for fail conditions between the measurement results and the test limits:

- **ABSolute** and **RELative** both check the results against the respective limit
- **OR** checks against both limits, failing if either of the limits is broken
- **AND** only displays a fail if both of the limits are broken

The absolute or relative power limit value for each inner offset channel can be set remotely with `[:SENSe]:SEMask:OFFSet[n]:INNeR:LIST:ABSolute` or `[:SENSe]:SEMask:OFFSet[n]:INNeR:LIST:RCARrier`.

You can turn off (not use) specific inner offset channels remotely with `[:SENSe]:SEMask:OFFSet[n]:INNeR:LIST:STATe`.

When sending the remote command, missing values are not permitted; that is, if you want to change values 2 and 6, you must send all values up to 6. Subsequent values remain unchanged. The query for this parameter always returns 12 values.

Remote Command	<code>[:SENSe]:SEMask:OFFSet[1] 2:INNeR:LIST:TEST ABSolute AND OR RELative, ...</code> <code>[:SENSe]:SEMask:OFFSet[1] 2:INNeR:LIST:TEST?</code>
Example	<code>:SEM:OFFS:INN:LIST:TEST ABS, ABS, ABS, ABS, ABS, ABS</code> <code>:SEM:OFFS:INN:LIST:TEST?</code>
Notes	Comma-separated list of values
Preset	<code>ABS, ABS, ABS, ABS, ABS, ABS, ABS, ABS, ABS, ABS, ABS, ABS</code>
State Saved	Saved in instrument state
Range	Absolute Relative Abs AND Rel Abs OR Rel

Show Abs2 Limit

Same as ["Show Abs2 Limit" on page 1542](#) under Limits.

Abs2 Start

Sets the 2nd absolute power level limit at the start frequency for the selected inner offset, ranging from –200 to +50 dBm.

The fail condition for each inner offset channel is set remotely using:

`[:SENSe]:SEMask:OFFSet[n]:INNeR:LIST:TEST:SABSolute`

You can turn off (not use) specific inner offset channels remotely using:

`[:SENSe]:SEMask:OFFSet[n]:INNeR:LIST:STATe`

The query returns values currently set to the 2nd absolute power test limits.

When sending the command, missing values are not permitted; that is, if you want to change values 2 and 6, you must send all values up to 6. Subsequent values remain unchanged. The query always returns 12 values.

Remote Command	<code>[:SENSe]:SEMAsk:OFFSet[1] 2:INNeR:LIST:START:SABSolute <real>, ...</code> <code>[:SENSe]:SEMAsk:OFFSet[1] 2:INNeR:LIST:START:SABSolute?</code>
Example	<code>:SEM:OFFS:INN:LIST:STAR:SABS -12.50 dBm, -12.50 dBm, -24.50 dBm, -11.50 dBm, -11.50 dBm, -11.50 dBm</code> <code>:SEM:OFFS:INN:LIST:STAR:SABS?</code>
Notes	Comma-separated list of values OFFSet 1 is for BTS, 2 for MS. Default is BTS
Preset	0 dBm, 0 dBm, 0 dBm, 0 dBm, 0 dBm, 0 dBm, 0 dBm, 0 dBm, 0 dBm, 0 dBm, 0 dBm, 0 dBm 0 dBm, 0 dBm, 0 dBm, 0 dBm, 0 dBm, 0 dBm, 0 dBm, 0 dBm, 0 dBm, 0 dBm, 0 dBm, 0 dBm
State Saved	Saved in instrument state
Min	-200 dBm
Max	50 dBm

Abs2 Stop

Sets the 2nd absolute power level limit at the stop frequency for the selected inner offset, ranging from -200 to +50 dBm. You can also toggle this function between **Couple** and **Manual**. If set to **Couple = ON**, the **Abs2 Stop** power level limit is coupled to "**Abs2 Start**" on page 1542, resulting in a flat limit line. If set to **Man (Couple = OFF)**, **Abs2 Start** and **Abs2 Stop** take different values, resulting in a sloped limit line.

The query returns values currently set to the offset stop 2nd absolute power limits.

When sending the command, missing values are not permitted; that is, if you want to change values 2 and 6, you must send all values up to 6. Subsequent values remain unchanged. The query always returns 12 values.

Remote Command	<code>[:SENSe]:SEMAsk:OFFSet[1] 2:INNeR:LIST:STOP:SABSolute <real>, ...</code> <code>[:SENSe]:SEMAsk:OFFSet[1] 2:INNeR:LIST:STOP:SABSolute?</code> <code>[:SENSe]:SEMAsk:OFFSet[1] 2:INNeR:LIST:STOP:SABSolute:COUPle ON OFF 1 0, ...</code> <code>[:SENSe]:SEMAsk:OFFSet[1] 2:INNeR:LIST:STOP:SABSolute:COUPle?</code>
Example	<code>:SEM:OFFS:INN:LIST:STOP:SABS -12.50 dBm, -24.50 dBm, -24.50 dBm, -11.50 dBm, -11.50 dBm, -11.50 dBm</code> <code>:SEM:OFFS:INN:LIST:STOP:SABS?</code> <code>:SEM:OFFS:INN:LIST:STOP:SABS:COUP ON, ON, ON, ON, ON, ON</code> <code>:SEM:OFFS:INN:LIST:STOP:SABS:COUP?</code>
Notes	Comma-separated list of values OFFSet 1 is for BTS, 2 for MS. Default is BTS

Couplings	Coupled to Abs Start if Auto is selected, that is, the Stop value is equal to the Start value
Preset	0 dBm, 0 dBm, 0 dBm, 0 dBm, 0 dBm, 0 dBm, 0 dBm, 0 dBm, 0 dBm, 0 dBm, 0 dBm, 0 dBm 0 dBm, 0 dBm, 0 dBm, 0 dBm, 0 dBm, 0 dBm, 0 dBm, 0 dBm, 0 dBm, 0 dBm, 0 dBm, 0 dBm ON, ON, ON, ON, ON, ON, ON, ON, ON, ON, ON, ON ON, ON, ON, ON, ON, ON, ON, ON, ON, ON, ON, ON
State Saved	Saved in instrument state Saved in instrument state
Range	Auto Man
Min	-200 dBm
Max	50 dBm

Fail Mask2

Selects one of the logical operations for fail conditions between the measurement results and the test limits:

(Primary Fail Mask selection) OR Abs2	OR	Checks against both Primary and Abs2 limits. The test fails if either of the limits is broken
(Primary Fail Mask selection) AND Abs2	AND	Checks against both Primary and Abs2 limits. The test fails if both of the limits are broken
Abs2 Disabled	OFF	Fail Mask2 is disabled

For examples, see ["Fail Mask2" on page 1521](#).

Note that the Primary Fail Mask selection is set by ["Fail Mask" on page 1541](#).

You can turn off (not use) specific inner offset channels remotely using:

`[:SENSe] :SEMAsk :OFFSet [n] :INNeR :LIST :STATe`

When sending the command, missing values are not permitted; that is, if you want to change values 2 and 6, you must send all values up to 6. Subsequent values remain unchanged. The query always returns 12 values.

Remote Command	<code>[:SENSe] :SEMAsk :OFFSet [1] 2 :INNeR :LIST :TEST :SABSolute AND OR OFF, ...</code> <code>[:SENSe] :SEMAsk :OFFSet [1] 2 :INNeR :LIST :TEST :SABSolute?</code>
Example	<code>:SEM :OFFS :INN :LIST :TEST :SABS AND, AND, OR, OFF, OFF, OFF</code> <code>:SEM :OFFS :INN :LIST :TEST :SABS?</code>
Notes	Comma-separated list of values
Preset	<code>OFF, OFF, OFF, OFF, OFF, OFF, OFF, OFF, OFF, OFF, OFF, OFF OFF, OFF, OFF, OFF, OFF, OFF, OFF, OFF, OFF, OFF</code>
State Saved	Saved in instrument state
Range	OR Abs2 AND Abs2 Abs2 Disabled

Meas Setup Summary Table

Lets you view and access many of the parameters in the **Meas Setup** menus on one screen.

Auto Couple

Immediately puts all **Auto/Man** functions into **Auto**. **Auto Couple** is confined to the current measurement only. It does not affect other measurements in the Mode.

In the **Auto** state, **Auto/Man** functions are said to be “coupled”, meaning their values change as you make changes to other values in the measurement. This helps ensure accurate measurements and optimum dynamic range. **Auto Couple** is an immediate action function, and when it is executed, all the **Auto/Man** controls for the current measurement are set to **Auto**, and all measurement settings coupled to the **Auto/Man** parameters are automatically set to their optimal values.

For further details of measurement-specific settings (if any), see "[Measurement-Specific Details](#)" on page 1546 below.

Remote Command	:COUPle ALL
Example	:COUP ALL
Backwards Compatibility SCPI	:COUPLE ALL NONE
Backwards Compatibility Notes	:COUP:NONE puts all Auto/Man parameters in manual mode, decoupling all the coupled instrument parameters. It is retained for backwards compatibility and is <i>not</i> recommended for making measurements or new designs

All **Auto/Man** parameter couplings in the measurement are set to **Auto**. This includes couplings that may be unavailable or grayed-out due to the current state. For example, in the Swept SA measurement, there is no **Auto/Man** coupling for **RBW** while in Zero Span. Nonetheless, if **Auto Couple** were executed while in Zero Span, it would set **RBW** to Auto "behind the scenes" so that, on exit from Zero Span, it would be in **Auto**.

Any **Auto/Man** selection specific (local) to the other measurements in the current Mode are not affected by **Auto Couple**. Any functions that are *not* coupled with other instrument parameters, such as ranging or leveling variables, such as **AutoRange** or **AutoScale**, are not affected.

Executing **Auto Couple** generates the informational message, "All Auto/Man functions have been set to Auto".

Each parameter, upon being set to **Auto**, selects and sets the appropriate auto-coupled value based on that parameter's coupling rules. The Dependency Resolver orchestrates the couplings for parameters that depend on one or more other parameters. The coupling and dependency rules for each parameter are defined in the section describing that parameter.

Executing **Auto Couple** does *not* affect markers, marker functions, trace or display attributes, or any other instrument setting other than those specifically mentioned above.

Measurement-Specific Details

TOI (SA Mode only)

Parameters affected by **Auto Couple** are:

- Center Frequency Step
- Resolution Bandwidth
- Span/RBW Ratio
- Sweep Time
- Video BANDwidth VBW/RBW ratio
- Upper and Lower Tone (set to Sense)
- Zero span measurement Resolution Bandwidth
- Zero span measurement Dwell Time

Harmonics (SA Mode only)

Parameters affected by **Auto Couple** are:

- Resolution Bandwidth
- Fundamental Frequency
- Dwell Time
- Range Table Resolution Bandwidths
- Range Table Dwell Times

Meas Preset

Restores all the measurement parameters to their default values.

Remote Command	<code>:CONFigure:SEMAsk</code>
Example	<code>:CONF:SEM</code>
Couplings	Restores all measurement parameters to their default values

3.9.18.2 Carrier

Used to set up parameters that define how the reference channel is measured.

Integ BW

Specifies the integration bandwidth used to calculate the power in the reference channel.

Remote Command	<code>[:SENSe]:SEMAsk:BANDwidth[1] 2:INTEgration <bandwidth></code> <code>[:SENSe]:SEMAsk:BANDwidth[1] 2:INTEgration?</code>								
Example	<code>:SEM:BAND:INT 10 MHz</code> <code>:SEM:BAND:INT?</code>								
Notes	10% . 100% of Channel Span Parameter Value Bandwidth sub op code, 1 is for BTS, 2 for MS. Default is BTS Note that Bandwidth sub op code 2 is supported only in non-SA Modes. In SA Mode, Bandwidth sub op code 1 is used for both BTS and MS If the ref channel is outside the frequency range, the result spectrum will be invalid								
Dependencies	Not shown in MSR, LTE-Advanced FDD/TDD and 5G NR Modes In order to maintain backwards compatible with legacy LTE FDD/TDD Modes, the remote command is supported in LTE & LTE-A converged application								
Couplings	Cannot be higher than the channel Span . If lower than 1/10 of channel Span , then the channel Span is reduced to be 10 times the Integ BW								
Preset	<table border="1"> <thead> <tr> <th>Mode</th> <th>Value</th> </tr> </thead> <tbody> <tr> <td>SA</td> <td>3.84 MHz</td> </tr> <tr> <td>WCDMA</td> <td>3.84 MHz 3.84 MHz</td> </tr> <tr> <td>WLAN</td> <td>See the table of "WLAN Mode Presets" on page 1548 below</td> </tr> </tbody> </table>	Mode	Value	SA	3.84 MHz	WCDMA	3.84 MHz 3.84 MHz	WLAN	See the table of " WLAN Mode Presets " on page 1548 below
Mode	Value								
SA	3.84 MHz								
WCDMA	3.84 MHz 3.84 MHz								
WLAN	See the table of " WLAN Mode Presets " on page 1548 below								
State Saved	Saved in instrument state								
Min/Max	1 kHz/Depends on instrument maximum frequency								

Backwards `[:SENSe]:SEMAsk:BWIDth[1]|2:INTEgration`
Compatibility SCPI

WLAN Mode Presets

Radio Std	Presets
802.11a/g (OFDM/DSSS-OFDM)	18 MHz
802.11n/ac (20 MHz)	
802.11b/g (DSSS/CCK/PBCC)	22 MHz
802.11n (40MHz)/ 802.11ac (40 MHz)	38 MHz
802.11ac (80 MHz)	78 MHz
802.11ac (160 MHz)	158 MHz
802.11ac (80 MHz + 80 MHz)	78 MHz
802.11ah (1 MHz)	0.9 MHz
802.11ah (2 MHz)	1.8 MHz
802.11ah (4 MHz)	3.8 MHz
802.11ah (8 MHz)	7.8 MHz
802.11ah (16 MHz)	15.8 MHz
802.11j/p (20 MHz)	18 MHz
802.11j/p (10 MHz)	9 MHz
802.11p (5 MHz)	4.5 MHz
802.11ax/be (20 MHz)	19.5 MHz
802.11ax/be (40 MHz)	39.0 MHz
802.11ax/be (80 MHz)	79.0 MHz
802.11ax/be (160 MHz)	159.0 MHz
802.11be (320 MHz)	319.0 MHz
802.11ax (80 MHz + 80 MHz)	79.0 MHz
802.11af (6 MHz)	5.7 MHz
802.11af (7 MHz)	6.65 MHz
802.11af (8 MHz)	7.6 MHz

Span

Specifies the span used to calculate the power in the reference channel.

Remote Command `[:SENSe]:SEMAsk:FREQuency[1]|2:SPAN <freq>`
`[:SENSe]:SEMAsk:FREQuency[1]|2:SPAN?`
`[:SENSe]:SEMAsk:FREQuency[1]|2:SPAN:AUTO ON | OFF | 1 | 0`

3 VMA Mode
3.9 SEM Measurement

	<code>[:SENSe] :SEMAsk :FREQuency [1] 2 :SPAN :AUTO ?</code>														
Example	<code>:SEM:FREQ:SPAN 3MHz</code> <code>:SEM:FREQ:SPAN?</code> <code>:SEM:FREQ:SPAN:AUTO OFF</code> <code>:SEM:FREQ:SPAN:AUTO?</code>														
Notes	<p>Frequency sub op code, 1 is for BTS, 2 for MS. Default is BTS</p> <p>Note that Frequency sub op code 2 is supported only in non-SA Modes. In SA Mode, Frequency sub op code 1 is used for both BTS and MS</p> <p>If the ref channel is outside the frequency range, the result spectrum will be invalid</p>														
Dependencies	<p>Not shown in MSR Mode</p> <p>In order to maintain backwards compatible with legacy LTE FDD/TDD Modes, the channel span key is supported in LTE & LTE-A converged application. The Auto/Man toggle is added to this key. This key is enabled and can be changed only in single carrier. The span state is always Auto in Multi-carriers</p> <p>Span Auto/Man state is only available in LTE/LTE-Advanced FDD/TDD and 5G NR Modes</p>														
Couplings	<p>Range 1 kHz to 50 MHz (although restricted by Chan Integ BW). If you set the channel Span lower than channel Integ BW, they will both track each other. As you increase the channel Span, Integ BW also increases if it is less than 1/10 of the channel Span</p> <p>For WLAN 802.11ac (80 + 80 MHz), the channel span is coupled with the difference between the center frequencies of the two carriers. When the difference is either less than 80 MHz, or greater than 565 MHz, a "setting conflict" error message is displayed</p> <p>Chan Span = Carrier Spacing + Chan IntegBW</p> <p>When the state of Span is Auto, the span value is automatically determined by multi-carrier configuration. Otherwise, the span value depends on user input</p> <p>When the span value is set manually, the state of span is automatically changes to Man</p> <p>This key is enabled and can be changed only in single carrier. The span state is always Auto in Multi-carriers</p>														
Preset	<table border="1"> <thead> <tr> <th>Mode</th> <th>Value</th> </tr> </thead> <tbody> <tr> <td>SA</td> <td>5.0 MHz</td> </tr> <tr> <td>WCDMA</td> <td>5.0 MHz 5.0 MHz</td> </tr> <tr> <td>LTEAFDD, LTEATDD</td> <td>5 MHz</td> </tr> <tr> <td>SGNR</td> <td>Automatically calculated</td> </tr> <tr> <td>WLAN</td> <td>See the table of "WLAN Mode Presets" on page 1550 below</td> </tr> <tr> <td>ON</td> <td></td> </tr> </tbody> </table>	Mode	Value	SA	5.0 MHz	WCDMA	5.0 MHz 5.0 MHz	LTEAFDD, LTEATDD	5 MHz	SGNR	Automatically calculated	WLAN	See the table of " WLAN Mode Presets " on page 1550 below	ON	
Mode	Value														
SA	5.0 MHz														
WCDMA	5.0 MHz 5.0 MHz														
LTEAFDD, LTEATDD	5 MHz														
SGNR	Automatically calculated														
WLAN	See the table of " WLAN Mode Presets " on page 1550 below														
ON															
State Saved	<p>Saved in instrument state</p> <p>Yes</p>														
Range	Auto Man														
Min/Max	1 kHz/Depends on instrument maximum frequency														

WLAN Mode Presets

Radio Std	Presets
802.11a/g (OFDM/DSSS-OFDM)	18 MHz
802.11n/ac (20 MHz)	
802.11b/g (DSSS/CCK/PBCC)	22 MHz
802.11n/ac (40 MHz)	38 MHz
802.11ac (80 MHz)	78 MHz
802.11ac (160 MHz)	158 MHz
802.11ac (80 MHz + 80 MHz)	320 MHz
802.11ah (1 MHz)	0.9 MHz
802.11ah (2 MHz)	1.8 MHz
802.11ah (4 MHz)	3.8 MHz
802.11ah (8 MHz)	7.8 MHz
802.11ah (16 MHz)	15.8 MHz
802.11j/p (20 MHz)	18 MHz
802.11j/p (10 MHz)	9 MHz
802.11p (5 MHz)	4.5 MHz
802.11ax/be (20 MHz)	19.5 MHz
802.11ax/be (40 MHz)	39.0 MHz
802.11ax/be (80 MHz)	79.0 MHz
802.11ax/be (160 MHz)	159.0 MHz
802.11be (320 MHz)	319.0 MHz
802.11ax (80 MHz + 80 MHz)	320.0 MHz
802.11af (6 MHz)	5.7 MHz
802.11af (7 MHz)	6.65 MHz
802.11af (8 MHz)	7.6 MHz

Sweep Time

Used to calculate the power in the reference channel. **Sweep Time** can be set manually or put into **Auto** mode.

For instruments with non-sweeping acquisitions, such as VXT, the time value is the acquisition time for an individual FFT segment, not the cumulated time for all FFT segments in the channel.

NOTE

On non-sweeping hardware, this control is grayed-out. The value shown on this control is an estimate, which is the turnaround time to complete the measurement of the entire carrier span, which is the sum of signal acquisition time, FFT time, and other overhead time. If you need to specify the same **Sweep Time** as you would for sweeping hardware, send `[:SENSe] :SEMAsk :SWEEp [1] | 2 :TIME <time>`. The measurement emulates the **Sweep Time** effect, but this emulation is not straightforward, and therefore the behavior is not specified. Instead, we recommend using "**Minimum Acquisition Time**" on page 1552, which provides better control.

Remote Command	<pre>[:SENSe] :SEMAsk :SWEEp [1] 2 :TIME <time> [:SENSe] :SEMAsk :SWEEp [1] 2 :TIME? [:SENSe] :SEMAsk :SWEEp [1] 2 :TIME :AUTO OFF 0 ON 1 [:SENSe] :SEMAsk :SWEEp [1] 2 :TIME :AUTO?</pre>						
Example	<pre>:SEM :SWE :TIME 9ms :SEM :SWE :TIME? :SEM :SWE :TIME :AUTO OFF :SEM :SWE :TIME :AUTO?</pre>						
Notes	<p>Sub op code 1 is for BTS, 2 for MS. Default is BTS</p> <p>Note that Sweep sub op code 2 is supported only in non-SA Modes. In SA Mode, Sweep sub op code 1 is used for both BTS and MS</p>						
Dependencies	<p>On non-sweeping hardware, this control is grayed out and the Auto/Man checkbox is invisible. The read-only value shows the estimated sweep time</p> <p>In those instruments, "Minimum Acquisition Time" on page 1552 is available</p>						
Couplings	<p>When the time is set manually, Auto is set to OFF</p> <p>If state is Auto, coupled with Channel Detector selection, Channel Resolution BW, Channel Video BW</p> <p>When set to Auto, the Time is automatically calculated</p>						
Preset	<p>Automatically calculated</p> <p>ON</p>						
State Saved	<p>Saved in instrument state</p> <p>Yes</p>						
Range	<p>OFF ON</p>						
Min	<p>Sweeping hardware</p> <p>Depends on Channel "Sweep Type" on page 1553:</p> <table border="1"> <thead> <tr> <th>Sweep Type</th> <th>Min</th> </tr> </thead> <tbody> <tr> <td>Swept</td> <td>1 ms</td> </tr> <tr> <td>FFT</td> <td>100 ns</td> </tr> </tbody> </table> <p>Non-sweeping hardware: N/A</p>	Sweep Type	Min	Swept	1 ms	FFT	100 ns
Sweep Type	Min						
Swept	1 ms						
FFT	100 ns						

Max	Sweeping hardware: 4000 s Non-sweeping hardware: N/A
Backwards	<code>[:SENSe]:SEMAsk:SWEEp[1] 2[:TIME]</code>
Compatibility SCPI	<code>[:SENSe]:SEMAsk:SWEEp[1] 2[:TIME]:AUTO</code>

Minimum Acquisition Time

Available on non-sweeping hardware.

Specifies the minimum acquisition time for each “chunk” of the measurement result. The instrument automatically divides **Span** into multiple chunks if needed. Therefore, the total signal acquisition time for the entire carrier span is:

$\sim(\sim\text{Minimum Acquisition Time}) * (\text{The number of chunks})$

When in **Auto**, this parameter’s value is determined by other parameters, such as **Span**, **RBW** and **VBW**.

You can manually increase this parameter value from this **Auto** value.

If increased, the instrument acquires signal for the specified time duration for each chunk. It performs additional FFTs, and averages or peak-holds the FFT results for a chunk, depending on **Detector** settings.

Note that the actual acquisition time for each chunk may exceed the **Minimum Acquisition Time** value, in order to satisfy FFT time required by other parameters, and to perform an integer number of FFTs.

Remote Command	<code>[:SENSe]:SEMAsk:SWEEp:ACQuisition:TIME <time></code> <code>[:SENSe]:SEMAsk:SWEEp:ACQuisition:TIME?</code> <code>[:SENSe]:SEMAsk:SWEEp:ACQuisition:TIME:AUTO OFF ON 0 1</code> <code>[:SENSe]:SEMAsk:SWEEp:ACQuisition:TIME:AUTO?</code>
Example	<code>:SEM:SWE:ACQ:TIME 500 ms</code> <code>:SEM:SWE:ACQ:TIME?</code> <code>:SEM:SWE:ACQ:TIME:AUTO OFF</code> <code>:SEM:SWE:ACQ:TIME:AUTO?</code>
Dependencies	Available only on non-sweeping hardware
Couplings	Coupled to Span , RBW , and VBW when in the Auto state If you manually set a value when in the Auto state, the state automatically changes to Man
Preset	Automatically calculated ON
State Saved	Saved in instrument state
Min	100 ns
Max	4.00 ks

Sweep Time Annotation (Remote Query Only)

Returns the **Sweep Time Annotation** value. Available only on non-sweeping hardware.

The value returned is the estimated turnaround time of each acquisition, in seconds. The turnaround time is the sum of the signal acquisition time, FFT time, and other overhead time, to complete the entire carrier span of each measurement cycle.

Remote Command	<code>[:SENSe] :SEMAsk :SWEep :ETIME?</code>
Example	<code>:SEM:SWE:ETIM?</code>
Dependencies	Available only on non-sweeping hardware
Preset	Automatically calculated

Sweep Type

Sets the **Sweep Type** used to calculate the power in the reference channel. **Sweep Type** can be set manually or put into **Auto** mode.

How to define Channel Sweep Time and Channel Sweep Type:

Channel Sweep Type Mode	Behavior
Auto	Channel Sweep Type is automatically selected depending on Sweep Type Rules Channel Sweep Time is automatically calculated depending on the selected sweep type
Man	Channel Sweep Type is user-selected
–	

Remote Command	<code>[:SENSe] :SEMAsk :SWEep [1] 2 :TYPE SWEep FFT</code> <code>[:SENSe] :SEMAsk :SWEep [1] 2 :TYPE?</code> <code>[:SENSe] :SEMAsk :SWEep [1] 2 :TYPE:AUTO OFF 0 ON 1</code> <code>[:SENSe] :SEMAsk :SWEep [1] 2 :TYPE:AUTO?</code>
Example	<code>:SEM:SWE:TYPE FFT</code> <code>:SEM:SWE:TYPE?</code> <code>:SEM:SWE:TYPE:AUTO OFF</code> <code>:SEM:SWE:TYPE:AUTO?</code>

Notes
 Sub op code, 1 is for BTS, 2 for MS. Default is BTS
 Note that Sweep sub op code 2 is supported only in non-SA Modes. In SA Mode, Sweep sub op code 1 is used for both BTS and MS

Dependencies	Grayed-out in VXT models M9410A/11A
Couplings	If Sweep Type is set manually, Sweep Type mode is set to MANua1 When Channel Sweep Type mode is Auto , Sweep Type is automatically selected according to Sweep Type Rules
Preset	Automatically calculated ON
State Saved	Saved in instrument state Yes
Range	OFF ON

Res BW

Sets the resolution bandwidth used to calculate the power in the reference channel. The Channel Resolution BW can be set manually or put into auto mode.

MSR Auto RBW:

In the MSR Mode, resolution bandwidth is predefined for each radio format. When carriers are configured with multiple radio formats, the narrowest RBW is selected.

Radio Format	RBW (kHz)	
LTE	1.4 MHz	13 kHz
	3 MHz	27 kHz
	5 MHz	47 kHz
	10 MHz	91 kHz
	15 MHz	150 kHz
	20 MHz	180 kHz
	200 kHz (NB-IoT, only available in FDD)	10 kHz
W-CDMA	75 kHz	

5G NR Auto RBW:

3 VMA Mode
3.9 SEM Measurement

Radio Format		RBW
5G NR	5 MHz	47 kHz
	10 MHz	91 kHz
	15 MHz	150 kHz
	20 MHz	180 kHz
	25 MHz	240 kHz
	30 MHz	270 kHz
	35 MHz	330 kHz
	40 MHz	390 kHz
	45 MHz	430 kHz
	50 MHz	470 kHz
	60 MHz	560 kHz
	70 MHz	680 kHz
	80 MHz	750 kHz
	90 MHz	820 kHz
	100 MHz	910 kHz
	200MHz	1.8 MHz
	400 MHz	3 MHz
800 MHz	3 MHz	
1600 MHz	3 MHz	
2000 MHz	3 MHz	

In the LTE-Advanced (both FDD and TDD) and 5G NR modes, the resolution bandwidth is predefined based on the corresponding bandwidth of the single carrier, which is listed above. When **Res BW** mode is **Auto**, the narrowest RBW is selected.

Remote Command	<pre>[:SENSe]:SEMask:BANDwidth[1] 2[:RESolution] <bandwidth> [:SENSe]:SEMask:BANDwidth[1] 2[:RESolution]? [:SENSe]:SEMask:BANDwidth[1] 2[:RESolution]:AUTO OFF ON 1 0 [:SENSe]:SEMask:BANDwidth[1] 2[:RESolution]:AUTO?</pre>
Example	<pre>:SEM:BAND 100 kHz :SEM:BAND? :SEM:BAND:AUTO ON :SEM:BAND:AUTO?</pre>
Notes	<p>Bandwidth sub op code, 1 is for BTS, 2 for MS. Default is BTS</p> <p>Note that Bandwidth sub op code 2 is supported only in non-SA modes. In SA Mode, Bandwidth sub op code 1 is used for both BTS and MS</p>
Couplings	If Res BW is set manually, Channel Resolution BW mode is set to MANual

	Coupled with Channel Detector selection, Channel Sweep Time and Channel Video BW When set to Auto , the resolution bandwidth is automatically calculated	
Preset	Mode	Values
	SA	100 kHz
	WCDMA	75 kHz
	LTE, LTETDD, MSR, LTEAFDD, LTEATDD	Auto (47 kHz)
	5G NR	Auto
	WLAN	100 kHz
	ON	
State Saved	Saved in instrument state Saved in instrument state	
Range	Auto Man	
Min	1 Hz	
Max	When Option FS1 or FS2 is installed: 10 MHz Otherwise: 8 MHz	
Backwards Compatibility SCPI	[:SENSe]:SEMAsk:BWIDth[1] 2[:RESolution] [:SENSe]:SEMAsk:BWIDth[1] 2[:RESolution]:AUTO	

Video BW

Sets the video bandwidth used to calculate the power in the reference channel. The **Channel Video BW** can be set manually or put into **Auto** mode.

Remote Command	[:SENSe]:SEMAsk:BA ND width[1] 2:VIDeo <bandwidth> [:SENSe]:SEMAsk:BA ND width[1] 2:VIDeo? [:SENSe]:SEMAsk:BA ND width[1] 2:VIDeo:AUTO OFF ON 1 0 [:SENSe]:SEMAsk:BA ND width[1] 2:VIDeo:AUTO?
Example	:SEM:BA ND :VID 100 kHz :SEM:BA ND :VID? :SEM:BA ND :VID:AUTO ON :SEM:BA ND :VID:AUTO?
Notes	Bandwidth sub op code, 1 is for BTS, 2 for MS. Default is BTS Note that Bandwidth sub op code 2 is supported only in non-SA Modes. In SA Mode, Bandwidth sub op code 1 is used for both BTS and MS
Couplings	If Video BW is set manually, Channel Video BW mode is set to MANua1 Coupled with Channel Detector selection, Channel Sweep Time and Channel Resolution BW When set to Auto , the video bandwidth is automatically calculated

3 VMA Mode
3.9 SEM Measurement

Preset	Mode	Values
	SA	100 kHz
	WCDMA	75 kHz
	LTE, LTEAFDD, LTETDD, LTEATDD, 5G NR, WLAN, MSR	Auto
	ON	
State Saved	Saved in instrument state	
	Yes	
Range	Auto Man	
Min/Max	1 Hz/50 MHz	
Backwards Compatibility SCPI	[:SENSe]:SEMAsk:BWIDth[1] 2:VIDeo [:SENSe]:SEMAsk:BWIDth[1] 2:VIDeo:AUTO	

VBW/RBW

Sets the Video BW/Resolution BW ratio to calculate the Channel Resolution BW and Channel Video BW. The VBW/RBW Ratio can be set manually or put into **Auto** mode.

Remote Command	[:SENSe]:SEMAsk:BANDwidth[1] 2:VIDeo:RATio <real> [:SENSe]:SEMAsk:BANDwidth[1] 2:VIDeo:RATio [:SENSe]:SEMAsk:BANDwidth[1] 2:VIDeo:RATio:AUTO OFF ON 1 0 [:SENSe]:SEMAsk:BANDwidth[1] 2:VIDeo:RATio:AUTO?
Example	:SEM:BAND:VID:RAT 0.1 :SEM:BAND:VID:RAT? :SEM:BAND:VID:RAT:AUTO ON :SEM:BAND:VID:RAT:AUTO?
Notes	Bandwidth sub op code, 1 is for BTS, 2 for MS. Default is BTS Note that Bandwidth sub op code 2 is supported only in non-SA Modes. In SA Mode, Bandwidth sub op code 1 is used for both BTS and MS
Couplings	When Video BW/Res BW is set manually, Channel VBW/RBW Ratio mode is set to MANual When set to Auto , the VBW/RBW Ratio is automatically calculated
Preset	SA, WCDMA: 1.0 LTE, LTETDD, LTEAFDD, LTEATDD, 5G NR, WLAN, MSR: Auto ON
State Saved	Saved in instrument state Saved in instrument state
Range	Auto Man

Min/Max	0.00001/3000000
Backwards Compatibility SCPI	<code>[:SENSe] :SEMAsk :BWIDth [1] 2 :VIDeo :RATio</code> <code>[:SENSe] :SEMAsk :BWIDth [1] 2 :VIDeo :RATio :AUTO</code>

Channel Detector

Accesses a menu of functions that enable you to control the detectors for reference channel. The following choices are available:

AUTO	The detector selected depends on marker functions, trace functions, average type, and the trace averaging function
NORMal	The detector determines the peak of the CW-like signals, and it yields alternating maximums and minimums of noise-like signals. This is also referred to as Rosenfell detection
AVERage	The detector determines the average of the signal within the sweep points. The averaging method depends upon the Average Type selection (voltage, power or log scales)
POSitive Peak	The detector determines the maximum of the signal within the sweep points
SAMPle	The detector indicates the instantaneous level of the signal at the center of the sweep points represented by each display point
NEGative Peak	The detector determines the minimum of the signal within the sweep points

Remote Command	<code>[:SENSe] :SEMAsk :DETector :CARRier [:FUNCTION] AVERage NEGative NORMal POSitive SAMPle</code> <code>[:SENSe] :SEMAsk :DETector :CARRier [:FUNCTION] ?</code> <code>[:SENSe] :SEMAsk :DETector :CARRier :AUTO ON OFF 1 0</code> <code>[:SENSe] :SEMAsk :DETector :CARRier :AUTO ?</code>
----------------	---

Example	<code>:SEM:DET:CARR NEG</code> <code>:SEM:DET:CARR?</code> <code>:SEM:DET:CARR:AUTO OFF</code> <code>:SEM:DET:CARR:AUTO?</code>
---------	--

Notes	When you manually select a detector (instead of selecting Auto), that detector is used regardless of other instrument settings Note: This detector setting affects the reference channel. There is no per-trace detector
-------	---

Couplings	See Couplings in "Trace Type" on page 1737
-----------	--

Preset	AVERage ON
--------	-----------------------------

State Saved	Saved in instrument state
-------------	---------------------------

Range	AVERage NEGative NORMal POSitive SAMPle
-------	--

Reference Carrier Average Type (Remote Command Only)

Select trace average type for the reference carrier.

Remote Command	<code>[:SENSe]:SEMAsk:AVERAge:CARRier:TYPE RMS LOG</code> <code>[:SENSe]:SEMAsk:AVERAge:CARRier:TYPE?</code>
Example	<code>:SEM:AVER:CARR:TYPE LOG</code> <code>:SEM:AVER:CARR:TYPE?</code>
Preset	RMS
State Saved	Saved in instrument state

Offset/Limits Config Table

This function is the same as ["Offset/Limits Config Table" on page 1481](#) under the ["Settings" on page 1475](#) tab.

Sets the power reference in the carrier that will be used to compute the relative values for the offsets.

3.9.18.3 Reference

Lets you set the Reference Power and parameters related to the Reference Power for SEM measurements.

Measurement Type

Accesses a menu that enables you to select one of the following measurement reference types:

Total Pwr Ref	TPRef	Sets the reference to the total carrier power and the measured data is shown in dBc and dBm
PSD Ref	PSDRef	Sets the reference to the mean power spectral density of the carrier and the measured data is shown in dB and dBm/Hz
Spectrum Peak Ref	SPRef	Sets the reference to the spectrum peak power of the carrier and the measured data is shown in dB and dBm

Remote Command	<code>[:SENSe]:SEMAsk:TYPE PSDRef TPRef SPRef</code> <code>[:SENSe]:SEMAsk:TYPE?</code>
Example	<code>:SEM:TYPE PSDR</code> <code>:SEM:TYPE?</code>
Preset	WLAN Mode: SPRef

	All other Modes: TPRef
State Saved	Saved in instrument state
Range	Total Pwr Reference PSD Reference Spectrum Peak Reference

Reference Power

Toggles between Measured Power (**ON**) and Manual Power (**OFF**) for Total Power Ref, PSD Ref, and Spectrum Peak Ref.

Remote Command	<code>[:SENSe]:SEMAsk:CARRier:AUTO[:STATe] OFF ON 1 0</code> <code>[:SENSe]:SEMAsk:CARRier:AUTO[:STATe]?</code>
Example	Set to Manual: <code>:SEM:CARR:AUTO OFF</code> Set to Measured: <code>:SEM:CARR:AUTO ON</code> <code>:SEM:CARR:AUTO?</code>
Notes	Available for all " Measurement Type " on page 1559s
Dependencies	Not available in MSR, LTEAFDD, LTEATDD, and 5G NR Modes
Preset	ON
State Saved	Saved in instrument state Saved in instrument state
Range	Auto Man

Power Ref

Selects the power reference type:

Option	SCPI	Description
Left & Right Carriers	LRCarriers	Powers of leftmost and rightmost carriers with Measure Carrier On in a sub-block are the references of left and right sides respectively. Only the frequency ranges of leftmost and rightmost carriers are swept and measured. Other frequency ranges in the RFBW are not measured. Left and right carriers are determined based on the carrier center frequencies If Measure Carriers of all the carriers in a sub-block are off, the reference power in a sub-block and all the relative power results are NaN . Relative limits are not evaluated
Max Power Carrier	MPCarrier	Maximum carrier power is the reference of measurement. All the configured carriers are measured If Measure Carriers of all the carriers are off, the reference power and all the relative power results are NaN . Relative limits are not evaluated

3 VMA Mode
3.9 SEM Measurement

Option	SCPI	Description								
Carrier Index	CINdex	Power of the specified carrier is the reference of measurement. Only the frequency range of the specified carrier is swept and measured, and other frequency ranges in the RFBW are not measured If Measure Carriers of this carrier index is off, the reference power and all the relative power results are NaN . Relative limits are not evaluated								
Manual	MANual	Power or PSD specified by the user is the reference of measurement. No carriers are measured and the manually specified value is used as reference								
Max Power Carrier in Sub-block	MPCSubblock	Maximum carrier power among the sub-block carriers with Measure Carrier On is the reference of measurement. All the configured carriers are measured If Measure Carriers of all the carriers in a sub-block are off, the reference power of the sub-block and all the relative power results referring to this sub-block are NaN , and these relative limits are not evaluated								
RF Bandwidth	RFBandwidth	Power or PSD of total of the RF bandwidth is the reference of measurement. Power not only in the carrier bands but also carrier gaps is integrated into the reference power. Measure Carrier On/Off does not affect the reference power frequency range because RF bandwidth is determined by the carrier configuration								
Aggregated Chan BW LTE-A and 5G NR Modes only	ACBandwidth	The assigned aggregated channel bandwidth power which is measured with a rectangular filter with measurement bandwidth specified as aggregated channel bandwidth based on the definition of each 3GPP standard. Calculated from the carrier configuration including SCS (Power Meas), the smallest SCS among the enabled SCSs of the selected component carrier. Measure Carrier On/Off affects the reference power frequency range If Measure Carriers of all the carriers are off, the reference power and all the relative power results are NaN and Relative limits are not evaluated								
Left & Right Sub-blocks 5G NR Mode only	LRSubblocks	The reference depends on the Number of Component Carriers (CC) and Carrier Allocation as follows: <table border="1" data-bbox="613 1276 1404 1680"> <thead> <tr> <th>Number of CCs</th> <th>Reference</th> </tr> </thead> <tbody> <tr> <td>1</td> <td>The carrier power is the reference</td> </tr> <tr> <td>2 or more, <i>and</i> Carrier Allocation is Contiguous</td> <td>Aggregated Channel power is the reference</td> </tr> <tr> <td>2 or more, <i>and</i> Carrier Allocation is Non-Contiguous</td> <td>Aggregated powers of left and right sub-blocks are the references. Left and right sub-blocks are determined by component carrier configuration</td> </tr> </tbody> </table>	Number of CCs	Reference	1	The carrier power is the reference	2 or more, <i>and</i> Carrier Allocation is Contiguous	Aggregated Channel power is the reference	2 or more, <i>and</i> Carrier Allocation is Non-Contiguous	Aggregated powers of left and right sub-blocks are the references. Left and right sub-blocks are determined by component carrier configuration
Number of CCs	Reference									
1	The carrier power is the reference									
2 or more, <i>and</i> Carrier Allocation is Contiguous	Aggregated Channel power is the reference									
2 or more, <i>and</i> Carrier Allocation is Non-Contiguous	Aggregated powers of left and right sub-blocks are the references. Left and right sub-blocks are determined by component carrier configuration									

The powers of carriers are not included in the reference power when their Measure Carriers are **Off**. When Measure Carriers of all the carriers in a sub-block are **Off**, the reference power and all the relative power results are **NaN**. Therefore, relative limits are not evaluated.

Meas Type = Total Power Ref

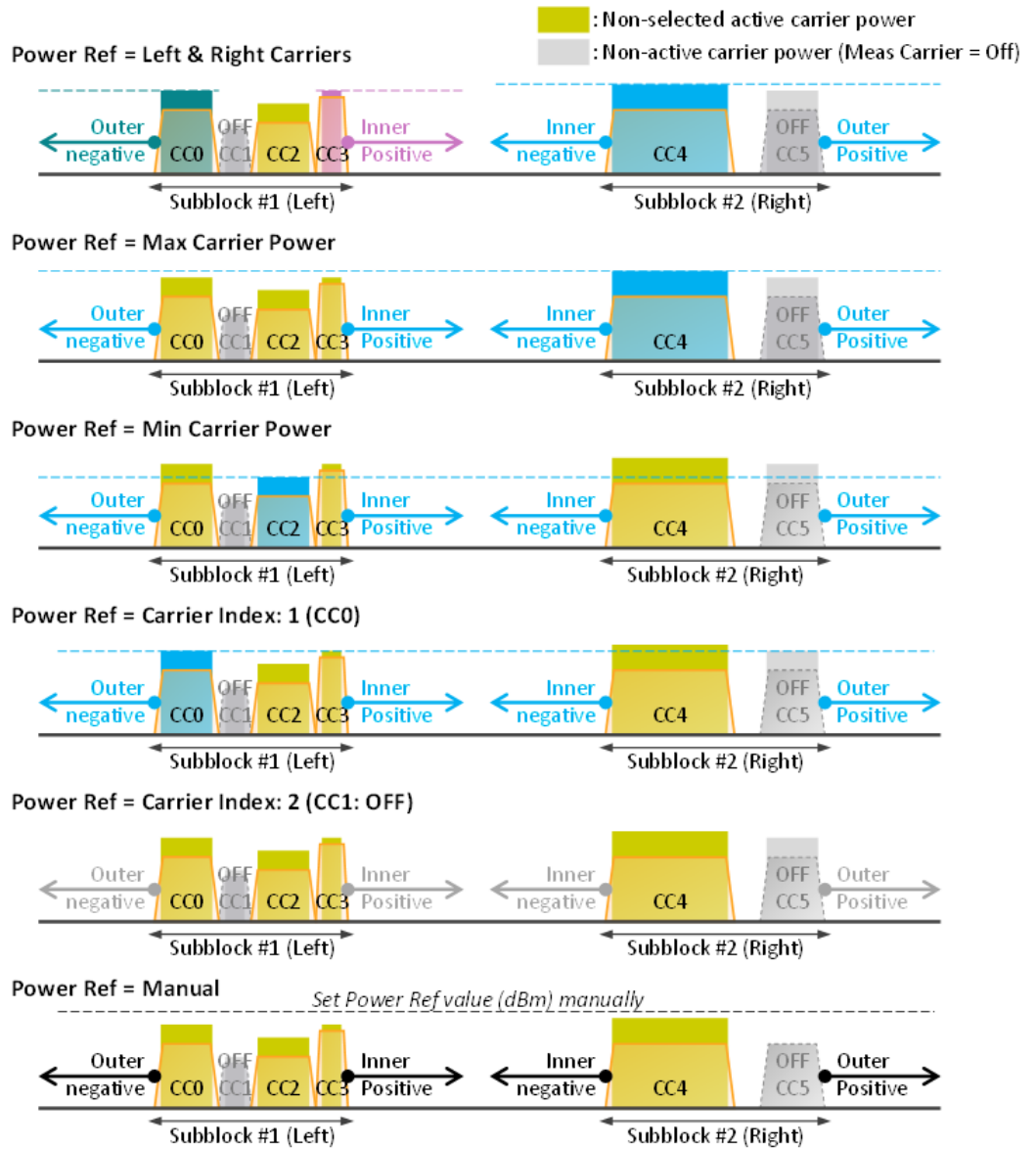

3 VMA Mode
 3.9 SEM Measurement

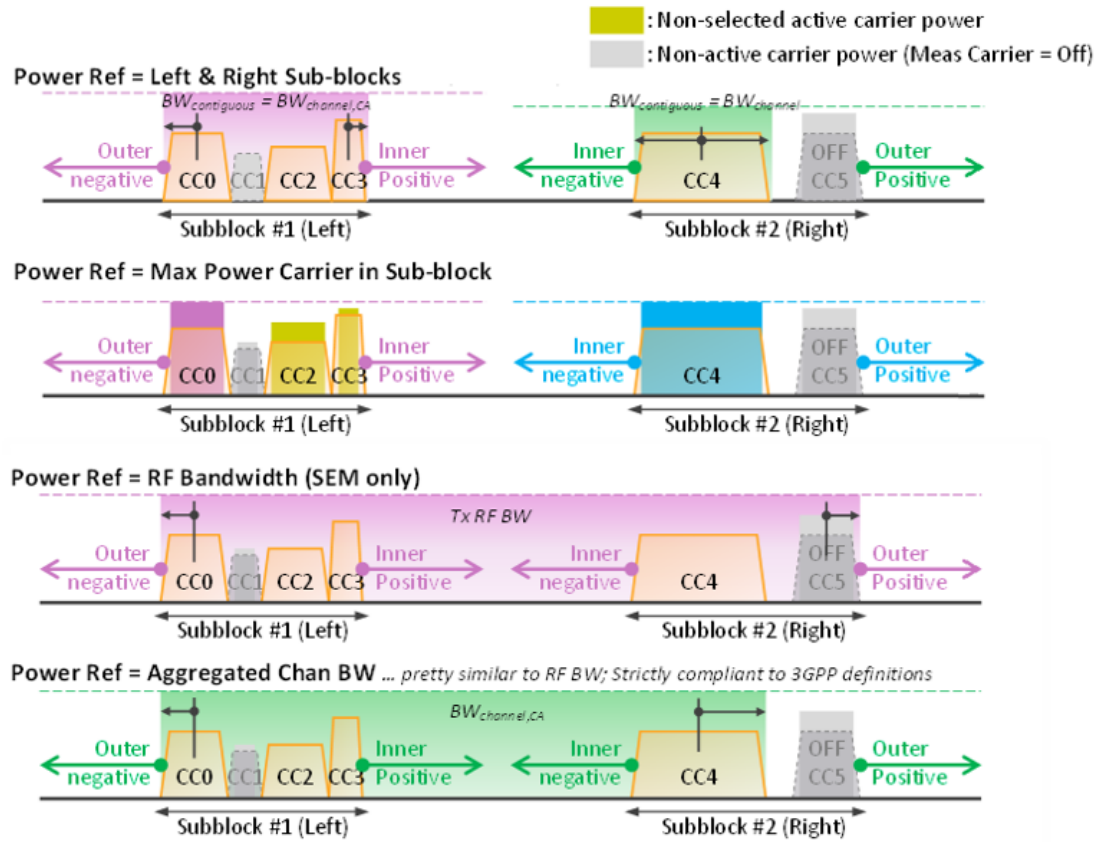

Meas Type = PSD Ref

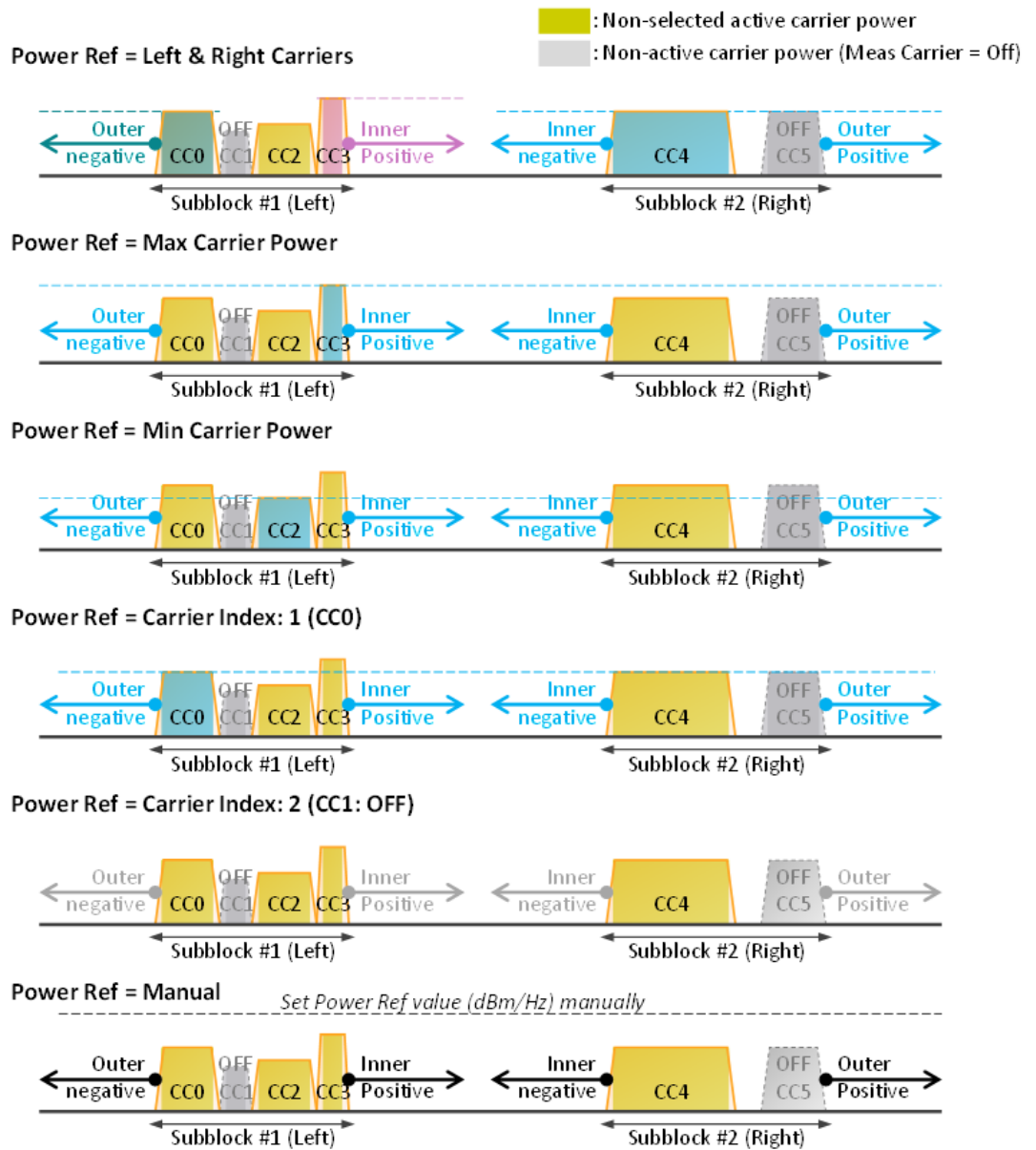

3 VMA Mode
3.9 SEM Measurement

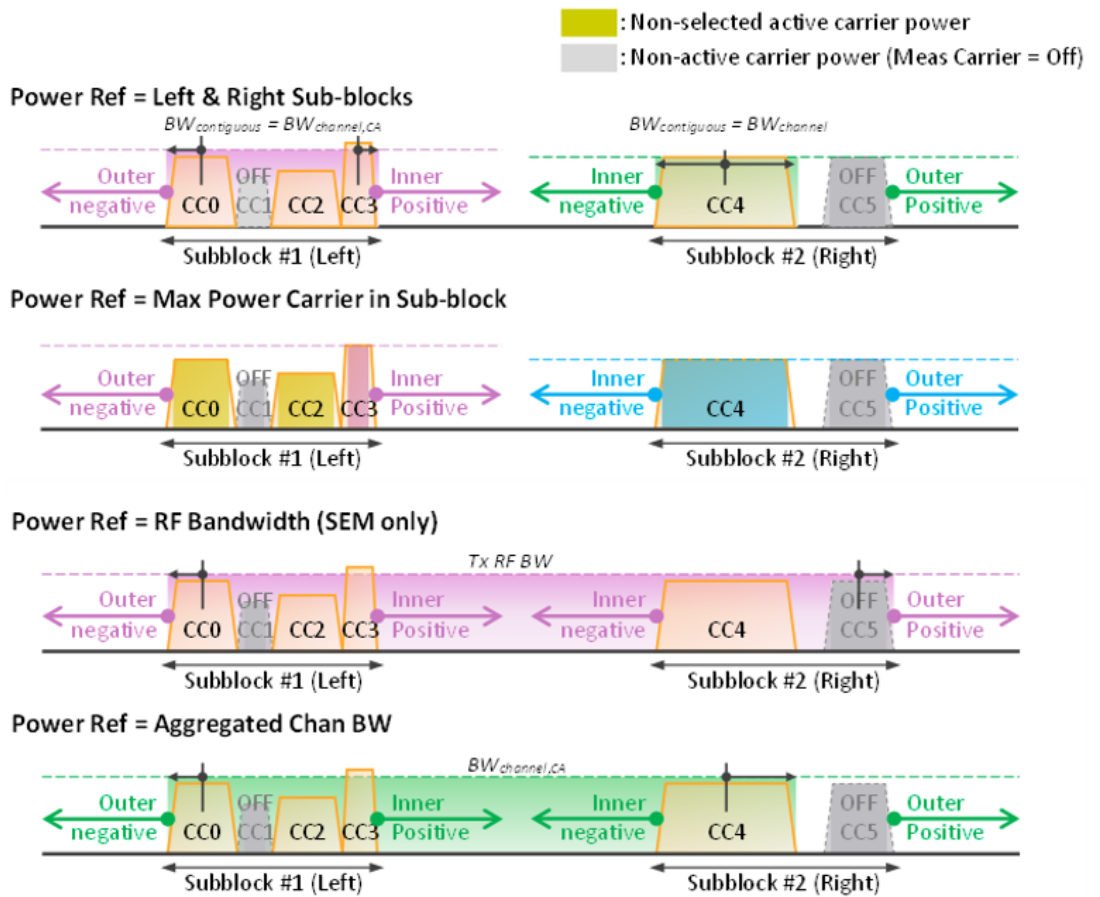

Remote Command	<code>[:SENSe] :SEMAsk :CARRier :PREFerence :TYPE LRCarriers MPCarrier CINDEX MANual MPCSubblock RFBandwidth ACBandwidth LRSubblocks</code> For option details, see above <code>[:SENSe] :SEMAsk :CARRier :PREFerence :TYPE?</code>
Example	<code>:SEM:CARR:PREF:TYPE CIND</code> <code>:SEM:CARR:PREF:TYPE?</code>
Notes	<code>LRSubblocks</code> is available only in 5G NR Mode <code>ACBandwidth</code> is available only in LTE-A and 5G NR Modes
Dependencies	Only available in MSR, LTE-A and 5G NR Modes
Preset	<code>MPCarrier</code>
State Saved	Saved in instrument state
Range	Left & Right Carriers Max Power Carriers Carrier Index Manual Max Power Carrier in Sub-block RF Bandwidth Aggregated Chan BW Left & Right Sub-blocks
Remote Command	<code>[:SENSe] :SEMAsk :CARRier :AUTO[:STATe] OFF ON 1 0</code> <code>[:SENSe] :SEMAsk :CARRier :AUTO[:STATe]?</code>

Example	<code>:SEM:CARR:AUTO OFF</code> <code>:SEM:CARR:AUTO?</code>
Preset	ON
State Saved	Saved in instrument state
Range	Auto Man

Carrier Index

Sets carrier index of the reference power. The power of the carrier selected by this index becomes reference power when "**Power Ref**" on page 1560 is Carrier Index.

Remote Command	<code>[:SENSe]:SEMAsk:CARRier:INDex <integer></code> <code>[:SENSe]:SEMAsk:CARRier:INDex?</code>
Example	<code>:SEM:CARR:IND 1</code> <code>:SEM:CARR:IND?</code>
Dependencies	Available only in MSR, LTE-A and 5G NR Modes
Preset	1
State Saved	Saved in instrument state
Min/Max	MSR Mode: 1/100 LTEAFDD,LTEATDD Mode:1/5 5G NR Mode: 16

Total Power Ref

Sets the power in the carrier (ref channel) that is used to compute the relative power values for the offsets. For modes other than MSR, LTEAFDD, LTEATDD, and 5G NR, when "**Reference Power**" on page 1560 is set to Measured, this value is set to the measured carrier reference power. When set to Manual, the result takes on the last measured value, or can be manually entered.

For WLAN 802.11ac (80 MHz + 80 MHz), the higher of the power readouts of the two carriers is used for computing the relative power values for the offset.

Remote Command	<code>[:SENSe]:SEMAsk:CARRier[:POWer] <real></code> <code>[:SENSe]:SEMAsk:CARRier[:POWer]?</code>
Example	<code>:SEM:CARR 100dBm</code> <code>:SEM:CARR?</code>
Notes	The min and max values given are for " Measurement Type " on page 1559 = Total Pwr Ref
Couplings	Coupled with Measurement Type . Active when Measurement Type is set to Total Power Ref. Otherwise, grayed-out

3 VMA Mode
3.9 SEM Measurement

	In MSR, LTE-A and 5G NR Modes, the control is active when Measurement Type is set to Total Power and Power Ref is set to Manual
Preset	Measured carrier reference power
State Saved	Saved in instrument state
Min/Max	-200 dBm/200 dBm
Annotation	Value is displayed on the left top of the Results window with the Channel Integ BW

PSD Ref

Sets the power spectral density in the carrier that is used to compute the relative power spectral density values for the offsets when "**Measurement Type**" on page 1559 is set to PSD Ref. When the state is set to **Auto**, this will be set to the measured carrier power spectral density.

For WLAN 802.11ac (80 MHz + 80 MHz), the higher of the power density readouts of the two carriers is used for computing the relative PSD values for the offset.

Remote Command	<code>[:SENSe] :SEMAsk :CARRier :CPSD <real></code> <code>[:SENSe] :SEMAsk :CARRier :CPSD ?</code>
Example	<code>:SEM :CARR :CPSD -80</code> <code>:SEM :CARR :CPSD ?</code>
Notes	Although the default value is defined, the value is recalculated by the measurement result just after completing the measurement Carrier sub op code. 1 for BTS, 2 for MS. Default is BTS
Couplings	Coupled with " Measurement Type " on page 1559. Active if Measurement Type is PSD. Otherwise, grayed-out In MSR, LTE-A and 5G NR Modes, active when Measurement Type is PSD and Power Ref is Manual
Preset	Measured carrier PSD reference power
State Saved	Saved in instrument state
Min/Max	-200/200
Annotation	Value is displayed on the right top of the Results window. If Meas Type selection is PSD Ref, the string is "PSD Ref" with BOLD font, otherwise, hide annotation

Spectrum Pk Ref

Sets the spectrum peak power in the carrier that is used to compute the relative power spectral density values for the offsets when "**Measurement Type**" on page 1559 is Spectrum Peak. When the state is set to **Auto**, this is set to the measured carrier spectrum peak power. When set to **Manual**, the result takes on the last measured value, or can be manually entered

Remote Command	<code>[:SENSe]:SEMAsk:CARRier:PEAK[:POWer] <real></code> <code>[:SENSe]:SEMAsk:CARRier:PEAK[:POWer]?</code>
Example	<code>:SEM:CARR:PEAK -80</code> <code>:SEM:CARR:PEAK:POWER?</code>
Notes	Although the default value is defined, the value is recalculated by the measurement result just after completing the measurement Carrier sub op code. 1 for BTS, 2 for MS. Default is BTS
Couplings	Coupled with " Measurement Type " on page 1559. Active when Measurement Type is "Spectrum Peak Ref". Otherwise, grayed-out In MSR, LTE-A and 5G NR Modes, active when Measurement Type is Spectrum Peak Ref and Power Ref is Manual
Preset	Measured carrier Spectrum Peak reference power
State Saved	Saved in instrument state
Min/Max	-200/200
Annotation	Value is displayed on the right top of the Results window. If Meas Type selection is Spectrum Peak Ref, the string is "Spectrum Peak Ref" with BOLD font, otherwise, hide annotation

Measure All Ref Carriers

When **ON**, all reference carriers configured are always measured irrespective of Measure Carrier on/off settings.

Remote Command	<code>[:SENSe]:SEMAsk:CARRier:MEASure:ALL ON OFF 1 0</code> <code>[:SENSe]:SEMAsk:CARRier:MEASure:ALL?</code>
Example	<code>:SEM:CARR:MEAS:ALL 1</code> <code>:SEM:CARR:MEAS:ALL?</code>
Dependencies	Only available in MSR, LTE-A and 5G NR Modes
Preset	0
State Saved	Saved in instrument state

Offset/Limits Config Table

This function is the same as "[Offset/Limits Config Table](#)" on page 1481 under the "[Settings](#)" on page 1475 tab.

Sets the power reference in the carrier that will be used to compute the relative values for the offsets.

3.9.18.4 Advanced

Contains controls for setting advanced instrument functions.

This tab does not appear in EXM, VXT.

Noise Floor Extension

Allows you to turn on/configure the **Noise Floor Extension** (NFE) function. Some Modes (such as Spectrum Analyzer Mode), support two states of NFE, Full and Adaptive. The **ON** state (in Modes that do not support Adaptive NFE) matches the FULL state (in Modes that *do* support Adaptive NFE).

In **ON** or FULL NFE, the expected noise power of the instrument (derived from a factory calibration) is subtracted from the trace data. This usually reduces the apparent noise level by about 10 dB in low band, and 8 dB in high band (>~3.6 GHz).

In Adaptive NFE, there is not the same dramatic visual impact on the noise floor as there is in Full NFE. Adaptive NFE controls the amount of correction that is applied based on other instrument settings like RBW, averaging and sweep time. Adaptive NFE controls the degree of potential improvement in the noise floor to give more improvement for those instrument settings that can make good use of the potential improvement, such as settings that provide more averaging. The result is that when not much averaging is being performed, the signal displays more like the NFE-off case; and when lots of averaging is being performed, the signal displays more like the full-NFE case.

Adaptive NFE (in Modes that support it) is recommended for general-purpose use. For fully ATE (automatic test equipment) applications, where the distraction of a person using the instrument is not a risk, Full NFE is recommended.

NFE works with any RBW, VBW, detector, any setting of Average Type, any amount of trace averaging, and any signal type. It is ineffective when the trace is not smoothed (smoothing processes include narrow VBWs, trace averaging, and long sweep times with the detector set to **Average** or **Peak**). It works best with extreme amounts of smoothing, and with the average detector, with Average Type set to **Power**.

In those cases where the cancellation is ineffective, it nonetheless has no undesirable side-effects. There is no significant speed impact to having **Noise Floor Extension ON**.

The best accuracy is achieved when substantial smoothing occurs in each point before trace averaging. Thus, when using the average detector, results are better with long sweep times and fewer trace averages. When using the sample detector, the VBW filter should be set narrow with less trace averaging, instead of a wide VBW filter with more trace averaging.

NOTE

Noise Floor Extension has no effect unless the RF Input is selected, therefore it does nothing when External Mixing is selected.

In Modes that support Adaptive NFE, the default state of NFE is Adaptive. In Modes that do not support Adaptive NFE, the default state of NFE is OFF. Prior to the introduction of Adaptive NFE (firmware version A. 18.00), the default state of NFE was OFF for all Modes.

With the introduction of Adaptive NFE, the menu control is changed from On|Off to Full|Adaptive|Off. For SCPI Backwards Compatibility, the existing SCPI command to turn NFE on and off was retained, and a new command was added to set the state to turn Adaptive On and Off

`[:SENSe]:CORRection:NOISe:FLOor ON|OFF|1|0` is retained, default changed to On for modes which support Adaptive NFE

`[:SENSe]:CORRection:NOISe:FLOor:ADAPtive ON|OFF|1|0` is added (for certain Modes), default=On

FULL = `:CORRection:NOISe:FLOor ON` plus
`:CORRection:NOISe:FLOor:ADAPtive ON`

Remote Command	<code>[:SENSe]:CORRection:NOISe:FLOor ON OFF 1 0</code> <code>[:SENSe]:CORRection:NOISe:FLOor?</code>
Example	<code>:CORR:NOIS:FLO ON</code>
Dependencies	Only appears in instruments with the NFE or NF2 license installed. In all others, the control does not appear, but the remote command will be accepted without error (but has no effect)
Couplings	When NFE is enabled in any Mode manually, a prompt is displayed reminding you to perform the Characterize Noise Floor operation if it is needed. If NFE is enabled via SCPI and a Characterize Noise Floor operation is needed, an error will be entered in the system error queue
Preset	Unaffected by Mode Preset . Turned ON at startup and by Restore Mode Defaults in Modes that support Adaptive. Turned OFF at startup and by Restore Mode Defaults in Modes that do not support Adaptive
State Saved	No
Remote Command	<code>[:SENSe]:CORRection:NOISe:FLOor:ADAPtive ON OFF 1 0</code> <code>[:SENSe]:CORRection:NOISe:FLOor:ADAPtive?</code>
Example	First turn NFE on, this is FULL mode: <code>:CORR:NOIS:FLO ON</code> Then set it to Adaptive: <code>:CORR:NOIS:FLO:ADAP ON</code>
Dependencies	Only available in Modes that support Adaptive NFE Only appears in instruments with the NFE or NF2 license installed. In all others, the control does not appear, but the remote command is accepted without error (but has no effect)
Couplings	Sending <code>:CORR:NOIS:FLO ON</code> turns NFE Adaptive OFF for backwards compatibility. To turn Adaptive ON , you must issue the commands in the proper order, as shown in the example above

Preset	Not affected by Mode Preset , but set to ON at startup and by Restore Mode Defaults
State Saved	No

More Information

The instrument is characterized in the factory (or during a field calibration) with a model of the noise, referred to the input mixer, versus frequency in each band and path combination. Bands are 0 (low band) and 1 through 4 (high band) in a 26.5 GHz instrument, for example. Paths include normal paths, preamp paths, the electronic attenuator, etc.

In most band/path combinations, the noise can be well characterized based on just two parameters and the instrument frequency response before compensation for frequency-dependent losses.

After the noise density at the input mixer is estimated, the effects of the input attenuator, RBW, detector, etc. are computed to get the estimated input-port-referred noise level.

In the simplest case, the measured power (signal plus analyzer noise) in each display point (bucket) is compensated by subtracting the estimated noise power, leaving just the signal power. This is the operation when the detector is **Average**, and the Average Type is set to **Power**.

In other cases, operation is often not quite as good but still highly effective. With peak detection, the noise floor is estimated based on the RBW and the duration of the bucket using the same equations used in the noise marker function. The voltage of the noise is subtracted from the voltage of the observed signal-plus-noise measurement to compute the estimated signal voltage. The peak detector is one example of processing that varies with detector to give good estimates of the signal level without the analyzer noise.

For best operation, the average detector and the power scale are recommended, as already stated. **Peak** detection for pulsed-RF can still give excellent effectiveness. FFT analysis does not work well, and does not do NFE well, with pulsed-RF signals, so this combination is not recommended. **Negative peak** detection is not very useful, either. **Sample** detection works well but is never better than the average detector because it does not smooth as well. The **Normal** detector is a combination of peak and negative peak behaviors and works about as well as these.

For best operation, extreme smoothing is desirable, as already stated. Using narrow VBWs works well but using very long bucket durations and the average detector works best. Reducing the number of trace points makes the buckets longer.

For best operation, the power scale (Average Type = **Power**) is optimum. When making CW measurements in the presence of noise without NFE, averaging on the decibel scale has the advantage of reducing the effect of noise. When using NFE, the NFE does an even better job than using the log scale ever could. Using NFE with

the log scale is not synergistic, though; NFE with the power scale works a little better than NFE with log averaging type.

The results from NFE with internal preamp can often be lower than the theoretical noise in a signal source at room temperature, a noise density of -174 dBm/Hz. This is expected and useful behavior, because NFE is designed to report the amount of input signal that is in excess of the thermal noise, not the amount that includes the thermal noise. This can be a useful behavior because thermal noise often interferes with what you want to measure, instead of being part of what you want to measure. Note that NFE is not adequately accurate to always be able to read below kTB.

Adaptive NFE provides an alternative to fully-on and fully-off NFE. Fully-on NFE can, notably in cases with little or no averaging of the spectrum, result in a display that is distractingly unfamiliar in the variability in response to low level signals. Fully-off NFE fails to achieve the potential improvement in dynamic range and associated accuracy of measurement of low-level signals. Adaptive NFE controls the degree of potential improvement in the noise floor to give more improvement for those instrument settings that can make good use of the potential improvement – those settings with high degrees of variance reduction through some variant of averaging. When the potential improvement is small, the display acts like the NFE-off case, and when it is high, it acts like the fully-on case, and in-between, application is a compromise between attractiveness and effectiveness.

On instruments with the NF2 license installed, the calibrated Noise Floor used by **Noise Floor Extension** should be refreshed periodically. Keysight recommends that the **Characterize Noise Floor** operation be performed after the first 500 hours of operation, *and* once every calendar year. The control to perform this is located in the **System, Alignments, Advanced** menu. If you have not done this yourself at the recommended interval, then when you turn on **Noise Floor Extension**, the instrument will prompt you to do so with a dialog that says:

“This action will take several minutes to perform. Please disconnect all cables from the RF input and press Enter to proceed. Press ESC to cancel, or Postpone to postpone for a week”

If you **Cancel**, you will be prompted again the next time you turn NFE on. If you postpone, you will be prompted again after a week passes and you then turn NFE on.

Enable Wideband IF for FFT

When **OFF**, the maximum FFT BW is limited to 40 MHz. When **ON**, FFT with more wideband IF is supported depending on the instrument. For example, the max FFT BW is 510 MHz with option B5X. When ON for R10/R20/R40, the max FFT BW is 1GHz.

3 VMA Mode
3.9 SEM Measurement

When this parameter is on and the following conditions are met, the measurement is performed with a single I/Q acquisition.

- Stop Freq of the outermost Offset range is within the available IQ acquisition BW
- Same RBW, VBW, Detector Type settings across all Offset ranges and Carrier
- Sweep Type = FFT and Sweep Time = Auto across all Offset ranges and Carrier

Remote Command	<code>[:SENSe]:SEMAsk:WBFFt:ENABle ON OFF 1 0</code> <code>[:SENSe]:SEMAsk:WBFFt:ENABle?</code>
Example	<code>:SEM:WBFF:ENAB 1</code> <code>:SEM:WBFF:ENAB?</code>
Dependencies	The maximum FFT BW depends on the μ W preselector and the current frequency. In hi-band, the μ W preselector must be disabled to apply the FFT with wideband IF. Otherwise, the maximum FFT BW is limited to 40 MHz
Preset	OFF
State Saved	Saved in instrument state
Range	ON OFF

3.9.18.5 Global

The controls in this menu apply to all Modes in the instrument.

Some controls (for example, "[Global Center Freq](#)" on page 1828) allow you to switch certain Meas Global parameters to a Mode Global state. These switches apply to all Modes that support global settings. For example, no matter what Mode you are in when you set **Global Center Freq** to **ON**, it applies to all Modes that support Global settings.

Other controls (for example, **Extend Low Band**) are actually set in this menu, but apply to all Modes.

Global Center Freq

The software maintains a Mode Global value called **Global Center Freq**.

When **Global Center Freq** is switched **ON**, the current Mode's center frequency is copied into the **Global Center Frequency**, and from then on all Modes that support global settings use the **Global Center Frequency**, so you can switch between any of these Modes and the **Center Frequency** remains unchanged.

Adjusting the **Center Frequency** of any Mode that supports Global Settings, while **Global Center Freq** is **ON**, modifies the **Global Center Freq**.

When **Global Center Freq** is switched **OFF**, the **Center Frequency** of the current Mode is unchanged, but now the **Center Frequency** of each Mode is once again independent.

When **Mode Preset** is pressed while **Global Center Freq** is **ON**, the **Global Center Freq** is preset to the preset **Center Frequency** of the current Mode.

This function resets to **OFF** when "**Restore Defaults**" on page 1829 is pressed, or when **System, Restore Defaults, All Modes** is pressed.

Remote Command	<code>:INSTRument:COUPlE:FREQuency:CENTer ALL NONE</code> <code>:INSTRument:COUPlE:FREQuency:CENTer?</code>
Example	<code>:INST:COUP:FREQ:CENT ALL</code> <code>:INST:COUP:FREQ:CENT?</code>
Preset	Set to OFF on Global Settings, Restore Defaults and System, Restore Defaults, All Modes
Range	ALL NONE
Preset	OFF
Backwards Compatibility SCPI	<code>:GLOBal:FREQuency:CENTer[:STATe] 1 0 ON OFF</code> <code>:GLOBal:FREQuency:CENTer[:STATe]?</code>

Global EMC Std

When this control is switched **ON**, the current Mode's EMC Std is copied into the **Global EMC Std**, and from then on all Modes that support global settings use the **Global EMC Std**, so you can switch between any of these Modes and the EMC Std remains unchanged.

Adjusting the EMC Std of any Mode that supports Global settings, while **Global EMC Std** is **ON** modifies the **Global EMC Std**.

When **Global EMC Std** is switched **OFF**, the EMC Std of the current Mode remains unchanged, but now the EMC Std of each Mode is once again independent. When **Mode Preset** is pressed while **Global EMC Std** is **ON**, **Global EMC Std** is preset to the preset EMC Std of the current Mode.

This function resets to **OFF** when "**Restore Defaults**" on page 1829 is pressed, or when **System, Restore Defaults, All Modes** is pressed.

Remote Command	<code>:INSTRument:COUPlE:EMC:STANdard ALL NONE</code> <code>:INSTRument:COUPlE:EMC:STANdard?</code>
Example	<code>:INST:COUP:EMC:STAN ALL</code> <code>:INST:COUP:EMC:STAN?</code>
Dependencies	Only available if Option EMC is installed
Preset	Set to OFF on Global Settings, Restore Defaults and System, Restore Defaults, All Modes
Range	ALL NONE

Restore Defaults

Resets all functions in the **Global** settings menu to **OFF**. Pressing **System, Restore Defaults, All Modes** has the same effect.

Remote Command	:INSTrument:COUPle:DEFault
Example	:INST:COUP:DEF
Backwards Compatibility SCPI	:GLOBal:DEFault

3.9.19 Sweep

Accesses controls to configure and control the acquisition of data, and the X-axis parameters of the instrument.

Depending on the selected mode and measurement, these controls might include: **Sweep Time, Continuous/Single, Pause/Resume, X Scale** and **Number of Points**.

3.9.19.1 Sweep/Control

Accesses controls that let you operate the sweep and control functions of the instrument, such as **Sweep Time** and **Continuous/Single**.

Sweep/Measure

Lets you toggle between **Continuous** and **Single** sweep or measurement operation. The single/continuous state is Meas Global, so the setting affects all measurements.

The front-panel key **Single/Cont** performs exactly the same function

See "[More Information](#)" on page 1576

Remote Command	:INITiate:CONTInuous OFF ON 0 1 :INITiate:CONTInuous?
Example	Put instrument into Single measurement operation: :INIT:CONT 0 :INIT:CONT OFF Put instrument into Continuous measurement operation: :INIT:CONT 1 :INIT:CONT ON
Preset	ON

Note that **:SYST:PRES** sets **:INIT:CONT** to **ON**, but ***RST** sets **:INIT:CONT** to **OFF**

State Saved	Saved in instrument state
Annunciation	<p>The Single/Continuous icon in the Meas Bar changes depending on the setting:</p> <ul style="list-style-type: none"> - A line with an arrow is Single - A loop with an arrow is Continuous
Backwards Compatibility Notes	<p>X-Series A-models had Single and Cont hardkeys in place of the SweepSingleCont softkey. In the X-Series A-models, if in single measurement, the Cont hardkey (and INIT:CONT ON) switched to continuous measurement, but never restarted a measurement and never reset a sweep</p> <p>X-Series B-models have a Cont/Single toggle control instead of Single and Cont hardkeys, but it is still true that, if in single measurement, the Cont/Single toggle control never restarts a measurement and never resets a sweep</p>

More Information

Continuous Mode	<p>The instrument takes repetitive sweeps, averages, measurements, etc., when in continuous mode. If in average or Max/Min Hold, and the average/hold count reaches the Average/Hold Num, the count stops incrementing, but the instrument keeps sweeping</p> <p>See the Trace key description under Trace Average for the averaging formula used both before and after the Average/Hold Num is reached. The trigger condition must be met prior to each sweep</p> <p>The type of trace processing for multiple sweeps is set under the Trace key, with choices of Trace Average, Max Hold, or Min Hold</p>
Single Mode	<p>The instrument takes a single sweep when in Single mode, or if in average or Max/Min Hold, or if there is a Waterfall window displayed, it takes multiple sweeps until the average/hold count reaches the Average/Hold Num, then the count stops incrementing, and the instrument stops sweeping</p> <p>See the Trace key description under Trace Average for the averaging formula used. The trigger condition must be met prior to the sweep</p> <p>The type of trace processing for multiple sweeps is set under the Trace key, with choices of Trace Average, Max Hold, or Min Hold</p>

If the instrument is in **Single** measurement mode, pressing the **Cont/Single** toggle control does not zero the count and does not cause the sweep to be reset; the only action is to put the instrument into Continuous measurement operation.

If the instrument is already in **Continuous** sweep:

- **:INIT:CONT 1** has no effect
- **:INIT:CONT 0** places the instrument in Single Sweep but has no effect on the current sequence until $k = N$, at which point the current sequence will stop and the instrument will go to the idle state

See "**Restart**" on page 1832 for details of **:INIT:IMMediate**.

If the instrument is already in **Single** sweep, `:INIT:CONT OFF` has no effect.

If the instrument is already in **Single** sweep, then pressing **Cont/Single** in the middle of a sweep does not restart the sweep or sequence. Similarly, pressing **Cont/Single** does not restart the sweep or sequence if the sweep is not in the idle state (for example, if you are taking a very slow sweep, or the instrument is waiting for a trigger). Even though pressing **Cont/Single** in the middle of a sweep does not restart the sweep, sending `:INIT:IMM` does reset it.

If the instrument is in **Single** sweep, and *not* Averaging/Holding, and you want to take one more sweep, press **Restart**.

If the instrument is in **Single** sweep, *and* Averaging/Holding, and you want to take one more sweep without resetting the Average trace or count, go to **Meas Setup** and increment the average count by 1 by pressing the **Step-Up** key while **Average/Hold Num** is the active function. You can also do this by sending `:CALC:AVER:TCON UP`.

Restart

Restarts the current sweep, or measurement, or set of averaged/held sweeps or measurements. If you are Paused, pressing **Restart** performs a Resume.

The front-panel key **Restart** performs exactly the same function.

The **Restart** function is accessed in several ways:

- Pressing the **Restart** key
- Sending `:INIT:IMM`
- Sending `:INIT:REST`

See "[More Information](#)" on page 1578

Remote Command	<code>:INITiate[:IMMEDIATE]</code> <code>:INITiate:REStart</code>
Example	<code>:INIT:IMM</code> <code>:INIT:REST</code>
Notes	<code>:INIT:REST</code> and <code>:INIT:IMM</code> perform exactly the same function
Couplings	Resets average/hold count k. For the first sweep overwrites all active (update = on) traces with new current data. For application modes, it resets other parameters as required by the measurement
Status Bits/OPC dependencies	This is an Overlapped command The <code>STATus:OPERation</code> register bits 0 through 8 are cleared , <i>except</i> bit 6 (Waiting for Periodic Sync). Initiating a measurement and Waiting for Periodic Sync could be asynchronous The <code>STATus:QUESTionable</code> register bit 9 (<code>INTEGRity</code> sum) is cleared The <code>SWEEPING</code> bit is set

	The MEASURING bit is set
Backwards Compatibility Notes	<p>For Spectrum Analysis Mode in ESA and PSA, the Restart hardkey and the :INIT:REST command restarted trace averages (displayed average count reset to 1) for a trace in Clear Write, but did not restart Max Hold and Min Hold</p> <p>In X-Series, the Restart hardkey and the :INIT:REST command restart not only Trace Average, but MaxHold and MinHold traces as well</p>

More Information

The **Restart** function first aborts the current sweep or measurement as quickly as possible. It then resets the sweep and trigger systems, sets up the measurement and initiates a new data measurement sequence with a new data acquisition (sweep) taken once the trigger condition is met.

If the instrument is in the process of aligning when a **Restart** is executed, the alignment finishes before the restart function is performed.

Even when set for **Single** operation, multiple sweeps may be taken when **Restart** is pressed (for example, when averaging/holding is on). Thus, when we say that **Restart** "restarts a measurement", depending on the current settings, we may mean that it:

- Restarts the current sweep
- Restarts the current measurement
- Restarts the current set of sweeps if any trace is in Trace Average, Max Hold or Min Hold
- Restarts the current set of measurements if Averaging, or Max Hold, or Min Hold is on for the measurement

If there is no Average or Max/Min Hold function (no trace in Trace Average or Hold, or **Average/Hold Num** set to 1), and no **Waterfall** window is being displayed, a single sweep is equivalent to a single measurement. A single sweep is taken after the trigger condition is met; and the instrument stops sweeping once that sweep has completed. However, with **Average/Hold Num** > 1, and at least one trace set to Trace Average, Max Hold, or Min Hold, or a **Waterfall** window being displayed, multiple sweeps/data acquisitions are taken for a single measurement. The trigger condition must be met prior to each sweep. The sweep is stopped when the average count k equals the number N set for **Average/Hold Num**.

Once the full set of sweeps has been taken, the instrument goes to the idle state. To take one more sweep without resetting the average count, increment the average count by 1, by pressing the **Step-Up** key while **Average/Hold Number** is the active function, or by sending the remote command **:CALC:AVER:TCN UP**.

Trace Update

The numeric results are not blanked at any time during the restart cycle.

For slow sweeps (see **Trace Update** section in **Trace/Detector**), the traces are updated real-time during the sweep. There may be a special circumstance in application mode measurements where an exception is made and the traces and/or results need to be blanked before displaying the new results.

To summarize, the following list shows what happens to the trace data on various events:

Event	Trace Effect
Clear/Write pressed (even if already in Clear/Write)	Set to mintracevalue
Max Hold pressed (even if already in Max Hold)	Set to mintracevalue
Min Hold pressed (even if already in Min Hold)	Set to maxtracevalue
Trace Average pressed (even if already in Trace Average)	Trace data unaffected but start new sweep/avg/hold
Restart pressed	Trace data unaffected but start new sweep/avg/hold
Parameter requiring restart changed (e.g., RBW)	Trace data unaffected but start new sweep/avg/hold

Sweep and Trigger Reset

Resetting the sweep system resets the average/hold count k to 0. It also resets the set point counter to 0. Resetting the trigger system resets the internal auto trig timer to the value set by the **Auto Trig** control.

Averaging

The weighting factor used for averaging is k . This k is also the average/hold count for how many valid sweeps (data acquisitions) have been done. This k is used for comparisons with N , as those comparisons always needs to be based on valid completed sweeps.

The displayed average/hold, K , shows the count for the sweep (data acquisition) in progress. $K = k + 1$, with a limit of N . The displayed value K changes from its previous value to 1 as soon as the trigger condition for the first data acquisition (sweep) is met.

Pause/Resume

Pauses a measurement after the current data acquisition is complete.

When paused, the label on the control changes to **Resume**. Pressing **Resume** unpauses the measurement. When paused, pressing **Restart** performs a Resume.

Remote Command	<code>:INITiate:PAUSe</code> <code>:INITiate:RESume</code>
Example	<code>:INIT:PAUS</code> <code>:INIT:RES</code>
Dependencies	Not displayed in Modes that do not support pausing
Annotation	Only on control

Abort (Remote Command Only)

Stops the current measurement. Aborts the current measurement as quickly as possible, resets the sweep and trigger systems, and puts the measurement into an "idle" state. If the instrument is in the process of aligning when `:ABORT` is sent, the alignment finishes *before* the abort function is performed, so `:ABORT` does not abort an alignment.

If the instrument is set for **Continuous** measurement, it sets up the measurement and initiates a new data measurement sequence with a new data acquisition (sweep) taken once the trigger condition is met.

If the instrument is set for **Single** measurement, it remains in the "idle" state until an `:INIT:IMM` command is received.

Remote Command	<code>:ABORT</code>
Example	<code>:ABOR</code>
Notes	If <code>:INIT:CONT</code> is ON , then a new continuous measurement will start immediately, with sweep (data acquisition) occurring once the trigger condition has been met If <code>:INIT:CONT</code> is OFF , then <code>:INIT:IMM</code> is used to start a single measurement, with sweep (data acquisition) occurring once the trigger condition has been met
Dependencies	For continuous measurement, <code>:ABORT</code> is equivalent to the Restart key Not all measurements support this command
Status Bits/OPC dependencies	The <code>STATus:OPERation</code> register bits 0 through 8 are cleared, <i>except</i> bit 6 (Waiting for Periodic Sync). Initiating a measurement and Waiting for Periodic Sync could be asynchronous The <code>STATus:QUESTionable</code> register bit 9 (INTEGRity sum) is cleared Since all the bits that feed into OPC are cleared by <code>:ABORT</code> , the Abort command will cause the <code>*OPC</code> query to return true

3.9.19.2 X Scale

Accesses controls that enable you to set the horizontal scale parameters.

Ref Value

Sets the X reference value.

Remote Command	<code>:DISPlay:SEMask:WINDow[1]:TRACe:X[:SCALE]:RLEVel <freq></code> <code>:DISPlay:SEMask:WINDow[1]:TRACe:X[:SCALE]:RLEVel?</code>
Example	<code>:DISP:SEM:WIND:TRAC:X:RLEV 10</code> <code>:DISP:SEM:WIND:TRAC:X:RLEV?</code>
Couplings	If " Auto Scaling " on page 1420 is ON , this value is automatically determined by the measurement result. If you set this value manually, Auto Scaling automatically changes to OFF
Preset	1.0 GHz
State Saved	Saved in instrument state
Min	-1000 GHz
Max	1000 GHz
Backwards Compatibility SCPI	<code>:DISPlay:SEMask:VIEW[1]:WINDow[1]:TRACe:X[:SCALE]:RLEVel</code>

Scale/Div

Sets the horizontal scale.

Remote Command	<code>:DISPlay:SEMask:WINDow[1]:TRACe:X[:SCALE]:PDIVision <freq></code> <code>:DISPlay:SEMask:WINDow[1]:TRACe:X[:SCALE]:PDIVision?</code>
Example	<code>:DISP:SEM:WIND:TRAC:X:PDIV 500</code> <code>:DISP:SEM:WIND:TRAC:X:PDIV?</code>
Couplings	If Auto Scaling is ON , this value is automatically determined by the measurement result. When you set this value manually, Auto Scaling automatically changes to OFF
Preset	Automatically Calculated
State Saved	Yes Saved in instrument state
Min	1 Hz
Max	100 GHz
Backwards Compatibility SCPI	<code>:DISPlay:SEMask:VIEW[1]:WINDow[1]:TRACe:X[:SCALE]:PDIVision</code>

Ref Position

Sets the reference position for the X axis to Left, Center or Right.

Remote Command	<code>:DISPlay:SEMask:WINDow[1]:TRACe:X[:SCALE]:RPOsition LEFT CENTer RIGHT</code> <code>:DISPlay:SEMask:WINDow[1]:TRACe:X[:SCALE]:RPOsition?</code>
Example	<code>:DISP:SEM:WIND:TRAC:X:RPOS LEFT</code> <code>:DISP:SEM:WIND:TRAC:X:RPOS?</code>
Preset	<code>CENTer</code>
State Saved	Saved in instrument state
Range	Left Center Right
Backwards Compatibility SCPI	<code>:DISPlay:SEMask:VIEW[1]:WINDow[1]:TRACe:X[:SCALE]:RPOsition</code>

Auto Scaling

Toggles the scale coupling function On or Off.

Remote Command	<code>:DISPlay:SEMask:WINDow[1]:TRACe:X[:SCALE]:COUPle 0 1 OFF ON</code> <code>:DISPlay:SEMask:WINDow[1]:TRACe:X[:SCALE]:COUPle?</code>
Example	<code>:DISP:SEM:WIND:TRAC:X:COUP ON</code> <code>:DISP:SEM:WIND:TRAC:X:COUP?</code>
Couplings	When Auto Scaling is ON and the Restart front-panel key is pressed, this function automatically determines the scale per division and reference values based on the measurement results When you set a value to either " Scale/Div " on page 1581 or " Ref Value " on page 1581 manually, Auto Scaling automatically changes to OFF
Preset	<code>ON</code>
State Saved	Saved in instrument state
Range	<code>OFF ON</code>
Backwards Compatibility SCPI	<code>:DISPlay:SEMask:VIEW[1]:WINDow[1]:TRACe:X[:SCALE]:COUPle</code>

3.9.19.3 Sweep Config

Accesses controls that enable you to configure the Sweep and Control functions of the instrument, such as Sweep Rules.

Points

Sets the number of points displayed in the traces. The current value of points is displayed in the bottom-right corner of the display.

Remote Command	<code>[:SENSe]:SEMAsk:SWEEp:POINTs <integer></code> <code>[:SENSe]:SEMAsk:SWEEp:POINTs?</code>
Example	<code>:SEM:SWE:POIN 4001</code> <code>:SEM:SWE:POIN?</code>
Preset	2001
State Saved	Saved in instrument state
Min	201
Max	10001
Annotation	On second line of annotations in bottom right corner

IF Dithering

Lets you turn IF Dithering on or off. This is a technique used in unpreselected instruments (such as Keysight's modular instruments) to enhance the rejection of images and internally-generated spurious signals.

Remote Command	<code>[:SENSe]:SWEEp:IF:DITHer OFF ON 0 1</code> <code>[:SENSe]:SWEEp:IF:DITHer?</code>
Dependencies	Only appears in Spectrum Analyzer Mode in VXT models
Preset	OFF
State Saved	Saved in instrument state

Image Protection

Lets you turn IF Protection on or off. This is a technique used in unpreselected instruments (such as Keysight's modular instruments) to detect and suppress images and spurs that may be present in non-preselected hardware.

IF Protection takes two sweeps and by correlating the data between them, provides a single, correct power-versus-frequency trace.

Remote Command	<code>[:SENSe]:SWEEp:IMAGeprot OFF ON 0 1</code> <code>[:SENSe]:SWEEp:IMAGeprot?</code>
Dependencies	Only appears in Spectrum Analyzer Mode in VXT model M9421A
Preset	ON
State Saved	Saved in instrument state

3.9.20 Trace

Lets you control the acquisition, display, storage, detection and manipulation of trace data for the available traces. The Trace Control tab of this menu contains radio-button selections for the trace type (**Clear/Write**, **Trace Average**, **Max Hold**, **Min Hold**) and **View/Blank** setting for the selected trace.

3.9.20.1 Select Trace

Specifies the *selected trace*, which is the trace that will be affected when you change trace settings.

Select Trace appears above the menu panel, indicating that it applies to *all* controls in the menu panel. **Select Trace** is blanked if you select a tab whose controls do *not* depend on the selected trace (for example, **Trace Function**).

Notes	The selected trace is remembered even when not in the Trace menu
Dependencies	For the Swept SA measurement: <ul style="list-style-type: none"> - In Image Suppress mode, when you select a trace it becomes the active trace, and the formerly active trace goes into View - When you turn on Image Suppress, Update turns off for all traces except the selected trace For the ACP measurement, when Meas Method is RBW , FAST or FPOwer , Select Trace is disabled
Preset	Trace 1
State Saved	Yes

3.9.20.2 Trace Control

The controls on this tab allow you to set the "**Trace Type**" on page 1737 and its update mode.

There are four Trace Types:

- **Clear/Write**
- **Trace Average**
- **Max Hold**
- **Min Hold**

Each type handles data in a different way.

Each trace also has two values that determine whether it is being written or not, and whether it is being displayed or not. These values, **Update** and **Display**, are described fully in the "[View/Blank](#)" on page 1742 control description. Essentially, when **Update** is **ON**, a trace is updating, and when **Update** is **OFF** it is not. When **Display** is **ON**, it is visible and when **Display** is **OFF** it is not. These terms are used throughout the descriptions in this section.

Trace Type

There are four trace Types:

Option	Parameter	SCPI Example	Details
Clear/Write	<code>WRITE</code>	<code>:TRAC2:TYPE WRIT</code>	See: " Clear/Write " on page 1588
Trace Average	<code>AVERage</code>	<code>:TRAC2:TYPE AVER</code>	See: " Trace Average " on page 1588
Maximum Hold	<code>MAXHold</code>	<code>:TRAC3:TYPE MAXH</code>	See: " Max Hold " on page 1589
Minimum Hold	<code>MINHold</code>	<code>:TRAC5:TYPE MINH</code>	See: " Min Hold " on page 1589

Full descriptions of each type are provided below. You may select one of these types for each trace. Re-selecting the current **Trace Type** initiates the same action that selecting it the first time did, even though it is already selected. For example, selecting **Clear/Write** while **Clear/Write** is already selected will nonetheless clear the trace and begin rewriting it.

Besides the **Trace Type**, the "[View/Blank](#)" on page 1742 state must be set to **Active** (**Update**: **ON**, **Display**: **ON**) for a trace to be updating and visible. Selecting any **Trace Type** automatically makes the trace **Active**.

See also: "[Trace Mode Backwards Compatibility Commands](#)" on page 1586

Remote Command	<p>For Swept SA Measurement (in SA Mode):</p> <pre>:TRACe[1] 2 ... 6:TYPE WRITE AVERage MAXHold MINHold</pre> <pre>:TRACe[1] 2 ... 6:TYPE?</pre> <p>For all other measurements:</p> <pre>:TRACe[1] 2 3:<meas>:TYPE WRITE AVERage MAXHold MINHold</pre> <pre>:TRACe[1] 2 3:<meas>:TYPE?</pre> <p>where <code><meas></code> is the identifier for the current measurement</p>
Example	<pre>:TRAC:TYPE WRIT</pre> <pre>:TRAC:TYPE?</pre>
Couplings	<p>Selecting a Trace Type (by pressing any of the Trace Type selections or sending <code>:TRAC:TYPE</code>) sets the Trace to Active (Update: ON, Display: OFF), even if the same trace type was already selected</p> <p>When Detector setting is "Auto" (<code>[:SENSe] : <meas> : DETector : AUTO?</code>), Detector (<code>[:SENSe] : <meas> : DETector [:FUNction] ?</code>) switches aligning with the switch of this parameter: "NORMAL" with <code>WRITE</code> (Clear Write), "AVERage" with <code>AVERage</code>, "POSitive (peak)" with <code>MAXHold</code>, and "NEGative (peak)" with <code>MINHold</code></p>

Preset	Swept SA and Monitor Spectrum: WRITe All other measurements: AVERage Following Preset , all traces are cleared (all trace points set to mintracevalue)
State Saved	The type of each trace is saved in instrument state
Annunciation	The type for each trace is indicated in the Trace annunciator panel on the Measurement Bar

Trace Mode Backwards Compatibility Commands

In earlier instruments, the “Trace Modes” were: Clear/Write, Max Hold, Min Hold, View and Blank. Averaging was global to all traces and was controlled under the **BW/Avg** menu.

In X-Series, trace averaging can be done on a per-trace basis. The Trace Modes (now called Trace Types) are Clear/Write, Trace Average, Max Hold and Min Hold. View and Blank are set separately under ["View/Blank" on page 1742](#).

While this provides more flexibility, it also gives rise to potential backwards compatibility problems. To mitigate these, the old Trace Mode command has been retained and a new Trace Type command has been added. The **:TRACe:MODE** command is retained for backwards compatibility, and the **:TRACe:TYPE**, **:TRACe:UPDate** and **:TRACe:DISPlay** commands introduced for ongoing use. The old Trace Modes are selected using **:TRAC:MODE**, whose parameters are mapped into calls to **:TRACe:TYPE**, **:TRACe:UPDate** and **:TRACe:DISPlay**, and the old global Averaging command **[:SENSe]:AVERage[:STATe]** is provided for backwards compatibility. See the individual command descriptions for details.

When **Average/Hold** in the **Meas Setup, Legacy Compatibility** menu is **ON**, the following is true for traces in Max Hold and Min Hold:

- They ignore the **Average/Hold** number; **Single** for Max Hold causes one sweep only, so switching to **Single** stops after the current sweep, and switching to **Cont** starts again without clearing the accumulated result
- Max Hold is not cleared on a **Restart**, **Single** or **:INIT:IMM**, but changing a measurement parameter, like frequency or bandwidth etc., still restarts the Max Hold

Preset	WRITe
State Saved	The trace mode is an alias only
Backwards Compatibility SCPI	:TRACe[1] 2 ... 6:MODE WRITe MAXHold MINHold VIEW BLANK :TRACe[1] 2 ... 6:MODE?
Backwards Compatibility Notes	The legacy :TRACe:MODE command is retained for backwards compatibility. In conjunction with the legacy :AVERage command, it works as follows: <ul style="list-style-type: none"> – :AVERage ON OFF sets/clears a variable that we will call average for the sake of this discussion. This variable is maintained by the instrument solely for backwards compatibility. See

the `[:SENSe]:AVERage[:STATe]` command description below

- `:TRACe:MODE WRITe` sets `:TRACe:TYPE WRITe` (Clear/Write) unless average is true, in which case it sets it to `:TRACe:TYPE AVERage`. It also sets `:TRACe:UPDate ON`, `:TRACe:DISPlay ON`, for the selected trace
- `:TRACe:MODE MAXHold` sets `:TRACe:TYPE MAXHold` (Max Hold). It also sets `:TRACe:UPDate ON`, `:TRACe:DISPlay ON`, for the selected trace
- `:TRACe:MODE MINHold` sets `:TRACe:TYPE MINHold` (Min Hold). It also sets `:TRACe:UPDate ON`, `:TRACe:DISPlay ON`, for the selected trace
- `:TRACe:MODE VIEW` sets `:TRACe:UPDate OFF`, `:TRACe:DISPlay ON`, for the selected trace
- `:TRACe:MODE BLANK` sets `:TRACe:UPDate OFF`, `:TRACe:DISPlay OFF`, for the selected trace

The query returns the same value as `:TRACe:TYPE?`, meaning that if you set `:TRACe:MODE:VIEW` or `:TRACe:MODE:BLANK`, the query response will not be what you sent

`:TRACe[n]:MODE` was formerly used to set the type or “writing mode” of the trace. At that time, View and Blank were writing modes. The new `:TRACe:TYPE` command should be used in the future, but `:TRACe:MODE` is retained to provide backwards compatibility

In X-Series, unlike earlier instruments, Max Hold and Min Hold now obey the Average Number and counts up to a terminal value as Average always has

As the **Average/Hold Number** now affects **Min Hold** and **Max Hold**, the operations that restart Averaging (for example, the **Restart** key) now also restart **Min Hold** and **Max Hold**

As a result of these changes, legacy code that restarts averaging while retaining a running Max Hold will need to be rewritten, because the Max Hold will now restart when the Average does

Also, previous to X-Series:

- Pressing **Max Hold** while already in **Max Hold** (or doing so remotely) had no effect. Now it will clear the trace and restart the sweep and the Max Hold sequence
- Changing the vertical scale (Log/Lin or dB/div) of the display restarted **Max Hold** and **Min Hold**. This is no longer the case

Preset	OFF
State Saved	The state of Average is saved in Instrument State for ghosting purposes
Backwards Compatibility SCPI	<code>[:SENSe]:AVERage[:STATe] ON OFF 1 0</code> <code>[:SENSe]:AVERage[:STATe]?</code>
Backwards Compatibility Notes	Previous to X-Series, Averaging (also sometimes known as trace averaging) was global to all traces, that is, it was either on or off for all active traces. The legacy command <code>[:SENSe]:AVERage [:STATe] ON OFF 1 0</code> was used to turn Averaging on or off In X-Series, Averaging is turned on or off on a per-trace basis, so it can be on for one trace and off for another For backwards compatibility, the old global Average State variable is retained solely as a legacy

variable, turned on and off and queried by the legacy command [:SENSe] :AVERAge [:STATe] OFF | ON | 0 | 1. When Average is turned on, any trace in Clear/Write will get put into Average. While Average is on, any trace put into Clear/Write by the old :TRAC :MODE command will instead get put into Average. When Average is turned off, any trace in Average will get put into Clear/Write

Trace Type Details

Clear/Write

Each trace update replaces the old data in the trace with new data.

Pressing **Clear/Write** for the selected trace, or sending :TRAC :TYPE WRIT for the specified trace, sets the trace type to **Clear/Write** and clears the trace, even if you are already in **Clear/Write**. Then a new sweep is initiated. Trigger conditions must be met before the sweep actually starts, and if in **Single** the sweep won't start until **Restart** is pressed.

Pressing **Clear/Write** stops the current sweep and initiates a new one, so **Trace Average**, **Max Hold** and **Min Hold** data may be interrupted in mid-sweep when **Clear/Write** is pressed, and therefore may not accurately reflect the displayed count. Therefore, when **Clear/Write** is pressed for one trace, **Trace Average**, **Max Hold** and **Min Hold** must restart for all traces.

When in **Clear/Write**, if a measurement-related instrument setting is changed (that is, one which requires new data to be taken, like **Center Frequency** or **Attenuation**), a new sweep is initiated but the trace is not cleared.

Trace Average

The instrument maintains and displays an average trace, which represents the cumulative average on a point-by-point basis of the new trace data and previous averaged trace data.

Pressing **Trace Average** (for the selected trace), or sending :TRAC :TYPE AVER (for the specified trace), sets the trace type to **Trace Average**, clears the trace, initiates a new sweep, and restarts the Average sequence.

Details of the count limiting behavior and the averaging calculations may be found under **Avg|Hold Number** and **Average Type** under **Meas Setup**.

When in **Trace Average**, if a measurement-related instrument setting is changed (that is, one which requires new data to be taken, like **Center Frequency** or **Attenuation**), the average restarts and a new sweep is initiated but the trace is not cleared.

Restarting the average means:

- The average/hold count k is set to 1, so that the next time the average trace is displayed it simply represents one trace of new data
- A new sweep is initiated
- Once the new sweep starts, the trace is overwritten with current trace data as the first trace of the new average

Remember that restarting averaging also restarts **Max Hold** and **Min Hold**, as there is only one count for Trace Average and Hold.

Max Hold

The instrument maintains and displays a max hold trace, which represents the maximum data value on a point-by-point basis of the new trace data and previous trace data. Details of the count limiting behavior may be found under **Avg|Hold Number** under **Meas Setup**.

Pressing **Max Hold** for the selected trace, or sending `:TRAC:TYPE MAXH` for the specified trace, sets the Trace Type to **Max Hold**, clears the trace, initiates a new sweep, and restarts the hold sequence, even if you are already in **Max Hold**.

When in **Max Hold**, if a measurement-related instrument setting is changed (that is, one which requires new data to be taken, like **Center Frequency** or **Attenuation**), the **Max Hold** sequence restarts and a new sweep is initiated but the trace is not cleared.

Restarting the **Max Hold** sequence means:

- The average/hold count k is set to 1, so that the next time the max hold trace is displayed it simply represents one trace of new data
- A new sweep is initiated.

Remember that restarting **Max Hold** also restarts averaging and **Min Hold**, as there is only one count for Trace Average and Hold.

Min Hold

The instrument maintains and displays a min hold trace, which represents the minimum data value on a point-point basis of the new trace data and previous trace data. Details of the count limiting behavior may be found under **Avg|Hold Number** under the **Meas Setup** functions.

Pressing **Min Hold** for the selected trace, or sending `:TRAC:TYPE MINH` for the specified trace, sets the Trace Type to **Min Hold**, clears the trace, initiates a new sweep, and restarts the hold sequence, even if you are already in **Min Hold**.

When in **Min Hold**, if a measurement-related instrument setting is changed (that is, one which requires new data to be taken, like **Center Frequency** or **Attenuation**), the **Min Hold** sequence restarts and a new sweep is initiated but the trace is not cleared.

Restarting the **Min Hold** sequence means:

- The average/hold count k is set to 1, so that the next time the min hold trace is displayed it simply represents one trace of new data
- A new sweep is initiated

Remember that restarting **Min Hold** also restarts **Max Hold** and averaging, because there is only one count for Trace Average and Hold.

Clear and Write | Restart Averaging | Restart Max/Min Hold

Starts the trace writing, as though the "Trace Type" on page 1737 had just been selected. The effect is exactly the same as reselecting the current **Trace Type** again – the control is provided because it may not be obvious that reselecting the same selection from a radio button menu will take any action.

This control displays different labels, depending on the selected Trace Type:

- **Clear/Write**: Clear and Write
- **Trace Average**: Restart Averaging
- **Max Hold**: Restart Max Hold
- **Min Hold**: Restart Min Hold

View/Blank

Lets you set the state of the two trace variables: **Update** and **Display**. The choices available in this dropdown menu are:

Active	Update and Display both ON
View	Update OFF ; Display ON
Blank	Update OFF ; Display OFF
Background	Update ON , Display OFF Allows a trace to be blanked <i>and</i> continue to update "in the background", which was not possible in the past

In the Swept SA measurement, a trace with **DisplayOFF** is indicated by a strikethrough of the type letter in the trace annotation panel in the Measurement Bar. A trace with **UpdateOFF** is indicated by dimming the type letter in the trace

annotation panel in the Measurement Bar. In the example below, Traces 3, 4, 5 and 6 have **UpdateOFF**, and Traces 4 and 6 have **DisplayOFF**.

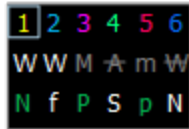

See: ["More Information" on page 1592](#)

Notes	For the commands to control the two variables, Update and Display, see "Trace Update State On/Off" on page 1591 and "Trace Display State On/Off" on page 1592 below
Dependencies	When Signal ID is on, this key is grayed-out
Couplings	<p>Selecting a Trace Type for a trace (pressing the key or sending the equivalent command) puts the trace in Active (Update ON and Display ON), even if that trace type was already selected</p> <p>Selecting a detector for a trace (pressing the key or sending <code>[:SENS] :DET :TRAC</code>) puts the trace in Active (UpdateON and DisplayON), even if that detector was already selected</p> <p>Selecting a "Math Function" on page 1745 other than OFF for a trace (pressing the key or sending the equivalent command) puts the trace in Active (UpdateON and DisplayON), even if that Math Mode was already selected</p> <p>Loading a trace from a file puts that trace in View regardless of the state it was in when it was saved; as does being the target of a Copy or a participant in an Exchange</p>

Trace Update State On/Off

Remote Command	<p>For Swept SA Measurement (in SA Mode):</p> <pre>:TRACe[1] 2 ... 6:UPDate[:STATe] ON OFF 1 0</pre> <pre>:TRACe[1] 2 ... 6:UPDate[:STATe]?</pre> <p>For all other measurements:</p> <pre>:TRACe[1] 2 3:<meas>:UPDate[:STATe] ON OFF 1 0</pre> <pre>:TRACe[1] 2 3:<meas>:UPDate[:STATe]?</pre> <p>where <meas> is the identifier for the current measurement</p>
Example	<p>Make trace 2 inactive (stop updating):</p> <pre>:TRAC2:UPD 0</pre>
Couplings	Whenever you set Update to ON for any trace, the Display is set to ON for that trace
Preset	<p>For Swept SA Measurement (in SA Mode):</p> <pre>1 0 0 0 0 0</pre> <p>ON for Trace 1; OFF for 2–6</p> <p>For all other measurements:</p> <pre>1 0 0</pre> <p>ON for Trace 1; OFF for 2 & 3</p>
State Saved	Saved in instrument state

Trace Display State On/Off

Remote Command	<p>For Swept SA Measurement (in SA Mode):</p> <pre>:TRACe[1] 2 ... 6:DISPlay[:STATe] ON OFF 1 0</pre> <pre>:TRACe[1] 2 ... 6:DISPlay[:STATe]?</pre> <p>For all other measurements:</p> <pre>:TRACe[1] 2 3:<meas>:DISPlay[:STATe] ON OFF 1 0</pre> <pre>:TRACe[1] 2 3:<meas>:DISPlay[:STATe]?</pre> <p>where <meas> is the identifier for the current measurement</p>
Example	<p>Make trace 1 visible:</p> <pre>:TRAC2:DISP 1</pre> <p>Blank trace 3:</p> <pre>:TRAC3:DISP 3</pre>
Couplings	Whenever you set Update to ON for any trace, the Display is set to ON for that trace
Preset	<p>For Swept SA Measurement (in SA Mode):</p> <pre>1 0 0 0 0 0</pre> <p>ON for Trace 1; OFF for 2–6</p> <p>For all other measurements:</p> <pre>1 0 0</pre> <p>ON for Trace 1; OFF for 2 & 3</p>
State Saved	Saved in instrument state

More Information

When a trace becomes inactive, any update from the **:SENSE** system (detectors) immediately stops, without waiting for the end of the sweep. The trace data remains unchanged, but stops updating. If the trace is blanked, this still does not affect the data in the trace. Traces that are blanked (**Display=OFF**) do not display nor appear on printouts, but their data stays intact, they may be queried, and markers may be placed on them

In most cases, inactive traces are static and unchanging; however, there are cases when an inactive trace will update, specifically:

- if data is written to that trace from remote
- if trace data is loaded from mass storage
- if the trace is the target of a **Copy** or participant in an **Exchange**
- if the trace is cleared using **Clear Trace**

Inactive traces that are also being displayed (traces in **View**) are displayed at half intensity. Traces in **View** display across the entire X-Axis of the instrument. Their

horizontal placement does not change, even if X-Axis settings subsequently are changed, although Y-Axis settings do affect the vertical placement of data.

When a trace becomes active (**Update=ON**), the trace is cleared, the average count is reset, and a new sweep is initiated.

Note that putting a trace into **Display=OFF** and/or **Update=OFF** does *not* restart the sweep and does *not* restart Averaging or Hold functions for any traces.

3.9.20.3 Math

Lets you turn on and configure Trace Math functions.

Math Function

Trace Math functions perform mathematical operations between traces and, in some cases, user-specified offsets. When in a Trace Math function, the indicated function is performed during the sweep with the math function used in place of a detector. The trace operands for the math function are set using the "[Operand 1 / Operand 2](#)" on page 1751 controls.

- See "[How trace math is processed](#)" on page 1597

Remote Command For option details, see "[Trace Math Options](#)" on page 1595

For Swept SA Measurement (in SA Mode):

```
:CALCulate:MATH <trace_num>, PDifference | PSUM | LOFFset | LDIFference |  
OFF, <trace_num>, <trace_num>, <real>,<real>  
:CALCulate:MATH? <trace_num>
```

where <trace_num> is any one of:

```
TRACE1|...|TRACE6
```

For all other measurements:

```
:CALCulate:<meas>:MATH <trace_num>, PDifference | PSUM | LOFFset |  
LDIFference | OFF, <trace_num>, <trace_num>, <real>,<real>  
:CALCulate[:<meas>]:MATH? <trace_num>
```

where:

<meas> is the identifier for the current measurement, and

<trace_num> is any one of:

```
TRACe1|TRACe2|TRACe3
```

Note that the format of the **TRACe<n>** parameter differs from that for the Swept SA Measurement

Example `:CALC:MATH TRACe3,PDIF,TRACE1,TRACE2,0,0`

Sets Trace 3 to Power Diff trace math function, and sets the First Trace operand (for Trace 3) to Trace 1 and the Second Trace operand (for Trace 3) to Trace 2

	<p><code>:CALC:MATH TRACE3,PSUM,TRACE1,TRACE2,0,0</code></p> <p>Sets Trace 3 to Power Sum trace math function and sets the First Trace operand (for Trace 3) to Trace 1 and the Second Trace operand (for Trace 3) to Trace 2</p> <p><code>:CALC:MATH TRACE3,LOFF,TRACE1,TRACE2,-6.00,0</code></p> <p>Sets Trace 3 to Log Offset trace math function, sets the First Trace operand (for Trace 3) to Trace 1, leaves the Second Trace operand (for Trace 3) unchanged (it is irrelevant for this function) and sets the Log Offset (for Trace 3) to -6 dB</p> <p><code>:CALC:MATH TRACE3,LDIF,TRACE1,TRACE2,0,-6.00</code></p> <p>Sets Trace 3 to Log Diff trace math function, sets the First Trace operand (for Trace 3) to Trace 1, sets the Second Trace operand (for Trace 3) to Trace 2, and sets the Log Difference reference (for Trace 3) to -6 dBm</p> <p><code>:CALC:MATH TRACE1,OFF,TRACE2,TRACE3,0,0</code></p> <p>Turns off trace math for trace 1</p>
Notes	<p>The Trace Math Function command has 6 main set of parameters:</p> <ul style="list-style-type: none"> - Set 1 defines the “result trace”: <code>TRACE1 ... TRACE6</code> - Set 2 defines the “function”: <code>PDIFference PSUM LOFFset LDIFference OFF</code> - Set 3 is a “trace operand” (1): <code>TRACE1 ... TRACE6</code> - Set 4 is a “trace operand” (2): <code>TRACE1 ... TRACE6</code> - Set 5 defines the “Log Offset” (in dB) - Set 6 defines the “Log Difference Reference” (in dBm) <p>Note that the trace math mode is an enumeration; that is, when a math function is set for a trace, it turns off any math function that is on for that trace, then sets the new math function</p> <p>The parameters sent in the command are reflected in the values in the control menu. There is no default for any parameter; all 6 parameters must be sent to satisfy the parser. Failure to specify a parameter will result in a missing parameter message</p> <p>The query returns the math mode, the operand traces, the offset and the reference for the specified trace, all separated by commas</p>
Dependencies	<p>Trace Math is not available if Normalize is on</p> <p>Trace Math is not available if Signal ID is on</p> <p>None of the trace operands can be the destination trace. If any of the three trace math commands is sent with a destination trace number matching one of the operands, a warning is generated and the function does not turn on</p>
Couplings	<p>When a math function is changed for a trace, that trace is set to Display = ON; and Update = ON</p>
Preset	<p>For Swept SA Measurement (in SA Mode):</p> <p><code>OFF,TRACE5,TRACE6,0,0 OFF,TRACE6,TRACE1,0,0 OFF,TRACE1,TRACE2,0,0 </code> <code>OFF,TRACE2,TRACE3,0,0 OFF,TRACE3,TRACE4,0,0 OFF,TRACE4,TRACE5,0,0</code></p>

	For all other measurements: <code>OFF, TRACE2, TRACE3, 0, 0 OFF, TRACE3, TRACE1, 0, 0 OFF, TRACE1, TRACE2, 0, 0</code>
State Saved	The trace math function for each trace is saved in instrument state
Annunciation	An "F" is shown on the trace annunciation panel in the Measurement Bar when a math function is on; and the function is annotated on the trace if Trace Annotation is on
Status Bits/OPC dependencies	*OPC can be used to detect the completion of a sweep, which will also correspond to the completion of the math operation, since all math takes place during the sweep

Trace Math Options

IMPORTANT

To generate a trace math result, *you must take a sweep*. The trace math engine, described below, operates in concert with the sweep engine in the instrument. Until a sweep has been taken, even if the constituent traces are not in Update mode, no result is generated.

Note that certain events can affect the trace in ways that affects all points at once. This can happen in any number of ways, including:

- A trace clear taking place
- A trace being loaded from the file system
- Trace data being sent in from the remote interface
- A copy or exchange of trace data

You should try to avoid these occurrences during a sweep, as they will tend to invalidate the math result being accumulated.

The Trace Math functions are:

Power Diff (Op1 - Op2)

Calculates a power difference between the **First Trace** operand and the **Second Trace** operand and puts the result in the destination trace.

During the sweep, the following formula is executed for each point in the trace operands, and the corresponding point is generated for the destination trace:

$$\text{DestinationTrace} = 10 \log_{10}(10^{(1/10)(\text{FirstTrace})} - 10^{(1/10)(\text{SecondTrace})})$$

The values of the trace points are assumed to be in a decibel scale, as they are internally stored.

If a point in **FirstTrace** is equal to **maxtracevalue**, the resultant point is also **maxtracevalue**.

Otherwise, if the result of the subtraction is less than or equal to 0, the resultant point is **mintracevalue**.

Power Sum (Op1 + Op2)

Calculates a power sum between the **First Trace** operand and the **Second Trace** operand and puts the result in the destination trace.

During the sweep, the following formula is executed for each point in the trace operands, and the corresponding point is generated for the destination trace.

$$\text{DestinationTrace} = 10 \log_{10}(10(1/10)(\text{FirstTrace}) + 10(1/10)(\text{SecondTrace}))$$

The values of the trace points are assumed to be in a decibel scale, as they are internally stored.

If a point in either trace operand is equal to **maxtracevalue**, the resultant point is also **maxtracevalue**.

Log Offset (Op1 + Offset)

Calculates a log offset from the **First Trace** operand and puts the result in the destination trace. This is like the B-DL function in some older instruments. The offset is entered on the **Offset** control, which only appears when this math function is in force for the selected trace. Each destination trace has its own offset.

During the sweep, the following formula is executed for each point in the trace operand, and the corresponding point is generated for the destination trace.

$$\text{DestinationTrace} = \text{FirstTrace} + \text{Offset}$$

The values of the trace points are assumed to be in dBm (as they are internally stored) and the offset is in dB.

If a point in the trace operand is equal to **maxtracevalue**, the resultant point is also **maxtracevalue**.

If a point in the trace operand is equal to **mintracevalue**, the resultant point is also **mintracevalue**.

Example: If offset is 25 dB, then our destination trace will be higher than the operand trace by 25 dB.

Note that the **Second Trace** operand is not used for this function.

Log Diff (Op1 - Op2 + Ref)

Offsets the difference between the **First Trace** operand and the **Second Trace** operand by a reference and puts the result in the destination trace. This is like the A-B+DL function in some older instruments. The Reference is entered on the **Reference** control, which only appears when this math function is in force for the

selected trace. Each destination trace has its own reference.

Offsets the difference between the **First Trace** operand and the **Second Trace** operand by a reference and puts the result in the destination trace. This is like the A-B+DL function in some older instruments. The Reference is entered on the **Reference** control, which only appears when this math function is in force for the selected trace. Each destination trace has its own reference.

During the sweep, the following formula is executed for each point in the trace operands, and the corresponding point is generated for the destination trace.

$$\text{DestinationTrace} = (\text{FirstTrace} - \text{SecondTrace}) + \text{Reference}$$

The values of the operand trace points are assumed to be in decibel units (as they are internally stored) and the reference is in dBm so the result is in dBm.

Example: If the first operand trace 1 is at 5 dBm, the second operand trace 2 is at -5 dBm, and the reference is -25 dBm, then the destination trace will be -15 dBm.

Example: If the first operand trace 1 is at 60 dBuV, the second operand trace 2 is at 50 dBuV, and the reference is 35 dBuV, then the destination trace will be 45 dBuV.

If a point in **FirstTrace** is equal to **maxtracevalue**, the resultant point is also **maxtracevalue**.

If a point in **FirstTrace** is equal to **mintracevalue**, the resultant point is also **mintracevalue**.

If neither of the above is true for a given point, then:

- If that point in **SecondTrace** is equal to **maxtracevalue**, the resultant point is **mintracevalue**.
- If that point in **SecondTrace** is equal to **mintracevalue**, the resultant point is **maxtracevalue**.

How trace math is processed

Whenever a trace math function is turned on, or the parameters and/or operands of an existing trace math function are changed, the destination trace is cleared. After the trace is cleared, all x-axis values in the trace, and the domain of the trace, are set to match the X-Axis settings of the first trace operand. When this is complete, a new sweep is initiated.

The process of acquiring data, processing it using the math and Average/Hold functions, and presenting it as trace data, consists of several functional blocks, as shown below:

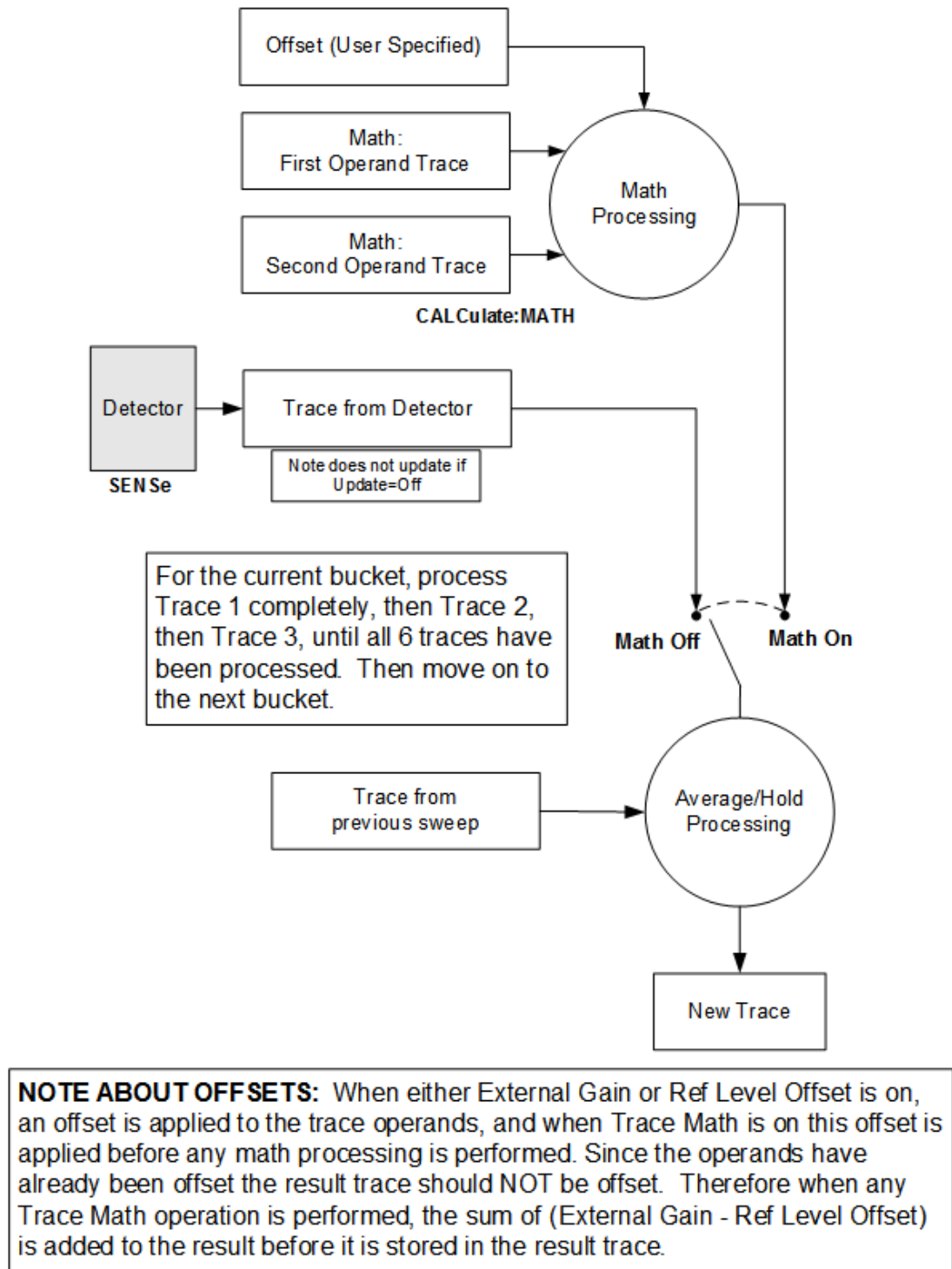

For each active trace, the current trace point is processed for **Trace 1**, then **Trace 2**, then **Trace 3**, etc. Trace data is taken from either the detector for that trace, or

from the mathematical result of up to two other traces and an offset, depending on whether trace math is on or not. The resultant data is then fed to the Average/Hold processing block, where (if the trace type is **Average**, **Max Hold**, or **Min Hold**) it is processed with previous trace data. The new trace data resulting from this process is then available for display, storage or remote output.

When the processing is complete for **Trace 1**, **Trace 2** is processed, and so on until all six traces have been processed. This allows a downstream trace to use as one of its math components a fully processed upstream trace. In other words, if math is **ON** for **Trace 4**, and its operand traces are **Trace 2** and **Trace 3**, then all detector, math, average and hold processing for Traces 2 and 3 is completed before the math is performed for **Trace 4**. When the current trace point is completed for all traces, the instrument moves on to the next trace point.

This allows very flexible and powerful math functions to be configured. For example, **Trace 1** can be an average trace, which can be fed with an offset to **Trace 2**, which can also be in **Max Hold**, allowing you to obtain the **Max Hold** of an Average trace.

Note that none of this processing is performed on inactive traces.

Note also that for any active trace with math **ON**, the Operand traces should have *lower* numbers than the trace (for example, using **Trace 4** as an operand for **Trace 1** will cause the data coming from **Trace 4** to be delayed by one sweep).

Operand 1 / Operand 2

These two controls select the first and second trace operands to be used for the trace math functions for the destination trace. The operands are common to all math functions for a given trace. The most recently sent **:CALCulate:MATH** command for a given trace sets the operands for that trace. Those settings are displayed on the trace operand controls for that trace.

Example	<p>The following examples are for the Swept SA measurement</p> <p>Set Trace 3 to Power Diff trace math function. Set the First Trace operand (for Trace 3) to Trace 1 and the Second Trace operand (for Trace 3) to Trace 2:</p> <pre>:CALC:MATH TRACE3,PDIF,TRACE1,TRACE2,0,0</pre> <p>Set Trace 3 to Log Offset trace math function. Set the First Trace operand (for Trace 3) to Trace 1, leave the Second Trace operand (for Trace 3) unchanged (it is irrelevant for this function) and set the Log Offset (for Trace 3) to -6 dB:</p> <pre>:CALC:MATH TRACE3,LOFF,TRACE1,TRACE2,-6.00,0</pre>
Notes	See " Math Function " on page 1745 for how to specify Operands 1 and 2 using :CALCulate:MATH
Dependencies	The destination trace cannot be an operand. The destination trace number is grayed-out on the dropdown
Preset	Operand 1: Trace number minus 2 (wraps at 1). For example, for Trace 1, Operand 1 presets to Trace

	5; for Trace 6, it presets to Trace 4 Operand 2: Trace number minus 1 (wraps at 1). For example, for Trace 1, Operand 2 presets to Trace 6; for Trace 6, it presets to Trace 5
State Saved	Operands 1 and 2 for each trace are stored in instrument state

Offset

Used by the Log Offset math function.

Example	The following example is for the Swept SA measurement Set Trace 3 to Log Offset trace math function, set the First Trace operand (for Trace 3) to Trace 1, leave the Second Trace operand (for Trace 3) unchanged (it is irrelevant for this function) and set the Log Offset (for Trace 3) to -6 dB: <code>:CALC:MATH TRACE3,LOFF,TRACE1,TRACE2,-6.00,0</code>
State Saved	The Log Offset value for each trace is saved in Instrument State
Min	-100 dB
Max	100 dB

Reference

Used by the Log Diff math function.

Example	The following example is for the Swept SA measurement Set Trace 3 to Log Diff trace math function, set the First Trace operand (for Trace 3) to Trace 1, set the Second Trace operand (for Trace 3) to Trace 2, and set the Log Difference reference (for Trace 3) to -6 dBm: <code>:CALC:MATH TRACE3,LDIF,TRACE1,TRACE2,0,-6.00</code>
State Saved	The Log Difference reference value for each trace is saved in instrument state
Min/Max	Same as reference level

3.9.20.4 Trace Function

Contains controls to:

- Copy and Exchange traces
- Preset or Clear all traces

From Trace

Selects the trace to be copied to or exchanged with the **"To Trace" on page 1753** when a **"Copy" on page 1753** or **"Exchange" on page 1754** is performed

Preset 1

To Trace

Selects the trace to be copied from or exchanged with the **"From Trace" on page 1753** when a **"Copy" on page 1753** or **"Exchange" on page 1754** is performed

Preset 2

Copy

Executes a Trace Copy based on the **"From Trace" on page 1753** and **"To Trace" on page 1753** parameters. The copy operation is from the **From Trace** to the **To Trace**. The action is performed once.

The X-Axis settings and domain of a trace are also copied.

Remote Command For Swept SA Measurement (in SA Mode):
`:TRACe:COPIY TRACE1 | ... | TRACE6, TRACE1 | ... | TRACE6`

For all other measurements:
`:TRACe:<meas>:COPIY TRACe1 | TRACe2 | TRACe3, TRACe1 | TRACe2 | TRACe3`

where `<meas>` is the identifier for the current measurement

Note that the format of the `TRACe<n>` parameter differs from that for the Swept SA Measurement

Example Copy Trace 1 to Trace 3 and put Trace 3 in Update=Off, Display=On
`:TRAC:COPIY TRACE1,TRACE3`

Notes The command is of the form:
`:TRACe:COPIY <source_trace>,<dest_trace>`

Dependencies When Signal ID is on, this key is grayed-out

Couplings The destination trace is put in **View** (Update = Off, Display = On) after the copy

Preset For Swept SA Measurement (in SA Mode):
`TRACE1, TRACE2`

For all other measurements:
`TRACe1, TRACe2`

Exchange

Executes a Trace Exchange based on the "From Trace" on page 1753 and "To Trace" on page 1753 parameters. The **From Trace** and **To Trace** values are exchanged with each other. The action is performed once.

The X-Axis settings and domain of a trace are also copied when it is exchanged with another trace.

Remote Command	<p>For Swept SA Measurement (in SA Mode): <code>:TRACe:EXCHange TRACE1 ... TRACE6, TRACE1 ... TRACE6</code></p> <p>For all other measurements: <code>:TRACe:<meas>:EXCHange TRACe1 TRACe2 TRACe3, TRACe1 TRACe2 TRACe3</code></p> <p>where <code><meas></code> is the identifier for the current measurement</p> <p>Note that the format of the <code>:TRACe<n></code> parameter differs from that for the Swept SA Measurement</p>
Example	<p>Exchange Trace 1 and Trace 2 and put both traces in Update=OFF, Display=ON: <code>:TRAC:EXCH TRACE1,TRACE2</code></p>
Notes	<p>The command is of the form: <code>:TRACe:EXCHange <trace_1>,<trace_2></code></p>
Couplings	Both traces are put in View (Update=Off, Display=On) after the exchange

Preset All Traces

Turns on Trace 1 and blanks all other traces. This is useful when you have many traces on and you want to return to having only Trace 1 on the display. Does not affect the trace type, detector or any other aspect of the trace system.

Remote Command	<code>:TRACe[:<meas>]:PRESet:ALL</code>
Example	<code>:TRAC:PRE:ALL</code>
Dependencies	When Signal ID is on, this key is grayed-out

Clear All Traces

Clears all traces. Does not affect the state of any function or variable in the instrument. Loads `mintracevalue` into all of the points for all traces, except traces in **Min Hold**, in which case it loads `maxtracevalue`, even if **Update = OFF**.

Remote Command	<code>:TRACe[:<meas>]:CLEar:ALL</code>
Example	<code>:TRAC:CLE:ALL</code>
Dependencies	When Signal ID is on, this key is grayed-out

3.9.20.5 Advanced

Contains controls for setting advanced trace functions of the instrument.

Measure Trace

Specifies which trace's scalar results are displayed in the **Metrics** window, and retrieved by sending a **:READ** or **:FETCh** query:

- Trace 1
- Trace 2
- Trace 3

Remote Command	<pre>:CALCulate:<meas>:MTRace TRACe1 TRACe2 TRACe3 :CALCulate:<meas>:MTRace? <meas> is the identifier for the current measurement; any one of CHPower ACPower OBWidth SEMask SPURious PVTime</pre>
Example	<pre>Channel Power :CALC:CHP:MTR TRAC1 :CALC:CHP:MTR?</pre>
Dependencies	In the ACP measurement, this control is grayed-out when Meas Method is set to RBW or FAST , and only Trace 1 is enabled
Preset	TRACe1
State Saved	No
Range	Trace 1 Trace 2 Trace 3

3.10 Spurious Emissions Measurement

The Spurious Emissions measurement identifies and determines the power level of spurious emissions in certain frequency bands.

Measurement Commands

The general functionality of "CONFigure" on page 2551, "INITiate" on page 2552, "FETCh" on page 2552, "MEASure" on page 2554, and "READ" on page 2553 are described in the section **SCPI Operation and Results Query** in the topic **Programming the Instrument**.

Note that, in general, `:CONF: <Measurement>` resets the specified measurement settings to their defaults. X-Series permits the addition of the `NDEFault` node to the command, which prevents a measurement preset after a measurement switch.

The tables below list measurement commands for this measurement.

Command	Function
<code>:INITiate:SPURious</code>	Initiates a trigger cycle for the <code>SPUR</code> measurement, but does not return any data. You must then use <code>:FETC:SPUR[n]?</code> to retrieve data
<code>:CONFigure?</code>	Does not change any measurement settings
<code>:CONFigure:SPURious</code>	Returns the long form name of current measurement, in this case, <code>SPURious</code>
<code>:CONFigure:SPURious</code>	Selects <code>SPUR</code> measurement with Meas Setup settings in preset state – same as "Meas Preset" on page 1716
<code>:CONFigure:SPURious:NDEFault</code>	Selects <code>SPUR</code> measurement <i>without</i> affecting settings

The following queries are used to retrieve data. The type of data returned depends on the value of `n`.

Command	Function
<code>:FETCh:SPURious[n]?</code>	Retrieves the data defined by <code>n</code>
<code>:MEASure:SPURious[n]?</code>	Switches to <code>SPUR</code> measurement, restores default values, starts the measurement, then retrieves the data defined by <code>n</code>
<code>:READ:SPURious[n]?</code>	Starts the measurement, then retrieves the data defined by <code>n</code>

Remote Command Results

The following table describes the results returned by the `:FETCh`, `:MEASure`, and `:READ` queries listed above, according to the index value `n`. Note that these queries are *not* available when viewing the Range Table.

The value of the constant `SCPI_NAN`, mentioned below, is 9.91E37.

3 VMA Mode
3.10 Spurious Emissions Measurement

n	Return Value
1 or omitted	<p>Returns a variable-length (1 + 6 * Spurs – up to 1201 entries) comma-separated list containing detailed information in the following format:</p> <p>Number of spurs in following list (Integer)</p> <p><i>[Repeat the following for each spur]</i></p> <ul style="list-style-type: none"> - Spur # - Range # Spur was located (Integer) - Frequency of Spur (Hz, Float64) - Amplitude of Spur (dBm, Float32) - Absolute Limit (dBm, Float32) - Pass or Fail (1 0, Boolean)
2 – 21 (Average Trace)	<p>Regardless of the Trace selection, returns a comma-separated list of the average trace data for the selected range (where range number = n – 1) using Detector 1. If selected range is not active, SCPI_NAN is returned for each trace data element</p>
22	<p>Returns the number of spurs found for the selected Measured Trace</p>
23 – 42 (Average Trace)	<p>Regardless of the Trace selection, returns a comma-separated list of the average trace data for the selected range (where range number = n – 22) using Detector 2. If selected range is not active or Detector 2 selection is off, SCPI_NAN is returned for each trace data element</p>
43 – 62 (Maximum Hold Trace)	<p>Regardless of the Trace selection, returns a comma-separated list of the maximum hold trace data for the selected range (where range number = n – 42) using Detector 1. If selected range is not active, SCPI_NAN is returned for each trace data element</p>
63 – 82 (Minimum Hold Trace)	<p>Regardless of the Trace selection, returns a comma-separated list of the minimum hold trace data for the selected range (where range number = n – 62) using Detector 1. If selected range is not active, SCPI_NAN is returned for each trace data element</p>
83-102	<p>Reserved</p>
103-122	<p>Reserved</p>
123-142 (Clear/Write Trace)	<p>Regardless of the Trace selection, returns a comma-separated list of the clear/write trace data for the selected range (where range number = n – 122) using Detector 1. If selected range is not active, SCPI_NAN is returned for each trace data element</p>
143-162 (Clear/Write Trace)	<p>Regardless of the Trace selection, returns a comma-separated list of the clear/write trace data for the selected range (where range number = n – 142) using Detector 2. If selected range is not active or Detector 2 selection is off, SCPI_NAN is returned for each trace data element</p>
163-182 (Trace 1)	<p>Returns a comma-separated list of the trace data of Trace 1 for the selected range (where range number = n – 162). If selected range is not active, SCPI_NAN is returned for each trace data element</p>
183-202 (Trace 2)	<p>Returns a comma-separated list of the trace data of Trace 2 for the selected range (where range number = n – 182). If selected range is not active, SCPI_NAN is returned for each trace data element</p>
203-222 (Trace 3)	<p>Returns a comma-separated list of the trace data of Trace 3 for the selected range (where range number = n – 202). If selected range is not active, SCPI_NAN is returned for each trace data element</p>
223	<p>Returns "Marker Table" on page 1610 data as a series of comma separated values in the following form:</p>

n	Return Value
	<p><Marker Number>, <Marker Trace>, <X>, <Y>, <Reserved>, <Reserved></p> <p>Only markers that are enabled are included. <Reserved> items are returned as SCPI_NAN</p> <p>The data is returned in the current sort order as displayed in the Marker Table</p>

3.10.1 Views

This measurement has two predefined views:

#	Name	SCPI
1	"Graph + Metrics" on page 1657	RESult
2	"All Ranges" on page 1657	ALL

These are multiple-window views. When in a multiple-window view, you select a window by touching it. The menu controls may sometimes change, depending on which window is selected.

Remote Command	:DISPlay:SPURious:VIEW[:SElect] RESult ALL :DISPlay:SPURious:VIEW[:SElect]?
Example	:DISP:SPUR:VIEW RANG :DISP:SPUR:VIEW?
Preset	RESult
State Saved	No
Range	Graph + Metrics All Ranges

3.10.1.1 Graph + Metrics

Windows: "Graph" on page 1607, "Table" on page 1608

Select Graph + Metrics to view measurement results.

- The upper window displays a trace of the range that contains the currently selected spur
- The lower window displays a list of spurs detected in a measurement cycle. The currently selected spur, which is highlighted, can be changed by the Spur control in the Meas Setup menu

Example	:DISP:SPUR:VIEW RES
---------	---------------------

3.10.1.2 All Ranges

Windows: "Graph" on page 1607,

Select All Ranges to view measurement results for all the ranges.

- The upper window displays a merged trace of all the ranges
- The lower window displays a list of spurs detected in a measurement cycle. The currently selected spur, which is highlighted, can be changed by the Spur control in the Meas Setup menu

Example `:DISP:SPUR:VIEW ALL`

3.10.2 Windows

The following windows are available in this measurement:

1. "Graph" on page 1607
2. "Table" on page 1608
3. "All Range Table" on page 1609
4. "Gate" on page 1610
5. "Marker Table" on page 1610

The **Gate** Window is available only when "Gate View On/Off" on page 2484 is **ON** in **Gate Settings** under **Trigger**.

3.10.2.1 Graph

Window #1 & #3

Appears in several Views, as follows:

View	Size	Position
Graph + Metrics	Three fifth, full width	Top
All Ranges	Three fifth, full width	Top
Gate View	One third, full width	Middle

When Graph + Metrics is selected

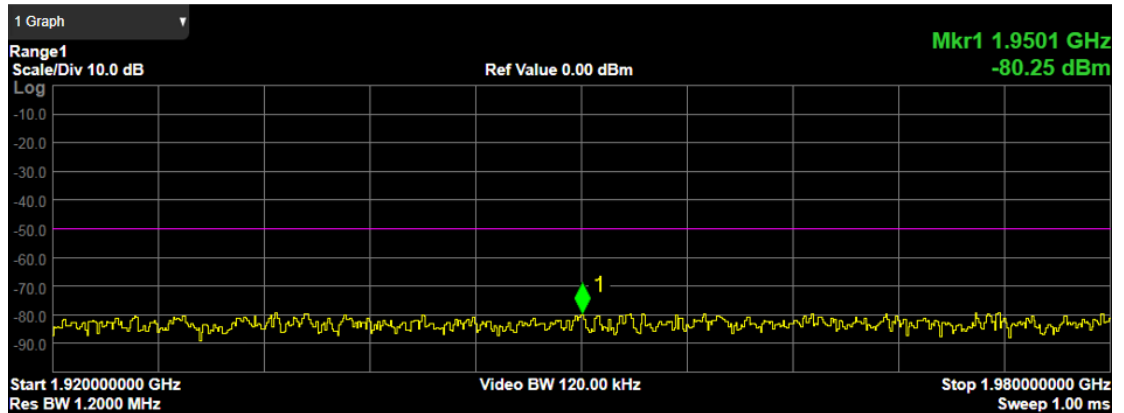

When All Ranges is selected

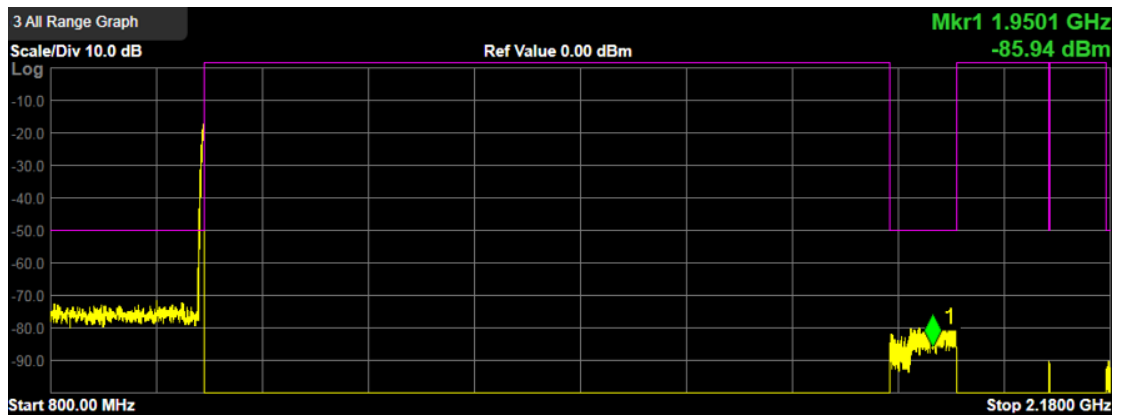

3.10.2.2 Table

Window #2

The spurs listed are within the current value of the Marker Peak Excursion setting of the absolute limit. All the spurs listed passed. Any spur that has failed the absolute limit has an 'F' beside it.

Result	Units	Min	Max
Spur	N/A	0	200
Range	N/A	1	20
Frequency	Hz	Analyzer Min	Analyzer Max
Amplitude	dBm	Analyzer Min	Analyzer Max
Limit	dBm	-200	50
Δ Limit	dBm	(Limit - Amplitude)	

Views in which the **Table** window appears:

3 VMA Mode
3.10 Spurious Emissions Measurement

View	Size	Position
Graph + Metrics	Two fifth, full width	Bottom
Gate View	One third, full width	Bottom

Spur	Range	Frequency	Amplitude	Limit	ΔLimit
1	1	1.966 GHz	-77.10 dBm	-50.00 dBm	-27.10 dB
2	1	1.946 GHz	-77.23 dBm	-50.00 dBm	-27.23 dB
3	1	1.935 GHz	-77.29 dBm	-50.00 dBm	-27.29 dB
4	1	1.950 GHz	-77.43 dBm	-50.00 dBm	-27.43 dB
5	1	1.958 GHz	-77.50 dBm	-50.00 dBm	-27.50 dB
6	1	1.973 GHz	-77.60 dBm	-50.00 dBm	-27.60 dB
7	1	1.948 GHz	-77.82 dBm	-50.00 dBm	-27.82 dB

Measure Trace

See "[Measure Trace](#)" on page 1755.

Trace Type

This is the trace type (and view/blank parameter) of a trace specified by Measure Trace.

3.10.2.3 All Range Table

Window #4

The spurs listed are within the current value of the Marker Peak Excursion setting of the absolute limit. All the spurs listed passed. Any spur that has failed the absolute limit displays 'F' beside it.

Result	Units	Min	Max
Spur	N/A	0	200
Range	N/A	1	20
Start Freq	See " Start Freq " on page 1683 under Meas Setup		
Stop Freq	See " Stop Freq " on page 1684 under Meas Setup		
RBW	See " Res BW " on page 1690 under Meas Setup		
Frequency	Hz	Analyzer Min	Analyzer Max
Amplitude	dBm	Analyzer Min	Analyzer Max
Limit	dBm	-200	50
Δ Limit	dBm	(Limit - Amplitude)	

Views in which the **All Range Table** window appears:

View	Size	Position
All Ranges	Two fifth, full width	Bottom
Gate View	One third, full width	Bottom

4 All Range Table

								Measure Trace	Trace 1
								Trace Type	Trace Average (Active)
Spur	Range	Start Freq	Stop Freq	RBW	Frequency	Amplitude	ΔLimit		
1	1	1.9200 GHz	1.9800 GHz	1.200 MHz	1.965500000 GHz	-77.10 dBm	-27.10 dB		
2	1	1.9200 GHz	1.9800 GHz	1.200 MHz	1.945600000 GHz	-77.23 dBm	-27.23 dB		
3	1	1.9200 GHz	1.9800 GHz	1.200 MHz	1.934900000 GHz	-77.29 dBm	-27.29 dB		
4	1	1.9200 GHz	1.9800 GHz	1.200 MHz	1.949800000 GHz	-77.43 dBm	-27.43 dB		
5	1	1.9200 GHz	1.9800 GHz	1.200 MHz	1.958000000 GHz	-77.50 dBm	-27.50 dB		
6	1	1.9200 GHz	1.9800 GHz	1.200 MHz	1.972500000 GHz	-77.60 dBm	-27.60 dB		
7	1	1.9200 GHz	1.9800 GHz	1.200 MHz	1.947600000 GHz	-77.82 dBm	-27.82 dB		

3.10.2.4 Gate

Window #5

Turning on "[Gate View On/Off](#)" on [page 2484](#) displays the **Gate** Window, which allows you to see your gating signal at the same time as the measured data.

Views in which the **Gate** window appears:

View	Size	Position
Gate View	One third, full width	Top

3.10.2.5 Marker Table

Window# 6

Displays a table containing detailed information about all the markers in the current measurement. It can be selected from the Data control on the Window Title. There is no specific view in which the **Marker Table** window turns on, it is on by demand.

3.10.3 Amplitude

Activates the **Amplitude** menu and selects **Reference Level** or **Reference Value** as the active function, depending on the measurement.

Some features in this menu apply to multiple measurements. Some other features apply only to specific measurements and their controls are blanked or grayed-out in measurements that do not support the feature.

3.10.3.1 Y Scale

Contains controls that pertain to the Y axis parameters of the measurement. These parameters control how data on the vertical (Y) axis is displayed and control instrument settings that affect the vertical axis.

Ref Value

Sets the value for the absolute power reference. The reference line is at the top, center, or bottom of the graticule, depending on the value of the Ref Position function.

Remote Command	<code>:DISPlay:SPURious:WINDow[1]:TRACe:Y[:SCALe]:RLEVe1 <real></code> <code>:DISPlay:SPURious:WINDow[1]:TRACe:Y[:SCALe]:RLEVe1?</code>
Example	<code>:DISP:SPUR:WIND:TRAC:Y:RLEV 10 dBm</code> <code>:DISP:SPUR:WIND:TRAC:Y:RLEV?</code>
Couplings	When "Auto Scaling" on page 1612 is ON (default), this value is automatically determined by the measurement result. When you set a value manually, Auto Scaling changes to OFF Attenuation is not coupled to "Ref Value" on page 1611
Preset	10.00 dBm
State Saved	Saved in instrument state
Min/Max	-/+250.00 dBm
Annotation	Ref <value> top left of graph
Backwards Compatibility SCPI	<code>[:SENSe]:SPURious:POWer[:RF]:LEVe1</code> <code>:DISPlay:SPURious:VIEW[1]:WINDow[1]:TRACe:Y[:SCALe]:RLEVe1</code>

Scale/Div

For measurements that support a logarithmic Y-Axis, **Scale/Div** sets the height of one division of the graticule in the current Y-Axis unit.

Scale/Div also determines the displayed amplitude range in the log plot graph. Since there are usually 10 vertical graticule division on the display, the total amplitude range of the graph is typically 10x this amount. For example, if Scale/Div is 10 dB, then the total range of the graph is 100 dB.

Remote Command	<code>:DISPlay:SPURious:WINDow[1]:TRACe:Y[:SCALe]:PDIVision <rel_ampl></code> <code>:DISPlay:SPURious:WINDow[1]:TRACe:Y[:SCALe]:PDIVision?</code>
Example	<code>:DISP:SPUR:WIND:TRAC:Y:PDIV 10 dB</code> <code>:DISP:SPUR:WIND:TRAC:Y:PDIV?</code>
Couplings	Coupled to "Scale Range" on page 1612 as follows $Scale/Div = Scale\ Range / 10$ (number of divisions) When "Auto Scaling" on page 1612 is ON, this value is automatically determined by the measurement result When you change a value, Auto Scaling automatically changes to OFF

Preset	Automatically calculated
State Saved	Saved in instrument state
Min	0.10 dB
Max	20 dB
Annotation	<value> dB/ left upper of graph
Backwards Compatibility SCPI	<code>:DISPlay:SPURious:VIEW[1]:WINDow[1]:TRACe:Y[:SCALe]:PDIVision</code>

Scale Range

Sets the Y-Axis scale range.

Remote Command	Replace <meas> with the identifier for the current measurement <code>:DISPlay:<meas>:WINDow[1]:TRACe:Y[:SCALe]:RANGe <rel_amp></code> <code>:DISPlay:<meas>:WINDow[1]:TRACe:Y[:SCALe]:RANGe?</code>
Example	<code>:DISP:CHP:WIND:TRAC:Y:RANG 100</code> <code>:DISP:CHP:WIND:TRAC:Y:RANG?</code>
Couplings	Coupled to Scale/Div as follows Scale Range = Scale/Div * 10 (number of divisions) When you change this value, Auto Scaling automatically changes to OFF
Preset	100 dB
State Saved	Saved in instrument state
Min	1
Max	200

Ref Position

Positions the reference level at the top, center, or bottom of the Y Scale display. Changing the reference position does not change the reference level value.

Preset	TOP
State Saved	Saved in instrument state
Range	Top Center Bottom
Annotation	The greater than (>) and less than (<) symbols are displayed on both sides of the graph to indicate the Reference Position

Auto Scaling

Toggles **Auto Scaling** On or Off.

3 VMA Mode
3.10 Spurious Emissions Measurement

Remote Command	<code>:DISPlay:SPURious:WINDow[1]:TRACe:Y[:SCALe]:COUPle 0 1 OFF ON</code>
Example	<code>:DISPlay:SPURious:WINDow[1]:TRACe:Y[:SCALe]:COUPle?</code> <code>:DISP:SPUR:WIND:TRAC:Y:COUP OFF</code> <code>:DISP:SPUR:WIND:TRAC:Y:COUP?</code>
Couplings	<p>When Auto Scaling is ON, and the Restart front-panel key is pressed, this function automatically sets the scale per division to 10 dB and determines the reference values based on the measurement results</p> <p>When you change the value of "Scale/Div" on page 1611, "Ref Value" on page 1611 or "Scale Range" on page 1612, Auto Scaling automatically changes to OFF</p> <p>When Auto Scaling is OFF, the measurement uses the current reference level settings</p> <p>When Auto Scaling is ON, the instrument automatically sets the reference level such that the absolute limit is positioned two divisions down from the top of the display. This is the most useful setting when searching for spurs. The algorithm used for determining the ref level is $\text{Ref Level} = \text{Absolute Limit} + (2 * \text{Scale/Div})$. All other reference level settings are left as the current base instrument settings</p>
Preset	1
State Saved	Saved in instrument state
Range	OFF ON
Backwards Compatibility SCPI	<code>[:SENSe] :SPURious:POWer[:RF] :RANGe:AUTO</code> <code>:DISPlay:SPURious:VIEW[1]:WINDow[1]:TRACe:Y[:SCALe]:COUPle</code>

3.10.3.2 Attenuation

Controls the attenuator functions and interactions between the attenuation system components.

There are two attenuator configurations in the X-Series. One is a Dual-Attenuator configuration consisting of a mechanical attenuator and an optional electronic attenuator. The other configuration uses a single attenuator with combined mechanical and electronic sections that controls all the attenuation functions. Different models in the X-Series come with different configurations.

- See "[Dual-Attenuator Configurations](#)" on page 1614
- See "[Single-Attenuator Configuration](#)" on page 1614

Most attenuation settings are the same for all measurements – they do not change as you change measurements. Settings like these are called “Meas Global” and are unaffected by **Meas Preset**.

Only available when the hardware set includes an input attenuator, which is typically only the case for Keysight’s benchtop instruments. For example, this tab does *not* appear in VXT models M9420A/10A/11A/15A/16A, M9410E/11E/15E/16E, nor in UXM. In UXM, all **Attenuation** and **Range** settings are disabled, as the expected

input power level is handled by the Call Processing App that drives the DUT power control.

Dependencies In measurements that support the I/Q inputs, unavailable when I/Q is the selected input. Replaced by the **Range** tab in that case

Dual-Attenuator Configurations

Configuration 1: Mechanical attenuator + optional electronic attenuator

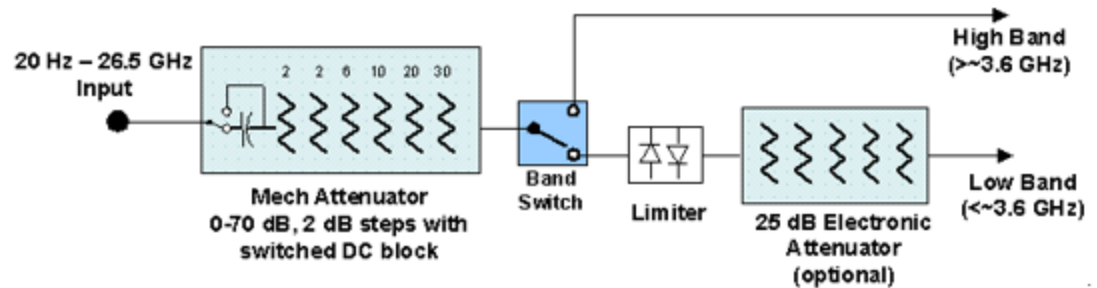

Configuration 2: Mechanical attenuator, no optional electronic attenuator

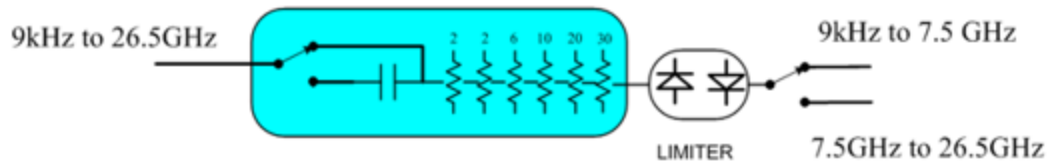

Note that Configuration 2 is not strictly speaking a dual-section attenuator, since there is no electronic section available. However, it behaves exactly like Configuration 1 without the Electronic Attenuator Option EA3, therefore for the sake of this document it is grouped into the “Dual-Attenuator” configuration.

Single-Attenuator Configuration

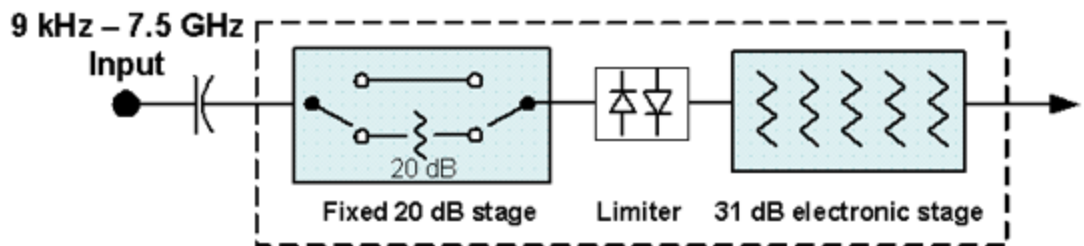

You can tell which attenuator configuration you have by pressing the Attenuation tab, which (in most Modes) opens the Attenuation menu. If the first control in the Attenuation menu says **Mech Atten** you have the Dual-Attenuator configuration. If the first control says **Atten** you have the Single-Attenuator configuration.



(Note that depending on the measurement, there may be no Auto/Man functionality on the Mech Atten control.)

In the Single-Attenuator configuration, you control the attenuation with a single control, as the fixed stage has only two states. In the Dual-Attenuator configuration, both stages have significant range, so you are given separate control of the mechanical and electronic attenuator stages.

When you have the Dual-Attenuator configuration, you may still have only a Single-Attenuator, because unless Option EA3 (the Electronic Attenuator option) is available, and you purchase it, you will have only the mechanical attenuator.

Full Range Atten

This control and **Attenuator Summary** only appear in N9041B, when the RF input is selected, the RF Input Port is set to RF Input 2, and the Full Range Attenuator is installed. The Full Range Attenuator adds a second input attenuator in front of RF Input 2, which enhances the protection and optimizes the performance of the extra internal mixers used by RF Input 2.

Remote Command	<code>[:SENSe]:POWer[:RF]:FRATten <rel_ampl></code> <code>[:SENSe]:POWer[:RF]:FRATten?</code>
Example	<code>:POW:FRAT 14</code> <code>:POW:FRAT?</code>
Notes	When you enter an amplitude value that falls between valid values, the value will be incremented to the next smallest valid value
Dependencies	Only appears if input RF is selected, RF Input Port 2 is selected, and the Full Range Attenuator exists
Couplings	This value is never changed by any coupling, but other couplings use this value. See Reference Level and " Mech Atten " on page 1766 command descriptions
Preset	20 dB
State Saved	Saved in instrument state
Min	0 dB
Max	Only valid values are 0, 6, 14, 20 dB
Annotation	When the Input is RF, and the Input Port is RF Input 2, and the Full Range Attenuator is installed:

On the Meas Bar, the field “Atten” displays as follows:

- If the sweep is entirely < 50 GHz, the value shown after “Atten:” is equal to Mech Atten + Elec Atten + Full Range Atten
- If the sweep is entirely > 50 GHz, the value shown after “Atten:” is equal to Full Range Atten
- If the sweep straddles 50 GHz, the value shown after “Atten:” is preceded by the symbol “>=” and is equal to Full Range Atten

In the **Amplitude**, **"Y Scale"** on page 1760 menu, and the Atten **Meas Bar** dropdown menu panel, a summary is displayed as follows:

“Total Atten below 50 GHz” followed by the value of Full Range Atten + Mech Atten + Elec Atten

“Total Atten above 50 GHz” followed by the value of Full Range Atten

For example, if Mech Atten = 6 dB, Elec Atten = 4 dB, and Full Range Atten = 20 dB, the summary below is shown:

- Attenuator summary:
- Total Atten below 50 GHz: 30 dB
- Total Atten above 50 GHz: 20 dB

Mech Atten

Labeled **Mech Atten** in Dual-Attenuator models, and **Atten** in Single-Attenuator models. In the Dual-Attenuator configuration, this control only affects the mechanical attenuator.

Lets you modify the attenuation applied to the RF input signal path. This value is normally auto-coupled to **Ref Level**, **"Internal Preamp"** on page 1788 Gain, any External Gain that is entered, and **Max Mixer Level** (if available), as described in the table below.

See **"Attenuator Configurations and Auto/Man"** on page 1618

Remote Command	<code>[:SENSe]:POWer[:RF]:ATTenuation <rel_amp></code> <code>[:SENSe]:POWer[:RF]:ATTenuation?</code>
Example	<code>:POW:ATT 20</code> Dual-Attenuator configuration: sets the mechanical attenuator to 20 dB Single-Attenuator mode: sets the main attenuation to 20 dB (see below for definition of “main” attenuation) In either case, if the attenuator was in Auto, it is set to Manual
Dependencies	Some measurements do not support Auto setting of Mech Atten . In these measurements, the Auto/Man selection is not available, and the Auto/Man toggle function is not available In Dual-Attenuator configurations, when the electronic attenuator is enabled, the mechanical attenuator has no auto setting, and the Auto/Man toggle function is not available. The state of

3 VMA Mode
 3.10 Spurious Emissions Measurement

Auto/Man is remembered and restored when the electronic attenuator is once again disabled. This is described in more detail in ["Elec Atten" on page 1769](#)

See ["Attenuator Configurations and Auto/Man" on page 1618](#) for more information on the **Auto/Man** functionality

Couplings	<p>If the RF Input Port is the RF Input:</p> <ul style="list-style-type: none"> - If the USB Preamp is connected to USB, use 0 dB for Mech Atten - Otherwise compute the auto-selected value of Mech Atten based on Reference Level, Int Preamp, External Gain, Ref Level Offset, Max Mixer Level, μW Path Control and IF Gain settings. Limit this value to be no less than 6 dB (total attenuation below 6 dB can never be chosen by Auto) - In N9041B, if the RF Input Port is RF Input 2, use the formula above and subtract the value of "Full Range Atten" on page 1765 from the result to determine the Mech Atten. Limit the value so that it is never lower than 0 dB and so that total attenuation, including Full Range Atten, is never less than 6 dB (total attenuation, including Full Range Atten below 6 dB, can never be chosen by Auto)
-----------	---

In External Mixing and BBIQ, where the attenuator is not in the signal path, the attenuator setting changes as described above when **Mech Atten** is in **Auto**, but no changes are made to the actual attenuator hardware setting until the input is changed back to the RF Input

For CXA-m with Option FSA (Fine-Step Attenuator or 2 dB steps), the FSA-like behavior is only available when the frequency setting is ≤ 7.5 GHz. So, when the frequency is changed from below 7.5 GHz to above 7.5 GHz, the attenuation setting changes to a multiple of 10 dB that is no smaller than the previous setting. For example, 4 dB attenuation changes to 10 dB

Preset	<p>Auto</p> <p>The Auto value is 10 dB</p>
--------	---

State Saved	Saved in instrument state
-------------	---------------------------

Min	<p>0 dB</p> <p>The attenuation set by this control cannot be decreased below 6 dB with the knob or step keys. Values below 6 dB must be directly entered from the keypad or via SCPI. This protects against setting a dangerously small attenuation value, which can put the instrument at risk of damage to input circuitry. If the current mechanical attenuation is below 6 dB, it can be increased with the knob and step keys, but not decreased</p>
-----	---

Max	CXA Option 503 or 507	50 dB
	EXA	60 dB
	All other models	70 dB

Note that in the Single-Attenuator configuration, the total of ATT and EATT cannot exceed 50 dB. So, if the EATT is set to 24 dB first, the main attenuation cannot be greater than 26 dB and will be reduced accordingly; if the main attenuator is set to 40 dB first, EATT cannot be greater than 10 dB

Annotation	<p>The current value for Total Atten is displayed in the Measurement Bar at the top of the display. A value appears for Electronic Attenuation only if the Electronic Attenuator is enabled. The annotation appears as:</p> <p><i>Atten: <total> dB (e<elec>)</i></p> <p>The e letter is in amber in Single-Attenuator configurations</p>
------------	---

For example:
 Dual-Attenuator configuration:
Atten: 24 dB (e14)
 Indicating the total attenuation is at 24 dB and the electronic attenuation is at 14 dB
 Single-Attenuator configuration:
A: 24 dB (e14)
 Indicating the total attenuation is at 24 dB and the “soft” attenuation is at 14 dB (see below for definition of “soft” attenuation)
 When in Manual, a # sign appears in front of Atten in the annotation

Auto Function

Remote Command	<code>[:SENSe]:POWer[:RF]:ATTenuation:AUTO OFF ON 0 1</code> <code>[:SENSe]:POWer[:RF]:ATTenuation:AUTO?</code>
Example	Turn Auto Mech Atten ON: <code>:POW:ATT:AUTO ON</code>
Dependencies	<code>:POW:ATT:AUTO</code> is only available in measurements that support Auto , such as Swept SA
Preset	<code>ON</code>

Attenuator Configurations and Auto/Man

As described under "[Attenuation](#)" on page 1763, there are two distinct attenuator configurations available in the X-Series, the Single Attenuator and Dual-Attenuator configurations.

In Dual-Attenuator configurations, we have mechanical attenuation and electronic attenuation, and current total attenuation is the sum of electronic + mechanical attenuation.

In Single-Attenuator configurations, we refer to the attenuation set using "[Mech Atten](#)" on page 1616 (or `:POW:ATT`) as the “main” attenuation; and the attenuation that is set by `:POW:EATT` as the “soft” attenuation (`:POW:EATT` is honored even in the Single-Attenuator configuration, for compatibility purposes). Then current total attenuation is the sum of main + soft attenuation.

See "[Elec Atten](#)" on page 1769 for more about “soft” attenuation.

NOTE

In some measurements, the **Mech Atten** control has an **Auto/Man** function. In these measurements, an **Auto/Man** switch is shown on the **Mech Atten** control:

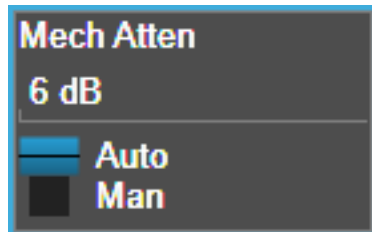

Note that in configurations that include an Electronic Attenuator, this switch is only shown when the Electronic Attenuator is disabled.

In other measurements, **Mech Atten** has no **Auto/Man** function. In these measurements, no switch is shown on the **Mech Atten** control:



Mech Atten also appears with no switch, as above, in configurations that include an Electronic Attenuator but when the Electronic Attenuator is enabled.

Elec Atten

Controls the Electronic Attenuator in Dual-Attenuator configurations. Does not appear in Single-Attenuator configurations, because the control of both the mechanical and electronic stages of the Single-Attenuator is integrated into the single **Atten** control.

This control includes an **Enable/Disable** toggle switch; it is only possible to enter a value for the Electronic Attenuator when this switch is in the **Enable** position.

For more details of the Electronic Attenuator, see ["More Information" on page 1621](#)

Remote Command	<code>[:SENSe]:POWer[:RF]:EATTenuation <rel_amp1></code> <code>[:SENSe]:POWer[:RF]:EATTenuation?</code>
Example	<code>:POW:EATT 10</code> <code>:POW:EATT?</code>
Notes	Electronic Attenuation's specification is defined only when Mech Atten is 6 dB
Dependencies	Only appears in Dual-Attenuator models with an Electronic Attenuator installed and licensed. Does not appear in models with the Single-Attenuator configuration, because in the Single-Attenuator configuration there is no "electronic attenuator"; there is only a single integrated attenuator (which has both a mechanical and electronic stage). However, in the Single-Attenuator configuration, EATT SCPI commands are accepted for compatibility with other X-series instruments, and set a "soft" attenuation. The "soft" attenuation is treated as an addition to the "main" attenuation value set by the Attenuation control or <code>:POW:ATT</code> , and affects the total attenuation displayed on the Attenuation

control and the Meas Bar

The electronic attenuator, and the “soft” attenuation function provided in Single-Attenuator configurations, are unavailable above the low band (0-3.6 GHz, 0-3.4 GHz, 0-3 GHz, depending on the model). If the low band range is from 0-3.6 GHz, and Stop Frequency of the instrument is > 3.6 GHz, then the **Enabled/Disabled** section of the **Elec Atten** control will be **OFF** and grayed-out

If "**Internal Preamp**" on page 1788 is **ON** (that is, set to Low Band or Full), the electronic attenuator (and the “soft” attenuation function provided in Single-Attenuator configurations) is unavailable. In this case the **Enabled/Disabled** section of the **Elec Atten** control will be **OFF** and grayed-out

If either of the above is true, and the SCPI command is sent, an error indicating that the electronic attenuator is unavailable is returned

If both the above are true, pressing the control generates error message -221, in other words, the frequency range lockout takes precedence

If the electronic/soft Attenuator is enabled, then the **Stop Freq** of the instrument is limited to 3.6 GHz and **Internal Preamp** is unavailable

If "**LNA**" on page 1790 is **ON**, the electronic attenuator (and the “soft” attenuation function provided in Single-Attenuator configurations) is unavailable. In this case the **Enabled/Disabled** section of the **Elec Atten** control will be **OFF** and grayed-out. This coupling works in the following modes/measurements:

- Channel Power, Occupied BW, ACP, SEM, Spurious Emissions, Power Stat CCDF measurements in all Modes
- Transmit On|Off Power measurement in 5GNR Mode
- Power vs. Time and Transmit Power measurement in GSM/EDGE Mode
- Burst Power measurement in Spectrum Analyzer Mode

The SCPI-only “soft” electronic attenuation for the single-attenuator configuration is not available in all measurements; in particular, it is not available in the Swept SA measurement

Couplings	Enabling and disabling the Electronic Attenuator affects the setting of the Mechanical Attenuator (in Dual-Attenuator configurations). This is described in more detail below and in " Mechanical Attenuator Transition Rules " on page 1621
Preset	0 dB
State Saved	Saved in instrument state
Min	0 dB
Max	Dual-Attenuator configuration: 24 dB Single-Attenuator configuration: the total of ATT and EATT cannot exceed 50 dB. So, if the EATT is set to 24 dB first, the main attenuation cannot be greater than 26 dB and will be reduced accordingly; if the main attenuator is set to 40 dB first, EATT cannot be greater than 10 dB
Annotation	See Annotation under the Mech Atten control description

Auto Function

Remote Command	<code>[:SENSe]:POWer[:RF]:EATTenuation:STATE OFF ON 0 1</code> <code>[:SENSe]:POWer[:RF]:EATTenuation:STATE?</code>
Example	<code>:POW:EATT:STAT ON</code>

:POW:EATT:STAT?

Preset **OFF** (Disabled) for Swept SA measurement
 ON (Enabled) for all other measurements that support the electronic attenuator

NOTE

The maximum **Center Frequency** for Low Band can change based on the selected IFBW for measurements that support IFBW (for example, Waveform measurement across all Modes that support it). In certain models (such as N9042B & N9032B), IFBW values ≤ 40 MHz have a maximum Low Band frequency of 3.6 GHz, while $40 \text{ MHz} < \text{IFBW} \leq 1 \text{ GHz}$ have a maximum of 3.3 GHz, and $1 \text{ GHz} < \text{IFBW} \leq 1.5 \text{ GHz}$ have a maximum of 3.5 GHz. This frequency is reflected in the disabled message displayed for Electrical Attenuator. For N9032B and N9042B IFBW values $> 1.5 \text{ GHz}$ do not support a **Center Frequency** that can reach the Low Band maximum frequency. In these cases, the Electrical Attenuator will remain disabled no matter the Center Frequency.

More Information

The electronic attenuator offers finer steps than the mechanical attenuator, has no acoustical noise, is faster, and is less subject to wear. These advantages primarily aid in remote operation and are negligible for front panel use. See ["Using the Electronic Attenuator: Pros and Cons" on page 1622](#) for a detailed discussion of the pros and cons of using the electronic attenuator.

For the Single-Attenuator configuration, for SCPI backwards compatibility, the "soft" attenuation feature replaces the Dual-Attenuator configuration's electronic attenuator. All the same couplings and limitations apply. See ["Attenuator Configurations and Auto/Man" on page 1768](#)

Mechanical Attenuator Transition Rules

When the Electronic Attenuator is enabled, the Mechanical Attenuator transitions to a state that has no Auto function. Below are the rules for transitioning the Mechanical Attenuator. Note that the information below *only* applies to the Dual-Attenuator configurations, and *only* when the Electronic Attenuator is installed:

When the Electronic Attenuation is enabled from a disabled state:

- The Mechanical Attenuator is initialized to 10 dB (this is its optimal performance setting). You can then set it as desired with SCPI, numeric keypad, step keys, or knob, and it behaves as it normally would in manual mode
- The Auto/Man state of (Mech) Atten is saved
- The Auto/Man toggle on the (Mech) Atten control disappears, and the auto rules are disabled

- The Electronic Attenuator is set to 10 dB less than the previous value of the Mechanical Attenuator, within the limitation that it must stay within the range of 0 to 24 dB of attenuation

Examples in the Dual-Attenuator configuration:

- Mech Atten at 20 dB. Elec Atten enabled, Mech Atten set to 10 dB, and Elec Atten set to 10 dB. New total attenuation equals the value before Elec Atten enabled
- Mech Atten at 0 dB. Elec Atten enabled, Mech Atten set to 10 dB, and Elec Atten set to 0 dB. New total attenuation does not equal the value before Elec Atten enabled
- Mech Atten at 40 dB. Elec Atten enabled, Mech Atten set to 10 dB, and Elec Atten set to 24 dB. New total attenuation does not equal the value before Elec Atten enabled

When the Electronic Attenuation is disabled from an enabled state:

- The Elec Atten control is grayed out
- The Auto/Man state of (Mech) Atten is restored
- If now in Auto, (Mech) Atten recouples
- If now in Man, (Mech) Atten is set to the value of total attenuation that existed before the Elec Atten was disabled. The resulting value is rounded up to the smallest value possible given the (Mech) Atten Step setting - (That is, 57 dB changes to 58 dB when (Mech) Atten Step is 2 dB)

Using the Electronic Attenuator: Pros and Cons

The electronic attenuator offers finer steps than the mechanical attenuator, has no acoustical noise, is faster, and is less subject to wear.

The “finer steps” advantage of the electronic attenuator is beneficial in optimizing the alignment of the instrument dynamic range to the signal power in the front panel as well as remote use. Thus, you can achieve improved relative signal measurement accuracy. Compared to a mechanical attenuator with 2 dB steps, the 1 dB resolution of the electronic attenuator only gives better resolution when the odd-decibel steps are used. Those odd-decibel steps are less accurately calibrated than the even-decibel steps, so one tradeoff for this superior relative accuracy is reduced absolute amplitude accuracy.

Another disadvantage of the electronic attenuator is that the spectrum analyzer loses its “Auto” setting, making operation less convenient.

Also, the relationship between the dynamic range specifications (TOI, SHI, compression, and noise) and instrument performance are less well-known with the

electrical attenuator. With the mechanical attenuator, TOI, SHI, and compression threshold levels increase dB-for-dB with increasing attenuation, and the noise floor does as well. With the electronic attenuator, there is an excess attenuation of about 1 to 3 dB between 0 and 3.6 GHz, making the effective TOI, SHI, and so forth, less well known. Excess attenuation is the actual attenuation relative to stated attenuation. Excess attenuation is accounted for in the instrument calibration.

Adjust Atten for Min Clipping

Sets the combination of mechanical and electronic attenuation and gain based on the current measured signal level so that clipping will be at a minimum.

This is an immediate action function, that is, it executes once, when the control is pressed.

The algorithms that are used for the adjustment are documented under ["Pre-Adjust for Min Clipping" on page 1773](#).

Remote Command	<code>[:SENSe]:POWer[:RF]:RANGe:OPTimize IMMEDIATE</code>
Example	<code>:POW:RANG:OPT IMM</code>
Notes	Executing Adjust Atten for Min Clipping initiates the measurement
Dependencies	Does not appear in the Swept SA, RTSA, Monitor Spectrum and Complex Spectrum measurements Appears in the Waveform measurement in BASIC and 5G NR Modes

Adjust Atten

Allows you to select;

- Electric attenuator only
- Combination of Electric attenuator and Mechanical attenuator

when `[:SENSe]:POWer[:RF]:RANGe:OPTimize IMMEDIATE` is executed.

Remote Command	<code>[:SENSe]:POWer[:RF]:RANGe:OPTimize:TYPE EONLY COMBined</code> <code>[:SENSe]:POWer[:RF]:RANGe:OPTimize:TYPE?</code>
Example	<code>:POW:RANG:OPT:TYPE EONL</code> <code>:POW:RANG:OPT:TYPE?</code>
Dependencies	Does not appear in the Swept SA, RTSA, Monitor Spectrum and Complex Spectrum measurements Appears in the Waveform measurement in BASIC and 5G NR Modes
Preset	<code>COMBined</code>
State Saved	Saved in instrument state

Pre-Adjust for Min Clipping

If this function is **ON**, it applies the adjustment described under "[Adjust Atten for Min Clipping](#)" on page 1772 each time a measurement restarts. Therefore, in Continuous measurement mode, it only executes before the first measurement.

In Dual-Attenuator models, you can set **Elec+Mech Atten**, in which case both attenuators participate in the autoranging, or **Elec Atten Only**, in which case the mechanical attenuator does not participate in the autoranging. This latter case results in less wear on the mechanical attenuator and is usually faster.

See "[Adjustment Algorithm](#)" on page 1625

Selection	SCPI	Note
Off	OFF	This is the default setting
On	ON	Available in Single-Attenuator instruments. For compatibility with models that do not have an input attenuator, the ON parameter is supported and mapped to COMBined
Elec Atten Only	ELECTrical	Selects only the electric attenuator to participate in auto ranging. This offers less wear on the mechanical attenuator and is usually faster
Elec+Mech Atten	COMBined	In Dual-Attenuator models, this selects both attenuators to participate in the autoranging

Remote Command	<code>[:SENSe]:POWer[:RF]:RANGe:OPTimize:ATTenuation OFF ON ELECTrical COMBined</code> <code>[:SENSe]:POWer[:RF]:RANGe:OPTimize:ATTenuation?</code>
Example	<code>:POW:RANG:OPT:ATT OFF</code> <code>:POW:RANG:OPT:ATT?</code>
Notes	The parameter option ELECTrical sets this function to ON in Single-Attenuator models The parameter option COMBined is mapped to ELECTrical in Single-Attenuator models. If you send COMBined , it sets the function to ON and returns ELEC to a query For SCPI compatibility with models that do not have an input attenuator, the ON parameter is honored and mapped to COMBined
Dependencies	Only appears in Dual-Attenuator models with an Electronic Attenuator installed In instruments with Dual-Attenuator model, when " Elec Atten " on page 1769 is OFF or grayed-out, " Pre-Adjust for Min Clipping " on page 1624 is grayed-out Does not appear in the Swept SA, RTSA, Monitor Spectrum and Complex Spectrum measurements Appears in the Waveform measurement in BASIC and 5G NR Modes
Preset	OFF when Elec Atten is Disabled at preset, otherwise ELEC
State Saved	Saved in instrument state

3 VMA Mode
 3.10 Spurious Emissions Measurement

Range	Dual-Attenuator models:	Off Elec Atten Only Mech + Elec Atten
	Single-Attenuator models:	Off On

Backwards Compatibility Command

Notes	<p>ON aliases to "Elec Atten Only" (:POW:RANG:OPT:ATT ELEC)</p> <p>OFF aliases to "Off" (:POW:RANG:OPT:ATT OFF)</p> <p>:POW:RANG:AUTO? returns true if :POW:RANG:OPT:ATT is not OFF</p>
Backwards Compatibility SCPI	<p>[:SENSe] :POWer [:RF] :RANGe:AUTO ON OFF 1 0</p> <p>[:SENSe] :POWer [:RF] :RANGe:AUTO?</p>

Adjustment Algorithm

The algorithms for the adjustment are documented below:

Single-Attenuator Models

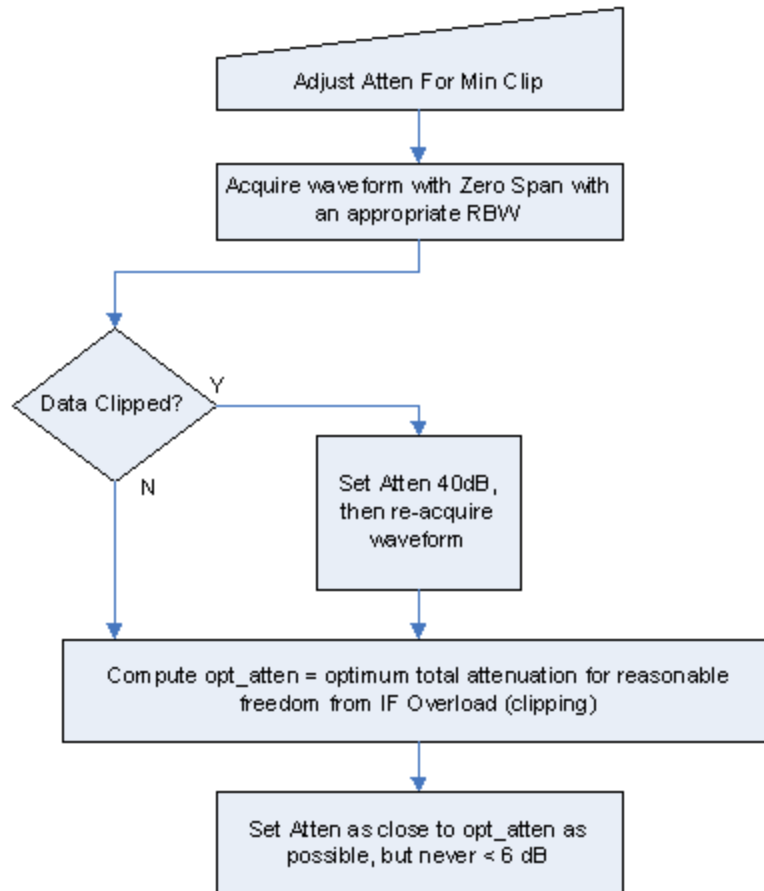

Dual-Attenuator models

"Adjust Atten for Min Clipping" on page 1772 or "Pre-Adjust for Min Clipping" on page 1624 selection is Mech + Elec Atten:

3 VMA Mode
 3.10 Spurious Emissions Measurement

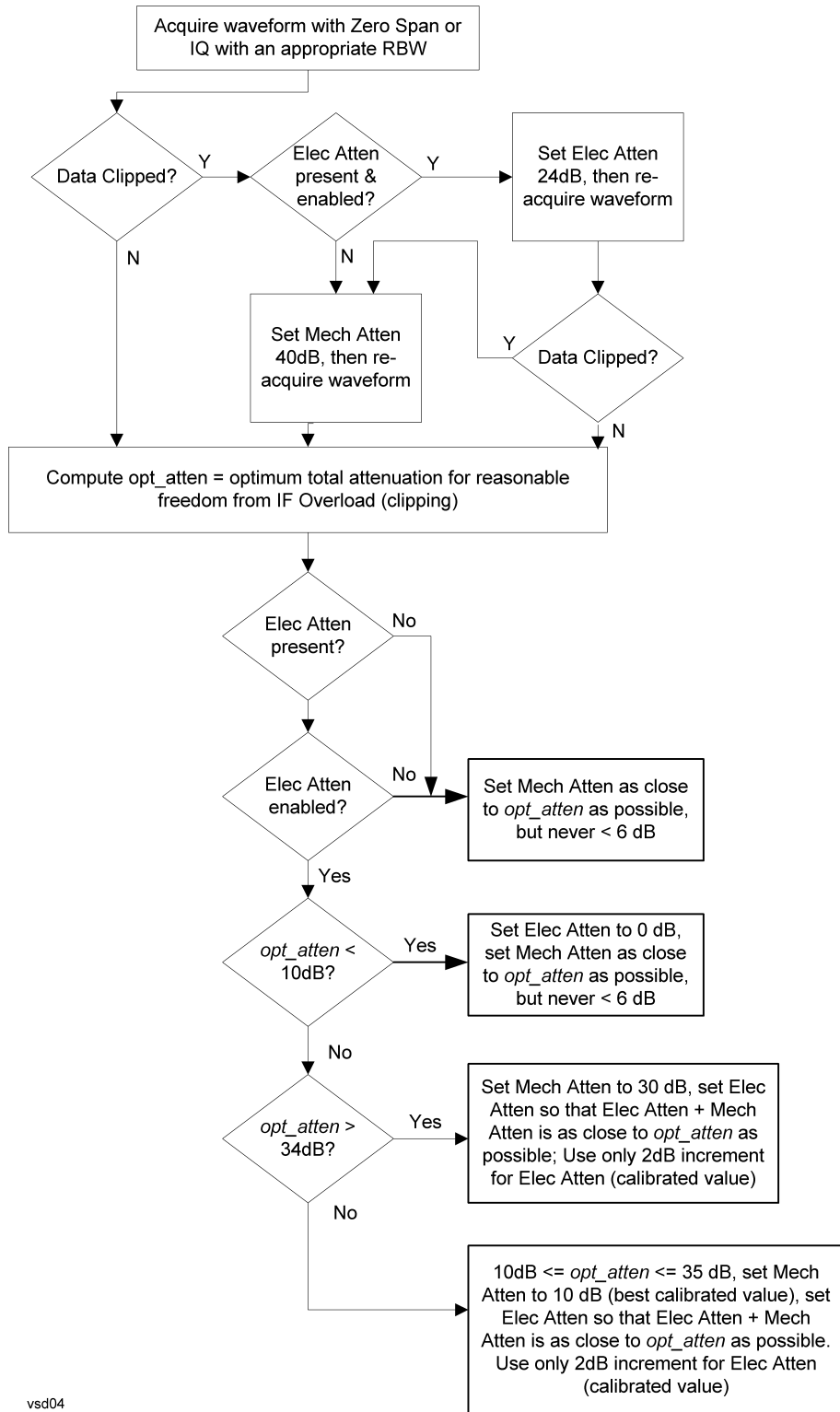

vsd04

"Pre-Adjust for Min Clipping" on page 1624 selection is Elec Only.

Note that the **Mech Atten** value is not adjusted, and the value previously set is used. Therefore, there is a case that IF Overload is still observed depending on the input signal level and the Mech Atten setting.

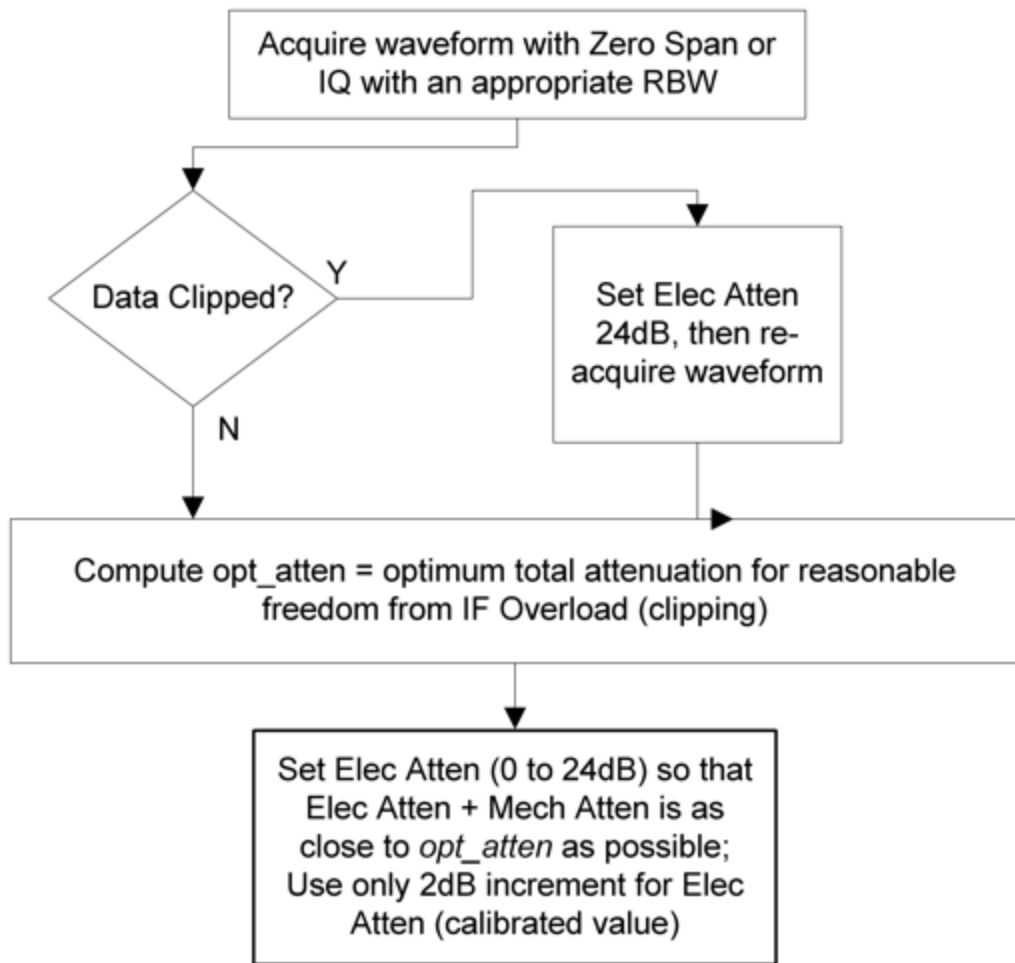

Mech Atten Step

Controls the step size used when making adjustments to the input attenuation.

Labeled **Mech Atten Step** in Dual-Attenuator models and **Atten Step** in Single-Attenuator models. In the Dual-Attenuator configuration, only affects the step size of the mechanical attenuator.

Remote Command `[:SENSe]:POWer[:RF]:ATTenuation:STEP[:INCRement] 10 dB | 2 dB`

3 VMA Mode
 3.10 Spurious Emissions Measurement

	<code>[:SENSe]:POWer[:RF]:ATTenuation:STEP[:INCRement]?</code>
Example	<code>:POW:ATT:STEP 2</code> <code>:POW:ATT:STEP?</code>
Notes	Has a toggle control on the front panel, but takes a specific value (in dB) when used remotely. The only valid values are 2 and 10
Dependencies	Blanked in EXA, CXA and CXA-m if option FSA (2 dB steps) is not present. If blanked, attempts to set it via SCPI yield an error
Couplings	When the attenuation step size changes, the current mechanical attenuation value is adjusted (if necessary) to be quantized to the new step size. That is, if step is set to 10 dB, mech atten is increased if necessary so it is a multiple of 10 dB
Preset	EXA, CXA and CXA-m: 10 dB (2 dB with option FSA) All other models: 2 dB
State Saved	Saved in instrument state

3.10.3.3 Range (Non-attenuator models)

Only available for Keysight's modular signal analyzers and certain other Keysight products, such as VXT and M941xE.

State Saved	No
-------------	----

Range

Represents the amplitude of the largest sinusoidal signal that could be present within the IF without being clipped by the ADC. For signals with high peak-to-average ratios, the range may need to exceed the rms signal power by a significant amount to avoid clipping.

This is a measurement global setting.

Remote Command	<code>[:SENSe]:POWer[:RF]:RANGe <real></code> <code>[:SENSe]:POWer[:RF]:RANGe?</code>
Example	<code>:POW:RANG 10 dBm</code> <code>:POW:RANG?</code>
Notes	The MIN and MAX values are affected by the External Gain parameters, and by the Center Frequency The hardware compensates for frequency response and alters the Range setting
Preset	0 dBm
State Saved	Yes
Min/Max	-/+100
Annotation	Meas Bar

Adjust Range for Min Clipping

Sets the combination of attenuation and gain based on the current measured signal level so that clipping will be at a minimum.

This is an "immediate action" function, that is, it executes once, when the key is pressed.

This key does not appear in measurements that do not support this functionality.

Remote Command	<code>[:SENSe]:POWer[:RF]:RANGe:OPTimize IMMEDIATE</code>
Notes	Executing Adjust Range for Min Clipping initiates the measurement
Dependencies	Does not appear in the Swept SA and Monitor Spectrum measurements

Pre-Adjust for Min Clipping

If this function is **ON**, it applies the adjustment described under Adjust Range For Min Clipping each time a measurement restarts. Therefore, in Continuous measurement mode, it only executes before the first measurement.

Remote Command	<code>[:SENSe]:POWer[:RF]:RANGe:OPTimize:ATTenuation OFF ON ELECTrical COMBined</code> <code>[:SENSe]:POWer[:RF]:RANGe:OPTimize:ATTenuation?</code>
Notes	Because there is no attenuator control available in these models, the control displays only ON and OFF choices. However, for SCPI compatibility with other platforms, all three parameters (ELECTrical , COMBined , and ON) are honored and all are mapped to ELECTrical , so if any of these three parameters is sent, a subsequent query will return ELEC
Dependencies	Does not appear in the Swept SA and Monitor Spectrum measurements
Preset	OFF for Swept SA measurement; ON for all other measurements that support Pre-Adjust for Min Clipping
State Saved	Saved in instrument state

Adjustment Algorithm

The algorithm for the adjustment is documented below:

3 VMA Mode
3.10 Spurious Emissions Measurement

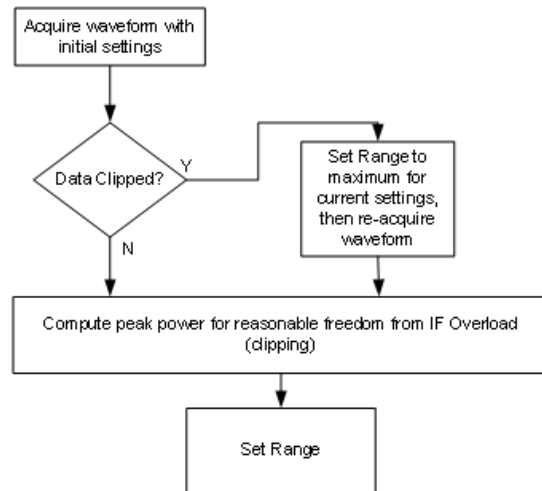

Peak-to-Average Ratio

Used with "[Range \(Non-attenuator models\)](#)" on page 1782 to optimize the level control in the instrument. The value is the ratio, in dB, of the peak power to the average power of the signal to be measured. A ratio of 0 should be used for sinusoidal signals; for 802.11g OFDM signals use 9 dB.

All Modes show the current value of Peak-to-Average ratio on the control. However, some Modes do not permit changing the value. In these situations, the control is grayed-out.

Remote Command	[:SENSe]:POWer[:RF]:RANGe:PARatio <real> [:SENSe]:POWer[:RF]:RANGe:PARatio?	
Example	:POW:RANG:PAR 12 dB	
Notes	In some Modes, this parameter is read-only; meaning the value will appear on the control and query via SCPI, but is not changeable. In such applications the control is grayed-out. Attempts to change the value via SCPI are ignored, but no error message is generated	
Dependencies	Does not appear in Spectrum Analyzer Mode	
Preset	VXT Models M9410A/11A	0 dB
	All Others	10 dB
State Saved	Saved in instrument state	
Min	0 dB	
Max	VXT Models M9410A/11A	50 dB
	All Others	20 dB

Mixer Lvl Offset

This is an advanced setting to adjust target Range at the input mixer, which in turn affects the signal level in the instrument's IF. This setting can be used when additional optimization is needed after setting "[Peak-to-Average Ratio](#)" on page 1784. Positive values of offset optimize noise performance over distortion, negative values optimize distortion performance over noise.

Remote Command	<code>[:SENSe]:POWer[:RF]:RANGe:MIXer:OFFSet <real></code> <code>[:SENSe]:POWer[:RF]:RANGe:MIXer:OFFSet?</code>	
Example	<code>:POW:RANG:MIX:OFFS -5 dB</code>	
Preset	0 dB	
State Saved	Saved in instrument state	
Min	VXT Models M9410A/11A	-34 dB
	All Others	-35 dB
Max	30 dB	

3.10.3.4 Signal Path

Contains controls that pertain to the routing of the signal through the frontend of the instrument.

In general, only appears in instruments whose hardware supports this signal routing. For example, this tab does not appear in many of the modular instrument products, including VXT Model M9420A, or UXM.

This tab *does* appear in VXT Models M9410A/11A/15A/16A and M9410E/11E/15E/16E, because "[Software Preselection](#)" on page 1801 is under this tab, and VXT Models M9410A/11A/15A/16A and M9410E/11E/15E/16E implement a version of Software Preselection.

Presel Center

Adjusts the centering of the preselector filter to optimize the amplitude accuracy at the frequency of the selected marker. If the selected marker is not on when **Presel Center** is pressed, the instrument turns on the selected marker, performs a peak search, and then performs centering on the marker's center frequency. If the selected marker is already on and between the start and stop frequencies of the instrument, the instrument performs the preselector calibration on that marker's frequency. If the selected marker is already on, but outside the frequency range

3 VMA Mode
3.10 Spurious Emissions Measurement

between **Start Freq** and **Stop Freq**, the instrument first performs a peak search, and then performs centering on the marker's center frequency.

The value displayed on "**Preselector Adjust**" on page 1787 changes to reflect the new preselector tuning.

Certain considerations should be observed to ensure proper operation, as detailed in "**Proper Preselector Operation**" on page 1633.

Remote Command	<code>[:SENSe] :POWer [:RF] :PCENter</code>
Example	<code>:POW:PCEN</code>
Notes	The rules outlined above under the control description apply for the remote command as well as the key. The result of the command depends on marker position, etc. Any message generated by the control press is also generated in response to the remote command
Dependencies	Does not appear in CXA-m, nor in VXT Models M9410A/11A/15A/16A, M9410E/11E/15E/16E Grayed-out if the microwave preselector is off <ul style="list-style-type: none"> - If the selected marker's frequency is below Band 1, an advisory message is generated "Preselector not used in this frequency range" and no action is taken - Grayed-out if entirely in Band 0, that is, if Stop Freq is below about 3.6 GHz Grayed-out if entirely above 50 GHz, that is, if Start Freq is above 50 GHz - Blanked in models that do not include a preselector, such as Option 503. If the remote command is sent in these instruments, accepted without error, and the query always returns 0 - Grayed-out in the Spectrogram View
Couplings	The active marker position determines where the centering will be attempted If the instrument is in a measurement such as averaging when centering is initiated, the act of centering the preselector restarts averaging, but the first average trace will not be taken until the centering is completed The offset applied to do the centering appears in " Preselector Adjust " on page 1787
Status Bits/OPC dependencies	When centering the preselector, *OPC does not return true until the process is complete and a subsequent measurement has completed, nor are results returned in response to <code>:READ</code> or <code>:MEASure</code> queries The Measuring bit remains set (true) while this command is operating, and does not go false until the subsequent sweep/measurement has completed

Proper Preselector Operation

Certain considerations should be observed to ensure proper operation:

1. If the selected marker is **Off**, the instrument turns on a marker, performs a peak search, and adjusts the preselector using the selected marker's frequency. It uses the "highest peak" peak search method unqualified by threshold or excursion, so that there is no chance of a 'no peak found' error. It continues with that peak, even if it is the peak of just noise. Therefore, for this operation to work properly, there should be a signal on-screen in a preselected range for the peak

search to find

2. If the selected marker is already **On**, the instrument attempts the centering at that marker's frequency. There is no preselector for signals below about 3.6 GHz, so if the marker is on a signal below 3.6 GHz, no centering is attempted, and an advisory message is generated
3. In some models, the preselector can be bypassed. If it is bypassed, no centering is attempted in that range and a message is generated

Preselector Adjust

Lets you manually adjust the preselector filter frequency to optimize its response to the signal of interest. Only available when "**Presel Center**" on page 1786 is available.

For general purpose signal analysis, using **Presel Center** is recommended. Centering the filter minimizes the impact of long-term preselector drift. **Preselector Adjust** can be used instead to manually optimize the preselector. One application of manual optimization would be to peak the preselector response, which both optimizes the signal-to-noise ratio and minimizes amplitude variations due to small (short-term) preselector drifting.

When **Presel Center** is performed, the offset applied to do the centering becomes the new value of **Preselector Adjust**.

Remote Command	<code>[:SENSe]:POWer[:RF]:PADJust <freq></code> <code>[:SENSe]:POWer[:RF]:PADJust?</code>
Example	<code>:POW:PADJ 100KHz</code> <code>:POW:PADJ?</code>
Notes	The value on the control is displayed to 0.1 MHz resolution
Dependencies	<ul style="list-style-type: none"> - Does not appear in CXA-m - Does not appear in VXT Models M9410A/11A/15A/16A - Does not appear in M9410E/11E/15E/16E - Grayed-out if microwave preselector is off - Grayed-out if entirely in Band 0, that is, if Stop Freq is lower than about 3.6 GHz - Grayed-out if entirely above 50 GHz, that is, if Start Freq is higher than 50 GHz - Blank in models that do not include a preselector, such as Option 503. If the command is sent in these instruments, it is accepted without error, and the query always returns 0 - Grayed-out in the Spectrogram View
Preset	0 MHz

State Saved	The Preselector Adjust value set by " Presel Center " on page 1786, or by manually adjusting Preselector Adjust Not saved in instrument state, and does not survive a Preset or power cycle
Min/Max	-/+500 MHz
Backwards Compatibility SCPI	<code>[:SENSe]:POWer[:RF]:MW:PADJust</code> <code>[:SENSe]:POWer[:RF]:MMW:PADJust</code> Backwards Compatibility Command
Notes	The command has no effect, and the query always returns MWAVE
Backwards Compatibility SCPI	<code>[:SENSe]:POWer[:RF]:PADJust:PRESelector MWAVE MMWave EXternal</code> <code>[:SENSe]:POWer[:RF]:PADJust:PRESelector?</code>

Internal Preamp

Accesses a menu of controls for the internal preamps. Turning on the preamp gives a better noise figure, but a poorer inter-modulation distortion (TOI) to noise floor dynamic range. You can optimize this setting for your measurement.

The instrument takes the preamp gain into account as it sweeps. If you sweep outside of the range of the preamp, the instrument will also account for that. The displayed result always reflects the correct gain.

For some measurements, when the preamp is on and any part of the displayed frequency range is below the lowest frequency for which the preamp has specifications, a warning condition message appears in the status line. For example, for a preamp with a 9 kHz lowest specified frequency: "Preamp: Accy unspec'd below 9 kHz".

Selection	Example	Note
Off	<code>:POW:GAIN OFF</code>	
Low Band	<code>:POW:GAIN ON</code> <code>:POW:GAIN:BAND LOW</code>	Sets the internal preamp to use only the low band. The frequency range of the installed (optional) low-band preamp is displayed in square brackets on the Low Band selection in the dropdown
Full Range	<code>:POW:GAIN ON</code> <code>:POW:GAIN:BAND FULL</code>	Sets the internal preamp to use its full range. The low band (0-3.6 GHz, 0-3.4 GHz, 0-3 GHz, depending on the model) is supplied by the low band preamp and the frequencies above low band are supplied by the high band preamp The frequency range of the installed (optional) low-band preamp is displayed in square brackets on the Full Range selection in the dropdown. If the high band option is not installed the Full Range selection does not appear

NOTE

The maximum **Center Frequency for Low Band**, displayed in square brackets, can change based on the selected IFBW for measurements that support IFBW (for example, Waveform measurement across all Modes that support it). In certain models (such as N9042B & N9032B), IFBW values ≤ 40 MHz have a maximum **Low Band** frequency of 3.6 GHz, while $40 \text{ MHz} < \text{IFBW} \leq 1 \text{ GHz}$ have a maximum of 3.3 GHz, and $1 \text{ GHz} < \text{IFBW} \leq 1.5 \text{ GHz}$ have a maximum of 3.5 GHz. IFBW values $> 1.5 \text{ GHz}$ do not support a **Center Frequency** that can reach the **Low Band** maximum frequency. In these cases, **N/A** is displayed in the square brackets for **Low Band**.

Remote Command	<code>[:SENSe]:POWer[:RF]:GAIN:BAND LOW FULL</code> <code>[:SENSe]:POWer[:RF]:GAIN:BAND?</code>
Example	<code>:POW:GAIN:BAND LOW</code> <code>:POW:GAIN:BAND?</code>
Dependencies	Not available on all hardware platforms. If the preamp is not present or is unlicensed, this control is not shown Does not appear in VXT Models M9410A/11A/15A/16A nor in M9410E/11E/15E/16E If <code>:POW:GAIN:BAND FULL</code> is sent when a low band preamp is available, the preamp band parameter is set to <code>LOW</code> instead of <code>FULL</code> , and an "Option not installed" message is generated Not available when the electronic/soft attenuator is enabled
Preset	<code>LOW</code>
State Saved	Saved in instrument state
Annotation	When the USB Preamp is not connected to USB, the Preamp annotation in the Meas Bar says "Off" if the preamp is off and displays the frequency range of the low band or full range preamp depending on the setting. For example, if the Preamp is set to Low Band and the Low Band is 3.6 GHz the annotation says "3.6 GHz". If it is a 13.6 GHz preamp and it is set to Full Range the annotation says "13.6 GHz" When the USB Preamp is connected to USB, the Preamp annotation says "Preamp: USB" if the internal preamp is off or "Preamp: USB, Int" if the internal preamp is on (only for measurements that support the USB preamp)

Auto Function

Remote Command	<code>[:SENSe]:POWer[:RF]:GAIN[:STATe] OFF ON 0 1</code> <code>[:SENSe]:POWer[:RF]:GAIN[:STATe]?</code>
Example	<code>:POW:GAIN OFF</code> <code>:POW:GAIN?</code>
Preset	<code>OFF</code>

LNA

Lets you turn the Low Noise Amplifier (LNA) on or off.

3 VMA Mode
 3.10 Spurious Emissions Measurement

LNA is an additional preamplifier that provides superior DANL and frequency range compared to "Internal Preamp" on page 1788. LNA provides lower system noise figure, especially at frequencies above 100 MHz, and can be operated up to the full range of 50 GHz instruments.

For best possible sensitivity, LNA can be turned on *together* with "Internal Preamp" on page 1788, although if you operate both preamps together, note that the TOI (distortion) specifications are impacted. The sensitivity improvement of this combination is substantial when operating in high band (frequencies above 3.6 GHz).

For more details about annotation, see "More Information" on page 1637

Remote Command	<code>[:SENSe]:POWer[:RF]:GAIN:LNA[:STATe] OFF ON 0 1</code> <code>[:SENSe]:POWer[:RF]:GAIN:LNA[:STATe]?</code>
Example	<code>:POW:GAIN:LNA ON</code>
Dependencies	Requires Option LNA, except for VXT models M9415A/16A Does not appear in VXT models M9420A/10A/11A M9410E/11E/15E/16E support LNA May not appear in some measurements LNA is not available when the electronic/soft attenuator is enabled
Preset	OFF
State Saved	Saved in State

More Information

When LNA is installed, the preamp annotation changes to show the state of both LNA and Internal Preamp. Below is an example:

```
Atten: 8 dB
Pre: Int on, LNA on
µW Path: LNP, On
Source: Off
```

Note that when operating entirely in the low band (below about 3.6 GHz), if LNA is on, Internal Preamp is switched off (even if you have its switch set to ON). This is because the noise performance is actually degraded in low band if both preamps are on. In this case, the annotation reflects the actual state of the two preamps, but the Internal Preamp annotation displays in amber, to warn you that the actual state of Internal Preamp does not match its switch control display:

```
Atten: 8 dB
Pre: Int off, LNA on
µW Path: LNP, On
Source: Off
```

μW Path Control

Options for this control include **μW Preselector Bypass** (Option MPB), **Low Noise Path** (Option LNP) and **Full Bypass Enable** in the High Band path circuits.

When the μW Preselector is bypassed, flatness is improved, but will be subject to spurs from out of band interfering signals. When **Low Noise Path Enable** is selected, the instrument automatically bypasses certain circuitry in the high frequency bands that can contribute to noise, when it is appropriate based on other instrument settings.

For most applications, the preset state is **Standard Path**, which provides the best remote-control throughput, minimizes acoustic noise from switching and minimizes the risk of wear in the hardware switches, particularly in remote test scenarios where both low band and high band setups will follow in rapid succession. In this path, the bypass of the low band/high band switch and microwave preamp is never activated, which can cause some noise degradation but preserves the life of the bypass switch.

For applications that utilize the wideband IF paths, the preset state is **μW Preselector Bypass**, if option MPB is present. This is because, when using a wideband IF such as the 140 MHz IF, the μW Preselector's bandwidth can be narrower than the available IF bandwidth, causing degraded amplitude flatness and phase linearity, so it is desirable to bypass the preselector in the default case.

You may choose **Low Noise Path Enable** for a lower noise floor, especially in the 21–26.5 GHz region, though without improving many measures of dynamic range, and without giving the best possible noise floor. The preamp, if purchased and used, gives better noise floor than does **Low Noise Path Enable**, but the preamp's compression threshold and third-order intercept are much poorer than that of **Low Noise Path Enable**.

A fourth choice is **Full Bypass Enable**, which combines **μW Preselector Bypass** and **Low Noise Path Enable**. Because this can bypass most of the circuitry between the input and the first mixer, care should be taken when using this setting to avoid damaging the mixer. **Full Bypass Enable** is only available if both options LNP and MPB are present, as well as option FBP.

Path	Example	Note
Standard Path	:POW:MW:PATH STD	Normal setting for most measurements. μW Preselector in circuit, Low Noise Path disabled
Low Noise Path Enable	:POW:MW:PATH LNP	See " Low Noise Path Enable " on page 1642
μW Preselector Bypass	:POW:MW:PATH MPB	See " μW Preselector Bypass " on page 1644
Full Bypass Enable	:POW:MW:PATH FULL	See " Full Bypass Enable " on page 1645

3 VMA Mode
3.10 Spurious Emissions Measurement

Remote Command	<code>[:SENSe]:POWer[:RF]:MW:PATH STD LNPath MPBypass FULL</code> <code>[:SENSe]:POWer[:RF]:MW:PATH?</code>														
Example	<code>:POW:MW:PATH LNP</code> Enables the Low Noise path <code>:POW:MW:PATH?</code>														
Notes	<p>When "Presel Center" on page 1786 is performed, the instrument momentarily switches to the Standard Path, regardless of the setting of μW Path Control</p> <p>The DC Block will always be switched in when the low noise path is switched in, to protect succeeding circuitry from DC. Note that this does not mean "when the low noise path is enabled" but when, based on the Low Noise Path rules, the path is actually switched in. This can happen when the selection is Low Noise Path Enable or Full Bypass Enable. In the case where the DC Block is switched in, the instrument is now AC-coupled. However, if you selected DC coupling, the UI would still behave as though it were DC-coupled, including all annunciation, warnings, status bits, and responses to SCPI queries. This is because, based on other settings, the instrument could switch out the low noise path at any time and hence go back to being DC-coupled</p> <p>Alignment switching ignores the settings in this menu, and restores them when finished</p>														
Dependencies	<p>Does not appear in CXA-m, VXT Models M9410A/11A/15A/16A, nor in M9410E/11E/15E/16E, BBIQ and External Mixing</p> <ul style="list-style-type: none"> - The Low Noise Path Enable selection does not appear unless Option LNP is present and licensed - The μW Preselector Bypass selection does not appear unless Option MPB is present and licensed - The Full Bypass Enable selection does not appear unless options LNP and MPB are both present as well as option FBP <p>In any of these cases, if the required options are not present and the SCPI command is sent, error - 241, "Hardware missing; Option not installed" is generated</p> <p>Low Noise Path Enable and Full Bypass Enable are grayed-out if the current measurement does not support them</p> <p>Low Noise Path Enable and Full Bypass Enable are not supported in Avionics and MMR Modes (non-modulation measurements). In any of these cases (that is, the feature is not supported in either measurement or Mode), if the SCPI command is sent, the following error is generated: -221, "Setting Conflict; Feature not supported for this measurement"</p>														
Preset	<table border="1"> <thead> <tr> <th>Mode</th> <th>Value</th> </tr> </thead> <tbody> <tr> <td>IQ Analyzer</td> <td>MPB option present and licensed: MPB</td> </tr> <tr> <td>Pulse</td> <td>MPB option not present and licensed: STD</td> </tr> <tr> <td>RTSA</td> <td></td> </tr> <tr> <td>Avionics</td> <td></td> </tr> <tr> <td>All other Modes</td> <td>STD</td> </tr> <tr> <td>-</td> <td></td> </tr> </tbody> </table>	Mode	Value	IQ Analyzer	MPB option present and licensed: MPB	Pulse	MPB option not present and licensed: STD	RTSA		Avionics		All other Modes	STD	-	
Mode	Value														
IQ Analyzer	MPB option present and licensed: MPB														
Pulse	MPB option not present and licensed: STD														
RTSA															
Avionics															
All other Modes	STD														
-															
State Saved	Save in instrument state														
Range	Standard Path Low Noise Path Enable μW Presel Bypass Full Bypass Enable														

Annotation In the Meas Bar, if the Standard path is chosen:
 μ W Path: Standard
 If Low Noise Path is enabled but the LNP switch is not thrown:
 μ W Path: LNP,Off
 If the Low Noise Path is enabled and the LNP switch is thrown:
 μ W Path: LNP,On
 If the preselector is bypassed:
 μ W Path: Bypass
 If Full Bypass Enable is selected but the LNP switch is not thrown:
 μ W Path: FByp,Off
 If Full Bypass Enable is selected and the LNP switch is thrown:
 μ W Path: FByp,On

μ W Path Control Auto

In VMA, WLAN, 5G NR, CQM Modes, an **Auto/Man** switch is added to μ W Path Control:



This allows the function to automatically switch based on certain Auto Rules as shown below:

VMA Mode

Measurement	μ W Path Control Auto behavior
Digital Demod	Use Standard Path unless tuned frequency > 3.6 GHz and IFBW > 15 MHz, in which case choose Preselector Bypass
Monitor Spectrum	Always Presel Bypass
IQ Waveform	Use Standard Path unless tuned frequency > 3.6 GHz and IFBW > 15 MHz, in which case choose Preselector Bypass
Custom OFDM	Use Standard Path unless tuned frequency > 3.6 GHz and IFBW > 15 MHz, in which case choose Preselector Bypass
Channel Power	Always Presel Bypass
Occupied BW	Always Presel Bypass
CCDF	Use Standard Path unless tuned frequency > 3.6 GHz and IFBW > 15 MHz, in which case choose Preselector Bypass

3 VMA Mode
 3.10 Spurious Emissions Measurement

Measurement	μ W Path Control Auto behavior
ACP	Always Presel Bypass
SEM	Always Presel Bypass
Spurious Emissions	Always Standard Path

WLAN Mode

Measurement	μ W Path Control Auto behavior
Modulation Analysis	Always Presel Bypass
Spectral Flatness	Always Presel Bypass
Power vs Time	Always Presel Bypass
Monitor Spectrum	Always Presel Bypass
IQ Waveform	Always Presel Bypass
Channel Power	Always Presel Bypass
Occupied BW	Always Presel Bypass
CCDF	Always Presel Bypass
SEM	For 11be 320M, when 'Enabled Wideband IF for FFT' is OFF or 'Sweep Type Rule' is Best Dynamic Range, auto μ W path is standard For other cases, auto μ W path is presel bypass if presel bypass is enabled, auto μ W path is standard if presel bypass is not enabled
Spurious Emissions	Always Standard Path

5G NR Mode

Measurement	μ W Path Control Auto behavior
Modulation Analysis	Use Standard Path unless tuned frequency > 3.6 GHz and IFBW > 15 MHz, in which case choose Full Bypass if conditions warrant(FBP Option is available and "Allow Full Bypass in Auto" is On), otherwise choose Preselector Bypass
Monitor Spectrum	Always Standard Path
IQ Waveform	Use Standard Path unless tuned frequency > 3.6 GHz and IFBW > 15 MHz, in which case choose Full Bypass if conditions warrant(FBP Option is available and "Allow Full Bypass in Auto" is On), otherwise choose Preselector Bypass
Channel Power	Always Standard Path
Occupied BW	Always Standard Path
CCDF	Use Standard Path unless tuned frequency > 3.6 GHz and IFBW > 15 MHz, in which case choose Preselector Bypass
ACP	Always Standard Path
SEM	Always Standard Path
Spurious	Always Standard Path

Measurement	μ W Path Control Auto behavior
Emissions	
Transmit On Off Power	Use Standard Path unless tuned frequency > 3.6 GHz and Info BW > 15 MHz, in which case choose Preselector Bypass
Channel Quality Mode	
Measurement	μ W Path Control Auto behavior
Group Delay	Use Standard Path unless tuned frequency > 3.6 GHz and IFBW > 15 MHz, in which case choose Full Bypass if conditions warrant(FBP Option is available and "Allow Full Bypass in Auto" is On), otherwise choose Preselector Bypass
Monitor Spectrum	Always Standard Path
IQ Waveform	Use Standard Path unless tuned frequency > 3.6 GHz and IFBW > 15 MHz, in which case choose Preselector Bypass
CCDF	Use Standard Path unless tuned frequency > 3.6 GHz and IFBW > 15 MHz, in which case choose Preselector Bypass

Remote Command	<code>[:SENSE]:POWER[:RF]:MW:PATH:AUTO ON OFF 1 0</code> <code>[:SENSE]:POWER[:RF]:MW:PATH:AUTO?</code>
Example	<code>:POW:MW:PATH:AUTO ON</code> <code>:POW:MW:PATH:AUTO?</code>
Dependencies	Only appears in VMA, WLAN, 5G NR and CQM Modes
Couplings	See " μW Path Control Auto " on page 1640 above
Preset	ON
Range	ON OFF

Low Noise Path Enable

Low Noise Path Enable provides a lower noise floor under some circumstances, particularly when operating in the 21–26.5 GHz region. With the Low Noise Path enabled, the low band/high band switch and microwave preamp are bypassed whenever *all* the following are true:

- The instrument is not in the Low Band, meaning:
- the start frequency is above 3.5 GHz and
- the stop frequency is above 3.6 GHz
- The internal preamp is not installed, or if installed, is set to **Off** or **Low Band**

Note that this means that, when any part of a sweep is done in Low Band, the Low Noise Path is not used, whether or not the **Low Noise Path Enable** is selected in the user interface. Also, if the preamp is turned on, the Low Noise Path is not used,

3 VMA Mode

3.10 Spurious Emissions Measurement

whether or not the **Low Noise Path Enable** is selected in the user interface. The only time the Low Noise Path is used is when **Low Noise Path Enable** is selected, the sweep is completely in High Band (> 3.6 GHz) and no preamp is in use.

For measurements that use IQ acquisition, the low noise path is used when **Center Frequency** is in High Band (> 3.6 GHz) and no preamp is in use. In other words, the rules above are modified to use only the center frequency to qualify which path to switch in. This is not the case for FFTs in the Swept SA measurement; they use the same rules as swept measurements.

Note that the Low Noise Path, while giving improved DANL, has the disadvantage of decreased TOI performance and decreased gain compression performance relative to the standard path.

Note also that the bypass switch is a mechanical switch and has finite life, so if the **Low Noise Path Enable** is selected, it is possible to cause frequent cycling of this switch by frequently changing instrument settings such that the above conditions hold true only some of the time. A user making tests of this nature should consider opting for the **Standard Path**, which will never throw the bypass switch, at the expense of some degraded noise performance.

The low noise path is useful for situations where the signal level is so low that the instrument performance is dominated by noise even with 0 dB attenuation, but still high enough that the preamp option would have excessive third-order intermodulation or compression. The preamp, if purchased and used, gives better noise floor than does the “Low Noise Path.” However, its compression threshold and third-order intercept are much poorer than that of the non-preamp path.

There are some applications, typically for signals around –30 dBm, for which the third-order dynamic range of the standard path is good enough, but the noise floor is not low enough even with 0 dB input attenuation. When the third-order dynamic range of the preamp path is too little and the noise floor of the standard path is too high, the Low Noise Path can provide the best dynamic range

The graph below illustrates the concept. It shows, in red, the performance of an instrument at different attenuation settings, both with the preamp on and off, in a measurement that is affected by both instrument noise and instrument TOI. The green shows the best available dynamic range, offset by 0.5 dB for clarity. The blue shows how the best available dynamic range improves for moderate signal levels with the low noise path switched in. In this illustration, the preamp improves the noise floor by 15 dB while degrading the third-order intercept by 30 dB, and the low noise path reduces loss by 8 dB. The attenuator step size is 2 dB.

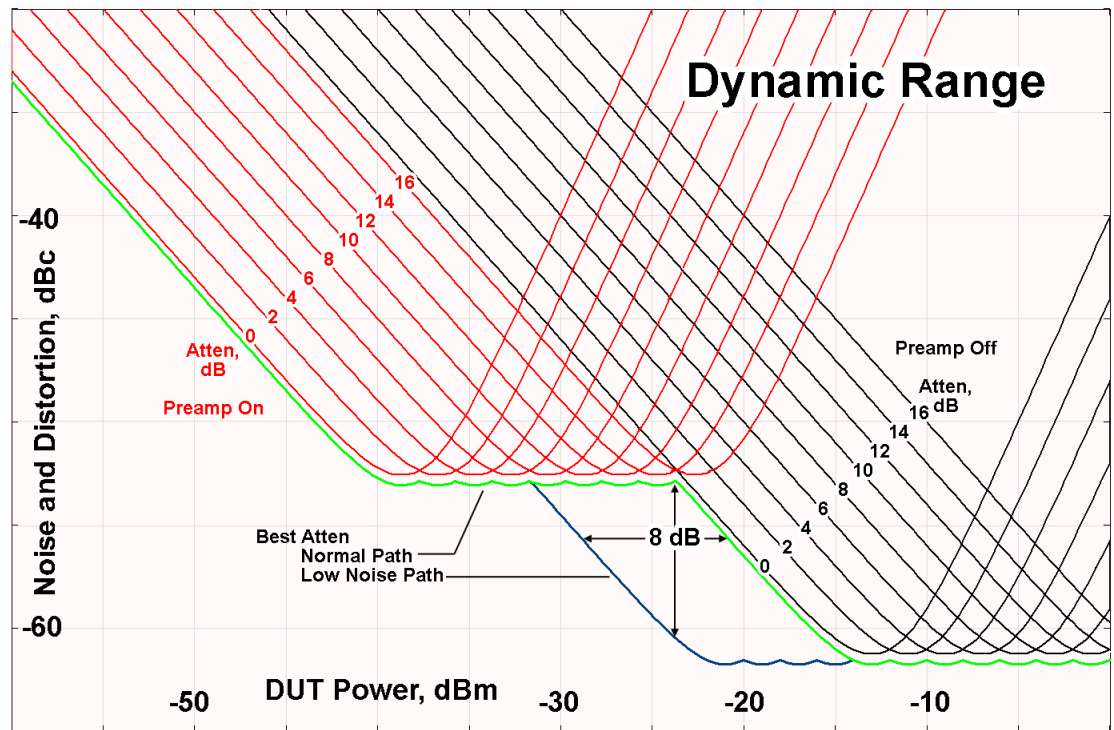

There are other times where selecting the low noise path improves performance, too. Compression-limited measurements such as finding the nulls in a pulsed-RF spectrum can profit from the low noise path in a way similar to the TOI-limited measurement illustrated. Accuracy can be improved when the low noise path allows the optimum attenuation to increase from a small amount like 0, 2 or 4 dB to a larger amount, giving better return loss at the instrument input. Harmonic measurements, such as second and third harmonic levels, are much improved using the low noise path because of the superiority of that path for harmonic (though not intermodulation) distortion performance.

μ W Preselector Bypass

Toggles the preselector bypass switch for band 1 and higher. When the microwave preselector is on, the signal path is preselected. When the microwave preselector is off, the signal path is not preselected. The preselected path is the normal path for the instrument.

The preselector is a tunable bandpass filter which prevents signals away from the frequency of interest from combining in the mixer to generate in-band spurious signals (images). The consequences of using a preselector filter are its limited bandwidth, the amplitude and phase ripple in its passband, and any amplitude and phase instability due to center frequency drift.

Option MPB or pre-selector bypass provides an unpreselected input mixer path for certain X-Series signal analyzers with frequency ranges above 3.6 GHz. This signal path allows a wider bandwidth and less amplitude variability, which is an advantage when doing modulation analysis and broadband signal analysis. The disadvantage is that, without the preselector, image signals will be displayed. Another disadvantage of bypassing the preselector is increased LO emission levels at the front panel input port.

Image responses are separated from the real signal by twice the 1st IF. For IF Paths of 10 MHz and 25 MHz, the 1st IF is 322.5 MHz, so the image response and the real signal will be separated by 645 MHz. The 1st IF will be different for other IF Path settings. When viewing a real signal and its corresponding image response in internal mixing, the image response will be to the left of the real signal.

Also, the image response and the real signal typically have the same amplitude and exhibit the same shape factor.

However, if Option FS1 (Fast Sweep Capability) is enabled, the image response in the Swept SA measurement appears lower in amplitude and has a much wider shape factor compared to the real signal.

Full Bypass Enable

With **Full Bypass Enable** selected, the microwave preselector is bypassed. In addition, the low band/high band switch and microwave preamp are bypassed whenever *all* the following are true:

- The instrument is not in the Low Band, meaning:
- the start frequency is above 3.5 GHz and
- the stop frequency is above 3.6 GHz.
- the internal preamp is not installed or if installed, is set to **Off** or **Low Band**

Note that this means that, when any part of a sweep is done in Low Band, the Low Noise Path is not used, whether or not the **Full Bypass Enable** is selected in the user interface. Also, if the preamp is turned on, the Low Noise Path is not used, whether or not the **Full Bypass Enable** is selected in the user interface. The only time the Low Noise Path is used is when **Full Bypass Enable** is selected, the sweep is completely in High Band (> 3.6 GHz) and no preamp is in use.

CAUTION

When **Full Bypass Enable** is selected, and "**Y Scale**" on page 1760 is set to 0 dB, there will be a direct AC connection between the input and the first converter when the Low Noise Path switches in (when Start Freq >3.6 GHz and the Preamp is either not licensed, set to Low Band, or Off). This puts the first converter at considerable risk to be damaged by high AC power. Consequently,

whenever **Full Bypass Enable** is selected, a warning message appears in the status bar:

“Full Bypass Enabled, maximum safe input power reduced”

Microwave Preselector Bypass Backwards Compatibility

Example	Bypass the microwave preselector: <code>:POW:MW:PRES OFF</code>
Notes	Included for Microwave Preselector Bypass backwards compatibility The ON parameter sets the STD path (<code>:POW:MW:PATH STD</code>) The OFF parameter sets path MPB (<code>:POW:MW:PATH MPB</code>)
Preset	ON
Backwards Compatibility SCPI	<code>[:SENSe]:POWer[:RF]:MW:PRESelector[:STATe] ON OFF 0 1</code> <code>[:SENSe]:POWer[:RF]:MW:PRESelector[:STATe]?</code>

Frequency Extender Preselection Bypass

Only applies to the high frequency path of the Frequency Extender, and only if the Frequency Extender allows it. For example, the V3050A high frequency path is 50 – 110 GHz and *does* allow control of the preselector bypass.

When the Frequency Extender’s preselection is bypassed, flatness is improved, but will be subject to spurs from out-of-band interfering signals. For bandwidths greater than 2.5 [GHz], it is recommended that the signal bypass the Frequency Extender Preselector since the max bandwidth of the Preselector can be as narrow as 2.5 [GHz].

For most applications, the preset state is **OFF**, which gives the best remote-control throughput, minimizes acoustic noise from switching, minimizes out of band spurs, and minimizes the risk of wear in the hardware switches.

Preselector and Bandwidth Conflict

When the Frequency Extender Preselector is applied and the signal bandwidth is greater than 2.5 [GHz], then a settings alert message will show to warn the user that the signal may be distorted due to the limitation of the Frequency Extender Preselector bandwidth.

An example of the settings alert message is shown below.

Settings Alert message in the Status Bar at the bottom of the display.



Settings Alert message in the error queue

Type	ID	
	159	Settings Alert - DETECTED; Presel/Meas BW conflict

Allow Full Bypass in Auto

Enable or disable Full Bypass in μ W Path Auto rule. See " [\$\mu\$ W Path Control](#)" on page 1791.

When this function is **ON**, and " [\$\mu\$ W Path Control](#)" on page 1791 is in **AUTO**, it is possible for the auto rules to select the **FULL** Bypass state, which bypasses both the Preamp and the Microwave Preselector. Otherwise, the auto rules never select the **FULL** Bypass state. This is convenient when making wideband measurements, but it also adds some risk of damage to the first converter.

CAUTION

When **Full Bypass Enable** is selected, and "[Y Scale](#)" on page 1760 is set to 0 dB, there will be a direct AC connection between the input and the first converter when the Low Noise Path switches in (when Start Freq > 3.6 GHz and the Preamp is either not licensed, set to **Low Band** or **Off**). This puts the first converter at considerable risk to be damaged by high AC power. Consequently, whenever **Full Bypass Enable** is selected, a warning message appears in the status bar:

"Full Bypass Enabled, maximum safe input power reduced"

Remote Command	<code>[:SENSe]:POWer[:RF]:MW:PATH:AUTO:FULL ON OFF 1 0</code> <code>[:SENSe]:POWer[:RF]:MW:PATH:AUTO:FULL?</code>
Example	<code>:POW:MW:PATH:AUTO:FULL ON</code> <code>:POW:MW:PATH:AUTO:FULL?</code>
Dependencies	Only appears if Option FBP is installed, and in the following measurements <ul style="list-style-type: none"> - 5GNRMode: Modulation Analysis and IQ Waveform - WLAN Mode: IQ Waveform - Channel Quality Mode: Group Delay and Noise Power Ratio
Preset	OFF
State Saved	Saved in instrument state

Software Preselection

Provided in some instruments, either to compensate for issues with provided hardware preselection or to provide the preselection function when there is no hardware preselector.

N9041B

Software Preselection compensates for the frequency range limit of the microwave preselector. Since the microwave preselector only goes up to 50 GHz, software preselection must be used to suppress and separate images above 50 GHz. The specific algorithm used for software preselection is specified by the SW Preselection Type selection – Normal or Advanced.

In N9041B, **Software Preselection** only applies for frequencies above 50 GHz, therefore it is only used for RF Input 2. Even if turned on, it is not used for other inputs, and never for frequencies below 50 GHz. This is why the label of this control contains the parenthetical note “(>~50 GHz)”.

Note that in N9041B, in Swept SA measurement, **Software Preselection** works even if the measurement is using an FFT Sweep Type. In measurements other than Swept SA, Software Preselection is not used if the measurement is using an FFT sweep type.

N9042B+V3050A

Software Preselection compensates for the frequency range limit of the microwave preselector. Since the microwave preselector only goes up to 50 GHz, software preselection must be used to suppress and separate images above 50 GHz. The specific algorithm used for software preselection is specified by the SW Preselection Type selection – Normal or Advanced.

For N9042B+V3050A, Software Preselection only applies for frequencies above 50 GHz, therefore it is only used for External RF. Even if it is turned on, it will not be used for other inputs and never for frequencies below 50 GHz. This is why the label of this control contains the parenthetical note “(>~50 GHz)”.

Note that for N9042B+V3050A, in the Swept SA measurement, Software Preselection works even if the measurement is using an FFT Sweep Type. In measurements other than Swept SA, Software Preselection is not used if the measurement is using an FFT Sweep Type.

VXT models M9410A/11A/15A/16A

Software Preselection is used to provide the preselection function, as there is no hardware preselector in these models. Two background traces are taken and compared point by point, and the point with the lowest amplitude from the two

3 VMA Mode
 3.10 Spurious Emissions Measurement

traces is used. This provides a method to reduce spurs that are internally generated within the VXT, but you should note the following when using Software Preselection:

- There is some speed cost due to the need to take multiple captures
- Taking the point with the lowest amplitude in each trace will make the average noise level lower at all points that do not have a spur. This can reduce the accuracy of the measurement of noise and noise-like signals

Because of the difficulty in identifying spurs manually, you are recommended to leave Software Preselection **ON** at all times in VXT models M9410A/11A. If you turn it off in order to speed up your measurement or improve noise accuracy, be aware of unwanted onscreen spurs.

Remote Command	<code>[:SENSe]:POWer[:RF]:SWPrese1:STATe 0 1 ON OFF</code> <code>[:SENSe]:POWer[:RF]:SWPrese1:STAT?</code>
Example	<code>:POW:SWPR:STAT 1</code> <code>:POW:SWPR:STAT?</code>
Dependencies	Only appears in N9041B, N9042B+V2050A, VXT models M9410A/11A and M9410E/11E. Does not appear in all measurements
Couplings	Affects Sweep Time Auto Tune supports Software Preselection , so Auto Tune should be performed after setting the Software Preselection state
Preset	N9041B OFF N9042B+V3050A ON M9410A/11A ON
State Saved	Saved in instrument state

SW Preselection Type

Specifies the algorithm used for software preselection.

Two hidden sweeps occur in succession. The second sweep is offset in LO frequency by $2 * IF / N$. For each point in each trace, the smaller amplitude from the two traces is taken and placed in that point in the selected trace. The Peak detector is auto-selected to improve the image suppression effectiveness. Responses of each trace that lie on top of one another will remain and are valid signals. Other signals are images, which are suppressed. The action of taking the smaller of the two traces will make the average noise level lower in all points that do not have an image, thus reducing the accuracy of the measurement of noise and noise-like signals.

- **NORMa1** - mathematically removes all image and multiple responses of signals present at the input
- **ADVanced** - any trace processing (such as “max hold” or trace averaging) is performed on the points of both candidate traces before the “select minimum” operation occurs. This form of processing works better for non-stationary signals, such as pulsed-RF signals

Remote Command	<code>[:SENSe]:POWer[:RF]:SWPResel NORMa1 ADVanced</code> <code>[:SENSe]:POWer[:RF]:SWPResel?</code>
Example	<code>:POW:SWPR NORM</code> <code>:POW:SWPR?</code>
Dependencies	Only appears in N9041B and N9042B+V3050A. Only appears in measurements that use the Swept method Grayed-out when "Software Preselection" on page 1801 is OFF. The grayout message is “Unavailable unless SW Presel enabled”
Preset	N9041B ADVanced N9042B+V3050A NORMa1
State Saved	Saved in instrument state

SW Preselection BW

Specifies the effective bandwidth to be used for Software Preselection.

The options are:

- **NORMa1** – when making Swept measurements, a software preselection algorithm is used which takes up to 4 background acquisitions, then post-processes the result. This algorithm can remove images from signals with an occupied bandwidth up to around 3 GHz. (Default/Preset setting). When making FFT measurements, this algorithm is not used, instead the same algorithm is used as for **NARRow** (below)
- **NARRow**– a software preselection algorithm is used which takes two background acquisitions, then post-processes the result to detect and remove images from wideband signals with occupied bandwidths up to 2 GHz. This increases the risk of images failing to be rejected, but improves the measurement speed

Remote Command	<code>[:SENSe]:POWer[:RF]:SWPResel:BW NORMa1 NARRow</code> <code>[:SENSe]:POWer[:RF]:SWPResel:BW?</code>
Example	<code>:POW:SWPR:BW NARR</code>
Dependencies	Only appears in N9041B and N9042B+V3050A. Only appears in measurements that use the Swept

3 VMA Mode
 3.10 Spurious Emissions Measurement

	method	
	Grayed-out when " Software Preselection " on page 1801 is OFF . The grayout message is "Unavailable unless SW Presel enabled"	
	For N9042B+V3050A, the parameter is SCPI-only, and always set to NARRow when Software Preselection is enabled	
Preset	N9041B	NORMa1
	N9042B+V3050A	NARRow
State Saved	Saved in instrument state	

High Freq Prefilter

Lets you set the state of Prefilter for center frequencies above 1310 MHz.

In VXT Models M9410A/11A and M9410E/11E in bypass frequency range (1310MHz~5GHz), the Receiver RF path has a bank of filters that come after the RF Attenuator in the signal path. Since this bank of filters precedes the mixer they are known as the "Prefilter" bank. Their purpose is to eliminate unwanted in-band mixing products by filtering out all but the desired frequencies before the signals get to the mixer. There are 13 prefilter bands to cover the frequencies between 9 kHz and 6000 MHz. The Prefilter provides the necessary rejection of the unwanted signal.

Remote Command	<code>[:SENSE]:<measurement>:PFILter[:STATE] ON OFF 1 0</code> <code>[:SENSE]:<measurement>:PFILter[:STATE]?</code>
Example	Enable High Freq Prefilter for the Complex Spectrum Measurement in BASIC Mode: <code>:SPEC:PFIL ON</code> Enable High Freq Prefilter for the IQ Waveform Measurement, in multiple Modes: <code>:WAV:PFIL ON</code> Enable High Freq Prefilter for the Swept SA Measurement in SA Mode: <code>:SAN:PFIL ON</code>
Dependencies	Only appears in VXT models M9410A/11A with center frequency above 1310 MHz, and M9410E/11E in frequency range 1310MHz~5GHz
Preset	See " Prefilter Presets " on page 1651 below
State Saved	Saved in instrument state

Prefilter Presets

Meas	Mode	Preset
SPEC	BASIC	OFF

Meas	Mode	Preset
WAV	BASIC, WCDMA, WLAN, LTEAFDD, LTEATDD, 5GNR, VMA	OFF
MON	WCDMA, WLAN, LTEAFDD, LTEATDD, 5GNR, VMA	OFF
RHO	WCDMA	OFF
CDP	WCDMA	OFF
PCON	WCDMA	OFF
EVMQ	WCDMA	OFF
CHP	WCDMA, WLAN, LTEAFDD, LTEATDD, 5GNR, VMA, SA	OFF
OBW	WCDMA, WLAN, LTEAFDD, LTEATDD, 5GNR, VMA, SA	OFF
ACP	WCDMA, LTEAFDD, LTEATDD, 5GNR, VMA, SA	OFF
SEM	WCDMA, WLAN, LTEAFDD, LTEATDD, 5GNR, VMA, SA	OFF
PST	WCDMA, WLAN, LTEAFDD, LTEATDD, 5GNR, VMA, SA	OFF
PVT	WLAN, LTEAFDD, LTEATDD, 5GNR	OFF
EVM	WLAN, LTEAFDD, LTEATDD, 5GNR	OFF
FLAT	WLAN	OFF
EVMM	WLAN	OFF
CEVM	LTEAFDD, LTEATDD	OFF
PAVT	5GNR, VMA	OFF
DDEM	VMA	OFF
OFDM	VMA	OFF
SAN	SA	ON
HARM	SA	ON

3.10.4 BW

There is no **BW** functionality in this measurement.

3.10.5 Display

Opens the **Display** menu, which lets you configure display items for the current Mode, Measurement View or Window.

3.10.5.1 Meas Display

Contains controls for setting up the display for the current Measurement, View, or Window.

Center Frequency On/Off

Turns the display of **Center Frequency** on the **Meas Bar** On or Off.

3 VMA Mode
3.10 Spurious Emissions Measurement

Remote Command	<code>:DISPlay:SPURious:FREQuency:CENTer[:STATe] ON OFF 1 0</code> <code>:DISPlay:SPURious:FREQuency:CENTer[:STATe]?</code>
Example	<code>:DISP:SPUR:FREQ:CENT ON</code> <code>:DISP:SPUR:FREQ:CENT?</code>
Preset	ON
State Saved	Yes

3.10.5.2 Annotation

Contains controls for setting up the annotation for the current Mode or Measurement.

Graticule

Turns the display graticule On or Off for all windows with graticules in all measurements in the current Mode. Also turns the graticule Y-Axis annotation on and off.

Remote Command	<code>:DISPlay:GRATicule[:STATe] OFF ON 0 1</code> <code>:DISPlay:GRATicule[:STATe]?</code>
Example	<code>:DISP:GRAT OFF</code>
Notes	The graticule is the set of horizontal and vertical lines that make up the grid/divisions for the X-Axis and Y-Axis
Preset	ON
State Saved	Saved in instrument state
Backwards Compatibility SCPI	<code>:DISPlay:WINDow[1]:TRACe:GRATicule:GRID[:STATe] OFF ON 0 1</code> <code>:DISPlay:WINDow[1]:TRACe:GRATicule:GRID[:STATe]?</code> This command is accepted for backwards compatibility with older instruments, but the WINDow , TRACe and GRID parameters are ignored

Screen Annotation

Controls the display of the annunciation and annotation around the graticule, including any annotation on lines (such as the display line, the threshold line, etc.) and the Y-Axis annotation, for all windows with screen annotation in all measurements in the current Mode.

This does *not* include marker annotation (or the N dB result). When **OFF**, the graticule expands to fill the entire graticule area, leaving only the 1.5% gap above the graticule, as described in the **Trace** section.

Remote Command	<code>:DISPlay:ANNotation:SCReen[:STATe] OFF ON 0 1</code> <code>:DISPlay:ANNotation:SCReen[:STATe]?</code>
Example	<code>:DISP:ANN:SCR OFF</code>
Dependencies	Grayed-out and forced to OFF when System Display Settings, Annotation is OFF
Preset	ON This remains OFF through a Preset when System Display Settings, Annotation is set to OFF
State Saved	Saved in instrument state

Trace Annotation

Turns on and off the labels on the traces, showing their detector (or their Math Mode) as described in the **Trace** section, for all windows in all measurements in the current Mode for which Trace Annotation on/off is supported.

If Trace Math is being performed on a trace, then the Trace Math annotation replaces the detector annotation.

For measurements that support limit lines, this key also turns on and off the labels on the Limit Lines. The label is the Limit number annotation and Limit Comment displayed on the graph. If the length of the comment is greater than 20 characters, the first 8 characters and the last 8 characters are displayed, joined with

Remote Command	<code>:DISPlay:ANNotation:TRACe[:STATe] ON OFF 1 0</code> <code>:DISPlay:ANNotation:TRACe[:STATe]?</code>
Example	<code>:DISP:ANN:TRAC OFF</code>
Preset	OFF
State Saved	Saved in instrument state

Control Annotation

Turns on and off the display of values on the Active Function controls for all measurements in the current Mode. This is a security feature.

Remote Command	<code>:DISPlay:ACTivefunc[:STATe] ON OFF 1 0</code> <code>:DISPlay:ACTivefunc[:STATe]?</code>
Example	<code>:DISP:ACT OFF</code>
Dependencies	Grayed out and forced to OFF when System Display Settings, Annotation is OFF
Preset	ON This remains OFF through a Preset when System Display Settings, Annotation is set to OFF
State Saved	Saved in instrument state

Meas Bar

Turns the Measurement Bar at the top of the screen on and off for all measurements in the current Mode. When **OFF**, the graticule area expands to fill the area formerly occupied by the Measurement Bar.

Remote Command	<code>:DISPlay:ANNotation:MBAR[:STATe] OFF ON 0 1</code> <code>:DISPlay:ANNotation:MBAR[:STATe]?</code>
Example	<code>:DISP:ANN:MBAR OFF</code>
Dependencies	Grayed out and forced to OFF when System Display Settings, Annotation is OFF
Preset	ON This remains OFF through a Preset when System Display Settings, Annotation is set to OFF
State Saved	Saved in instrument state

Display Enable (Remote Command Only)

Turns the display on/off, including the display drive circuitry. The backlight stays lit to confirm that the instrument is on. The display enable setting is mode global. There are three reasons for turning the display off:

1. To increase speed as much as possible by freeing the instrument from having to update the display
2. To reduce emissions from the display, drive circuitry
3. For security purposes

If you have turned off the display:

- and you are in local operation, the display can be turned back on by pressing any key or by sending `:SYSTem:DEFaults MISC` or `:DISPlay:ENABle ON` (neither `*RST` nor `:SYSTem:PRESet` enable the display)
- and you are in remote operation, the display can be turned back on by pressing the **Local** or **Esc** keys, or by sending `:SYSTem:DEFaults MISC` or `:DISPlay:ENABle ON` (neither `*RST` nor `:SYSTem:PRESet` enable the display)
- and you are using either the `:SYSTem:KLOCK` command or GPIB local lockout, then *no* front-panel key press will turn the display back on. You must turn it back on remotely.

If the display is **OFF**, many SCPI commands related to User Views and Multiscreen functionality do not work, and return the error messages “-221, Settings conflict; Screen SCPI cannot be used when Display is disabled” or “221, Settings conflict; View SCPI cannot be used while Display is disabled”. These commands include:

Name	Command
Select User View	:DISPlay:VIEW:ADVanced:SElect
Rename User View	:DISPlay:VIEW:ADVanced:REName
Delete User View	:DISPlay:VIEW:ADVanced:DELeTe
Create User View	:DISPlay:VIEW:ADVanced:NAME
Select Screen	:INSTrument:SCReen:SElect
Delete Screen	:INSTrument:SCReen:DELeTe
Delete All But This Screen	:INSTrument:SCReen:DELeTe:ALL
Add Screen	:INSTrument:SCReen:CREate
Rename Screen	:INSTrument:SCReen:REName
Sequencer On/Off	:SYSTem:SEQuencer

Remote Command	:DISPlay:ENABle OFF ON 0 1
Example	:DISP:ENAB OFF
Couplings	:DISP:ENAB OFF turns Backlight OFF and :DISP:ENAB ON turns Backlight ON, but changing Backlight settings does <i>not</i> change the state of :DISP:ENAB
Preset	ON Set by :SYST:DEF MISC, but not affected by *RST or :SYSTem:PRESet
State Saved	Not saved in instrument state
Backwards Compatibility Notes	:SYST:PRES no longer turns on :DISPlay:ENABle as it did in legacy analyzers

3.10.5.3 View

Contains controls for selecting the current **View**, and for editing User Views.

Views

This measurement has two predefined views:

#	Name	SCPI
1	"Graph + Metrics" on page 1657	RESult
2	"All Ranges" on page 1657	ALL

These are multiple-window views. When in a multiple-window view, you select a window by touching it. The menu controls may sometimes change, depending on which window is selected.

3 VMA Mode

3.10 Spurious Emissions Measurement

Remote Command	<code>:DISPlay:SPURious:VIEW[:SElect] RESult ALL</code> <code>:DISPlay:SPURious:VIEW[:SElect]?</code>
Example	<code>:DISP:SPUR:VIEW RANG</code> <code>:DISP:SPUR:VIEW?</code>
Preset	<code>RESult</code>
State Saved	No
Range	Graph + Metrics All Ranges

Graph + Metrics

Windows: ["Graph" on page 1607](#), ["Table" on page 1608](#)

Select Graph + Metrics to view measurement results.

- The upper window displays a trace of the range that contains the currently selected spur
- The lower window displays a list of spurs detected in a measurement cycle. The currently selected spur, which is highlighted, can be changed by the Spur control in the Meas Setup menu

Example	<code>:DISP:SPUR:VIEW RES</code>
---------	----------------------------------

All Ranges

Windows: ["Graph" on page 1607](#),

Select All Ranges to view measurement results for all the ranges.

- The upper window displays a merged trace of all the ranges
- The lower window displays a list of spurs detected in a measurement cycle. The currently selected spur, which is highlighted, can be changed by the Spur control in the Meas Setup menu

Example	<code>:DISP:SPUR:VIEW ALL</code>
---------	----------------------------------

User View

Lets you choose a View from the saved User Views for the current measurement. This panel only appears if a User View exists for the current measurement.

Remote Command	<code>:DISPlay:VIEW:ADVanced:SElect <alphanumeric></code> <code>:DISPlay:VIEW:ADVanced:SElect?</code>
----------------	--

Example	Select Baseband as the current View <code>:DISP:VIEW:ADV:SEL "Baseband"</code>
Notes	<p>You must be in the measurement whose View you are trying to set to send the command. You can only set Views for the current measurement using this command</p> <p>For predefined views, the parameter is derived from the view name that is shown in the View list in the user interface. For example, if you are trying to select the Trace Zoom view in the Swept SA measurement, you send:</p> <pre>:DISP:VIEW:ADV:SEL "Trace Zoom"</pre> <p>because "Trace Zoom" is the name of the View as seen in the Mode/Meas dialog or in the Display, View menu</p> <p>You <i>cannot</i> use the legacy View parameter (which in this case would be <code>TZOOM</code>) with</p> <pre>:DISP:VIEW:ADV:SEL</pre> <p><alphanumeric> is case insensitive; you can specify mixed case, however the name will be evaluated on a single case. Thus, both of the following forms work:</p> <pre>:DISP:VIEW:ADV:SEL "Trace Zoom"</pre> <pre>:DISP:VIEW:ADV:SEL "TRACE ZOOM"</pre> <p>If the specified view is not a valid View, the query returns the error message "-224, Illegal parameter value; View with the name <alphanumeric> does not exist"</p> <p>If the display is disabled (via <code>:DISP:ENAB OFF</code>) then the error message "-221, Settings conflict; View SCPI cannot be used while Display is disabled" is generated</p>
Backwards Compatibility SCPI	<p>The legacy node</p> <pre>:DISPlay:VIEW[:SElect]</pre> <p>is retained for backwards compatibility, but it only supports predefined views</p>

Restore Layout to Default

Restores the Layout to the default for Basic.

Modified Views are very temporary; if you exit the current measurement they are discarded, and they are not saved in State. To retain this View for later use, and to be able to return easily to your original Basic View, you can save your edited View as a "User View".

Save Layout as New View

Saves your new View as a User View. An alpha keyboard appears, which lets you name your new View; the default is the old View name plus a number.

Remote Command	<code>:DISPlay:VIEW:ADVanced:NAME <alphanumeric></code>
Example	<pre>:DISP:VIEW:ADV:NAME "Baseband"</pre> <p>Creates a new View named Baseband from the current View, and selects it as the current View</p>

Notes	<p><code><alphanumeric></code> is case insensitive; you can specify mixed case, however the name will be evaluated on a single case</p> <p>If <code><alphanumeric></code> name already exists as a View, the error message “-224, Illegal parameter value; View <code><alphanumeric></code> already exists” is generated</p> <p>If the display is disabled (via <code>:DISP:ENAB OFF</code>) then the error message “-221, Settings conflict; User View SCPI cannot be used while Display is disabled” is generated</p>
-------	---

Re-Save User View

You can re-edit a User View; if you make changes, then an asterisk will appear next to the User View’s name. You can then tap **Re-Save User View** to save it back to its existing name, or **Save Layout as New View** to add another, new User View.

This is a front panel function only, there is no remote command available to perform this function. To do this remotely, you must first perform **Save Layout as New View**, then delete the old User View and rename the new one with the name of the View you just deleted.

Rename User View

You can rename the current View by giving it a new unique name. Only User Views can be renamed, if the current View is a Predefined View, an error occurs.

Remote Command	<code>:DISPlay:VIEW:ADVanced:REName <alphanumeric></code>
----------------	---

Example	<code>:DISP:VIEW:ADV:REN “Baseband”</code>
---------	--

Notes	<p><code><alphanumeric></code> is case insensitive; you can specify mixed case, however the name will be evaluated on a single case</p> <p>If the <code><alphanumeric></code> specifying the new name is already present in the list of View names, the error message “-224, Illegal parameter value; View <code><alphanumeric></code> already exists” is generated</p> <p>If the current View is a Predefined View, the error message “-224, Illegal parameter value; Cannot rename a Predefined View” is generated</p> <p>If the display is disabled (via <code>:DISP:ENAB OFF</code>) then the error message “-221, Settings conflict; View SCPI cannot be used while Display is disabled” is generated</p>
-------	--

Delete User View

You can delete the current View if it is a User View. The default view becomes the current view for the Measurement.

Remote Command	<code>:DISPlay:VIEW:ADVanced:DElete</code>
----------------	--

Example	<code>:DISP:VIEW:ADV:DEL</code>
Notes	<p><code><alphanumeric></code> is case insensitive; you can specify mixed case, however the name will be evaluated on a single case</p> <p>If the <code><alphanumeric></code> is not present in the list of View names, the error message “-224, Illegal parameter value; View <alphanumeric> does not exist” is generated</p> <p>If the current View is a Predefined View, the error message “-224, Illegal parameter value; Cannot delete a Predefined View” is generated</p> <p>If the display is disabled (via <code>:DISP:ENAB OFF</code>) then the error message “-221, Settings conflict; View SCPI cannot be used while Display is disabled” is generated</p>

Delete All User Views

Deletes all previously saved User Views. The default view becomes the current view for the Measurement if a User View was the current view when this command was executed.

Remote Command	<code>:DISPlay:VIEW:ADVanced:DElete:ALL</code>
Example	<code>:DISP:VIEW:ADV:DEL:ALL</code>
Notes	Disabled if there are no User Views

View Editor Remote Commands

The following remote commands help you manage Views and User Views. Note that the SCPI node for User Views handles both Predefined and User Views. The legacy nodes, `:DISPlay:VIEW[:SElect]` and `:DISPlay:VIEW:NSEL`, are retained for backwards compatibility, but they only support predefined views.

View Listing Query

Returns a string containing a comma-separated list of names for *all* the Views, including User Views, available for the current Measurement.

Remote Command	<code>:DISPlay:VIEW:ADVanced:CATalog?</code>
Example	<code>:DISP:VIEW:ADV:CAT?</code>
Notes	<p>Returns a quoted string of the available Views for the current measurement, separated by commas. The list includes names for <i>all</i> the Views, including User Views, available for the current Measurement</p> <p>Example:</p> <p><code>"Normal,Trace Zoom,Spectrogram,Baseband,myView1,yourView1"</code></p> <p>No distinction is made between Predefined and User Views</p>

If you switch measurements with the display disabled (via `:DISP:ENAB OFF`), then query the list of available Views, the result is undefined

User View Listing Query

Returns a string containing a comma-separated list of names for *only* the User Views available for the current Measurement.

Remote Command	<code>:DISPlay:VIEW:ADVanced:USER:CATalog?</code>
Example	<code>:DISP:VIEW:ADV:USER:CAT?</code>
Notes	Returns a quoted string of the available User Views for the current measurement, separated by commas. Example: <code>"Baseband,myView1,yourView1"</code> If you switch measurements with the display disabled (see "Display Enable (Remote Command Only)" on page 1812), then query the list of available Views, the result is undefined

3.10.6 Frequency

Opens the **Frequency** menu, which contains controls that allow you to control the Frequency and Channel parameters of the instrument.

Some settings in the **Frequency** menu are the same for all measurements in the current Mode – they do not change as you change measurements. Settings like these are called “Meas Global” and are unaffected by ["Meas Preset" on page 1716](#). For example, ["Center Frequency" on page 1685](#) is the same for all measurements – it does not change as you change measurements.

3.10.6.1 Settings

Contains controls that pertain to the X axis parameters of the measurement. These parameters control how data on the vertical (X) axis is displayed and control instrument settings that affect the horizontal axis.

Center Frequency

Sets the frequency that corresponds to the horizontal center of the graticule. While adjusting **Center Frequency**, display span is held constant (see ["Range Settings" on page 1681](#)).

The **Center Frequency** setting is the same for all measurements within a Mode, that is, it is Meas Global. Some Modes are also able to share a Mode Global center

frequency value. If this is the case, then a **Global** tab appears in the **Meas Setup** menu.

The **Center Frequency** function sets (and queries) the center frequency for the currently selected input. If your instrument has multiple inputs, and you select another input, **Center Frequency** changes to the value for that input. SCPI commands are available to directly set **Center Frequency** for a specific input.

Center Frequency is remembered as you go from input to input. Thus, you can set a **Center Frequency** of 10 GHz with the RF Input selected, change to BBIQ and set a **Center Frequency** of 20 MHz, then switch to External Mixing and set a **Center Frequency** of 60 GHz. When you return to the RF Input, **Center Frequency** reverts to 10 GHz; back to BBIQ and it is 20 MHz; back to External Mixing and it is 60 GHz.

Remote Command	<code>[:SENSe] :FREQuency :CENTer <freq></code> <code>[:SENSe] :FREQuency :CENTer ?</code>
Example	Set Center Frequency to 50 MHz: <code>:FREQ:CENT 50 MHz</code> Increment Center Frequency by the value of " CF Step " on page 1666: <code>:FREQ:CENT UP</code> Return the current value of Center Frequency : <code>:FREQ:CENT?</code>
Notes	This command sets the RF, External Mixing or I/Q Center Frequency depending on the selected input <ul style="list-style-type: none"> - For RF input it is equivalent to <code>:FREQ:RF :CENT</code> - For I/Q input it is equivalent to <code>:FREQ:IQ :CENT</code> - For External Mixer it is equivalent to <code>:FREQ:EMIX :CENT</code> Preset and Max values depend on Hardware Options If no terminator (for example, MHz) is sent, the terminator Hz is used. If a terminator with unit other than Frequency is used, an invalid suffix error message is generated
Dependencies	Not available in the MSR, LTE-Advanced FDD/TDD and 5G NR Modes
Preset	Depends on instrument maximum frequency, Mode, measurement, and selected input See " Center Frequency Presets " on page 1663, " RF Center Freq " on page 1665, " Ext Mix Center Freq " on page 1665, " I/Q Center Freq " on page 1666 and " VXT Models with Radio Heads/CIU Frequency Range " on page 1664
State Saved	Saved in instrument state
Min/Max	Depends on instrument maximum frequency, Mode, measurement, and selected input See " Center Frequency Presets " on page 1663, " RF Center Freq " on page 1665, " I/Q Center Freq " on page 1666 and " VXT Models with Radio Heads/CIU Frequency Range " on page 1664
Annotation	Center <value> appears in the lower left corner of the display
Status Bits/OPC dependencies	Non-overlapped

Center Frequency Presets

The following table provides the Center Frequency Presets for the Spectrum Analyzer mode, and the Max Freq, for the various frequency options:

Freq Option	CF after Mode Preset	Stop Freq after Mode Preset	Max Freq (can't tune above)
503 (all but CXA)	1.805 GHz	3.6 GHz	3.7 GHz
503 (CXA)	1.505 GHz	3.0 GHz	3.08 GHz
507 (all but CXA)	3.505 GHz	7.0 GHz	7.1 GHz
507 (CXA)	3.755 GHz	7.5 GHz	7.58 GHz
508 (all but MXE)	1.805 GHz	3.6 GHz	8.5 GHz
508 (MXE)	4.205 GHz	8.4 GHz	8.5 GHz
513	6.805 GHz	13.6 GHz	13.8 GHz
526 (except CXA and MXE)	13.255 GHz	26.5 GHz	27.0 GHz*
526 (CXA)	13.255 GHz	26.5 GHz	26.55 GHz
526 (MXE)	1.805 GHz	3.6 GHz	27.0 GHz
532	16.005 GHz	32.0 GHz	32.5 GHz
540	20.005 GHz	40.0 GHz	40.5 GHz
543	21.505 GHz	43.0 GHz	43.0 GHz
544	22.005 GHz	44.0 GHz	45.0 GHz
550	25.005 GHz	50.0 GHz	52 GHz
F03 (CXA-m)	1.505 GHz	3.0 GHz	3.08 GHz
F07 (CXA-m)	3.755 GHz	7.5 GHz	7.575 GHz
F13 (CXA-m)	6.805 GHz	13.6 GHz	13.8 GHz
F26 (CXA-m)	13.255 GHz	26.5 GHz	26.55 GHz
504 (M9421A, M8920A)	2.145 GHz	3.88GHz	3.88 GHz
506 (M9421A, M8920A)	3.245 GHz	6.08GHz	6.08 GHz
F06 (M9410A/11A)	1.0 GHz	6.08 GHz	6.08 GHz
F06 (M9415A)	1 GHz	1.08 GHz	6.6 GHz
F08 (M9415A)	1 GHz	1.08 GHz	8.6 GHz
F12 (M9415A)	1 GHz	1.08 GHz	12.9 GHz

*For option 526, the Max CF in RTSA is 26.999999995 GHz.

N9041B Center Freq Presets

Input	CF after Mode Preset	Stop Freq after Mode Preset	Max Freq (can't tune above)
Input 1, all models	25.005 GHz	50.0 GHz	52 GHz

Input	CF after Mode Preset	Stop Freq after Mode Preset	Max Freq (can't tune above)
Input 2, opt 585	42.505 GHz	85.0 GHz	86 GHz
Input 2, opt 590	45.005 GHz	90.0 GHz	92 GHz
Input 2, opt 5CX	55.005 GHz	110.0 GHz	110 GHz

Input 2, CXA and MXE

Model	CF after Mode Preset	Stop Freq after Mode Preset	Max Freq (can't tune above)
CXA opt C75	0.7505 GHz	1.5 GHz	1.58 GHz
MXE	505 MHz	1 GHz	1.000025 GHz

Tracking Generator Frequency Limits (CXA only)

Tracking Generator Option	Min Freq (clips to this freq when turn TG on and can't tune below while TG on)	If above this Freq, Stop Freq clipped to this Freq when TG turned on	Max Freq (can't tune above) while TG on
T03	9 kHz	3.0 GHz	3.08 GHz
T06	9 kHz	6.0 GHz	6.05 GHz

Tracking Generator Frequency Limits(CXA-m only)

Tracking Generator Option	Min Freq (clips to this freq when turn TG on and can't tune below while TG on)	If above this Freq, Stop Freq clipped to this Freq when TG turned on	Max Freq (can't tune above) while TG on
T03	2 MHz	3.08 GHz	3.08 GHz
T07	2 MHz	7.575 GHz	7.575 GHz
T13	2 MHz	13.8 GHz	13.8 GHz
T26	2 MHz	26.55 GHz	26.55 GHz

VXT Models with Radio Heads/CIU Frequency Range

The following table shows the Center Frequency Presets and Range for VXT modes with Radio Heads/CIU.

Products with Radio Heads/CIU	Preset	Start frequency	Stop frequency
M9421A + CIU	6 GHz	5.9 GHz	12 GHz
M9410A + CIU	6 GHz	5.9 GHz	12 GHz
M9410A + CIU + RRH	25 GHz	24.25 GHz	43.5 GHz

RF Center Freq

Specifies the RF Center Frequency. Sets the center frequency to use when the RF input is selected, even if the RF input is not the input that is selected at the time the command is sent. Note that **Center Frequency** in the **Frequency** menu on the front panel always applies to the currently selected input.

Remote Command	<code>[:SENSe] :FREQuency:RF:CENTer <freq></code> <code>[:SENSe] :FREQuency:RF:CENTer?</code>
Example	<code>:FREQ:RF:CENT 30 MHz</code> <code>:FREQ:RF:CENT?</code>
Notes	This command is the same in all Modes, but the parameter is Measurement Global, so the value is independent in each Mode and common across all the measurements in the Mode
Dependencies	If the electronic/soft attenuator is enabled, any attempt to set Center Frequency such that the stop frequency would be >3.6 GHz fails and results in an advisory message. If the equivalent SCPI command is sent, this same message is generated as part of a “-221, Settings conflict” warning
Preset	See " Center Frequency Presets " on page 1663 above
State Saved	Saved in instrument state
Min	-79.999995 MHz
Max	See " Center Frequency Presets " on page 1663 above. Basically, instrument maximum frequency -5 Hz If the knob or step keys are being used, also depends on span (see " Range Settings " on page 1681)

Ext Mix Center Freq

Specifies the External Mixer Center Frequency. Sets the center frequency to use when the External Mixer is selected, even if the External Mixer input is not the input that is selected at the time the command is sent. Note **Center Frequency** in the **Frequency** menu on the front panel always applies to the currently selected input.

Remote Command	<code>[:SENSe] :FREQuency:EMIXer:CENTer <freq></code> <code>[:SENSe] :FREQuency:EMIXer:CENTer?</code>
Example	<code>:FREQ:EMIX:CENT 60 GHz</code> <code>:FREQ:EMIX:CENT?</code>
Notes	This command is the same in all Modes, but the parameter is Measurement Global, so the value is independent in each Mode and common across all the measurements in the Mode
Couplings	When returning to External Mixing after having switched to one of the other inputs (for example, RF), you return to the settings that you had when you left External Mixing. So, you return to the band you were in with the Center Frequency that you had. However, span (" Range " on page 1680) is not an input-dependent parameter, so the instrument returns to the span from the previous input, limited as necessary by the current mixer setup
Preset	When Mode Preset is performed while in External Mixing, the start frequency of the current Mode is set to the nominal Min Freq of the lowest harmonic range in the Harmonic Table for the current mixer

setup. Similarly, the stop frequency of the current Mode is set to the nominal Max Freq of the highest harmonic range in the Harmonic Table. **Center Frequency** thus presets to the point arithmetically equidistant from these two frequencies

Note that, if the current measurement has a limited span/range available to it, and cannot achieve the span shown in the table (**Range** = Stop Freq – Start Freq), the instrument uses the maximum span the measurement allows, and still sets **Center Frequency** to the midpoint of the start and stop Freq values in the Harmonic Table

When **Restore Input/Output Defaults** is performed, the mixer presets to the 11970A, whose start and stop frequencies are 26.5 and 40 GHz respectively. The center of these two frequencies is 33.25 GHz

Therefore, after **Restore Input/Output Defaults**, if you go to External Mixing and do **Mode Preset** while in Spectrum Analyzer Mode, the resulting **Center Frequency** is 33.25 GHz

State Saved	Yes
Min	The minimum frequency in the currently selected mixer band +5 Hz If the knob or step keys are being used, also depends on Range
Max	The maximum frequency in the currently selected mixer band –5 Hz If the knob or step keys are being used, also depends on Range

I/Q Center Freq

Specifies the I/Q Center Frequency. Sets the center frequency to use when the I/Q input is selected, even if the I/Q input is not the input that is selected at the time the command is sent. Note that **Center Frequency** in the **Frequency** menu on the front panel always applies to the currently selected input.

Remote Command	<code>[:SENSe] :FREQuency :IQ :CENTer <freq></code> <code>[:SENSe] :FREQuency :IQ :CENTer?</code>
Example	<code>:FREQ:IQ:CENT 30 MHz</code>
Notes	This command is the same in all Modes, but the parameter is Measurement Global, so the value is independent in each Mode and common across all the measurements in the Mode
Preset	0 Hz
State Saved	Saved in instrument state
Min/Max	–/+40.049995 MHz

CF Step

Changes the step size for "**Center Frequency**" on page 1685. Once a step size has been selected and the center frequency function is active, the step keys (and the **UP | DOWN** parameters for **Center Frequency** from remote commands) change the center frequency by the step-size value. The step size function is useful for finding harmonics and sidebands beyond the current frequency span of the instrument.

Note that the start and stop frequencies also step by the **CF Step** value.

3 VMA Mode

3.10 Spurious Emissions Measurement

Remote Command	<code>[:SENSe]:FREQuency:CENTer:STEP[:INCRement] <freq></code> <code>[:SENSe]:FREQuency:CENTer:STEP[:INCRement]?</code>
Example	Increase the current center frequency value by 500 MHz: <code>:FREQ:CENT:STEP 500 MHz</code> <code>:FREQ:CENT UP</code>
Notes	Preset and Max values depend on Hardware Options
Dependencies	Not available in MSR, LTE-A FDD/TDD and 5G NR Modes If the electronic/soft attenuator is enabled, any attempt to change the value of the center frequency >3.6 GHz by pressing the Up -arrow key, fails and results in an advisory message. If the equivalent SCPI command is sent, this same message is generated as part of a “-221, Settings conflict” warning
Couplings	When auto-coupled, CF Step size is set to 10% of Range
Preset	Auto
State Saved	Saved in instrument state
Min/Max	-/+ (the maximum frequency of the instrument) That is, 27 GHz max freq instrument has a CF Step range of +/- 27 GHz. Note that this is the maximum frequency, given the current settings of the instrument, so in External Mixing, for example, it is the maximum frequency of the current mixer band
Status Bits/OPC dependencies	non-overlapped
Auto Function	
Remote Command	<code>[:SENSe]:FREQuency:CENTer:STEP:AUTO OFF ON 0 1</code> <code>[:SENSe]:FREQuency:CENTer:STEP:AUTO?</code>
Example	<code>:FREQ:CENT:STEP:AUTO ON</code> <code>:FREQ:CENT:STEP:AUTO?</code>
Preset	ON

3.10.7 Marker

Accesses a menu that enables you to select, set up and control the markers for the current measurement. If there are no active markers, **Marker** selects marker 1, sets it to Normal and places it at the center of the display. If the selected marker is Off, it is set to Normal and placed it at the center of the screen on the trace determined by the **Marker Trace** rules.

3.10.7.1 Select Marker

Specifies the selected marker. The term “selected marker” is used throughout this document to specify which marker will be affected when you change marker settings, perform a **Peak Search**, etc.

The **Select Marker** control appears above the menu panel, indicating that it applies to all controls in the Marker menu panels. **Select Marker** is blanked if you select a tab whose controls do *not* depend on the selected marker (for example, Counter).

On any menu tab that displays **Select Marker**, the first control is always **Marker Frequency | Time**.

Notes	The selected marker is remembered even when not in the Marker menu and is used if a Search is done, or a Band Function is turned on, or for Signal Track, or Continuous Peak
Preset	Marker 1
State Saved	The number of the selected marker is saved in instrument state
Annunciation	Appears in the marker results block label for Normal and Delta markers

3.10.7.2 Settings

The controls on this tab include the **Marker** active function and a radio button selection for the marker control mode (**Normal**, **Delta**, or **Off**) for the selected marker, as well as additional functions that help you use markers.

Marker Frequency

Sets the marker X-Axis value in the current marker X-Axis Scale unit. It has no effect if the control mode is **OFF**, but is the SCPI equivalent of entering an X value if the control mode is **Normal** (**POSition**) or **DELTA**.

Remote Command	<code>:CALCulate:SPURious:MARKer[1] 2 ... 12:X <freq></code> <code>:CALCulate:SPURious:MARKer[1] 2 ... 12:X?</code>
Example	<code>:CALC:SPUR:MARK2:X 25 kHz</code> <code>:CALC:SPUR:MARK3:X?</code>
Notes	If no suffix is sent, uses the fundamental units for the current marker X Axis Scale. If a suffix is sent that does not match the current marker X Axis Scale unit, an error "Invalid suffix" is generated The query returns the marker's absolute X Axis value if the control mode is Normal , or the offset from the marker's reference marker if the control mode is Delta . The query is returned in the fundamental units for the current marker X Axis scale: Hz for Frequency and Inverse Time, seconds for Period and Time
Preset	After a preset, all markers are turned OFF , so Marker X-Axis Value query returns Not A Number (NAN)
State Saved	Saved in instrument state
Min/Max	-/+9.9E+37
Annotation	Mkr # <X value> and <Marker value> upper right on graph

Marker X Axis Position (Remote Command Only)

Sets the marker X-Axis Scale position in trace points. This setting has no effect if the control mode is **Off**, but is the SCPI equivalent of entering a value if the control mode is **Normal** or **Delta** - except in trace points rather than X-Axis Scale units. The entered value is immediately translated into the current X-Axis Scale units for setting the value of the marker.

Remote Command	<code>:CALCulate:SPURious:MARKer[1] 2 ... 12:X:POsition <real></code> <code>:CALCulate:SPURious:MARKer[1] 2 ... 12:X:POsition?</code>
Example	<code>:CALC:SPUR:MARK10:X:POS 300</code> <code>:CALC:SPUR:MARK10:X:POS?</code>
Notes	The query returns the marker's absolute X-Axis value in trace points if the control mode is Normal , or the offset from the marker's reference marker in trace points if the control mode is Delta . The value is returned as a real number, not an integer, corresponding to the translation from X-Axis Scale units to trace points. When a Marker is turned on, it is placed center of the screen on the trace. Therefore, the default value depends on instrument condition. If the marker is OFF , the response is Not A Number
Preset	After a preset, all markers are turned OFF , so Marker X-Axis Value query returns Not A Number (NAN)
State Saved	Saved in instrument state
Min/Max	-/+9.9E+37

Marker Y Axis Value (Remote Query only)

Returns the marker Y Axis value in the current marker Y Axis unit.

Remote Command	<code>:CALCulate:SPURious:MARKer[1] 2 ... 12:Y?</code>
Example	<code>:CALC:SPUR:MARK11:Y?</code>
Notes	Returns the marker Y-Axis result, if the control mode is Normal or Delta . If the marker is OFF , the response is Not A Number In the Complex Spectrum measurement, when the marker is on and Marker Trace is set to IQ, it returns I and Q values Case #1 - MarkerTrace SPEC, I or Q: returns a single double value - <code>>:CALC:SPEC:MARK1:Y?</code> - <code>-2.402406506109E+001</code> Case #2 - MarkerTrace IQ: returns a double array of two values, the first is I, and the second is Q - <code>>:CALC: SPEC:MARK1:Y?</code> - <code>-3.006944493834E-003,+9.9870666467354E-004</code> The IQ selection is for backward compatibility purposes. It is recommended that the users use the I and/or Q selection instead

Preset	Result dependent on Marker setup and signal source
State Saved	No
Backwards Compatibility SCPI	<code>:CALCulate:SPURious:MARKer[1] 2 ... 12:FUNCtion:RESult?</code>

Marker Mode

Sets the marker control mode to **POSition** (Normal), **DELta**, or **OFF**. All interactions and dependencies detailed under the control description are enforced when the remote command is sent. If the selected marker is **OFF**, pressing **Marker** sets it to **POSition** and places it at the center of the screen on the trace determined by the **Marker Trace** rules. At the same time, **Marker X Axis Value** appears on the Active Function area.

The default active function is the active function for the currently selected marker control mode. If the current control mode is **OFF**, there is no active function, and the active function is turned off.

Remote Command	<code>:CALCulate:SPURious:MARKer[1] 2 ... 12:MODE POSition DELTa OFF</code> <code>:CALCulate:SPURious:MARKer[1] 2 ... 12:MODE?</code>
Example	<code>:CALC:SPUR:MARK:MODE POS</code> <code>:CALC:SPUR:MARK:MODE?</code>
Preset	OFF
State Saved	Saved in instrument state
Range	POSition DELta OFF
Annotation	Mkr # <X value> and <Marker value> upper right on graph When Marker Trace is Polar in WCDMA mode: Mkr # <Chip Value (RHO & QPSKEVM)/Symbol Value (CDP)>, <X value> and <Y value> upper right on graph

Backwards Compatibility SCPI Commands

Sets or queries the state of a marker. Setting a marker that is **OFF** to **ON** (1) puts it in **POSition** mode and places it at the center of the screen.

Example	<code>:CALC:SPUR:MARK3:STAT 1</code> <code>:CALC:SPUR:MARK3:STAT?</code>
Preset	OFF
State Saved	Saved in instrument state

Range	OFF ON
Backwards Compatibility SCPI	:CALCulate:SPURious:MARKer[1] 2 ... 12:STATe OFF ON 0 1 :CALCulate:SPURious:MARKer[1] 2 ... 12:STATe?

Delta Marker (Reset Delta)

Pressing this control has exactly the same effect as selecting **Delta** in "**Marker Mode**" on page 1670. The selected marker becomes a Delta Marker. If the selected marker is already a Delta marker, the reference marker is moved to the current position of the selected marker, thus resetting the Delta to zero.

Marker Settings Diagram

Lets you configure the Marker system using a visual utility.

All Markers Off

Turns off all markers.

Remote Command	:CALCulate:SPURious:MARKer:AOFF
Example	:CALC:SPUR:MARK:AOFF

Couple Markers

When this function is **ON**, moving any marker causes an equal X-Axis movement of every other marker that is not **OFF**. By "equal X-Axis movement" we mean that we preserve the difference between each marker's X-Axis value (in the fundamental x-axis units of the trace that marker is on), and the X-Axis value of the marker being moved (in the same fundamental X-Axis units).

This may result in markers going off screen.

Remote Command	:CALCulate:SPURious:MARKer:COUple[:STATe] ON OFF 1 0 :CALCulate:SPURious:MARKer:COUple[:STATe]?
Example	:CALC:SPUR:MARK:COUP ON :CALC:SPUR:MARK:COUP?
Preset	OFF Preset by Mode Preset and All Markers Off
State Saved	Saved in instrument state

3.10.7.3 Peak Search

The controls on this tab allow you to move the marker to selected peaks of the signal, giving you enormous analysis capabilities, particularly when combined with the Delta Marker function.

NOTE

Pressing the **Peak Search** hardkey automatically moves you to the **Peak Search** page of the **Marker** menu *and* performs a peak search.

Pressing the **Peak Search** tab once you are already *in* the **Marker** menu does *not* perform a peak search.

Marker Frequency

This is the fundamental control that you use to move a marker around on the trace. It is the same as "[Marker Frequency](#)" on page 1668 on the **Settings** tab.

Peak Search

Moves the selected marker to the trace point that has the maximum y-axis value for that marker's trace.

NOTE

Pressing the **Peak Search** hardkey automatically moves you to the **Peak Search** page of the **Marker** menu *and* performs a peak search.

Remote Command `:CALCulate:SPURious:MARKer[1]|2|...|12:MAXimum`

Example `:CALC:SPUR:MARK2:MAX`
`:SYST:ERR?`

can be used to query the errors to determine if a peak is found. The message "No peak found" will be returned after an unsuccessful search

Notes Sending this command selects the subcoded marker
In W-CDMA Mode, this command does not work when the selected marker is located on the polar trace. In this case, the command is ignored

Next Peak

Moves the selected marker to the peak that is next lower in amplitude than the current marker value.

3 VMA Mode
3.10 Spurious Emissions Measurement

If the selected marker was **OFF**, then it is turned on as a **POSition** marker and a peak search is performed.

Remote Command	:CALCulate:SPURious:MARKer[1] 2 ... 12:MAXimum:NEXT
Example	:CALC:SPUR:MARK2:MAX:NEXT
Notes	Sending this command selects the subopcoded marker
State Saved	Not part of saved state

Next Pk Right

Moves the selected marker to the nearest peak right of the current marker.

If the selected marker was **OFF**, then it is turned on as a **POSition** marker and a peak search is performed.

Remote Command	:CALCulate:SPURious:MARKer[1] 2 ... 12:MAXimum:RIGHT
Example	:CALC:SPUR:MARK2:MAX:RIGH
Notes	Sending this command selects the subopcoded marker
State Saved	Not part of saved state

Next Pk Left

Moves the selected marker to the nearest peak left of the current marker.

If the selected marker was **OFF**, then it is turned on as a **POSition** marker and a peak search is performed.

Remote Command	:CALCulate:SPURious:MARKer[1] 2 ... 12:MAXimum:LEFT
Example	:CALC:SPUR:MARK2:MAX:LEFT
State Saved	Not part of saved state

Minimum Peak

Moves the selected marker to the minimum Y-Axis value on the current trace.

If the selected marker is **OFF**, it is turned **ON** before the minimum search is performed.

Remote Command	:CALCulate:SPURious:MARKer[1] 2 ... 12:MINimum
Example	:CALC:SPUR:MARK:MIN
Notes	Sending this command selects the subopcoded marker
State Saved	Not part of saved state

Pk-Pk Search

Finds and displays the amplitude and frequency differences between the highest and lowest y-axis value. It places the selected marker on the minimum value on its selected trace, and places that marker's reference marker on the peak of its selected trace.

This function turns on the reference marker and sets its mode to **Fixed** or **Normal** if it is not already on. (These markers may be on two different traces.)

If the selected marker is **OFF**, a **Delta** type marker is turned on and the peak-to-peak search is done. If the selected marker is on, but it is not a **Delta** marker, then it is changed to delta, which turns on the reference marker if needed, and then it performs the peak-to-peak function.

Remote Command	:CALCulate:SPURious:MARKer[1] 2 ... 12:PTPeak
Example	:CALC:SPUR:MARK:PTP
Notes	Turns on the Marker D active function Sending this command selects the subopcoded marker
Dependencies	Pk-Pk Search is not available when Coupled Markers is ON
Couplings	The selected marker becomes a Delta marker if not already in Delta mode
State Saved	Not part of saved state

Marker Delta

Pressing this control has the same effect as selecting **Delta** in "**Marker Mode**" on [page 1670](#) on the **Settings** tab. The selected marker becomes a **Delta** marker. If the selected marker is already a **Delta** marker, the reference marker is moved to the current position of the selected marker, thus resetting the delta to zero.

The control is duplicated here to allow you to conveniently perform a peak search, and change the marker's control mode to **Delta**, without having to access two separate menus.

3.10.7.4 Properties

The controls on this tab are used to set certain properties of the selected marker.

Marker Frequency

This is the fundamental control that you use to move a marker around on the trace. It is the same as "**Marker Frequency**" on [page 1668](#) on the **Settings** tab.

Relative To

Selects the marker to which the selected marker is relative (its reference marker).

Every marker has another marker to which it is relative. This marker is referred to as the “reference marker” for that marker. This attribute is set by the **Marker, Properties, Relative To** control. The marker must be a **Delta** marker to make this attribute relevant. If it is a **Delta** marker, the reference marker determines how the marker is controlled and how its value is displayed. A marker cannot be relative to itself.

Remote Command	<code>:CALCulate:SPURious:MARKer[1] 2 ... 12:REference <integer></code>
Example	<code>:CALC:SPUR:MARK3:REF 5</code> <code>:CALC:SPUR:MARK:REF?</code>
Notes	This command causes the marker specified with the subopcode to become selected Range (for SCPI command): 1 to 12. If the range is exceeded the value is clipped A marker cannot be relative to itself, so that choice is not available, and if sent from SCPI generates error -221: “Settings conflict; marker cannot be relative to itself” When queried a single value is returned (the specified marker numbers relative marker)
Couplings	If the reference marker is off it is turned on in Normal mode at the delta marker location
Preset	The preset default “Relative To” marker (reference marker) is the next higher numbered marker (current marker +1). For example, if marker 2 is selected, then it’s default reference marker is marker 3. The exception is marker 12, which has a default reference of marker 1 Set to the defaults by using Restore Mode Defaults . This is not reset by Marker Off , All Markers Off , or Preset
State Saved	Saved in instrument state. Not affected by Markers Off , hence not affected by Preset or power cycle
Min	1
Max	12
Annunciation	Appears in the marker label of a Delta marker

Marker Trace

Selects the trace on which you want your marker placed. A marker is associated with one and only one trace. This trace is used to determine the placement, result, and X-Axis Scale of the marker. All markers have an associated trace; it is from that trace that they determine their attributes and behaviors, and it is to that trace that they go when they become **Normal** markers.

Specifying a **Marker Trace** manually or with this command associates the marker with the specified trace. If the marker is not **OFF**, it moves the marker from the trace

it was on to the new trace. If the marker is **OFF**, it stays off but is now associated with the specified trace.

The query returns the number of the trace on which the marker is currently placed.

Remote Command	<code>:CALCulate:SPURious:MARKer[1] 2 ... 12:TRACe:ATTached TRACe1 TRACe2 TRACe3</code> <code>:CALCulate:SPURious:MARKer[1] 2 ... 12:TRACe:ATTached?</code>
Example	<code>:CALC:SPUR:MARK2:TRAC:ATT TRAC2</code> <code>:CALC:SPUR:MARK2:TRAC:ATT?</code>
Notes	A marker may be placed on a blanked and/or inactive trace, even though the trace is not visible and/or updating An application may register a trace name to be displayed on the control instead of a trace number
Couplings	The state of Marker Trace is not affected by " Auto Couple " on page 1825 Sending the remote command causes the addressed marker to become selected
Preset	<code>TRACe1</code>
State Saved	Saved in instrument state
Range	<code>TRACe1 TRACe2 TRACe3</code>

Marker Settings Diagram

Lets you configure the **Marker** system using a visual utility. It is the same as "[Marker Settings Diagram](#)" on page 1671 under **Settings**.

3.10.8 Meas Setup

Contains functions for setting up the measurement parameters, and for setting up parameters global to all measurements in the Mode.

3.10.8.1 Settings

Contains frequently-used **Meas Setup** functions, to which you will want the fastest access.

Avg/Hold Num

Specifies the number of measurement averages used to calculate the measurement result. The average is displayed at the end of each sweep.

Remote Command	<code>[:SENSe]:SPURious:AVERage:COUNT <integer></code> <code>[:SENSe]:SPURious:AVERage:COUNT?</code>
Example	<code>:SPUR:AVER:COUN 2500</code>

3 VMA Mode
3.10 Spurious Emissions Measurement

	<code>:SPUR:AVER:COUN?</code>
Preset	10
State Saved	Saved in instrument state
Min/Max	1/10000

Averaging On/Off

Turns Averaging on or off.

NOTE

In this measurement, the **Average Type** is preset to the **Log-Pwr Avg (Video)** method. Other averaging methods are not available.

Remote Command	<code>[:SENSe]:SPURious:AVERage[:STATe] ON OFF 1 0</code> <code>[:SENSe]:SPURious:AVERage[:STATe]?</code>
Example	<code>:SPUR:AVER ON</code> <code>:SPUR:AVER?</code>
Preset	OFF
State Saved	Saved in instrument state
Range	ON OFF

Average Mode

Lets you set the Averaging Mode. Options are:

- **EXponential**: The measurement averaging continues using the specified number of averages to compute each averaged value. The average will be displayed at the end of each sweep
- **REPeat**: The measurement resets the average counter each time the specified number of averages is reached

Remote Command	<code>[:SENSe]:SPURious:AVERage:TCONtrol EXponential REPeat</code> <code>[:SENSe]:SPURious:AVERage:TCONtrol?</code>
Example	<code>:SPUR:AVER:TCON REP</code> <code>:SPUR:AVER:TCON?</code>
Preset	EXponential
State Saved	Saved in instrument state
Range	EXponential REPeat

Average Type

Enables you to control the way averaging is done by choosing one of the following averaging scales: Log-Power (Video) or Power (RMS).

There are three different averaging processes in the measurement, and all of them are affected by this setting: Trace Averaging, the Average detector, and VBW filtering.

Control Selection	SCPI	Type
Log-Pwr (Video)	LOG	Simulates the traditional spectrum analyzer type of averaging by averaging the log of the power
Power (RMS)	RMS	True power averaging that is equivalent to taking the RMS value of the voltage. This is the most accurate type of averaging

Remote Command	<code>[:SENSe]:SPURious:AVERage:TYPE LOG RMS</code> <code>[:SENSe]:SPURious:AVERage:TYPE?</code>
Example	<code>:SPUR:AVER:TYPE LOG</code> <code>:SPUR:AVER:TYPE?</code>
Couplings	Sending this command will affect the VBW Average Type
Preset	LOG
State Saved	Yes
Range	Log-Pwr (Video) Power (RMS)

Meas Type

Selects either **EXAMine** or **FULL** measurement type. This parameter is coupled to "Average Mode" on page 1677. Therefore, if the **EXAMine** measurement type is selected, the measurement sets the Average Mode to exponential. If the **FULL** measurement type is selected, the measurement sets the Average Mode to repeat. The behavior of each measurement type is described in the table below. When averaging is on, trace averaging is used as each active range is measured. Averaging is not used at any other time.

Type	Single		Continuous	
	No Spurs Found	Spurs Found	No Spurs Found	Spurs Found
EXAMine	All active ranges are measured. On completion the measurement is set to the idle state and the 'No	All active ranges are measured, and the spurs found reported. On completion	All active ranges are measured. On completion the SA remains set to last range checked with an active	All active ranges are measured, and the spurs found

3 VMA Mode
 3.10 Spurious Emissions Measurement

Type	Single		Continuous	
	No Spurs Found	Spurs Found	No Spurs Found	Spurs Found
	Spurs' happening is displayed	the measurement is set to the idle state and the trace containing the worst spur restored. The spur control is enabled. A marker is also added which is set to the frequency of the worst spur	trace and the 'No Spurs' happening is displayed	reported. On completion the SA is set to the range containing the worst spur found and continually sweeps this range. Note that the trace is continually updated but the metrics results aren't updated until restart to keep the initial results as references. Use marker readouts to refer the latest results. The spur control is enabled. A marker is also added which is set to the frequency of the worst spur
FULL	All active ranges are measured. On completion measurement is set to idle state and the 'No Spurs' happening is displayed	All active ranges are measured, and spurs found reported. On completion the measurement is set to the idle state, displaying the trace of the last active range	Measurement continually cycles through all active ranges	All active ranges are measured, and spurs found reported. On each cycle of the active ranges the spurs found are reset. This ensures any remote queries retrieve the trace data that matches the currently

	Type	Single		Continuous	
		No Spurs Found	Spurs Found	No Spurs Found	Spurs Found
Remote Command	<code>[:SENSe]:SPURious:TYPE EXAMine FULL</code> <code>[:SENSe]:SPURious:TYPE?</code>				displayed results
Example	<code>:SPUR:TYPE FULL</code> <code>:SPUR:TYPE?</code>				
Preset	<code>EXAMine</code>				
State Saved	Saved in instrument state				
Range	<code>EXAMine FULL</code>				

Spur

Displays any spurs found. Only enabled when the measurement type is set to **EXAMine**, and turns on upon completion of a measurement. Once the **Spur** control has been enabled, you can view any spur. The measurement sets the instrument to the range in which the currently selected spur was found. The range settings only change if the spur selected is in a range that is different from the current range settings. A marker is used to identify the currently selected spur on the trace.

Remote Command	<code>[:SENSe]:SPURious:SPUR <integer></code> <code>[:SENSe]:SPURious:SPUR?</code>
Example	<code>:SPUR:SPUR 55</code> <code>:SPUR:SPUR?</code>
Preset	1
State Saved	No
Min/Max	1/200

Range

Selects the sweep range of the display trace. **Marker** operation, such as peak search is performed in the selected range.

For more details, see ["Range Settings" on page 1681](#).

Preset	1
State Saved	No
Min/Max	1/20

Spur Report Mode

Selects the spurious report mode. Options are:

Limit Line Test	LIMTest	Report only spurs above the limit line. Any spurs reported will cause the measurement to fail. See Abs Start Limit for more information
All Spurs	ALL	Report all spurs detected by Peak Threshold and Peak Excursion
Minimum Margin	MMARgin	Report only the spur with the minimum margin from the limit line. For the spur above the limit, its margin is defined as the negative margin. If there are more than one spurs above the limit, only one spur with the largest negative margin is reported

Remote Command	<code>[:SENSe]:SPURious:REPT:MODE ALL LIMTest MMARgin</code> <code>[:SENSe]:SPURious:REPT:MODE?</code>
Example	<code>:SPUR:REPT:MODE LIMIT</code> <code>:SPUR:REPT:MODE?</code>
Dependencies	MMARgin is available only when option N9060A-7FP is installed
Preset	ALL
State Saved	Saved in instrument state
Range	All Spurs Limit Test Minimum Margin

Range Settings

This dialog enables you to set range parameters. As you change values, the instrument settings are updated with the new parameter values.

In SA Mode, and most other Modes, each **Range** is defined by its Start Freq and Stop Freq. The index tabs that appear on the left side of this dialog let you change different sets of **Range** parameters; the **Ranges** themselves (Start Freq and Stop Freq) are the same in each of these tabs. In some measurements, **Center Frequency** and **Span** are also shown, but these depend on the Start Freq and Stop Freq parameters for each **Range**.

In MSR Mode, each **Range** is defined by the parameters under the **Frequency** Index tab. The parameters for each **Range** are defined using the other index tabs, tied to the **Frequency** tab by the **Range** number, which appears in the leftmost column of each table.

Each **Range** has an **Enabled** checkbox, which lets you decide whether to use the **Range** or not. The checkbox state is the same for all tabs.

	<p>GHz</p> <p>LTE, LTEAFDD: 9 kHz, 150 kHz, 30 MHz, 1 GHz, 1.92GHz, 1.98 GHz, 2.18 GHz, 1.5 GHz, 1.5 GHz, 1.5 GHz, 1.5 GHz, 1.5 GHz, 1.5 GHz, 1.5 GHz, 1.5 GHz, 1.5 GHz, 1.5 GHz, 1.5 GHz, 1.5 GHz</p> <p>WLAN:</p> <p>9 kHz, 150 kHz, 30 MHz, 1GHz, 1.5 GHz, 1.5 GHz, 1.5 GHz, 1.5 GHz, 1.5 GHz, 1.5 GHz, 1.5 GHz, 1.5 GHz, 1.5 GHz, 1.5 GHz, 1.5 GHz, 1.5 GHz, 1.5 GHz, 1.5 GHz</p> <p>MSR: 9 kHz, 150 kHz, 30 MHz, 1 GHz, 1.92GHz, 1.98 GHz, 2.18 GHz, 1.5 GHz, 1.5 GHz, 1.5 GHz, 1.5 GHz, 1.5 GHz, 1.5 GHz, 1.5 GHz, 1.5 GHz, 1.5 GHz</p>
State Saved	Saved in instrument state
Min/Max	<p>-80 MHz/Hardware Dependent:</p> <ul style="list-style-type: none"> - Option 503: 3699999990 - Option 508: 8499999990 - Option 513: 13799999990 - Option 526: 26999999990

Stop Freq

Sets the stop frequency of the instrument. This parameter can send up to 20 values.

When sending the remote command, missing values are not permitted. If you want to change values 2 and 6, then you must send all values up to 6. Subsequent values will remain as they were.

The query always returns 20 values.

Remote Command	<pre>[:SENSe]:SPURious[:RANge][:LIST]:FREQuency:STOP <freq>, <freq>, <freq>, <freq>, <freq>, <freq>, <freq>, <freq>, <freq>, <freq>, <freq>, <freq>, <freq>, <freq>, <freq>, <freq>, <freq>, <freq>, <freq>, <freq></pre> <pre>[:SENSe]:SPURious[:RANge][:LIST]:FREQuency:STOP?</pre>
Example	<pre>:SPUR:FREQ:STOP 150kHz, 30MHz, 1GHz, 2.1GHz, 2.1GHz, 2.1774GHz, 2.18GHz, 12.75GHz, 2.5GHz, 2.5GHz, 2.5GHz, 2.5GHz, 2.5GHz, 2.5GHz, 2.5GHz, 2.5GHz, 2.5GHz, 2.5GHz, 2.5GHz, 2.5GHz, 2.5GHz</pre> <pre>:SPUR:FREQ:STOP?</pre>
Preset	<p>SA Mode: +1.98000000E+009, +1.91960000E+009, +2.10150000E+009, +2.18000000E+009, +1.00000000E+009, +2.50000000E+009, +2.50000000E+009, +2.50000000E+009, +2.50000000E+009, +2.50000000E+009, +2.50000000E+009, +2.50000000E+009, +2.50000000E+009, +2.50000000E+009, +2.50000000E+009, +2.50000000E+009, +2.50000000E+009, +2.50000000E+009, +2.50000000E+009, +2.50000000E+009</p> <p>WCDMA Mode: 150kHz, 30MHz, 1GHz, 2.1GHz, 2.1GHz, 2.1774GHz, 2.18GHz, 12.75GHz, 2.5GHz, 2.5GHz, 2.5GHz, 2.5GHz, 2.5GHz, 2.5GHz, 2.5GHz, 2.5GHz, 2.5GHz, 2.5GHz, 2.5GHz, 2.5GHz, 2.5GHz</p> <p>LTETDD, LTEATDD, 5G NR Modes: 150kHz, 30MHz, 1GHz, 1.90GHz, 2.01GHz, 2.025GHz, 12.75GHz, 2.5GHz, 2.5GHz, 2.5GHz, 2.5GHz, 2.5GHz, 2.5GHz, 2.5GHz, 2.5GHz, 2.5GHz, 2.5GHz, 2.5GHz, 2.5GHz, 2.5GHz, 2.5GHz</p>

3 VMA Mode
 3.10 Spurious Emissions Measurement

	2.5GHz LTE, LTEAFDD Modes: 150kHz, 30MHz, 1GHz, 1.92GHz, 1.98GHz, 2.1GHz, 12.75GHz, 2.5GHz, 2.5GHz, 2.5GHz, 2.5GHz, 2.5GHz, 2.5GHz, 2.5GHz, 2.5GHz, 2.5GHz, 2.5GHz, 2.5GHz, 2.5GHz WLAN Mode: 150kHz, 30 MHz, 1GHz, 12.75GHz, 2.5 GHz, 2.5 GHz, 2.5 GHz, 2.5 GHz, 2.5 GHz, 2.5 GHz, 2.5 GHz, 2.5 GHz, 2.5 GHz, 2.5 GHz, 2.5 GHz, 2.5 GHz MSR Mode: 150kHz, 30MHz, 1GHz, 1.92GHz, 1.98GHz, 2.1GHz, 12.75GHz, 2.5GHz, 2.5GHz, 2.5GHz, 2.5GHz, 2.5GHz, 2.5GHz, 2.5GHz, 2.5GHz, 2.5GHz, 2.5GHz, 2.5GHz
State Saved	Yes
Min/Max	-79999990/Hardware Dependent: - Option 503: 3.7 GHz - Option 508: 8.5 GHz - Option 513: 13.8 GHz - Option 526: 27.0 GHz

Center Frequency

Sets the frequency that corresponds to the horizontal center of the graticule. While adjusting **Center Frequency**, display span is held constant (see "[Range Settings](#)" on [page 1681](#)).

The **Center Frequency** setting is the same for all measurements within a Mode, that is, it is Meas Global. Some Modes are also able to share a Mode Global center frequency value. If this is the case, then a **Global** tab appears in the **Meas Setup** menu.

The **Center Frequency** function sets (and queries) the center frequency for the currently selected input. If your instrument has multiple inputs, and you select another input, **Center Frequency** changes to the value for that input. SCPI commands are available to directly set **Center Frequency** for a specific input.

Center Frequency is remembered as you go from input to input. Thus, you can set a **Center Frequency** of 10 GHz with the RF Input selected, change to BBIQ and set a **Center Frequency** of 20 MHz, then switch to External Mixing and set a **Center Frequency** of 60 GHz. When you return to the RF Input, **Center Frequency** reverts to 10 GHz; back to BBIQ and it is 20 MHz; back to External Mixing and it is 60 GHz.

Remote Command	<code>[:SENSe]:FREQuency:CENTer <freq></code> <code>[:SENSe]:FREQuency:CENTer?</code>
Example	Set Center Frequency to 50 MHz: <code>:FREQ:CENT 50 MHz</code> Increment Center Frequency by the value of " CF Step " on page 1666 : <code>:FREQ:CENT UP</code>

	Return the current value of Center Frequency : :FREQ:CENT?
Notes	This command sets the RF, External Mixing or I/Q Center Frequency depending on the selected input <ul style="list-style-type: none"> – For RF input it is equivalent to :FREQ:RF:CENT – For I/Q input it is equivalent to :FREQ:IQ:CENT – For External Mixer it is equivalent to :FREQ:EMIX:CENT <p>Preset and Max values depend on Hardware Options If no terminator (for example, MHz) is sent, the terminator Hz is used. If a terminator with unit other than Frequency is used, an invalid suffix error message is generated</p>
Dependencies	Not available in the MSR, LTE-Advanced FDD/TDD and 5G NR Modes
Preset	Depends on instrument maximum frequency, Mode, measurement, and selected input See "Center Frequency Presets" on page 1686 , "RF Center Freq" on page 1688 , "Ext Mix Center Freq" on page 1689 , "I/Q Center Freq" on page 1690 and "VXT Models with Radio Heads/CIU Frequency Range" on page 1688
State Saved	Saved in instrument state
Min/Max	Depends on instrument maximum frequency, Mode, measurement, and selected input See "Center Frequency Presets" on page 1686 , "RF Center Freq" on page 1688 , "I/Q Center Freq" on page 1690 and "VXT Models with Radio Heads/CIU Frequency Range" on page 1688
Annotation	Center <value> appears in the lower left corner of the display
Status Bits/OPC dependencies	Non-overlapped

Center Frequency Presets

The following table provides the Center Frequency Presets for the Spectrum Analyzer mode, and the Max Freq, for the various frequency options:

Freq Option	CF after Mode Preset	Stop Freq after Mode Preset	Max Freq (can't tune above)
503 (all but CXA)	1.805 GHz	3.6 GHz	3.7 GHz
503 (CXA)	1.505 GHz	3.0 GHz	3.08 GHz
507 (all but CXA)	3.505 GHz	7.0 GHz	7.1 GHz
507 (CXA)	3.755 GHz	7.5 GHz	7.58 GHz
508 (all but MXE)	1.805 GHz	3.6 GHz	8.5 GHz
508 (MXE)	4.205 GHz	8.4 GHz	8.5 GHz
513	6.805 GHz	13.6 GHz	13.8 GHz
526 (except CXA and MXE)	13.255 GHz	26.5 GHz	27.0 GHz*

3 VMA Mode
 3.10 Spurious Emissions Measurement

Freq Option	CF after Mode Preset	Stop Freq after Mode Preset	Max Freq (can't tune above)
526 (CXA)	13.255 GHz	26.5 GHz	26.55 GHz
526 (MXE)	1.805 GHz	3.6 GHz	27.0 GHz
532	16.005 GHz	32.0 GHz	32.5 GHz
540	20.005 GHz	40.0 GHz	40.5 GHz
543	21.505 GHz	43.0 GHz	43.0 GHz
544	22.005 GHz	44.0 GHz	45.0 GHz
550	25.005 GHz	50.0 GHz	52 GHz
F03 (CXA-m)	1.505 GHz	3.0 GHz	3.08 GHz
F07 (CXA-m)	3.755 GHz	7.5 GHz	7.575 GHz
F13 (CXA-m)	6.805 GHz	13.6 GHz	13.8 GHz
F26 (CXA-m)	13.255 GHz	26.5 GHz	26.55 GHz
504 (M9421A, M8920A)	2.145 GHz	3.88GHz	3.88 GHz
506 (M9421A, M8920A)	3.245 GHz	6.08GHz	6.08 GHz
F06 (M9410A/11A)	1.0 GHz	6.08 GHz	6.08 GHz
F06 (M9415A)	1 GHz	1.08 GHz	6.6 GHz
F08 (M9415A)	1 GHz	1.08 GHz	8.6 GHz
F12 (M9415A)	1 GHz	1.08 GHz	12.9 GHz

*For option 526, the Max CF in RTSA is 26.999999995 GHz.

N9041B Center Freq Presets

Input	CF after Mode Preset	Stop Freq after Mode Preset	Max Freq (can't tune above)
Input 1, all models	25.005 GHz	50.0 GHz	52 GHz
Input 2, opt 585	42.505 GHz	85.0 GHz	86 GHz
Input 2, opt 590	45.005 GHz	90.0 GHz	92 GHz
Input 2, opt 5CX	55.005 GHz	110.0 GHz	110 GHz

Input 2, CXA and MXE

Model	CF after Mode Preset	Stop Freq after Mode Preset	Max Freq (can't tune above)
CXA opt C75	0.7505 GHz	1.5 GHz	1.58 GHz
MXE	505 MHz	1 GHz	1.000025 GHz

Tracking Generator Frequency Limits (CXA only)

Tracking Generator Option	Min Freq (clips to this freq when turn TG on and can't tune below while TG on)	If above this Freq, Stop Freq clipped to this Freq when TG turned on	Max Freq (can't tune above) while TG on
T03	9 kHz	3.0 GHz	3.08 GHz
T06	9 kHz	6.0 GHz	6.05 GHz

Tracking Generator Frequency Limits(CXA-m only)

Tracking Generator Option	Min Freq (clips to this freq when turn TG on and can't tune below while TG on)	If above this Freq, Stop Freq clipped to this Freq when TG turned on	Max Freq (can't tune above) while TG on
T03	2 MHz	3.08 GHz	3.08 GHz
T07	2 MHz	7.575 GHz	7.575 GHz
T13	2 MHz	13.8 GHz	13.8 GHz
T26	2 MHz	26.55 GHz	26.55 GHz

VXT Models with Radio Heads/CIU Frequency Range

The following table shows the Center Frequency Presets and Range for VXT modes with Radio Heads/CIU.

Products with Radio Heads/CIU	Preset	Start frequency	Stop frequency
M9421A + CIU	6 GHz	5.9 GHz	12 GHz
M9410A + CIU	6 GHz	5.9 GHz	12 GHz
M9410A + CIU + RRH	25 GHz	24.25 GHz	43.5 GHz

RF Center Freq

Specifies the RF Center Frequency. Sets the center frequency to use when the RF input is selected, even if the RF input is not the input that is selected at the time the command is sent. Note that **Center Frequency** in the **Frequency** menu on the front panel always applies to the currently selected input.

Remote Command	<code>[:SENSe] :FREQuency:RF:CENTer <freq></code> <code>[:SENSe] :FREQuency:RF:CENTer?</code>
Example	<code>:FREQ:RF:CENT 30 MHz</code> <code>:FREQ:RF:CENT?</code>
Notes	This command is the same in all Modes, but the parameter is Measurement Global, so the value is independent in each Mode and common across all the measurements in the Mode
Dependencies	If the electronic/soft attenuator is enabled, any attempt to set Center Frequency such that the stop frequency would be >3.6 GHz fails and results in an advisory message. If the equivalent SCPI command is sent, this same message is generated as part of a “-221, Settings conflict” warning

3 VMA Mode
3.10 Spurious Emissions Measurement

Preset	See "Center Frequency Presets" on page 1686 above
State Saved	Saved in instrument state
Min	-79.999995 MHz
Max	See "Center Frequency Presets" on page 1686 above. Basically, instrument maximum frequency -5 Hz If the knob or step keys are being used, also depends on span (see "Range Settings" on page 1681)

Ext Mix Center Freq

Specifies the External Mixer Center Frequency. Sets the center frequency to use when the External Mixer is selected, even if the External Mixer input is not the input that is selected at the time the command is sent. Note **Center Frequency** in the **Frequency** menu on the front panel always applies to the currently selected input.

Remote Command	<code>[:SENSe] :FREQUency:EMIXer:CENTer <freq></code> <code>[:SENSe] :FREQUency:EMIXer:CENTer?</code>
Example	<code>:FREQ:EMIX:CENT 60 GHz</code> <code>:FREQ:EMIX:CENT?</code>
Notes	This command is the same in all Modes, but the parameter is Measurement Global, so the value is independent in each Mode and common across all the measurements in the Mode
Couplings	When returning to External Mixing after having switched to one of the other inputs (for example, RF), you return to the settings that you had when you left External Mixing. So, you return to the band you were in with the Center Frequency that you had. However, span ("Range" on page 1680) is not an input-dependent parameter, so the instrument returns to the span from the previous input, limited as necessary by the current mixer setup
Preset	When Mode Preset is performed while in External Mixing, the start frequency of the current Mode is set to the nominal Min Freq of the lowest harmonic range in the Harmonic Table for the current mixer setup. Similarly, the stop frequency of the current Mode is set to the nominal Max Freq of the highest harmonic range in the Harmonic Table. Center Frequency thus presets to the point arithmetically equidistant from these two frequencies Note that, if the current measurement has a limited span/range available to it, and cannot achieve the span shown in the table (Range = Stop Freq - Start Freq), the instrument uses the maximum span the measurement allows, and still sets Center Frequency to the midpoint of the start and stop Freq values in the Harmonic Table When Restore Input/Output Defaults is performed, the mixer presets to the 11970A, whose start and stop frequencies are 26.5 and 40 GHz respectively. The center of these two frequencies is 33.25 GHz Therefore, after Restore Input/Output Defaults , if you go to External Mixing and do Mode Preset while in Spectrum Analyzer Mode, the resulting Center Frequency is 33.25 GHz
State Saved	Yes
Min	The minimum frequency in the currently selected mixer band +5 Hz If the knob or step keys are being used, also depends on Range
Max	The maximum frequency in the currently selected mixer band -5 Hz If the knob or step keys are being used, also depends on Range

I/Q Center Freq

Specifies the I/Q Center Frequency. Sets the center frequency to use when the I/Q input is selected, even if the I/Q input is not the input that is selected at the time the command is sent. Note that **Center Frequency** in the **Frequency** menu on the front panel always applies to the currently selected input.

Remote Command	<code>[:SENSe]:FREQuency:IQ:CENTer <freq></code> <code>[:SENSe]:FREQuency:IQ:CENTer?</code>
Example	<code>:FREQ:IQ:CENT 30 MHz</code>
Notes	This command is the same in all Modes, but the parameter is Measurement Global, so the value is independent in each Mode and common across all the measurements in the Mode
Preset	0 Hz
State Saved	Saved in instrument state
Min/Max	-/+40.049995 MHz

Span

Sets the span of the instrument. This parameter can send up to 20 values. The location where the span occurs in the list sent to the measurement corresponds to the range the value is associated with.

When sending the remote command, missing values are not permitted. If you want to change values 2 and 6, then you must send all values up to 6. Subsequent values will remain as they were.

The query always returns 20 values.

Remote Command	<code>[:SENSe]:SPURious[:RANGe][:LIST]:FREQuency:SPAN <freq>, <freq>, <freq>, <freq>, <freq>, <freq>, <freq>, <freq>, <freq>, <freq>, <freq>, <freq>, <freq>, <freq>, <freq>, <freq>, <freq>, <freq>, <freq>, <freq></code> <code>[:SENSe]:SPURious[:RANGe][:LIST]:FREQuency:SPAN?</code>
Example	<code>:SPUR:FREQ:SPAN 9 kHz, 150 kHz, 30 MHz, 1GHz, 1.5 GHz, 1.5 GHz, 1.5 GHz, 1.5 GHz, 1.5 GHz, 1.5 GHz, 1.5 GHz, 1.5 GHz, 1.5 GHz, 1.5 GHz, 1.5 GHz, 1.5 GHz, 1.5 GHz, 1.5 GHz, 1.5 GHz, 1.5 GHz, 1.5 GHz</code> <code>:SPUR:FREQ:SPAN?</code>
Preset	(Preset of Stop Freq) - (Preset of Start Freq)
State Saved	No
Min/Max	0Hz/Instrument maximum frequency + 80MHz

Res BW

Sets the resolution bandwidth of the instrument. This parameter can send up to 20 values.

	1, OFF ON 0 1, OFF ON 0 1	
	[:SENSe]:SPURious[:RANGe][:LIST]:BANDwidth[:RESolution]:AUTO?	
Example	:SPUR:BWID:AUTO ON, ON, ON, OFF, OFF, OFF, OFF, OFF, ON, ON, ON, ON, OFF, OFF, OFF, OFF, OFF, ON, ON :SPUR:BWID:AUTO?	
Preset	SA Mode	OFF, OFF, OFF, OFF, OFF, ON, ON, ON, ON, ON, ON, ON, ON, ON, ON, ON, ON, ON, ON, ON, ON
	WCDMA Mode	OFF, OFF, OFF, OFF, OFF, OFF, OFF, OFF, ON, ON, ON, ON, ON, ON, ON, ON, ON, ON, ON, ON, ON
	LTE, LTEAFDD, LTETDD, LTEATDD, 5G NR Modes	OFF, OFF, OFF, OFF, OFF, OFF, OFF, OFF, ON, ON, ON, ON, ON, ON, ON, ON, ON, ON, ON, ON, ON
	WLAN Mode	OFF, OFF, OFF, OFF, ON, ON, ON, ON, ON, ON, ON, ON, ON, ON, ON, ON, ON, ON, ON, ON, ON
	MSR Mode	OFF, OFF, OFF, OFF, OFF, OFF, OFF, OFF, ON, ON, ON, ON, ON, ON, ON, ON, ON, ON, ON, ON, ON
State Saved	Saved in instrument state	
Backwards Compatibility SCPI	[:SENSe]:SPURious[:RANGe][:LIST]:BWIth[:RESolution]:AUTO	

Meas BW

Allows you to specify a multiplier of Res BW for the measurement integration bandwidth.

Meas BW is multiplier integer number. It shows a ratio between Integration BW and Resolution BW of the measurement result:

$$\text{Integ BW} = \text{Meas BW} * \text{Resolution BW}$$

Integration BW is desired resolution bandwidth and Resolution BW is actual bandwidth for sweep. Measurement sweeps with Resolution BW and **Meas BW** compensates sweep resolution bandwidth to Integration BW.

When sending the remote command, missing values are not permitted; that is, if you want to change values 2 and 6, you must send all values up to 6. Subsequent values will remain as they were. The query always returns 20 values.

Remote Command	[:SENSe]:SPURious[:RANGe][:LIST]:BANDwidth:IMULTi <integer>, ... [:SENSe]:SPURious[:RANGe][:LIST]:BANDwidth:IMULTi?	
Example	:SPUR:BAND:IMUL 1,1,1,1,1,1 :SPUR:BAND:IMUL?	

3 VMA Mode
3.10 Spurious Emissions Measurement

Notes	Comma-separated list of values
Preset	1, 1, 1, 1, 1, 1, 1, 1, 1, 1, 1, 1, 1, 1, 1, 1, 1, 1, 1, 1
State Saved	Yes
Max	1000
Min/Max	1
Backwards Compatibility SCPI	<code>[:SENSe]:SPURious[:RANGe][:LIST]:BWIDth:IMULti</code>

Video BW

Sets the **Video BW** mode of the instrument. This can be Auto, where the instrument determines the optimum setting, or Manual, where you determine the setting. This parameter can send up to 20 values. The location in the list sent corresponds to the range the value is associated with. When sending the remote command, missing values are not permitted; that is, if you want to change values 2 and 6, then you must send all values up to 6. Subsequent values will remain as they were.

The query always returns 20 values.

Remote Command	<code>[:SENSe]:SPURious[:RANGe][:LIST]:BANDwidth:VIDeo <freq>, <freq>, <freq>, <freq>, <freq>, <freq>, <freq>, <freq>, <freq>, <freq>, <freq>, <freq>, <freq>, <freq>, <freq>, <freq>, <freq>, <freq>, <freq></code> <code>[:SENSe]:SPURious[:RANGe][:LIST]:BANDwidth:VIDeo?</code>
Example	<code>:SPUR:BAND:VID 1kHz, 10kHz, 100kHz, 1MHz, 1MHz, 1MHz, 1MHz, 3MHz, 3MHz, 3MHz, 3MHz, 3MHz, 3MHz, 3MHz, 3MHz, 3MHz, 3MHz, 3MHz, 3MHz</code> <code>:SPUR:BAND:VID?</code>
Preset	SA, WCDMA, WLAN Modes: Automatically calculated LTE, LTEAFDD, MSR Modes: 4.7kHz, 47kHz, 470kHz, 5MHz, 470kHz, 5MHz, 5MHz, 300kHz, 300kHz, 300kHz, 300kHz, 300kHz, 300kHz, 300kHz, 300kHz, 300kHz, 300kHz, 300kHz, 300kHz, 300kHz LTETDD, LTEATDD Modes: 4.7kHz, 47kHz, 470kHz, 5MHz, 5MHz, 5MHz, 5MHz, 300kHz, 300kHz, 300kHz, 300kHz, 300kHz, 300kHz, 300kHz, 300kHz, 300kHz, 300kHz, 300kHz, 300kHz 5G NR Mode: 100 Hz, 1 kHz, 10 kHz, 100 kHz, 100 kHz, 100 kHz, 100 kHz, 300 kHz, 300 kHz, 300 kHz, 300 kHz, 300 kHz, 300 kHz, 300 kHz, 300 kHz, 300 kHz, 300 kHz, 300 kHz, 300 kHz
State Saved	Saved in instrument state
Min/Max	1 Hz/50 MHz
Backwards Compatibility SCPI	<code>[:SENSe]:SPURious[:RANGe][:LIST]:BWIDth:VIDeo</code>

Auto Function

Enabled

Same as the **Enabled** checkbox under the **Bandwidth** tab. See ["Enabled" on page 1682](#)

Frequency Type

Selects the frequency type as either **ABSolute** or **OFFSet**:

ABSolute The frequency range is determined by Abs Start Freq and Abs Stop Freq. Absolute and offset frequencies are not coupled

OFFSet The frequency range is determined based on Offset Start Freq and Offset Stop Freq. Abs Start Freq and Abs Stop Freq are coupled with the offset parameters and show the actual frequency ranges. The following coupling equations are used to calculate Abs Start Freq and Abs Stop Freq

When Offset Side is Negative:

$$[\text{Abs Start Freq}] = [\text{OB Start Freq}] - [\text{Offset Stop Freq}]$$

$$[\text{Abs Stop Freq}] = [\text{OB Start Freq}] - [\text{Offset Start Freq}]$$

When Offset Side is Positive:

$$[\text{Abs Start Freq}] = [\text{OB Stop Freq}] + [\text{Offset Start Freq}]$$

$$[\text{Abs Stop Freq}] = [\text{OB Stop Freq}] + [\text{Offset Stop Freq}]$$

When changing OB Start/Stop Freq, Abs Start/Stop Freq is changed and Offset Start/Stop Freq remains unchanged.

When changing Offset Start/Stop Freq, Abs Start/Stop Freq is changed and OB Start/Stop Freq remains unchanged.

Remote Command	<pre>[:SENSe]:SPURious[:RANGe][:LIST]:FREQuency:TYPE ABSolute OFFSet, ABSolute OFFSet, ABSolute OFFSet, ABSolute OFFSet, ABSolute OFFSet, ABSolute OFFSet, ABSolute OFFSet, ABSolute OFFSet, ABSolute OFFSet, ABSolute OFFSet, ABSolute OFFSet, ABSolute OFFSet, ABSolute OFFSet, ABSolute OFFSet, ABSolute OFFSet, ABSolute OFFSet</pre>
Example	<pre>[:SENSe]:SPURious[:RANGe][:LIST]:FREQuency:TYPE? :SPUR:FREQ:TYPE OFFS, OFFS, ABS, ABS, ABS :SPUR:FREQ:TYPE?</pre>
Couplings	<p>Freq Type automatically changes to OFFSet when you change a value of Offset Start Freq, Offset Stop Freq or Offset Side, and automatically changes to ABSolute when you change a value of Abs Start Freq or Abs Stop Freq</p>
Preset	<pre>ABSolute, ABSolute, ABSolute, ABSolute, ABSolute, ABSolute, ABSolute, ABSolute, ABSolute, ABSolute, ABSolute, ABSolute, ABSolute, ABSolute,</pre>

	<code>ABSolute, ABSolute, ABSolute, ABSolute, ABSolute, ABSolute</code>
State Saved	Saved in instrument state
Range	<code>ABSolute OFFSet</code>

Abs Start Freq

Sets the start frequency of the instrument. This parameter can send up to 20 values. The location where the start frequency occurs in the list sent to the measurement corresponds to the range the value is associated with.

This parameter is coupled with either Offset Start Freq or Offset Stop Freq. The coupling equations are shown in ["Enabled" on page 1695](#).

When sending the remote command, missing values are not permitted; that is, if you want to change values 2 and 6 you must send all values up to 6. Subsequent values will remain as they were.

The query always returns 20 values.

Remote Command	<code>[:SENSe]:SPURious[:RANGe][:LIST]:FREQUency:STARt <freq>, <freq>, <freq>, <freq>, <freq>, <freq>, <freq>, <freq>, <freq>, <freq>, <freq>, <freq>, <freq>, <freq>, <freq>, <freq>, <freq>, <freq></code> <code>[:SENSe]:SPURious[:RANGe][:LIST]:FREQUency:STARt?</code>
Example	<code>:SPUR:FREQ:STAR 9 kHz, 150 kHz, 30 MHz, 1GHz, 1.5 GHz, 1.5 GHz, 1.5 GHz, 1.5 GHz, 1.5 GHz, 1.5 GHz, 1.5 GHz, 1.5 GHz, 1.5 GHz, 1.5 GHz, 1.5 GHz, 1.5 GHz, 1.5 GHz, 1.5 GHz, 1.5 GHz</code> <code>:SPUR:FREQ:STAR?</code>
Preset	9 kHz, 150 kHz, 30 MHz, 1 GHz, 1.92GHz, 1.98 GHz, 2.18 GHz, 1.5 GHz, 1.5 GHz, 1.5 GHz, 1.5 GHz, 1.5 GHz, 1.5 GHz, 1.5 GHz, 1.5 GHz, 1.5 GHz, 1.5 GHz, 1.5 GHz, 1.5 GHz, 1.5 GHz
State Saved	Saved in instrument state
Min/Max	-80 MHz/Hardware Dependent <ul style="list-style-type: none"> - Option 503: 3699999990 - Option 508: 8499999990 - Option 513: 13799999990 - Option 526: 26999999990

Abs Stop Freq

Sets the stop frequency of the instrument. This parameter can send up to 20 values. The location in the list sent corresponds to the range the value is associated with.

3 VMA Mode
 3.10 Spurious Emissions Measurement

This parameter is coupled with either ["Offset Start Freq" on page 1697](#) or ["Offset Stop Freq" on page 1698](#). The coupling equations are shown in ["Enabled" on page 1695](#).

The location of where the stop frequency occurs in the list sent to the measurement corresponds to the range the value is associated with.

When sending the remote command, missing values are not permitted; that is, if you want to change values 2 and 6 you must send all values up to 6. Subsequent values will remain as they were.

The query always returns 20 values.

Remote Command	<code>[:SENSe]:SPURious[:RANGe][:LIST]:FREQuency:STOP <freq>, <freq>, <freq>, <freq>, <freq>, <freq>, <freq>, <freq>, <freq>, <freq>, <freq>, <freq>, <freq>, <freq>, <freq>, <freq>, <freq>, <freq>, <freq>, <freq></code> <code>[:SENSe]:SPURious[:RANGe][:LIST]:FREQuency:STOP?</code>
Example	<code>:SPUR:FREQ:STOP 150kHz, 30MHz, 1GHz, 2.1GHz, 2.1GHz, 2.1774GHz, 2.18GHz, 12.75GHz, 2.5GHz, 2.5GHz, 2.5GHz, 2.5GHz, 2.5GHz, 2.5GHz, 2.5GHz, 2.5GHz, 2.5GHz, 2.5GHz, 2.5GHz, 2.5GHz, 2.5GHz</code> <code>:SPUR:FREQ:STOP?</code>
Preset	150kHz, 30MHz, 1GHz, 1.92GHz, 1.98GHz, 2.1GHz, 12.75GHz, 2.5GHz, 2.5GHz, 2.5GHz, 2.5GHz, 2.5GHz, 2.5GHz, 2.5GHz, 2.5GHz, 2.5GHz, 2.5GHz, 2.5GHz, 2.5GHz, 2.5GHz, 2.5GHz
State Saved	Yes
Min/Max	-79999990/Hardware Dependent: <ul style="list-style-type: none"> - Option 503: 3.7 GHz - Option 508: 8.5 GHz - Option 513: 13.8 GHz - Option 526: 27.0 GHz

Offset Start Freq

Sets the range frequency as offset from one of the operating band edges. This parameter can send up to 20 values. The location where the start frequency occurs in the list sent to the measurement corresponds to the range the value is associated with. When sending the remote command, missing values are not permitted; that is, if you want to change values 2 and 6 you must send all values up to 6. Subsequent values will remain as they were.

The query always returns 20 values.

This parameter is coupled with either ["Abs Start Freq" on page 1696](#) or ["Abs Stop Freq" on page 1696](#) using the coupling equations shown in ["Enabled" on page 1695](#).

This value is clipped to keep Abs Start/Stop Freq within the available frequency range. This clipping applies even when OB Start Freq, OB Stop Freq or Offset Side is changed.

Remote Command	<code>[:SENSe]:SPURious[:RANGe][:LIST]:OFFSet:FREQuency:STARt <freq>, <freq>, <freq>, <freq>, <freq>, <freq>, <freq>, <freq>, <freq>, <freq>, <freq>, <freq>, <freq>, <freq></code> <code>[:SENSe]:SPURious[:RANGe][:LIST]:OFFSet:FREQuency:STARt?</code>
Example	<code>:SPUR:OFFS:FREQ:STAR 9 kHz, 150 kHz, 30 MHz, 1GHz, 1.5 GHz, 1.5 GHz, 1.5 GHz, 1.5 GHz,1.5 GHz,1.5 GHz, 1.5 GHz, 1.5 GHz, 1.5 GHz,1.5 GHz,1.5 GHz,1.5 GHz,1.5 GHz</code> <code>:SPUR:OFFS:FREQ:STAR?</code>
Preset	10 MHz, 20 MHz, 30 MHz, 30 MHz, 30 MHz, 30 MHz, 30 MHz, 30 MHz, 30 MHz, 30 MHz, 30 MHz, 30 MHz, 30 MHz, 30 MHz, 30 MHz, 30 MHz
State Saved	Saved in instrument state
Min/Max	-80 MHz/SA Max Freq - 10Hz (Hardware Dependent)

Offset Stop Freq

Sets the range frequency as offset from one of operating band edges. This parameter can send up to 20 values. The location in the list sent corresponds to the range the value is associated with.

The location of where the stop frequency occurs in the list sent to the measurement corresponds to the range the value is associated with.

When sending the remote command, missing values are not permitted. If you want to change values 2 and 6, then you must send all values up to 6. Subsequent values will remain as they were. The query always returns 20 values.

This parameter is coupled with either ["Abs Start Freq" on page 1696](#) or ["Abs Stop Freq" on page 1696](#) using the coupling equations shown in ["Enabled" on page 1695](#).

This value is clipped to keep Abs Start/Stop Freq inside the available frequency range. This clipping applies even when OB Start Freq, OB Stop Freq or Offset Side is changed.

Remote Command	<code>[:SENSe]:SPURious[:RANGe][:LIST]:OFFSet:FREQuency:STOP <freq>, <freq>, <freq>, <freq>, <freq>, <freq>, <freq>, <freq>, <freq>, <freq>, <freq>, <freq>, <freq>, <freq></code> <code>[:SENSe]:SPURious[:RANGe][:LIST]:OFFSet:FREQuency:STOP?</code>
Example	<code>:SPUR:OFFS:FREQ:STOP 150kHz, 30MHz, 1GHz, 2.1GHz, 2.1GHz, 2.1774GHz, 2.18GHz, 12.75GHz, 2.5GHz, 2.5GHz, 2.5GHz, 2.5GHz, 2.5GHz, 2.5GHz, 2.5GHz, 2.5GHz, 2.5GHz, 2.5GHz, 2.5GHz, 2.5GHz</code> <code>:SPUR:OFFS:FREQ:STOP?</code>
Preset	20 MHz,30 MHz, 30 MHz, 30 MHz, 30 MHz, 30 MHz, 30 MHz, 30 MHz, 30 MHz, 30 MHz, 30 MHz, 30 MHz, 30 MHz, 30 MHz, 30 MHz, 30 MHz

Preset	SSTop
State Saved	Saved in instrument state
Range	All Start/Stop Frequency Center Frequency/Span

Enabled

Same as Enabled under the **Bandwidth** index tab. See ["Enabled" on page 1682](#).

Start Freq

Same as the Start Freq column under the **Bandwidth** index tab. See ["Start Freq" on page 1683](#).

Stop Freq

Same as the Stop Freq column under the **Bandwidth** index tab. See ["Stop Freq" on page 1684](#).

Center Frequency

Sets the center frequency of the instrument. This parameter can send up to 20 values. The location where the center frequency occurs in the list sent to the measurement corresponds to the range the value is associated with.

When sending the remote command, missing values are not permitted. If you want to change values 2 and 6 you must send all values up to 6. Subsequent values will remain as they were.

The query always returns 20 values.

Remote Command	<code>[:SENSe]:SPURious[:RANGe][:LIST]:FREQuency:CENTer <freq>, <freq>, <freq>, <freq>, <freq>, <freq>, <freq>, <freq>, <freq>, <freq>, <freq>, <freq>, <freq>, <freq>, <freq>, <freq>, <freq>, <freq>, <freq>, <freq></code> <code>[:SENSe]:SPURious[:RANGe][:LIST]:FREQuency:CENTer?</code>
Example	<code>:SPUR:FREQ:CENT 9 kHz, 150 kHz, 30 MHz, 1GHz, 1.5 GHz, 1.5 GHz, 1.5 GHz, 1.5 GHz,1.5 GHz,1.5 GHz,1.5 GHz,1.5 GHz,1.5 GHz,1.5 GHz,1.5 GHz,1.5 GHz,1.5 GHz,1.5 GHz,1.5 GHz,1.5 GHz</code> <code>:SPUR:FREQ:CENT?</code>
Preset	(Preset of Start Freq + Preset of Stop Freq)/2
State Saved	No
Min/Max	-79.999995 MHz/ Instrument maximum frequency – 5 Hz

3 VMA Mode
3.10 Spurious Emissions Measurement

Preset	OFF, OFF, OFF, OFF, OFF, OFF, OFF, OFF, OFF, OFF, OFF, OFF, OFF, OFF, OFF, OFF, OFF, OFF, OFF, OFF
State Saved	Saved in instrument state
Range	Low High

Enabled

Same as the **Enabled** checkbox under the **Bandwidth** tab. See ["Enabled" on page 1682](#).

Res BW

Same as the **Enabled** checkbox under the **Bandwidth** tab. See ["Res BW" on page 1690](#).

Meas BW

Same as the Meas BW column under the **Bandwidth** tab. See ["Meas BW" on page 1692](#).

Video BW

Sets the **Video BW** mode of the instrument. This can be Auto, where the instrument determines the optimum setting, or Manual, where you determine the setting. This parameter can send up to 20 values. The location in the list sent corresponds to the range the value is associated with. When sending the remote command, missing values are not permitted; that is, if you want to change values 2 and 6, then you must send all values up to 6. Subsequent values will remain as they were.

The query always returns 20 values.

Remote Command	<code>[:SENSe]:SPURious[:RANGe][:LIST]:BANDwidth:VIDeo <freq>, <freq>, <freq>, <freq>, <freq>, <freq>, <freq>, <freq>, <freq>, <freq>, <freq>, <freq>, <freq>, <freq>, <freq>, <freq>, <freq>, <freq>, <freq>, <freq></code> <code>[:SENSe]:SPURious[:RANGe][:LIST]:BANDwidth:VIDeo?</code>
Example	<code>:SPUR:BAND:VID 1kHz, 10kHz, 100kHz, 1MHz, 1MHz, 1MHz, 1MHz, 3MHz, 3MHz, 3MHz, 3MHz, 3MHz, 3MHz, 3MHz, 3MHz, 3MHz, 3MHz, 3MHz, 3MHz, 3MHz</code> <code>:SPUR:BAND:VID?</code>
Preset	SA, WCDMA, WLAN Modes: Automatically calculated LTE, LTEAFDD, MSR Modes: 4.7kHz, 47kHz, 470kHz, 5MHz, 470kHz, 5MHz, 5MHz, 300kHz, 300kHz, 300kHz, 300kHz, 300kHz, 300kHz, 300kHz, 300kHz, 300kHz, 300kHz, 300kHz, 300kHz, 300kHz LTETDD, LTEATDD Modes:

3 VMA Mode
 3.10 Spurious Emissions Measurement

Remote Command	[:SENSe]:SPURious[:RANGe][:LIST]:ATTenuation <rel_ampl>, <rel_ampl>, <rel_ampl>, <rel_ampl>, <rel_ampl>, <rel_ampl>, <rel_ampl>, <rel_ampl>, <rel_ampl>, <rel_ampl>, <rel_ampl>, <rel_ampl>, <rel_ampl>, <rel_ampl>, <rel_ampl> [:SENSe]:SPURious[:RANGe][:LIST]:ATTenuation?
Example	:SPUR:ATT 10dB, 10dB, 10dB, 10dB, 10dB, 10dB, 10dB, 10dB, 10dB, 10dB, 10dB, 10dB, 10dB, 10dB, 10dB :SPUR:ATT?
Couplings	“---“ is displayed as value when Auto state is ON, to indicate attenuation value under AMPTD Y Scale is being used
Preset	10dB, 10dB, 10dB, 10dB, 10dB, 10dB, 10dB, 10dB, 10dB, 10dB, 10dB, 10dB, 10dB, 10dB, 10dB, 10dB, 10dB, 10dB
State Saved	Saved in instrument state
Min/Max	0 dB/70 dB
Auto Function	
Remote Command	[:SENSe]:SPURious[:RANGe][:LIST]:ATTenuation:AUTO OFF ON 0 1, OFF ON 0 1, OFF ON 0 1, OFF ON 0 1, OFF ON 0 1, OFF ON 0 1, OFF ON 0 1, OFF ON 0 1, OFF ON 0 1, OFF ON 0 1, OFF ON 0 1, OFF ON 0 1, OFF ON 0 1, OFF ON 0 1, OFF ON 0 1, OFF ON 0 1, OFF ON 0 1, OFF ON 0 1, OFF ON 0 1, OFF ON 0 1 [:SENSe]:SPURious[:RANGe][:LIST]:ATTenuation:AUTO?
Example	:SPUR:ATT:AUTO 0,0 :SPUR:ATT:AUTO?
Preset	ON, ON
State Saved	Saved in instrument state
Range	Auto Man

IF Gain

Same as the IF Gain column under the **Atten** tab. See "[IF Gain](#)" on page 1702.

Detector/Sweep

Lets you set Sweep, IF Gain, and Detector parameters for each Range.

Frequency Range

Allows you to switch the displayed **Frequency Range** columns. When **ALL** is selected, Start Frequency, Stop Frequency, Center Frequency, and Span are

displayed.

This control appears only in instruments with a 4U size front panel.

Remote Command	<code>:DISPlay:SPURious:VIEW:RANGe:TABLE:FMODE ALL SStop CSPan</code> <code>:DISPlay:SPURious:VIEW:RANGe:TABLE:FMODE?</code>
Example	<code>:DISP:SPUR:VIEW:RANG:TABL:FMOD ALL</code> <code>:DISP:SPUR:VIEW:RANG:TABL:FMOD?</code>
Preset	<code>SStop</code>
State Saved	Saved in instrument state
Range	All Start/Stop Frequency Center Frequency/Span

Enabled

Same as the **Enabled** checkbox under the **Bandwidth** tab. See "[Enabled](#)" on page 1682.

Start Freq

Same as the Start Freq column under the **Bandwidth** tab. See "[Start Freq](#)" on page 1683. This column does not appear in MSR mode.

Stop Freq

Same as the Stop Freq column under the **Bandwidth** tab. See "[Stop Freq](#)" on page 1684. This column does not appear in MSR mode.

Center Frequency

Same as the Center column under the **Bandwidth** index tab. See "[Center Frequency](#)" on page 1700.

Span

Same as the Span column under the **Bandwidth** tab. See "[Span](#)" on page 1690. This column does not appear in MSR mode.

Sweep Time

Sets the **Sweep Time** mode of the instrument. This can be **Auto**, where the instrument determines the optimum setting, or **Manual**, where you determine the setting.

This parameter can send up to 20 values. The location in the list sent corresponds to the range of the associated value. When sending the remote command, missing values are not permitted. If you want to change values 2 and 6, then you must send all values up to 6. Subsequent values will remain as they were.

The query always returns 20 values.

Remote Command	<code>[:SENSe]:SPURious[:RANGe][:LIST]:SWEep:TIME <time>, <time>, <time>, <time>, <time>, <time>, <time>, <time>, <time>, <time>, <time>, <time>, <time>, <time>, <time>, <time>, <time>, <time>, <time>, <time></code> <code>[:SENSe]:SPURious[:RANGe][:LIST]:SWEep:TIME?</code>
Example	<code>:SPUR:SWE:TIME 10,10,10,10,10,10,10,10,10,10,10,10,10,10,10,10,10,10,10,10</code> <code>:SPUR:SWE:TIME?</code>
Preset	Automatically calculated
State Saved	Saved in instrument state
Min/Max	1.0E-3/2.0E+3

Auto Function

Remote Command	<code>[:SENSe]:SPURious[:RANGe][:LIST]:SWEep:TIME:AUTO OFF ON 0 1,OFF ON 0 1,OFF ON 0 1,OFF ON 0 1,OFF ON 0 1,OFF ON 0 1,OFF ON 0 1,OFF ON 0 1,OFF ON 0 1,OFF ON 0 1,OFF ON 0 1</code> <code>[:SENSe]:SPURious[:RANGe][:LIST]:SWEep:TIME:AUTO?</code>
Example	<code>:SPUR:SWE:TIME:AUTO</code> <code>ON,ON,ON,ON,ON,ON,ON,ON,ON,ON,ON,ON,ON,ON,ON,ON,ON,ON,ON,ON</code> <code>:SPUR:SWE:TIME:AUTO?</code>
Preset	<code>ON, ON</code>
State Saved	Saved in instrument state
Range	<code>OFF ON</code>

Points

Sets the number of points per sweep for the measurement. This parameter can send up to 20 values. The location in the list sent corresponds to the range of the associated value. When sending the remote command, missing values are not permitted. If you want to change values 2 and 6, then you must send all values up to 6. Subsequent values will remain as they were. The query always returns 20 values.

The Points mode can be manual, where you determine the setting or auto, where the instrument determines the number of trace points to ensure the sweep points resolution equals RBW/2. This is calculated using the following algorithm:

$$\text{Points} = (\text{Stop Freq} - \text{Start Freq}) / (\text{ResBW} / 2)$$

3 VMA Mode
 3.10 Spurious Emissions Measurement

	<pre> NEGative NORMal POSitive SAMPlE RMS, AVERage NEGative NORMal POSitive SAMPlE RMS, AVERage NEGative NORMal POSitive SAMPlE RMS, AVERage NEGative NORMal POSitive SAMPlE RMS, AVERage NEGative NORMal POSitive SAMPlE RMS, AVERage NEGative NORMal POSitive SAMPlE RMS, AVERage NEGative NORMal POSitive SAMPlE RMS, AVERage NEGative NORMal POSitive SAMPlE RMS, AVERage NEGative NORMal POSitive SAMPlE RMS, AVERage NEGative NORMal POSitive SAMPlE RMS, AVERage NEGative NORMal POSitive SAMPlE RMS, AVERage NEGative NORMal POSitive SAMPlE RMS, AVERage NEGative NORMal POSitive SAMPlE RMS, AVERage NEGative NORMal POSitive SAMPlE RMS, AVERage NEGative NORMal POSitive SAMPlE RMS, AVERage NEGative NORMal POSitive SAMPlE RMS, AVERage NEGative NORMal POSitive SAMPlE RMS</pre> <pre>[[:SENSe]:SPURious[:RANGe][:LIST]:DETector[1][:FUNCTION]?</pre>
Example	<pre>:SPUR:DET NORM, :SPUR:DET?</pre>
Notes	For backwards compatibility, NORMal is available as a command parameter. However, this is treated the same as RMS internally, so the query never returns NORMal
Preset	POS, POS, POS, POS, POS, POS, POS, POS, POS, POS, POS, POS, POS, POS, POS, POS, POS, POS, POS, POS
State Saved	Saved in instrument state
Range	Normal Average Peak Sample Negative Peak

Detector 2

Sets the detector to be used by the trace for display purposes only.

Remote Command	<pre>[[:SENSe]:SPURious[:RANGe][:LIST]:DETector2[:FUNCTION] OFF AVERage NEGative NORMal POSitive SAMPlE RMS, OFF AVERage NEGative NORMal POSitive SAMPlE RMS, OFF AVERage NEGative NORMal POSitive SAMPlE RMS, OFF AVERage NEGative NEGative NORMal POSitive SAMPlE RMS, OFF AVERage NEGative NORMal POSitive SAMPlE RMS, OFF AVERage NEGative NORMal POSitive SAMPlE RMS, OFF AVERage NEGative NORMal POSitive SAMPlE RMS, OFF AVERage NEGative NORMal POSitive SAMPlE RMS, OFF AVERage NEGative NORMal POSitive SAMPlE RMS, OFF AVERage NEGative NORMal POSitive SAMPlE RMS, OFF AVERage NEGative NORMal POSitive SAMPlE RMS, OFF AVERage NEGative NORMal POSitive SAMPlE RMS, OFF AVERage NEGative NORMal POSitive SAMPlE RMS, OFF AVERage NEGative NORMal POSitive SAMPlE RMS, OFF AVERage NEGative NORMal POSitive SAMPlE RMS, OFF AVERage NEGative NORMal POSitive SAMPlE RMS, OFF AVERage NEGative NORMal POSitive SAMPlE RMS, OFF AVERage NEGative NORMal POSitive SAMPlE RMS, OFF AVERage NEGative NORMal POSitive SAMPlE RMS, OFF AVERage NEGative NORMal POSitive SAMPlE RMS</pre> <pre>[[:SENSe]:SPURious[:RANGe][:LIST]:DETector2[:FUNCTION]?</pre>
Example	<pre>:SPUR:DET2 AVER, AVER</pre>

:SPUR:DET?	
Notes	For backward compatibility, "NORMa1" is available as a SCPI command parameter. However, this is treated same as "RMS" internally, so the query never returns "NORMa1" as its results
Preset	OFF, OFF, OFF, OFF, OFF, OFF, OFF, OFF, OFF, OFF, OFF, OFF, OFF, OFF, OFF, OFF, OFF, OFF, OFF, OFF
State Saved	Saved in instrument state
Range	Off Normal Average Peak Sample Negative Peak

Limits

Lets you set Start and Stop Limits and Threshold values for each Range.

Frequency Range

Same as **Frequency Range** under the **Bandwidth** tab. See "[Frequency Range](#)" on [page 1705](#). This control does not appear in MSR mode.

Enabled

Same as the **Enabled** checkbox under the **Bandwidth** tab. See "[Enabled](#)" on [page 1682](#).

Start Freq

Same as the Start Freq column under the **Bandwidth** tab. See "[Start Freq](#)" on [page 1683](#). This column does not appear in MSR.

Stop Freq

Same as the Stop Freq column under the **Bandwidth** tab. See "[Stop Freq](#)" on [page 1684](#). This column does not appear in MSR.

Center Frequency

Same as the Center column under the **Bandwidth** tab. See "[Center Frequency](#)" on [page 1700](#). This column does not appear in MSR mode.

Span

Same as the Span column under the **Bandwidth** tab. See "[Span](#)" on page 1690. This column does not appear in MSR mode.

Abs Start Limit

Determines the limit above which spurs will report a failing. If Abs Stop Limit Mode is set to **Auto**, this is coupled to **Abs Stop Limit** to make a flat limit line. If set to **Man**, Abs Start Limit and Abs Stop Limit can take different values to make a sloped limit line.

If the Limit Line Test parameter is off, then any spurs that are found to be above the current 'Peak Excursion' are added to the results table. From these spurs, the amplitude is checked using the abs limit start and abs limit stop parameters, then the limit is calculated. An 'F' is appended to the amplitude value of the spur if the measured amplitude is above the limit. If the Limit Line Test is on, only the spurs whose amplitudes exceed the limit are reported.

This parameter can send up to 20 values. The location in the list sent corresponds to the range of the associated value. When sending the remote command, missing values are not permitted. If you want to change values 2 and 6, then you must send all values up to 6. Subsequent values will remain as they were.

The query always returns 20 values.

Remote Command	<pre>:CALCulate:SPURious[:RANGe][:LIST]:LIMit:ABSolute[:UPPer]:DATA[:START] <ampl>, <ampl>, <ampl>, <ampl>, <ampl>, <ampl>, <ampl>, <ampl>, <ampl>, <ampl>, <ampl>, <ampl>, <ampl>, <ampl>, <ampl>, <ampl>, <ampl>, <ampl>, <ampl>, <ampl>, <ampl>, <ampl> :CALCulate:SPURious[:RANGe][:LIST]:LIMit:ABSolute[:UPPer]:DATA[:START]?</pre>
Example	<pre>:CALC:SPUR:LIM:ABS:DATA 0,0 :CALC:SPUR:LIM:ABS:DATA?</pre>
Preset	<pre>SA Mode: -5.00000000E+001, -5.00000000E+001, -5.00000000E+001, -5.00000000E+001, - 5.00000000E+001, -5.00000000E+001, -5.00000000E+001, -5.00000000E+001, - 5.00000000E+001, -5.00000000E+001, -5.00000000E+001, -5.00000000E+001, - 5.00000000E+001, -5.00000000E+001, -5.00000000E+001, -5.00000000E+001, - 5.00000000E+001, -5.00000000E+001, -5.00000000E+001, -5.00000000E+001 WCDMA Mode: -36dBm, -36dBm, -36dBm, -30dBm, -25dBm, -15dBm, -25dBm, -30dBm, -50dBm, - 50dBm, -50dBm, -50dBm, -50dBm, -50dBm, -50dBm, -50dBm, -50dBm, -50dBm, -50dBm, -50dBm, -50dBm LTE, LTEAFDD, MSR Modes: -36dBm, -36dBm, -36dBm, -30dBm, -96dBm, -30dBm, -30dBm, - 50dBm, -50dBm, -50dBm, -50dBm, -50dBm, -50dBm, -50dBm, -50dBm, -50dBm, -50dBm, -50dBm, -50dBm, -50dBm LTETDD, LTEATDD, 5G NR Modes: -36dBm, -36dBm, -36dBm, -30dBm, -30dBm, -30dBm, -30dBm, - 50dBm, -50dBm, -50dBm, -50dBm, -50dBm, -50dBm, -50dBm, -50dBm, -50dBm, -50dBm, -50dBm, -50dBm, -50dBm</pre>

	-50dBm, -50dBm WLAN Mode: -36dBm, -36dBm, -36dBm, -30dBm, -50dBm, -50dBm, -50dBm, -50dBm, -50dBm, -50dBm, -50dBm, -50dBm, -50dBm, -50dBm, -50dBm, -50dBm, -50dBm, -50dBm, -50dBm
State Saved	Saved in instrument state
Min/Max	-200.0 dBm/50.0 dBm

Abs Stop Limit

Determines the limit above which spurs will report a failing. If Abs Stop Limit Mode is set to **Auto**, this is coupled to **Abs Start Limit** to make a flat limit line. If set to **Man**, Abs Start Limit and Abs Stop Limit can take different values to make a sloped limit line.

Abs Stop Limit Mode, when set to Couple, couples Abs Start Limit and Abs Stop Limit to make a flat limit line. If set to Man, Abs Start and Abs Stop can take different values to make a sloped limit line.

This parameter can send up to 20 values. The location in the list sent corresponds to the range of the associated value. When sending the remote command, missing values are not permitted; that is, if you want to change values 2 and 6, then you must send all values up to 6. Subsequent values will remain as they were. The query for this parameter always returns 20 values.

Remote Command	<code>:CALCulate:SPURious[:RANGE][:LIST]:LIMit:ABSolute[:UPPer]:DATA:STOP <ampl>, <ampl>, <ampl>, <ampl>, <ampl>, <ampl>, <ampl>, <ampl>, <ampl>, <ampl>, <ampl>, <ampl>, <ampl>, <ampl>, <ampl>, <ampl>, <ampl>, <ampl>, <ampl>, <ampl></code> <code>:CALCulate:SPURious[:RANGE][:LIST]:LIMit:ABSolute[:UPPer]:DATA:STOP?</code>
Example	<code>:CALC:SPUR:LIM:ABS:DATA:STOP -25, -25, -25, -25, -25, -25, -25, -25, -25, -25, -25, -25, -25, -25, -25, -25, -25, -25, -25, -25</code> <code>:CALC:SPUR:LIM:ABS:DATA:STOP?</code>
Preset	SA Mode: -5.00000000E+001, -5.00000000E+001, -5.00000000E+001, -5.00000000E+001, -5.00000000E+001, -5.00000000E+001, -5.00000000E+001, -5.00000000E+001, -5.00000000E+001, -5.00000000E+001, -5.00000000E+001, -5.00000000E+001, -5.00000000E+001, -5.00000000E+001, -5.00000000E+001, -5.00000000E+001, -5.00000000E+001, -5.00000000E+001, -5.00000000E+001, -5.00000000E+001 WCDMA Mode: -36dBm, -36dBm, -36dBm, -30dBm, -25dBm, -15dBm, -25dBm, -30dBm, -50dBm, -50dBm, -50dBm, -50dBm, -50dBm, -50dBm, -50dBm, -50dBm, -50dBm, -50dBm, -50dBm, -50dBm, -50dBm LTETDD, LTEATDD, 5G NR Modes: -36dBm, -36dBm, -36dBm, -30dBm, -30dBm, -30dBm, -30dBm, -50dBm, -50dBm, -50dBm, -50dBm, -50dBm, -50dBm, -50dBm, -50dBm, -50dBm, -50dBm, -50dBm, -50dBm, -50dBm, -50dBm LTE, LTEAFDD, MSR Modes: -36dBm, -36dBm, -36dBm, -30dBm, -96dBm, -30dBm, -30dBm, -50dBm, -50dBm, -50dBm, -50dBm, -50dBm, -50dBm, -50dBm, -50dBm, -50dBm, -50dBm, -50dBm, -50dBm, -50dBm, -50dBm, -50dBm

	+6.00000000E+000, +6.00000000E+000, +6.00000000E+000, +6.00000000E+000, +6.00000000E+000, +6.00000000E+000, +6.00000000E+000, +6.00000000E+000
State Saved	Saved in instrument state
Min/Max	0.0 dB/100.0 dB

Pk Threshold

Sets the minimum amplitude of signals that can be identified as peaks. For example, if a value of -90 dBm is selected, only peaks that rise and fall more than the peak excursion value which are above -90 dBm are identified.

This parameter can send up to 20 values. The location in the list sent corresponds to the range of the associated value. When sending the remote command, missing values are not permitted. If you want to change values 2 and 6, then you must send all values up to 6. Subsequent values will remain as they were.

The query always returns 20 values.

Remote Command	<code>[:SENSe]:SPURious[:RANGe][:LIST]:PEAK:THReshold <real>, <real>, <real>, <real>, <real>, <real>, <real>, <real>, <real>, <real>, <real>, <real>, <real>, <real>, <real>, <real>, <real>, <real>, <real>, <real></code> <code>[:SENSe]:SPURious[:RANGe][:LIST]:PEAK:THReshold?</code>
Example	<code>:SPUR:PEAK:THR 0,0,0</code> <code>:SPUR:PEAK:THR?</code>
Preset	-9.00000000E+001, -9.00000000E+001, -9.00000000E+001, -9.00000000E+001, -9.00000000E+001, -9.00000000E+001, -9.00000000E+001, -9.00000000E+001, -9.00000000E+001, -9.00000000E+001, -9.00000000E+001, -9.00000000E+001, -9.00000000E+001, -9.00000000E+001, -9.00000000E+001, -9.00000000E+001, -9.00000000E+001, -9.00000000E+001, -9.00000000E+001, -9.00000000E+001
State Saved	Saved in instrument state
Min/Max	-200/0

Meas Setup Summary Table

Lets you view and access many of the parameters in the Meas Setup menus on one screen.

Auto Couple

Immediately puts all **Auto/Man** functions into **Auto**. **Auto Couple** is confined to the current measurement only. It does not affect other measurements in the Mode.

In the **Auto** state, **Auto/Man** functions are said to be “coupled”, meaning their values change as you make changes to other values in the measurement. This helps ensure

3 VMA Mode

3.10 Spurious Emissions Measurement

accurate measurements and optimum dynamic range. **Auto Couple** is an immediate action function, and when it is executed, all the **Auto/Man** controls for the current measurement are set to **Auto**, and all measurement settings coupled to the **Auto/Man** parameters are automatically set to their optimal values.

For further details of measurement-specific settings (if any), see "[Measurement-Specific Details](#)" on page 1715 below.

Remote Command	:COUPl ^e ALL
Example	:COUP ALL
Backwards Compatibility SCPI	:COUPLE ALL NONE
Backwards Compatibility Notes	:COUP:NONE puts all Auto/Man parameters in manual mode, decoupling all the coupled instrument parameters. It is retained for backwards compatibility and is <i>not</i> recommended for making measurements or new designs

All **Auto/Man** parameter couplings in the measurement are set to **Auto**. This includes couplings that may be unavailable or grayed-out due to the current state. For example, in the Swept SA measurement, there is no **Auto/Man** coupling for **RBW** while in Zero Span. Nonetheless, if **Auto Couple** were executed while in Zero Span, it would set **RBW** to Auto "behind the scenes" so that, on exit from Zero Span, it would be in **Auto**.

Any **Auto/Man** selection specific (local) to the other measurements in the current Mode are not affected by **Auto Couple**. Any functions that are *not* coupled with other instrument parameters, such as ranging or leveling variables, such as **AutoRange** or **AutoScale**, are not affected.

Executing **Auto Couple** generates the informational message, "All Auto/Man functions have been set to Auto".

Each parameter, upon being set to **Auto**, selects and sets the appropriate auto-coupled value based on that parameter's coupling rules. The Dependency Resolver orchestrates the couplings for parameters that depend on one or more other parameters. The coupling and dependency rules for each parameter are defined in the section describing that parameter.

Executing **Auto Couple** does *not* affect markers, marker functions, trace or display attributes, or any other instrument setting other than those specifically mentioned above.

Measurement-Specific Details

TOI (SA Mode only)

Parameters affected by **Auto Couple** are:

- Center Frequency Step
- Resolution Bandwidth
- Span/RBW Ratio
- Sweep Time
- Video BANDwidth VBW/RBW ratio
- Upper and Lower Tone (set to Sense)
- Zero span measurement Resolution Bandwidth
- Zero span measurement Dwell Time

Harmonics (SA Mode only)

Parameters affected by **Auto Couple** are:

- Resolution Bandwidth
- Fundamental Frequency
- Dwell Time
- Range Table Resolution Bandwidths
- Range Table Dwell Times

Meas Preset

Restores all measurement parameters to their default values.

Remote Command **:CONFigure:SPURious**

Example **:CONF:SPUR**

Fast Spurious Meas (Remote Command only)

This command is the backward compatibility command for the Fast Spurious Measurement. Since this command is another representation of Spurious Report Mode, it is coupled with that command.

- When set to **ON**, only spurs above the limit line are reported. This is the same as Spurious Report Mode **LIMTest**

3 VMA Mode

3.10 Spurious Emissions Measurement

- When set to **OFF**, all detected spurs are reported. This is the same as Spurious Report Mode **ALL**

Remote Command	<code>[:SENSe]:SPURious:FSMeas ON OFF 1 0</code> <code>[:SENSe]:SPURious:FSMeas?</code>
Example	<code>:SPUR:FSM ON</code> <code>:SPUR:FSM?</code>
Couplings	If <code>:SPUR:REPT:MODE</code> is ALL , this parameter is OFF If <code>:SPUR:REPT:MODE</code> is LIMTest , this parameter is ON
Preset	OFF
State Saved	Saved in instrument state

3.10.8.2 Advanced

Contains controls for setting advanced functions of the instrument.

This tab does not appear in VXT.

Noise Floor Extension

Allows you to turn on/configure the **Noise Floor Extension** (NFE) function. Some Modes (such as Spectrum Analyzer), support two states of NFE, Full and Adaptive. The **ON** state (in Modes that do not support Adaptive NFE) matches the **FULL** state (in Modes that *do* support Adaptive NFE).

In **ON** or **FULL** NFE, the expected noise power of the instrument (derived from a factory calibration) is subtracted from the trace data. This will usually reduce the apparent noise level by about 10 dB in low band, and 8 dB in high band (>~3.6 GHz).

In Adaptive NFE, there is not the same dramatic visual impact on the noise floor as there is in Full NFE. Adaptive NFE controls the amount of correction that is applied based on other instrument settings like RBW, averaging and sweep time. Adaptive NFE controls the degree of potential improvement in the noise floor to give more improvement for those instrument settings that can make good use of the potential improvement, such as settings that provide more averaging. The result is that when not much averaging is being performed, the signal displays more like the NFE-off case; and when lots of averaging is being performed, the signal displays more like the full-NFE case.

Adaptive NFE (in Modes that support it) is recommended for general-purpose use. For fully ATE (automatic test equipment) applications, where the distraction of a person using the instrument is not a risk, Full NFE is recommended.

NFE works with any RBW, VBW, detector, any setting of Average Type, any amount of trace averaging, and any signal type. It is ineffective when the trace is not

smoothed (smoothing processes include narrow VBWs, trace averaging, and long sweep times with the detector set to Average or Peak). It works best with extreme amounts of smoothing, and with the average detector, with the Average Type set to Power.

In those cases where the cancellation is ineffective, it nonetheless has no undesirable side-effects. There is no significant speed impact in having **Noise Floor Extension** on.

The best accuracy is achieved when substantial smoothing occurs in each point before trace averaging. Thus, when using the average detector, results are better with long sweep times and fewer trace averages. When using the sample detector, the VBW filter should be set narrow with less trace averaging, instead of a wide VBW filter with more trace averaging.

NOTE

Noise Floor Extension has no effect unless the RF Input is selected, therefore it does nothing when **External Mixing** is selected.

In Modes that support Adaptive NFE, the default state of NFE is **Adaptive**. In Modes that do not support Adaptive NFE, the default state of NFE is **OFF**. Prior to the introduction of Adaptive NFE (firmware version A.18.00), the default state of NFE was **OFF** for all Modes.

With the introduction of Adaptive NFE, the menu control is changed from **On/Off** to **Full/Adaptive/Off**. For SCPI Backwards Compatibility, the existing SCPI command to turn NFE on and off was retained, and a new command was added to set the state to turn Adaptive On and Off

`[:SENSe] :CORRection:NOISe:FLOor ON|OFF|1|0` is retained, default changed to On for modes which support Adaptive NFE

`[:SENSe] :CORRection:NOISe:FLOor:ADAPtive ON|OFF|1|0` is added (for certain Modes), default=On

FULL = `:CORRection:NOISe:FLOor ON` plus
`:CORRection:NOISe:FLOor:ADAPtive ON`

Remote Command	<code>[:SENSe] :CORRection:NOISe:FLOor ON OFF 1 0</code> <code>[:SENSe] :CORRection:NOISe:FLOor?</code>
Example	<code>:CORR:NOIS:FLO ON</code>
Dependencies	Only appears in instruments with the NFE or NF2 license installed. In all others, the control does not appear, but the SCPI command is accepted without error (but has no effect)
Couplings	If NFE is enabled in any Mode manually, a prompt is displayed reminding you to perform the Characterize Noise Floor operation if it is needed If NFE is enabled via SCPI and a Characterize Noise Floor operation is needed, an error will be entered in the system error queue
Preset	Unaffected by Mode Preset . Turned ON at startup and by Restore Mode Defaults in Modes that support Adaptive. Turned OFF at startup and by Restore Mode Defaults in Modes that do not support

3 VMA Mode
3.10 Spurious Emissions Measurement

	Adaptive
State Saved	No
Remote Command	<code>[:SENSe]:CORRection:NOISe:FLOor:ADAPtive ON OFF 1 0</code> <code>[:SENSe]:CORRection:NOISe:FLOor:ADAPtive?</code>
Example	First turn NFE on, this is Full mode <code>:CORR:NOIS:FLO ON</code> Then set it to Adaptive <code>:CORR:NOIS:FLO:ADAP ON</code>
Dependencies	Only available in Modes that support Adaptive NFE Only appears in instruments with the NFE or NF2 license installed. In all others, the control does not appear, however the SCPI command is accepted without error, but has no effect
Couplings	Sending <code>:CORR:NOIS:FLO ON</code> turns NFE Adaptive OFF for backwards compatibility, so to turn Adaptive on, you must issue the commands in the proper order, as shown in the example above
Preset	Not affected by Mode Preset , but set to ON at startup and by Restore Mode Defaults
State Saved	No

More Information

The instrument is characterized in the factory (or during a field calibration) with a model of the noise, referred to the input mixer, versus frequency in each band and path combination. Bands are 0 (low band) and 1 through 4 (high band) in a 26.5 GHz instrument, for example. Paths include normal paths, preamp paths, the electronic attenuator, etc.

In most band/path combinations, the noise can be well characterized based on just two parameters and the instrument frequency response before compensation for frequency-dependent losses.

After the noise density at the input mixer is estimated, the effects of the input attenuator, RBW, detector, etc. are computed to get the estimated input-port-referred noise level.

In the simplest case, the measured power (signal plus analyzer noise) in each display point (bucket) is compensated by subtracting the estimated noise power, leaving just the signal power. This is the operation when the detector is Average, and the Average Type is set to Power.

In other cases, operation is often not quite as good but still highly effective. With peak detection, the noise floor is estimated based on the RBW and the duration of the bucket using the same equations used in the noise marker function. The voltage of the noise is subtracted from the voltage of the observed signal-plus-noise measurement to compute the estimated signal voltage. The peak detector is one example of processing that varies with detector to give good estimates of the signal level without the analyzer noise.

For best operation, the average detector and the power scale are recommended, as already stated. Peak detection for pulsed-RF can still give excellent effectiveness. FFT analysis does not work well, and does not do NFE well, with pulsed-RF signals, so this combination is not recommended. Negative peak detection is not very useful, either. Sample detection works well, but is never better than the average detector because it doesn't smooth as well. The Normal detector is a combination of peak and negative peak behaviors, and works about as well as these.

For best operation, extreme smoothing is desirable, as already stated. Using narrow VBWs works well, but using very long bucket durations and the average detector works best. Reducing the number of trace points will make the buckets longer.

For best operation, the power scale (Average Type = Power) is optimum. When making CW measurements in the presence of noise without NFE, averaging on the decibel scale has the advantage of reducing the effect of noise. When using NFE, the NFE does an even better job than using the log scale ever could. Using NFE with the log scale is not synergistic, though; NFE with the power scale works a little better than NFE with log averaging type.

The results from NFE with internal preamp can often be lower than the theoretical noise in a signal source at room temperature, a noise density of -174 dBm/Hz. This is expected and useful behavior, because NFE is designed to report the amount of input signal that is in excess of the thermal noise, not the amount that includes the thermal noise. This can be a useful behavior because thermal noise often interferes with what you want to measure, instead of being part of what you want to measure. Note that NFE is not adequately accurate to always be able to read below kTB.

Adaptive NFE provides an alternative to fully-on and -off NFE. Fully-on NFE can, notably in cases with little or no averaging of the spectrum, result in a display that is distractingly unfamiliar in the variability in response to low level signals. Fully-off NFE fails to achieve the potential improvement in dynamic range and associated accuracy of measurement of low-level signals. Adaptive NFE controls the degree of potential improvement in the noise floor to give more improvement for those instrument settings that can make good use of the potential improvement—those settings with high degrees of variance reduction through some variant of averaging. When the potential improvement is small, the display acts like the NFE-off case, and when it is high, it acts like the fully-on case, and in-between, application is a compromise between attractiveness and effectiveness.

On instruments with the NF2 license installed, the calibrated Noise Floor used by Noise Floor Extensions should be refreshed periodically. Keysight recommends that the **Characterize Noise Floor** operation be performed after the first 500 hours of operation, and once every calendar year. The control to perform this is located in the **System, Alignments, Advanced** menu. If you have not done this yourself at the recommended interval, then when you turn on Noise Floor Extensions, the instrument will prompt you to do so with a dialog that says:

“This action will take several minutes to perform. Please disconnect all cables from the RF input and press Enter to proceed. Press ESC to cancel, or Postpone to postpone for a week”

If you Cancel, you will be prompted again the next time you turn NFE on. If you postpone, you will be prompted again after a week passes and you then turn NFE on.

3.10.8.3 Global

The controls in this menu apply to all Modes in the instrument.

Some controls (for example, "[Global Center Freq](#)" on page 1828) allow you to switch certain Meas Global parameters to a Mode Global state. These switches apply to all Modes that support global settings. For example, no matter what Mode you are in when you set **Global Center Freq** to **ON**, it applies to all Modes that support Global settings.

Other controls (for example, **Extend Low Band**) are actually set in this menu, but apply to all Modes.

Global Center Freq

The software maintains a Mode Global value called **Global Center Freq**.

When **Global Center Freq** is switched **ON**, the current Mode's center frequency is copied into the **Global Center Frequency**, and from then on all Modes that support global settings use the **Global Center Frequency**, so you can switch between any of these Modes and the **Center Frequency** remains unchanged.

Adjusting the **Center Frequency** of any Mode that supports Global Settings, while **Global Center Freq** is **ON**, modifies the **Global Center Freq**.

When **Global Center Freq** is switched **OFF**, the **Center Frequency** of the current Mode is unchanged, but now the **Center Frequency** of each Mode is once again independent.

When **Mode Preset** is pressed while **Global Center Freq** is **ON**, the **Global Center Freq** is preset to the preset **Center Frequency** of the current Mode.

This function resets to **OFF** when "[Restore Defaults](#)" on page 1829 is pressed, or when **System, Restore Defaults, All Modes** is pressed.

Remote Command	:INSTrument:COUPle:FREQuency:CENTer ALL NONE
	:INSTrument:COUPle:FREQuency:CENTer?
Example	:INST:COUP:FREQ:CENT ALL
	:INST:COUP:FREQ:CENT?

Preset	Set to OFF on Global Settings, Restore Defaults and System, Restore Defaults, All Modes
Range	ALL NONE
Preset	OFF
Backwards Compatibility SCPI	:GLOBal:FREQuency:CENTer[:STATE] 1 0 ON OFF :GLOBal:FREQuency:CENTer[:STATE]?

Global EMC Std

When this control is switched **ON**, the current Mode's EMC Std is copied into the **Global EMC Std**, and from then on all Modes that support global settings use the **Global EMC Std**, so you can switch between any of these Modes and the EMC Std remains unchanged.

Adjusting the EMC Std of any Mode that supports Global settings, while **Global EMC Std** is **ON** modifies the **Global EMC Std**.

When **Global EMC Std** is switched **OFF**, the EMC Std of the current Mode remains unchanged, but now the EMC Std of each Mode is once again independent. When **Mode Preset** is pressed while **Global EMC Std** is **ON**, **Global EMC Std** is preset to the preset EMC Std of the current Mode.

This function resets to **OFF** when "**Restore Defaults**" on page 1829 is pressed, or when **System, Restore Defaults, All Modes** is pressed.

Remote Command	:INSTrument:COUPle:EMC:STANdard ALL NONE :INSTrument:COUPle:EMC:STANdard?
Example	:INST:COUP:EMC:STAN ALL :INST:COUP:EMC:STAN?
Dependencies	Only available if Option EMC is installed
Preset	Set to OFF on Global Settings, Restore Defaults and System, Restore Defaults, All Modes
Range	ALL NONE

Restore Defaults

Resets all functions in the **Global** settings menu to **OFF**. Pressing **System, Restore Defaults, All Modes** has the same effect.

Remote Command	:INSTrument:COUPle:DEFault
Example	:INST:COUP:DEF
Backwards Compatibility SCPI	:GLOBal:DEFault

3.10.9 Sweep

Accesses controls to configure and control the acquisition of data, and the X-axis parameters of the instrument.

Depending on the selected mode and measurement, these controls might include: **Sweep Time**, **Continuous/Single**, **Pause/Resume**, **X Scale** and **Number of Points**.

3.10.9.1 Sweep/Control

Accesses controls that let you operate the sweep and control functions of the instrument, such as **Sweep Time** and **Continuous/Single**.

Sweep/Measure

Lets you toggle between **Continuous** and **Single** sweep or measurement operation. The single/continuous state is Meas Global, so the setting affects all measurements.

The front-panel key **Single/Cont** performs exactly the same function

See "[More Information](#)" on page 1724

Remote Command	<code>:INITiate:CONTinuous OFF ON 0 1</code> <code>:INITiate:CONTinuous?</code>
Example	Put instrument into Single measurement operation: <code>:INIT:CONT 0</code> <code>:INIT:CONT OFF</code> Put instrument into Continuous measurement operation: <code>:INIT:CONT 1</code> <code>:INIT:CONT ON</code>
Preset	ON Note that <code>:SYST:PRES</code> sets <code>:INIT:CONT</code> to ON , but <code>*RST</code> sets <code>:INIT:CONT</code> to OFF
State Saved	Saved in instrument state
Annunciation	The Single/Continuous icon in the Meas Bar changes depending on the setting: <ul style="list-style-type: none"> - A line with an arrow is Single - A loop with an arrow is Continuous
Backwards Compatibility Notes	X-Series A-models had Single and Cont hardkeys in place of the SweepSingleCont softkey. In the X-Series A-models, if in single measurement, the Cont hardkey (and <code>INIT:CONT ON</code>) switched to continuous measurement, but never restarted a measurement and never reset a sweep X-Series B-models have a Cont/Single toggle control instead of Single and Cont hardkeys, but it is still

true that, if in single measurement, the **Cont/Single** toggle control never restarts a measurement and never resets a sweep

More Information

Continuous Mode	<p>The instrument takes repetitive sweeps, averages, measurements, etc., when in continuous mode. If in average or Max/Min Hold, and the average/hold count reaches the Average/Hold Num, the count stops incrementing, but the instrument keeps sweeping</p> <p>See the Trace key description under Trace Average for the averaging formula used both before and after the Average/Hold Num is reached. The trigger condition must be met prior to each sweep</p> <p>The type of trace processing for multiple sweeps is set under the Trace key, with choices of Trace Average, Max Hold, or Min Hold</p>
Single Mode	<p>The instrument takes a single sweep when in Single mode, or if in average or Max/Min Hold, or if there is a Waterfall window displayed, it takes multiple sweeps until the average/hold count reaches the Average/Hold Num, then the count stops incrementing, and the instrument stops sweeping</p> <p>See the Trace key description under Trace Average for the averaging formula used. The trigger condition must be met prior to the sweep</p> <p>The type of trace processing for multiple sweeps is set under the Trace key, with choices of Trace Average, Max Hold, or Min Hold</p>

If the instrument is in **Single** measurement mode, pressing the **Cont/Single** toggle control does not zero the count and does not cause the sweep to be reset; the only action is to put the instrument into Continuous measurement operation.

If the instrument is already in **Continuous** sweep:

- **:INIT:CONT 1** has no effect
- **:INIT:CONT 0** places the instrument in Single Sweep but has no effect on the current sequence until $k = N$, at which point the current sequence will stop and the instrument will go to the idle state

See "[Restart](#)" on page 1832 for details of **:INIT:IMMEDIATE**.

If the instrument is already in **Single** sweep, **:INIT:CONT OFF** has no effect.

If the instrument is already in **Single** sweep, then pressing **Cont/Single** in the middle of a sweep does not restart the sweep or sequence. Similarly, pressing **Cont/Single** does not restart the sweep or sequence if the sweep is not in the idle state (for example, if you are taking a very slow sweep, or the instrument is waiting for a trigger). Even though pressing **Cont/Single** in the middle of a sweep does not restart the sweep, sending **:INIT:IMM** does reset it.

If the instrument is in **Single** sweep, and *not* Averaging/Holding, and you want to take one more sweep, press **Restart**.

If the instrument is in **Single** sweep, *and* Averaging/Holding, and you want to take one more sweep without resetting the Average trace or count, go to **Meas Setup** and increment the average count by 1 by pressing the **Step-Up** key while **Average/Hold Num** is the active function. You can also do this by sending **:CALC: AVER: TCON UP**.

Restart

Restarts the current sweep, or measurement, or set of averaged/held sweeps or measurements. If you are Paused, pressing **Restart** performs a Resume.

The front-panel key **Restart** performs exactly the same function.

The **Restart** function is accessed in several ways:

- Pressing the **Restart** key
- Sending **:INIT: IMM**
- Sending **:INIT: REST**

See "[More Information](#)" on page 1726

Remote Command	:INITiate[: IMMEDIATE] :INITiate: RESTart
Example	:INIT: IMM :INIT: REST
Notes	:INIT: REST and :INIT: IMM perform exactly the same function
Couplings	Resets average/hold count k. For the first sweep overwrites all active (update = on) traces with new current data. For application modes, it resets other parameters as required by the measurement
Status Bits/OPC dependencies	This is an Overlapped command The STATus: OPERation register bits 0 through 8 are cleared , <i>except</i> bit 6 (Waiting for Periodic Sync). Initiating a measurement and Waiting for Periodic Sync could be asynchronous The STATus: QUESTionable register bit 9 (INTegrity sum) is cleared The SWEEPING bit is set The MEASURING bit is set
Backwards Compatibility Notes	For Spectrum Analysis Mode in ESA and PSA, the Restart hardkey and the :INIT: REST command restarted trace averages (displayed average count reset to 1) for a trace in Clear Write , but did not restart Max Hold and Min Hold In X-Series, the Restart hardkey and the :INIT: REST command restart not only Trace Average , but MaxHold and MinHold traces as well

More Information

The **Restart** function first aborts the current sweep or measurement as quickly as possible. It then resets the sweep and trigger systems, sets up the measurement and initiates a new data measurement sequence with a new data acquisition (sweep) taken once the trigger condition is met.

If the instrument is in the process of aligning when a **Restart** is executed, the alignment finishes before the restart function is performed.

Even when set for **Single** operation, multiple sweeps may be taken when **Restart** is pressed (for example, when averaging/holding is on). Thus, when we say that **Restart** "restarts a measurement", depending on the current settings, we may mean that it:

- Restarts the current sweep
- Restarts the current measurement
- Restarts the current set of sweeps if any trace is in Trace Average, Max Hold or Min Hold
- Restarts the current set of measurements if Averaging, or Max Hold, or Min Hold is on for the measurement

If there is no Average or Max/Min Hold function (no trace in Trace Average or Hold, or **Average/Hold Num** set to 1), and no **Waterfall** window is being displayed, a single sweep is equivalent to a single measurement. A single sweep is taken after the trigger condition is met; and the instrument stops sweeping once that sweep has completed. However, with **Average/Hold Num** >1, and at least one trace set to Trace Average, Max Hold, or Min Hold, or a **Waterfall** window being displayed, multiple sweeps/data acquisitions are taken for a single measurement. The trigger condition must be met prior to each sweep. The sweep is stopped when the average count k equals the number N set for **Average/Hold Num**.

Once the full set of sweeps has been taken, the instrument goes to the idle state. To take one more sweep without resetting the average count, increment the average count by 1, by pressing the **Step-Up** key while **Average/Hold Number** is the active function, or by sending the remote command **:CALC: AVER: TCON UP**.

Trace Update

The numeric results are not blanked at any time during the restart cycle.

For slow sweeps (see **Trace Update** section in **Trace/Detector**), the traces are updated real-time during the sweep. There may be a special circumstance in

application mode measurements where an exception is made and the traces and/or results need to be blanked before displaying the new results.

To summarize, the following list shows what happens to the trace data on various events:

Event	Trace Effect
Clear/Write pressed (even if already in Clear/Write)	Set to mintracevalue
Max Hold pressed (even if already in Max Hold)	Set to mintracevalue
Min Hold pressed (even if already in Min Hold)	Set to maxtracevalue
Trace Average pressed (even if already in Trace Average)	Trace data unaffected but start new sweep/avg/hold
Restart pressed	Trace data unaffected but start new sweep/avg/hold
Parameter requiring restart changed (e.g., RBW)	Trace data unaffected but start new sweep/avg/hold

Sweep and Trigger Reset

Resetting the sweep system resets the average/hold count k to 0. It also resets the set point counter to 0. Resetting the trigger system resets the internal auto trig timer to the value set by the **Auto Trig** control.

Averaging

The weighting factor used for averaging is k . This k is also the average/hold count for how many valid sweeps (data acquisitions) have been done. This k is used for comparisons with N , as those comparisons always needs to be based on valid completed sweeps.

The displayed average/hold, K , shows the count for the sweep (data acquisition) in progress. $K = k + 1$, with a limit of N . The displayed value K changes from its previous value to 1 as soon as the trigger condition for the first data acquisition (sweep) is met.

Pause/Resume

Pauses a measurement after the current data acquisition is complete.

When paused, the label on the control changes to **Resume**. Pressing **Resume** unpauses the measurement. When paused, pressing **Restart** performs a Resume.

Remote Command **:INITiate:PAUSE**
 :INITiate:RESume

Example	<code>:INIT:PAUS</code> <code>:INIT:RES</code>
Dependencies	Not displayed in Modes that do not support pausing
Annotation	Only on control

Abort (Remote Command Only)

Stops the current measurement. Aborts the current measurement as quickly as possible, resets the sweep and trigger systems, and puts the measurement into an "idle" state. If the instrument is in the process of aligning when `:ABORT` is sent, the alignment finishes *before* the abort function is performed, so `:ABORT` does not abort an alignment.

If the instrument is set for **Continuous** measurement, it sets up the measurement and initiates a new data measurement sequence with a new data acquisition (sweep) taken once the trigger condition is met.

If the instrument is set for **Single** measurement, it remains in the "idle" state until an `:INIT:IMM` command is received.

Remote Command	<code>:ABORT</code>
Example	<code>:ABOR</code>
Notes	If <code>:INIT:CONT</code> is ON , then a new continuous measurement will start immediately, with sweep (data acquisition) occurring once the trigger condition has been met If <code>:INIT:CONT</code> is OFF , then <code>:INIT:IMM</code> is used to start a single measurement, with sweep (data acquisition) occurring once the trigger condition has been met
Dependencies	For continuous measurement, <code>:ABORT</code> is equivalent to the Restart key Not all measurements support this command
Status Bits/OPC dependencies	The <code>STATus:OPERation</code> register bits 0 through 8 are cleared , <i>except</i> bit 6 (Waiting for Periodic Sync). Initiating a measurement and Waiting for Periodic Sync could be asynchronous The <code>STATus:QUEStionable</code> register bit 9 (INTEGRITY sum) is cleared Since all the bits that feed into OPC are cleared by <code>:ABORT</code> , the Abort command will cause the <code>*OPC</code> query to return true

3.10.9.2 Sweep Config

Accesses controls that enable you to configure the Sweep and Control functions of the instrument, such as Sweep Rules.

Sweep Type

Sets the **Sweep Type** of the spurious measurement to either **Auto** or **Swept**.

3 VMA Mode
3.10 Spurious Emissions Measurement

When in **Auto**, the selections of swept type of ranges are governed by the Best Speed Sweep Type Rule, and FFT analysis might be chosen for some ranges if it speeds up the measurement.

Remote Command	<code>[:SENSe]:SPURious[:RANGe]:ALL:SWEep:TYPE:AUTO OFF ON 0 1</code> <code>[:SENSe]:SPURious[:RANGe]:ALL:SWEep:TYPE:AUTO?</code>
Example	<code>:SPUR:ALL:SWE:TYPE:AUTO 1</code> <code>:SPUR:ALL:SWE:TYPE:AUTO?</code>
Dependencies	Available only when Option N9060A-7FP is installed
Preset	ON
State Saved	Saved in instrument state
Range	Auto Swept
Annotation	When in Auto , and the instrument is in FFT analysis, an indicator, “FFT” is displayed at the right bottom of range spectrum trace window

Sweep Time Rules

Switches the instrument between **NORMa1** and **ACCuracy** sweep states.

Setting **Auto Sweep Time** to **Accy** (**ACCuracy**) results in slower sweep times, usually about three times as long, but yields better amplitude accuracy for CW signals. The instrument amplitude accuracy specifications only apply when **Auto Sweep Time** is set to **Accy**.

Additional amplitude errors which occur when **Auto Sweep Time** is set to **Norm** are usually well under 0.1 dB, though this is not guaranteed. Because of the faster sweep times and still low errors, **Norm** is the preferred setting of **Auto Sweep Time**. **Auto Sweep Time** is set to **Norm** on a **Preset**. This means that in the Preset state, instrument amplitude accuracy specifications do not apply.

Remote Command	<code>[:SENSe]:SPURious:SWEep:TIME:AUTO:RULEs NORMa1 ACCuracy</code> <code>[:SENSe]:SPURious:SWEep:TIME:AUTO:RULEs?</code>
Example	<code>:SPUR:SWE:TIME:AUTO:RUL ACC</code> <code>:SPUR:SWE:TIME:AUTO:RUL?</code>
Notes	This command is implemented as <code>[:SENSe]:SPURious[:RANGe]</code> <code>[:LIST]:SWEep:TIME:AUTO:RULEs</code> to avoid illegal SCPI node definition, so this command should be used as <code>[:SENSe]:SPURious:SWEep:TIME:AUTO:RULEs</code>
Dependencies	Does not appear in SA Mode in VXT
Preset	NORMa1
State Saved	Saved in instrument state
Range	NORMa1 ACCuracy

3.10.10 Trace

Lets you control the acquisition, display, storage, detection and manipulation of trace data for the available traces.

The "Trace Control" on page 1736 tab of this menu contains radio-button selections for the trace type (**Clear/Write, Trace Average, Max Hold, Min Hold**) and **View/Blank** setting for the selected trace.

A trace is a series of data points, each having an x and a y value. The x value is frequency (or time, in zero span) and the y value is amplitude. Each data point is referred to as a *trace point*. In any given trace, trace point 0 is the first point, and trace point (*sweep_points - 1*) is the last. For example, in a 1001 point trace, the first point is 0 and the last is 1000. Another term sometimes used to describe traces is *bucket*. A bucket is the frequency span of a trace point, equal to the point spacing. For swept analysis, the y value in each bucket is measured while the instrument is sweeping across the bucket. The selected detector determines how it is measured.

When in **Single** Mode, Measurements and their Views save the trace data from the last acquisition. This is true on multiple screens. The marker and trace data will be present whenever the measurement is brought back into focus. The measurement switches for these measurements do not clear the traces, so the data will be present until the next acquisition is completed.

Invalid Data Indicator

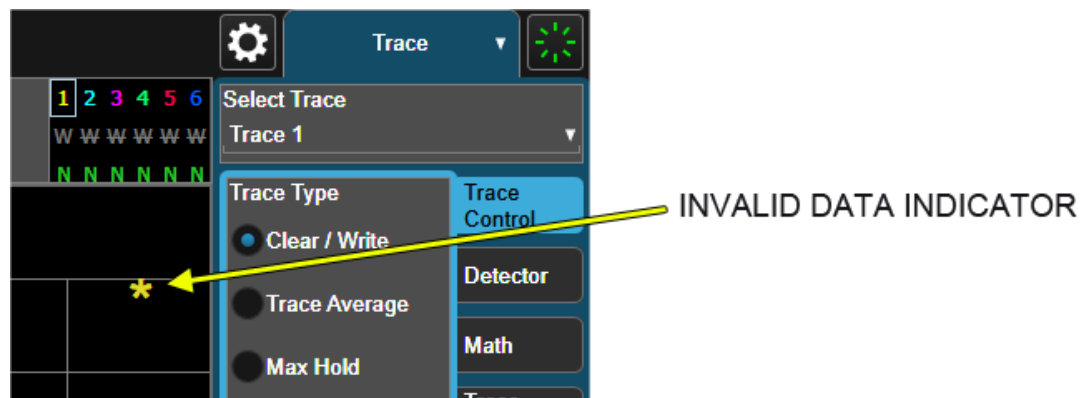

The Invalid Data Indicator is displayed whenever the data on the display does not match the settings of the instrument. The most common example of this is when instrument settings have changed in the time since the data in the traces on the display was taken. This means that the screen annotation cannot be guaranteed to match the trace data. For example, if you change **Center Frequency**, the Invalid Data Indicator will display until the trace has been retaken.

3 VMA Mode

3.10 Spurious Emissions Measurement

If any Trace is in View mode (displaying but not updating) and instrument settings are changed, the Invalid Data Indicator will display as long as that trace remains in View. Traces that are blanked do not turn on the Invalid Data Indicator.

Not all instrument settings require display of the invalid data indicator when they change; only changes that require a new acquisition will cause it to display. For example, changing the Y-Axis scale of the instrument does not cause the invalid data indicator to display, unless the attenuation changes.

The Invalid Data Indicator is also turned on:

- When the counter is turned on, until the completion of the first count
- When a trace is imported from mass storage and the trace's parameters do not match the current instrument settings
- When a trace is sent to the instrument from a remote interface (since there is no way to know if its settings match)

NOTE

The Invalid Data Indicator has an associated status bit that can be checked at any time to determine whether the indicator is on.

Trace right-click menu

If you right-click on a trace (or touch and hold a trace and wait for the circle to close) you will see the Trace Right-Click Menu:

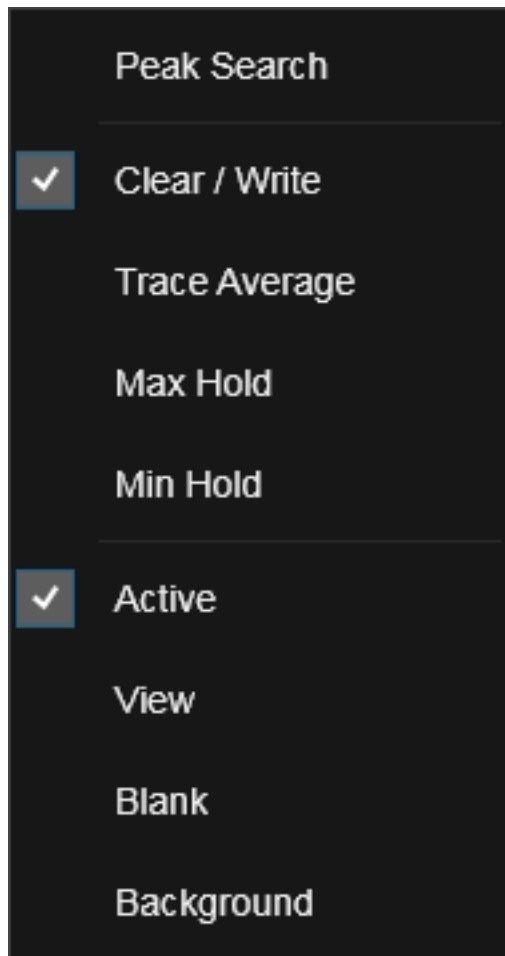

If you now tap or click on one of the items in this menu, the instrument will perform the corresponding function. **Peak Search** finds the highest peak on the selected Trace. **Clear/Write**, **Trace Average**, **Max Hold** and **Min Hold** set the "Trace Type" on [page 1737](#). **Active**, **View**, **Blank**, and **Background** set the "View/Blank" on [page 1742](#) type.

Waterfall Window

If you right-click on the trace (or touch and hold the trace and wait for the circle to close) in the **Waterfall** window (for example, in the Spectrogram View) you will see the Waterfall Trace Right-Click Menu:

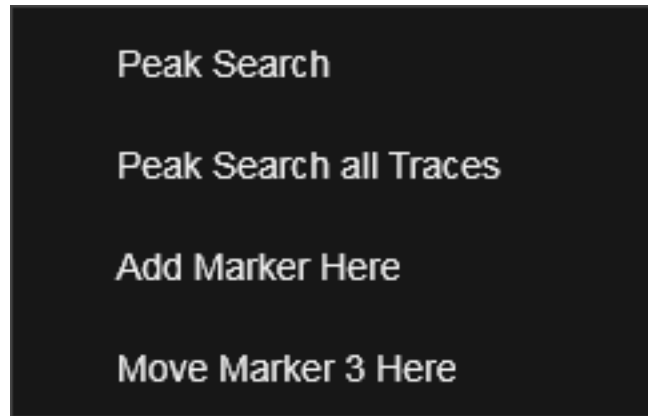

In this menu, **Peak Search** works as above. **Peak Search all Traces** finds the highest peak in the Waterfall window. **Add Marker Here** takes the lowest numbered Marker that is currently Off and turns it On as a **Normal** marker in the Waterfall window at the point where you right-clicked (or touched-and-held). **Move Marker n Here** moves the currently selected Marker to the point in the Waterfall window where you right-clicked (or touched-and-held).

Trace Update Indicator

Trace updates can take one of two forms:

1. The trace is updated in a single operation that affects all of the points in the trace at once. This happens, for example, in the case of very fast (< 200 ms) sweeps, single-chunk FFT's, and the initial math operation after a math function is set for a trace
2. The trace is updated in a series of discrete steps, with measurement data being gathered between each step. This will be the case for slow sweeps, multi-chunk FFTs, gated sweeps, etc.

In the first case, no update indicator is required. In the second case, however, a visual indicator exists on the trace where the new data is being written. The indicator is a green caret (^), which moves across the bottom of the graticule showing the current trace point.



Trace Annunciator Panel

This panel appears on the right hand side of the Meas Bar. Here is an explanation of the fields in this panel, as shown below:

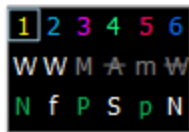

Top Line

On the top line, each trace number is shown, in the trace color. A box is drawn around the currently selected trace.

Middle Line

Below each trace number, is a letter signifying the trace type for that trace number, where

W	Clear/Write
A	Trace Average
M	Max Hold
m	Min Hold

If the letter is white, it means the trace is being updated (**Update = ON**); if the letter is dimmed, it means the trace is not being updated (**Update = OFF**). A strikethrough indicates that the trace is blanked (**Display = OFF**). Note that it is possible for a trace to be updating *and* blanked, which is useful if the trace is a trace math component.

Bottom Line

The third line shows the detector type for each trace, or, if trace math is on for that trace, it shows “f” (for “math function”). It is not always possible to have a unique detector for each trace, but the instrument hardware provides the maximum flexibility of detector selection in order to maintain the highest accuracy. The letters used for this readout are

N	Normal
A	Average
P	peak
p	negative peak
S	Sample
Q	Quasi Peak
E	EMI Average
R	RMS Average
f	math function

If the letter is green, the detector is in Auto. If white, the detector has been manually selected.

In the example above, the panel is indicating the following:

3 VMA Mode

3.10 Spurious Emissions Measurement

- Trace 1: Visible, being updated, in Clear/Write, with Normal detector auto selected
- Trace 2: Visible, being updated, in Clear/Write, being written to with a math function
- Trace 3: Visible, not updating, data was taken in Max Hold, with the peak detector auto selected
- Trace 4: Blanked, not updating, data was taken with Averaging turned on, Sample detector manually selected
- Trace 5: Visible, not updating, data was taken in Min Hold with Negative Peak detector auto selected
- Trace 6: Blanked, not updating, in Clear/Write, with Normal detector manually selected

Trace Annotation

When **Trace Annotation** (see **Display**) is **ON**, each non-blanked trace is labeled on the trace with the detector used to take it, unless a Trace Math function is on for that trace, in which case it is labeled with the **"Math Function"** on page 1745.

The detector labels are:

NORM	Normal
PEAK	Peak
SAMP	Sample
NPEAK	Negative Peak
RMS	Average detector with Power Average (RMS)
LG AVG	Average detector with Log-Pwr Average
VAVG	Average detector with Voltage Average
QPEAK	Quasi Peak
EMI AVG	EMI Average
RMS AVG	RMS Average

The trace math labels are:

PDIF	Power Difference
PSUM	Power Sum
LOFF	Log Offset
LDIF	Log Difference

3.10.10.1 Select Trace

Specifies the *selected trace*, which is the trace that will be affected when you change trace settings.

Select Trace appears above the menu panel, indicating that it applies to *all* controls in the menu panel. **Select Trace** is blanked if you select a tab whose controls do *not* depend on the selected trace (for example, **Trace Function**).

Notes	The selected trace is remembered even when not in the Trace menu
Dependencies	For the Swept SA measurement: <ul style="list-style-type: none"> - In Image Suppress mode, when you select a trace it becomes the active trace, and the formerly active trace goes into View - When you turn on Image Suppress, Update turns off for all traces except the selected trace For the ACP measurement, when Meas Method is RBW , FAST or FPOwer , Select Trace is disabled
Preset	Trace 1
State Saved	Yes

3.10.10.2 Trace Control

The controls on this tab allow you to set the "[Trace Type](#)" on page 1737 and its update mode.

There are four Trace Types:

- **Clear/Write**
- **Trace Average**
- **Max Hold**
- **Min Hold**

Each type handles data in a different way.

Each trace also has two values that determine whether it is being written or not, and whether it is being displayed or not. These values, **Update** and **Display**, are described fully in the "[View/Blank](#)" on page 1742 control description. Essentially, when **Update** is **ON**, a trace is updating, and when **Update** is **OFF** it is not. When **Display** is **ON**, it is visible and when **Display** is **OFF** it is not. These terms are used throughout the descriptions in this section.

Trace Type

There are four trace Types:

Option	Parameter	SCPI Example	Details
Clear/Write	WRITe	:TRAC2:TYPE WRIT	See: "Clear/Write" on page 1740
Trace Average	AVERage	:TRAC2:TYPE AVER	See: "Trace Average" on page 1740
Maximum Hold	MAXHold	:TRAC3:TYPE MAXH	See: "Max Hold" on page 1741
Minimum Hold	MINHold	:TRAC5:TYPE MINH	See: "Min Hold" on page 1741

Full descriptions of each type are provided below. You may select one of these types for each trace. Re-selecting the current **Trace Type** initiates the same action that selecting it the first time did, even though it is already selected. For example, selecting **Clear/Write** while **Clear/Write** is already selected will nonetheless clear the trace and begin rewriting it.

Besides the **Trace Type**, the "**View/Blank**" on page 1742 state must be set to **Active** (**Update: ON, Display: ON**) for a trace to be updating and visible. Selecting any **Trace Type** automatically makes the trace **Active**.

See also: "**Trace Mode Backwards Compatibility Commands**" on page 1738

Remote Command	<p>For Swept SA Measurement (in SA Mode):</p> <pre>:TRACe[1] 2 ... 6:TYPE WRITe AVERage MAXHold MINHold</pre> <pre>:TRACe[1] 2 ... 6:TYPE?</pre> <p>For all other measurements:</p> <pre>:TRACe[1] 2 3:<meas>:TYPE WRITe AVERage MAXHold MINHold</pre> <pre>:TRACe[1] 2 3:<meas>:TYPE?</pre> <p>where <meas> is the identifier for the current measurement</p>
Example	<pre>:TRAC:TYPE WRIT</pre> <pre>:TRAC:TYPE?</pre>
Couplings	<p>Selecting a Trace Type (by pressing any of the Trace Type selections or sending <code>:TRAC:TYPE</code>) sets the Trace to Active (Update: ON, Display: OFF), even if the same trace type was already selected</p> <p>When Detector setting is "Auto" (<code>[:SENSe] : <meas> : DETector : AUTO ?</code>), Detector (<code>[:SENSe] : <meas> : DETector [:FUNCTION] ?</code>) switches aligning with the switch of this parameter: "NORMal" with WRITe (Clear Write), "AVERage" with AVERage, "POSitive (peak)" with MAXHold, and "NEGative (peak)" with MINHold</p>
Preset	<p>Swept SA and Monitor Spectrum: WRITe</p> <p>All other measurements: AVERage</p> <p>Following Preset, all traces are cleared (all trace points set to mintracevalue)</p>
State Saved	The type of each trace is saved in instrument state
Annunciation	The type for each trace is indicated in the Trace annunciator panel on the Measurement Bar

Trace Mode Backwards Compatibility Commands

In earlier instruments, the “Trace Modes” were: Clear/Write, Max Hold, Min Hold, View and Blank. Averaging was global to all traces and was controlled under the **BW/Avg** menu.

In X-Series, trace averaging can be done on a per-trace basis. The Trace Modes (now called Trace Types) are Clear/Write, Trace Average, Max Hold and Min Hold. View and Blank are set separately under ["View/Blank" on page 1742](#).

While this provides more flexibility, it also gives rise to potential backwards compatibility problems. To mitigate these, the old Trace Mode command has been retained and a new Trace Type command has been added. The `:TRACe:MODE` command is retained for backwards compatibility, and the `:TRACe:TYPE`, `:TRACe:UPDate` and `:TRACe:DISPlay` commands introduced for ongoing use. The old Trace Modes are selected using `:TRAC:MODE`, whose parameters are mapped into calls to `:TRACe:TYPE`, `:TRACe:UPDate` and `:TRACe:DISPlay`, and the old global Averaging command `[:SENSe]:AVERage[:STATe]` is provided for backwards compatibility. See the individual command descriptions for details.

When **Average/Hold** in the **Meas Setup, Legacy Compatibility** menu is **ON**, the following is true for traces in Max Hold and Min Hold:

- They ignore the **Average/Hold** number; **Single** for Max Hold causes one sweep only, so switching to **Single** stops after the current sweep, and switching to **Cont** starts again without clearing the accumulated result
- Max Hold is not cleared on a **Restart**, **Single** or `:INIT:IMM`, but changing a measurement parameter, like frequency or bandwidth etc., still restarts the Max Hold

Preset	<code>WRITE</code>
State Saved	The trace mode is an alias only
Backwards Compatibility SCPI	<code>:TRACe[1] 2 ... 6:MODE WRITE MAXHold MINHold VIEW BLANK</code> <code>:TRACe[1] 2 ... 6:MODE?</code>
Backwards Compatibility Notes	<p>The legacy <code>:TRACe:MODE</code> command is retained for backwards compatibility. In conjunction with the legacy <code>:AVERage</code> command, it works as follows:</p> <ul style="list-style-type: none"> – <code>:AVERage ON OFF</code> sets/clears a variable that we will call average for the sake of this discussion. This variable is maintained by the instrument solely for backwards compatibility. See the <code>[:SENSe]:AVERage[:STATe]</code> command description below – <code>:TRACe:MODE WRITE</code> sets <code>:TRACe:TYPE WRITE</code> (Clear/Write) unless average is true, in which case it sets it to <code>:TRACe:TYPE AVERage</code>. It also sets <code>:TRACe:UPDate ON</code>, <code>:TRACe:DISPlay ON</code>, for the selected trace – <code>:TRACe:MODE MAXHold</code> sets <code>:TRACe:TYPE MAXHold</code> (Max Hold). It also sets <code>:TRACe:UPDate ON</code>, <code>:TRACe:DISPlay ON</code>, for the selected trace

3 VMA Mode
 3.10 Spurious Emissions Measurement

- `:TRACe:MODE MINHold` sets `:TRACe:TYPE MINHold` (Min Hold). It also sets `:TRACe:UPDate ON`, `:TRACe:DISPlay ON`, for the selected trace
- `:TRACe:MODE VIEW` sets `:TRACe:UPDate OFF`, `:TRACe:DISPlay ON`, for the selected trace
- `:TRACe:MODE BLANK` sets `:TRACe:UPDate OFF`, `:TRACe:DISPlay OFF`, for the selected trace

The query returns the same value as `:TRACe:TYPE?`, meaning that if you set `:TRACe:MODE:VIEW` or `:TRACe:MODE:BLANK`, the query response will not be what you sent

`:TRACe[n]:MODE` was formerly used to set the type or “writing mode” of the trace. At that time, View and Blank were writing modes. The new `:TRACe:TYPE` command should be used in the future, but `:TRACe:MODE` is retained to provide backwards compatibility

In X-Series, unlike earlier instruments, Max Hold and Min Hold now obey the Average Number and counts up to a terminal value as Average always has

As the **Average/Hold Number** now affects **Min Hold** and **Max Hold**, the operations that restart Averaging (for example, the **Restart** key) now also restart **Min Hold** and **Max Hold**

As a result of these changes, legacy code that restarts averaging while retaining a running Max Hold will need to be rewritten, because the Max Hold will now restart when the Average does

Also, previous to X-Series:

- Pressing **Max Hold** while already in **Max Hold** (or doing so remotely) had no effect. Now it will clear the trace and restart the sweep and the Max Hold sequence
- Changing the vertical scale (Log/Lin or dB/div) of the display restarted **Max Hold** and **Min Hold**. This is no longer the case

Preset	<code>OFF</code>
State Saved	The state of Average is saved in Instrument State for ghosting purposes
Backwards Compatibility SCPI	<code>[:SENSe]:AVERage[:STATe] ON OFF 1 0</code> <code>[:SENSe]:AVERage[:STATe]?</code>
Backwards Compatibility Notes	<p>Previous to X-Series, Averaging (also sometimes known as trace averaging) was global to all traces, that is, it was either on or off for all active traces. The legacy command <code>[:SENSe]:AVERage[:STATe] ON OFF 1 0</code> was used to turn Averaging on or off</p> <p>In X-Series, Averaging is turned on or off on a per-trace basis, so it can be on for one trace and off for another</p> <p>For backwards compatibility, the old global Average State variable is retained solely as a legacy variable, turned on and off and queried by the legacy command <code>[:SENSe]:AVERage[:STATe] OFF ON 0 1</code>. When Average is turned on, any trace in Clear/Write will get put into Average. While Average is on, any trace put into Clear/Write by the old <code>:TRAC:MODE</code> command will instead get put into Average. When Average is turned off, any trace in Average will get put into Clear/Write</p>

Trace Type Details

Clear/Write

Each trace update replaces the old data in the trace with new data.

Pressing **Clear/Write** for the selected trace, or sending `:TRAC:TYPE WRIT` for the specified trace, sets the trace type to **Clear/Write** and clears the trace, even if you are already in **Clear/Write**. Then a new sweep is initiated. Trigger conditions must be met before the sweep actually starts, and if in **Single** the sweep won't start until **Restart** is pressed.

Pressing **Clear/Write** stops the current sweep and initiates a new one, so **Trace Average**, **Max Hold** and **Min Hold** data may be interrupted in mid-sweep when **Clear/Write** is pressed, and therefore may not accurately reflect the displayed count. Therefore, when **Clear/Write** is pressed for one trace, **Trace Average**, **Max Hold** and **Min Hold** must restart for all traces.

When in **Clear/Write**, if a measurement-related instrument setting is changed (that is, one which requires new data to be taken, like **Center Frequency** or **Attenuation**), a new sweep is initiated but the trace is not cleared.

Trace Average

The instrument maintains and displays an average trace, which represents the cumulative average on a point-by-point basis of the new trace data and previous averaged trace data.

Pressing **Trace Average** (for the selected trace), or sending `:TRAC:TYPE AVER` (for the specified trace), sets the trace type to **Trace Average**, clears the trace, initiates a new sweep, and restarts the Average sequence.

Details of the count limiting behavior and the averaging calculations may be found under **Avg|Hold Number** and **Average Type** under **Meas Setup**.

When in **Trace Average**, if a measurement-related instrument setting is changed (that is, one which requires new data to be taken, like **Center Frequency** or **Attenuation**), the average restarts and a new sweep is initiated but the trace is not cleared.

Restarting the average means:

- The average/hold count k is set to 1, so that the next time the average trace is displayed it simply represents one trace of new data
- A new sweep is initiated

3 VMA Mode

3.10 Spurious Emissions Measurement

- Once the new sweep starts, the trace is overwritten with current trace data as the first trace of the new average

Remember that restarting averaging also restarts **Max Hold** and **Min Hold**, as there is only one count for Trace Average and Hold.

Max Hold

The instrument maintains and displays a max hold trace, which represents the maximum data value on a point-by-point basis of the new trace data and previous trace data. Details of the count limiting behavior may be found under **Avg|Hold Number** under **Meas Setup**.

Pressing **Max Hold** for the selected trace, or sending `:TRAC:TYPE MAXH` for the specified trace, sets the Trace Type to **Max Hold**, clears the trace, initiates a new sweep, and restarts the hold sequence, even if you are already in **Max Hold**.

When in **Max Hold**, if a measurement-related instrument setting is changed (that is, one which requires new data to be taken, like **Center Frequency** or **Attenuation**), the **Max Hold** sequence restarts and a new sweep is initiated but the trace is not cleared.

Restarting the **Max Hold** sequence means:

- The average/hold count k is set to 1, so that the next time the max hold trace is displayed it simply represents one trace of new data
- A new sweep is initiated.

Remember that restarting **Max Hold** also restarts averaging and **Min Hold**, as there is only one count for Trace Average and Hold.

Min Hold

The instrument maintains and displays a min hold trace, which represents the minimum data value on a point-point basis of the new trace data and previous trace data. Details of the count limiting behavior may be found under **Avg|Hold Number** under the **Meas Setup** functions.

Pressing **Min Hold** for the selected trace, or sending `:TRAC:TYPE MINH` for the specified trace, sets the Trace Type to **Min Hold**, clears the trace, initiates a new sweep, and restarts the hold sequence, even if you are already in **Min Hold**.

When in **Min Hold**, if a measurement-related instrument setting is changed (that is, one which requires new data to be taken, like **Center Frequency** or **Attenuation**), the **Min Hold** sequence restarts and a new sweep is initiated but the trace is not cleared.

Restarting the **Min Hold** sequence means:

- The average/hold count k is set to 1, so that the next time the min hold trace is displayed it simply represents one trace of new data
- A new sweep is initiated

Remember that restarting **Min Hold** also restarts **Max Hold** and averaging, because there is only one count for Trace Average and Hold.

Clear and Write | Restart Averaging | Restart Max/Min Hold

Starts the trace writing, as though the "Trace Type" on page 1737 had just been selected. The effect is exactly the same as reselecting the current **Trace Type** again – the control is provided because it may not be obvious that reselecting the same selection from a radio button menu will take any action.

This control displays different labels, depending on the selected Trace Type:

- **Clear/Write:** Clear and Write
- **Trace Average:** Restart Averaging
- **Max Hold:** Restart Max Hold
- **Min Hold:** Restart Min Hold

View/Blank

Lets you set the state of the two trace variables: **Update** and **Display**. The choices available in this dropdown menu are:

Active	Update and Display both ON
View	Update OFF ; Display ON
Blank	Update OFF ; Display OFF
Background	Update ON , Display OFF Allows a trace to be blanked <i>and</i> continue to update "in the background", which was not possible in the past

In the Swept SA measurement, a trace with **DisplayOFF** is indicated by a strikethrough of the type letter in the trace annotation panel in the Measurement Bar. A trace with **UpdateOFF** is indicated by dimming the type letter in the trace annotation panel in the Measurement Bar. In the example below, Traces 3, 4, 5 and 6 have **UpdateOFF**, and Traces 4 and 6 have **DisplayOFF**.

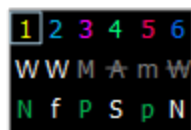

3 VMA Mode
 3.10 Spurious Emissions Measurement

See: ["More Information" on page 1744](#)

Notes	For the commands to control the two variables, Update and Display, see "Trace Update State On/Off" on page 1743 and "Trace Display State On/Off" on page 1743 below
Dependencies	When Signal ID is on, this key is grayed-out
Couplings	<p>Selecting a Trace Type for a trace (pressing the key or sending the equivalent command) puts the trace in Active (Update ON and Display ON), even if that trace type was already selected</p> <p>Selecting a detector for a trace (pressing the key or sending <code>[:SENS] :DET :TRAC</code>) puts the trace in Active (UpdateON and DisplayON), even if that detector was already selected</p> <p>Selecting a "Math Function" on page 1745 other than OFF for a trace (pressing the key or sending the equivalent command) puts the trace in Active (UpdateON and DisplayON), even if that Math Mode was already selected</p> <p>Loading a trace from a file puts that trace in View regardless of the state it was in when it was saved; as does being the target of a Copy or a participant in an Exchange</p>

Trace Update State On/Off

Remote Command	<p>For Swept SA Measurement (in SA Mode): <code>:TRACe[1] 2 ... 6:UPDate[:STATe] ON OFF 1 0</code> <code>:TRACe[1] 2 ... 6:UPDate[:STATe]?</code></p> <p>For all other measurements: <code>:TRACe[1] 2 3:<meas>:UPDate[:STATe] ON OFF 1 0</code> <code>:TRACe[1] 2 3:<meas>:UPDate[:STATe]?</code></p> <p>where <meas> is the identifier for the current measurement</p>
Example	<p>Make trace 2 inactive (stop updating): <code>:TRAC2:UPD 0</code></p>
Couplings	Whenever you set Update to ON for any trace, the Display is set to ON for that trace
Preset	<p>For Swept SA Measurement (in SA Mode): <code>1 0 0 0 0 0</code> ON for Trace 1; OFF for 2–6</p> <p>For all other measurements: <code>1 0 0</code> ON for Trace 1; OFF for 2 & 3</p>
State Saved	Saved in instrument state

Trace Display State On/Off

Remote Command	<p>For Swept SA Measurement (in SA Mode): <code>:TRACe[1] 2 ... 6:DISPlay[:STATe] ON OFF 1 0</code> <code>:TRACe[1] 2 ... 6:DISPlay[:STATe]?</code></p> <p>For all other measurements:</p>
----------------	--

	<pre>:TRACe[1] 2 3:<meas>:DISPlay[:STATe] ON OFF 1 0</pre> <pre>:TRACe[1] 2 3:<meas>:DISPlay[:STATe]?</pre> <p>where <meas> is the identifier for the current measurement</p>
Example	<p>Make trace 1 visible:</p> <pre>:TRAC2:DISP 1</pre> <p>Blank trace 3:</p> <pre>:TRAC3:DISP 3</pre>
Couplings	Whenever you set Update to ON for any trace, the Display is set to ON for that trace
Preset	<p>For Swept SA Measurement (in SA Mode):</p> <pre>1 0 0 0 0 0</pre> <p>ON for Trace 1; OFF for 2–6</p> <p>For all other measurements:</p> <pre>1 0 0</pre> <p>ON for Trace 1; OFF for 2 & 3</p>
State Saved	Saved in instrument state

More Information

When a trace becomes inactive, any update from the **:SENSe** system (detectors) immediately stops, without waiting for the end of the sweep. The trace data remains unchanged, but stops updating. If the trace is blanked, this still does not affect the data in the trace. Traces that are blanked (**Display=OFF**) do not display nor appear on printouts, but their data stays intact, they may be queried, and markers may be placed on them

In most cases, inactive traces are static and unchanging; however, there are cases when an inactive trace will update, specifically:

- if data is written to that trace from remote
- if trace data is loaded from mass storage
- if the trace is the target of a **Copy** or participant in an **Exchange**
- if the trace is cleared using **Clear Trace**

Inactive traces that are also being displayed (traces in **View**) are displayed at half intensity. Traces in **View** display across the entire X-Axis of the instrument. Their horizontal placement does not change, even if X-Axis settings subsequently are changed, although Y-Axis settings do affect the vertical placement of data.

When a trace becomes active (**Update=ON**), the trace is cleared, the average count is reset, and a new sweep is initiated.

Note that putting a trace into **Display=OFF** and/or **Update=OFF** does *not* restart the sweep and does *not* restart Averaging or Hold functions for any traces.

3.10.10.3 Math

Lets you turn on and configure Trace Math functions.

Math Function

Trace Math functions perform mathematical operations between traces and, in some cases, user-specified offsets. When in a Trace Math function, the indicated function is performed during the sweep with the math function used in place of a detector. The trace operands for the math function are set using the "[Operand 1 / Operand 2](#)" on page 1751 controls.

- See "[How trace math is processed](#)" on page 1749

Remote Command For option details, see "[Trace Math Options](#)" on page 1747

For Swept SA Measurement (in SA Mode):

```
:CALCulate:MATH <trace_num>, PDIFference | PSUM | LOFFset | LDIFference | OFF, <trace_num>, <trace_num>, <real>,<real>
```

```
:CALCulate:MATH? <trace_num>
```

where <trace_num> is any one of:

```
TRACe1|...|TRACe6
```

For all other measurements:

```
:CALCulate:<meas>:MATH <trace_num>, PDIFference | PSUM | LOFFset | LDIFference | OFF, <trace_num>, <trace_num>, <real>,<real>
```

```
:CALCulate[:<meas>]:MATH? <trace_num>
```

where:

<meas> is the identifier for the current measurement, and

<trace_num> is any one of:

```
TRACe1|TRACe2|TRACe3
```

Note that the format of the **TRACe<n>** parameter differs from that for the Swept SA Measurement

Example

```
:CALC:MATH TRACe3,PDIF,TRACe1,TRACe2,0,0
```

Sets Trace 3 to Power Diff trace math function, and sets the First Trace operand (for Trace 3) to Trace 1 and the Second Trace operand (for Trace 3) to Trace 2

```
:CALC:MATH TRACe3,PSUM,TRACe1,TRACe2,0,0
```

Sets Trace 3 to Power Sum trace math function and sets the First Trace operand (for Trace 3) to Trace 1 and the Second Trace operand (for Trace 3) to Trace 2

```
:CALC:MATH TRACe3,LOFF,TRACe1,TRACe2,-6.00,0
```

	<p>Sets Trace 3 to Log Offset trace math function, sets the First Trace operand (for Trace 3) to Trace 1, leaves the Second Trace operand (for Trace 3) unchanged (it is irrelevant for this function) and sets the Log Offset (for Trace 3) to -6 dB</p> <p><code>:CALC:MATH TRACE3,LDIF,TRACE1,TRACE2,0,-6.00</code></p> <p>Sets Trace 3 to Log Diff trace math function, sets the First Trace operand (for Trace 3) to Trace 1, sets the Second Trace operand (for Trace 3) to Trace 2, and sets the Log Difference reference (for Trace 3) to -6 dBm</p> <p><code>:CALC:MATH TRACE1,OFF,TRACE2,TRACE3,0,0</code></p> <p>Turns off trace math for trace 1</p>
Notes	<p>The Trace Math Function command has 6 main set of parameters:</p> <ul style="list-style-type: none"> - Set 1 defines the “result trace”: <code>TRACE1 ... TRACE6</code> -Set 2 defines the “function”: <code>PDIFference PSUM LOFFset LDIFference OFF</code> - Set 3 is a “trace operand” (1): <code>TRACE1 ... TRACE6</code> - Set 4 is a “trace operand” (2): <code>TRACE1 ... TRACE6</code> - Set 5 defines the “Log Offset” (in dB) - Set 6 defines the “Log Difference Reference” (in dBm) <p>Note that the trace math mode is an enumeration; that is, when a math function is set for a trace, it turns off any math function that is on for that trace, then sets the new math function</p> <p>The parameters sent in the command are reflected in the values in the control menu. There is no default for any parameter; all 6 parameters must be sent to satisfy the parser. Failure to specify a parameter will result in a missing parameter message</p> <p>The query returns the math mode, the operand traces, the offset and the reference for the specified trace, all separated by commas</p>
Dependencies	<p>Trace Math is not available if Normalize is on</p> <p>Trace Math is not available if Signal ID is on</p> <p>None of the trace operands can be the destination trace. If any of the three trace math commands is sent with a destination trace number matching one of the operands, a warning is generated and the function does not turn on</p>
Couplings	When a math function is changed for a trace, that trace is set to Display = ON ; and Update = ON
Preset	<p>For Swept SA Measurement (in SA Mode):</p> <p><code>OFF,TRACE5,TRACE6,0,0 OFF,TRACE6,TRACE1,0,0 OFF,TRACE1,TRACE2,0,0 </code> <code>OFF,TRACE2,TRACE3,0,0 OFF,TRACE3,TRACE4,0,0 OFF,TRACE4,TRACE5,0,0</code></p> <p>For all other measurements:</p> <p><code>OFF,TRACE2,TRACE3,0,0 OFF,TRACE3,TRACE1,0,0 OFF,TRACE1,TRACE2,0,0</code></p>
State Saved	The trace math function for each trace is saved in instrument state
Annunciation	An “f” is shown on the trace annunciation panel in the Measurement Bar when a math function is on;

	and the function is annotated on the trace if Trace Annotation is on
Status Bits/OPC dependencies	*OPC can be used to detect the completion of a sweep, which will also correspond to the completion of the math operation, since all math takes place during the sweep

Trace Math Options

IMPORTANT

To generate a trace math result, *you must take a sweep*. The trace math engine, described below, operates in concert with the sweep engine in the instrument. Until a sweep has been taken, even if the constituent traces are not in Update mode, no result is generated.

Note that certain events can affect the trace in ways that affects all points at once. This can happen in any number of ways, including:

- A trace clear taking place
- A trace being loaded from the file system
- Trace data being sent in from the remote interface
- A copy or exchange of trace data

You should try to avoid these occurrences during a sweep, as they will tend to invalidate the math result being accumulated.

The Trace Math functions are:

Power Diff (Op1 - Op2)

Calculates a power difference between the **First Trace** operand and the **Second Trace** operand and puts the result in the destination trace.

During the sweep, the following formula is executed for each point in the trace operands, and the corresponding point is generated for the destination trace:

$$\text{DestinationTrace} = 10 \log_{10}(10^{(1/10)(\text{FirstTrace})} - 10^{(1/10)(\text{SecondTrace})})$$

The values of the trace points are assumed to be in a decibel scale, as they are internally stored.

If a point in **FirstTrace** is equal to **maxtracevalue**, the resultant point is also **maxtracevalue**.

Otherwise, if the result of the subtraction is less than or equal to 0, the resultant point is **mintracevalue**.

Power Sum (Op1 + Op2)

Calculates a power sum between the **First Trace** operand and the **Second Trace** operand and puts the result in the destination trace.

During the sweep, the following formula is executed for each point in the trace operands, and the corresponding point is generated for the destination trace.

$$\text{DestinationTrace} = 10 \log(10(1/10)(\text{FirstTrace}) + 10(1/10)(\text{SecondTrace}))$$

The values of the trace points are assumed to be in a decibel scale, as they are internally stored.

If a point in either trace operand is equal to **maxtracevalue**, the resultant point is also **maxtracevalue**.

Log Offset (Op1 + Offset)

Calculates a log offset from the **First Trace** operand and puts the result in the destination trace. This is like the B-DL function in some older instruments. The offset is entered on the **Offset** control, which only appears when this math function is in force for the selected trace. Each destination trace has its own offset.

During the sweep, the following formula is executed for each point in the trace operand, and the corresponding point is generated for the destination trace.

$$\text{DestinationTrace} = \text{FirstTrace} + \text{Offset}$$

The values of the trace points are assumed to be in dBm (as they are internally stored) and the offset is in dB.

If a point in the trace operand is equal to **maxtracevalue**, the resultant point is also **maxtracevalue**.

If a point in the trace operand is equal to **mintracevalue**, the resultant point is also **mintracevalue**.

Example: If offset is 25 dB, then our destination trace will be higher than the operand trace by 25 dB.

Note that the **Second Trace** operand is not used for this function.

Log Diff (Op1 - Op2 + Ref)

Offsets the difference between the **First Trace** operand and the **Second Trace** operand by a reference and puts the result in the destination trace. This is like the A-B+DL function in some older instruments. The Reference is entered on the **Reference** control, which only appears when this math function is in force for the selected trace. Each destination trace has its own reference.

Offsets the difference between the **First Trace** operand and the **Second Trace** operand by a reference and puts the result in the destination trace. This is like the A-

B+DL function in some older instruments. The Reference is entered on the **Reference** control, which only appears when this math function is in force for the selected trace. Each destination trace has its own reference.

During the sweep, the following formula is executed for each point in the trace operands, and the corresponding point is generated for the destination trace.

$$\text{DestinationTrace} = (\text{FirstTrace} - \text{SecondTrace}) + \text{Reference}$$

The values of the operand trace points are assumed to be in decibel units (as they are internally stored) and the reference is in dBm so the result is in dBm.

Example: If the first operand trace 1 is at 5 dBm, the second operand trace 2 is at -5 dBm, and the reference is -25 dBm, then the destination trace will be -15 dBm.

Example: If the first operand trace 1 is at 60 dBuV, the second operand trace 2 is at 50 dBuV, and the reference is 35 dBuV, then the destination trace will be 45 dBuV.

If a point in **FirstTrace** is equal to **maxtracevalue**, the resultant point is also **maxtracevalue**.

If a point in **FirstTrace** is equal to **mintracevalue**, the resultant point is also **mintracevalue**.

If neither of the above is true for a given point, then:

- If that point in **SecondTrace** is equal to **maxtracevalue**, the resultant point is **mintracevalue**.
- If that point in **SecondTrace** is equal to **mintracevalue**, the resultant point is **maxtracevalue**.

How trace math is processed

Whenever a trace math function is turned on, or the parameters and/or operands of an existing trace math function are changed, the destination trace is cleared. After the trace is cleared, all x-axis values in the trace, and the domain of the trace, are set to match the X-Axis settings of the first trace operand. When this is complete, a new sweep is initiated.

The process of acquiring data, processing it using the math and Average/Hold functions, and presenting it as trace data, consists of several functional blocks, as shown below:

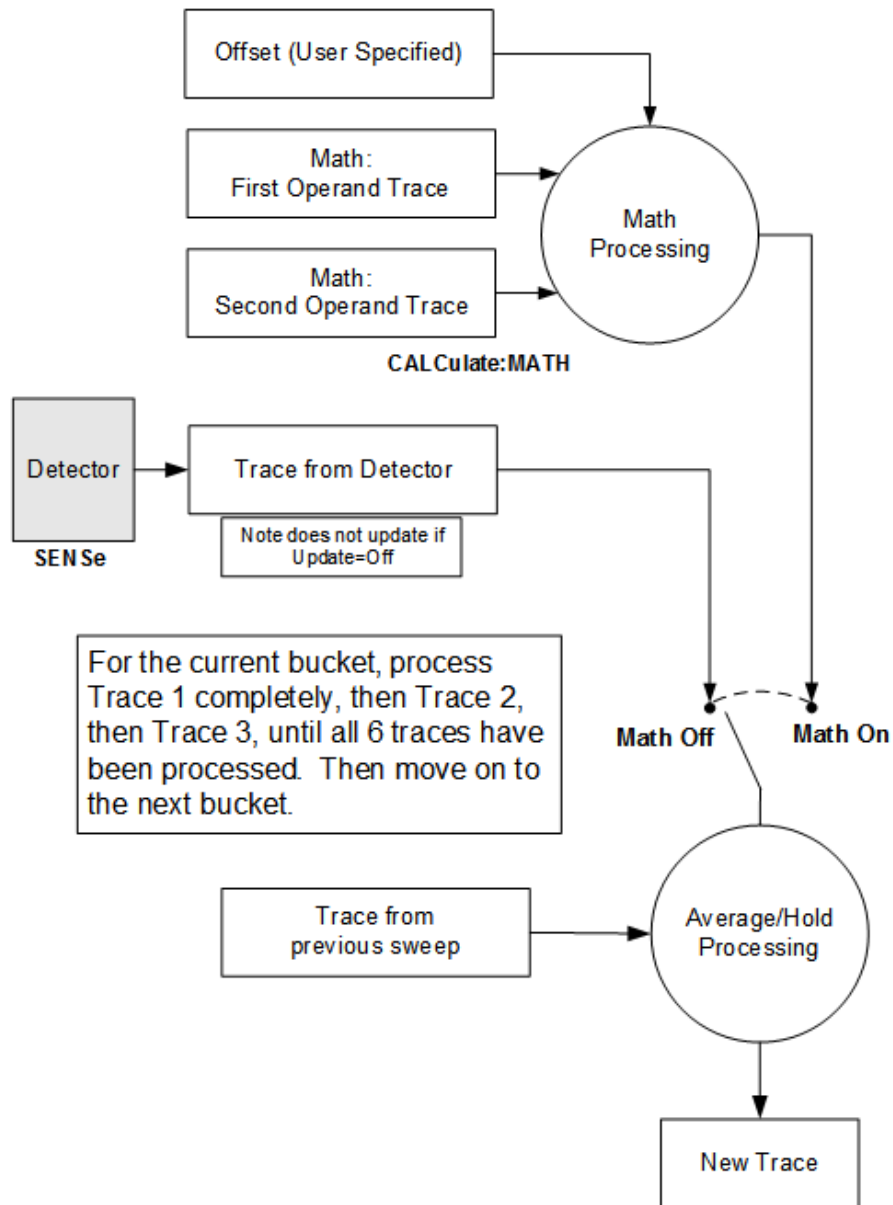

NOTE ABOUT OFFSETS: When either External Gain or Ref Level Offset is on, an offset is applied to the trace operands, and when Trace Math is on this offset is applied before any math processing is performed. Since the operands have already been offset the result trace should NOT be offset. Therefore when any Trace Math operation is performed, the sum of (External Gain - Ref Level Offset) is added to the result before it is stored in the result trace.

For each active trace, the current trace point is processed for **Trace 1**, then **Trace 2**, then **Trace 3**, etc. Trace data is taken from either the detector for that trace, or

from the mathematical result of up to two other traces and an offset, depending on whether trace math is on or not. The resultant data is then fed to the Average/Hold processing block, where (if the trace type is **Average**, **Max Hold**, or **Min Hold**) it is processed with previous trace data. The new trace data resulting from this process is then available for display, storage or remote output.

When the processing is complete for **Trace 1**, **Trace 2** is processed, and so on until all six traces have been processed. This allows a downstream trace to use as one of its math components a fully processed upstream trace. In other words, if math is **ON** for **Trace 4**, and its operand traces are **Trace 2** and **Trace 3**, then all detector, math, average and hold processing for Traces 2 and 3 is completed before the math is performed for **Trace 4**. When the current trace point is completed for all traces, the instrument moves on to the next trace point.

This allows very flexible and powerful math functions to be configured. For example, **Trace 1** can be an average trace, which can be fed with an offset to **Trace 2**, which can also be in **Max Hold**, allowing you to obtain the **Max Hold** of an Average trace.

Note that none of this processing is performed on inactive traces.

Note also that for any active trace with math **ON**, the Operand traces should have *lower* numbers than the trace (for example, using **Trace 4** as an operand for **Trace 1** will cause the data coming from **Trace 4** to be delayed by one sweep).

Operand 1 / Operand 2

These two controls select the first and second trace operands to be used for the trace math functions for the destination trace. The operands are common to all math functions for a given trace. The most recently sent **:CALCulate:MATH** command for a given trace sets the operands for that trace. Those settings are displayed on the trace operand controls for that trace.

Example	<p>The following examples are for the Swept SA measurement</p> <p>Set Trace 3 to Power Diff trace math function. Set the First Trace operand (for Trace 3) to Trace 1 and the Second Trace operand (for Trace 3) to Trace 2:</p> <pre>:CALC:MATH TRACE3,PDIF,TRACE1,TRACE2,0,0</pre> <p>Set Trace 3 to Log Offset trace math function. Set the First Trace operand (for Trace 3) to Trace 1, leave the Second Trace operand (for Trace 3) unchanged (it is irrelevant for this function) and set the Log Offset (for Trace 3) to -6 dB:</p> <pre>:CALC:MATH TRACE3,LOFF,TRACE1,TRACE2,-6.00,0</pre>
Notes	See " Math Function " on page 1745 for how to specify Operands 1 and 2 using :CALCulate:MATH
Dependencies	The destination trace cannot be an operand. The destination trace number is grayed-out on the dropdown
Preset	Operand 1: Trace number minus 2 (wraps at 1). For example, for Trace 1, Operand 1 presets to Trace

	5; for Trace 6, it presets to Trace 4 Operand 2: Trace number minus 1 (wraps at 1). For example, for Trace 1, Operand 2 presets to Trace 6; for Trace 6, it presets to Trace 5
State Saved	Operands 1 and 2 for each trace are stored in instrument state

Offset

Used by the Log Offset math function.

Example	The following example is for the Swept SA measurement Set Trace 3 to Log Offset trace math function, set the First Trace operand (for Trace 3) to Trace 1, leave the Second Trace operand (for Trace 3) unchanged (it is irrelevant for this function) and set the Log Offset (for Trace 3) to -6 dB: <code>:CALC:MATH TRACE3,LOFF,TRACE1,TRACE2,-6.00,0</code>
State Saved	The Log Offset value for each trace is saved in Instrument State
Min	-100 dB
Max	100 dB

Reference

Used by the Log Diff math function.

Example	The following example is for the Swept SA measurement Set Trace 3 to Log Diff trace math function, set the First Trace operand (for Trace 3) to Trace 1, set the Second Trace operand (for Trace 3) to Trace 2, and set the Log Difference reference (for Trace 3) to -6 dBm: <code>:CALC:MATH TRACE3,LDIF,TRACE1,TRACE2,0,-6.00</code>
State Saved	The Log Difference reference value for each trace is saved in instrument state
Min/Max	Same as reference level

3.10.10.4 Trace Function

Contains controls to:

- Copy and Exchange traces
- Preset or Clear all traces

From Trace

Selects the trace to be copied to or exchanged with the **"To Trace" on page 1753** when a **"Copy" on page 1753** or **"Exchange" on page 1754** is performed

Preset 1

To Trace

Selects the trace to be copied from or exchanged with the **"From Trace" on page 1753** when a **"Copy" on page 1753** or **"Exchange" on page 1754** is performed

Preset 2

Copy

Executes a Trace Copy based on the **"From Trace" on page 1753** and **"To Trace" on page 1753** parameters. The copy operation is from the **From Trace** to the **To Trace**. The action is performed once.

The X-Axis settings and domain of a trace are also copied.

Remote Command For Swept SA Measurement (in SA Mode):
`:TRACe:COPIY TRACE1 | ... | TRACE6, TRACE1 | ... | TRACE6`

For all other measurements:
`:TRACe:<meas>:COPIY TRACe1 | TRACe2 | TRACe3, TRACe1 | TRACe2 | TRACe3`

where `<meas>` is the identifier for the current measurement

Note that the format of the `TRACe<n>` parameter differs from that for the Swept SA Measurement

Example Copy Trace 1 to Trace 3 and put Trace 3 in Update=Off, Display=On
`:TRAC:COPIY TRACE1,TRACE3`

Notes The command is of the form:
`:TRACe:COPIY <source_trace>,<dest_trace>`

Dependencies When Signal ID is on, this key is grayed-out

Couplings The destination trace is put in **View** (Update = Off, Display = On) after the copy

Preset For Swept SA Measurement (in SA Mode):
`TRACE1, TRACE2`

For all other measurements:
`TRACe1, TRACe2`

Exchange

Executes a Trace Exchange based on the "From Trace" on page 1753 and "To Trace" on page 1753 parameters. The **From Trace** and **To Trace** values are exchanged with each other. The action is performed once.

The X-Axis settings and domain of a trace are also copied when it is exchanged with another trace.

Remote Command	For Swept SA Measurement (in SA Mode): :TRACe:EXCHange TRACE1 ... TRACE6, TRACE1 ... TRACE6 For all other measurements: :TRACe:<meas>:EXCHange TRACe1 TRACe2 TRACe3, TRACe1 TRACe2 TRACe3 where <meas> is the identifier for the current measurement Note that the format of the :TRACe<n> parameter differs from that for the Swept SA Measurement
Example	Exchange Trace 1 and Trace 2 and put both traces in Update=OFF, Display=ON: :TRAC:EXCH TRACE1,TRACE2
Notes	The command is of the form: :TRACe:EXCHange <trace_1>,<trace_2>
Couplings	Both traces are put in View (Update=Off, Display=On) after the exchange

Preset All Traces

Turns on Trace 1 and blanks all other traces. This is useful when you have many traces on and you want to return to having only Trace 1 on the display. Does not affect the trace type, detector or any other aspect of the trace system.

Remote Command	:TRACe[:<meas>]:PRESet:ALL
Example	:TRAC:PRE:ALL
Dependencies	When Signal ID is on, this key is grayed-out

Clear All Traces

Clears all traces. Does not affect the state of any function or variable in the instrument. Loads **mintracevalue** into all of the points for all traces, except traces in **Min Hold**, in which case it loads **maxtracevalue**, even if **Update = OFF**.

Remote Command	:TRACe[:<meas>]:CLEar:ALL
Example	:TRAC:CLE:ALL
Dependencies	When Signal ID is on, this key is grayed-out

3.10.10.5 Advanced

Contains controls for setting advanced trace functions of the instrument.

Measure Trace

Specifies which trace's scalar results are displayed in the **Metrics** window, and retrieved by sending a **:READ** or **:FETCh** query:

- Trace 1
- Trace 2
- Trace 3

Remote Command	<pre>:CALCulate:<meas>:MTRace TRACe1 TRACe2 TRACe3 :CALCulate:<meas>:MTRace? <meas> is the identifier for the current measurement; any one of CHPower ACPower OBWidth SEMask SPURious PVTime</pre>
Example	<pre>Channel Power :CALC:CHP:MTR TRAC1 :CALC:CHP:MTR?</pre>
Dependencies	In the ACP measurement, this control is grayed-out when Meas Method is set to RBW or FAST , and only Trace 1 is enabled
Preset	TRACe1
State Saved	No
Range	Trace 1 Trace 2 Trace 3

3.11 Phase and Amplitude vs Time Measurement

This measurement performs narrow band long capture; phase and amplitude variation over the capture is computed.

The steps involved in the PAVT measurement include:

- 1 Instrument Setup You configure the measurement for Center Frequency, Triggering, and Amplitude. Adjust the Amplitude Reference level, Range, or Adjust Range for Min Clipping as appropriate for the transmitted signal. Once the amplitude settings are obtained, ensure that the transmitted signal remains within the dynamic range of the instrument for proper measurement to be performed
- 2 Determine Frequency Error Provide the Frequency Error, or perform a measurement of Frequency Error. The Frequency Error measurement is at narrow band with a specific sample rate. When the measurement is run, the transmitted signal must not change in frequency
- 3 Actual measurement This is a long capture of the transmitted signal as the phase and amplitude of the signal changes. The power and phase for the entire captured signal will be calculated from the measured data and Frequency Error

Based on the Phase and Power calculated, additional manipulation on the data occurs to reduce the result to the request number of segments and to make the results relative to the first segment.

The first segment is called the Relative Baseline; the absolute values of the first segment are stored into the Relative Baseline result and then normalized to obtain 0° phase and 0 dB reference.

Measurement Operation

The 1st segment (the Relative Baseline) is initiated when the Trigger conditions are met, and all following segments are computed immediately thereafter based on the Meas Offset, Meas Interval, and Meas Transient. The measurement time of each segment is linear progression (segments are equally spaced).

3 VMA Mode
 3.11 Phase and Amplitude vs Time Measurement

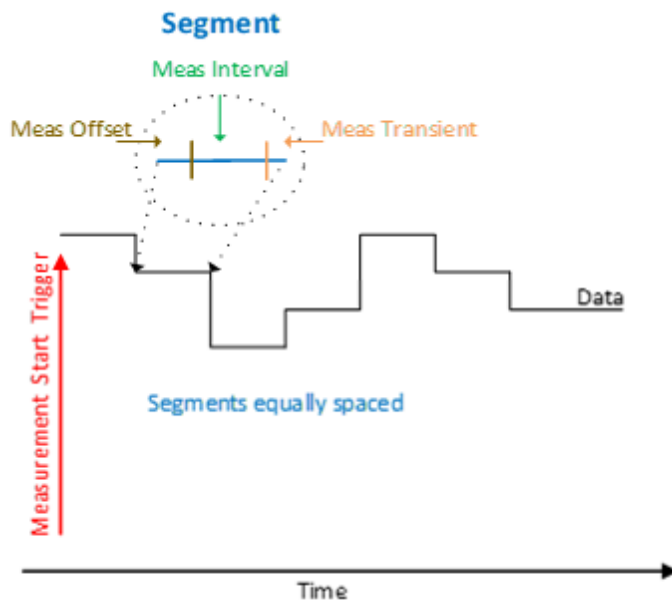

Phase and Amplitude vs Time Measurement Commands

The following commands and queries can be used to configure the measurement, then retrieve the measurement results:

```
:CONFigure:PAVTime
:CONFigure:PAVTime:NDEFault
:INITiate:PAVTime
:FETCh:PAVTime[n]?
:READ:PAVTime[n]?
:MEASure:PAVTime[n]?
```

Remote Command Results for Phase and Amplitude vs Time

The following table describes the results returned by the FETCh, MEASure, and READ queries listed above, according to the index value *n*. All the return values are floating point numbers in scientific notation, they are listed in the table as integers or simple real values for readability. If no result is available, NaN (9.91E+37) is returned.

n	Results Returned
0	Returns the number of measured segments (points)
not specified or 1	Returns scalar results for the segments measured in quadruple format, Phase, Amplitude, Time and Delta Frequency Error

n	Results Returned
	<p>For example if "Segments" on page 1821 = 5, then the return result would look like: 0, 0, 0, -168E-03, -9.63E-03, 0.9212E-03, 0.999E-03, 161.455E-03, 70.976E-03, -0.612E-03, 2.000E-03, -87.325E-03, 59.676E-03, -0.347E-03, 2.999E-03, 301.646E-03, 104.21E-03, -0.318E-03, 4.000E-03, 358.402E-03</p>
2	<p>Returns scalar Phase results for the segments measured, equivalent to the Phase values from the n = 1 query For example if Segments = 5, then the return result would look like: 0,10,-10,20,-30</p>
3	<p>Returns scalar Amplitude results for the segments measured, equivalent to the Amplitude values from the n = 1 query For example if Segments = 5, then the return result would look like: 0,-.5,-1.2,1.2,2.5</p>
4	<p>Returns scalar Time results for the segments measured, equivalent to the Time values from the n = 1 query For example if Segments = 5, then the return result would look like: 0,10,20,30,40</p>
5	<p>Returns scalar Frequency Error results for the segments measured For example if Segments = 5, then the return result would look like: 0,100000,120000,-80000,90000</p>
6	<p>Returns the Relative Baseline results</p> <ol style="list-style-type: none"> <li data-bbox="358 1094 456 1121">1. Phase <li data-bbox="358 1150 505 1178">2. Amplitude <p>For example: 125, -15.25</p>

3.11.1 Views

The PAVT measurement has one view: "[Normal](#)" on page 1807.

This is a multiple-window View. When in a multiple-window View, you select a window by touching it. The menu controls may sometimes change depending on which window is selected.

3.11.1.1 Normal

Windows: "[Graph](#)" on page 1759, "[Results](#)" on page 1759

The PAVT measurement provides tabular result and graphical display.

Some features in this menu apply to multiple measurements. Some other features apply only to specific measurements and their controls are blanked or grayed-out in measurements that do not support the feature.

3.11.3.1 Y Scale

Contains controls that pertain to the Y axis parameters of the measurement. These parameters control how data on the vertical (Y) axis is displayed and control instrument settings that affect the vertical axis.

Scale

Selects the active scale for parameter adjustments of the menu.

Remote Command	<code>:DISPlay:PAVTime:VIEW[1]:WINDow[1]:TRACe:Y[:SCALe] AMPLitude PHASe</code> <code>:DISPlay:PAVTime:VIEW[1]:WINDow[1]:TRACe:Y[:SCALe]?</code>
Example	<code>:DISP:PAVT:VIEW:WIND:TRAC:Y AMPL</code> <code>:DISP:PAVT:VIEW:WIND:TRAC:Y?</code>
Preset	PHASe
State Saved	Saved in instrument state
Range	Amplitude Phase

Ref Value

The reference line is at the top, center, or bottom of the graticule, depending on the value of "Ref Position" on page 1762.

Amplitude Scale

Sets the value for the reference position for the Amplitude Scale.

Remote Command	<code>:DISPlay:PAVTime:VIEW[1]:WINDow[1]:TRACe:Y[:SCALe]:AMPLitude:RLEVel <rel_> ampl></code> <code>:DISPlay:PAVTime:VIEW[1]:WINDow[1]:TRACe:Y[:SCALe]:AMPLitude:RLEVel?</code>
Example	<code>:DISP:PAVT:VIEW:WIND:TRAC:Y:AMPL:RLEV -10 dB</code> <code>:DISP:PAVT:VIEW:WIND:TRAC:Y:AMPL:RLEV?</code>
Preset	Automatically calculated
State Saved	Saved in instrument state
Min/Max	-100/+100 dB
Annotation	Ref <value> top of graph

Phase Scale

Sets the value for the reference position for the Phase Scale. The reference line is at the top, center, or bottom of the graticule, depending on the value of **Ref Position**.

Remote Command	<code>:DISPlay:PAVTime:VIEW[1]:WINDow[1]:TRACe:Y[:SCALe]:PHASe:RLEVel <real></code> <code>:DISPlay:PAVTime:VIEW[1]:WINDow[1]:TRACe:Y[:SCALe]:PHASe:RLEVel?</code>
Example	<code>:DISP:PAVT:VIEW:WIND:TRAC:Y:PHAS:RLEV 90</code> <code>:DISP:PAVT:VIEW:WIND:TRAC:Y:PHAS:RLEV?</code>
Preset	Automatically calculated
State Saved	Saved in instrument state
Min/Max	-1000/+1000
Annotation	Ref <value> / top of graph

Scale/Div

Sets the units per division in the graph window.

Amplitude Scale

Sets the units per division of the amplitude vertical scale in the graph window.

Remote Command	<code>:DISPlay:PAVTime:VIEW[1]:WINDow[1]:TRACe:Y[:SCALe]:AMPLitude:PDIVision <rel_ ampl></code> <code>:DISPlay:PAVTime:VIEW[1]:WINDow[1]:TRACe:Y[:SCALe]:AMPLitude:PDIVision?</code>
Example	<code>:DISP:PAVT:VIEW:WIND:TRAC:Y:AMPL:PDIV 5</code> <code>:DISP:PAVT:VIEW:WIND:TRAC:Y:AMPL:PDIV?</code>
Preset	Automatically calculated
State Saved	Saved in instrument state
Range	0.10 dB to 20.00 dB
Min	0.10 dB
Max	20.00 dB
Annotation	<value> dB/ left upper of graph

Phase Scale

Sets the units per division of the phase vertical scale in the graph window.

Remote Command	<code>:DISPlay:PAVTime:VIEW[1]:WINDow[1]:TRACe:Y[:SCALe]:PHASe:PDIVision <real></code> <code>:DISPlay:PAVTime:VIEW[1]:WINDow[1]:TRACe:Y[:SCALe]:PHASe:PDIVision?</code>
Example	<code>:DISP:PAVT:VIEW:WIND:TRAC:Y:PHAS:PDIV 5</code>

	<code>:DISP:PAVT:VIEW:WIND:TRAC:Y:PHAS:PDIV?</code>
Preset	Automatically calculated
State Saved	Saved in instrument state
Range	1 to 100
Min	1
Max	100
Annotation	<value> / left upper of graph

Ref Position

Positions the reference level at the top, center or bottom of the Y Scale display.

Amplitude Scale

Positions the Amplitude scale reference level at the top, center or bottom of the Y Scale display. Changing the reference position does not change the value of "Ref Value" on page 1760.

Remote Command	<code>:DISPlay:PAVTime:VIEW[1]:WINDow[1]:TRACe:Y[:SCALE]:AMPLitude:RPOSition TOP CENTER BOTTom</code> <code>:DISPlay:PAVTime:VIEW[1]:WINDow[1]:TRACe:Y[:SCALE]:AMPLitude:RPOSition?</code>
Example	<code>:DISP:PAVT:VIEW:WIND:TRAC:Y:AMPL:RPOS TOP</code> <code>:DISP:PAVT:VIEW:WIND:TRAC:Y:AMPL:RPOS?</code>
Preset	<code>CENTER</code>
State Saved	Saved in instrument state
Range	Top Center Bottom
Annotation	> and < are displayed both side of graph to indicate Reference Position

Phase Scale

Positions the Phase Scale reference level at the top, center or bottom of the Y Scale display. Changing the reference position does not change the value of "Ref Value" on page 1760.

Remote Command	<code>:DISPlay:PAVTime:VIEW[1]:WINDow[1]:TRACe:Y[:SCALE]:PHASe:RPOSition TOP CENTER BOTTom</code> <code>:DISPlay:PAVTime:VIEW[1]:WINDow[1]:TRACe:Y[:SCALE]:PHASe:RPOSition?</code>
Example	<code>:DISP:PAVT:VIEW:WIND:TRAC:Y:PHAS:RPOS TOP</code> <code>:DISP:PAVT:VIEW:WIND:TRAC:Y:PHAS:RPOS?</code>
Preset	<code>CENTER</code>

State Saved	Saved in instrument state
Range	Top Center Bottom
Annotation	> and < are displayed both side of graph to indicate Reference Position

3.11.3.2 Attenuation

Controls the attenuator functions and interactions between the attenuation system components.

There are two attenuator configurations in the X-Series. One is a Dual-Attenuator configuration consisting of a mechanical attenuator and an optional electronic attenuator. The other configuration uses a single attenuator with combined mechanical and electronic sections that controls all the attenuation functions. Different models in the X-Series come with different configurations.

- See ["Dual-Attenuator Configurations"](#) on page 1763
- See ["Single-Attenuator Configuration"](#) on page 1764

Most attenuation settings are the same for all measurements – they do not change as you change measurements. Settings like these are called “Meas Global” and are unaffected by **Meas Preset**.

Only available when the hardware set includes an input attenuator, which is typically only the case for Keysight’s benchtop instruments. For example, this tab does *not* appear in VXT models M9420A/10A/11A/15A/16A, M9410E/11E/15E/16E, nor in UXM. In UXM, all **Attenuation** and **Range** settings are disabled, as the expected input power level is handled by the Call Processing App that drives the DUT power control.

Dependencies	In measurements that support the I/Q inputs, unavailable when I/Q is the selected input. Replaced by the Range tab in that case
--------------	--

Dual-Attenuator Configurations

Configuration 1: Mechanical attenuator + optional electronic attenuator

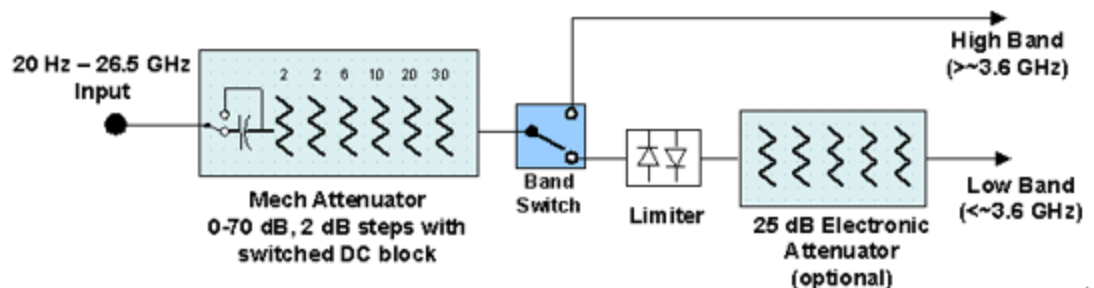

Configuration 2: Mechanical attenuator, no optional electronic attenuator

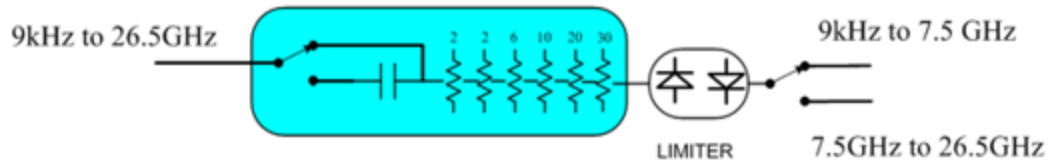

Note that Configuration 2 is not strictly speaking a dual-section attenuator, since there is no electronic section available. However, it behaves exactly like Configuration 1 without the Electronic Attenuator Option EA3, therefore for the sake of this document it is grouped into the “Dual-Attenuator” configuration.

Single-Attenuator Configuration

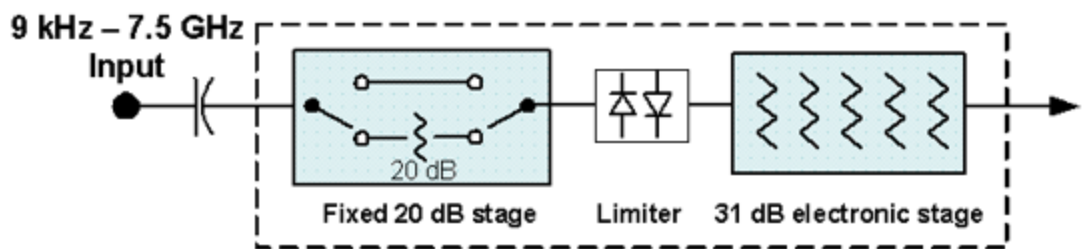

You can tell which attenuator configuration you have by pressing the Attenuation tab, which (in most Modes) opens the Attenuation menu. If the first control in the Attenuation menu says **Mech Atten** you have the Dual-Attenuator configuration. If the first control says **Atten** you have the Single-Attenuator configuration.

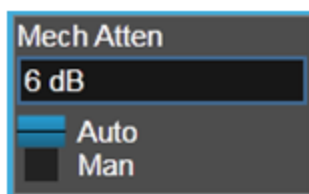

Dual Attenuator



Single Attenuator

(Note that depending on the measurement, there may be no Auto/Man functionality on the Mech Atten control.)

In the Single-Attenuator configuration, you control the attenuation with a single control, as the fixed stage has only two states. In the Dual-Attenuator configuration, both stages have significant range, so you are given separate control of the mechanical and electronic attenuator stages.

When you have the Dual-Attenuator configuration, you may still have only a Single-Attenuator, because unless Option EA3 (the Electronic Attenuator option) is available, and you purchase it, you will have only the mechanical attenuator.

Full Range Atten

This control and **Attenuator Summary** only appear in N9041B, when the RF input is selected, the RF Input Port is set to RF Input 2, and the Full Range Attenuator is installed. The Full Range Attenuator adds a second input attenuator in front of RF Input 2, which enhances the protection and optimizes the performance of the extra internal mixers used by RF Input 2.

Remote Command	<code>[:SENSe]:POWer[:RF]:FRATten <rel_amp1></code> <code>[:SENSe]:POWer[:RF]:FRATten?</code>
Example	<code>:POW:FRAT 14</code> <code>:POW:FRAT?</code>
Notes	When you enter an amplitude value that falls between valid values, the value will be incremented to the next smallest valid value
Dependencies	Only appears if input RF is selected, RF Input Port 2 is selected, and the Full Range Attenuator exists
Couplings	This value is never changed by any coupling, but other couplings use this value. See Reference Level and " Mech Atten " on page 1766 command descriptions
Preset	20 dB
State Saved	Saved in instrument state
Min	0 dB
Max	Only valid values are 0, 6, 14, 20 dB
Annotation	<p>When the Input is RF, and the Input Port is RF Input 2, and the Full Range Attenuator is installed: On the Meas Bar, the field "Atten" displays as follows:</p> <ul style="list-style-type: none"> - If the sweep is entirely < 50 GHz, the value shown after "Atten:" is equal to Mech Atten + Elec Atten + Full Range Atten - If the sweep is entirely > 50 GHz, the value shown after "Atten:" is equal to Full Range Atten - If the sweep straddles 50 GHz, the value shown after "Atten:" is preceded by the symbol ">=" and is equal to Full Range Atten <p>In the Amplitude, "Y Scale" on page 1760 menu, and the Atten Meas Bar dropdown menu panel, a summary is displayed as follows: "Total Atten below 50 GHz" followed by the value of Full Range Atten + Mech Atten + Elec Atten "Total Atten above 50 GHz" followed by the value of Full Range Atten</p> <p>For example, if Mech Atten = 6 dB, Elec Atten = 4 dB, and Full Range Atten = 20 dB, the summary below is shown:</p> <ul style="list-style-type: none"> - Attenuator summary:

-
- Total Atten below 50 GHz: 30 dB
 - Total Atten above 50 GHz: 20 dB

Mech Atten

Labeled **Mech Atten** in Dual-Attenuator models, and **Atten** in Single-Attenuator models. In the Dual-Attenuator configuration, this control only affects the mechanical attenuator.

Lets you modify the attenuation applied to the RF input signal path. This value is normally auto-coupled to **Ref Level**, "[Internal Preamp](#)" on page 1788 Gain, any External Gain that is entered, and **Max Mixer Level** (if available), as described in the table below.

See "[Attenuator Configurations and Auto/Man](#)" on page 1768

Remote Command	<code>[:SENSe]:POWer[:RF]:ATTenuation <rel_amp></code> <code>[:SENSe]:POWer[:RF]:ATTenuation?</code>
Example	<code>:POW:ATT 20</code> Dual-Attenuator configuration: sets the mechanical attenuator to 20 dB Single-Attenuator mode: sets the main attenuation to 20 dB (see below for definition of "main" attenuation) In either case, if the attenuator was in Auto, it is set to Manual
Dependencies	Some measurements do not support Auto setting of Mech Atten . In these measurements, the Auto/Man selection is not available, and the Auto/Man toggle function is not available In Dual-Attenuator configurations, when the electronic attenuator is enabled, the mechanical attenuator has no auto setting, and the Auto/Man toggle function is not available. The state of Auto/Man is remembered and restored when the electronic attenuator is once again disabled. This is described in more detail in " Elec Atten " on page 1769 See " Attenuator Configurations and Auto/Man " on page 1768 for more information on the Auto/Man functionality
Couplings	If the RF Input Port is the RF Input: <ul style="list-style-type: none"> - If the USB Preamp is connected to USB, use 0 dB for Mech Atten - Otherwise compute the auto-selected value of Mech Atten based on Reference Level, Int Preamp, External Gain, Ref Level Offset, Max Mixer Level, μW Path Control and IF Gain settings. Limit this value to be no less than 6 dB (total attenuation below 6 dB can never be chosen by Auto) - In N9041B, if the RF Input Port is RF Input 2, use the formula above and subtract the value of "Full Range Atten" on page 1765 from the result to determine the Mech Atten. Limit the value so that it is never lower than 0 dB and so that total attenuation, including Full Range Atten, is never less than 6 dB (total attenuation, including Full Range Atten below 6 dB, can never be chosen by Auto) In External Mixing and BBIQ, where the attenuator is not in the signal path, the attenuator setting changes as described above when Mech Atten is in Auto , but no changes are made to the actual

3 VMA Mode
 3.11 Phase and Amplitude vs Time Measurement

	attenuator hardware setting until the input is changed back to the RF Input For CXA-m with Option FSA (Fine-Step Attenuator or 2 dB steps), the FSA-like behavior is only available when the frequency setting is ≤ 7.5 GHz. So, when the frequency is changed from below 7.5 GHz to above 7.5 GHz, the attenuation setting changes to a multiple of 10 dB that is no smaller than the previous setting. For example, 4 dB attenuation changes to 10 dB	
Preset	Auto The Auto value is 10 dB	
State Saved	Saved in instrument state	
Min	0 dB The attenuation set by this control cannot be decreased below 6 dB with the knob or step keys. Values below 6 dB must be directly entered from the keypad or via SCPI. This protects against setting a dangerously small attenuation value, which can put the instrument at risk of damage to input circuitry. If the current mechanical attenuation is below 6 dB, it can be increased with the knob and step keys, but not decreased	
Max	CXA Option 503 or 507	50 dB
	EXA	60 dB
	All other models	70 dB
	Note that in the Single-Attenuator configuration, the total of ATT and EATT cannot exceed 50 dB. So, if the EATT is set to 24 dB first, the main attenuation cannot be greater than 26 dB and will be reduced accordingly; if the main attenuator is set to 40 dB first, EATT cannot be greater than 10 dB	
Annotation	The current value for Total Atten is displayed in the Measurement Bar at the top of the display. A value appears for Electronic Attenuation only if the Electronic Attenuator is enabled. The annotation appears as: <i>Atten: <total> dB (e<elec>)</i> The e letter is in amber in Single-Attenuator configurations For example: Dual-Attenuator configuration: <i>Atten: 24 dB (e14)</i> Indicating the total attenuation is at 24 dB and the electronic attenuation is at 14 dB Single-Attenuator configuration: <i>A: 24 dB (e14)</i> Indicating the total attenuation is at 24 dB and the "soft" attenuation is at 14 dB (see below for definition of "soft" attenuation) When in Manual, a # sign appears in front of Atten in the annotation	

Auto Function

Remote Command	<code>[:SENSe]:POWer[:RF]:ATTenuation:AUTO OFF ON 0 1</code> <code>[:SENSe]:POWer[:RF]:ATTenuation:AUTO?</code>
Example	Turn Auto Mech AttenON : <code>:POW:ATT:AUTO ON</code>

Dependencies	: POW:ATT:AUTO is only available in measurements that support Auto , such as Swept SA
Preset	ON

Attenuator Configurations and Auto/Man

As described under "[Attenuation](#)" on page 1763, there are two distinct attenuator configurations available in the X-Series, the Single Attenuator and Dual-Attenuator configurations.

In Dual-Attenuator configurations, we have mechanical attenuation and electronic attenuation, and current total attenuation is the sum of electronic + mechanical attenuation.

In Single-Attenuator configurations, we refer to the attenuation set using "[Mech Atten](#)" on page 1766 (or : POW:ATT) as the "main" attenuation; and the attenuation that is set by : POW:EATT as the "soft" attenuation (: POW:EATT is honored even in the Single-Attenuator configuration, for compatibility purposes). Then current total attenuation is the sum of main + soft attenuation.

See "[Elec Atten](#)" on page 1769 for more about "soft" attenuation.

NOTE

In some measurements, the **Mech Atten** control has an **Auto/Man** function. In these measurements, an **Auto/Man** switch is shown on the **Mech Atten** control:

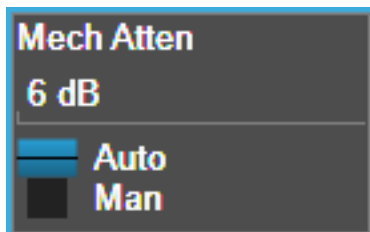

Note that in configurations that include an Electronic Attenuator, this switch is only shown when the Electronic Attenuator is disabled.

In other measurements, **Mech Atten** has no **Auto/Man** function. In these measurements, no switch is shown on the **Mech Atten** control:



Mech Atten also appears with no switch, as above, in configurations that include an Electronic Attenuator but when the Electronic Attenuator is enabled.

Elec Atten

Controls the Electronic Attenuator in Dual-Attenuator configurations. Does not appear in Single-Attenuator configurations, because the control of both the mechanical and electronic stages of the Single-Attenuator is integrated into the single **Atten** control.

This control includes an **Enable/Disable** toggle switch; it is only possible to enter a value for the Electronic Attenuator when this switch is in the **Enable** position.

For more details of the Electronic Attenuator, see ["More Information" on page 1770](#)

Remote Command	<code>[:SENSe]:POWer[:RF]:EATTenuation <rel_ampl></code> <code>[:SENSe]:POWer[:RF]:EATTenuation?</code>
Example	<code>:POW:EATT 10</code> <code>:POW:EATT?</code>
Notes	Electronic Attenuation's specification is defined only when Mech Atten is 6 dB
Dependencies	<p>Only appears in Dual-Attenuator models with an Electronic Attenuator installed and licensed. Does not appear in models with the Single-Attenuator configuration, because in the Single-Attenuator configuration there is no "electronic attenuator"; there is only a single integrated attenuator (which has both a mechanical and electronic stage). However, in the Single-Attenuator configuration, EATT SCPI commands are accepted for compatibility with other X-series instruments, and set a "soft" attenuation. The "soft" attenuation is treated as an addition to the "main" attenuation value set by the Attenuation control or <code>:POW:ATT</code>, and affects the total attenuation displayed on the Attenuation control and the Meas Bar</p> <p>The electronic attenuator, and the "soft" attenuation function provided in Single-Attenuator configurations, are unavailable above the low band (0-3.6 GHz, 0-3.4 GHz, 0-3 GHz, depending on the model). If the low band range is from 0-3.6 GHz, and Stop Frequency of the instrument is > 3.6 GHz, then the Enabled/Disabled section of the Elec Atten control will be OFF and grayed-out</p> <p>If "Internal Preamp" on page 1788 is ON (that is, set to Low Band or Full), the electronic attenuator (and the "soft" attenuation function provided in Single-Attenuator configurations) is unavailable. In this case the Enabled/Disabled section of the Elec Atten control will be OFF and grayed-out</p> <p>If either of the above is true, and the SCPI command is sent, an error indicating that the electronic attenuator is unavailable is returned</p> <p>If both the above are true, pressing the control generates error message -221, in other words, the frequency range lockout takes precedence</p> <p>If the electronic/soft Attenuator is enabled, then the Stop Freq of the instrument is limited to 3.6 GHz and Internal Preamp is unavailable</p> <p>If "LNA" on page 1790 is ON, the electronic attenuator (and the "soft" attenuation function provided in Single-Attenuator configurations) is unavailable. In this case the Enabled/Disabled section of the Elec Atten control will be OFF and grayed-out. This coupling works in the following modes/measurements:</p> <ul style="list-style-type: none"> - Channel Power, Occupied BW, ACP, SEM, Spurious Emissions, Power Stat CCDF measurements in all Modes - Transmit On Off Power measurement in 5GNR Mode

- Power vs. Time and Transmit Power measurement in GSM/EDGE Mode
- Burst Power measurement in Spectrum Analyzer Mode

The SCPI-only “soft” electronic attenuation for the single-attenuator configuration is not available in all measurements; in particular, it is not available in the Swept SA measurement

Couplings	Enabling and disabling the Electronic Attenuator affects the setting of the Mechanical Attenuator (in Dual-Attenuator configurations). This is described in more detail below and in " Mechanical Attenuator Transition Rules " on page 1771
Preset	0 dB
State Saved	Saved in instrument state
Min	0 dB
Max	Dual-Attenuator configuration: 24 dB Single-Attenuator configuration: the total of ATT and EATT cannot exceed 50 dB. So, if the EATT is set to 24 dB first, the main attenuation cannot be greater than 26 dB and will be reduced accordingly; if the main attenuator is set to 40 dB first, EATT cannot be greater than 10 dB
Annotation	See Annotation under the Mech Atten control description

Auto Function

Remote Command	<code>[:SENSe]:POWer[:RF]:EATTenuation:STATe OFF ON 0 1</code> <code>[:SENSe]:POWer[:RF]:EATTenuation:STATe?</code>
Example	<code>:POW:EATT:STAT ON</code> <code>:POW:EATT:STAT?</code>
Preset	OFF (Disabled) for Swept SA measurement ON (Enabled) for all other measurements that support the electronic attenuator

NOTE

The maximum **Center Frequency** for Low Band can change based on the selected IFBW for measurements that support IFBW (for example, Waveform measurement across all Modes that support it). In certain models (such as N9042B & N9032B), IFBW values ≤ 40 MHz have a maximum Low Band frequency of 3.6 GHz, while $40 \text{ MHz} < \text{IFBW} \leq 1 \text{ GHz}$ have a maximum of 3.3 GHz, and $1 \text{ GHz} < \text{IFBW} \leq 1.5 \text{ GHz}$ have a maximum of 3.5 GHz. This frequency is reflected in the disabled message displayed for Electrical Attenuator. For N9032B and N9042B IFBW values $> 1.5 \text{ GHz}$ do not support a **Center Frequency** that can reach the Low Band maximum frequency. In these cases, the Electrical Attenuator will remain disabled no matter the Center Frequency.

More Information

The electronic attenuator offers finer steps than the mechanical attenuator, has no acoustical noise, is faster, and is less subject to wear. These advantages primarily

aid in remote operation and are negligible for front panel use. See ["Using the Electronic Attenuator: Pros and Cons" on page 1772](#) for a detailed discussion of the pros and cons of using the electronic attenuator.

For the Single-Attenuator configuration, for SCPI backwards compatibility, the "soft" attenuation feature replaces the Dual-Attenuator configuration's electronic attenuator. All the same couplings and limitations apply. See ["Attenuator Configurations and Auto/Man" on page 1768](#)

Mechanical Attenuator Transition Rules

When the Electronic Attenuator is enabled, the Mechanical Attenuator transitions to a state that has no Auto function. Below are the rules for transitioning the Mechanical Attenuator. Note that the information below *only* applies to the Dual-Attenuator configurations, and *only* when the Electronic Attenuator is installed:

When the Electronic Attenuation is enabled from a disabled state:

- The Mechanical Attenuator is initialized to 10 dB (this is its optimal performance setting). You can then set it as desired with SCPI, numeric keypad, step keys, or knob, and it behaves as it normally would in manual mode
- The Auto/Man state of (Mech) Atten is saved
- The Auto/Man toggle on the (Mech) Atten control disappears, and the auto rules are disabled
- The Electronic Attenuator is set to 10 dB less than the previous value of the Mechanical Attenuator, within the limitation that it must stay within the range of 0 to 24 dB of attenuation

Examples in the Dual-Attenuator configuration:

- Mech Atten at 20 dB. Elec Atten enabled, Mech Atten set to 10 dB, and Elec Atten set to 10 dB. New total attenuation equals the value before Elec Atten enabled
- Mech Atten at 0 dB. Elec Atten enabled, Mech Atten set to 10 dB, and Elec Atten set to 0 dB. New total attenuation does not equal the value before Elec Atten enabled
- Mech Atten at 40 dB. Elec Atten enabled, Mech Atten set to 10 dB, and Elec Atten set to 24 dB. New total attenuation does not equal the value before Elec Atten enabled

When the Electronic Attenuation is disabled from an enabled state:

- The Elec Atten control is grayed out
- The Auto/Man state of (Mech) Atten is restored
- If now in Auto, (Mech) Atten recouples
- If now in Man, (Mech) Atten is set to the value of total attenuation that existed before the Elec Atten was disabled. The resulting value is rounded up to the smallest value possible given the (Mech) Atten Step setting - (That is, 57 dB changes to 58 dB when (Mech) Atten Step is 2 dB)

Using the Electronic Attenuator: Pros and Cons

The electronic attenuator offers finer steps than the mechanical attenuator, has no acoustical noise, is faster, and is less subject to wear.

The “finer steps” advantage of the electronic attenuator is beneficial in optimizing the alignment of the instrument dynamic range to the signal power in the front panel as well as remote use. Thus, you can achieve improved relative signal measurement accuracy. Compared to a mechanical attenuator with 2 dB steps, the 1 dB resolution of the electronic attenuator only gives better resolution when the odd-decibel steps are used. Those odd-decibel steps are less accurately calibrated than the even-decibel steps, so one tradeoff for this superior relative accuracy is reduced absolute amplitude accuracy.

Another disadvantage of the electronic attenuator is that the spectrum analyzer loses its “Auto” setting, making operation less convenient.

Also, the relationship between the dynamic range specifications (TOI, SHI, compression, and noise) and instrument performance are less well-known with the electrical attenuator. With the mechanical attenuator, TOI, SHI, and compression threshold levels increase dB-for-dB with increasing attenuation, and the noise floor does as well. With the electronic attenuator, there is an excess attenuation of about 1 to 3 dB between 0 and 3.6 GHz, making the effective TOI, SHI, and so forth, less well known. Excess attenuation is the actual attenuation relative to stated attenuation. Excess attenuation is accounted for in the instrument calibration.

Adjust Atten for Min Clipping

Sets the combination of mechanical and electronic attenuation and gain based on the current measured signal level so that clipping will be at a minimum.

This is an immediate action function, that is, it executes once, when the control is pressed.

The algorithms that are used for the adjustment are documented under "[Pre-Adjust for Min Clipping](#)" on page 1773.

Remote Command	<code>[:SENSe]:POWer[:RF]:RANGe:OPTimize IMMEDIATE</code>
Example	<code>:POW:RANG:OPT IMM</code>
Notes	Executing Adjust Atten for Min Clipping initiates the measurement
Dependencies	Does not appear in the Swept SA, RTSA, Monitor Spectrum and Complex Spectrum measurements Appears in the Waveform measurement in BASIC and 5G NR Modes

Adjust Atten

Allows you to select;

- Electric attenuator only
- Combination of Electric attenuator and Mechanical attenuator

when `[:SENSe]:POWer[:RF]:RANGe:OPTimize IMMEDIATE` is executed.

Remote Command	<code>[:SENSe]:POWer[:RF]:RANGe:OPTimize:TYPE EONLY COMBined</code> <code>[:SENSe]:POWer[:RF]:RANGe:OPTimize:TYPE?</code>
Example	<code>:POW:RANG:OPT:TYPE EONL</code> <code>:POW:RANG:OPT:TYPE?</code>
Dependencies	Does not appear in the Swept SA, RTSA, Monitor Spectrum and Complex Spectrum measurements Appears in the Waveform measurement in BASIC and 5G NR Modes
Preset	<code>COMBined</code>
State Saved	Saved in instrument state

Pre-Adjust for Min Clipping

If this function is **ON**, it applies the adjustment described under "**Adjust Atten for Min Clipping**" on page 1772 each time a measurement restarts. Therefore, in Continuous measurement mode, it only executes before the first measurement.

In Dual-Attenuator models, you can set **Elec+Mech Atten**, in which case both attenuators participate in the autoranging, or **Elec Atten Only**, in which case the mechanical attenuator does not participate in the autoranging. This latter case results in less wear on the mechanical attenuator and is usually faster.

See "**Adjustment Algorithm**" on page 1774

Selection	SCPI	Note
Off	<code>OFF</code>	This is the default setting
On	<code>ON</code>	Available in Single-Attenuator instruments. For compatibility with models that do not have an input attenuator, the ON parameter is supported and mapped to <code>COMBined</code>

Selection	SCPI	Note				
Elec Atten Only	ELECTrical	Selects only the electric attenuator to participate in auto ranging. This offers less wear on the mechanical attenuator and is usually faster				
Elec+Mech Atten	COMBined	In Dual-Attenuator models, this selects both attenuators to participate in the autoranging				
Remote Command	[:SENSe]:POWer[:RF]:RANGe:OPTimize:ATTenuation OFF ON ELECTrical COMBined [:SENSe]:POWer[:RF]:RANGe:OPTimize:ATTenuation?					
Example	:POW:RANG:OPT:ATT OFF :POW:RANG:OPT:ATT?					
Notes	<p>The parameter option ELECTrical sets this function to ON in Single-Attenuator models</p> <p>The parameter option COMBined is mapped to ELECTrical in Single-Attenuator models. If you send COMBined, it sets the function to ON and returns ELEC to a query</p> <p>For SCPI compatibility with models that do not have an input attenuator, the ON parameter is honored and mapped to COMBined</p>					
Dependencies	<p>Only appears in Dual-Attenuator models with an Electronic Attenuator installed</p> <p>In instruments with Dual-Attenuator model, when "Elec Atten" on page 1769 is OFF or grayed-out, "Pre-Adjust for Min Clipping" on page 1773 is grayed-out</p> <p>Does not appear in the Swept SA, RTSA, Monitor Spectrum and Complex Spectrum measurements</p> <p>Appears in the Waveform measurement in BASIC and 5G NR Modes</p>					
Preset	OFF when Elec Atten is Disabled at preset, otherwise ELEC					
State Saved	Saved in instrument state					
Range	<table border="0"> <tr> <td>Dual-Attenuator models:</td> <td>Off Elec Atten Only Mech + Elec Atten</td> </tr> <tr> <td>Single-Attenuator models:</td> <td>Off On</td> </tr> </table>		Dual-Attenuator models:	Off Elec Atten Only Mech + Elec Atten	Single-Attenuator models:	Off On
Dual-Attenuator models:	Off Elec Atten Only Mech + Elec Atten					
Single-Attenuator models:	Off On					

Backwards Compatibility Command

Notes	ON aliases to "Elec Atten Only" (:POW:RANG:OPT:ATT ELEC) OFF aliases to "Off" (:POW:RANG:OPT:ATT OFF) :POW:RANG:AUTO? returns true if :POW:RANG:OPT:ATT is not OFF
Backwards Compatibility SCPI	[:SENSe]:POWer[:RF]:RANGe:AUTO ON OFF 1 0 [:SENSe]:POWer[:RF]:RANGe:AUTO?

Adjustment Algorithm

The algorithms for the adjustment are documented below:

Single-Attenuator Models

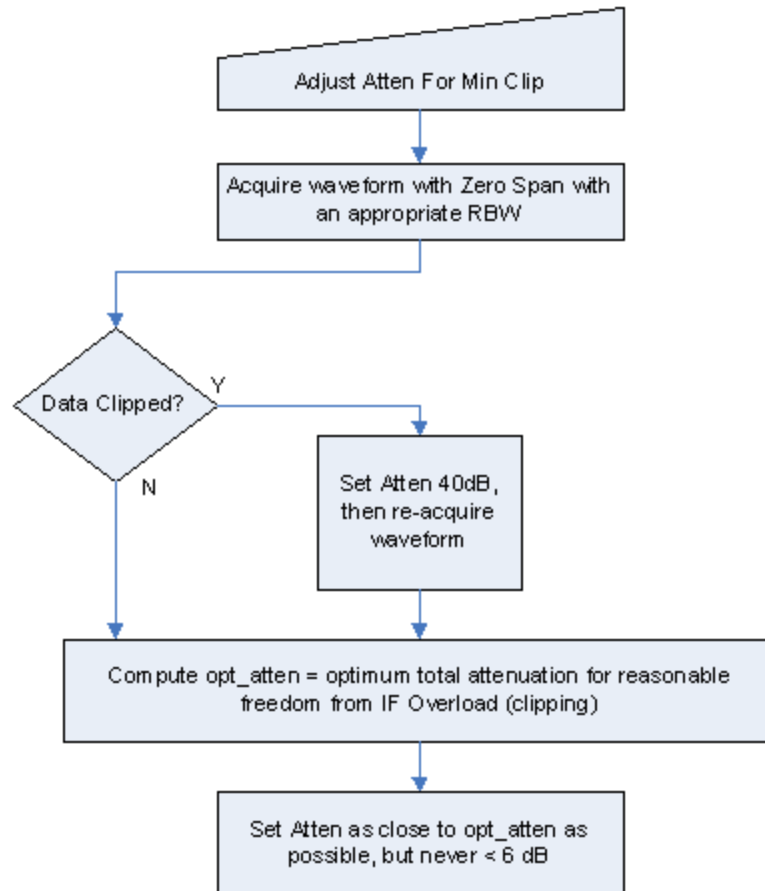

Dual-Attenuator models

"Adjust Atten for Min Clipping" on page 1772 or "Pre-Adjust for Min Clipping" on page 1773 selection is Mech + Elec Atten:

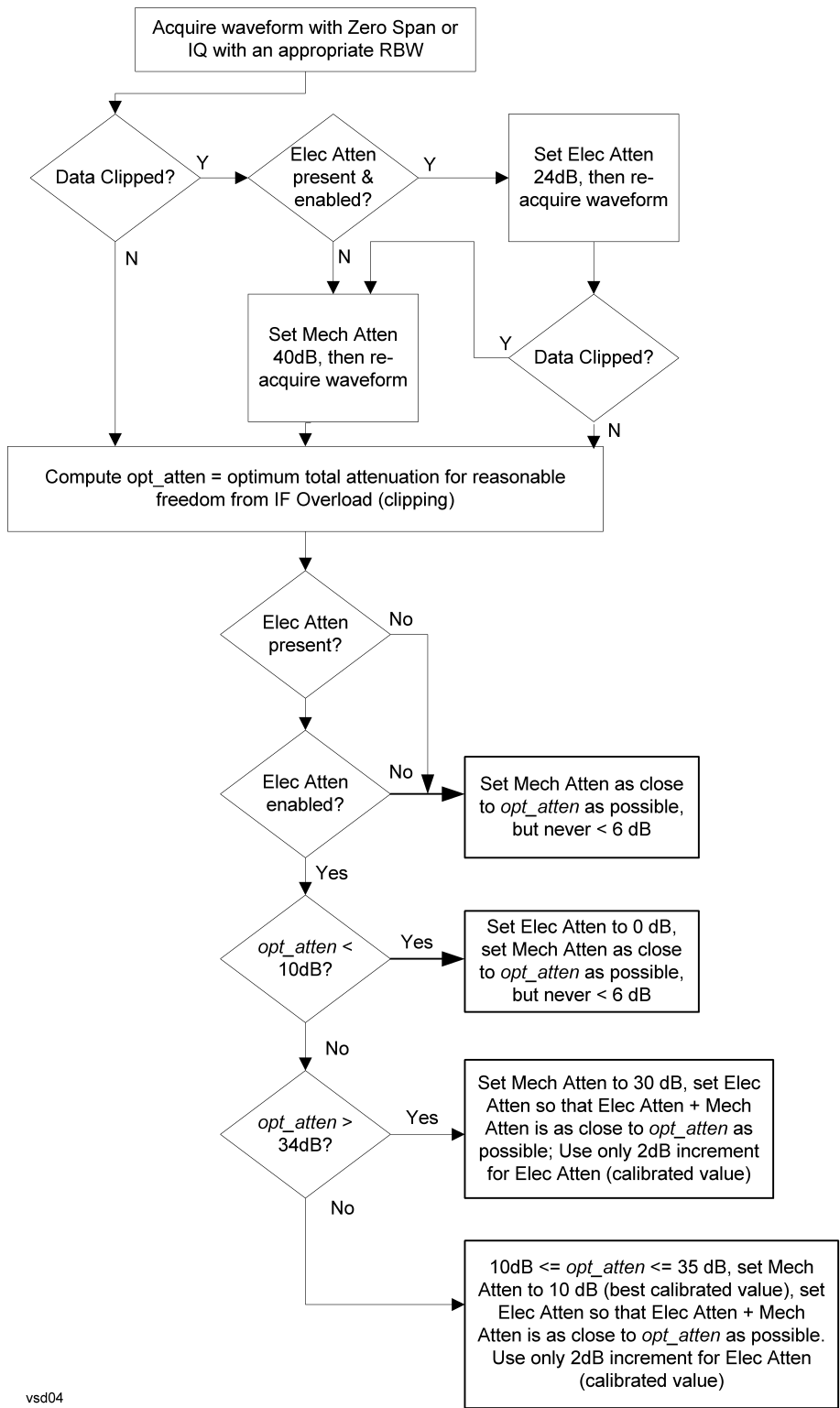

vsd04

"Pre-Adjust for Min Clipping" on page 1773 selection is Elec Only.

Note that the **Mech Atten** value is not adjusted, and the value previously set is used. Therefore, there is a case that IF Overload is still observed depending on the input signal level and the Mech Atten setting.

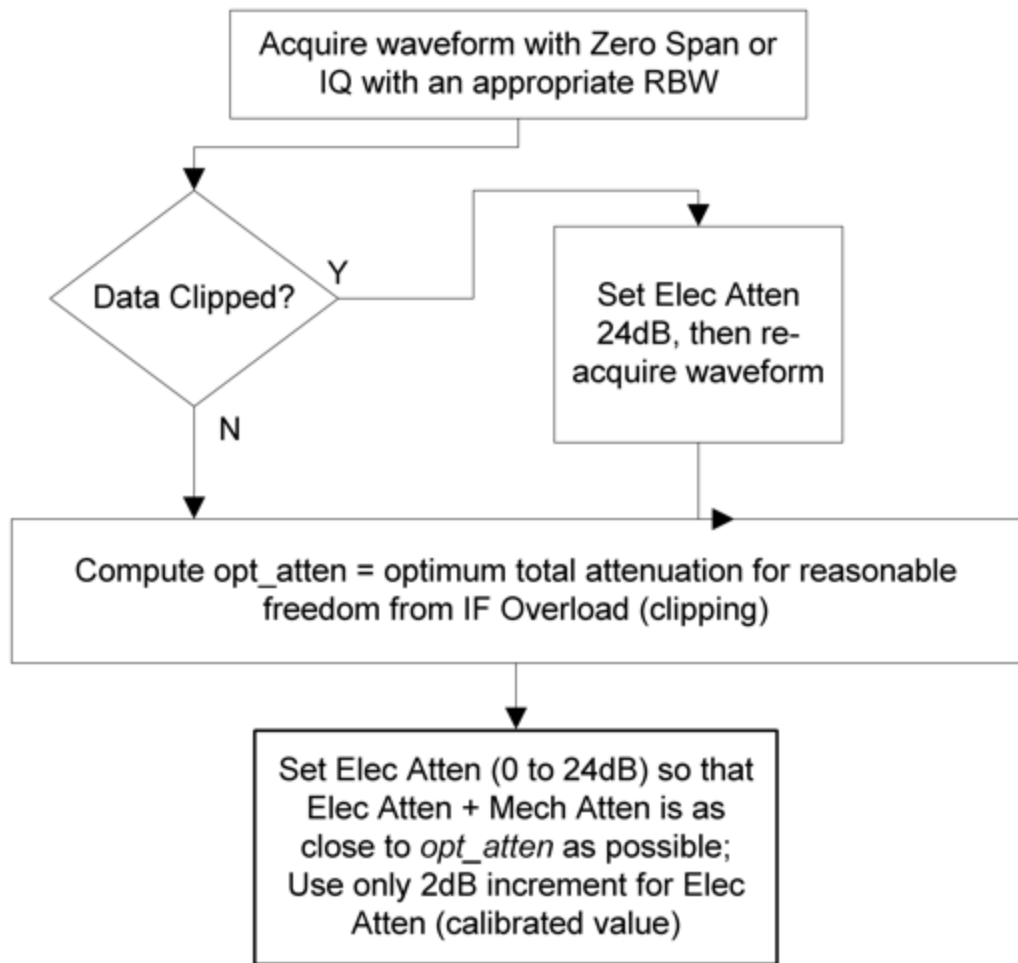

Mech Atten Step

Controls the step size used when making adjustments to the input attenuation.

Labeled **Mech Atten Step** in Dual-Attenuator models and **Atten Step** in Single-Attenuator models. In the Dual-Attenuator configuration, only affects the step size of the mechanical attenuator.

Remote Command `[:SENSe]:POWer[:RF]:ATTenuation:STEP[:INCRement] 10 dB | 2 dB`

	<code>[:SENSe]:POWer[:RF]:ATTenuation:STEP[:INCRement]?</code>
Example	<code>:POW:ATT:STEP 2</code> <code>:POW:ATT:STEP?</code>
Notes	Has a toggle control on the front panel, but takes a specific value (in dB) when used remotely. The only valid values are 2 and 10
Dependencies	Blanked in EXA, CXA and CXA-m if option FSA (2 dB steps) is not present. If blanked, attempts to set it via SCPI yield an error
Couplings	When the attenuation step size changes, the current mechanical attenuation value is adjusted (if necessary) to be quantized to the new step size. That is, if step is set to 10 dB, mech atten is increased if necessary so it is a multiple of 10 dB
Preset	EXA, CXA and CXA-m: 10 dB (2 dB with option FSA) All other models: 2 dB
State Saved	Saved in instrument state

3.11.3.3 Range (Baseband Input models)

Only available when Option BBA is present (I/Q Baseband Inputs), the current measurement supports option BBA, and I/Q is the selected input. In these cases, replaces the **Attenuation** tab.

Each input channel (I and Q) has four internal gain ranges. The maximum allowed voltage in each gain range is slightly more than the nominal value, so the break point between ranges is a few millivolts higher than the nominal (setting a peak voltage of 0.502 mV will still map to the 0.5 V Peak range).

Gain Setting	Volts RMS	Volts Peak	Volts Peak - Peak	dBm (50Ω)	Break Point
0 dB	0.7071	1.0	2.0	10	n/a
6 dB	0.3536	0.5	1.0	4	0.502 V Peak
12 dB	0.1768	0.25	0.5	-2	0.252 V Peak
18 dB	0.0884	0.125	0.25	-8	0.127 V Peak

Dependencies	Available only when the selected input is I/Q. If the current measurement does not support baseband inputs, an error will be displayed: "No result; Meas invalid with I/Q inputs"
State Saved	No

Range Auto/Man

The **Auto** setting for **Range** causes the range to be set based on the Y Scale settings. When **Range** is **Auto**, the I & Q Range are set based on the top of the Y Scale when the Y scale is in dB units (for example, power), or to the max(abs(top), abs(bottom)) when the Y scale reference is not at the top of the screen.

3 VMA Mode
 3.11 Phase and Amplitude vs Time Measurement

Not all measurements support **Range Auto/Man**. If **Auto** is not supported in the current measurement, this control is grayed-out, displaying **Man**, and **MAN** is returned to a SCPI query, but this does *not* change the Auto/Man setting for **Range**. When you switch to a measurement that supports **Auto**, it goes back to **Auto** if it was previously in **Auto** mode.

Remote Command	<code>[:SENSe]:VOLTage:IQ:RANGe:AUTO OFF ON 0 1</code> <code>[:SENSe]:VOLTage:IQ:RANGe:AUTO?</code>
Example	Put the I Range and Q Range in manual <code>:VOLT:IQ:RANG:AUTO OFF</code> <code>:VOLT:IQ:RANG:AUTO?</code>
Dependencies	If Auto is not supported, sending the SCPI command generates an error
Couplings	When in Auto , both I Range and Q Range are set to the same value, computed as follows: Maximum absolute value is computed for the Y Scale. The top and bottom of the graph are computed based on Ref Value, Scale/Div, and Ref Position. Formula: YMax = max(abs(top), abs(bottom)) The I Range and Q Range are then set to YMax
Preset	ON
State Saved	Saved in instrument state
Annotation	When in Man, the Range annotation is preceded by "#" This is an alternate form of the command to match the POWer form of the I Range and Q Range SCPI.
Remote Command	<code>[:SENSe]:POWer:IQ:RANGe:AUTO OFF ON 0 1</code> <code>[:SENSe]:POWer:IQ:RANGe:AUTO?</code>
Example	Put the I Range and Q Range in manual <code>:POW:IQ:RANG:AUTO OFF</code> <code>:POW:IQ:RANG:AUTO?</code>
Notes	<code>:POW:IQ:RANG:AUTO</code> is an alternate form of <code>:VOLT:IQ:RANG:AUTO</code> , to maintain consistency with I Range and Q Range, which support both the POWer and VOLTage forms of the command
Preset	ON
Range	Auto Man

I Range

The internal gain range for the I channel when the Input Path is I Only or I and I/Q. Used for both the I and Q channels when the Input Path is I+jQ.

Remote Command	<code>[:SENSe]:VOLTage:IQ[:I]:RANGe[:UPPer] <voltage></code> <code>[:SENSe]:VOLTage:IQ[:I]:RANGe[:UPPer]?</code>
Example	Set the I Range to 0.5 V Peak <code>:VOLT:IQ:RANG 0.5 V</code>

	<code>:VOLT:IQ:RANG?</code>
Notes	The numeric entries are mapped to the smallest gain range whose break point is greater than or equal to the value, or 1 V Peak if the value is greater than 1 V
Couplings	When " Q Same as I " on page 1782 is On, the I Range value will be copied to " Q Range " on page 1781 Changing the value also sets Range = Man
Preset	Complex SPECTrum Measurement: 0.5 V Peak All others: 1 V Peak
State Saved	Saved in instrument state
Range	1 V Peak (10 dBm @ 50 Ω) 0.5 V Peak (4 dBm @ 50Ω) 0.25 V Peak (-2 dBm @ 50Ω) 0.125 V Peak (-8 dBm @ 50Ω)
Min	0.125 V
Max	1 V
Annotation	The Range annotation replaces the RF Input context's "Atten" annotation "Rng: <I Range>". When Range = Man the annotation is preceded by "#" The I Range is not annotated in Input Path Q Only. When I Range and Q Range are the same, the annotation is "Rng: <Range>". When I Range and Q Range are different and the Input Path is Ind I/Q, the annotation is "Rng: <I Range>, <Q Range>" and "Peak" is removed from the text. Examples: "Rng: 1 V Peak" the I Range is 1 V Peak "Rng: 1 V, 0.5 V " the I Range is 1 V Peak and the Q Range is 0.5 V Peak This is an alternate form of the command to allow entry as a power.
Remote Command	<code>[:SENSe]:POWer:IQ[:I]:RANGe[:UPPer] <ampl></code> <code>[:SENSe]:POWer:IQ[:I]:RANGe[:UPPer]?</code>
Example	Set the I Range to 0.5 V Peak when Reference Z is 50 Ω, and to 1.0 V Peak when Reference Z is 75 Ω <code>:POW:IQ:RANG 4 dBm</code> <code>:POW:IQ:RANG?</code>
Notes	The POWer form of the command is provided for convenience. It maps to the same underlying gain range parameter as the VOLTage form The Reference Z (not the I channel Input Z) is used to convert the power to peak voltage, which is then used to set the I Range as with the VOLTage form of the command. The power values of the 4 range states (1V Peak, 0.5V Peak, 0.25V Peak, and 0.125V Peak) will vary with Reference Z. Here are some examples: 50 Ω: 10, 4, -2, -8 75 Ω: 8.2, 2.2, -3.8, -9.8 600 Ω: -0.8, -6.8, -12.8, -18.9
Preset	10.0 dBm
Range	-20 dBm to 10 dBm
Min	-20 dBm
Max	10 dBm

Q Range

The internal gain range for the Q channel. **Q Range** only applies to Input Path Q Only and Ind I/Q. For input I+jQ "[I Range](#)" on page 1779 determines both I and Q channel range settings.

Remote Command	<code>[:SENSe]:VOLTage:IQ:Q:RANGe[:UPPer] <voltage></code> <code>[:SENSe]:VOLTage:IQ:Q:RANGe[:UPPer]?</code>
Example	Set the Q Range to 0.5 V Peak: <code>:VOLT:IQ:Q:RANG 0.5 V</code> <code>:VOLT:IQ:Q:RANG?</code>
Notes	The numeric entries are mapped to the smallest gain range whose break point is greater than or equal to the value, or 1 V Peak if the value is greater than 1 V Q Range is only used for Input Path Q Only and Ind I/Q. For input I+jQ, " I Range " on page 1779 determines both I and Q channel range settings
Couplings	When " Q Same as I " on page 1782 is On, the " I Range " on page 1779 value is copied to Q Range and the range value keys are disabled Changing the value also sets Range = Man
Preset	1 V Peak
State Saved	Saved in instrument state
Range	1 V Peak (10 dBm @ 50Ω) 0.5 V Peak (4 dBm @ 50Ω) 0.25 V Peak (-2 dBm @ 50Ω) 0.125 V Peak (-8 dBm @ 50Ω)
Min	0.125 V
Max	1 V
Annotation	The Range annotation replaces the RF Input context's "Atten" annotation "Rng: <Q Range>". When Range = Man the annotation is preceded by "#" The Q Range is not annotated in Input Path I Only or I+jQ. When I Range and Q Range are the same, the annotation is "Rng: <Range>". When I Range and Q Range are different and the Input Path is Ind I/Q, the annotation is "Rng: <I Range>, <Q Range>" and "Peak" is removed from the text. Examples: "Rng: 1 V Peak" the Q Range is 1 V Peak "Rng: 1 V, 0.5 V" the I Range is 1 V Peak and the Q Range is 0.5 V Peak This is an alternate form of the command to allow entry as a power.
Remote Command	<code>[:SENSe]:POWer:IQ:Q:RANGe[:UPPer] <amp;lt;1></code> <code>[:SENSe]:POWer:IQ:Q:RANGe[:UPPer]?</code>
Example	Sets the Q Range to 0.5 V Peak when Reference Z is 50 Ω, and to 1.0 V Peak when Reference Z is 75 Ω: <code>:POW:IQ:Q:RANG 4 dBm</code> <code>:POW:IQ:Q:RANG?</code>
Notes	The POWer form of the command is provided for convenience. It maps to the same underlying gain

range parameter as the **VOLTage** form of the command

The Reference Z (not the Q channel Input Z) is used to convert the power to peak voltage, which is then used to set the Q Range as with the **VOLTage** form of the command. The power values of the 4 range states (1V Peak, 0.5V Peak, 0.25V Peak, and 0.125V Peak) will vary with Reference Z. Here are some examples:

50 Ω: 10, 4, -2, -8

75 Ω: 8.2, 2.2, -3.8, -9.8

600 Ω: -0.8, -6.8, -12.8, -18.9

Preset	10.0 dBm
Range	-20 dBm to 10 dBm
Min	-20 dBm
Max	10 dBm

Q Same as I

Many, but not all, usages require the I and Q channels to have an identical setup. To simplify channel setup, **Q Same as I** causes the Q channel range to be mirrored from the I channel. That way, you only need to set up one channel (the I channel). The I channel values are copied to the Q channel, so at the time **Q Same as I** is Off, the I and Q channel setups will be identical.

Remote Command	<code>[:SENSe] :VOLTage P OWer : IQ : M IRR ored OFF ON 0 1</code> <code>[:SENSe] :VOLTage P OWer : IQ : M IRR ored ?</code>
Example	Turn off the mirroring of I Range to Q Range <code>:VOLT : IQ : M IRR OFF</code> <code>:P OW : IQ : M IRR OFF</code>
Couplings	When ON , the " I Range " on page 1779 value is mirrored (copied) to the " Q Range " on page 1781
Preset	ON
State Saved	Saved in instrument state
Range	OFF ON

3.11.3.4 Range (Non-attenuator models)

Only available for Keysight's modular signal analyzers and certain other Keysight products, such as VXT and M941xE.

State Saved	No
-------------	----

Range

Represents the amplitude of the largest sinusoidal signal that could be present within the IF without being clipped by the ADC. For signals with high peak-to-average ratios, the range may need to exceed the rms signal power by a significant amount to avoid clipping.

This is a measurement global setting.

Remote Command	<code>[:SENSe]:POWer[:RF]:RANGe <real></code> <code>[:SENSe]:POWer[:RF]:RANGe?</code>
Example	<code>:POW:RANG 10 dBm</code> <code>:POW:RANG?</code>
Notes	The MIN and MAX values are affected by the External Gain parameters, and by the Center Frequency . The hardware compensates for frequency response and alters the Range setting.
Preset	0 dBm
State Saved	Yes
Min/Max	-/+100
Annotation	Meas Bar

Adjust Range for Min Clipping

Sets the combination of attenuation and gain based on the current measured signal level so that clipping will be at a minimum.

This is an "immediate action" function, that is, it executes once, when the key is pressed.

This key does not appear in measurements that do not support this functionality.

Remote Command	<code>[:SENSe]:POWer[:RF]:RANGe:OPTimize IMMEDIATE</code>
Notes	Executing Adjust Range for Min Clipping initiates the measurement.
Dependencies	Does not appear in the Swept SA and Monitor Spectrum measurements.

Pre-Adjust for Min Clipping

If this function is **ON**, it applies the adjustment described under Adjust Range For Min Clipping each time a measurement restarts. Therefore, in Continuous measurement mode, it only executes before the first measurement.

Remote Command	<code>[:SENSe]:POWer[:RF]:RANGe:OPTimize:ATTenuation OFF ON ELEctrical COMBined</code>
----------------	---

	<code>[:SENSe]:POWer[:RF]:RANGe:OPTimize:ATTenuation?</code>
Notes	Because there is no attenuator control available in these models, the control displays only ON and OFF choices. However, for SCPI compatibility with other platforms, all three parameters (ELECTrical , COMBined , and ON) are honored and all are mapped to ELECTrical , so if any of these three parameters is sent, a subsequent query will return ELEC
Dependencies	Does not appear in the Swept SA and Monitor Spectrum measurements
Preset	OFF for Swept SA measurement; ON for all other measurements that support Pre-Adjust for Min Clipping
State Saved	Saved in instrument state

Adjustment Algorithm

The algorithm for the adjustment is documented below:

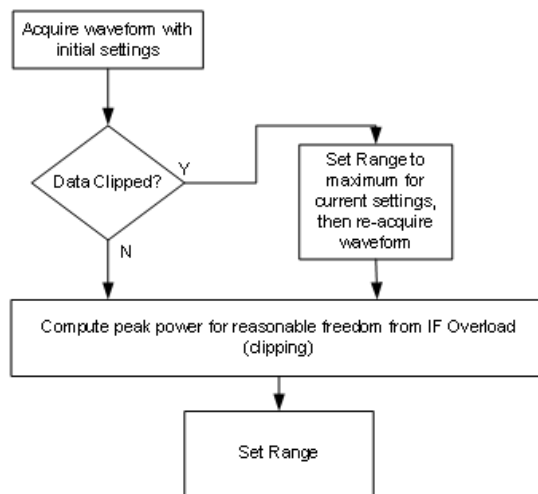

Peak-to-Average Ratio

Used with "**Range (Non-attenuator models)**" on page 1782 to optimize the level control in the instrument. The value is the ratio, in dB, of the peak power to the average power of the signal to be measured. A ratio of 0 should be used for sinusoidal signals; for 802.11g OFDM signals use 9 dB.

All Modes show the current value of Peak-to-Average ratio on the control. However, some Modes do not permit changing the value. In these situations, the control is grayed-out.

Remote Command	<code>[:SENSe]:POWer[:RF]:RANGe:PARatio <real></code> <code>[:SENSe]:POWer[:RF]:RANGe:PARatio?</code>
Example	<code>:POW:RANG:PAR 12 dB</code>
Notes	In some Modes, this parameter is read-only; meaning the value will appear on the control and query

3 VMA Mode
 3.11 Phase and Amplitude vs Time Measurement

	via SCPI, but is not changeable. In such applications the control is grayed-out. Attempts to change the value via SCPI are ignored, but no error message is generated	
Dependencies	Does not appear in Spectrum Analyzer Mode	
Preset	VXT Models M9410A/11A	0 dB
	All Others	10 dB
State Saved	Saved in instrument state	
Min	0 dB	
Max	VXT Models M9410A/11A	50 dB
	All Others	20 dB

Mixer Lvl Offset

This is an advanced setting to adjust target Range at the input mixer, which in turn affects the signal level in the instrument's IF. This setting can be used when additional optimization is needed after setting "[Peak-to-Average Ratio](#)" on page 1784. Positive values of offset optimize noise performance over distortion, negative values optimize distortion performance over noise.

Remote Command	<code>[:SENSe]:POWer[:RF]:RANGe:MIXer:OFFSet <real></code> <code>[:SENSe]:POWer[:RF]:RANGe:MIXer:OFFSet?</code>	
Example	<code>:POW:RANG:MIX:OFFS -5 dB</code>	
Preset	0 dB	
State Saved	Saved in instrument state	
Min	VXT Models M9410A/11A	-34 dB
	All Others	-35 dB
Max	30 dB	

3.11.3.5 Signal Path

Contains controls that pertain to the routing of the signal through the frontend of the instrument.

In general, only appears in instruments whose hardware supports this signal routing. For example, this tab does not appear in many of the modular instrument products, including VXT Model M9420A, or UXM.

This tab *does* appear in VXT Models M9410A/11A/15A/16A and M9410E/11E/15E/16E, because ["Software Preselection" on page 1801](#) is under this tab, and VXT Models M9410A/11A/15A/16A and M9410E/11E/15E/16E implement a version of Software Preselection.

Presel Center

Adjusts the centering of the preselector filter to optimize the amplitude accuracy at the frequency of the selected marker. If the selected marker is not on when **Presel Center** is pressed, the instrument turns on the selected marker, performs a peak search, and then performs centering on the marker's center frequency. If the selected marker is already on and between the start and stop frequencies of the instrument, the instrument performs the preselector calibration on that marker's frequency. If the selected marker is already on, but outside the frequency range between **Start Freq** and **Stop Freq**, the instrument first performs a peak search, and then performs centering on the marker's center frequency.

The value displayed on ["Preselector Adjust" on page 1787](#) changes to reflect the new preselector tuning.

Certain considerations should be observed to ensure proper operation, as detailed in ["Proper Preselector Operation" on page 1787](#).

Remote Command	<code>[:SENSe] :POWer [:RF] :PCENter</code>
Example	<code>:POW:PCEN</code>
Notes	The rules outlined above under the control description apply for the remote command as well as the key. The result of the command depends on marker position, etc. Any message generated by the control press is also generated in response to the remote command
Dependencies	Does not appear in CXA-m, nor in VXT Models M9410A/11A/15A/16A, M9410E/11E/15E/16E Grayed-out if the microwave preselector is off <ul style="list-style-type: none"> - If the selected marker's frequency is below Band 1, an advisory message is generated "Preselector not used in this frequency range" and no action is taken - Grayed-out if entirely in Band 0, that is, if Stop Freq is below about 3.6 GHz Grayed-out if entirely above 50 GHz, that is, if Start Freq is above 50 GHz - Blanked in models that do not include a preselector, such as Option 503. If the remote command is sent in these instruments, accepted without error, and the query always returns 0 - Grayed-out in the Spectrogram View
Couplings	The active marker position determines where the centering will be attempted If the instrument is in a measurement such as averaging when centering is initiated, the act of centering the preselector restarts averaging, but the first average trace will not be taken until the centering is completed The offset applied to do the centering appears in "Preselector Adjust" on page 1787
Status Bits/OPC	When centering the preselector, *OPC does not return true until the process is complete and a

dependencies subsequent measurement has completed, nor are results returned in response to **:READ** or **:MEASure** queries
 The **Measuring** bit remains set (true) while this command is operating, and does not go false until the subsequent sweep/measurement has completed

Proper Preselector Operation

Certain considerations should be observed to ensure proper operation:

1. If the selected marker is **Off**, the instrument turns on a marker, performs a peak search, and adjusts the preselector using the selected marker's frequency. It uses the "highest peak" peak search method unqualified by threshold or excursion, so that there is no chance of a 'no peak found' error. It continues with that peak, even if it is the peak of just noise. Therefore, for this operation to work properly, there should be a signal on-screen in a preselected range for the peak search to find
2. If the selected marker is already **On**, the instrument attempts the centering at that marker's frequency. There is no preselector for signals below about 3.6 GHz, so if the marker is on a signal below 3.6 GHz, no centering is attempted, and an advisory message is generated
3. In some models, the preselector can be bypassed. If it is bypassed, no centering is attempted in that range and a message is generated

Preselector Adjust

Lets you manually adjust the preselector filter frequency to optimize its response to the signal of interest. Only available when "**Presel Center**" on page 1786 is available.

For general purpose signal analysis, using **Presel Center** is recommended. Centering the filter minimizes the impact of long-term preselector drift. **Preselector Adjust** can be used instead to manually optimize the preselector. One application of manual optimization would be to peak the preselector response, which both optimizes the signal-to-noise ratio and minimizes amplitude variations due to small (short-term) preselector drifting.

When **Presel Center** is performed, the offset applied to do the centering becomes the new value of **Preselector Adjust**.

Remote Command	[:SENSe]:POWer[:RF]:PADJust <freq> [:SENSe]:POWer[:RF]:PADJust?
Example	:POW:PADJ 100KHz :POW:PADJ?
Notes	The value on the control is displayed to 0.1 MHz resolution
Dependencies	- Does not appear in CXA-m

- Does not appear in VXT Models M9410A/11A/15A/16A
- Does not appear in M9410E/11E/15E/16E
- Grayed-out if microwave preselector is off
- Grayed-out if entirely in Band 0, that is, if Stop Freq is lower than about 3.6 GHz
- Grayed-out if entirely above 50 GHz, that is, if Start Freq is higher than 50 GHz
- Blank in models that do not include a preselector, such as Option 503. If the command is sent in these instruments, it is accepted without error, and the query always returns 0
- Grayed-out in the **Spectrogram** View

Preset	0 MHz
State Saved	The Preselector Adjust value set by " Presel Center " on page 1786, or by manually adjusting Preselector Adjust Not saved in instrument state, and does not survive a Preset or power cycle
Min/Max	-/+500 MHz
Backwards Compatibility SCPI	<code>[:SENSe]:POWer[:RF]:MW:PADJust</code> <code>[:SENSe]:POWer[:RF]:MMW:PADJust</code> Backwards Compatibility Command
Notes	The command has no effect, and the query always returns MWAVE
Backwards Compatibility SCPI	<code>[:SENSe]:POWer[:RF]:PADJust:PRESelector MWAVE MMWave EXTernal</code> <code>[:SENSe]:POWer[:RF]:PADJust:PRESelector?</code>

Internal Preamp

Accesses a menu of controls for the internal preamps. Turning on the preamp gives a better noise figure, but a poorer inter-modulation distortion (TOI) to noise floor dynamic range. You can optimize this setting for your measurement.

The instrument takes the preamp gain into account as it sweeps. If you sweep outside of the range of the preamp, the instrument will also account for that. The displayed result always reflects the correct gain.

For some measurements, when the preamp is on and any part of the displayed frequency range is below the lowest frequency for which the preamp has specifications, a warning condition message appears in the status line. For example, for a preamp with a 9 kHz lowest specified frequency: "Preamp: Accy unspec'd below 9 kHz".

3 VMA Mode
 3.11 Phase and Amplitude vs Time Measurement

Selection	Example	Note
Off	:POW:GAIN OFF	
Low Band	:POW:GAIN ON :POW:GAIN:BAND LOW	Sets the internal preamp to use only the low band. The frequency range of the installed (optional) low-band preamp is displayed in square brackets on the Low Band selection in the dropdown
Full Range	:POW:GAIN ON :POW:GAIN:BAND FULL	Sets the internal preamp to use its full range. The low band (0-3.6 GHz, 0-3.4 GHz, 0-3 GHz, depending on the model) is supplied by the low band preamp and the frequencies above low band are supplied by the high band preamp The frequency range of the installed (optional) low-band preamp is displayed in square brackets on the Full Range selection in the dropdown. If the high band option is not installed the Full Range selection does not appear

NOTE The maximum **Center Frequency for Low Band**, displayed in square brackets, can change based on the selected IFBW for measurements that support IFBW (for example, Waveform measurement across all Modes that support it). In certain models (such as N9042B & N9032B), IFBW values ≤ 40 MHz have a maximum **Low Band** frequency of 3.6 GHz, while $40 \text{ MHz} < \text{IFBW} \leq 1 \text{ GHz}$ have a maximum of 3.3 GHz, and $1 \text{ GHz} < \text{IFBW} \leq 1.5 \text{ GHz}$ have a maximum of 3.5 GHz. IFBW values $> 1.5 \text{ GHz}$ do not support a **Center Frequency** that can reach the **Low Band** maximum frequency. In these cases, **N/A** is displayed in the square brackets for **Low Band**.

Remote Command	<code>[:SENSe]:POWer[:RF]:GAIN:BAND LOW FULL</code> <code>[:SENSe]:POWer[:RF]:GAIN:BAND?</code>
Example	<code>:POW:GAIN:BAND LOW</code> <code>:POW:GAIN:BAND?</code>
Dependencies	Not available on all hardware platforms. If the preamp is not present or is unlicensed, this control is not shown Does not appear in VXT Models M9410A/11A/15A/16A nor in M9410E/11E/15E/16E If <code>:POW:GAIN:BAND FULL</code> is sent when a low band preamp is available, the preamp band parameter is set to <code>LOW</code> instead of <code>FULL</code> , and an "Option not installed" message is generated Not available when the electronic/soft attenuator is enabled
Preset	<code>LOW</code>
State Saved	Saved in instrument state
Annotation	When the USB Preamp is not connected to USB, the Preamp annotation in the Meas Bar says "Off" if the preamp is off and displays the frequency range of the low band or full range preamp depending on the setting. For example, if the Preamp is set to Low Band and the Low Band is 3.6 GHz the annotation says "3.6 GHz". If it is a 13.6 GHz preamp and it is set to Full Range the annotation says "13.6 GHz"

When the USB Preamp is connected to USB, the Preamp annotation says "Preamp: USB" if the internal preamp is off or "Preamp: USB, Int" if the internal preamp is on (only for measurements that support the USB preamp)

Auto Function

Remote Command	<code>[:SENSe]:POWer[:RF]:GAIN[:STATe] OFF ON 0 1</code> <code>[:SENSe]:POWer[:RF]:GAIN[:STATe]?</code>
Example	<code>:POW:GAIN OFF</code> <code>:POW:GAIN?</code>
Preset	<code>OFF</code>

LNA

Lets you turn the Low Noise Amplifier (LNA) on or off.

LNA is an additional preamplifier that provides superior DANL and frequency range compared to "[Internal Preamp](#)" on page 1788. LNA provides lower system noise figure, especially at frequencies above 100 MHz, and can be operated up to the full range of 50 GHz instruments.

For best possible sensitivity, LNA can be turned on *together* with "[Internal Preamp](#)" on page 1788, although if you operate both preamps together, note that the TOI (distortion) specifications are impacted. The sensitivity improvement of this combination is substantial when operating in high band (frequencies above 3.6 GHz).

For more details about annotation, see "[More Information](#)" on page 1791

Remote Command	<code>[:SENSe]:POWer[:RF]:GAIN:LNA[:STATe] OFF ON 0 1</code> <code>[:SENSe]:POWer[:RF]:GAIN:LNA[:STATe]?</code>
Example	<code>:POW:GAIN:LNA ON</code>
Dependencies	Requires Option LNA, except for VXT models M9415A/16A Does not appear in VXT models M9420A/10A/11A M9410E/11E/15E/16E support LNA May not appear in some measurements LNA is not available when the electronic/soft attenuator is enabled
Preset	<code>OFF</code>
State Saved	Saved in State

More Information

When **LNA** is installed, the preamp annotation changes to show the state of both **LNA** and **Internal Preamp**. Below is an example:

```
Atten: 8 dB  
Pre: Int on, LNA on  
μW Path: LNP, On  
Source: Off
```

Note that when operating entirely in the low band (below about 3.6 GHz), if **LNA** is on, **Internal Preamp** is switched off (even if you have its switch set to **ON**). This is because the noise performance is actually degraded in low band if both preamps are on. In this case, the annotation reflects the actual state of the two preamps, but the **Internal Preamp** annotation displays in amber, to warn you that the actual state of **Internal Preamp** does not match its switch control display:

```
Atten: 8 dB  
Pre: Int off, LNA on  
μW Path: LNP, On  
Source: Off
```

μW Path Control

Options for this control include **μW Preselector Bypass** (Option MPB), **Low Noise Path** (Option LNP) and **Full Bypass Enable** in the High Band path circuits.

When the **μW Preselector** is bypassed, flatness is improved, but will be subject to spurs from out of band interfering signals. When **Low Noise Path Enable** is selected, the instrument automatically bypasses certain circuitry in the high frequency bands that can contribute to noise, when it is appropriate based on other instrument settings.

For most applications, the preset state is **Standard Path**, which provides the best remote-control throughput, minimizes acoustic noise from switching and minimizes the risk of wear in the hardware switches, particularly in remote test scenarios where both low band and high band setups will follow in rapid succession. In this path, the bypass of the low band/high band switch and microwave preamp is never activated, which can cause some noise degradation but preserves the life of the bypass switch.

For applications that utilize the wideband IF paths, the preset state is **μW Preselector Bypass**, if option MPB is present. This is because, when using a wideband IF such as the 140 MHz IF, the **μW Preselector's** bandwidth can be narrower than the available IF bandwidth, causing degraded amplitude flatness and phase linearity, so it is desirable to bypass the preselector in the default case.

You may choose **Low Noise Path Enable** for a lower noise floor, especially in the 21–26.5 GHz region, though without improving many measures of dynamic range, and

without giving the best possible noise floor. The preamp, if purchased and used, gives better noise floor than does **Low Noise Path Enable**, but the preamp's compression threshold and third-order intercept are much poorer than that of **Low Noise Path Enable**.

A fourth choice is **Full Bypass Enable**, which combines **μW Preselector Bypass** and **Low Noise Path Enable**. Because this can bypass most of the circuitry between the input and the first mixer, care should be taken when using this setting to avoid damaging the mixer. **Full Bypass Enable** is only available if both options LNP and MPB are present, as well as option FBP.

Path	Example	Note
Standard Path	:POW:MW:PATH STD	Normal setting for most measurements. μW Preselector in circuit, Low Noise Path disabled
Low Noise Path Enable	:POW:MW:PATH LNP	See " Low Noise Path Enable " on page 1796
μW Preselector Bypass	:POW:MW:PATH MPB	See " μW Preselector Bypass " on page 1798
Full Bypass Enable	:POW:MW:PATH FULL	See " Full Bypass Enable " on page 1798

Remote Command	<code>[:SENSe] :POWer [:RF] :MW :PATH STD LNPath MPBypass FULL</code> <code>[:SENSe] :POWer [:RF] :MW :PATH ?</code>
Example	<code>:POW:MW:PATH LNP</code> Enables the Low Noise path <code>:POW:MW:PATH ?</code>
Notes	When " Presel Center " on page 1786 is performed, the instrument momentarily switches to the Standard Path, regardless of the setting of μW Path Control The DC Block will always be switched in when the low noise path is switched in, to protect succeeding circuitry from DC. Note that this does not mean "when the low noise path is enabled" but when, based on the Low Noise Path rules, the path is actually switched in. This can happen when the selection is Low Noise Path Enable or Full Bypass Enable . In the case where the DC Block is switched in, the instrument is now AC-coupled. However, if you selected DC coupling, the UI would still behave as though it were DC-coupled, including all annunciation, warnings, status bits, and responses to SCPI queries. This is because, based on other settings, the instrument could switch out the low noise path at any time and hence go back to being DC-coupled Alignment switching ignores the settings in this menu, and restores them when finished
Dependencies	Does not appear in CXA-m, VXT Models M9410A/11A/15A/16A, nor in M9410E/11E/15E/16E, BBIQ and External Mixing <ul style="list-style-type: none"> - The Low Noise Path Enable selection does not appear unless Option LNP is present and licensed - The μW Preselector Bypass selection does not appear unless Option MPB is present and licensed - The Full Bypass Enable selection does not appear unless options LNP and MPB are both present as well as option FBP

3 VMA Mode
 3.11 Phase and Amplitude vs Time Measurement

In any of these cases, if the required options are not present and the SCPI command is sent, error - 241, "Hardware missing; Option not installed" is generated

Low Noise Path Enable and **Full Bypass Enable** are grayed-out if the current measurement does not support them

Low Noise Path Enable and **Full Bypass Enable** are not supported in Avionics and MMR Modes (non-modulation measurements). In any of these cases (that is, the feature is not supported in either measurement or Mode), if the SCPI command is sent, the following error is generated: -221, "Setting Conflict; Feature not supported for this measurement"

Preset	Mode	Value
	IQ Analyzer	MPB option present and licensed: MPB
	Pulse	MPB option not present and licensed: STD
	RTSA	
	Avionics	
	All other Modes	STD
	-	

State Saved Save in instrument state

Range Standard Path | Low Noise Path Enable | μ W Presel Bypass | Full Bypass Enable

Annotation In the Meas Bar, if the Standard path is chosen:
 μ W Path: Standard
 If Low Noise Path is enabled but the LNP switch is not thrown:
 μ W Path: LNP,Off
 If the Low Noise Path is enabled and the LNP switch is thrown:
 μ W Path: LNP,On
 If the preselector is bypassed:
 μ W Path: Bypass
 If Full Bypass Enable is selected but the LNP switch is not thrown:
 μ W Path: FByP,Off
 If Full Bypass Enable is selected and the LNP switch is thrown:
 μ W Path: FByP,On

μ W Path Control Auto

In VMA, WLAN, 5G NR, CQM Modes, an **Auto/Man** switch is added to μ W Path Control:



This allows the function to automatically switch based on certain Auto Rules as shown below:

VMA Mode

Measurement	μ W Path Control Auto behavior
Digital Demod	Use Standard Path unless tuned frequency > 3.6 GHz and IFBW > 15 MHz, in which case choose Preselector Bypass
Monitor Spectrum	Always Presel Bypass
IQ Waveform	Use Standard Path unless tuned frequency > 3.6 GHz and IFBW > 15 MHz, in which case choose Preselector Bypass
Custom OFDM	Use Standard Path unless tuned frequency > 3.6 GHz and IFBW > 15 MHz, in which case choose Preselector Bypass
Channel Power	Always Presel Bypass
Occupied BW	Always Presel Bypass
CCDF	Use Standard Path unless tuned frequency > 3.6 GHz and IFBW > 15 MHz, in which case choose Preselector Bypass
ACP	Always Presel Bypass
SEM	Always Presel Bypass
Spurious Emissions	Always Standard Path

WLAN Mode

Measurement	μ W Path Control Auto behavior
Modulation Analysis	Always Presel Bypass
Spectral Flatness	Always Presel Bypass
Power vs Time	Always Presel Bypass
Monitor Spectrum	Always Presel Bypass
IQ Waveform	Always Presel Bypass
Channel Power	Always Presel Bypass
Occupied BW	Always Presel Bypass
CCDF	Always Presel Bypass
SEM	For 11be 320M, when 'Enabled Wideband IF for FFT' is OFF or 'Sweep Type Rule' is Best Dynamic Range, auto μ W path is standard For other cases, auto μ W path is preselector bypass if preselector bypass is enabled, auto μ W path is standard if preselector bypass is not enabled
Spurious Emissions	Always Standard Path

5G NR Mode

3 VMA Mode

3.11 Phase and Amplitude vs Time Measurement

Measurement	μ W Path Control Auto behavior
Modulation Analysis	Use Standard Path unless tuned frequency > 3.6 GHz and IFBW > 15 MHz, in which case choose Full Bypass if conditions warrant(FBP Option is available and "Allow Full Bypass in Auto" is On), otherwise choose Preselector Bypass
Monitor Spectrum	Always Standard Path
IQ Waveform	Use Standard Path unless tuned frequency > 3.6 GHz and IFBW > 15 MHz, in which case choose Full Bypass if conditions warrant(FBP Option is available and "Allow Full Bypass in Auto" is On), otherwise choose Preselector Bypass
Channel Power	Always Standard Path
Occupied BW	Always Standard Path
CCDF	Use Standard Path unless tuned frequency > 3.6 GHz and IFBW > 15 MHz, in which case choose Preselector Bypass
ACP	Always Standard Path
SEM	Always Standard Path
Spurious Emissions	Always Standard Path
Transmit On Off Power	Use Standard Path unless tuned frequency > 3.6 GHz and Info BW > 15 MHz, in which case choose Preselector Bypass

Channel Quality Mode

Measurement	μ W Path Control Auto behavior
Group Delay	Use Standard Path unless tuned frequency > 3.6 GHz and IFBW > 15 MHz, in which case choose Full Bypass if conditions warrant(FBP Option is available and "Allow Full Bypass in Auto" is On), otherwise choose Preselector Bypass
Monitor Spectrum	Always Standard Path
IQ Waveform	Use Standard Path unless tuned frequency > 3.6 GHz and IFBW > 15 MHz, in which case choose Preselector Bypass
CCDF	Use Standard Path unless tuned frequency > 3.6 GHz and IFBW > 15 MHz, in which case choose Preselector Bypass

Remote Command	<code>[:SENSe]:POWer[:RF]:MW:PATH:AUTO ON OFF 1 0</code> <code>[:SENSe]:POWer[:RF]:MW:PATH:AUTO?</code>
Example	<code>:POW:MW:PATH:AUTO ON</code> <code>:POW:MW:PATH:AUTO?</code>
Dependencies	Only appears in VMA, WLAN, 5G NR and CQM Modes
Couplings	See " μW Path Control Auto " on page 1793 above
Preset	ON
Range	ON OFF

Low Noise Path Enable

Low Noise Path Enable provides a lower noise floor under some circumstances, particularly when operating in the 21–26.5 GHz region. With the Low Noise Path enabled, the low band/high band switch and microwave preamp are bypassed whenever *all* the following are true:

- The instrument is not in the Low Band, meaning:
- the start frequency is above 3.5 GHz and
- the stop frequency is above 3.6 GHz
- The internal preamp is not installed, or if installed, is set to **Off** or **Low Band**

Note that this means that, when any part of a sweep is done in Low Band, the Low Noise Path is not used, whether or not the **Low Noise Path Enable** is selected in the user interface. Also, if the preamp is turned on, the Low Noise Path is not used, whether or not the **Low Noise Path Enable** is selected in the user interface. The only time the Low Noise Path is used is when **Low Noise Path Enable** is selected, the sweep is completely in High Band (> 3.6 GHz) and no preamp is in use.

For measurements that use IQ acquisition, the low noise path is used when **Center Frequency** is in High Band (> 3.6 GHz) and no preamp is in use. In other words, the rules above are modified to use only the center frequency to qualify which path to switch in. This is not the case for FFTs in the Swept SA measurement; they use the same rules as swept measurements.

Note that the Low Noise Path, while giving improved DANL, has the disadvantage of decreased TOI performance and decreased gain compression performance relative to the standard path.

Note also that the bypass switch is a mechanical switch and has finite life, so if the **Low Noise Path Enable** is selected, it is possible to cause frequent cycling of this switch by frequently changing instrument settings such that the above conditions hold true only some of the time. A user making tests of this nature should consider opting for the **Standard Path**, which will never throw the bypass switch, at the expense of some degraded noise performance.

The low noise path is useful for situations where the signal level is so low that the instrument performance is dominated by noise even with 0 dB attenuation, but still high enough that the preamp option would have excessive third-order intermodulation or compression. The preamp, if purchased and used, gives better noise floor than does the “Low Noise Path.” However, its compression threshold and third-order intercept are much poorer than that of the non-preamp path.

There are some applications, typically for signals around –30 dBm, for which the third-order dynamic range of the standard path is good enough, but the noise floor is not low enough even with 0 dB input attenuation. When the third-order dynamic

3 VMA Mode
3.11 Phase and Amplitude vs Time Measurement

range of the preamp path is too little and the noise floor of the standard path is too high, the Low Noise Path can provide the best dynamic range

The graph below illustrates the concept. It shows, in red, the performance of an instrument at different attenuation settings, both with the preamp on and off, in a measurement that is affected by both instrument noise and instrument TOI. The green shows the best available dynamic range, offset by 0.5 dB for clarity. The blue shows how the best available dynamic range improves for moderate signal levels with the low noise path switched in. In this illustration, the preamp improves the noise floor by 15 dB while degrading the third-order intercept by 30 dB, and the low noise path reduces loss by 8 dB. The attenuator step size is 2 dB.

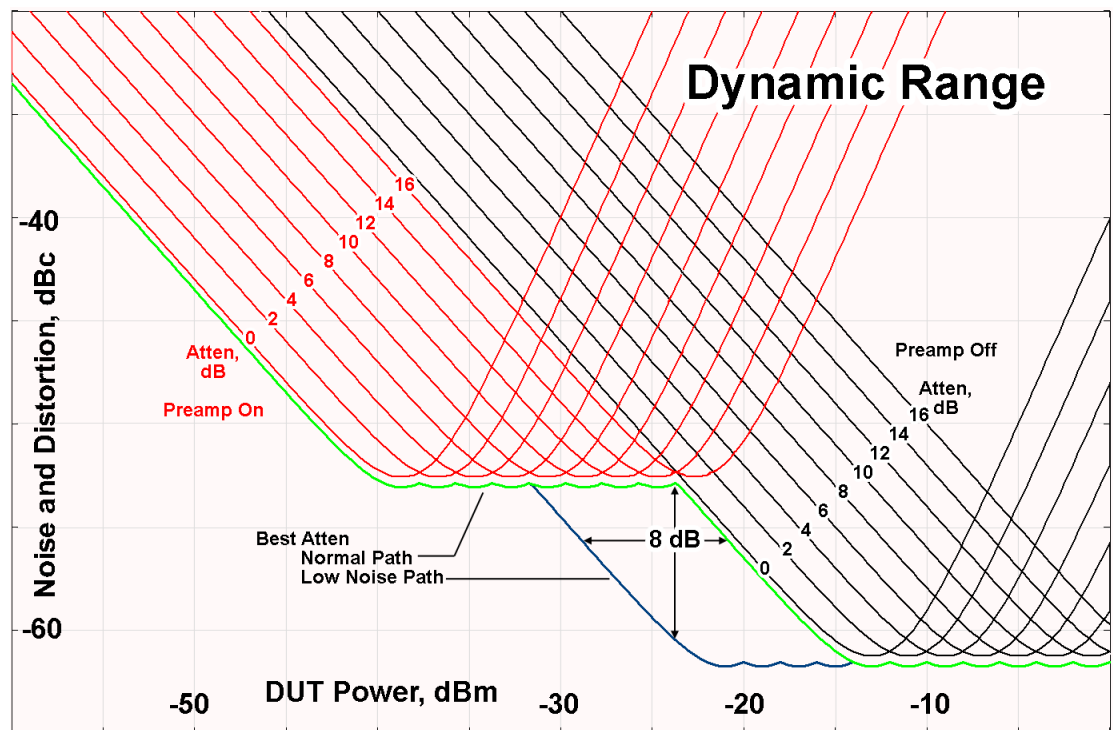

There are other times where selecting the low noise path improves performance, too. Compression-limited measurements such as finding the nulls in a pulsed-RF spectrum can profit from the low noise path in a way similar to the TOI-limited measurement illustrated. Accuracy can be improved when the low noise path allows the optimum attenuation to increase from a small amount like 0, 2 or 4 dB to a larger amount, giving better return loss at the instrument input. Harmonic measurements, such as second and third harmonic levels, are much improved using the low noise path because of the superiority of that path for harmonic (though not intermodulation) distortion performance.

μW Preselector Bypass

Toggles the preselector bypass switch for band 1 and higher. When the microwave preselector is on, the signal path is preselected. When the microwave preselector is off, the signal path is not preselected. The preselected path is the normal path for the instrument.

The preselector is a tunable bandpass filter which prevents signals away from the frequency of interest from combining in the mixer to generate in-band spurious signals (images). The consequences of using a preselector filter are its limited bandwidth, the amplitude and phase ripple in its passband, and any amplitude and phase instability due to center frequency drift.

Option MPB or pre-selector bypass provides an unpreselected input mixer path for certain X-Series signal analyzers with frequency ranges above 3.6 GHz. This signal path allows a wider bandwidth and less amplitude variability, which is an advantage when doing modulation analysis and broadband signal analysis. The disadvantage is that, without the preselector, image signals will be displayed. Another disadvantage of bypassing the preselector is increased LO emission levels at the front panel input port.

Image responses are separated from the real signal by twice the 1st IF. For IF Paths of 10 MHz and 25 MHz, the 1st IF is 322.5 MHz, so the image response and the real signal will be separated by 645 MHz. The 1st IF will be different for other IF Path settings. When viewing a real signal and its corresponding image response in internal mixing, the image response will be to the left of the real signal.

Also, the image response and the real signal typically have the same amplitude and exhibit the same shape factor.

However, if Option FS1 (Fast Sweep Capability) is enabled, the image response in the Swept SA measurement appears lower in amplitude and has a much wider shape factor compared to the real signal.

Full Bypass Enable

With **Full Bypass Enable** selected, the microwave preselector is bypassed. In addition, the low band/high band switch and microwave preamp are bypassed whenever *all* the following are true:

- The instrument is not in the Low Band, meaning:
- the start frequency is above 3.5 GHz and
- the stop frequency is above 3.6 GHz.
- the internal preamp is not installed or if installed, is set to **Off** or **Low Band**

Note that this means that, when any part of a sweep is done in Low Band, the Low Noise Path is not used, whether or not the **Full Bypass Enable** is selected in the user

interface. Also, if the preamp is turned on, the Low Noise Path is not used, whether or not the **Full Bypass Enable** is selected in the user interface. The only time the Low Noise Path is used is when **Full Bypass Enable** is selected, the sweep is completely in High Band (> 3.6 GHz) and no preamp is in use.

CAUTION

When **Full Bypass Enable** is selected, and "**Y Scale**" on page 1760 is set to 0 dB, there will be a direct AC connection between the input and the first converter when the Low Noise Path switches in (when Start Freq >3.6 GHz and the Preamp is either not licensed, set to Low Band, or Off). This puts the first converter at considerable risk to be damaged by high AC power. Consequently, whenever **Full Bypass Enable** is selected, a warning message appears in the status bar:

"Full Bypass Enabled, maximum safe input power reduced"

Microwave Preselector Bypass Backwards Compatibility

Example	Bypass the microwave preselector: :POW:MW:PRES OFF
Notes	Included for Microwave Preselector Bypass backwards compatibility The ON parameter sets the STD path (:POW:MW:PATH STD) The OFF parameter sets path MPB (:POW:MW:PATH MPB)
Preset	ON
Backwards Compatibility SCPI	[:SENSe]:POWer[:RF]:MW:PRESelector[:STATe] ON OFF 0 1 [:SENSe]:POWer[:RF]:MW:PRESelector[:STATe]?

Frequency Extender Preselection Bypass

Only applies to the high frequency path of the Frequency Extender, and only if the Frequency Extender allows it. For example, the V3050A high frequency path is 50 – 110 GHz and *does* allow control of the preselector bypass.

When the Frequency Extender's preselection is bypassed, flatness is improved, but will be subject to spurs from out-of-band interfering signals. For bandwidths greater than 2.5 [GHz], it is recommended that the signal bypass the Frequency Extender Preselector since the max bandwidth of the Preselector can be as narrow as 2.5 [GHz].

For most applications, the preset state is **OFF**, which gives the best remote-control throughput, minimizes acoustic noise from switching, minimizes out of band spurs, and minimizes the risk of wear in the hardware switches.

Preselector and Bandwidth Conflict

When the Frequency Extender Preselector is applied and the signal bandwidth is greater than 2.5 [GHz], then a settings alert message will show to warn the user that the signal may be distorted due to the limitation of the Frequency Extender Preselector bandwidth.

An example of the settings alert message is shown below.

Settings Alert message in the Status Bar at the bottom of the display.



Settings Alert message in the error queue

Type	ID	
	159	Settings Alert - DETECTED; Presel/Meas BW conflict

Allow Full Bypass in Auto

Enable or disable Full Bypass in μ W Path Auto rule. See " [\$\mu\$ W Path Control](#)" on page 1791.

When this function is **ON**, and " [\$\mu\$ W Path Control](#)" on page 1791 is in **AUTO**, it is possible for the auto rules to select the **FULL** Bypass state, which bypasses both the Preamp and the Microwave Preselector. Otherwise, the auto rules never select the **FULL** Bypass state. This is convenient when making wideband measurements, but it also adds some risk of damage to the first converter.

CAUTION

When **Full Bypass Enable** is selected, and "[Y Scale](#)" on page 1760 is set to 0 dB, there will be a direct AC connection between the input and the first converter when the Low Noise Path switches in (when Start Freq > 3.6 GHz and the Preamp is either not licensed, set to **Low Band** or **Off**). This puts the first converter at considerable risk to be damaged by high AC power. Consequently, whenever **Full Bypass Enable** is selected, a warning message appears in the status bar:

"Full Bypass Enabled, maximum safe input power reduced"

Remote Command `[:SENSe] :POWer [:RF] :MW:PATH:AUTO:FULL ON | OFF | 1 | 0`
 `[:SENSe] :POWer [:RF] :MW:PATH:AUTO:FULL?`

3 VMA Mode

3.11 Phase and Amplitude vs Time Measurement

Example	<code>:POW:MW:PATH:AUTO:FULL ON</code> <code>:POW:MW:PATH:AUTO:FULL?</code>
Dependencies	Only appears if Option FBP is installed, and in the following measurements <ul style="list-style-type: none">- 5GNRMode: Modulation Analysis and IQ Waveform- WLAN Mode: IQ Waveform- Channel Quality Mode: Group Delay and Noise Power Ratio
Preset	<code>OFF</code>
State Saved	Saved in instrument state

Software Preselection

Provided in some instruments, either to compensate for issues with provided hardware preselection or to provide the preselection function when there is no hardware preselector.

N9041B

Software Preselection compensates for the frequency range limit of the microwave preselector. Since the microwave preselector only goes up to 50 GHz, software preselection must be used to suppress and separate images above 50 GHz. The specific algorithm used for software preselection is specified by the SW Preselection Type selection – Normal or Advanced.

In N9041B, **Software Preselection** only applies for frequencies above 50 GHz, therefore it is only used for RF Input 2. Even if turned on, it is not used for other inputs, and never for frequencies below 50 GHz. This is why the label of this control contains the parenthetical note “(>~50 GHz)”.

Note that in N9041B, in Swept SA measurement, **Software Preselection** works even if the measurement is using an FFT Sweep Type. In measurements other than Swept SA, Software Preselection is not used if the measurement is using an FFT sweep type.

N9042B+V3050A

Software Preselection compensates for the frequency range limit of the microwave preselector. Since the microwave preselector only goes up to 50 GHz, software preselection must be used to suppress and separate images above 50 GHz. The specific algorithm used for software preselection is specified by the SW Preselection Type selection – Normal or Advanced.

For N9042B+V3050A, Software Preselection only applies for frequencies above 50 GHz, therefore it is only used for External RF. Even if it is turned on, it will not be

used for other inputs and never for frequencies below 50 GHz. This is why the label of this control contains the parenthetical note “(>~50 GHz)”.

Note that for N9042B+V3050A, in the Swept SA measurement, Software Preselection works even if the measurement is using an FFT Sweep Type. In measurements other than Swept SA, Software Preselection is not used if the measurement is using an FFT Sweep Type.

VXT models M9410A/11A/15A/16A

Software Preselection is used to provide the preselection function, as there is no hardware preselector in these models. Two background traces are taken and compared point by point, and the point with the lowest amplitude from the two traces is used. This provides a method to reduce spurs that are internally generated within the VXT, but you should note the following when using Software Preselection:

- There is some speed cost due to the need to take multiple captures
- Taking the point with the lowest amplitude in each trace will make the average noise level lower at all points that do not have a spur. This can reduce the accuracy of the measurement of noise and noise-like signals

Because of the difficulty in identifying spurs manually, you are recommended to leave Software Preselection **ON** at all times in VXT models M9410A/11A. If you turn it off in order to speed up your measurement or improve noise accuracy, be aware of unwanted onscreen spurs.

Remote Command	<code>[:SENSe]:POWer[:RF]:SWPrese1:STATe 0 1 ON OFF</code> <code>[:SENSe]:POWer[:RF]:SWPrese1:STAT?</code>
Example	<code>:POW:SWPR:STAT 1</code> <code>:POW:SWPR:STAT?</code>
Dependencies	Only appears in N9041B, N9042B+V2050A, VXT models M9410A/11A and M9410E/11E. Does not appear in all measurements
Couplings	Affects Sweep Time Auto Tune supports Software Preselection , so Auto Tune should be performed after setting the Software Preselection state
Preset	N9041B OFF N9042B+V3050A ON M9410A/11A ON
State Saved	Saved in instrument state

SW Preselection Type

Specifies the algorithm used for software preselection.

Two hidden sweeps occur in succession. The second sweep is offset in LO frequency by $2 * IF / N$. For each point in each trace, the smaller amplitude from the two traces is taken and placed in that point in the selected trace. The Peak detector is auto-selected to improve the image suppression effectiveness. Responses of each trace that lie on top of one another will remain and are valid signals. Other signals are images, which are suppressed. The action of taking the smaller of the two traces will make the average noise level lower in all points that do not have an image, thus reducing the accuracy of the measurement of noise and noise-like signals.

- **NORMa1** - mathematically removes all image and multiple responses of signals present at the input
- **ADVanced** - any trace processing (such as “max hold” or trace averaging) is performed on the points of both candidate traces before the “select minimum” operation occurs. This form of processing works better for non-stationary signals, such as pulsed-RF signals

Remote Command	<code>[:SENSe]:POWer[:RF]:SWPreSel NORMa1 ADVanced</code> <code>[:SENSe]:POWer[:RF]:SWPreSel?</code>
Example	<code>:POW:SWPR NORM</code> <code>:POW:SWPR?</code>
Dependencies	Only appears in N9041B and N9042B+V3050A. Only appears in measurements that use the Swept method Grayed-out when "Software Preselection" on page 1801 is OFF. The grayout message is “Unavailable unless SW Presel enabled”
Preset	N9041B ADVanced N9042B+V3050A NORMa1
State Saved	Saved in instrument state

SW Preselection BW

Specifies the effective bandwidth to be used for Software Preselection.

The options are:

- **NORMa1** – when making Swept measurements, a software preselection algorithm is used which takes up to 4 background acquisitions, then post-processes the result. This algorithm can remove images from signals with an occupied

bandwidth up to around 3 GHz. (Default/Preset setting). When making FFT measurements, this algorithm is not used, instead the same algorithm is used as for **NARRow** (below)

- **NARRow**– a software preselection algorithm is used which takes two background acquisitions, then post-processes the result to detect and remove images from wideband signals with occupied bandwidths up to 2 GHz. This increases the risk of images failing to be rejected, but improves the measurement speed

Remote Command	<code>[:SENSe]:POWer[:RF]:SWPResel:BW NORMa1 NARRow</code> <code>[:SENSe]:POWer[:RF]:SWPResel:BW?</code>
Example	<code>:POW:SWPR:BW NARR</code>
Dependencies	Only appears in N9041B and N9042B+V3050A. Only appears in measurements that use the Swept method Grayed-out when " Software Preselection " on page 1801 is OFF . The grayout message is "Unavailable unless SW Presel enabled" For N9042B+V3050A, the parameter is SCPI-only, and always set to NARRow when Software Preselection is enabled
Preset	N9041B NORMa1 N9042B+V3050A NARRow
State Saved	Saved in instrument state

High Freq Prefilter

Lets you set the state of Prefilter for center frequencies above 1310 MHz.

In VXT Models M9410A/11A and M9410E/11E in bypass frequency range (1310MHz~5GHz), the Receiver RF path has a bank of filters that come after the RF Attenuator in the signal path. Since this bank of filters precedes the mixer they are known as the "Prefilter" bank. Their purpose is to eliminate unwanted in-band mixing products by filtering out all but the desired frequencies before the signals get to the mixer. There are 13 prefilter bands to cover the frequencies between 9 kHz and 6000 MHz. The Prefilter provides the necessary rejection of the unwanted signal.

Remote Command	<code>[:SENSe]:<measurement>:PFILter[:STATe] ON OFF 1 0</code> <code>[:SENSe]:<measurement>:PFILter[:STATe]?</code>
Example	Enable High Freq Prefilter for the Complex Spectrum Measurement in BASIC Mode: <code>:SPEC:PFIL ON</code> Enable High Freq Prefilter for the IQ Waveform Measurement, in multiple Modes: <code>:WAV:PFIL ON</code>

3 VMA Mode
 3.11 Phase and Amplitude vs Time Measurement

	Enable High Freq Prefilter for the Swept SA Measurement in SA Mode: :SAN:PFIL ON
Dependencies	Only appears in VXT models M9410A/11A with center frequency above 1310 MHz, and M9410E/11E in frequency range 1310MHz~5GHz
Preset	See " Prefilter Presets " on page 1805 below
State Saved	Saved in instrument state

Prefilter Presets

Meas	Mode	Preset
SPEC	BASIC	OFF
WAV	BASIC, WCDMA, WLAN, LTEAFDD, LTEATDD, 5GNR, VMA	OFF
MON	WCDMA, WLAN, LTEAFDD, LTEATDD, 5GNR, VMA	OFF
RHO	WCDMA	OFF
CDP	WCDMA	OFF
PCON	WCDMA	OFF
EVMQ	WCDMA	OFF
CHP	WCDMA, WLAN, LTEAFDD, LTEATDD, 5GNR, VMA, SA	OFF
OBW	WCDMA, WLAN, LTEAFDD, LTEATDD, 5GNR, VMA, SA	OFF
ACP	WCDMA, LTEAFDD, LTEATDD, 5GNR, VMA, SA	OFF
SEM	WCDMA, WLAN, LTEAFDD, LTEATDD, 5GNR, VMA, SA	OFF
PST	WCDMA, WLAN, LTEAFDD, LTEATDD, 5GNR, VMA, SA	OFF
PVT	WLAN, LTEAFDD, LTEATDD, 5GNR	OFF
EVM	WLAN, LTEAFDD, LTEATDD, 5GNR	OFF
FLAT	WLAN	OFF
EVMM	WLAN	OFF
CEVM	LTEAFDD, LTEATDD	OFF
PAVT	5GNR, VMA	OFF
DDEM	VMA	OFF
OFDM	VMA	OFF
SAN	SA	ON
HARM	SA	ON

3.11.4 BW

For this measurement, bandwidth is determined by the algorithm, and is not user-adjustable.

3.11.5 Display

Opens the **Display** menu, which lets you configure display items for the current Mode, Measurement View or Window.

3.11.5.1 Meas Display

Contains controls for setting up the display for the current Measurement, View or Window.

Display Type

Allows you to display Phase and Amplitude traces in absolute values, or values relative to the 1st sample point's phase and amplitude. The 1st sample point's phase and amplitude are different from the Relative Baseline values, which only reflect the segment averaged phase and amplitude values. Setting **Display Type** to **RELative** enables the phase and amplitude traces to start from 0 degree and 0 dB, so there is no need to adjust scale or reference between measurements.

Remote Command	<code>:DISPlay:PAVTime:TYPE ABSolute RELative</code> <code>:DISPlay:PAVTime:TYPE?</code>
Example	<code>:DISP:PAVT:TYPE REL</code> <code>:DISP:PAVT:TYPE?</code>
Preset	<code>ABSolute</code>
State Saved	Yes
Range	<code>ABSolute RELative</code>

3.11.5.2 View

Contains controls for selecting the current **View**, and for editing User Views.

Views

The PAVT measurement has one view: "**Normal**" on page 1807.

This is a multiple-window View. When in a multiple-window View, you select a window by touching it. The menu controls may sometimes change depending on which window is selected.

Normal

Windows: "Graph" on page 1759, "Results" on page 1759

The PAVT measurement provides tabular result and graphical display.

User View

Lets you choose a View from the saved User Views for the current measurement. This panel only appears if a User View exists for the current measurement.

Remote Command	<code>:DISPlay:VIEW:ADVanced:SElect <alphanumeric></code> <code>:DISPlay:VIEW:ADVanced:SElect?</code>
Example	Select Baseband as the current View <code>:DISP:VIEW:ADV:SEL "Baseband"</code>
Notes	<p>You must be in the measurement whose View you are trying to set to send the command. You can only set Views for the current measurement using this command</p> <p>For predefined views, the parameter is derived from the view name that is shown in the View list in the user interface. For example, if you are trying to select the Trace Zoom view in the Swept SA measurement, you send:</p> <pre>:DISP:VIEW:ADV:SEL "Trace Zoom"</pre> <p>because "Trace Zoom" is the name of the View as seen in the Mode/Meas dialog or in the Display, View menu</p> <p>You <i>cannot</i> use the legacy View parameter (which in this case would be <code>TZOom</code>) with</p> <pre>:DISP:VIEW:ADV:SEL</pre> <p><code><alphanumeric></code> is case insensitive; you can specify mixed case, however the name will be evaluated on a single case. Thus, both of the following forms work:</p> <pre>:DISP:VIEW:ADV:SEL "Trace Zoom"</pre> <pre>:DISP:VIEW:ADV:SEL "TRACE ZOOM"</pre> <p>If the specified view is not a valid View, the query returns the error message "-224, Illegal parameter value; View with the name <alphanumeric> does not exist"</p> <p>If the display is disabled (via <code>:DISP:ENAB OFF</code>) then the error message "-221, Settings conflict; View SCPI cannot be used while Display is disabled" is generated</p>
Backwards Compatibility SCPI	The legacy node <code>:DISPlay:VIEW[:SElect]</code> is retained for backwards compatibility, but it only supports predefined views

Restore Layout to Default

Restores the Layout to the default for Basic.

Modified Views are very temporary; if you exit the current measurement they are discarded, and they are not saved in State. To retain this View for later use, and to be able to return easily to your original Basic View, you can save your edited View as a “User View”.

Save Layout as New View

Saves your new View as a User View. An alpha keyboard appears, which lets you name your new View; the default is the old View name plus a number.

Remote Command	<code>:DISPlay:VIEW:ADVanced:NAME <alphanumeric></code>
Example	<code>:DISP:VIEW:ADV:NAME "Baseband"</code> Creates a new View named Baseband from the current View, and selects it as the current View
Notes	<code><alphanumeric></code> is case insensitive; you can specify mixed case, however the name will be evaluated on a single case If <code><alphanumeric></code> name already exists as a View, the error message “-224, Illegal parameter value; View <alphanumeric> already exists” is generated If the display is disabled (via <code>:DISP:ENAB OFF</code>) then the error message “-221, Settings conflict; User View SCPI cannot be used while Display is disabled” is generated

Re-Save User View

You can re-edit a User View; if you make changes, then an asterisk will appear next to the User View’s name. You can then tap **Re-Save User View** to save it back to its existing name, or **Save Layout as New View** to add another, new User View.

This is a front panel function only, there is no remote command available to perform this function. To do this remotely, you must first perform **Save Layout as New View**, then delete the old User View and rename the new one with the name of the View you just deleted.

Rename User View

You can rename the current View by giving it a new unique name. Only User Views can be renamed, if the current View is a Predefined View, an error occurs.

Remote Command	<code>:DISPlay:VIEW:ADVanced:REName <alphanumeric></code>
Example	<code>:DISP:VIEW:ADV:REN "Baseband"</code>
Notes	<code><alphanumeric></code> is case insensitive; you can specify mixed case, however the name will be evaluated on a single case If the <code><alphanumeric></code> specifying the new name is already present in the list of View names, the error message “-224, Illegal parameter value; View <alphanumeric> already exists” is generated

If the current View is a Predefined View, the error message “-224, Illegal parameter value; Cannot rename a Predefined View” is generated

If the display is disabled (via `:DISP:ENAB OFF`) then the error message “-221, Settings conflict; View SCPI cannot be used while Display is disabled” is generated

Delete User View

You can delete the current View if it is a User View. The default view becomes the current view for the Measurement.

Remote Command	<code>:DISPlay:VIEW:ADVanced:DELeTe</code>
----------------	--

Example	<code>:DISP:VIEW:ADV:DEL</code>
---------	---------------------------------

Notes	<p><code><alphanumeric></code> is case insensitive; you can specify mixed case, however the name will be evaluated on a single case</p> <p>If the <code><alphanumeric></code> is not present in the list of View names, the error message “-224, Illegal parameter value; View <code><alphanumeric></code> does not exist” is generated</p> <p>If the current View is a Predefined View, the error message “-224, Illegal parameter value; Cannot delete a Predefined View” is generated</p> <p>If the display is disabled (via <code>:DISP:ENAB OFF</code>) then the error message “-221, Settings conflict; View SCPI cannot be used while Display is disabled” is generated</p>
-------	--

Delete All User Views

Deletes all previously saved User Views. The default view becomes the current view for the Measurement if a User View was the current view when this command was executed.

Remote Command	<code>:DISPlay:VIEW:ADVanced:DELeTe:ALL</code>
----------------	--

Example	<code>:DISP:VIEW:ADV:DEL:ALL</code>
---------	-------------------------------------

Notes	Disabled if there are no User Views
-------	-------------------------------------

View Editor Remote Commands

The following remote commands help you manage Views and User Views. Note that the SCPI node for User Views handles both Predefined and User Views. The legacy nodes, `:DISPlay:VIEW[:SElect]` and `:DISPlay:VIEW:NSEL`, are retained for backwards compatibility, but they only support predefined views.

View Listing Query

Returns a string containing a comma-separated list of names for *all* the Views, including User Views, available for the current Measurement.

Remote Command	<code>:DISPlay:VIEW:ADVanced:CATalog?</code>
Example	<code>:DISP:VIEW:ADV:CAT?</code>
Notes	<p>Returns a quoted string of the available Views for the current measurement, separated by commas. The list includes names for <i>all</i> the Views, including User Views, available for the current Measurement</p> <p>Example: <code>"Normal,Trace Zoom,Spectrogram,Baseband,myView1,yourView1"</code></p> <p>No distinction is made between Predefined and User Views</p> <p>If you switch measurements with the display disabled (via <code>:DISP:ENAB OFF</code>), then query the list of available Views, the result is undefined</p>

User View Listing Query

Returns a string containing a comma-separated list of names for *only* the User Views available for the current Measurement.

Remote Command	<code>:DISPlay:VIEW:ADVanced:USER:CATalog?</code>
Example	<code>:DISP:VIEW:ADV:USER:CAT?</code>
Notes	<p>Returns a quoted string of the available User Views for the current measurement, separated by commas.</p> <p>Example: <code>"Baseband,myView1,yourView1"</code></p> <p>If you switch measurements with the display disabled (see "Display Enable (Remote Command Only)" on page 1812), then query the list of available Views, the result is undefined</p>

3.11.5.3 Annotation

Contains controls for setting up the annotation for the current Mode or Measurement.

Graticule

Turns the display graticule On or Off for all windows with graticules in all measurements in the current Mode. Also turns the graticule Y-Axis annotation on and off.

3 VMA Mode
3.11 Phase and Amplitude vs Time Measurement

Remote Command	<code>:DISPlay:GRATicule[:STATe] OFF ON 0 1</code> <code>:DISPlay:GRATicule[:STATe]?</code>
Example	<code>:DISP:GRAT OFF</code>
Notes	The graticule is the set of horizontal and vertical lines that make up the grid/divisions for the X-Axis and Y-Axis
Preset	<code>ON</code>
State Saved	Saved in instrument state
Backwards Compatibility SCPI	<code>:DISPlay:WINDow[1]:TRACe:GRATicule:GRID[:STATe] OFF ON 0 1</code> <code>:DISPlay:WINDow[1]:TRACe:GRATicule:GRID[:STATe]?</code> This command is accepted for backwards compatibility with older instruments, but the <code>WINDow</code> , <code>TRACe</code> and <code>GRID</code> parameters are ignored

Screen Annotation

Controls the display of the annunciation and annotation around the graticule, including any annotation on lines (such as the display line, the threshold line, etc.) and the Y-Axis annotation, for all windows with screen annotation in all measurements in the current Mode.

This does *not* include marker annotation (or the N dB result). When `OFF`, the graticule expands to fill the entire graticule area, leaving only the 1.5% gap above the graticule, as described in the **Trace** section.

Remote Command	<code>:DISPlay:ANNotation:SCReen[:STATe] OFF ON 0 1</code> <code>:DISPlay:ANNotation:SCReen[:STATe]?</code>
Example	<code>:DISP:ANN:SCR OFF</code>
Dependencies	Grayed-out and forced to <code>OFF</code> when System Display Settings, Annotation is <code>OFF</code>
Preset	<code>ON</code> This remains <code>OFF</code> through a Preset when System Display Settings, Annotation is set to <code>OFF</code>
State Saved	Saved in instrument state

Trace Annotation

Turns on and off the labels on the traces, showing their detector (or their Math Mode) as described in the **Trace** section, for all windows in all measurements in the current Mode for which Trace Annotation on/off is supported.

If Trace Math is being performed on a trace, then the Trace Math annotation replaces the detector annotation.

For measurements that support limit lines, this key also turns on and off the labels on the Limit Lines. The label is the Limit number annotation and Limit Comment

displayed on the graph. If the length of the comment is greater than 20 characters, the first 8 characters and the last 8 characters are displayed, joined with

Remote Command	<code>:DISPlay:ANNotation:TRACe[:STATe] ON OFF 1 0</code> <code>:DISPlay:ANNotation:TRACe[:STATe]?</code>
Example	<code>:DISP:ANN:TRAC OFF</code>
Preset	<code>OFF</code>
State Saved	Saved in instrument state

Control Annotation

Turns on and off the display of values on the Active Function controls for all measurements in the current Mode. This is a security feature.

Remote Command	<code>:DISPlay:ACTivefunc[:STATe] ON OFF 1 0</code> <code>:DISPlay:ACTivefunc[:STATe]?</code>
Example	<code>:DISP:ACT OFF</code>
Dependencies	Grayed out and forced to <code>OFF</code> when System Display Settings, Annotation is <code>OFF</code>
Preset	<code>ON</code> This remains <code>OFF</code> through a Preset when System Display Settings, Annotation is set to <code>OFF</code>
State Saved	Saved in instrument state

Meas Bar

Turns the Measurement Bar at the top of the screen on and off for all measurements in the current Mode. When `OFF`, the graticule area expands to fill the area formerly occupied by the Measurement Bar.

Remote Command	<code>:DISPlay:ANNotation:MBAR[:STATe] OFF ON 0 1</code> <code>:DISPlay:ANNotation:MBAR[:STATe]?</code>
Example	<code>:DISP:ANN:MBAR OFF</code>
Dependencies	Grayed out and forced to <code>OFF</code> when System Display Settings, Annotation is <code>OFF</code>
Preset	<code>ON</code> This remains <code>OFF</code> through a Preset when System Display Settings, Annotation is set to <code>OFF</code>
State Saved	Saved in instrument state

Display Enable (Remote Command Only)

Turns the display on/off, including the display drive circuitry. The backlight stays lit to confirm that the instrument is on. The display enable setting is mode global.

3 VMA Mode
 3.11 Phase and Amplitude vs Time Measurement

There are three reasons for turning the display off:

1. To increase speed as much as possible by freeing the instrument from having to update the display
2. To reduce emissions from the display, drive circuitry
3. For security purposes

If you have turned off the display:

- and you are in local operation, the display can be turned back on by pressing any key or by sending `:SYSTEM:DEFAULTS MISC` or `:DISPLAY:ENABLE ON` (neither `*RST` nor `:SYSTEM:PRESET` enable the display)
- and you are in remote operation, the display can be turned back on by pressing the **Local** or **Esc** keys, or by sending `:SYSTEM:DEFAULTS MISC` or `:DISPLAY:ENABLE ON` (neither `*RST` nor `:SYSTEM:PRESET` enable the display)
- and you are using either the `:SYSTEM:KLOCK` command or GPIB local lockout, then *no* front-panel key press will turn the display back on. You must turn it back on remotely.

If the display is **OFF**, many SCPI commands related to User Views and Multiscreen functionality do not work, and return the error messages “-221, Settings conflict; Screen SCPI cannot be used when Display is disabled” or “221, Settings conflict; View SCPI cannot be used while Display is disabled”. These commands include:

Name	Command
Select User View	<code>:DISPLAY:VIEW:ADVANCED:SELECT</code>
Rename User View	<code>:DISPLAY:VIEW:ADVANCED:RENAME</code>
Delete User View	<code>:DISPLAY:VIEW:ADVANCED:DELETE</code>
Create User View	<code>:DISPLAY:VIEW:ADVANCED:NAME</code>
Select Screen	<code>:INSTRUMENT:SCREEN:SELECT</code>
Delete Screen	<code>:INSTRUMENT:SCREEN:DELETE</code>
Delete All But This Screen	<code>:INSTRUMENT:SCREEN:DELETE:ALL</code>
Add Screen	<code>:INSTRUMENT:SCREEN:CREATE</code>
Rename Screen	<code>:INSTRUMENT:SCREEN:RENAME</code>
Sequencer On/Off	<code>:SYSTEM:SEQUENCER</code>

Remote Command	<code>:DISPLAY:ENABLE OFF ON 0 1</code> <code>:DISPLAY:ENABLE?</code>
Example	<code>:DISP:ENAB OFF</code>
Couplings	<code>:DISP:ENAB OFF</code> turns Backlight OFF and <code>:DISP:ENAB ON</code> turns Backlight ON , but changing Backlight settings does <i>not</i> change the state of <code>:DISP:ENAB</code>

Preset	ON Set by :SYST:DEF MISC , but not affected by *RST or :SYSTem:PRESet
State Saved	Not saved in instrument state
Backwards Compatibility Notes	:SYST:PRES no longer turns on :DISPlay:ENABle as it did in legacy analyzers

3.11.6 Frequency

Opens the **Frequency** menu, which contains controls that allow you to control the Frequency parameters of the instrument.

Some features in this menu are the same for all measurements in the current Mode – they do not change as you change measurements. Settings like these are called “Meas Global” and are unaffected by Meas Preset. For example, the Center Freq setting is the same for all measurements – it does not change as you change measurements.

3.11.6.1 Settings

Contains controls that pertain to the frequency parameters of the measurement. These parameters control where the instrument is tuned, and implications to the measurement algorithm.

Center Frequency

This function sets (and queries) the **Center Frequency** for the currently selected input. If your instrument has multiple inputs, and you select another input, **Center Frequency** changes to the value for that input. SCPI commands are available to directly set the value for a specific input.

Center Frequency is remembered as you go from input to input.

See:

- ["RF Center Freq" on page 1817](#)
- ["Ext Mix Center Freq" on page 1818](#)
- ["I/Q Center Freq" on page 1819](#)
- ["Center Frequency Presets" on page 1815](#)

Remote Command	[:SENSe]:FREQuency:CENTer <freq>
----------------	---

3 VMA Mode
 3.11 Phase and Amplitude vs Time Measurement

	<code>[:SENSe] :FREQuency:CENTer?</code>
Example	<code>:FREQ:CENT 50 MHz</code> sets Center Frequency to 50 MHz <code>:FREQ:CENT UP</code> increments the Center Frequency by the value of CF Step <code>:FREQ:CENT?</code> returns the current value of Center Frequency
Notes	Preset and Max values are dependent on Hardware Options (5xx), port selections or other aspects of the particular instrument in use If no terminator (e.g., MHz) is sent, the terminator Hz is used. If a terminator with unit other than Frequency is used, an invalid suffix error message is generated
Couplings	For E7760A, if the Input Port selected is a mmWave port, and option RF4 is not present, the frequency of the instrument and source must be the same. Thus, changing this instrument frequency will also update the source frequency. If option RF4 is present, the frequency of the instrument and source are independent
Preset	Depends on instrument's maximum frequency, mode, measurement, and selected input See "Center Frequency Presets" on page 1815 , "RF Center Freq" on page 1817 , "Ext Mix Center Freq" on page 1818 , and "I/Q Center Freq" on page 1819
State Saved	Saved in instrument state
Min	Depends on instrument's maximum frequency, mode, measurement, and selected input See "Center Frequency Presets" on page 1815 , "RF Center Freq" on page 1817 , "Ext Mix Center Freq" on page 1818 , and "I/Q Center Freq" on page 1819
Max	Depends on instrument maximum frequency, mode, measurement, and selected input See "Center Frequency Presets" on page 1815 , "RF Center Freq" on page 1817 , "Ext Mix Center Freq" on page 1818 , and "I/Q Center Freq" on page 1819
Status Bits/OPC dependencies	Non-overlapped

Center Frequency Presets

The following table provides the Center Frequency Presets for the Spectrum Analyzer mode, and the Max Freq, for the various frequency options:

Freq Option	CF after Mode Preset	Stop Freq after Mode Preset	Max Freq (can't tune above)
503 (all but CXA)	1.805 GHz	3.6 GHz	3.7 GHz
503 (CXA)	1.505 GHz	3.0 GHz	3.08 GHz
507 (all but CXA)	3.505 GHz	7.0 GHz	7.1 GHz
507 (CXA)	3.755 GHz	7.5 GHz	7.58 GHz
508 (all but MXE)	1.805 GHz	3.6 GHz	8.5 GHz

Freq Option	CF after Mode Preset	Stop Freq after Mode Preset	Max Freq (can't tune above)
508 (MXE)	4.205 GHz	8.4 GHz	8.5 GHz
513	6.805 GHz	13.6 GHz	13.8 GHz
526 (except CXA and MXE)	13.255 GHz	26.5 GHz	27.0 GHz*
526 (CXA)	13.255 GHz	26.5 GHz	26.55 GHz
526 (MXE)	1.805 GHz	3.6 GHz	27.0 GHz
532	16.005 GHz	32.0 GHz	32.5 GHz
540	20.005 GHz	40.0 GHz	40.5 GHz
543	21.505 GHz	43.0 GHz	43.0 GHz
544	22.005 GHz	44.0 GHz	45.0 GHz
550	25.005 GHz	50.0 GHz	52 GHz
F03 (CXA-m)	1.505 GHz	3.0 GHz	3.08 GHz
F07 (CXA-m)	3.755 GHz	7.5 GHz	7.575 GHz
F13 (CXA-m)	6.805 GHz	13.6 GHz	13.8 GHz
F26 (CXA-m)	13.255 GHz	26.5 GHz	26.55 GHz
504 (M9421A, M8920A)	2.145 GHz	3.88GHz	3.88 GHz
506 (M9421A, M8920A)	3.245 GHz	6.08GHz	6.08 GHz
F06 (M9410A/11A)	1.0 GHz	6.08 GHz	6.08 GHz
F06 (M9415A)	1 GHz	1.08 GHz	6.6 GHz
F08 (M9415A)	1 GHz	1.08 GHz	8.6 GHz
F12 (M9415A)	1 GHz	1.08 GHz	12.9 GHz

*For option 526, the Max CF in RTSA is 26.999999995 GHz.

N9041B Center Freq Presets

Input	CF after Mode Preset	Stop Freq after Mode Preset	Max Freq (can't tune above)
Input 1, all models	25.005 GHz	50.0 GHz	52 GHz
Input 2, opt 585	42.505 GHz	85.0 GHz	86 GHz
Input 2, opt 590	45.005 GHz	90.0 GHz	92 GHz
Input 2, opt 5CX	55.005 GHz	110.0 GHz	110 GHz

Input 2, CXA and MXE

Model	CF after Mode Preset	Stop Freq after Mode Preset	Max Freq (can't tune above)
CXA opt C75	0.7505 GHz	1.5 GHz	1.58 GHz

3 VMA Mode

3.11 Phase and Amplitude vs Time Measurement

Model	CF after Mode Preset	Stop Freq after Mode Preset	Max Freq (can't tune above)
MXE	505 MHz	1 GHz	1.000025 GHz

Tracking Generator Frequency Limits (CXA only)

Tracking Generator Option	Min Freq (clips to this freq when turn TG on and can't tune below while TG on)	If above this Freq, Stop Freq clipped to this Freq when TG turned on	Max Freq (can't tune above) while TG on
T03	9 kHz	3.0 GHz	3.08 GHz
T06	9 kHz	6.0 GHz	6.05 GHz

Tracking Generator Frequency Limits(CXA-m only)

Tracking Generator Option	Min Freq (clips to this freq when turn TG on and can't tune below while TG on)	If above this Freq, Stop Freq clipped to this Freq when TG turned on	Max Freq (can't tune above) while TG on
T03	2 MHz	3.08 GHz	3.08 GHz
T07	2 MHz	7.575 GHz	7.575 GHz
T13	2 MHz	13.8 GHz	13.8 GHz
T26	2 MHz	26.55 GHz	26.55 GHz

RF Center Freq

Specifies the RF Center Frequency. This command sets the Center Frequency to be used when the RF input is selected, even if the RF input is not the input that is selected at the time the command is sent. Note that the **Center Freq** function in the **Frequency** menu on the front panel always applies to the currently selected input.

Remote Command	<code>[:SENSe] :FREQuency:RF:CENTer <freq></code> <code>[:SENSe] :FREQuency:RF:CENTer?</code>
Example	<code>:FREQ:RF:CENT 30 MHz</code> <code>:FREQ:RF:CENT?</code>
Notes	This command is the same in all modes, but the parameter is Measurement Global. So the value is independent in each mode and common across all the measurements in the mode
Dependencies	If the electronic/soft attenuator is enabled, any attempt to set Center Frequency such that the Stop Frequency would be >3.6 GHz fails and results in an advisory message. If the equivalent SCPI command is sent, this same message is generated as part of a "-221, Settings conflict" warning
Preset	See table above
State Saved	Saved in instrument state
Min	-79.999995 MHz

Max	See table above. Basically, instrument maximum frequency - 5 Hz If the knob or step keys are being used, also depends on Span
Ext Mix Center Freq	
Specifies the External Mixer Center Frequency. This command sets the Center Frequency to be used when the External Mixer is selected, even if the External Mixer input is not the input which is selected at the time the command is sent. Note that the Center Freq function in the Frequency menu on the front panel always applies to the currently selected input.	
Remote Command	<code>[:SENSe] :FREQuency:EMIXer:CENTer <freq></code> <code>[:SENSe] :FREQuency:EMIXer:CENTer?</code>
Example	<code>:FREQ:EMIX:CENT 60 GHz</code> <code>:FREQ:EMIX:CENT?</code>
Notes	This command is the same in all modes, but the parameter is Measurement Global. So the value is independent in each mode and common across all the measurements in the mode
Dependencies	Ext Mix Center Freq is not available in VXT Models M9410A/11A
Couplings	When returning to External Mixing after having been switched to one of the other inputs (e.g., RF), you will come back into the settings that you had when you left External Mixing. So you will come back to the band you were in with the Center Frequency that you had. However, Span is not an input-dependent parameter, therefore you will bring the span over from the other input. Therefore, the instrument comes back with the span from the previous input, limited as necessary by the current mixer setup
Preset	When a Mode Preset is performed while in External Mixing, the Start frequency of the current Mode is set to the nominal Min Freq of the lowest harmonic range in the Harmonic Table for the current mixer setup. Similarly, the Stop frequency of the current Mode is set to the nominal Max Freq of the highest harmonic range in the Harmonic Table. The Center Freq thus presets to the point arithmetically equidistant from these two frequencies Note that if the current measurement has a limited Span available to it, and cannot achieve the Span shown in the table (Span=Stop Freq – Start Freq), the instrument uses the maximum Span the measurement allows, and still sets the Center Freq to the midpoint of the Start and Stop Freq values in the Harmonic Table When Restore Input/Output Defaults is performed, the mixer presets to the 11970A, whose Start and Stop frequencies are 26.5 and 40 GHz respectively. The center of these two frequencies is 33.25 GHz. Therefore, after a Restore Input/Output Defaults, if you go into External Mixing and do a Mode Preset while in the Spectrum Analyzer Mode, the resulting Center Freq is 33.25 GHz
State Saved	Yes
Min	The minimum frequency in the currently selected mixer band + 5 Hz If the knob or step keys are being used, also depends on Span
Max	The maximum frequency in the currently selected mixer band - 5 Hz If the knob or step keys are being used, also depends on Span

I/Q Center Freq

Specifies the I/Q Center Frequency. This command sets the Center Frequency to be used when the I/Q input is selected, even if the I/Q input is not the input which is selected at the time the command is sent. Note that the **Center Freq** function in the **Frequency** menu on the front panel always applies to the currently selected input.

Remote Command	<code>[:SENSe] :FREQuency:IQ:CENTer <freq></code> <code>[:SENSe] :FREQuency:IQ:CENTer?</code>
Example	<code>:FREQ:IQ:CENT 30 MHz</code>
Notes	This command is the same in all modes, but the parameter is Measurement Global. So the value is independent in each mode and common across all the measurements in the mode
Dependencies	I/Q Center Freq is not available in VXT Models M9410A/11A
State Saved	Saved in instrument state
Min	-40.049995 MHz
Max	40.049995 MHz

CF Step

Changes the step size for "**Center Frequency**" on page 1814, and start/stop frequency functions. Once a step size has been selected and the Center Frequency function is active, the step keys (and the **UP | DOWN** parameters for Center Frequency from remote commands) change Center Frequency by the step-size value.

Remote Command	<code>[:SENSe] :FREQuency:CENTer:STEP[:INCRement] <freq></code> <code>[:SENSe] :FREQuency:CENTer:STEP[:INCRement]?</code> <code>[:SENSe] :FREQuency:CENTer:STEP:AUTO OFF ON 0 1</code> <code>[:SENSe] :FREQuency:CENTer:STEP:AUTO?</code>
Example	<code>:FREQ:CENT:STEP 500 MHz</code> <code>:FREQ:CENT UP</code> increases the current center frequency value by 500 MHz <code>:FREQ:CENT:STEP?</code> <code>:FREQ:CENT:STEP:AUTO ON</code> <code>:FREQ:CENT:STEP:AUTO?</code>
Notes	Preset and Max values are depending on Hardware Options (503, 507, 508, 513, 526)
Dependencies	Span, RBW, Center frequency If the electronic/soft attenuator is enabled, any attempt to change the value of the center frequency >3.6 GHz by pressing the Up-arrow key, fails and results in an advisory message. If the equivalent SCPI command is sent, this same message is generated as part of a "-221, Settings conflict" warning This control does not appear in 5G NR Mode

Couplings	When auto-coupled in a non-zero span, the center frequency step size is set to 10% of the span. When auto-coupled in zero span, the center frequency step size is set to the equivalent -3 dB RBW value
Preset	Auto ON
State Saved	Saved in instrument state
Min	– (the maximum frequency of the instrument). That is, 27 GHz max freq instrument has a CF step range of +/- 27 GHz. Note that this is the maximum frequency given the current settings of the instrument, so in External Mixing, for example, it is the maximum frequency of the current mixer band
Max	The maximum frequency of the instrument. That is, 27 GHz max freq instrument has a CF step range of +/- 27 GHz. Note that this is the maximum frequency given the current settings of the instrument, so in External Mixing, for example, it is the maximum frequency of the current mixer band
Status Bits/OPC dependencies	non-overlapped

Freq Offset

Enables you to set a frequency offset value to account for frequency conversions outside of the instrument. This value is added to the display readout of the marker frequency, center frequency, start frequency, stop frequency, and all other absolute frequency settings in the instrument including frequency count. When a frequency offset is entered, the value appears below the center of the graticule. To eliminate an offset, perform a Mode Preset or set the frequency offset to 0 Hz.

See "[More Information](#)" on page 1821.

Remote Command	<code>[:SENSe] :FREQuency :OFFSet <freq></code> <code>[:SENSe] :FREQuency :OFFSet ?</code>
Example	<code>:FREQ:OFFS 10 MHz</code> <code>:FREQ:OFFS?</code>
Notes	Preset and Max values are dependent on Hardware Options (503, 507, 508, 513, 526)
Preset	See " Center Frequency Presets " on page 1815
State Saved	Saved in instrument state
Min	-500 GHz
Max	500 GHz
Annotation	If Frequency Offset is not zero, "Freq Offset <value>" appears on the upper line of the annotation, below the graticule, in the center
Status Bits/OPC dependencies	Non-overlapped

More Information

This command does not affect any bandwidths or the settings of relative frequency parameters such as delta markers or span. It does not affect the current hardware settings of the instrument, but only the displayed frequency values. Entering an offset does not affect the trace position or display, just the value of the start and stop frequency and the values represented by the trace data. The frequency values of exported trace data, queried trace data, markers, trace data used in calculations such as N dB points, trace math, etc., are all affected by Freq Offset. Changing the offset, even on a trace that is not updating will immediately change all of the above, without taking new data.

NOTE

If a trace is exported with a nonzero Freq Offset, the exported data will contain the trace data with the offset applied. Therefore, if that trace were to be imported back into the instrument, you would want Freq Offset to be 0, or the offset would be applied again to data that is already offset. No such care need be taken when saving a State+Trace file because the data and state are saved together.

3.11.7 Marker

There is no **Marker** functionality in the PAVT Measurement.

3.11.8 Meas Setup

Contains functions for setting up the measurement parameters and also contains functions for setting up parameters global to all measurements in the mode.

3.11.8.1 Settings

Contains frequently used Meas Setup functions to which you will want the fastest access.

Segments

Sets the number of measurement results. A Segment is comprised of a Measurement Offset, Measurement Interval, and Measurement Transient.

Remote Command `[:SENSe]:PAVTime:SEGMents <integer>`
`[:SENSe]:PAVTime:SEGMents?`

Example `:PAVT:SEGM 360`
`:PAVT:SEGM?`

Preset	180
State Saved	Saved in instrument state
Min	1
Max	1000

Total Meas Time

Information only. Returns the result of (Meas Offset + Meas Interval + Meas Transient)*Segments.

Remote Command	<code>[:SENSe]:PAVTime:MTIME?</code>
Example	<code>:PAVT:MTIM?</code>
State Saved	Saved in instrument state

Meas Interval

Sets the duration of acquisition window within the segment.

Remote Command	<code>[:SENSe]:PAVTime:SEGMENTS:INTERVAL <time></code> <code>[:SENSe]:PAVTime:SEGMENTS:INTERVAL?</code>
Example	<code>:PAVT:SEGM:INT 10 us</code> <code>:PAVT:SEGM:INT?</code>
Couplings	Meas Interval must be > 0 s and less than (Max Capture Length/Segments) - Meas Offset - Meas Transient
Preset	1 ms
State Saved	Saved in instrument state
Min	100 ns
Max	(Max Capture Length/Segments) - Meas Offset - Meas Transient

Meas Offset

Sets the offset prior to "[Meas Interval](#)" on page 1822 within the segment.

Remote Command	<code>[:SENSe]:PAVTime:SEGMENTS:OFFSet <time></code> <code>[:SENSe]:PAVTime:SEGMENTS:OFFSet?</code>
Example	<code>:PAVT:SEGM:OFFS 1 us</code> <code>:PAVT:SEGM:OFFS?</code>
Couplings	Meas Offset must be >= 0 s and less than (Max Capture Length/Segments) - Meas Interval - Meas Transient

3 VMA Mode
 3.11 Phase and Amplitude vs Time Measurement

Preset	0
State Saved	Saved in instrument state
Min	0
Max	(Max Capture Length/Segments) - Meas Interval - Meas Transient

Meas Transient

Sets the time between the end of the "Meas Interval" on page 1822 and the end of the segment.

Remote Command	<code>[:SENSe]:PAVTime:SEGMents:TRANsient <time></code> <code>[:SENSe]:PAVTime:SEGMents:TRANsient?</code>
Example	<code>:PAVT:SEGM:TRAN 1 us</code> <code>:PAVT:SEGM:TRAN?</code>
Couplings	Meas Transient must be ≥ 0 s and less than (Max Capture Length/Segments) - Meas Offset - Meas Interval
Preset	0
State Saved	Saved in instrument state
Min/Max	Min = 0 Max = (Max Capture Length/Segments) - Meas Offset - Meas Interval

Measure Frequency Error

Measures the frequency error of the input signal at the center frequency.

This is an "immediate action" function, that is, it executes once, when the control is pressed; the trigger is effectively Free Run, because the acquisition occurs immediately regardless of the instrument trigger setting.

Remote Command	<code>[:SENSe]:PAVTime:FERRor:IMMediate</code>
Example	<code>:PAVT:FERR:IMM</code>
Status Bits/OPC dependencies	Non-overlapped

Frequency Error

The offset of the input signal from the Center Frequency. The frequency error can be determined by the instrument using "Measure Frequency Error" on page 1823, or is can be supplied by the user.

Remote Command	<code>[:SENSe]:PAVTime:FERRor <freq></code>
----------------	---

	<code>[:SENSe] :PAVTime:FERRor?</code>
Example	<code>:PAVT:FERR 10 MHz</code> <code>:PAVT:FERR?</code>
Preset	0 Hz
State Saved	Saved in instrument state
Min	-100 MHz
Max	100 MHz
Status Bits/OPC dependencies	Non-overlapped

Frequency Error Measurement Time

Sets the acquisition time for "Measure Frequency Error" on page 1823.

Remote Command	<code>[:SENSe] :PAVTime:FERRor:TIME <time></code> <code>[:SENSe] :PAVTime:FERRor:TIME?</code>
Example	<code>:PAVT:FERR:TIME 1 us</code> <code>:PAVT:FERR:TIME?</code>
Preset	10 ms
State Saved	Saved in instrument state
Min/Max	100 ns/500 ms

Segment Frequency Error Correction

Sets the Segment Frequency Error Correction to On or Off. When **ON**, frequency error is calculated simultaneously with each sample point's IQ values. The phase results are compensated with this real time frequency error, as well as the **Frequency Error** entered by user or calculated by "Measure Frequency Error" on page 1823.

Remote Command	<code>[:SENSe] :PAVTime:FERRor:CORRection[:STATe] OFF ON 0 1</code> <code>[:SENSe] :PAVTime:FERRor:CORRection[:STATe]?</code>
Example	<code>:PAVT:FERR:CORR ON</code> <code>:PAVT:FERR:CORR?</code>
Preset	OFF
State Saved	Saved in instrument state

Sync Type (Models with Multiple Receivers only)

Sets the Sync Type when multiple receivers in one instrument need to sync at data acquisition. This setting is available when the instrument supports multiple receivers. Only one receiver can be set as Primary, and the others can only be set as Secondary.

Remote Command	<code>[[:SENSe]:PAVTime:SYNC OFF PRIMary SECondary [:SENSe]:PAVTime:SYNC?</code>
Example	<code>:PAVT:SYNC SEC :PAVT:SYNC?</code>
Notes	UXM: Only Transceiver A can be configured as Primary, and Transceiver B as Secondary. Otherwise, an error message is issued This control appears only in models with multiple receivers
Preset	OFF
State Saved	Yes
Range	OFF Primary Secondary

Auto Couple

Immediately puts all **Auto/Man** functions into **Auto**. **Auto Couple** is confined to the current measurement only. It does not affect other measurements in the Mode.

In the **Auto** state, **Auto/Man** functions are said to be “coupled”, meaning their values change as you make changes to other values in the measurement. This helps ensure accurate measurements and optimum dynamic range. **Auto Couple** is an immediate action function, and when it is executed, all the **Auto/Man** controls for the current measurement are set to **Auto**, and all measurement settings coupled to the **Auto/Man** parameters are automatically set to their optimal values.

For further details of measurement-specific settings (if any), see "[Measurement-Specific Details](#)" on page 1826 below.

Remote Command	<code>:COUPle ALL</code>
Example	<code>:COUP ALL</code>
Backwards Compatibility SCPI	<code>:COUPLE ALL NONE</code>
Backwards Compatibility Notes	<code>:COUP:NONE</code> puts all Auto/Man parameters in manual mode, decoupling all the coupled instrument parameters. It is retained for backwards compatibility and is <i>not</i> recommended for making measurements or new designs

All **Auto/Man** parameter couplings in the measurement are set to **Auto**. This includes couplings that may be unavailable or grayed-out due to the current state. For example, in the Swept SA measurement, there is no **Auto/Man** coupling for **RBW** while in Zero Span. Nonetheless, if **Auto Couple** were executed while in Zero Span, it would set **RBW** to Auto "behind the scenes" so that, on exit from Zero Span, it would be in **Auto**.

Any **Auto/Man** selection specific (local) to the other measurements in the current Mode are not affected by **Auto Couple**. Any functions that are *not* coupled with other instrument parameters, such as ranging or leveling variables, such as **AutoRange** or **AutoScale**, are not affected.

Executing **Auto Couple** generates the informational message, "All Auto/Man functions have been set to Auto".

Each parameter, upon being set to **Auto**, selects and sets the appropriate auto-coupled value based on that parameter's coupling rules. The Dependency Resolver orchestrates the couplings for parameters that depend on one or more other parameters. The coupling and dependency rules for each parameter are defined in the section describing that parameter.

Executing **Auto Couple** *does not* affect markers, marker functions, trace or display attributes, or any other instrument setting other than those specifically mentioned above.

Measurement-Specific Details

TOI (SA Mode only)

Parameters affected by **Auto Couple** are:

- Center Frequency Step
- Resolution Bandwidth
- Span/RBW Ratio
- Sweep Time
- Video BANDwidth VBW/RBW ratio
- Upper and Lower Tone (set to Sense)
- Zero span measurement Resolution Bandwidth
- Zero span measurement Dwell Time

Harmonics (SA Mode only)

Parameters affected by **Auto Couple** are:

- Resolution Bandwidth
- Fundamental Frequency
- Dwell Time
- Range Table Resolution Bandwidths
- Range Table Dwell Times

Meas Preset

Restores all the measurement parameters to their default values.

Remote Command	<code>:CONFigure:PAVTime</code>
Example	<code>:CONF:PAVT</code>
Couplings	Selecting Meas Preset restores all measurement parameters to their default values

3.11.8.2 Advanced

Contains controls for setting advanced functions of the instrument.

IF Gain

Sets the IF Gain function to Auto, Low Gain or High Gain. These settings affect sensitivity and IF overloads.

Remote Command	<code>[:SENSe]:PAVTime:IF:GAIN[:STATe] ON OFF 1 0</code> <code>[:SENSe]:PAVTime:IF:GAIN[:STATe]?</code> <code>[:SENSe]:PAVTime:IF:GAIN:AUTO[:STATe] ON OFF 1 0</code> <code>[:SENSe]:PAVTime:IF:GAIN:AUTO[:STATe]?</code>
Example	<code>:PAVT:IF:GAIN ON</code> <code>:PAVT:IF:GAIN?</code> <code>:PAVT:IF:GAIN:AUTO ON</code> <code>:PAVT:IF:GAIN:AUTO?</code>
Notes	ON = high gain OFF = low gain

Dependencies	The IF Gain controls (FFT IF Gain and Swept IF Gain) have no effect when the U7227A USB Preamp-lifier is connected. This is not annotated or reflected on any control; there are no controls grayed out nor any SCPI locked out. The instrument simply behaves as though both FFT IF Gain and Swept IF Gain are set to Low regardless of the setting on the controls This control is not available in VXT model M9421A, EXM, or UXM
Preset	OFF OFF
State Saved	Saved in instrument state
Range	Low Gain High Gain

3.11.8.3 Global

The controls in this menu apply to all Modes in the instrument.

Some controls (for example, "[Global Center Freq](#)" on page 1828) allow you to switch certain Meas Global parameters to a Mode Global state. These switches apply to all Modes that support global settings. For example, no matter what Mode you are in when you set **Global Center Freq** to **ON**, it applies to all Modes that support Global settings.

Other controls (for example, **Extend Low Band**) are actually set in this menu, but apply to all Modes.

Global Center Freq

The software maintains a Mode Global value called **Global Center Freq**.

When **Global Center Freq** is switched **ON**, the current Mode's center frequency is copied into the **Global Center Frequency**, and from then on all Modes that support global settings use the **Global Center Frequency**, so you can switch between any of these Modes and the **Center Frequency** remains unchanged.

Adjusting the **Center Frequency** of any Mode that supports Global Settings, while **Global Center Freq** is **ON**, modifies the **Global Center Freq**.

When **Global Center Freq** is switched **OFF**, the **Center Frequency** of the current Mode is unchanged, but now the **Center Frequency** of each Mode is once again independent.

When **Mode Preset** is pressed while **Global Center Freq** is **ON**, the **Global Center Freq** is preset to the preset **Center Frequency** of the current Mode.

This function resets to **OFF** when "[Restore Defaults](#)" on page 1829 is pressed, or when **System, Restore Defaults, All Modes** is pressed.

Remote	:INSTRument:COUPlE:FREQuency:CENTer ALL NONE
--------	--

3 VMA Mode
3.11 Phase and Amplitude vs Time Measurement

Command	:INSTRument:COUPle:FREQuency:CENTer?
Example	:INST:COUP:FREQ:CENT ALL :INST:COUP:FREQ:CENT?
Preset	Set to OFF on Global Settings, Restore Defaults and System, Restore Defaults, All Modes
Range	ALL NONE
Preset	OFF
Backwards Compatibility SCPI	:GLOBal:FREQuency:CENTer[:STATe] 1 0 ON OFF :GLOBal:FREQuency:CENTer[:STATe]?

Global EMC Std

When this control is switched **ON**, the current Mode's EMC Std is copied into the **Global EMC Std**, and from then on all Modes that support global settings use the **Global EMC Std**, so you can switch between any of these Modes and the EMC Std remains unchanged.

Adjusting the EMC Std of any Mode that supports Global settings, while **Global EMC Std** is **ON** modifies the **Global EMC Std**.

When **Global EMC Std** is switched **OFF**, the EMC Std of the current Mode remains unchanged, but now the EMC Std of each Mode is once again independent. When **Mode Preset** is pressed while **Global EMC Std** is **ON**, **Global EMC Std** is preset to the preset EMC Std of the current Mode.

This function resets to **OFF** when "**Restore Defaults**" on page 1829 is pressed, or when **System, Restore Defaults, All Modes** is pressed.

Remote Command	:INSTRument:COUPle:EMC:STANdard ALL NONE :INSTRument:COUPle:EMC:STANdard?
Example	:INST:COUP:EMC:STAN ALL :INST:COUP:EMC:STAN?
Dependencies	Only available if Option EMC is installed
Preset	Set to OFF on Global Settings, Restore Defaults and System, Restore Defaults, All Modes
Range	ALL NONE

Restore Defaults

Resets all functions in the **Global** settings menu to **OFF**. Pressing **System, Restore Defaults, All Modes** has the same effect.

Remote Command	:INSTRument:COUPle:DEFault
----------------	----------------------------

Example	<code>:INST:COUP:DEF</code>
Backwards Compatibility SCPI	<code>:GLOBal:DEFault</code>

3.11.9 Sweep

Contains controls that allow you to control the sweep and measurement functions of the instrument.

3.11.9.1 Sweep/Control

Accesses controls that let you operate the sweep and control functions of the instrument, such as **Sweep Time** and **Continuous/Single**.

Sweep/Measure

Lets you toggle between **Continuous** and **Single** sweep or measurement operation. The single/continuous state is Meas Global, so the setting affects all measurements.

The front-panel key **Single/Cont** performs exactly the same function

See "[More Information](#)" on page 1831

Remote Command	<code>:INITiate:CONTinuous OFF ON 0 1</code> <code>:INITiate:CONTinuous?</code>
----------------	--

Example	Put instrument into Single measurement operation: <code>:INIT:CONT 0</code> <code>:INIT:CONT OFF</code> Put instrument into Continuous measurement operation: <code>:INIT:CONT 1</code> <code>:INIT:CONT ON</code>
---------	---

Preset	ON Note that <code>:SYST:PRES</code> sets <code>:INIT:CONT</code> to ON , but <code>*RST</code> sets <code>:INIT:CONT</code> to OFF
--------	---

State Saved	Saved in instrument state
-------------	---------------------------

Annunciation	The Single/Continuous icon in the Meas Bar changes depending on the setting: <ul style="list-style-type: none"> - A line with an arrow is Single - A loop with an arrow is Continuous
--------------	--

Backwards Compatibility Notes	X-Series A-models had Single and Cont hardkeys in place of the SweepSingleCont softkey. In the X-Series A-models, if in single measurement, the Cont hardkey (and <code>INIT:CONT ON</code>) switched to continuous measurement, but never restarted a measurement and never reset a sweep
-------------------------------	---

X-Series B-models have a **Cont/Single** toggle control instead of **Single** and **Cont** hardkeys, but it is still true that, if in single measurement, the **Cont/Single** toggle control never restarts a measurement and never resets a sweep

More Information

Continuous Mode	<p>The instrument takes repetitive sweeps, averages, measurements, etc., when in continuous mode. If in average or Max/Min Hold, and the average/hold count reaches the Average/Hold Num, the count stops incrementing, but the instrument keeps sweeping</p> <p>See the Trace key description under Trace Average for the averaging formula used both before and after the Average/Hold Num is reached. The trigger condition must be met prior to each sweep</p> <p>The type of trace processing for multiple sweeps is set under the Trace key, with choices of Trace Average, Max Hold, or Min Hold</p>
Single Mode	<p>The instrument takes a single sweep when in Single mode, or if in average or Max/Min Hold, or if there is a Waterfall window displayed, it takes multiple sweeps until the average/hold count reaches the Average/Hold Num, then the count stops incrementing, and the instrument stops sweeping</p> <p>See the Trace key description under Trace Average for the averaging formula used. The trigger condition must be met prior to the sweep</p> <p>The type of trace processing for multiple sweeps is set under the Trace key, with choices of Trace Average, Max Hold, or Min Hold</p>

If the instrument is in **Single** measurement mode, pressing the **Cont/Single** toggle control does not zero the count and does not cause the sweep to be reset; the only action is to put the instrument into Continuous measurement operation.

If the instrument is already in **Continuous** sweep:

- **:INIT:CONT 1** has no effect
- **:INIT:CONT 0** places the instrument in Single Sweep but has no effect on the current sequence until $k = N$, at which point the current sequence will stop and the instrument will go to the idle state

See "**Restart**" on page 1832 for details of **:INIT:IMMEDIATE**.

If the instrument is already in **Single** sweep, **:INIT:CONT OFF** has no effect.

If the instrument is already in **Single** sweep, then pressing **Cont/Single** in the middle of a sweep does not restart the sweep or sequence. Similarly, pressing **Cont/Single** does not restart the sweep or sequence if the sweep is not in the idle state (for example, if you are taking a very slow sweep, or the instrument is waiting for a trigger). Even though pressing **Cont/Single** in the middle of a sweep does not restart the sweep, sending **:INIT:IMM** does reset it.

If the instrument is in **Single** sweep, and *not* Averaging/Holding, and you want to take one more sweep, press **Restart**.

If the instrument is in **Single** sweep, *and* Averaging/Holding, and you want to take one more sweep without resetting the Average trace or count, go to **Meas Setup** and increment the average count by 1 by pressing the **Step-Up** key while **Average/Hold Num** is the active function. You can also do this by sending **:CALC:AVER:TCON UP**.

Restart

Restarts the current sweep, or measurement, or set of averaged/held sweeps or measurements. If you are Paused, pressing **Restart** performs a Resume.

The front-panel key **Restart** performs exactly the same function.

The **Restart** function is accessed in several ways:

- Pressing the **Restart** key
- Sending **:INIT:IMM**
- Sending **:INIT:REST**

See "[More Information](#)" on page 1833

Remote Command	:INITiate[:IMMEDIATE] :INITiate:REStart
Example	:INIT:IMM :INIT:REST
Notes	:INIT:REST and :INIT:IMM perform exactly the same function
Couplings	Resets average/hold count k. For the first sweep overwrites all active (update = on) traces with new current data. For application modes, it resets other parameters as required by the measurement
Status Bits/OPC dependencies	This is an Overlapped command The STATus:OPERation register bits 0 through 8 are cleared , <i>except</i> bit 6 (Waiting for Periodic Sync). Initiating a measurement and Waiting for Periodic Sync could be asynchronous The STATus:QUEStionable register bit 9 (INTEgrity sum) is cleared The SWEEPING bit is set The MEASURING bit is set
Backwards Compatibility Notes	For Spectrum Analysis Mode in ESA and PSA, the Restart hardkey and the :INIT:REST command restarted trace averages (displayed average count reset to 1) for a trace in Clear Write , but did not restart Max Hold and Min Hold In X-Series, the Restart hardkey and the :INIT:REST command restart not only Trace Average , but MaxHold and MinHold traces as well

More Information

The **Restart** function first aborts the current sweep or measurement as quickly as possible. It then resets the sweep and trigger systems, sets up the measurement and initiates a new data measurement sequence with a new data acquisition (sweep) taken once the trigger condition is met.

If the instrument is in the process of aligning when a **Restart** is executed, the alignment finishes before the restart function is performed.

Even when set for **Single** operation, multiple sweeps may be taken when **Restart** is pressed (for example, when averaging/holding is on). Thus, when we say that **Restart** "restarts a measurement", depending on the current settings, we may mean that it:

- Restarts the current sweep
- Restarts the current measurement
- Restarts the current set of sweeps if any trace is in Trace Average, Max Hold or Min Hold
- Restarts the current set of measurements if Averaging, or Max Hold, or Min Hold is on for the measurement

If there is no Average or Max/Min Hold function (no trace in Trace Average or Hold, or **Average/Hold Num** set to 1), and no **Waterfall** window is being displayed, a single sweep is equivalent to a single measurement. A single sweep is taken after the trigger condition is met; and the instrument stops sweeping once that sweep has completed. However, with **Average/Hold Num** >1, and at least one trace set to Trace Average, Max Hold, or Min Hold, or a **Waterfall** window being displayed, multiple sweeps/data acquisitions are taken for a single measurement. The trigger condition must be met prior to each sweep. The sweep is stopped when the average count k equals the number N set for **Average/Hold Num**.

Once the full set of sweeps has been taken, the instrument goes to the idle state. To take one more sweep without resetting the average count, increment the average count by 1, by pressing the **Step-Up** key while **Average/Hold Number** is the active function, or by sending the remote command `:CALC:AVER:TCON UP`.

Trace Update

The numeric results are not blanked at any time during the restart cycle.

For slow sweeps (see **Trace Update** section in **Trace/Detector**), the traces are updated real-time during the sweep. There may be a special circumstance in

application mode measurements where an exception is made and the traces and/or results need to be blanked before displaying the new results.

To summarize, the following list shows what happens to the trace data on various events:

Event	Trace Effect
Clear/Write pressed (even if already in Clear/Write)	Set to mintracevalue
Max Hold pressed (even if already in Max Hold)	Set to mintracevalue
Min Hold pressed (even if already in Min Hold)	Set to maxtracevalue
Trace Average pressed (even if already in Trace Average)	Trace data unaffected but start new sweep/avg/hold
Restart pressed	Trace data unaffected but start new sweep/avg/hold
Parameter requiring restart changed (e.g., RBW)	Trace data unaffected but start new sweep/avg/hold

Sweep and Trigger Reset

Resetting the sweep system resets the average/hold count k to 0. It also resets the set point counter to 0. Resetting the trigger system resets the internal auto trig timer to the value set by the **Auto Trig** control.

Averaging

The weighting factor used for averaging is k . This k is also the average/hold count for how many valid sweeps (data acquisitions) have been done. This k is used for comparisons with N , as those comparisons always needs to be based on valid completed sweeps.

The displayed average/hold, K , shows the count for the sweep (data acquisition) in progress. $K = k + 1$, with a limit of N . The displayed value K changes from its previous value to 1 as soon as the trigger condition for the first data acquisition (sweep) is met.

Pause/Resume

Pauses a measurement after the current data acquisition is complete.

When paused, the label on the control changes to **Resume**. Pressing **Resume** unpauses the measurement. When paused, pressing **Restart** performs a Resume.

Remote Command **:INITiate:PAUse**

	<code>:INITiate:RESume</code>
Example	<code>:INIT:PAUS</code> <code>:INIT:RES</code>
Dependencies	Not displayed in Modes that do not support pausing
Annotation	Only on control

Abort (Remote Command Only)

Stops the current measurement. Aborts the current measurement as quickly as possible, resets the sweep and trigger systems, and puts the measurement into an "idle" state. If the instrument is in the process of aligning when `:ABORT` is sent, the alignment finishes *before* the abort function is performed, so `:ABORT` does not abort an alignment.

If the instrument is set for **Continuous** measurement, it sets up the measurement and initiates a new data measurement sequence with a new data acquisition (sweep) taken once the trigger condition is met.

If the instrument is set for **Single** measurement, it remains in the "idle" state until an `:INIT:IMM` command is received.

Remote Command	<code>:ABORT</code>
Example	<code>:ABOR</code>
Notes	If <code>:INIT:CONT</code> is ON , then a new continuous measurement will start immediately, with sweep (data acquisition) occurring once the trigger condition has been met If <code>:INIT:CONT</code> is OFF , then <code>:INIT:IMM</code> is used to start a single measurement, with sweep (data acquisition) occurring once the trigger condition has been met
Dependencies	For continuous measurement, <code>:ABORT</code> is equivalent to the Restart key Not all measurements support this command
Status Bits/OPC dependencies	The <code>STATus:OPERation</code> register bits 0 through 8 are cleared , <i>except</i> bit 6 (Waiting for Periodic Sync). Initiating a measurement and Waiting for Periodic Sync could be asynchronous The <code>STATus:QUESTionable</code> register bit 9 (INTegrity sum) is cleared Since all the bits that feed into OPC are cleared by <code>:ABORT</code> , the Abort command will cause the <code>*OPC</code> query to return true

3.11.10 Trace

Trace functionality is not supported in the Phase and Amplitude vs Time measurement.

4 System



The **System** hardkey and the “gear” icon both open the **System Settings** dialog, which allows you to access various configuration menus and dialogs. The line of tabs down the left side let you choose various pages for configuring your instrument.

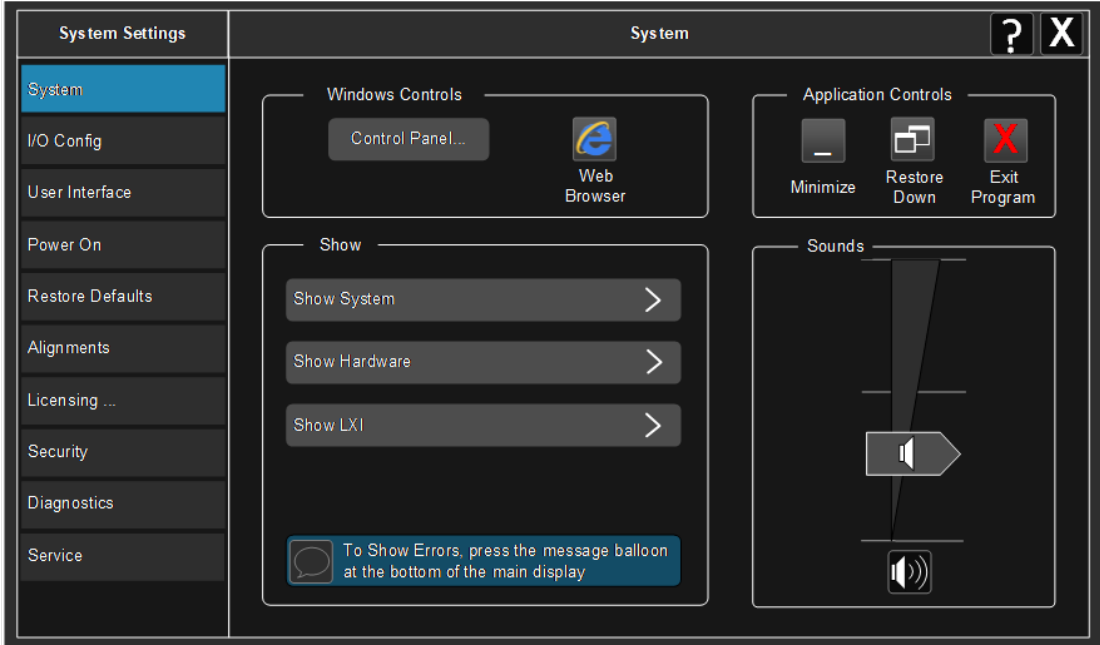

Notes No remote command for this key specifically

4.1 System

Allows access to several general system functions, including three **Show** screens for viewing system parameters. Several such **Show** screens are available on this and other **System** menu pages. They can also be accessed with the SCPI command described here.

Remote Command	<code>:SYSTem:SHOW OFF ERRor SYSTem HARDware LXI HWSTatistics ALIGNment SOFTware CAPPlication</code> <code>:SYSTem:SHOW?</code>
Example	<code>:SYST:SHOW SYST</code>
Notes	Displays (or exits) the System information screens
Preset	OFF
State Saved	No
Range	OFF ERRor SYSTem HARDware LXI HWSTatistics ALIGNment SOFTware CAPPlication

4.1.1 Show System

This screen is divided into three groups: product descriptive information, options tied to the hardware, and software products. Swipe up and down on this screen to scroll the display.

System Settings	< System	Show System	? X
System	Keysight Technologies	Keysight UXA	Keysight UXA Signal Analyzer
I/O Config	Product Number	N9040B	
User Interface	Serial Number	US00091133	
Power On	Instrument S/W Revision	A.15.00_P0053	
Restore Defaults	Revision Date	11/17/2014 11:37:12 AM	
Alignments	Computer System	Windows 7 , Service Pack 1	
Licensing ...	Computer Name	A-N9040B-91133	
Security	IP Address	141.121.151.83	
Diagnostics	IPv6 Address	2002:8d79:9753::8d79:9753	
Service	Link-Local IPv6 Address	fe80::46e:1db5:7286:68ac%3	
	Host ID	N9040B,US00091133	
	mDNS Enabled	Yes	
	mDNS Host Name	A-N9040B-91133	
	mDNS Service Name	Keysight N9040B Signal Analyzer - US00091133	
	Option	Name / Description	
	N9040B-PC6	Intel(R) Core(TM) i7-3615QE CPU @ 2.30GHz, 16 GB	
	N9040B-SSD	INTEL SSDSC2BB080G4 ATA DEVICE	
	N9040B-W7X	Windows Embedded Standard 7, 64 bit OS	

Example `:SYST:SHOW SYST`

4.1.1.1 Show System contents (Remote Query Only)

Returns the contents of the **Show System** screen (the entire contents, not just the currently displayed page).

Remote Command `:SYSTem:CONFigure[:SYSTem]?`

Example `:SYST:CONF?`

Notes The output is an IEEE Block format of the **Show System** contents. Each line is separated by a new-line character

4.1.1.2 Computer System description (Remote Query Only)

Returns the **Computer System** description, which consists of the operating system and patch level, as reported by operating system.

Remote Command `:SYSTem:CSYStem?`

Example `:SYST:CSYS?`

Notes Returns the Computer System name and service pack level

4.1.2 Show Hardware

Displays details of the installed hardware. This information can be used to determine versions of hardware assemblies and field-programmable devices, in the advent of future upgrades or potential repair needs.

The screen is divided into two groups: product descriptive information and hardware information. The hardware information is listed in a table format.

Example `:SYST:SHOW HARD`

4.1.3 Show LXI

Displays the product number, serial number, firmware revision, computer name, IP address, Host ID, LXI Class, LXI Version, MAC Address, and the Auto-MDIX Capability.

Example `:SYST:SHOW LXI`

4.1.4 Show Support Subscriptions

Displays the software support subscription information for the licenses available on the instrument.

Shows the software license, description, software support expiration date (format is **YYYY.MMDD**), and the software support status. The **Software Version Date** (format is **YYYY.MMDD**) shown in the header indicates the date required to access the latest software enhancements included in this version of the software. If any license has a **Software Support Expiration Date** earlier than the **Software Version Date**, then enhancements may be available that the license does *not* enable.

System Settings	System		Support Subscriptions
System	Keysight PXA	Keysight PXA Signal Analyzer	
	Product Number	N9030A	
	Instrument S/W Revision	A.20.10	
	Software Version Date	2017.1221	
I/O Config	Software License	Description	Software Support Expiration Date
User Interface	N6141EM0E-1FP	EMC Software for X-Series	2018.0430 ✓
Power On	N9030EMCA-1FP	Basic Electro-Magnetic Compatibility Functionality	2018.0430 ✓
Restore Defaults	N9030FP2A-1FP	Fast Power Measurements, up to 40 MHz bandwidth	2018.0430 ✓
Alignments	N9030FT2A-1FP	Frequency Mask Trigger >3.6 us signal duration	2018.0430 ✓
Licensing	N9030RBEA-1FP	RBW Extended, >10 MHz RBW Filter	2018.0430 ✓
Security	N9030RT2A-1FP	Real-time analysis up to maximum BW, optimum detection	2018.0430 ✓
Diagnostics	N9030TDSA-1FP	Time Domain Scan, requires N6141A/C, and DP2 or B40	2018.0430 ✓
Service	N9054EM0E-1FP	Flexible Digital Demod App, VMA	2018.0430 ✓
Debug	N9054EM1E-1FP	Custom OFDM App, VMA	2018.0430 ✓
	N9061EM0E-1FP	Remote Language Compatibility	2018.0430 ✓
	N9062EM0E-1FP	RS FSP, FSU, FSE, ESU SCPI Language Compatibility	2018.0430 ✓
	N9063EM0E-1FP	Analog Demod Measurement Application	2018.0430 ✓
	N9067EM0E-1FP	Pulse Application	2018.0430 ✓
	N9068EM0E-1FP	Phase Noise Measurement Application	2018.0430 ✓
	N9069EM0E-1FP	Noise Figure Measurement Application	2018.0430 ✓
	N9071EM0E-1FP	GSM/EDGE Measurement Application	2018.0430 ✓
	N9074EM0E-1FP	Single App Combined GSM/EDGE Measurements	2018.0430 ✓

Example `:SYST:SHOW SSINformation`

4.1.5 Show Support ID

Displays the Support ID for each license available in the instrument. Shows the **Software License**, **Description**, software support expiration date, and **Support ID** for that license.

Each license has a copy icon, which copies just the **Support ID** for that license to the Windows clipboard. This is useful to avoid typing mistakes when entering this value into another program or web site.

The **Copy all to clipboard ...** control copies all the data to the Windows clipboard, in comma-separated value (CSV) format.

System Settings	System	Support ID
System	Keysight PXA Product Number Instrument S/W Revision Software Version Date	Keysight PXA Signal Analyzer N9030A A.20.10 2017.1221
I/O Config	Software License	Description
User Interface	N6141EM0E-1FP	EMC Software for X-Series
Power On	N6141EM0E-1NP	EMC Software for X-Series (Network)
Restore Defaults	N9030EMCA-1FP	Basic Electro-Magnetic Compatibility Functi
Alignments	N9030FP2A-1FP	Fast Power Measurements, up to 40 MHz b
Licensing	N9030FT2A-1FP	Frequency Mask Trigger >3.6 us signal durc
Security	N9030RBEA-1FP	RBW Extended, >10 MHz RBW Filter
Diagnostics	N9030RT2A-1FP	Real-time analysis up to maximum BW, opti
Service	N9030TDSA-1FP	Time Domain Scan, requires N6141A/C, an
Debug	N9054EM0E-1FP	Flexible Digital Demod App, VMA
	N9054FM1F-1FP	Custom OFDM App, VMA

Example `:SYST:SHOW SID`

4.1.6 Control Panel...

Opens the Windows Control Panel. **Control Panel** is used to configure certain elements of Windows that are not configured via the Multitouch UI System menus.

NOTE This feature is *not* available if Option SF1 is installed.

Control Panel is a separate Windows application, so to return to the Instrument Application, either:

- Exit by tapping on the red **X** in the upper right-hand corner
- Use **Alt+Tab**. Press and hold the **Alt** key and press and release the **Tab** key until the Instrument logo is showing in the window in the center of the screen, then release the **Alt** key

Notes No remote command for this key

4.1.7 Web Browser

Launches the instrument's default **Web Browser**. Usually, the default is Microsoft Edge. A mouse and external keyboard are highly desirable for using the browser. To return focus to the Instrument Application, close the browser (or use **Alt-Tab**).

NOTE

This feature is *not* available if Option SF1 is installed.

4.1.8 Application Controls

Lets you Minimize or Exit the application.

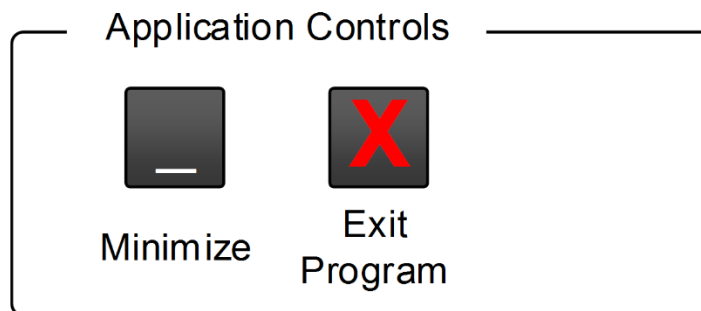

Pressing **Exit Program** displays a prompt asking if you are sure you want to close the program. If you select **OK**, the entire analyzer application will shut down, and you will lose any unsaved trace or measurement data.

Notes

No equivalent remote command for this key

4.1.9 Sounds

Lets you adjust the speaker volume using the slider, or mute/unmute the speaker, by tapping the **Speaker** icon.

Moving the slider up and down changes the speaker volume, and *also* unmutes the speaker if muted.

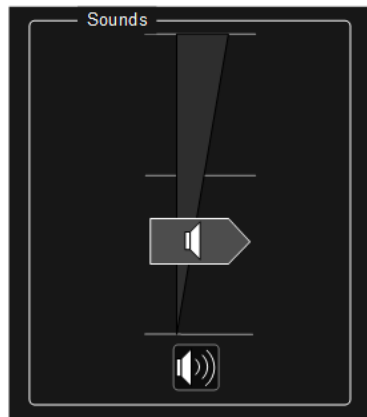

Icon when muted

4.2 I/O Config

Allows you to specify and change the I/O configuration for remote control. Controls in this menu allow configuration of the I/O ports used for SCPI remote control over GPIB and LAN.

The SCPI LAN parameters are set using controls in this menu, but configuration of LAN settings themselves is performed using the Windows Control Panel (DHCP, Gateway, Subnet Mask, etc.).

The USB port is also available for remote control, but requires no configuration.

4.2.1 GPIB

Allows you to configure the GPIB I/O port.

Dependencies	Not available in UXM
--------------	----------------------

4.2.1.1 GPIB Address

Select the GPIB remote address.

Remote Command	<code>:SYSTem:COMMunicate:GPIB[1][:SELF]:ADDRess <integer></code>
Example	<code>:SYST:COMM:GPIB:ADDR 17</code>
Notes	If the GPIB port address is changed, all further communication must use the <i>new</i> address
Preset	Unaffected by Preset , but set to 18 by Restore Defaults > "Misc" on page 1892
State Saved	No
Min	0
Max	30

4.2.1.2 GPIB Controller

Sets the GPIB port into Controller (**ON**) or Device (**OFF**) mode. In the normal state, **GPIB Controller** is disabled (**OFF**), which allows the instrument to be controlled by a remote computer. When **GPIB Controller** is enabled (**ON**), the instrument can run software applications that use the instrument's computer as a GPIB controller for devices connected to the GPIB port.

NOTE

When **GPIB Controller** is enabled, the analyzer application itself cannot be controlled over GPIB. In this case, it can be controlled via LAN or USB. The GPIB port cannot be a Controller and Device at the same time. Only one Controller can be active on the GPIB bus at any given time. If the instrument is the Controller, an external PC cannot also be a Controller.

To control the instrument from the software that is performing GPIB Controller operation, you can use an internal TCP/IP connection to the analyzer application. Use the following IP Address to send commands to the analyzer application:

`TCPIP0:localhost:inst0:INSTR`

Remote Command	<code>:SYSTem:COMMunicate:GPIB[1][:SELF]:CONTroller[:ENABLE] ON OFF 0 1</code> <code>:SYSTem:COMMunicate:GPIB[1][:SELF]:CONTroller[:ENABLE]?</code>
Example	Set GPIB port to Controller: <code>:SYST:COMM:GPIB:CONT ON</code> Set GPIB port to Device: <code>:SYST:COMM:GPIB:CONT OFF</code>
Notes	When the instrument becomes the Controller, Bit 0 in the Standard Event Status Register is set. When the instrument relinquishes Controller capability, bit 0 is cleared
Preset	Unaffected by Preset, but set to OFF (Disabled) by Restore Defaults > "Misc" on page 1892
State Saved	No
Range	Disabled Enabled

4.2.2 SCPI LAN

Displays a menu for identifying and changing SCPI over a LAN configuration. There are several ways to send SCPI remote commands to the instrument over LAN.

Having multiple users simultaneously accessing the instrument over the LAN may lead to communication problems. These controls can help to prevent that, by disabling the telnet, socket, and/or SICL capability.

NOTE

When multiple instances of the application are running, Telnet port 5023, socket port 5025, SICL server inst0 and HiSLIP server Device 0 will be assigned to the first instance; Telnet port 5123, socket port 5125, SICL server inst1 and HiSLIP server Device 1 will be assigned to the second instance; Telnet port 5223, socket port 5225, SICL server inst2 and HiSLIP server Device 2 will be assigned to the third instance; Telnet port 5323, socket port 5325, SICL server inst3 and HiSLIP server Device 3 will be assigned to the fourth instance.

- "SCPI Telnet" on page 1845
- "SCPI Socket" on page 1845
- "SICL Server" on page 1846
- "HiSLIP Server" on page 1847
- "Verbose SCPI On/Off" on page 1847
- "SCPI Socket Control Port (Remote Query Only)" on page 1849

4.2.2.1 SCPI Telnet

Turns SCPI LAN telnet capability On or Off, allowing you to limit SCPI access over LAN through telnet.

Remote Command	<code>:SYSTem:COMMunicate:LAN:SCPI:TELNet:ENABle OFF ON 0 1</code> <code>:SYSTem:COMMunicate:LAN:SCPI:TELNet:ENABle?</code>
Example	<code>:SYST:COMM:LAN:SCPI:TELN:ENAB OFF</code>
Preset	Unaffected by Preset , but set to ON by Restore Defaults > "Misc" on page 1892 If not set up or specified, the Secure Instrument Communications configuration setting: is ON
State Saved	No
Range	OFF ON

4.2.2.2 SCPI Socket

Turns the capability to establish Socket LAN sessions **ON** or **OFF**, to limit SCPI access over LAN through socket sessions.

Connection String & Copy Button

In "SCPI LAN" on page 1844, the full SCPI connection string is displayed to the right of the **SCPI Socket ON/OFF** control. Pressing **Copy**, to the right of the string, copies the connection string to the Windows clipboard.

Remote Command	<code>:SYSTem:COMMunicate:LAN:SCPI:SOCKet:ENABle OFF ON 0 1</code> <code>:SYSTem:COMMunicate:LAN:SCPI:SOCKet:ENABle?</code>
Example	<code>:SYST:COMM:LAN:SCPI:SOCK:ENAB OFF</code>
Dependencies	If the Secure Instrument Communications configuration has disabled this connection, local changes are not allowed, and an attempt to do so results in error -221, "Disabled by Secure Instrument Communications configuration"

Preset	Unaffected by Preset , but set to ON by Restore Defaults > " Misc " on page 1892 If not set up or specified, the Secure Instrument Communications configuration setting: is ON
State Saved	No
Range	OFF ON

4.2.2.3 SICL Server

Turns the **SICL Server** capability **ON** or **OFF**, to limit SCPI access over LAN through the SICL server. (SICL IEEE 488.2 protocol.)

Parameter	Description	Setting
Maximum Connections	The maximum number of connections that can be accessed simultaneously	5
Instrument Name	The name (same as the remote SICL address) of your instrument	inst0
Instrument Logical Unit	The unique integer assigned to your instrument when using SICL LAN	8
Emulated GPIB Name	The name (same as the remote SICL address) of the device used when communicating with your instrument	gpib7
Emulated GPIB Logical Unit	The unique integer assigned to your device when it is being controlled using SICL LAN	8
Emulated GPIB Address	The emulated GPIB address assigned to your transmitter tester when it is a SICL server (the same as your GPIB address)	18

Connection String & Copy Button

In "**SCPI LAN**" on page 1844, the full connection string is displayed to the right of the **SICL Server ON/OFF** control. Pressing **Copy**, to the right of the string copies the connection string to the Windows clipboard.

Remote Command	:SYSTem:COMMunicate:LAN:SCPI:SICL:ENABle OFF ON 0 1 :SYSTem:COMMunicate:LAN:SCPI:SICL:ENABle?
Example	:SYST:COMM:LAN:SCPI:SICL:ENAB OFF
Dependencies	Not available in UXM If the Secure Instrument Communications configuration has disabled this connection, local changes are not allowed, and an attempt to do so results in error -221, "Disabled by Secure Instrument Communications configuration"
Preset	Unaffected by Preset , but set to ON by Restore Defaults > " Misc " on page 1892 If not set up or specified, the Secure Instrument Communications configuration setting: is ON
State Saved	No
Range	OFF ON

4.2.2.4 HiSLIP Server

Turns the **HiSLIP Server** capability **ON** or **OFF**, to limit SCPI access over LAN through the HiSLIP server.

HiSLIP stands for High-Speed LAN Instrument Protocol, and is part of the IVI-6.1 specification.

Example of a VISA connection string used to connect to the HiSLIP Server on an X-Series Spectrum Analyzer:

`TCPIP0::a-n9030a-93016::hislip0::INSTR`

In the example above, **hislip0** is the HiSLIP device name that VISA users must include in HiSLIP VISA Address strings. Your HiSLIP device name may differ, depending on your VISA settings.

Connection String & Copy Button

In "**SCPI LAN**" on page 1844, the full connection string is displayed to the right of the **HiSLIP Server ON/OFF** control. Pressing **Copy**, to the right of the string copies the connection string to the Windows clipboard.

Remote Command	<code>:SYSTem:COMMunicate:LAN:SCPI:HISLip:ENABle OFF ON 0 1</code>
Example	<code>:SYST:COMM:LAN:SCPI:HISL:ENAB OFF</code>
Preset	Unaffected by Preset , but set to ON by Restore Defaults > "Misc" on page 1892 If not set up or specified, the Secure Instrument Communications configuration setting: is ON
State Saved	No
Range	OFF ON

4.2.2.5 Verbose SCPI On/Off

When you turn **Verbose SCPI ON**, additional information is returned by `:SYSTem:ERRor?`. The additional information consists of the characters that stimulated the error. This can aid you in debugging your test programs, by indicating where in the parsing of a SCPI command the instrument encountered an invalid command or query.

Specifically, with **Verbose SCPI ON**, `:SYSTem:ERRor?` is expanded to show the SCPI data received, with the indicator `<Err>` at the point in the stream that the error occurred.

Verbose SCPI has no effect on the **Show Errors** screen or front-panel Message Line; and only changes the response to `:SYST:ERR?`.

See the example below, where the invalid command `:SENS:BOGUS` is sent:

Normal response to `:SYST:ERR?` (using the Telnet window):

```
SCPI> SENS:BOGUS
SCPI> SYST:ERR?
-113,"Undefined header"
```

After turning on **Verbose SCPI**:

```
SCPI> SYST:BOGUS
SCPI> SYST:ERR?
-113,"Undefined header;SYST:BOGUS<Err>"
```

Remote Command	<code>:SYSTem:ERRor:VERBoSe OFF ON 0 1</code> <code>:SYSTem:ERRor:VERBoSe?</code>
Example	<code>:SYST:ERR:VERB ON</code>
Preset	Unaffected by Preset , but set to OFF by Restore Defaults > " Misc " on page 1892
State Saved	No
Range	OFF ON

4.2.2.6 Device Clear on Disconnect

When using HiSLIP (High Speed LAN Instrument Protocol), Telnet, or Sockets, a communication session with the instrument is opened when you connect, and closed when you disconnect. This differs from other connections such as GPIB, USB and VXI-11 connections, which are never actually closed but stay open as long as the instrument is running.

When a session is closed, a Device Clear function is generated, which affects the entire instrument, not just the current connection. Thus, when using HiSLIP, Telnet, or Sockets, unexpected Device Clears may occur, which can disrupt measurements in ways that GPIB and VXI-11 “sessions” do not.

Device Clear on Disconnect enables these auto-generated Device Clears for Telnet, Socket, and HiSLIP sessions. For backwards compatibility, they are *not* generated unless you explicitly enable them.

There is no change in VXI-11, USB, or GPIB session behavior. These sessions do not close when you disconnect, have never generated Device Clear events, and still do not generate Device Clear events, regardless of the setting of this switch.

Remote Command	<code>:SYSTem:COMMunicate:LAN:SCPI:EOSession:DCLear:ENABle 0 1 ON OFF</code> <code>:SYSTem:COMMunicate:LAN:SCPI:EOSession:DCLear:ENABle?</code>
Example	<code>:SYST:COMM:LAN:SCPI:EOS:DCL:ENAB ON</code>
Preset	Unaffected by Preset , but set to OFF by Restore Defaults > " Misc " on page 1892

State Saved	No
Range	OFF ON

4.2.2.7 SCPI Socket Control Port (Remote Query Only)

Returns the TCP/IP port number of the control socket associated with the SCPI socket session. This query lets you obtain the unique port number to open when a device clear is to be sent to the instrument. Every time a connection is made to the SCPI socket, the instrument creates a peer control socket. The port number for this socket is random. You must use this command to obtain the port number of the control socket. To force a device clear on this socket, open the port and send the string `DCL\n` to the instrument.

If this query is sent to a non-SCPI Socket interface, then 0 is returned.

Remote Command	<code>:SYSTem:COMMunicate:LAN:SCPI:SOCKet:CONTRol?</code>
Example	<code>:SYST:COMM:LAN:SCPI:SOCK:CONT?</code>
Preset	Unaffected by Preset or Restore Defaults > "Misc" on page 1892
State Saved	No
Range	0 to 65534
Min	0
Max	65534
Backwards Compatibility SCPI	<code>:SYSTem:COMMunicate:TCPIp:CONTRol?</code>

4.2.2.8 SCPI Instrument Port (Remote Query Only)

Some MIMO applications need to be able to determine the port to use to communicate with the instrument. This query returns the port number to use for communications.

Remote Command	<code>:SYSTem:COMMunicate:LAN:INSTrument:PORT?</code>
-------------------	---

4.2.3 Web Password Reset

The embedded web server contains certain capabilities that are password-protected; modifying the LAN configuration of the instrument, and access to web pages that can change the settings of the instrument. The default password from the factory is:

`measure4u`

This control lets you set the web password as desired, or to reset the password to the factory default.

Selecting **Web Password Reset** displays a control for resetting the password as desired, or to the factory default. The built-in alpha keyboard appears. You may change the password from the factory default of “**measure4u**”.

You can cancel this entry by pressing the **Cancel (ESC)** front-panel key.

Dependencies Not available in UXM

4.2.4 System IDN Response

Allows you to specify a response to ***IDN?**, return the instrument to the **FACTory** response if you have changed it, or, if your test software is expecting the ***IDN** response to indicate Agilent Technologies, configure the instrument to respond with Agilent as the manufacturer.

The current ***IDN** response is displayed at the top of the panel, followed by the **System IDN Response** and **User IDN** controls.

4.2.4.1 System IDN Response

To select the factory-set response, select **FACTory**. To specify your own response, select **USER**. You can enter your desired response using **"User IDN" on page 1851**.

If your test software expects the response to indicate Agilent Technologies as the Manufacturer, you can configure this response by selecting **AGILent**.

Remote Command	:SYSTem:IDN:CONFigure FACTory AGILent USER For option details, see "More Information" on page 1850 :SYSTem:IDN:CONFigure?
Example	:SYST:IDN:CONF FACT
Notes	Affects the response returned by all Modes of the instrument, unless the current Mode has <i>also</i> specified a custom response, in which case the current Mode’s custom IDN response takes precedence over the System’s, but only while that Mode is current Survives shutdown and restart of the software and therefore survives a power cycle
Preset	The *IDN response is reset to FACTory by Restore Defaults >"Misc" on page 1892 or Restore Defaults >"All" on page 1893 and survives subsequent running of the software

More Information

Here are details of the options available for the System ***IDN** response:

Factory

SCPI example: `:SYST:IDN:CONF FACT`

Selects the factory default configuration of `*IDN?`, which indicates the Manufacturer as Keysight Technologies. For example,

`"Keysight Technologies,N9040B,MY00012345,A.15.00"`

where the fields are Manufacturer, Model Number, Serial Number, Firmware Revision.

NOTE

In products that run multiple instances of the X-Series Application, all instances use the *same* factory System IDN response.

Agilent

SCPI example: `:SYST:IDN:CONF AGIL`

Starting with software version x.14.50, the `*IDN?` response in the Factory configuration indicates the Manufacturer as Keysight Technologies. If your test software is expecting the response to indicate Agilent Technologies, you can configure the response with this menu selection or SCPI command.

For example:

`"Agilent Technologies,N9020A,MY00012345,A.05.01"`

NOTE

In products that run multiple instances of the X-Series Application, all instances use the *same* Agilent System IDN response.

User

SCPI example: `:SYST:IDN:CONF USER`

Selects your customized configuration of `*IDN?`

Enter your desired response using "User IDN" on page 1851.

4.2.4.2 User IDN

Allows you to specify your own response to `*IDN?`. You may enter your desired response with the Alpha Editor or a plugin PC keyboard. Once the value is entered, select **USER** under **System IDN Response**.

When you select this control, the active function becomes the current User string and is highlighted, so typing replaces it. If instead you wish to edit the existing string, press the left or right arrow to go to the beginning or the end.

If you enter a null string (for example, by clearing the User String while editing and then pressing **Done**), the instrument automatically reverts to the **FACTory** setting.

NOTE

In products that run multiple instances of the X-Series Application, all instances use the *same* User System IDN response.

Remote Command	<code>:SYSTem:IDN <string></code> <code>:SYSTem:IDN?</code>
Notes	<p>The <code><string></code> must consist of four fields, each separated by a comma, example: <code>:SYST:IDN "XYZ Corp,Model 12,012345,A.01.01"</code></p> <p>The four fields are <code><manufacturer></code>, <code><model number></code>, <code><serial number></code>, <code><firmware revision></code>. The fields are comma-delimited, so text within a field cannot contain a comma</p> <p>This affects the response given in all Modes of the instrument, unless the current Mode has also specified a custom response, in which case the current Mode's custom IDN response takes precedence over the System's, but only while that Mode is current</p> <p>Survives shutdown and restart of the software and therefore survives a power cycle</p> <p>Null string as parameter restores the FACTory setting, example: <code>:SYST:IDN ""</code></p>
Preset	Unaffected by Preset , but set to the original FACTory setting by Restore Defaults > "Misc" on page 1892

4.2.4.3 SYSTem:PERSONa (Remote Commands Only)

The `:SYSTem:PERSONa` command set permits setting of individual fields of the `*IDN?` response.

- `"SYSTem:PERSONa:DEFault"` on page 1852
- `"SYSTem:PERSONa:MANUFACTurer"` on page 1853
- `"SYSTem:PERSONa:MANUFACTurer:DEFault"` on page 1853
- `"SYSTem:PERSONa:MODel"` on page 1853
- `"SYSTem:PERSONa:MODel:DEFault"` on page 1854

SYSTem:PERSONa:DEFault

Resets the `*IDN` response to the instrument default.

Remote Command	<code>:SYSTem:PERSONa:DEFault</code> <code>:SYSTem:PERSONa:DEFault?</code>
Notes	<code>:SYST:PERs:DEF?</code> returns the default value of <code>*IDN?</code> even if the current setting of <code>*IDN?</code> is the

non-default value. The query return type is a `<string>`

`:SYST:PERS:DEF`

is equivalent to:

`:SYSTem:IDN ""`

`:SYSTem:IDN:CONF DEF`

SYSTem:PERSONa:MANufacturer

Sets the **MANufacturer** field of the `*IDN?` response. This is the first field of the `*IDN?` response.

Remote Command `:SYSTem:PERSONa:MANufacturer <string>`

`:SYSTem:PERSONa:MANufacturer?`

Notes When setting the **MANufacturer** field, the current IDN response string is modified to replace the manufacturer field with the string specified by the command. If the resulting IDN response matches one of the predefined responses (`:SYST:IDN:CONF FACT | AGIL`), then the `:SYST:IDN:CONF` is set to the corresponding value. If the IDN response with the new manufacturer field is not one of the predefined values, then `:SYST:IDN:CONF` will be set to **USER** and `:SYST:IDN` will be set to the new IDN response string

The query returns the current value of the `*IDN?` Manufacturer field

SYSTem:PERSONa:MANufacturer:DEFAULT

Resets the **MANufacturer** field of the `*IDN?` response to the default value.

Remote Command `:SYSTem:PERSONa:MANufacturer:DEFAULT`

`:SYSTem:PERSONa:MANufacturer:DEFAULT?`

Notes The query returns the default **MANufacturer** field value of `*IDN?` even if the current setting of `*IDN?` is the non-default value. The return type is a `<string>`

SYSTem:PERSONa:MODEL

Sets the **MODEL** field of the `*IDN?` response. This is the second field of the `*IDN?` response.

Remote Command `:SYSTem:PERSONa:MODEL <string>`

`:SYSTem:PERSONa:MODEL?`

Notes When setting the **MODEL** field, the current IDN response string is modified to replace the model field with the string specified by the command. If the resulting IDN response matches one of the predefined responses (`:SYST:IDN:CONF FACT | AGIL`), then `:SYST:IDN:CONF` is set to the corresponding value. If the IDN response with the new model field is not one of the predefined values, then `:SYST:IDN:CONF` will be set to **USER** and `:SYST:IDN` will be set to the new IDN response string

The query returns the current value of the `*IDN?MODE1` field

SYSTem:PERSONa:MODEl:DEFault

Resets the `MODE1` field of the `*IDN?` response to the default value.

Remote Command	<code>:SYSTem:PERSONa:MODEl:DEFault</code> <code>:SYSTem:PERSONa:MODEl:DEFault?</code>
Notes	The query returns the default <code>MODE1</code> field value of <code>*IDN?</code> even if the current setting of <code>*IDN?</code> is the non-default value. The return type is a <code><string></code>

4.2.5 LXI

Accesses various `LXI` configuration properties.

Dependencies	Not available in UXM
--------------	----------------------

4.2.5.1 LAN Reset

Resets the LAN connection. This sets parameters as follows, and restarts the LAN operation:

DHCP	Enabled
Automatic IP Address	Enabled
ICMP Ping Responder	Enabled
Web Password	<code>keysight</code>
Dynamic DNS	Enabled
mDNS and DNS-SD	Enabled
Dynamic Link Local Addressing	Enabled
Auto Negotiation	Enabled

There is no SCPI command for this function.

4.2.5.2 Device Identification (Remote Command Only)

Enabling LXI device identification places the LXI Status Indicator in the **Identify** state. Disabling LXI device identification places the LXI Status Indicator in the **No Fault** state. The LXI Status indicator is in the upper left region of the instrument's graphical user interface.

Remote Command	<code>:LXI:IDENTify[:STATe] OFF ON 0 1</code>
----------------	---

	<code>:LXI:IDENTify[:STATe]?</code>
Example	<code>:LXI:IDEN ON</code>
Preset	Not part of Preset , but reset to OFF by Restore Defaults > "All" on page 1893
State Saved	No
Range	OFF ON

4.2.6 Restore I/O Config Defaults

Causes the group of settings associated with the **I/O Config** menu to be reset to their default values. This also happens on **Restore Misc Defaults**, which has a SCPI command.

When **Restore I/O Config Defaults** is selected, a message appears saying:

`This will reset all of the I/O Config variables to their default state, including the GPIB address and SCPI LAN settings`

`It will not affect Alignment data or settings`

`This action cannot be undone. Do you want to proceed?`

The message provides **OK** and **Cancel** buttons so you can affirm or cancel the operation.

4.2.7 Query USB Connection (Remote Query Only)

Enables you to determine the speed of the USB connection.

Remote Command	<code>:SYSTem:COMMunicate:USB:CONNectioN?</code>	
Example	<code>:SYST:COMM:USB:CONN?</code>	
Notes	NONE	Indicates no USB connection has been made
	LSpeed	Indicates a USB low speed connection (1.5 Mbps) Note that this is reserved for future use, the T+M488 protocol is not supported on low-speed connections
	HSPeed	Indicates that a USB high speed connection (480 Mbps) has been negotiated
	FSPeed	Indicates that a USB full speed connection (12 Mbps) has been negotiated
State Saved	No	
Range	NONE LSpeed HSPeed FSPeed	

4.2.8 USB Connection Status (Remote Query Only)

Lets you determine the current status of the USB connection.

Remote Command	<code>:SYSTem:COMMunicate:USB:STATus?</code>
Example	<code>:SYST:COMM:USB:STAT?</code>
Notes	<p>SUSPended – Indicates that the USB bus is currently in its suspended state. The bus is in the suspended state when:</p> <ul style="list-style-type: none"> – The bus is not connected to any controller – The controller is currently powered off – The controller has explicitly placed the USB device into the suspended state <p>When in the suspended state, no USB activity, including start of frame packets are received</p> <p>ACTive – Indicates that the USB device is in the active state. When the device is in the active state, it receives periodic frame starts, but is not necessarily receiving or transmitting data</p>
State Saved	No
Range	<code>SUSPended ACTive</code>

4.2.9 USB Packet Count (Remote Query Only)

Lets you determine the number of packets received and transmitted on the USB bus.

Remote Command	<code>:SYSTem:COMMunicate:USB:PACKets?</code>
Example	<code>:SYST:COMM:USB:PACK?</code>
Notes	<p>Two integers are returned:</p> <ol style="list-style-type: none"> 1. The number of packets received since application invocation 2. The number of packets transmitted since application invocation <p>If no packets have been received or transmitted, the response is <code>0,0</code></p> <p>The packet count is initialized to <code>0,0</code> when the instrument application is started</p>
State Saved	No

4.2.10 Lock Remote I/O Session (Remote Command only)

An instrument can support multiple remote I/O sessions at the same time. However, you cannot *simultaneously* send remote commands from multiple sessions to the same instrument. The results in such a case are undefined.

Ensure that only *one* session actively controls the instrument at a time. Other sessions must wait until the active session finishes the instrument control.

To help achieve this cooperative instrument sharing, the following remote commands are provided:

- "Lock Remote I/O Request (Remote Query only)" on page 1858
- "Unlock Remote I/O Session (Remote Command only)" on page 1859
- "Remote I/O Session Lock Name (Remote Query only)" on page 1860
- "Remote I/O Session Lock Owner (Remote Query only)" on page 1860

Example Procedure for Lock Usage

Step	Action
1	Each session tries to obtain a lock by sending <code>:SYSTem:LOCK:REQuest?</code> This query can be sent simultaneously from multiple sessions
2	Only one session will be granted. The granted session receives <code>1</code> in response to its query
3	The granted session actively controls the instrument Meanwhile, other sessions must wait, and must periodically send <code>:SYSTem:LOCK:REQuest?</code> , requesting the lock
4	When the active session finishes its task, it releases the lock by sending <code>:SYSTem:LOCK:RELease</code>
5	Now the lock has become available, so when one of the waiting sessions sends <code>:SYSTem:LOCK:REQuest?</code> , it receives <code>1</code> in response, granting the lock to that session

By repeating steps 3, 4, and 5 above, multiple sessions can share the same instrument in a cooperative fashion.

NOTE

A session can query its own unique session name by sending `:SYSTem:LOCK:NAME?`. This session name is determined by the instrument.

A session also can query the name of the currently granted session by sending `:SYSTem:LOCK:OWNer?`.

NOTE

Remote I/O interfaces are grouped in two types: single-session interface and multi-session interface. Both types of interfaces can be used for cooperative instrument sharing.

The recommended interface is LAN HiSLIP.

Interface	Single-session	Multi-Session
GPIB	ü	
USB-488	ü	
LAN VXI-11 (SICL)	ü	
LAN Socket		ü
LAN HiSLIP		ü
LAN Telnet		ü

If using a single-session interface, care must be taken to ensure only one client uses the single-session interface.

In particular, LAN VXI-11 (SICL) interface is a single-session interface, even though multiple clients could simultaneously connect to this interface. Such multiple VXI-11 clients share the same session context; the same status registers and the same error queue. Even a SCPI query response can be received by another client. Furthermore, the lock obtained by `:SYSTem:LOCK:REQuest?` is shared among all VXI-11 clients, allowing all of them to actively control the instrument.

If a LAN VXI-11 (SICL) interface must be used by multiple clients for a cooperative instrument sharing, then VISA locking *must* be used, *in addition to* Remote I/O Session Lock.

4.2.10.1 Lock Remote I/O Request (Remote Query only)

You can lock the SCPI control of the instrument to the I/O Interface and Session by sending `:SYSTem:LOCK:REQuest?`. This permits cooperative sharing of the instrument between multiple computers, or multiple sessions from the same computer.

Remote Command	<code>:SYSTem:LOCK:REQuest?</code>
Example	<code>:SYST:LOCK:REQ?</code>
Notes	Returns 1 if the lock request is granted, or 0 if the request is denied Lock requests on an individual interface and session can be nested and each request will increase an internal lock count by 1. For every granted request, send <code>:SYST:LOCK:REL</code> to decrement the internal lock count to fully relinquish the lock When the instrument is locked, Bit 0 is set in the Operation Instrument status register

Disconnecting the individual interface and session releases the lock if the lock is granted to the interface and session

A Device Clear over any interface and session releases the lock, regardless of the interface and session which obtained the lock

The following queries are permitted over any interface and session, even if an interface has the instrument locked:

- *IDN?
- *OPT?
- *STB?
- *ESR?
- :SYSTem:DATE?
- :SYSTem:TIME?
- :SYSTem:PON:TIME?
- Queries in the :STATus subsystem
- Queries in the :SYSTem:ERRor subsystem
- Queries in the :SYSTem:LKEY subsystem
- Queries in the :SYSTem:LOCK subsystem
- Queries in the :SYSTem:METRics subsystem
- Queries in the :SYSTem:MODuLe subsystem

All other commands and queries result in error: -203, "Command protected; Instrument locked by another I/O session"

State Saved	Not part of Save/Recall
-------------	-------------------------

4.2.10.2 Unlock Remote I/O Session (Remote Command only)

You can unlock the SCPI control of the current I/O Interface and Session by sending **:SYSTem:LOCK:RELease**. Lock requests on an individual interface and session can be nested, and each request increases an internal lock count by 1. For every granted request, you will need to perform a release. The lock is not relinquished until the internal lock count reaches 0.

Remote Command	:SYSTem:LOCK:RELease
----------------	-----------------------------

Example	:SYST:LOCK:REL
---------	-----------------------

Notes	When the instrument is unlocked, Bit 0 is cleared in the Operation Instrument status register
-------	---

4.2.10.3 Remote I/O Session Lock Name (Remote Query only)

Use this query to obtain the name of the current I/O Interface and Session.

Remote Command	<code>:SYSTem:LOCK:NAME?</code>
Example	<code>:SYST:LOCK:NAME?</code>
Notes	<p>The information returned is a string of the format: <code><I/O Interface>[/<IP address>/<Session ID>]</code></p> <p>Where IP address and Session ID are only provided for interfaces that provide multiple sessions</p> <p>Single Session interfaces (GPIB, USB-488, and LAN VXI-11) only list interface name</p> <p>Session ID is an internally generated identifier. It is not guaranteed to be consistent across instrument software versions (the identifier is subject to change when the software of the instrument is updated). The absolute value of Session ID is not significant, but the identifier will be consistent for a given software version, and can be relied upon for lock owner logic comparisons</p>

4.2.10.4 Remote I/O Session Lock Owner (Remote Query only)

Use this query to determine which I/O Interface and Session has the SCPI locked.

If no interface and session has the SCPI locked, then the return value is **NONE**.

Remote Command	<code>:SYSTem:LOCK:OWNer?</code>
Example	<code>:SYST:LOCK:OWN?</code>
Notes	<p>The information returned is a string of the format: <code><I/O Interface>[/<IP address>/<Session ID>]</code></p> <p>Where IP address and Session ID are only provided for interfaces that provide multiple sessions</p> <p>Single Session interfaces (GPIB, USB-488, and LAN VXI-11) only list interface name</p> <p>Session ID is an internally generated identifier. It is not guaranteed to be consistent across instrument software versions (the identifier is subject to change when the software of the instrument is updated). The absolute value of Session ID is not significant, but the identifier will be consistent for a given software version, and can be relied upon for lock owner logic comparisons</p> <p>If no interface and session has the SCPI locked, then the return value is NONE</p>

4.2.11 Multiple Network Interface Card Configuration (Remote Commands Only)

Systems that have multiple Network Interface Cards (NICs) require additional configuration information. The following keys can be added to the XApps configuration file:

- **PrimaryNICIPv4** – IP address value is a string with the exact IP V4 format. Required field in IP v4 networks.
- **PrimaryNICIPv6** – IP address value is a string with the exact IP V6 format. Required field in IP v6 networks.

These commands do not apply to instruments that have only one NIC. The commands apply to all modular deployments that have a controller with multiple NICs.

To configure and query these configuration options, the following remote commands are provided:

- "Multiple Network Adapters Enabled (Remote Query Only)" on page 1861
- "Config IPV4 Address (Remote Command Only)" on page 1862
- "Config IPV6 Address (Remote Command Only)" on page 1862
- "List All Physical Network Adapter IP Addresses (Remote Query Only)" on page 1862

4.2.11.1 Multiple Network Adapters Enabled (Remote Query Only)

Remote Command	<code>:SYSTem:COMMunicate:LAN:MULTiple:NIC:ENABled?</code>
Example	<code>:SYSTem:COMMunicate:LAN:MULTiple:NIC:ENABled?</code>
Notes	Applies to Instruments that have multiple Network Adapters. When more than one network adapter is present in the system, and they are Enabled (that is, they have a valid IP Address), this query returns: <ul style="list-style-type: none">- 1, if more than one NIC enabled- 0, if only one or No NICs are enabled
State Saved	No

4.2.11.2 Config IPV4 Address (Remote Command Only)

Remote Command	<code>:SYSTem:COMMunicate:LAN:IPV4:CONFig <ipaddress></code> <code>:SYSTem:COMMunicate:LAN:IPV4:CONFig?</code>
Example	<code>:SYSTem:COMMunicate:LAN:IPV4:CONFig "192.168.1.146"</code> <code>:SYSTem:COMMunicate:LAN:IPV4:CONFig?</code>
Notes	<p>Applies to instruments that have multiple Network Adapters. When more than one network adapter is present in the system, you must specify in the instrument config file the IP address to use to enable Remoting channel bindings. If this is not provided, Remoting connections are likely to fail on systems where multiple NICs are enabled</p> <p>Sets the valid IPV4 address, passed in as string in the config file</p> <p>The query returns IPV4 address, as a string</p> <p>If config file is missing, "" (empty string) is returned</p> <p>Changing the IPV4 value requires a restart of the instrument software, to ensure that servers use the configured IP address</p>
State Saved	No

4.2.11.3 Config IPV6 Address (Remote Command Only)

Remote Command	<code>:SYSTem:COMMunicate:LAN:IPV6:CONFig <ipaddress></code> <code>:SYSTem:COMMunicate:LAN:IPV6:CONFig?</code>
Example	<code>:SYSTem:COMMunicate:LAN:IPV6:CONFig "2001:0db8:85a3:0000:0000:8a2e:0370:7334"</code> <code>:SYSTem:COMMunicate:LAN:IPV6:CONFig?</code>
Notes	<p>Applies to instruments that have multiple Network Adapters. When more than one network adapter is present in the system, you must specify in the instrument config file the IP address to use to enable Remoting channel bindings. If this is not provided, Remoting connections are likely to fail on systems where multiple NICs are enabled</p> <p>Sets the valid IPV6 address, passed in as string in the config file</p> <p>The query returns IPV6 address, as a string</p> <p>If config file is missing, "" (empty string) is returned</p> <p>Changing the IPV6 value requires a restart of the instrument software, to ensure servers use the configured IP address</p>
State Saved	No

4.2.11.4 List All Physical Network Adapter IP Addresses (Remote Query Only)

Remote Command	<code>:SYSTem:COMMunicate:LAN:PHYSical:IPADdress:LIST?</code>
Example	<code>:SYSTem:COMMunicate:LAN:PHYSical:IPADdress:LIST?</code>

4 System
4.2 I/O Config

: "192.168.1.146, 2001:0db8:85a3:0000:0000:8a2e:0370:7334"

Notes Returns the IP Addresses of the physical network adapters found in the PC/Instrument

State Saved No

4.3 Preload / Unload Modes

The X-Series platform supports many Modes. Each Mode that is loaded uses a portion of the total available memory. At some point, this may result in insufficient free memory. This can occur during a measurement, or when loading a new Mode. A limited number of Modes can be loaded without impacting performance.

Preload / Unload Modes allows you to select and enable Modes to be preloaded at startup, and to specify the default **Power-On Mode**.

The dialog includes the following controls:

- "Power-On Mode" on page 1864
- "Table of Modes" on page 1865
- "Preload: Select All, Preload: Deselect All" on page 1865
- "Move Up, Move Down" on page 1865
- "Unload" on page 1865

Modes that are not preloaded may be loaded at runtime as needed, resources permitting. However, note that loading more Modes increases memory consumption and may adversely impact performance.

When a memory-full situation occurs, the instrument notifies you with the following message:

Out of memory; Insufficient resources. Please save state if needed. You have following options:

1. Open System Settings > Configure Preload Modes to unload unused Modes
2. Reconfigure preloaded Modes on the above dialog, close and restart the analyzer SW
3. Close and restart the analyzer SW

Option 1 allows you to unload unused Modes and continue running the software, without having to restart it.

The command `:INSTRument:UNLoad <mode>` provides equivalent functionality; see "Unload" on page 1865.

4.3.1 Power-On Mode

Displays a list of licensed Modes. Use this control to change the factory default Power-On Mode. The instrument will execute the selected Mode after power up. Selecting the Power-On Mode here automatically enables that Mode for preloading.

4.3.2 Table of Modes

The table of Modes becomes scrollable when the number of Modes exceeds the dialog's displayable size.

Use the check boxes in the **Preload** column to enable or disable the preloading of the Modes that you want.

Use the check boxes in the **Unload** column to select the Modes that you want to unload.

The Unload check boxes are grayed-out when the Modes are used by other Modes.

Example:

5G NR & V2X Mode cannot be loaded when either Sequence Analyzer Mode or Power Amplifier Mode are already loaded, because these Modes use 5G NR & V2X Mode. To unload 5G NR & V2X Mode, both Sequence Analyzer Mode and Power Amplifier Mode must be unloaded first.

When the active Mode is unloaded, the screen becomes blank except for the message; **"No Mode is active"**. You can then select another desired Mode.

When multiple screens are open, and a Mode is unloaded, inactive screens that have that Mode as their active Modes are closed.

The active screen is never closed.

4.3.3 Preload: Select All, Preload: Deselect All

Toggles the **Preload** checkbox state for all Applications listed, except for the Power-On Application, which is always selected.

4.3.4 Move Up, Move Down

The default order in which Applications are listed in the table is the order in which they are displayed in the **Mode/Measurement/View** Selector dialog. To change the order in this list, select the desired Application row from the table, then click **Move Up** or **Move Down** to move it to the desired position.

4.3.5 Unload

Unloads the specified Mode.

Remote `:INSTRument:UNLoad <mode>`

Command	
Example	<code>:INST:UNL NR5G</code>
Notes	<p>Error message if the specified Mode is not available, -224,"Illegal parameter value;<mode> is not a valid choice"</p> <p>Error message if the specified Mode is not loaded and therefore cannot be unloaded, -221,"Settings conflict;<mode> is not loaded"</p> <p>Error message if the specified Mode is used by other Modes and therefore cannot be unloaded, -221,"Settings conflict;<mode> is used by <other modes>"</p> <p>Error message if the specified Mode does not support Unload Mode feature and therefore cannot be unloaded, -221,"Settings conflict;Feature not supported for this Mode"</p>

4.3.6 Loaded Modes (Remote Query Only)

Returns a list of loaded Modes.

Remote Command	<code>:SYSTem:APPLication:LOADed?</code>
Example	<code>:SYST:APPL:LOAD?</code>
Preset	Not affected by Preset

4.3.7 User Interface

Configures functions specific to the User Interface, such as the menu panel orientation and the display color theme.

4.3.7.1 Menu Panel Position

Allows the Menu Panel to be positioned on the **RIGHT** or **LEFT** side of the display.

Remote Command	<code>:SYSTem:DISPlay:MPPosition RIGHT LEFT</code> <code>:SYSTem:DISPlay:MPPosition?</code>
Example	<code>:SYST:DISP:MPP LEFT</code>
Preset	This is unaffected by Preset but is set to RIGHT by Restore Defaults > "User Interface" on page 1891 or Restore Defaults > "All" on page 1893
State Saved	Power On Persistent (survives shutdown and restart)

4.3.7.2 Menu Panel Tabs

Allows the **Menu Panel Tabs** to be positioned on the **RIGHT** or **LEFT** side of the menu panel.

Remote Command	:SYSTem:DISPlay:MPTab RIGHT LEFT :SYSTem:DISPlay:MPTab?
Example	:SYST:DISP:MPT LEFT
Preset	This is unaffected by Preset but is set to RIGHT by Restore Defaults > "User Interface" on page 1891 or Restore Defaults > "All" on page 1893
State Saved	Power On Persistent (survives shutdown and restart)

4.3.7.3 Annotations Local Settings/All Off

Overrides the annotation settings for all measurement in all modes and turns them all off. This provides the security based "annotation off" function of previous instruments; hence it uses the legacy SCPI command.

When this control is set to **All Off**, the **Screen Annotation**, **Meas Bar**, **Trace Annotation**, and **Control Annotation** controls under the **Display, Annotation** menu are grayed-out and forced to **OFF** for all measurements in all modes. When **Local Settings** is selected, you can set the local annotation settings on a measurement-by-measurement basis.

Remote Command	:DISPlay:WINDow[1]:ANNotation[:ALL] OFF ON 0 1 :DISPlay:WINDow[1]:ANNotation[:ALL]?
Example	:DISP:WIND:ANN OFF
Preset	This is unaffected by Preset but is set to ON by Restore Defaults > "User Interface" on page 1891, Restore Defaults > "Misc" on page 1892 or Restore Defaults > "All" on page 1893
State Saved	Power On Persistent (survives shutdown and restart)
Backwards Compatibility Notes	The WINDow parameter and optional subopcode is included for backwards compatibility but ignored – all windows are equally affected

4.3.7.4 Display Theme

Allows you to change the **Display Theme**. This is similar to the Themes selection under Page Setup and Save Screen Image.

The two available themes are:

- **FILLED**: this is the normal theme using filled objects
- **OUTLine**: this theme uses color, but does not use fill for most areas on the display. It is ideal for images that need to be printed on inkjet printers. Although setting **Display Theme** to **OUTLine** does not affect screen image saves or prints, it does show you exactly how screen images will look when using the **OUTLine** theme under **Save Screen Image**, and how prints will look when using the **OUTLine** theme under **Page Setup**.

NOTE

Although the **OUTLine** theme eliminates most of the filled area, some objects remain filled. In particular, the selected marker remains filled with the green marker color, to distinguish it from the other markers. This is important, as it is the selected marker whose readout appears in the upper right corner of the display.

Remote Command	<code>:DISPlay:THEMe TDColor TDMonochrome FCOLor FMONochrome FILLed OUTLine</code> <code>:DISPlay:THEMe?</code>
Example	<code>:SYST:DISP:THEM OUTL</code> sets the display style to OUTLine
Notes	To permit code compatibility with A-model X-Series Signal Analyzer instruments, the command parameters from the A-models are mapped as follows: <ul style="list-style-type: none"> – TDColor and TDMonochrome are both mapped to FILLED (exact full color representation of what is on the screen) – FCOLor and FMONochrome are both mapped to OUTLine (uses color for traces and other items, but most filled areas are white) <p>There is no Monochrome theme in the B-model instruments, so the monochrome commands for the A-model instruments yield color themes</p> <p>The query of <code>:DISPlay:THEMe?</code> always returns FILLED or OUTLine. It never returns FCOLor, FMONochrome, TDColor, or TDMonochrome</p>
Preset	This is unaffected by Preset but is set to FILLED by Restore Defaults > "User Interface" on page 1891 , Restore Defaults > "Misc" on page 1892 or Restore Defaults > "All" on page 1893
State Saved	Power On Persistent (survives shutdown and restart)

4.3.7.5 Backlight

Turns the display **Backlight** on and off. This setting may interact with settings under the Windows **Power** menu.

When the backlight is **OFF**, pressing ESC, TAB, SPACE, ENTER, UP, DOWN, LEFT, RIGHT, DEL, BKSP, CTRL, or ALT turns the backlight **ON** without affecting the

4 System

4.3 Preload / Unload Modes

application. Pressing any other key turns backlight **ON**, and could potentially perform the action as well.

Remote Command	<code>:DISPlay:BACKlight ON OFF</code> <code>:DISPlay:BACKlight?</code>
Example	Turn backlight ON : <code>:DISP:BACK ON</code> Turn backlight OFF : <code>:DISP:BACK OFF</code>
Preset	Pressing any key turns the backlight back ON , as does Restore Defaults > "User Interface" on page 1891, Restore Defaults > "Misc" on page 1892 or Restore Defaults > "All" on page 1893
State Saved	Not saved in State

4.3.7.6 Backlight Intensity

Allows the **Backlight Intensity** to be controlled from the UI settings panel.

Remote Command	<code>:SYSTem:DISPlay:BACKlight:INTensity <integer></code> <code>:SYSTem:DISPlay:BACKlight:INTensity?</code>
Example	<code>:SYST:DISP:BACK:INT 67</code>
Preset	100
State Saved	Power On Persistent (survives shutdown and restart)
Range	0-100

4.3.7.7 Hints

Hints are descriptions that provide additional information for a control. You can set **Hints** to be enabled or disabled.

Remote Command	<code>:SYSTem:DISPlay:HINTs[:STATe] OFF ON 0 1</code> <code>:SYSTem:DISPlay:HINTs?</code>
Example	<code>:SYST:DISP:HINT OFF</code>
Preset	This is unaffected by Preset but is set to ON by Restore Defaults > "User Interface" on page 1891 or Restore Defaults > "All" on page 1893
State Saved	Power On Persistent (survives shutdown and restart)

4.3.7.8 Numeric Entry Auto Open

Configures whether the **Numeric Entry** Panel will appear immediately when an active function control is activated (Auto Open **ON**), or be deferred until you touch it again or begin to enter a value (Auto Open **OFF**). When configured for Auto Open

OFF (the default), adjusting the value with the front panel Up/Down keys or the RPG hides the **Numeric Entry** Panel.

Remote Command	:SYSTem:DISPlay:NEPimmediate ON OFF 1 0
Command	:SYSTem:DISPlay:NEPimmediate?
Example	:SYST:DISP:NEP OFF
Preset	This is unaffected by Preset but is set to ON by Restore Defaults > "User Interface" on page 1891 or Restore Defaults > "All" on page 1893
State Saved	Power On Persistent (survives shutdown and restart)

4.3.7.9 Touch On/Off

Turns the touch functionality on and off on the display. If **OFF**, you can turn it back on using the front panel **Touch On/Off** key, or by using a mouse to toggle this control.

Preset	Always starts up ON Unaffected by Preset but is turned ON by Restore Defaults > "User Interface" on page 1891 or Restore Defaults > "All" on page 1893
State Saved	Not saved in state, not affected by Preset , not Power On Persistent (does not survive shutdown and restart)

4.3.7.10 Control Size

Configures the size of the controls in the user interface. This can be used to make screen dumps from a large screen instrument match those from a smaller screen instrument, to make the controls more readable on a large-screen instrument, or to display more information on a smaller screen instrument.

Remote Command	:DISPlay:UINTErface:CSIZE SMALL LARGE
Command	:DISPlay:UINTErface:CSIZE?
Example	:DISP:UINT:CSIZ LARG
Preset	This is unaffected by Preset but is set to SMALL by Restore Defaults > "User Interface" on page 1891 or Restore Defaults > "All" on page 1893
State Saved	Power On Persistent (survives shutdown and restart)

4.3.7.11 Quick Save Mode

When **Quick Save Mode** is **NORMa1** (the default setting), the instrument does an immediate save of a new file of the same type and to the same directory as the previous **Save** action. When **Quick Save Mode** is in the **PROMpt** state, instead of immediately performing a **Save**, the Alpha Keyboard appears with the proposed

4 System
4.3 Preload / Unload Modes

auto-filename in the entry area. You can then press **Enter** to accept the auto filename, or edit the name then press **Enter**. This allows you to easily save a file with a custom file name.

Remote Command	:MMEemory:STORe:QSAVe NORMa1 PROMpt
Example	:MMEemory:STORe:QSAVe?
Example	:MMEemory:STOR:QSAV PROM
Preset	This is unaffected by Preset but is set to NORMa1 by Restore Defaults > "User Interface" on page 1891 or Restore Defaults > "All" on page 1893
State Saved	Power On Persistent (survives shutdown and restart)

4.3.7.12 Screen Tabs Left/Right

This switch, when in the **RIGHT** position, makes the screen tabs start on the right and build across to the left, thus minimizing the finger travel over to the screen tab when there is only one screen. When tabs are added from right to left, they appear as below:

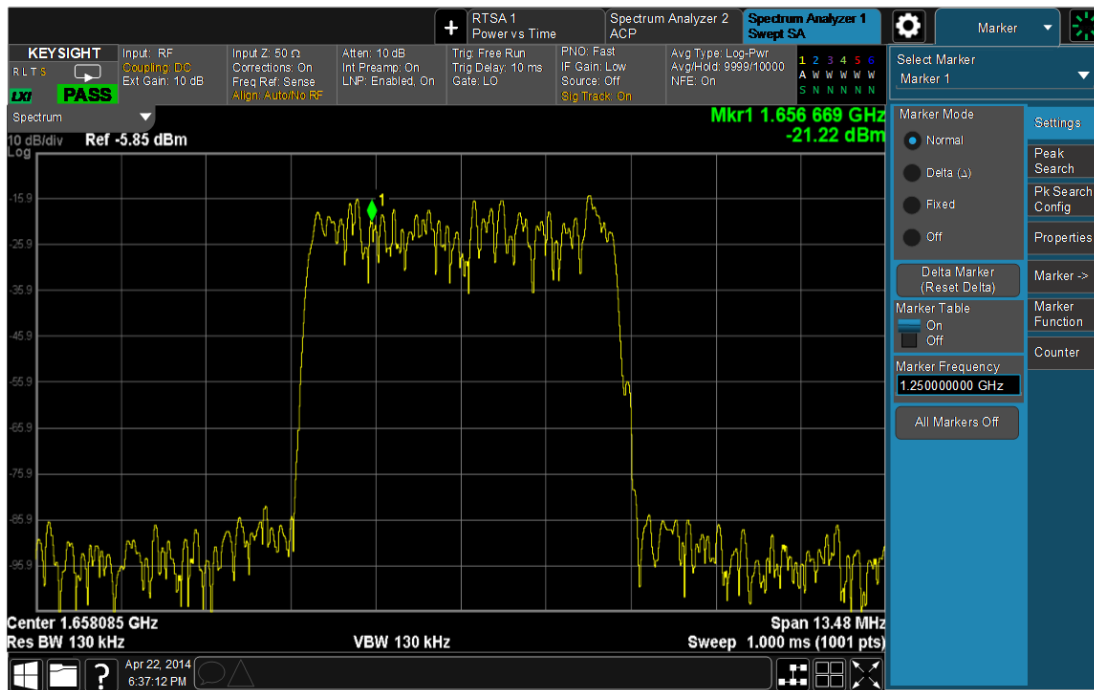

The default is **LEFT**.

Remote Command	:DISPlay:UINTERface:STAB RIGHT LEFT
Command	:INSTrument:SCREen:STAB?

Example	:DISP:UINt:STAB RIGH
Preset	This is unaffected by Preset but is set to LEFT by Restore Defaults > "User Interface" on page 1891 or Restore Defaults > "All" on page 1893
State Saved	Power On Persistent (survives shutdown and restart)

4.3.7.13 Hide Screen Tabs in Full Screen

This switch, when in the **ON** position, causes the Screen Tabs to be hidden when in Full Screen view, thus maximizing the display area available for results. By also turning off the Meas Bar (in the **Display, Annotation** menu), you can maximize the available area for results, as shown below:

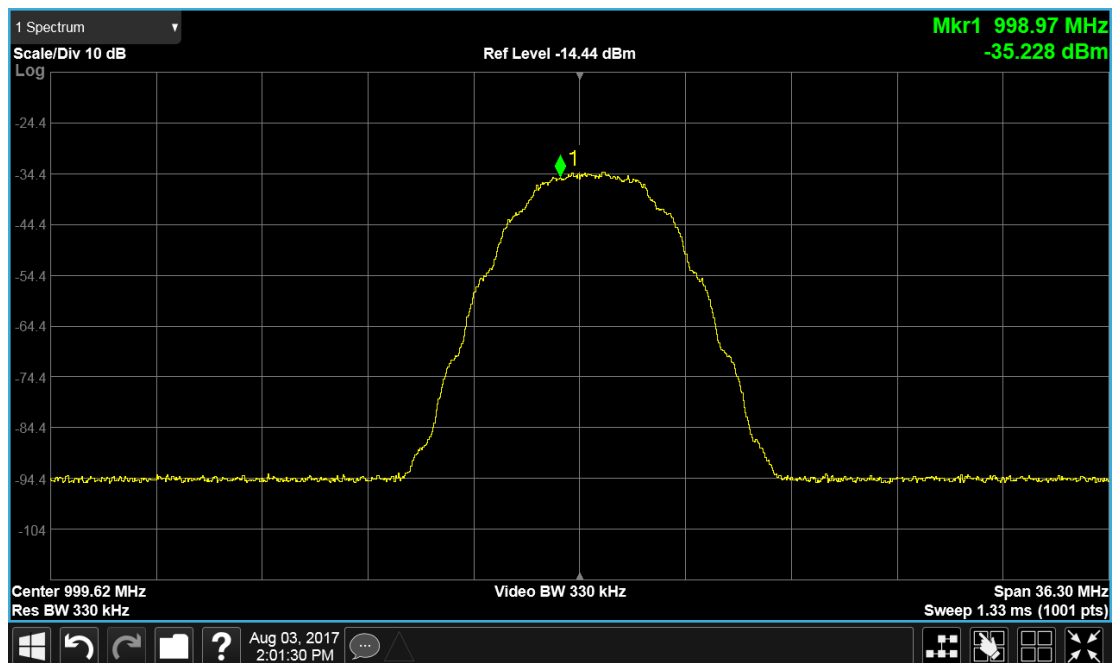

Remote Command	:DISPlay:UINtErface:HTABs ON OFF 1 0 :DISPlay:UINtErface:HTABs? :DISPlay:UINtErface:STFScreen ON OFF 1 0 Implemented but with wrong sense; ON turns them off and OFF turns them on; so, don't document to customer
----------------	---

Example	:DISP:UINt:HTAB ON Hide the tabs in full screen
Preset	This is unaffected by Preset but is set to OFF by Restore Defaults > "User Interface" on page 1891 or Restore Defaults > "All" on page 1893
State Saved	Power On Persistent (survives shutdown and restart)

4.3.7.14 2-Screen Orientation

When you add a second Screen using the “+” control on the Screen Tabs bar, normally the screen is added to the right of the first screen. However, sometimes it is better to add the new screen below the first screen rather than to the right, as shown below.

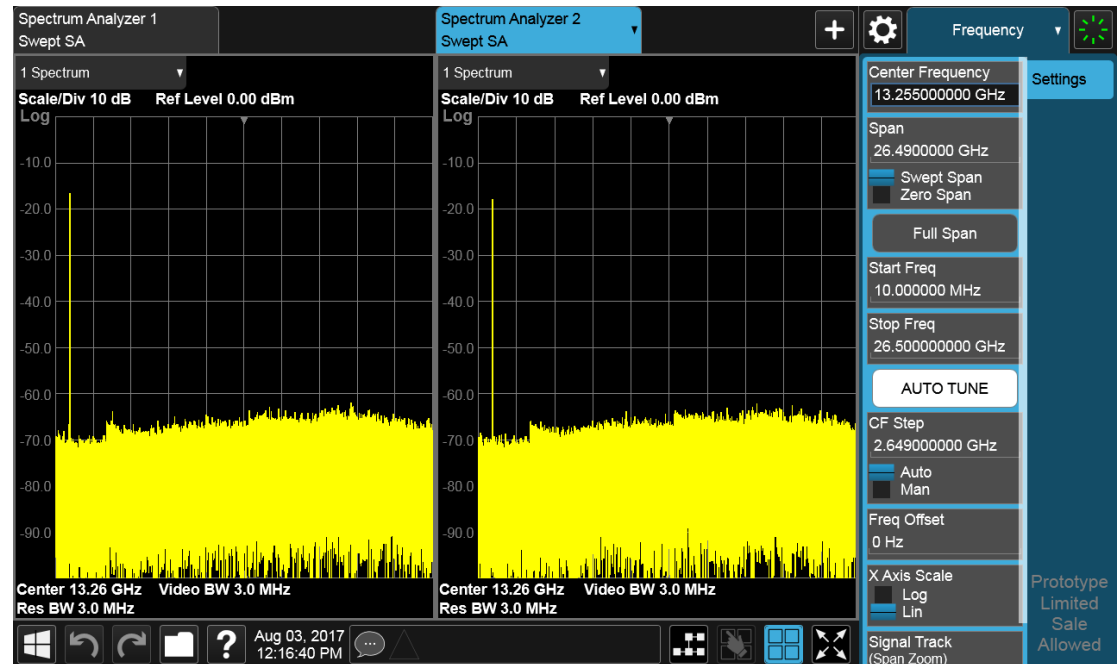

New screen added to the right (horizontal orientation)

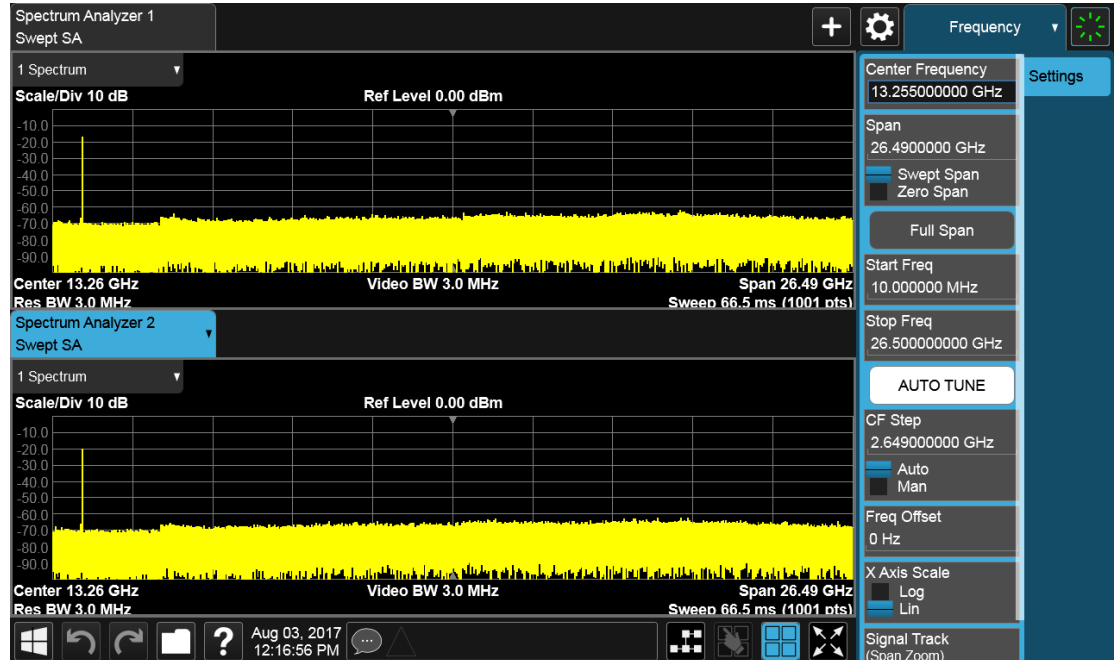

New screen added below (vertical orientation)

The **2-Screen Orientation** switch allows you to choose between these two orientations for 2-Screen configurations. The default is the **HORizontal** configuration, two Screens side-by-side.

Remote Command	<code>:INSTrument:SCReen:ORientation VERTical HORizontal</code>
Example	<code>:INST:SCR:ORI VERT</code> Set the 2 screens to be above/below each other
Preset	HOR This is unaffected by Preset but is set to HORizontal by Restore Defaults > "User Interface" on page 1891 or Restore Defaults > "All" on page 1893

4.3.7.15 Clock Format

Allows the **Clock Format** to be switched between 12-Hour Format (**HR12**) and 24-Hour Format (**HR24**).

Remote Command	<code>:SYSTem:DISPlay:CFORmat HR12 HR24</code> <code>:SYSTem:DISPlay:CFORmat?</code>
Example	<code>:SYST:DISP:CFOR HR12</code>
Preset	HR12
State Saved	Power On Persistent (survives shutdown and restart)
Range	12-Hour 24-Hour

4.3.7.16 Language

Accesses the selection of **Language** displayed on the menus and controls. **ENGLISH** is the default.

All Measurement Applications that share common controls will display the localized controls.

The description on the control labels is bounded by the control size. Any given language will have labels in that language that are shorter or longer than the equivalent label in English. Any localized text on the controls that does not fit the label size remains in English. Thus, for any given menu, controls may be displayed in English *and* the selected language.

- Labels that are acronyms, engineering, or technology specific terms may remain in English.
- All Application and Measurement names remain in English.
- All data in exported files remain in English.
- The Diagnostic and Service menus in the System Subsystem remain in English.
- The Windows operating system must remain in English. Changing the **Region and Language** settings in the Windows Control Panel is not supported.

External keyboards in English are supported. Localized external keyboards are not supported. When the language selected is not English, a message is displayed to explain that any external keyboard must remain in English.

Other aspects of the Graphical User Interface remain in English. The Remote User Interface (SCPI) remains in English.

Remote Command	<code>:SYSTem:DISPlay:LANGuage ENGLISH RUSSian</code>
----------------	---

	<code>:SYSTem:DISPlay:LANGuage?</code>
--	--

Example	<code>:SYST:DISP:LANG ENGL</code>
---------	-----------------------------------

	<code>:SYST:DISP:LANG RUSS</code>
--	-----------------------------------

Requires Option AKT

Preset	This is unaffected by Preset but is set to ENGLISH by Restore Defaults > " User Interface " on page 1891, Restore Defaults > " Misc " on page 1892 or Restore Defaults > " All " on page 1893
--------	---

4.3.7.17 Restore User Interface Defaults

Causes the group of settings associated with the **User Interface** menu to be reset to their default values. This also happens on **Restore Misc Defaults**.

When **User Interface** is selected, a message appears saying:

This will reset all of the User Interface variables to their default state, including the menu panel location, display theme, and language.

It will not affect Alignment data or settings.

This action cannot be undone. Do you want to proceed?

The message provides **OK** and **Cancel** buttons for you to affirm or cancel the operation.

Example :SYST:DEF UINT

4.3.7.18 User Interface Type (Remote Query Only)

Use this query to determine if the instrument is running the Multi-Touch user interface or Softkey user interface. This is an easy way to distinguish between A-models (Softkey) instruments and Touch UI (Multi-Touch) instruments.

Remote Command :DISP:UINterface:TYPE?

Example :DISP:UINT:TYPE?

Notes The query returns **MULTITOUCH** for instruments with the Multi-Touch UI or **SOFTKEY** for instruments with the Softkey UI

4.4 Power On

Lets you select how the instrument should power on.

NOTE

In products that run multiple instances of the X-Series Application, the same Power On type is shared between all the instances.

4.4.1 Power On State

Lets you select whether the instrument powers up in a default state, or some other state. The options are:

- **MODE** and Input/Output Defaults
- **USER** Preset
- **LAST** State

Remote Command	<code>:SYSTem:PON:TYPE MODE USER LAST</code> <code>:SYSTem:PON:TYPE?</code>
Example	<code>:SYST:PON:TYPE MODE</code> <code>:SYST:PON:TYPE USER</code> <code>:SYST:PON:TYPE LAST</code>
Preset	This is unaffected by Preset but is set to MODE by Restore Defaults > "All" on page 1893
State Saved	No
Backwards Compatibility SCPI	<code>:SYSTem:PON:TYPE PRESet</code> The PRESet parameter is supported for backward compatibility only, and behaves the same as MODE

Mode and Input/Output Defaults

When the instrument is powered-on in **MODE** and Input/Output Defaults, it performs "**Restore Mode Defaults**" on page 1998 for all Modes in the instrument, and performs **Restore Input/Output Defaults**.

Persistent parameters (such as Amplitude Correction tables or Limit tables) are not affected at power-on, even though they are normally cleared by **Restore Input/Output Defaults** and/or **Restore Mode Defaults**.

User Preset

Sets **Power On State** to **USER** Preset. When the instrument is powered on in User Preset, it will **User Preset** each mode and switch to the "**Power On Application**" on page 1879. **Power On User Preset** does not affect any settings other than those set by a normal **User Preset**.

Backwards Compatibility Note: Power On: **User Preset** causes the instrument to power up in the "**Power On Application**" on page 1879, *not* the last Mode the instrument was in prior to shutdown. Also, **Power On: User Preset** will **User Preset** all Modes. This does *not* exactly match legacy behavior.

NOTE

In products that run multiple instances of the X-Series Application, the same **User Preset** is shared between all the instances.

NOTE

An instrument can never power up for the first time in **USER** preset.

Last State

Sets **Power On State** to **LAST**. When the instrument is powered on, it will put all modes in the last state they were in prior to when the instrument was put into Power Standby, and it will start up in the mode it was last in prior to powering off the instrument. The saving of the active mode prior to shutdown happens behind the scenes when a controlled shutdown is requested, either via the front panel **Standby** key, or the remote command **:SYSTem:PDOWn**. The non-active modes are saved as they are deactivated and recalled by Power On: Last State.

Power On: Last State only works if you completed a controlled shutdown prior to powering on in **LAST**. If a controlled shutdown is not completed when in **Power On: Last State**, the instrument powers up in the last active Mode, but it may not power up in the active Mode's last state. If an invalid Mode state is detected, a **Mode Preset** occurs. To control the shutdown under remote control, use **:SYSTem:PDOWn**.

Backwards Compatibility Note: It is no longer possible to power-up the instrument in the last Mode the instrument was running with that Mode in the preset state. (ESA/PSA **SYST:PRESET:TYPE MODE** with **SYST:PON:PRESET**) You can power-on the instrument in the last Mode the instrument was running in its last state (**:SYST:PON:TYPE LAST**), or you can specify the Mode to power-up in its preset state (**:SYST:PON:MODE <mode>**).

NOTE

In products that run multiple instances of the X-Series Application, each instance has a unique **Last State**.

NOTE

An instrument can never power up for the first time in **LAST**.

If line power to the instrument is interrupted, for example by pulling the line cord plug or by switching off power to a test rack, **Power On Last State** may not work properly. For proper operation, **Power On Last State** depends on your shutting down the instrument using the **Standby** key or the `:SYSTem:PDOWn` command. This ensures the last state of each Mode is saved and can be recalled during a power-up.

4.4.2 Power On Application

Accesses a menu that lists the available Modes, and lets you select which Mode is to be the **Power On Application**. Whichever application is selected runs at power-on when the Power On Type is set to “**MODE** and Input/Output Defaults”.

NOTE

In products that run multiple instances of the X-Series Application, the same Power On Application is shared between all the instances.

Remote Command	<code>:SYSTem:PON:MODE <mode></code> where <code><mode></code> is an item from the same set that can be sent using the <code>:INSTrument[:SElect]</code> command <code>:SYSTem:PON:MODE?</code>						
Example	<code>:SYST:PON:MODE SA</code>						
Notes	The displayed list of possible Modes (and remote parameters) depends on which Modes are installed in the instrument						
Preset	Unaffected by Preset but is set by Restore Defaults > "All" on page 1893 to SA , except in the cases noted below:						
	<table border="1"> <tr> <td>N8973B, N8974B, N8975B, N8976B</td> <td>NFIG</td> </tr> <tr> <td>VXT models</td> <td>BASIC</td> </tr> <tr> <td>M9410E/11E/15E/16E</td> <td>BASIC</td> </tr> </table>	N8973B, N8974B, N8975B, N8976B	NFIG	VXT models	BASIC	M9410E/11E/15E/16E	BASIC
N8973B, N8974B, N8975B, N8976B	NFIG						
VXT models	BASIC						
M9410E/11E/15E/16E	BASIC						
State Saved	No						

4.4.3 FPGA Configuration

Lets you choose which FPGA image you want loaded into the instrument.

Depending on your hardware configuration, your instrument may contain a Field Programmable Gate Array (FPGA) which handles much of the processing for some of the mathematically intensive features, such as Time Domain Scan (Option TDS) and Enhanced Sweep Speed (Option FS2). The FPGA is not big enough to hold the

functionality for both options, so you must decide which FPGA program you want loaded.

When licenses allow for both FPGA image versions to be available, and you have not explicitly chosen an FPGA image version, then, when the firmware is updated, the Time Domain Scan version will be loaded. In the absence of all licenses, the Enhanced Sweep Speed version will be loaded. Once you have explicitly chosen an FPGA image version, using the FPGA Configuration dialog, any future firmware updates will continue to load the chosen version as long as it is licensed.

Example: loading the Time Domain Scan FPGA image, removing the TDS license, and then updating the firmware will result in the Enhanced Sweep Speed version being loaded.

When multiple capabilities are licensed, the FPGA Configuration presents a dialog that tells you that there is insufficient space to fit all the licensed capabilities, and asks you to choose one of the FPGA programs (images).

If you remove licenses, it is possible to end up with an unlicensed capability loaded in the FPGA while a licensed capability is not loaded. In this case, the dialog does not present the **Preference** group and shows a message about unlicensed/licensed capabilities. You can dismiss the dialog if the licensed capability is not currently needed, and you do not want to take the time to load the licensed FPGA image. However, this dialog will continue to appear each time the instrument is restarted.

Behavior when the Enhanced Sweep Speed FPGA Image is Loaded

When the Enhanced Sweep Speed version of the FPGA image is loaded, sweep behavior still depends on the licenses:

- Option FS2 gives full FPGA enhanced sweep speed
- Option FS1 gives software implemented enhanced sweep speed
- Neither Option FS1 nor FS2 – no enhanced sweep speed
- Both Options FS1 and FS2 – same as Option FS2, the full FPGA enhanced sweep speed

If EMI Receiver Mode and TDS option are licensed, and the Enhanced Sweep Speed FPGA image is loaded, then you will not have the proper FPGA image loaded to fully support EMI Receiver Mode. In particular, the Frequency Scan measurement cannot use Scan Type “Time Domain Scan” (this is the normally the default Scan Type for instruments with the TDS option). Instead, EMI Receiver Mode behaves as if the TDS option is not licensed.

Behavior when the Time Domain Scan FPGA Image is loaded

When the Time Domain Scan version of the FPGA image is loaded, EMI Receiver Mode works as expected with the TDS option licensed, but the Option FS2 capability

silently reverts to FS1 behavior.

Switching Between Enhanced Sweep Speed and Time Domain Scan FPGA Images

You cannot have both full TDS and FS2 images at the same time, so to switch to the other image, you must go through the process of reloading the FPGA by choosing the desired image with the Selected FPGA control, and pressing "**Load FPGA**" on [page 1883](#), or issuing the "Load FPGA" SCPI command below with the proper parameter.

Incorrect FPGA Configuration

If EMI Receiver Mode, Option TDS, or Option FS2 license is removed while the FPGA image for that license is loaded, the instrument ends up in an incorrect configuration, since the loaded FPGA image version has support for unlicensed functionality that is not accessible and does not support the currently licensed functionality. It will still function, but when the instrument recognizes this situation at startup, it automatically displays the **FPGA Configuration** dialog. The only selections available will be the licensed ones, but you can choose to dismiss the dialog and continue with the current FPGA image version if you do not want to take the time to load the correct FPGA image. The dialog will continue to be presented at each startup until the correct FPGA image is loaded.

FPGA Updates When Firmware Installs

The FPGA image and X-Series firmware are tightly coupled, so whenever the firmware is updated, the FPGA image is also checked and updated if needed. The rules for choosing between Time Domain Scan and Enhanced Sweep Speed versions of the FPGA image are:

1. Always use Time Domain Scan FPGA image for MXE
2. If neither EMC Mode nor Option TDS nor Option FS2 are licensed, the Enhanced Sweep Speed FPGA image is loaded
3. If EMC Mode and Option TDS are licensed and Option FS2 is not licensed, the Time Domain Scan FPGA image is loaded
4. If EMC Mode and Option TDS are not licensed, and Option FS2 is licensed, the Enhanced Sweep Speed FPGA image is loaded
5. If all are licensed
 - a. If "**FPGA Load Preference**" on [page 1882](#) is **Time Domain Scan**, the Time Domain Scan FPGA image is loaded

- b. If **FPGA Load Preference** is **Enhanced Sweep Speed**, the Enhanced Sweep Speed FPGA image is loaded
- c. If **FPGA Load Preference** is **Prompt at Startup**:
 - a. If the last FPGA Configuration Load was Time Domain Scan, the Time Domain Scan FPGA image is loaded
 - b. If the last FPGA Configuration Load was Enhanced Sweep Speed, the Enhanced Sweep Speed FPGA image is loaded
 - c. If no FPGA has been explicitly loaded, the Time Domain Scan FPGA image is loaded

4.4.3.1 FPGA Load Preference

Select either image from the radio buttons at the top of the dialog:

Option	SCPI	Description
Time Domain Scan	TDS	Load the Time Domain Scan version of the FPGA image
Enhanced Sweep Speed	FS2	Load the Enhanced Sweep Speed version of the FPGA image
Prompt at Startup	PROMpt	Prompt at each startup, displaying the FPGA Configuration dialog. You can choose to continue with the currently loaded FPGA image version, or load a different version

If you select the image that is already loaded, you will not be prompted again. If you select a different one, the Selected FPGA control changes to that one and you must then press "**Load FPGA**" on page 1883 to load the other image.

When installing new firmware, the **FPGA Load Preference** setting is used to load the preferred FPGA image version if more than one version is available. Selecting **Prompt at Startup** causes you to be prompted at each startup to select the desired version of the FPGA image.

Remote Command	<code>:SYSTem:PON:FPGA:PREFERENCE TDS FS2 PROMpt</code>
Example	<code>:SYST:PON:FPGA:PREF TDS</code> <code>:SYST:PON:FPGA:PREF?</code>
Notes	This SCPI is always available, but if the hardware does not support multiple FPGA image choices, the returned value is always: NA = Not available for this hardware Also, when not supported, any attempt to change away from NA generates error -224, "Illegal parameter value"
Dependencies	Dialogs and menus available only when EMC Mode, Option TDS and Option FS2 are all licensed

Preset	PROMpt Not affected by Mode Preset but set to PROMpt by Restore Defaults >"All" on page 1893 or Power On
--------	---

4.4.3.2 Load FPGA

Depending on the "**FPGA Load Preference**" on page 1882 selection, there may be a mismatch between the desired FPGA image, and the one that is currently loaded. In that case the **Load FPGA** control at the bottom of the dialog is not grayed-out, and you must press it to actually load the desired FPGA image. The image that is currently loaded is shown on the right:



If you have a mismatch, but do not actually load the other image, the **FPGA Load Preference** is remembered, but the image you had before remains until you return to this dialog and press **Load FPGA**, or until the next time the instrument firmware is updated.

If you press **Load FPGA**, the X-series software exits, the FPGA update program runs, and the instrument reboots. After rebooting, the new image will be loaded in the FPGA.

NOTE This can take 15 minutes or more.

CAUTION If power is lost during the FPGA load process, the FPGA can become corrupted, in which case the only solution is to return it to Keysight for servicing.

Remote Command	<code>:SYSTem:PON:FPGA:LOAD TDS FS2</code>
Example	<code>:SYST:PON:FPGA:LOAD TDS</code> For options, see Dependencies row below <code>:SYST:PON:FPGA:LOAD?</code>
Notes	If the specified FPGA image version is the one already loaded, then the command does nothing. If the FPGA image needs to change, the analyzer software exits (terminating the SCPI session), and the FPGA update utility is launched. Once the FPGA has updated, the instrument will reboot This SCPI is always available, but if the hardware does not support multiple FPGA image choices, the value returned is always: NA = Not available for this hardware Also, when not supported, any attempt to change away from NA generates error -224, "Illegal parameter value"
Dependencies	Available only when there are multiple versions of the FPGA image that could be loaded

Selection limited to licensed features:

- **TDS** selection requires EMC Mode and Option TDS
- **FS2** requires Option FS2

The UI is blanked when there is only one licensed selection, and that selection is already loaded.

Sending the SCPI for an unlicensed selection results in error:

-224, "Illegal parameter value; <option> is not licensed"

Preset

None. Not affected by **Mode Preset** nor any ["Restore Defaults" on page 1890](#)

4.4.4 Restore Power On Defaults

This selection causes the **Power On** settings to be reset to their default values.

When this button is pressed, a message appears saying:

This will reset Power On State and Power On Application to their default state.

It will not affect Alignment data or settings.

This action cannot be undone. Do you want to proceed?

The message provides **OK** and **Cancel** buttons for you to confirm or cancel the operation.

Example

`:SYST:DEF PON`

4.4.5 Configure Applications – Desktop application

The **Configure Applications** utility runs from the instrument's desktop. You must close the Instrument Application before running **Configure Applications**.

This utility can be used to:

- select applications (Modes) for preload
- determine how many Modes can fit in memory at one time
- specify the order of the Modes in the Mode menu.

The utility consists of a window with instructions, a set of **Select Application** checkboxes, a "fuel bar" style memory gauge, and keys that help you set up your configuration.

NOTE

In products that run multiple instances of the X-Series Application, the same **Configure Applications utility is shared between all the instances.**

For more details, see the following topics:

- "Preloading Applications" on page 1885
- "Access to Configure Applications utility" on page 1885
- "Virtual memory usage" on page 1886

Example

Display the Config Applications screen:

```
:SYST:SHOW CAPP
```

Preloading Applications

During runtime, if a Mode that is not preloaded is selected using the **Mode** menu or by sending SCPI commands, there will be a pause while the Application is loaded. During this pause, a message that says "**Loading application, please wait ...**" is displayed. Once loaded, the application stays loaded, so the next time you select it during a session, there is no delay.

Preloading lets you "preload" at startup, to eliminate the runtime delay. Preloading an application causes it to be loaded into the instrument's memory when the analyzer program starts up. If you do this, the delay will increase the time it takes to start up the analyzer program, but this may be preferable to having to wait the first time you select an application. Note that, once an application is loaded into memory, it cannot be unloaded without exiting and restarting the analyzer program.

Note that there are more applications available for X-Series than can fit into Windows Virtual Memory. By allowing you to choose which licensed applications to load at startup, the **Configure Applications** utility allows you to make optimal use of the instrument memory.

Access to Configure Applications utility

A version of the utility runs the first time you power up the instrument after purchasing it from Keysight. The utility automatically configures preloads so that as many licensed applications as possible are preloaded while keeping the total estimated virtual memory usage below the limit. This auto-configuration only takes place at the very first run, and after analyzer software upgrades.

At any time, you can manually start the **Configure Applications** utility by closing the analyzer application and double-tapping the **Configure Applications** icon on the desktop.

The utility's main dialog looks like this:

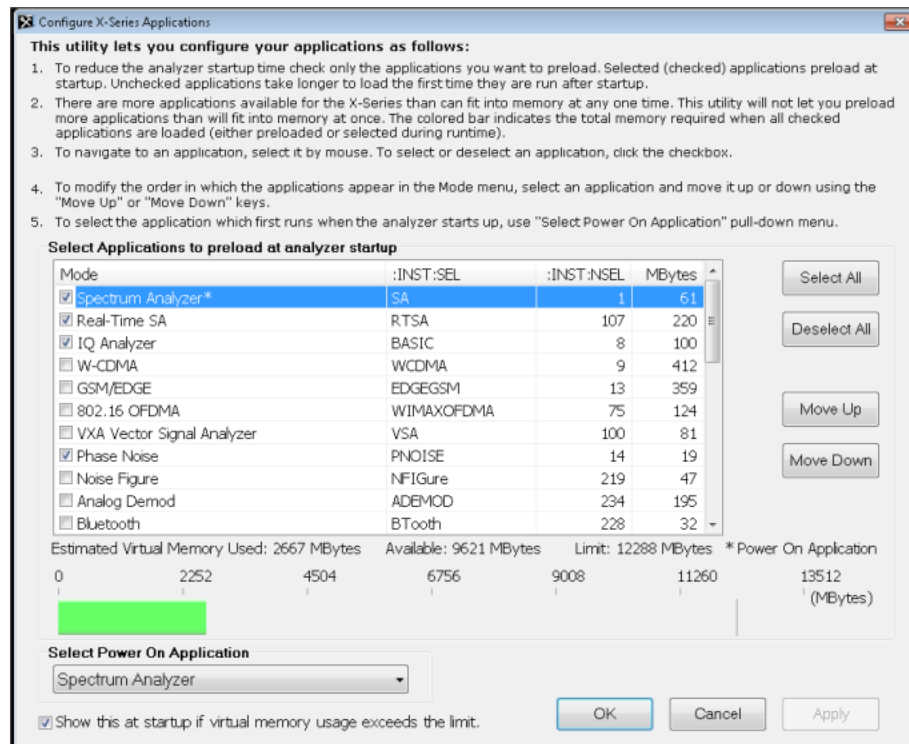

Instructions are provided below and in the utility. Use the utility to find a configuration that works best for you, and then restart the analyzer program.

- Select All** Marks all applications in the selection list. This allows you to enable all applications licensed on the instrument for pre-loading, or is a convenience for selecting all applications in one operation and then letting you deselect individual applications
- Deselect All** Clears the marks from all applications in the selection list, except the Power On application. The Power On application cannot be eliminated from the pre-load list
- Move Up** The application list is the order that applications appear in the Mode Menu. These keys let you shift the selected application up or down in the list, thus moving the selected application earlier or later in the Mode Menu
- Move Down**
- Select Power On Application** This is the same as the "Power On Application" selection on the Power On page of the System Settings dialog

Virtual memory usage

There are more applications available for X-Series than can fit into memory at any one time, so the **Configure Applications** utility includes a memory tracker that serves two purposes:

1. It will not let you preload more applications than will fit into memory at once
2. You can determine how many of your favorite applications can reside in memory at one time

The utility provides a graphical representation of the amount of memory (note that the amount of memory shown here is *virtual* memory, which is a limitation imposed by the operating system, not by the amount of physical memory you have in your instrument). You select applications to preload by checking the boxes on the left. Checked applications preload at startup. The colored fuel bar indicates the total memory required when all the checked applications are loaded (either preloaded or selected during runtime).

Here is what the fuel bar colors mean:

- RED: the applications you have selected cannot all fit into the instrument's memory. You must deselect applications until the fuel bar turns yellow
- YELLOW: the applications you have selected can all fit into the instrument's memory, but there is less than 10% of the memory left, probably not enough to load any other applications, either via preload or by selecting a Mode while the instrument is running
- GREEN: The indicator is green when <90% of the memory limit is consumed. This means the applications you have selected can all fit into the instrument's memory with room to spare. You will be able to load one or more other applications without running out of memory

If Sequence Analyzer is selected to be preloaded, all apps that are part of the Sequencer Mode (GSM/EDGE, WCDMA, CDMA2K and 1xEVDO) are preloaded (if licensed).

4.4.6 Configure Applications - Instrument boot-up

When the Instrument Application starts, a dialog box similar to the one you see when you run **Configure Applications** is displayed, allowing you to choose which licensed applications are to be loaded. This dialog is only displayed if the memory required to pre-load all the licensed applications exceeds the virtual memory available.

4.4.7 Configure Applications - Remote Commands

The following topics provide details on using remote commands to configure the list of applications you want to load into the instrument memory, or query the virtual memory utilization for your applications.

- "Configuration list (Remote Command Only)" on page 1888
- "Configuration Memory Available (Remote Query Only)" on page 1888
- "Configuration Memory Total (Remote Query Only)" on page 1888
- "Configuration Memory Used (Remote Query Only)" on page 1889
- "Configuration Application Memory (Remote Query Only)" on page 1889

4.4.7.1 Configuration list (Remote Command Only)

Used to set or query the list of applications to be loaded in-memory.

Remote Command	<code>:SYSTem:PON:APPLication:LLISt <string of INSTRument:SElect names></code> <code>:SYSTem:PON:APPLication:LLISt?</code>
Example	<code>:SYST:PON:APPL:LLIS "SA,BASIC,WCDMA"</code>
Notes	<code><string of INSTRument:SElect names></code> contains items that are valid options for the <code>:INSTRument:SElect</code> command The order of the <code><INSTRument:SElect names></code> specifies the order in which the applications are loaded into memory, and the order that they appear in the Mode menu Error message -225 "Out of Memory" is reported when more applications are listed than can reside in virtual memory. When this occurs, the existing applications load list is unchanged
Preset	Not affected by Preset
State Saved	Not saved in instrument state

4.4.7.2 Configuration Memory Available (Remote Query Only)

Returns the amount of Virtual Memory remaining.

Remote Command	<code>:SYSTem:PON:APPLication:VMEMory[:AVAIlable]?</code>
Example	<code>:SYST:PON:APPL:VMEM?</code>
Preset	Not affected by Preset

4.4.7.3 Configuration Memory Total (Remote Query Only)

Returns the limit of Virtual Memory allowed for applications.

Remote Command	<code>:SYSTem:PON:APPLication:VMEMory:TOTal?</code>
Example	<code>:SYST:PON:APPL:VMEM:TOT?</code>
Preset	Not affected by Preset

4.4.7.4 Configuration Memory Used (Remote Query Only)

Returns the amount of Virtual Memory used by all measurement applications.

Remote Command	<code>:SYSTem:PON:APPLication:VMEMory:USED?</code>
Example	<code>:SYST:PON:APPL:VMEM:USED?</code>
Preset	Not affected by Preset

4.4.7.5 Configuration Application Memory (Remote Query Only)

Returns the amount of Virtual Memory a particular application consumes.

Remote Command	<code>:SYSTem:PON:APPLication:VMEMory:USED:NAME? <INSTrument:SElect name></code>
Example	<code>:SYST:PON:APPL:VMEM:USED:NAME? CDMA2K</code>
Notes	<code><INSTrument:SElect name></code> is an item from the same set used by the <code>:INSTru-ment:SElect</code> command If the name provided is invalid, 0 (zero) is returned
Preset	Not affected by Preset

4.5 Restore Defaults

Provides initialization of system setting groups, including the option to set the entire instrument back to a factory default state.

NOTE

In products that run multiple instances of the X-Series Application, all instances have the same factory default states for **Restore Defaults**.

Remote Command	:SYSTem:DEFault [ALL] ALIGn INPut MISC MODes PON UINTerface SCReen
Example	:SYST:DEF
State Saved	No

4.5.1 Input/Output

Input/Output Preset resets the group of settings and data associated with the **Input/Output** front-panel key to their default values. These settings are not affected by a **Mode Preset** because they are associated with connections to the instrument, which you will probably not want to reset every time you press **Mode Preset**.

By using **Input/Output Preset** and "[Restore Mode Defaults](#)" on page 1998, a full preset of the current mode will be performed, with the caveat that since **Input/Output Preset** is a global function, it will affect *all* modes.

This is the same as the **Input/Output Preset** button in the **Preset** dropdown and the **Input/Output** menu.

When **Input/Output** is selected, a message appears saying:

This will reset all of the Input/Output variables to their default state, including which input is selected, all Amplitude Correction settings and data, all External Mixing settings, all Frequency Reference settings and all Output settings

It will not affect Alignment data or settings

This action cannot be undone. Do you want to proceed?

The dialog includes **OK** and **Cancel** controls, for you to confirm or cancel the operation.

Example	:SYST:DEF INP
---------	---------------

4.5.2 I/O Config

Causes the group of settings associated with the **I/O Config** menu to be reset to their default values. This also happens on **Restore Misc Defaults**, which has a SCPI command, although **I/O Config** does not.

When **I/O Config** is selected, a message appears saying:

This will reset all of the I/O Config variables to their default state, including the GPIB address and SCPI LAN settings

It will not affect Alignment data or settings

This action cannot be undone. Do you want to proceed?

The dialog includes **OK** and **Cancel** controls, for you to affirm or cancel the operation.

4.5.3 User Interface

Causes the group of settings associated with the **User Interface** menu to be reset to their default values. This also happens on a **Restore Misc Defaults**.

When **User Interface** is selected, a message appears saying:

This will reset all of the User Interface variables to their default state, including the menu panel location, display theme, and language

It will not affect Alignment data or settings

This action cannot be undone. Do you want to proceed?

The dialog includes **OK** and **Cancel** controls, for you to affirm or cancel the operation.

Example `:SYST:DEF UINT`

4.5.4 Power On

Causes the **Power On** settings to be reset to their default values.

The Power On settings are **Power On State** and **Power On Application**.

When **Power On** is selected, a message appears saying:

This will reset Power On State and Power On Application to their default state

It will not affect Alignment data or settings

This action cannot be undone. Do you want to proceed?

The dialog includes **OK** and **Cancel** controls, for you to affirm or cancel the operation.

Example :SYST:DEF PON

4.5.5 Alignments

Causes the **Alignments** system settings to be reset to their default values. This does not affect any Alignment data stored in the system.

After performing this function, it may impact the auto-alignment time of the instrument until a new alignment baseline has been established.

When **Alignments** is selected, a message appears saying:

This will reset all of the settings for the Alignment system to their default values

No alignment data will be erased

This action cannot be undone. Do you want to proceed?

The dialog includes **OK** and **Cancel** controls, for you to affirm or cancel the operation.

Example :SYST:DEF ALIG

4.5.6 Misc

Causes miscellaneous system settings to be reset to their default values.

CAUTION This function resets the GPIB address to 18.

When **Misc** is selected, a message appears saying:

This will reset miscellaneous system settings to their default values. This includes settings for I/O Config (GPIB and SCPI LAN), the User Interface, the Save/Recall system, and the Preset type

It will not affect Alignment data or settings

This action cannot be undone. Do you want to proceed?

The dialog includes **OK** and **Cancel** controls, for you to affirm or cancel the operation.

This Miscellaneous group contains settings that are *not* part of the other Restore Defaults groups. These include:

- All settings on the **I/O Config** page of the **System Settings** dialog
- All settings in the following table:

4 System
4.5 Restore Defaults

Miscellaneous Setting	Default Value
The SYST:PRES:TYPE	MODE
Auto File Name Number	000
Save Type	State
State Save To	Register 1
Screen Save To	SCREEN000.png
Save/Recall Shortcuts	Deleted
Display Theme	Filled
Backlight	ON
System Annotation	Local Settings
Language	English
DISP:ENABLE	ON
Full Screen	Off

Example `:SYST:DEF MISC`

4.5.7 All

Comprehensively resets **All** instrument settings to their factory default values.

Resets all **System Settings** groups, performs "[Restore Mode Defaults](#)" on page 1998 for all Modes in the instrument, and switches back to the power-on mode. Does not affect the User Preset file, or any user saved files.

When **All** is selected, a message appears:

This will reset all of the settings in the instrument to their factory default values, including the state of all Modes and Screens, the GPIB settings, the Alignment settings, and the Power On Mode

It will not affect Alignment data or settings

This action cannot be undone. We recommend canceling this operation and restoring settings individually (I/O Config, User Interface, Alignments, etc.) instead

Do you want to proceed?

The dialog includes **OK** and **Cancel** controls, for you to confirm or cancel the operation.

NOTE

If you are using a Keysight USB External Mixer, then you will need to perform **Refresh USB Mixer Connection** (SCPI command `:MIX:BAND USB`) after **Restore Defaults > All**.

Example	<code>:SYST:DEF ALL</code>
Couplings	All causes the currently running measurement to be aborted, and sets all modes to a consistent state, so it is unnecessary to couple any settings Backwards Compatibility SCPI
Notes	<code>:SYST:PRES:PERS</code> is the same as <code>:SYST:DEF ALL</code>
Backwards Compatibility SCPI	<code>:SYSTem:PRESet:PERsistent</code>

4.6 Alignments

Accesses the alignment system of the instrument. You can control the automatic alignments, view alignment statistics and manually perform alignments.

The current setting of the alignment system is displayed in the Meas Bar along the top of the display. For conditions that may cause specifications to be impacted, this annotation will be in amber.

4.6.1 Auto Align

Lets you configure the automatic background alignments and the alerts from the automatic alignment system.

Dependencies	Does not appear in VXT or M9410E/11E/15E/16E
--------------	--

4.6.1.1 Auto Align

Configures the method the automatic background alignment will use when it runs.

Automatic background alignments are run periodically between measurement acquisitions. The instrument's software determines when alignments are to be performed to maintain warranted operation. The recommended setting for Auto Align is Normal.

Auto Align execution *cannot* be aborted with the **Cancel (ESC)** key. To interrupt **Auto Align** execution, select **Auto Align Off**.

Remote Command	<code>:CALibration:AUTO ON LIGHT PARTial OFF</code> For details of each option, see " Auto Align Options " on page 1896 <code>:CALibration:AUTO?</code>
Example	<code>:CAL:AUTO ON</code>
Notes	While Auto Align is executing, bit 0 of Status Operation register is set
Couplings	Auto Align is set to Off if Restore Align Data is invoked
Preset	This is unaffected by Preset but is set to ON by Restore Defaults > " Alignments " on page 1892
State Saved	No
Annotation	In the Meas Bar: <ul style="list-style-type: none"> - Normal with "All But RF" off: Auto (white) - Normal with "All But RF" on: Auto/No RF (amber) - Partial: Partial (amber)

	- Off: Off (amber)
Status Bits/OPC dependencies	When Auto Align is executing, Bit 0 in the Status Operational register is set An interfering signal at the RF Input may prevent automatic alignment of the RF subsystem. If this occurs, the Error Condition message “Align RF skipped” is reported, the Status Questionable Calibration bit 11 is set, and the alignment proceeds. When a subsequent alignment of the RF subsystem succeeds, either by the next cycle of automatic alignment or from an Align Now, RF, the Error Condition and Status Questionable Calibration bit 11 are cleared
Backwards Compatibility SCPI	:CALibration:AUTO ALERT Parameter ALERT is for backwards compatibility only, and is mapped to PARTIAL

Auto Align Options

The available settings for Auto Align are as follows:

Normal

SCPI example **:CAL:AUTO ON**

Auto Align, Normal turns on the automatic alignment of all measurement systems. This selection maintains the instrument in warranted operation across varying temperature and over time.

If the condition “Align Now All required” is set, transitioning to **Auto Align, Normal** performs the required alignments, clears the “Align Now All required” condition, then continues with further alignments as required to maintain the instrument adequately aligned for warranted operation.

When **Auto Align, Normal** is selected, the **Auto Align Off** time is set to zero.

When **Auto Align, Normal** is selected, the Meas Bar indicates Align: Auto (in white) or Align: Auto/No RF (in amber). The amber color reminds you that you are responsible for maintaining the RF alignment of the instrument.

Alignment processing because of the transition to **Normal** is executed sequentially. Thus, ***OPC?** or ***WAI** following **:CAL:AUTO ON** will return when the alignment processing is complete.

Light

SCPI example **:CAL:AUTO LIGH**

Auto Align, Light turns on the automatic alignment of all measurement systems. The **Auto Align, Light** selection allows more drift in amplitude accuracy to allow much less frequent measurement interruptions to perform alignments. The temperature changes required to trigger each alignment are increased by a factor of three. Alignments also expire from time as well as temperature. In a stable thermal

4 System

4.6 Alignments

environment, the alignments occur one-ninth as often as in Normal. With these less frequent alignments, all accuracy specifications (those expressed with $\pm x$ dB tolerances) change by nominally a factor of 1.4.

If the condition “Align Now, All required” is set, transitioning to **Auto Align, Light** performs the required alignments, clears the “Align Now, All required” condition, and continues with further alignments as required to maintain the instrument adequately aligned for warranted operation.

Alignment processing because of the transition to **Light** is executed sequentially. Thus, ***OPC?** or ***WAI** following **:CAL:AUTO LIGHT** will return when the alignment processing is complete.

When **Auto Align, Light** is selected, the **Auto Align Off** time is set to zero.

When **Auto Align, Light** is selected, the Settings Panel indicates Align: Light.

Partial

SCPI example **:CAL:AUTO PART**

Auto Align, Partial disables the full automatic alignment and the maintenance of warranted operation for the benefit of improved measurement throughput. Accuracy is retained for the Resolution Bandwidth filters and the IF Passband, which is critical to FFT accuracy, demodulation, and many measurement applications. With Auto Align set to Partial, you are now responsible for maintaining warranted operation by updating the alignments when they expire. The Auto Align, Alert mechanism will notify you when alignments have expired. One solution to expired alignments is to perform the Align All, Now operation. Another is to return the Auto Align selection to Normal.

Auto Align, Partial is recommended for measurements where the throughput is so important that a few percent of improvement is more valued than an increase in the accuracy errors of a few tenths of a decibel. One good application of **Auto Align, Partial** would be an automated environment where the alignments can be called during overhead time when the device-under-test is exchanged.

When **Auto Align, Partial**, is selected the elapsed time counter begins for **Auto Align Off** time.

When **Auto Align, Partial** is selected, the Settings Panel indicates Align: Partial in an amber color. The amber color reminds you that you are responsible for maintaining the warranted operation of the instrument.

Off

SCPI example **:CAL:AUTO OFF**

Auto Align, Off disables automatic alignment and the maintenance of warranted operation, for the benefit of maximum measurement throughput. With **Auto Align**

set to **Off**, you are now responsible for maintaining warranted operation by updating the alignments when they expire. The Auto Align, Alert mechanism will notify you when alignments have expired. One solution to expired alignments is to perform the **Align All, Now** operation. Another is to return the **Auto Align** selection to **Normal**.

The **Auto Align Off** setting is rarely the best choice, because **Partial** gives almost the same improvement in throughput while maintaining the warranted performance for a much longer time. The choice is intended for unusual circumstances, such as the measurement of radar pulses where you might want the revisit time to be as consistent as possible.

When **Auto AlignOff** is selected, the **Auto Align Off** time is initialized and the elapsed time counter begins.

When **Auto AlignOff** is selected, the Settings Panel indicates Align: Off in an amber color. The amber color reminds you that you are responsible for maintaining the warranted operation of the instrument.

4.6.1.2 All but RF

Configures automatic alignment to include or exclude the RF subsystem. (Eliminating the automatic alignment of the RF subsystem prevents the input impedance from changing. The normal input impedance of 50 ohms can change to an open circuit when alignments are being used. Some devices under test do not behave acceptably under such circumstances, for example by showing instability.)

When **All but RF** is **ON**, the operator is responsible for performing an **Align Now RF** when RF-related alignments expire. The Auto Align, Alert mechanism will notify you to perform an **Align Now All** when the combination of time and temperature variation is exceeded.

When **All But RF** is **ON**, the Settings Panel indicates Align: Auto/No RF (in amber). The amber color reminds you that you are responsible for maintaining the RF alignment of the instrument.

Remote Command	:CALibration:AUTO:MODE ALL NRF
Example	:CAL:AUTO:MODE NRF
Preset	Unaffected by Preset but set to ALL by Restore Defaults > " Alignments " on page 1892
State Saved	No

4.6.1.3 Alert

The instrument signals an **Alert** when conditions exist such that you will need to perform a full alignment (for example, **Align Now All**). Alert can be configured in one

4 System
4.6 Alignments

of four settings:

Setting	Option
Time & Temperature	TTEmperture
Time & Temperature Light	LIGHT
7 days	WEEK
None	NONE

With **Auto Align** set to **Normal**, the configuration of **Alert** is not relevant, because the instrument's software maintains the instrument in warranted operation.

A confirmation is required when a selection other than **TTEmperture** is chosen. This prevents accidental deactivation of alerts. When setting **Alert** from the front panel to any value but **TTEmperture**, confirmation is required to transition into this setting of Alert. The confirmation dialog is:

This will suppress alerts from the Alignment system, which would notify you when an Alignment is required to maintain warranted operation. Without the alerts you will be responsible for performing an Align Now All at appropriate intervals to maintain warranted operation

Do you want to proceed?

The dialog includes **OK** and **Cancel** controls, for you to affirm or cancel the operation.

No confirmation is required when **Alert** is configured through a remote command.

For more information see "[Time & Temperature](#)" on page 1899

Remote Command	:CALibration:AUTO:ALERt TTEmperture LIGHT DAY WEEK NONE
Example	:CAL:AUTO:ALER TTEM
Preset	Unaffected by Preset but set to TTEmperture by Restore Alignment Defaults
State Saved	No
Status Bits/OPC dependencies	When an alert is generated, the condition message "Align Now All required" appears in the Status Bar, and bit 14 is set in the Status Questionable Calibration register

The settings for **Alert** are detailed below.

Time & Temperature

SCPI Example

CAL:AUTO:ALER TTEM

The instrument signals an alert when alignments expire due to the combination of the passage of time and changes in temperature. The alert is the Error Condition message "Align Now All required". If this choice for Alert is selected, the absence of an alert means that the instrument alignment is sufficiently up-to-date to maintain warranted accuracy.

Time & Temperature Light

SCPI Example

`CAL:AUTO:ALER LIGH`

This is a light version of Time & Temperature which means for this setting the time/temperature changes required to trigger an alert are increased by a factor of three and the time alerts will occur one-ninth as often as for Time and Temperature.

24 hours

SCPI Example

`CAL:AUTO:ALER DAY`

The instrument signals an alert after a time span of 24 hours since the last successful full alignment (for example, **Align Now All** or completion of a full **Auto Align**). You may want to select this option in an environment where the temperature is stable on a daily basis, at a small risk of accuracy errors in excess of the warranted specifications. The alert is the Error Condition message “Align Now All required”.

7 days

SCPI Example

`CAL:AUTO:ALER WEEK`

The instrument signals an alert after a time span of 168 hours since the last successful full alignment (for example, **Align Now All** or completion of a full **Auto Align**). You may want to select this option in an environment where the temperature is stable on a weekly basis, at a modest risk of accuracy degradations in excess of warranted performance. The alert is the Error Condition message “Align Now All required”.

None

SCPI Example

`CAL:AUTO:ALER NONE`

The instrument does not signal an alert. This is provided for rare occasions where you are making a long measurement that cannot tolerate **Auto Align** interruptions, and must have the ability to capture a screen image at the end of the measurement without an alert posted to the display. Keysight does not recommend using this selection in any other circumstances, because of the risk of accuracy performance drifting well beyond expected levels without the operator being informed.

4.6.2 Align Now

Accesses alignment processes that are immediate action operations. They perform complete operations and run until they are complete.

Executing immediate alignments from SCPI can be problematic due to the length of time required for the alignments to complete. Alignment commands are by their

nature sequential, meaning they must complete before any other SCPI commands can be processed. In many cases the alignment itself will take longer than the typical SCPI timeout value. Furthermore, status cannot be easily queried while a sequential command is running.

For this reason, overlapped versions of the **Align Now** commands are provided. When using these No-Operation-Pending (**NPENDING**) commands, the SCPI thread will not be blocked (will be released immediately), so that you can use **:STATus:OPERation:CONDition?** to query the alignment status bit and use **:STATus:QUEStionable:CALibration:CONDition?** to check the alignment results. As an example, **:CALibration[:ALL]:NPENDING** is the overlapped replacement for **:CALibration[:ALL]**.

While the alignment is executing, the coming NOP calibration will be ignored, and **error message “Setting Conflict, Alignment is in process”** will be posted. Also, any other operations to the instrument will be pended and postponed until the alignment is completed. The operations include: Preset, Initiate a new measurement, Device clear and so on. Accordingly, changing parameters will not take effect although the UI is updated immediately. To avoid unexpected timeouts and results, these operations are not recommended during any such alignments.

NOTE

The Alignments are not performed if the MIMO Sync is running, because the MIMO and Alignments require the same hardware resource. If the instrument is in MIMO Sync and you press a button to execute Alignments, a pop-up window appears as below. Click **OK** to stop MIMO and execute Alignments.

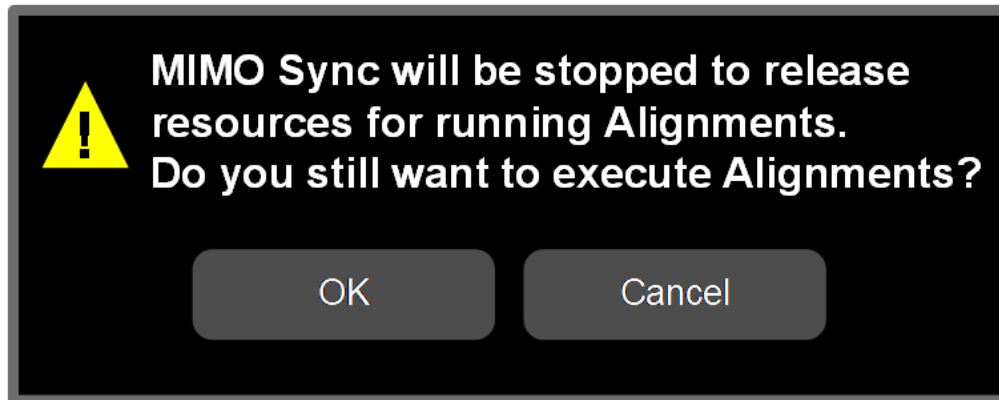

If the instrument is in MIMO sync, and you send a SCPI command to run Alignments, the align process is not executed, and a warning is generated. To execute Alignments, you must first stop MIMO via SCPI (or manually).

Controls in this Dialog

The selection and order of controls displayed in this dialog depends on the instrument type and options. Select the control of interest from the following list:

- "Align Now All" on page 1902
- "Align Now All but RF" on page 1904
- "Align Now RF" on page 1906
- "Align Now Expired" on page 1907
- "Align Now Preselector" on page 1908
- "Align Now All but RF Preselector" on page 1909
- "Align Now RF Presel Only (20 Hz to 3.6 GHz)" on page 1909
- "Align Now External Mixer" on page 1910
- "Align Source" on page 1911
- "Align Receiver" on page 1912
- "Align Fast" on page 1912
- "Align LO Leakage" on page 1913
- "Align IF Cable" on page 1913
- "Align RRH Amplitude" on page 1913
- "Align LO Clock" on page 1914
- "Align VXT Transceiver" on page 1915
- "Align External Mixer Path" on page 1919
- "Align Low Band" on page 1920
- "Align High Band" on page 1920

4.6.2.1 Align Now All

In PXE, the key label is **Align Now All (plus RF Presel 20 Hz – 3.6 GHz)**

Immediately executes an alignment of all subsystems. The instrument stops any measurement currently underway, performs the alignment, then restarts the measurement from the beginning (similar to pressing the **Restart** key).

If an interfering user signal is present at the RF Input, the alignment is performed on all subsystems except the RF. After completion, the Error Condition message "Align RF skipped" is generated. In addition, the Error Condition message "Align Now, RF

4 System
4.6 Alignments

required” is generated, and bits 11 and 12 are set in the Status Questionable Calibration register.

The query form of the remote commands (:CALibration[:ALL]? or *CAL?) invokes the alignment of all subsystems and returns a success or failure value. An interfering user signal is not grounds for failure; if the alignment was able to succeed on all portions but unable to align the RF because of an interfering signal, the resultant will be the success value.

Successful completion of **Align Now All** will clear the “Align Now All required” Error Condition, and clear bit 14 in the Status Questionable Calibration register. It will also begin the elapsed time counter for Last Align Now All Time, and capture the Last Align Now All Temperature.

If the Align RF subsystem succeeded in aligning (no interfering signal present), the elapsed time counter begins for Last Align Now, RF Time, and the temperature is captured for the Last Align Now, RF Temperature. In addition, the Error Conditions “Align RF skipped” are cleared, the Error Condition “Align Now, RF required” is cleared, and bits 11 and 12 are cleared in the Status Questionable Calibration register

Align Now All can be interrupted, by pressing the **Cancel (ESC)** front-panel key, or remotely with Device Clear followed by the :ABORt SCPI command. When this occurs, the Error Condition message “Align Now All required” is generated, and bit 14 is set in the Status Questionable Condition register. This is because new alignment data may be employed for an individual subsystem, but not a cohesive set of data for all subsystems.

In many cases, you might find it more convenient to change alignments to **Normal**, instead of executing **Align Now All**. When the Auto Align process transitions to **Normal**, the instrument will immediately start to update only the alignments that have expired, thus efficiently restoring the alignment process.

Remote Command	:CALibration[:ALL] :CALibration[:ALL]?
Example	:CAL
Notes	:CALibration[:ALL]? returns 0 if successful, or 1 if failed :CALibration[:ALL]? is the same as *CAL? While Align Now All is performing the alignment, the Calibrating bit (Bit 0 in the Status Operation register) is set. Completion, or termination, will clear Bit 0 in the Status Operation register This command is sequential; it must complete before further SCPI commands are processed. Interrupting the alignment from remote is accomplished by invoking Device Clear followed by the :ABORt command Successful completion will clear bit 14 in the Status Questionable Calibration register An interfering user signal is not grounds for failure of Align Now All . However, Bits 11 and 12 are set in the Status Questionable Calibration register to indicate Align Now, RF is required An interfering user-supplied signal will result in the instrument requiring an Align Now, RF with the

	interfering signal removed
Couplings	<p>Initializes the time for the Last Align Now All Time</p> <p>Records the temperature for the Last Align Now All Temperature</p> <p>If Align RF component succeeded, initializes the time for the Last Align Now, RF Time</p> <p>If Align RF component succeeded, records the temperature for the Last Align Now, RF Temperature</p>
Status Bits/OPC dependencies	Bits 11, 12, or 14 may be set in the Status Questionable Calibration register
IEEE Command	
Remote Command	<code>*CAL</code>
Example	<code>*CAL?</code>
Notes	<p>Returns 0 if successful, or 1 if failed</p> <p><code>:CALibration[:ALL]?</code> is exactly the same as <code>*CAL?</code>, including all conditions, status register bits, and couplings</p> <p>See additional remarks described with <code>:CALibration[:ALL]?</code></p> <p>Overlapped Command</p>
Remote Command	<code>:CALibration[:ALL]:NPending</code>
Example	<code>:CAL:NPEN</code>
Notes	<p><code>:CALibration[:ALL]:NPending</code> is the same as <code>:CALibration[:ALL]</code>, including all conditions, status register bits, except this SCPI command <i>does not block</i> the SCPI session, so you should use status register bits to query whether the calibration is successfully completed or not</p> <p>Typical usage is:</p> <ol style="list-style-type: none"> 1. <code>:CALibration:ALL:NPending</code> (Start a calibration) 2. <code>:STATus:OPERation:CONDition?</code> (Check if the calibration is completed or not, If bit 0 is set, then the system is doing calibration, you should repeat this SCPI query until the bit is cleared) 3. <code>:STATus:QUEStionable:CALibration:CONDition?</code> (Check if there are any errors/-failures in previous calibration procedure)

4.6.2.2 Align Now All but RF

In PXE, the key label is **Align Now All but RF (not including RF Presel)**

Immediately executes an alignment of all subsystems except the RF subsystem. The instrument will stop any measurement currently underway, perform the alignment, and then restart the measurement from the beginning (similar to pressing the **Restart** key). This can be used to align portions of the instrument that are not impacted by an interfering user input signal.

4 System
4.6 Alignments

This operation might be chosen instead of **All** if you do not want the device under test to experience a large change in input impedance, such as a temporary open circuit at the instrument input.

The query form of the remote commands (**:CALibration:NRF?**) invokes the alignment and returns a success or failure value.

Successful completion of **Align Now All but RF** clears the “Align Now All required” Error Condition, and clears Bit 14 in the Status Questionable Calibration register. If “Align Now All required” was in effect prior to executing **All but RF**, the Error Condition message “Align Now RF required” is generated and Bit 12 in the Status Questionable Calibration register is set. It will also begin the elapsed time counter for Last Align Now All Time, and capture the Last Align Now All Temperature.

Align Now All but RF can be interrupted, by pressing the **Cancel (ESC)** front-panel key, or remotely with Device Clear followed by the **:ABORt** SCPI command. When this occurs, the Error Condition message “Align Now All required” is generated, and Bit 14 is set in the Status Questionable Condition register. This is because new alignment data may be used for an individual subsystem, but not a full new set of data for all subsystems.

Remote Command	:CALibration:NRF :CALibration:NRF?
Example	:CAL:NRF
Notes	Returns 0 if successful, or 1 if failed While Align Now All but RF is performing the alignment, Bit 0 in the Status Operation register is set. Completion, or termination, will clear Bit 0 in the Status Operation register This command is sequential; it must complete before further SCPI commands are processed. Interrupting the alignment from remote is accomplished by invoking Device Clear followed by the :ABORt command Successful completion clears Bit 14 in the Status Questionable Calibration register and sets Bit 12 if invoked with “Align Now All required”
Couplings	Initializes the time for the Last Align Now All Time Records the temperature for the Last Align Now All Temperature
Status Bits/OPC dependencies	Bits 12 or 14 may be set in the Status Questionable Calibration register

Overlapped Command

Remote Command	:CALibration:NRF:NPENDING
Example	:CAL:NRF:NPEN
Notes	:CALibration:NRF:NPENDING is the same as :CALibration:NRF , including all conditions, status register bits, except that this SCPI command <i>does not block</i> the SCPI session, so you should use status register bits to query whether the calibration is successfully completed or not Typical usage is:

-
1. `:CALibration:NRF:NPENDING` (start the All but RF calibration)
 2. `:STATus:OPERation:CONDition?` (If bit 0 is set, then the system is doing calibration, you should do re-query until this bit is cleared)
 3. `:STATus:QUESTionable:CALibration:CONDition?` (to check if there are any errors/-failures in previous calibration procedure)

4.6.2.3 Align Now RF

In PXE, the key label is **Align Now RF Only**

Immediately executes an alignment of the RF subsystem. The instrument stops any measurement currently underway, performs the alignment, then restarts the measurement from the beginning (similar to pressing the **Restart** key).

This operation might be desirable if the alignments had been set to not include RF alignments, or if previous RF alignments could not complete because of interference which has since been removed.

If an interfering user signal is present at the RF Input, the alignment will terminate and generate the Error Condition message “Align RF skipped”, and Error Condition “Align Now, RF required”. In addition, bits 11 and 12 will be set in the Status Questionable Calibration register.

The query form of the remote commands (`:CALibration:RF?`) invokes the alignment of the RF subsystem and returns a success or failure value. An interfering user signal is grounds for failure.

Successful completion of **Align Now RF** begins the elapsed time counter for Last Align Now, RF Time, and capture the Last Align Now, RF Temperature.

Align Now RF can be interrupted, by pressing the **Cancel (ESC)** front-panel key, or remotely with Device Clear followed by the `:ABORT` SCPI command. When this occurs, the Error Condition message “Align Now, RF required” is generated, and Bit 12 is set in the Status Questionable Condition register. None of the new alignment data is used.

Remote Command	<code>:CALibration:RF</code> <code>:CALibration:RF?</code>
----------------	---

Example	<code>:CAL:RF</code>
---------	----------------------

Notes	<p>Returns 0 if successful, or 1 if failed (including interfering user signal)</p> <p>While Align Now RF is performing the alignment, Bit 0 in the Status Operation register is set. Completion, or termination, clears Bit 0 in the Status Operation register</p> <p>This command is sequential; it must complete before further SCPI commands are processed. Interrupting the alignment from remote is accomplished by invoking Device Clear followed by the <code>:ABORT</code> command</p>
-------	---

4 System
4.6 Alignments

	<p>Successful completion clears the Error Conditions “Align RF skipped” and the Error Conditions “Align RF failed” and “Align Now, RF required”, and clears Bits 3, 11, and 12 in the Status Questionable Calibration register</p> <p>A failure encountered during alignment generates the Error Condition message “Align RF failed” and sets Bit 3 in the Status Questionable Calibration register</p> <p>An interfering user signal will result in Bits 11 and 12 being set in the Status Questionable Calibration register, to indicate Align Now, RF is required</p> <p>An interfering user supplied signal results in the instrument requiring Align Now RF with the interfering signal removed</p>
Couplings	<p>Initializes the time for the Last Align Now, RF Time</p> <p>Records the temperature for the Last Align Now, RF Temperature</p>
Status Bits/OPC dependencies	Bits 11, 12, or 14 may be set in the Status Questionable Calibration register

Overlapped Command

Remote Command	<code>:CALibration:RF:NPENding</code>
Example	<code>:CAL:RF:NPEN</code>
Notes	<p><code>:CALibration:RF:NPENding</code> is the same as <code>:CALibration:RF</code>, including all conditions, status register bits, except that this SCPI command <i>does not block</i> the SCPI session, so you should use status register bits to query whether the calibration is successfully completed or not</p> <p>Typical usage is:</p> <ol style="list-style-type: none"> 1. <code>:CALibration:RF:NPENding</code> (Start a RF calibration) 2. <code>:STATus:OPERation:CONDition?</code> (If Bit 0 is set, then the system is doing calibration, you should do re-query until this bit is cleared) 3. <code>:STATus:QUESTionable:CALibration:CONDition?</code> (to check if there are any errors/-failures in previous calibration procedure)

4.6.2.4 Align Now Expired

Alignments can be Expired when **Auto Align** is **PARTial** or **OFF**.

This control runs the alignments that have expired. This differs from performing **Align All, Now.**, which performs an alignment of all subsystems regardless of whether they are needed or not, whereas **Execute Expired Alignments** aligns only the individual subsystems that have become due.

Remote Command	<code>:CALibration:EXPIred</code>
	<code>:CALibration:EXPIred?</code>
Example	<code>:CAL:EXP?</code>
Notes	<code>:CALibration:EXPIred?</code> returns 0 if successful, or 1 if failed

While **Align Now Expired** is performing the alignment, the Calibrating bit (Bit 0 in the Status Operation register) is set. Completion, or termination, clears Bit 0 in the Status Operation register

This command is sequential; that is, it must complete before further SCPI commands are processed. Interrupting the alignment from remote is accomplished by invoking Device Clear followed by **:ABORt**

Successful completion clears bit 14 in the Status Questionable Calibration register

An interfering user signal is not grounds for failure of **Align Now Expired**. However, if RF Alignment was required, Bits 11 and 12 are set in the Status Questionable Calibration register to indicate Align Now, RF is required

Status Bits/OPC dependencies Bits 11, 12, or 14 may be set in the Status Questionable Calibration register

4.6.2.5 Align Now Preselector

Normally, Preselector Alignment runs during power up, and during the twenty minutes after power up, whenever there is a 1-degree internal temperature change.

This alignment is also run when an "**Align Now All**" on page 1902 is performed. This feature is helpful during the 20-minute warm-up time to correct for preselector drift while alignments are being held off. This feature can also be used in lieu of using the Preselector Center functionality, to improve speed throughput for remote testing with minimal impact to amplitude accuracy specs. The algorithm centers the preselector at the upper and lower operating frequencies of the YTF preselector.

The **Align Now Preselector** alignment is *not* a substitute for the Characterizer Preselector Advanced Alignment, which creates the default preselector centering curves for the YTF Preselector and is typically run annually.

Remote Command **:CALibration:PRESelector**
:CALibration:PRESelector?

Example **:CAL:PRES**

Notes Returns 0 if successful, or 1 if failed (including interfering user signal)

While **Align Now Preselector** is performing the alignment, Bit 0 in the Status Operation register is set. Completion, or termination, clears Bit 0 in the Status Operation register

This command is sequential; that is, it must complete before further SCPI commands are processed. Interrupting the alignment from remote is accomplished by invoking Device Clear followed by **:ABORt**

Successful completion clears the Error Conditions "Align Preselector failed" and clears Bit 3 in the Status Questionable Calibration Failure (Extended) register

A failure encountered during alignment generates the Error Condition message "Align Preselector failed" and sets Bit 3 in the Status Questionable Calibration Failure (Extended) register

Status Bits/OPC dependencies Bit 3 may be set in the Status Questionable Calibration Failure (Extended) register

4.6.2.6 Align Now All but RF Preselector

Only available in models with the RF Preselector, such as the N9048B. It is identical to the "Align Now All" on page 1902 (plus RF Presel) function, except that the RF Preselector is only partially aligned. Only the System Gain, Mechanical attenuator and Electronic attenuator alignments on the RF Preselector path are aligned. The purpose of these alignments is to improve the RF Preselector path amplitude variation compared to the bypass path.

Remote Command	<code>:CALibration:NRFPreselector</code> <code>:CALibration:NRFPreselector?</code>
Example	<code>:CAL:NRFPre</code>
Dependencies	Only appears in N9048B. Sending the SCPI command or query in other models generates an error
Status Bits/OPC dependencies	Bits 12 or 14 may be set in the Status Questionable Calibration register

4.6.2.7 Align Now RF Presel Only (20 Hz to 3.6 GHz)

Only available in models with the RF Preselector, such as the N9048B. It executes an alignment of the RF Preselector section. The receiver will stop any measurement currently underway, perform the alignment, and then restart the measurement from the beginning (similar to pressing the **Restart** key). *Only* the RF Preselector is aligned; no Align Now All function is performed first.

The query (`:CALibration:RFPreselector:ONLY?`) invokes the alignment of the RF Preselector on both Conducted and Radiated Band, and returns a success or failure value. Successful completion clears the "Align 20 Hz to 3.6 GHz required" Error Condition, and clears Bit 1 and Bit 2 in the Status Questionable Calibration Extended Needed register.

The elapsed time counter will begin for Last Align Now, Conducted Time and Last Align Now Radiated Time and the temperature is captured for Last Align Now, Conducted Temperature and Last Align Now, Radiated Temperature. The alignment can be interrupted by pressing the **Cancel (ESC)** front-panel key or remotely with Device Clear followed by the `:ABORT` SCPI command. When this occurs, the Error Condition "Align 20 Hz to 3.6 GHz required" is set because new alignment data may be employed for an individual subsystem, but not a cohesive set of data for all subsystems.

The "Align 20 Hz to 3.6 GHz required" Error Condition will appear when this alignment has expired. The user is now responsible to perform the Align Now, 20 Hz to 3.6 GHz in order to keep the receiver in warranted operation. This alignment can only be performed by the user, as it is not part of the Auto Align process.

Remote Command	<code>:CALibration:RFPreselector:ONLY</code>
----------------	--

	<code>:CALibration:RFPSelector:ONLY?</code>
Example	<code>:CAL:RFPS:ONLY</code>
Notes	<p>Query returns 0 if successful, or 1 if failed</p> <p>When Align 20 Hz to 3.6 GHz is performing the alignment, bit 0 in the Status Operation register is set. Completion, or termination, will clear bit 0 in the Status Operation register</p> <p>This command is sequential; it must complete before further SCPI commands are processed. Interrupting the alignment from remote is accomplished by invoking Device Clear followed by the <code>:ABORt</code> command. Successful completion clears Bits 1 and 2 in the Status Questionable Calibration Extended Needed register and Bits 0 and 1 in Status Questionable Calibration Extended Failure register</p> <p>A failure encountered during alignment sets the Error Condition “20 Hz to 3.6 GHz Alignment Failure”, sets Bits 1 and 2 in the Status Questionable Calibration Extended Needed register, and Bit 9 in Status Questionable Calibration register</p>
Dependencies	<p>Only appears in N9048B. Sending the SCPI command or query in other models generates an error</p> <p>This key is grayed-out if the instrument is displaying an “Align Now All required” message. If you press the key while it is grayed-out, you will see the informational message, “Align Now All required first”</p>
Couplings	<p>Initializes the time for the Last Align Conducted Now, Conducted Time</p> <p>Initializes the time for the Last Align Radiated Now, Radiated Time</p> <p>Records the temperature for the Last Align Conducted Now, Conducted Temperature</p> <p>Records the temperature for the Last Align Radiated Now, Radiated Temperature</p>
Status Bits/OPC dependencies	<p>Bit 8 or 9 may be set in the Status Questionable Calibration register</p> <p>Bit 1 and 2 may be set in the Status Questionable Calibration Extended Needed register</p> <p>Bit 0 and 1 may be set in the Status Questionable Calibration Extended Failure register</p>

4.6.2.8 Align Now External Mixer

Immediately executes an alignment of the External Mixer that is plugged into the USB port. The instrument stops any measurement currently underway, performs the alignment, then restarts the measurement from the beginning (similar to pressing the **Restart** key). As this alignment calibrates the LO power to the mixer, this is considered an LO alignment; and failure is classified as an LO alignment failure.

The query (`:CALibration:EMIXer?`) invokes the alignment of the External Mixer and returns a success or failure value.

Remote Command	<code>:CALibration:EMIXer</code> <code>:CALibration:EMIXer?</code>
Example	<code>:CAL:EMIX</code>
Notes	<p>Returns 0 if successful, or 1 if failed</p> <p>While Align Now External Mixer is performing the alignment, Bit 0 in the Status Operation register is set. Completion, or termination, clears Bit 0 in the Status Operation register</p> <p>This command is sequential; it must complete before further SCPI commands are processed.</p>

	<p>Interrupting the alignment from remote is accomplished by invoking Device Clear followed by the :ABORT command</p> <p>A failure encountered during alignment generate the Error Condition message “Align LO failed” and sets Bit 5 in the Status Questionable Calibration register. Successful completion clears the “Align LO failed” message and Bit 5 in the Status Questionable Calibration register</p>
Dependencies	This control does not appear unless option EXM is present and is grayed-out, unless a USB mixer is plugged in to the USB
Status Bits/OPC dependencies	Bit3 may be set in the Status Questionable Calibration Extended Failure register

4.6.2.9 Align Source

Accesses source alignment processes that are immediate action operations. They perform complete operations and run until they are complete.

The instrument stops any sequence of the source, performs the alignment, then restarts the sequence from the beginning.

Note: This alignment corrects slow-rate drift, which does not impair specifications for time periods shorter than one week. Thus, it is required to perform this alignment on a weekly basis to maintain specifications. This alignment typically takes >2 minutes to complete.

There is no alert available for the source alignment. Operators are responsible for checking temperature shift since the last **Align Now Source** to determine whether the source alignment needs to be executed.

Remote Command	:CALibration:INTernal:SOURce[:ALL] :CALibration:INTernal:SOURce[:ALL]?
Example	:CAL:INT:SOUR
Notes	:CAL:INT:SOUR? Initiates an Alignment and returns 0 if successful, or 1 if failed
Dependencies	Only appears in VXT models M9410A/11A
Couplings	Initializes the time for the Last Align Source Now, All Time Records the temperature for the Last Align Source Now, All Temperature

Overlapped Command

Remote Command	:CALibration:INTernal:SOURce[:ALL]:NPending
Example	:CAL:INT:SOUR:NPEN
Notes	:CALibration:INTernal:SOURce[:ALL]:NPending is the same as :CALibration:INTernal:SOURce[:ALL] , including all conditions and status register bits, except that this SCPI command <i>does not block</i> the SCPI session, so you should use status register bits to query whether the calibration is successfully completed or not Typical usage is:

	<ol style="list-style-type: none"> 1. <code>:CALibration:INTernal:SOURce:NPending</code> (start an internal source calibration) 2. <code>:STATus:OPERation:CONDition?</code> (Check if the calibration is completed or not, If Bit 0 is set, then the system is doing calibration. Repeat this query until the bit is cleared) 3. <code>:STATus:QUEStionable:CALibration:EXTended:FAILure:CONDition?</code> (Check if Bit 14 is set or not. If this bit is set, that means there are some errors in previous internal source calibration)
Dependencies	Only appears in VXT models M9410A/11A

4.6.2.10 Align Receiver

Accesses receiver alignment processes that are immediate action operations. They perform complete operations and run until they are complete.

NOTE

This alignment corrects slow-rate drift, which does not impair specifications for time periods shorter than one week. Thus, it is required to perform this alignment on a weekly basis to maintain specifications. This alignment typically takes >2 minutes to complete.

There is no alert available for the receiver alignment. Operators are responsible for checking temperature shift since the last Align Now, Align Receiver, to determine whether the receiver alignment needs to be executed.

Remote Command	<code>:CALibration:INTernal:RECeiver[:ALL]</code> <code>:CALibration:INTernal:RECeiver[:ALL]?</code>
Example	<code>:CAL:INT:REC</code>
Notes	The query initiates an Alignment and returns 0 if successful, or 1 if failed
Dependencies	Only appears in VXT models M9410A/11A
Couplings	Initializes the time for the Last Align Receiver Now, All Time Records the temperature for the Last Align Receiver Now, All Temperature

4.6.2.11 Align Fast

Accesses fast alignment processes, which are immediate action operations and perform complete operations, running until they are complete.

This aligns the subsystem that is most sensitive to temperature and time and includes:

- compensating the DC offset, gain imbalance and quadrature phase imbalance of IQ Modulator and/or Demodulator
- compensating the gain offset of RF path

4 System

4.6 Alignments

It is suggested to perform Fast Alignment every 8 hours or when temperature has changed more than 5°C from the previous Fast Alignment.

Remote Command	<code>:CALibration:INTernal:FAST[:ALL]</code> <code>:CALibration:INTernal:FAST[:ALL]?</code>
Example	<code>:CAL:INT:FAST</code>
Notes	The query initiates an Alignment and returns 0 if successful, or 1 if failed
Dependencies	Only appears in VXT models M9410A/11A /15A/16A

4.6.2.12 Align LO Leakage

Accesses LO Leakage alignment processes, which are immediate action operations and perform complete operations, running until they are complete.

This alignment reduce the LO Leakage of the instrument.

Remote Command	<code>:CALibration:INTernal:LOLeakage</code> <code>:CALibration:INTernal:LOLeakage?</code>
Example	<code>:CAL:INT:LOL</code>
Notes	The query initiates an Alignment and returns 0 if successful, or 1 if failed
Dependencies	Only appears in VXT models M9410A/11A /15A/16A

4.6.2.13 Align IF Cable

Accesses IF Cable alignment processes, which are immediate action operations and perform complete operations, running until they are complete.

This alignment aligns the IF cabling to the remote heads.

Remote Command	<code>:CALibration:INTernal:RRHead:IFCable</code> <code>:CALibration:INTernal:RRHead:IFCable?</code>
Example	<code>:CAL:INT:RRH:IFC</code>
Notes	The query initiates an Alignment and returns 0 if successful, or 1 if failed
Dependencies	Only appears in VXT based solutions with M1740A/41A/42A/49A/49B RRH
Backwards Compatibility SCPI	<code>:CALibration:INTernal:IFCable</code> <code>:CALibration:INTernal:IFCable?</code>

4.6.2.14 Align RRH Amplitude

This is an immediate action operation, which runs until complete.

Aligns the Amplitude of Remote Radio Head. This operation could take quite a long time to run.

CAUTION

For M1741A/49A/49B RRH, make sure to connect 50-ohm terminations to Head Tx/Rx 1 and 2 ports.

Remote Command	<code>:CALibration:INTernal:RRHead:AMPLitude</code> <code>:CALibration:INTernal:RRHead:AMPLitude?</code>
Example	<code>:CAL:INT:RRH:AMPL?</code>
Notes	The query initiates an Alignment and returns 0 if successful, or 1 if failed
Dependencies	Only appears in VXT based solutions with M1741A/42A/49A/49B RRH
Backwards	<code>:CALibration:INTernal:RRHAmp</code>
Compatibility SCPI	<code>:CALibration:INTernal:RRHAmp?</code>

4.6.2.15 Align Fast RRH Amplitude

This is an immediate action operation, which runs until complete.

Compare to Align RRH Amplitude, it aligns the amplitude of Remote Radio Head with a wider frequency interval. This operation takes about one minute.

Remote Command	<code>:CALibration:INTernal:RRHead:AMPLitude:FAST</code> <code>:CALibration:INTernal:RRHead:AMPLitude:FAST?</code>
Example	<code>:CAL:INT:RRH:AMPL:FAST?</code>
Notes	The query initiates an alignment and returns 0 if successful, or 1 if failed
Dependencies	Only appears in VXT based solutions with M1742A RRH

4.6.2.16 Align RRH LO Power

This is an immediate action operation, which runs until complete.

Aligns the LO Power of Remote Radio Head.

Remote Command	<code>:CALibration:INTernal:RRHead:LOPower</code> <code>:CALibration:INTernal:RRHead:LOPower?</code>
Example	<code>:CAL:INT:RRH:LOP</code>
Notes	The query initiates an alignment and returns 0 if successful, or 1 if failed
Dependencies	Only appears in VXT based solutions with M1741A/49A/49B RRH

4.6.2.17 Align LO Clock

This is an immediate action operation, which runs until complete.

Synchronizes RRH LO Clocks.

Remote Command	<code>:CALibration:INTernal:RRHead:LOSync</code> <code>:CALibration:INTernal:RRHead:LOSync?</code>
Example	<code>:CAL:INT:RRH:LOS?</code>
Notes	The query initiates an Alignment and returns 0 if successful, or 1 if failed
Dependencies	Only appears in VXT based solutions with M1741A/42A/49A/49B RRH
Backwards	<code>:CALibration:INTernal:LOSync</code>
Compatibility SCPI	<code>:CALibration:INTernal:LOSync?</code>

4.6.2.18 Align VXT Transceiver

In M941xE(M941xA+M9471A) system, accesses alignment processes in VXT Transceiver(M9410A/11A/15A/16A), which are immediate action operations and perform complete operations, running until they are complete.

The instrument stops any measurement currently underway, performs the alignment, then restarts the measurement from the beginning (similar to pressing the **Restart** key).

There is no alert available for the VXT Transceiver alignment. Operators are responsible for checking temperature shift since the last **Align VXT Transceiver** to determine whether the VXT Transceiver alignment needs to be executed.

Remote Command	<code>:CALibration:INTernal:VXT:TRANSceiver</code> <code>:CALibration:INTernal:VXT:TRANSceiver?</code>
Example	<code>:CAL:INT:VXT:TRAN</code>
Notes	The query initiates an Alignment and returns 0 if successful, or 1 if failed
Dependencies	Only appears on M9410E/11E/15E/16E

4.6.2.19 Align up down converter

In M941xE(M941xA+M9471A) system, accesses alignment processes in up down converter (M9471A), which are immediate action operations and perform complete operations, running until they are complete.

The instrument stops any measurement currently underway, performs the alignment, then restarts the measurement from the beginning (similar to pressing the **Restart** key).

There is no alert available for the up down converter alignment. Operators are responsible for checking temperature shift since the last **Align up down converter** to determine whether the up down converter alignment needs to be executed.

Remote Command	<code>:CALibration:UPDown:CONVerter</code> <code>:CALibration:UPDown:CONVerter?</code>
Example	<code>:CAL:UPD:CONV</code>
Notes	The query initiates an Alignment and returns 0 if successful, or 1 if failed
Dependencies	Only appears on M9410E/11E/15E/16E

4.6.2.20 Align Selected Freq Ranges

VXT models M9410A/11A provide five alignments: **Align Now All**, **Align Source**, **Align Receiver**, **Align Fast** and **Align LO Leakage**. Every time you execute one of these alignments, the system performs a full span alignment. To save time, it is possible to limit the range of alignment frequency settings. **Align Selected Freq Ranges** allows you to set the start and stop frequency of an alignment.

The example below shows the steps for processing Align Receiver on VXT model M9410A, specifying a frequency range from 1.3 GHz to 1.8 GHz, and 2.5 GHz to 3.9 GHz.

- First row: set the Start and Stop Frequency to 1.3 GHz and 1.8 GHz. Enable the first row
- Second row: set the Start and Stop Frequency to 2.5 GHz and 3.9 GHz. Enable the second row
- Click **Align Receiver**. A message appears: “Aligning Selected Freq Ranges 1 of 7”

The equivalent SCPI command sequence is:

```
:CAL:INT:ASFR ON
:CAL:INT:ASFR:FRAN 1.3 GHz, 1.8 GHz, 2.5 GHz, 3.9 GHz
:CAL:INT:REC
```

Remote Command	<code>:CALibration:INTernal:ASFRanges[:STATe] ON OFF 1 0</code> <code>:CALibration:INTernal:ASFRanges?</code>
Example	<code>:CAL:INT:ASFR ON</code> <code>:CAL:INT:ASFR?</code>
Notes	When Align Selected Freq Ranges is ON , the table is displayed for setting up the frequency ranges to be aligned
Dependencies	Only available in: <ul style="list-style-type: none"> – VXT models M9410A/11A – VXT models M9410A/11A with RRH and/or CIU – M9410E/11E

Only functional for the following alignments:

- Align Now All of VXT models M9410A/11A and M9410E/11E
- Align Source
- Align Receiver
- Align Fast
- Align LO Leakage
- Align VXT Transceiver of M910E/11E
- Align Up Down Converter of M9410E/11E

Align Selected Freq Ranges only guarantees the hardware performance within the frequency range

Preset **OFF**

Enable Extended Freq Range

Allows you to set frequency ranges for VXT models M9410A/11A/15A with Remote Head and/or CIU. When Enable Extended Freq Range is not active, the frequency range is limited by VXT models only.

Remote Command **:CALibration:INTernal:ASFRanges:EXTend[:STATE] ON | OFF | 1 | 0**
:CALibration:INTernal:ASFRanges:EXTend[:STATE]?

Example **:CAL:INT:ASFR:EXT ON**
:CAL:INT:ASFR:EXT?

Dependencies Only available in VXT models M9410A/11A/15A/16A with Remote Head and/or CIU
Only available when **Align Specified Freq Ranges** is **ON**

Preset **OFF**

Frequency Range

Allows you to set the alignment frequency range.

Remote Command **:CALibration:INTernal:ASFRanges:FRANges <startFreq>,<stopFreq>[,<startFreq>,<stopFreq>][,<startFreq>,<stopFreq>][,<startFreq>,<stopFreq>][,<startFreq>,<stopFreq>]**

Example **:CAL:INT:ASFR:FRAN 1.3 GHz,1.8 GHz,2.5 GHz,3.9 GHz**
:CAL:INT:ASFR:FRAN?

Notes **<startFreq>**: Start frequency of an alignment
<stopFreq>: Stop frequency of an alignment
To process alignment for a single frequency point, set **<startFreq> = <stopFreq>**

Dependencies	<p>Only appears when "Align VXT Transceiver" on page 1915 is ON</p> <p>Error message "Invalid alignment frequency range" is reported if start and stop frequencies are invalid, such as:</p> <ol style="list-style-type: none"> 1. Stop frequency - Start frequency < 0 2. the count of start and stop frequency is not even 3. the frequency is out of range. See "More Information" on page 1918 4. more than 5 pairs of start and stop frequency are listed
Preset	1.0 GHz, 2.0 GHz

More Information

When **"Enable Extended Freq Range" on page 1917** is not active, the frequency range depends on the VXT models. The table below lists the Start and Stop Frequency Ranges for VXT models M9410A/11A/15A:

Hardware	Options	Min Frequency	Max Frequency
M9410A/11A	F06	330 MHz	6.08 GHz
M9410A/11A	F06 & EP6	330 MHz	6.6 GHz
M9410A/11A	F06 & LFE & EP6	6.5 kHz	6.6 GHz
M9415A/16A	F06	330 MHz	6.6 GHz
M9415A/16A	F08	330 MHz	8.6 GHz
M9415A/16A	F12	330 MHz	12.9 GHz

When **Enable Extended Freq Range** is active, the frequency range depends on the extensions connected to VXT models. The table below lists the Start and Stop Frequency Range of VXT models with Radio Heads/CIU:

Connected with Radio Heads/CIU	Min frequency	Max frequency	IF Frequency range
VXT + CIU	5.9 GHz	12 GHz	1.4 GHz ~ 4.6 GHz
VXT + CIU + RRH	24.25 GHz	43.5 GHz	2.5 GHz ~ 4.5 GHz
VXT + M1742A	10 GHz	32 GHz	3.0 GHz ~ 5.5 GHz

NOTE

The Min frequency and Max frequency are also the preset frequencies. It is recommended to keep the preset frequency range for VXT models with extensions. An alignment with the full IF Frequency range will be executed ignoring the specific ranges.

The table below lists the Frequency Range of M941xE(VXT Models with M9471A)

4 System
4.6 Alignments

Products with M9471A	Preset	Receiver minimum settable frequency	Source minimum settable (center)frequency	Minimum center frequency with Spec	Receiver maximum settable(center) frequency	Source maximum settable (center) frequency
M941xE without LFE option	1 GHz	330.000005 MHz	330 MHz	380MHz	26.499999995 GHz	26.5GHz
M941xE with LFE option (LFE option in M9411A or M9471A)	1 GHz	750.005 kHz	750 kHz	1MHz	26.499999995 GHz	26.5GHz

NOTE The minimum spec frequency is 380 MHz, but the receiver minimum settable center frequency is 330.000005 MHz, the source minimum settable center frequency is 330 MHz.

With Option LFE in M9411A or in M9471A, the receiver minimum settable frequency is 750.005 kHz, the source minimum settable frequency is 750 kHz, but Spec to customer only ensure down to 1 MHz.

Enable

Enables or disables the selected frequency ranges.

Preset **Row 1: ON**
Other rows: OFF

4.6.2.21 Align External Mixer Path

Immediately executes an alignment of the External Mixer Path inside the VXT models M9415A/16A. External Mixer Path is used when the RF Port is connected to an external Remote Radio Head (RRH). It provides a better performance compared to the normal path. External Mixer Path Alignment covers frequencies from 2.4 GHz to 3.4 GHz of the external mixer path.

NOTE This alignment corrects slow-rate drift, which does not impair specifications for time periods shorter than one week. Thus, you need only perform this alignment on a weekly basis to maintain specifications. This alignment typically takes >2 minutes to complete.

There is no alert for the External Mixer Path alignment. You are responsible for checking the temperature shift since the last **Align Now, External Mixer Path**, to determine whether the external mixer path alignment needs to be executed.

Remote Command	<code>:CALibration:INTernal:EMPath</code> <code>:CALibration:INTernal:EMPath?</code>
Example	<code>:CAL:INT:EMP</code>
Notes	The query initiates an alignment and returns 0 if successful, or 1 if failed
Dependencies	Only appears in VXT models M9415A/16A when Option MXP is installed
Couplings	Initializes the time for the Last Align External Mixer Path Now, All Time Records the temperature for the Last Align External Mixer Path Now, All Temperature

4.6.2.22 Align Low Band

Accesses Low Band alignment processes that are immediate action operations. They perform complete operations and run until they are complete. Low Band Alignment covers frequencies from 380 MHz to 4.3 GHz of the non-external mixer path.

NOTE

This alignment corrects slow-rate drift, which does not impair specifications for time periods shorter than one week. Thus, you need only perform this alignment on a weekly basis to maintain specifications. This alignment typically takes >2 minutes to complete.

There is no alert for the Low Band alignment. You are responsible for checking the temperature shift since the last **Align Now, Align Low Band**, to determine whether the Low Band alignment needs to be executed.

Remote Command	<code>:CALibration:INTernal:LBAND[:ALL]</code> <code>:CALibration:INTernal:LBAND[:ALL]?</code>
Example	<code>:CAL:INT:LBAN</code>
Notes	The query initiates an Alignment, and returns 0 if successful, or 1 if failed
Dependencies	Only appears in VXT models M9415A/16A
Couplings	Initializes the time for the Last Align Low Band Now, All Time Records the temperature for the Last Align Low Band Now, All Temperature

4.6.2.23 Align High Band

Accesses High Band alignment processes that are immediate action operations. They perform complete operations and run until they are complete. High Band Alignment covers frequencies from 4.3 GHz to 12 GHz of the non-external mixer path.

NOTE

This alignment corrects slow-rate drift, which does not impair specifications for time periods shorter than one week. Thus, you need only perform this alignment on a weekly basis to maintain specifications. This alignment typically takes >2 minutes to complete.

There is no alert for the High Band alignment. You are responsible for checking the temperature shift since last **Align Now, Align High Band**, to determine whether the High Band alignment needs to be executed.

Remote Command	<code>:CALibration:INTernal:HBAND[:ALL]</code> <code>:CALibration:INTernal:HBAND[:ALL]?</code>
Example	<code>:CAL:INT:HBAN</code>
Notes	The query initiates an Alignment, and returns 0 if successful, or 1 if failed
Dependencies	Only appears in VXT models M9415A/16A
Couplings	Initializes the external time for the Last Align High Band Now, All Time Records the temperature for the Last Align High Band Now, All Temperature

4.6.3 Path Delay Calibration

Path Delay Calibration is used to remove the time delay differences between multiple power channels of a module.

Dependencies	Only available in VXT modules M9410A/11A Only for modules with matched Digital board hardware version, which means the modules are in same FPGA version The matched hardware version information is in below table
--------------	--

	Digital board Hardware version	Matched module
M9410A	2,3,4,6,10,11	Yes
M9410A	12, 13	Yes
M9411A	18	Yes
M9411A	20,21	Yes
M9411A	12,13	Yes
M9411A	0,1,2,3,4,6,10,11	Yes

4.6.3.1 Source Path Delay Calibration

Accesses the Source Path Delay Calibration processes, which are immediate-action operations and perform complete operations, running until they are complete.

NOTE Connect the RF In of the primary module to the OUT port (COMMON, PORT 1) of the combiner.

NOTE Before performing Path Delay Calibration of Sources, please confirm that:

NOTE Each of the RF Out ports is connected to the RF In port of the Primary channel, using an RF combiner.

NOTE The cables between the combiner and the Source output ports are of the same length.

NOTE A pop-up window appears (as shown below); press OK to continue calibration.

NOTE If the is in MIMO sync, and you send a SCPI command to run Calibration, the calibration process is not executed and instrument a warning is generated (“-221,Setting Conflict; Calibrations are not available while MIMO Sync is On”). To execute Calibration, you must first stop MIMO, manually or via SCPI.

Remote Command :CALibration:PDElay:SOURce
 :CALibration:PDElay:SOURce?

Example :CAL:PDEL:SOUR

Notes The query initiates an Alignment and returns 0 if successful, or 1 if failed
 If the calibration process detected a faulty state, an error will be generated: “Misc/System Alignment Failure”. Calibration will be aborted. Please see event log for more information:

1. Cables are not connected
2. Power control failure
3. Hardware failure
4. M9300A 10MHz reference open failure

Dependencies Only appears in VXT models M9410A/11A
 Only for modules with matched Digital board hardware version, which means the modules are in same FPGA version

4.6.3.2 Path Delay Correction On/Off(Remote Command only)

On/Off the path delay correction to enable the calibration data on the source of the module.

Remote Command	<code>:CALibration:PDElay:CORRection ON OFF</code> <code>:CALibration:PDElay:CORRection?</code>
Example	<code>:CAL:PDEL:CORR ON</code>
Notes	If the Path Delay Calibration has never been performed and there is no calibration correction data in the controller, an alert is generated
Preset	<code>OFF</code>
Range	<code>ON OFF</code>

4.6.4 Show Alignment Statistics

Shows alignment information you can use to ensure that the instrument is operating in a specific manner. The **Show Alignment Statistics** screen is where you can view time and temperature information.

Values displayed are only updated when the **Show Alignment Statistics** screen is invoked. They are not updated while the **Show Alignment Statistics** screen is being displayed. The remote commands that access this information obtain current values.

Note that some of these statistics only display if your instrument supports them; for example, Last Source Align Now All Time only shows up in instruments which contain a source which supports auto alignments.

An example of the **Show Alignment Statistics** screen would be similar to:

Std Header	Product Number: N9020A Serial Number: US46340924 Firmware Revision: A.01.01		
Instrument Info	Time since start-up:	300 hrs	
	Current Temperature:	+28 degC	
Auto Align Info	Time while Auto Align off:	90 min	
Std Align Now	Time since last Align Now All:	12.5 hrs	Times & Temperature delta. Shown as "... " if none since start-up.
	Temperature since last Align Now All:	-1.3 degC	
	Time since last Align Now RF:	5 min	
	Temperature since last Align Now RF:	+0.1 degC	
If TG Option (Not Zorro1)	Time since last Align TG:	2.5 hrs	Time & Temperature 'stamp'
	Temperature since last Align TG:	+0.2 degC	
Opts 508,513 526	Last Characterize Preselector:	Jun 1, 2006 15:00:00	
	Last Characterize Preselector Temperature:	+32.1 degC	

“Time while Auto Align off” is not available in VXT models M9410A/11A.

A successful **Align Now, RF** sets the Last Align RF temperature to the current temperature, and resets the Last Align RF time. A successful **Align Now All** or **Align Now All but RF** sets the Last Align Now All temperature to the current temperature, and resets the Last Align Now All time. A successful **Align Now All** also resets the Last Align RF items if the RF portion of the **Align Now** succeeded.

Example `:SYST:SHOW ALIGN`

Notes The values displayed on the screen are only updated upon entry to the screen, and not updated while the screen is being displayed

The following data-specific queries are available:

Query Time since Startup

Remote Command `:SYSTem:PON:TIME?`

Example `:SYST:PON:TIME?`

Notes Value is the time since the most recent start-up in seconds

State Saved No

Query Current Temperature

Remote Command `:CALibration:TEMPerature:CURRent?`

Example `:CAL:TEMP:CURR?`

Notes Value is in degrees Centigrade

State Saved No

Query Current Temperature at Remote Radio Head

Remote Command	<code>:CALibration:TEMPerature:CURRent:RRHead?</code>
Example	<code>:CAL:TEMP:CURR:RRH?</code>
Notes	Value is in degrees Centigrade
Dependencies	Only appears when Align RRH Amplitude is available
State Saved	No

Query Current Temperature at Remote Radio Head LO

Remote Command	<code>:CALibration:TEMPerature:CURRent:RRHead:LO?</code>
Example	<code>:CAL:TEMP:CURR:RRH:LO?</code>
Notes	Value is in degrees Centigrade
Dependencies	Only appears when Align RRH LO Power is available
State Saved	No

Query Time since Last Align Now All

Remote Command	<code>:CALibration:TIME:LALL?</code>
Example	<code>:CAL:TIME:LALL?</code>
Notes	Value is the elapsed time, in seconds, since the last successful Align Now All or Align Now All but RF was executed
State Saved	No

Query Temperature of Last Align Now All

Remote Command	<code>:CALibration:TEMPerature:LALL?</code>
Example	<code>:CAL:TEMP:LALL?</code>
Notes	Value is in degrees Centigrade at which the last successful Align Now All or Align Now All but RF was executed
State Saved	No

Query Time since Last Align Now Receiver

Remote Command	<code>:CALibration:TIME:INTernal:RECeiver?</code>
Example	<code>:CAL:TIME:INT:REC?</code>
Notes	Value in hours since the last successful Align Now Receiver
Dependencies	Only appears in VXT models M9410A/11A
State Saved	No

Query Temperature of Last Align Now Receiver

Remote Command	<code>:CALibration:TEMPerature:INTernal:RECeiver?</code>
Example	<code>:CAL:TEMP:INT:REC?</code>
Notes	Value in degrees Centigrade when the last successful Align Now Receiver was executed
Dependencies	Only appears in VXT models M9410A/11A
State Saved	No

Query Time since Last Align Now Source

Remote Command	<code>:CALibration:TIME:INTernal:SOURce?</code>
Example	<code>:CAL:TIME:INT:SOUR?</code>
Notes	Value in hours since the last successful Align Now Source
Dependencies	Only appears in VXT models M9410A/11A
State Saved	No

Query Temperature of Last Align Now Source

Remote Command	<code>:CALibration:TEMPerature:INTernal:SOURce?</code>
Example	<code>:CAL:TEMP:INT:SOUR?</code>
Notes	Value in degrees Centigrade when the last successful Align Now Source was executed
Dependencies	Only appears in VXT models M9410A/11A
State Saved	No

Query Time since Last Align Now Fast

Remote Command	<code>:CALibration:TIME:INTernal:FAST?</code>
Example	<code>:CAL:TIME:INT:FAST?</code>
Notes	Value in hours since the last successful Align Now Fast
Dependencies	Only appears in VXT models M9410A/11A/15A/16A
State Saved	No

Query Temperature of Last Align Now Fast

Remote Command	<code>:CALibration:TEMPerature:INTernal:FAST?</code>
Example	<code>:CAL:TEMP:INT:FAST?</code>
Notes	Value in degrees Centigrade when the last successful Align Now Fast was executed
Dependencies	Only appears in VXT models M9410A/11A/15A/16A
State Saved	No

Query Time since Last Align Now LO Leakage

Remote Command	<code>:CALibration:TIME:INTernal:LOLeakage?</code>
Example	<code>:CAL:TIME:INT:LOL?</code>
Notes	Value in hours since the last successful Align Now LO Leakage
Dependencies	Only appears in VXT models M9410A/11A/15A/16A
State Saved	No

Query Temperature of Last Align Now LO Leakage

Remote Command	<code>:CALibration:TEMPerature:INTernal:LOLeakage?</code>
Example	<code>:CAL:TEMP:INT:LOL?</code>
Notes	Value in degrees Centigrade when the last successful Align Now LO Leakage was executed
Dependencies	Only appears in VXT models M9410A/11A/15A/16A
State Saved	No

Query Time since Last Align Now IF Cable

Remote Command	<code>:CALibration:TIME:INTernal:RRHead:IFCable?</code>
Example	<code>:CAL:TIME:INT:RRH:IFC?</code>
Notes	Value in hours since the last successful Align Now IF Cable
Dependencies	Only appears in VXT based solutions with M1740A/41A/42A/49A/49B RRH
State Saved	No
Backwards Compatibility SCPI	<code>:CALibration:TIME:INTernal:IFCable?</code>

Query Temperature of Last Align Now IF Cable

Remote Command	<code>:CALibration:TEMPerature:INTernal:RRHead:IFCable?</code>
Example	<code>:CAL:TEMP:INT:RRH:IFC?</code>
Notes	Value in degrees Centigrade when the last successful Align Now IF Cable was executed
Dependencies	Only appears in VXT based solutions with M1740A/41A/42A/49A/49B RRH
State Saved	No
Backwards Compatibility SCPI	<code>:CALibration:TEMPerature:INTernal:IFCable?</code>

Query Time since Last Align LO Clock

Remote Command	<code>:CALibration:TIME:INTernal:RRHead:LOSync?</code>
----------------	--

Example	<code>:CAL:TIME:INT:RRH:LOS?</code>
Notes	Value in hours since the last successful Align LO Clock
Dependencies	Only appears in VXT based solutions with M1741A/42A/49A/49B RRH
State Saved	No
Backwards Compatibility SCPI	<code>:CALibration:TIME:INTernal:LOSync?</code>

Query Temperature of Last Align LO Clock

Remote Command	<code>:CALibration:TEMPerature:INTernal:RRHead:LOSync?</code>
Example	<code>:CAL:TEMP:INT:RRH:LOS?</code>
Notes	Value in degrees Centigrade when the last successful Align LO Clock was executed
Dependencies	Only appears in VXT based solutions with M1741A/42A/49A/49B RRH
State Saved	No
Backwards Compatibility SCPI	<code>:CALibration:TEMPerature:INTernal:LOSync?</code>

Query Time since Last Align RRH Amplitude

Remote Command	<code>:CALibration:TIME:INTernal:RRHead:AMPLitude?</code>
Example	<code>:CAL:TIME:INT:RRH:AMPL?</code>
Notes	Value in hours since the last successful Align RRH Amplitude
Dependencies	Only appears in VXT based solutions with M1741A/42A/49A/49B RRH
State Saved	No
Backwards Compatibility SCPI	<code>:CALibration:TIME:INTernal:RRHAmp?</code>

Query Temperature of Last Align RRH Amplitude

Remote Command	<code>:CALibration:TEMPerature:INTernal:RRHead:AMPLitude?</code>
Example	<code>:CAL:TEMP:INT:RRH:AMPL?</code>
Notes	Value in degrees Centigrade when the last successful Align RRH Amplitude was executed
Dependencies	Only appears in VXT based solutions with M1741A/42A/49A/49B RRH
State Saved	No
Backwards Compatibility SCPI	<code>:CALibration:TEMPerature:INTernal:RRHAmp?</code>

Query Time since Last Align Fast RRH Amplitude

Remote Command	<code>:CALibration:TIME:INTernal:RRHead:AMPLitude:FAST?</code>
Example	<code>:CAL:TIME:INT:RRH:AMPL:FAST?</code>
Notes	Value in hours since the last successful Align Fast RRH Amplitude
Dependencies	Only appears in VXT based solutions with M1742A RRH
State Saved	No

Query Temperature of Last Align Fast RRH Amplitude

Remote Command	<code>:CALibration:TEMPerature:INTernal:RRHead:AMPLitude:FAST?</code>
Example	<code>:CAL:TEMP:INT:RRH:AMPL:FAST?</code>
Notes	Value in degrees Centigrade when the last successful Align Fast RRH Amplitude was executed
Dependencies	Only appears in VXT based solutions with M1742A RRH
State Saved	No

Query Time since Last Align RRH LO Power

Remote Command	<code>:CALibration:TIME:INTernal:RRHead:LOPower?</code>
Example	<code>:CAL:TIME:INT:RRH:LOP?</code>
Notes	Value in hours since the last successful Align RRH LO Power
Dependencies	Only appears in VXT based solutions with M1741A/49A/49B RRH
State Saved	No

Query Temperature of Last Align RRH LO Power

Remote Command	<code>:CALibration:TEMPerature:INTernal:RRHead:LOPower?</code>
Example	<code>:CAL:TEMP:INT:RRH:LOP?</code>
Notes	Value in degrees Centigrade when the last successful Align RRH LO Power was executed
Dependencies	Only appears in VXT based solutions with M1741A/49A/49B RRH
State Saved	No

Query Time since Last Align Now RF

Remote Command	<code>:CALibration:TIME:LRF?</code>
Example	<code>:CAL:TIME:LRF?</code>
Notes	Value is the elapsed time, in seconds, since the last successful Align Now, RF was executed, either individually or as a component of Align Now All
State Saved	No

Query Temperature of Last Align Now RF

Remote Command	<code>:CALibration:TEMPerature:LRF?</code>
Example	<code>:CAL:TEMP:LRF?</code>
Notes	Value is in degrees Centigrade at which the last successful Align Now RF was executed, either individually or as a component of Align Now All
State Saved	No

Query Time since Last Align IF

Remote Command	<code>:CALibration:TIME:LIF?</code>
Example	<code>:CAL:TIME:LIF?</code>
Notes	Value is the elapsed time, in seconds, since the last successful Align IF was executed
State Saved	No

Query Temperature of Last Align IF

Remote Command	<code>:CALibration:TEMPerature:LIF?</code>
Example	<code>:CAL:TEMP:LIF?</code>
Notes	Value is in degrees Centigrade at which the last successful Align IF was executed
State Saved	No

Query Time since Last Characterize Preselector

Remote Command	<code>:CALibration:TIME:LPreselector?</code>
Example	<code>:CAL:TIME:LPR?</code>
Notes	Value is the date and time the last successful Characterize Preselector was executed. The date is separated from the time by a space character Returns "" if no Characterize Preselector has ever been performed on the instrument
Dependencies	In models that do not include preselectors, this command is not enabled and any attempt to set or query yields an error
State Saved	No

Query Temperature of Last Characterize Preselector

Remote Command	<code>:CALibration:TEMPerature:LPreselector?</code>
Example	<code>:CAL:TEMP:LPR?</code>
Notes	Value is in degrees Centigrade at which the last successful Characterize Preselector was executed

4 System
4.6 Alignments

Dependencies	In models that do not include preselectors, this command is not enabled and any attempt to set or query yields an error
--------------	---

State Saved	No
-------------	----

Query Time since Auto Align Off

Remote Command	<code>:CALibration:AUTO:TIME:OFF?</code>
----------------	--

Example	<code>:CAL:AUTO:TIME:OFF?</code>
---------	----------------------------------

Notes	Value is the elapsed time, in seconds, since Auto Align has been set to Off or Off with Alert . The value is 0 if Auto Align is ALL or NORF
-------	---

State Saved	No
-------------	----

Query Time since Last Align Now 20 Hz - 30 MHz

Remote Command	<code>:CALibration:TIME:RFPSelector:LCONducted?</code>
----------------	--

Example	<code>:CAL:TIME:RFPS:LCON?</code>
---------	-----------------------------------

Notes	Values are the date and time the last successful Align Now, 20 Hz - 30 MHz was executed. The date is separated from the time by a semi-colon character
-------	---

State Saved	No
-------------	----

Query Temperature of Last Align Now 20 Hz - 30 MHz

Remote Command	<code>:CALibration:TEMPerature:RFPSelector:LCONducted?</code>
----------------	---

Example	<code>:CAL:TEMP:RFPS:LCON?</code>
---------	-----------------------------------

Notes	Value is in degrees Centigrade at which the last successful Align Now, 20 Hz - 30 MHz was executed
-------	---

State Saved	No
-------------	----

Query Time since Last Align Now 30 MHz - 3.6 GHz

Remote Command	<code>:CALibration:TIME:RFPSelector:LRADiated?</code>
----------------	---

Example	<code>:CAL:TIME:RFPS:LRAD?</code>
---------	-----------------------------------

Notes	Value is the date and time the last successful Align Now, 30 MHz - 3.6 GHz was executed. The date is separated from the time by a semi-colon character
-------	---

State Saved	No
-------------	----

Query Temperature of Last Align Now 30 MHz - 3.6 MHz

Remote Command	:CALibration:TEMPerature:RFPSelector:LRADiated?
Example	:CAL:TEMP:RFPS:LRAD?
Notes	Value is in degrees Centigrade at which the last successful Align Now, 30 MHz – 3.6 GHz was executed
State Saved	No

Query Next Scheduled Alignment Time

Remote Command	:CALibration:RFPSelector:SCHeduler:TIME:NEXT? Returns data using the following format: YYYY/MM/DD; HH:MM:SS
Example	:CAL:RFPS:SCH:TIME:NEXT?
Notes	The next run time will be updated based on the start date/time and recurrence set by the user “date” is representation of the date the task will run in the form: YYYY/MM/DD where: <ul style="list-style-type: none"> - YYYY is the four-digit representation of year. (for example, 2009) - MM is the two-digit representation of month. (for example, 01 to 12) - DD is the two-digit representation of the day. (for example, 01 to 28, 29, 30 or 31 depending on the month and year) “time” is a representation of the time of day the task will run in the form: HH:MM:SS where: <ul style="list-style-type: none"> - HH is the two-digit representation of the hour in 24-hour format - MM is the two-digit representation of minute - SS is the two-digit representation of seconds
State Saved	No

Query Time since Last Align Now External Mixer Path

Remote Command	:CALibration:TIME:INTernal:EMPath?
Example	:CAL:TIME:INT:EMP?
Notes	Value in hours since the last successful Align Now External Mixer Path
Dependencies	Only appears option MXP is installed
State Saved	No

Query Temperature of Last Align Now External Mixer Path

Remote Command	<code>:CALibration:TEMPerature:INTernal:EMPath?</code>
Example	<code>:CAL:TEMP:INT:EMP?</code>
Notes	Value in degrees Centigrade when the last successful Align Now External Mixer Path was executed
Dependencies	Only appears option MXP is installed
State Saved	No

Query Time since Last Align Now Low Band

Remote Command	<code>:CALibration:TIME:INTernal:LBANd?</code>
Example	<code>:CAL:TIME:INT:LBAN?</code>
Notes	Value in hours since the last successful Align Now Low Band
Dependencies	Only appears in VXT models M9415A/16A
State Saved	No

Query Temperature of Last Align Now Low Band

Remote Command	<code>:CALibration:TEMPerature:INTernal:LBANd?</code>
Example	<code>:CAL:TEMP:INT:LBAN?</code>
Notes	Value in degrees Centigrade when the last successful Align Now Low Band was executed
Dependencies	Only appears in VXT models M9415A/16A
State Saved	No

Query Time since Last Align Now High Band

Remote Command	<code>:CALibration:TIME:INTernal:HBAN?</code>
Example	<code>:CAL:TIME:INT:HBAN?</code>
Notes	Value in hours since the last successful Align Now High Band
Dependencies	Only appears in VXT models M9415A/16A
State Saved	No

Query Temperature of Last Align Now High Band

Remote Command	<code>:CALibration:TEMPerature:INTernal:HBANd?</code>
Example	<code>:CAL:TEMP:INT:HBAN?</code>
Notes	Value in degrees Centigrade when the last successful Align Now High Band was executed
Dependencies	Only appears in VXT models M9415A/16A
State Saved	No

Query Time since Last Align VXT Transceiver

Remote Command	:CALibration:TIME:INTernal:VXT:TRANsceiver?
Example	:CAL:TIME:INT:VXT:TRAN?
Notes	Value in hours since the last successful Align VXT Transceiver Returns NaN if Align VXT Transceiver has never been performed on the instrument
Dependencies	Only appears in M9410E/11E/15E/16E
State Saved	No

Query Temperature of Last Align VXT Transceiver

Remote Command	:CALibration:TEMPerature:INTernal:VXT:TRANsceiver?
Example	:CAL:TEMP:INT:VXT:TRAN?
Notes	Value in degrees Centigrade when the last successful Align VXT Transceiver was executed Returns 9.91E+37(NaN) if Align VXT Transceiver has never been performed on the instrument
Dependencies	Only appears in M9410E/11E/15E/16E
State Saved	No

Query Time since Last Align Up Down Converter

Remote Command	:CALibration:TIME:UPDown:CONVerter?
Example	:CAL:TIME:UPD:CONV?
Notes	Value in hours since the last successful Align Up Down Converter Returns NaN if Align Up Down Converter has never been performed on the instrument
Dependencies	Only appears in M9410E/11E/15E/16E
State Saved	No

Query Temperature of Last Align Up Down Converter

Remote Command	:CALibration:TEMPerature:UPDown:CONVerter?
Example	:CAL:TEMP:UPD:CONV?
Notes	Value in degrees Centigrade when the last successful Align Up Down Converter was executed Returns 9.91E+37(NaN) if Align Up Down Converter has never been performed on the instrument
Dependencies	Only appears in VXT models M9410A/11A and M9410E/11E
State Saved	No

Query Time since Last Path Delay Calibration

Remote Command	:CALibration:TIME:PDElay:SOURce?
----------------	----------------------------------

Example	<code>:CAL:TIME:PDEL:SOUR?</code>
Notes	The value is the elapsed time in hours since the last successful Path Delay Calibration has been performed Returns NaN if the Path Delay Calibration has never been performed
State Saved	No

Query Temperature of Last Path Delay Calibration

Remote Command	<code>:CALibration:TEMPerature:PDElay:SOURce?</code>
Example	<code>:CAL:TEMP:PDEL:SOUR?</code>
Notes	The value is in degrees Centigrade at which the last successful Path Delay Calibration has been performed Returns 9.91E+37(NaN) if the Path Delay Calibration has never been performed
State Saved	No

4.6.5 Timebase DAC

Lets you change the setting of the **Timebase DAC** from a factory calibrated setting to your own desired setting.

The display shows the current **Timebase DAC** setting at the top, and gives you a choice of **CALibrated** or **USER** setting. There is also a field for you to enter your desired setting.

Dependencies	Does not appear in VXT and M941xE
--------------	-----------------------------------

4.6.5.1 Timebase DAC

Allows control of the internal 10 MHz reference oscillator timebase. This may be used to adjust for minor frequency alignment between your signal's reference and the internal frequency reference. This adjustment has no effect if the instrument is operating with an External Frequency Reference.

If the value of the **Timebase DAC** changes (by switching to **CALibrated** from **USER** with **User Value** set to a different value, or in **USER** with a new value entered) an alignment may be necessary. The alignment system will take appropriate action; which will either invoke an alignment or cause an **Alert**.

The **CALibrated** setting sets the **Timebase DAC** to the value established during factory or field calibration. In this case the value displayed at the top of the screen is the calibrated value.

The **USER** setting sets the **Timebase DAC** to the value set on the **User Value** control. In this case the value displayed at the top of the screen is the user value.

Remote Command	<code>:CALibration:FREQuency:REFerence:MODE CALibrated USER</code> <code>:CALibration:FREQuency:REFerence:MODE?</code>
Example	<code>:CAL:FREQ:REF:MODE CAL</code>
Notes	If the value of the timebase is changed the alignment system automatically performs an alignment or alerts that an alignment is due
Dependencies	Not available in UXM
Preset	Unaffected by Preset , but set to CALibrated by Restore Defaults > "Alignments" on page 1892
State Saved	No

4.6.5.2 User Value

Lets you set the **Timebase DAC** to a value other than the value established during the factory or field calibration. The current value of the DAC is displayed at the top of the screen. This will be the Calibrated value if **Timebase DAC** is set to **CALibrated**.

Remote Command	<code>:CALibration:FREQuency:REFerence:FINE <integer></code> <code>:CALibration:FREQuency:REFerence:FINE?</code>
Example	<code>:CAL:FREQ:REF:FINE 8191</code>
Notes	If the value of the timebase is changed the alignment system automatically performs an alignment or alerts that an alignment is due
Couplings	Setting <code>:CAL:FREQ:REF:FINE</code> sets <code>:CAL:FREQ:REF:MODE USER</code>
Preset	Unaffected by Preset , but set to the factory setting by Restore Defaults > "Alignments" on page 1892
State Saved	No
Min	0
Max	16383
Backwards Compatibility SCPI	<code>:CALibration:FREQuency:REFerence:COARse</code> ESA hardware contained two DAC controls for the Timebase. In X-Series the command <code>:CALibration:FREQuency:REFerence:FINE</code> is the method for adjusting the timebase. The COARse option is provided as an alias to FINE
	Backwards Compatibility Command
Remote Command	<code>:CALibration:FREQuency:REFerence:COARse <integer></code> <code>:CALibration:FREQuency:REFerence:COARse?</code>
Example	<code>:CAL:FREQ:REF:COAR 8191</code>
Notes	This is an alias for <code>:CAL:FREQ:REF:FINE</code> . Any change to COARse is reflected in FINE and <i>vice-versa</i> . See <code>:CAL:FREQ:REF:FINE</code> for description of functionality
Couplings	Setting <code>:CAL:FREQ:REF:COAR</code> sets <code>:CAL:FREQ:REF:MODE USER</code>

4.6.6 Advanced

Accesses alignment processes that are immediate action operations that perform operations that run until complete. **Advanced** alignments are performed on an irregular basis, or require additional operator interaction.

Dependencies	Not available in UXM
--------------	----------------------

4.6.6.1 Characterize Preselector

The Preselector tuning curve drifts over temperature and time. Recognize that the Amplitude, Presel Center function adjusts the preselector for accurate amplitude measurements at an individual frequency. Characterize Preselector improves the amplitude accuracy by ensuring the Preselector is approximately centered at all frequencies without the use of the Amplitude, Presel Center function. Characterize Preselector can be useful in situations where absolute amplitude accuracy is not of utmost importance, and the throughput savings or convenience of not performing a Presel Center is desired. Presel Center is required prior to any measurement for best (and warranted) amplitude accuracy.

Keysight recommends that the Characterize Preselector operation be performed yearly as part of any calibration, but performing this operation every three months can be worthwhile.

Characterize Preselector immediately executes a characterization of the Preselector, which is a YIG-tuned filter (YTF). The instrument stops any measurement currently underway, performs the characterization, then restarts the measurement from the beginning (similar to pressing the **Restart** key).

The query (**:CALibration:YTF?**) invokes the alignment of the YTF subsystem, and returns a success or failure value.

A failure encountered during alignment generates the Error Condition message “Characterize Preselector failure” and sets Bit 3 in the **STATus:QUESTIONable:CALibration:EXTended:FAILure** status register. Successful completion of **Characterize Preselector** clears this Condition. It also begins the elapsed time counter for Last Characterize Preselector Time, and captures the Last Characterize Preselector Temperature.

The last Characterize Preselector Time and Temperature survives across the power cycle, as this operation is performed infrequently.

NOTE

The Characterize Preselector function can be interrupted, by pressing the Cancel (ESC) front-panel key, or remotely with Device Clear followed by the :ABORT SCPI command. None of the new characterization data is then used.

However, since the old characterization data is purged at the beginning of the characterization, you now have an uncharacterized preselector. You should re-execute this function and allow it to finish before making any further preselected measurements.

Remote Command	<code>:CALibration:YTF</code> <code>:CALibration:YTF?</code>
Example	<code>:CAL:YTF</code>
Notes	<p><code>:CALibration:YTF?</code> returns 0 if successful, or 1 if failed (including interfering user signal)</p> <p>While Advanced, Characterize Preselector is performing the alignment, Bit 0 in the Status Operation register is set. Completion, or termination, clears Bit 0 in the Status Operation register</p> <p>This command is sequential; it must complete before further SCPI commands are processed. Interrupting the alignment from remote is accomplished by invoking Device Clear followed by the <code>:ABORt</code> command</p> <p>Successful completion clears Bit 9 in the Status Questionable Calibration register</p> <p>A failure encountered during alignment generates the Error Condition message “Characterize Preselector failed” and sets Bit 9 in the Status Questionable Calibration register</p> <p>For Options that support frequencies > 3.6 GHz only</p>
Dependencies	This control does not appear in models that do not contain preselectors. In these models the SCPI command is accepted without error, but no action is taken
Couplings	<p>Initializes the time for the Last Characterize Preselector Time</p> <p>Records the temperature for the Last Characterize Preselector Temperature</p> <p>Overlapped Command</p>
Remote Command	<code>:CALibration:YTF:NPENding</code>
Example	<code>:CAL:YTF:NPEN</code>
Notes	<p><code>:CALibration:YTF:NPENding</code> is the same as <code>:CALibration:YTF</code>, including all conditions, status register bits, except that this SCPI command <i>does not block</i> the SCPI session, so you should use status register bits to query if the calibration is successfully completed or not</p> <p>Typical usage is:</p> <ol style="list-style-type: none"> 1. <code>:CALibration:YTF:NPENding</code> (Start a YTF calibration) 2. <code>:STATus:OPERation:CONDition?</code> (Check if the calibration is completed or not, If Bit 0 is set, then the system is doing calibration, and you should repeat this query until the bit is cleared) 3. <code>:STATus:QUESTionable:CALibration:EXTended:FAILure:CONDition?</code> (Check whether Bit 2 is set. If this bit is set, that means there are some errors in previous internal source calibration)

4.6.6.2 Characterize Reference Clock

Calibrates the Reference Input Phase with the External Reference Output. This feature is only available when either option DP2 or B40 is present. It requires connecting the 10 MHz OUT to the EXT REF IN port with a BNC cable before running the characterization.

See "[Front panel guided calibration sequence](#)" on page 1940

Remote Command	<code>:CALibration:REference:CLOCK?</code>
Example	<code>:CAL:REF:CLOC:INIT?</code> connect cable <code>:CAL:REF:CLOC?</code> disconnect cable <code>:CAL:REF:CLOC:END?</code>
Notes	<code>:CALibration:REference:CLOCK?</code> returns 0 if successful, or 1 if failed
Dependencies	Option DP2 or B40
Couplings	Initializes the time for the Last Characterize Reference Clock Time Records the temperature for the Last Characterize Reference Clock Temperature. Expected to be run after <code>:CAL:REF:CLOC:INIT</code> , and before <code>:CAL:REF:CLOC:END</code>
Remote Command	<code>:CALibration:REference:CLOCK:INITialize?</code>
Example	<code>:CAL:REF:CLOC:INIT?</code>
Notes	Returns 0 if successful, or 1 if failed
Dependencies	Option DP2 or B40
Couplings	Expected to be run before sending <code>:CAL:REF:CLOC?</code> . This will stop the current measurement when it has completed (does not abort the current data acquisition), and prepare the instrument for the expected cabling
Remote Command	<code>:CALibration:REference:CLOCK:END?</code>
Example	<code>:CAL:REF:CLOC:END?</code>
Notes	Returns 0 if successful, or 1 if failed
Dependencies	Option DP2 or B40
Couplings	Expected to be run after sending <code>:CAL:REF:CLOC?</code> , and after removing the cable used in that Characterize Reference Clock step. This will resume any queued measurements, and concludes the reference clock characterization
Remote Command	<code>:CALibration:TIME:REference:CLOCK?</code>
Example	<code>:CAL:TIME:REference:CLOCK?</code>

Notes	Value is the date and time the last successful Characterize Reference Clock was executed. The date is separated from the time by a space character. Returns "" if Characterize Reference Clock has never been performed on the instrument
Dependencies	Option DP2 or B40
State Saved	No

Front panel guided calibration sequence

When selecting **Characterize Reference Clock** via the front panel, the following form is displayed.

Step 1 of the guided calibration sequence:

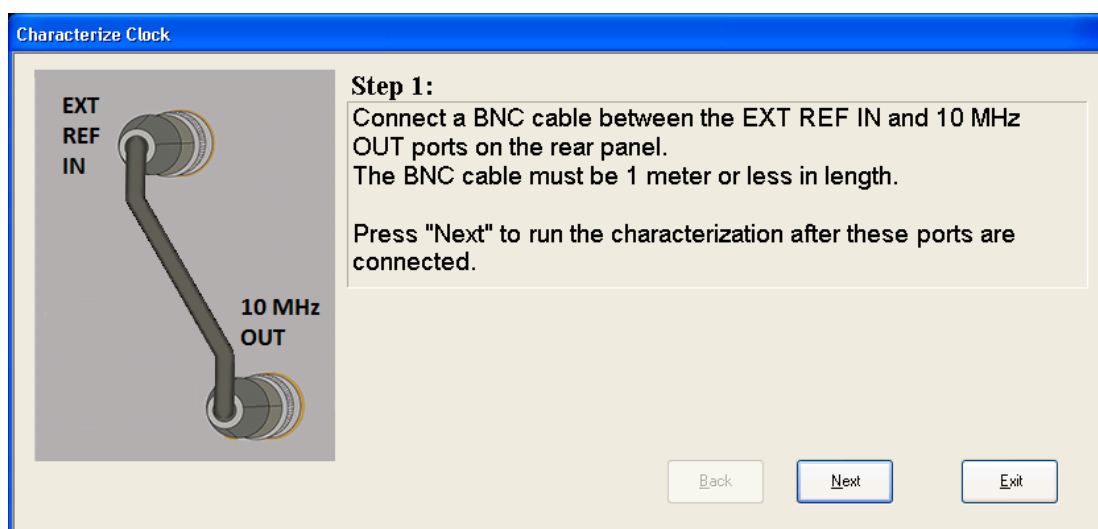

Step 2 of the guided calibration sequence:

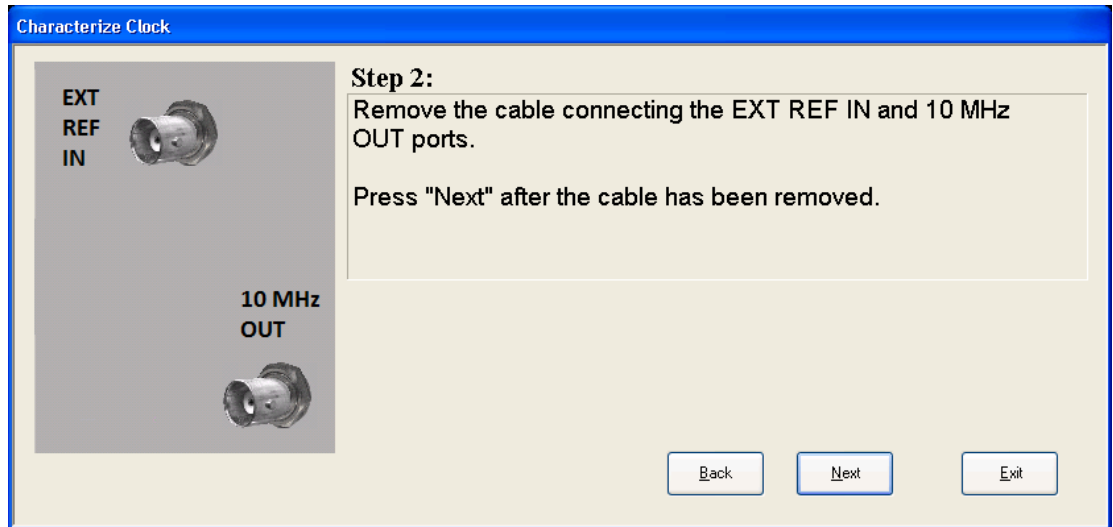

Step 3 of the guided calibration sequence:

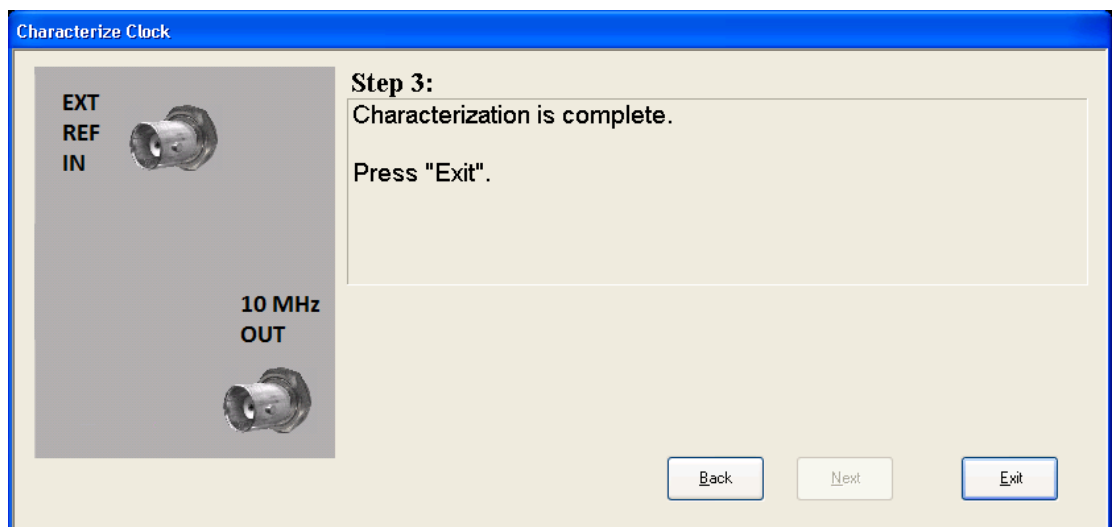

4.6.6.3 Characterize Noise Floor

On instruments with the NF2 license installed, the calibrated Noise Floor used by Noise Floor Extensions should be refreshed periodically. To do this, press **Characterize Noise Floor**. When you press this control, the instrument stops any measurement currently underway, and a dialog appears with an **OK** and **Cancel** button that says:

This action will take several minutes to perform. Please disconnect all cables from the RF input and press Enter to proceed. Press ESC to cancel

When you press **Enter** or **OK**, the characterization proceeds. After the characterization, the instrument restarts the measurement from the beginning

(similar to pressing the **Restart** key). The characterization takes many minutes to run.

The noise floor model used by Noise Floor Extensions includes an estimation of the temperature behavior of the noise floor, but this is only an estimation. The noise floor changes little with the age of the components. However, even small changes in the estimated level of the noise floor can make large changes in the effective noise floor, because the effective noise floor is the error in the estimation of the noise floor. Keysight recommends that the **Characterize Noise Floor** operation be performed when the instrument is operating at an ambient temperature that is significantly different than the ambient temperature at which this alignment was last run. In addition, Keysight recommends that the **Characterize Noise Floor** operation be performed after the first 500 hours of operation, and once every calendar year.

The noise floor model from the last operation of **Characterize Noise Floor** survives across the power cycle.

NOTE

The **Characterize Noise Floor** function can be interrupted, by pressing the **Cancel (ESC)** front-panel key, or remotely with Device Clear followed by the `:ABORt SCPI` command. None of the new characterization data is then used. However, since the old characterization data is purged at the beginning of the characterization, you now have an uncharacterized noise floor. You should re-execute this function and allow it to finish before making any further measurements with NFE. Until you do, the instrument will display a “Characterize Noise Floor required” message and set bit 12 in the Status Questionable Calibration register (`STATus:QUEStionable:CALibration:EXTended:NEEDed`).

Remote Command	<code>:CALibration:NFLoor</code> <code>:CALibration:NFLoor?</code>
Example	<code>:CAL:NFL</code>
Notes	<code>:CALibration:NFLoor?</code> returns 0 if successful, or 1 if failed (including interfering user signal) This command is sequential; it must complete before further commands are processed. Interrupting the alignment from remote is accomplished by invoking Device Clear followed by the <code>:ABORt</code> command
Dependencies	This control does not appear in models that do not contain NF2. In these models the command is accepted without error, but no action is taken
Couplings	Successful completion of Characterize Noise Floor begin the elapsed time counter or the Last Characterize Noise Floor Time
Remote Command	<code>:CALibration:TIME:NFLoor?</code>
Example	<code>:CAL:TIME:NFL?</code>
Notes	Value is the date and time the last successful Characterize Noise Floor was executed. The date is separated from the time by a space character Returns “” if no Characterize Noise Floor has ever been performed on the instrument

4 System
4.6 Alignments

Dependencies	In models that do not include NF2, this command is not enabled and any attempt to set or query yields an error
State Saved	No
Remote Command	<code>:CALibration:TEMPerature:NFLoor?</code>
Example	<code>:CAL:TEMP:NFL?</code>
Notes	Value is the temperature of the last successful Characterize Noise Floor was executed Returns "" if no Characterize Noise Floor has ever been performed on the instrument
Dependencies	In models that do not include NF2, this command is not enabled and any attempt to set or query yields an error
State Saved	No
Remote Command	<code>:CALibration:TIME:ELAPsed:NFLoor?</code>
Example	<code>:CAL:TIME:ELAP:NFL?</code>
Notes	Value is the elapsed time the instrument was powered-on since the last successful Characterize Noise Floor was executed Returns "" if no Characterize Noise Floor has ever been performed on the instrument
Dependencies	In models that do not include NF2, this command is not enabled and any attempt to set or query yields an error
State Saved	No

4.6.6.4 Calibration Temperature History

The following queries let you retrieve various statistics regarding the Calibration Temperature history.

Minimum Temperature Within Last Number of Seconds

Lets you query the minimum temperature within the last number of seconds. If no data exists for the requested time, the returned value is 9.91e+37.

Remote Command	<code>:CALibration:TEMPerature:MINimum? <seconds></code>
Example	<code>:CAL:TEMP:MIN? 60</code>

Maximum Temperature Within Last Number of Seconds

Lets you query the maximum temperature within the last number of seconds. If no data exists for the requested time, the returned value is 9.91e+37.

Remote Command	<code>:CALibration:TEMPerature:MAXimum? <seconds></code>
Example	<code>:CAL:TEMP:MAX? 60</code>

Temperature Seconds Ago

Lets you query temperature X seconds ago. If no data exists for the requested time, the returned value is 9.91e+37.

Remote Command `:CALibration:TEMPerature:AGO? <seconds>`

Example `:CAL:TEMP:AGO? 75`

Oldest Temperature Value

Lets you query the oldest recorded temperature value.

Remote Command `:CALibration:TEMPerature:OLDest[:TEMPerature]?`

Example `:CAL:TEMP:OLD?`

Oldest Temperature Time

Lets you query how long ago the oldest temperature value was recorded.

Remote Command `:CALibration:TEMPerature:OLDest:SECONDS?`

Example `:CAL:TEMP:OLD:SEC?`

4.6.6.5 TDS Alignment

Only appears in N9038B (MXE-B) when Option TDS is installed and licensed.

The TDS alignment includes [AlignNowAll](#) and [RFPrese1](#) alignment. Immediately executes an alignment of the TDS subsystem. The instrument stops any measurement currently underway, performs the alignment, and then restarts the measurement from the beginning (similar to pressing the **Restart** key).

Align TDS can be interrupted by pressing the **Cancel (ESC)** front-panel key or from remote with Device Clear followed by `:ABORT`. When this occurs, no new TDS alignment data will be employed.

Remote Command `:CALibration:TDS`
Params missing? What does the query return?
`:CALibration:TDS?`

Example `:CAL:TDS`

Notes This command is sequential; it must complete before further commands are processed. Interrupting the alignment from remote is accomplished by invoking Device Clear followed by the `:ABORT` command

Dependencies Only appears in N9038B (MXE-B) models with Option TDS installed and licensed

4.6.6.6 Backup or Restore Align Data...

Opens the utility for backing-up or restoring alignment data. Since this utility cannot be run while the instrument software is running, a prompt tells you to shut down the instrument first:

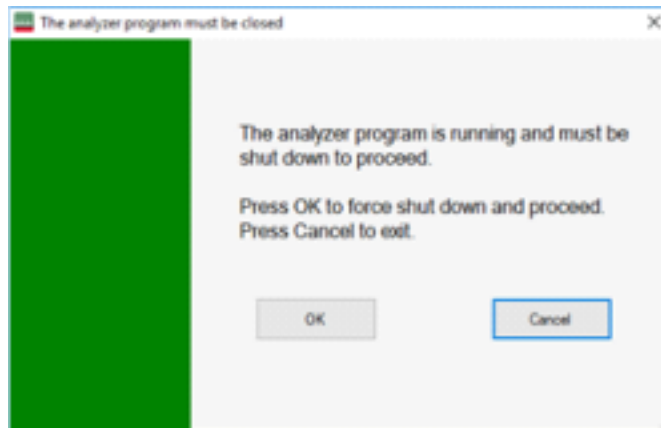

Press **OK** and the instrument will shut down and open the backup utility.

Alignment data for the instrument resides on the hard drive in a database. Keysight uses high quality hard drives; however, it is highly recommended the alignment data be backed-up to storage outside of the instrument. Additionally, for customers who use multiple CPU Assemblies or multiple disk drives, the alignment that pertains to the instrument must be transferred to the resident hard drive after a CPU or hard drive is replaced. This utility facilitates backing-up and restoring the alignment data.

NOTE

This utility allows you to navigate to any location of the Windows file system. If you are backing up alignment data to storage outside of the instrument, then it is assumed that you will use a USB memory device, or Mapped Network Drive.

Processor Assembly types PC6 and PC7 contain a removable SD memory card. When one of these CPUs is installed, the Backup and Restore Alignment Data wizard defaults to the SD card as the backup location. At every power-on, the software will check to determine if the calibration data on the SD memory card (the backup) is newer than the data in use on the disk. In such situations, before the application is loaded, you are given the opportunity to restore the data from the backup. If you respond **Yes**, the Backup and Restore Alignment Data wizard (see ["Alignment Data Wizard \(without Flash\)" on page 1946](#)) will be invoked to perform the restore.

Processor Assembly types PC6S and PC7S contain an internal flash EEPROM, as well as a removable SD card. When one of these CPUs is installed, the Backup and Restore Alignment Data wizard defaults to the internal flash as the backup location.

As with the PC6 and PC7, at every power-on, the software compares the timestamp of the backup on the flash and the timestamp of the alignment data in use on the disk. If the backup on the flash has newer data, you are given the opportunity to restore the data from the backup before the application is loaded. If you respond **Yes**, the Backup and Restore Alignment Data wizard (see "[Alignment Data Wizard \(with Flash\)](#)" on page 1956) will be invoked and will prompt you to restore that backup.

For purposes of these instructions, "alignment data" and "calibration data" are used interchangeably.

Dependencies	Not available in UXM
Remote Command	<code>:CALibration:DATA:DEFault</code>
Example	<code>:CAL:DATA:DEF</code>
Notes	Restores the alignment data files to their default state
Couplings	Sets Auto Align to OFF . Sets Bit 14 in the Status Questionable Calibration register. The Error Condition message "Align Now All required" is generated

Alignment Data Wizard (without Flash)

Guides you through the operation of backing-up or restoring the alignment data.

4 System
4.6 Alignments

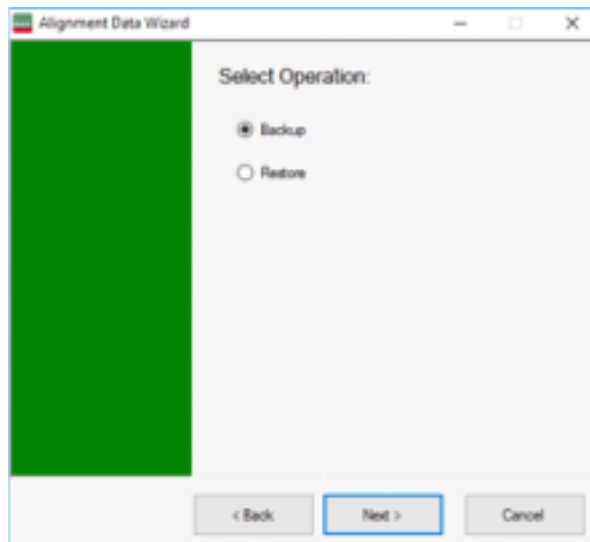
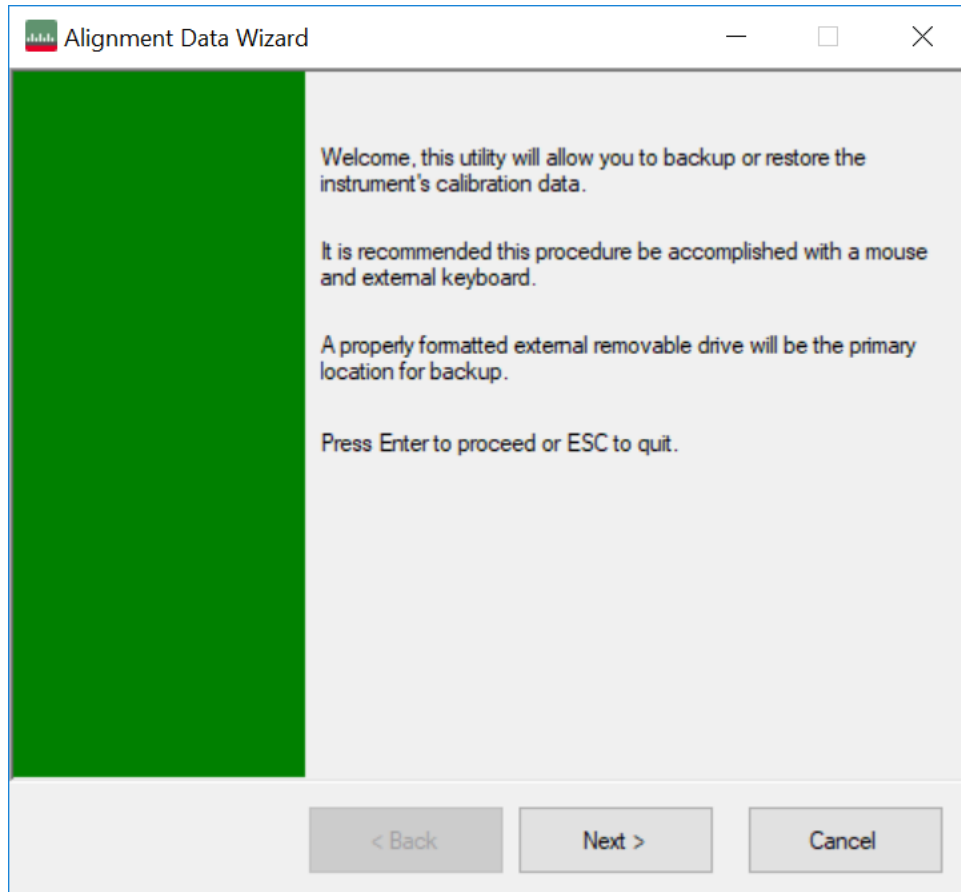

The default backup location for instruments *without* internal flash will be the first drive identified as an external drive (USB or LAN) if such is available; or, if not, the internal D: partition.

The default file name is `<model number>_<serial number>_<date in YYYYMMDDHHMMSS>.bkz`.

The default file extension for legacy backup files was `.bak`. The Backup and Restore operations support both the `.bak` (legacy format) and `.bkz` formats.

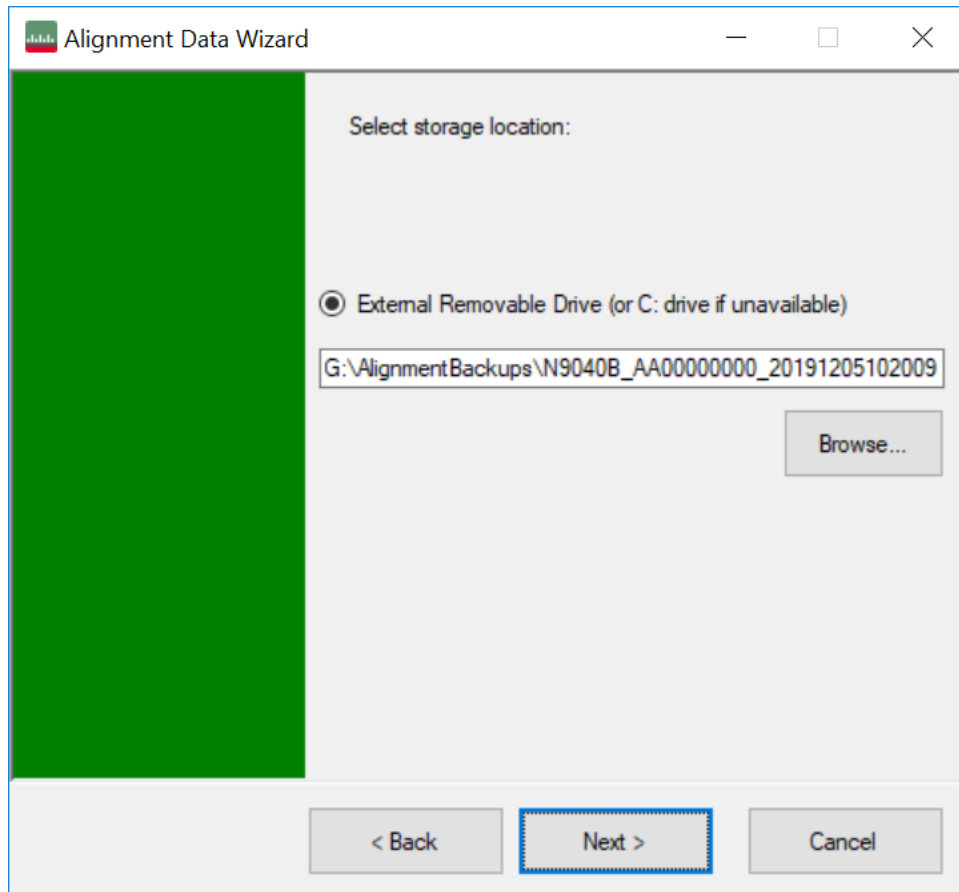

If a USB drive is present, it will be selected by default. The path defaults to the `AlignmentBackups` folder, and a filename is automatically created, in the form: `<model>_<serial number>_<date><time>.bkz`

If you wish to enter a customer filename, you can do so with an external keyboard, or by opening the onscreen Alpha keyboard, by pressing the **Keyboard** hardkey on the front panel:



When the **Next >** button is pressed, you will be prompted to create a new folder if the chosen path does not yet exist.

4 System
4.6 Alignments

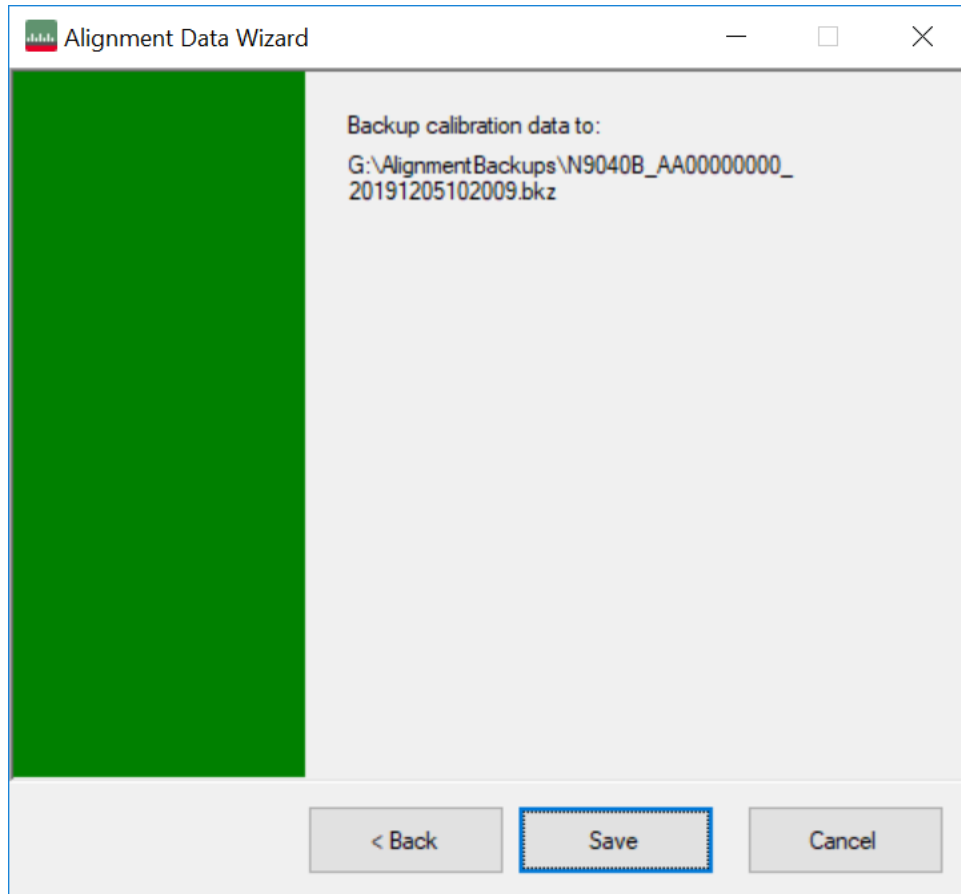

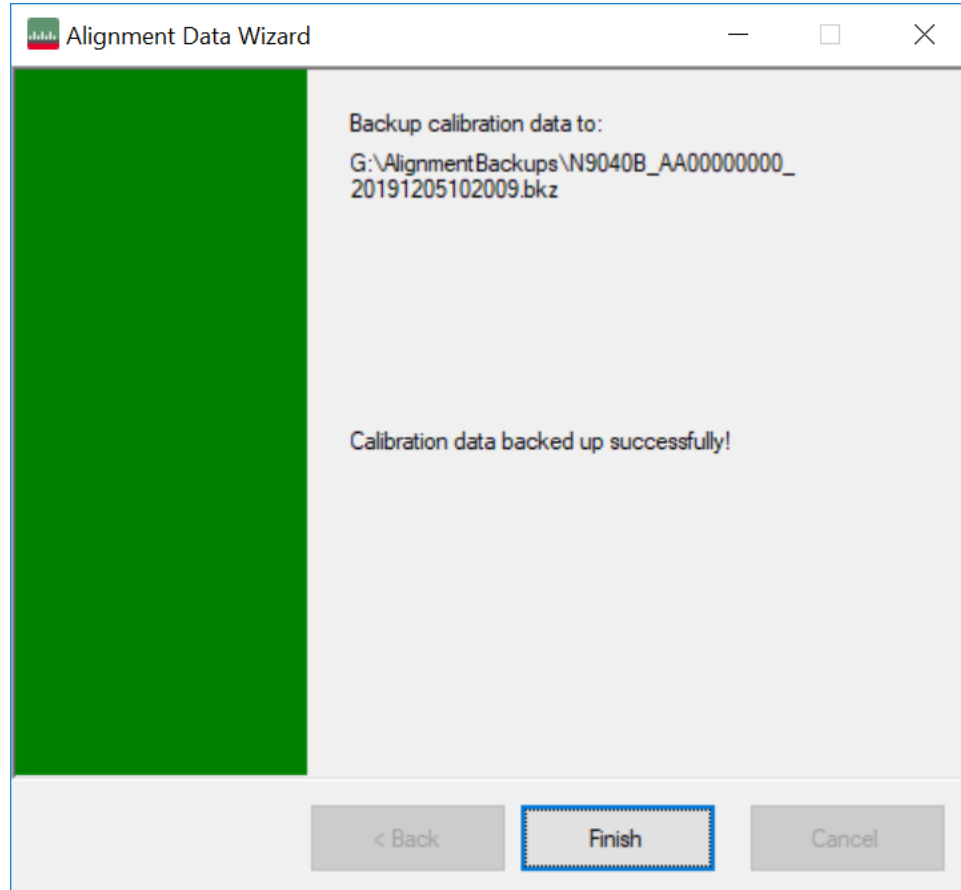

The restore operation checks the validity of the restore file using the database's built-in file validation. If the restore file is corrupt, the existing alignment data will remain in use.

If the serial number information in the backup file being restored is different from that of the instrument, the following message appears (the serial numbers shown are examples):

4 System
4.6 Alignments

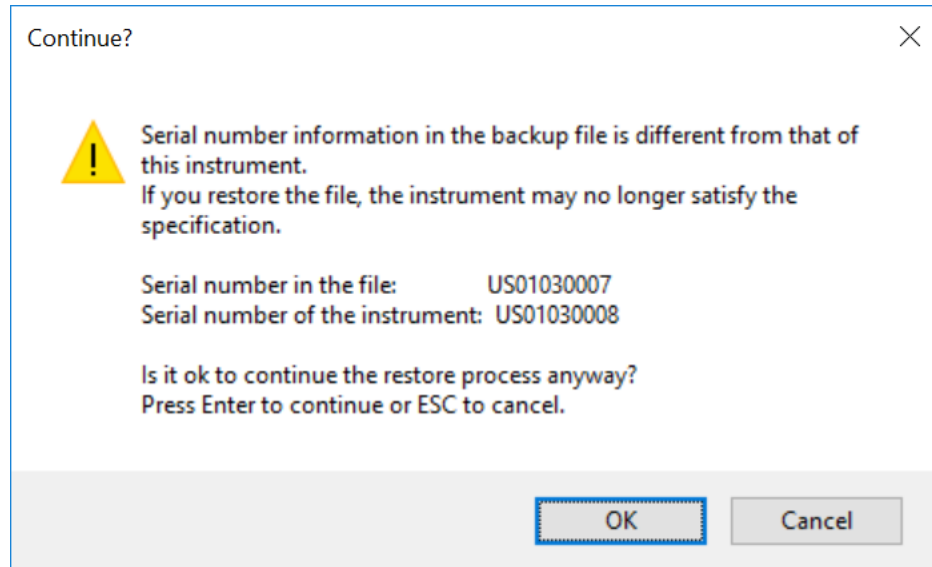

The default restore location for instruments *without* internal flash will be the first drive identified as an external drive (USB or LAN) if such is available; or, if not, the internal D: partition. The default restore file will be the most recent file that matches the default backup file name format: `<model number>_<serial number>_<date>.bkz`

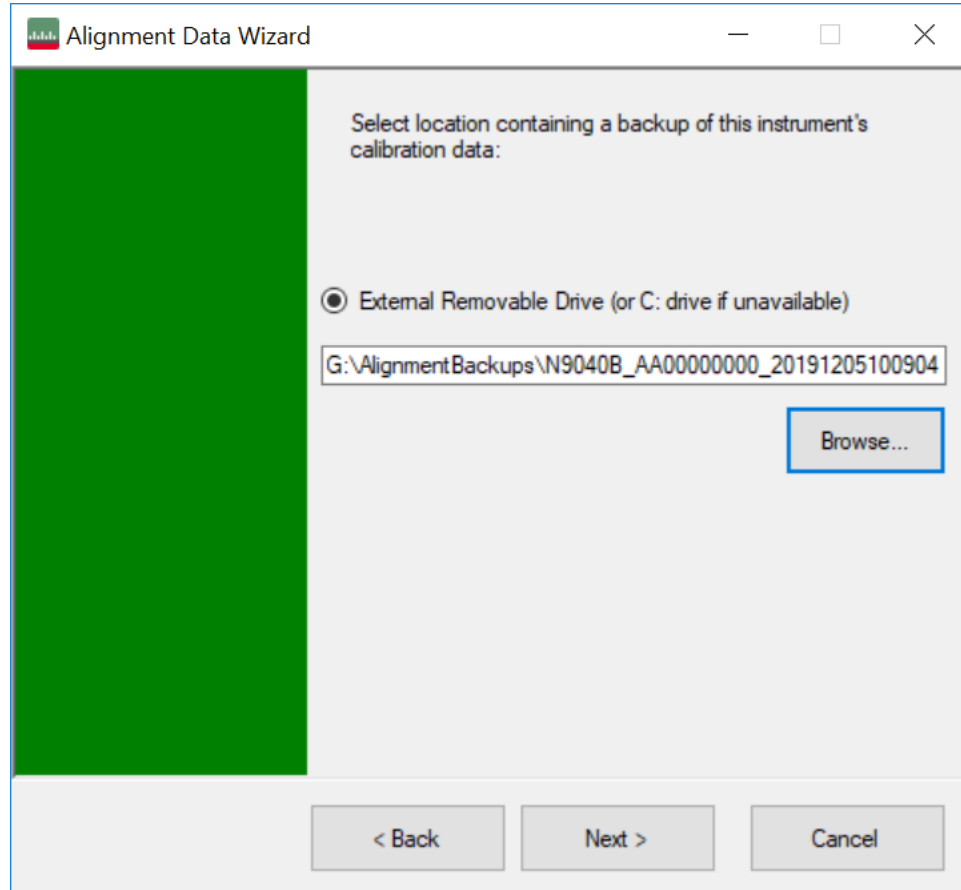

Changing the drive letter also modifies the path displayed in the box below. When this step is first loaded, the drive drop-down menu is populated with connected drives, which provide you with read access.

The path defaults to the **AlignBackups** folder. The most recent backup (*.bkz or *.bak) file in the folder will also be selected by default.

4 System
4.6 Alignments

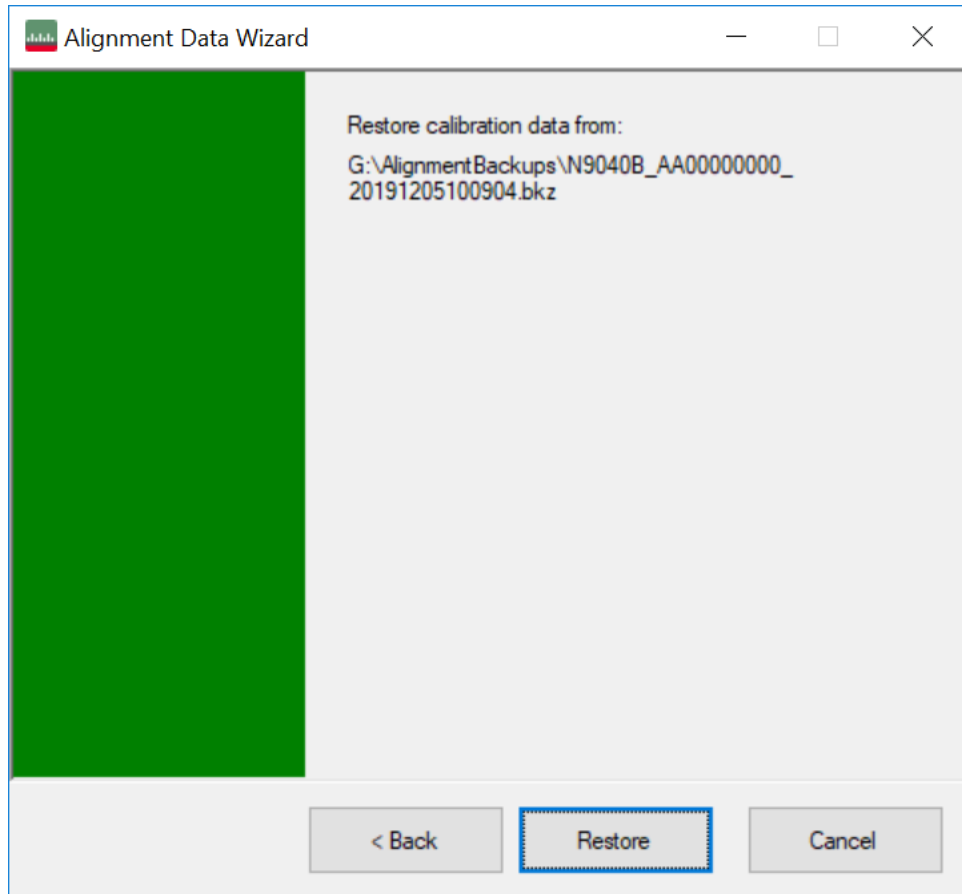

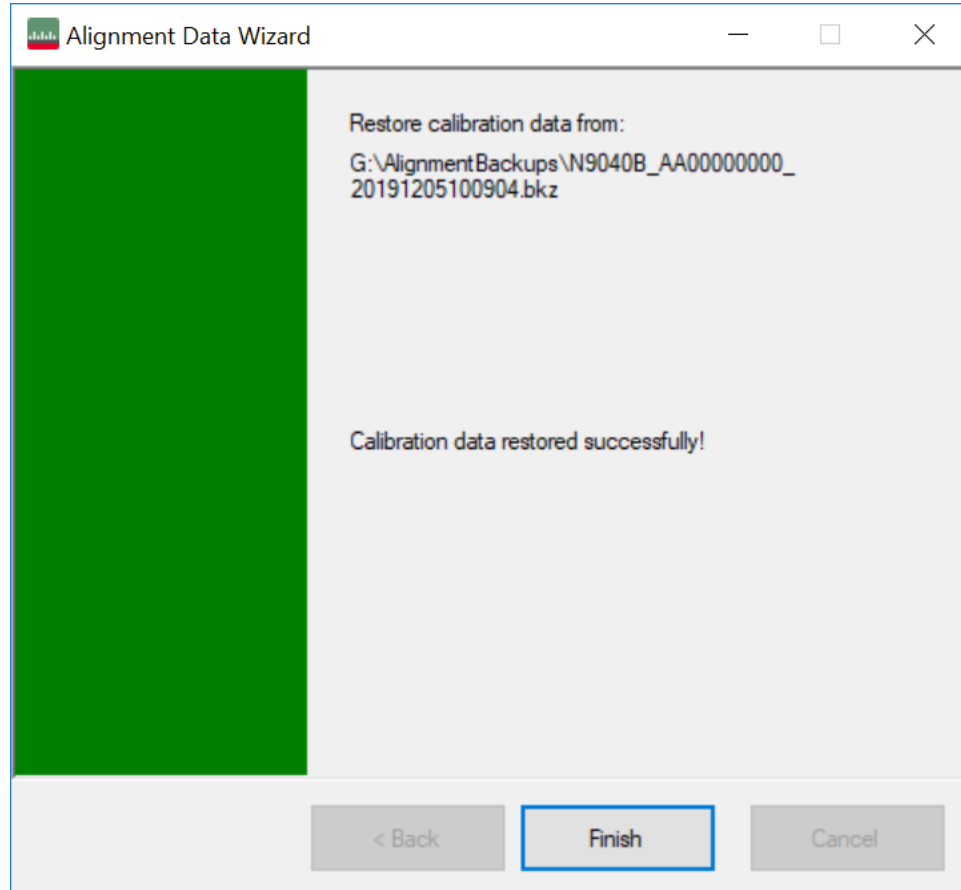

When restoring data in the legacy `.bak` format, Administrator privileges are required. You will be prompted when you attempt a restore (indicated by the UAC Shield on the **Restore** button below).

4 System
4.6 Alignments

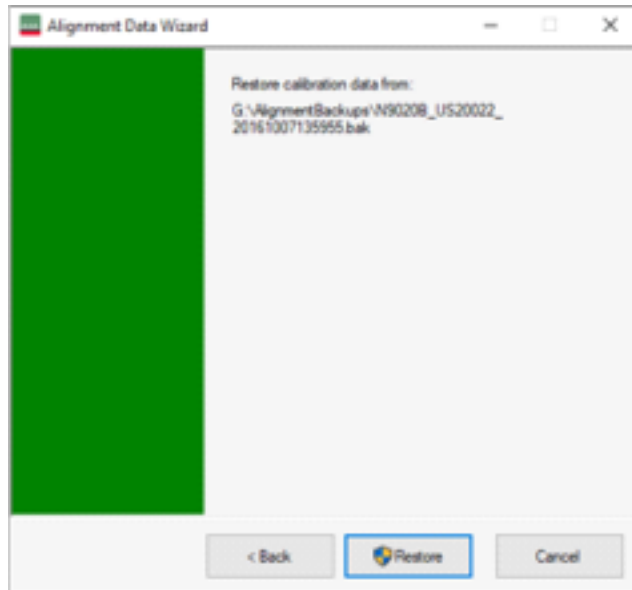

Perform Backup (without Flash) (Remote Command Only)

Invokes an alignment data backup operation to the provided location.

NOTE

Keysight recommends that the specified location should be external to the instrument (USB or Mapped Network Drive).

Remote Command `:CALibration:DATA:BACKup <filename>`

Example `:CAL:DATA:BACK "F:\AlignDataBackup_N9020A_US00000001_2008140100.bkz"`

Perform Restore (without Flash) (Remote Command Only)

Invokes an alignment data restore operation from the provided filename.

Remote Command `:CALibration:DATA:RESTore <filename>`

Example `:CAL:DATA:REST "F:\ AlignDataBackup_N9020A_US00000001_2008140100.bkz"`

Alignment Data Wizard (with Flash)

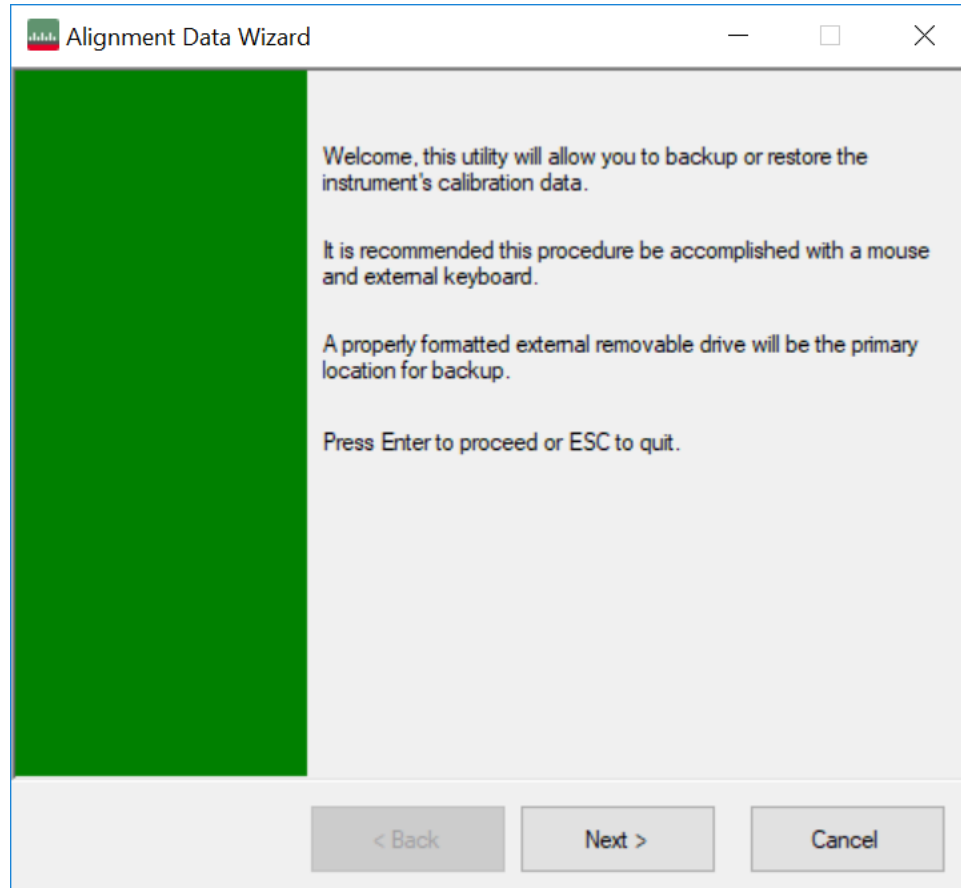

If your instrument has Processor Assembly type PC6S or PC7S (see ["Show System" on page 1837](#)) the instrument has an internal flash EEPROM that can store a backup of the alignment data. In this case, the interface to the Alignment Data Wizard is enhanced to accommodate this internal storage. This section details the use of this internal flash. For details on using external storage, see the previous section (["Alignment Data Wizard \(without Flash\)" on page 1946](#)).

The Alignment Data Wizard guides you through the operations of backing up or restoring alignment data.

4 System
4.6 Alignments

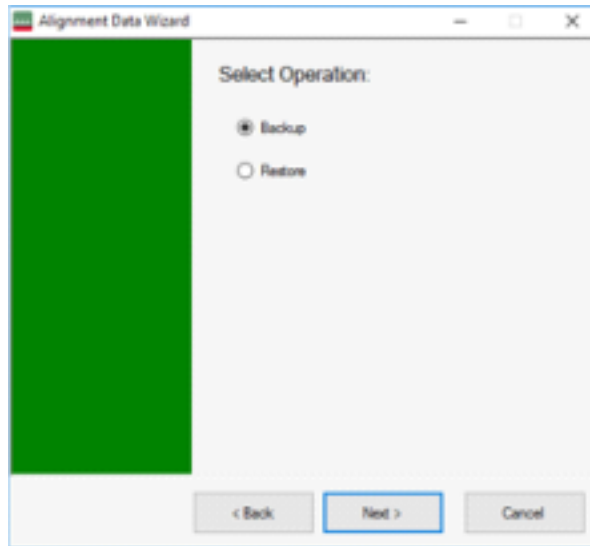

Having selected **Backup** or **Restore**, you then select the source or destination for the alignment data. As shown below, you can select either:

- Internal flash EEPROM, or,
- External Removable Drive (which includes the SD card described in "[Backup or Restore Align Data...](#)" on page 1945)

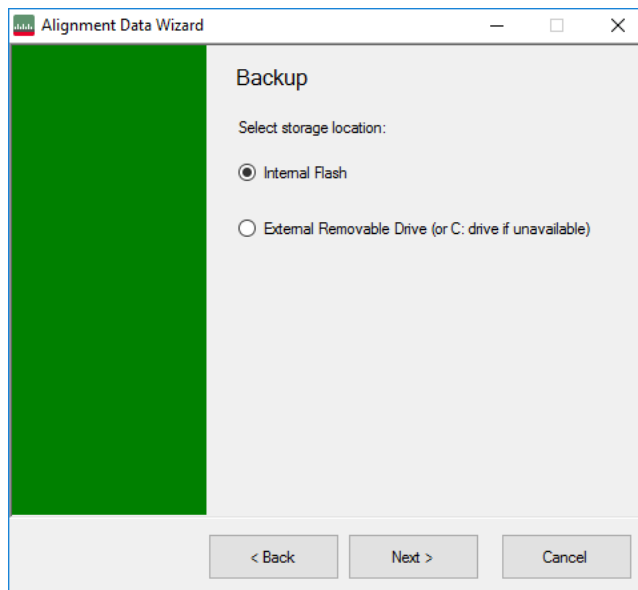

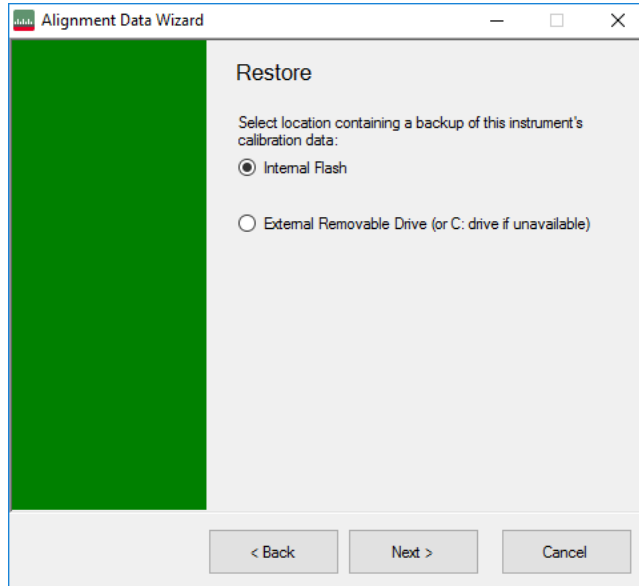

The final page of the wizard asks you to confirm the choices made in the previous pages. When the operation is complete, an indication is displayed on the same page, as below.

Backup

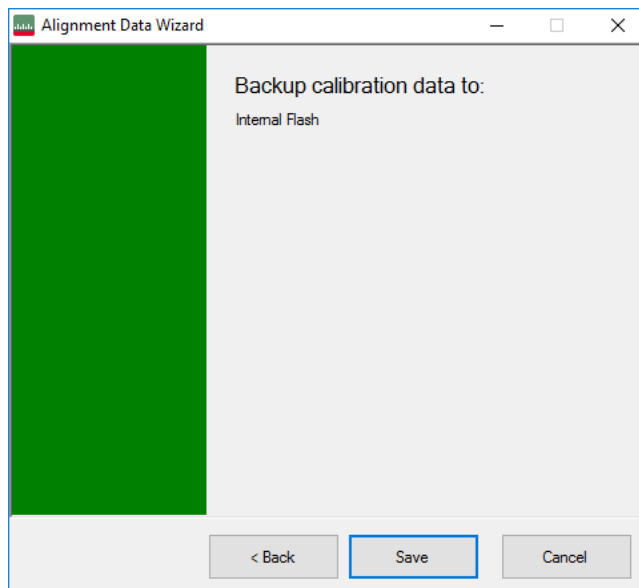

4 System
4.6 Alignments

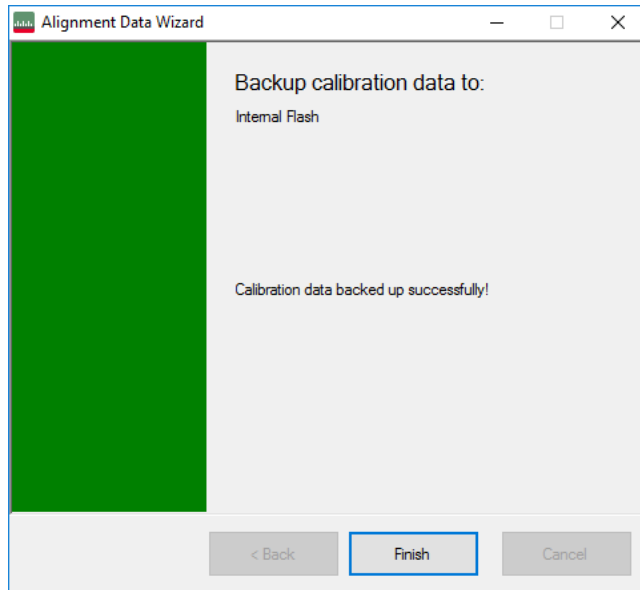

Restore

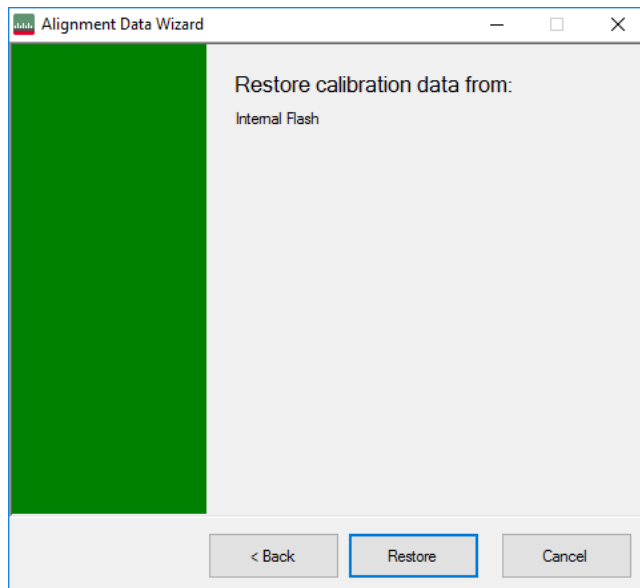

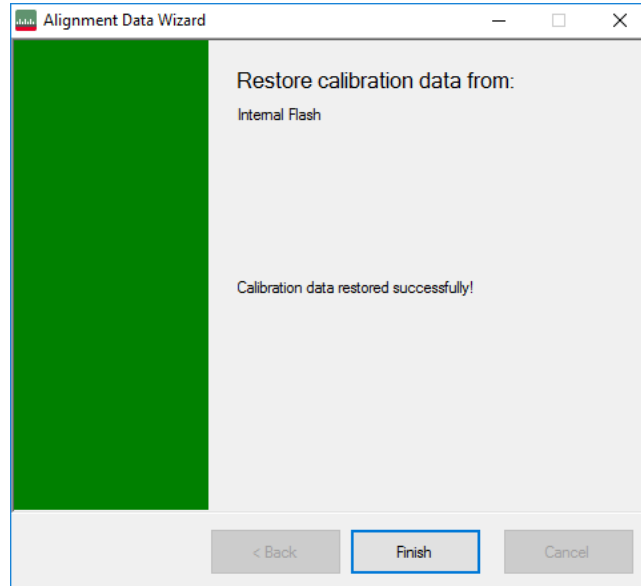

When restoring alignment data, if the serial number information in the backup file being restored is different from that of the instrument, the following message appears (the serial numbers shown are examples):

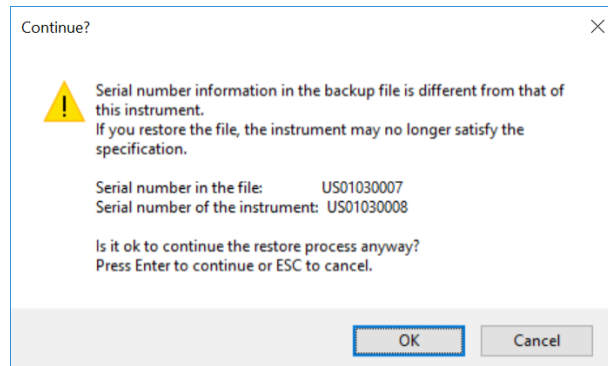

Immediately before the actual restoration, a final confirmation message is displayed detailing what is being restored and the current database that will be overwritten on the disk (the dates and versions are examples):

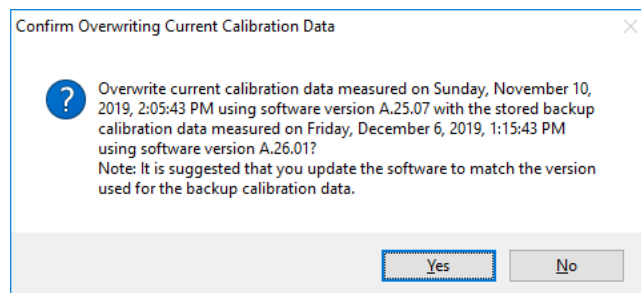

4 System

4.6 Alignments

When backing up alignment data to the flash, if there is already an existing backup on the flash, a final confirmation message is displayed detailing what is being backed up and what will be overwritten on the flash (again, the dates and versions are examples):

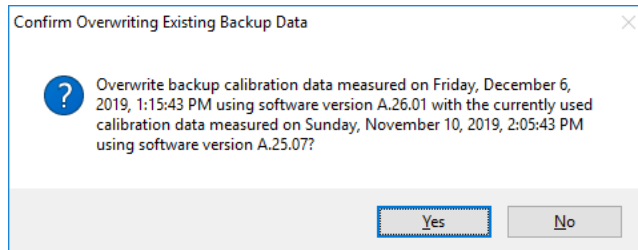

Perform Backup (with Flash) (Remote Command Only)

Invokes an alignment data backup operation to the internal flash EEPROM.

Remote Command `:CALibration:DATA:INTernal:BACKup`

Example `:CAL:DATA:INT:BACK`

Perform Restore (With Flash) (Remote Command Only)

Invokes an alignment data restore operation from the internal flash EEPROM.

Remote Command `:CALibration:DATA:INTernal:RESTore`

Example `:CAL:DATA:INT:REST`

Restore Alignment Defaults

Causes the Alignment system settings to be reset to their default values. This does not affect any Alignment data stored in the system.

After performing this function, it may impact the auto-alignment time of the instrument until a new alignment baseline has been established.

When **Alignments** is selected, a message appears saying:

`This will reset all of the settings for the Alignment system to their default values`

`No alignment data will be erased`

`This action cannot be undone. Do you want to proceed?`

The dialog includes **OK** and **Cancel** controls, for you to affirm or cancel the operation.

Align Now All must be executed if the value of the Timebase DAC results in a change.

Example	<code>:SYST:DEF ALIG</code>												
Notes	<p>Alignment processing that results as the transition to Auto Align Normal will be executed sequentially; thus <code>*OPC?</code> or <code>*WAI</code> will wait until the alignment processing is complete</p> <p>The parameters affected are:</p> <table border="1"> <thead> <tr> <th>Parameter</th> <th>Setting</th> </tr> </thead> <tbody> <tr> <td>Timebase DAC</td> <td>Calibrated</td> </tr> <tr> <td>Timebase DAC setting</td> <td>Calibrated value</td> </tr> <tr> <td>Auto Align State</td> <td>Normal (if the instrument is not operating with default alignment data, Off otherwise)</td> </tr> <tr> <td>Auto Align All but RF</td> <td>Off</td> </tr> <tr> <td>Auto Align Alert</td> <td>Time & Temperature</td> </tr> </tbody> </table>	Parameter	Setting	Timebase DAC	Calibrated	Timebase DAC setting	Calibrated value	Auto Align State	Normal (if the instrument is not operating with default alignment data, Off otherwise)	Auto Align All but RF	Off	Auto Align Alert	Time & Temperature
Parameter	Setting												
Timebase DAC	Calibrated												
Timebase DAC setting	Calibrated value												
Auto Align State	Normal (if the instrument is not operating with default alignment data, Off otherwise)												
Auto Align All but RF	Off												
Auto Align Alert	Time & Temperature												

4.6.6.7 oGRF Preselector

This menu and all its submenus are only available in models with the RF Preselector, such as N9038B, or N9048B.

Dependencies	Only available in RF Preselector models
--------------	---

Align Now, 20 Hz to 30 MHz

Immediately executes an alignment of the receiver subsystem. The receiver will stop any measurement currently underway, perform an Align Now All, then perform the RF Preselector alignment, and then restart the measurement from the beginning (similar to pressing the Restart key).

The query `:CALibration:RFPSelector:CONDucted?` invokes the alignment of the RF Preselector on Conducted Band and returns a success or failure value. Successful completion clears the “Align 20 Hz to 30 MHz required” Error Condition, and clears bit 1 in the Status Questionable Calibration Extended Needed register. The elapsed time counter will begin for Last Align Now, Conducted Time, and the temperature is captured for the Last Align Now, Conducted Temperature. The alignment can be interrupted by pressing the Cancel (ESC) front-panel key or remotely with Device Clear followed by the `:ABORt` SCPI command. When this occurs, the Error Condition “Align 20 Hz to 30 MHz required” is set because new alignment data may be employed for an individual subsystem, but not a cohesive set of data for all subsystems.

4 System
4.6 Alignments

The “Align 20 Hz to 30 MHz required” Error Condition will appear when this alignment has expired. User is now responsible to perform the Align Now, 20 Hz to 30 MHz to keep the receiver in warranted operation. This alignment can only be performed by user as it is not part of the Auto Align process.

Remote Command	<code>:CALibration:RFPSelector:CONDUCTed</code> <code>:CALibration:RFPSelector:CONDUCTed?</code>
Example	<code>:CAL:RFPS:COND</code>
Notes	<p>The query returns 0 if successful, or 1 if failed</p> <p>When Align 20 Hz to 30 MHz is performing the alignment, bit 0 in the Status Operation register is set. Completion, or termination, will clear bit 0 in the Status Operation register</p> <p>This command is sequential; it must complete before further SCPI commands are processed. Interrupting the alignment from remote is accomplished by invoking Device Clear followed by the <code>:ABORt</code> command. Successful completion will clear bit 1 in the Status Questionable Calibration Extended Needed register and bit 0 in Status Questionable Calibration Extended Failure register</p> <p>A failure encountered during alignment will set the Error Condition “20 Hz to 30 MHz Alignment Failure” and set both bit 1 in the Status Questionable Calibration Extended Needed register and bit 9 in Status Questionable Calibration register</p>
Dependencies	Does not appear in non-RF Preselector models, setting or querying the SCPI will generate an error
Couplings	<p>Initializes the time for the Last Align Conducted Now, Conducted Time</p> <p>Records the temperature for the Last Align Conducted Now, Conducted Temperature</p>
State Saved	No
Status Bits/OPC dependencies	<p>Bit 8 or 9 may be set in the Status Questionable Calibration register</p> <p>Bit 1 may be set in the Status Questionable Calibration Extended Needed register</p> <p>Bit 0 may be set in the Status Questionable Calibration Extended Failure register</p>

Align Now, 30 MHz to 3.6 GHz

Immediately executes an alignment of the receiver subsystem. The receiver will stop any measurement currently underway, perform an Align Now All, then perform the RF Preselector alignment, and then restart the measurement from the beginning (similar to pressing the **Restart** key).

The query (`:CALibration:RFPSelector:RADiated?`) invokes the alignment of the RF Preselector on Radiated Band and returns a success or failure value. Successful completion clears the “Align 30 MHz to 3.6 GHz required” Error Condition, and clears bit 2 in the Status Questionable Calibration Extended Needed register. The elapsed time counter begins for Last Align Now, Radiated Time, and the temperature is captured for the Last Align Now, Radiated Temperature. The alignment can be interrupted by pressing the **Cancel (ESC)** front-panel key, or remotely with Device Clear followed by `:ABORt`. When this occurs, the Error Condition “Align 30 MHz to 3.6 GHz required” is set, because new alignment data may be employed for an individual subsystem, but not a cohesive set of data for all subsystems.

The “Align 30 MHz to 3.6 GHz required” Error Condition appears when this alignment has expired. You must now perform **Align Now, 30 MHz to 3.6 GHz** to keep the receiver in warranted operation.

Remote Command	<code>:CALibration:RFPSelector:RADiated</code> <code>:CALibration:RFPSelector:RADiated?</code>
Example	<code>:CAL:RFPS:RAD</code>
Notes	<p>The query returns 0 if successful, or 1 if failed</p> <p>When Align 30 MHz to 3.6 GHz is performed, alignment, bit 0 in the Status Operation register is set. Completion, or termination, clears bit 0 in the Status Operation register</p> <p>This command is sequential; it must complete before further SCPI commands are processed. Interrupting the alignment from remote is accomplished by invoking Device Clear followed by <code>:ABORT</code>. Successful completion clears bit 2 in the Status Questionable Calibration Extended Needed register and bit 1 in Status Questionable Calibration Extended Failure register</p> <p>A failure encountered during alignment sets the Error Condition “30 MHz to 3.6 GHz Alignment Failure” and sets both bit 2 in the Status Questionable Calibration Extended Needed register and bit 9 in Status Questionable Calibration register</p>
Dependencies	Does not appear in non-RF Preselector models, setting or querying the SCPI will generate an error
Couplings	<p>Initializes the time for the Last Align Radiated Now, Radiated Time</p> <p>Records the temperature for the Last Align Radiated Now, Radiated Temperature</p>
State Saved	No
Status Bits/OPC dependencies	<p>May set Bit 8 or 9 in the Status Questionable Calibration register</p> <p>May set Bit 2 in the Status Questionable Calibration Extended Needed register</p> <p>May set Bit 1 in the Status Questionable Calibration Extended Failure register</p>

Align Now, 20 Hz to 3.6 GHz

Immediately executes an alignment of the receiver subsystem. The receiver will stop any measurement currently underway, perform an Align Now All, then perform the RF Preselector alignment, and then restart the measurement from the beginning (similar to pressing the **Restart** key).

The query (`:CALibration:RFPSelector:FULL?`) invokes the alignment of the RF Preselector on both Conducted and Radiated Band and return a success or failure value. Successful completion clears the “Align 20 Hz to 3.6 GHz required” Error Condition, and clears bit 1 and bit 2 in the Status Questionable Calibration Extended Needed register. The elapsed time counter begins for Last Align Now, Conducted Time and Last Align Now Radiated Time and the temperature is captured for Last Align Now, Conducted Temperature and Last Align Now, Radiated Temperature. The alignment can be interrupted by pressing the **Cancel (ESC)** front-panel key or remotely with Device Clear, followed by `:ABORT`. When this occurs, the Error Condition “Align 20 Hz to 3.6 GHz required” is set, because new alignment data may be employed for an individual subsystem, but not a cohesive set of data for all subsystems.

4 System
4.6 Alignments

The “Align 20 Hz to 3.6 GHz required” Error Condition appears when this alignment has expired. You must now perform the Align Now, 20 Hz to 3.6 GHz to keep the receiver in warranted operation.

Remote Command	<code>:CALibration:RFPSelector:FULL</code> <code>:CALibration:RFPSelector:FULL?</code>
Example	<code>:CAL:RFPS:FULL</code>
Notes	The query returns 0 if successful, or 1 if failed When Align 20 Hz to 3.6 GHz is performed, alignment, bit 0 in the Status Operation register is set. Completion, or termination, clears bit 0 in the Status Operation register This command is sequential; it must complete before further SCPI commands are processed. Interrupting the alignment from remote is accomplished by invoking Device Clear, followed by <code>:ABORT</code> . Successful completion clears bit 1, bit 2 in the Status Questionable Calibration Extended Needed register and bit 0, bit 1 in Status Questionable Calibration Extended Failure register A failure encountered during alignment sets the Error Condition “20 Hz to 3.6 GHz Alignment Failure” and sets bit 1, bit 2 in the Status Questionable Calibration Extended Needed register and bit 9 in Status Questionable Calibration register
Dependencies	Does not appear in non-RF Preselector models, setting or querying the SCPI generates an error
Couplings	Initializes the time for the Last Align Conducted Now, Conducted Time Initializes the time for the Last Align Radiated Now, Radiated Time Records the temperature for the Last Align Conducted Now, Conducted Temperature Records the temperature for the Last Align Radiated Now, Radiated Temperature
State Saved	No
Status Bits/OPC dependencies	May set Bit 8 or 9 in the Status Questionable Calibration register May set Bit 1 and 2 in the Status Questionable Calibration Extended Needed register May set Bit 0 and 1 in the Status Questionable Calibration Extended Failure register

Alert

Enables or disables the display of RF Preselector alignment required message on the status line. The instrument powers up with Alert **ON**.

Remote Command	<code>:CALibration:RFPSelector:ALERT ON OFF 0 1</code> <code>:CALibration:RFPSelector:ALERT?</code>
Example	<code>:CAL:RFPS:ALER OFF</code>
Notes	Error Condition is generated when alert is ON and any of the RF Preselector alignments has expired
Preset	Unaffected by Preset, but set to ON by Restore Defaults > "Alignments" on page 1892
State Saved	No
Range	OFF ON

4.6.6.8 Scheduler

Setting the Scheduler to **ON** triggers execution of the scheduled task based on the recurrence and time set in the scheduler since the last successful of the specific alignment. A warning condition of “RF Preselector alignment scheduler is ON” appears when the scheduler is set to **ON**. **OFF** prevents the Scheduler from running any scheduled task.

Remote Command	:CALibration:RFPSelector:SCHeDuler:STATe ON OFF 0 1
Example	:CAL:RFPS:SCH:STAT OFF
Preset	Unaffected by Preset, but set to ON by Restore Defaults > "Alignments" on page 1892
State Saved	No
Range	OFF ON

Schedule Setup

Lets you schedule a task to run automatically at the background based on the recurrence and time set in the scheduler. Make sure that the instrument’s local time is accurate, because the Scheduler relies on this information to execute the task.

This dialog contains the following controls:

- "Task" on page 1966
- "Date/Time" on page 1967
- "Hour" on page 1968
- "Minute" on page 1968
- "Recurrence" on page 1968
- "Number of Weeks" on page 1968
- "Day" on page 1969

Task

There are 3 tasks that can be selected for the scheduler to run.

- Task 1 is the 20 Hz to 30 MHz alignment
- Task 2 is the 30 MHz to 3.6 GHz alignment

4 System
4.6 Alignments

- Task 3 is the 20 Hz to 3.6 GHz alignment

Remote Command	<code>:CALibration:RFPSelector:SCHeduler:TASK T1 T2 T3</code> <code>:CALibration:RFPSelector:SCHeduler:TASK?</code>
Example	<code>:CAL:RFPS:SCH:TASK T1</code>
Notes	Changing the task does not reset the Scheduler time, and the alignment is based on the current scheduled configuration to occur
Preset	Unaffected by Preset but set to T3 by Restore Defaults > "Alignments" on page 1892
State Saved	No
Range	Task 1 Task 2 Task 3

Date/Time

Lets you configure the scheduler to run a task starting from this date and time. The date and time rely on the instrument's local time to execute a scheduled task. The date format is "YYYY/MM/DD" and the time is 24-hour clock.

Remote Command	<code>:CALibration:RFPSelector:SCHeduler:TIME:START "date", "time"</code> <code>:CALibration:RFPSelector:SCHeduler:TIME:START?</code> This query returns data using the format "YYYY/MM/DD; HH:MM:SS"
Example	<code>:CAL:RFPS:SCH:TIME:STAR "2009/8/20", "12:00:00"</code>
Notes	<p>"date" is the date the task will run, in the form YYYY/MM/DD where:</p> <ul style="list-style-type: none"> - YYYY is the four-digit representation of year (for example, 2009) - MM is the two-digit representation of month (for example, 01 to 12) - DD is the two-digit representation of the day (for example, 01 to 28, 29, 30 or 31 depending on the month and year) <p>"time" is the time of day the task will run, in the form HH:MM:SS where:</p> <ul style="list-style-type: none"> - HH is the two-digit representation of the hour in 24-hour format - MM is the two-digit representation of minute - SS is the two-digit representation of seconds
Preset	Unaffected by Preset but set to Current date and 00:00:00 by Restore Defaults > "Alignments" on page 1892
State Saved	No

Hour

Lets you configure the hour for the scheduled task. The command to configure the date and time parameters of the scheduler is the same; but they each have their own front panel-control.

Notes	See "Date/Time" on page 1967
Preset	Unaffected by Preset but set to Current hour and 00 by Restore Defaults > "Alignments" on page 1892
State Saved	No

Minute

Lets you configure the minute for the scheduled task. The command to configure the date and time parameters of the scheduler is the same; but they each have their own front panel-control.

Notes	See "Date/Time" on page 1967
Preset	Unaffected by Preset but set to Current minute and 00 by Restore Defaults > "Alignments" on page 1892
State Saved	No

Recurrence

Lets you configure the scheduler to run the task recurrently on a scheduled date and time. You can schedule it to run daily, weekly, or alternate weeks.

Remote Command	<code>:CALibration:RFPSelector:Scheduler:REcurrence DAY WEEK OFF</code>
Example	<code>:CAL:RFPS:SCH:REC DAY</code>
Preset	Unaffected by Preset but set to OFF by Restore Defaults > "Alignments" on page 1892
State Saved	No
Range	<code>DAY WEEK OFF</code>

Number of Weeks

Lets you set the number of weeks that the scheduler will wait to trigger a task.

Remote Command	<code>:CALibration:RFPSelector:Scheduler:REcurrence:WEEK <integer></code>
Example	<code>:CALibration:RFPSelector:Scheduler:REcurrence:WEEK?</code>

4 System
4.6 Alignments

Example	<code>:CAL:RFPS:SCH:REC:WEEK 2</code>
Notes	New scheduled date to run the alignment task is updated when this parameter is changed
State Saved	No
Range	1-52
Min	1
Max	52

Day

Lets you set the Day of the Week the scheduler will run a scheduled task.

Remote Command	<code>:CALibration:RFPSelector:SCHeduler:RECurrence:DAY SUN MON TUE WED THU FRI SAT</code> <code>:CALibration:RFPSelector:SCHeduler:RECurrence:DAY?</code>
Example	<code>:CAL:RFPS:SCH:REC:DAY SUN</code>
State Saved	No
Range	Sunday Monday Tuesday Wednesday Thursday Friday Saturday

4.7 Licensing

Accesses capabilities for configuring the licenses in your instrument.

4.7.1 License Manager

Opens the License Explorer for Fixed and Transportable licenses.

NOTE

This feature is not available if Option SF1 is installed.

For help on licensing, select **Help** in the menu bar at the top of the License Explorer window.

There are also several remote commands available for licensing. See:

- ["Install License \(Remote Command Only\)" on page 1978](#)
- ["Remove License \(Remote Command Only\)" on page 1978](#)
- ["List Licenses \(Remote Query Only\)" on page 1979](#)
- ["Validate License \(Remote Query Only\)" on page 1980](#)
- ["Host ID Query \(Remote Query Only\)" on page 1980](#)
- ["List Borrowed Licenses \(Remote Query Only\)" on page 1975](#)
- ["Return a Borrowed License \(Remote Command Only\)" on page 1976](#)

Notes

No equivalent remote command for this control

4.7.2 System Software Version Date

The date of the newest features introduced in this release of the firmware. This is *not* necessarily the same as the build date of the firmware, because the version date only changes when new features are added. For example, if A.18.06 has only defect fixes and no new features compared to A.18.05, then both A.18.05 and A.18.06 would have the same software version date.

For any feature to be enabled, the SW Support Expiration Date of the enabling license must be greater than or equal to the software version date when that feature was first introduced. See the Keysight web site for features related to a specific software application and their required support date.

The SCPI response is 3 integer values: `<year>, <month>, <day>`.

Remote Command :SYSTem:SOFTware:VERSion:DATE?

Example :SYST:SOFT:VERS:DATE?

4.7.3 Software Support Expiration Date

This date is encoded in each software license's Version field in the **YYYY.MMDD** format. It specifies the end date of the support contract associated with this license. When a support contract is renewed, a new license is issued with an updated Version corresponding to the new contract's end date. The functionality available for a license is determined by the features available before the expiration date. For example, if feature X is introduced in a release with System Software Version Date of **2017.0831**, then a license with a Software Support Expiration Date of **2017.0831** or greater would enable feature X, but **2017.0830** or earlier would not enable feature X.

The SCPI response is 3 integer values: **<year>, <month>, <day>**.

Remote Command :SYSTem:LKEY:SOFTware:SUPPort:EXPIration:DATE? <feature>

Example :SYST:LKEY:SOFT:SUPP:EXP:DATE? "N9084EM0E-1FP"

Dependencies When **<feature>** is not a valid license, one of the following errors will be issued:

- -224, "IllegalParameterValue;License is not installed"
- -224, "IllegalParameterValue;Unknown license feature"
- -224, "IllegalParameterValue;Support contract not offered for this license"

4.7.4 Network Licenses

Network Licenses are available over the customer's network from a server the customer configures. The server has a count for each license and will only allow instruments to "check-out" a license up to that count. Once the count is reached for a specific license, further check-outs fail until one of the licenses is checked back in to the server. What this means is that it is possible for an instrument to have different features available to it based on what licenses are still available on the server when it tries to get licenses.

Setting up network licenses is done via the [Keysight Floating License Manager](#) (available on external Keysight web) and it has an Installation Guide that can be downloaded from that web page.

4.7.4.1 Application Licenses

Application Licenses (like N9077EM0E-1NP) are automatically checked out when entering the Mode that uses them, and they are automatically checked-in when leaving that Mode. Because the server may have already checked out the last license for the application to another instrument, there is now the possibility that a mode switch will fail because a required license could not be checked out from the server. If the server has a limited number of licenses compared to the number of users desiring to use that license, this may mean that switching from Mode A to Mode B then back to Mode A may fail when returning to Mode A because another instrument checked out the last available license while the user was in Mode B. Also, for Modes with multiple licenses for different features (like Multi-Standard Radio), the features available may also change when switching out of the Mode and back into it.

So, when using network licenses, it is necessary to check `:SYST:ERR?` after every Mode switch, to verify that it successfully switched. If the Mode's required licenses were not successfully checked out, the instrument posts the error:

```
-310,"System error; feature not licensed"
```

There is also a potential performance issue when using network licenses, because the instrument must communicate with the server on each license check-out and check-in. This operation is usually fast (a few milliseconds), but it depends on the network communication lag between the instrument and server. For remote servers on slow or congested networks, this could be significantly slower than that.

4.7.4.2 Instrument Software Options

Instrument software licenses are those that are reported via `*OPT?` the same as HW options. For example, N9040RT1B-1NP is an instrument software option, and is reported via `*OPT?` as `RT1`. Note that the license is composed of the model number (in this case `N9040B`) combined with the option code (`RT1`).

When instrument software options are available from a network server, the instrument automatically checks them out at start-up, and only checks them in when shutting down.

4.7.4.3 License Checked Out Query (Remote Query Only)

Shows whether the specified license is checked out from a server. Since network served licenses may not always be available when there are limited licenses available compared to the desired number of users, the features available on an instrument can vary. Use this query to see whether the feature is currently checked-out to the instrument. The return value is boolean (0 or 1), returning 1 if the feature

exists and is checked out from a server. Note that querying a license that is local to the instrument (-xFP or -xTP) also returns 0, even though the license exists and is valid, because it does not require a check-out. Also, querying a license that does not exist returns 0.

Remote Command	<code>:SYSTem:LKEY:COU? <feature></code>
Example	<code>:SYST:LKEY:COU? "N9080EM0E"</code> 1
Notes	<code><"OptionInfo"></code> contains the feature and the version. You must specify the feature but can omit the version. If you omit the version, the system regards it as the latest one Return Value: 0 if not checked out, 1 if checked out

4.7.4.4 List Licenses Checked Out (Remote Query Only)

Lists the licenses checked out from a server. Since network served licenses may not always be available when there are limited licenses available compared to the desired number of users, the features available on an instrument can vary. Use this query to see which features are currently checked-out to the instrument.

Remote Command	<code>:SYSTem:LKEY:COU:LIST?</code>
Example	<code>:SYST:LKEY:COU:LIST?</code> #284 N9073EM0E,2018.0831 N9077EM0E,2018.0831 N9080EM0E,2018.0831 N9081EM0E,2018.0831

4.7.4.5 Borrowed Network Licenses

Network licenses can be borrowed from the network license server for a time. The maximum amount of time a license can be borrowed is specified in the license installed on the server and is set at the time the license is generated by Keysight. As part of the borrow operation, you specify how long to borrow the license. This borrow period is in hours and can be any time up to the maximum allowed by the license. Once borrowed, the license appears as a local license and can be used even when not connected to the network, and the instrument software treats them the same as other time-based licenses that are installed on the instrument. This means the licenses are validated when the instrument is started and then are used without the overhead of checking them out and back in when switching Modes. At the time of the borrow, a time is specified for how long the license will be borrowed. When that time expires, the license is automatically returned to the network license server

even if the instrument is not connected to the network. If you are done with the license before it automatically returns to the network server, the license can be explicitly returned earlier.

4.7.4.6 Borrow a License

Licenses are borrowed by using the Keysight License Manager 6 application. This can be launched from the **System Licensing** screen.

Graphic

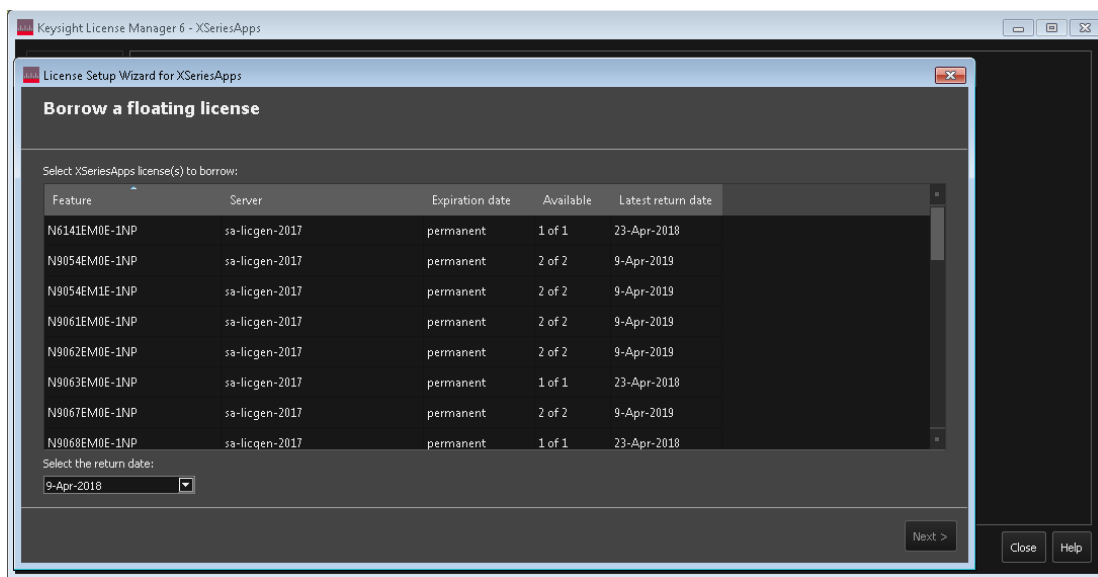

The corresponding remote command is:

Remote Command	<code>:SYSTem:LKEY:BORRow "<feature>[,<version>]",<return date></code> <code>:SYSTem:LKEY:BORRow? "<feature>[,<version>]"</code>
Example	<code>:SYST:LKEY:BORR "N9080EM0E", "20-Aug-2018"</code> <code>:SYST:LKEY:BORR? "N9080EM0E"</code> <code>: "20-Aug-2018"</code>
Notes	If <code><version></code> is not specified, the highest available version will be borrowed The <code><return date></code> is the day when the borrow will automatically be returned to the server
Dependencies	For the command, when <code><feature></code> is not a valid license, or when a license is not currently available for borrowing, one of the following errors is issued: <ul style="list-style-type: none"> - -224, "IllegalParameterValue;License is not installed" - -224, "IllegalParameterValue;Unknown license feature"

-
- -224, "IllegalParameterValue;License not available for borrowing"

Additionally, the return date is evaluated. If it is not a valid date, the following error is issued:

- -224, "IllegalParameterValue;Invalid return date"
- -200, "Execution error; No Available Borrow Licenses For Feature: <feature>"

The return date may be clipped to the maximum borrow allowed by the license. When this happens, the following warning is issued:

- -221, "Return date clipped to maximum of <max date>"

For the query, the return is the borrow return date (as a string in **dd-mmm-yyyy** format) if the license is borrowed. In all other cases, (not borrowed, not installed, etc.) the return is an empty string

4.7.4.7 Listing Borrowed Licenses and Return a Borrowed License

The Keysight License Manager 6 can also be used to see the currently borrowed licenses or return a license before the automatic return time.

Graphic

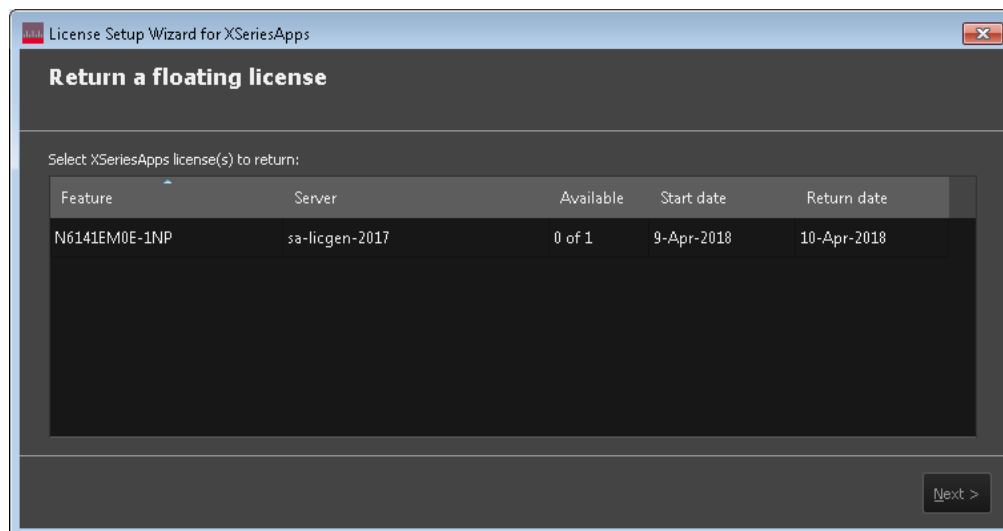

List Borrowed Licenses (Remote Query Only)

Remote Command :SYSTem:LKEY:BORRow:LIST?

Example :SYST:LKEY:BORR:LIST?

#266

```
N9073EM0E, 2018.0831, 20-Aug-2018
```

```
N9077EM0E, 2018.0831, 20-Aug-2018
```

Return a Borrowed License (Remote Command Only)

Remote Command	<code>:SYSTem:LKEY:BORRow:RETurn "<feature>"</code>
Example	<code>:SYST:LKEY:BORR:RET "N9080EM0E"</code>
Dependencies	When <code><feature></code> is not a valid license or when a license is not borrowed, one of the following errors is issued: <ul style="list-style-type: none"> - -224, "IllegalParameterValue;License is not installed" - -224, "IllegalParameterValue;Unknown license feature" - -224, "IllegalParameterValue;License not borrowed"

4.7.4.8 Enabling Network Checkouts While Borrowed

The default for borrowed license use is that you will be explicitly borrowing all desired network licenses, and that all other available network licenses should be ignored. This allows you to intentionally limit the functionality available to the instrument to what is explicitly borrowed.

For example, the RT1/RT2 options that enable the RTSA Mode are automatically checked out when the instrument is started, because the hardware must be configured for them at startup time. If you do not intend to use RTSA, then by borrowing only the licenses you want to use and disabling other network checkouts, the RT1/RT2 licenses will not be checked out at startup. This leave more RTSA licenses available for others to use. Note that the instrument must be restarted after the borrowing has been done to ensure the release of any network licenses already acquired.

If your intent in borrowing is to ensure access to a particular feature or application, but you still want to opportunistically use other features or applications, the default behavior can be changed to enable network license checkouts even when licenses have been borrowed.

Remote Command	<code>:SYSTem:LKEY:BORRow:NETWork:COU:ENABle</code>
Example	<code>:SYST:LKEY:BORR:NETW:COU:ENAB 0</code> <code>:SYST:LKEY:BORR:NETW:COU:ENAB?</code>
Dependencies	Only visible when licensing is configured to use a network server. SCPI is always available
Preset	Unaffected by Preset but set to 0 by Restore Defaults > "Misc" on page 1892 or Restore Defaults > "All" on page 1893
State Saved	Power On Persistent (survives shutdown and restart)

4.7.5 USB Portable Licenses

The USB Portable license is implemented with a physical dongle that is a USB device, like a USB thumb drive. It has a Host ID fixed in the dongle HW. It does not contain any writable data and so is acceptable to high security A/D customers. Transporting licenses from one instrument to another just requires moving the dongle and license files to the desired instrument. The license files can be installed on many instruments, but they will only be valid the one instrument that has the dongle. The use of USB portable licenses requires that the Keysight Floating License Manager is installed on the instrument. The licenses can then be added to the instrument's server.

USB Portable licenses are checked out and in like Network licenses. Because the licenses are local, there will be no network latency involved in the check-out/check-in, but there can still be a slight performance degradation compared to Fixed and Transportable licenses. If the instrument allows multiple concurrent instances of the X-Series software (as is the case for modular products), there may also be availability issues if all licenses are already checked out to other X-Series instances. Plugging/un-plugging the dongle is equivalent to transporting a license to/from the instrument, however, the software must be restarted whenever the dongle is plugged in.

4.7.6 Configuring Network and USB Portable Licenses

The Keysight Floating License Manager must be used to configure the Network or USB Portable licenses before the licenses can be used. Currently, an instrument can only be configured for Network or USB Portable licenses or both.

- To set up USB Portable licenses, in the Keysight Floating License Manager select "Start a floating license server with a license file" and add files containing the USB Portable licenses desired
- To set up Network licenses, in the Keysight Floating License Manager select "Connect to a floating license server" and enter the network server's name preceded by the "@" character (example: "@myserver")
- To set up both Network and USB Portable license, first configure the USB Portable license, then configure the Network licenses, but append ";@localhost" to the server name (example: "@myserver;@localhost"). Whenever the configuration is changed, the X-Series software must be restarted

4.7.7 Floating License Manager

Opens the License Explorer for Network and USB Portable licenses.

NOTE This feature is not available if Option SF1 is installed.

For help on licensing, select **Help** in the menu bar at the top of the License Explorer window.

4.7.8 Install License (Remote Command Only)

Used to add a license to the instrument.

An example of such a command would be as below. The parameter is a unique 120-character code for each license.

```
SYST:LKEY "N9073A-1FP", "027253AD27F83CDA5673A9BA5F427FDA5E4F25AEB1017638211AC9F60D9C639FE539735909C551DE0A91"
```

Another example using one of the optional clauses.

```
SYST:LKEY "N9063EM0E-1FP,2019.0330", "02220210867E187713C9AFD4C90EA0DE2B674615DD0255798EE5B237A146A0D4E411E0ABFE04D3CAFDFFA", "ISSUED=30-Mar-2018"
```

NOTE This command does not work for Transportable, Network or USB Portable licenses.

Remote Command	<code>:SYSTem:LKEY <"OptionInfo">, <"LicenseInfo">, <"Optional1">, <"Optional2">, <"Optional3">, <"Optional4">, <"Optional5"></code>
Notes	<p><code><"OptionInfo"></code> contains the feature and the version. You must specify the feature but can omit the version. If you omit the version, the system regards it as the latest one, since the system knows which version is supported for each feature</p> <p><code><"LicenseInfo"></code> contains the signature, the expiration date, and serial number for transport if transportable. You must specify the signature, but you can omit the other information. If you omit the expiration date, the system regards it as permanent. If you omit the serial number, the system regards it as non-transportable. As a result, this supports reverse compatibility</p> <p><code><"Optional#"></code> are optional parameters that may be needed to match the information in the original license</p>

4.7.9 Remove License (Remote Command Only)

Removes a particular license.

An example of such a command would be as below. The parameter is a unique 120-character code for each license.

```
SYST:LKEY:DEL "N9073A-
```

4 System
4.7 Licensing

1FP”, ”027253AD27F83CDA5673A9BA5F427FDA5E4F25AEB1017638211AC9F60D9C639FE53973590
9C551DE0A91”

NOTE

This command does not work for Transportable, Network or USB Portable licenses.

Remote Command	:SYSTem:LKEY:DELeTe <"OptionInfo">,<"LicenseInfo">
----------------	--

Notes	<"OptionInfo"> contains the feature and the version. You must specify the feature but can omit the version. If you omit the version, the system regards it as the latest one, if more than one version is installed <"LicenseInfo"> contains the signature, the expiration date, and whether be transportable. You must specify the signature, but you can omit the other information. If you omit the expiration date, the system regards it as permanent. If you omit the transportability, the system regards it as non-transportable. As a result, this supports reverse compatibility
-------	---

4.7.10 List Licenses (Remote Query Only)

Returns a list of installed licenses.

Remote Command	:SYSTem:LKEY:LIST?
----------------	--------------------

Notes	Return Value: An <arbitrary block data> of all the installed instrument licenses The format of each license is as follows <Feature>,<Version>,<Signature>,<Expiration Date>,<Serial Number for Transport>,... Return Value Example: #3136 N9073A-1FP,1.000,B043920A51CA N9060A-2FP,1.000,4D1D1164BE64 N9020A-508,1.000,389BC042F920 N9073A-1F1,1.000,5D71E9BA814C,13-aug-2005 <arbitrary block data> is: #NMMM<data> Where: N is the number of digits that describes the number of MMM characters. For example, if the data was 55 bytes, N would be 2 MMM would be the ASCII representation of the number of bytes. In the previous example, N would be 55 <data> ASCII contents of the data Additional fields may appear depending on the type of license (Fixed, Transportable, Network, USB Portable)
-------	---

4.7.11 Validate License (Remote Query Only)

Lets you query whether a particular license is currently valid.

Remote Command	<code>:SYSTem:LKEY? <"OptionInfo"></code>
Example	<code>:SYST:LKEY? "N9073A-1FP"</code>
Notes	<p><code><"OptionInfo"></code> contains the feature and the version. You must specify the feature but can omit the version. If you omit the version, the system regards it as the latest one</p> <p>Return Value: <code><"LicenseInfo"></code> if the license is valid, null otherwise <code><"LicenseInfo"></code> contains the signature, the expiration date, and serial number if transportable</p> <p>Return Value Example: <code>"B043920A51CA"</code></p>

4.7.12 Host ID Query (Remote Query Only)

Returns the Host ID as a string.

Remote Command	<code>:SYSTem:HID?</code>
----------------	---------------------------

4.8 Security

Accesses capabilities for operating the instrument in a security-controlled environment.

The **Security** page of the **System** menu has two controls: **USB Read/Write** and **Restore Security Defaults**.

Dependencies	Not available in UXM
--------------	----------------------

4.8.1 USB Write Protect

The Windows operating system can be configured to disable write access to the USB ports for users who are in a secure environment where transferring data from the instrument is prohibited. The **USB Write Protect** control is a convenient way for you to disable write access to USB.

NOTE

This control is only available to users with Administrator privileges.

Remote Command	<code>:SYSTem:SECurity:USB:WPRotect[:ENABle] ON OFF 0 1</code> <code>:SYSTem:SECurity:USB:WPRotect[:ENABle]?</code>
----------------	--

Example	Set USB ports to Read-only: <code>:SYST:SEC:USB:WPR ON</code> Set USB ports to Read-Write: <code>:SYST:SEC:USB:WPR OFF</code>
---------	--

Notes	When the USB ports are in Read-only mode, then no data can be stored to USB, including the internal USB memory used for a back-up location for the calibration data
-------	---

Dependencies	Grayed-out unless the current user has Administrator privileges
--------------	---

Preset	Unaffected by Preset or any "Restore Defaults" on page 1890. A Keysight Recovery sets the USB to write protect OFF
--------	---

State Saved	No
-------------	----

Range	Read-Write Read only
-------	------------------------

4.8.2 Restore Security Defaults

Sets USB Read/Write to Enable.

NOTE

This control is only available to users with Administrator privileges.

4.9 Diagnostics

Displays a slider that allows you to view Hardware Statistics.

Dependencies	Not available in UXM
--------------	----------------------

4.9.1 Show Hardware Statistics

Provides a display of various hardware statistics. The statistics include the following:

- Mechanical relay cycles (on models with mechanical relays)
- High and Low temperature extremes
- Elapsed time that the instrument has been powered-on (odometer)

Modular instruments display only time and temperature information.

Example	<code>:SYST:SHOW HWST</code>
---------	------------------------------

Notes	The values displayed on the screen are only updated upon entry to the screen and not updated while the screen is being displayed
-------	--

4.9.2 Pathwave Calibration Advisor...

This is a separate application that helps maintain your instrument at peak performance. You can set the cal interval, configure cal due reminders, check the cal status, view cal certificates and test reports, and contact Keysight for a cal service.

The embedded help documentation can be accessed in the instrument at: <C:\Program Files\Keysight\Calibration Advisor\PCA.chm>, or via the ? button at the top right of the **PathWave Calibration Advisor** window.

4.9.3 Query the Mechanical Relay Cycle Count (Remote Query Only)

Returns the count of mechanical relay cycles.

Remote Command	<code>:SYSTem:MRELAY:COUNT?</code>
----------------	------------------------------------

Example	<code>:SYST:MREL:COUN?</code>
---------	-------------------------------

Notes	Query Only The return value is a comma-separated list of the individual counts for each mechanical relay The position of the relays in the list is:
-------	---

“<Cal Signal>, <AC/DC>, <2dB #1 Atten>, <2dB #2 Atten>, <6dB Atten>, <10dB Atten>, <20dB Atten>, <30dB Atten>, <Fixed Atten>, <Low Noise Path Switch>, <PreSel Bypass>”

Items in the list not pertaining to your hardware configuration return as -999 for those items

Dependencies *Not supported by E6607C*

4.9.4 Query the Operating Temperature Extremes (Remote Query Only)

Returns the low operating temperature extreme value. The value survives a power-cycle and is the temperature extreme encountered since the value was reset by the factory or service center.

Remote Command `:SYSTem:TEMPerature:LEXTreme?`

Example `:SYST:TEMP:LEXT?`

Notes Value is in degrees Celsius at which the lowest operating temperature has been recorded since 1st power-up

State Saved No

Returns the high operating temperature extreme value. The value survives a power-cycle and is the temperature extreme encountered since the value was reset by the factory or service center.

Remote Command `:SYSTem:TEMPerature:HEXTreme?`

Example `:SYST:TEMP:HEXT?`

Notes Value is in degrees Celsius at which the highest operating temperature has been recorded since 1st power-up

State Saved No

4.9.5 Query the Elapsed Time since 1st power on (Remote Query Only)

Returns the elapsed on-time in minutes since 1st power-on.

Remote Command `:SYSTem:PON:ETIMe?`

Example `:SYST:PON:ETIM?`

Notes Query Only

4.10 Service

Accesses capabilities performed in the factory or under instructions from repair procedures. This key is only visible when the logged-in user is “**advanceduser**” or “**saservice**”. The first access to the **Service** menu after invoking the instrument application will require an authentication Service Code.

Dependencies	Not available in UXM
--------------	----------------------

4.11 System Remote Commands (Remote Commands Only)

These commands have no front-panel key equivalent.

- "List installed Options (Remote Query Only)" on page 1985
- "Lock the Front-panel keys (Remote Command Only)" on page 1986
- "Lock Workstation (Remote Command Only)" on page 1986
- "List SCPI Commands (Remote Query Only)" on page 1988
- "Front Panel activity history (Remote Query only)" on page 1988
- "SCPI activity history (Remote Query only)" on page 1989
- "Instrument start time (Remote Query only)" on page 1989
- "SCPI Version Query (Remote Query Only)" on page 1990
- "Date (Remote Command Only)" on page 1990
- "Time (Remote Command Only)" on page 1990
- "Input Overload Enable (Remote Command Only)" on page 1991
- "Power Up (Remote Query Only)" on page 1991

4.11.1 List installed Options (Remote Query Only)

Lists the installed options that pertain to the instrument (signal analyzer).

Remote Command	<code>:SYSTem:OPTions?</code>
Example	<code>:SYST:OPT?</code>
Notes	The return string is a comma-separated list of the installed options. For example: <code>"503,P03,PFR"</code> <code>:SYSTem:OPTions?</code> and <code>*OPT?</code> are the same
State Saved	No

4.11.2 Lock the Front-panel keys (Remote Command Only)

Disables the instrument keyboard to prevent local input when the instrument is controlled remotely. Annunciation showing a “K” for **KLOCK** (keyboard lock) alerts the local user that the keyboard is locked. **KLOCK** is similar to the GPIB Local Lockout function; namely that no front-panel keys are active except for the **Power Standby** key. (The instrument is allowed to be turned-off if **KLOCK** is **ON**.) The **KLOCK** command is used in remote control situations where Local Lockout cannot be used.

Although primary intent of **KLOCK** is to lock-out the front panel, it will lock-out externally connected keyboards through USB. **KLOCK** has no effect on externally connected pointing devices (mice).

The front panel ‘**Local**’ key (**Cancel/Esc**) has no effect if **KLOCK** is **ON**.

See also "[Local Button](#)" on page 137.

Remote Command	<code>:SYSTem:KLOCK OFF ON 0 1</code> <code>:SYSTem:KLOCK?</code>
Example	<code>:SYST:KLOC ON</code>
Notes	Keyboard lock remains in effect until turned-off, or until the instrument is power-cycled
Preset	Initialized to OFF at startup, unaffected by Preset
State Saved	No

4.11.3 Lock Workstation (Remote Command Only)

Performs the same functionality as the **Win+L** function or the “Lock” function on the **CTL-ALT-DEL** screen in Windows.

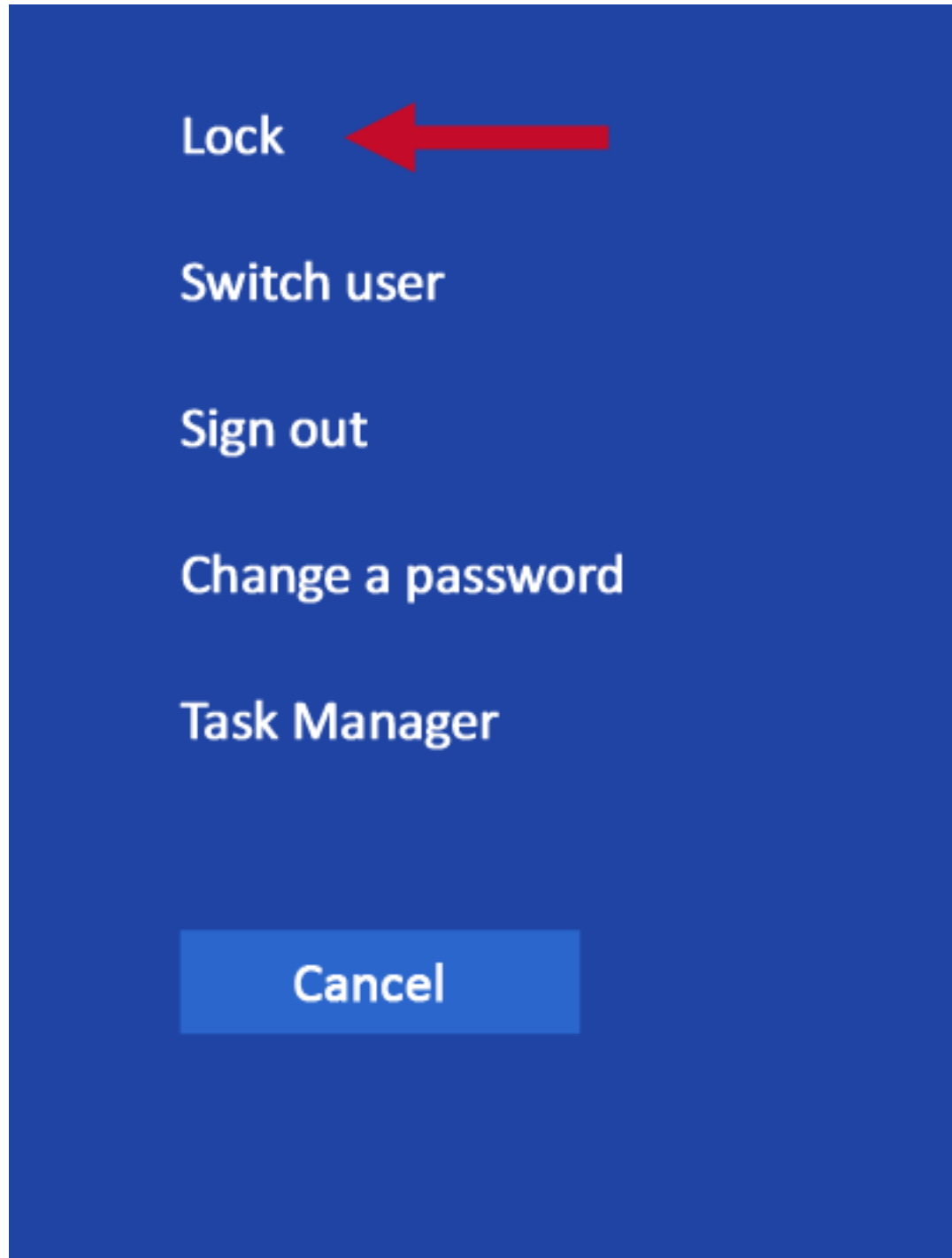

As soon as you do this, the computer is locked. The initial login screen appears; no-one can access the computer at that point unless they have an account and know the account's password.

Failure to initiate adds an error to the Windows event log for SA;

"LockWorkStation - Failed to initiate function"

See also "Local Button" on page 137.

Remote Command	<code>:SYSTem:LWSTation</code>
Example	<code>:SYST:LWST</code>
Notes	The lock remains in effect until a user logs in
State Saved	No

4.11.4 List SCPI Commands (Remote Query Only)

Outputs a list of the valid SCPI commands for the currently selected Mode.

Remote Command	<code>:SYSTem:HELP:HEADers?</code>
Example	<code>:SYST:HELP:HEAD?</code>
Notes	The output is an IEEE Block format, with each command separated with the New-Line character (<code>0x0A</code>)

4.11.5 Front Panel activity history (Remote Query only)

Instrument front panel usage can be monitored using `:SYSTem:METRics:FPANel?`. The monitoring occurs for front panel hardkey or softkey operation (including mouse or touch operation on instruments with Multi-Touch User Interface). The information of the usage pertains to the activity since the instrument application was started; the information does not persist after the application is terminated, or the instrument has been rebooted.

To prevent the front panel from being placed into Remote the monitoring must occur via an I/O protocol such as LAN Socket, or the remote program performing the monitoring must explicitly place the instrument into Local after the query has been performed.

Remote Command	<code>:SYSTem:METRics:FPANel?</code>
Example	<code>:SYST:METR:FPAN?</code>
Notes	<p>The return value is a string with the format "<code>YYYY-MM-DD<space>HH:MM:SS</code>", in instrument local time</p> <p>If no front panel activity has occurred since the instrument was booted (instrument application started), the return value will be the time the instrument application started. The instrument application start time can be obtained with the query <code>:SYSTem:METRics:STIME?</code></p>

4.11.6 SCPI activity history (Remote Query only)

Instrument remote operation usage via SCPI can be monitored using `:SYSTem:METRics:SCPI?`. The monitoring occurs for SCPI control from any I/O channel (GPIB, USB, or LAN). The information of the usage pertains to the activity since the instrument application was started; the information does not persist after the application is terminated, or the instrument has been rebooted.

Remote Command	<code>:SYSTem:METRics:SCPI?</code>
Example	<code>:SYST:METR:SCPI?</code>
Notes	<p>The return value is a string with the format “YYYY-MM-DD<space>HH:MM:SS”, in instrument local time</p> <p>The following commands are excluded from the history accounting:</p> <ul style="list-style-type: none"> - <code>*IDN?</code> - <code>*OPT?</code> - <code>:SYSTem:DATE?</code> - <code>:SYSTem:TIME?</code> - <code>:SYSTem:PON:TIME?</code> - Queries in the <code>:SYSTem:ERRor</code> subsystem - Queries in the <code>:SYSTem:LKEY</code> subsystem - Queries in the <code>:SYSTem:METRics</code> subsystem - Queries in the <code>:SYSTem:MODuLe</code> subsystem <p>If no SCPI activity has occurred since the instrument was booted (instrument application started), the return value will be the time the instrument application started. The instrument application start time can be obtained with <code>:SYSTem:METRics:STIME?</code></p>

4.11.7 Instrument start time (Remote Query only)

To determine if instrument activity has occurred, `:SYSTem:METRics:STIME?` can be used to determine the instrument application start time.

Remote Command	<code>:SYSTem:METRics:STIME?</code>
Example	<code>:SYST:METR:STIM?</code>
Notes	<p>The return value is a string with the format “YYYY-MM-DD<space>HH:MM:SS”, in instrument local time</p>

4.11.8 SCPI Version Query (Remote Query Only)

Returns the SCPI version number with which the instrument complies. The SCPI industry standard changes regularly. This command indicates the version used when the instrument SCPI commands were defined.

Remote Command	<code>:SYSTem:VERSion?</code>
----------------	-------------------------------

Example	<code>:SYST:VERS?</code>
---------	--------------------------

4.11.9 Date (Remote Command Only)

The recommended access to the Date, Time, and Time zone of the instrument is through the Windows native control (Control Panel, or accessing the Task Bar). You may also access this information remotely, as shown in here and in "[Time \(Remote Command Only\)](#)" on page 1990.

Sets or queries the date in the instrument.

Remote Command	<code>:SYSTem:DATE "<year>,<month>,<day>"</code>
----------------	--

	<code>:SYSTem:DATE?</code>
--	----------------------------

Example	<code>:SYST:DATE "2006,05,26"</code>
---------	--------------------------------------

Notes	<p><code><year></code> is the four-digit representation of year (for example, 2006)</p> <p><code><month></code> is the two-digit representation of year (01 to 12)</p> <p><code><day></code> is the two-digit representation of day (01 to 28, 29, 30, or 31, depending on the month and year)</p>
-------	--

Unless the current account has Power User or Administrator privileges, sending this command generates an error, and no action is taken

4.11.10 Time (Remote Command Only)

Sets or queries the time in the instrument.

Remote Command	<code>:SYSTem:TIME "<hour>,<minute>,<second>"</code>
----------------	--

	<code>:SYSTem:TIME?</code>
--	----------------------------

Example	<code>:SYST:TIME "13,05,26"</code>
---------	------------------------------------

Notes	<p><code><hour></code> is the two-digit representation of the hour in 24-hour format</p> <p><code><minute></code> is the two-digit representation of minute</p> <p><code><second></code> is the two-digit representation of second</p>
-------	--

Unless the current account has Power User or Administrator privileges, sending this command generates an error, and no action is taken

4.11.11 Input Overload Enable (Remote Command Only)

Input Overload errors are reported using the Input Overload status bit (bit 12 in the Measurement Integrity Status Register). Input Overloads (for example, ADC Overload errors) can come and go with great frequency, generating many error events (for example, for signals just on the verge of overload), and so are not put into the SCPI error queue by default. Normally the status bit is the only way for detecting these errors remotely.

Use this command to enable or disable Input Overload reporting to the SCPI queue. By default, reporting is disabled. Send `:SYSTem:ERRor:OVERload ON` to enable, or `:SYSTem:ERRor:OVERload OFF` to disable. In either case, Input Overloads *always* set the status bit.

NOTE For versions of firmware before A.10.01, Input Overload was only a Warning and so was never available in the SCPI queue, although it did set the status bit. For A.10.01 and later, Input Overload is an error, which can be enabled to the SCPI queue using this command.

Remote Command	<code>:SYSTem:ERRor:OVERload[:STATe] 0 1 OFF ON</code>
Example	Enable overload errors: <code>:SYST:ERR:OVER 1</code>
Preset	Set to OFF by Restore Misc Defaults (no Overload errors go to SCPI)
State Saved	Saved in instrument state

4.11.12 Power Up (Remote Query Only)

Returns a list of errors encountered during the application boot-up, such as: mismatch FW-FPGA, missing Calibration data, missing hardware, and construction errors.

Remote Command	<code>:SYSTem:ERRor:PUP?</code>
Notes	If no error occurs, the return value is: "No Power Up Errors" Return Value: <code><List of error strings></code> in <code><IEEE488 Block></code> format Return Value Example: "Power up errors, see details in Windows Event Log" "Unmatched FPGA Version(s), See details in Windows Event Log"

5 Preset

The Preset functions can be accessed in two ways:

- By pressing the **Mode Preset** or **User Preset** front panel keys:



- From the menu "**Preset Dropdown**" on page 1995, which appears when you press the green **Preset** icon (in the upper right corner of the display):



Types of Preset

The table below shows all possible presets, their corresponding SCPI commands and front-panel access methods.

Instrument settings are tiered in scope from those local to the current measurement to those global to all measurements and Modes. There are presets tailored to each scope. The table identifies the scope of each preset type.

NOTE

To get a Mode back to a fully predefined state, you should execute "**Restore Mode Defaults**" on page 1998 and "**Input/Output Preset**" on page 1999, but since **Input/Output Preset** is a global function, it affects *all* Modes.

Type Of Preset	SCPI Command	Scope of Preset	Front Panel Access
"Auto Couple" on page 1825	:COUPle ALL	Local to the current measurement, only affects Auto/Man variables	Meas Setup menu
Meas Preset	:CONFigure:<meas>	Local to the current measurement Does not preset the RF Source	Meas Setup menu
"Mode Preset" on page 1996	:SYSTem:PRESet	Local to the current Mode, global to all measurements in the Mode, affects most but not all parameters in the Mode Does not affect Input/Output or System variables Presets the RF Source	Mode Preset key " Preset Dropdown " on page 1995
"Restore Mode	:INSTrument:DEFault	Local to the current Mode, global to	"Preset

Type Of Preset	SCPI Command	Scope of Preset	Front Panel Access
Defaults" on page 1998		all measurements in the Mode, affects all parameters in the Mode, but does not affect Input/Output or System variables Does not preset the RF Source.	Dropdown" on page 1995
"Restore Defaults All Modes" on page 2005	:SYSTem:DEFault MODEs	Affects all parameters in <i>all</i> Modes, but does not affect Input/Output or System variables Presets the RF Source	"Preset Dropdown" on page 1995
"Restore Screen Defaults" on page 2008	:SYSTem:DEFault SCReen	Deletes all Screens but one, restores that screen to its default mode and performs Mode Preset for that mode Does not affect Input/Output or System variables Presets the RF Source	"Preset Dropdown" on page 1995
"User Preset" on page 2001	:SYSTem:PRESet :USER	Local to the current Mode, global to all measurements in the Mode, affects all parameters in the Mode, as well as Input/Output variables Does not affect System variables	User Preset key "Preset Dropdown" on page 1995
"User Preset All Modes" on page 2004	:SYSTem:PRESet :USER :ALL	Same as User Preset , but affects all Modes in the current Screen	"Preset Dropdown" on page 1995
"User Preset All Screens" on page 2006		Affects the entire Screen Configuration; global to all Modes and Screens	"Preset Dropdown" on page 1995
*RST	*RST	Same as Mode Preset . Additionally always sets Single/Cont to Single	Not available from front panel
"Input/Output Preset" on page 1999	:SYSTem:DEFault INPut	Affects all Input/Output variables Does not preset the RF Source	Input/Output menu "Preset Dropdown" on page 1995 System > Restore Defaults
"Full Mode Preset" on page 2000	:SYSTem:PRESet :FULL	Same as Mode Preset + Restore Mode Defaults + Input/Output Preset . Essentially a factory preset of the current Mode Presets the RF Source	"Preset Dropdown" on page 1995
"Restore User	:SYSTem:DEFault UINTErface	Affects all variables in the "User	System > Restore

Type Of Preset	SCPI Command	Scope of Preset	Front Panel Access
Interface Defaults" on page 1875		Interface" group Does not preset the RF Source	Defaults User Interface tabs
"Restore Power On Defaults" on page 1884	<code>:SYSTem:DEFault PON</code>	Affects all variables in the "Power On" group Presets the RF Source	System > Restore Defaults Power On tabs
"Restore Alignment Defaults" on page 1961	<code>:SYSTem:DEFault ALIGn</code>	Affects all variables in the "Alignments" group Presets the RF Source	System > Restore Defaults Alignments tabs
"Restore Defaults" on page 1890 (Misc)	<code>:SYSTem:DEFault MISC</code>	Affects various variables not reset by other commands Presets the RF Source	System > Restore Defaults
"Restore Defaults" on page 1890 (All)	<code>:SYSTem:DEFault [ALL]</code> <code>:SYSTem:PRESet:PERSistent</code>	Affects all variables Presets the RF Source	System > Restore Defaults

5.1 Preset Dropdown

The Preset dropdown contains the following controls. In the image below, click a control for details of that control.

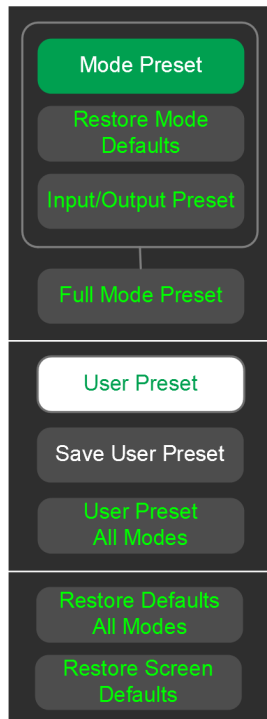

5.2 Mode Preset

Returns the current Mode to a known state. **Mode Preset** only presets the current Screen; it does not affect any other Screens.

Mode Preset also presets the RF Source. In this sense, it is equivalent to pressing **Source Preset** on the **Input/Output, RF Source** menu panel.

Mode Preset can be executed from the "**Preset Dropdown**" on page 1995, or by pressing the **Mode Preset** front panel key:



It does the following for the currently active Mode:

- Aborts the currently running measurement
- Switches to the default measurement and displays the default menu for that measurement
- Sets most parameters for the Mode and all its Measurements to a preset state
- Clears the input and output buffers
- Sets Status Byte to 0

Mode Preset does *not* cause a Mode switch, nor affect any **Input/Output** or **System** settings (those set in the **System Settings** dialog).

Furthermore, some Mode settings are unaffected by **Mode Preset** (for example, Noise Floor Extensions, Limit Line data, reference marker numbers, etc.) These are only reset by "**Restore Mode Defaults**" on page 1998. In each parameter's definition table there is a note that indicates whether it is reset by **Mode Preset** or by **Restore Mode Defaults**.

See "**Preset**" on page 1992 for more details.

Remote Command	<code>:SYSTem:PRESet</code>
Example	<code>:SYST:PRES</code>
Notes	<code>*RST</code> is preferred over <code>:SYST:PRES</code> for remote operation. <code>*RST</code> performs Mode Preset , as done by the <code>:SYST:PRES</code> command, and sets the measurement mode to Single measurement rather than Continuous , for optimal remote control throughput See also " *RST - Reset " on page 2546
Status Bits/OPC dependencies	Clears all pending OPC bits. The Status Byte is set to 0

5 Preset

5.2 Mode Preset

Backwards Compatibility Notes

In X-Series, the legacy “Factory Preset” has been replaced by **Mode Preset**, which only presets the currently active Mode, not the entire instrument. In X-Series, you preset the entire instrument by using **System, Restore System Defaults All**, which behaves essentially the same way as restore System Defaults did in ESA and PSA

There is also no “Preset Type” as there was in PSA. The green **Mode Preset** front-panel key does a Mode Preset, and the **User Preset** front-panel key does a User Preset. The old **PRESet:TYPE** command is ignored (without generating an error), and **SYST:PRES** without a parameter does **Mode Preset**

The settings and correction data under the **Input/Output** front-panel key (examples: Input Z Corr, Ext Amp Gain, etc.) are no longer part of any Mode, so they are not preset by **Mode Preset**. They are preset by **Restore Input/Output Defaults, Restore System Defaults All**. Note that because “**User Preset**” on [page 2001](#) performs Recall State, and all these settings are saved in State, they *are* recalled when using **User Preset**

5.3 Restore Mode Defaults

Most settings within a Mode are affected by "[Mode Preset](#)" on page 1996, but some Mode settings are unaffected (for example, Noise Floor Extensions, Limit Line data, reference marker numbers, etc.) **Restore Mode Defaults** resets all these additional settings, as well as all the **Mode Preset** settings, *except* the RF Source.

In each parameter's definition table, there is a note that indicates whether that parameter is reset by **Mode Preset** or by **Restore Mode Defaults**.

Note that a Recall State affects all a Mode's settings, both the **Mode Preset** settings and the ones additionally affected by **Restore Mode Defaults**.

Restore Mode Defaults can be executed from the "[Preset Dropdown](#)" on page 1995.

When **Restore Mode Defaults** is selected, a message appears saying

*This will reset all of the current Mode's variables to their default state.
This action cannot be undone. Do you want to proceed?*

The message provides **OK** and **Cancel** buttons, to let you confirm or cancel the reset operation.

Remote Command	<code>:INSTRUMENT:DEFAULT</code>
Example	<code>:INST:DEF</code>
Notes	Clears all pending OPC bits. The Status Byte is set to 0
Couplings	Causes the currently running measurement to be aborted, and causes the default measurement to be active. Sets the Mode to a consistent state, with all default couplings set

5.4 Input/Output Preset

Resets the group of settings and data associated with the **Input/Output** front-panel key to their default values. These settings are not affected by "**Mode Preset**" on page 1996, because they are generally associated with connections to the instrument, which generally should remain unaltered.

All the variables set under the **Input/Output** front panel key are reset by **Input/Output Preset**, including Amplitude Corrections and Data (described in the **Corrections** section), with the exception of **RF Source** settings, which are unaffected.

By using **Input/Output Preset** and "**Restore Mode Defaults**" on page 1998, a full preset of the current Mode can be performed, with the caveat that, since **Input/Output Preset** is a global function, it affects *all* Modes.

Input/Output Preset can be executed from the **Input/Output** menu, from the "**Preset Dropdown**" on page 1995, or from the **Restore Defaults** menu under the **System** key.

When **Input/Output Preset** is selected, a message appears saying:

"This will reset all of the Input/Output variables to their default state, including which input is selected, all Amplitude Correction settings and data, all External Mixing settings, all Frequency Reference settings and all Output settings.

It will not affect Alignment data or settings.

It will not affect RF Source settings.

This action cannot be undone. Do you want to proceed?"

The message provides **OK** and **Cancel** buttons, to let you confirm or cancel the operation.

Example

```
:SYST:DEF INP
```

Presets all **Input/Output** variables to their factory default values

5.5 Full Mode Preset

Same as performing "Mode Preset" on page 1996, "Restore Mode Defaults" on page 1998, and "Input/Output Preset" on page 1999. Essentially a factory preset of the current Mode.

When **Full Mode Preset** is selected, a message appears saying:

This will reset all of the current Mode's variables and all of the Input/Output variables to their default state, including Input and Output selection and settings, Amplitude Correction, Frequency Reference and RF Source settings.

It will not affect Alignment data or settings.

This action cannot be undone. Do you want to proceed?

The message provides **OK** and **Cancel** buttons, to let you confirm or cancel the operation.

Remote Command	:SYSTem:PRESet:FULL
Example	:SYST:PRES:FULL
Status Bits/OPC dependencies	Clears all pending OPC bits. The Status Byte is set to 0

5.6 User Preset

Recalls a state previously saved using ["Save User Preset" on page 2003](#). You can save a **User Preset** state for each Mode, allowing you to define your own favorite state for each Mode and recall it at the touch of a single button.

User Preset can be executed by pressing the **User Preset** front panel key, or from the ["Preset Dropdown" on page 1995](#).



Because **User Preset** is actually a Recall State, rather than a predefined Preset, it works a little differently from ["Mode Preset" on page 1996](#), in that it affects all the variables that normally only reset on ["Restore Mode Defaults" on page 1998](#), and it affects the **Input/Output** variables, because both of these are included in State files.

A default **User Preset** file is provided for each Mode, which simply matches the current Mode's state after **Restore Mode Defaults** and ["Input/Output Preset" on page 1999](#) has been performed.

NOTE

In products that run multiple instances of the X-Series Application, all instances use the same location to save User Preset state. So, saving User Preset of one instance will overwrite the Save User Preset of another instance.

Remote Command	<code>:SYSTem:PRESet:USER</code>
Example	<p>Save the User Preset: <code>:SYST:PRES:USER:SAVE</code></p> <p>Recall the User Preset: <code>:SYST:PRES:USER</code></p>
Notes	<p><code>:SYST:PRES:USER:SAVE</code> is used to save the current state as the user preset state</p> <p>If loading a User Preset file from a different instrument, some settings may be limited and/or coupled differently, since the capabilities of the mode may have changed from when the User Preset file was saved</p>
Status Bits/OPC dependencies	Clears all pending OPC bits. The Status Byte is set to 0
Backwards Compatibility Notes	<p>In X-Series A-models, the User Preset key opened a menu that let you select from User Preset, Save User Preset, or User Preset All Modes. In B-models, the User Preset key immediately performs a User Preset, and the menu items are found under the Preset dropdown</p> <p>User Preset actually loads a state, and in legacy analyzers, it was possible to load a state without affecting the trace data, limit lines or correction data. Similarly, it was possible to do a User Preset without affecting the trace data, limit lines or correction data</p>

In X-Series, "state" always includes all of this data; so whenever state is loaded, or **User Preset** is executed, all the traces, limit lines and corrections are affected

In ESA and PSA, **User Preset** affected the entire instrument's state. In X-Series, **User Preset** only recalls the state for the active Mode. There is a User Preset file for each Mode. **User Preset** can never cause a Mode switch as it could in legacy analyzers. If you want to recall all Modes to their user preset file state, perform User Preset *after* switching into each Mode

User Preset recalls Mode state, which can now include data, such as traces, whereas in ESA and PSA, User Preset did not affect data

5.7 Save User Preset

Saves the state of the currently active Mode in a unique location, for recall by the key "**User Preset**" on page 2001. Each Mode has one such location, so, for each Mode, one User Preset can be defined.

Save User Preset can be executed from the "**Preset Dropdown**" on page 1995.

All the Mode variables are saved, including those reset by "**Mode Preset**" on page 1996, those only reset by "**Restore Mode Defaults**" on page 1998, and all **Input/Output** variables, so when you subsequently press **User Preset**, the instrument returns to the exact same setup that existed when you pressed **Save User Preset**. Thus, **User Preset** has wider scope than **Mode Preset**.

Remote Command	<code>:SYSTem:PRESet:USER:SAVE</code>
Example	<code>:SYST:PRES:USER:SAVE</code>
Notes	<code>:SYST:PRES:SAVE</code> creates the same file as if you requested <code>*SAV</code> or <code>:MMEM:STOR:STAT</code> , except that Save User Preset does not allow you to specify the file name or location

5.8 User Preset All Modes

Recalls all the User Preset files for each Mode, switches to the Power-on Mode, and activates the saved measurement from the Power-on Mode **User Preset** file.

User Preset All Modes can be executed from the "[Preset Dropdown](#)" on page 1995

See also "[User Preset](#)" on page 2001.

Remote Command	<code>:SYSTem:PRESet:USER:ALL</code>
Example	<code>:SYST:PRES:USER:SAVE</code> <code>:SYST:PRES:USER:ALL</code>
Notes	<code>:SYST:PRES:USER:SAVE</code> is used to save the current state as the user preset state
Status Bits/OPC dependencies	Clears all pending OPC bits. The Status Byte is set to 0

5.9 Restore Defaults All Modes

Resets all Modes in the current Screen back to their default states, just as **Restore Mode Defaults** does, switches the current Screen to the Power-on Mode, and causes the default measurement for the **Power On Mode** to be active in the current Screen. Only the current Screen is affected.

Restore Defaults All Modes can be executed from the "Preset Dropdown" on page 1995.

When **Restore Defaults All Modes** is selected, a message appears saying:

This will reset all of the variables for all of the Modes in the current Screen to their default state. This action cannot be undone. Do you want to proceed?

The message provides **OK** and **Cancel** buttons.

Example	<code>:SYST:DEF MOD</code>
Couplings	Causes the currently running measurement to be aborted, a switch to the Power-on Mode, and activates the default measurement for the Power-on Mode

5.10 User Preset All Screens

Recalls a screen configuration previously saved using "[Save User Preset All Screens](#)" on page 2007. The complete configuration of all Screens is loaded, including the state of each Screen.

Because **User Preset All Screens** performs a Recall State as part of its function, it affects all variables that are normally only reset by "[Restore Mode Defaults](#)" on page 1998, and affects **Input/Output** variables, because both are included in State files.

Note that recalling a screen configuration in this manner wipes out your current screen configuration, and all states of all Screens.

Notes	<p>"Save User Preset All Screens" on page 2007 is used to save the current screen configuration as the "user preset all screens" configuration</p> <p>If loading a User Preset All Screens file from a different instrument, some settings may be limited and/or coupled differently, since the capabilities of the Mode may have changed from when the User Preset All Screens file was saved</p>
Status Bits/OPC dependencies	<p>Clears all pending OPC bits</p> <p>The Status Byte is set to 0</p>

5.11 Save User Preset All Screens

Saves the current Screen Configuration in a unique location, for recall by "[User Preset All Screens](#)" on page 2006.

Save User Preset All Screens can be executed from the "[Preset Dropdown](#)" on page 1995.

Besides the screen configuration, *all* Mode variables of all Screens are saved, including those reset by "[Mode Preset](#)" on page 1996, and those only reset by "[Restore Mode Defaults](#)" on page 1998, as well as all **Input/Output** variables, so when you subsequently press **User Preset All Screens**, the instrument returns to the exact Screen setup that existed when you pressed **Save User Preset All Screens**.

Notes Creates the same file as if you requested **Screen Config + State** save, except that **Save User Preset All Screens** does not allow you to specify the file name or location

5.12 Restore Screen Defaults

Resets the Screen configuration to the factory default; deleting all screens, all screen names, all screen states, and setting "Multiscreen" on page 177 to Off. A single screen will remain, set to the Power-on Mode, in a preset state with the default screen name.

Restore Screen Defaults can be executed from the "Preset Dropdown" on page 1995.

When **Restore Screen Defaults** is selected, a message appears saying:

This function will delete all defined screens and their settings. This action cannot be undone.

Do you want to proceed?

The message provides **OK** and **Cancel** buttons.

Example `:SYST:DEF SCReen`

5.13 Preset Type (Remote Command Only)

Remote Command	<code>:SYSTem:PRESet:TYPE FACTory MODE USER</code> <code>:SYSTem:PRESet:TYPE?</code>
Example	<code>:SYST:PRES:TYPE FACT</code>
Notes	Supported for backwards compatibility only. It is a no-op, which does not change the behavior of any preset operation
Preset	Unaffected by Preset, but set to MODE by Restore System Defaults->All
State Saved	No

5.14 Restart Instrument (Shutdown)

Shuts down the instrument, then reboots it.

Remote Command `:SYSTem:PUP`

Example `:SYST:PUP`

5.15 Restart Application (Application Shutdown)

Restarts the instrument application without rebooting the instrument. Before you send this command, make sure you have saved any trace or measurement data that you want to preserve.

Remote Command	<code>:SYSTem:PUP:PROcess</code>
Example	<code>:SYST:PUP:PROC</code> After sending this command, you must wait for the instrument software to restart
Notes	You cannot use <code>*WAI</code> or <code>*OPC?</code> to synchronize operation after a restart. This command stops and restarts the instrument application, so the SCPI operation is terminated and restarted A remote program must wait a fixed time before resuming sending commands to the instrument. The appropriate wait time depends on which applications are pre-loaded

5.16 System Log Off (Remote Command Only)

Provides a means to terminate all open Windows applications, and log off the current user. This is equivalent to performing the Windows command:

```
shutdown -l -f -t0
```

Remote
Command

```
:SYSTem:LOFF
```

Example

```
:SYST:LOFF
```

Notes

Initiates an immediate log off of the current user. Exits the instrument application, so any unsaved measurement results will be lost. You cannot use ***WAI** or ***OPC?** to synchronize operation. In addition to the instrument application, all other Windows programs will be terminated, without the opportunity to save any work in progress. To perform a subsequent login, and regain instrument operation, human intervention will be required

5.17 Power Standby (Instrument Shutdown)

Pressing the power switch powers down the instrument. You are warned that shutting down will cause the application to lose unsaved data, and the instrument lets you respond to this warning before shutting down.

The command below has the same effect, except that you can specify Normal mode (**NORMa1**) or Forced mode(**FORCe**):

- In **NORMa1** mode, the system waits until you respond to the warning prompt
- In **FORCe** mode, the system shuts down after 20 seconds, and all data will be lost

If the instrument is not properly shut down prior to removal of line power, the system will validate the Journaling File System and the Power-On Last State (if the instrument is in Power-On Last State) during the following power-on. If a problem is detected, a message appears indicating that the system 'recovered' from an inappropriate shutdown. This is only an issue if **Power-On Type** is Last State. If the Last State is not valid, the instrument will power up in the last active Mode, but will perform "**Mode Preset**" on page 1996.

Remote Command	:SYSTem:PDOWn [NORMa1 FORCe]
Example	:SYST:PDOW Executes a normal shutdown
Notes	If no parameter is sent, NORMa1 is assumed

6 Input/Output

Accesses menus that let you control the Input/Output parameters of the instrument. In general, these are functions associated with external connections to the instrument, either to the inputs or the outputs.

Input/output connections tend to be based on situation-specific hardware set up. For that reason, input/output settings do *not*, in general, change when you perform a Mode Preset. You can revert to the default values in one of three ways:

- Use **Restore Input/Output Defaults**, in the **Input/Output** menu
- Use **System->Restore System Defaults->Input/Output Settings**
- Use **System -> Restore System Defaults->All**

The settings survive a Preset and a Power cycle.

A few Input/Output settings *do* respond to Mode Preset. For example, if the Calibrator is on, **Preset** turns it off, and if DC coupling is in effect, **Preset** switches it to AC. These exceptions are noted in the SCPI tables for the excepted functions.

Input/Output features are common across multiple Modes and Measurements. In general, they do not change when you change Mode or Measurement, although some controls appear only in certain measurements.

6.1 RF Source

Lets you control and configure the internal RF Source. This tab only appears in models that support a built-in independent RF Source, which include E7760B, and modular products such as EXM and VXT.

External Source Control and built-in Tracking Sources are controlled using the **Source** tab in **Meas Setup**.

Dependencies	Only appears in models that support a built-in independent RF Source, such as E7760B, EXM and VXT
--------------	---

6.1.1 RF Output

Sets the source RF power output state.

Remote Command	<code>:OUTPut[:EXTernal][:STATe] ON OFF 1 0</code> <code>:OUTPut[:EXTernal][:STATe]?</code>
Example	<code>:OUTP OFF</code> <code>:OUTP?</code>
Notes	This setting is for the independent mode and has no effect on the " List Sequencer " on page 2025. If Sequencer is ON , the List Sequencer controls the source output, and this key is grayed-out When Sequencer is OFF , makes source leave List Sequencer and this setting is blanked out, taking effect immediately
Dependencies	For E7760B, the RF Output cannot be set to ON if the RF Output port is set to NONE . If you attempt to set RF Output to ON in this situation, the error message -221, "Settings conflict; Source Output is not available while Output Port is None" is displayed <code>:OUTPut:EXTernal[:STATe]</code> is supported only when Option ESC is installed. Otherwise, only <code>:OUTPut[:STATe]</code> is supported
Preset	OFF
Range	ON OFF

6.1.2 RF Output Port

Specifies the RF Output Port used by the internal source.

Switching from the RF Output port to one of the RFIO ports changes the transmitter performance of the instrument.

The **NONE** selection is available to allow setting a half-duplex port to an Input, if it was previously assigned as an Output. Set the Output to **NONE** first, then any port can be assigned as an Input.

When using VXT M9410A/11A/15A/16A with Remote Radio Heads (such as the Keysight M1740A mmWave Transceiver for 5G), the choices in the dropdown menu appear as:

Head h RFHD p

For example, if you have two Radio Heads (numbered 1 and 2), each of which have two RF half-duplex ports, the choices for these ports will appear as below:

Head and Port	Choice in dropdown	SCPI parameter
Head 1, port RF Tx/Rx 1	Head 1 RFHD 1	RRH1RFHD1
Head 1, port RF Tx/Rx 2	Head 1 RFHD 2	RRH1RFHD2
Head 2, port RF Tx/Rx 1	Head 2 RFHD 1	RRH2RFHD1
Head 2, port RF Tx/Rx 2	Head 2 RFHD 2	RRH2RFHD2

When using the E7770A Common Interface Unit, outputs may come from the DUT IF OUT ports on the rear of the CIU or the half-duplex ports on the front of the CIU labeled DUT IF In/Out. You would select GUI parameter IF Out n or SCPI parameter IFOutn for the DUT IF OUT ports or GUI parameter IFHD n or SCPI parameter IFHDn for the DUT IF In/Out ports. See ["RF Input Port" on page 2129](#) "Parameters for VXT M9410A/11A/15A/16A and EXM when used with Radio Heads/CIU" for more details.

Remote Command `[:SENSe]:FEED:RF:PORT:OUTPut RFOut | RFIO1 | RFIO2 | RFIO3 | RFIO4 | RFHD | RFFD | A1 | A2 | A3 | B1 | B2 | B3 | IFIO1 | IFIO2 | GEN | TR | RRHhRFHDp | IFOutn | IFHDn | NONE`

For details of each option, see ["Port Options" on page 2017](#)

`[:SENSe]:FEED:RF:PORT:OUTPut?`

Example

Set output to RF Output:

`:FEED:RF:PORT:OUTP RFO`

Set output to Radio Head 1, RF Tx/Rx Port 2:

`:FEED:RF:PORT:OUTP RRH1RFHD2`

Dependencies

Only appears in models that support multiple output ports. If the SCPI command is sent with unsupported parameters in any other model, an error is generated, -221, "Settings conflict; option not installed"

RFHD and **RFFD** are only available on VXT. Option HDX is required to enable RFHD port. Option FDX is required to enable RFFD port

For E7760B: Ports IFIO1 and IFIO2 are available if Option RF2 is installed. Ports A1, A2, A3, B1, B2, B3 are available if Option RF3 is installed. Attempting to select a port for which the option is not present generates the error, -241, "Hardware missing; Output not available"

A port cannot be selected as an Output while it is occupied as an Input. If the SCPI command is sent while the port is occupied, an error is generated, -221, "Settings conflict; Output Port is not available while occupied by Input"

Additionally, the mmWave ports are divided into two banks: the A Bank and the B Bank. A port cannot be selected as an Output if any port on the *same* bank is occupied as an Input. If the SCPI command is sent for this situation, an error is generated, -221 "Settings conflict; Output Port is not available while

6 Input/Output
6.1 RF Source

	<p>port bank is occupied by Input”</p> <p>Lastly, if RF3 is present, and RF4 is absent, a mmWave port cannot be selected as an Output if the Input Port is occupied by wwWave Transceiver with a different frequency range. If the SCPI command is sent for this situation an error is generated, -221 “Settings conflict; Output Port is not available while occupied by Input of incompatible frequency”</p> <p>Ports GEN and TR are only available in modular analyzers, and only when the M9470A module is installed, such as in M8920A. Option HDX is required to enable the T/R port</p> <p>When any output is selected in a measurement that does not support it, the "No result; Meas invalid with this output" error condition occurs, and the measurement returns invalid data when queried</p>
Preset	Unaffected by Mode Preset , but set to default by Source Preset or Restore System Defaults -> All
State Saved	Saved in State
Backwards Compatibility SCPI	<p>:FEED:RF:PORT:OUTPut IFIO1</p> <p>IFIO1 is treated as IF01 and sets the IF output to be the port labeled DUT IF Out on the CIU rear panel. This is for compatibility with earlier implementations on EXM and VXT when using the E7770A Common Interface Unit</p>

Port Options

Value	Notes
RF Output RFOut	<p>On EXM with hardware M9430A, if RF Output is selected as RF Output Port, use the settings in the Half Duplex Config menu to determine which port (RFIO3 or RFIO4) will be used</p> <p>On EXM with hardware M9431A, this setting is not supported. If the SCPI command is sent with this setting, an error is generated, -221, “Settings conflict; option not installed”</p>
RFHD	<p>RFHD port is exclusive for RF Input and RF Output. If HD Port is chosen as RF Input port, pressing this key, or sending SCPI to set it, generates error message: “-221, Settings conflict; RFHD is being used as RF Input Port”</p> <p>Option HDX is required to enable RFHD port</p>
RFFD	Option FDX is required to enable RFFD port
GEN	Selects the Gen port on M8920A/20B
T/R TR	Selects the T/R port on M8920A/20B
RRHhRFHDp	<p>Used to select a port on a Radio Head (such as the Keysight M1740A mmWave Transceiver) as an output</p> <p>RRHhRFHDp corresponds to Head h, port RF Tx/Rx p. For example, RRH1RFHD2 = the port labeled RF Tx/Rx 2 on Head 1</p>

6.1.3 Half Duplex Output Port

Specifies whether **RFIO3** or **RFIO4** is the Half Duplex Output port.

Remote Command	[:SENSE]:HDUPlex:PORT:OUTPut RFIO3 RFIO4
----------------	--

Example	<code>:HDUPlex:PORT:OUTPut RFI03</code> <code>:HDUPlex:PORT:OUTPut?</code>
Dependencies	Only appears in EXM If RFI03 is selected as “Half Duplex Input Port”, then “Half Duplex Output Port” will be set to RFI04 automatically If RFI04 is selected as “Half Duplex Input Port”, then “Half Duplex Output Port” will be set to RFI03 automatically
Preset	RFI04
State Saved	Saved in State

6.1.4 RF Power

Lets you control the amplitude of the Source output. Same as "RF Power" on page 2018 in **Amplitude Setup**.

Example	<code>:SOUR:POW -100 dBm</code>
---------	---------------------------------

6.1.5 T/R Port High Power Attenuator

Controls whether additional attenuation is added at the T/R Port. The T/R port has two output paths, one that provides a 16 dB attenuator, another that bypasses this attenuator. When this control is **ON**, the path includes the 16 dB attenuator, so the maximum output level for this path is 0 dBm. When this control is **OFF**, the 16 dB attenuator is bypassed, so the maximum output level for this path is +5 dBm.

Example	<code>:FEED:RF:PORT:TR:HPOW:ATT ON</code>
---------	---

6.1.6 Amplitude Setup

Lets you access the **Amplitude Setup** panel.

Notes	This menu under this control is for independent mode, and has no effect on "List Sequencer" on page 2025. If "Sequencer" on page 2026 is ON , the List Sequencer controls the source output, and this control is grayed-out on the front panel, to indicate out-of-scope. When you set "Sequencer" on page 2026 to OFF , makes source leave List Sequencer and this control is blanked out
-------	--

6.1.6.1 RF Power

Lets you adjust the power level of the source using the numeric keypad, step keys, or RPG. Pressing any digit, 0 through 9 on the numeric keypad displays the unit terminator.

6 Input/Output
6.1 RF Source

Please refer to the "RF Power Range" on page 2019 table below for the valid ranges.

Remote Command	<code>:SOURce:POWer[:LEVel][:IMMediate][:AMPLitude] <ampl></code> <code>:SOURce:POWer[:LEVel][:IMMediate][:AMPLitude]?</code>
Example	<code>:SOUR:POW -100 dBm</code>
Notes	<p>Amplitude corrections can be specified for use with the source. In the event of amplitude corrections being applied, the valid ranges for the RF power do not change dependent on the current amplitude correction setting. If the combination of RF power + amplitude correction is higher or lower than the source output range, the Source Unleveled bit is set, and the "Source Unleveled" indicator will appear on status panel to indicate that the source cannot maintain the output power that has been requested</p> <p>When signal generator is unable to maintain the requested output level, the "Source Unleveled" indicator will appear on status panel. When the source output setting is restored to the normal range, the "Source Unleveled" is removed from status panel</p> <p>Internal source has list sequence mode, which comprises of several steps which contain separate output power, frequency and waveform etc. When the source list sequence playing is complete, the last step keeps playing, and user can use this command to change the list sequence last step's output power</p> <p>For EXT, The multiport adapter RFIO TX ports and GPS ports cannot ensure power accuracy when power setting is lower than -130dBm, this power setting value is defined by the sum of RF Power setting and related amplitude correction value. But user settable value could be lower than this limit. When application detected there exists power setting lower than -130dBm on MPA RFIO TX ports, then popup warning message . When application detected there exists power setting lower than -130dBm on MPA GPS ports, then popup warning message . This is only warning message, and check is performed when RF is ON</p>
Dependencies	The RF power is dependent on the RF output port and frequency, such that the current frequency and selected output port determine the valid range of power values
Couplings	For if AWGN State is ON and ARB State is ON , this setting is adjusted to the value to maintain the AWGN power relationship defined by Power Control Mode and other noise settings
Preset	-100 dBm
Min	The range of values depends on the current frequency and selected RF output port. See "RF Power Range" on page 2019 below for the valid ranges
Max	The range of values depends on the current frequency and selected RF output port. Refer to "RF Power Range" on page 2019 below for the valid ranges

RF Power Range

RF Output Port	Frequency Range	Min Output Power	Max Output Power
High Power RF Out	10 MHz ≤ f ≤ 6 GHz	-150 dBm	20 dBm
RFIO 1 & RFIO 2	10 MHz ≤ f ≤ 6 GHz	-150 dBm	0 dBm

Note: This is the UI power range, which is larger than the actual specification.

VXT model M9420A

RF Output Port	Frequency Range	Min Output Power	Max Output Power without Option "1EA"	Max Output Power with Option "1EA"
RF Output	60 MHz \leq f \leq 6 GHz	-150 dBm	10 dBm	25 dBm
RFHD	60 MHz \leq f \leq 6 GHz	-150 dBm	10 dBm	15 dBm
RFFD	60 MHz \leq f \leq 6 GHz	-150 dBm	0 dBm	0 dBm

Note 1: This is the UI power range, which is larger than the actual specification.

Note 2: Max output power with Option 1EA can be set to 25 dBm, but Meas Uncal (measurement uncalibrated) warning is given in the Status Bar in the lower right corner of the screen when output power set higher than 20 dBm.

VXT models M9410A/11A

Ports	Option LFE	Frequency Range	Min Output Power	Max Output Power without option "1EA"	Max Output Power with "1EA"
RF Output	With Option LFE	1 MHz \leq f \leq 60 MHz	-150 dBm	5 dBm	5 dBm
		60 MHz \leq f \leq 380MHz	-150 dBm	5 dBm	25 dBm
	Without Option LFE	380 MHz \leq f \leq 6 GHz	-150 dBm	5 dBm	25 dBm
RFHD		1 MHz \leq f \leq 6 GHz	-150 dBm	5 dBm	5 dBm

Note 1: Min Output Power is the UI power range, which is smaller than the actual specification.

Note 2: Max output power with Option 1EA can be set to 25 dBm for RF Output Port, but Meas Uncal (measurement uncalibrated) warning is given in the Status Bar in the lower right corner of the screen when the output power is set higher than 20 dBm.

Note 3: Option LFE provides Low Frequency Extension, which covers frequency from 1 MHz to 380 MHz.

VXT models M9415A/16A

RF Output Port	Frequency Range	Min Output Power	Max Output Power without Option "1EA"	Max Output Power with Option "1EA"
RF Output	$380 \text{ MHz} \leq f \leq 12.3 \text{ GHz}$	-150 dBm	5 dBm	25 dBm
RFHD	$380 \text{ MHz} \leq f \leq 12.3 \text{ GHz}$	-150 dBm	5 dBm	18 dBm

Note 1: For RF output port, the Max output power with Option 1EA can be set to 25 dBm for RF Output Port, but Meas Uncal (measurement uncalibrated) warning is given in the Status Bar in the lower right corner of the screen when the output power is set higher than 20 dBm.

Note 2: For RFHD port, the Max output power with Option 1EA can be set to 18 dBm for RF Output Port, but Meas Uncal (measurement uncalibrated) warning is given in the Status Bar in the lower right corner of the screen when the output power is set higher than 15 dBm.

M9410E/11E/15E/16E

Ports	Option LFE	Frequency Range	Min Output Power	Max Output Power
RF Output	With Option LFE	$1 \text{ MHz} \leq f \leq 380 \text{ MHz}$	-150 dBm	13 dBm
		$380 \text{ MHz} \leq f \leq 25.9 \text{ GHz}$	-150 dBm	25 dBm
	Without Option LFE	$380 \text{ MHz} \leq f \leq 25.9 \text{ GHz}$	-150 dBm	25 dBm
RFHD		$1 \text{ MHz} \leq f \leq 25.9 \text{ GHz}$	-150 dBm	5 dBm

VXT Models with Remote Radio Heads/CIU

RRH	Port	Frequency Range	Min Output Power	Max Output Power
M1742A	Head h RFHD p	$10 \text{ GHz} \leq f \leq 32 \text{ GHz}$	-150 dBm	10 dBm

M8920A/20B

RF Output Port	Frequency Range	Min Output Power	Max Output Power
Gen	100 kHz ≤ f ≤ 6 GHz	-150 dBm	without option 1EA: 3 dBm with option 1EA: 15 dBm
T/R	100 kHz ≤ f ≤ 6 GHz	-150 dBm	T/R port high power attenuator On: -15 dBm T/R port high power attenuator Off: 3 dBm

Note: This is the UI power range, which is larger than the actual specification.

6.1.6.2 Set Reference Power

Turns the power reference state to **ON**, sets the reference power value to the current RF output power, maintains this power at the RF output, and sets the displayed power to 0.00 dB. All subsequent RF power values entered under **Source**, **Amplitude**, **RF Power** are interpreted as being relative to this reference power.

When you use a power reference, the signal generator outputs an RF power that is set relative to the reference power by the value entered under **Source**, **Amplitude**, **RF Power** as follows:

Output power = reference power – entered power

Where:

- reference power equals the original RF Power entered under **Source>Amplitude>RF Power** and set as the reference power
- entered power equals a new value entered under **Source>Amplitude>Amptd Offset**

In addition, the displayed power value is the same as a new value entered under **Source**, **Amplitude**, **RF Power**.

NOTE

If Power Ref is **ON** with a reference value set, entering a value under **Source**, **Amplitude**, **RF Power** and pressing **Set Reference Power** adds that value to the existing Power Ref value.

If you wish to change the reference power value to a new value entered under **Source**, **Amplitude**, **RF Power**, first set Power Ref to **OFF**, then press **Set Reference Power**.

Dependencies Unavailable, and grayed-out, when "List Sequencer" on page 2025 is **ON**

6.1.6.3 Power Ref

Lets you toggle the state of the power reference. When you use a power reference, the signal generator outputs an RF power that is set relative to the reference power by the value entered under **Source>Amplitude>RF Power** as follows:

Output power = reference power + entered power

Where:

- reference power equals the original RF Power entered under **Source>Amplitude>RF Power** and set as the reference power
- entered power equals a new value entered under **Source>Amplitude>Amptd Offset**

For more information on Reference Frequency, see ["Set Reference Power" on page 2022](#).

Remote Command	<code>:SOURce:POWer:REFerence <ampl></code> <code>:SOURce:POWer:REFerence?</code>
Example	<code>:SOUR:POW:REF 0.00 dBm</code>
Dependencies	Unavailable and grayed-out when "List Sequencer" on page 2025 is ON
Couplings	Coupled to "Set Reference Power" on page 2022 , such that pressing Set Reference Power updates the reference power with the current output power
Preset	0.00 dBm
Min	-125.00 dBm
Max	10.00 dBm
Auto Function	

Remote Command	<code>:SOURce:POWer:REFerence:STATe OFF ON 0 1</code> <code>:SOURce:POWer:REFerence:STATe?</code>
Example	<code>:SOUR:POW:REF:STATE ON</code>
Preset	OFF

6.1.6.4 Power Unit

Modifies the units for RF Power and Power Ref. The change is immediate and does not force a restart.

Remote Command	<code>:SOURce:POWer[:LEVel][:IMMediate][:AMPLitude]:UNIT DBM W V DBUV</code> <code>:SOURce:POWer[:LEVel][:IMMediate][:AMPLitude]:UNIT?</code>
Example	Set the RF Power units to volts:

	<code>:SOUR:POW:UNIT V</code>
Couplings	RF Power and Power Ref units are modified by Power Unit
Preset	dBm
State Saved	Saved in Instrument State

6.1.6.5 Amptd Offset

Lets you specify the RF output power offset value.

When the amplitude offset is set to zero (0) and you set a new offset value (positive or negative), the displayed amplitude value changes as follows, and the RF output power does not change:

Displayed value = output power + offset value

Where:

- output power equals the original RF Power entered under **Source, Amplitude, RF Power**
- offset value equals the value entered under **Source, Amplitude, Amptd Offset**

When the amplitude offset is set to a value other than zero (0) and you enter a new RF power value under **Source, Amplitude, RF Power**, the displayed power will be the same as the value entered and the RF output power will be equal to the value entered minus the offset value as follows:

Output power = entered power – offset power

Displayed Power = output power + offset power

Displayed power = entered power

Where:

- entered power equals the amplitude entered under **Source, Amplitude, RF Power**
- offset power equals the value previously entered and set under **Source, Amplitude, Amptd Offset**

Remote Command	<code>:SOURce:POWer[:LEVel][:IMMEDIATE]:OFFSet <rel_amp1></code> <code>:SOURce:POWer[:LEVel][:IMMEDIATE]:OFFSet?</code>
Example	<code>:SOUR:POW:OFFS 0.00 dB</code>
Notes	The amplitude Offset unit follows the units set in Power Unit
Dependencies	Unavailable, and grayed-out, when List Sequencer is ON
Preset	0.00 dB

6 Input/Output

6.1 RF Source

Min	-200.00 dB
Max	200.00 dB

6.1.6.6 Amplitude Increment

Changes the step size for the RF Power function. Once an increment size has been selected and the RF Amplitude function is active, the step keys (and the **UP | DOWN** parameters for RF Power from remote commands) change the RF Power by the set value. This feature exists in EXG and MXG.

Remote Command	<code>:SOURce:POWer:STEP[:INCRement] <amp1></code> <code>:SOURce:POWer:STEP[:INCRement]?</code>
Example	<code>:SOUR:POW:STEP 1</code>
Notes	The Amplitude Increment unit follows the units set in Power Unit
Couplings	Coupled to the Step size of the RF Power function
Preset	1 dB
Min	0.1 dB
Max	10 dB

6.1.7 Frequency

Lets you control the frequency of the Source. Same as "[Frequency](#)" on page 2050 under "[Frequency Setup](#)" on page 2050.

Example	<code>:SOUR:FREQ 1.00 GHz</code>
---------	----------------------------------

6.1.8 List Sequencer

Accesses sub-menus for configuring the **List Sequencer**.

List sequences allow you to enter frequencies and amplitudes at unequal intervals in nonlinear ascending, descending or random order. Each step within the list can also include its own waveform file for playback, step duration, trigger event and trigger output.

The complexities involved in configuring the **List Sequencer** do not lend themselves to manual configuration; hence the manual configuration for this feature is limited. For easier configuration of the List Sequencer, it is recommended that you use either SCPI, or load a tab-delimited file containing the setup parameters in a tabular form. The details of the SCPI for configuring the List Sequencer can be found in "[Step Configuration \(Remote Command Only\)](#)" on page 2041.

Once the **List Sequencer** has been configured using the front panel, SCPI, or by loading a tab-delimited file, the sequence must be initiated using the front panel **Initiate Sequence** key, or the corresponding SCPI command.

Dependencies	Not available in E7760B
--------------	-------------------------

6.1.8.1 Sequencer

Sets the state of "[List Sequencer](#)" on page 2025

- When **List Sequencer** is **ON**, the source outputs the sequence defined by the sequencer
- When **List Sequencer** is **OFF**, the source outputs a single waveform segment or sequence (independent mode) at a single frequency and amplitude

Remote Command	<code>:SOURce:LIST[:STATe] ON OFF 1 0</code> <code>:SOURce:LIST[:STATe]?</code>
----------------	--

Example	<code>:SOUR:LIST OFF</code>
---------	-----------------------------

Notes	When the sequencer is ON , the List Sequencer controls the output of the source
-------	--

Dependencies	Not available in E7760B
--------------	-------------------------

Couplings	When in Sequence Analyzer Mode, and the List Sequencer state is OFF , Include Source is forced to NO , and the Include Source key is grayed-out When in Sequence Analyzer Mode, and the List Sequencer state is ON , Include Source is available to set, and an ARB memory related operation such as load or delete will be rejected
-----------	---

Preset	OFF
--------	------------

Range	ON OFF
-------	------------------------

6.1.8.2 Initiate Sequence

Arms the sequence for single execution. Once the sequence is armed, the source begins the sequence as soon as the trigger is received. If trigger is set to **Free Run**, the sequence starts immediately.

Remote Command	<code>:SOURce:LIST:TRIGger[:IMMediate]</code>
----------------	---

Example	<code>:SOUR:LIST:TRIG</code>
---------	------------------------------

Notes	When in Sequence Analyzer Mode, and Include Source is ON , the Initiate List Sequencer operation is rejected, and the key is grayed-out if the file needed by the sequencer is not already in ARB memory, the sequence cannot be initiated, and an error is generated There is a blocking SCPI query that can be used to check whether source list sequence was initiated successfully (see " Remote Software Trigger (Remote command Only) " on page 2050)
-------	--

Dependencies	In Sequence Analyzer Mode, if Meas Setup , Include Source is set to YES , Source , List Sequencer , Initiate Sequence is disabled Not available in E7760B
--------------	--

6.1.8.3 Repetition

Accesses a sub-menu to select the repetition type for the List Sequencer globally. It cannot be changed between different sequence steps.

In **Single**, the Source list plays one time after initiation. In **Continuous**, the Source list plays continuously after initiation.

This setting is available on EXM.

Remote Command	<code>:SOURce:LIST:REPetition:TYPE SINGle CONTInuous</code>
Example	<code>:SOUR:LIST:REP:TYPE SING</code> <code>:SOUR:LIST:REP:TYPE?</code>
Dependencies	Available on EXM Not available in E7760B
Preset	<code>SINGle</code>
Range	<code>SINGle CONTInuous</code>

6.1.8.4 Trig Out Type

Accesses a sub-menu to select the output trigger type for the List Sequencer globally. It cannot be changed between different sequence steps. It sets the output trigger type for the whole source sequence.

Remote Command	<code>:SOURce:LIST:TRIGger:OUTPut:TYPE STEP MARKer</code> <code>:SOURce:LIST:TRIGger:OUTPut:TYPE?</code>
Notes	<code>STEP</code> = Start of Step <code>MARKer</code> = Data Marker
Dependencies	Available on EXM Not available in E7760B
Preset	<code>STEP</code>
Backwards Compatibility SCPI	<code>:SOURce:LIST:TRIGgerout:TYPe BEGInningofstep DATAmarker</code>

6.1.8.5 Select Data Marker

When "**Trig Out Type**" on page 2027 is set to Data **MARKer**, specifies which marker to route.

Remote Command	<code>:SOURce:LIST:TRIGger:OUTPut:TYPE:MARKer M1 ... M4</code> <code>:SOURce:LIST:TRIGger:OUTPut:TYPE:MARKer?</code>
----------------	---

Backwards Compatibility :SOURce:LIST:TRIGgerout:TYPE:Marker
SCPI

6.1.8.6 Manual Trigger Now

Provides a software trigger event to the List Sequencer. During execution of a sequence, if the sequencer is halted on any step that has been configured with a “Manual” step trigger, then this keypress causes the sequencer to continue and execute the step.

Notes No remote command, front panel only

6.1.8.7 List Sequencer Setup

Accesses the List Sequencer setup menus.

Number of Steps

Lets you specify the number of steps within the list sequence.

Remote Command :SOURce:LIST:NUMBer:STEPs <integer>
:SOURce:LIST:NUMBer:STEPs?

Example :SOUR:LIST:NUMB:STEP 1

Notes Increasing the number of steps creates additional steps at the end of the list, with all the settings within the steps set to their default values
Decreasing the number of steps removes steps from the end of the list. The settings within the removed steps are not reset. This means that increasing the number of steps again would allow you to retrieve these steps

Dependencies The Step Count parameter is increased or decreased when you insert or delete a point from within the GUI interface to the sequencer
Not available in E7760B

Preset 1

Min 1

Max 1000

Go To Step

Lets you select the step number you wish to view or edit.

Preset 1

Min	1
Max	Step Count

Insert Step Before

Inserts a new step, with default values, before the currently selected step. Inserting a step automatically increases the Step Count parameter by 1. If a sequence has already reached the upper limit of 1000 steps, then this operation is rejected, and error -221, "Setting Conflict; Cannot insert more steps, maximum number of steps reached" is displayed.

Notes	If the list already contains the maximum limit (1000 steps), pressing this control has no effect
-------	--

Delete Step

Deletes the current step. Deleting a step automatically decreases the Step Count parameter by 1. If the sequence only has one step left, then this operation is rejected, and error -221, "Setting conflict; Cannot delete current step, minimum number of steps reached" is displayed

Notes	If the list already contains the minimum limit of 1 step, pressing this control has no effect
-------	---

Clear List

Clears the list. Clearing the list sets the number of steps to the default value (1) and sets the parameters for the only step to their default values.

Step Trigger

Lets you select the trigger input for the current step.

Remote Command	<code>:SOURce:LIST:STEP[1] 2 ... 1000:SETup:INPut:TRIGger IMMEDIATE INTERNAL EXTERNAL2 KEY BUS EXTERNAL4</code> For details of options, see " More Information " on page 2030 <code>:SOURce:LIST:STEP[1] 2 ... 1000:SETup:INPut:TRIGger?</code>
Example	<code>:SOUR:LIST:STEP2:SET:INP:TRIG BUS</code> <code>:SOUR:LIST:STEP2:SET:INP:TRIG?</code>
Notes	SCPI is supported after A.09.40
Dependencies	Not available in E7760B
Preset	<code>IMMEDIATE</code>
Range	<code>IMMEDIATE INTERNAL EXTERNAL2 KEY BUS EXTERNAL4</code>

More Information

Parameter	SCPI	Notes
Free Run	IMM	Sets the trigger input for the current step to Free Run
Internal	INT	Sets the trigger input for the current step to Internal
Manual (Trigger Key)	KEY	Sets the trigger input for the current step to Manual (Trigger Key). Any step in the sequence set to Manual will cause the sequence execution to stop until the manual trigger key is pressed. Sending the Bus Trigger SCPI command will have no effect. At any point in the sequence where the List Sequencer is paused waiting for a software trigger, a pop-up dialog is displayed until the trigger event occurs
Bus	BUS	Sets the trigger input for the current step to Bus. Any step in the sequence set to Bus will cause the sequence execution to stop until the Bus Trigger command is sent. Pressing the manual trigger key has no effect. At any point in the sequence where the List Sequencer is paused waiting for a software trigger, a pop-up dialog is displayed until the trigger event occurs
External 2	EXT2	Sets the trigger input for the current step to External 2 Note: When on EXM, trigger 2 is a bi-directional trigger port. So, when trigger 2 has been configured as OUTPUT type, choosing External 2 as the input trigger for the current step will generate error

Transition Time

Lets you specify the transition time for the current step.

The following table lists recommended values for appropriate settling times to allow for changes within the source.

Value Changed	Recommended Transition Time
Frequency	500 μ s
Amplitude	100 μ s to within 0.1 dB 20 μ s to within 1.0 dB

If the Transition Time value is shorter than the time necessary for the hardware to settle and a List Sequence is initiated, a **warning** is generated. If the Transition Time value is longer than the Step Duration, an error is generated when initiating a source list sequence. For source list sequence, transition time is included in the step duration length. If the Transition Time value is longer than the Step Duration Time, the real step duration length is extended to equal the transition time and cause a timing shift.

Remote Command	<code>:SOURce:LIST:STEP[1] 2 ... 1000:SETup:TRANSition:TIME <time></code> <code>:SOURce:LIST:STEP[1] 2 ... 1000:SETup:TRANSition:TIME?</code>
Example	<code>:SOUR:LIST:STEP2:SET:TRAN:TIME 1ms</code>

6 Input/Output
6.1 RF Source

	<code>:SOUR:LIST:STEP2:SET:TRAN:TIME?</code>
Notes	SCPI is supported after A.09.40
Dependencies	Not available in E7760B
Preset	1.0 ms
Min	0.0 ms
Max	4.0 ks

Band

Lets you select the radio band for use in the current step.

Remote Command	<code>:SOURce:LIST:STEP[1] 2 ... 1000:SETup:RADio:BAND <band></code>
	where <band> is one of: NONE PGSM EGSM RGSM DCS1800 PCS1900 GSM450 GSM480 GSM700 GSM850 TGSM810 USCELL USPCS JAPAN KOREAN NMT IMT2K UPPER SECOND PAMR400 PAMR800 IMTEXT PCS1DOT9G AWS US2DOT5G PUBLIC LOWER BANDI BANDII BANDIII BANDIV BANDV BANDVI BANDVII BANDVIII BANDIX BANDX BANDXI BANDXII BANDXIII BANDXIV BANDXIX BAND1 BAND2 BAND3 BAND4 BAND5 BAND6 BAND7 BAND8 BAND9 BAND10 BAND11 BAND12 BAND13 BAND14 BAND17 BAND18 BAND19 BAND20 BAND21 BAND24 BAND25 BAND26 BAND27 BAND28 BAND29 BAND30 BAND31 BAND65 BAND66 BAND67 BAND68 BAND71 BAND252 BAND255 BAND33 BAND34 BAND35 BAND36 BAND37 BAND38 BAND39 BAND40 BAND41 BAND42 BAND43 BAND44 BAND45 BAND46 BANDA BANDB BANDC BANDD BANDE BANDF N1 N2 N3 N5 N7 N8 N12 N20 N25 N28 N34 N38 N39 N40 N41 N50 N51 N66 N70 N71 N74 N75 N76 N77 N78 N79 N80 N81 N82 N83 N84 N86 N257 N258 N260 N261 <code>:SOURce:LIST:STEP[1] 2 ... 1000:SETup:RADio:BAND?</code>

Example	<code>:SOUR:LIST:STEP2:SET:RAD:BAND PGSM</code> <code>:SOUR:LIST:STEP2:SET:RAD:BAND?</code>
---------	--

Notes	SCPI is supported after A.09.40
Dependencies	Not available in E7760B

Here are the Radio Standards for each Band, and a SCPI example for each (Step 2 is assumed):

Band	Standard	SCPI Example
None	None	<code>:SOUR:LIST:STEP2:SET:RAD:BAND NONE</code>
P-GSM	GSM/EDGE	<code>:SOUR:LIST:STEP2:SET:RAD:BAND PGSM</code>
E-GSM	GSM/EDGE	<code>:SOUR:LIST:STEP2:SET:RAD:BAND EGSM</code>
R-GSM	GSM/EDGE	<code>:SOUR:LIST:STEP2:SET:RAD:BAND RGSM</code>
DCS 1800	GSM/EDGE	<code>:SOUR:LIST:STEP2:SET:RAD:BAND DCS1800</code>

Band	Standard	SCPI Example
PCS 1900	GSM/EDGE	:SOUR:LIST:STEP2:SET:RAD:BAND PCS1900
GSM 450	GSM/EDGE	:SOUR:LIST:STEP2:SET:RAD:BAND GSM450
GSM 480	GSM/EDGE	:SOUR:LIST:STEP2:SET:RAD:BAND GSM480
GSM 700	GSM/EDGE	:SOUR:LIST:STEP2:SET:RAD:BAND GSM700
GSM 850	GSM/EDGE	:SOUR:LIST:STEP2:SET:RAD:BAND GSM850
T-GSM 810	GSM/EDGE	:SOUR:LIST:STEP2:SET:RAD:BAND T-GSM810
US Cell	CDMA 2000	:SOUR:LIST:STEP2:SET:RAD:BAND USCELL
US PCS	CDMA 2000	:SOUR:LIST:STEP2:SET:RAD:BAND PCS
Japan Cell	CDMA 2000	:SOUR:LIST:STEP2:SET:RAD:BAND JAPAN
Korean PCS	CDMA 2000	:SOUR:LIST:STEP2:SET:RAD:BAND KOREAN
NMT 450	CDMA 2000	:SOUR:LIST:STEP2:SET:RAD:BAND NMT
IMT 2000	CDMA 2000	:SOUR:LIST:STEP2:SET:RAD:BAND IMT2K
Upper 700	CDMA 2000	:SOUR:LIST:STEP2:SET:RAD:BAND UPPER
Secondary 800	CDMA 2000	:SOUR:LIST:STEP2:SET:RAD:BAND SECOND
400 Euro PAMR	CDMA 2000	:SOUR:LIST:STEP2:SET:RAD:BAND PAMR400
800 PAMR	CDMA 2000	:SOUR:LIST:STEP2:SET:RAD:BAND PAMR800
2.5 GHz IMT EXT	CDMA 2000	:SOUR:LIST:STEP2:SET:RAD:BAND IMTEXT
US PCS 1.9 GHz	CDMA 2000	:SOUR:LIST:STEP2:SET:RAD:BAND PCS1DOT9G
AWS	CDMA 2000	:SOUR:LIST:STEP2:SET:RAD:BAND AWS
US 2.5 GHz	CDMA 2000	:SOUR:LIST:STEP2:SET:RAD:BAND US2DOT5G
700 Public Safety	CDMA 2000	:SOUR:LIST:STEP2:SET:RAD:BAND PUBLIC
C2K Lower 700	CDMA 2000	:SOUR:LIST:STEP2:SET:RAD:BAND LOWER
Band I	W-CDMA	:SOUR:LIST:STEP2:SET:RAD:BAND BANDI
Band II	W-CDMA	:SOUR:LIST:STEP2:SET:RAD:BAND BANDII
Band III	W-CDMA	:SOUR:LIST:STEP2:SET:RAD:BAND BANDIII
Band IV	W-CDMA	:SOUR:LIST:STEP2:SET:RAD:BAND BANDIV
Band V	W-CDMA	:SOUR:LIST:STEP2:SET:RAD:BAND BANDV
Band VI	W-CDMA	:SOUR:LIST:STEP2:SET:RAD:BAND BANDVI
Band VII	W-CDMA	:SOUR:LIST:STEP2:SET:RAD:BAND BANDVII
Band VIII	W-CDMA	:SOUR:LIST:STEP2:SET:RAD:BAND BANDVIII
Band IX	W-CDMA	:SOUR:LIST:STEP2:SET:RAD:BAND BANDIX
Band X	W-CDMA	:SOUR:LIST:STEP2:SET:RAD:BAND BANDX
Band XI	W-CDMA	:SOUR:LIST:STEP2:SET:RAD:BAND BANDXI
Band XII	W-CDMA	:SOUR:LIST:STEP2:SET:RAD:BAND BANDXII
Band XIII	W-CDMA	:SOUR:LIST:STEP2:SET:RAD:BAND BANDXIII
Band XIV	W-CDMA	:SOUR:LIST:STEP2:SET:RAD:BAND BANDXIV

6 Input/Output
6.1 RF Source

Band	Standard	SCPI Example
Band XIX	W-CDMA	:SOUR:LIST:STEP2:SET:RAD:BAND BANDXIX
Band 1	LTE FDD	:SOUR:LIST:STEP2:SET:RAD:BAND BAND1
Band 2	LTE FDD	:SOUR:LIST:STEP2:SET:RAD:BAND BAND2
Band 3	LTE FDD	:SOUR:LIST:STEP2:SET:RAD:BAND BAND3
Band 4	LTE FDD	:SOUR:LIST:STEP2:SET:RAD:BAND BAND4
Band 5	LTE FDD	:SOUR:LIST:STEP2:SET:RAD:BAND BAND5
Band 6	LTE FDD	:SOUR:LIST:STEP2:SET:RAD:BAND BAND6
Band 7	LTE FDD	:SOUR:LIST:STEP2:SET:RAD:BAND BAND7
Band 8	LTE FDD	:SOUR:LIST:STEP2:SET:RAD:BAND BAND8
Band 9	LTE FDD	:SOUR:LIST:STEP2:SET:RAD:BAND BAND9
Band 10	LTE FDD	:SOUR:LIST:STEP2:SET:RAD:BAND BAND10
Band 11	LTE FDD	:SOUR:LIST:STEP2:SET:RAD:BAND BAND11
Band 12	LTE FDD	:SOUR:LIST:STEP2:SET:RAD:BAND BAND12
Band 13	LTE FDD	:SOUR:LIST:STEP2:SET:RAD:BAND BAND13
Band 14	LTE FDD	:SOUR:LIST:STEP2:SET:RAD:BAND BAND14
Band 17	LTE FDD	:SOUR:LIST:STEP2:SET:RAD:BAND BAND17
Band 18	LTE FDD	:SOUR:LIST:STEP2:SET:RAD:BAND BAND18
Band 19	LTE FDD	:SOUR:LIST:STEP2:SET:RAD:BAND BAND19
Band 20	LTE FDD	:SOUR:LIST:STEP2:SET:RAD:BAND BAND20
Band 21	LTE FDD	:SOUR:LIST:STEP2:SET:RAD:BAND BAND21
Band 24	LTE FDD	:SOUR:LIST:STEP2:SET:RAD:BAND BAND24
Band 25	LTE FDD	:SOUR:LIST:STEP2:SET:RAD:BAND BAND25
Band 26	LTE FDD	:SOUR:LIST:STEP2:SET:RAD:BAND BAND26
Band 27	LTE FDD	:SOUR:LIST:STEP2:SET:RAD:BAND BAND27
Band 28	LTE FDD	:SOUR:LIST:STEP2:SET:RAD:BAND BAND28
Band 29	LTE FDD	:SOUR:LIST:STEP2:SET:RAD:BAND BAND29
Band 30	LTE FDD	:SOUR:LIST:STEP2:SET:RAD:BAND BAND30
Band 31	LTE FDD	:SOUR:LIST:STEP2:SET:RAD:BAND BAND31
Band 65	LTE FDD	:SOUR:LIST:STEP2:SET:RAD:BAND BAND65
Band 66	LTE FDD	:SOUR:LIST:STEP2:SET:RAD:BAND BAND66
Band 67	LTE FDD	:SOUR:LIST:STEP2:SET:RAD:BAND BAND67
Band 68	LTE FDD	:SOUR:LIST:STEP2:SET:RAD:BAND BAND68
Band 71	LTE FDD	:SOUR:LIST:STEP2:SET:RAD:BAND BAND71
Band 252	LTE FDD	:SOUR:LIST:STEP2:SET:RAD:BAND BAND252
Band 255	LTE FDD	:SOUR:LIST:STEP2:SET:RAD:BAND BAND255
Band 33	LTE TDD	:SOUR:LIST:STEP2:SET:RAD:BAND BAND33

Band	Standard	SCPI Example
Band 34	LTE TDD	:SOUR:LIST:STEP2:SET:RAD:BAND BAND34
Band 35	LTE TDD	:SOUR:LIST:STEP2:SET:RAD:BAND BAND35
Band 36	LTE TDD	:SOUR:LIST:STEP2:SET:RAD:BAND BAND36
Band 37	LTE TDD	:SOUR:LIST:STEP2:SET:RAD:BAND BAND37
Band 38	LTE TDD	:SOUR:LIST:STEP2:SET:RAD:BAND BAND38
Band 39	LTE TDD	:SOUR:LIST:STEP2:SET:RAD:BAND BAND39
Band 40	LTE TDD	:SOUR:LIST:STEP2:SET:RAD:BAND BAND40
Band 41	LTE TDD	:SOUR:LIST:STEP2:SET:RAD:BAND BAND41
Band 42	LTE TDD	:SOUR:LIST:STEP2:SET:RAD:BAND BAND42
Band 43	LTE TDD	:SOUR:LIST:STEP2:SET:RAD:BAND BAND43
Band 44	LTE TDD	:SOUR:LIST:STEP2:SET:RAD:BAND BAND44
Band 45	LTE TDD	:SOUR:LIST:STEP2:SET:RAD:BAND BAND45
Band 46	LTE TDD	:SOUR:LIST:STEP2:SET:RAD:BAND BAND46
Band A	TD-SCDMA	:SOUR:LIST:STEP2:SET:RAD:BAND BANDA
Band B	TD-SCDMA	:SOUR:LIST:STEP2:SET:RAD:BAND BANDB
Band C	TD-SCDMA	:SOUR:LIST:STEP2:SET:RAD:BAND BANDC
Band D	TD-SCDMA	:SOUR:LIST:STEP2:SET:RAD:BAND BANDD
Band E	TD-SCDMA	:SOUR:LIST:STEP2:SET:RAD:BAND BANDE
Band F	TD-SCDMA	:SOUR:LIST:STEP2:SET:RAD:BAND BANDF
N 1	5G NR	:SOUR:LIST:STEP2:SET:RAD:BAND N1
N 2	5G NR	:SOUR:LIST:STEP2:SET:RAD:BAND N2
N 3	5G NR	:SOUR:LIST:STEP2:SET:RAD:BAND N3
N 5	5G NR	:SOUR:LIST:STEP2:SET:RAD:BAND N5
N 7	5G NR	:SOUR:LIST:STEP2:SET:RAD:BAND N7
N 8	5G NR	:SOUR:LIST:STEP2:SET:RAD:BAND N8
N 12	5G NR	:SOUR:LIST:STEP2:SET:RAD:BAND N12
N 20	5G NR	:SOUR:LIST:STEP2:SET:RAD:BAND N20
N 25	5G NR	:SOUR:LIST:STEP2:SET:RAD:BAND N25
N 28	5G NR	:SOUR:LIST:STEP2:SET:RAD:BAND N28
N 34	5G NR	:SOUR:LIST:STEP2:SET:RAD:BAND N34
N 38	5G NR	:SOUR:LIST:STEP2:SET:RAD:BAND N38
N 39	5G NR	:SOUR:LIST:STEP2:SET:RAD:BAND N39
N 40	5G NR	:SOUR:LIST:STEP2:SET:RAD:BAND N40
N 41	5G NR	:SOUR:LIST:STEP2:SET:RAD:BAND N41
N 50	5G NR	:SOUR:LIST:STEP2:SET:RAD:BAND N50
N 51	5G NR	:SOUR:LIST:STEP2:SET:RAD:BAND N51

6 Input/Output
6.1 RF Source

Band	Standard	SCPI Example
N 66	5G NR	:SOUR:LIST:STEP2:SET:RAD:BAND N66
N 70	5G NR	:SOUR:LIST:STEP2:SET:RAD:BAND N70
N 71	5G NR	:SOUR:LIST:STEP2:SET:RAD:BAND N71
N 74	5G NR	:SOUR:LIST:STEP2:SET:RAD:BAND N74
N 75	5G NR	:SOUR:LIST:STEP2:SET:RAD:BAND N75
N 76	5G NR	:SOUR:LIST:STEP2:SET:RAD:BAND N76
N 77	5G NR	:SOUR:LIST:STEP2:SET:RAD:BAND N77
N 78	5G NR	:SOUR:LIST:STEP2:SET:RAD:BAND N78
N 79	5G NR	:SOUR:LIST:STEP2:SET:RAD:BAND N79
N 80	5G NR	:SOUR:LIST:STEP2:SET:RAD:BAND N80
N 81	5G NR	:SOUR:LIST:STEP2:SET:RAD:BAND N81
N 82	5G NR	:SOUR:LIST:STEP2:SET:RAD:BAND N82
N 83	5G NR	:SOUR:LIST:STEP2:SET:RAD:BAND N83
N 84	5G NR	:SOUR:LIST:STEP2:SET:RAD:BAND N84
N 86	5G NR	:SOUR:LIST:STEP2:SET:RAD:BAND N86
N 257	5G NR	:SOUR:LIST:STEP2:SET:RAD:BAND N257
N 258	5G NR	:SOUR:LIST:STEP2:SET:RAD:BAND N258
N 260	5G NR	:SOUR:LIST:STEP2:SET:RAD:BAND N260
N 261	5G NR	:SOUR:LIST:STEP2:SET:RAD:BAND N261

Device

Lets you specify the radio band link direction for the steps within the list sequence. The link is used in conjunction with the channel band and channel number to determine the output frequency.

Setting	Option	Description
Uplink	UP	The source calculates the uplink frequency according to an uplink formula together with selected channel band and channel number
Downlink	DOWN	The source calculates the downlink frequency according to a downlink formula together with selected channel band and channel number

Remote Command	:SOURce:LIST:STEP[1] 2 ... 1000:SETup:RADio:BAND:LINK DOWN UP :SOURce:LIST:STEP[1] 2 ... 1000:SETup:RADio:BAND:LINK?
Example	:SOUR:LIST:STEP2:SET:RAD:BAND:LINK UP :SOUR:LIST:STEP2:SET:RAD:BAND:LINK?
Notes	SCPI is supported after A.09.40

Dependencies	Not available in E7760B
Preset	DOWN
Range	DOWN UP

Freq/Chan

Lets you select the frequency or channel value for the current step. If the Band selection for the current row is **NONE**, you enter a frequency. Otherwise, enter a channel, which causes the frequency to be automatically selected, based on the Band selection.

Entering a Frequency

If the Band selection for the current row is **NONE**, enter a Frequency. This field in the table allows you to select the frequency value for the current step.

Remote Command	:SOURce:LIST:STEP[1] 2 ... 1000:SETup:CNFRrequency <double> :SOURce:LIST:STEP[1] 2 ... 1000:SETup:CNFRrequency?	
Example	:SOUR:LIST:STEP2:SET:CNFR 1GHz :SOUR:LIST:STEP2:SET:CNFR?	
Notes	SCPI is supported after A.09.40 Used to setup channel number or frequency setting, according to the current Radio Band setting. If Radio Band is NONE , then the value is frequency. If Radio Band is not NONE , then the value is channel number	
Dependencies	Not available in E7760B	
Couplings	The frequency value is coupled to the channel band and number for the step, such that updates to the radio band and channel number will update the frequency value to the corresponding absolute frequency. The reverse is also true, changing the frequency value causes the value of the channel number to be updated	
Preset	1.00 GHz	
Min	10.00 MHz	
Max	Hardware Dependent:	
	Option 503	3.6 GHz
	Option 504	3.9 GHz
	Option 506	6.00 GHz
	Option F06	6.08 GHz
	Option F06 & EP6	6.60 GHz

Entering a Channel

If the Band selection for the current row is not **NONE**, enter a Channel Number. This field in the table allows you to select the channel value for the current step. The frequency is selected automatically, based on the Band.

Example	<code>:SOUR:LIST:STEP2:SET:CNFR 124</code> <code>:SOUR:LIST:STEP2:SET:CNFR?</code>
Notes	SCPI is supported after A.09.40 Used to setup channel number or frequency setting, according to current Radio Band setting. If Radio Band is NONE , then the value is a frequency. If Radio Band is not NONE , then the value is a channel number
Dependencies	Not available in E7760B
Couplings	The channel number is coupled to the step frequency value. When the step frequency value is changed, the channel number increases or decreases to match the new step frequency. If the step frequency is not at an exact match for a channel number, the nearest channel number is displayed, along with a greater-than or less-than sign, to indicate the frequency is above or below the channel number
Preset	1
Min/Max	0/10838 (See " Channel " on page 2053 for valid ranges)

Power

Lets you specify the power value for the current step.

Remote Command	<code>:SOURce:LIST:STEP[1] 2 ... 1000:SETup:AMPLitude <double></code> <code>:SOURce:LIST:STEP[1] 2 ... 1000:SETup:AMPLitude?</code>
Example	<code>:SOUR:LIST:STEP2:SET:AMPL -50dBm</code> <code>:SOUR:LIST:STEP2:SET:AMPL?</code>
Dependencies	The RF power is dependent on the RF output port and frequency, such that the current frequency and selected output port determine the valid range of power values Not available in E7760B
Preset	-100 dBm
Min/Max	The range of values depends on the current frequency and selected RF output port See " RF Power " on page 2018 and the RF Power Range table for valid ranges

Waveform

Lets you select the waveform to be played back during the current step. Options are: CW, a Waveform file, Continue the previous step's waveform, or Off.

Remote Command	<code>:SOURce:LIST:STEP[1] 2 ... 1000:SETup:WAVEform <string></code>
----------------	--

	<p>where <code><string></code> is one of: "CW", "waveform name", "Cont", "Off" For full details of options, see "More Information" on page 2038 <code>:SOURce:LIST:STEP[1] 2 ... 1000:SETup:WAVeform?</code></p>
Example	<code>:SOUR:LIST:STEP2:SET:WAV "CW"</code> <code>:SOUR:LIST:STEP2:SET:WAV?</code>
Notes	SCPI is supported after A.09.40
Dependencies	Not available in E7760B For VXT models M9410A/11A/16A, if the Waveform is not Continue Previous, there is always a time gap between the current step and the previous step
Preset	CW
Range	"CW", "waveform name", "Cont", "Off"

More Information

Parameter	SCPI	Notes
CW	"CW"	Sets the current step to output a CW tone
Selected Waveform	"waveform name"	Inserts a waveform from the Select Waveform dialog as the waveform for playback during the current step If the selected waveform contains header (which contains ARB play parameters), source list sequence will automatically apply header settings of the selected waveform in that step
Continue Previous	"Cont"	Sets the current step to continue with playback of the waveform from the previous step. When continuing the previous waveform, the ARB playback will not pause while the source retunes to the new frequency or amplitude that may be defined for the new step
Off	"Off"	Disable RF output of the current step

Waveform File

Pressing the slide–aside field of this column (>) opens the ["Select Waveform" on page 2094](#) screen, which lets you select a waveform in ARB memory to playback during the current step. When you select a waveform, and press **OK**, it returns to the List Sequencer Setup screen with that file name in the table.

Step Duration

Lets you select the duration of play for the current step.

6 Input/Output
6.1 RF Source

The duration can be set to be either the number of times for the ARB file associated with the sequence to play, or a specific time value, or continuous. If the step is set to play a CW tone, the step duration cannot be set to a play count.

Remote Command	<code>:SOURce:LIST:STEP[1] 2 ... 1000:SETup:DURation:TYPE TIME COUNT CONTInuous CABort</code> See "Option Details" on page 2039 <code>:SOURce:LIST:STEP[1] 2 ... 1000:SETup:DURation:TYPE?</code>
Example	<code>:SOUR:LIST:STEP2:SET:DUR:TYPE TIME</code> <code>:SOUR:LIST:STEP2:SET:DUR:TYPE?</code>
Dependencies	Not available in E7760B If in VXT models M9410A/11A/16A, Step Duration is TIME or Play COUNT , only Free Run is available for the next step. Otherwise, an error message is generated: "Parameter error; only Free Run is available as step trigger on step<n>"
Range	TIME COUNT CONTInuous CABort

Option Details

Parameter	SCPI	Notes
Time	TIME	Sets the duration of the current step to be a time value for the length of time the step will play When TIME is selected, the Time may be set using the second field under Step Duration and/or by the "Duration Time" on page 2039 command
Count	COUNT	Sets the duration of the current step to be an integer value for the number of times (play count) the ARB file is selected for playback during this step. For example, a 5 second ARB will be set to play 5 times during the step When COUNT is selected, the Count may be set using the second field under Step Duration and/or by the "Play Count" on page 2040 command
Continuous	CONTInuous	Sets the current step to be played continuously until the next step starts. The waveform will always play completely before transitioning to the next step
Continuous Abort	CABort	Sets the current step to be played continuously or until the trigger event of the next step is detected. When a trigger event is received, the waveform play will be aborted after the interval specified by the Duration Time parameter and it will then transition to the next step When Continuous Abort is selected, the Duration Time may be set using the second field under Step Duration and/or by the "Duration Time" on page 2039 command

Duration Time

Lets you specify the length of time the current step will play when ["Step Duration" on page 2038](#) is Time.

When "[Step Duration](#)" on page 2038 is Continuous Abort, this parameter specifies the maximum duration that the waveform will continue to play after a step trigger is received before the transition to the next waveform will occur. Duration is limited to a maximum of 20 seconds.

If the Transition Time value is longer than the Step Duration Time, an error is generated when initiating a source list sequence. For source list sequence, transition time is included in the step duration length (not occupy additional time). If the Transition Time value is longer than the Step Duration Time, the real step duration length is extended to equal the transition time and cause a timing shift.

Remote Command	<code>:SOURce:LIST:STEP[1] 2 ... 1000:SETup:DURation:TCOunt <double></code> <code>:SOURce:LIST:STEP[1] 2 ... 1000:SETup:DURation:TCOunt?</code>
Example	<code>:SOUR:LIST:STEP2:SET:DUR:TCO 1s</code> <code>:SOUR:LIST:STEP2:SET:DUR:TCO?</code>
Notes	When Repetition is Single , the last step continues playing after the sequence is completed. In this extended playing time, <code>:STAT:OPER:COND?</code> returns 0 for the Source Sweeping Status Bit (bit 9) SCPI is supported after A.09.40 If current Duration Type is Continuous , then error -221, "Settings conflict; Cannot accept time or count input when step duration type is Continuous on step #" is displayed
Dependencies	Not available in E7760B
Preset	VXT models M9410A/11A/16A: 2.0 ms All others: 1.00 ms
Min	For VXT models M9410A/11A/16A, the minimum duration time for first step is 1.2 ms. If the Waveform is "waveform name", the minimum duration time is 1.2 ms All others: 100 µs
Max	1800 s

Play Count

Lets you specify the number of times the current ARB waveform file will play during a step when "[Step Duration](#)" on page 2038 is Count.

["Duration Time" on page 2039](#)

Remote Command	<code>:SOURce:LIST:STEP[1] 2 ... 1000:SETup:DURation:TCOunt <double></code> <code>:SOURce:LIST:STEP[1] 2 ... 1000:SETup:DURation:TCOunt?</code>
Example	<code>:SOUR:LIST:STEP2:SET:DUR:TCO 10</code> <code>:SOUR:LIST:STEP2:SET:DUR:TCO?</code>
Notes	SCPI is supported after A.09.40 This command is reused by Play Count and Duration Time if Duration Type is set to Play Count or Duration Time If Duration Type is Continuous , then error -221, "Settings conflict; Cannot accept time or count input

6 Input/Output
6.1 RF Source

	when step duration type is Continuous on step #" is displayed If Play Count is set for the last step, the last step of ARB keeps playing as if set to Continuous after play count setting is reached
Dependencies	Not available in E7760B
Preset	1
Min	1
Max	65536

Trig Out

Lets you specify the trigger output for the current step. The trigger output signal is sent at the start of the step.

When this is **ON**, a trigger event occurs on both Internal and External2 paths. Selecting **OFF** turns off trigger output.

Remote Command	<code>:SOURce:LIST:STEP[1] 2 ... 1000:SETup:OUTPut:TRIGger ON OFF 1 0</code> <code>:SOURce:LIST:STEP[1] 2 ... 1000:SETup:OUTPut:TRIGger?</code>
Example	<code>:SOUR:LIST:STEP2:SET:OUTP:TRIG ON</code> <code>:SOUR:LIST:STEP2:SET:OUTP:TRIG?</code>
Notes	SCPI is supported after A.09.40
Dependencies	Not available in E7760B
Preset	OFF
Range	ON OFF

Step Configuration (Remote Command Only)

Used to configure the List Sequencer, as detailed in the table below. The command is defined such that you send one command per step, with the step number being specified as a subopcode of the SCPI command. Each command includes all the parameter settings for the step. As a step is set up, the values entered are run through several levels of validation.

Remote Command	<code>:SOURce:LIST:STEP[1] 2 ... 1000:SETup <step_trigger>, <trans_time>, <band>, <link_type>, <freq_chan>, <power>, <waveform>, <duration>, <time_count>, <trig_state></code> For details of each option, see " Step Configuration Parameters " on page 2042 below <code>:SOURce:LIST:STEP[1] 2 ... 1000:SETup?</code>
Example	<code>:SOUR:LIST:STEP1:SET INT, 1ms, PGSM, DOWN, 10, -25 dBm, "GSM_Test1.bin", TIME, 10ms, OFF</code>
Dependencies	The range of subopcode values is 1 to 1000, and the value you enter is determined by the number of

steps you have configured. For details see ["Number of Steps" on page 2028](#)
If you attempt to remotely set or query a subopcode that is out of range, an error is generated

Step Configuration Parameters

There are 10 parameters for each step, which must be in the following order in the command:

- | | | |
|---|---|---|
| 1 | Step Trigger
<step_trigger> | Data Type: enum
Specifies the input trigger for the step. For further details, see "Step Trigger" on page 2029 |
| 2 | Transition Time
<trans_time> | Data Type: enum
Specifies the transition time for the step, in seconds. For further details, see "Transition Time" on page 2030 |
| 3 | Radio Band
<band> | Data Type: enum
Specifies the radio band for the step, as any one of:
NONE PGSM EGSM RGSM DCS1800 PCS1900 TGSM810 GSM450 GSM480 GSM700 GSM850 BANDI BANDII BANDIII BANDIV BANDV BANDVI BANDVII BANDVIII BANDIX BANDX BANDXI BANDXII BANDXIII BANDXIV BANDXIX USCELL USPCS JAPAN KOREAN NMT IMT2K UPPER SECOND PAMR400 PAMR800 IMTEXT PCS1DOT9G AWS US2DOT5G PUBLIC LOWER NONE BAND1 BAND2 BAND3 BAND4 BAND5 BAND6 BAND7 BAND8 BAND10 BAND11 BAND12 BAND13 BAND14 BAND17 BAND18 BAND19 BAND20 BAND21 BAND24 BAND25 BAND26 BAND33 BAND34 BAND35 BAND36 BAND37 BAND38 BAND39 BAND40 BAND41 BAND42 BAND43 BANDA BANDB BANDC BANDD BANDE BANDF N1 N2 N3 N5 N7 N8 N12 N20 N25 N28 N34 N38 N39 N40 N41 N50 N51 N66 N70 N71 N74 N75 N76 N77 N78 N79 N80 N81 N82 N83 N84 N86 N257 N258 N260 N261
For further details, see "Band" on page 2031 |
| 4 | Radio Band Link
<link_type> | Data Type: enum
Specifies the radio band link direction for the step, as either of:
DOWN UP
For further details, see "Device" on page 2035
The old Device BTS MS is obsolete, but is still supported, acting as an alias for the Link parameter |
| 5 | Frequency/Channel Number
<freq_chan> | Data Type: freq/chan num
Specifies the frequency in Hz or the channel number for the step. The channel number and frequency are combined as one parameter that represents the frequency or channel number depending on the radio band setting. If the radio band is set to NONE , this value is interpreted as a frequency value in Hz. If the radio band is set to a valid band, this value is interpreted as a channel number
For further details, see "Freq/Chan" on page 2036 |

6 Input/Output

6.1 RF Source

6	Power <power>	Data Type: ampl Specifies the output power for the step in dBm. For details of the valid ranges see "Power" on page 2037								
7	Waveform <waveform>	Data Type: string Specifies the waveform for playback during the step. The step can output either a new ARB waveform, continue playback of the previous waveform, or output a CW tone. The options for specifying these are: <table border="0" style="margin-left: 20px;"> <tr> <td style="vertical-align: top;"><filename></td> <td>Plays the specified waveform from the start. The filename value is the name of the file within ARB playback memory, it does not include the windows path to the file on the HDD. If you enter a filename for a waveform that does not reside within ARB playback memory, an error is generated</td> </tr> <tr> <td style="vertical-align: top;">CONT</td> <td>Continues playback of the ARB file from the previous step</td> </tr> <tr> <td style="vertical-align: top;">CW</td> <td>Outputs a CW tone</td> </tr> <tr> <td style="vertical-align: top;">OFF</td> <td>Disables RF output</td> </tr> </table> For further details, see "Waveform" on page 2037 and "Waveform File" on page 2038	<filename>	Plays the specified waveform from the start. The filename value is the name of the file within ARB playback memory, it does not include the windows path to the file on the HDD. If you enter a filename for a waveform that does not reside within ARB playback memory, an error is generated	CONT	Continues playback of the ARB file from the previous step	CW	Outputs a CW tone	OFF	Disables RF output
<filename>	Plays the specified waveform from the start. The filename value is the name of the file within ARB playback memory, it does not include the windows path to the file on the HDD. If you enter a filename for a waveform that does not reside within ARB playback memory, an error is generated									
CONT	Continues playback of the ARB file from the previous step									
CW	Outputs a CW tone									
OFF	Disables RF output									
8	Step Duration <duration>	Data Type: enum Specifies the duration of the step, as one of: TIME COUNT CONTinuous The duration can be specified to be either time, or play count of the ARB file associated with the step, or continuous. If Waveform is set to CW , this value cannot be set to Play Count and an error will be generated. If CONTinuous is selected, the following Time or Count value is ignored. For further details, see "Step Duration" on page 2038								
9	Time or Count <time_count>	Data Type: time/int Specifies time duration in seconds, or play count of the ARB file associated with the step For further details, see "Play Count" on page 2040								
10	Output Trigger <trig_state>	Data Type: boolean Specifies the output trigger state for the step, as one of: ON OFF 1 0 For further details, see "Trig Out" on page 2041								

–

Step Configuration of Step Trigger parameter list (Remote Command Only)

Configures the “Step Trigger” parameter array of the whole List Sequencer at one time. The number of arrays is the same as the step number defined in ["Number of](#)

[Steps](#) on page 2028. As a step is setup, the value entered runs through several levels of validation.

Remote Command	<code>:SOURce:LIST:SETup:INPut:TRIGger <enum>, <enum>, <enum>, ...</code> <code>:SOURce:LIST:SETup:INPut:TRIGger?</code>
Example	<code>:SOUR:LIST:SET:INP:TRIG IMM,INT,EXT2</code> <code>:SOUR:LIST:SET:INP:TRIG?</code>
Notes	The command is to setup below parameter array of whole list sequence Step Trigger <enum> - specifies the input trigger for the step. For details of the valid types of step trigger see "Step Trigger" on page 2029 If input parameter number exceeds the step number defined by "Number of Steps" on page 2028 , then error -221 "Settings conflict; The number of input parameters is too large and is truncated to current list step number" is generated, and only those parameters whose index number falls in number of steps will be updated
Dependencies	The range is 1 to 1000, which is determined by the number of steps you have configured. For details see "Number of Steps" on page 2028

Step Configuration of Transition Time parameter list (Remote Command Only)

Configures the "Transition Time" parameter array of the whole List Sequencer at once. The array size is the same as step number defined in ["Number of Steps" on page 2028](#). As a step is setup, the value entered runs through several levels of validation.

Remote Command	<code>:SOURce:LIST:SETup:TRANSition:TIME <time>, <time>, <time>, ...</code> <code>:SOURce:LIST:SETup:TRANSition:TIME?</code>
Example	<code>:SOUR:LIST:SET:TRAN:TIME 1ms,1ms,1ms</code> <code>:SOUR:LIST:SET:TRAN:TIME?</code>
Notes	The command is to setup below parameter array of whole list sequence Transition Time <time> - specifies the transition time for the step in seconds. For details of the valid ranges for the transition time see "Transition Time" on page 2030 If input parameter number exceeds the step number defined by "Number of Steps" on page 2028 , then the error -221, "Settings conflict; The number of input parameters is too large and is truncated to current list step number" is generated, and only those parameters whose index number falls in number of steps will be updated
Dependencies	The range is 1 to 1000 which is determined by the number of steps you have configured. For details see "Number of Steps" on page 2028

Step Configuration of Radio Band parameter list (Remote Command Only)

Configures the **Radio Band** parameter array of the whole List Sequencer at once. The size of the array is the same as the step number defined in ["Number of Steps"](#)

on page 2028. As a step is set up, the value entered runs through several levels of validation.

Remote Command	<code>:SOURce:LIST:SETup:RADio:BAND <enum>, <enum>, <enum>, ...</code> <code>:SOURce:LIST:SETup:RADio:BAND?</code>
Example	<code>:SOUR:LIST:SET:RAD:BAND PGSM, EGSM, RGSM</code> <code>:SOUR:LIST:SET:RAD:BAND?</code>
Notes	The command sets up the parameter array of whole list sequence Radio Band <enum> - specifies the radio band for the step. For available options, see "Band" on page 2031 If the input parameter number exceeds the step number defined by "Number of Steps" on page 2028, then error -221, "Settings conflict; The number of input parameters is too large and is truncated to current list step number" is generated, and only those parameters whose index number falls within the number of steps will be updated
Dependencies	The range is 1 to 1000, which is determined by the number of steps you have configured. For details see "Number of Steps" on page 2028

Step Configuration of Radio Band Link parameter list (Remote Command Only)

Configures the **Radio Band Link** parameter array of the whole List Sequencer at one time. The number of arrays is same as step number defined in "Number of Steps" on page 2028. As a step is set up, the value entered runs through several levels of validation.

Remote Command	<code>:SOURce:LIST:SETup:RADio:BAND:LINK <enum>, <enum>, <enum>, ...</code> <code>:SOURce:LIST:SETup:RADio:BAND:LINK?</code>
Example	<code>:SOUR:LIST:SET:RAD:BAND:LINK DOWN,UP,UP</code> <code>:SOUR:LIST:SET:RAD:BAND:LINK?</code>
Notes	The command sets up the parameter array of whole list sequence Radio Band Link <enum> - specifies the radio band link direction for the step. Options are: <code>DOWN UP</code> If input parameter number exceeds the step number defined by "Number of Steps" on page 2028, then error -221, "Settings conflict; The number of input parameters is too large and is truncated to current list step number" is generated, and only those parameters whose index number falls within the number of steps will be updated
Dependencies	The range is 1 to 1000, which is determined by the number of steps you have configured. For details see "Number of Steps" on page 2028

Step Configuration of Frequency/Channel Number parameter list (Remote Command Only)

Configures the **Frequency** or **Channel Number** parameter array of the whole List Sequencer at one time. The number of arrays is same as step number defined in ["Number of Steps" on page 2028](#). As a step is set up, the value entered runs through several levels of validation.

Remote Command	<code>:SOURce:LIST:SETup:CNFRrequency <double>, <double>, <double>, ...</code> <code>:SOURce:LIST:SETup:CNFRrequency?</code>
Example	<code>:SOUR:LIST:SET:CNFR 1GHz,100MHz,100MHz</code> <code>:SOUR:LIST:SET:CNFR?</code> <code>:SOUR:LIST:SET:CNFR 124,124,124</code> <code>:SOUR:LIST:SET:CNFR?</code>
Notes	<p>The command sets up the parameter array of whole list sequence</p> <p>Frequency/Channel Number <freq>/<chan num> - specifies the frequency in Hz or the channel number for the step. The channel number and frequency are combined as one parameter that represents the frequency or channel number depending on the radio band setting. If the radio band is set to NONE, this value is interpreted as a frequency value in Hz. If the radio band is set to a valid band, this value is interpreted as a channel number. For details of the valid ranges for frequency and channel numbers, see "Freq/Chan" on page 2036 and "Freq/Chan" on page 2036</p> <p>This command is used to setup/query channel number or frequency setting, according to current Radio Band setting of that step. If Radio Band is NONE, then it is frequency. If Radio Band is not NONE, then it is channel number</p> <p>If input parameter number exceeds the step number defined by "Number of Steps" on page 2028, then generate error -221, "Settings conflict; The number of input parameters is too large and is truncated to current list step number", and only those parameters whose index number falls in legal step number will be updated</p>
Dependencies	The range is 1 to 1000, which is determined by the number of steps you have configured. For details see "Number of Steps" on page 2028

Step Configuration of Power parameter list (Remote Command Only)

Configures the **Power** parameter array of the whole List Sequencer at one time. The number of arrays is the same as step number defined in ["Number of Steps" on page 2028](#). As a step is set up, the value entered runs through several levels of validation.

Remote Command	<code>:SOURce:LIST:SETup:AMPLitude <ampl>, <ampl>, <ampl>, ...</code> <code>:SOURce:LIST:SETup:AMPLitude?</code>
Example	<code>:SOUR:LIST:SET:AMPL -50dBm,-40dBm,-30dBm</code> <code>:SOUR:LIST:SET:AMPL?</code>
Notes	The command sets up the parameter array of whole list sequence

Power **<ampl>** - specifies the output power for the step in dBm. For details of the valid ranges, see ["Power" on page 2037](#)

If input parameter number exceeds the step number defined by ["Number of Steps" on page 2028](#), then error -221, "Settings conflict; The number of input parameters is too large and is truncated to current list step number" is generated, and only those parameters whose index number falls within legal step number will be updated

Dependencies The range is 1 to 1000, which is determined by the number of steps you have configured. For details see ["Number of Steps" on page 2028](#)

Step Configuration of Waveform parameter list (Remote Command Only)

Configures the **Waveform** parameter array of the whole List Sequencer at one time. The number of arrays is same as step number defined in ["Number of Steps" on page 2028](#). As a step is set up, the value entered runs through several levels of validation.

Remote Command `:SOURce:LIST:SETup:WAVEform <string>, <string>, <string>, ...`
`:SOURce:LIST:SETup:WAVEform?`

Example `:SOUR:LIST:SET:WAV "CW", "Off", "CONT"`
`:SOUR:LIST:SET:WAV?`

Notes Sets up or queries the parameter array of whole list sequence
Waveform **<string>** - specifies the waveform for playback during the step. The step can output either a new ARB waveform, continue playback of the previous waveform, or output a CW tone. The options for specifying these are:

<filename>	Plays the specified waveform from the start. The filename value is the name of the file within ARB playback memory, it does not include the windows path to the file on the HDD. If you enter a filename for a waveform that does not reside within ARB playback memory, an error is generated
CONT	Continues playback of the ARB file from the previous step
CW	Outputs a CW tone
OFF	Disables the RF output

If input parameter number exceeds the step number defined by ["Number of Steps" on page 2028](#), then error -221, "Settings conflict; The number of input parameters is too large and is truncated to current list step number" is generated, and only those parameters whose index number falls within number of steps will be updated

Dependencies The range is 1 to 1000 which is determined by the number of steps you have configured. For details see ["Number of Steps" on page 2028](#)

Range `"filename" | "CW" | "Off" | "CONT"`

Step Configuration of Step Duration parameter list (Remote Command Only)

Configures the **Step Duration** parameter array of the whole List Sequencer at one time. The number of arrays is same as step number defined in "[Number of Steps](#)" on [page 2028](#). As a step is set up, the value entered runs through several levels of validation.

Remote Command	<code>:SOURce:LIST:SETup:DURation:TYPE <enum>, <enum>, <enum>, ...</code> <code>:SOURce:LIST:SETup:DURation:TYPE?</code>
Example	<code>:SOUR:LIST:SET:DUR:TYPE COUN,TIME,CONT</code> <code>:SOUR:LIST:SET:DUR:TYPE?</code>
Notes	<p>Sets up or queries the parameter array of whole list sequence</p> <p>Step Duration <enum> - specifies the duration of the step. The duration can be specified to be either time, or play count of the ARB file associated with the step, or continuous. If Waveform is set to "CW", this value cannot be set to Play Count and an error will be generated. If continuous is selected, the following Time or Count value is ignored. For further details of this setting, see "Step Duration" on page 2038</p> <p>Options are: TIME COUNT CONTInuous</p> <p>If input parameter number exceeds the step number defined by "Number of Steps" on page 2028, then error -221, "Settings conflict; The number of input parameters is too large and is truncated to current list step number" is generated, and only those parameters whose index number falls within number of steps will be updated</p>
Dependencies	The range is 1 to 1000, which is determined by the number of steps you have configured. For details see " Number of Steps " on page 2028

Step Configuration of Duration Time or Play Count parameter list (Remote Command Only)

Configures the **Duration Time** or **Play Count** parameter array of the whole List Sequencer at one time. The number of arrays is same as step number defined in "[Number of Steps](#)" on [page 2028](#). As a step is set up, the value entered runs through several levels of validation.

Remote Command	<code>:SOURce:LIST:SETup:TOCount <time/int>, <time/int>, <time/int>, ...</code> <code>:SOURce:LIST:SETup:TOCount?</code>
Example	<code>:SOUR:LIST:SET:TOC 1s,2s,3s</code> <code>:SOUR:LIST:SET:TOC?</code> <code>:SOUR:LIST:SET:TOC 5,6,7</code> <code>:SOUR:LIST:SET:TOC?</code>
Notes	Sets up or queries the parameter array of whole list sequence

	<p>Time or Count <time/int> - specifies time duration in seconds or play count of the ARB file associated with the step</p> <p>If input parameter number exceeds the step number defined by "Number of Steps" on page 2028, then an error is generated, and only those parameters whose index number falls within number of steps will be updated</p> <p>If current "Step Duration" on page 2038 is "Continuous", then error -221, "Settings conflict; Cannot accept time or count input when step duration type is Continuous on step #" is generated</p>
Dependencies	The range is 1 to 1000, which is determined by the number of steps you have configured. For details see "Number of Steps" on page 2028

Step Configuration of Output Trigger parameter list (Remote Command Only)

Configures the **Output Trigger** parameter array of the whole List Sequencer at one time. The number of arrays is same as step number defined in ["Number of Steps" on page 2028](#). As a step is set up, the value entered runs through several levels of validation.

Remote Command	<pre>:SOURce:LIST:SETup:OUTPut:TRIGger <bool>, <bool>, <bool>, ... :SOURce:LIST:SETup:OUTPut:TRIGger?</pre>
Example	<pre>:SOUR:LIST:SET:OUTP:TRIG ON,OFF,ON :SOUR:LIST:SET:OUTP:TRIG?</pre>
Notes	<p>Sets up or queries the parameter array of whole list sequence</p> <p>Output Trigger <Boolean> - specifies the output trigger for the step. Options are: ON OFF 1 0</p> <p>If input parameter number exceeds the step number defined by "Number of Steps" on page 2028, then error -221, "Settings conflict; The number of input parameters is too large and is truncated to current list step number" is generated, and only those parameters whose index number falls within legal step number are updated</p>
Dependencies	The range is 1 to 1000, which is determined by the number of steps you have configured. For details see "Number of Steps" on page 2028

Clear List (Remote Command Only)

The SCPI equivalent of the Clear List UI feature described in ["Clear List" on page 2029](#).

Remote Command	<pre>:SOURce:LIST:SETup:CLEar</pre>
Example	<pre>:SOUR:LIST:SETup:CLE</pre>
Dependencies	Not available in E7760B

6.1.8.8 Remote Software Trigger (Remote command Only)

During execution of a list sequence, the sequence halts and waits at any step that has Step Trigger set to “Bus”. Sending this command triggers the step and continues the sequence.

Remote Command	<code>:SOURCE:LIST:TRIGGER:INITiate[:IMMEDIATE]</code>
Example	<code>:SOUR:LIST:TRIG:INIT</code>
Dependencies	Not available in E7760B

6.1.8.9 Query List Sequence Initiation Armed Status (Remote Query Only)

This is a blocking SCPI query to determine whether a source list sequence has been initiated successfully.

Remote Command	<code>:SOURCE:LIST:INITiation:ARMed?</code>
Example	<code>:SOUR:LIST:INIT:ARMed?</code>
Notes	<p>Returns “1” if list sequence has been initiated successfully, or “0” if not. If the response is “0”, use <code>:SYST:ERR?</code> to query the actual error</p> <p>Like <code>*OPC?</code>, this command can be blocked until event/status “IsSourceSweeping” occurs, and then returns. Doing so can help a script query the armed status only once during the time interval of the initiation. As an ancillary to the existing <code>:SOUR:LIST:TRIGGER[:IMMEDIATE]</code> (see "Initiate Sequence" on page 2026), send this query after <code>:SOUR:LIST:TRIG</code>. Otherwise, this query will return “1” immediately</p> <p>The return data is in the following format: Integer</p> <p>There is an alias: <code>:SOURCE:LIST:TRIGGER:INITiation:ARMed?</code></p>
Dependencies	Not available in E7760B

6.1.9 Frequency Setup

Lets you access the Frequency Setup sub-menu panel.

Notes	The menu under this control is for independent mode and has no effect on the "List Sequencer" on page 2025 . If "Sequencer" on page 2026 is ON , the List Sequencer controls the source output and this key is grayed-out, to indicate out-of-scope. When "Sequencer" on page 2026 is OFF , source leaves List Sequencer and this button is blanked out
-------	---

6.1.9.1 Frequency

Lets you set the RF Output Frequency. You can adjust the frequency of the source using the numeric keypad, step keys, or RPG. Pressing any digit (0 through 9) on the

6 Input/Output
6.1 RF Source

numeric keypad displays the unit terminator.

Remote Command	:SOURce:FREQuency[:CW] <freq> :SOURce:FREQuency[:CW]?	
Example	:SOUR:FREQ 1.00 GHz	
Notes	Internal source has list sequence mode, which comprises of several steps that contain separate output power, frequency and waveform etc. When the source list sequence playing is complete, the last step keeps playing, and you can use this command to change the list sequence last step's output frequency	
Couplings	The frequency value is coupled to the current channel band and number, such that updates to the band and number will update the frequency value to the corresponding absolute frequency	
Preset	E7760B	Depends on port selected
	EXM, with license F1A or 5WC	2.412 GHz
	VXT Models with Radio Heads/CIU	See " VXT Models with Remote Radio Heads/CIU " on page 2052
	M941xE(VXT Models with M9471A)	See " M941xE(VXT Models with M9471A) " on page 2052
	All other models	1.00 GHz
Min	E7760B	Depends on port selected
	VXT model M9420A	60 MHz
	VXT models M9410A/11A/15A/16A	380 MHz
	VXT model M9411A with Option LFE	1 MHz
	VXT Models with Radio Heads/CIU	See " VXT Models with Remote Radio Heads/CIU " on page 2052
	M941xE(VXT Models with M9471A)	See " M941xE(VXT Models with M9471A) " on page 2052
	All other models	10.00 MHz
Max	Hardware Dependent:	
	Option 503	3.6 GHz
	Option 504	3.8 GHz
	Option 506	6.00 GHz
	Option F06	6.00 GHz
	Parameters for " VXT models M9415A/16A " on page 2052	
	Parameters for " VXT Models with Remote Radio Heads/CIU " on page 2052	
	Parameters for " M941xE(VXT Models with M9471A) " on page 2052	
	For E7760B: Depends on port selected	
	For EXM, if license 5WC is present, the frequency range should be limited to: 1.1GHz-1.7GHz, 2.4GHz-2.5GHz, 4.8GHz-6.0GHz. If the user-defined frequency is outside of range, reports error message "Settings conflict; Frequency is outside available range"	

VXT models M9410A/11A

RF Output Port	Preset	Min Without Option “LFE”	Min With Option “LFE”	Max
RF Output	1 GHz	380 MHz	1 MHz	6 GHz
RFHD	1 GHz	380 MHz	1 MHz	6 GHz

VXT models M9415A/16A

Freq Option	Preset	Min	Max
F06	1 GHz	380 MHz	6.0 GHz
F08	1 GHz	380 MHz	8.0 GHz
F12	1 GHz	380 MHz	12.3 GHz

E7760B

RF Output Port	Preset	Min	Max
IFIO	16 GHz	2 GHz	18 GHz
M1650A	58.32 GHz	55 GHz	69 GHz
M1720A	28 GHz	25 GHz	29 GHz

VXT Models with Remote Radio Heads/CIU

Products with Radio Heads/CIU	Preset	Min frequency	Max frequency
VXT + CIU	6 GHz	5.9 GHz	12 GHz
VXT + CIU + RRH	28 GHz	24.25 GHz	43.5 GHz
VXT + M1742A RRH	28 GHz	10 GHz	32 GHz

M941xE(VXT Models with M9471A)

Products with M9471A	Preset	Minimum settable frequency	Minimum frequency with Spec	Maximum settable frequency
M941xE without LFE option	1 GHz	330 MHz	380MHz	26.5GHz
M941xE with LFE option (LFE option in M9411A or M9471A)	1 GHz	750 kHz	1MHz	26.5GHz

NOTE

The minimum spec frequency is 380 MHz, minimum settable center frequency is 330 MHz.

With Option LFE in M9411A or in M9471A, the minimum settable frequency is 750 kHz, but Spec to customer only ensure down to 1 MHz.

6.1.9.2 Channel

The frequency of the source can be specified by a channel number of a given frequency band. This control allows you to specify the current channel number. For the appropriate range of channel numbers for a given frequency band, see the following tables: ["GSM/EDGE Channel Number Ranges" on page 2053](#), ["W-CDMA Channel Number Ranges" on page 2054](#), ["LTE FDD Channel Number Ranges" on page 2055](#), and ["LTE TDD Channel Number Ranges" on page 2057](#).

Channel is not available on E7760B.

Remote Command	:SOURce:FREQuency:CHANnels:NUMBER <int>
Example	:SOUR:LIST:STEP2:SET:RAD:NUMB 1
Notes	Grayed-out when the "Radio Standard/Radio Band" on page 2058 is set to NONE
Couplings	The channel number is coupled to the frequency value when "Radio Standard/Radio Band" on page 2058 is not set to NONE When the frequency value is changed, the channel number increases or decreases to match the new frequency. If the frequency is not at an exact match for a channel number, the nearest channel number is displayed, with > or < indicating whether the frequency is above or below the channel number
Preset	1
Min/Max	See "GSM/EDGE Channel Number Ranges" on page 2053 , "W-CDMA Channel Number Ranges" on page 2054 , "LTE FDD Channel Number Ranges" on page 2055 , and "LTE TDD Channel Number Ranges" on page 2057

GSM/EDGE Channel Number Ranges

Band	Link (Device)	Range	Frequency (MHz)
P-GSM	Uplink (MS)	1 £ n £ 124	890.0 + 0.2*n
	Downlink (BS)	1 £ n £ 124	935.0 + 0.2*n
E-GSM	Uplink (MS)	0 £ n £ 124	890.0 + 0.2*n
		975 £ n £ 1023	890.0 + 0.2*(n-1024)
	Downlink (BS)	0 £ n £ 124	935.0 + 0.2*n
DCS 1800	Uplink (MS)	512 £ n £ 885	1710.200 + 0.20*(n-512)
		1805.200 + 0.20*(n-512)	
	Downlink (BS)	512 £ n £ 885	1805.200 + 0.20*(n-512)
PCS 1900	Uplink (MS)	512 £ n £ 810	1850.200 + 0.2*(n-512)
	Downlink (BS)	512 £ n £ 810	1930.200 + 0.2*(n-512)
R-GSM	Uplink (MS)	0 £ n £ 124	890.0 + 0.2*n
		955 £ n £ 1023	890.0 + 0.2*(n-1024)
	Downlink (BS)	0 £ n £ 124	935.0 + 0.2*n

Band	Link (Device)	Range	Frequency (MHz)
GSM 450	Uplink (MS)	955 £ n £ 1023	$935.0 + 0.2*(n-1024)$
	Downlink (BS)	256 £ n £ 293	$450.6 + 0.2*(n-259)$
GSM 480	Uplink (MS)	256 £ n £ 293	$460.6 + 0.2*(n-259)$
	Downlink (BS)	306 £ n £ 340	$479.000 + 0.2*(n-306)$
GSM 850	Uplink (MS)	306 £ n £ 340	$489.000 + 0.2*(n-306)$
	Downlink (BS)	128 £ n £ 251	$824.200 + 0.2*(n-128)$
GSM 700	Uplink (MS)	128 £ n £ 251	$869.200 + 0.2*(n-128)$
	Downlink (BS)	438 £ n £ 516	$777.200 + 0.2*(n-438)$
T-GSM810	Uplink (MS)	438 £ n £ 516	$747.200 + 0.2*(n-438)$
	Downlink (BS)	350 £ n £ 425	$806.0 + 0.2*(n-350)$
		350 £ n £ 425	$851.0 + 0.2*(n-350)$

W-CDMA Channel Number Ranges

Band	Link (Device)	Range	Frequency (MHz)
Band I	Downlink	10562 £ n £ 10838	$n \div 5$
	Uplink	9612 £ n £ 9888	$n \div 5$
Band II	Downlink	412 £ n £ 687	$n \div 5 + 1850.1$
		9662 £ n £ 9938	$n \div 5$
	Uplink	12 £ n £ 287	$n \div 5 + 1850.1$
		350 £ n £ 425	$n \div 5$
Band III	Downlink	1162 £ n £ 1513	$n \div 5 + 1575$
	Uplink	937 £ n £ 1288	$n \div 5 + 1525$
Band IV	Downlink	537 £ n £ 1738	$n \div 5 + 1805$
		1887 £ n £ 2087	$n \div 5 + 1735.1$
	Uplink	1312 £ n £ 1513	$n \div 5 + 1450$
		1662 £ n £ 1862	$n \div 5 + 1380.1$
Band V	Downlink	1007 £ n £ 1087	$n \div 5 + 670.1$
		4357 £ n £ 4458	$n \div 5$
	Uplink	782 £ n £ 862	$n \div 5 + 670.1$
		4132 £ n £ 4233	$n \div 5$
Band VI	Downlink	1037 £ n £ 1062	$n \div 5 + 670.1$
		4387 £ n £ 4413	$n \div 5$
	Uplink	812 £ n £ 837	$n \div 5 + 670.1$
		4162 £ n £ 4188	$n \div 5$
Band VII	Downlink	2237 £ n £ 2563	$n \div 5 + 2175$
		2587 £ n £ 2912	$n \div 5 + 2105.1$

6 Input/Output
6.1 RF Source

Band	Link (Device)	Range	Frequency (MHz)
	Uplink	2012 ≤ n ≤ 2338	n ÷ 5 + 2100
		2362 ≤ n ≤ 2687	n ÷ 5 + 2030.1
Band VIII	Downlink	2937 ≤ n ≤ 3088	n ÷ 5 + 340
		Uplink	2712 ≤ n ≤ 2863
Band IX	Downlink	9237 ≤ n ≤ 9387	n ÷ 5
		Uplink	8762 ≤ n ≤ 8912
Band X	Downlink	3112 ≤ n ≤ 3388	n ÷ 5 + 1490
		3412 ≤ n ≤ 3687	n ÷ 5 + 1430.1
	Uplink	2887 ≤ n ≤ 3163	n ÷ 5 + 1135
Band XI	Downlink	3187 ≤ n ≤ 3462	n ÷ 5 + 1075.1
		3712 ≤ n ≤ 3812	n ÷ 5 + 736
	Uplink	3487 ≤ n ≤ 3587	n ÷ 5 + 733
Band XII	Downlink	3837 ≤ n ≤ 3903	n ÷ 5 - 37
		3927 ≤ n ≤ 3992	n ÷ 5 - 54.9
	Uplink	3612 ≤ n ≤ 3678	n ÷ 5 - 22
		3702 ≤ n ≤ 3767	n ÷ 5 - 39.9
Band XIII	Downlink	4017 ≤ n ≤ 4043	n ÷ 5 - 55
		4067 ≤ n ≤ 4092	n ÷ 5 - 64.9
	Uplink	3792 ≤ n ≤ 3818	n ÷ 5 + 21
		3702 ≤ n ≤ 3767	n ÷ 5 - 39.9
Band XIV	Downlink	4117 ≤ n ≤ 4143	n ÷ 5 - 63
		4167 ≤ n ≤ 4192	n ÷ 5 - 72.9
	Uplink	3892 ≤ n ≤ 3918	n ÷ 5 + 12
Band XIX	Downlink	3942 ≤ n ≤ 3967	n ÷ 5 + 2.1
		712 ≤ n ≤ 763	n ÷ 5 + 735
		787 ≤ n ≤ 837	n ÷ 5 + 720.1
	Uplink	312 ≤ n ≤ 363	n ÷ 5 + 770
		387 ≤ n ≤ 437	n ÷ 5 + 755.1

LTE FDD Channel Number Ranges

The carrier frequency in the uplink and downlink is designated by the E-UTRA Absolute Radio Frequency Channel Number (EARFCN) in the range 0 - 65535. The relation between EARFCN and the carrier frequency in MHz for the downlink is given by the following equation, where F_{DL_low} and $N_{Offs-DL}$ are given in table 5.4.4-1 and N_{DL} is the downlink EARFCN.

$$F_{DL} = F_{DL_low} + 0.1(N_{DL} - N_{Offs-DL})$$

The relation between EARFCN and the carrier frequency in MHz for the uplink is given by the following equation where F_{UL_low} and $N_{Offs-UL}$ are given in table 5.4.4-1 and N_{UL} is the uplink EARFCN.

$$F_{UL} = F_{UL_low} + 0.1(N_{UL} - N_{Offs-UL})$$

Band	Downlink			Uplink		
	F_{DL_low} (MHz)	$N_{Offs-DL}$	Range of N_{DL}	F_{UL_low} (MHz)	$N_{Offs-UL}$	Range of N_{UL}
1	2110	0	0 – 599	1920	18000	18000 – 18599
2	1930	600	600 – 1199	1850	18600	18600 – 19199
3	1805	1200	1200 – 1949	1710	19200	19200 – 19949
4	2110	1950	1950 – 2399	1710	19950	19950 – 20399
5	869	2400	2400 – 2649	824	20400	20400 – 20649
6	875	2650	2650 – 2749	830	20650	20650 – 20749
7	2620	2750	2750 – 3449	2500	20750	20750 – 20449
8	925	3450	3450 – 3799	880	21450	21450 – 21799
9	1844.9	3800	3800 – 4149	1749.9	21800	21800 – 22149
10	2110	4150	4150 – 4749	1710	22150	22150 – 22749
11	1475.9	4750	4750 – 4949	1427.9	22750	22750 – 22949
12	729	5010	5010 – 5179	699	23010	23010 – 23179
13	746	5180	5180 – 5279	777	23180	23180 – 23279
14	758	5280	5280 – 5379	788	23280	23280 – 23379
...						
17	734	5730	5730 – 5849	704	23730	23730 – 23849
18	860	5850	5850 – 5999	815	23850	23850 – 23999
19	875	6000	6000 – 6149	830	24000	24000 – 24149
20	791	6150	6150 – 6449	832	24150	24150 – 24449
21	1495.9	6450	6450 – 6599	1447.9	24450	24450 – 24599
...						
24	1525	7700	7700 – 8039	1626.5	25700	25700 – 26039
25	1930	8040	8040 – 8689	1850	26040	26040 – 26689
26	859	8690	8690 – 9039	814	26690	26690 – 27039
...						

Note: The channel numbers that designate carrier frequencies so close to the operating band edges that the carrier extends beyond the operating band edge shall not be used. This implies that the first 7, 15, 25, 50, 75 and 100 channel numbers at the lower operating band edge and the last 6, 14, 24, 49, 74 and 99 channel numbers at the upper operating band edge shall not be used for channel bandwidths of 1.4, 3, 5, 10, 15 and 20 MHz respectively.

LTE TDD Channel Number Ranges

The carrier frequency in the uplink and downlink is designated by the E-UTRA Absolute Radio Frequency Channel Number (EARFCN) in the range 0 - 65535. The relation between EARFCN and the carrier frequency in MHz for the downlink is given by the following equation, where F_{DL_low} and $N_{Offs-DL}$ are given in table 5.4.4-1 and N_{DL} is the downlink EARFCN.

$$F_{DL} = F_{DL_low} + 0.1(N_{DL} - N_{Offs-DL})$$

The relation between EARFCN and the carrier frequency in MHz for the uplink is given by the following equation where F_{UL_low} and $N_{Offs-UL}$ are given in table 5.4.4-1 and N_{UL} is the uplink EARFCN.

$$F_{UL} = F_{UL_low} + 0.1(N_{UL} - N_{Offs-UL})$$

Band	Downlink			Uplink		
	F_{DL_low} (MHz)	$N_{Offs-DL}$	Range of N_{DL}	F_{UL_low} (MHz)	$N_{Offs-UL}$	Range of N_{UL}
33	1900	36000	36000 - 36199	1900	36000	36000 - 36199
34	2010	36200	36200 - 36349	2010	36200	36200 - 36349
35	1850	36350	36350 - 36949	1850	36350	36350 - 36949
36	1930	36950	36950 - 37549	1930	36950	36950 - 37549
37	1910	37550	37550 - 37749	1910	37550	37550 - 37749
38	2570	37750	37750 - 38249	2570	37750	37750 - 38249
39	1880	38250	38250 - 38649	1880	38250	38250 - 38649
40	2300	38650	38650 - 39649	2300	38650	38650 - 39649
41	2496	39650	39650 - 41589	2496	39650	39650 - 41589
42	3400	41590	41590 - 43589	3400	41590	41590 - 43589
43	3600	43590	43590 - 45589	3600	43590	43590 - 45589

Note: The channel numbers that designate carrier frequencies so close to the operating band edges that the carrier extends beyond the operating band edge shall not be used. This implies that the first 7, 15, 25, 50, 75 and 100 channel numbers at the lower operating band edge and the last 6, 14, 24, 49, 74 and 99 channel numbers at the upper operating band edge shall not be used for channel bandwidths of 1.4, 3, 5, 10, 15 and 20 MHz respectively.

6.1.9.3 Radio Setup

Lets you select the radio standard and associated radio band. You can also set the Radio Band Link to Uplink or Downlink.

Radio Standard/Radio Band

Lets you select the radio standard and associated radio band. The first column in the dialog lets you set the Radio Standard; for each standard, and the second column in the dialog changes to show you the available bands.

Once you have selected the radio standard, you can then set an active channel band. The radio standard and the active channel band allow you to use the ["Channel" on page 2053](#) control to set Channel numbers, thus setting ["Frequency" on page 2050](#) automatically.

Remote Command	<pre>:SOURce:FREQuency:CHANnels:BAND <band></pre> <p>where <band> is one of:</p> <p>NONE PGSM EGSM RGSM DCS1800 PCS1900 GSM450 GSM480 GSM700 GSM850 TGSM810 USCELL USPCS JAPAN KOREAN NMT IMT2K UPPER SECOND PAMR400 PAMR800 IMTEXT PCS1DOT9G AWS US2DOT5G PUBLIC LOWER BANDI BANDII BANDIII BANDIV BANDV BANDVI BANDVII BANDVIII BANDIX BANDX BANDXI BANDXII BANDXIII BANDXIV BANDXIX BAND1 BAND2 BAND3 BAND4 BAND5 BAND6 BAND7 BAND8 BAND9 BAND10 BAND11 BAND12 BAND13 BAND14 BAND17 BAND18 BAND19 BAND20 BAND21 BAND24 BAND25 BAND26 BAND27 BAND28 BAND29 BAND30 BAND31 BAND65 BAND66 BAND67 BAND68 BAND71 BAND252 BAND255 BAND33 BAND34 BAND35 BAND36 BAND37 BAND38 BAND39 BAND40 BAND41 BAND42 BAND43 BAND44 BAND45 BAND46 BANDA BANDB BANDC BANDD BANDE BANDF N1 N2 N3 N5 N7 N8 N12 N20 N25 N28 N34 N38 N39 N40 N41 N50 N51 N66 N70 N71 N74 N75 N76 N77 N78 N79 N80 N81 N82 N83 N84 N86 N257 N258 N260 N261</p> <pre>:SOURce:FREQuency:CHANnels:BAND?</pre>
Example	<pre>:SOUR:LIST:STEP2:SET:RAD:BAND PGSM</pre>
Notes	<p>Setting this to NONE grays-out "Channel" on page 2053 under Frequency Setup</p> <p>Here are the members of each group in Radio Standard and a SCPI example for each:</p> <p>None – no Radio Standard</p> <p>None <code>:SOUR:FREQ:CHAN:BAND NONE</code></p> <p>GSM</p> <p>Sets GSM/EDGE as the radio standard for use and accesses the GSM/EDGE specific channel band sub-menus.</p> <p>P-GSM <code>:SOUR:FREQ:CHAN:BAND PGSM</code></p> <p>E-GSM <code>:SOUR:FREQ:CHAN:BAND EGSM</code></p> <p>R-GSM <code>:SOUR:FREQ:CHAN:BAND RGSM</code></p> <p>DCS 1800 <code>:SOUR:FREQ:CHAN:BAND DCS1800</code></p>

6 Input/Output

6.1 RF Source

PCS 1900	:SOUR:FREQ:CHAN:BAND PCS1900
GSM 450	:SOUR:FREQ:CHAN:BAND GSM450
GSM 480	:SOUR:FREQ:CHAN:BAND GSM480
GSM 700	:SOUR:FREQ:CHAN:BAND GSM700
GSM 850	:SOUR:FREQ:CHAN:BAND GSM850
T-GSM 810	:SOUR:FREQ:CHAN:BAND T-GSM810

W-CDMA

Sets WCDMA as the radio standard for use and accesses the W-CDMA specific channel band sub-menus.

Band I	:SOUR:FREQ:CHAN:BAND BANDI
Band II	:SOUR:FREQ:CHAN:BAND BANDII
Band III	:SOUR:FREQ:CHAN:BAND BANDIII
Band IV	:SOUR:FREQ:CHAN:BAND BANDIV
Band V	:SOUR:FREQ:CHAN:BAND BANDV
Band VI	:SOUR:FREQ:CHAN:BAND BANDVI
Band VII	:SOUR:FREQ:CHAN:BAND BANDVII
Band VIII	:SOUR:FREQ:CHAN:BAND BANDVIII
Band IX	:SOUR:FREQ:CHAN:BAND BANDIX
Band X	:SOUR:FREQ:CHAN:BAND BANDX
Band XI	:SOUR:FREQ:CHAN:BAND BANDXI
Band XII	:SOUR:FREQ:CHAN:BAND BANDXII
Band XIII	:SOUR:FREQ:CHAN:BAND BANDXIII
Band XIV	:SOUR:FREQ:CHAN:BAND BANDXIV
Band XIX	:SOUR:FREQ:CHAN:BAND BANDXIX

LTE

Sets LTE FDD as the radio standard for use and accesses the LTE FDD specific channel band sub-menus.

Band 1	:SOUR:FREQ:CHAN:BAND BAND1
Band 2	:SOUR:FREQ:CHAN:BAND BAND2
Band 3	:SOUR:FREQ:CHAN:BAND BAND3
Band 4	:SOUR:FREQ:CHAN:BAND BAND4
Band 5	:SOUR:FREQ:CHAN:BAND BAND5
Band 6	:SOUR:FREQ:CHAN:BAND BAND6
Band 7	:SOUR:FREQ:CHAN:BAND BAND7
Band 8	:SOUR:FREQ:CHAN:BAND BAND8

Band 9	: SOUR : FREQ : CHAN : BAND BAND9
Band 10	: SOUR : FREQ : CHAN : BAND BAND10
Band 11	: SOUR : FREQ : CHAN : BAND BAND11
Band 12	: SOUR : FREQ : CHAN : BAND BAND12
Band 13	: SOUR : FREQ : CHAN : BAND BAND13
Band 14	: SOUR : FREQ : CHAN : BAND BAND14
Band 17	: SOUR : FREQ : CHAN : BAND BAND17
Band 18	: SOUR : FREQ : CHAN : BAND BAND18
Band 19	: SOUR : FREQ : CHAN : BAND BAND19
Band 20	: SOUR : FREQ : CHAN : BAND BAND20
Band 21	: SOUR : FREQ : CHAN : BAND BAND21
Band 24	: SOUR : FREQ : CHAN : BAND BAND24
Band 25	: SOUR : FREQ : CHAN : BAND BAND25
Band 26	: SOUR : FREQ : CHAN : BAND BAND26
Band 27	: SOUR : FREQ : CHAN : BAND BAND27
Band 28	: SOUR : FREQ : CHAN : BAND BAND28
Band 29	: SOUR : FREQ : CHAN : BAND BAND29
Band 30	: SOUR : FREQ : CHAN : BAND BAND30
Band 31	: SOUR : FREQ : CHAN : BAND BAND31
Band 65	: SOUR : FREQ : CHAN : BAND BAND65
Band 66	: SOUR : FREQ : CHAN : BAND BAND66
Band 67	: SOUR : FREQ : CHAN : BAND BAND67
Band 68	: SOUR : FREQ : CHAN : BAND BAND68
Band 71	: SOUR : FREQ : CHAN : BAND BAND71
Band 252	: SOUR : FREQ : CHAN : BAND BAND252
Band 255	: SOUR : FREQ : CHAN : BAND BAND255

LTE TDD

Sets LTE TDD as the radio standard for use and accesses the LTE TDD specific channel band sub-menus.

Band 33	: SOUR : FREQ : CHAN : BAND BAND33
Band 34	: SOUR : FREQ : CHAN : BAND BAND34
Band 35	: SOUR : FREQ : CHAN : BAND BAND35
Band 36	: SOUR : FREQ : CHAN : BAND BAND36
Band 37	: SOUR : FREQ : CHAN : BAND BAND37
Band 38	: SOUR : FREQ : CHAN : BAND BAND38
Band 39	: SOUR : FREQ : CHAN : BAND BAND39

6 Input/Output

6.1 RF Source

Band 40	:SOUR:FREQ:CHAN:BAND BAND40
Band 41	:SOUR:FREQ:CHAN:BAND BAND41
Band 42	:SOUR:FREQ:CHAN:BAND BAND42
Band 43	:SOUR:FREQ:CHAN:BAND BAND43
Band 44	:SOUR:FREQ:CHAN:BAND BAND44
Band 45	:SOUR:FREQ:CHAN:BAND BAND45
Band 46	:SOUR:FREQ:CHAN:BAND BAND46

5G NR

Sets 5G NR as the radio standard for use and accesses the 5G NR specific channel band sub-menus.

N 1	:SOUR:FREQ:CHAN:BAND N1
N 2	:SOUR:FREQ:CHAN:BAND N2
N 3	:SOUR:FREQ:CHAN:BAND N3
N 5	:SOUR:FREQ:CHAN:BAND N5
N 7	:SOUR:FREQ:CHAN:BAND N7
N 8	:SOUR:FREQ:CHAN:BAND N8
N 12	:SOUR:FREQ:CHAN:BAND N12
N 20	:SOUR:FREQ:CHAN:BAND N20
N 25	:SOUR:FREQ:CHAN:BAND N25
N 28	:SOUR:FREQ:CHAN:BAND N28
N 34	:SOUR:FREQ:CHAN:BAND N34
N 38	:SOUR:FREQ:CHAN:BAND N38
N 39	:SOUR:FREQ:CHAN:BAND N39
N 40	:SOUR:FREQ:CHAN:BAND N40
N 41	:SOUR:FREQ:CHAN:BAND N41
N 50	:SOUR:FREQ:CHAN:BAND N50
N 51	:SOUR:FREQ:CHAN:BAND N51
N 66	:SOUR:FREQ:CHAN:BAND N66
N 70	:SOUR:FREQ:CHAN:BAND N70
N 71	:SOUR:FREQ:CHAN:BAND N71
N 74	:SOUR:FREQ:CHAN:BAND N74
N 75	:SOUR:FREQ:CHAN:BAND N75
N 76	:SOUR:FREQ:CHAN:BAND N76
N 77	:SOUR:FREQ:CHAN:BAND N77
N 78	:SOUR:FREQ:CHAN:BAND N78
N 79	:SOUR:FREQ:CHAN:BAND N79
N 80	:SOUR:FREQ:CHAN:BAND N80

N 81	:SOUR:FREQ:CHAN:BAND N81
N 82	:SOUR:FREQ:CHAN:BAND N82
N 83	:SOUR:FREQ:CHAN:BAND N83
N 84	:SOUR:FREQ:CHAN:BAND N84
N 86	:SOUR:FREQ:CHAN:BAND N86
N 257	:SOUR:FREQ:CHAN:BAND N257
N 258	:SOUR:FREQ:CHAN:BAND N258
N 260	:SOUR:FREQ:CHAN:BAND N260
N 261	:SOUR:FREQ:CHAN:BAND N261

Radio Band Link

Lets you specify the channel band type as either uplink or downlink link direction. This value is used in conjunction with the channel band and channel number to determine the absolute frequency output by the source.

- When set to **Uplink (UP)**, the source calculates the uplink frequency using an uplink formula together with the selected channel band and channel number
- When set to **Downlink (DOWN)** the source calculates the downlink frequency using a downlink formula together with the selected channel band and channel number

Remote Command	:SOURce:RADio:BAND:LINK DOWN UP :SOURce:RADio:BAND:LINK?
Example	:SOUR:RAD:BAND:LINK UP
Preset	DOWN
Range	DOWN UP
Backwards Compatibility SCPI	:SOURce:RADio:DEVIce BTS MS :SOURce:RADio:DEVIce?
Backwards Compatibility Notes	DOWN = BTS UP = MS

6.1.9.4 Set Reference Frequency

Lets you set the frequency reference. Pressing this control turns the frequency reference state to **ON**, sets the reference frequency value to the current frequency, maintains this frequency at the RF output, and sets the displayed frequency to 0.00 Hz. All subsequent frequencies entered under Source>Frequency>Frequency are interpreted as being relative to this reference frequency.

6 Input/Output
6.1 RF Source

When you use a frequency reference, the signal generator outputs a frequency that is set relative to the reference frequency by the value entered under **Source, Frequency, Frequency** as follows:

Output frequency = reference frequency - entered frequency

Where:

- reference frequency equals the original RF frequency entered under **Source>Frequency>Frequency** and set as the reference frequency
- entered frequency equals a new value entered under **Source, Frequency, Frequency**

In addition, the displayed frequency value will be the same as the value entered under **Source>Frequency>Frequency**.

NOTE

If **Freq Reference** is **ON** with a reference value set, entering a value under **Source, Frequency, Frequency** and pressing **Set Frequency Reference** adds that value to the existing **Freq Reference** value.

If you wish to change the reference frequency value to the new value entered under **Source, Frequency, Frequency**, first set **Freq Reference** **OFF** then press **Set Frequency Reference**.

Remote Command	: SOURce:FREQuency:REFerence:SET
Example	: SOUR:FREQ:REF:SET
Dependencies	Unavailable, and grayed-out, when List Sequencer is ON

6.1.9.5 Freq Reference

Lets you toggle the state of the frequency reference. When the frequency reference state is **ON**, an annunciator is displayed on the main source view to indicate this state to the user.

When you use a frequency reference, the signal generator outputs a frequency that is set relative to the reference frequency by the value entered under **Source, Frequency, Frequency** as follows:

Output frequency = reference frequency + entered frequency

Where:

- reference frequency equals the original RF frequency entered under **Source, Frequency, Frequency** and set as the reference frequency
- entered frequency equals a new value entered under **Source, Frequency, Frequency**

For more information on Reference Frequency, see ["Set Reference Frequency" on page 2062](#).

Remote Command	<code>:SOURce:FREQuency:REFerence <freq></code> <code>:SOURce:FREQuency:REFerence?</code>						
Example	<code>:SOUR:FREQ:REF 0.00 Hz</code>						
Dependencies	Unavailable, and grayed-out, when List Sequencer is ON						
Couplings	The frequency reference state is coupled to the frequency reference set immediate action. When the reference set immediate action key is pressed, or the SCPI command issued, it turns the frequency reference state ON						
Preset	0.00 Hz						
Min	0.00 Hz						
Max	Hardware Dependent: <table border="1" data-bbox="406 772 1404 903"> <tr> <td>Option 503</td> <td>3.6 GHz</td> </tr> <tr> <td>Option 504</td> <td>3.8 GHz</td> </tr> <tr> <td>Option 506</td> <td>6.00 GHz</td> </tr> </table> For E7760B: Dependent on port selected Auto Function	Option 503	3.6 GHz	Option 504	3.8 GHz	Option 506	6.00 GHz
Option 503	3.6 GHz						
Option 504	3.8 GHz						
Option 506	6.00 GHz						
Remote Command	<code>:SOURce:FREQuency:REFerence:STATe OFF ON 0 1</code> <code>:SOURce:FREQuency:REFerence:STATe?</code>						
Example	<code>:SOUR:FREQ:REF:STATe ON</code>						
Preset	OFF						

6.1.9.6 Freq Offset

Lets you specify the frequency offset value. When the frequency offset state is **ON**, an annunciator is displayed on the main source view to indicate this state.

When the frequency offset is set to zero (0) and you set a new offset value, the displayed frequency value changes as follows, and the RF output frequency does not change:

Displayed value = output frequency + offset value

Where:

- output frequency equals the original frequency entered under **Source, Frequency, Frequency**
- offset value equals the value entered under **Source, Frequency, Freq Offset**

6 Input/Output
6.1 RF Source

When the frequency offset is set to a value other than zero (0) and you enter a new frequency value under **Source, Frequency, Frequency**, the displayed frequency will be the same as the value entered and the RF output frequency will be equal to the value entered minus the offset value as follows:

Output frequency = entered frequency – offset frequency

Displayed frequency = output frequency + offset frequency

Displayed frequency = entered frequency

Where:

- entered frequency equals the frequency entered under **Source, Frequency, Frequency**
- offset frequency equals the value previously entered and set under **Source, Frequency, Freq Offset**

Remote Command	<code>:SOURce:FREQuency:OFFSet <freq></code> <code>:SOURce:FREQuency:OFFSet?</code>
Example	<code>:SOUR:FREQ:OFFS 0 Hz</code>
Dependencies	Unavailable, and grayed-out, when List Sequencer is ON
Preset	0 Hz
Min/Max	-/+100.00 GHz

6.1.9.7 Freq Increment

Changes the step size for the RF Output Frequency function. Once an increment size has been selected and the RF Output Frequency function is active, the step keys (and the **UP | DOWN** parameters for RF Frequency from remote commands) change the RF Output Frequency by the increment set value.

This feature exists in EXG and MXG.

Remote Command	<code>:SOURce:FREQuency:STEP[:INCRement] <freq></code> <code>:SOURce:FREQuency:STEP[:INCRement]?</code>
Example	<code>:SOUR:FREQ:STEP 1.0 kHz</code>
Couplings	Coupled to the Step size of the RF Frequency function
Preset	Hardware Dependent. 10% of the span preset value
Min	1 Hz
Max	Hardware Dependent:
	Option 503 3.6 GHz
	Option 504 3.8 GHz

Option 506 6.00 GHz

For E7760B: Dependent on port selected

For EXM, if license 5WC is present, the frequency range should be limited to: 1.1GHz-1.7GHz, 2.4GHz-2.5GHz, 4.8GHz-6.0GHz. If the user-defined frequency is outside of range, reports error message "Settings conflict; Frequency is outside available range"

6.1.9.8 Rx/Tx Coupling

Allows coupling between the frequency of the Internal Source, RF Output Frequency, and the instrument Center Frequency. For all settings except **NONE**, this parameter couples the **Center Frequency** of the instrument to the RF Output Frequency of the source. Valid setting changes result in the Analyzer CF and RF Output Frequency parameters being set to the same value, plus the "Rx/Tx Offset" on page 2067.

The four states for coupling are:

SOURCE	Source follows Analyzer Coupling is in one direction only. Changes to the Center Frequency will result in the RF Output Frequency being set to the same value, with any Rx/Tx Frequency Offset applied. Changes to the RF Output Frequency will not change the Center Frequency and will change Rx/Tx Frequency Coupling to None
ANALYZER	Analyzer follows Source Coupling is in one direction only. Changes to the RF Output Frequency will result in the Center Frequency being set to the same value, with any Rx/Tx Frequency Offset applied. Changes to the Center Frequency will not change the RF Output Frequency and will change Rx/Tx Frequency Coupling to None
BOTH	Analyzer/Source Coupled Coupling is bi-directional. Changes to the Center Frequency will result in the RF Output Frequency being set to the same value, with any Rx/Tx Frequency Offset applied. Changes to the RF Output Frequency will result in the Center Frequency being set to the same value, with any Rx/Tx Frequency Offset applied
NONE	None RF Output Frequency and CF Frequency are independently controlled

Remote Command `:SOURCE:FREQUENCY:COUPLING NONE | BOTH | SOURCE | ANALYZER`
`:SOURCE:FREQUENCY:COUPLING?`

Example `:SOUR:FREQ:COUP BOTH`

Dependencies Only appears in Radio Test Mode

Preset **NONE**

Input/Output Preset

State Saved Yes

6.1.9.9 Rx/Tx Offset

Lets you offset the RF Output Frequency of the source from the **Center Frequency** of the instrument. See ["Rx/Tx Coupling" on page 2066](#) for coupling behavior.

Remote Command	<code>:SOURce:FREQuency:COUPling:OFFSet <freq></code> <code>:SOURce:FREQuency:COUPling:OFFSet?</code>						
Example	<code>:SOUR:FREQ:COUP:OFF 100 kHz</code>						
Dependencies	Grayed-out when "Rx/Tx Coupling" on page 2066 is set to NONE . If the grayed-out control is selected, the following message appears: "The parameter cannot be changed when Rx/Tx Coupling is Off" Only appears in Radio Test Mode						
Preset	0 Hz (Input/Output Preset)						
Min	-6 GHz						
Max	Hardware Dependent: <table border="1" data-bbox="406 903 1404 1039"> <tr> <td>Option 503</td> <td>3.6 GHz</td> </tr> <tr> <td>Option 504</td> <td>3.8 GHz</td> </tr> <tr> <td>Option 506</td> <td>6.00 GHz</td> </tr> </table> For E7760B: Dependent on port selected For E6640A, if license 5WC is present, the frequency range should be limited to: 1.1GHz-1.7GHz, 2.4GHz-2.5GHz, 4.8GHz-6.0GHz. If the user-defined frequency is outside of range, UI reports an error message: "Settings conflict; Frequency is outside available range"	Option 503	3.6 GHz	Option 504	3.8 GHz	Option 506	6.00 GHz
Option 503	3.6 GHz						
Option 504	3.8 GHz						
Option 506	6.00 GHz						

6.1.10 Modulation

Lets you toggle the state of modulation.

Remote Command	<code>:OUTPut:MODulation[:STATe] ON OFF 1 0</code> <code>:OUTPut:MODulation[:STATe]?</code>
Example	<code>:OUTP:MOD OFF</code>
Notes	This setting is for independent mode and has no effect on the "List Sequencer" on page 2025 . If Sequencer is ON , the List Sequencer controls the source output, and this key is grayed-out When Sequencer is OFF , source leaves List Sequencer, and this setting is blanked out, taking effect immediately When Modulation is ON , the "MOD" annunciator is displayed in the system settings panel. When Modulation is OFF , the "MOD" annunciator is cleared If Sequencer is ON , the "MOD" annunciator will be replaced by "SEQ" in the system settings panel, indicating that the output is controlled by List Sequencer

Preset	OFF
Range	ON OFF

6.1.11 Modulation Setup

Allows access to the menus for setting up the available modulation types.

Not available in E7760B.

AM/FM/PM are not available for VXT models M9415A/16A and M9415E/16E .

6.1.11.1 AM

Enables or disables amplitude modulation.

Turning **AMON** when another modulation format is already on results in the previous modulation format being turned off, and generates an error.

Remote Command	<code>:SOURce:AM:STATe ON OFF 1 0</code> <code>:SOURce:AM:STATe?</code>
Example	<code>:SOUR:AM:STAT OFF</code>
Dependencies	Not available in E7760B
Preset	OFF
Range	ON OFF

6.1.11.2 AM Mod Depth

Lets you set the amplitude modulation depth in percent.

Remote Command	<code>:SOURce:AM[:DEPTh][:LINear] <real></code> <code>:SOURce:AM[:DEPTh][:LINear]?</code>
Example	<code>:SOUR:AM 0.1</code>
Dependencies	Not available in E7760B
Preset	0.1 %
Min	0.1 %
Max	95.0 %

6.1.11.3 AM Rate

Lets you set the internal amplitude modulation rate.

6 Input/Output
6.1 RF Source

Remote Command	<code>:SOURce:AM:INTernal:FREQuency <freq></code> <code>:SOURce:AM:INTernal:FREQuency?</code>
Example	<code>:SOUR:AM:INT:FREQ 40.0 Hz</code>
Dependencies	Not available in E7760B
Preset	400.0 Hz
Min	10 Hz
Max	40 kHz

6.1.11.4 AM Rate Increment

Changes the step size for "AM Rate" on page 2068. Once an increment size has been selected and **AM Rate** is active, the step keys (and the **UP | DOWN** parameters for **AM Rate** from remote commands) change **AM Rate** by the increment value.

Remote Command	<code>:SOURce:AM:INTernal:FREQuency:STEP[:INCRement] <freq></code> <code>:SOURce:AM:INTernal:FREQuency:STEP[:INCRement]?</code>
Example	<code>:SOUR:AM:INT:FREQ:STEP 100 Hz</code> <code>:SOUR:AM:INT:FREQ:STEP?</code>
Couplings	Coupled to the increment size of AM Rate
Preset	10 Hz
State Saved	Yes
Min	1 Hz
Max	40 kHz

6.1.11.5 FM

Enables or disables frequency modulation.

Turning **FMON** when another modulation format is already on results in the previous modulation format being turned off and the generation of an error.

Remote Command	<code>:SOURce:FM:STATe ON OFF 1 0</code> <code>:SOURce:FM:STATe?</code>
Example	<code>:SOUR:FM:STAT OFF</code>
Dependencies	Not available in E7760B
Preset	OFF
Range	ON OFF

6.1.11.6 FM Deviation

Lets you set the frequency modulation deviation.

Remote Command	<code>:SOURce:FM[:DEVIation] <freq></code> <code>:SOURce:FM[:DEVIation]?</code>
Example	<code>:SOUR:FM 1.00 kHz</code>
Dependencies	Not available in E7760B
Preset	1.00 Hz
Min	1.00 Hz
Max	100.00 kHz

6.1.11.7 FM Rate

Lets you set the internal frequency modulation rate.

Remote Command	<code>:SOURce:FM:INTernal:FREQuency <freq></code> <code>:SOURce:FM:INTernal:FREQuency?</code>
Example	<code>:SOUR:FM:INT:FREQ 40.0 Hz</code>
Dependencies	Not available in E7760B
Preset	400.0 Hz
Min	10 Hz
Max	40 kHz

6.1.11.8 FM Rate Increment

Changes the step size for "FM Rate" on page 2070. Once an increment size has been selected and **FM Rate** is active, the step keys (and the **UP | DOWN** parameters for **FM Rate** from remote commands) change **FM Rate** by the increment value.

Remote Command	<code>:SOURce:FM:INTernal:FREQuency:STEP[:INCRement] <freq></code> <code>:SOURce:FM:INTernal:FREQuency:STEP[:INCRement]?</code>
Example	<code>:SOUR:FM:INT:FREQ:STEP 100 Hz</code> <code>:SOUR:FM:INT:FREQ:STEP?</code>
Couplings	Coupled to the increment size of FM Rate
Preset	10 Hz
State Saved	Yes
Min	1 Hz
Max	40 kHz

6.1.11.9 PM

Enables or disables phase modulation.

Turning **PMON** when another modulation format is already on results in the previous modulation format being turned **OFF** and the generation of an error.

Remote Command	<code>:SOURce:PM:STATe ON OFF 1 0</code> <code>:SOURce:PM:STATe?</code>
Example	<code>:SOUR:PM:STAT OFF</code>
Dependencies	Not available in E7760B
Preset	OFF
Range	ON OFF

6.1.11.10 PM Deviation

Lets you set the phase modulation deviation in radian.

Remote Command	<code>:SOURce:PM[:DEVIation] <real></code> <code>:SOURce:PM[:DEVIation]?</code>	
Example	<code>:SOUR:PM 1.00</code>	
Dependencies	Not available in E7760B	
Preset	0.1 rad	
Min	0.1 rad	
Max	Instrument Type	Value
	M9410A/11A	10.0 rad
	All Others	20.0 rad

6.1.11.11 PM Rate

Lets you set the internal phase modulation rate.

Remote Command	<code>:SOURce:PM:INTernal:FREQuency <freq></code> <code>:SOURce:PM:INTernal:FREQuency?</code>
Example	<code>:SOUR:PM:INT:FREQ 40.0 Hz</code>
Dependencies	Not available in E7760B
Preset	400.0 Hz

Min	10 Hz
Max	40 kHz

6.1.11.12 PM Rate Increment

Changes the step size for "PM Rate" on page 2071. Once an increment size has been selected and **PM Rate** is active, the step keys (and the **UP | DOWN** parameters for **PM Rate** from remote commands) change **PM Rate** by the increment value.

Remote Command	<code>:SOURce:PM:INTernal:FREQuency:STEP[:INCRement] <freq></code> <code>:SOURce:PM:INTernal:FREQuency:STEP[:INCRement]?</code>
Example	<code>:SOUR:PM:INT:FREQ:STEP 100 Hz</code> <code>:SOUR:PM:INT:FREQ:STEP?</code>
Couplings	Coupled to the increment size of PM Rate
Preset	10 Hz
State Saved	Yes
Min	1 Hz
Max	40 kHz

6.1.11.13 ARB Setup

Accesses menus for setting up the Arbitrary Waveform Generator.

Basic Control

Lets you set up the basic ARB parameters and select a waveform to play.

ARB State

Lets you toggle the state of the ARB function. When the ARB is **ON**, a "MOD" annunciator is displayed in the system settings panel. When the ARB is **OFF**, the MOD annunciator is cleared

Remote Command	<code>:SOURce:RADio:ARB[:STATe] ON OFF 1 0</code> <code>:SOURce:RADio:ARB[:STATe]?</code>
Example	<code>:SOUR:RAD:ARB OFF</code> <code>:SOUR:RAD:ARB?</code>
Notes	If ARB is ON , and you then load or delete another file to ARB memory, the playing waveform segment may not keep phase continuity during the ARB memory operation. The waveform will be replayed after the ARB operation is finished

6 Input/Output
6.1 RF Source

Dependencies	<p>This setting is for the independent mode, and has no effect on "List Sequencer" on page 2025. If Sequencer is ON, this will make the source enter List Sequencer mode, and even if ARB state is ON, the ARB file will not be played. When Sequencer is OFF, source leaves List Sequencer and this setting takes effect immediately</p> <p>The ARB can only be turned on when there is a waveform file selected for playback. On the GUI, If no waveform is selected, this key is grayed out. If you send the SCPI command to turn the ARB on with no waveform selected for playback, the ARB state remains OFF and an error is generated</p> <p>-If you try to recall a certain set of states in which the selected waveform is not in ARB memory and the ARB state is ON, errors are reported</p>
Preset	OFF
Range	ON OFF

Sample Rate

Lets you set the ARB waveform playback sample rate.

See ["More Information" on page 2074](#)

Remote Command	<pre>:SOURce:RADio:ARB:SCLock:RATE <freq></pre> <pre>:SOURce:RADio:ARB:SCLock:RATE?</pre>	
Example	<pre>:SOUR:RAD:ARB:SCL:RATE 48.00 MHz</pre>	
Notes	<p>If there is a sample rate specified in the header of the waveform file, changing that sample rate is not recommended, as it may cause problems with burst timing</p> <p>For E7760B, the Sample Rate is fixed. If this control is attempted to be set the error -221, "Settings conflict; Sample Rate is fixed" is generated</p>	
Dependencies	<p>When a new waveform is selected for playback the settings contained within the associated waveform header file are applied to the ARB. The sample rate is one of the values stored within the header file. If the newly selected waveform file has an associated header file, the sample rate is updated with the value from the header file. The sample rate will remain unchanged if the newly selected waveform does not have an associated header file</p>	
Preset		
	E7760B	2.64 GHz
	Option B40	50 MHz
	Option B85	100 MHz
	Option B1X	200 MHz
	Option B3X	375 MHz
	Option B6X	750 MHz
	Option B4X	500 MHz
	Option B8X	1.0 GHz
	Option B12	1.5 GHz

Min	E7760B: 2.64 GHz All Others: 1.00 kHz		
Max	Hardware Dependent:		
	E7760B		2.64 GHz
	VXT model M9420A	Option B40	50 MHz
		Option B85	100 MHz
		Option B1X	200 MHz
	VXT models M9410A/11A and M9410E/11E	Option B40	50 MHz
		Option B3X	375 MHz
		Option B6X	750 MHz
		Option B12	1.5 GHz
	VXT models M9415A/16A and M9415E/16E	Option B4X	500 MHz
		Option B8X	1.0 GHz
		Option B12	1.5 GHz

For VXT models M9410A/11A/15A/16A, M9410E/11E/15E/16E and E6680A/81A, the sample rate is only limited by the option, but the IF BW is limited by center frequency in addition to options. See ["More Information" on page 2074](#). Performance is guaranteed only when the bandwidth of the selected waveform is smaller than the Max IF BW

More Information

Although the range of Sample Rate only depends on the installed option, the Maximum IF BW depends on options as well as the Center Frequency.

VXT models M9410A/11A, E6680A and E6681A

Option Limitation:

Option	Maximum IF BW
B40	40 MHz
B3X	300 MHz
B6X	600 MHz
B12	1200 MHz

Center Frequency Limitation:

Center Frequency	Maximum IF BW
6.5 kHz ~ 9 kHz (Option LFE)	(CF - 6.5 kHz) * 2
9 kHz ~ 100 kHz (Option LFE)	5 kHz

6 Input/Output

6.1 RF Source

Center Frequency	Maximum IF BW
100 kHz ~ 1 MHz (Option LFE)	50 kHz
1 MHz ~ 10 MHz (Option LFE)	500 kHz
10 MHz ~ 20 MHz (Option LFE)	5 MHz
20 MHz ~ 60 MHz (Option LFE)	10 MHz
60 MHz ~ 80 MHz (Option LFE)	20 MHz
80 MHz ~ 380 MHz (Option LFE)	40 MHz
330 MHz ~ 380 MHz (without Option LFE)	(CF - 330 MHz) * 2
380 MHz ~ 550 MHz	100 MHz
550 MHz ~ 1310 MHz	200 MHz
1310 MHz ~ 2000 MHz (without Option EP6)	600 MHz
2000 MHz ~ 5480 MHz (without Option EP6)	1200 MHz
5480 MHz ~ 6080 MHz (without Option EP6)	(6080 MHz - CF) * 2
1310 MHz ~ 1900 MHz (Option EP6)	600 MHz
1900 MHz ~ 6000 MHz (Option EP6)	1200 MHz
6000 MHz ~ 6600 MHz (Option EP6)	(6600 MHz - CF) * 2

VXT models M9415A/16A

Option Limitation:

Option	Maximum IF BW
B4X	400 MHz
B8X	800 MHz
B12	1200 MHz

Center Frequency Limitation:

Center Frequency	Maximum IF BW
330 MHz ~ 380 MHz	(CF - 330 MHz) * 2
380 MHz ~ 550 MHz	100 MHz
550 MHz ~ 1310 MHz	200 MHz
1310 MHz ~ 2000 MHz	600 MHz
2000 MHz ~ 12300 MHz	1200 MHz
12300 MHz ~ 12900 MHz	(12900 MHz - CF) * 2

M9410E/11E

Option Limitation:

Option	Maximum IF BW
B40	40 MHz
B3X	300 MHz
B6X	600 MHz
B12	1200 MHz

Center Frequency Limitation:

Center Frequency	Maximum IF BW
1 MHz ~ 10 MHz (Option LFE)	500 kHz
10 MHz ~ 20 MHz (Option LFE)	5 MHz
20 MHz ~ 60 MHz (Option LFE)	10 MHz
60 MHz ~ 80 MHz (Option LFE)	20 MHz
80 MHz ~ 380 MHz (Option LFE)	40 MHz
330 MHz ~ 380 MHz (without Option LFE)	$(CF - 330 \text{ MHz}) * 2$
380 MHz ~ 550 MHz	100 MHz
550 MHz ~ 1310 MHz	200 MHz
1310 MHz ~ 2000 MHz (without Option EP6)	600 MHz
2000 MHz ~ 25.9 GHz (without Option EP6)	1200 MHz
1310 MHz ~ 1900 MHz (Option EP6)	600 MHz
1900 MHz ~ 25.9 GHz (Option EP6)	1200 MHz
25.9 GHz ~ 26.5 GHz	$\text{Min}(\text{Max BW by option}, 2 * (26.5 \text{ GHz} - \text{Center Freq}))$

M9415E/16E

Option Limitation:

Option	Maximum IF BW
B4X	400 MHz
B8X	800 MHz
B12	1200 MHz

Center Frequency Limitation:

Center Frequency	Maximum IF BW
1 MHz ~ 10 MHz (Option LFE)	500 kHz
10 MHz ~ 20 MHz (Option LFE)	5 MHz
20 MHz ~ 60 MHz (Option LFE)	10 MHz
60 MHz ~ 80 MHz (Option LFE)	20 MHz
80 MHz ~ 380 MHz (Option LFE)	40 MHz

6 Input/Output
6.1 RF Source

Center Frequency	Maximum IF BW
330 MHz ~ 380 MHz (without Option LFE)	(CF - 330 MHz) * 2
380 MHz ~ 550 MHz	100 MHz
550 MHz ~ 1310 MHz	200 MHz
1310 MHz ~ 2000 MHz	600 MHz
2000 MHz ~ 25.9 GHz	1200 MHz
25.9 GHz ~ 26.5 GHz	Min(Max BW by option, 2*(26.5 GHz-Center Freq))

Run-Time Scaling

Lets you adjust the run-time scaling value. The run-time scaling value is applied in real-time while the waveform is playing.

Remote Command	<code>:SOURce:RADio:ARB:RSCaling <real></code> <code>:SOURce:RADio:ARB:RSCaling?</code>
Example	<code>:SOUR:RAD:ARB:RSC 100.00</code>
Notes	Cannot be set in EXM and VXT. Grayed-out in menu, and the value is fixed at 70.00%
Dependencies	When a new waveform is selected for playback the settings contained within the associated waveform header file are applied to the ARB. The run-time scaling is one of the values stored within the header file. If the newly selected waveform file has an associated header file, the run-time scaling is updated with the value from the header file. The run-time scaling will remain unchanged if the newly selected waveform does not have an associated header file
Preset	70.00 %
Min	1.00 %
Max	100.00 %

Baseband Freq Offs

Lets you adjust the value by which the baseband frequency is offset relative to the carrier.

Remote Command	<code>:SOURce:RADio:ARB:BASEband:FREQuency:OFFSet <freq></code> <code>:SOURce:RADio:ARB:BASEband:FREQuency:OFFSet?</code>
Example	<code>:SOUR:RAD:ARB:BAS:FREQ:OFFS 0.00 Hz</code>
Dependencies	When a new waveform is selected for playback the settings contained within the associated waveform header file are applied to the ARB. The baseband frequency offset is one of the values stored within the header file. If the newly selected waveform file has an associated header file, the baseband frequency offset is updated with the value from the header file. The baseband frequency offset will remain unchanged if the newly selected waveform does not have an associated header file Not available in E7760B

Preset	0.00 Hz
Min	-50.00 MHz
Max	50.00 MHz

Baseband Power

Lets you quickly control the power of the modulator prior to up-conversion to the RF carrier.

Remote Command	<code>:SOURce:RADio:ARB:BASEband:POWer <ampl></code> <code>:SOURce:RADio:ARB:BASEband:POWer?</code>
Example	<code>:SOUR:RAD:ARB:BAS:POW -10 dB</code>
Notes	The Source Power level equals RF Power plus Baseband Power. For example, if the RF Power is set to -10 dBm and the Baseband Power is set to -4 dB, the actual Source Power level is -14 dBm Can be used to change the output level very quickly compared to the RF Power
Dependencies	Only appears in VXT models M9410A/11A/15A/16A and M9410E/11E/15E/16E
Preset	0 dB
Min	-50 dB
Max	20 dB

Mkr 1-4 Polarity

Lets you set the polarity of markers 1 through 4 respectively.

Remote Command	<code>:SOURce:RADio:ARB:MPOLarity:MARKer1 ... 4 POSitive NEGative</code> <code>:SOURce:RADio:ARB:MPOLarity:MARKer1 ... 4?</code>
Example	<code>:SOUR:RAD:ARB:MPOL:MARK1 NEG</code>
Dependencies	When a new waveform is selected for playback the settings contained within the associated waveform header file are applied to the ARB. The marker polarity is one of the values stored within the header file. If the newly selected waveform file has an associated header file, the marker polarity is updated with the value from the header file. The marker polarity will remain unchanged if the newly selected waveform does not have an associated header file Not available in E7760B
Preset	<code>POSitive</code>
Range	<code>POSitive NEGative</code>

Pulse/RF Blank

Lets you select which marker is used for **Pulse/RF Blank**. This function blanks the RF when the marker signal goes low. The marker polarity determines when the

6 Input/Output
6.1 RF Source

marker signal is high. For a positive polarity, this is during the marker points. For a negative polarity, this is when there are no marker points.

Marker points should be set before using this function. Enabling this function without setting maker points may create a continuous low or high signal, dependent on the marker polarity. This causes either no RF output, or a continuous RF output.

Remote Command	<code>:SOURce:RADio:ARB:MDEStination:PULSe NONE M1 M2 M3 M4</code> For option details, see "More Information" on page 2079 <code>:SOURce:RADio:ARB:MDEStination:PULSe?</code>
Example	<code>:SOUR:RAD:ARB:MDES:PULS NONE</code>
Dependencies	When a new waveform is selected for playback the settings contained within the associated waveform header file are applied to the ARB. The Pulse/RF Blank setting is one of the values stored within the header file. If the newly selected waveform file has an associated header file, the Pulse/RF Blank setting is updated with the value from the header file. The Pulse/RF Blank setting remains unchanged if the newly selected waveform does not have an associated header file
Range	<code>NONE M1 M2 M3 M4</code>

More Information

Parameter	SCPI	Notes
None	<code>NONE</code>	Sets no marker to be used for Pulse/RF Blank function, essentially turning the RF blanking function off
Marker 1	<code>M1</code>	Sets marker 1 to be used for Pulse/RF Blank
Marker 2	<code>M2</code>	Sets marker 2 to be used for Pulse/RF Blank
Marker 3	<code>M3</code>	Sets marker 3 to be used for Pulse/RF Blank
Marker 4	<code>M4</code>	Sets marker 4 to be used for Pulse/RF Blank

ALC Hold

Lets you specify which marker is routed for use within **ALC Hold**. This function holds the ALC circuitry at the average value of the sample points set by the marker.

ALC Hold operates during the low periods of the marker signal. The marker polarity determines when the marker signal is high. For positive polarity, this is during the marker points. For a negative polarity, this is when there are no maker points.

Remote Command	<code>:SOURce:RADio:ARB:MDEStination:ALCHold NONE M1 M2 M3 M4</code> For option details, see "Option Details" on page 2080 <code>:SOURce:RADio:ARB:MDEStination:ALCHold?</code>
Example	<code>:SOUR:RAD:ARB:MDES:ALCH NONE</code>
Dependencies	When a new waveform is selected for playback the settings contained within the associated waveform header file are applied to the ARB. The ALC Hold setting is one of the values stored within the header file. If the newly selected waveform file has an associated header file, the ALC Hold setting is updated

with the value from the header file. The **ALC Hold** setting remains unchanged if the newly selected waveform does not have an associated header file

Not available in E7760B, and VXT models M9410A/11A/15A/16A and M9410E/11E/15E/16E

Range [NONE](#) | [M1](#) | [M2](#) | [M3](#) | [M4](#)

Option Details

Parameter	SCPI	Notes
None	NONE	Use no marker for ALC Hold , essentially turning ALC Hold off
Marker 1	M1	Use marker 1 for ALC Hold
Marker 2	M2	Use marker 2 for ALC Hold
Marker 3	M3	Use marker 3 for ALC Hold
Marker 4	M4	Use marker 4 for ALC Hold

Trigger Type

Determines the behavior of the waveform when it plays.

Remote Command	:SOURce:RADio:ARB:TRIGger:TYPE CONTInuous SINGle SADVance :SOURce:RADio:ARB:TRIGger:TYPE?
Example	:SOUR:RAD:ARB:TRIG:TYPE CONT :SOUR:RAD:ARB:TRIG:TYPE?
Preset	CONTInuous
Range	Continuous Single Seg Adv

Continuous trigger

Sets the active trigger type to **Continuous**. If **Continuous** is already selected as the active trigger type, pressing this control allows access to the **Continuous trigger** type setup menu. In **Continuous** trigger mode, the waveform repeats continuously.

Remote Command	:SOURce:RADio:ARB:TRIGger:TYPE:CONTInuous[:TYPE] FREE TRIGger RESet See " Option Details " on page 2081 :SOURce:RADio:ARB:TRIGger:TYPE:CONTInuous[:TYPE]?
Example	:SOUR:RAD:ARB:TRIG:TYPE:CONT FREE
Preset	FREE
Range	Free Run Trigger + Run Reset + Run

Option Details

Parameter	SCPI	Notes
Free Run	FREE	Sets the waveform generator to play a waveform sequence or segment continuously, without waiting for a trigger. In this mode, the waveform generator does not respond to triggers
Trigger + Run	TRIGger	Sets the waveform generator to play a waveform sequence or segment continuously when the first trigger is received, and to ignore any subsequent triggers
Reset + Run	RESet	Sets the waveform generator to play a waveform sequence or segment continuously when the first trigger is received. Subsequent triggers reset the waveform sequence or segment to the start, and then play it continuously

Single trigger

Sets the active trigger type to **Single**. If **Single** is already selected as the active trigger type, pressing this control allows access to the single trigger type setup menu. In **Single** trigger mode, the waveform plays once.

Remote Command	:SOURce:RADio:ARB:RETRigger ON OFF IMMEDIATE See "Option Details" on page 2081 :SOURce:RADio:ARB:RETRigger?
Example	:SOUR:RAD:ARB:RETR OFF
Notes	ON : Buffered Trigger OFF : No Retrigger IMMEDIATE : Restart on Trigger This is defined as an enumerated SCPI command, with ON OFF being considered as enumerated types rather than Boolean. This means the query returns OFF instead of 0, and ON instead of 1
Preset	ON

Option Details

Parameter	SCPI	Notes
No Retrigger	OFF	Sets the waveform generator to play a waveform sequence or segment once when a trigger is received. Any triggers then received during playback are ignored
Buffered Trigger	ON	Sets the waveform generator to play a waveform sequence or segment once when a trigger is received. If a trigger is received during playback, the waveform generator plays the sequence or segment to the end, then plays the sequence or segment once more
Restart on Trigger	IMMEDIATE	Sets the waveform generator to play a waveform sequence or segment once when a trigger is received. If a trigger is received during playback, the waveform generator resets and plays the sequence or segment from the start

Segment Advance trigger

Sets the active trigger type to **Segment Advance**. If **Segment Advance** is already selected as the active trigger type, pressing this control allows access to the segment advance trigger type setup menu.

Segment Advance triggering allows you to control the playback of waveform segments within a waveform sequence. When a trigger is received the ARB advances to the next waveform segment within the waveform sequence. This type of triggering ignores the repetition count for the waveform segment within the waveform sequence. For example, if a waveform segment has a repetition count of 10 and you select single segment advance triggering mode, the waveform segment will only play once.

Segment Advance triggering can also be used for waveform segments only. In this situation, the same waveform segment is played again when a trigger is received.

Remote Command	<code>:SOURce:RADio:ARB:TRIGger:TYPE:SADVance[:TYPE] SINGle CONTinuous</code> See " Option Details " on page 2082 <code>:SOURce:RADio:ARB:TRIGger:TYPE:SADVance[:TYPE]?</code>
Example	<code>:SOUR:RAD:ARB:TRIG:TYPE:SADV SING</code>
Dependencies	Not available in E7760B
Preset	<code>CONTinuous</code>
Range	<code>SINGle CONTinuous</code>

Option Details

Parameter	SCPI	Notes
Single	<code>SINGle</code>	Once a trigger is received a segment is played once. If a trigger is received during playback of a segment, the segment plays to completion and the next segment is played once
Continuous	<code>CONTinuous</code>	Once a trigger is received a segment is played continuously. When subsequent triggers are received, the currently playing segment plays to completion and then the next segment is played continuously
Trigger Initiate	Front panel only	If " Trigger Source " on page 2082 is set to <code>KEY</code> , initiates an immediate trigger event

Trigger Source

Determines how the source receives the trigger that starts the waveform playing. Grayed-out if "[Trigger Type](#)" on page 2080 is free run, since free run triggers immediately with no trigger source required.

6 Input/Output

6.1 RF Source

Remote Command	<code>:SOURce:RADio:ARB:TRIGger[:SOURce] KEY BUS EXTerna11 EXTerna12 PXI</code> See "Option Details" on page 2083 <code>:SOURce:RADio:ARB:TRIGger[:SOURce]?</code>
Example	<code>:SOUR:RAD:ARB:TRIG KEY</code>
Notes	For E7760B, the available selections are KEY BUS
Dependencies	Grayed-out if Trigger Type is Continuous, Free Run
Preset	EXTerna12 For E7760B: BUS
Range	Key Bus External11 External 2 PXI

Option Details

Parameter	SCPI	Notes
Key	KEY	The waveform is triggered when you press the front panel Trigger key
Bus	BUS	Enables triggering over GPIB, LAN, or USB using: :SOURce:RADio:ARB:TRIGger:INITiate
External 1	EXTerna11	Enables triggering a waveform by an externally-applied signal
External 2	EXTerna12	Enables triggering a waveform by an externally-applied signal Note: in EXM, trigger 2 is a bi-directional trigger port, so when trigger 2 has been configured as OUTPUT type, selecting External 2 as the input trigger for the current step generates an error Note 2: in VXT model M9420A, triggers on an externally connected trigger source marked Trigger 1 on the front panel
PXI	PXI	Enables triggering a waveform by a PXI backplane Line applied signal

Bus Trigger Command (Remote Command Only)

Used to initiate an immediate trigger event if ["Trigger Source" on page 2082](#) is set to [BUS](#).

Remote Command	<code>:SOURce:RADio:ARB:TRIGger:INITiate</code>
Example	<code>:SOUR:RAD:ARB:TRIG:INIT</code>

Sync to Trigger Source

There is a time interval (system processing time) between the trigger event and the beginning of playing waveform. Turn on this control to compensate the system latency at the cost of cutting off the beginning of the ARB. The figure below shows the turn-on and turn-off behavior of the control.

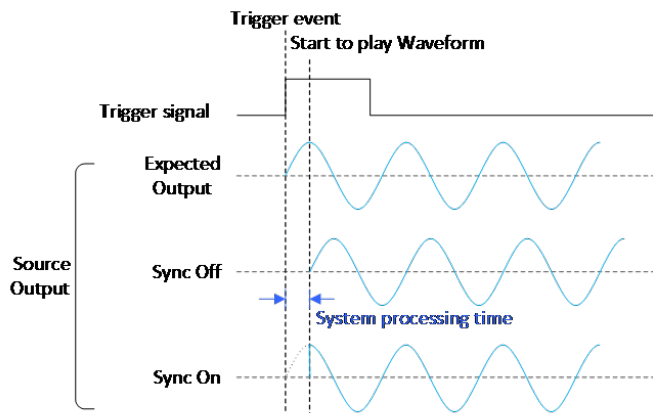

Remote Command	<code>:SOURce:RADio:ARB:TRIGger:SYNC[:STATe] ON OFF 1 0</code> <code>:SOURce:RADio:ARB:TRIGger:SYNC[:STATe]?</code>
Example	<code>:SOUR:RAD:ARB:TRIG:SYNC ON</code> <code>:SOUR:RAD:ARB:TRIG:SYNC?</code>
Notes	Compensates for the instrument internal latency. The negative trigger delay compensates the external latency (that is, heads and cables). See "External Trigger Delay" on page 2084 and "PXI Trigger Delay" on page 2087 The first PerARB trigger is cut off if Sync to Trigger Source is ON
Dependencies	Only available when "Trigger Source" on page 2082 is EXTernal1 , EXTernal2 , or PXI
Preset	OFF
Range	ON OFF

External Trigger Delay

Lets you toggle the state and value of external trigger delay. The value you enter sets a delay time between when an external trigger is received and when it is applied to the waveform. Only active if ["Trigger Source" on page 2082](#) is **EXTernal1** or **EXTernal2**.

Negative trigger delay is only supported by VXT models M9410A/11A/15A/16A and M9410E/11E/15E/16E (see ["More Information" on page 2085](#)).

Remote Command	<code>:SOURce:RADio:ARB:TRIGger[:SOURce]:EXTernal:DELay <time></code> <code>:SOURce:RADio:ARB:TRIGger[:SOURce]:EXTernal:DELay?</code>
----------------	--

6 Input/Output
6.1 RF Source

Example	:SOUR:RAD:ARB:TRIG:EXT:DEL 100ns :SOUR:RAD:ARB:TRIG:EXT:DEL?		
Notes	External trigger delay time set by users will be rounded to the nearest integer multiple of the resolution		
Dependencies	Unavailable and grayed-out when Trigger Source is not set to EXTernal11 or EXTernal12 Not available in E7760B		
Preset	1 ms		
Min	VXT models M9410A/11A/15A/16A and M9410E/11E/15E/16E: -10 s All others: 0 s		
Max	Instrument/Condition	Value	Derivation
	VXT models M9410A/11A/15A/16A	11.45324612 s	2.666667ns*(2 ³² -1)
	M9410E/11E/15E/16E	11.45324612 s	2.666667ns*(2 ³² -1)
	Continuous – Trigger + Run	11.45324612 s	2.666667ns*(2 ³² -1)
	Other trigger conditions	17.17986918 s	4 ns*(2 ³² -1)
	All others	8.589934588 s	4ns*(2 ³¹ - 1) = 8589934588 ns

Auto Function

Remote Command	:SOURce:RADio:ARB:TRIGger[:SOURce]:EXTernal:DELay:STATe OFF ON 0 1 :SOURce:RADio:ARB:TRIGger[:SOURce]:EXTernal:DELay:STATe?
Example	:SOUR:RAD:ARB:TRIG:EXT:DEL:STAT ON :SOUR:RAD:ARB:TRIG:EXT:DEL:STAT?
Preset	OFF

More Information

There is a time interval (system processing time) between the trigger event and the beginning of playing waveform. The figure below shows you the behavior. The negative trigger delay allows you to specify the beginning of a waveform.

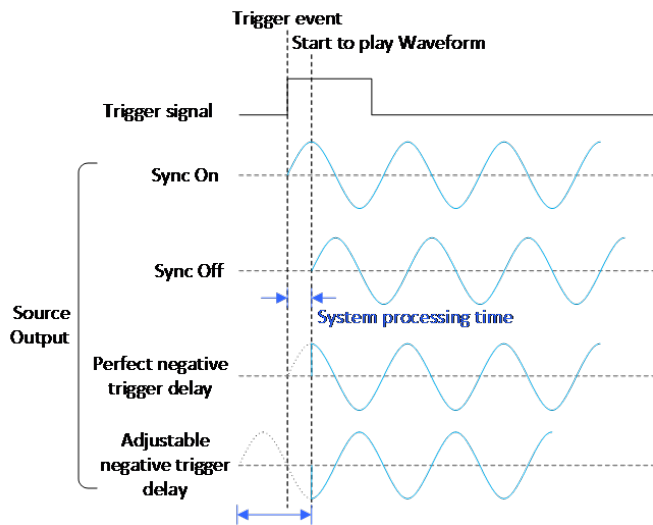

Note: the first PerArb trigger signal will be missed when the trigger delay is negative.

External Trigger Polarity

Sets the polarity of the external trigger. When **POSitive** is selected, trigger event happens on a rising edge of the external trigger in signal. When **NEGative** is selected, trigger event happens on a falling edge of the external trigger in signal.

Active only if "**Trigger Source**" on page 2082 is **EXTernal1** or **EXTernal2**.

Remote Command	<code>:SOURce:RADio:ARB:TRIGger[:SOURce]:EXTernal:SLOPe POSitive NEGative</code> <code>:SOURce:RADio:ARB:TRIGger[:SOURce]:EXTernal:SLOPe?</code>
Example	<code>:SOUR:RAD:ARB:TRIG:EXT:SLOP POS</code> <code>:SOUR:RAD:ARB:TRIG:EXT:SLOP?</code>
Dependencies	Unavailable and grayed-out when " Trigger Source " on page 2082 is not EXTernal1 or EXTernal2 Not available in E7760B
Preset	POSitive
Range	POSitive NEGative

Select PXI Line

Controls which `PXI_TRIG[0..7]` backplane line is used for the trigger source.
Only appears in modular analyzer products.

Remote Command	<code>:SOURce:RADio:ARB:TRIGger[:SOURce]:PXI:LINE <line></code> <code>:SOURce:RADio:ARB:TRIGger[:SOURce]:PXI:LINE?</code>
Example	<code>:SOUR:RAD:ARB:TRIG:PXI:LINE 2</code>
Dependencies	Unavailable and grayed-out when "Trigger Source" on page 2082 is not set to <code>PXI</code> Not available in E7760B
Preset	0
State Saved	Saved in instrument state
Range	[0,7]

PXI Trigger Delay

Lets you toggle the state and value of PXI trigger delay. The value you enter sets a delay time between when an PXI trigger is received and when it is applied to the waveform.

Only active if "Trigger Source" on page 2082 is `PXI`.

Remote Command	<code>:SOURce:RADio:ARB:TRIGger[:SOURce]:PXI:DElay <time></code> <code>:SOURce:RADio:ARB:TRIGger[:SOURce]:PXI:DElay?</code>		
Example	<code>:SOUR:RAD:ARB:TRIG:PXI:DEL 100ns</code> <code>:SOUR:RAD:ARB:TRIG:PXI:DEL?</code>		
Notes	PXI trigger delay time set by users will be rounded to the nearest integer multiple of the resolution		
Dependencies	Unavailable and grayed-out when "Trigger Source" on page 2082 is not <code>PXI</code> Not available in E7760B		
Preset	1 ms		
Min	VXT models M9410A/11A/15A/16A and M9410E/11E/15E/16E: -10 s		
Max	Instrument/Condition	Value	Derivation
	VXT models M9410A/11A/15A/16A	11.45324612 s	$2.666667\text{ns} * (2^{32}-1)$
	M9410E/11E/15E/16E	11.45324612 s	$2.666667\text{ns} * (2^{32}-1)$
	Continuous - Trigger + Run" trigger	11.45324612 s	$2.666667\text{ns} * (2^{32}-1)$
	Other trigger conditions	17.17986918 s	$4\text{ ns} * (2^{32}-1)$
	All Others	8.589934588 s	$4\text{ns} * (2^{31} - 1)$

Auto Function

Remote Command	:SOURce:RADio:ARB:TRIGger[:SOURce]:PXI:DElay:STATe OFF ON 0 1 :SOURce:RADio:ARB:TRIGger[:SOURce]:PXI:DElay:STATe?
Example	:SOUR:RAD:ARB:TRIG:PXI:DEL:STAT ON :SOUR:RAD:ARB:TRIG:PXI:DEL:STAT?
Preset	OFF

PXI Trigger Polarity

Sets the polarity of the PXI trigger:

- When **POSitive** is selected, trigger event happens on a rising edge of the PXI trigger in signal
- When **NEGative** is selected, trigger event happens on a falling edge of the PXI trigger in signal

Active only if "[Trigger Source](#)" on page 2082 is **PXI**.

Remote Command	:SOURce:RADio:ARB:TRIGger[:SOURce]:PXI:SLOPe POSitive NEGative :SOURce:RADio:ARB:TRIGger[:SOURce]:PXI:SLOPe?
Example	:SOUR:RAD:ARB:TRIG:PXI:SLOP POS :SOUR:RAD:ARB:TRIG:PXI:SLOP?
Dependencies	Unavailable and grayed-out when " Trigger Source " on page 2082 is PXI Not available in E7760B
Preset	POSitive
Range	POSitive NEGative

I/Q Adjustments

Enables or disables the I/Q adjustments.

Remote Command	:SOURce:RADio:ARB:IQADjustment:[STATe] OFF ON 0 1 :SOURce:RADio:ARB:IQADjustment:[STATe]?
Example	:SOUR:RAD:ARB:IQAD ON :SOUR:RAD:ARB:IQAD?
Dependencies	Not available in E7760B
Preset	OFF

I/Q Gain

Lets you adjust the ratio of I to Q while preserving the composite, vector magnitude. Adding Gain (+x dB) to the signal increases the I component and decreases the Q component proportionally. Reducing Gain (-x dB) decreases the I component and increases the Q component proportionally.

Remote Command	<code>:SOURce:RADio:ARB:IQADjustment:GAIN <value><unit></code> <code>:SOURce:RADio:ARB:IQADjustment:GAIN?</code>
Example	<code>:SOUR:RAD:ARB:IQAD:GAIN 0.5</code> <code>:SOUR:RAD:ARB:IQAD:GAIN?</code>
Notes	Effective only if the I/Q adjustment function is ON
Dependencies	Unavailable and grayed-out when the ARB state is OFF Not available in E7760B
Preset	+0.00000000E+000
Min	-1 dB
Max	1 dB

I/Q Delay

Lets you change the absolute phase of both I and Q with respect to triggers and markers. A positive value delays I and Q. This value affects both the external I/Q out signals and the baseband signal modulated on the RF output. This adjustment does not affect external I/Q inputs.

Remote Command	<code>:SOURce:RADio:ARB:IQADjustment:DELaY <value><unit></code> <code>:SOURce:RADio:ARB:IQADjustment:DELaY?</code>									
Example	<code>:SOUR:RAD:ARB:IQAD:DEL 10ps</code> <code>:SOUR:RAD:ARB:IQAD:DEL?</code>									
Notes	User-set IQ delay time values are rounded to the nearest integer multiple of the resolution									
Dependencies	Unavailable and grayed-out when the ARB state is off Not available in E7760B									
Preset	+0.00000000E+000									
Min/Max	<table border="1"> <thead> <tr> <th>Instrument Type</th> <th>Min</th> <th>Max</th> </tr> </thead> <tbody> <tr> <td>M9410A/11A/15A/16A</td> <td>-80ns</td> <td>80ns</td> </tr> <tr> <td>All Others</td> <td>-250ns</td> <td>250ns</td> </tr> </tbody> </table>	Instrument Type	Min	Max	M9410A/11A/15A/16A	-80ns	80ns	All Others	-250ns	250ns
Instrument Type	Min	Max								
M9410A/11A/15A/16A	-80ns	80ns								
All Others	-250ns	250ns								

RMS

Lets you directly specify current RMS value used to playback currently selected waveform.

For EXM, note that an incorrect RMS value may cause inaccurate power output that is sensitive to RMS value.

This setting is also updated by RMS in waveform header or updated when invoking RMS calculation operation.

This setting can be saved to the header of currently selected waveform by ["Save Header" on page 2110](#).

Remote Command	<code>:SOURCE:RADio:ARB:RMS <float></code> <code>:SOURCE:RADio:ARB:RMS?</code>
Example	<code>:SOUR:RAD:ARB:HEAD:RMS 0.7</code> <code>:SOUR:RAD:ARB:HEAD:RMS?</code>
Notes	The valid range for this setting is 0 to 1.414 (linear). Values outside the range are clipped to the closest boundary This value does not affect Source List Sequencer, which always uses the RMS value included in each ARB header. If this setting is to take effect in List Sequencer, use "Save Header" on page 2110 to save the current RMS value to the header, then play the ARB in Source List Sequencer
Dependencies	When a new waveform is selected for playback this setting is updated by the RMS value included in the associated waveform header file. If the selected waveform has no associated header file or the header file does not include the RMS value then the instrument will try to calculate the value automatically based on the RMS Calculation Mode setting Pressing Calculate also updates this setting
Preset	0
Range	0 ~ 1.414

RMS Calculation Mode

Lets you specify the mode to calculate the current RMS.

Remote Command	<code>:SOURCE:RADio:ARB:RMS:CALCulation:MODE AUTO M1 M2 M3 M4</code> See "Option Details" on page 2091 <code>:SOURCE:RADio:ARB:RMS:CALCulation:MODE?</code>
Example	<code>:SOUR:RAD:ARB:RMS:CALC:MODE AUTO</code>
Notes	If no waveform is selected, or selected waveform is waveform sequence, the key is grayed-out
Preset	<code>AUTO</code>
Range	<code>AUTO M1 M2 M3 M4</code>

Option Details

Parameter	SCPI	Notes
Auto	AUTO	In Auto, RMS is calculated based on the whole sample range of the currently selected waveform
Marker 1	M1	Marker 1 designates the sample range for RMS calculation
Marker 2	M2	Marker 2 designates the sample range for RMS calculation
Marker 3	M3	Marker 3 designates the sample range for RMS calculation
Marker 4	M4	Marker 4 designates the sample range for RMS calculation

Calculate

Lets you calculate current RMS based on mode selected. Updates the setting in the ["RMS" on page 2090](#) control.

Remote Command	:SOURce:RADio:ARB:RMS:CALCulate
Example	:SOUR:RAD:ARB:RMS:CALC
Notes	<p>If no waveform is selected, invoking this operation generates error “-221 Setting conflict; No waveform is selected for RMS operation”</p> <p>Grayed-out if no waveform is selected, or selected waveform is waveform sequence</p> <p>If selected waveform does not contain marker data, but "RMS Calculation Mode" on page 2090 is set to marker, invoking a calculation operation generates error “-221 Setting conflict; There is no marker for currently selected waveform, auto RMS calculation mode is used instead”, and "RMS Calculation Mode" on page 2090 is coupled to Auto mode automatically</p> <p>RMS calculation is not suitable for waveform sequence. If selected waveform is waveform sequence file, invoking this operation generates error “-221 Setting conflict; RMS calculation does not apply to waveform sequence”</p> <p>You can still edit current RMS as play parameter, and save current RMS to waveform sequence header for later use</p>

Use Header RMS

Lets you quickly set RMS to value in ARB header. Updates the setting in the ["RMS" on page 2090](#) control.

Notes	<p>Grayed-out if no waveform is selected</p> <p>If no waveform is selected, invoking this operation generates error “-221 Setting conflict; No waveform is selected for RMS operation”</p>
-------	--

Real-Time 5G NR Compensation

Phase compensation is a new concept introduced into 5G NR baseband signal generation in TS38.211 as below, to address a typical 5G scenario that Tx and Rx frequencies may not be the same. In that case, without properly compensating the phase, receiver would not be able to correctly demodulate the received signal.

Modulation and up-conversion to the carrier frequency f_0 of the complex-valued OFDM baseband signal for antenna port p , subcarrier spacing configuration μ , and OFDM symbol l in a subframe assumed to start at $t = 0$ is given by the following equation for all channels and signals except PRACH:

$$Re \left\{ s_l^{(p,\mu)}(t) \cdot e^{j2\pi f_0(t - t_{start,l}^\mu - N_{CP,l}^\mu T_c)} \right\}$$

$$Re \left\{ s_l^{(p,\mu)}(t) \cdot e^{j2\pi f_0(t - t_{start,l}^\mu - N_{CP,l}^\mu T_c)} \right\}$$

From the 3GPP specification equation above, it can be observed that phase compensation is performed for a specific transmission frequency f_0 . So that means, even if a same signal configuration needs to be transmitted at multiple frequencies, we'll have to generate a different waveform for each frequency point. As a result, the number of test waveforms will increase significantly along with the frequency number. This would be a big challenge for test engineers, considering the complexity of 5G NR signal configurations - they have to maintain a large waveform library and identify each waveform carefully with its "frequency tag".

Real-Time 5G NR Phase Compensation allows you to play the same 5G NR waveform while performing phase compensation along with transmission frequency change automatically. This control allows you to turn on or off the real-time phase compensation for 5G NR waveform.

Remote Command	<code>:SOURce:RADio:ARB:NR5G:PHASe[:STATe] ON OFF 1 0</code> <code>:SOURce:RADio:ARB:NR5G:PHASe[:STATe]?</code>
Example	<code>:SOUR:RAD:ARB:NR5G:PHAS ON</code> <code>:SOUR:RAD:ARB:NR5G:PHAS?</code>
Dependencies	Only appears when Option RPC is present If the waveform is not for 5G NR, there may be error message and the output signal may be incorrect To ensure that you do <i>not</i> compensate for phase twice, once at waveform generation and again during playback, turn off this control if you had turned on phase compensation while generating the waveform
Preset	<code>OFF</code>
Range	<code>ON OFF</code>

SCS

Sets the SCS for real-time 5G NR phase compensation.

Remote Command	:SOURce:RADio:ARB:NR5G:PHASe:SCS SCS15K SCS30K SCS60K SCS60KECP SCS120K SCS240K SCS480K		
	:SOURce:RADio:ARB:NR5G:PHASe:SCS?		
Example	:SOUR:RAD:ARB:NR5G:PHAS:SCS SCS15K		
	:SOUR:RAD:ARB:NR5G:PHAS:SCS?		
Preset	SCS30K		
Range	μ	CP	Value
	0		15 kHz
	1		30 kHz
	2	Normal	60 kHz
		Extended	60 kHz
	3		120 kHz
	4		240 kHz
	5		480 kHz

Filter

Sets the state of Filter usage after real-time 5G NR phase compensation.

Remote Command	:SOURce:RADio:ARB:NR5G:PHASe:FILTer[:STATe] ON OFF 1 0		
	:SOURce:RADio:ARB:NR5G:PHASe:FILTer[:STATe]?		
Example	:SOUR:RAD:ARB:NR5G:PHAS:FILT ON		
	:SOUR:RAD:ARB:NR5G:PHAS:FILT?		
Preset	OFF		
Range	ON OFF		

Filter Bandwidth

Sets the Filter Bandwidth if Filter is used.

By searching <FilterBandwidth> node in the *.scp file, you can get the correct filter bandwidth value for phase compensation.

Remote	:SOURce:RADio:ARB:NR5G:PHASe:FILTer:BANDwidth <freq>
--------	--

Command	:SOURce:RADio:ARB:NR5G:PHASe:FILTer:BANDwidth?
Example	:SOUR:RAD:ARB:NR5G:PHAS:FILT:BAND 99MHz :SOUR:RAD:ARB:NR5G:PHAS:FILT:BAND?
Preset	100 MHz
Min	10 Hz
Max	1200 MHz

Select Waveform

Lets you select a waveform segment or sequence to be played by the ARB player. Presents you with a list of waveform segments files and waveform sequence files. The list of waveform segment files and waveform sequence files contains the names of all the waveform segments and waveform sequence files currently loaded into ARB playback memory.

Waveform sequences are not available in E7760B.

Waveforms formatted as ***.mat**, ***.csv** and ***.txt** are supported by models with a built-in source, such as VXT and EXM.

NOTE

To load a file from the hard drive into ARB memory, go to the **Recall, Waveform dialog**

NOTE

Selecting a waveform file does not result in automatic adjustments to burst timing; that adjustment occurs only when a waveform is loaded to ARB memory.

Remote Command	:SOURce:RADio:ARB:WAVEform <string> :SOURce:RADio:ARB:WAVEform?
Example	:SOUR:RAD:ARB:WAV "test_waveform.bin"
Notes	<p>If the intended waveform is not in the memory yet, then issuing this command invokes ARB loading operation first, which involves a delay of unpredictable length, so this command should be followed by *OPC?, which holds off subsequent commands until the loading operation is complete</p> <p><string> - specifies the name of the waveform segment or waveform sequence to be played by the ARB</p> <p>Sequence Analyzer Mode only:</p> <ul style="list-style-type: none"> - If Include Source is Yes, and you attempt to play a waveform sequence but not all the required waveform segments are in the ARB playback memory, the application rejects the loading operation and an error is generated - If Include Source is No, and you attempt to play a waveform sequence but not all the required waveform segments are contained in the ARB playback memory, the application attempts to load the required segments from either the default directory or the current directory. If the ARB memory

does not have enough space for all the waveform segments to be loaded, an error is generated and none of the waveform segments is loaded

If ARB is **ON**, and you attempt to play a waveform sequence but not all the waveform segments within the sequence could be found to be loaded into ARB memory, an error is generated. The selected waveform keeps the previous value and ARB state remains On

If you specify a waveform segment via SCPI but the waveform segment is not present within ARB playback memory, and cannot be found for auto loading within the current directory or the default directory, an error is generated and the file selection remains unchanged

If you select a waveform for playback and the waveform requires a license that is not installed on the instrument, an error is generated

If ARB is **ON** and you load a file to ARB memory or delete a file from ARB memory, the playing waveform segment may not keep phase continuity during the ARB memory operation. The waveform will be replayed after the ARB operation is finished

Segments in ARB Memory

Shows you which files are loaded into the ARB memory and lets you select a file for playback.

Recall Waveform

This is the same as **Recall From File** in the **Recall, Waveform** dialog.

Delete Segment From ARB Mem

This is the same as **Delete Segment From ARB Mem** in the **Recall, Waveform** dialog.

Delete All From ARB Memory

This is the same as **Delete All From ARB Memory** in the **Recall, Waveform** dialog.

Query ARB Memory File List (Remote Query Only)

Queries the test set for the list of waveform segments in the ARB memory.

NOTE

Returns a string for waveform segment names in ARB memory. If you require a string list of waveform segments in the ARB memory, use **"Query ARB Memory Full File List (Remote Query Only)"** on page 2096

Remote Command	<code>:SOURce:RADio:ARB:CATalog?</code>						
Example	<code>:SOUR:RAD:ARB:CAT?</code>						
Notes	The return data is in the following format:						
	<table border="1"> <tr> <td><code><integer></code></td> <td>Memory used, in kB</td> </tr> <tr> <td><code><integer></code></td> <td>Memory free, in kB</td> </tr> <tr> <td><code><string> ...</code></td> <td>Comma-separated list of waveform segments within ARB memory</td> </tr> </table>	<code><integer></code>	Memory used, in kB	<code><integer></code>	Memory free, in kB	<code><string> ...</code>	Comma-separated list of waveform segments within ARB memory
<code><integer></code>	Memory used, in kB						
<code><integer></code>	Memory free, in kB						
<code><string> ...</code>	Comma-separated list of waveform segments within ARB memory						

Query ARB Memory Full File List (Remote Query Only)

Queries the test set for the string list of waveform segments in the ARB memory. Returns a string list for waveform segment names in the ARB memory.

Remote Command	<code>:SOURce:RADio:ARB:FCATalog?</code>								
Example	<code>:SOUR:RAD:ARB:FCAT?</code>								
Notes	The return data is in the following format:								
	<table border="1"> <tr> <td><code><integer></code></td> <td>Memory used, in kB</td> </tr> <tr> <td><code><integer></code></td> <td>Memory free, in kB</td> </tr> <tr> <td><code><integer></code></td> <td>File count in ARB memory</td> </tr> <tr> <td><code><string>, <string>, ... <string></code></td> <td>Comma-separated string list of waveform segments within ARB memory</td> </tr> </table>	<code><integer></code>	Memory used, in kB	<code><integer></code>	Memory free, in kB	<code><integer></code>	File count in ARB memory	<code><string>, <string>, ... <string></code>	Comma-separated string list of waveform segments within ARB memory
<code><integer></code>	Memory used, in kB								
<code><integer></code>	Memory free, in kB								
<code><integer></code>	File count in ARB memory								
<code><string>, <string>, ... <string></code>	Comma-separated string list of waveform segments within ARB memory								

EXT returns: 27499,2069653,3,"c2k.wfm", "gsm.wfm", "wcdma.wfm"

Waveform Sequences

Not available in E7760B.

Lets you build new sequences or edit existing sequences. The Sequences table displayed in this dialog shows you the sequences in the current directory. You may build a new sequence or select one of the sequences in the table and tap **Edit Selected Sequence**. The default current directory is `C:\NVARB`. Tapping any element of this path lets you select an alternate route. Tapping the **Computer** arrow lets you select a different drive. Tapping the **Back** arrow navigates to the previously selected directory.

Build New Sequence

Lets you build a new sequence of waveform segments. When you build a sequence you are building the "current sequence", and the next time you press "Build New

6 Input/Output
6.1 RF Source

Sequence” the sequence you have been building will still be there, allowing you to add or remove segments from it.

Segment

Shows the segment number assigned to this row.

Waveform

Shows the file name for the waveform inserted into this row. Use ["Insert Waveform" on page 2098](#) to insert a waveform.

Repetitions

Lets you specify the number of times the currently selected waveform is played within the sequence.

Preset	1
Min	1
Max	65535

Marker 1 – Marker 4

Lets you enable or disable Marker 1, 2, 3, or 4 for the currently selected waveform. For a waveform sequence, you can enable and disable markers on a per-segment basis, allowing you to output markers from some waveform segments within the sequence, but not for others.

Preset	Enabled
Range	Enabled Disabled

Sync Seq File

Enables or disables the saving of secondary modules' waveform sequence files based on the current primary module segment's waveform settings.

Remote Command	<code>:SOURce:RADio:ARB:SEquence:SYNC ON OFF</code> <code>:SOURce:RADio:ARB:SEquence:SYNC?</code>
Example	<code>:SOUR:RAD:ARB:SEQ:SYNC OFF</code>
Notes	Available only on primary modules If this setting is ON , when Sync Config is not NONE , the responding secondary module's waveform

sequence file will be saved accordingly when save sequence... on the primary module, and the primary sequence file name should end with **xxx0.seq**, so the secondary module will be named according to the **"Naming Rule" on page 2098**

Waveform names in sequence files should also follow the **Naming Rule**

Dependencies	Not available in E7760B
Preset	OFF
Range	ON OFF

Naming Rule

If Sync Config is not 2x2 +2x2 or 1x1+1x1, the waveform files to be used should follow this naming convention: the waveform file for the primary source should end in 0; the waveform files for the controlled sources should end in 1, 2, or 3 (reflecting the order of the TRXs). For example, for DL 11AC80 3X3 MIMO, sequence file names for TRX1, TRX2 and TRX3 should be xxx0.xx, xxx1.xx and xxx2.xx

If Sync Config is 2x2+2x2, the waveform files to be used should follow this naming convention: the waveform file for the primary source of first 2x2 should end in 0_0; the waveform files for the secondary source of first 2x2 should end in 0_1; the waveform files for the primary source of second 2x2 should end in 1_0; the waveform files for the secondary source of second 2x2 should end in 1_1. For example, for DL 11AC80 2x2 + 2x2 MIMO, waveform file names for TRX1, TRX2, TRX3 and TRX4 should be xxx0_0.xx, xxx0_1.xx, xxx1_0.xx and xxx1_1.xx

If Sync Config is 1x1+1x1, the waveform files to be used should follow this naming convention: the waveform file for the first source should end in 0_0; the waveform files for the second source should end in 1_0. For example, for DL 11AC80 1x1 + 1x1 MIMO, waveform file names for TRX1 and TRX2 should be xxx0_0.xx and xxx1_0.xx

Insert Waveform

Lets you select a waveform segment to be added to the sequence.

NOTE

To load a file from the hard drive into ARB memory, go to the **Recall, Waveform** dialog

Segments in ARB Memory

Shows you which files are loaded into the ARB memory and lets you select a file for inclusion in the sequence.

Delete Segment From ARB Mem

This is the same as **Delete Segment From ARB Mem** in the **Recall, Waveform** dialog.

Delete All From ARB Memory

This is the same as **Delete All From ARB Memory** in the **Recall, Waveform** dialog.

Delete Segment

Lets you delete the selected segment from the waveform sequence.

Save Sequence

Lets you save the newly built Waveform Sequence to the disk drive.

Sequence files have the extension **.seq**. The default filename is **WfmSequence_0000.seq**, where the 4-digit number is the lowest number that does not conflict with any filename in the current directory. Use "File Name" and "File Type" to specify your waveform sequence. The newly build sequence will be stored in the current directory.

Build New Sequence (Remote Command Only)

This is the SCPI equivalent of the waveform sequence creation features described in "[Build New Sequence](#)" on page 2096.

Writes a waveform sequence file to the hard disk. You must specify the waveform sequence file path and filename which will be saved on the hard disk, and the waveform segment file path and name which will be nested into the waveform sequence file. You can utilize mass storage unit specifier (MSUS) "NVWFM" or use a real full path representation. See the example below. MSUS "NVWFM" is mapped to D:\NVARB directory on test set hard disk.

Any number of segments, up to a segment count limit of 64, can be used to create a sequence. Repeated segments are included in the count limit.

Each waveform segment name string length upper limit is 128 chars. Do not attempt to insert a waveform with a name string that exceeds 128 chars.

The internal source does not support nesting one waveform sequence file into another waveform sequence file.

Remote `:SOURce:RADio:ARB:SEquence[:MWAVeform] <filename>, <waveform1>, <reps>, NONE`

Command	<pre> M1 M2 M3 M4 M1M2 M1M3 M1M4 M2M3 M2M4 M3M4 M1M2M3 M1M2M4 M1M3M4 M2M3M4 M1M2M3M4 ALL, \{<waveform2>, <reps>, NONE M1 M2 M3 M4 M1M2 M1M3 M1M4 M2M3 M2M4 M3M4 M1M2M3 M1M2M4 M1M3M4 M2M3M4 M1M2M3M4 ALL,\}</pre>
---------	--

For additional description of each item, see ["For Setup SCPI" on page 2100](#) below
`:SOURce:RADio:ARB:SEQuence[:MWAVEform]? <filename>`

For additional description of each item, see ["For Query SCPI" on page 2101](#) below

Example	<p>For setup:</p> <pre>:SOUR:RAD:ARB:SEQ "NVWFM:testSeq1.seq", "NVWFM:wfmSegment1.wfm",10, M2M3M4, "NVWFM:wfmSegment2.wfm", 20, M1M3</pre>
---------	--

Or

```
:SOUR:RAD:ARB:SEQ "D:\NVARB\testSeq1.seq", "D:\NVARB\wfmSegment1.wfm",10,
M2M3M4, "D:\NVARB\wfmSegment2.wfm", 20, M1M3
```

For query, must specify which waveform sequence file to query

```
:SOUR:RAD:ARB:SEQ? "NVWFM:testSeq1.seq"
```

Or

```
:SOUR:RAD:ARB:SEQ? "D:\NVARB\testSeq1.seq"
```

For Setup SCPI

For the Setup SCPI command, the parameters are:

`<filename>` - String Type

This variable specifies the path and name for the waveform sequence file. The path supports MSUS (NVWFM) or a real full path representation. See example.

`<waveform1>` - String Type

This variable specifies the path and name of the first existing waveform segment. The path supports MSUS (NVWFM) or a real full path representation. See example.

The segment file must reside within ARB playback memory before it can be played by the ARB player.

`<reps>` - Integer Type

This variable specifies the number of times a segment or sequence plays before moving on to the next segment or sequence.

`<marker>` - Enum Type

NONE – This choice disables all four markers for the waveform. Disabling markers means that the waveform sequence ignores the segments or sequence marker settings.

M1, M2, M3, M4 – these choices, either individually or a combination of them, enable the markers for the waveform segment or sequence. Markers not specified are ignored for that segment or sequence.

6 Input/Output

6.1 RF Source

ALL – This choice enables all four markers in the waveform segment or sequence.

<waveform2> - String type.

This variable specifies the name of a second existing waveform segment. The path supports MSUS (NVWFM) and real full path representation both. See example.

The segment file must reside within ARB playback memory before it can be played by the ARB player.

<reps> same as above, for the 2nd waveform segment.

<marker> same as above, for the 2nd waveform segment.

You can insert several waveform segments into a waveform sequence file. Just repeat inserting waveform segments as described above.

Error Checks for Setup SCPI command:

If you do not specify a filename, or you use an unsupported MSUS (that is, not NVWFM), or have an error in the waveform sequence file path, an error is generated. If the specified waveform sequence file name suffix is not “.seq”, error is generated.

If you use an unsupported MSUS (that is, not NVWFM), or have an error in the waveform segment file path, an error is generated.

If the first specified waveform file cannot be found, an error is generated.

If you nest one waveform sequence file into another waveform sequence file, an error is generated.

If the specified repetition value is larger than 65535 or smaller than 1, an error is generated.

If the specified marker type is unrecognized, an error is generated.

For Query SCPI

For the Query the parameters are:

<filename> - String type.

This variable specifies the path and name of the waveform sequence file being queried. The path supports MSUS (NVWFM) or a real full path representation. See example.

The return value is a **<string>**, which includes each waveform segment file name, repetitions, and marker type. For example:

```
>:SOUR:RAD:ARB:SEQ? "NVWFM:testSeq1.seq",  
<"wfmSegment1. wfm, 10, ALL, wfmSegment2.wfm, 20, M1M3",
```

Error Checks for Query SCPI command:

If you do not specify a filename, an error is generated.

If the waveform sequence file name is empty, an error is generated. If the specified waveform sequence file cannot be found, an error is generated.

Edit Selected Sequence

This dialog lets you edit an existing sequence of waveform segments. A table of the segments in the currently selected sequence displays, allowing you to insert waveform segments or edit the characteristics of each segment.

Segment

This field in the table shows the segment number assigned to this row.

Waveform

This field in the table shows the file name for the waveform inserted into this row. Use ["Insert Waveform" on page 2098](#) to insert a waveform.

Repetitions

Lets you specify the number of times the currently selected waveform is played within the sequence.

Preset	1
Min	1

Marker 1 – Marker 4

Lets you enable or disable Marker 1, 2, 3, or 4 for the currently selected waveform. For a waveform sequence, you can enable and disable markers on a per-segment basis, allowing you to output markers from some waveform segments within the sequence, but not for others.

Notes	No remote command, front panel only
Preset	Enabled
Range	Enabled Disabled

Sync Seq File

Change this setting to enable/disable the function of saving secondary modules' waveform sequence files based on the current primary segment's waveform settings.

Remote Command	See "Sync Seq File" on page 2097
Notes	Available only on primary modules If this setting is ON , when Sync Config is not NONE , the responding secondary module's waveform sequence file will be saved accordingly when save sequence... on the primary module, and the primary sequence file name should end with xxx0.seq , so the secondary module will be named according to the "Naming Rule" on page 2103 Waveform names in sequence files should also follow the Naming Rule
Dependencies	Not available in E7760B
Preset	OFF
Range	ON OFF

Naming Rule

If Sync Config is not 2x2 + 2x2 or 1x1 + 1x1, the waveform files to be used should follow this naming convention: the waveform file for the primary source should end in 0; the waveform files for the controlled sources should end in 1, 2, or 3 (reflecting the order of the TRXs). For example, for DL 11AC80 3X3 MIMO, sequence file names for TRX1, TRX2 and TRX3 should be xxx0.xx, xxx1.xx and xxx2.xx

If Sync Config is 2x2+2x2, the waveform files to be used should follow this naming convention: the waveform file for the primary source of first 2x2 should end in 0_0; the waveform files for the secondary source of first 2x2 should end in 0_1; the waveform files for the primary source of second 2x2 should end in 1_0; the waveform files for the secondary source of second 2x2 should end in 1_1. For example, for DL 11AC80 2x2 + 2x2 MIMO, waveform file names for TRX1, TRX2, TRX3 and TRX4 should be xxx0_0.xx, xxx0_1.xx, xxx1_0.xx and xxx1_1.xx

If Sync Config is 1x1+1x1, the waveform files to be used should follow this naming convention: the waveform file for the first source should end in 0_0; the waveform files for the second source should end in 1_0. For example, for DL 11AC80 1x1 + 1x1 MIMO, waveform file names for TRX1 and TRX2 should be xxx0_0.xx and xxx1_0.xx

Insert Waveform

This dialog p select a waveform segment to be added to the sequence.

NOTE

To load a file from the hard drive into ARB memory, go to the Recall, Waveform dialog

Segments in ARB Memory

This table shows you which files are loaded into the ARB memory and lets you select a file for inclusion in the sequence.

Delete Segment From ARB Mem

Deletes a segment from ARB memory. This is the same as **Delete Segment From ARB Mem** in the **Recall, Waveform** dialog.

Delete All From ARB Memory

Removes all segments from ARB memory. This is the same as **Delete All From ARB Memory** in the **Recall, Waveform** dialog.

Delete Segment

Lets you delete the current segment from the waveform sequence.

Notes No remote command, front panel only

Waveform Utilities

Not available in E7760B.

Only appears if there is at least one Multi-pack license installed in the instrument.

On modular instruments, such as EXM , multi-pack license operations are only allowed on the default module, that is, "TRX1" module for EXM.

For EXM, if access multi-pack license sub-menu from modules other than "TRX1", an advisory message like "Please go to "TRX1" to operate multi-pack license" will display.

Add Waveform

Use this dialog to select and add waveforms. Pressing **OK** in this dialog adds the currently highlighted waveform to the next available slot, and returns you to the **"Waveform Utilities" on page 2104** dialog.

6 Input/Output

6.1 RF Source

Remote Command	<code>:SYSTem:LKEY:WAVeform:ADD <string></code> or <code>:SYSTem:LICense[:FPACK]:WAVeform:ADD <string></code>
Example	<code>:SYST:LKEY:WAV:ADD "mywaveform.wfm"</code> or <code>:SYST:LIC:WAV:ADD "mywaveform.wfm"</code>
Notes	<p>The second form, <code>:SYSTem:LICense[:FPACK]:WAVeform:ADD</code>, is provided for consistency with Keysight signal sources. You can use either form</p> <p>Since adding a waveform segment to a Multi-Pack license causes the license slot to enter the trial period of only 48 hours, pressing this key causes a confirmation dialog to be displayed to ensure you do want to add the waveform segment to the Multi-Pack</p> <p>If you attempt to license a waveform that is already licensed using another slot an error is generated</p> <p>For EXM, if current module is not "TRX1" module, the key is grayed-out, and error message is generated "-221 Setting conflict; Not allowed on current module. Go to "TRX1" to operate multi-pack license" when invoking SCPI</p>
Dependencies	Only available if the currently selected file is a secure waveform requiring a license, and there is at least one slot available within at least one multi-pack license. Unavailable if the waveform highlighted is a secure waveform, but is already licensed

Replace Selected Waveform

Lets you replace the waveform in the currently selected slot with the waveform currently selected in the Multi-Pack License Waveform Add view. Pressing **OK** in this dialog replaces the waveform in the currently selected slot with that currently highlighted, and returns you to the ["Waveform Utilities" on page 2104](#) dialog.

Remote Command	<code>:SYSTem:LKEY:WAVeform:REPLace <int>, <string></code> or <code>:SYSTem:LICense[:FPACK]:WAVeform:REPLace <int>, <string></code>
Example	<code>:SYST:LKEY:WAV:REPL 1, "myotherwaveform.wfm"</code> or <code>:SYST:LIC:WAV:REPL 1, "myotherwaveform.wfm"</code>
Notes	<p>The second command form, <code>:SYSTem:LICense[:FPACK]:WAVeform:REPLace</code> is provided for consistency with Keysight signal sources. You can use either form</p> <p>If you attempt to license a waveform that is already licensed using another slot an error is generated</p> <p>Waveform slot number <int> is positive. If you attempt to input a slot number less than or equals 0, an error is generated</p> <p>For EXM, if current module is not "TRX1" module, the key is grayed-out, and error message is generated "-221 Setting conflict; Not allowed on current module. Go to "TRX1" to operate multi-pack license" when invoking SCPI</p>

Clear Waveform from Slot

Lets you clear the waveform from the selected slot.

Remote Command	<code>:SYSTem:LKEY:WAVeform:CLEar <int></code> or <code>:SYSTem:LICense[:FPACK]:WAVeform:CLEar <int></code>
Example	<code>:SYST:LKEY:WAV:CLE 1</code> or <code>:SYST:LIC:WAV:CLE 1</code>
Notes	The second form: <code>:SYSTem:LICense[:FPACK]:WAVeform:CLEar</code> is provided for consistency with the style of Keysight signal sources. You can use either form Waveform slot number <code><int></code> is positive. If you attempt to input a slot number less than or equal to 0, an error is generated For EXM, if current module is not "TRX1" module, the key is grayed-out, and error message is generated "-221 Setting conflict; Not allowed on current module. Go to "TRX1" to operate multi-pack license" when invoking SCPI
Dependencies	Only available if the currently selected slot is in the trial state

Lock Waveform in Slot

If the selected slot is in the trial state or the lock required state, the waveform that occupies the slot is locked and permanently licensed.

Remote Command	<code>:SYSTem:LKEY:WAVeform:LOCK <int></code> or <code>:SYSTem:LICense[:FPACK]:WAVeform:LOCK <int></code>
Example	<code>:SYST:LKEY:WAV:LOCK 1</code> or <code>:SYST:LIC:WAV:LOCK 1</code>
Notes	The command form <code>:SYSTem:LICense[:FPACK]:WAVeform:LOCK</code> is provided for consistency with Keysight signal sources. You can use either form Waveform slot number <code><int></code> is positive. If you attempt to input a slot number less than or equal to 0, an error is generated For EXM, if current module is not "TRX1" module, the key is grayed-out, and error message is generated "-221 Setting conflict; Not allowed on current module. Go to "TRX1" to operate multi-pack license" when invoking SCPI
Dependencies	Only available if the currently selected slot is in the trial state, or the lock required state

Slot Status Query (Remote Command Only)

Returns the status of the specified slot.

Remote Command	<code>:SYSTem:LKEY:WAVeform:STATus? <int></code> or <code>:SYSTem:LICense[:FPACK]:WAVeform:STATus? <int></code>
Example	<code>:SYST:LKEY:WAV:STAT? 1</code> <"Locked" or <code>:SYST:LIC:WAV:STAT? 1</code> <"Locked"
Notes	The command form <code>:SYSTem:LICense[:FPACK]:WAVeform:STATus</code> is provided for consistency with Keysight signal sources. You can use either form Waveform slot number <code><int></code> is positive. If you attempt to input a slot number less than or equal to 0, an error is generated Result type is string. If input slot number exceeds total available slot numbers, "Nonexistent" is returned
Range	"Locked" "Available" "Trail" "LockRequired" "Nonexistent"

Slots Free Query (Remote Query Only)

Returns the number of license slots free.

Remote Command	<code>:SYSTem:LKEY:WAVeform:FREE?</code> or <code>:SYSTem:LICense[:FPACK]:WAVeform:FREE?</code>
Example	<code>:SYST:LKEY:WAV:FREE?</code> or <code>:SYST:LIC:WAV:FREE?</code>
Notes	The second form: <code>:SYSTem:LICense[:FPACK]:WAVeform:FREE</code> is provided for consistency with the style of Keysight signal sources. You can use either one

Slots Used Query (Remote Query Only)

Returns the number of license slots used.

Remote Command	<code>:SYSTem:LKEY:WAVeform:USED?</code> or <code>:SYSTem:LICense[:FPACK]:WAVeform:USED?</code>
----------------	---

Example	<code>:SYST:LKEY:WAV:USED?</code> or <code>:SYST:LIC:WAV:USED?</code>
---------	---

Notes	The second form: SCPI <code>:SYSTem:LIcense[:FPACK]:WAVeform:USED</code> is provided for consistency with the style of Keysight signal sources. You can use either form
-------	---

Slot Waveform Name Query (Remote Command Only)

Returns the waveform name of the specified slot.

Remote Command	<code>:SYSTem:LKEY:WAVeform:NAME? <int></code> or <code>:SYSTem:LIcense[:FPACK]:WAVeform:NAME? <int></code>
----------------	---

Example	<code>:SYST:LKEY:WAV:NAME? 1</code> <"CDMA2K_22.wfm" or <code>:SYST:LIC:WAV:NAME? 1</code> <"CDMA2K_22.wfm"
---------	---

Notes	Waveform slot number <code><int></code> is positive. If you attempt to input a slot number less than or equal to 0, an error is generated Result type is string. If input slot number exceeds total available slot numbers, "Nonexistent" is returned If no waveform stored in the specified slot, then empty string is returned
-------	--

Slot Waveform Unique ID Query (Remote Command Only)

Returns the waveform unique ID of the specified slot.

Remote Command	<code>:SYSTem:LKEY:WAVeform:UID? <int></code> or <code>:SYSTem:LIcense[:FPACK]:WAVeform:UID? <int></code>
----------------	---

Example	<code>:SYST:LKEY:WAV:UID? 2</code> <"1346752140" or <code>:SYST:LIC:WAV:UID? 2</code> <"1346752140"
---------	---

Notes	Waveform slot number <code><int></code> is positive. If you attempt to input a slot number less than or equal to 0, an error is generated Result type is string. If input slot number exceeds total available slot numbers, "Nonexistent" is returned
-------	--

Only Signal Studio waveform has a unique ID, which is a positive number. User-generated waveforms have no unique ID. If no waveform is stored in the specified slot, returns "0"

Locked Waveform Name List Query (Remote Query Only)

Returns the waveform name list of locked.

Remote Command : **SOURce:RADio:ARB:MPLicensed:NAME:LOCKed?**

Example : **SOUR:RAD:ARB:MPL:NAME:LOCKed?**
 < "CDMA2K_27.wfm","GSM_MCS1.WFM","c2kWfm.wfm"

Locked Waveform Unique ID List Query (Remote Query Only)

Returns the waveform unique id list of locked.

Remote Command : **SOURce:RADio:ARB:MPLicensed:UID:LOCKed?**

Example : **SOUR:RAD:ARB:MPL:UID:LOCKed?**
 < "2996927136","3812603511","3710986266"

Notes Each Signal Studio waveform has a unique id recorded in header. If the unique ids are same, that means they are the same waveform. For this reason, in addition to the locked waveform name list query, there is also a locked waveform unique id list query

Multi-Pack License multi-module control state (Remote Command Only)

When **ON**, multi-pack license operations (such as adding/locking/replacinwaveform etc.) from TRXs other than TRX1 are allowed. If **OFF**, only TRX1 is allowed to operate multi-pack license, while other TRXs are only able to show the related multi-pack license information.

Remote Command : **:SERVice[:PRODUCTION]:SOURce:MCONtrol:MPLicense[:STATE] ON | OFF | 1 | 0**
 :SERVice[:PRODUCTION]:SOURce:MCONtrol:MPLicense[:STATE]?

Example : **:SERV:SOUR:MCON:MPL OFF**

Notes Only effective in modular-based OBTs, such as EXM

Preset **OFF**

Range **ON|OFF**

Header Utilities

If there is currently a waveform selected for playback, this table shows you the header information for the file. You can clear the header information out or edit it and save it.

Dependencies	Only available if there is currently a waveform selected for playback. Grayed-out if no waveform is selected
--------------	--

Clear Header

Lets you clear the header information from the file header associated with the currently selected waveform.

Remote Command	<code>:SOURce:RADio:ARB:HEADer:CLEar</code>
Example	<code>:SOUR:RAD:ARB:HEAD:CLE</code>
Notes	Attempting to clear the header details via SCPI when no waveform was selected for playback generates an error

Save Header

Lets you save new file header information details to the file.

Remote Command	<code>:SOURce:RADio:ARB:HEADer:SAVE</code>
Example	<code>:SOUR:RAD:ARB:HEAD:SAVE</code>
Notes	Attempting to save the header details via SCPI when no waveform was selected for playback generates an error

Query Waveform Unique ID (Remote Query Only)

Each Signal Studio waveform contains a unique waveform ID, which recorded in the header. This command allows you to query the unique waveform ID from the header.

Remote Command	<code>:MMEMory:HEADer:ID? "<file name>"</code>
Example	<p>Query the waveform already loaded into the ARB memory:</p> <pre><code>:MMEM:HEAD:ID? "test.wfm"</code></pre> <p>Query the waveform on the hard disk by absolute path:</p> <pre><code>:MMEM:HEAD:ID? "D:\NVARB\test.wfm"</code></pre>

6 Input/Output
6.1 RF Source

Query the waveform on the hard disk by MSUS:
:MMEM:HEAD:ID? "NVWFM:test.wfm"

Notes The queried waveform file can be in ARB memory, or on hard disk. If want to query ARB in ARB memory, then give out the file name directly. If want to query ARB on the hard disk, then absolute file path or MSUS should be given along with the file name. The valid MSUS is **NVWFM**, which is mapped to **D:\NVARB** on the hard disk
If the file cannot be found in ARB memory or on hard disk, an error is generated and value -1 is returned

Query Selected Waveform Header info (Remote Query Only)

Returns a listing of the current selected ARB header info. If no ARB selected, then empty string is returned.

Remote Command :SOURCE:RADio:ARB:HEADer:INFormation?

Example :SOUR:RAD:ARB:HEAD:INF?

Notes After each colon of field title string, related header info string is appended
The field title string in "Range" part cannot change, for Sequence Studio needs to accurately match those string character to know which header info field it is
Below are the abbreviation descriptions:

DESC	Description
SR	Sample Rate
RTS	Run Time Scaling
RMS	Root Mean Square
M1P	Marker 1 Polarity
M2P	Marker 2 Polarity
M3P	Marker 3 Polarity
M4P	Marker 4 Polarity
ALCHR	ALC Hold Routing
RFBR	RF Blank Routing
FOFF	Frequency Offset
AWGNST	AWGN State
AWGNCN	AWGN C/N Ratio
AWGNCBW	AWGN Carrier Bandwidth
AWGNNBW	AWGN Noise Bandwidth
AWGNCRMS	AWGN Carrier RMS
ORP	DAC Over Range Protection

	UID	Unique ID
	LICSTS	License Status
Range	"DESC:", "SR:", "RTS:", "RMS:", "M1P:", "M2P:", "M3P:", "M4P:", "ALCHR:", "RFBR:", "FOFF:", "AWGNST:", "AWGNCN:", "AWGNCBW:", "AWGNNBW:", "AWGNCRMS:", "ORP:", "UID:", "LICSTS"	

6.1.12 Trigger Initiate

Initiates an immediate trigger event if the trigger source (under ARB Setup) is set to [KEY](#).

Dependencies Grayed-out unless Trigger Source is set to [KEY](#) and an ARB waveform is configured

6.1.13 Source Sync

Accesses a menu for setting up Source Synchronization for multiple models.

Only appears in modular products such as VXT, and only when the instrument is configured for MIMO analysis.

6.1.13.1 Sync Config

Lets you config MIMO type for source.

Grayed-out when Primary and Secondary modules are in Sync State.

Remote Command	:SOURce:SYNC:CONFig NONE TWO THRee FOUR SIX EIGHt DONE DTWO DTHR DFOU See "Option Details" on page 2113 :SOURce:SYNC:CONFig?	
Example	:SOUR:SYNC:CONF TWO	
Dependencies	EXM	2x2 and 1x1+1x1 MIMO are supported when license E6640A-M22 is enabled <hr/> 2x2 and 3x3 MIMO are supported when license E6640A-M33 is enabled <hr/> 2x2, 3x3, 4x4 and 2x2+2x2 MIMO are supported when license E6640A-M44 is enabled <hr/>
	VXT models M9410A/11A	No-Across chassis MIMO is supported when license M941xA-MMO is enabled <hr/> Across chassis MIMO is supported when license M941xA-MTS is enabled

6 Input/Output
6.1 RF Source

	VXT models M9415A/16A	No-Across chassis MIMO is supported when license M941xA-MMO is enabled
Range	NONE TWO THRee FOUR SIX EIGHT DONE DTWO DTHR DFOU	

Option Details

Parameter	SCPI	Notes
None	NONE	Sets MIMO Config type as None
2x2	TWO	Sets 2x2 as MIMO Config Type. 2 models are configured to Sync
3x3	THRee	Sets 3x3 as MIMO Config Type. 3 models are configured to Sync
4x4	FOUR	Sets 4x4 as MIMO Config Type. 4 models are configured to Sync
6x6	SIX	Sets 6x6 as MIMO Config Type. 6 models are configured to Sync
8x8	EIGHT	Sets 8x8 as MIMO Config Type. 8 models are configured to Sync
1x1+1x1	DONE	Sets 1x1+1x1 as MIMO Config Type. 2 models are configured to Sync with different center frequency. Use Segment 2 Setup to config the second model
2x2+2x2	DTWO	Sets 2x2+2x2 as MIMO Config Type. 2 groups of 2x2 MIMO. First group consists of Primary and TRX1. Second group consists of TRX2 and TRX3. Segment 2 Setup allows you to config the second group
3x3+3x3	DTHR	Sets 3x3+3x3 as MIMO Config Type. 2 groups of 3x3 MIMO. First group consists of Primary, TRX1 and TRX2. Second group consists of TRX3, TRX4 and TRX5. Segment 2 Setup allows you to config the second group
4x4+4x4	DFOU	Sets 4x4+4x4 as MIMO Config Type. 2 groups of 4x4 MIMO. First group consists of Primary, TRX1, TRX2 and TRX3. Second group consists of TRX4, TRX5, TRX6 and TRX7. Segment 2 Setup allows you to config the second group

6.1.13.2 Sync Type

Grayed-out when models are in Sync State.

Remote Command	:SOURce:SYNC:TYPE PRIMary SECondary OFF For details of parameter options, see "Options" on page 2114 :SOURce:SYNC:TYPE?
Example	:SOUR:SYNC:TYPE PRIM
Preset	OFF
Range	PRIMary SECondary OFF

Options

Parameter	Notes
OFF	This model is not listed in the Secondary module List
SECondary	Use <code>:SOURce:SYNC:CONNected:NAME?</code> to obtain the Primary's name in Sync State
PRIMary	Sync Setup is only available for Primary

6.1.13.3 Sync Settings

Grayed-out when Primary and Secondary are in Sync State.

Dependencies Grayed-out when Sync Type is set to **OFF** or Secondary

Secondary Module List

Lists the parameters of Secondary modules. The Selected checkbox in each row allows you to select the Secondary module when the Sync Type is set to Primary.

- When Sync Config is set to NxN, use this control to enable N-1 Secondary modules
- When Sync Config is set to NxN+NxN, use this control to enable 2N-1 Secondary modules

See "[More Information](#)" on page 2114

Remote Command	<code>:SOURce:SYNC:REMOte:SECOndary<integer> ON OFF 1 0</code> <code>:SOURce:SYNC:REMOte:SEC<integer>?</code>
Example	<code>:SOUR:SYNC:REM:SEC1 ON</code> <code>:SOUR:SYNC:REM:SEC2 OFF</code>
Notes	<code><integer></code> Secondary module number in Available Models
Preset	OFF

More Information

Parameter	SCPI Example	Notes
Available Secondary modules	<code>:SOUR:SYNC:REM:SEC:List?</code>	All the available Secondary models are listed
IP Address	<code>:SOUR:SYNC:REM:SEC1:ADDR?</code>	Refer to Remote Chassis to add the IP Address for remote chassis

6 Input/Output
6.1 RF Source

Parameter	SCPI Example	Notes
Slot Number	:SOUR:SYNC:REM:SEC2:SLOT?	“Local Host” indicates that the Primary and Secondary modules share the same chassis
Socket Port	:SOUR:SYNC:REM:SEC2:SPOR?	Indicates the slot number of available models
Secondary module Order		Indicates the socket port of available models
		Shows you the models to be Secondary devices
		Use Selected to choose from available Secondary models

Sync Settings

Lets you apply the source settings of the Primary module to its Secondary modules.

Remote Command	:SOURce:SYNC:SETTings:ENABle ON OFF 1 0 :SOURce:SYNC:SETTings:ENABle?
Example	:SOUR:SYNC:SETT:ENAB ON :SOUR:SYNC:SETT:ENAB?
Notes	When Sync Settings is ON , the source settings of Primary are applied to Secondary modules. The supported settings are Amplitude, Frequency, Trigger Source, Trigger Type, RF Output and waveform related information When Sync Segment 2 is switched ON , this Toggle is set ON simultaneously
Dependencies	Waveform files naming convention: For NxN MIMO: <ul style="list-style-type: none"> - xxx0.wfm for Primary - xxx[n].wfm for TRX[n] For example, in 3x3 MIMO: <ul style="list-style-type: none"> - xxx0.wfm for Primary - xxx1.wfm for TRX1 - xxx2.wfm for TRX2 For NxN+NxN MIMO, in the first group: <ul style="list-style-type: none"> - xxx0_0.wfm for Primary - xxx0_n.wfm for TRX[n] in the second group: <ul style="list-style-type: none"> - xxx1_n.wfm for TRX[n+N] For example, in 3x3+3x3 MIMO: <ul style="list-style-type: none"> - xxx0_0 for Primary

	<ul style="list-style-type: none"> - xxx0_1.wfm for TRX1 - xxx0_2.wfm for TRX2 - xxx1_0.wfm for TRX3 - xxx1_1.wfm for TRX4
	xxx1_2.wfm for TRX5
Preset	OFF
Range	ON OFF

Sync Segment 2

Lets you config the models in the second group of NxN+NxN MIMO.

Remote Command	<pre>:SOURCE:SYNC:SETTINGS:SEGMENT2:ENABLE ON OFF 1 0 :SOURCE:SYNC:SETTINGS:SEGMENT2:ENABLE?</pre>
Example	<pre>:SOUR:SYNC:SETT:SEGM2:ENAB ON :SOUR:SYNC:SETT:SEGM2:ENAB?</pre>
Notes	Only Frequency in settings is supported
Dependencies	When this setting is ON , Sync Settings will be turned on accordingly
Preset	OFF
Range	ON OFF

Segment 2 Frequency

When Sync Segment 2 is **ON**, allows you to set the frequency of models in the second group of NxN+NxN MIMO.

Remote Command	<pre>:SOURCE:SYNC:SETTINGS:SEGMENT2:FREQUENCY <freq> :SOURCE:SYNC:SETTINGS:SEGMENT2:FREQUENCY?</pre>
Example	<pre>:SOUR:SYNC:SETT:SEGM2:FREQ 1.00 GHz :SOUR:SYNC:SETT:SEGM2:FREQ?</pre>
Preset	1.00 GHz
Min	VXT models M9410A/11A/15A/16A: 380 MHz
Max	Hardware Dependent VXT models M9410A/11A/15A/16A: <ul style="list-style-type: none"> - Option F06 = 6.0 GHz

IP Address

Sets up the controller's IP address of Remote Secondary models.

Remote Command	<code>:SOURCE:SYNC:REMOte:ADDReSS <string></code>
Example	<code>:SOUR:SYNC:REM:ADDR "192.168.1.2"</code>
Notes	<code><string></code> - IP Address

SCPI Socket Port

Sets up the controller's SCPI socket port of Remote Secondary models.

Remote Command	<code>:SOURCE:SYNC:REMOte:IPPoRT <integer></code>
Example	<code>:SOUR:SYNC:REM:IPP 5025</code>
Notes	<code><integer></code> - Port

Add Secondary Module

Lets you connect the remote chassis specified by IP Address and Socket Port.

Remote Command	<code>:SOURCE:SYNC:REMOte:ADDReSS:ADD</code>
Example	<code>:SOUR:SYNC:REM:ADDR:ADD</code>
Notes	Example of how to add a remote chassis: <code>:SOUR:SYNC:REM:ADDR "192.168.1.2"</code> <code>:SOUR:SYNC:REM:IPP 5025</code> <code>:SOUR:SYNC:REM:ADDR:ADD</code> Once a remote chassis is connected, the "Secondary Module List" on page 2114 shows you the available Secondary modules

Delete Secondary Module

Lets you delete a selected remote chassis IP Address from the ["Secondary Module List" on page 2114](#) .

Remote Command	<code>:SOURCE:SYNC:REMOte:ADDReSS:DELeTe</code>
Example	<code>:SOUR:SYNC:REM:ADDR:DEL</code>
Notes	Example of how to delete a remote chassis: <code>:SOUR:SYNC:REM:ADDR "192.168.1.2"</code>

`:SOUR:SYNC:REM:ADDR:DEL`

Sync Runtime Settings (Remote Command Only)

Lets you Sync runtime settings to the Secondary modules without restarting Sync.

Remote Command	<code>:SOURce:SYNC:RTSetting:STATe ON OFF 1 0</code> <code>:SOURce:SYNC:RTSetting:STATe?</code>
Example	<code>:SOUR:SYNC:RTS:STAT ON</code> <code>:SOUR:SYNC:RTS:STAT?</code>
Notes	When OFF , Sync is interrupted when changing frequency or power settings on the Primary module. After applying the new settings to the Secondary modules, Sync will restart When ON , setting changes on the Primary module are applied to the Secondary modules immediately without interrupting Sync status. This is the default behavior. The supported settings are Amplitude and Frequency
Preset	ON
Range	ON OFF

6.1.13.4 Sync Start

Lets you start synchronizing Primary and Secondary modules to play Arb synchronously.

When the Sync connection is built successfully, Primary and Secondary modules are in the Sync State.

Sync Start and Sync Config menu are grayed-out when Primary and Secondary modules are in Sync State.

Remote Command	<code>:SOURce:SYNC:START</code>
Example	<code>:SOUR:SYNC:STAR</code>
Notes	If you change the source settings during Sync State, an error message appears in the status bar: "Settings conflict; Sync connection is already established" and the change will not be applied until Sync Stop

6.1.13.5 Sync Stop

Stops the synchronization.

When Sync Stops, Sync Config menu and Sync Start will be available.

Remote Command	<code>:SOURce:SYNC:STOP</code>
Example	<code>:SOUR:SYNC:STOP</code>

6.1.13.6 Sync Connected (Remote Query Only)

Lets you query the state of synchronization.

Remote Command	<code>:SOURce:SYNC:CONNected?</code>
----------------	--------------------------------------

Example	<code>:SOUR:SYNC:CONN?</code>
---------	-------------------------------

Returns: 1 when synchronization is established, 0 when synchronization is stopped

6.1.14 Source Preset

Lets you preset the source settings to their default values.

Remote Command	<code>:SOURce:PRESet</code>
----------------	-----------------------------

Example	<code>:SOUR:PRES</code>
---------	-------------------------

6.2 Input

The controls on this tab let you select and configure the instrument's inputs.

6.2.1 Select Input

Lets you choose which signal input you want to analyze:

- "RF Input" on page 2122
- "External Mixer" on page 2122
- "I/Q" on page 2125

See also:

- "External Mixer Setup" on page 2147
- "I/Q Setup" on page 2167

Remote Command	<code>[:SENSe] :FEED RF AIQ EMIXer</code> <code>[:SENSe] :FEED?</code>
Example	Select the RF Input: <code>:FEED RF</code> Select External Mixing: <code>:FEED EMIX</code> Select BBIQ: <code>:FEED AIQ</code>
Dependencies	I/Q only appears when Option BBA present Ext Mix only appears when Option EXM present
Couplings	Connecting a U7227A USB Preamplifier to one of the instrument's USB ports causes the Input to automatically switch to the RF Input. If the RF Calibrator is on, it is turned off. Subsequently disconnecting the USB Preamp from USB does not change the Input selection, nor restore the previous selection <code>[:SENSe] :FEED RF</code> turns the calibrator OFF
Preset	Unaffected by Preset or power cycle. Survives a Mode Preset and mode changes Set to RF by Restore Input/Output Defaults or Restore System Defaults->All
State Saved	Saved in instrument state
Annotation	Displayed in the Meas Bar as "Input:." followed by: RF or Ext Mix or I/Q depending on which input is selected

6 Input/Output

6.2 Input

Backwards Compatibility SCPI	<p><code>[:SENSe]:FEED AREFERENCE</code></p> <p>In the PSA the calibrator was one of the inputs and selected using the AREF parameter to the same :FEED command that switched the inputs. In the X-Series, it is controlled in a separate menu and overrides the input selection. For code compatibility, <code>[:SENSe]:FEED AREFERENCE</code> is provided, and is aliased to <code>[:SENSe]:FEED:AREF REF50</code>, which causes the input to be switched to the 50 MHz calibrator. <code>[:SENSe]:FEED RF</code> switches the input back to the RF port and turns the calibrator OFF, thus providing full compatibility with the PSA calibrator function</p> <p>Note that after sending this, <code>[:SENSe]:FEED?</code> does <i>not</i> return “AREF” but instead the currently selected input:</p> <pre>[:SENSe]:FEED IQ IONLy QONLy [:SENSe]:FEED?</pre> <p>The parameters <code>IQ IONLy QONLy</code> are supported for backwards compatibility with the E44406A</p> <pre>[:SENSe]:FEED IQ aliases to [:SENSe]:FEED:IQ:TYPE IQ [:SENSe]:FEED IONLy aliases to [:SENSe]:FEED:IQ:TYPE IONLy [:SENSe]:FEED QONLy aliases to [:SENSe]:FEED:IQ:TYPE QONLy [:SENSe]:FEED? always returns AIQ, whatever type of legacy parameter IQ IONLy QONLy has been used</pre>
Backwards Compatibility Notes	<p>Most of the settings in the X-Series Input/Output system, including External Gain, Amplitude Corrections settings and data, etc., are shared by all modes and are not changed by a mode switch. Furthermore, most variables under the Input/Output menu are not affected by Mode Preset. Both of these behaviors represent a departure from legacy behavior</p> <p>In X-Series, Input/Output settings are reset by using Restore Input/Output Defaults. They can also be reset to their default values by System->Restore System Defaults-> In/Out Config, or by System ->Restore System Defaults -> All (and corresponding SCPI)</p> <p>While this matches most use cases better, it does create some code compatibility issues. For example, Amplitude Corrections are no longer turned off by Mode Preset, but instead by Restore Input/Output Defaults</p> <p>Although Input/Output settings are not part of each Mode’s State, they are saved in Save State files, so that all of the instrument settings can be recalled with Recall, State, as in legacy instruments</p>
Notes	<p>In legacy analyzers you choose between the Internal mixer or an External Mixer. In X-Series, the External Mixer is one of the choices for the Input and is selected using the <code>FEED</code> command (<code>[:SENSe]:FEED EXTMixer</code>)</p> <p>For compatibility, the <code>:INPut:MIXer EXTernal INTernal</code> legacy command is mapped as follows:</p> <ol style="list-style-type: none"> 1. When <code>:INPut:MIXer EXTernal</code> is received, <code>:SENSe:FEED EMIXer</code> is executed 2. When <code>:INPut:MIXer INTernal</code> is received, <code>:SENSe:FEED RF</code> is executed 3. When <code>:INPut:MIXer?</code> is received, the response is <code>INT</code> if any input other than the external mixer is selected, and <code>EXT</code> if the external mixer is selected
Preset	<code>INT</code>

Backwards Compatibility SCPI	<code>:INPut:MIXer EXTERNAL INTERNAL</code> <code>:INPut:MIXer?</code>
------------------------------	---

Backwards Compatibility Notes	PSA supports the following SCPI Command : <code>:INPut:MIXer:TYPE PRESelected UNPReselect</code> <code>:INPut:MIXer:TYPE?</code> PSA does not support the <code>:INPut:MIXer:TYPE</code> command
-------------------------------	---

RF Input

Selects the front-panel RF input port to be the instrument signal input. If RF is already selected, pressing this key accesses the RF input setup functions.

External Mixer

Lets you select an External Mixer through which to apply signal input to the instrument. When selected, the LO/IF port becomes the input to the instrument.

External Mixing requires option EXM. The External Mixer key will not appear unless option EXM is installed. The presence of the LO/IF connector alone does not indicate that you have Option EXM licensed. To verify that option EXM is installed, press **System, Show, System**.

When External Mixer is selected, the **Center Freq** key controls the setting of the Center Freq in external mixing, which is separate from the settings of Center Freq for the RF Input or BBIQ. Each input retains its unique settings for Center Freq. A unique SCPI command is provided solely for the external mixing Center Freq (see the **Center Freq** key description), which only affects the External Mixer CF, although sending the generic Center Freq command while External Mixer is selected also controls the External Mixer CF.

Unless option EXM is present, the External Mixer key is blanked, and all SCPI commands associated with menus accessed by this key return an error. Manual FFT mode is available with external mixing, but not with Signal ID. All settings under this key, and all Frequency settings, are remembered when you go out of External Mixer, so that when **External Mixer** is chosen again, all the external mixer functions will retain their previous settings, with the exception of Signal ID which is set to OFF (Signal ID is also set to Off unless External Mixer is the selected Input). Note that this differs from ESA and PSA, in which all external mixer settings including Center Frequency are lost when you turn off External Mixing or Preset the instrument.

X-series instruments have a combined LO Out/IF In connection, whereas earlier instruments used separate ports for the LO Out and the IF in. Internal diplexers in the instrument and the mixer simplify the connection for users – only a single SMA cable is required.

6 Input/Output
6.2 Input

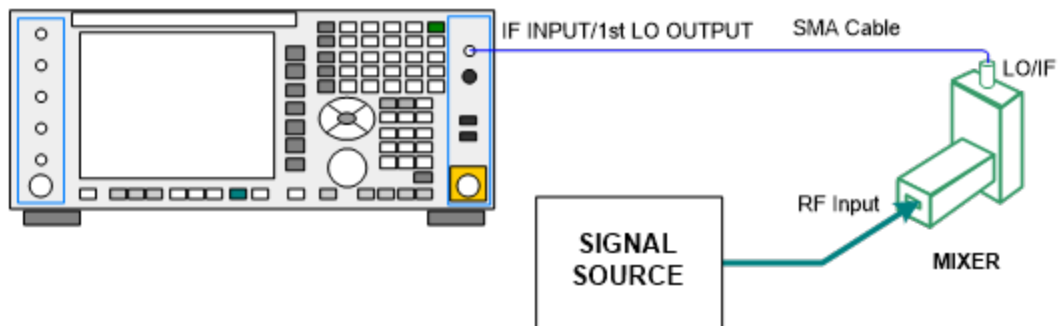

Legacy HP/Agilent and some third-party mixers have separate LO In and IF out connections. This requires you to use an external diplexer to connect these mixers. A diplexer can easily be purchased for this purpose (for example, Diplexer Model # DPL.26 or # DPL.313B from OML Inc., Morgan Hill, California, USA).

The connection diagram for such a legacy mixer is:

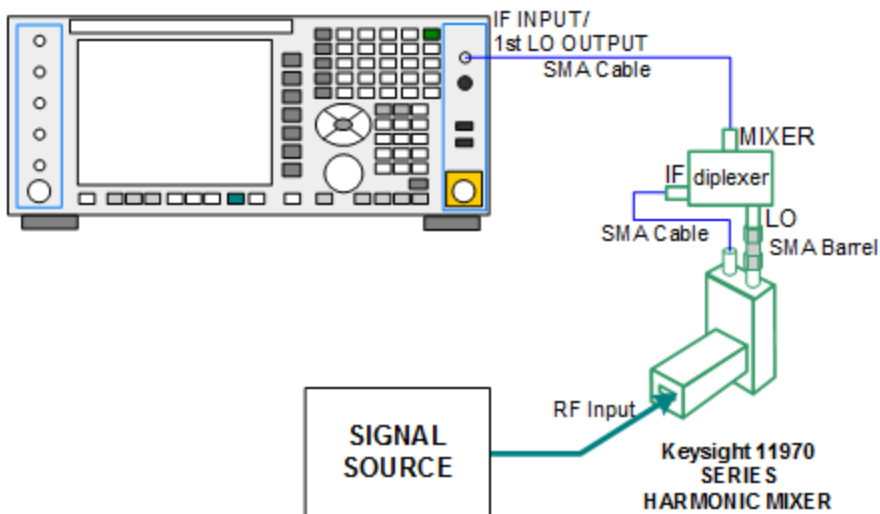

In addition, External Mixing in the X-Series supports the new Keysight M1970 series of Harmonic Mixers, which provide a USB connection for download of calibration data and additional control.

The connection diagram for one of the Keysight USB mixers is:

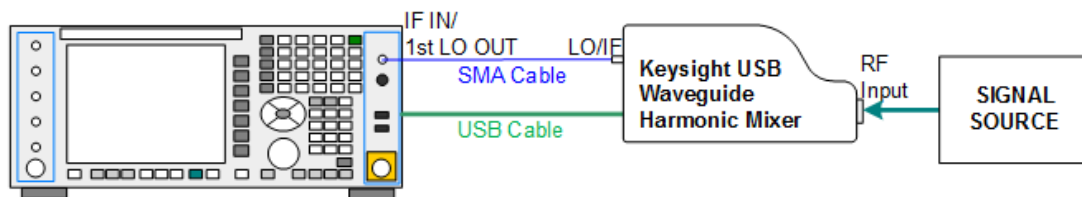

Also available in the M197x series are the M1971 series USB Mixers, which provide additional inputs and outputs for special functionality as described below. These mixers have multiple signal paths which allow them to function in three different states:

- Normal, in which the mixer functions as a classic external mixer with a single conversion:

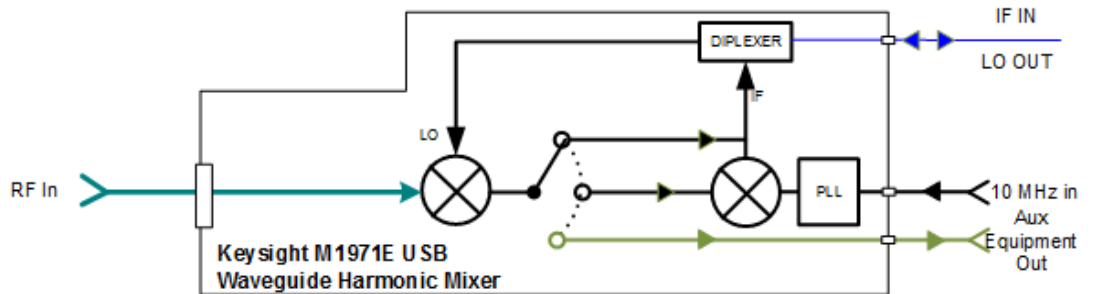

- Dual Conversion, which gives you a wider image-free range. In Dual Conversion, the first conversion is to a higher IF frequency and you provide a 10 MHz signal to which an internal PLL is locked, to effect a second downconversion:

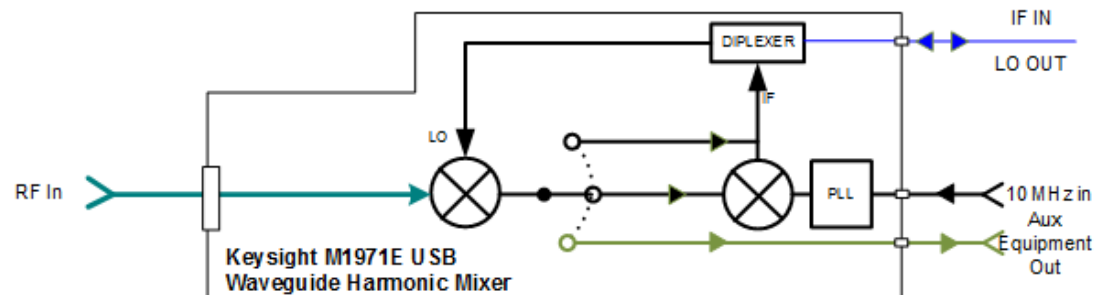

- Aux Equipment, wherein the first mixer output drives an output connector on the mixer and the instrument is out of the circuit:

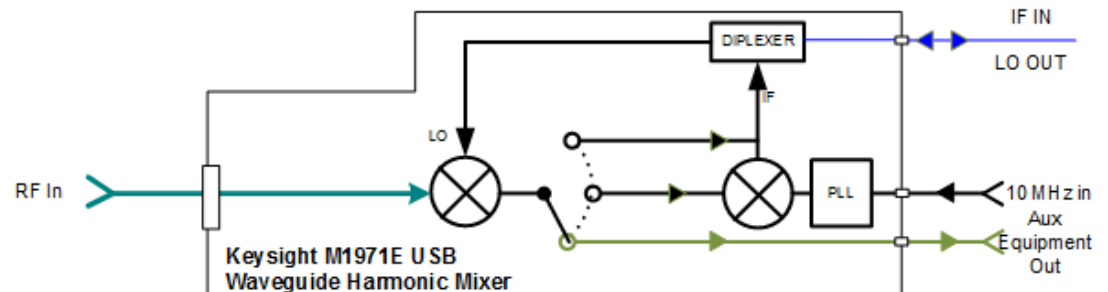

External Mixing is only supported in certain Modes and Measurements in the X-Series, as shown in the table below. When External Mixer is selected in a

6 Input/Output
6.2 Input

measurement that does not support it, the "No result; Meas invalid with Ext Mixing" error condition occurs:

Mode	Measurements	Sig ID (Image Suppress only)
Spectrum Analyzer	Swept SA	Y*
	TOI	Y
	Harmonics	N
	Spurious Emissions	Y
	Channel Power	Y
	Occupied BW	Y
	ACP	Y
	Spectrum Emissions Mask	Y
	CCDF	N
	Burst Power	N
	List Sweep	N
Phase Noise	Monitor Spectrum	Y
	Log Plot	Y
	Spot Frequency	N
	Waveform	N
I/Q Analyzer	Complex Spectrum	N
	Waveform	N
Vector Signal Analyzer	Vector Analysis	N
	Analog Demod	N
	Digital Demod	N
Analog Demod	AM	N
	FM	N
	PM	N
	FM Stereo	N

* the Swept SA measurement also supports Image Shift

I/Q

Selects the front-panel I/Q input ports to be the instrument signal input. If I/Q is already selected, pressing this key accesses the I/Q setup menu.

The Baseband I/Q functionality is a hardware option. It is option BBA. If the option is not installed, none of the I/Q functionality is enabled.

The Baseband I/Q has four input ports and one output port. The input ports are I, I-bar, Q, and Q-bar. The I and I-bar together compose the I channel, and the Q and Q-

bar together compose the Q channel. Each channel has two modes of operation, Single-Ended (also called "unbalanced") and Differential Input (also called "balanced"). When in Single-Ended operation, only the main port (I or Q) is used, and the complementary port (I-bar or Q-bar) is ignored. When in Differential Input mode, both main and complementary ports are used.

The input settings (range, attenuation, skew, impedance, external gain) apply to the channels, not the individual ports.

The system supports a variety of 1 M Ω input passive probes as well as the Keysight 113x Series active differential probes using the Infinimax probe interface.

The Keysight 113x Series active probes can be used for both single ended and differential measurements. In either case a single connection is made for each channel (on either the I or Q input). The input is automatically configured to 50 Ω single ended and the probe power is supplied through the Infinimax interface. The probe can be configured for a variety of input coupling and low frequency rejection modes. In addition, a wide range of offset voltages and probe attenuation accessories are supported at the probe interface. The active probe has the advantage that it does not significantly load the circuit under test, even with unity gain probing.

With passive 1 M Ω probes, the probe will introduce a capacitive load on the circuit, unless higher attenuation is used at the probe interface. Higher attenuation reduces the signal level and degrades the signal-to-noise-ratio of the measurement. Passive probes are available with a variety of attenuation values for a moderate cost. Most Keysight passive probes can be automatically identified by the system, setting the input impedance setting required as well as the nominal attenuation. For single ended measurements a single probe is used for each channel. Other passive probes can be used, with the attenuation and impedance settings configured manually.

For full differential measurements, the system supports probes on each of the four inputs. The attenuation of the probes should be the same for good common mode rejection and channel match.

Both active and passive probes in single ended and differential configurations can be calibrated. This calibration uses the Cal Out BNC connection and a probe connection accessory. The calibration achieves excellent absolute gain flatness in a probed measurement. It matches both the gain and frequency response of the I and Q channels as well as any delay skew, resulting in high accuracy in derived measurements such as Error Vector Magnitude (EVM).

When a probe is connected a status message will be displayed. The message will indicate if calibration data is available or not. Calibration data is saved for each type of probe (including "none") for each port and will be reapplied whenever that type of probe is re-connected to the same port. For probes with EEPROM identification, the calibration data will be stored based on the unique probe identifier and will reapply data for that particular probe if it is available. The data will not follow a probe from one port to another. For probes without EEPROM identification, the instrument

6 Input/Output

6.2 Input

cannot distinguish between different probes of the same type, and it will use the data from the last calibration for that probe type on that port.

When in differential mode, both the main and complementary probes are expected to be of the same type.

In some situations, the I and Q channels should be configured identically. In other situations, it is convenient to control them independently. Some menus have a "Q Same as I" setting that will cause the Q channel configuration to mirror the I channel configuration, avoiding the overhead of double data entry when the channels should be the same.

The output port is for calibrating the I/Q input ports, although it can also be manually controlled.

There are two types of calibrations available: cable calibration and probe calibration. The cable calibration will guide the user through connecting each input port in turn. All ports must be calibrated together. The probe calibration is done for a specific channel (I or Q). If in Single-Ended mode, only the main port is calibrated. When in Differential Input mode, the user is guided through calibrating both main and complementary ports.

The front panel I/Q port LEDs indicate the current state of that port. On (green) indicates it is active, and off (dark) indicates it is not in use. For example, the Cal Out port LED is on if and only if there is signal coming out of that port.

The input is a context, and some parameters have separate values for each context. The SCPI for these parameters has an optional "[:RF|IQ]" node. If the specific context is omitted, the command acts on the current input context's value. Here are the parameters that are input context sensitive:

- Center Frequency
- Trigger Source

It is important to distinguish between the I and Q input ports and the displayed I and Q data values. The I and Q input ports feed into a digital receiver that does digital tuning and filtering. The I and Q data seen by the user (either on the display or through SCPI) corresponds to the real ("I") and the imaginary ("Q") output from the digital receiver. When the input path is I+jQ or I Only and the center frequency is 0 Hz the I input ends up in as the real output from the receiver and appears as "I" data. Likewise, when the input path is I+jQ and the center frequency is 0 Hz, the Q input ends up as the imaginary output from the receiver and appears as "Q" data. However, when the input path is Q Only, the Q input is sent to the receiver as $Q+j0$, so the receiver output has the Q input coming out on the real output, and so in Q Only, the signal from the Q input port appears as the "I" data. Another situation where the I and Q data do not necessarily correspond directly to the I and Q inputs is when the center frequency is non-zero. The digital processing involved in the tuning

is a complex operation. This will result in I Only data appearing as both "I" and "Q" data, the same as that signal would appear if seen through the RF input port.

BBIQ is only supported in certain Modes and Measurements in the X-Series. When I/Q is selected in a measurement that does not support it, the "No Result; Meas invalid with I/Q inputs" message appears. This is error 135

Baseband I/Q Remote Language Compatibility

For the Agilent E4406A VSA Series Transmitter Tester, Option B7C provided baseband I/Q inputs. Code compatibility has been provided to allow many of the commands for Option B7C to function properly with X-Series. X-Series has hardware differences and additional capabilities (for example, E4406A does not have independent settings of I & Q, nor does it provide for probe calibrations), which make 100% compatibility impossible.

The following commands are supported:

```
:CALibration:IQ:FLATness
```

```
:INPut:IMPedance:IQ U50 | B50 | U1M | B1M
```

```
:INPut:IMPedance:REFerence <integer>
```

[:SENSe] :FEED RF | IQ | IONLY | QONLY | AREFERENCE | IFALIgn supports all parameters except IFALIgn. The FEED? query returns only RF | AIQ | AREF.

The following commands are not supported:

```
:CALibration:GIQ
```

```
:CALibration:IQ:CMR
```

```
:INPut:IQ:ALIGn OFF | ON | 0 | 1
```

The Rohde & Schwarz FSQ-B71 also provides baseband I/Q inputs. A certain amount of code compatibility is provided in X-Series, but hardware differences make this a somewhat limited set.

Supported:

The "<1|2>" is supported as "[1]".

```
INPut<1|2>:IQ:BALAnced[:STATe] ON | OFF
```

```
INPut<1|2>:IQ:TYPE I | Q | IQ
```

```
INPut<1|2>:IQ:IMPedance LOW | HIGH
```

Not Supported:

```
DIAGnostic<1|2>:SERVice:IQ:CALibration:DC 0 | 0.1 | 0.178 | 0.316 | 0.562 | 1.0
```

```
DIAGnostic<1|2>:SERVice:IQ:CALibration:DESTination IHIGH | ILOW | QHIGH | QLOW
```

```
DIAGnostic<1|2>:SERVice:IQ:CALibration:PULSe: PRATe 10 kHz | ... | 4 MHz
```

```
DIAGnostic<1|2>:SERVice:IQ:INPut IQ | GND | CALDc | CALPulse
```

6 Input/Output

6.2 Input

```
INPut<1|2>:SElect AIQ | RF
TRACe<1|2>:IQ:DATA:FORMat COMPatible | IQBlock | IQPair>
TRACe<1|2>:IQ:DATA:MEMory? <offset samples>,<# of samples>
TRACe<1|2>:IQ:DATA?
TRACe<1|2>:IQ:SET <filter type>,<rbw>,<sample rate>,<trigger source>,<trigger
slope>,<pretrigger samples>,<# of samples>
TRACe<1|2>:IQ:SRATe 10.0kHz to 81.6MHz
TRACe<1|2>:IQ[:STATe] ON | OFF
```

The Rohde & Schwarz FMU has the following SCPI, which is *not* supported (these commands start/abort the probe calibration procedure, which is manually interactive from the front panel):

```
CALibration:ABORT
CALibration:PROBe[:START]
```

6.2.2 RF Input Port

Specifies the RF input port used. Only appears on units with multiple RF inputs, and lets you switch between the inputs.

Instruments that include multiple RF Input ports include:

- N9041B
- N9000B (CXA)
- N9048B (PXE)
- VXT, M941xE and EXM
- M8920A/20B
- E7760B

NOTE

Switching input ports may change the receiver performance of the instrument.

See ["Instruments with 2 Inputs" on page 2131](#)

Remote Command `[:SENSe]:FEED[:RF]:PORT[:INPut] <port>`

For instrument-specific definitions of `<port>`, see:

["Parameters for UXA/PXA/MXA/EXA/CXA/MXE/PXE/NFA" on page 2131](#)

["Parameters for EXT, EXF and EXM Wireless Test Sets" on page 2132](#)

	<p>"Parameters for VXT M9410A/11A/15A16A, M9410E/11E/15E/16E and M9420A Vector Transceivers" on page 2132</p> <p>"Parameters for VXT M9410A/11A/15A/16A and EXM when used with Radio Heads/CIU" on page 2134</p> <p>"Parameters for E7760B Wideband Transceiver" on page 2137</p> <p>"Parameters for M8920A/20B Radio Test Set" on page 2138</p> <p>"Parameters for UXM Wireless Test Set" on page 2138</p> <p><code>[:SENSe] : FEED [:RF] : PORT [:INPut] ?</code></p>
Example	<p>Use the port labeled RF Input when the selected input is RF: <code>:FEED:RF:PORT RFIN</code></p> <p>Use the port labeled RF Input 2 when the selected input is RF: <code>:FEED:RF:PORT RFIN2</code></p>
Dependencies	<p>Only appears when RF Input is selected as the Input</p> <p>Only appears in models that support multiple inputs. If the SCPI command is sent with unsupported parameters in any other model, an error is generated, -221, "Settings conflict; option not installed"</p> <p>When any input is selected in a measurement that does not support it, the "No result; Meas invalid with this input" error condition occurs, and the measurement returns invalid data when queried</p>
Couplings	<p>When switching between inputs, you may find the new input has a different frequency range than the current input. This means the frequency at the new input may be limited, depending on where you were tuned</p> <p>When you switch from an input whose maximum frequency is greater than the input to which you are switching:</p> <ol style="list-style-type: none"> 1. If the current Stop Freq is below the Max Freq for the new input, then neither Stop Freq or Start Freq needs to change 2. But if the current Stop Freq is above the Max Freq for the new input, Stop Freq must change; so, it is set to the Max Freq for the new input 3. If the Stop Freq is forced to change then, if possible, the Span is preserved with the new Stop Freq; however, the Start Freq can't go below zero <p>Example: Input 2 has a Max Freq of 110 GHz and Input 1 has a Max Freq of 52 GHz</p> <p>Case 1: Input 2 is selected and Start Freq=40 GHz, Stop Freq=60 GHz. Change to Input 1. Stop Freq changes to 52 GHz so, to preserve Span, Start Freq is set to 32 GHz</p> <p>Case 2: Input 2 is selected and Start Freq=40 GHz, Stop Freq=110 GHz. Change to Input 1. Stop Freq changes to 52 GHz. Span was 70 GHz, but new Span maximum is 52 GHz so Start Freq is set to 0 Hz</p> <p>Case 3: Input 2 is selected and Start Freq=10 GHz, Stop Freq=20 GHz. Change to Input 1. No change is necessary, Start Freq and Stop Freq don't change</p>
Preset	<p>Unaffected by Mode Preset, but set to <code>RFIN</code> on Restore Input/Output Defaults or Restore System Defaults -> All, unless noted in the platform-specific sections below</p>
State Saved	<p>Saved in instrument state</p>
Annotation	<p>Annotation in the Meas Bar reads as follows: When input is RF In: Input: RF</p>

6 Input/Output
6.2 Input

	When input is RF In 2: Input: RF2
Backwards Compatibility SCPI	<code>:INPut<1 2>:TYPE INPUT1 INPUT2</code> <code>:INPut<1 2>:TYPE?</code>
	Included for R&S ESU compatibility. In MXE, the INPUT1 parameter is aliased to RFIN and the INPUT2 parameter is aliased to RFIN2

Instruments with 2 Inputs

In models with two inputs, the second input usually has a different maximum frequency than the first input. For your convenience, the actual “Max Freq” value is allowed to go slightly higher than the nominal Max Freq for the second input, just as is the case with the first input.

Model	Nominal Input 2 Max Freq	Absolute Input 2 Max Freq	Transition rule for switching from Input 1 to Input 2
N9038A	1 GHz	1.000025 GHz	If Stop Freq is above 1.000025 GHz, it is set to 1.000025 GHz, otherwise it does not change If Start Freq is above 1.000024990 Hz, Start Freq is set to 1.000024990 Hz and Span to 10 Hz, otherwise nothing changes
N9000A with option C75	1.5 GHz	1.58 GHz	If Stop Freq is above 1.58 GHz, it is set to 1.58 GHz, otherwise it does not change If Start Freq is above 1.579999990 GHz, Start Freq is set to 1.579999990 GHz and Span to 10 Hz, otherwise nothing changes

Parameters for UXA/PXA/MXA/EXA/CXA/MXE/PXE/NFA

<port>	Input
<code>RFIN</code>	RF Input
<code>RFIN2</code>	RF Input 2
<code>ERFIN</code>	External RF

Example	Set the RF input to be RF Input: <code>:FEED:RF:PORT RFIN</code>
	Set the RF input to be RF Input 2 if that port exists: <code>:FEED:RF:PORT RFIN2</code>
	Set the RF input to be External RF if the V3050A unit is connected: <code>:FEED:RF:PORT ERFIN</code>
Dependencies	If the command is sent with <code>RFIN2</code> or <code>ERFIN</code> and that port does not exist, an error is generated, -221, “Settings conflict; option not installed” <code>ERFIN</code> requires option “EXW”

Couplings	Connecting a V3050A changes the Preset to ERFIN and automatically switches the input to ERFIN . Disconnecting the V3050A changes the Preset back to RFIN and automatically switches the input to RFIN
Preset	ERFIN when V3050A is connected, otherwise RFIN
Annotation	Annotation in the Meas Bar reads as follows: <ul style="list-style-type: none"> - When input is RFIN: Input: RF - When input is RFIN2: Input: RF2 - When input is ERFIN: Input: Ext RF

Parameters for EXT, EXF and EXM Wireless Test Sets

<port>	Input
RFIO1	RFIO 1
RFIO2	RFIO 2
RFIO3	RF3 I O
RFIO4	RF4 I O

See also "[Parameters for VXT M9410A/11A/15A/16A and EXM when used with Radio Heads/CIU](#)" on page 2134

Example	Set the RF input to RFIO 1: :FEED:RF:PORT RFIO1
Dependencies	In EXF, or in EXM with hardware M9430A, if RF Input is selected as RF Input Port, you need to choose the settings in the Half Duplex Config menu to determine which port (RFIO3 or RFIO4) will be used In EXM with hardware M9431A, this setting is not supported. If the SCPI command is sent with this setting, an error is generated, -221, "Settings conflict; option not installed"
Preset	RFIO1
Annotation	Annotation in the Meas Bar reads as follows: <ul style="list-style-type: none"> - When input is RFIO1: Input: RFIO1 - When input is RFIO2: Input: RFIO2 - When input is RFIO3: Input: RFIO3 - When input is RFIO4: Input: RFIO4

Parameters for VXT M9410A/11A/15A/16A, M9410E/11E/15E/16E and M9420A Vector Transceivers

<port>	Input
RFIN	RF Input

6 Input/Output
6.2 Input

<port>	Input
RFFD	RFIO FD
RFHD	RFIO HD, Half Duplex

Example

```
:FEED:RF:PORT RFIN
:FEED:RF:PORT RFFD
:FEED:RF:PORT RFHD
:FEED:RF:PORT NONE
```

Notes

RFIN sets the RF input to be the RF Input port, labeled RF Input

RFFD sets the RF input to be the full duplex port, labeled RFIO FD. Note that Option “FDX” is required to enable this port

RFHD sets the RF input to be the half duplex port, labeled Half Duplex (M9410A/11A/15A/16A) or RFIO HD (M9420A)

M9410E/11E/15E/16E also has HD port, which is the HD port on M9471A module

NONE sets the RF In port and Half Duplex port (if HD Port is not set to RF Output) to connect to 50Ω load, as shown below:

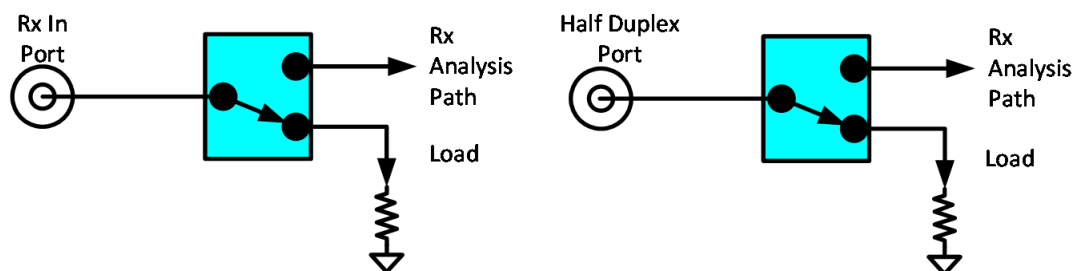

When using Source only, set RF Input to **NONE** to provide better isolation. When the input port is set to **NONE**, an error appears in the status area:

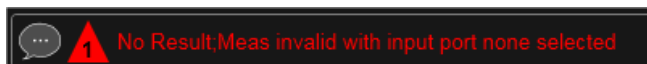

Dependencies

Option HDX is required to enable the Half Duplex (RFIO HD) port

You cannot set this port to be the input if it is already set to be the output. Attempting to do so generates error message: “-221, Settings conflict; RF Input cannot be set to RFIO HD when RF Output is RFIO HD”

NONE is not available in VXT model M9420A

Preset

RFIN

Annotation

Annotation in the Meas Bar reads as follows:

When input is RF Input: Input: RF

When input is RFIO FD: Input: RFFD

When input is RFIO HD or Half Duplex: Input: RFHD

When input is None: Input: NONE

Parameters for VXT M9410A/11A/15A/16A and EXM when used with Radio Heads/CIU

<port>	Input
RRH h RFHD p	Head h , RF Tx/Rx p , for example RRH1RFHD2 = Head 1, RF Tx/Rx 2
IFIN n	DUT IF IN for Channel n , for example IFIN1 = DUT IF IN for Channel 1
IFHD n	DUT IF In/Out for Channel n , for example IFHD1 = DUT IF In/Out for Channel 1

When using a Remote Radio Head (RRH), such as the Keysight M1740A mmWave Transceiver for 5G, with the VXT or EXM, the choices in the dropdown are dependent on which heads are installed. For example, in the case where two M1740As are present, each with two ports, the dropdown will look like this:

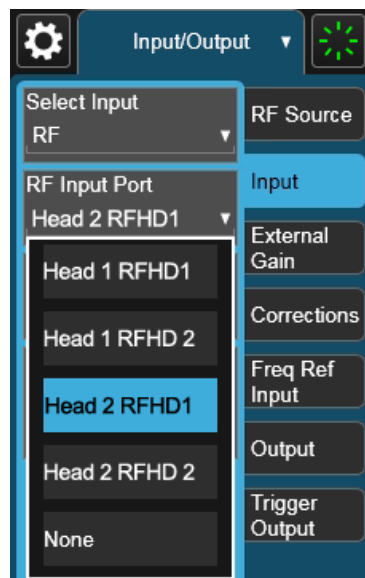

Note the inclusion of the **None** choice, which allows the input port to become unassigned, and thus allows any Output port to be assigned without concern about an Input port conflict. When the input port is unassigned, an error appears in the status area:

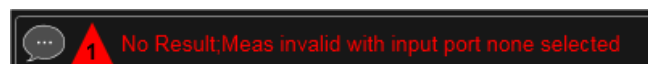

The user interface parameter RFHD p corresponds to the port labeled RF Tx/Rx p ; for example, RFHD 2 means the port labeled RF Tx/Rx 2 on the M1740A.

When using a E7770A Common Interface Unit, you may make connections to the half-duplex port on the front of the CIU labeled DUT IF In/Out, and/or to ports on the rear of the CIU labeled DUT IF IN and DUT IF OUT. For example, if your DUT has an IF Output you will usually connect it to one of the DUT IF IN ports on the rear panel of the CIU. The user interface parameter IFIN n corresponds to the DUT IF IN port for Channel n on the CIU, so you would choose IFIN 1 in the dropdown to

6 Input/Output
6.2 Input

connect to the DUT IF IN port for Channel 1, and the corresponding SCPI parameter would be IFIN1. See the figure below:

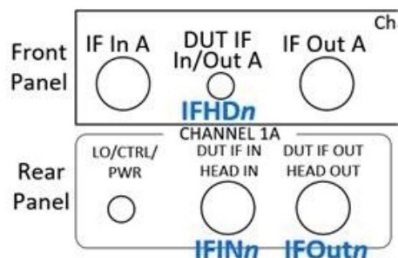

The following table lists the GUI parameter for each input or output on the CIU, and the SCPI parameter for the RF Input Port command (`[:SENSe] :FEED [:RF] :PORT [:INPut]`) and the RF Output Port command (`[:SENSe] :FEED :RF :PORT :OUTPut`):

Port	Port name on CIU	Name displayed in GUI	SCPI parameter for RF Input Port and Output Port commands
IF input port	DUT IF IN	IF In n	<code>IFINn</code> , for example <code>IFIN1</code>
IF output port	DUT IF OUT	IF Out n	<code>IFOutn</code> , for example <code>IFO1</code>
IF port, half duplex	DUT IF In/Out	IFHD n	<code>IFHDn</code> , for example, <code>IFHD1</code>

NOTE

The value of n for each port, in the multiple-port use case, may vary according to your system configuration. For the value of n for your use case, consult the Startup Guide for your particular system (for example S9100A).

An example of the GUI for the CIU ports appears below:

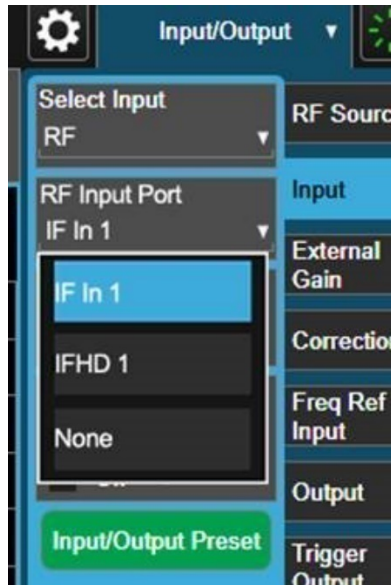

Example	<p>Set the RF input to be the port labeled RF Tx/Rx 2 on Head 1: :FEED:RF:PORT RRH1RFHD2</p> <p>Set the RF input to be the Channel 1 port labeled DUT IF IN on the CIU: :FEED:RF:PORT IFIN1</p>
Notes	<p>Parameter RRHhRFHDp corresponds to Head h, port RF Tx/Rx p; for example, RRH1RFHD2 = the port labeled RF Tx/Rx 2 on Head 1</p> <p>For the CIU, the parameter IFINc corresponds to the DUT IF IN for channel c. For example, IFIN1 would connect to the DUT IF IN port for Channel 1</p>
Dependencies	<p>The Radio Head and CIU parameters only appear when a Remote Radio Head or CIU is connected to the instrument. If these parameters are sent at any other time, an error is generated, “-221, Settings conflict; option not installed”</p>
Preset	RRH1RFHD1
Annotation	<p>Annotation in the Meas Bar reads as follows: Input:Hd <i>h</i> RFHD <i>p</i></p> <p>For example, in the case above, with RFHD 2 on Head 1 selected: Input:Hd 1 RFHD 1</p> <p>When using the CIU:</p> <ul style="list-style-type: none"> - When input is IFIN1: Input: IFIN 1 - When input is IFIN2: Input: IFIN 2 - When input is IFIN3: Input: IFIN 3 - When input is IFIN4: Input: IFIN 4
Backwards	:FEED:RF:PORT A1

6 Input/Output
6.2 Input

Compatibility SCPI A1 is treated as RRH1RFHD1 and sets the RF input to be the port labeled RF Tx/Rx 1 on Head 1
:FEED:RF:PORT B1

B1 is treated as RRH1RFHD2 and sets the RF input to be the port labeled RF Tx/Rx 2 on Head 1
:FEED:RF:PORT IFIO2

IFIO2 is treated as IFIN1, and sets the IF input to be the port labeled “DUT IF In/Out” on the CIU rear panel

Parameters for E7760B Wideband Transceiver

<port>	Input
A n	Bank A, Channel n , for example A1
B n	Bank B, Channel n , for example B1
IFIO n	IF In/Out for Channel n , for example IFIO1

Example Set the RF input to A1:
:FEED:RF:PORT A1

Set the RF input to B3:
:FEED:RF:PORT B3

Set the RF input to IFIO1:
:FEED:RF:PORT IFIO1

Dependencies Ports A1, A2, A3, B1, B2, and B3 are available if Option RF3 is installed. Ports IFIO1 and IFIO2 are available if option RF2 is installed

Note that for E7760B:

- Attempting to select a port for which the option is not present will generate the error, -241, “Hardware missing; Input not available”
- A port cannot be selected as an Input while it is occupied as an Output. Sending such a command while the port is occupied generates error: -221, “Settings conflict; Input Port is not available while occupied by Output”
- The mmWave ports are divided into two banks; the A Bank and the B Bank. A port cannot be selected as an Input if any port on the same bank is occupied as an Output. Sending a command for this situation generates error: -221 “Settings conflict; Input Port is not available while port bank is occupied by Output”

If RF3 is present and RF4 is absent, a mmWave port cannot be selected as an Input if the Output Port is occupied by mmWave Transceiver with a different frequency range. Sending a command for this situation generates error: -221 “Settings conflict; Input Port is not available while occupied by Output of incompatible frequency”

Preset E7760B with Option RF2: IFIO1
E7760B without Option RF2: the first port with mmWave Transceiver attached. If no mmWave Transceiver attached: NONE

Annotation Annotation in the Meas Bar reads as follows:

- When input is A1: Input: A1
- When input is A2: Input: A2
- When input is A3: Input: A3
- When input is B1: Input: B2
- When input is B2: Input: B2
- When input is B3: Input: B3
- When input is IFIO1: Input: IFIO1
- When input is IFIO2: Input: IFIO2

Parameters for M8920A/20B Radio Test Set

<port>	Input
ANT	Ant
TR	T/R

Example Set the RF input to be the Antenna port on M9470A, labeled **Ant**:
`:FEED:RF:PORT ANT`

Set the RF input to be the T/R port on M9470A and M8920A/20B, labeled **T/R**. Note that Option HDX is required to enable the T/R port:
`:FEED:RF:PORT TR`

Dependencies **ANT** and **TR** are only available in modular analyzers, and only when the M9470A module is installed, such as in M8920A. Option HDX is required to enable the T/R port

Preset **ANT**

Annotation Annotation in the Meas Bar reads as follows:

- When input is Ant: Input: Ant
- When input is T/R: Input: T/R

Parameters for UXM Wireless Test Set

<port>	Input
RFIN	RF Input
RFIO1	RFIO 1
RFIO2	RFIO 2

Example Set the RF input to RFIO 2:
`:FEED:RF:PORT RFIO2`

Preset **RFIN**

6.2.3 SA Frequency Extender Firmware Update (Front Panel Only)

When a Frequency Extender device (for example, V3050A) is connected and selected, if a firmware update is available for that device, this control will be visible. Because the measurement will be stopped for the duration of the firmware update, and because the update cannot be un-done, a confirmation dialog will be presented before proceeding with the firmware update. The update can take some time, so while in process, a modal dialog will be shown indicating that the update is in process and warning not to disconnect the device or turn off power. Typically, the update will take about a minute, but time can vary with the model of the Frequency Extender. When complete, the modal dialog will be dismissed, and a pop-up message will be shown for a few seconds indicating the success or failure of the update.

See ["Error Messages" on page 2139](#)

Notes	Measurement is stopped while the update is in process
Dependencies	Not available unless an External RF device is connected, External RF is the selected RF Input Port, and there is a firmware update available for the device

Error Messages

Update Already in Process Error

If a firmware update is already in process, the following message is displayed:

```
Another external device FW update is already in process. Only one update is allowed at a time
```

If received, wait until the current FW update is complete and then try again if still needed.

Unknown Assembly Error

When updating the firmware, the target hardware assembly needs to be identified. If for some reason the assembly cannot be identified, the firmware will not be able to initiate the update, and this error message will be displayed:

```
Error updating FW for external device model <model number>' serial number <serial number>
```

```
Could not find HW assembly, cannot perform FW update
```

The `<model number>` and `<serial number>` contain the actual numbers for the device.

This is a failure that warrants investigation, so you should contact Keysight Customer Support for service.

Error During Firmware Update Process

If there is an execution problem during the FW update, the specific error message(s) is written to the SA Event Log and this error message is displayed:

```
Error updating FW for external device model <model number>' serial number
<serial number>
```

Error during FW update. See windows event log for more details

The <model number> and <serial number> contain the actual numbers for the device.

6.2.4 SA Frequency Extender Cable Correction

An SA Frequency Extender, such as V3050A, is attached to the instrument with several cables. Keysight provides several cables for purchase with the frequency extender. Typically, these are 1-, 2-, or 3-meter cables for the RF and IF connections. Keysight has characterized these cables and can correct for their loss. This control allows you to specify which cable is being used.

If you are using another type of cable, the instrument *cannot* automatically correct for it, so this function must be set to **OFF**. In this case, you can use RCal to characterize the corrections.

Remote Command	<code>:INPut:FEXtender:CABLe:CORRection OFF V3050A1M V3050A2M V3050A3M</code>
Example	<code>:INP:FEXT:CABL:CORR V3050A1M</code>
Notes	The RF Input Port selections that support an SA Frequency Extender (such as V3050A) are: N9042B: External RF No other instruments support an SA Frequency Extender
Dependencies	An SA Frequency Extender must be attached, and the frequency extender's port must be the selected input for this control to be visible <ul style="list-style-type: none"> - If the instrument does not support frequency extenders, the SCPI command returns error -241, "Hardware missing; option not available" - If the instrument does support frequency extenders, but a frequency extender is not attached, the SCPI command returns error -241, "Hardware missing; Cable selection only available when supporting frequency extender attached" <p>When a frequency extender is attached, the control is not visible unless the frequency extender's port is the selected RF input, but the command will still be available. Setting the cable selection when the frequency extender's port is not active has no effect until the port is selected</p>
Preset	Unaffected by Mode Preset but set to preset value by Restore Input/Output Defaults or Restore System Defaults -> All
State Saved	Saved in instrument state

6.2.5 Half Duplex Input Port

Specify whether **RFIO3** or **RFIO4** is the Half Duplex Input port.

6 Input/Output
6.2 Input

Remote Command	<code>[:SENSe]:HDUPlex:PORT:INPut RFI03 RFI04</code>
Example	<code>:HDUPlex:PORT:INPut RFI03</code> <code>:HDUPlex:PORT:INPut?</code>
Dependencies	Only appears in EXM If RFI03 is selected as “Half Duplex Output Port”, then “Half Duplex Input Port” will be set to RFI04 automatically. If RFI04 is selected as “Half Duplex Output Port”, then “Half Duplex Input Port” will be set to RFI03 automatically
Preset	RFI03
State Saved	Saved in State

6.2.6 Port Information (Remote Command Only)

Provides information about an instrument port. The return information consists of two comma-separated fields:

- Field 1: the connection status (0 or 1)
- Field 2: a string of port information

The return information is device-dependent.

Remote Command	<code>[:SENSe]:FEED[:RF]:PORT:INformation? RFIN RFIN2 RFFD RFHD A1 A2 A3 B1 B2 B3 IFIO1 IFIO2 ANT TR</code>
Example	<code>:FEED:PORT:INF? A1</code> example = 1 , ”US56160060” where 1 is the connection status and ”US56160060” is the port information
Notes	For E7760B: The connection status (first field in the return value) indicates: 0 – the port is either not licensed for use or is not connected to a mmWave Transceiver 1 – the port is licensed; and for the case of mmWave ports, the port is connected to a mmWave Transceiver The port information (second field in the return value) contains: ” (empty string) – no applicable information Serial Number – the serial number of the connected mmWave Transceiver If you send an incompatible parameter, the return values are: 0,”
Dependencies	Only valid for E7760B

6.2.7 RF Preselector

In models that support the RF Preselector, such as PXE (N9048B), allows you to turn the preselector on or off.

NOTE

When using the RF Preselector, if your measurement starts below 3.6 GHz and finishes above 3.6 GHz, the preselector bypass switch will have to switch in and out for every measurement. When this is the case, you will hear a clicking sound from the instrument and a warning message will be displayed: “Settings Alert: Mechanical switch cycling”. You are advised to *avoid* such setups as much as possible, to minimize switch wear. Pressing **Mode Preset** resets Stop Freq to 3.6 GHz, to exit this state, or you can manually set Stop Freq to be below 3.6 GHz.

Remote Command	<code>[:SENSe]:POWer[:RF]:RFPSelector[:STATe] 1 0 ON OFF</code> <code>[:SENSe]:POWer[:RF]:RFPSelector[:STATe]?</code>
Example	<code>:POW:RFPS 1</code> <code>:INP:PRES:STAT ON</code>
Notes	Set full compliance measurement: <code>[:SENSe]:POWer[:RF]:RFPSelector[:STATe] 1 ON</code> Set pre-compliance measurement: <code>[:SENSe]:POWer[:RF]:RFPSelector[:STATe] 0 OFF</code>
Dependencies	Only appears when RF Input is selected as the Input Only appears in MXE and PXE The RF Preselector is not available in all measurements. The key is grayed out in measurements that do not support it, unless you are in a Mode in which no measurements support it, in which case the key does not appear at all. If the preselector is unavailable, it is forced to Off. Attempting to turn it on or off in measurements that do not support it generates the error message: -221, Settings conflict; Feature not supported for this measurement The RF Preselector is not available when FFT Sweep Type is manually selected. Attempting to turn it on or off when this is the case generates an error message: -221, Settings conflict; RF Presel unavailable when Sweep Type=Manual FFT Only appears in Modes that support the RF Preselector, in other Modes, sending the SCPI command or query generates an error In Frequency Scan measurement, this key is grayed-out when final measurement is running. Warning message “Function not available while measurement is running” appears if the grayed-out key is pressed
Preset	ON
Annotation	When RF Preselector=On, “RF PRESEL” is displayed on the Settings Panel
Backwards Compatibility SCPI	<code>:INPut<1 2>:PRESelection[:STATe] ON OFF</code> <code>:INPut<1 2>:PRESelection[:STATe]?</code> Included for R&S ESU compatibility

6.2.8 Notch Filter

In some models that support the RF Preselector, such as PXE, there is also a notch filter to suppress signals in the frequency band from 2.4 GHz to 2.5 GHz. This control allows you to turn the notch filter on or off.

Remote Command	<code>[:SENSe]:POWer[:RF]:RFPSelector:NFIlter[:STATe] OFF ON 0 1</code> <code>[:SENSe]:POWer[:RF]:RFPSelector:NFIlter[:STATe]?</code>
Example	<code>:POW:RFPS:NFIL 1</code> <code>:POW:RFPS:NFIL?</code>
Dependencies	<p>Only appears when RF Input is selected as the Input</p> <p>Only appears in models that support the notch filter, such as PXE. Attempting to turn it on or off via SCPI in models that do not support it generates error message: -241 Hardware missing; Not available for this model number</p> <p>Only appears in measurements that support the Notch Filter, such as EMI Receiver measurements. Attempting to turn it on or off via SCPI in measurements that do not support it generates error message: -221, Settings conflict; Feature not supported for this measurement</p> <p>In Frequency Scan measurement, this control is grayed-out when final measurement is running, aligned with the RF Preselector key. The warning message "Function not available while measurement is running" appears if the grayed-out control is pressed</p>
Preset	<code>OFF</code>
State Saved	Saved in instrument state
Range	<code>OFF ON</code>
Annotation	<p>Due to limited space in the Measurement Bar, Notch Filter annotation is shown as part of the RF Presel state</p> <ul style="list-style-type: none"> - <code>RF Presel: On, NF</code>, when both RF Presel and Notch Filter are turned on - <code>RF Presel: On</code>, when RF Presel = on and Notch Filter= off - <code>RF Presel: Off</code>, when RF Presel = off
Backwards	<code>:INPut<1 2>:PRESelection:FILTer:NOTCh[:STATe] ON OFF</code>
Compatibility SCPI	<code>:INPut<1 2>:PRESelection:FILTer:NOTCh[:STATe]?</code>

6.2.9 RF Calibrator

Lets you choose a calibrator signal to look at or turns the calibrator off.

Remote Command	<code>[:SENSe]:FEED:AREFERENCE REF50 REF4800 OFF</code> <code>[:SENSe]:FEED:AREFERENCE?</code>
Example	Select the 50 MHz amplitude reference as the signal input: <code>:FEED:AREF REF50</code>

	Select the 4.8 GHz amplitude reference as the signal input: <code>:FEED:AREF REF4800</code>
	Turn the calibrator "off" (switches back to the selected input - RF or I/Q): <code>:FEED:AREF OFF</code>
Dependencies	Only appears when RF Input is selected as the Input Selecting an input (RF, Ext Mix or I/Q) turns the Calibrator OFF . This is true whether the input is selected using the menu panel or <code>[:SENSe] :FEED</code> The 4.8 GHz internal reference is only available in some models and frequency range options. If the 4.8 GHz reference is not present, the 4.8 GHz choice does not show, and if the REF4800 parameter is sent, the instrument generates an error
Couplings	When one of the calibrator signals is selected, the instrument routes that signal (an internal amplitude reference) to the instrument, and changes the main input selection to RF so the calibrator signal can be seen. When you turn the calibrator off it does not switch back to the previously selected input
Preset	OFF
State Saved	Saved in instrument state
Annunciation	An advisory message is sent, indicating that the input is set to internal
	Backwards Compatibility SCPI
Notes	For ESA backwards compatibility In the ESA the calibrator was a separate output which you connected to the input and switched on with this command In X-Series, the ON parameter is aliased to <code>[:SENSe] :FEED:AREF REF50</code> and the OFF parameter is aliased to <code>[:SENSe] :FEED:AREF OFF</code> When <code>:CALibration:SOURce:STATe?</code> is received, 1 is returned if any of the references is selected, or 0 if the Calibrator is OFF
Preset	OFF
Backwards Compatibility SCPI	<code>:CALibration:SOURce:STATe OFF ON 0 1</code> <code>:CALibration:SOURce:STATe?</code>

6.2.10 RF Coupling

Specifies alternating current (**AC**) or direct current (**DC**) coupling at the instrument RF input port. Selecting **AC** coupling switches in a blocking capacitor that blocks any DC voltage present at the instrument input. This decreases the input frequency range of the instrument, but prevents damage to the input circuitry of the instrument if there is a DC voltage present at the RF input.

NOTE

When operating in DC coupled mode, ensure protection of the instrument input circuitry by limiting the DC part of the input level to within 200 mV of 0 Vdc. In AC or DC coupling, limit the input RF power to +30 dBm (1 Watt).

6 Input/Output

6.2 Input

Remote Command	<code>:INPut:COUPling AC DC</code> <code>:INPut:COUPling?</code>
Example	<code>:INP:COUP DC</code>
Dependencies	Only appears when RF Input is selected as the Input Does not appear in models that are always AC coupled. When the SCPI command to set DC coupling is sent to these models, it generates the error "Illegal parameter value; This model is always AC coupled" In these models, <code>:INP:COUP?</code> always returns AC Does not appear in models that are always DC coupled. When the SCPI command to set AC coupling is sent to these models, it generates the error "Illegal parameter value; This instrument is always DC coupled" In these models, <code>:INP:COUP?</code> always returns DC
Preset	AC on models that support AC coupling On models that are always DC coupled, such as millimeter wave models (frequency ranges 30 GHz and above), the preset is DC
State Saved	Saved in instrument state

Annunciation When the RF Input is selected, and AC coupling is selected, annunciators appear in the Meas Bar to that effect:



appears in the settings panel (the row of annunciators across the top of the display) to that effect, as shown below:

When the RF Input is selected, and DC coupling is in effect, the annunciator changes as shown below:



Note the amber color, which indicates that you should exercise caution when applying a signal to any DC coupled input (see note above this table for the specific cautions)

On models that support both AC and DC coupling: when DC coupling is selected, a warning condition message appears in the status line "DC coupled" as shown below:

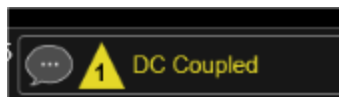

On models that support both AC and DC coupling: when AC coupling is selected, and any part of the displayed frequency range is below 10 MHz, a warning condition message appears in the status line: "AC: Accy unspec'd below 10 MHz"

In AC coupling mode, you can view signals below the corner frequency of the DC block, but below a certain frequency the amplitude accuracy is not specified.

The lowest frequency for which specifications apply is:

X-Series Model	Lowest Freq for meeting specs when AC coupled	Lowest Freq for meeting specs when DC coupled
CXA-503/507	100 kHz	n/a

X-Series Model	Lowest Freq for meeting specs when AC coupled	Lowest Freq for meeting specs when DC coupled
CXA-C75 Input 2	1 MHz	n/a
CXA-513/526	10 MHz	9 kHz
CXA-m	10 MHz	9 kHz
EXA	10 MHz	9 kHz
MXA	10 MHz	20 Hz
PXA	10 MHz	3 Hz
UXA	10 MHz	3 Hz

Some amplitude specifications apply only when coupling is set to DC. Refer to the appropriate amplitude specifications and characteristics for your instrument.

6.2.11 Input Z Correction

Sets the input impedance for unit conversions. This affects the results when the y-axis unit is voltage or current units (dBmV, dB μ V, dB μ A, V, A), but not when it is power units (dBm, W). The impedance you select is for computational purposes only, since the actual impedance is set by internal hardware to 50 ohms. Setting the computational input impedance to 75 ohms is useful when using a 75 ohm to 50-ohm adapter to measure a 75-ohm device on an instrument with a 50-ohm input impedance.

There are a variety way to make 50-to-75-ohm transitions, such as impedance transformers or minimum loss pads. The choice of the solution that is best for your measurement situation requires balancing the amount of loss that you can tolerate with the amount of measurement frequency range that you need. If you are using one of these pads/adaptors with the **Input Z Corr** function, you might also want to use the **Ext Gain** key. This function is used to set a correction value to compensate for the gain (loss) through your pad. This correction factor is applied to the displayed measurement values.

Remote Command	<code>[:SENSe]:CORRection:IMPedance[:INPut][:MAGNitude] 50 75</code> <code>[:SENSe]:CORRection:IMPedance[:INPut][:MAGNitude]?</code>
Example	Set the input impedance correction to 75 ohms: <code>:CORR:IMP 75</code>
Couplings	In CXA option C75, when RF Input 2 is selected, the Input Z Correction automatically changes to 75 ohms. You may then change it to whatever is desired. When the main RF Input is selected, the Input Z Correction automatically changes to 50 ohms. You may then change it to whatever is desired
Preset	Unaffected by Preset, but set to 50 ohms by Restore Input/Output Defaults or Restore System Defaults->All Some instruments/options may have 75 ohms available
State Saved	Saved in instrument state

6.2.12 All Screens Use Same Input

If **ON**, then all Screens share the same Input settings. This is the default state.

If **OFF**, then certain settings are allowed to be local to each Screen, meaning one Screen can have them set one way and another can have them set another way.

The Input settings that become local to each Screen when **All Screens Use Same Input** is **OFF** are:

Input Tab:

- Selected Input (RF, Ext Mix, BBIQ)
- RF Input Port (only appears in instruments with multiple RF ports, such as N9041B, MXE, and CXA)
- RF Coupling (AC/DC)
- Input Z Correction

External Gain Tab:

- External Preamp
- MS
- BTS

Corrections Tab:

- For each Correction, whether it is on or off

Note that if **All Screens Use Same Input** is **OFF** and you press the + control to create a new Screen, the new Screen contains a copy of the old Screen's state, including all its Input/Output variables.

Remote Command	:INSTrument:COUPle:SCReen:INPut ON OFF 1 0
----------------	--

Example	:INST:COUP:SCR:INP OFF
---------	------------------------

Preset	ON
--------	----

Not affected by **Input/Output Preset**, but set to **ON** by **Restore Input/Output Defaults**

6.2.13 External Mixer Setup

Lets you select the mixer type, and lets you configure your mixer (if necessary). The first page of the dialog shows you the current settings for the selected mixer. These

settings may be dependent on which IF path is currently in use, whether a + or – harmonic is currently selected, etc.

To apply any amplitude correction factors needed to correct mixer flatness, you enter values into one of the Correction tables (under **Input/Output, Corrections**). The correction conversion loss values can be extracted from data supplied with the mixer or from manual measurements you make to determine the conversion loss. Note that the correction applied by the Correction tables is global to the instrument; therefore, you should make sure to turn off the External Mixer corrections when you are not using the External Mixer input.

NOTE

Keysight USB Mixers automatically supply their flatness data to the instrument, and the correction is applied internally. No correction needs be entered, and the correction does not appear in the user-accessible Corrections tables. You are free to enter additional corrections into the Correction tables under **Input/Output, Corrections.**

Notes	The setup summary on the menu panel appears just above this control, showing the current external mixer setup
Dependencies	Only appears when External Mixer is selected as the Input
State Saved	All settings in the External Mixer Setup dialog are part of the Input/Output system, and hence are saved whenever State is saved

The **External Mixer Setup** screen looks like this:

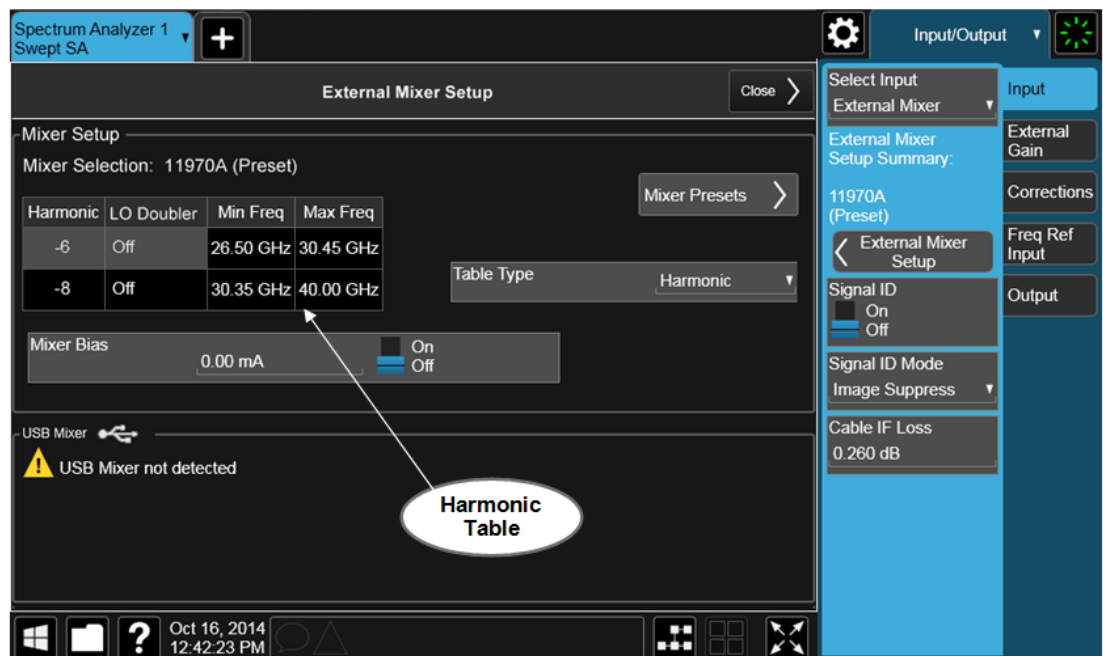

6 Input/Output

6.2 Input

The current Mixer selection (the current or most recently connected USB Mixer, or the most recent Mixer Preset, or **Custom** if you have modified the setup) reads out at the top of this screen as **Mixer Selection**

The Harmonic Table currently being used reads out below the Mixer Selection. It shows each range being used for the current mixer. Note that a band may be made up of up to 3 ranges. Each range represents a choice of mixer harmonic and doubler state. When you select a Mixer Preset, it sets the instrument Start and Stop frequency to the values shown in the Harmonic Table; Start Freq is set to the Min Freq for the bottom range, and Stop Freq is set to the Max Freq for the top range. In many cases you can exceed these nominal values; the absolute maximum and minimum frequency for each preset are shown in the tables that accompany the control descriptions for the Mixer Presets.

NOTE

If the current measurement has a limited Span available to it and cannot achieve the Span shown in the table (Span = Stop Freq - Start Freq), the instrument uses the maximum Span the measurement allows, and sets **Center Frequency to the midpoint of the Start and Stop Freq values in the Harmonic Table.**

You may edit some of the Harmonic and LO Doubler fields in the Harmonic Table, as shown by the gray backgrounds of these fields. When you edit the Harmonic Table, the Mixer Selection changes to **Custom**. To change it back you must go back into the Mixer Presets menu and select a Preset.

When you edit the Harmonic Table, the nominal Min Freq and Max Freq that are available will usually be different than the Preset you were using; and the absolute frequency limits will change as well. This may result in a change to your Start and/or Stop Freq, if the current values fall outside the new range, requiring you to retune your Center Freq to get your signal back in the center.

The instrument supports the Keysight M1970 Series Harmonic Mixers with USB connection. While in External Mixing, if one of these mixers is plugged in to a USB port, it is automatically detected and displayed in the "USB Mixer" area of the setup screen, including its model number and serial number.

The instrument assumes that if you plug a mixer into the USB you want to use that mixer, so:

1. If a USB mixer is connected to the USB port, the Mixer Presets button is grayed-out, as none of the presets make sense with a USB Mixer connected. Note that once the instrument has acquired the USB Mixer, the mixer selection will remain if it is subsequently unplugged from the USB, allowing you to plug it back in with no change to your settings. However, once you unplug it, the Mixer Presets control ceases to be grayed-out, allowing you to preset to a different mixer
2. When Restore Input/Output Defaults is performed, if a Keysight USB Mixer is plugged into the instrument's USB port, the Mixer Selection remains unchanged

- When recalling an instrument state, if a Keysight USB Mixer is plugged into the instrument's USB port, and the Mixer Selection in the recalled state is for a USB Mixer that does not match the mixer currently plugged in, you will have to unplug your mixer and then plug it back in to get the instrument to recognize your mixer

As long as the selection in Ext Mixer Setup shows one of the USB mixers, the **Mixer Bias** control is grayed-out and the Harmonic Table is no longer editable, as shown by the fact that the fields in the Harmonic Table are now black and the **Table Type** control is grayed-out.

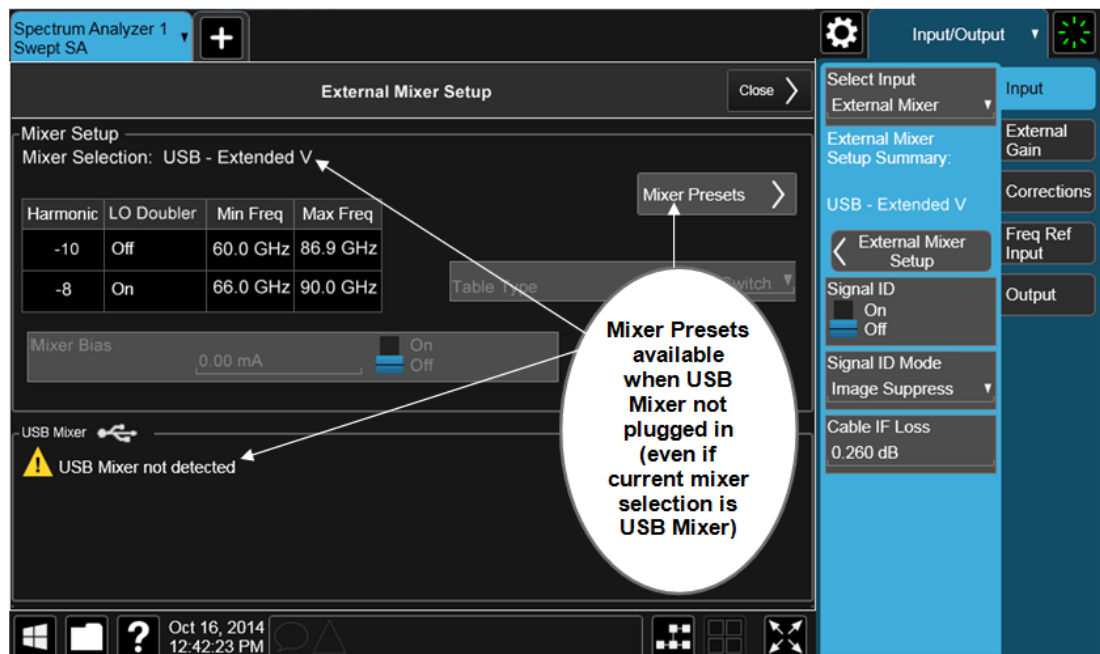

Only one USB Mixer is supported at a time. To switch to a different USB Mixer, disconnect the one that is no longer being used prior to connecting a new one.

The **Mixer Selection** displayed and menu panel readback for the Keysight M1970 series mixers is:

Mixer Model	Mixer Selection display on Setup Screen	Readback
Keysight M1970E: Option 001: 60 to 90 GHz Waveguide Harmonic Mixer	USB - M1970E-001 E-Band	USB Mixer E-Band
Keysight M1971E: Option 001: 60 to 90 GHz Waveguide Harmonic Mixer	USB - M1971E-001 E-Band	USB Mixer E-Band
Keysight M1971E: Option 003: 55 to 90 GHz	USB - M1971E-003 Extended E-Band	USB Mixer

6 Input/Output
6.2 Input

Mixer Model	Mixer Selection display on Setup Screen	Readback
GHz Waveguide Harmonic Mixer		Extended E
Keysight M1971V: Option 001: 50 to 75 GHz Waveguide Harmonic Mixer	USB - M1971E-001 V-Band	USB Mixer V-Band
Keysight M1971W: Option 001: 75 to 110 GHz Waveguide Harmonic Mixer	USB - M1971E-001 W-Band	USB Mixer W-Band
Keysight M1970V Option 001: 50 to 75 GHz Waveguide Harmonic Mixer	USB - M1970V-001 V-Band	USB Mixer V-Band
Keysight M1970V Option 002: 50 to 80 GHz Waveguide Harmonic Mixer	USB - M1970V-002 Extended V-Band	USB Mixer Extended V
Keysight M1970W Option 001: 75 to 110 GHz Waveguide Harmonic Mixer	USB - M1970W-001 W-Band	USB Mixer W-Band

The Keysight USB mixer essentially acts as a “remote front end” and is fully calibrated over the specified frequency range, without requiring any user interaction. This is particularly useful at high mm-wave frequencies, where cable loss is typically quite large, and it is desirable to bring the front end right up to the device under test, rather than bringing the mm-wave signal to the instrument using a lossy and uncalibrated cable or waveguide connection.

Connecting the mixer to the USB port on the instrument switches you to External Mixing, aborts the current measurement, and initiates an alignment of the mixer. A popup message, “USB Mixer connected” appears on the display. When a USB mixer and the LO/IF cable are connected the alignment is performed. When the alignment begins, an “Aligning” popup replaces the previous message on the display. When the alignment completes, the current measurement restarts.

6.2.13.1 Mixer Presets

Presets the mixer setup for the particular type of mixer that you are using.

These presets are divided into four groups:

- One for legacy HP/Agilent/Keysight mixers (11970)
- Three for general purpose mixers:

- presets that use a single harmonic and no doubling
- presets that use a single harmonic but double the LO
- presets that use multiple harmonics

Note that the IF/LO port provides a 3.8-14 GHz LO in two bands: 3.8-8.7 (LO fundamental), and 8.6-14 GHz (doubled LO).

In most cases, once you have executed the preset, you will not need to adjust any further settings.

Remote Command	<pre>[:SENSe]:MIXer:BAND A Q U V W NA ND NE NF NG NJ NK NQ NU NV NW NY NEXT DD DF DG DJ DK DQ DV DW DY DEXT MA ME MU MCOAX USB VDIWR6PT5M4 [:SENSe]:MIXer:BAND?</pre>								
Example	<pre>:MIX:BAND A :MIX:BAND?</pre>								
Notes	<p>A Q U V W select HP/Agilent/Keysight 11970 mixer presets NA ND NE NF NG NJ NK NQ NU NV NW NY NEXT select single harmonic, non-doubled LO presets DD DF DG DJ DK DQ DV DW DY DEXT select single harmonic, doubled LO presets MA ME MU MCOAX select multiple harmonic presets VDIWR6PT5M4 selects presets for the VDI WR6.5CCD-M4 external mixer (a Compact Down-Converter in the Keysight N9029ACST Series) VDIWR6PT5M4 requires Model N9042B with the EXW option. To use this selection, you must connect cables from the external mixer to the High LO Out and High IF In ports (not the Ext Mixer port) of the N9042B All these presets are detailed in their respective control descriptions The query returns the most recent preset, <i>unless</i> the harmonic table has been edited after the preset was executed. If the harmonic table has been edited, returns CUSTOM The command USB refreshes the USB mixer connection and automatically detects the mixer band. The query returns the following if a Keysight USB Mixer is plugged into the instrument's USB port:</p> <table border="1"> <tr> <td>USB E</td> <td>Keysight E-Band USB Mixer</td> </tr> <tr> <td>USB V</td> <td>Keysight V-Band USB Mixer</td> </tr> <tr> <td>USB VEXT</td> <td>Keysight Extended V-Band USB Mixer</td> </tr> <tr> <td>USB W</td> <td>Keysight W-Band USB Mixer</td> </tr> </table> <p>Note that the parameters CUSTOM, USB V, USB VEXT, and USB W are query responses only, and cannot be sent to the instrument The following cross-reference matches the mixer band designators used by Keysight to the EIA waveguide designations:</p>	USB E	Keysight E-Band USB Mixer	USB V	Keysight V-Band USB Mixer	USB VEXT	Keysight Extended V-Band USB Mixer	USB W	Keysight W-Band USB Mixer
USB E	Keysight E-Band USB Mixer								
USB V	Keysight V-Band USB Mixer								
USB VEXT	Keysight Extended V-Band USB Mixer								
USB W	Keysight W-Band USB Mixer								

6 Input/Output
6.2 Input

EIA	Keysight	Freq Range
WR-28	A	26.5 - 40 GHz
WR-22	Q	33 - 50 GHz
WR-19	U	40 - 60 GHz
WR-15	V	50 - 75 GHz
WR-12	E	60 - 90 GHz
WR-10	W	75 - 110 GHz
WR-8	F	90 - 140 GHz
WR-6	D	110 - 170 GHz
WR-5	G	140 - 220 GHz
WR-3	J	220 - 325 GHz

Preset

When **Restore Input/Output Defaults** is performed, an “A” mixer preset is also issued (11970A band), unless a Keysight USB Mixer is plugged into the instrument’s USB port, in which case the Mixer Selection remains unchanged

When using Keysight USB Mixers, if **Restore All Defaults (:SYSTEM:DEFault)** has been performed, either remove and reinsert the USB cable or press the **Refresh USB Mixer Connection** control

VDI CCD (N9029)

These presets select a setup that uses a single harmonic and no LO doubling.

This setup is used with an external mixer in the series VDI CCD (N9029ACST). The currently supported example is the D-band mixer VDI WR6.5CCD-M4.

Mixer	Readout on setup dialog and menu panel	Harm #	RF start	RF stop	RF center
WR6.5 M4 (D-band)	VDI WR6.5CCD-M4	-4	110	170	140

This mixer setup is enabled only for model N9042B with the EXW option You must connect cables from this external mixer to the High LO Out and High IF In ports (not the Ext Mixer port) of the N9042B, as illustrated below:

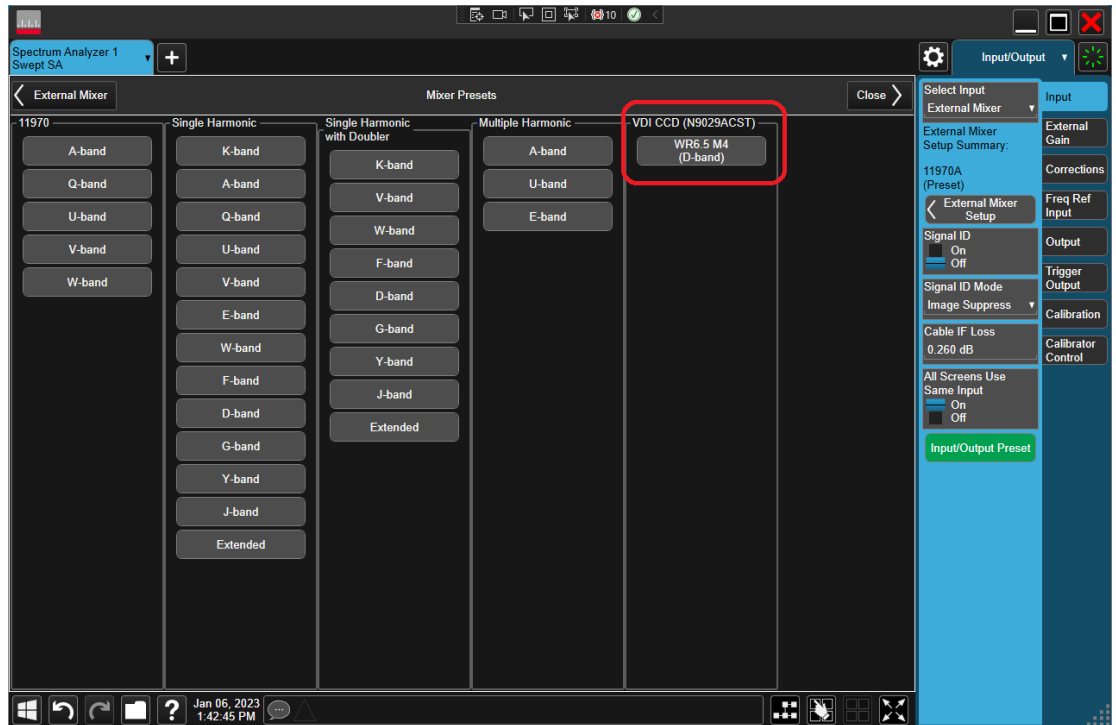

11970

Lets you preset for a model in the HP/Agilent/Keysight 11970 series.

Because the X-Series has an LO range of 3.8 - 14 GHz, and older analyzers had an LO range of 3.0 - 6.8 GHz, the harmonic numbers used in the X-Series may differ from those used on older analyzers for the same mixers. Additionally, some of the 11970 mixers cannot be operated over their full range with the X-Series without switching harmonics. Consequently, you will find that some of the bands (A-Band, for example) are broken into two ranges for use with the X-Series.

6 Input/Output
6.2 Input

Below are the 11970A presets. The 11970U and the 11970W use a single harmonic. The other three switch harmonic mid-band. Both harmonic ranges are shown in the table. None of these mixers use LO doubling.

The 11970 K-band mixer and the 11974 preselected mixer series are not supported.

Preset	Readout on setup dialog and menu panel	Range	Harm #	RF start	RF stop	RF center
A-band	11970A	1	-6	26.5	30.45	28.475
		2	-8	30.35	40	35.175
Q-band	11970Q	1	-8	33	40.8	36.9
		2	-10	39.8	50	44.9
U-band	11970U	..	-10	40	60	50
V-band	11970V	1	-12	50	66	58
		2	-14	53	75	64
W-band	11970W	..	-18	75	110	92.5

Single Harmonic

These presets select a setup that uses a single harmonic and no doubling for the LO.

Mixer	Readout on setup dialog and menu panel	Harm #	RF start	RF stop	RF center
K-band	K-band Single Harmonic, no doubler	-4	18	26.5	22.25
A-band	A-band Single Harmonic, no doubler	-6	26.5	40	33.25
D-band	D-band Single Harmonic, no doubler	-20	110	170	140
E-band	E-band Single Harmonic, no doubler	-12	60	90	75
F-band	F-band Single Harmonic, no doubler	-18	90	140	115
Q-band	Q-band Single Harmonic, no doubler	-6	33	50	41.5
U-band	U-band Single Harmonic, no doubler	-8	40	60	50
V-band	V-band Single Harmonic, no doubler	-10	50	75	62.5
W-band	W-band Single Harmonic, no doubler	-14	75	110	92.5
G-band	G-band Single Harmonic, no doubler	-26	140	220	180
Y-band	Y-band Single Harmonic, no doubler	-30	170	260	215
J -band	J-band Single Harmonic, no doubler	-38	220	325	272.5
Extended	Extended Single Harmonic, no doubler	-40	155	345	250

Single Harmonic with doubler

These presets select a setup that uses a single harmonic and doubling for the LO.

Mixer	Readout on setup dialog and menu panel	Harm #	RF start	RF stop	RF center
D-band	D-band Single Harmonic w/doubler	-14	110	170	140
F-band	F-band Single Harmonic w/doubler	-10	90	140	115
G-band	G-band Single Harmonic w/doubler	-16	140	220	180
J-band	J-band Single Harmonic w/doubler	-24	220	325	272.5
K-band	K-band Single Harmonic w/doubler	-2	18	26.5	22.25
Q-band	Q-band Single Harmonic w/doubler	-4	33	50	41.5
V-band	V-band Single Harmonic w/doubler	-6	50	75	62.5
W-band	W-band Single Harmonic w/doubler	-8	75	110	92.5
Y-band	Y-band Single Harmonic w/doubler	-20	170	260	215
Extended	Extended Single Harmonic w/doubler	-28	245	390	317.5

Multiple Harmonics

These presets select a setup that uses multiple harmonics and may or may not use doubling for the LO.

Mixer	Readout on setup dialog and menu panel	Range	Harm #	Dblr?	RF start	RF stop	RF Center
A-band	A-band Multiple Harmonic	1	-4	N	26.5	34.1	30.3
		2	-4	Y	33.1	40	36.55
E-band	E-band Multiple Harmonic	1	-6	Y	60	83	71.5
		2	-8	Y	65	90	77.5
U-band	U-band Multiple Harmonic	1	-6	N	40	51.5	45.75
		2	-6	Y	49.5	60	54.75
Coaxial	Coaxial Multiple Harmonic	1	-4	N	26.5	34	30.25
		2	-4	Y	32.5	55	43.75
		3	-6	Y	50	70	60

6.2.13.2 Mixer Bias

Adjusts an internal bias source for use with external mixers. The bias signal is present on the center conductor of the IF input connector on the front panel. The shunt current range is from -10 mA to 10 mA, and it can be set whether Mixer Bias state is On or Off, but it will only be applied if it is On.

The bias remains as set if you switch to another input (for example, the RF Input).

Remote	<code>[:SENSe] :MIXer :BIAS <real></code>
Command	<code>[:SENSe] :MIXer :BIAS?</code>

6 Input/Output
6.2 Input

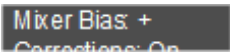
Example	<code>:MIX:BIAS 0</code> <code>:MIX:BIAS?</code>
Preset	Unaffected by Preset, but set to OFF (0) by Restore Input/Output Defaults
State Saved	Saved in instrument state
Min	-10 mA
Max	10 mA
Annunciation	When the bias is turned on this (together with the bias polarity) is indicated in the Meas Bar with a plus or minus sign:  otherwise, it reads "Off" Auto Function
Remote Command	<code>[:SENSe]:MIXer:BIAS:STATe OFF ON 0 1</code> <code>[:SENSe]:MIXer:BIAS:STATe?</code>
Example	<code>:MIX:BIAS:STAT 0</code> <code>:MIX:BIAS:STAT?</code>
Preset	OFF

6.2.13.3 Table Type

Determines the Custom Mixer configuration type. You can choose: Single Row, Harmonic Switching, or Doubler Switching. For details, see ["Available Types" on page 2157](#).

The Harmonic Table can be configured as:

- A single row (meaning only one harmonic number is used and the LO Doubler is either on or off)
- Two rows where the harmonic number switches between the first row and the second
- Two rows where the LO Doubler state switches between the first row and the second

Available Types

Table Type	Behavior
Single Row	The External Mixer always stays in the same Harmonic Number and the LO Doubler is either on or off and does not change state during a sweep. You may change the Harmonic Number and you may change the state of the Doubler
Harmonic	The External Mixer switches the Harmonic Number in the middle of the sweep. The LO Doubler may be on

Table Type	Behavior
Switching	or off, but it is the same for both Harmonic Numbers. You can set the initial Harmonic Number, and when it switches it decrements by two when the harmonic is negative and increments by two when the harmonic is positive For example, if you set the initial number to -6, when it switches it will go to -8. If you set the harmonic number to 8, when it switches it will go to 10
Doubler Switching	The External Mixer switches the doubler from Off to On in the middle of the sweep. You can set the Harmonic Number, but it stays the same for the Doubler Off state as for the Doubler On state. The LO Doubler control is grayed-out in this table type

Editable Fields

Table Type	Fields you can edit
Single Row	Harmonic and LO Doubler cells
Harmonic Switching	Harmonic and LO Doubler cells (only the first row)
Doubler Switching	Harmonics cell (only the first row)

Note that you cannot add or delete rows from the table; you can only modify the rows that are already there.

Remote Command	<code>[:SENSe]:MIXer:TTYPe SINGLE HARMonic DOUBler</code> <code>[:SENSe]:MIXer:TTYPE?</code>
Example	<code>:MIX:TTYP SING</code>
Couplings	When you change the Table Type, the Mixer Selection changes to Custom
Preset	Depends on the current Mixer Preset. Unaffected by Mode Preset , but Restore Input/Output Defaults presets the Mixer to 11970A, for which the Table Type is Harmonic Switching
State Saved	Saved in instrument state

6.2.13.4 Select VDI CCD Correction

Selects the appropriate VDI CCD Correction data by mixer Serial Number.

Remote Command	<code>[:SENSe]:VCORrection:SElect NONE <serialNumber></code> <code>[:SENSe]:VCORrection:SElect?</code>
Example	<code>:VCOR:SEL NONE</code> <code>:VCOR:SEL 123123</code>
Dependencies	Requires EXW (External Mixing Wide Bandwidth) and Ampcor (Amplitude Correction) licenses
Couplings	When the External Mixer Model or VDI CCD Corrections data changes, this field checks whether VDI CCD corrections are stored for the currently-selected External Mixer Model, and automatically selects the first serial number found, or NONE if no matching corrections are found When setting this parameter via SCPI, if no match is found for the given serial number, the parameter

is set to **NONE**. If the correction should be automatically selected, this can be done by setting the value via SCPI to **Any** (see ["External Mixer Setup" on page 2147](#))

State Saved Saved in instrument state

6.2.13.5 Delete All VDI CCD Corrections

Erases all stored VDI CCD corrections.

Remote Command	<code>[:SENSe]:VCORrection:DELeTe</code>
Example	<code>:VCOR:DEL</code>
Dependencies	Requires EXW (External Mixing Wide Bandwidth) and Ampcor (Amplitude Correction) licenses
Couplings	When the VDI CCD corrections are deleted from memory, "Select VDI CCD Correction" on page 2158 is set to NONE

6.2.13.6 Harmonic

Lets you enter the **Harmonic** value with its associated sign (mixing mode). Only the first row of the table is editable. When you edit a value or change ["Table Type" on page 2157](#), the Mixer Selection changes to **Custom**.

In **Custom** mode, the maximum start and stop frequencies are strictly set by the LO range and the harmonic number you have chosen. The undoubled LO range is approximately 3.8 - 8.7 GHz, and (for LOs that support doubling) the doubled range is approximately 8.0 - 14.0 GHz. That range times the harmonic you have selected determines the tuning range. If your frequency is currently outside that range when you edit the Harmonic Table, the frequency will be changed to fall at the edge of the range. To change it back, go to the **Mixer Presets** menu and select a Preset.

The harmonic number is a signed integer, where the sign distinguishes between positive and negative mixing products. Desired mixing products occur at an IF frequency that equals the difference between the RF frequency (f_{RF}) and the LO frequency (Nf_{LO}). When this difference is positive, we can say $f_{IF} = f_{RF} - Nf_{LO}$. When this difference is negative, we can say $f_{IF} = Nf_{LO} - f_{RF}$. Thus, a negative harmonic means the instrument will be tuned such that the harmonic of the LO is higher than the indicated frequency by the frequency of the first IF. A positive harmonic means the instrument will be tuned such that the harmonic of the LO is lower than the indicated frequency by the frequency of the first IF.

Remote Command	<code>[:SENSe]:MIXer:HARMonic <integer></code>
Example	<code>:MIX:HARM -28</code> <code>:MIX:HARM?</code>
Notes	The query returns the harmonic value of the first row of the harmonic table

Couplings	When you set a value for Harmonic via SCPI, the Mixer Selection changes to Custom
Preset	Unaffected by Mode Preset , but Restore Input/Output Defaults turns editing off, the Harmonic Table returns to normal, and the Mixer is preset to 11970A, which has -6 in the first row of its Harmonic Table
State Saved	Saved in instrument state
Min	-400
Max	400

6.2.13.7 LO Doubler

Lets you specify whether the Doubler is on or off. Only the first row of the table is editable, and the LO Doubler field is only editable in Single Row and Harmonic Switching table types. When you edit a value or change the Table Type, the Mixer Selection changes to **Custom**.

The LO Doubler setting controls the choice of the LO doubler state for LO's that support doubled operation. In Single Row mode it is either on or off for the one row in the table. In Harmonic Switching mode it is on for both rows or off for both rows. In Doubler switching it is off for row 1 and on for row 2, so it is not editable.

In LOs that support doubling, the fundamental band is approximately 3.8 – 8.7 GHz, and the doubled band is approximately 8.0 – 14 GHz. The higher LO frequency can result in a lower mixer harmonic and reduced mixer conversion loss.

Remote Command	<code>[:SENSe] :MIXer :LODoubler ON OFF 0 1</code> <code>[:SENSe] :MIXer :LODoubler ?</code>
Example	<code>:MIX :LOD 0</code> <code>:MIX :LOD ?</code>
Notes	The query returns the doubler value of the first row of the harmonic table
Dependencies	Grayed-out and set to OFF when "Table Type" on page 2157 is set to Doubler Switching Grayout message: "-221 Settings conflict; Function unavailable while Table Type=Doubler Switching"
Couplings	When you set a value via SCPI, the Mixer Selection changes to Custom
Preset	Unaffected by Mode Preset , but Restore Input/Output Defaults turns off editing, the Harmonic Table returns to normal, and the Mixer is preset to 11970A, which has the doubler Off in the first row of its Harmonic Table
State Saved	Saved in instrument state

6.2.13.8 Refresh USB Mixer Connection

Re-reads the USB devices and refreshes connection to Keysight USB mixers. This operation is the same as physically removing and reinserting the mixer's USB connection.

Example	<code>:MIX:BAND USB</code>
Notes	When using Keysight USB Mixers, if Restore All Defaults (<code>:SYSTem:DEFault</code>) has been performed, either remove and reinsert the USB cable or press Refresh USB Mixer Connection

6.2.14 Mixer Path

Determines which path you wish to use when using M1971 series USB mixers:

- **NORMa1**, in which they function as a classic external mixer with a single conversion
- **DUAL** Conversion, in which the first conversion is to a higher IF frequency (nominally 1.5 GHz) and you provide a 10 MHz signal to which an internal PLL is locked, to effect a second downconversion. The higher IF frequency used in Dual Conversion increases the image frequency offset, giving you a wider image-free conversion range. This reduces aliasing effects and improves the image suppress functionality for wideband signals
- **AUX** Equipment, wherein the first mixer output drives an output connector on the mixer and the instrument is out of the circuit. When you connect an M1971 Mixer to USB, the instrument will pull the IF and RF flatness data from the USB mixer and write this data to a user-accessible file in CSV format for your use when Aux Equipment is selected

Remote Command	<code>[:SENSe]:MIXer:MPATH NORMa1 DUAL AUX</code> <code>[:SENSe]:MIXer:MPATH?</code>
Example	<code>:MIX:MPAT NORM</code>
Dependencies	<p>Only appears when an M1971 series Mixer is connected to the USB port of the instrument</p> <p>When AUX Equipment is the selection, Sig Id is turned off to avoid shifting the LO. It is <i>not</i> turned back on when a different path is selected</p> <p>When AUX Equipment is the selection, there is no valid result, so the instrument displays a “No Result; Meas invalid with Aux Equip” error condition message (error 135)</p> <p>DUAL Conversion is grayed-out unless in the Swept SA measurement. If grayed-out and the command is sent, generates error:”-221, Settings Conflict; Dual Conversion mixer path is only available in Swept SA”</p> <p>If in DUAL Conversion and you exit Swept SA, reverts to NORMa1 setting. If you subsequently return to Swept SA, does <i>not</i> automatically return to DUAL Conversion</p> <p>When DUAL Conversion is selected, if no signal is sensed at the 10 MHz input port, an error condition is generated, “Ref missing or out of range; M1971” (error 521). This also lights the Error LED on the mixer itself</p>
Couplings	When AUX path is selected, the instrument switches to Zero Span
Preset	NORMa1
State Saved	Saved in instrument state

Annotation	In the Meas Bar, if an M1971 series Mixer is connected to the USB port of the instrument, the field Mixer Path appears and says: <ul style="list-style-type: none"> - Normal for Normal - 2xConv for Dual Conversion - Aux for Aux Equipment
------------	---

6.2.15 User IF Freq

Specifies the desired IF frequency when using the Aux Equipment path. This setting determines the LO frequency that the instrument will drive into the mixer to correspond to the specified center frequency. Note that the Aux Equipment path always uses “Negative Mixing”, that is, the LO frequency is always higher than the RF frequency.

Remote Command	<code>[:SENSe]:MIXer:UIFFreq <real></code> <code>[:SENSe]:MIXer:UIFFreq?</code>
Example	<code>:MIX:UIFF 300 MHz</code>
Dependencies	Only appears if an M1971 mixer is connected to USB and the Mixer Path is Aux Equipment
Preset	1.2 GHz
State Saved	Saved in Input/Output state
Min	0 GHz
Max	4 GHz

6.2.16 Signal ID On/Off

Toggles the Signal ID (signal identification) function On or Off. This function lets you identify multiple responses of a single input signal that are generated when using un-preselected external mixers. The use of mixers without pre-selecting filters offers the advantage of improved receiver sensitivity because of the absence of the filter insertion loss, but results in multiple responses due to images and undesired harmonic mixing products.

While in **Signal ID**, basic spectrum analyzer functions work normally (for example, you can change Span normally), but some functions are disabled (for example, some traces are unavailable).

There are two forms of **Signal ID**, Image Suppress and Image Shift. Choose the one most appropriate for your application. For Image Shift, an LO-shifted and an unshifted trace are taken in Trace 1 and Trace 2 and displayed together. Any peaks that are not the same in both traces are images. For Image Suppress, image

6 Input/Output
6.2 Input

cancellation is performed in the background using two hidden traces, and the result displayed in Trace 1, which shows only the valid signals.

When **Signal ID** is **ON**, this is indicated in the Meas Bar as Signal ID: On. The annotation is displayed in amber to alert you, because it can cause unexpected behavior if you are not aware that it is on.

Remote Command	<code>[:SENSe]:SIDentify[:STATe] OFF ON 0 1</code> <code>[:SENSe]:SIDentify[:STATe]?</code>
Example	<code>:SID 0</code> <code>:SID?</code>
Notes	Signal ID uses data from two successive sweeps. Therefore, if the instrument is in single sweep mode, two sweep triggers are used to generate the data needed for signal identification For the Log Plot measurement in the Phase Noise Mode, Signal ID works only in the segment of LO sweeping where the offsets are greater than the Rejection Offset setting. When turning it on, you may notice a discontinuity in the Phase Noise trace at the Rejection Offset setting frequency by a few dB due to the under response inherent to Signal ID
Dependencies	Only appears when External Mixer is selected as the Input Not available in some measurements. If Signal ID does not appear or is grayed-out while in your measurement, then it is not available Because Signal ID uses data from two successive sweeps, several trace and sweep functions are grayed-out in Signal ID . See the documentation for your measurement for details on which trace functions are grayed-out Not available with Signal Track, in which case Signal ID is grayed-out Turned off when External Mixer is turned off. Signal ID cannot be turned on when using internal mixing Rules for auto coupling of the Sweep and FFT controls are changed with Signal ID ON . For both the dynamic range case and the speed case, swept is chosen whenever any form of Signal ID is on. If Manual FFT is selected, Signal ID is grayed-out If Signal ID is selected in a measurement that does not support it, a warning message is generated
Couplings	The Auto Rules for detector selection select Normal for all active traces when Signal ID is turned ON
Preset	Unaffected by Preset, but set to OFF by Restore Input/Output Defaults
Annunciation	When Signal ID is on this is indicated in the Meas Bar as Signal ID: On. The annotation is displayed in amber color to alert you to the fact that Signal ID is on, as it can cause unexpected behavior if you are not aware that it is on

6.2.17 Signal ID Mode

Determines the **Signal ID** mode to use, either Image Suppress or Image Shift.

Image Suppress

Mathematically removes all image and multiple responses of signals present at the mixer input. Two hidden sweeps are taken in succession. The second sweep is offset in LO frequency by $2 * IF / N$. For each point in each trace, the smaller amplitude

from the two traces is taken and placed in that point in the selected trace. The Peak detector is auto-selected to improve the image suppression effectiveness. Responses of each trace that lie on top of one another will remain and are valid signals, others are images and are suppressed. The action of taking the smaller of the two traces will make the average noise level lower in all points that do not have an image, thus reducing the accuracy of the measurement of noise and noise-like signals.

NOTE

When changing from Image Shift to Image Suppress mode, Trace 2 is blanked, as it was used for Image Shift and contains data that you will probably not want to see in Image Suppress

Image Shift

Like the Image Suppress mode, Image Shift is a two-sweep sequence. The data from the first sweep is placed in Trace 1 and the data from the second (LO frequency shifted by $2 * IF / N$) sweep is placed in Trace 2. On alternate sweeps, the alternate trace (trace 2) is placed in front of trace 1. This way, you can see a signal at the same place on alternate sweeps, showing in yellow (trace1) and blue (trace2). Signal responses of Trace 1 and Trace 2 that have the same horizontal position are considered to be in the current band and therefore can be analyzed with the amplitude and frequency measurement systems of the SA. All other responses are invalid and should be ignored.

NOTE

This function takes control of and uses Trace 1 and Trace 2. Any data in these traces prior to activating Image Shift will be lost.

Remote Command	<code>[:SENSe] :SIDentify :MODE ISUPpress IShift</code> <code>[:SENSe] :SIDentify :MODE ?</code>
Example	<code>:SID:MODE ISUP</code> <code>:SID:MODE ISH</code> <code>:SID:MODE ?</code>
Dependencies	Only appears when External Mixer is selected as the Input
Preset	Unaffected by Preset, but set to <code>ISUPpress</code> by Restore Input/Output Defaults
State Saved	Saved in instrument state

6.2.18 Cable IF Loss

The loss at the IF in the IF/LO cable can be compensated for with this function, by entering the loss in dB for your cable.

6 Input/Output

6.2 Input

The cable loss will depend on the IF frequency. The IF frequency varies depending on which IF path your measurement is using. For best accuracy, characterize your cable's loss for the IF frequency or frequencies you will be using.

IF Frequencies

10 MHz path	322.5 MHz
25 MHz path	322.5 MHz
40 MHz path	250 MHz
140 MHz path	300 MHz

Remote Command	<code>[:SENSe]:MIXer:CIFLoss <rel_amp1></code> <code>[:SENSe]:MIXer:CIFLoss?</code>
Example	<code>:MIX:CIFL 0.23 DB</code> <code>:MIX:CIFL?</code>
Dependencies	Only appears when External Mixer is selected as the Input
Preset	0.26 dB
State Saved	Saved in instrument state
Min	-100
Max	100

6.2.19 I/Q Path

Selects which I/Q input channels are active. The LED next to each I/Q input port will be on when that port is active.

The analysis bandwidth for each channel is the same as that of the instrument. For example, the base N9020A has a bandwidth of 10 MHz. With I/Q input the I and Q channels would each have an analysis bandwidth of 10 MHz, giving 20 MHz of bandwidth when the I/Q Path is I+jQ. With option B25, the available bandwidth becomes 25 MHz, giving 25 MHz each to I and Q and 50 MHz to I+jQ.

I/Q voltage to power conversion processing is dependent on the I/Q Path selected:

- With I+jQ input, we know that the input signal may not be symmetrical about 0 Hz, because it has a complex component. Therefore, above 0 Hz only the positive frequency information is displayed, and below 0 Hz only the negative frequency information is displayed
- With all other Input Path selections, the input signal has no complex component and therefore is always symmetrical about 0 Hz. In this case, by convention, the power conversion shows the combined voltage for both the positive and negative frequencies. The information displayed below 0 Hz is the mirror of the

information displayed above 0 Hz. This results in a power reading 6.02 dB higher (for both) than would be seen with only the positive frequency voltage. Note also that, in this case the real signal may have complex modulation embedded in it, but that must be recovered by further signal processing

Remote Command	<code>[:SENSe]:FEED:IQ:TYPE IQ IONLy QONLy</code> For option details, see More Information <code>[:SENSe]:FEED:IQ:TYPE?</code>
Example	Set the input to be both the I and Q channels, combined as $I + j * Q$: <code>:FEED:IQ:TYPE IQ</code> Set the input to be only the I channel: <code>:FEED:IQ:TYPE IONL</code> Set the input to be only the Q channel: <code>:FEED:IQ:TYPE QONL</code> Turn on both I and Q channels and treat I as channel 1 and Q as channel 2: <code>:FEED:IQ:TYPE IND</code>
Dependencies	Only appears when I/Q is the selected input
Preset	<code>IQ</code>
State Saved	Yes Unaffected by Preset, but set to the default value by Restore Input/Output Defaults or Restore System Defaults->All Backwards Compatibility SCPI
Notes	For R&S FSQ-B71 compatibility
Preset	<code>IQ</code>
Backwards Compatibility SCPI	<code>:INPut[1]:IQ:TYPE IQ I Q</code> <code>:INPut[1]:IQ:TYPE?</code>

More Information

I+jQ

Sets the signal input to be both the I and Q channels. The I and Q channel data will be combined as $I + j * Q$.

I Only

Sets the signal input to be only the I channel. The Q channel will be ignored. The data collected is still complex. When the center frequency is 0 the imaginary part will always be zero, but for any other center frequency both the real and imaginary parts will be significant.

Q Only

6 Input/Output

6.2 Input

Sets the signal input to be only the Q channel. The I channel will be ignored. The Q channel will be sent to the digital receiver block as $Q+j0$. The receiver's output is still complex. When the center frequency is 0 the imaginary part will always be zero, but for any other center frequency both the real and imaginary parts will be significant. Note that since the receiver's real output is displayed as the "I" data, when the center frequency is 0, the Q Only input appears as the "I" data.

6.2.20 Reference Z

Sets the value of the impedance to be used in converting voltage to power for the I and Q channels. This does not change the hardware's path impedance (see ["Input Z" on page 2168](#)).

Remote Command	<code>:INPut:IMPedance:REference <integer></code> <code>:INPut:IMPedance:REference?</code>
Example	Set the I/Q reference impedance to 50 Ω <code>:INP:IMP:REF 50</code>
Dependencies	Only appears when I/Q is the selected input
Preset	50 Ω
State Saved	Yes Unaffected by a Preset, but set to the default value by Restore Input/Output Defaults or Restore System Defaults->All
Min/Max	1 Ω - 1 M Ω

6.2.21 I/Q Setup

Lets you set up and calibrate various parameters for the I/Q inputs.

Dependencies	Only appears when I/Q is the selected input
--------------	---

6.2.21.1 I Setup

Accesses the channel setup parameters for the I channel.

Differential

Selects differential input on or off for the I channel. For differential input (also called balanced input), the instrument uses both main and complementary ports. When differential input is off (also called single-ended or unbalanced input), the instrument uses only the main port.

Remote Command	<code>:INPut:IQ[:I]:DIFFerential OFF ON 0 1</code> <code>:INPut:IQ[:I]:DIFFerential?</code>
Example	Put the I channel in Differential mode: <code>:INP:IQ:DIFF ON</code> Put the I channel in Single Ended mode: <code>:INP:IQ:DIFF OFF</code>
Notes	When I Differential Input = On, the instrument checks for attenuation mismatches between the I and I-bar ports. If the difference in attenuation values exceeds 0.5 dB, a Settings Alert error condition, error 159 is set When I Differential Input = On, and IQ Path is I+jQ, the Q Differential input must also be On. Similarly, when I Differential Input = Off, and IQ Path is I+jQ, the Q Differential input must also be Off. If the states of the two inputs do not match, an error condition message is generated, 159, Settings Alert; I/Q mismatch: Differential
Couplings	Some active probes include built-in differential capability. When one of these probes is sensed, this key is disabled. Since the differential capability is handled in the probe, the Instrument will use only the main port and the key will show that the Instrument's Differential Input mode is Off (indicating that the complementary port is not in use) When Q Same as I is On, the value set for I will also be copied to Q
Preset	OFF (Single Ended) Unaffected by Mode Preset, but set to the default value by Restore Input/Output Defaults or Restore System Defaults->All
State Saved	Yes
Annotation	The LED on the I-bar port indicates the Differential Input setting Backwards Compatibility Command
Notes	For R&S FSQ-B71 compatibility, with no independent settings for the I and Q channels. Therefore, it is tied only to the I channel and does not provide an equivalent for the Q channel. For proper operation of the backwards compatibility command, Q Same as I should be ON
Preset	OFF
Backwards Compatibility SCPI	<code>:INPut[1]:IQ:BALanced[:STATe] OFF ON 0 1</code> <code>:INPut[1]:IQ:BALanced[:STATe]?</code>

Input Z

Selects the input impedance for the I channel. The impedance applies to both the I and I-bar ports.

The input impedance controls the hardware signal path impedance match. It is not used for converting voltage to power. The voltage to power conversion always uses the Reference Z parameter. The Reference Z parameter applies to both I and Q channels.

6 Input/Output

6.2 Input

Remote Command	<code>:INPut[1]:IQ[:I]:IMPedance LOW HIGH</code> <code>:INPut[1]:IQ[:I]:IMPedance?</code>
Example	Set the I channel input impedance to 1 M Ω : <code>:INP:IQ:IMP HIGH</code> Set the I channel input impedance to 50 Ω : <code>:INP:IQ:IMP LOW</code>
Notes	LOW = 50 Ω , HIGH = 1 M Ω When IQ Path is I+jQ, the I Input Z setting must be the same as the Q Input Z setting. If the settings of the two inputs do not match, an error condition message is generated, 159; Settings Alert; I/Q mismatch: Input Z
Couplings	Input impedance is a built-in characteristic of a probe. Therefore, whenever a probe is sensed, this key is disabled, and the value is set to match the probe When no probe is sensed on Q and Q Same as I is On, the value set for I will also be copied to Q
Preset	LOW Unaffected by Mode Preset, but set to the default value by Restore Input/Output Defaults or Restore System Defaults->All
State Saved	Yes
Annotation	"I:<I Input Z>" (examples, "I:50 Ω " or "I:1M Ω ") in the Measurement Bar. The annotation shows both the I and Q Input Z values

Skew

Sets the skew factor for the I channel. The skew will shift the channel's data in time. Use this to compensate for differences in the electrical lengths of the input paths due to cabling.

Remote Command	<code>[:SENSe]:CORRection:IQ[:I]:SKEW <seconds></code> <code>[:SENSe]:CORRection:IQ[:I]:SKEW?</code>
Example	Delay the data for the I channel by 10 ns: <code>:CORR:IQ:SKEW 10 ns</code>
Preset	0
State Saved	Yes Unaffected by Mode Preset, but set to the default value by Restore Input/Output Defaults or Restore System Defaults->All
Range	0 s to 100 ns
Min	0 s
Max	+100 ns

Combined Differential/Input Z (Remote Command Only)

For backwards compatibility only. It combines the Differential Input and Input Z selections into a single command.

Notes	<p>Provided for E4406A code compatibility</p> <p>The enum values translate as follows:</p> <table border="1"> <tr> <td>U50</td> <td>Differential Input = Off, Input Z = 50 Ω</td> </tr> <tr> <td>B50</td> <td>Differential Input = On, Input Z = 50 Ω</td> </tr> <tr> <td>U1M</td> <td>Differential Input = Off, Input Z = 1 MΩ</td> </tr> <tr> <td>B1M</td> <td>Differential Input = On, Input Z = 1 MΩ</td> </tr> </table> <p>Combines the Input Z (50 Ω or 1 M Ω) parameter with the Differential Input (Off = "Unbalanced", On = "Balanced") parameter into a single enumeration</p> <p>This backwards-compatibility command was for an instrument without independent settings for the I and Q channels. Therefore, it is tied only to the I channel and does not provide an equivalent for the Q channel. For proper operation of the backwards-compatibility command, Q Same as I should be set to ON</p> <p>Note also the subtle difference between this command and the backwards-compatibility command for Input Z. The Input Z SCPI has "IQ" before "IMP", while this command has that order reversed</p>	U50	Differential Input = Off, Input Z = 50 Ω	B50	Differential Input = On, Input Z = 50 Ω	U1M	Differential Input = Off, Input Z = 1 M Ω	B1M	Differential Input = On, Input Z = 1 M Ω
U50	Differential Input = Off, Input Z = 50 Ω								
B50	Differential Input = On, Input Z = 50 Ω								
U1M	Differential Input = Off, Input Z = 1 M Ω								
B1M	Differential Input = On, Input Z = 1 M Ω								
Couplings	Does not have an independent parameter, but instead is tied to the Differential Input and Input Z parameters. The coupling for those parameters apply to this command too								
Preset	U50								
Backwards Compatibility SCPI	:INPut:IMPedance:IQ U50 B50 U1M B1M :INPut:IMPedance:IQ?								

6.2.21.2 I Probe

Access the probe setup parameters for the I channel.

Dependencies	<p>Only appears when I/Q is the selected input</p> <p>The set of I/Q probe setup parameters will change based on the type of probe that is sensed. All probe types have the Attenuation parameter, and all probe types can be calibrated. The remaining parameters are only available for some probe types and will not be shown when not available. The probe type is determined by and reported for only for the I and Q ports, never the I-bar or Q-bar ports. The menu title will be "<ch>: <probe id>", where "<ch>" is either "I" or "Q" and "<probe id>" is the type of probe. For example, for the I Probe setup with an Keysight 1130A probe connected to the I port, the title will be "I: 1130A".</p>
--------------	--

6 Input/Output
6.2 Input

Probe calibration data is stored for each probe type for each channel. When no probe is sensed, the probe type "Unknown" is used, and this is also treated like a probe type with its own calibration data. When a probe is changed, the calibration data for that probe type for that port is restored. An advisory message will be displayed showing the new probe type and the calibration status. The calibration data is stored permanently (survives a power cycle) and is not affected by a Preset or any of the Restore commands. When the probe has EEPROM identification (most newer Keysight probes have this), the calibration data is stored by probe serial number and port, so if you have two probes of the same type, the correct calibration data will be used for each. For probes that do not have EEPROM identification, the calibration data is stored by probe type and port and the instrument cannot distinguish between different probes of the same type. In all cases (with or without EEPROM identification), the calibration data is port specific, so it will not follow a specific probe from port to port if the probe is moved.

The "Unknown" probe type is used whenever no probe is sensed. When no calibration data exists for "Unknown" the latest cable calibration data is used.

Attenuation

The attenuation is part of the calibration data stored with the probe type and is initially the value that was returned by the last calibration. You can modify this value and any changes will be stored with the calibration data and will survive power cycles and presets. When a probe calibration is performed the attenuation value will be overwritten by the calibration.

Remote Command	<code>[:SENSe]:CORRection:IQ:I:ATTenuation:RATio <real></code> <code>[:SENSe]:CORRection:IQ:I:ATTenuation:RATio?</code>
Example	Set the attenuation for the current I probe to 100.00:1: <code>:CORR:IQ:I:ATT:RAT 100</code>
Notes	Each probe type has its own attenuation setting. As probes are changed the attenuation value will reflect the new probe's setting. Changing the attenuation affects only the current probe type's setting and leaves all others unchanged When the IQ Path is I+jQ, the Q probe attenuation setting must match the I Probe attenuation setting within 1 dB. If this is not the case, an error condition message is generated, 159; Settings Alert; I/Q mismatch: Attenuation
Preset	1
State Saved	Saved with probe calibration data. Survives a power cycle and is not affected by Preset or Restore
Min/Max	0.001/10000 This is an alternate form of the SCPI command that allows input as a power instead of a ratio.
Remote Command	<code>[:SENSe]:CORRection:IQ:I:ATTenuation <rel_amp1></code> <code>[:SENSe]:CORRection:IQ:I:ATTenuation?</code>

Example	Set the attenuation for the current I probe type to 100.00:1: <code>:CORR:IQ:I:ATT 20 dB</code>
Min/Max	-60 dB /+80 dB

Offset

Some active probes have DC offset capability. When one of these probes is connected, this control will be visible. The signal is adjusted for the DC offset before entering the instrument's port. This allows for removal of a DC offset before reaching the instrument's input port voltage limits. For example, a signal that varies 1 V peak-to-peak with a DC offset equal to the instrument's max input voltage would exceed the input limits of the instrument for half its cycle. Removing the DC offset allows the instrument to correctly process the entire signal.

Remote Command	<code>:INPut:OFFSet:I <voltage></code> <code>:INPut:OFFSet:I?</code>
Example	Remove a DC offset of -0.5 V from the I channel input: <code>:INP:OFFS:I -0.5</code>
Notes	Only some probe types support Offset . For those that do, each probe type has its own Offset setting. As probes are changed, the Offset value will reflect the new probe's setting. Changing Offset affects only the current probe type's setting and leaves all others unchanged
Preset	0 V
State Saved	Saved with probe calibration data. Survives power cycle and is not affected by Preset or Restore
Min/Max	-18 V/+18 V

Coupling

Some probe types allow coupling to reject low frequencies. This filters out the DC component of a signal that is composed of a DC bias plus some AC signal. This control is visible only for probe types that have this capability.

Remote Command	<code>:INPut:COUPling:I DC LFR1 LFR2</code> <code>:INPut:COUPling:I?</code>
Example	Turn off low frequency rejection on the I channel, allowing signals down to DC: <code>:INP:COUP:I DC</code> Turn on low frequency rejection on the I channel for frequencies lower than 1.7 Hz: <code>:INP:COUP:I LFR1</code> Turn on low frequency rejection on the I channel for frequencies lower than 0.14 Hz: <code>:INP:COUP:I LFR2</code>
Notes	Only some probe types support Coupling . For those that do, each probe type has its own Coupling setting. As probes are changed, the Coupling value will reflect the new probe's setting. Changing

6 Input/Output

6.2 Input

	Coupling affects only the current probe type's setting and leaves all others unchanged
Preset	DC
State Saved	Saved with probe calibration data. Survives a power cycle and is not affected by a Preset or Restore
Range	DC AC 1.7 Hz LFR1 AC 0.14 Hz LFR2

Clear Calibration

Clears the calibration data for the current port and probe. It does not clear the data for other probe types or other ports. If the sensed probe has EEPROM identification, only the data for that specific probe is cleared. After this command has completed, the probe calibration state will be the same as if no probe calibration had ever been performed for the specified channel and probe. The probe attenuation will be the default value for that probe type and the Cable Calibration frequency response corrections will be used. This command is dependent on the Differential Input state. When Differential Input is on, both the data for the probe attached to the main port and the data for the probe attached to the complementary port are cleared. When Differential Input is off, only data for the probe attached to the main port is cleared.

Remote Command	<code>:CALibration:IQ:PROBe:I:CLEar</code>
Example	Clear the calibration data for the I channel and the current probe (with EEPROM identification) or probe type (without EEPROM identification): <code>:CAL:IQ:PROBe:I:CLE</code>

6.2.21.3 Calibrate

Invokes the guided probe calibration. The guided probe calibration is context sensitive and depends on the channel (I or Q) and the Differential Input state. The calibration is only performed on the selected channel. When the Differential control is switched to Differential, both the probe attached to the main port and the probe attached to the complementary port are calibrated. When the Differential control is switched to Single Ended, only the probe attached to the main port is calibrated.

Calibrating the Baseband I/Q ports requires several steps and manual connections. The Guided Calibration will interactively step you through the required steps, displaying diagrams to help with the connections. The steps will vary depending on the setup.

In the Guided Calibration windows, the date and time of the last calibration are displayed. If any of the items listed are displayed in yellow, this indicates that the calibration for that item is inconsistent with the latest calibration, and you should complete the entire calibration process before you exit the calibration. For passive probes with Differential On, any calibration that is more than a day older than the most recent calibration will be displayed with the color amber.

The I/Q probe calibration creates correction data for one of the front panel I/Q channels. When the probe has EEPROM identification, the data is unique to that specific probe. When the probe does not have EEPROM identification, the data will be used for all probes of the same type. The data is also unique to the channel, so calibration data for the I channel will not be used for the Q channel and vice versa.

The guided calibration (front panel only) will show connection diagrams and guide you through the I/Q Isolation Calibration and through calibrating each port. The calibration data for each port is stored separately, so as soon as a port is calibrated that data is saved and will be used. If a user presses "Exit" to exit the calibration process, the data for the port already completed will still be used. It is recommended that a calibration be completed once started, or if exited, that it be properly done before the next use of the probe. The "Next" button will perform the calibration for the current port and then proceed to the next step in the calibration procedure. The "Back" button will return to the prior port in the procedure. Both softkeys and dialog buttons are supplied for ease of use. The dialog buttons are for mouse use and the softkeys for front panel use.

The calibration can also be done via SCPI, but no connection diagrams will be shown. You will need to make the correct connections before issuing each port calibration command. Again, it is recommended that all ports be calibrated at the same time.

For Active probes or when Differential is Off, only the main port is calibrated, otherwise both the main and complementary ports are calibrated.

The instrument state remains as it was prior to entering the calibration procedure except while a port is actually being calibrated. Once a port is calibrated it returns to the prior state. A port calibration is in process only from the time the "Next" button is pressed until the next screen is shown. For SCPI, this corresponds to the time from issuing the CAL:IQ:PROB:I|B|Q|QB command until the operation is complete.

For example, if the prior instrument state is Cal Out = Off, Input = I+jQ, and Differential = Off, then up until the time the "Next" button is pressed the I Input and Q Input LEDs are on and the Cal Out, I-bar Input and Q-bar Input LEDs are off. Once the "Next" button is pressed for the I port calibration, only the Cal Out and I Input LEDs will be on, and the others will be off. When the screen progresses to the next step ("Next" button again enabled), the prior state is restored and only the I Input and Q Input LEDs are on (Cal Out is off again).

I/Q Isolation Calibration

I/Q Isolation Calibration must be run before calibrating any port with either the I/Q Cable Calibration or I/Q Probe Calibration. This calibration is performed with nothing connected to any of the front panel I/Q ports. This is the first step in both the I/Q Cable Calibration and the I/Q Probe Calibration. This dialog appears if the Calibration is being run for the first time. It can also be accessed by pressing Back

6 Input/Output

6.2 Input

from the I Input Cal, the Q Input Cal, or the I/Q Cable Cal. Pressing Next from this dialog runs the calibration

Remote Command	<code>:CALibration:IQ:ISOLation</code>
Example	<code>:CAL:IQ:ISOL</code>
Notes	All front panel I/Q ports must be unconnected
State Saved	No

I/Q Isolation Calibration Time (Remote Query Only)

Returns the last date and time that the I/Q Isolation Calibration was performed.

Remote Command	<code>:CALibration:IQ:ISOLation:TIME?</code>
Example	<code>:CAL:IQ:ISOL:TIME?</code>
Notes	Returns 6 integer values: year, month, day, hour, minute, second. When no calibration has been performed, all values are 0
Annunciation	Guided Calibration, Isolation Calibration, Last Calibration

I Port

The I port calibration is performed with the probe body attached to the front panel's I port, and the probe tip connected via an adapter to the Cal Out port. The guided calibration will show a diagram of the required connections.

Remote Command	<code>:CALibration:IQ:PROBe:I</code>
Example	<code>:CAL:IQ:PROB:I</code>
Notes	The I port must be connected to the Cal Out port before issuing the command The calibration data is saved as soon as the port is calibrated and will survive power cycles. It is not reset by any preset or restore data commands
State Saved	No

I Port Probe Calibration Time (Remote Query Only)

Return the last date and time that the I/Q Probe Calibration was performed for a specific port.

Remote Command	<code>:CALibration:IQ:PROBe:I :TIME?</code>
Example	<code>:CAL:IQ:PROB:I:TIME?</code>

Notes	This returns 6 integer values: year, month, day, hour, minute, second. When no calibration has been performed, all values are 0. The value is specific to both the port and probe, so the value will change as probes are connected or disconnected
-------	---

I-bar Port

The I-bar port calibration is performed with the probe body attached to the front panel's I-bar port and the probe tip connected via an adapter to the Cal Out port. The I-bar probe calibration is only available for passive probes with Differential On. The guided calibration will show a diagram of the required connections.

Remote Command	<code>:CALibration:IQ:PROBe:IBar</code>
----------------	---

Example	<code>:CAL:IQ:PROB:IB</code>
---------	------------------------------

Notes	The I-bar port must be connected to the Cal Out port before issuing the command The calibration data is saved as soon as the port is calibrated and will survive power cycles. It is not reset by any preset or restore data commands
-------	--

State Saved	No
-------------	----

I-bar Port Probe Calibration Time (Remote Query Only)

Return the last date and time that the I/Q Probe Calibration was performed for a specific port.

Remote Command	<code>:CALibration:IQ:PROBe:IBAR:TIME?</code>
----------------	---

Example	<code>:CAL:IQ:PROB:IBAR:TIME?</code>
---------	--------------------------------------

Notes	Returns 6 integer values: year, month, day, hour, minute, second. When no calibration has been performed, all values are 0. The value is specific to both the port and probe, so the value will change as probes are connected or disconnected
-------	--

Annunciation	Guided Calibration, Probe Calibration, Last Calibration
--------------	---

6.2.21.4 Q Setup

Access the channel setup parameters for the Q channel.

Dependencies	Only appears when I/Q is the selected input
--------------	---

Q Same as I

Many, but not all, usages require the I and Q channels have an identical setup. To simplify channel setup, the Q Same as I will cause the Q channel parameters to be

6 Input/Output
6.2 Input

mirrored from the I channel. That way you only need to set up one channel (the I channel). The I channel values are copied to the Q channel, so at the time Q Same as I is turned off the I and Q channel setups will be identical. This does not apply to Probe settings or to parameters that are determined by the probe.

Remote Command	<code>:INPut:IQ:MIRROred OFF ON 0 1</code> <code>:INPut:IQ:MIRROred?</code>
Example	Turn off the mirroring of parameters from I to Q: <code>:INP:IQ:MIRR OFF</code>
Couplings	Only displayed for the Q channel. When Yes, the I channel values for some parameters are mirrored (copied) to the Q channel. However, when a parameter is determined by the type of probe and a probe is sensed, the probe setting is always used and the I channel setting is ignored. The following parameters are mirrored: Differential Input (when not determined by probe) Input Z (when not determined by probe)
Preset	Unaffected by Preset, but set to the default value (Q Same as I set to ON) by Restore Input/Output Defaults or Restore System Defaults->All
State Saved	Saved in instrument state
Range	OFF ON

Differential

Selects differential input on or off for the Q channel. For differential input (also called balanced input), the instrument uses both the Q and Q-bar ports. When differential input is off (also called single-ended or unbalanced input), the instrument uses only the Q port.

Remote Command	<code>:INPut:IQ:Q:DIFFerential OFF ON 0 1</code> <code>:INPut:IQ:Q:DIFFerential?</code>
Example	Put the Q channel in Differential mode: <code>:INP:IQ:Q:DIFF ON</code> Put the Q channel in Single Ended mode: <code>:INP:IQ:Q:DIFF OFF</code>
Notes	When Differential Input = ON , the instrument checks for attenuation mismatches between the Q and Q-bar ports. If the difference in attenuation values exceeds 0.5 dB a Settings Alert error condition, error 159 will be set When Q Differential Input = ON , and IQ Path is I+jQ, the I Differential input must also be ON . Similarly, when Q Differential Input = OFF , and IQ Path is I+jQ, the I Differential input must also be OFF . If the states of the two inputs do not match, an error condition message is generated, 159; Settings Alert; I/Q mismatch: Differential
Couplings	Some active probes include built-in differential capability. When one of these probes is sensed, this key is disabled. Since the differential capability is handled in the probe, the Instrument will use only the main port and the key will show that the Instrument's Differential Input mode is Off (indicating that the

	complementary port not in use) When a differential probe is not sensed and Q Same as I is On, the value set for I will be copied to Q. This key is disabled when Q Same as I is On
Preset	OFF
State Saved	Yes Unaffected by a Preset, but set to the default value by Restore Input/Output Defaults or Restore System Defaults->All
Range	OFF ON
Annotation	The LED on the Q-bar port indicates the Differential Input setting

Input Z

Selects the input impedance for the Q channel. The impedance applies to both the Q and Q-bar ports.

The input impedance controls the hardware signal path impedance match. It is not used for converting voltage to power. The voltage to power conversion always uses the Reference Z parameter. The Reference Z parameter applies to both I and Q channels.

Remote Command	:INPut[1]:IQ:Q:IMPedance LOW HIGH :INPut[1]:IQ:Q:IMPedance?
Example	Set the Q channel input impedance to 1 M Ω : :INP:IQ:Q:IMP HIGH Set the Q channel input impedance to 50 Ω : :INP:IQ:Q:IMP LOW
Notes	LOW = 50 Ω , HIGH = 1 MΩ When IQ Path is I+jQ, the I Input Z setting must be the same as the Q Input Z setting. If the settings of the two inputs do not match, an error condition message is generated, 159; Settings Alert; I/Q mismatch: Input Z
Couplings	Input impedance is a built-in characteristic of a probe. Therefore, whenever a probe is sensed, this key is disabled, and the value is set to match the probe When no probe is sensed and Q Same as I is On, the value set for I will also be copied to Q. This key is disabled when Q Same as I is On
Preset	LOW
State Saved	Yes Unaffected by a Preset, but set to the default value by Restore Input/Output Defaults or Restore System Defaults->All
Range	50 Ω 1 MΩ
Annotation	"Q:<Q Input Z>" (examples, "Q:50 Ω " or "Q:1M Ω ") in the Measurement Bar. The annotation shows both the I and Q Input Z values

Skew

Sets the skew factor for the Q channel. The skew will shift the channel's data in time. Use this to compensate for differences in the electrical lengths of the input paths due to cabling and probes.

Remote Command	<code>[:SENSe]:CORRection:IQ:Q:SKEW <seconds></code> <code>[:SENSe]:CORRection:IQ:Q:SKEW?</code>
Example	Delay the data for the Q channel by 10 ns <code>:CORR:IQ:Q:SKEW 10 ns</code>
Preset	0
State Saved	Yes Unaffected by a Preset, but set to the default value by Restore Input/Output Defaults or Restore System Defaults->All
Min/Max	0 s/ 100 ns

6.2.21.5 Q Probe

Accesses the probe setup parameters for the Q channel. See "[Combined Differential/Input Z \(Remote Command Only\)](#)" on page 2170.

Dependencies	Only appears when I/Q is the selected input
--------------	---

Attenuation

The attenuation is part of the calibration data stored with the probe type and is initially the value that was returned by the last calibration. You can modify this value and any changes will be stored with the calibration data and will survive power cycles and presets. When a probe calibration is performed the attenuation value will be overwritten by the calibration.

Remote Command	<code>[:SENSe]:CORRection:IQ:Q:ATTenuation:RATio <real></code> <code>[:SENSe]:CORRection:IQ:Q:ATTenuation:RATio?</code>
Example	Set the attenuation for the current Q probe to 100.00:1: <code>:CORR:IQ:Q:ATT:RAT 100</code>
Notes	Each probe type has its own attenuation setting. As probes are changed the attenuation value will reflect the new probe's setting. Changing the attenuation affects only the current probe type's setting and leaves all others unchanged When the IQ Path is I+jQ, the Q probe attenuation setting must match the I Probe attenuation setting within 1 dB. If this is not the case, an error condition message is generated, 159; Settings Alert; I/Q mismatch: Attenuation

Preset	Each probe type has its own default. The default for the "Unknown" probe type is 1:1
State Saved	Saved with probe calibration data. Survives a power cycle and is not affected by Preset or Restore
Min/Max	0.001/10000 This is an alternate form of the SCPI command that allows input as a power instead of a ratio.
Remote Command	<code>[:SENSe]:CORRection:IQ:Q:ATTenuation <rel_ampl></code> <code>[:SENSe]:CORRection:IQ:Q:ATTenuation?</code>
Example	Set the attenuation for the current Q probe type to 100.00:1: <code>:CORR:IQ:Q:ATT 20 dB</code>
Min/Max	-60 dB /+80 dB

Offset

Some active probes have DC offset capability. When one of these probes is connected this control will be visible. The signal is adjusted for the DC offset before entering the instrument's port. This allows for removal of a DC offset before reaching the instrument's input port voltage limits. For example, a signal that varies 1 V peak-to-peak with a DC offset equal to the instrument's max input voltage would exceed the input limits of the instrument for half its cycle. Removing the DC offset allows the instrument to correctly process the entire signal.

Remote Command	<code>:INPut:OFFSet:Q <voltage></code> <code>:INPut:OFFSet:Q?</code>
Example	Remove a DC offset of -0.5 V from the Q channel input: <code>:INP:OFFS:Q -0.5</code>
Notes	Only some probe types support Offset . For those that do, each probe type has its own Offset setting. As probes are changed, the Offset value will reflect the new probe's setting. Changing Offset affects only the current probe type's setting and leaves all others unchanged
Preset	0 V
State Saved	Saved with probe calibration data. Survives power cycle and is not affected by Preset or Restore
Min/Max	-18 V/+18 V

Coupling

Some probe types allow coupling to reject low frequencies. This filters out the DC component of a signal that is composed of a DC bias plus some AC signal. This control is visible only for probe types that have this capability.

Remote Command	<code>:INPut:COUPling:Q DC LFR1 LFR2</code> <code>:INPut:COUPling:Q?</code>
----------------	--

6 Input/Output

6.2 Input

Example	Turn off low frequency rejection on the Q channel, allowing signals down to DC: <code>:INP:COUP:Q DC</code> Turn on low frequency rejection on the Q channel for frequencies lower than 1.7 Hz: <code>:INP:COUP:Q LFR1</code> Turn on low frequency rejection on the Q channel for frequencies lower than 0.14 Hz: <code>:INP:COUP:Q LFR2</code>
Notes	Only some probe types support Coupling . For those that do, each probe type has its own Coupling setting. As probes are changed, the Coupling value will reflect the new probe's setting. Changing Coupling affects only the current probe type's setting and leaves all others unchanged
Preset	DC
State Saved	Saved with probe calibration data. Survives a power cycle and is not affected by a Preset or Restore
Range	DC AC 1.7 Hz LFR1 AC 0.14 Hz LFR2

Clear Calibration

Clears the calibration data for the current port and probe. It does not clear the data for other probe types or other ports. If the sensed probe has EEPROM identification, only the data for that specific probe is cleared. After this command has completed, the probe calibration state will be the same as if no probe calibration had ever been performed for the specified channel and probe. The probe attenuation will be the default value for that probe type and the Cable Calibration frequency response corrections will be used. This command is dependent on the Differential Input state. When Differential Input is on, both the data for the probe attached to the main port and the data for the probe attached to the complementary port are cleared. When Differential Input is off, only data for the probe attached to the main port is cleared.

Remote Command	<code>:CALibration:IQ:PROBe:Q:CLEar</code>
Example	Clear the calibration data for the Q channel and the current probe (with EEPROM identification) or probe type (without EEPROM identification): <code>:CAL:IQ:PROBe:I:CLE</code>

6.2.21.6 Calibrate

Invokes the guided probe calibration. The guided probe calibration is context sensitive and depends on the channel (I or Q) and the Differential Input state. The calibration is only performed on the selected channel. When the Differential control is switched to Differential, both the probe attached to the main port and the probe attached to the complementary port are calibrated. When the Differential control is switched to Single Ended, only the probe attached to the main port is calibrated.

The I/Q Isolation Calibration must be run before calibrating any port with either the I/Q Cable Calibration or I/Q Probe Calibration. See "[I/Q Isolation Calibration](#)" on [page 2174](#)

Q Port

The Q port calibration is performed with the probe body attached to the front panel's Q port and the probe tip connected via an adapter to the Cal Out port. The guided calibration will show a diagram of the required connections.

Remote Command	<code>:CALibration:IQ:PROBe:Q</code>
Example	<code>:CAL:IQ:PROB:Q</code>
Notes	The Q port must be connected to the Cal Out port before issuing the command The calibration data is saved as soon as the port is calibrated and survives power cycles. It is not reset by any preset or restore data commands
State Saved	No

Q Port Probe Calibration Time (Remote Query Only)

Return the last date and time that the I/Q Probe Calibration was performed for a specific port.

Remote Command	<code>:CALibration:IQ:PROBe:Q:TIME?</code>
Example	<code>:CAL:IQ:PROB:Q:TIME?</code>
Notes	Returns 6 integer values: year, month, day, hour, minute, second. When no calibration has been performed, all values are 0. The value is specific to both the port and probe, so the value will change as probes are connected or disconnected
Annunciation	Guided Calibration, Probe Calibration, Last Calibration

Q-bar Port

The Q-bar port calibration is performed with the probe body attached to the front panel's Q-bar port and the probe tip connected via an adapter to the Cal Out port. The Q-bar probe calibration is only available for passive probes with Differential On. The guided calibration will show a diagram of the required connections.

Remote Command	<code>:CALibration:IQ:PROBe:QBar</code>
Example	<code>:CAL:IQ:PROB:QB</code>
Notes	The Q-bar port must be connected to the Cal Out port before issuing the command

6 Input/Output
6.2 Input

The calibration data is saved as soon as the port is calibrated and will survive power cycles. It is not reset by any preset or restore data commands

State Saved No

Q-bar Probe Calibration Time (Remote Query Only)

Return the last date and time that the I/Q Probe Calibration was performed for a specific port.

Remote Command `:CALibration:IQ:PROBe:QBAR:TIME?`

Example `:CAL:IQ:PROB:QBAR:TIME?`

Notes Returns 6 integer values: year, month, day, hour, minute, second. When no calibration has been performed, all values are 0. The value is specific to both the port and probe, so the value will change as probes are connected or disconnected

Annunciation Guided Calibration, Probe Calibration, Last Calibration

6.2.22 I/Q Cable Calibrate

The I/Q cable calibration creates correction data for each of the front panel I/Q ports. This calibration data is used whenever no probe specific calibration data is available. It is important that all ports are calibrated using the same short BNC cable so that the data is comparable from port to port.

The guided calibration (front panel only) will show connection diagrams and guide you through the isolation calibration and calibrating each port. The calibration data for each port is stored separately, so as soon as a port is calibrated that data is saved and will be used. If you press "Exit" to exit the calibration process, the data for the ports already completed will still be used. It is recommended that a calibration be completed once started, or if exited, that it be properly done before the next use of the I/Q ports. The "Next" button will perform the calibration for the current port and then proceed to the next step in the calibration procedure. The "Back" button will return to the prior port in the procedure. Both keys and dialog buttons are supplied for ease of use. The dialog buttons are for mouse use and the softkeys for front panel use.

The calibration can also be done via SCPI, but no connection diagrams will be shown. You will have to make the correct connections before issuing each port calibration command. Again, it is recommended that all ports be calibrated at the same time.

The instrument state remains as it was prior to entering the calibration procedure except while a port is actually being calibrated. Once a port is calibrated it returns to the prior state. A port calibration is in process only from the time the "Next" button is

pressed until the next screen is shown. For SCPI, this corresponds to the time from issuing the CAL:IQ:FLAT:I|B|Q|QB command until the operation is complete.

For example, if the prior instrument state is Cal Out = Off, Input = I+jQ, and Differential = Off, then up until the time the "Next" button is pressed the I Input and Q Input LEDs are on and the Cal Out, I-bar Input and Q-bar Input LEDs are off. Once the "Next" button is pressed for the I port calibration, only the Cal Out and I Input LEDs will be on and the others will be off. When the screen progresses to the next step ("Next" button again enabled), the prior state is restored and only the I Input and Q Input LEDs are on (Cal Out is off again).

The last calibration date and time for each port will be displayed. Any calibrations that are more than a day older than the most recent calibration will be displayed with the color amber.

The I/Q Isolation Calibration must be run before calibrating any port with either the I/Q Cable Calibration or I/Q Probe Calibration. See "[I/Q Isolation Calibration](#)" on [page 2174](#)

Dependencies	Only appears when I/Q is the selected input
--------------	---

6.2.22.1 I Port

The I port calibration is performed with the front panel's I port connected via a short BNC cable to the Cal Out port. The guided calibration will show a diagram of the required connections.

Remote Command	:CALibration:IQ:FLATness:I
----------------	----------------------------

Example	:CAL:IQ:FLAT:I
---------	----------------

Notes	<p>The recommended procedure is to use the same BNC cable to calibrate all I/Q ports. All I/Q ports should be calibrated sequentially during the procedure</p> <p>The calibration data is saved as soon as the port is calibrated and will survive power cycles. It is not reset by any preset or restore data commands</p> <p>The I port must be connected to the Cal Out port before issuing the command</p>
-------	--

State Saved	No
-------------	----

6.2.22.2 I-bar Port

The I-bar port calibration is performed with the front panel's I-bar port connected via a short BNC cable to the Cal Out port. The guided calibration will show a diagram of the required connections.

Remote Command	:CALibration:IQ:FLATness:IBAR
----------------	-------------------------------

6 Input/Output

6.2 Input

Example	<code>:CAL:IQ:FLAT:IBAR</code>
Notes	<p>The recommended procedure is to use the same BNC cable to calibrate all I/Q ports. All I/Q ports should be calibrated sequentially during the procedure</p> <p>The calibration data is saved as soon as the port is calibrated and will survive power cycles. It is not reset by any preset or restore data commands</p> <p>The I-bar port must be connected to the Cal Out port before issuing the command</p>
State Saved	No

6.2.22.3 Q Port

The Q port calibration is performed with the front panel's Q port connected via a short BNC cable to the Cal Out port. The guided calibration will show a diagram of the required connections.

Remote Command	<code>:CALibration:IQ:FLATness:Q</code>
Example	<code>:CAL:IQ:FLAT:Q</code>
Notes	<p>The recommended procedure is to use the same BNC cable to calibrate all I/Q ports. All I/Q ports should be calibrated sequentially during the procedure</p> <p>The calibration data is saved as soon as the port is calibrated and will survive power cycles. It is not reset by any preset or restore data commands</p> <p>The Q port must be connected to the Cal Out port before issuing the command</p>
State Saved	No

6.2.22.4 Q-bar Port

The Q-bar port calibration is performed with the front panel's Q-bar port connected via a short BNC cable to the Cal Out port. The guided calibration will show a diagram of the required connections.

Remote Command	<code>:CALibration:IQ:FLATness:QBAR</code>
Example	<code>:CAL:IQ:FLAT:QBAR</code>
Notes	<p>The recommended procedure is to use the same BNC cable to calibrate all I/Q ports. All I/Q ports should be calibrated sequentially during the procedure</p> <p>The calibration data is saved as soon as the port is calibrated and will survive power cycles. It is not reset by any preset or restore data commands</p> <p>The Q-bar port must be connected to the Cal Out port before issuing the command</p>
State Saved	No

6.2.22.5 I/Q Cable Calibration Time (Remote Query Only)

Returns the last date and time that the I/Q Cable Calibration was performed for a specific port.

Remote Command	<code>:CALibration:IQ:FLATness:I IBAR Q QBAR:TIME?</code>
Example	<code>:CAL:IQ:FLAT:I:TIME?</code>
Notes	Returns 6 integer values: year, month, day, hour, minute, second. When no calibration has been performed, all values are 0
Annunciation	Guided Calibration, Cable Calibration, Last Calibration

6.2.23 Audio Input Channel

Determines which Audio Input to be used for audio measurements.

Remote Command	<code>[:SENSe]:FEED:AFINput:PORT CH1 CH2</code> <code>[:SENSe]:FEED:AFINput:PORT?</code>
Example	<code>:FEED:AFIN CH1</code>
Dependencies	Only appears in Radio Test Mode Only appears in modular products, and only if an M9260A Audio Analyzer module is installed
Preset	Unaffected by Mode Preset, but set to Channel 1 by Input/Output Preset

6.2.24 Audio Calibrator

Lets you turn on the internal calibrator in the X-Series Audio board.

Remote Command	<code>[:SENSe]:FEED:AFALign OFF REF10</code> <code>[:SENSe]:FEED:AFALign?</code>
Example	<code>:FEED:AFAL REF10</code>
Dependencies	Only appears in Measuring Receiver Mode's Audio Measurements when Option 107 is present
Preset	<code>OFF</code>

6.2.25 Audio Coupling

Lets you set AC or DC coupling for the currently selected audio input.

Remote Command	<code>[:SENSe]:AFINput[1] 2:COUPling AC DC</code> <code>[:SENSe]:AFINput[1] 2:COUPling?</code>
----------------	---

6 Input/Output

6.2 Input

Example	<code>:AFIN:COUP AC</code>
Dependencies	Only appears in Measuring Receiver Mode and Radio Test Mode In Measuring Receiver Mode, only appear in Audio Measurements, and only if Option 107 is present In Radio Test Mode, only appears in modular products, and only if an M9260A Audio Analyzer module is installed
Preset	<code>AC</code>

6.2.26 Audio Input Ground

Lets you float or ground the low side of the currently selected audio input channel. When you choose `FLOat`, the low side of the input is disconnected from ground.

Remote Command	<code>[:SENSe]:AFINput[1] 2:LOW FLOat GROund</code> <code>[:SENSe]:AFINput[1] 2:LOW?</code>
Example	<code>:AFIN2:LOW FLO</code>
Dependencies	Only appears in Radio Test Mode Only appears in modular products, and only if an M9260A Audio Analyzer module is installed
Preset	Unaffected by Mode Preset, but set to <code>GROund</code> by Input/Output Preset

6.2.27 Audio In Impedance

Lets you set the Impedance of the currently selected audio input channel. The value you enter is rounded up to the nearest allowed value.

Remote Command	<code>[:SENSe]:AFINput[1] 2:IMPedance 50 600 1000000</code> <code>[:SENSe]:AFINput[1] 2:IMPedance?</code>
Example	<code>:AFIN:IMP 50</code>
Dependencies	Only appears in Radio Test Mode Only appears in modular products, and only if an M9260A Audio Analyzer module is installed
Preset	Unaffected by Mode Preset, but set to 600 by Input/Output Preset

6.2.28 Input/Output Preset

Resets the group of settings and data associated with the **Input/Output** front-panel key to their default values. These settings are not affected by **Mode Preset** because they are generally associated with connections to the instrument, which you generally would not want to reset every time you press **Mode Preset**.

This is the same as the control in the **Preset** dropdown, and also the same as **Input/Output** button in the **Restore Defaults** menu under **System**.

All the variables set under the **Input/Output** front panel key are reset by **Input/Output Preset**, including Amplitude Corrections and Data (described in the **Corrections** section), with the exception of RF Source settings, which are unaffected.

By using **Input/Output Preset** and **Restore Mode Defaults**, a full preset of the current mode will be performed, with the caveat that since **Input/Output Preset** is a global function it will affect *all* Modes.

When **Input/Output Preset** is selected, a message appears saying:

“This will reset all of the Input/Output variables to their default state, including which input is selected, all Amplitude Correction settings and data, all External Mixing settings, all Frequency Reference settings and all Output settings.

It will not affect Alignment data or settings.

It will not affect RF Source settings.

This action cannot be undone. Do you want to proceed?”

Use the **OK** or **Cancel** buttons to affirm or cancel the operation.

Example

:SYST:DEF INP

presets all Input/Output variables to their factory default values

6.3 External Gain

Contains controls that allow you to compensate for gain or loss in the measurement system outside the instrument. The External Gain is subtracted from the amplitude readout (or the loss is added to the amplitude readout). So, the displayed signal level represents the signal level at the output of the device-under-test, which can be the input of an external device that provides gain or loss.

Entering an External Gain value does not affect the Reference Level, therefore the trace position on screen changes, as do all of the values represented by the trace data. Thus, the values of exported trace data, queried trace data, marker amplitudes, trace data used in calculations such as N dB points, trace math, peak threshold, etc., are all affected by External Gain. Changing the External Gain, even on a trace that is not updating, immediately changes all of the above, without new data needing to be taken.

NOTE

Changing the External Gain causes the instrument to immediately stop the current sweep and prepare to begin a new sweep. The data will not change until the trace data updates because the offset is applied to the data as it is taken. If a trace is exported with a nonzero External Gain, the exported data will contain the trace data with the offset applied.

In Spectrum Analyzer Mode, a Preamp is the common external device providing gain or loss. In a measurement application mode like GSM or W-CDMA, the gain or loss could be from a BTS (Base Transceiver Station) or an MS (Mobile Station). So, in the Spectrum Analyzer mode MS and BTS would be grayed out and the only choice would be Ext Preamp. Similarly, in some of the digital communications applications, Ext Preamp will be grayed out and you would have a choice of MS or BTS.

The Ext Preamp, MS, and BS controls may be grayed-out depending on which measurement is currently selected. If any of the grayed-out controls are pressed, or the equivalent SCPI command is sent, an advisory message is generated.

6.3.1 External Preamp

This function is similar to the reference level offset function. Both affect the displayed signal level. Ref Lvl Offset is a mathematical offset only, no instrument configuration is affected. Ext Preamp gain is used when determining the auto-coupled value of the Attenuator. The External Gain value and the Maximum Mixer Level settings are both part of the automatic setting equation for the RF attenuation setting. (10 dB of Attenuation is added for every 10 dB of External Gain.)

Note that the Ref Lvl Offset and Maximum Mixer Level are described in the Amplitude section. They are reset by Mode Preset. The External Preamp Gain is reset by the "Restore Input/Output Defaults" or "Restore System Defaults->All" functions.

The Swept SA Measurement in SA Mode only supports the "Ext Preamp" function under External Gain. The other External Gain functions are grayed-out, and generate a settings conflict, if the SCPI for them is sent.

See ["More Information" on page 2190](#)

Remote Command	<code>[:SENSe]:CORRection:SA[:RF]:GAIN <rel_amp1></code> <code>[:SENSe]:CORRection:SA[:RF]:GAIN?</code>
Example	Set the Ext Gain value to 10 dB: <code>:CORR:SA:GAIN 10</code> Set the Ext Gain value to -10 dB (that is, an attenuation of 10 dB): <code>:CORR:SA:GAIN -10</code>
Notes	Does not auto return This command is new in X-Series
Dependencies	The reference level limits are determined in part by the External Gain/Atten, Max Mixer Level, and RF Atten Grayed-out in Modes that do not support External Gain
Preset	Unaffected by Preset, but set to 0 dB by Restore Input/Output Defaults or Restore System Defaults->All 0.00 dB, Gain
State Saved	Saved in instrument state
Min	-120 dB
Max	120 dB
Annotation	Displayed in the Meas Bar as "Ext Gain <value>". When the gain is zero, no annotation is shown
Backwards Compatibility SCPI	<code>[:SENSe]:CORRection:OFFSet[:MAGNitude]</code> The legacy Ext Preamp Gain key is now called Ext Gain and the sub-menu has choices of Ext Preamp MS BTS for backwards compatibility The MS and BTS choices are unavailable in Swept SA and the Ext Preamp is unavailable in the cell comms measurements

More Information

The U7227A USB Preamplifier is an accessory for the X-Series Signal Analyzer that provides gain externally, and whose gain settings are automatically loaded into the instrument over USB whenever it is connected to one of the instrument's USB ports.

While the USB Preamplifier is plugged into one of the instrument's USB ports, the instrument will consider it to be in the signal path of the RF Input and will apply the

6 Input/Output

6.3 External Gain

calibration data from the USB Preamp to measurements taken at the RF Input (on 2 input boxes, it will be considered to be in the signal path of RF Input 1; it is not supported for RF Input 2).

The USB Preamplifier contains its own cal data. This includes a noise trace suitable for use with NFE, for those models which support NFE. The act of connecting the Preamp to USB will cause the cal data to be downloaded from the preamp. When this happens, an informational message is provided saying "Cal data loaded from USB Preamp". The instrument will then automatically apply the calibration factors loaded from the Preamp in any measurement that supports the USB Preamp.

The External Preamp Gain setting may still be used, even though it is not required for the USB Preamp (since the USB Preamp supplies its own gain data to the instrument which is applied automatically). Connecting the USB Preamp does not change the External Preamp Gain setting, however unless you have another gain or attenuation element in the signal path, the appropriate setting for External Preamp Gain is 0 dB.

Overload detection and reporting will apply when the USB preamplifier is connected to USB. The USB Preamplifier has its own overload detector which reports overloads to the instrument over USB. This generates an error condition, "Input Overload; USB Preamp."

If, while the USB Preamp is connected to USB, a measurement is selected that does not support the USB preamplifier, the "No result; Meas invalid with Preamp" error condition is generated.

6.3.2 External Gain - MS

Sets an external gain/attenuation value for MS (Mobile Station) tests.

Remote Command	<code>[:SENSe]:CORRection:MS[:RF]:GAIN <rel_amp1></code> <code>[:SENSe]:CORRection:MS[:RF]:GAIN?</code>
Example	Set the Ext Gain value to 10 dB: <code>:CORR:MS:GAIN 10</code> Set the Ext Gain value to -10 dB (that is, a loss of 10 dB): <code>:CORR:MS:GAIN -10</code>
Notes	Does not auto return
Dependencies	The reference level limits are determined in part by the External Gain, Max Mixer Level, RF Atten Grayed-out in modes that do not support MS
Preset	Unaffected by Preset, but set to 0 dB by Restore Input/Output Defaults or Restore System Defaults->All 0.00 dB, Gain
State Saved	Saved in instrument state

Min	-100 dB
Max	100 dB
Backwards Compatibility SCPI	
Example	Set the Ext Gain value to -10 dB, and subsequently querying :LOSS will give 10 dB: <code>:CORR:MS:LOSS 10</code> Set the Ext Gain value to 10 dB. Subsequently querying :LOSS will return -10 dB: <code>:CORR:MS:LOSS -10</code>
Notes	A positive value of <code><rel_amp1></code> in the above command means a loss and a negative value indicates a gain If <code>:LOSS</code> is set, <code>:GAIN</code> is set to the negative value of the parameter sent If <code>:LOSS</code> is queried, it returns the negative of <code>:GAIN</code>
Preset	Unaffected by Preset, but set to 0 dB by Restore Input/Output Defaults or Restore System Defaults->All
Min/Max	-/+100 dB
Backwards Compatibility SCPI	<code>[:SENSe]:CORRection:MS[:RF]:LOSS <rel_amp1></code> <code>[:SENSe]:CORRection:MS[:RF]:LOSS?</code>

6.3.3 External Gain - BTS

Sets an external attenuation value for BTS (Base Transceiver Station) tests.

Remote Command	<code>[:SENSe]:CORRection:BTS[:RF]:GAIN <rel_amp1></code> <code>[:SENSe]:CORRection:BTS[:RF]:GAIN?</code>
Example	Set the Ext Gain value to 10 dB: <code>:CORR:BTS:GAIN 10</code> Set the Ext Gain value to -10 dB (that is, a loss of 10 dB): <code>:CORR:BTS:GAIN -10</code>
Notes	Does not auto return
Dependencies	The reference level limits are determined in part by the External Gain, Max Mixer Level, RF Atten Grayed-out in modes that do not support BTS
Preset	Unaffected by Preset, but set to 0 dB by Restore Input/Output Defaults or Restore System Defaults->All 0.00 dB, Gain
State Saved	Saved in instrument state
Min	-100 dB
Max	100 dB
Backwards Compatibility SCPI	

6 Input/Output

6.3 External Gain

Example	<p>Set the Ext Gain value to -10 dB, and subsequently querying :LOSS will give 10 dB: :CORR:BTS:LOSS 10</p> <p>Set the Ext Gain value to 10 dB. Subsequently querying :LOSS will return -10 dB: :CORR:BTS:LOSS -10</p>
Notes	<p>A positive value of <rel_amp1> in the above command means a loss and a negative value indicates a gain</p> <p>If :LOSS is set, :GAIN is set to the negative value of the parameter sent</p> <p>If :LOSS is queried, it returns the negative of :GAIN</p>
Preset	Unaffected by Preset, but set to 0 dB by Restore Input/Output Defaults or Restore System Defaults->All
Min/Max	-/+100 dB
Backwards Compatibility SCPI	<p>[:SENSe]:CORRection:BTS[:RF]:LOSS <rel_amp1></p> <p>[:SENSe]:CORRection:BTS[:RF]:LOSS?</p>

6.3.4 I Ext Gain

Affects the I channel input. However, when Q Gain in I+jQ is set to Same as I Gain, this value is applied to both I and Q channel inputs.

Remote Command	<p>[:SENSe]:CORRection:IQ:I:GAIN <rel_amp1></p> <p>[:SENSe]:CORRection:IQ:I:GAIN?</p>
Example	<p>Set the I Ext Gain to 10 dB: :CORR:IQ:I:GAIN 10</p> <p>Set the I Ext Gain to -10 dB (that is, a loss of 10 dB): :CORR:IQ:I:GAIN -10</p>
Dependencies	<p>Not available unless option BBA is installed</p> <p>Grayed-out when I/Q Path is Q Only</p>
Preset	<p>0 dB</p> <p>Unaffected by Preset, but set to 0 dB by Restore Input/Output Defaults or Restore System Defaults->All</p>
State Saved	Yes
Min/Max	-/+100 dB
Annotation	<p>Ext Gain: <I Ext Gain> dB</p> <p>No annotation is shown when Input is not I/Q. Also not shown when I Ext Gain is 0.00 dB. I Ext Gain is not shown for Input Path Q Only. When the Input Path is Independent I and Q and I Ext Gain is not the same as Q Ext Gain, both are shown. "Ext Gain: <I Ext Gain> dB, <Q Ext Gain> dB"</p>

6.3.5 Q Ext Gain

Affects the Q channel input.

Remote Command	<code>[:SENSe]:CORRection:IQ:Q:GAIN <rel_amp1></code> <code>[:SENSe]:CORRection:IQ:Q:GAIN?</code>
Example	Set the Q Ext Gain to 10 dB: <code>:CORR:IQ:Q:GAIN 10</code> Set the Q Ext Gain to -10 dB (that is, a loss of 10 dB): <code>:CORR:IQ:Q:GAIN -10</code>
Dependencies	Not available unless option BBA is installed Grayed-out when Q gain in I+jQ is set to Same as I Gain
Preset	0 dB Unaffected by Preset, but set to 0 dB by Restore Input/Output Defaults or Restore System Defaults->All
State Saved	Saved in instrument state
Min/Max	-/+100 dB
Annotation	Ext Gain: <Q Ext Gain> dB No annotation is shown when Input is not I/Q. Also not shown when Q Ext Gain is 0.00 dB. Q Ext Gain is not shown for Input Path I Only or I+jQ. When Input Path is Independent I and Q and when I and Q Ext Gain are both non-zero but are the same the annotation will be "Ext Gain: <Ext Gain> dB" and when I Ext Gain is not the same as Q Ext Gain, both are shown. "Ext Gain: <I Ext Gain> dB, <Q Ext Gain> dB"

6.3.6 Q Gain in I+jQ

When Same as I Gain (**ON**) is selected, I Ext Gain value is applied to both I and Q channel input if the Input Path is I+jQ.

When Independent (**OFF**) is selected, I and Q Ext Gain values are applied to I and Q channel input independently.

Remote Command	<code>[:SENSe]:CORRection:IQ:Q:GAIN:COUPle ON OFF 0 1</code> <code>[:SENSe]:CORRection:IQ:Q:GAIN:COUPle?</code>
Example	<code>:CORR:IQ:Q:GAIN:COUP ON</code> <code>:CORR:IQ:Q:GAIN:COUP?</code>
Preset	ON
State Saved	Yes
Range	Same as I Gain Independent

6.4 Data Source

Contains controls that let you select the source of the data being fed to the instrument analysis engine.

The ability to Save and Record files of I/Q data is an important feature of some X-Series applications, and the Data Source controls allow you to switch back and forth from actual data at the instrument input and recorded data from a File.

In addition, some measurements allow you to retain a single measurement record in a Capture Buffer, and some measurements allow you to retain a specified length data record internally in a Recorded data area.

So, for measurements that support it, the controls on this tab allow you to select data from the instrument inputs, a recalled recording File, the Capture Buffer, or the Recorded data area. For measurements that do not support these features, the **Data Source** tab does not appear, and if `:FEED:DATA SCPI` is sent, an Undefined Header error is generated.

The available choices depend on which measurement you are running. All measurements support Input; Capture Buffer and File are only available in certain measurements, as shown in the table below. The choice of the internal Recorded data area is only available in Pulse Mode.

Measurement	Capture Buffer	File
WCDMA Code Domain	x	
WCDMA Mod Accuracy	x	
VMA Digital Demod		x
VMA Custom OFDM		x
5G NR Modulation Analysis		x
FDD LTE-A Modulation Analysis		x
TDD LTE-A Modulation Analysis		x
WLAN Modulation Analysis	x	x
WLAN Spectral Flatness		x
WLAN MIMO Modulation Analysis		x
Analog Demod AM		x
Analog Demod PM		x
Analog Demod FM		x
Analog Demod FM Stereo		x
Bluetooth Transmit Analysis	x	x
IoT & SRComms LoRa CSS Demod		x

How to Record and Playback I/Q Data

In several Demod measurements (and certain other measurements), it is possible to record I/Q data to files on your hard drive or network, and then recall these files for subsequent playback. These are the measurements shown in the table above with an “x” in the **File** column.

The Recording and Playback of signal data files is a multi-step process which involves controls in several menus (listed below).

Menus involved in Record/Playback:

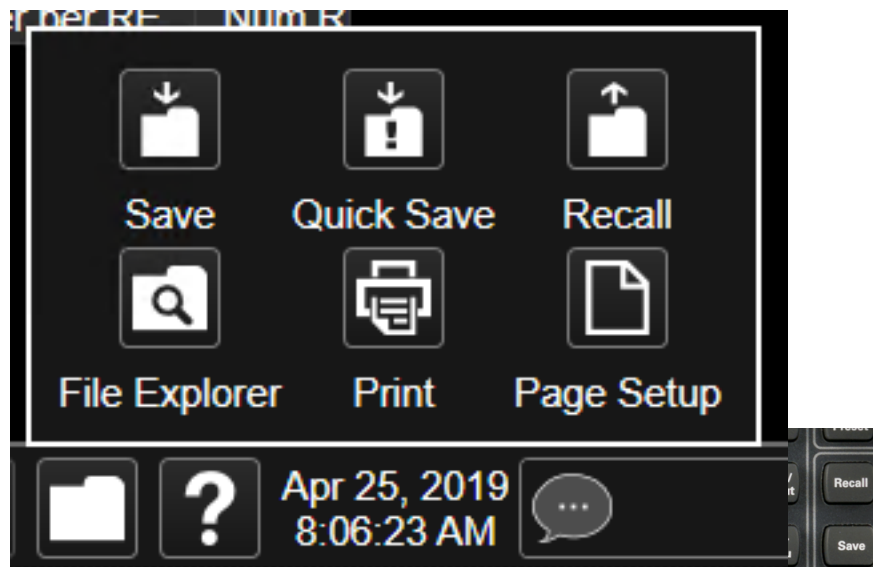

- **Save, Recording** (under the **Save** hardkey or the **Save** icon in the **File** panel)
- **Recall, Recording** (under the **Recall** hardkey or the **Recall** icon in the **File** panel)
- **Sweep, Recording** tab
- **Sweep, Playback** tab
- **Input/Output, Data Source** tab (this tab)

Saving a Recording

When you save a recording, a certain number of measurement records are saved to a Recording file. The amount of data that is saved varies depending on the measurement and measurement settings. The following example uses VMA Digital Demod to illustrate the process.

6 Input/Output

6.4 Data Source

If you press the **Recording** tab in the **Sweep** menu, you will see a certain number of parameters displayed on the menu panel. Before you save a Recording, these parameters are all 0, as shown below:

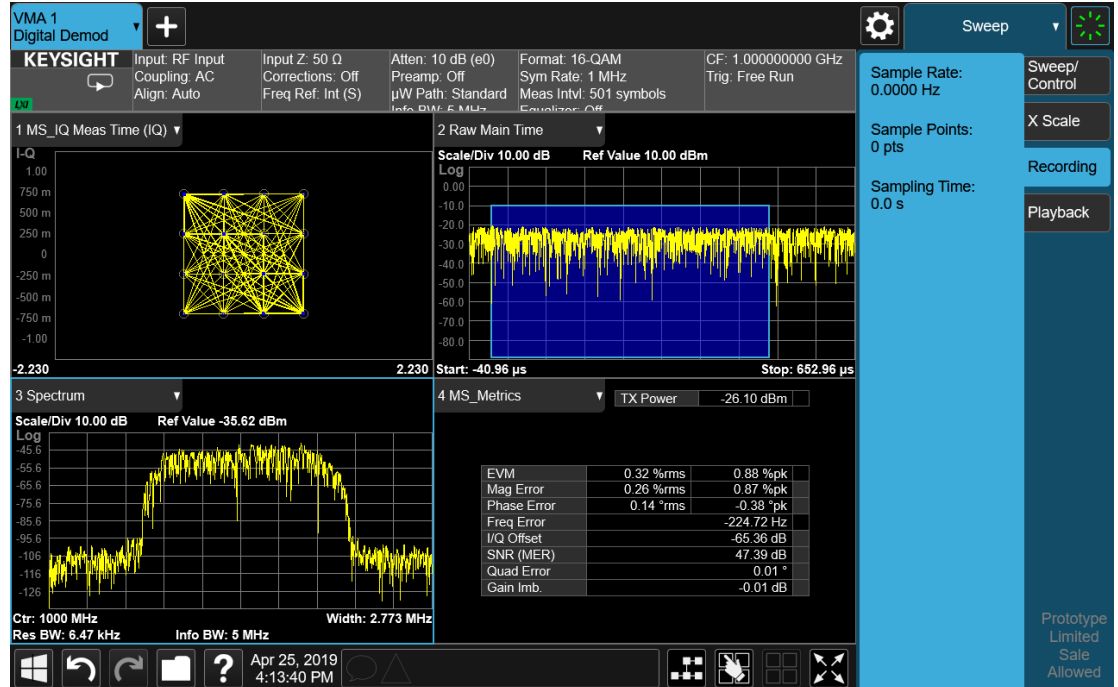

To save the data for the current measurement, press the **Save** hardkey (or the **Save** icon in the **File** panel) and press the **Recording** tab on the left side of the **Save** panel:

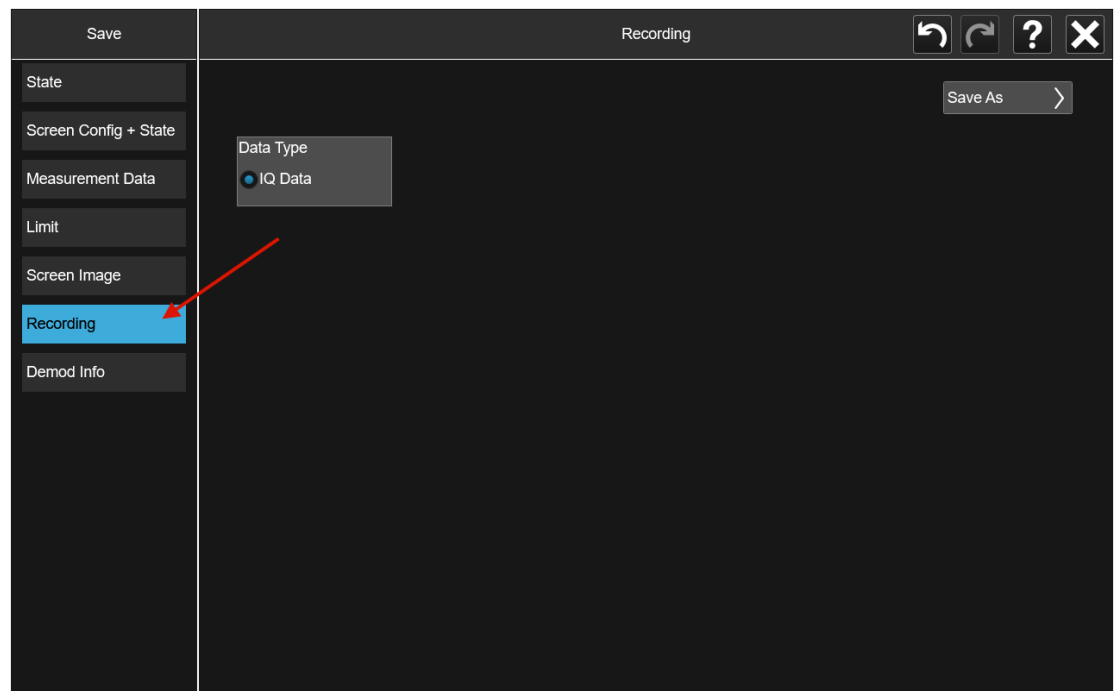

Then press **Save As** and choose the file type you would like to use for the Save (**CSV**, **SDF**, **TXT**, **BIN**, **BINX**). You can find details of the file formats in **Save > Recording**.

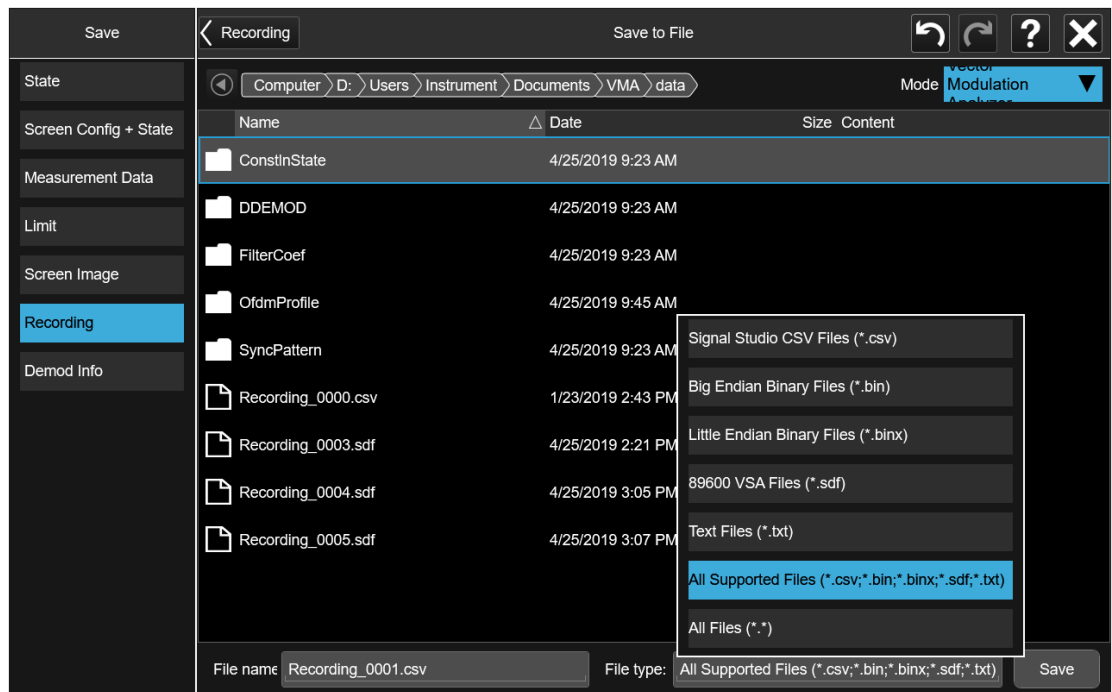

Then press **Save** to save the raw I/Q data of the current measurement.

After the Save, you will see that the data on the Recording panel has changed to describe the data in the file you just saved. You should note this data in case you need to refer to it when you recall the file, particularly as not all file formats include the Sample Rate that was used to save the data. In particular, **BIN** and **BINX** files do not include sampling rate information inside the file, so after recalling one of these file types, you will need to set the Sample Rate manually in the **Sweep, Playback** menu.

6 Input/Output

6.4 Data Source

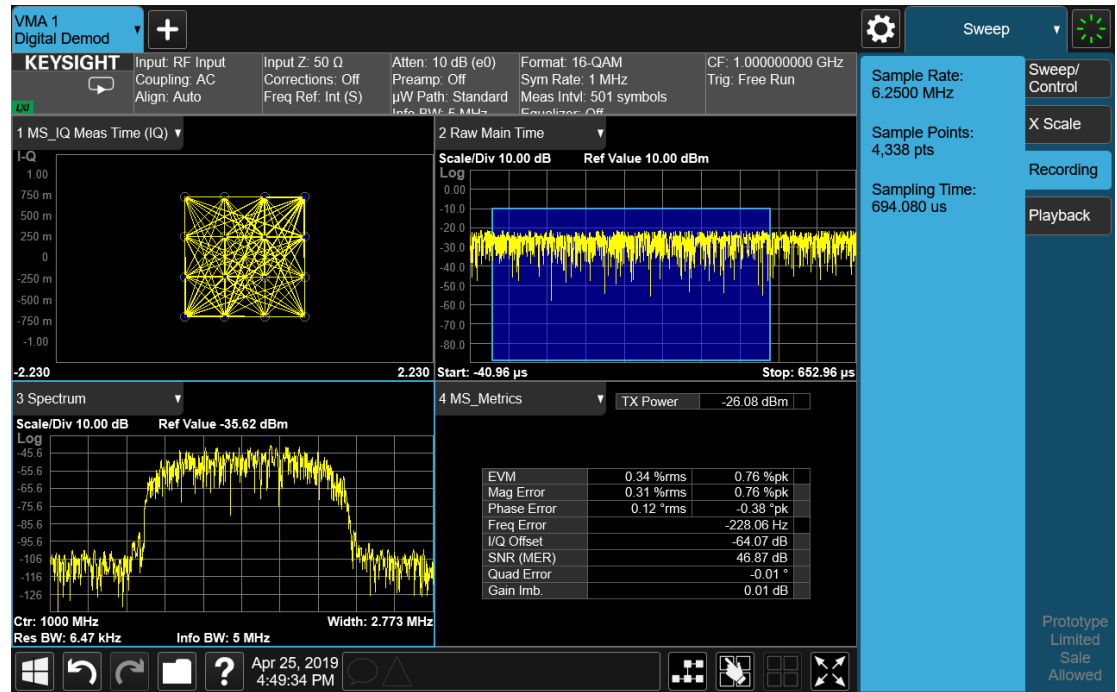

Step 2: Recalling a Recording

If you press the **Playback** tab in the **Sweep** menu, you will see a certain number of parameters displayed on the menu panel. Before you recall a Recording, these parameters are all 0, as shown below:

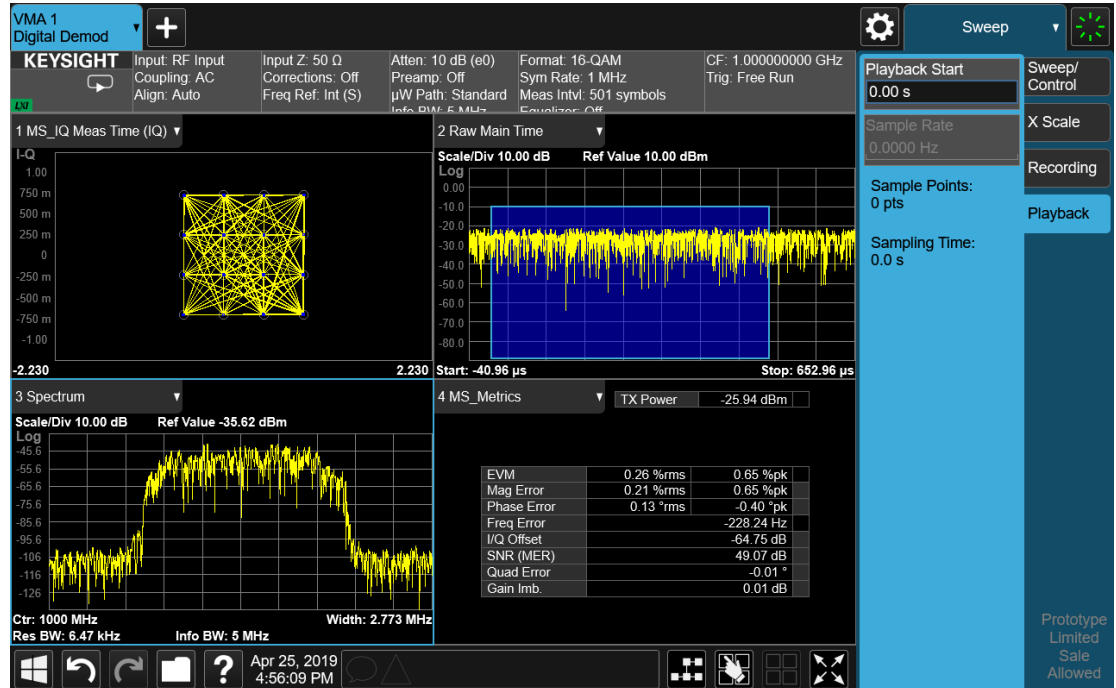

To recall a Recording, press the **Recall** hardkey (or the **Recall** icon in the **File** panel) and press the **Recording** tab on the left side of the **Recall** panel. Then press **Recall From** and choose the file you would like to recall. This will read the raw I/Q data from the specified file and feed it to the current measurement.

After the Recall, you will see that the data on the Recording panel has changed to describe the data in the file you just recalled:

6 Input/Output

6.4 Data Source

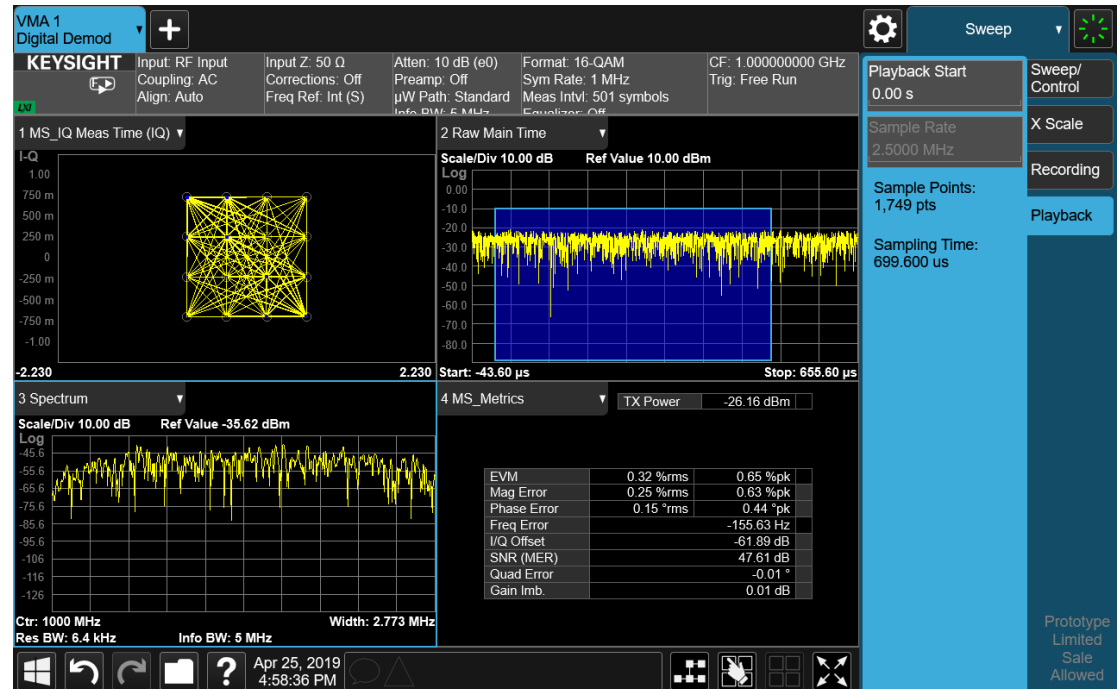

Note that the **Sample Rate** key is grayed out if the file type you loaded contains Sample Rate information. **BIN** and **BINX** files do not include sampling rate information inside the file, so after recalling one of these file types, you will need to set the Sample Rate. You should have noted the Sample Rate that was displayed on the **Sweep, Recording** menu panel after you saved the file.

After the recall is performed, you will also see that the **Data Source** control has switched to **File**. You can see this on the **Data Source** menu panel, and also on the dropdown from the Measurement Bar on the far-left side of the instrument:

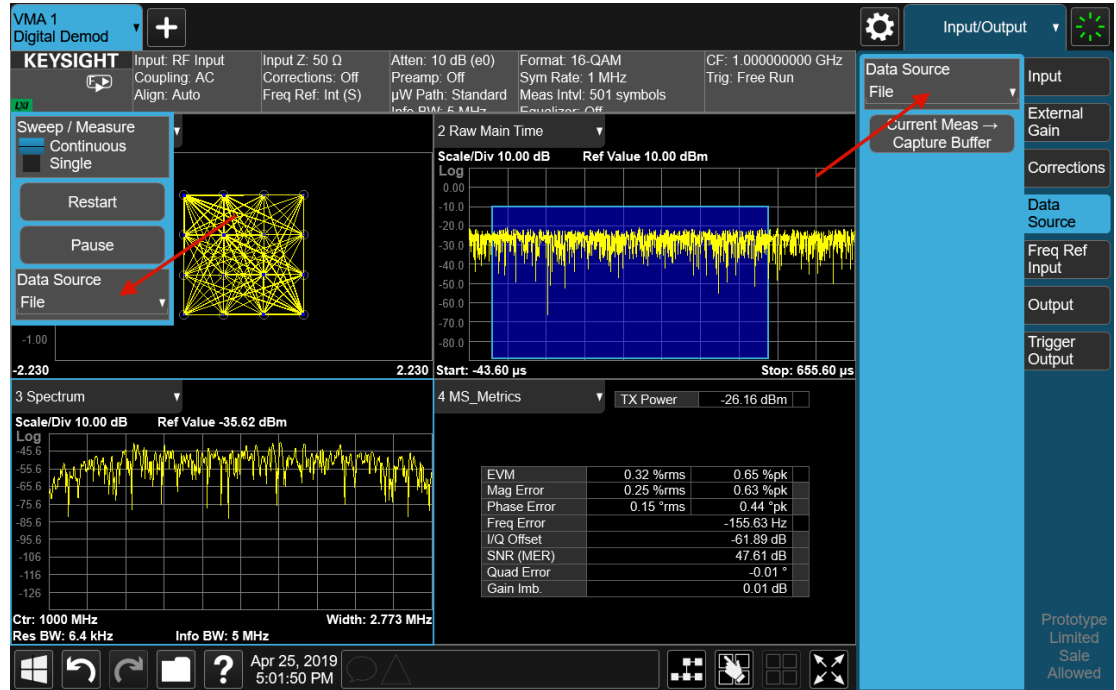

You can also see that the control indicator on the measurement bar has an “F” in it and the playback symbol (right facing triangle) displayed:

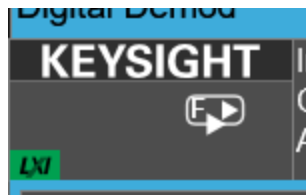

This indicates that the instrument is in **Continuous Playback** mode and is using data from a File.

If you select **Single** in the control dropdown, the indicator will change to show that it is in **Single Pause** mode as below:

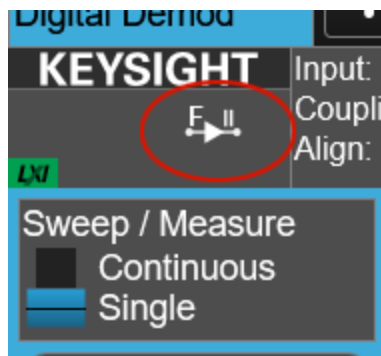

6 Input/Output

6.4 Data Source

You can now examine data in the recorded file which you loaded. How you do this depends on whether you are in **Continuous Playback** mode or **Single Pause** mode.

If you wish to return to looking at data at the instrument input, simply change the **Data Source** control from **File** back to **Input**.

Looking at your Recorded data

To examine the data you loaded, go to the **Playback** menu panel under **Sweep**. How you proceed from here depends on whether you are in **Continuous Playback** mode or **Single Pause** mode.

Continuous Playback mode

In this mode, turn the knob clockwise or use the **Up** key on the front panel to move through successive records in the recording. You will see the Playback Start control change from 0 to successively higher values as you move through the records.

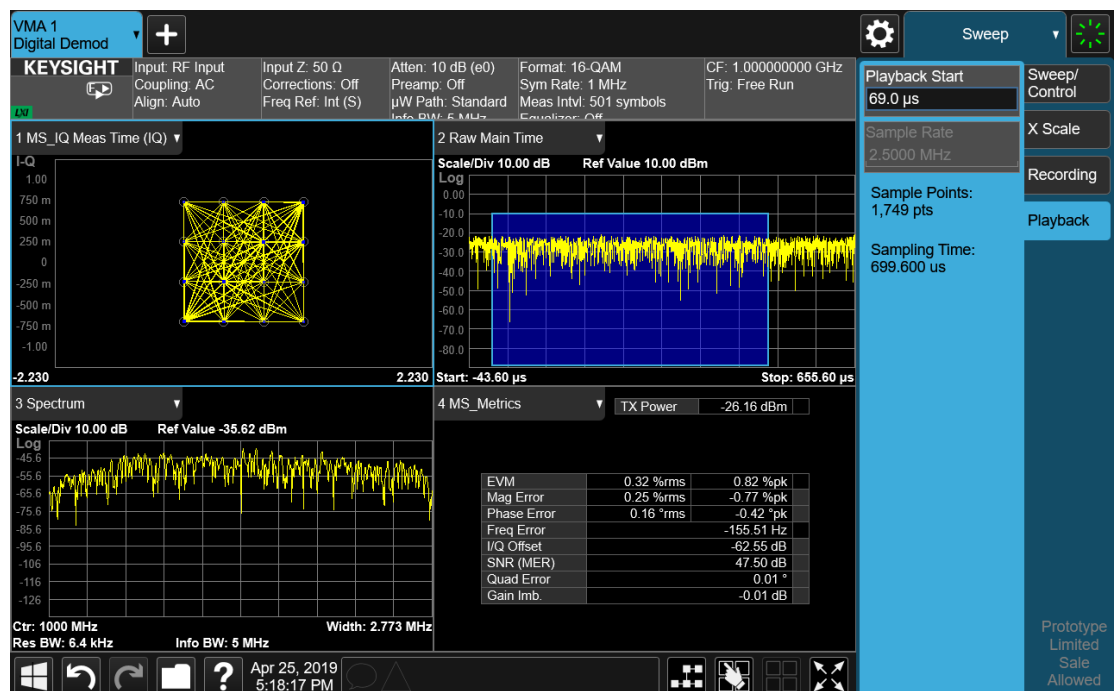

Single Pause mode

In this mode, you can only look at one record. Set the Playback Start time to the desired offset from zero and press **Restart**. A single record will be displayed.

Note that until you press **Restart**, the “invalid data” indicator (yellow asterisk) will be displayed in each window as below:

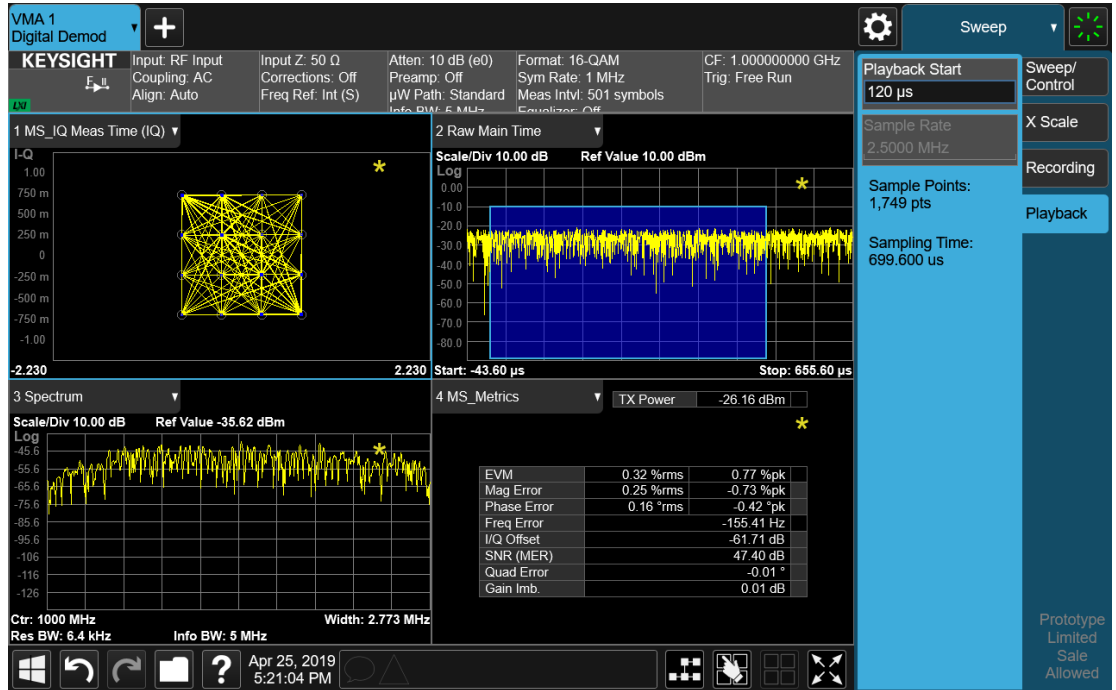

Once you press Restart, the invalid data indicator will disappear, as below:

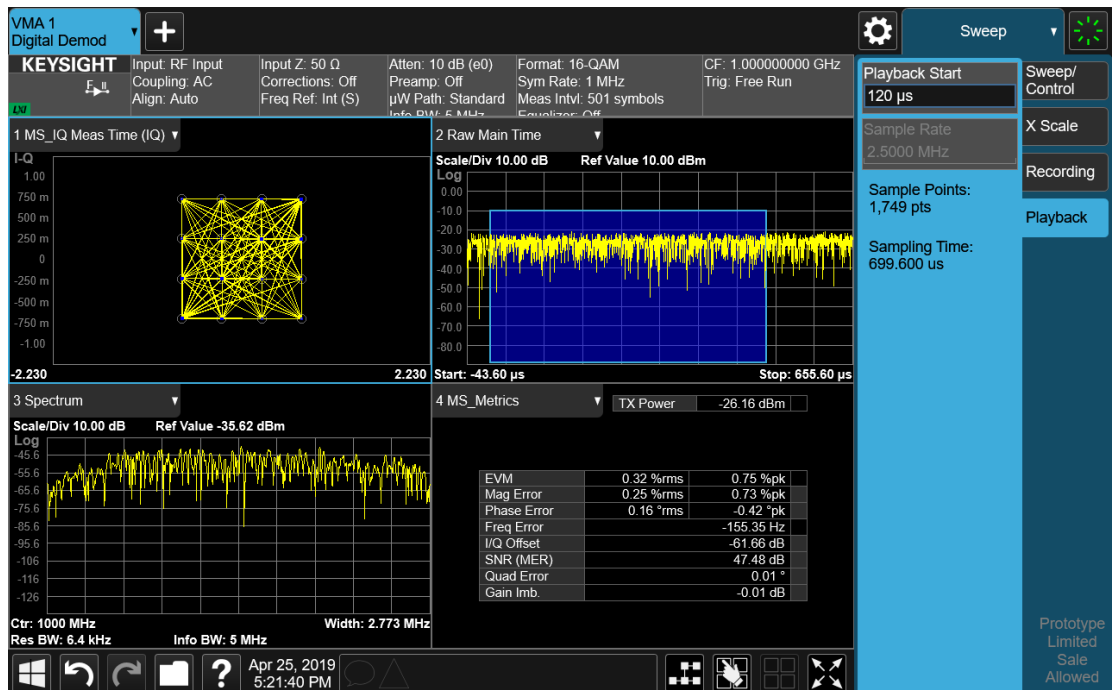

6.4.1 Data Source

Lets you select the input to the analysis engine. The following options are available:

Input	INPut	A hardware input signal (the default). This causes the measurement to take its input data from the hardware input (for example RF, I/Q, or EXTMixer) currently selected on the Input tab under Input/Output
Capture Buffer	STORed	Data stored in a storage buffer from a single earlier acquisition. Selecting "Capture Buffer" allows you to use data that has been previously stored using the "Current Meas -> Capture Buffer" control. You can make a measurement and then, if you want to make a different measurement using the exact same data, store the raw data using the "Current Meas -> Capture Buffer" control and select "Capture Buffer" as the Data Source, then switch to the other measurement. You must have previously done a "Current Meas -> Capture Buffer" before the Capture Buffer choice is available for use
Recorded	RECORded	Data recorded to memory from a set of earlier acquisitions. Selecting "Recorded" lets you use the record buffer, previously filled by using the "Recording" tab in the Sweep menu, as the input (only available in the Pulse measurement)
File	FILE	Data recorded on a storage device from a set of earlier acquisitions. If you load a Recording using Recording under the Recall key, "File" is automatically selected, which lets you use the recorded data as though it were coming from the Input

See "[Data Source](#)" on page 2195 for a table of available choices on a per-measurement basis.

Remote Command	<code>[:SENSe]:FEED:DATA INPut STORed RECORded FILE</code> <code>[:SENSe]:FEED:DATA?</code>
Example	Cause the measurement to look at the input selection: <code>:FEED:DATA INP</code> Cause stored measurement data to be used with a different measurement that supports this: <code>:FEED:DATA STOR</code>
Dependencies	If you switch to a measurement that does not support the currently selected Data Source, the instrument switches Data Source to "Input". Attempting to select an unavailable Data Source via SCPI generates an error The Data Source setting is independent for each mode. Not all Data Sources are available in all modes
Preset	Unaffected by Preset, but set to INPut by Restore Input/Output Defaults or Restore System Defaults->All
State Saved	Saved in instrument state
Backwards Compatibility SCPI	<code>[:SENSe]:FEED:SOURce INPut STORed</code> <code>[:SENSe]:FEED:SOURce?</code>

6.4.2 Current Meas -> Capture Buffer

Stores the raw data of one measurement in the internal memory of the instrument where it can then be used by a different measurement by pressing **Stored Data**. When raw data is stored, then the data source selection switch automatically changes to **Stored Data**. Stored raw data cannot be directly accessed. There is no save/recall function to save the raw data in an external media. If you want to get the stored raw data, you must first perform a measurement using the stored raw data. Now you can access the used raw data, which is the same as stored raw data, using the **:FETch** or **:READ** commands.

Remote Command	[:SENSe] :FEED:DATA:STORe
Example	:FEED:DATA:STOR stores recorded data
Notes	Command only; no query
Dependencies	Grayed-out in the SA measurement
Backwards Compatibility SCPI	[:SENSe] :FEED:SOURce:STORe

6.5 Corrections

Accesses the **Corrections** menu, which lets you select, turn on and off, and configure and edit Corrections. You can also select, turn on and off and configure Complex Corrections and Corrections Groups.

Corrections arrays provide Amplitude Corrections, and can be entered by the user, sent over SCPI, or loaded from a file. They allow you to correct the response of the instrument for various use cases. X-Series supports eight separate Corrections arrays, each of which can contain up to 2000 points. They can be turned on and off individually and any or all can be on at the same time. Corrections Groups let you load several (Amplitude) Corrections at a time into a Correction Group.

Complex Correction arrays provide both Amplitude and Phase Corrections, and can be loaded from a file. Currently the file type supported has the extension .s2p. Complex Corrections operate in much the same manner as Corrections - the X-series supports eight separate Complex Corrections arrays, each of which can contain up to 30000 points, and each Complex Correction can be turned on and off individually and any or all can be on at the same time. Some Modes, such as Spectrum Analyzer Mode, only support only the Amplitude (Magnitude) element of Complex Corrections. Other Modes, such as IQ Analyzer Mode and VMA, support both the Amplitude and Phase elements of Complex Corrections. If a Complex Correction is turned on in a Measurement that does not support Phase, only the Magnitude information will be used for the Correction.

Trace data is in absolute units and corrections data is in relative units. You can edit the Corrections arrays in the Corrections editor using the "Edit Correction" dialog (you cannot edit the Complex Corrections arrays; they can only be loaded from a file).

In zero span measurements (such as Zero Span in the Swept SA measurement), where the frequency is always the center frequency of the instrument, we apply the (interpolated) correction for the center frequency to all points in the trace. In the event where there are two correction amplitudes at the center frequency, we apply the first one in the table.

Note that the corrections are applied as the data is taken; therefore, a trace in **View** (Update Off) will not be affected by changes made to the corrections after the trace is put in **View**.

The **Corrections** tab only appears in Modes and Measurements that support Corrections and/or Complex Corrections. In other Modes, sending SCPI for Corrections and/or Complex Corrections will generate a Settings Conflict message

Corrections and Complex Corrections arrays are not affected by a Preset, because they are in the Input/Output system. They also survive shutdown and restarting of the instrument application, which means they will survive a power cycle. Corrections

and Complex Corrections arrays are reset (deleted) by Restore Input/Output Defaults. The following commands delete the correction registers:

- User Preset the current mode :**SYST:PRES:USER**
- User Preset all modes :**SYST:PRES:USER ALL**
- Full mode preset :**SYST:PRES:FULL**
- Restore power on default :**SYST:DEF PON**
- Restore all defaults :**SYST:DEF; :SYST:DEF ALL**
- Preset Input/Output variables :**SYST:DEF INP**
- Delete all corrections :**CORR:CSET:ALL:DEL**

The instrument Save State and Save Screen Config + State includes the data in the correction registers. If a measurement setup is saved and then recalled at a later time, the correction data will be recalled as well. This feature is useful for recreating the full instrument condition, but the user has to be careful that the recalled correction data is the desired data. For example, if the state is recalled on a different instrument different correction data might be needed. Or if the system is recalibrated, the correction data in the save state would then be stale. Applications that use measured data for corrections will generally need to reload the correction data from file whenever a state is recalled; this ensures that the correction data is current and applies to hardware in use.

In the EXM and EXF, on the RF Input/Output panel, there are two full-duplex RF ports (RFIO1 and RFIO2), RF Input and RF Output. When RF Input is selected, it will correspond to one input port from two half-duplex RF ports (RFIO3 and RFIO4), and when RF Output is selected, it will correspond to one output port from two half-duplex RF ports (RFIO3 and RFIO4). So, there are 8 sets of corrections in all that can be applied to the RF ports. Ports cannot share the same set of corrections, but a single port can have multiple corrections applied to it. The correction data is applied to incoming signals as well as transmitted signals and is in the form of a list of spot frequencies and amplitude correction levels.

Annotation	In EMI Mode, you can choose to display the correction details in the graph area by turning on Display, Annotation, Correction Annotation
------------	--

6.5.1 Select Correction

Specifies the selected correction. The term "selected correction" is used throughout this document to specify which correction will be affected by the functions.

Notes	The selected correction is remembered even when not in the correction menu
Preset	Set to Correction 1 by Restore Input/Output Defaults

6.5.2 Correction On/Off

Turning the Selected Correction from **OFF** to **ON** allows the values in it to be applied to the data. This state transition also automatically turns on "Apply Corrections" (sets it to **ON**), otherwise the correction would not take effect.

A new sweep is initiated if an amplitude correction is switched on or off. Note that changing, sending or loading corrections data does *not* directly initiate a sweep, however in general these operations will turn corrections on, which *does* initiate a sweep.

Remote Command	<code>[:SENSe]:CORRection:CSET[1] 2 ... 16[:STATe] ON OFF 1 0</code> <code>[:SENSe]:CORRection:CSET[1] 2 ... 16[:STATe]?</code>
Example	<code>:SENS:CORR:CSET1 ON</code>
Dependencies	Changing this from OFF to ON automatically turns on "Apply Corrections" Note that if any Correction is turned on that has a transducer unit set (other than "None"), the Y-Axis Unit of the instrument is forced to that Transducer Unit. All other Y-Axis Unit choices are grayed-out This command generates an "Option not available" error unless you have the proper option installed in your instrument
Preset	Not affected by Preset. Set to OFF by Restore Input/Output Defaults
State Saved	Saved in instrument state
Annotation	If <i>any</i> Correction is turned on, Corr in the Meas Bar displays in amber to indicate Corrections are in use
Backwards Compatibility Notes	Unlike legacy instruments, Preset does not turn Corrections off (Restore Input/Output Defaults does)

6.5.3 Correction Port

Maps one of the sets of corrections to a particular I/O port. This control allows any Input port (including External Mixing, BBIQ, the RF2 input, etc.) to be mapped to a specific Correction, so that the Correction is only applied when that Port is being used by the current Screen. You can also map any internal source Output port to a specific Correction.

When Current Input (CINPut) is selected for **Correction Port**, it chooses the current input port of the current Screen for the selected Correction. In other words, the Correction applies to whichever input is selected. If the input changes, the correction applies to the new input.

When using the VXT M9410A/11A with Remote Radio Heads (such as the Keysight M1740A mmWave Transceiver for 5G), the choices in the dropdown menu appear as :

Head h RFHD p

For example, if you have two Radio Heads (numbered 1 and 2), each of which have two RF half duplex ports, the choices for these ports appear as below:

Head and Port	Choice in dropdown	SCPI parameter
Head 1, port RF Tx/Rx 1	Head 1 RFHD 1	RRH1RFHD1
Head 1, port RF Tx/Rx 2	Head 1 RFHD 2	RRH1RFHD2
Head 2, port RF Tx/Rx 1	Head 2 RFHD 1	RRH2RFHD1
Head 2, port RF Tx/Rx 2	Head 2 RFHD 2	RRH2RFHD2

Remote Command `[:SENSe]:CORRection:CSET[1]|2|...|16:RF:PORT CINPut | RFIN | RFIN2 | AIQ | EMIXer | RFIO1 | RFIO2 | RFIO3 | RFIO4 | RFOut | RFHD | RFFD | ANT | GEN | TR | A1 | A2 | A3 | B1 | B2 | B3 | IFIO1 | IFIO2 | RRHnRFHDp | ERFIN`

See "Parameter Options" on page 2210

`[:SENSe]:CORRection:CSET[1]|2|...|16:RF:PORT?`

Example Set Correction Port for Correction 1 to apply to the currently selected input:

`:CORR:CSET:RF:PORT CINP`

Set Correction Port for Correction 4 to apply to Radio Head 1, RF Tx/Rx Port 2:

`:CORR:CSET4:RF:PORT RRH1RFHD2`

Notes The **RF** node in this command is retained for backwards compatibility, even though the scope of the Correction Port command goes beyond the RF ports and includes BBIQ and External Mixing

Dependencies **RFIN2** | **AIQ** | **EMIXer** are only available on C/E/M/P/UXA analyzers with the appropriate options loaded

RFOut is only available on modular products such as VXT

ANT, **GEN** and **TR** are only available in VXT and only when the M9470A module is installed, such as in the M8920A. Option "HDX" is required to enable the TR port

RFHD and **RFFD** are only available on VXT. Option HDX is required to enable RFHD port and option FDY is required to enable RFFD port

RFIO3 and **RFIO4** are only available on EXM with hardware M9431A

RFIN and **RFOut** are not available on EXM with hardware M9431A

ERFIN requires option "EXW"

Preset Unaffected by Preset. Set as below by **Restore Input/Output Defaults**:

For VXT: **RFIN**

For EXM, EXF: **RFIO1**

For all other models: **CINPut** (the currently selected input)

State Saved Saved in State

Parameter Options

Note that the presence of these ports is highly hardware dependent.

6 Input/Output
6.5 Corrections

Correction Port	SCPI	Note
Current Input	CINPut	The correction will be applied to whichever input is currently selected in the Input menu
RF Input	RFIN	Main RF Port Not available on EXM with hardware M9431A
RF Input 2	RFIN2	Second RF Port, labeled RF Input 2 Only available on certain instruments. Not available on modular instruments
BBIQ input	AIQ	Requires option BBA Not available on modular instruments
External Mixer	EMIXer	Requires option EXM Not available on modular instruments
Antenna	ANT	Antenna input port on M9470A, labeled Ant
Generator	GEN	Generator output port on M9470A, labeled Gen
T/R	TR	T/R port on M9470A, labeled T/R
RF Full Duplex	RFFD	On modular instruments, labeled RFFD . Option “FDX” is required to enable RFFD port
RF Half Duplex	RFHD	On modular instruments, labeled RFHD . Option “HDX” is required to enable RFHD port
A1	A1	On E7760B
A2	A2	On E7760B
A3	A3	On E7760B
B1	B1	On E7760B
B2	B2	On E7760B
B3	B3	On E7760B
IFIO1	IFIO1	On E7760B
IFIO2	IFIO2	On E7760B
RF Output	RFOut	Appears on some modular instruments Not available on EXM with hardware M9431A
RFIO1	RFIO1	Appears on some modular instruments
RFIO2	RFIO2	Appears on some modular instruments
RFIO3	RFIO3	Only available in EXM with hardware M9431A
RFIO4	RFIO4	Only available in EXM with hardware M9431A
GPS out	GPS	Appears on some modular instruments
GNSS out	GNSS	Appears on some modular instruments

6.5.4 Correction Direction

Selects whether corrections will be applied when the device associated with the specified correction is being used as an input, an output or in both directions. The choices are:

INPut	Correct the port only when the port is used as an Input
OUTPut	Correct the port only when the port is used as an Output
BOTH	Correct the port when the port is used as either an Input or an Output (or both)

A port that is only an Output is always corrected as an output if the Correction is On. A port that is only an Input is always corrected as an Input if the Correction is On. For a port that can be either an Input or an Output (or both), the Correction is determined by the Correction Direction setting. The default is **BOTH**, which means that by default a port that can be either an Input or an Output (or both) is corrected in both directions if the Correction is On.

Remote Command	<code>[:SENSe]:CORRection:CSET[1] 2 ... 16:DIRection INPut OUTPut BOTH</code> <code>[:SENSe]:CORRection:CSET[1] 2 ... 16:DIRection?</code>
Example	<code>:CORR:CSET2:DIR INP</code>
Dependencies	The Correction Direction control only appears when Correction Port selects a port that can either function as an input or an output (or both simultaneously), such as RFIO HD, RFFD or T/R. If the SCPI command is sent to any other port, it is accepted but ignored
Preset	Not affected by a Preset. Set to BOTH by Restore Input/Output Defaults
State Saved	Saved in State
Backwards Compatibility SCPI	The following SCPI results in the selection of BOTH (included for compatibility with early Multitouch implementations): <code>[:SENSe]:CORRection:CSET[1] 2 ... 8:DIRection BIDirectiona</code> included for compatibility with A-models modular products: <code>[:SENSe]:CORRection:CSET[1] 2 ... 8:RF:PORT:RFFD SOURce ANALyzer BOTH</code> <code>[:SENSe]:CORRection:CSET[1] 2 ... 8:RF:PORT:RFIO1 SOURce ANALyzer BOTH</code> <code>[:SENSe]:CORRection:CSET[1] 2 ... 8:RF:PORT:RFIO2 SOURce ANALyzer BOTH</code> <code>[:SENSe]:CORRection:CSET[1] 2 ... 8:RF:PORT:RFIO3 SOURce ANALyzer BOTH</code> <code>[:SENSe]:CORRection:CSET[1] 2 ... 8:RF:PORT:RFIO4 SOURce ANALyzer BOTH</code>

6.5.5 Edit Correction

Invokes the integrated editing facility for this correction set. When entering the menu, the editor window turns on, the selected correction is turned **On**, **Apply Corrections** is set to **On**, the amplitude scale is set to **Log**, and the Amplitude Correction (“Ampcor”) trace is displayed. The actual, interpolated correction trace is shown in green for the selected correction. Note that since the actual interpolated correction is shown, the correction trace may have some curvature to it. This trace represents only the correction currently being edited, rather than the total, accumulated amplitude correction for all amplitude corrections which are currently on, although the total, accumulated correction for all corrections which are turned on is still applied to the data traces.

Because corrections data is always in dB, but the Y-axis of the instrument is in absolute units, it is necessary to establish a reference line for display of the Corrections data. The reference line is halfway up the display and represents 0 dB of correction. It is labeled "0 dB CORREC". It is drawn in blue. Corrections data is always in dB. Whatever dB value appears in the correction table represents the correction to be applied to that trace at that frequency. So, if a table entry shows 30 dB that means we ADD 30 dB to each trace to correct it before displaying it. By definition all points are connected. If a gap is desired for corrections data, enter 0 dB.

Note that a well-designed Corrections array should start at 0 dB and end at 0 dB. This is because whatever the high-end point is will be extended to the top frequency of the instrument, and whatever the low-end point is will be extended down to 0 Hz. So, for a Corrections array to have no effect outside its range, you should start and end the array at 0 dB.

NOTE

The table editor only operates properly if the instrument is sweeping, because its updates are tied to the sweep system. Thus, you should not try to use the editor in single sweep, and its response will be sluggish during compute-intensive operations like narrow-span FFT sweeps.

When exiting the edit menu (by using the **Return** key or by pressing an instrument front-panel key), the editor window turns off and the Ampcor trace is no longer displayed; however, **Apply Corrections** remains **On**, any correction that was on while in the editor remains on, and the amplitude scale returns to its previous setting.

Corrections arrays are not affected by a Preset, because they are in the Input/Output system. They also survive shutdown and restarting of the instrument application, which means they will survive a power cycle.

When editing a correction, the editor remembers which correction and which element in the correction array you were editing, and returns you to that correction and that element when you return to the editor after leaving it.

6.5.5.1 Select Correction

Specifies the selected correction. The term "selected correction" is used throughout this document to specify which correction will be affected by the functions.

Notes	The selected correction is remembered even when not in the correction menu
Preset	Set to Correction 1 by Restore Input/Output Defaults

6.5.5.2 Frequency

Touching a frequency value makes the touched row the current row and lets you edit the frequency.

Min	0
Max	1 THz

6.5.5.3 Amplitude

Touching an amplitude value makes the touched row the current row and lets you edit the amplitude.

Min	-1000 dB
Max	1000 dB

6.5.5.4 Go to Row

Lets you move through the table to edit the desired point.

Min	1
Max	2000

6.5.5.5 Insert Row Below

Inserts a point below the current point. The new point is a copy of the current point and becomes the current point. The new point is not yet entered into the underlying table, and the data in the row is displayed in light gray. To enter the row into the table, press the **Enter** key, or tap either value and edit it.

6.5.5.6 Delete Row

Deletes the currently-selected point, whether or not that point is being edited, and selects the Navigate functionality. The point following the currently-selected point (or the point preceding if there is none) will be selected.

6.5.5.7 Scale X Axis

Matches the X-Axis to the selected Correction, as well as possible. Sets the Start and Stop Frequency to contain the minimum and maximum Frequency of the selected Correction. The range between Start Frequency and Stop Frequency is 12.5% above the range between the minimum and maximum Frequency, so that span exceeds this range by one graticule division on either side. If in zero-span, or there is no data in the Ampcor table, or the frequency range represented by the table is zero, no action is taken. Standard clipping rules apply if the value in the table is outside the allowable range for the X-Axis.

6 Input/Output
6.5 Corrections

Dependencies If either the first or last point in the array is outside the frequency range of the current input, an error message is generated:
“-221. Settings conflict; Start or Stop Freq out of range for current input settings”

6.5.5.8 Delete Correction

Deletes the correction values for this set. When this key is pressed, a prompt appears on the screen saying “Please press **Enter** or **OK** key to delete correction. Press **ESC** or **Cancel** to close this dialog.” The deletion is only performed if you press **OK** or **Enter**.

Remote Command `[:SENSe]:CORRection:CSET[1]|2|...|16:DELeTe`

Example `:CORR:CSET:DEL`
`:CORR:CSET1:DEL`
`:CORR:CSET4:DEL`

Notes Pressing this key when no corrections are present is accepted without error

6.5.5.9 Correction Graph

The **Correction Graph** embedded in the Edit Correction dialog lets you edit the Amplitude Correction visually. Each node in the Correction is represented by a gray circle. The current node has a blue outline in the table and a blue circle in the graph. Touch any circle and drag it where you want it to go.

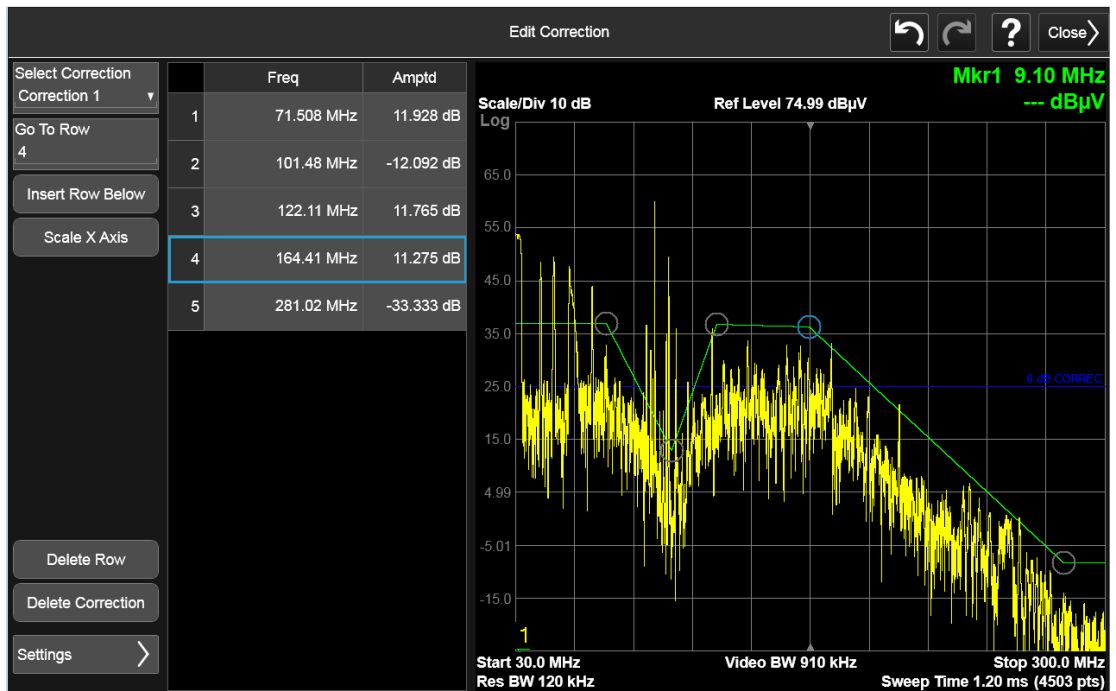

6.5.6 Edit Correction Settings

Opens another menu page that lets you set certain properties of the selected correction, such as Interpolation, Transducer Unit, Description and Comment.

6.5.6.1 Select Correction

Specifies the selected correction. The term "selected correction" is used throughout this document to specify which correction will be affected by the functions.

Notes	The selected correction is remembered even when not in the correction menu
Preset	Set to Correction 1 by Restore Input/Output Defaults

6.5.6.2 Freq Interpolation

Controls how the correction values per-bucket are calculated. We interpolate between frequencies in either the logarithmic or linear scale.

This setting is handled and stored individually per correction set.

VXT models M9410A/11A/15A/16A only support Linear Interpolation. For more details, see ["Interpolation" on page 2216](#)

Remote Command	<code>[:SENSe]:CORRection:CSET[1] 2 ... 16:X:SPACing LINear LOGarithmic</code>
Example	<code>:CORR:CSET:X:SPAC LIN</code>
Preset	Unaffected by Preset. Set to Linear by Restore Input/Output Defaults
State Saved	Saved in instrument state

Interpolation

For each bucket processed by the application, all of the correction factors at the frequency of interest (center frequency of each bucket) are summed and added to the amplitude. All trace operations and post processing treat this post-summation value as the true signal to use.

To effect this correction, the goal, for any particular start and stop frequency, is to build a correction trace, whose number of points matches the current Sweep Points setting of the instrument, which will be used to apply corrections on a bucket-by-bucket basis to the data traces.

6 Input/Output
6.5 Corrections

For amplitudes that lie between two user specified frequency points, we interpolate to determine the amplitude value. You may select either linear or logarithmic interpolation between the frequencies.

If we interpolate on a log scale, we assume that the line between the two points is a straight line on the log scale. For example, let's say the two points are (2,4) and (20,1). A straight line between them on a log scale looks like:

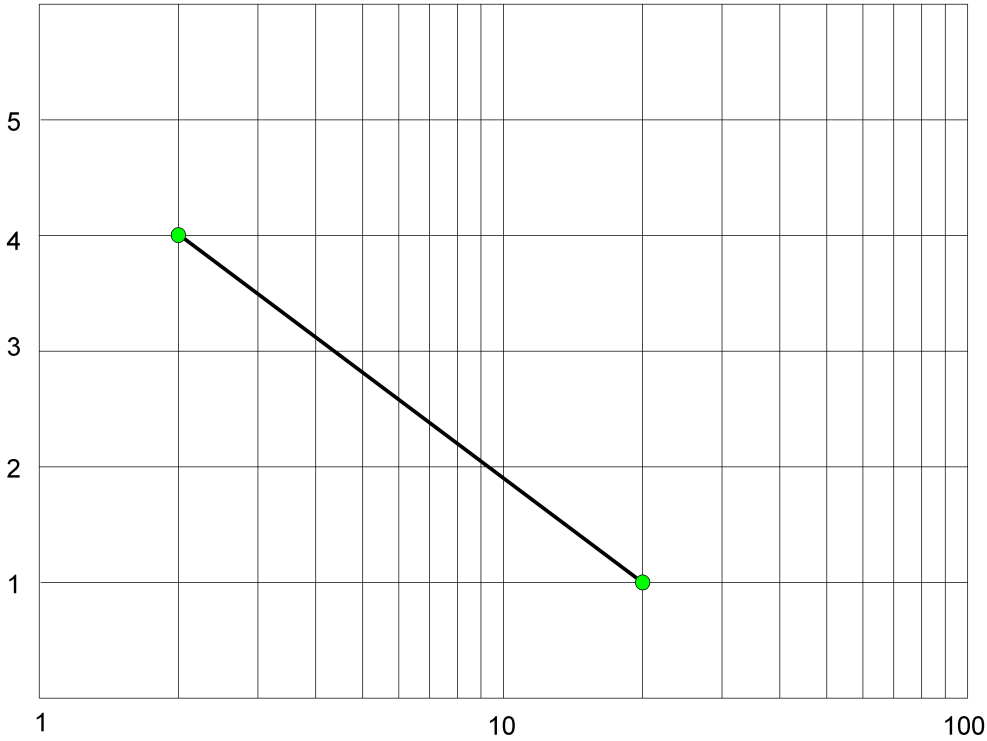

vsd17

On a linear scale (like that of the spectrum analyzer), this translates to:

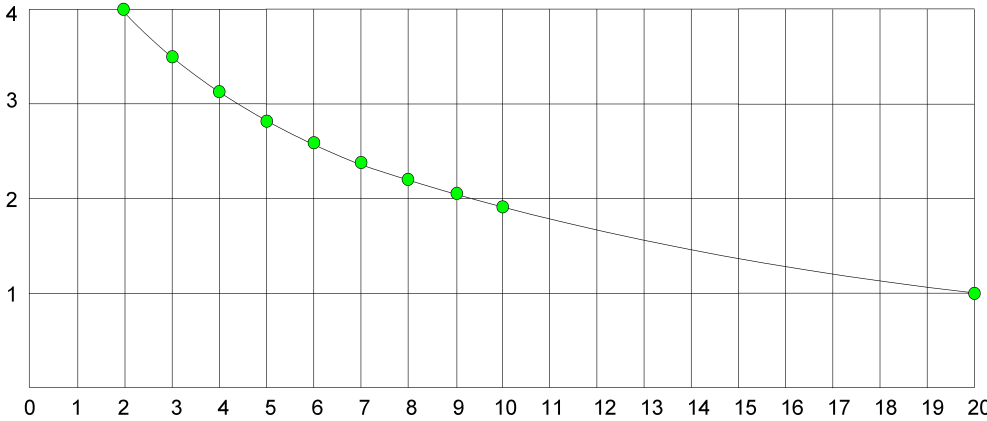

vsd19

If we interpolate on a linear scale, we assume that the two points are connected by a straight line on the linear scale, as below:

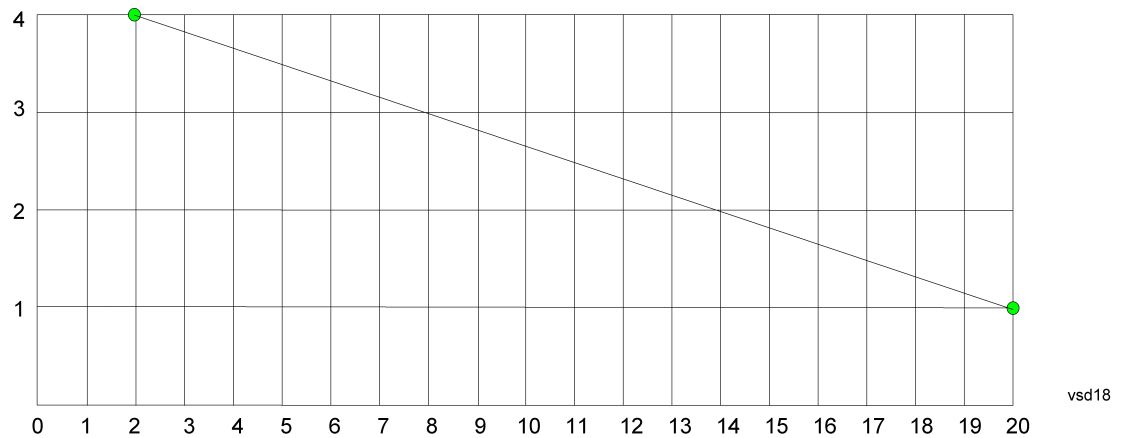

The correction to be used for each bucket is taken from the interpolated correction curve at the center of the bucket.

6.5.6.3 Transducer Unit

For devices (like antennas) that make measurements of field strength or flux density, the correction array should contain within its values the appropriate conversion factors such that, when the data on the instrument is presented in dBμV, the display is calibrated in the appropriate units. The "Transducer Unit" used for the conversion is contained within the corrections array database. It may be specified or loaded in from an external file or SCPI.

When an array with a Transducer Unit other than "None" is turned on, the Y Axis Unit of the instrument is forced to that unit. When this array is turned on, and it contains a Transducer Unit other than "None", the Y Axis Unit of the instrument is forced to that Transducer Unit., and all other Y Axis Unit choices are grayed out.

Transducer Unit only appears in certain Modes, it does not appear in all Modes that support Corrections.

See ["Examples" on page 2219](#)

Remote Command	<code>[:SENSe]:CORRection:CSET[1] 2 ... 16:ANTenna[:UNIT] GAUSS PTES1a UVM UAM UA NOConversion</code> <code>[:SENSe]:CORRection:CSET[1] 2 ... 16:ANTenna[:UNIT]?</code>
Example	<code>:CORR:CSET:ANT GAUS</code>
Dependencies	Only one Transducer units can be on at any given time. Note that this means that if a correction file with a Transducer Unit is loaded into a particular Correction, all other Corrections are set to that same Transducer unit When Normalize is On (in the Trace, Normalize menu) Transducer Unit is grayed-out and forced to None
Preset	Unaffected by Preset. Set to NOC by Restore Input/Output Defaults
State Saved	Saved in instrument state

Examples

The units that may be specified and what appears in the file and on the screen are shown below:

Transducer Unit	SCPI Example	In the Correction file	On the screen (also Y Axis Unit forced to)
dB μ V/m	:CORR:CSET:ANT UVM	Antenna Unit= μ V/m	dB μ V/m
dB μ A/m	:CORR:CSET:ANT UVA	Antenna Unit= μ A/m	dB μ A/m
dB μ A	:CORR:CSET:ANT UA	Antenna Unit= μ A	dB μ A
dBpT	:CORR:CSET:ANT PTES	Antenna Unit=pTesla	dBpT
DBG	:CORR:CSET:ANT GAUS	Antenna Unit=Gauss	DBG
None	:CORR:CSET:ANT NOC	Antenna Unit= (or no line at all)	none (not forced)

6.5.6.4 Description

Sets an ASCII description field which will be stored in an exported file. Can be displayed in the active function area by selecting as the active function, if desired to appear in a screen capture.

Remote Command	<code>[:SENSe]:CORRection:CSET[1] 2 ... 16:DESCription "text"</code> <code>[:SENSe]:CORRection:CSET[1] 2 ... 16:DESCription?</code>
Example	<code>:CORR:CSET1:DESC "11941A Antenna correction"</code>
Notes	45 chars max; may not fit on display if max chars used
Preset	Unaffected by a Preset. Set to empty by Restore Input/Output Defaults
State Saved	Saved in instrument state

6.5.6.5 Comment

Sets an ASCII comment field which will be stored in an exported file. Can be displayed in the active function area by selecting as the active function, if desired to appear in a screen capture.

Remote Command	<code>[:SENSe]:CORRection:CSET[1] 2 ... 16:COMMeNT "text"</code> <code>[:SENSe]:CORRection:CSET[1] 2 ... 16:COMMeNT?</code>
----------------	--

Example	<code>:CORR:CSET1:COMM "this is a comment"</code>
Notes	60 chars max; may not fit on display if max chars used
Preset	Unaffected by Preset. Set to empty by Restore Input/Output Defaults
State Saved	Saved in instrument state

6.5.7 Complex Corrections

This dialog is used to set up and display information about the **Complex Corrections** set. It also lets you view and edit certain information such as the Description and Comment for the selected Complex Correction.

Complex Corrections (loaded from **.s2p** files) support both magnitude and phase corrections, whereas standard corrections (loaded from standard Ampcor **.csv** files) support only magnitude corrections.

When loading an **.s2p** file, the component representing S21 is the one that is used to generate the complex correction. If no S21 component is present, a Mass Storage error is reported.

NOTE

Data types RI, MA, and DB are supported.

The phase components of the S2P file are taken to be in degrees, not in radians. You must provide the phase correction in degrees.

Unlike Correction files, S2P files describe device characteristics, rather than the correction required to compensate for those characteristics; so, when an S2P file is loaded, both the magnitude and phase are negated to turn it into a correction

Complex Corrections and standard corrections can be turned on at the same time. For example, you could turn on Correction 2, Correction 4, and Complex Correction 1 and 2, all at the same time. The magnitude part of all the corrections would add, and the phase part of the complex corrections would add.

You can have up to 64 Complex Corrections loaded simultaneously. Each Complex Correction can hold up to 30,000 points.

You can load a standard correction into Complex Corrections, but it will only provide a magnitude correction, not a phase correction.

NOTE

A standard correction (from a CSV file) can be loaded into a Complex Correction, but when it is loaded the Phase correction is set to 0 for all points.

Some measurements, like Swept SA, have no phase component to the measurement, but nonetheless support Complex Corrections. For such measurements, only the Magnitude part of the Complex Correction is applied.

6.5.7.1 Go To Row (Select Correction)

Specifies the selected complex correction. The selected correction will be identified by the blue outlined row in the dialog.

The "selected complex correction" is an important concept when sending SCPI commands to the Complex Corrections system, because in each case the SCPI command is directed to the currently selected Complex Correction and that will be the Correction which is modified by the SCPI command.

Remote Command	<code>[:SENSe]:CCORrection:CSET:SElect <integer></code> <code>[:SENSe]:CCORrection:CSET:SElect?</code>
Example	<code>:CCOR:CSET:SEL 3</code> <code>:CCOR:CSET:SEL?</code>
Notes	The selected correction is remembered even when not in the correction menu
Preset	Set to Correction 1 by Restore Input/Output Defaults
Min	1
Max	64

6.5.7.2 Delete Row

Deletes the currently-selected Complex Correction and clears all entries in that row to the default.

Remote Command	<code>[:SENSe]:CCORrection:CSET:DElete</code>
Example	Select correction 3: <code>:CCOR:CSET:SEL 3</code> Delete correction 3: <code>:CCOR:CSET:DEL</code>

6.5.7.3 Delete All

Deletes all complex corrections and clears all entries in all rows to the default.

When this key is pressed a prompt is placed on the screen that says "Please press Enter or OK key to delete all complex corrections. Press ESC or Cancel to close this dialog." The deletion is only performed if you press **OK** or **Enter**.

Remote Command	<code>[:SENSe]:CCORrection:CSET:ALL:DElete</code>
Example	<code>:CCOR:CSET:ALL:DEL</code>

6.5.7.4 Correction On

Checking or unchecking this box turns the Selected Complex Correction **ON** or **OFF**. Turning it **ON** causes the values in it to be applied to the data. This state transition also automatically turns on "Apply Corrections" (sets it to **ON**), otherwise the correction would not take effect.

A new sweep/acquisition is initiated if a complex correction is switched on or off. Note that changing, sending or loading corrections data does *not* directly initiate a sweep, however in general these operations will turn corrections on, which *does* initiate a sweep.

Remote Command	<code>[:SENSe]:CCORrection:CSET[:STATe] ON OFF 1 0</code> <code>[:SENSe]:CCORrection:CSET[:STATe]?</code>
Example	Select correction 3: <code>:CCOR:CSET:SEL 3</code> Turn correction 3 on: <code>:CCOR:CSET ON</code>
Dependencies	Changing this from OFF to ON automatically turns on "Apply Corrections" Grayed-out if Complex Corrections is not supported by the current measurement. A warning or SCPI error is generated if you try to turn it on under these circumstances: "Feature not supported for this measurement"
Preset	Not affected by Preset. Set to OFF by Restore Input/Output Defaults
State Saved	Saved in instrument state
Annotation	If <i>any</i> Complex Correction is turned on, CC in the Meas Bar will display in amber to indicate Complex Corrections are in use

6.5.7.5 Correction Port

Maps one of the sets of corrections to a particular I/O port. This control allows any Input port (including External Mixing, BBIQ, the RF2 input, etc.) to be mapped to a specific Correction, so that the Correction is only applied when that Port is being used by the current Screen. You can also map any internal source Output port to a specific Correction.

When Current Input (CINPut) is selected for **Correction Port**, it chooses the current input port of the current Screen for the selected Correction. In other words, the Correction applies to whichever input is selected. If the input changes, the correction applies to the new input.

When using the VXT M9410A/11A with Remote Radio Heads (such as the Keysight M1740A mmWave Transceiver for 5G), the choices in the dropdown menu will appear as

Head h RFHD p

6 Input/Output
6.5 Corrections

For example, if you have two Radio Heads (numbered 1 and 2), each of which have two RF half duplex ports, the choices for these ports will appear as below:

Head and Port	Choice in dropdown	SCPI parameter
Head 1, port RF Tx/Rx 1	Head 1 RFHD 1	RRH1RFHD1
Head 1, port RF Tx/Rx 2	Head 1 RFHD 2	RRH1RFHD2
Head 2, port RF Tx/Rx 1	Head 2 RFHD 1	RRH2RFHD1
Head 2, port RF Tx/Rx 2	Head 2 RFHD 2	RRH2RFHD2

See also the parameters, notes and examples table under "[Correction Port](#)" on page 2209.

Remote Command	<pre>[:SENSe]:CCORrection:CSET:PORT CINPut RFIN RFIN2 AIQ EMIXer RFOut RFIO1 RFIO2 RFIO3 RFIO4 RFHD RFFD ANT GEN TR A1 A2 A3 B1 B2 B3 IFIO1 IFIO2 RRHnRFHD ERFIN [:SENSe]:CCORrection:CSET:PORT?</pre>
Example	<p>Select correction 2: :CCOR:CSET:SEL 2</p> <p>Set correction 2 to RFIN: :CCOR:CSET:PORT RFIN</p> <p>Set Correction 2 to Radio Head 1, RF Tx/Rx Port 2: :CCOR:CSET:PORT RRH1RFHD2</p>
Dependencies	<p>RFIN2 AIQ EMIXer are only available on C/E/M/P/UXA analyzers with the appropriate options loaded</p> <p>RFOut is only available on modular products such as VXT</p> <p>ANT, GEN and TR are only available in VXT and only when the M9470A module is installed, such as in the M8920A. Option "HDX" is required to enable the TR port</p> <p>RFHD and RFFD are only available on VXT. Option HDX is required to enable RFHD port and Option FDX is required to enable RFFD port</p> <p>RFIO3 and RFIO4 are only available on EXM with hardware M9431A</p> <p>RFIN and RFOut are not available on EXM with hardware M9431A</p> <p>ERFIN requires option "EXW"</p>
Preset	Not affected by Preset. Set to CINPut by Restore Input/Output Defaults
State Saved	Saved in State

6.5.7.6 Direction

Selects whether corrections will be applied when the device associated with the specified correction is being used as an input, an output or in both directions. The choices are:

INPut Correct the port only when the port is used as an Input

	OUTPut	Correct the port only when the port is used as an Output
	BOTH	Correct the port when the port is used as either an Input or an Output (or both)
Remote Command	[:SENSe]:CCORrection:CSET:DIRection INPut OUTPut BOTH [:SENSe]:CCORrection:CSET:DIRection?	
Example	Firstly, select correction 4: :CCOR:CSET:SEL 4 Set correction 4 to Input: :CCOR:CSET:DIR INP	
Dependencies	For Inputs, the only choice is INPut , so an empty table cell is displayed. For Outputs, the only choice is OUTPut , so an empty table cell is displayed. If the SCPI command is sent while one of these ports is selected, it is accepted but ignored For a port that can be either an Input or an Output (or both), such as RFHD, RFFD or T/R, all three choices are available	
Preset	Not affected by Preset. Set to BOTH by Restore Input/Output Defaults	
State Saved	Saved in State	
Backwards Compatibility SCPI	The following SCPI will result in the selection of BOTH (included for compatibility with early Multitouch implementations): [:SENSe]:CCORrection:CSET:DIRection BIDirectiona	

6.5.7.7 Description

Shows the Description field for the selected Complex Correction. The Description field is loaded from the second line of the **.s2p** file. (Note that, if line 2 begins with “!”, the ! is not displayed in the Description field.)

Remote Command	[:SENSe]:CCORrection:CSET:DESCription "text" [:SENSe]:CCORrection:CSET:DESCription?	
Example	Firstly, select correction 4: :CCOR:CSET:SEL 4 :CCOR:CSET:DESC "PNA data import 1-1-18"	
Notes	45 chars max; may not fit on display if max chars used	
Preset	Unaffected by Preset. Set to empty by Restore Input/Output Defaults	
State Saved	Saved in instrument state	

6.5.7.8 Comment

Shows the Comment field for the selected Complex Correction. The Comment field is loaded from the third line of the **.s2p** file. (Note that, if line 3 begins with “!”, the ! is not displayed in the Comment field.)

6 Input/Output
6.5 Corrections

Remote Command	<code>[:SENSe]:CCORrection:CSET:COMMeNt "text"</code> <code>[:SENSe]:CCORrection:CSET:COMMeNt?</code>
Example	Firstly, select correction 4: <code>:CCOR:CSET:SEL 4</code> <code>:CCOR:CSET:COMM "this is a comment"</code>
Notes	60 chars max; may not fit on display if max chars used
Preset	Unaffected by Preset. Set to empty by Restore Input/Output Defaults
State Saved	Saved in instrument state

6.5.7.9 File

Shows the file from which the selected correction was loaded. If correction was loaded with a SCPI command (see ["Set Data \(Remote Command Only\)" on page 2226](#)) displays "(SCPI)". If no correction is loaded, displays "(No correction loaded)"

Notes	60 chars max; may not fit on display if max chars used
State Saved	Saved in instrument state

6.5.7.10 Freq Interpolation (Remote Command Only)

Controls how the correction values per-bucket are calculated. We interpolate between frequencies in either the logarithmic or linear scale.

This setting is handled and stored individually per correction set.

VXT models M9410A/11A/15A/16A and M9410E/11E/15E/16E only support Linear Interpolation.

See ["Interpolation" on page 2216](#) under Corrections.

Remote Command	<code>[:SENSe]:CCORrection:CSET:X:SPACing LINear LOGarithmic</code> <code>[:SENSe]:CCORrection:CSET:X:SPACing?</code>
Example	Firstly, select correction 4: <code>:CCOR:CSET:SEL 4</code> Set linear interpolation: <code>:CCOR:CSET:X:SPAC LIN</code>
Preset	Unaffected by Preset. Set to LINear by Restore Input/Output Defaults
State Saved	Saved in instrument state

6.5.7.11 Set Data (Remote Command Only)

Lets you set the magnitude part of a complex correction's data via a SCPI command. This is provided for compatibility with the similar command for standard corrections, to allow you to use Complex Corrections as an extension to standard corrections.

Sending this command sets the phase part of the selected correction to 0 for all points.

The command takes an ASCII series of alternating frequency and amplitude points, each value separated by commas.

The values sent in the command will totally replace all existing correction points in the specified set.

A Complex Correction array can contain 30000 points maximum.

Remote Command	<code>[:SENSe]:CCORrection:CSET:DATA <freq>, <ampl>, ...</code> <code>[:SENSe]:CCORrection:DATA?</code>		
Example	<p>Firstly, select correction 4: <code>:CCOR:CSET:SEL 4</code></p> <p>This defines two correction points at (10 MHz, -1.0 dB) and (20 MHz, 1.0 dB) for correction set 4: <code>:CCOR:CSET:DATA 10000000,-1.0,20000000,1.0</code></p>		
Preset	Empty after Restore Input/Output Defaults . Survives a shutdown or restart of instrument application (including a power cycle)		
State Saved	Saved in instrument state		
Min/Max		Min	Max
	Freq	0 Hz	1 THz
	Amptd	-1000 dBm	+1000 dBm

6.5.8 Apply Corrections

When you turn on Apply Corrections, all of the Corrections that are turned On are applied to the measured data. When you turn off Apply Corrections, no Corrections are applied, even if they are turned On.

With this switch you can turn the entire Corrections system on and off without affecting the settings of any individual Corrections. Turning Apply Corrections On and Off has no effect on the On/Off switches under the individual Corrections.

6 Input/Output
6.5 Corrections

Apply Corrections affects both normal Corrections and Complex Corrections. Normal Corrections are turned On and Off using the Correction switch under Select Correction:

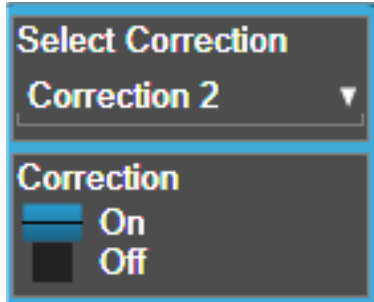

Complex Corrections are turned On and Off using the checkboxes in the Complex Corrections dialog:

Correction	On	Port	Direction	
1	<input checked="" type="checkbox"/>	Current Input	Input	D
2	<input type="checkbox"/>	Current Input	Input	

See "[Correction On/Off](#)" on page 2209) and "[Complex Corrections](#)" on page 2220.

Remote Command	<code>[:SENSe]:CORRection:CSET:ALL[:STATe] ON OFF 1 0</code> <code>[:SENSe]:CORRection:CSET:ALL[:STATe]?</code>
Example	<code>:SENS:CORR:CSET:ALL OFF</code> This command makes sure that no amplitude corrections are applied, regardless of their individual on/off settings
Couplings	Whenever you turn on any Correction or Complex Correction, Apply Corrections is automatically set to ON
Preset	Not affected by Preset. Set to OFF by Restore Input/Output Defaults
State Saved	Saved in instrument state
Annunciation	When ON , 'CORREC' appears in the Meas Bar as long as at least one of the individual corrections is enabled

6.5.9 Delete All Corrections

Erases all correction values for all Amplitude Correction sets and Complex Corrections.

When this key is pressed a prompt is placed on the screen that says “Please press Enter or OK key to delete all corrections. Press ESC or Cancel to close this dialog.” The deletion is only performed if you press **OK** or **Enter**.

Remote Command	<code>[:SENSe]:CORRection:CSET:ALL:DELeTe</code>
Example	<code>:CORR:CSET:ALL:DEL</code>

6.5.10 Correction Group On/Off

Turns the Correction Group on and off. The Correction Group allow you to preload Correction files and associate them with specific frequency ranges, so that they can be switched in and out during a sweep at the appropriate frequencies. Use the control “Edit Correction Group” below to set up your Correction Group.

The state of each Correction will be set dynamically depending on the active measurement frequency. Only the correction selected for the range that matches the active measurement frequency will be turned on, and vice versa.

Note that the Corrections in the Correction Group, although they are loaded into memory, are independent of the main Correction registers at the top of the Corrections menu, and will not display under the Select Correction, Correction On/Off or Edit Correction functions.

Remote Command	<code>[:SENSe]:CORRection:CSET:GRoup[:STATe] ON OFF 1 0</code> <code>[:SENSe]:CORRection:CSET:GRoup[:STATe]?</code>
Example	<code>:SENS:CORR:CSET:GRO ON</code>
Dependencies	Correction group is supported in EMI Receiver Mode, and in Spectrum Analyzer Mode if option EMC or EMI Receiver Mode is present. If you switch to other measurements or modes, correction group is turned off and the Correction Group functions are not visible
Couplings	When on, Correction 1 through 8 is set to OFF and the correction on/off state keys are grayed out. If the grayed-out key is pressed, it generates an advisory message. If sending the SCPI to turn it on, this same message is generated as part of Settings conflict
Preset	Not affected by Preset. Set to OFF by Restore Input/Output Defaults
State Saved	Saved in instrument state

6.5.11 Break

If break is turned on, the scan or sweep will be paused when it reaches the boundary of correction group ranges. At the same time, a window at the size of ~ 6.5cm x 3.5 cm is prompt at the upper right-hand corner of the graticule.

When running Frequency Scan measurement of Emi Receiver application, the message prompt is like below. You are given the option to resume the scan or stop the scan.

6 Input/Output
6.5 Corrections

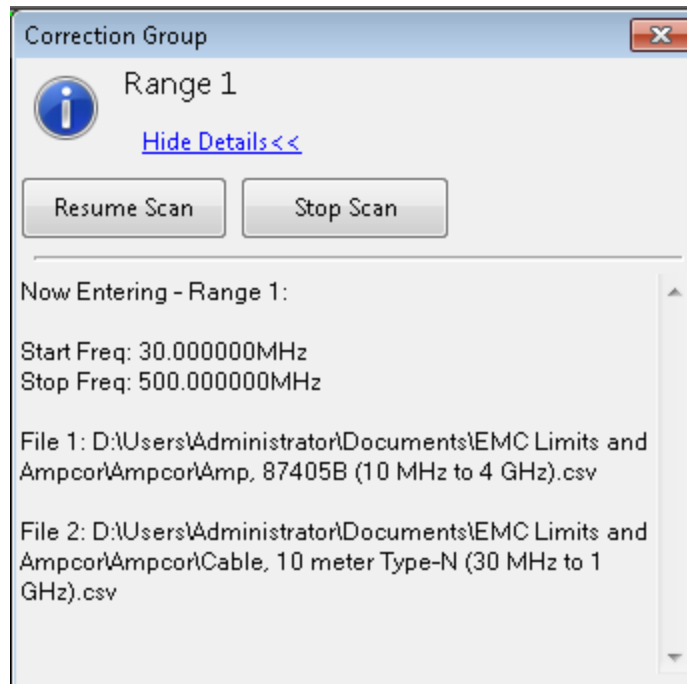
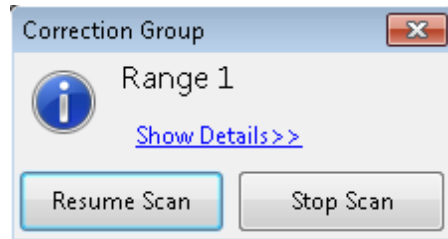

When running the Swept SA measurement in Spectrum Analyzer Mode, the message prompt is as below. You are given the option to resume the sweep or turn off the break. If in Continuous sweep, the sweep will resume after the break is turned off.



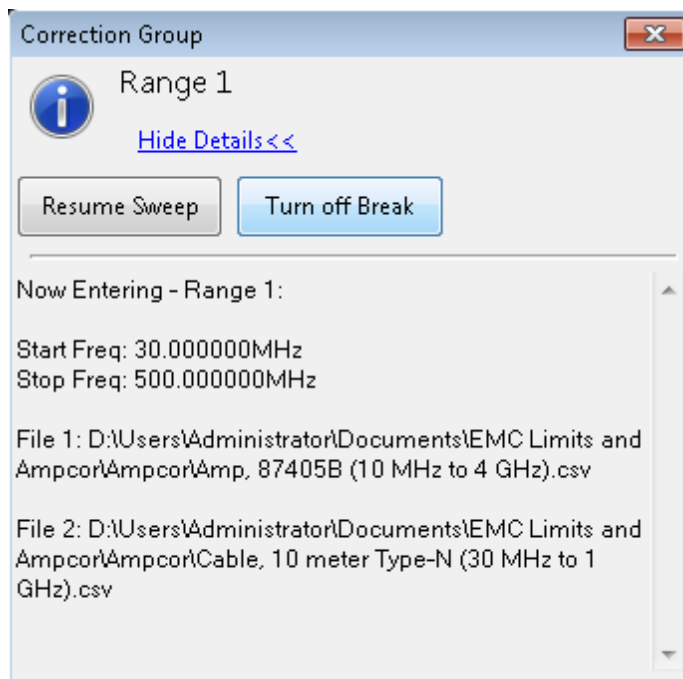

Remote Command	<code>[:SENSe]:CORRection:CSET:GROup:BRak ON OFF 1 0</code> <code>[:SENSe]:CORRection:CSET:GROup:BRak?</code>
Example	<code>:SENS:CORR:CSET:GRO:BR ON</code>
Notes	<p>When running the Frequency Scan measurement in EMI Receiver Mode, if break is turned on when a SCPI is sent to start the scan, the scan pauses when it reaches the boundary of correction group ranges. Bit 8 (Paused) of status operation register is set to true. To resume, send <code>:INITiate2:RESume</code>. To stop the scan, send <code>:ABORT</code></p> <p>When running the Swept SA measurement in Spectrum Analyzer Mode, the break state does not affect the operation of sweep when SCPI to control the sweep is sent. Instead, the SCPI commands close the message prompt if it is showing at the point the commands are sent, and the break is turned off. The SCPI includes:</p> <p><code>:INITiate:IMMEdiate</code> <code>:INITiate:REStart</code> <code>:INITiate:CONTinuous ON OFF 1 0</code> <code>:ABORT</code></p>
Dependencies	Correction group is supported in EMI Receiver Mode, and in Spectrum Analyzer Mode if option EMC or EMI Receiver mode is present. If you switch to other measurements or modes, correction group is turned off and the Correction Group functions (like Break) are not visible
Preset	Not affected by Preset. Set to OFF by Restore Input/Output Defaults
State Saved	Saved in instrument state

6.5.12 Reload Corrections From Files

Because the Correction data for the Correction Group is loaded into memory from Correction files at the time the Group is defined, it will be necessary to reload some or all of the data if any of the files changes. This function reloads all of the correction data from all of the correction files defined in all of the ranges in the Correction Group.

Remote Command	<code>[:SENSe] :CORRection:CSET:GROup:RELoad</code>
Example	<code>:MMEM:STOR:CORR:GRO:REL</code>
Notes	If invalid data is found in the files, the correction group will be set to off, and an Execution error is generated. Error icon appears on the status column correction group table
Dependencies	Correction group is supported in EMI Receiver Mode, and in Spectrum Analyzer mode if option EMC or EMI Receiver Mode is present. If you switch to other measurements or modes, correction group is turned off and the Correction Group functions (like Reload Correction From File) are not visible
Annotation	If reload fails, error icons appear in the status column of correction group editor for the range that has the error

6.5.13 Edit Correction Group

Opens the Table Editor for the correction group. The content of correction group table including the correction data loaded from the files is not affected by Preset, and it survives power cycle. You can set it to empty with **Restore Input/Output Defaults**.

Dependencies	Correction group is supported in EMI Receiver Mode, and in Spectrum Analyzer Mode if option EMC or EMI Receiver Mode is present. If you switch to other measurements or modes, correction group is turned off and the Correction Group functions (like Edit Correction Group) are not visible
--------------	---

6.5.13.1 Go to Row

Lets you move through the table to edit the desired point.

Min	1
Max	2000

6.5.13.2 Insert Row Below

Inserts a point below the current point. The new point starts from the current range stop frequency and becomes the current point. The new point is not yet entered into the underlying table, and the data in the row is displayed in light gray.

6.5.13.3 Delete Row

Deletes the currently-selected point, whether or not that point is being edited, and selects the Navigate functionality. The point following the currently-selected point (or the point preceding if there is none) will be selected.

6.5.13.4 Select File

Indicate the correction files in which the specify file and remove file operations will take effect.

Preset	Unaffected by a Preset. Set to empty by Restore Input/Output Defaults
--------	--

6.5.13.5 Specify File

Displays the file browsing menu. When a file is selected, correction data will be loaded from the file. The correction data remains until the file is removed or the range is deleted.

Notes	<p>If the file is empty, error -250 is reported. If the file does not exist error -256 is reported. If there is a mismatch of data type, error -250 is reported</p> <p>Only one file with antenna unit can be supported per range. If you try to add another file which contains an antenna unit, a Mass Storage error is generated</p> <p>All ranges have to use a common antenna unit. If you try to add a correction file that contains a different antenna unit, a Mass Storage error is generated</p> <p>If you try to add a correction file that contains data that does not cover the range frequency, the file cannot be added, and an Execution error is generated</p>
-------	---

6.5.13.6 Remove File

Removes the selected file. When a file is removed, correction data for that file will be removed as well.

Dependencies	The key is grayed-out if there the file has not been specified. If the grayed-out key is pressed, an advisory message is generated
--------------	--

6.5.13.7 Correction Trace Display

Enables you to view the correction traces of all corrections that are added to the range currently selected. A 2-column table in the function of frequency and the accumulated amplitude correction is displayed at the left pane.

Preset	OFF
State Saved	Saved in instrument state

6.5.13.8 Description

Provides a description of up to 60 characters by which you can easily identify the correction group. The descriptions will be stored in the exported file and can be displayed in the active function area by selecting them as the active function, if desired to be in a saved screen dump.

Remote Command	<code>[:SENSe]:CORRection:CSET:GROup:DESCRiption "text"</code>
Example	<code>:CORR:CSET:GRO:DESC "Radiated Setup"</code>
Notes	60 chars max; may not fit on display if max chars used
Preset	Unaffected by Preset. Set to empty by Restore Input/Output Defaults
State Saved	Saved in instrument state

6.5.13.9 Comment

Provides a comment of up to 60 characters by which you can easily identify the correction group. The comments will be stored in the exported file and can be displayed in the active function area by selecting them as the active function, if desired to be in a saved screen dump.

Remote Command	<code>[:SENSe]:CORRection:CSET:GROup:COMMeNt "text"</code>
Example	<code>:CORR:CSET:GRO:COMM "For internal only"</code>
Notes	60 chars max; may not fit on display if max chars used
Preset	Unaffected by Preset. Set to empty by Restore Input/Output Defaults
State Saved	Saved in instrument state

6.5.13.10 Start Frequency

Touching a **Start Frequency** value makes the touched row the current row and lets you edit the start frequency.

Notes	You cannot set the Start Frequency to a value greater than Stop Frequency or equal to Stop Frequency. You cannot set the Start Frequency to a value that would create a span of less than 10 Hz. If you try to do any of these, the Stop Frequency will change to maintain a minimum span of 10 Hz If you change the Start Frequency of the selected range to a value smaller than the previous range's Stop Frequency, the Stop Frequency of the previous range will be changed to the same value
-------	---

	If you change the Start Frequency of the selected range to a value out of the correction data frequency range, an error icon appears on the status column and an Execution error is generated
Preset	Unaffected by Preset. Set to empty by Restore Input/Output Defaults
Min	0
Max	1 THz

6.5.13.11 Stop Frequency

Touching a **Stop Frequency** value makes the touched row the current row and lets you edit the stop frequency.

Notes	You cannot set the Stop Frequency to a value greater than Start Frequency or smaller than Start Frequency. You cannot set the Stop Frequency to a value that would create a span of less than 10 Hz. If you try to do any of these, the Start Frequency will change to maintain a minimum span of 10 Hz If you change the Stop Frequency of the selected range to a value greater the next range's Start Frequency, the Start Frequency of the next range will be changed to the same value If you change the Stop Frequency of the selected range to a value out of the correction data frequency range, an error icon appears on the status column and an Execution error is generated
Preset	Unaffected by Preset. Set to empty by Restore Input/Output Defaults
Min	0
Max	1 THz

6.5.14 Merge Correction Data (Remote Command Only)

Accepts an ASCII series of alternating frequency and amplitude points, each value separated by commas. The difference between this command and **Set Data** is that this merges new correction points into an existing set.

If any new point has the same frequency as an existing correction point, the existing point's amplitude is replaced by that of the new point.

An Ampcor array can contain 2000 total points, maximum.

Remote Command	<code>[[:SENSE]:CORRection:CSET[1] 2 ... 16:DATA:MERGe <freq>, <ampl>, ...</code>
Example	<code>:CORR:CSET1:DATA:MERGE 15000000,-5.0,25000000,5.0</code> This adds two correction points at (15 MHz, -5.0 dB) and (25 MHz, 5.0 dB) to whatever values already exist in correction set 1
Preset	Empty after Restore Input/Output Defaults . Survives shutdown/restart of instrument application (including power cycle)

Min/Max	Min	Max
Freq	0 Hz	1 THz
Amptd	-1000 dBm	+1000 dBm

6.5.15 Set (Replace) Data (Remote Command Only)

Accepts an ASCII series of alternating frequency and amplitude points, each value separated by commas.

The values sent in the command totally replace all existing correction points in the specified set.

An Ampcor array can contain 2000 points maximum.

Remote Command	<code>[:SENSe]:CORRection:CSET[1] 2 ... 16:DATA <freq>, <amp1>, ...</code> <code>[:SENSe]:CORRection:CSET[1] 2 ... 16:DATA?</code>
Example	<code>:CORR:CSET1:DATA 10000000,-1.0,20000000,1.0</code> This defines two correction points at (10 MHz, -1.0 dB) and (20 MHz, 1.0 dB) for correction set 1
Preset	Empty after Restore Input/Output Defaults . Survives a shutdown or restart of instrument application (including a power cycle)
State Saved	Saved in instrument state
Min	Freq: 0 Hz Amptd: -1000 dBm
Max	Freq: 1 THz Amptd: +1000 dBm

6.5.16 Correction Group Range Data (Remote Command Only)

Accepts an ASCII series of alternating start frequency, stop frequency and file names, each value separated by commas.

The values sent in the command replace the content of correction group.

The default path for CSV files is:

`D:\My Documents\amplitudeCorrections\`

Remote Command	<code>[:SENSe]:CORRection:CSET:GR0up[1] 2 ... 10:DATA <startFreq>,<stopFreq>,<filename1>,<filename2>,...,<filename8></code> See Notes below for explanation of the <filenameN> parameters <code>[:SENSe]:CORRection:CSET:GR0up[1] 2 ... 10:DATA?</code>
----------------	---

Example	<code>:CORR:CSET:GRO:DATA 10000000,20000000,"myAmpcor.csv"</code> <code>myAmpcor.csv</code> refers to the Amplitude Correction data from the file <code>myAmpcor.csv</code> in the default path
Notes	<code><filename></code> is the string containing the path of the correction files <code><filename2></code> , <code><filename3></code> , <code><filename4></code> , <code><filename5></code> , <code><filename6></code> , <code><filename7></code> , <code><filename8></code> are optional. You can define only <code><filename1></code> . The file name defined is added to corresponding File keys based on the sequence sent in the command. File keys with no file name set in the SCPI will be emptied Data for ranges 1 to 10 must be set in ascending order. If you try to set the data for a correction group range that is not connecting to the range currently available, a Data out of range error is generated If the file defined in data is empty, error -250 is reported. If the file does not exist, error -256 is reported. If there is a mismatch of data type, error -250 is reported Only one file with antenna unit can be supported per range. If you try to add another file that contains an antenna unit, a Mass Storage error is generated All ranges have to use a common antenna unit. If you try to add a correction file that contains a different antenna unit, a Mass Storage error is generated
Preset	Reset to Not a Number (9.91e+37) for frequencies and "" for File 1 through File 8 after Restore Input/Output Defaults . Survives a shutdown or restart of instrument application (including a power cycle)
State Saved	Saved in instrument state
Min	Start Freq and Stop Freq: 0 Hz
Max	Start Freq and Stop Freq:1 THz

6.5.17 Delete Correction Group Range (Remote Command Only)

Deletes all range values of corrections Group.

Remote Command	<code>[:SENSe] :CORRection:CSET:GROup:DELeTe</code>
Example	<code>:CORR:CSET:GRO:DEL</code>
Notes	Sending this command when no range is defined in table is accepted without error

6.6 Freq Ref Input

Lets you configure the External Frequency Reference input on the rear panel.

6.6.1 Freq Ref Input

Specifies the frequency reference as being the internal reference, an external reference at the rear panel input labeled EXT REF IN, a 1 pulse per second signal at the EXT REF IN input, or automatically sensing the appropriate reference.

See "[More Information](#)" on page 2239

Remote Command	<code>[:SENSe]:ROSCillator:SOURce:TYPE INTernal EXTernal SENSe PULSe</code> <code>[:SENSe]:ROSCillator:SOURce:TYPE?</code>
Example	<code>:ROSC:SOUR:TYPE SENS</code> <code>:ROSC:SOUR:TYPE INT</code> <code>:ROSC:SOUR:TYPE EXT</code> <code>:ROSC:SOUR:TYPE PULS</code>
Dependencies	The PULSe parameter, and support of the 1 pps signal at the EXT REF IN input, are not available in some models. If not available, the choice does not appear, and sending the PULSe parameter via SCPI generates an error For VXT models M9420A/10A/11A/15A and M9410E/11E/15E/16E the only available selection is EXTernal1 , unless M9420A/10A/11A/15A is configured in MIMO mode as Primary module. If configured in MIMO mode as Primary module, the available selection is INTernal EXTernal SENSe For EXM the only available selections are INTernal EXTernal SENSe For E7760B and M8920A/20B the only available selections are INTernal EXTernal Not available in UXM
Preset	Unaffected by Preset, but set to EXTernal in VXT models M9420A/10A/11A/15A, INTernal for E7760B, and SENSe for other models, by Restore Input/Output Defaults or Restore System Defaults->All
State Saved	Saved in instrument state
Annunciation	In the Meas Bar: If you set this to Internal and no external reference is plugged in: Freq Ref: Internal If you set this to Internal and an external reference between 1 and 50 MHz, or a 1 pps signal, IS plugged in: Freq Ref: Internal (in amber, as a warning sign) If you set this to External and an External Reference between 1 and 50 MHz is plugged in: Freq Ref: External

	<p>If you set this to External and no External Reference is sensed: Freq Ref: External (in amber, as a warning sign) When set to Pulse and a 1 pps signal is plugged in: Freq Ref: Pulse If you set this to Pulse and no Pulse Reference is sensed: Freq Ref: Pulse (in amber, as a warning sign) When set to Sense and neither a signal between 1 and 50 MHz nor a 1 pps signal is detected at the EXT REF IN input, "Sense:Int" is displayed: Freq Ref: Sense,Int When set to Sense and a signal within 5 ppm of the External Ref Freq (as set on the Ext Ref Freq control) is detected at the EXT REF IN input: Freq Ref: Sense,Ext When set to Sense and a 1 pps signal is detected at the EXT REF IN input, "Sense:Pulse" is displayed: Freq Ref: Sense,Pls</p>
Status Bits/OPC dependencies	<p>STATUS:QUESTIONABLE:FREQUENCY bit 1 set if unlocked Note: In EXM, the status bit is not set for non-controlling instances. To determine if the frequency reference is unlocked, the controlling instance must be queried</p>
Backwards Compatibility Notes	<p>Freq Ref In was not saved in state in the legacy instruments. It is part of state in the X-Series</p>
Remote Query	
Remote Command	<p>[:SENSe] :ROSCillator :SOURce?</p>
Notes	<p>Returns the current switch setting. This means:</p> <ol style="list-style-type: none"> 1. If it was set to SENSe but there is no external reference nor 1 pps signal, so the instrument is actually using the internal reference, then this query returns INTernal1, not SENSe 2. If it was set to SENSe and there is an external reference present, the query returns EXTernal1, not SENSe 3. If it was set to SENSe and there is a 1 pps signal present, the query returns PULSe, not SENSe 4. If it was set to EXTernal1, then the query returns EXTernal1 5. If it was set to INTernal1, then the query returns INTernal1 6. If it was set to PULSe, then the query returns PULSe <p>Note: In EXM, the SCPI query always returns INTernal1 for non-controlling instances</p>
Preset	<p>For VXT models M9420A/10A/11A/15A: EXTernal1 For E7760B, M8920A/20B: INTernal1 All other models: SENSe</p>
Backwards	<p>[:SENSe] :ROSCillator :SOURce? was query-only in ESA which always returned whichever</p>

6 Input/Output

6.6 Freq Ref Input

Compatibility Notes	<p>reference the instrument was using. The instrument automatically switched to the ext ref if it was present</p> <p>In PSA (which had no sensing), <code>[:SENSe]:ROSCillator:SOURce</code> set the reference (INT or EXT), so again its query returned the actual routing</p> <p>Thus, the query is 100% backwards compatible with both instruments</p> <p>Backwards Compatibility Command</p>
Notes	<p>For PSA compatibility the command form is provided and is directly mapped to <code>[:SENSe]:ROSCillator:SOURce:TYPE</code></p> <p>Note: In EXM, the command does nothing for non-controlling instances</p>
Backwards Compatibility SCPI	<code>[:SENSe]:ROSCillator:SOURce INTernal EXTernal</code>

More Information

When the frequency reference is set to internal, the internal 10 MHz reference is used even if an external reference is connected.

When the frequency reference is set to external, the instrument will use the external reference. However, if there is no external signal present, or it is not within the proper amplitude range, a condition error message is generated. When the external signal becomes valid, the error is cleared.

When the frequency reference is set to Pulse, the instrument expects a 1 pulse per second signal at the EXT REF IN input. The instrument uses this signal to adjust the frequency of the internal reference.

If Sense is selected, the instrument checks whether a signal is present at the external reference connector. If it senses a signal within 5 ppm of the External Ref Freq (as set on the **External Ref Freq** control), it will automatically switch to the external reference. If it senses a 1 pulse per second signal, it enters Pulse mode, wherein the signal is used to adjust the internal reference. When no signal is present, it automatically switches to the internal reference. No message is generated as the reference switches between pulse, external and internal. The monitoring of the external reference occurs approximately on 1 millisecond intervals, and never occurs in the middle of a measurement acquisition, only at the end of the measurement (end of the request).

If for any reason the instrument's frequency reference is not able to obtain lock, Status bit 1 in the Questionable Frequency register will be true and a condition error message is generated. When lock is regained, Status bit 1 in the Questionable Frequency register will be cleared and the condition error will be cleared.

If an external frequency reference is being used, you must enter the frequency of the external reference if it is not exactly 10 MHz. The **External Ref Freq** key is provided for this purpose.

For VXT models M9420A/10A/11A/15A, there is no internal frequency reference. To work correctly, a 100MHz external frequency reference signal is needed to connect to the front panel of the module. The default Freq Ref In setting is “External” and it cannot be set to any other types.

For VXT models M9410A/11A, External Freq Ref Input controls the “100 MHz In” port on the front panel. For VXT models M9415A/16A, External Freq Ref Input controls the “REF In” port on the front panel. For M941xE, the External Freq Ref Input is the reference in port on M941xA module.

NOTE

In EXM, a common frequency reference module serves all instrument instances, but only one instance of the software application can change the reference input type (INT or EXT or SENSE). The software application allowed to change the reference input is called the primary or controlling instance; by default, the leftmost instrument instance is the controlling instance. This can be changed in the config file “[E66XXModules.config](#)” located in the folder [E:\Keysight\Instrument](#). For the non-controlling instance(s) the reference input types (in SCPI commands, and in the Virtual Front Panel menus) are blanked and unavailable for use.

Sense

If **Sense** is selected, the instrument checks whether a signal is present at the external reference connector. If it senses a signal within 5 ppm of the External Ref Freq (as set by **External Ref Freq**), it uses this signal as an External Reference. If it senses a 1 pulse per second signal, it uses this signal to adjust the internal reference by adjusting the User setting of the Timebase DAC. When no signal is present, it automatically switches to the internal reference.

If set to **SENSe** and the instrument senses a 1 pulse per second signal, it sets the **System, Alignments, Timebase DAC** setting to **User**. This setting survives Preset and Power Cycle but is set to **Calibrated** by **System, Restore Defaults, Align** or **System, Restore Defaults, All**

Internal

The internal reference is used. A 1 pps signal at the EXT REF IN port, or a signal there between 1 and 50 MHz, causes a warning triangle to appear in the settings panel next to the word “INTERNAL”, but will otherwise be ignored.

External

The external reference is used.

Pulse

The internal reference continues to be the frequency reference for the instrument in that it determines the reference contribution to the phase noise, but its average frequency is adjusted to follow the 1 pps signal at the EXT REF IN input. Therefore, the instrument frequency accuracy will be dominated by the aging rate of the 1 pps signal instead of the aging rate of the internal reference, except during the time it takes to lock to a new 1 pps signal, approximately 10 minutes.

Sets the System, Alignments, Timebase DAC setting to “User”. This setting survives Preset and Power Cycle, but it set to “Calibrated” on a System, Restore Defaults, Align or a System, Restore Defaults, All

When a 1 pps signal is present at the EXT REF IN input, and either **Pulse** or **Sense** is selected, the internal reference frequency is affected by this signal; in effect, it “learns” a new accuracy setting. This setting can be seen by going to the **System, Alignments, Timebase Dac** menu, and looking at the **User** key in that menu. You will note that User has become automatically selected, and that the value shown on the **User** key is the updated value of the timebase DAC as “learned” from the 1 pps signal. Note that this replaces any value the user might have previously set on this key.

Once the setting is learned the user may remove the 1 pps signal; the User setting for the Timebase DAC is retained until you manually select “Calibrated” or execute a System, Restore Defaults, Align or a System, Restore Defaults, All. If you want to make the User setting permanent there is information in the Service Guide that tells you how to change the Calibrated setting of the Timebase DAC.

Note also that if the 1 pps signal is removed when Sense is selected, the instrument will simply switch to the normal state of the Internal reference and display SENSE:INT in the Settings Panel. However, if the 1 pps signal is removed when Pulse is selected, the instrument will generate an error

The J7203A Atomic Frequency Reference is an accessory for the X-Series Signal Analyzer that provides a highly accurate 1 pps timebase to use in conjunction with the Pulse setting. With the J7203A, the 1 pps signal is guaranteed to meet the input requirements of the EXT REF IN port, and the improved accuracy of the instrument’s internal frequency reference is specified. This is the only 1 pps signal that is guaranteed to function properly with the X-Series.

6.6.2 Ext Ref Freq

This key tells the instrument the frequency of the external reference. When the external reference is in use (either because the reference has been switched to External or because the Reference has been switched to Sense and there is a valid external reference present) this information is used by the instrument to determine the internal settings needed to lock to that particular external reference signal.

For the instrument to stay locked, the value entered must be within 5 ppm of the actual external reference frequency. So, it is important to get it close, or you risk an unlock condition.

Note that this value only affects the instrument's ability to lock. It does not affect any calculations or measurement results. See "Freq Offset" in the Frequency section for information on how to offset frequency values.

Remote Command	<code>[:SENSe]:ROSCillator:EXTernal:FREQuency <freq></code> <code>[:SENSe]:ROSCillator:EXTernal:FREQuency?</code>
Example	Set the external reference frequency to 20 MHz, but does not select the external reference: <code>:ROSC:EXT:FREQ 20 MHz</code> Select the external reference: <code>:ROSC:SOUR:TYPE EXT</code>
Dependencies	Still available with Internal or Pulse selected, to allow setup for when External is in use. However, the setting has no effect if the Internal Reference is in use (Freq Ref In set to Internal, Pulse, or SENSE:INT or SENSE:PULSE) Not available in UXM For VXT models M9420A/10A/11A/15A/16A and M9410E/11E/15E/16E: only 100 MHz is available
Preset	Unaffected by Mode Preset , Input/Output Preset , or Restore Defaults, Input/Output , but set to 100 MHz for VXT models and 10 MHz for other models, by Restore Defaults, Misc , or Restore Defaults, All , or Default External Ref Freq
State Saved	Power On Persistent (survives power cycle)
Min/Max	See " Minimum & Maximum Values " on page 2242

Minimum & Maximum Values

Model	Min	Max
CXA, N897xB, E7760B, M8920A/20B, CXA-m	10 MHz	10 MHz
EXA without option R13	10 MHz	10 MHz
EXA with option R13	10 MHz	20 MHz
MXA, PXA, EXM	10 MHz	50 MHz

6 Input/Output
6.6 Freq Ref Input

Model	Min	Max
VXT models	100 MHz	100 MHz
M9410E/11E/15E/16E	100 MHz	100 MHz
All other models	1 MHz	100 MHz

6.6.3 Default External Ref Freq

Restores the External Ref Freq to its default of 10 MHz.

When you set an External Ref Freq value with the **Ext Ref Freq** control, that Frequency is persistent; is not affected by Mode Preset or Input/Output Preset, and survives shutdown and power cycle. This control allows you to reset the External Ref Freq to its default value.

NOTE

The persistence of the External Ref Freq is a new behavior as of firmware version A.18.00, necessitating the addition of this control. In versions before A.18.00, the frequency reset on a power cycle/restart. Thus, you may need to use this command to retain backwards compatibility.

Remote Command	<code>[:SENSe]:ROSCillator:EXTernal:FREQuency:DEFault</code>
Example	<code>:ROSC:EXT:FREQ:DEF</code> resets the external ref frequency
Notes	Command only; no query
Dependencies	Grayed-out if the Ext Ref Freq is already set to the default Does not appear in EXM, UXM, VXT models or M8920A/20B

6.6.4 LO Ref Input

This parameter sets the LO Reference signal Input to External or Internal.

Remote Command	<code>[:SENSe]:ROSCillator:LO:INPut INTernal EXTernal</code> See " Option Details " on page 2244 <code>[:SENSe]:ROSCillator:LO:INPut?</code>
Example	<code>:ROSC:LO:INP EXT</code> <code>:ROSC:LO:INP?</code>
Dependencies	Only available in VXT models M9410A/11A/15A/16A when MIMO is on
Preset	<code>INTernal</code>
State Saved	Saved in instrument state

Option Details

Parameter	SCPI	Notes
Internal	<code>INTernal</code>	When Internal is selected, internal reference signal will be used to synchronize the LO board
External	<code>EXTernal</code>	When External is selected, external reference signal will be used to synchronize the LO board. Route the correct reference signal to the specified port before changing the LO Ref Input to External For VXT models M9410A/11A, a 4.8 GHz reference signal is required to rout to the 4.8 GHz In port

6.6.5 Ref Lock BW

Lets you adjust the Frequency Reference phase lock bandwidth. This control is available in some models of the X-Series.

It is possible to improve the phase noise of the instrument by several dB, even tens of dB, by using an external reference with excellent phase noise. When an external reference is used the instrument's close-in phase noise improves to match that of the reference.

Normally a narrow loop bandwidth is used to phase lock to the external reference. However, the Ref Lock BW control allows you to choose a wider loop bandwidth to reduce the phase noise at low offset frequencies, especially 4 to 400 Hz offset. The Wide setting represents about a 60 Hz loop bandwidth, the Narrow setting about 15 Hz.

When using an external reference with superior phase noise, Keysight recommends setting the external reference phase-locked-loop bandwidth to Wide to take advantage of that superior performance.

When using an external reference with inferior phase noise performance, Keysight recommends setting the bandwidth to Narrow.

In these relationships, inferior and superior phase noise are with respect to -134 dBc/Hz at 30 Hz offset from a 10 MHz reference. Because most reference sources have phase noise behavior that falls off at a rate of 30 dB/decade, this is usually equivalent to -120 dBc/Hz at 10 Hz offset.

In instruments with EP1 or EP2, this control only affects the external reference loop bandwidth. In instruments with EP0, this control also affects the loop bandwidth used when the Internal reference is selected (reference set manually to Internal or Pulse, or set to Sense and set by sensing to Internal or Pulse).

Remote Command `[:SENSe]:ROSCillator:BAWdth WIDE | NARRow`
 `[:SENSe]:ROSCillator:BAWdth?`

6 Input/Output
6.6 Freq Ref Input

Example	<code>:ROSC:BAND WIDE</code>
Dependencies	In instruments with EP1 or EP2: the control is available (not grayed-out) even with Internal or Pulse selected, to allow setup for when External is in use. However, the setting has no effect if the Internal Reference is in use Only appears in instruments equipped with the required hardware Does not appear in EXM, UXM, VXT models, or E7760B
Preset	Unaffected by Preset, but set to NARRow by Restore Input/Output Defaults or Restore System Defaults -> All
State Saved	Saved in Input/Output state

6.6.6 Reference Oscillator On/Off (Remote Command Only)

Provided for PSA code compatibility.

In PSA it turned the Reference Oscillator on and off, however in the X-Series the reference oscillator cannot be turned off, so no hardware is affected when it is received.

If queried it returns the state you set with the command, but note that this does not necessarily reflect the actual state of the Reference Oscillator, which is always **ON**.

Example	<code>:ROSCillator:OUTP ON</code>
Preset	Unaffected by Preset, but set to ON by Restore Input/Output Defaults or Restore System Defaults -> All
Backwards Compatibility SCPI	<code>[:SENSe]:ROSCillator:OUTPut[:STATe] ON OFF 1 0</code> <code>[:SENSe]:ROSCillator:OUTPut[:STATe]?</code>

6.6.6.1 Select Ref

Lets you select the reference model to control.

The reference status is not saved in a state file, because Reference is a standard alone module.

Remote Command	<code>[:SENSe]:ROSCillator:PXIReference:SElect NONE M9300a</code> <code>[:SENSe]:ROSCillator:PXIReference:SElect?</code>
Example	<code>:ROSC:PXIR:SEL M9300</code> <code>:ROSC:PXIR:SEL?</code>
Dependencies	Only Keysight M9300A Frequency Reference is supported
State Saved	No

6.6.6.2 Freq Ref In

Specifies the frequency reference as being the internal reference, an external reference at the front panel input labeled **Ref In**.

Remote Command	<code>[:SENSe]:ROSCillator:PXIReference:SOURce INTernal EXTernal</code> <code>[:SENSe]:ROSCillator:PXIReference:SOURce?</code>
Example	<code>:ROSC:PXIR:SOUR INT</code> <code>:ROSC:PXIR:SOUR?</code>
Dependencies	Only available when Select Ref is not NONE
Preset	INTernal
State Saved	Saved in instrument state

6.6.6.3 External Freq Ref

Tells the PXIe Ref module the frequency of the external reference. When the external reference is in use this information is used by the Ref module to determine the internal settings needed to lock to that particular external reference signal.

For the instrument to stay locked, the value entered must be within 5 ppm of the actual external reference frequency. So, it is important to get it close, or you risk an unlock condition.

Remote Command	<code>[:SENSe]:ROSCillator:PXIReference:EXTernal:FREQuency <freq></code> <code>[:SENSe]:ROSCillator:PXIReference:EXTernal:FREQuency?</code>
Example	Set the external reference frequency to 20 MHz, but does not select the external reference: <code>:ROSC:PXIR:EXT:FREQ 20 MHz</code> Select the external reference: <code>:ROSC:PXIR:SOUR EXT</code>
Dependencies	Only available when Select Ref is not NONE
Preset	10 MHz
State Saved	Yes
Min	1 MHz
Max	110 MHz

6.6.6.4 Ext Ref Locked (Remote Query Only)

Returns the External Reference locked status

Remote Command	<code>[:SENSe]:ROSCillator:PXIReference:EXTernal:LOCK?</code>
----------------	--

6 Input/Output

6.6 Freq Ref Input

Example	<code>:ROSC:PXIR:EXT:LOCK?</code>
Notes	Returns "1" if the Freq Ref Input is External and Reference is locked. Otherwise returns "0" When the Freq Ref Input is External and Reference is unlocked, the following warning message appears in the status bar: <code>Settings Alert; M9300A Ext Ref Unlocked</code>
Dependencies	Only available when Select Ref is not NONE

6.7 Output

Accesses controls that configure various output settings, like the frequency reference output, IF outputs and analog output.

Not all measurements support all output functions. For example, the Swept SA Measurement does not support the Digital Bus function or the I/Q Cal Out function under the **Output** tab; although the controls are visible, the outputs do not function in this measurement.

In addition, if the appropriate license is not present, some controls may not appear. In Modes/Measurements that do not support particular controls, the controls may appear, but no output will be generated if they are selected.

This tab does not appear in EXM or VXT model M9420A.

6.7.1 Analog Out

Lets you control which signal is fed to the “Analog Out” connector on the instrument rear panel.

In the Auto state, the Analog Output will automatically be set to the most sensible setting for the current mode or measurement.

If you make a selection manually from the **Analog Out** menu, the manually selected choice will remain in force until you change it (or re-select Auto), even if you switch to a mode or measurement for which the selected output does not apply.

Remote Command	:OUTPut:ANALog OFF SVIDeo LOGVideo LINVideo DAUDio!See Option Details :OUTPut:ANALog?
Example	:OUTP:ANAL SVIDeo causes the analog output type to be Screen Video
Preset	Unaffected by Preset, but set to DAUDio by Restore Input/Output Defaults or Restore System Defaults->All
State Saved	Saved in Input/Output State
Backwards Compatibility Notes	Prior to A.04.00, OFF was the default functionality except when in the Analog Demod application or with Tune and Listen, in which case it was DAUDio , and there was no selection menu. For backwards compatibility with earlier X-Series firmware versions, Auto (:OUTP:ANAL:AUTO ON) duplicates the prior behavior The DNWB and SANalyzer parameters, which were legal in PSA but perform no function in the X-Series, are accepted without error Auto Function

6 Input/Output
6.7 Output

Remote Command	<code>:OUTPut:ANALog:AUTO OFF ON 0 1</code> <code>:OUTPut:ANALog:AUTO?</code>
Example	<code>:OUTP:ANAL:AUTO ON</code>
Preset	ON

Option Details

Source	SCPI	Notes
Off	OFF	The Analog Output is off
Screen Video	SVIDeo	Selects the analog output to be the screen video signal. In this mode, the pre-detector data is output to the Analog Out connector. The output looks very much like the trace displayed on the instrument's screen, and depends on the Log/Lin display Scale, Reference Level, and dB per division, but is not influenced by the selected detector or any digital flatness corrections or trace post-processing (like Trace Averaging)
Log Video	LOGVidéo	Selects the analog output to be the log of the video signal. In this mode, the pre-detector data is output to the Analog Out connector with a Log scaling. The output is referenced to the current level at the mixer, does not depend on display settings like Reference Level or dB per division, and it is not influenced by the selected detector or any digital flatness corrections or trace post-processing (like Trace Averaging), but does change with input attenuation
Linear Video	LINVidéo	Selects the analog output to be the envelope signal on a linear (voltage) scale. In this mode, the pre-detector data is output to the Analog Out connector with a Linear scaling. The output is based on the current Reference Level, and is not influenced by the selected detector or any digital flatness corrections or trace post-processing (like Trace Averaging)
Demod Audio	DAUDio	Selects the analog output to be the demodulation of the video signal. When Demod Audio is selected, the demodulated audio signal appears at this output whenever the Analog Demod application is demodulating a signal or when Analog Demod Tune and Listen is operating in the Swept SA measurement When Analog Out is in the Auto state, this output is auto-selected when in the Analog Demod mode or when Analog Demod Tune and Listen is operating in the Swept SA measurement

The table below specifies the range for each output.

Analog Out	Nominal Range exc (10% overrange)	Scale Factor	Notes
Off	0 V		
Screen Video	0 – 1 V open circuit	10%/division	8566 compatible
Log Video	0 – 1 V terminated	1/(192.66 dB/V)	dB referenced to mixer level, 1V out for –10 dBm at the mixer
Linear Video	0 – 1 V terminated	100%/V	Linear referenced to Ref Level, 1 V out for RF envelope at the Ref Level

Analog Out	Nominal Range exc (10% overrange)	Scale Factor	Notes
Demod Audio	(varies with instrument setting)		

Notes about the Analog Outputs

Screen Video

This mode is similar to the Analog Output of the HP 8566 family and the Video Out (opt 124) capability of the Keysight PSA analyzer (E4444x), although there are differences in the behavior.

Screen Video output changes while in FFT Sweeps, so for measurements that use exclusively FFT Sweeps, or if the user manually chooses FFT Sweeps, the Screen Video output will look different than it does in swept mode

Because the Screen Video output uses one of the two IF processing channels, only one detector is available while Screen Video is selected. All active traces will change to use the same detector as the selected trace when Screen Video is activated.

Screen Video output is not available while any EMI Detector is selected (Quasi Peak, RMS Average or EMI Average), because these detectors use both IF processing channels. Consequently, if the user chooses an EMI Detector, there will be no Screen Video output.

The output holds at its last value during an alignment and during a marker count. After a sweep:

- If a new sweep is to follow (as in Continuous sweep mode), the output holds at its last value during the retrace before the next sweep starts. If the instrument is in zero-span, there is no retrace, as the instrument remains tuned to the Center Frequency and does not sweep. Therefore, in zero-span, the output simply remains live between display updates
- If no new sweep is to follow (as in Single sweep mode), the output remains live, and continues to show the pre-detector data

This function depends on optional capability; the selection is not available, and the command will generate an “Option not available” error unless you have Option YAV or YAS licensed in your instrument.

The Screen Video function is intended to be very similar to the 8566 Video Output and the PSA Option 124. However, unlike the PSA, it is not always on; it must be switched on by the Screen Video key. Also, unlike the PSA, there are certain dependencies (detailed above) – for example, the Quasi Peak Detector is unavailable when Screen Video is on.

6 Input/Output

6.7 Output

Furthermore, the PSA Option 124 hardware was unipolar, and its large range was padded to be exactly right for use as a Screen Video output. In the X-Series, the hardware is bipolar and has a wider range to accommodate the other output choices. Therefore, the outputs won't match up exactly and users may have to modify their setup when applying the X-Series in a PSA application.

Log Video

Log Video shows the RF Envelope with the Reference equal to the Mixer Level. The output is designed so that full scale (1 V) corresponds to -10 dBm at the mixer. The full range (0-1 V) covers 192.66 dB ; thus, 0 V corresponds to -202.66 dBm at the mixer.

Because the Log Video output uses one of the two IF processing channels, only one detector is available while Screen Video is selected. All active traces will change to use the same detector as the selected trace when Log Video is activated.

Log Video output is not available while any EMI Detector is selected (Quasi Peak, RMS Average or EMI Average), because these detectors use both IF processing channels. Consequently, if the user chooses an EMI Detector, there will be no Log Video output.

The output holds at its last value during an alignment, during a marker count, and during retrace (after a sweep and before the next sweep starts).

This function depends on optional capability. The choice will not appear, and the command will generate an "Option not available" error unless you have Option YAV licensed in your instrument.

Log Video output changes while in FFT Sweeps, so for measurements that use exclusively FFT Sweeps, or if the user manually chooses FFT Sweeps, the Log Video output will look different than it does in swept mode.

Linear Video

Linear Video shows the RF Envelope with the Reference equal to the Ref Level. The scaling is set so that 1 V output occurs with an instantaneous video level equal to the reference level, and 0 V occurs at the bottom of the graticule. This scaling gives you the ability to control the gain without having another setup control for the key. But it requires you to control the look of the display (the reference level) in order to control the analog output.

This mode is ideal for looking at Amplitude Modulated signals, as the linear envelope effectively demodulates the signal.

Because the Linear Video output uses one of the two IF processing channels, only one detector is available while Linear Video is selected. All active traces will change to use the same detector as the selected trace when Log Video is activated.

Linear Video output is not available while any EMI Detector is selected (Quasi Peak, RMS Average or EMI Average), because these detectors use both IF processing

channels. Consequently, if the user chooses an EMI Detector, there will be no Linear Video output.

The output holds at its last value during an alignment and during a marker count and during retrace (after a sweep and before the next sweep starts).

This function depends on optional capability; the choice will not appear, and the command will generate an “Option not available” error unless you have Option YAV licensed in your instrument. Linear Video output changes while in FFT Sweeps, so for measurements that use exclusively FFT Sweeps, or if the user manually chooses FFT Sweeps, the Linear Video output will look different than it does in swept mode.

Demod Audio

When Analog Out is in the Auto state, this output is auto-selected when in the Analog Demod mode or when **Analog Demod Tune and Listen** is operating in the Swept SA measurement.

If any other Analog Output is manually selected when in the Analog Demod mode or when **Analog Demod Tune and Listen** is operating in the Swept SA measurement, a condition warning message appears. This choice only appears if the Analog Demod application (N9063A), the N6141A or W6141A application, or Option EMC is installed and licensed, otherwise the choice will not appear, and the command will generate an “Option not available” error.

The output holds at its last value during an alignment and during a marker count. It is not held between sweeps, in order for Tune and Listen to work properly.

When Demod Audio is the selected Analog Output, all active traces are forced to use the same detector, and the CISPR detectors (QPD, EMI Avg, RMS Avg) are unavailable

6.7.2 Screen Video Level

Lets you control the amplitude of the Analog Output when Screen Video is selected.

- The 1V (**NORMAL**) setting provides a nominal output of 1 V peak-to-peak into an open circuit. This matches the traditional behavior of X-series instruments
- The 2V (**COMPATIBLE**) setting provides a nominal output of 2 V peak-to-peak into an open circuit. This matches the legacy behavior of PSA and earlier analyzers

Remote Command `:OUTPut:ANALog:SVIDeo NORMAL | COMPATible`

`:OUTPut:ANALog:SVIDeo?`

Example `:OUTP:ANAL:SVID COMP`

causes the Screen Video level to be 2 V

6 Input/Output
6.7 Output

Dependencies	Only appears if Screen Video is the selected Analog Output
Preset	Unaffected by Preset, but set to NORM by Restore Input/Output Defaults or Restore System Defaults->All
State Saved	Saved in Input/Output State

6.7.3 Digital Bus Out

Turns on the LVDS Digital Output port for outputting digital acquisition data.

- When **ON**, all acquisitions are streamed to the output port including acquisitions for internal purposes such as Alignment. The internal processing and routing of acquisitions continues as usual and is unaffected by the state of Bus Out
- When **OFF**, no signal appears on the LVDS port

Remote Command	<code>:OUTPut:DBUS[1][:STATE] ON OFF 1 0</code> <code>:OUTPut:DBUS[1][:STATE]?</code>
Example	<code>:OUTP:DBUS ON</code>
Dependencies	Requires option RTL or control is not displayed Digital Bus Out and Wideband Digital Bus cannot both be ON at the same time, so: <ul style="list-style-type: none"> – When Wideband Digital Bus is turned ON, if Digital Bus Out is already ON, an advisory message is displayed, “Wideband Digital Bus On, Digital Bus (narrow band) forced to Off” – When Digital Bus Out is turned ON, if Wideband Digital Bus is already ON, an advisory message is displayed, “Digital Bus (narrow band) On, Wideband Digital Bus forced to Off”
Preset	OFF Set by Restore Input/Output Defaults
State Saved	Saved in Input/Output State

6.7.4 Wideband Digital Bus

Turns on the LVDS port on the Wideband IF, which causes the I/Q pairs from the current measurement to be sent to this port.

NOTE

This control is grayed-out in all Modes except RTSA, which offers the only measurement that supports wideband streaming.

- When **ON**, the internal processing and routing of acquisitions continues as usual, and the display of measurement data is unaffected
- When **OFF**, no signal appears on the LVDS port

Remote Command	<code>:OUTPut:DBUS2[:STATe] OFF ON 0 1</code> <code>:OUTPut:DBUS2[:STATe]?</code>
Example	<code>:OUTP:DBUS2 ON</code>
Notes	If this command is sent while running a measurement that does not support Wideband Digital Bus , the message “Settings conflict; Feature not supported for this measurement” is displayed
Dependencies	Requires option RTS or control is not displayed Digital Bus Out and Wideband Digital Bus cannot both be ON at the same time, so: <ul style="list-style-type: none"> – When Wideband Digital Bus is turned ON, if Digital Bus Out is already ON, an advisory message is displayed, “Wideband Digital Bus On, Digital Bus (narrow band) forced to Off” – When Digital Bus Out is turned ON, if Wideband Digital Bus is already ON, an advisory message is displayed, “Digital Bus (narrow band) On, Wideband Digital Bus forced to Off”
Preset	OFF Set by Restore Input/Output Defaults
State Saved	Saved in Input/Output State

Here is the Wideband LVDS connector as viewed from the rear panel. The pin assignments are listed below:

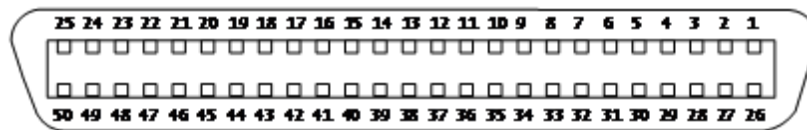

I-Cable

Connection	“-“ pin #	+“ pin #
GND	1	26
N/C	2	27
Stream_I[00]	3	28
Stream_I[01]	4	29
Stream_I[02]	5	30
Stream_I[03]	6	31
GND	7	32
Stream_I[04]	8	33
Stream_I[05]	9	34
Stream_I[06]	10	35
Stream_I[07]	11	36
GND	12	37
Stream_I[08]	13	38
Stream_I[09]	14	39

6 Input/Output
6.7 Output

Connection	“-“ pin #	“+” pin #
Stream_I[10]	15	40
Stream_I[11]	16	41
GND	17	42
Stream_I[12]	18	43
Stream_I[13]	19	44
Stream_I[14]	20	45
Stream_I[15]	21	46
GND	22	47
GND	23	48
Stream_VALID	24	49
Stream_CLK	25	50

Q-Cable

Connection	“-“ pin #	“+” pin #
GND	1	26
Stream_ALT	2	27
Stream_Q[00]	3	28
Stream_Q[01]	4	29
Stream_Q[02]	5	30
Stream_Q[03]	6	31
GND	7	32
Stream_Q[04]	8	33
Stream_Q[05]	9	34
Stream_Q[06]	10	35
Stream_Q[07]	11	36
GND	12	37
Stream_Q[08]	13	38
Stream_Q[09]	14	39
Stream_Q[10]	15	40
Stream_Q[11]	16	41
GND	17	42
Stream_Q[12]	18	43
Stream_Q[13]	19	44
Stream_Q[14]	20	45
Stream_Q[15]	21	46
GND	22	47

Connection	“-“ pin #	“+” pin #
GND	23	48
Stream_MARK_1	24	49
Stream_MARK_2	25	50
Stream_I	16 bit "I" Data	
Stream_Q[15:0]	16 bit "Q" Data	
Stream_VALID	Data valid, when '1' then I/Q data is valid	
Stream_CLK	150 MHz DDR clock	
Stream_MARK_1	Stream Mark Bit 1	
Stream_MARK_2	Stream Mark Bit 2	
Stream_ALT	currently unused	

6.7.5 Data Stream

Lets you choose data or a test pattern to output to the Wideband IF LVDS port. This can help you set up your streaming target devices.

Remote Command	<code>:OUTPut:DBUS2:DATA MEASure TEST</code> <code>:OUTPut:DBUS2:DATA?</code>
Example	<code>:OUTP:DBUS2:DATA TEST</code>
Notes	Selecting TEST routes a test pattern to the Wideband Digital Bus stream output
Preset	MEAS (set by Restore Input/Output Defaults)
State Saved	Saved in Input/Output State

6.7.6 I/Q Cal Out

The Baseband I/Q "Cal Out" port can be turned on with either a 1 kHz or a 250 kHz square wave. This can be turned on independent of the input selection. Preset resets this to **OFF**.

Remote Command	<code>:OUTPut:IQ:OUTPut IQ1 IQ250 OFF</code> <code>:OUTPut:IQ:OUTPut?</code>
Example	<code>:OUTP:IQ:OUTP IQ1</code>
Dependencies	Only available with Option BBA
Couplings	An I/Q Cable Calibration or an I/Q Probe Calibration will change the state of the Cal Out port as needed by the calibration routine. When the calibration is finished the I/Q Cal Out is restored to the pre-calibration state
Preset	OFF

State Saved	Saved in instrument state
Range	1 kHz Square Wave 250 kHz Square Wave Off

6.7.7 Aux IF Out

Controls the signals that appear on the SMA output on the rear panel labeled **AUX IF OUT**

NOTE

Aux IF Out is valid for the RF Input and for the External Mixer input. In external mixing, the Aux IF output level is set by factory default to accommodate expected IF levels for the RF path. When using the External Mixing path, the **Aux IF Out** levels (for all three options CR3, CRP and ALV) will therefore be uncalibrated.

Remote Command	<code>:OUTPut:AUX SIF AIF LOGVideo OFF</code> See " Option Details " on page 2257 and " Notes on the Aux IF Outputs " on page 2258 below <code>:OUTPut:AUX?</code>
Dependencies	Does not appear in models that do not support the Aux IF Out
Preset	Unaffected by Preset, but set to OFF by Restore Input/Output Defaults or Restore System Defaults->All
State Saved	Saved in Input/Output state
Backwards Compatibility Notes	In PSA, the IF output had functionality equivalent to the SIF option in X-Series' Aux IF Out menu. In X-Series, it is necessary to switch Aux IF Out to SIF to get this functionality, whereas in PSA it is always on, since there are no other choices Hence, if you are migrating remote code from PSA, and you use the IF Output in PSA, you will need to add a command to switch this function to SIF

Option Details

The Aux IF Output options are:

Source	SCPI	Notes
Off	OFF	No signal is output from the AUX IF OUT connector on the rear panel The connector appears as an open-circuit (that is, it is not terminated in any way)
Second IF	SIF	The 2 nd IF output is routed to the rear panel connector. Annotation on the menu panel shows the current 2 nd IF frequency in use in the instrument
Arbitrary IF	AIF	The 2 nd IF output is mixed with a local oscillator and mixer to produce an arbitrary IF output between 10 MHz and 75 MHz with 500 kHz resolution. The phase noise in this mode will not be as good as in Second IF mode The IF output frequency is adjustable, through an active function which appears on the menu panel, from 10 MHz to 75 MHz with 500 kHz resolution Note that, in instruments with Options B2X or B5X, the Arbitrary IF Output is only

Source	SCPI	Notes
Fast Log Video	LOGVideo	<p>practical when the IF Bandwidth is ≤ 40 MHz, IF Path is ≤ 40 MHz, or FFT Width is ≤ 40 MHz</p> <p>The 2nd IF output is passed through a log amp and the log envelope of the IF signal is sent to the rear panel. The open circuit output level varies by about 25 mV per dB, with a top-of-screen signal producing about 1.6 Volts. The output impedance is nominally 50 ohms</p> <p>This mode is intended to meet the same requirement as Option E4440A-H7L Fast Rise Time Video Output on E4440A PSA Series, allowing you to characterize pulses with fast rise times using standard measurement suites on modern digital scopes</p>

Notes on the Aux IF Outputs

Second IF

Does not appear unless Option CR3 is installed.

The frequency of the 2nd IF depends on the current IF signal path as shown in the table below:

IF Path Selected	Frequency of "Second IF" Output
10 MHz	322.5 MHz
25 MHz	322.5 MHz
40 MHz	250 MHz
85-160 MHz	300 MHz
255 MHz	750 MHz
510 MHz	877.1484375 MHz

The signal quality, such as signal to noise ratio and phase noise, are excellent in this mode.

Arbitrary IF

Does not appear unless Option CRP is installed.

The bandwidth of this IF output varies with band and center frequency, but is about 40 MHz at the -3 dB width. When the output is centered at lower frequencies in its range, signal frequencies at the bottom of the bandwidth will "fold". For example, with a 40 MHz bandwidth (20 MHz half-bandwidth), and a 15 MHz IF center, a signal -20 MHz relative to the spectrum analyzer center frequency will have a relative response of about -3 dB with a frequency 20 MHz below the 15 MHz IF center. This -5 MHz frequency will fold to become a +5 MHz signal at the IF output. Therefore, lower IF output frequencies are only useful with known band-limited signals.

Fast Log Video

Does not appear unless Option ALV is installed.

The output is off during an alignment but not during a marker count, and is not blanked during retrace (after a sweep and before the next sweep starts).

6.7.8 Arbitrary IF Freq

Sets the frequency of the Arbitrary IF when "Aux IF Out" on page 2257 is set to AIF.

NOTE In instruments with Options B2X or B5X, the Arbitrary IF Output is only practical when the IF Bandwidth is ≤ 40 MHz, IF Path is ≤ 40 MHz, or FFT Width is ≤ 40 MHz.

Remote Command	:OUTPut:AUX:AIF <value> :OUTPut:AUX:AIF?
Example	:OUTP:AUX:AIF 50 MHZ
Dependencies	Only appears if "Aux IF Out" on page 2257 is AIF
Preset	Unaffected by a Preset, but set to 70 MHz by Restore Input/Output Defaults or Restore System Defaults->All
State Saved	Saved in Input/Output State
Min	10 MHz
Max	75 MHz

6.7.9 Ext/Wide IF Out

Causes the signal that is normally routed to the IF to be routed instead to the **Ext IF Out** connector on the rear panel (N9041B) or **Wide IF Out** connector on the front panel (N9042B) or rear panel (N9032B). This is available in N9041B when RF Input 2 is the selected input port and in N9032B/N9042B on RF Input and, when V3050A is attached, External RF Input.

Only one IF output (**Ext/Wide IF Out**, IF2 Out, or Aux IF Out) can be selected at a time, so switching Ext/Wide IF Out to **ON** changes IF2 Out and Aux IF Out to **OFF**, and setting Aux IF Out to something other than **OFF** or IF2 Out to **ON** forces Ext/Wide IF Out to **OFF**.

Remote Command	:OUTPut:EIF ON OFF 1 0 :OUTPut:EIF?
Example	:OUTP:EIF ON
Dependencies	Only appears in N9041B, N9032B, and N9042B For N9041B, enabled when RF Input 2 is the selected input. When RF Input 2 is not selected, the control is grayed out and forced to Off and attempting to set it On will result in an error message

	For N9032B/N9042B, enabled on RF Input and on External RF Input when V3050A is attached When this switch is ON , no measurement is displayed, and the error “No result; meas invalid with Ext/Wide IF Out set to On” appears in the Status bar
Preset	OFF Not affected by Mode Preset , but set to OFF by Input/Output Preset
State Saved	Saved in Input/Output state
Annotation	None (but error message appears when on)
Status Bits/OPC dependencies	STATUS:QUESTIONABLE:INTEGRITY bit 1 is set when Ext/Wide IF Out is ON . This indicates an error, because no valid data is on the screen or available via SCPI. However, the signal at the Ext/Wide IF Out port is still valid given the other settings

6.7.10 IF2 Out

Causes the signal that is normally routed to the IF, when the 1 GHz IF Path is selected, to be routed instead to the **IF2 Out** connector on the rear panel.

Only one IF output (Ext IF Out, **IF2 Out**, or Aux IF Out) can be selected at a time, so switching IF2 Out to On changes Ext IF Out and Aux IF Out to Off, and setting Aux IF Out to something other than Off or Ext IF Out to On forces IF2 Out to Off.

This control only appears if Option H1G is installed. It is only available when the 1 GHz IF Path is chosen, either directly or indirectly. In all other paths it is visible but grayed out and forced to Off. Attempting to set it On when the 1GHz path is not selected generates an error.

- Direct selection of the 1 GHz path: Measurements that directly support the 1 GHz path have a 1 GHz selection in the IF Path menu in Meas Setup
- Indirect selection of the 1 GHz path: certain measurements, like CCDF, always choose the widest available path, and so will choose the 1 GHz path if it is available, even if there is no IF Path menu in the measurement. IF2 Out will be visible when this results in the 1 GHz path being selected, even if there is no control or readout indicating that the 1 GHz path is chosen

Remote Command	:OUTPut:IF2 ON OFF 1 0 :OUTPut:IF2?
Example	:OUTP:IF2 ON
Dependencies	Only appears in UXA and only when Option H1G is installed When this is ON , no measurement is displayed, and the error “No result; meas invalid with IF2 Out set to On” appears in the Status bar
Preset	OFF Not affected by Mode Preset but set to OFF by Input/Output Preset
State Saved	Saved in Input/Output state

6 Input/Output
6.7 Output

Annotation	None (but error message appears when on)
Status Bits/OPC dependencies	STATUS:QUESTIONABLE:INTEGRITY bit 1 is set when IF2 Out is ON . This indicates an error, because no valid data is on the screen or available via SCPI. However, the signal at the IF2 Out port is still valid given the other settings

6.7.11 REF Out

Lets you toggle the state of REF Out. The REF Out port is designed for MIMO, which provides the reference daisy chain for the Primary and Secondary modules.

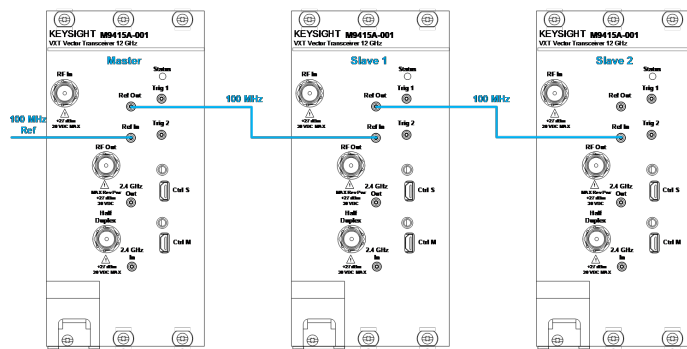

Remote Command	<code>:OUTPut:EREFerence:OUTPut ON OFF 1 0</code> <code>:OUTPut:EREFerence:OUTPut?</code>
Example	<code>:OUTP:EREF:OUTP ON</code> <code>:OUTP:EREF:OUTP?</code>
Notes	Used to route the 100 MHz reference signal on the REF In port to the REF Out port
Dependencies	Only available in VXT models M9415A/16A and M9415E/16E when Freq Ref Input is External, and Ext Ref Freq is 100 MHz
Preset	OFF
Range	ON OFF

6.7.12 LO Ref Out

Turns the LO Reference Signal Out on or off. **LO Ref Out** is used to provide reference daisy chain in MIMO or Phase Coherency.

For VXT models M9410A/11A, controls the **4.8 GHz Out** port on the front panel. Setting it **ON** outputs a 4.8 GHz reference signal.

Remote Command	<code>:OUTPut:ROSCillator:LO:OUTPut ON OFF 1 0</code> <code>:OUTPut:ROSCillator:LO:OUTPut?</code>
Example	<code>:OUTP:ROSC:LO:OUTP ON</code> <code>:OUTP:ROSC:LO:OUTP?</code>
Dependencies	Only available in VXT models M9410A/11A/15A/16A and M9410E/11E/15E/16E
Preset	<code>OFF</code>

6.8 Trigger Output

Accesses controls that configure the **Trigger Output** settings.

6.8.1 Trig 1 – 4 Out

Selects the type of output signal that will be output from the available **Trig n Out** connectors, where **n** = 1, 2, 3, or 4.

Some instruments do *not* support **Trig 2 Out** through **Trig 4 Out** outputs, nor their associated controls.

For most instruments, **Trig 1 Out** applies to the connector labeled **Trigger 1**, but for VXT model M9420A, it is labeled **Trigger 4**.

The front panel includes separate controls for each available trigger: **Trig 1 Out – Trig 4 Out**. The remote command can be used for *any* of the **Trig n Out** connectors, by specifying the appropriate parameter (for example **TRIG1**, **TRIG2**, etc.).

NOTE

Option **TARMed** is *not* available in modular instruments.

Remote Command	<pre>:TRIGger[1] 2 ... 4[:SEquence]:OUTPut HSWP MEASuring MAIN GATE GTRigger OEVen TARMed SP0int S1Marker S2Marker S3Marker S4Marker PARB FSYNc OFF</pre> <p>See "Trigger Out Options" on page 2264</p> <pre>:TRIGger[1] 2 ... 4[:SEquence]:OUTPut?</pre>
Example	<pre>:TRIG:OUTP HSWP :TRIG2:OUTP GATE</pre>
Notes	<p>Trig 2 Out is used as the source trigger out in EXM and VXT model M9420A</p> <p>The available choices in EXM and VXT model M9420A are S1Marker, S2Marker, S3Marker, S4Marker and OFF</p> <p>For Power Amplifier Mode, Trig 2 Out is set to Source Marker2 when Burst Shape & Mask is ON. In this case, Trigger 2 is used to output PA Enable Mask</p>
Dependencies	<p>Trig 2 Out through Trig 4 Out are not supported in all models. In models that do not support them, the Trig n Out control is blanked, and sending the SCPI command for this output generates an error, "Hardware missing; Not available for this model number"</p> <p>Querying Trig 2 Out through Trig 4 Out in models that do not support them returns OFF</p> <p>For VXT models M9410A/11A/15A/16A and M9410E/11E/15E/16E:</p> <ul style="list-style-type: none"> - When Trig n Out Device is ANALyzer, only MEASuring, MAIN and OFF are available - When Trig n Out Device is SOURce, only S1Marker, S2Marker, S3Marker, S4Marker, PARB, FSYNc and OFF are available

	For VXT model M9421A, Trig 2 Out is used as the Analyzer trigger output								
Preset	Unaffected by Preset, but preset to the following values by Restore Input/Output Defaults or Restore System Defaults->All :								
	<table border="1"> <tr> <td>Trigger 1</td> <td>Sweeping (HSWP)</td> </tr> <tr> <td>Trigger 2</td> <td>Gate</td> </tr> <tr> <td>Trigger 3</td> <td>Sweeping (HSWP)</td> </tr> <tr> <td>Trigger 4</td> <td>Gate</td> </tr> </table>	Trigger 1	Sweeping (HSWP)	Trigger 2	Gate	Trigger 3	Sweeping (HSWP)	Trigger 4	Gate
Trigger 1	Sweeping (HSWP)								
Trigger 2	Gate								
Trigger 3	Sweeping (HSWP)								
Trigger 4	Gate								
State Saved	Saved in instrument state								

Trigger Out Options

Source	SCPI	Notes
Off	OFF	Selects no signal to be output to the Trig n Out connector
Sweeping	HSWP	Selects the Sweeping Trigger signal to be output to the Trig n Out connector when a measurement is made This signal has historically been known as HSWP (High = Sweeping), and is 5 V TTL level with 50 Ω output impedance
Measuring	MEASuring	Selects the Measuring trigger signal to be output to the Trig n Out connector. This signal is true while the Measuring status bit is true
Main Trigger	MAIN	Selects the current instrument trigger signal to be output to the Trig n Out connector Note: For multi segment sweeps, only the first sweep segment uses the selected trigger signal. All other sweep segments trigger using Free-Run and the trigger output will reflect that
Gate Trigger	GTRigger	Selects the gate trigger signal to be output to the Trig n Out connector. This is the source of the gate timing, not the actual gate signal
Gate	GATE	Selects the gate signal to be output to the Trig n Out connector. The gate signal has been delayed and its length determined by delay and length settings. When the polarity is positive, a high on the Trig n Out connector represents the time the gate is configured to pass the signal
Odd/Even Trace Point	OEVen	Selects either the odd or even trace points as the signal to be output to the Trig n Out connector when performing swept spectrum analysis. When the polarity is positive, this output goes high during the time the instrument is sweeping past the first point (Point 0) and every other following trace point. The opposite is true if the polarity is negative
Trigger Armed	TARMed	Selects the “trigger armed” trigger signal to be output to the Trig n Out connector. This signal is true when the instrument reaches its trigger armed state <i>Not available in modular instruments</i>
Source Point Trigger	SPOint	Selects the gate signal to be output to the Trig n Out connector for use as the Point Trigger when operating an external source in Tracking mode. When Ext Trigger 1 is

Source	SCPI	Notes
		selected as the Point Trigger under Source , the Source Point Trigger under Trig 1 Out automatically gets selected. A similar pattern is used for the other Ext Trigger inputs; for example, when Ext Trigger 2 is selected as the Point Trigger under Source , the Source Point Trigger under Trig 2 Out automatically gets selected
Source Marker 1	S1Marker	Only available in VXT and M941xE. For M9420A, only for TRIG2 , for M9410A/11A/15A/16A available for both TRIG1 and TRIG2 Selects the Trigger Output at Marker 1 in the Waveform file that is currently playing
Source Marker 2	S2Marker	Only available in VXT and M941xE. For M9420A, only for TRIG2 , for M9410A/11A/15A/16A and M9410E/11E/15E/16E available for both TRIG1 and TRIG2 Selects the Trigger Output at Marker 2 in the Waveform file that is currently playing
Source Marker 3	S3Marker	Only available in VXT and M941xE. For M9420A, only for TRIG2 , for M9410A/11A/15A/16A and M9410E/11E/15E/16E available for both TRIG1 and TRIG2 Selects the Trigger Output at Marker 3 in the Waveform file that is currently playing
Source Marker 4	S4Marker	Only available in VXT and M941xE. For M9420A, only for TRIG2 , for M9410A/11A/15A/16A and M9410E/11E/15E/16E available for both TRIG1 and TRIG2 Selects the Trigger Output at Marker 4 in the Waveform file that is currently playing
PerArb	PARB	Only available in VXT Models M9410A/11A/15A/16A and M9410E/11E/15E/16E Selects the Trigger Output as PerArb. PerArb is a synchronization trigger which is generated by the ARB at the beginning of each repetition of playing the signal
FSYnc	FSYnc	Only available in VXT Models M9410A/11A/15A/16A and M9410E/11E/15E/16E Selects the Trigger Output as FSYnc , routing the Periodic Timer Sync Source signal to the specified Trigger output. That is, the signal selected by :TRIGger[:SEquence]:FRAMe:SYnc is routed to the specified trigger output The following example specifies that External 1 trigger will be used as the Periodic Timer Sync Source, and this signal will then be routed to the Trigger 2 output: TRIG:FRAM:SYnc EXT1 TRIG2:OUTP FSYnc
		–

6.8.2 Trig 1 – 4 Out Polarity

Sets the output to the **Trig n Out** connector to trigger on either the positive or negative polarity.

Remote Command	:TRIGger[1] 2 ... 4[:SEquence]:OUTPut:POLarity POSitive NEGative :TRIGger[1] 2 ... 4[:SEquence]:OUTPut:POLarity?
Example	:TRIG1:OUTP:POL POS

Dependencies	You can only send TRIG parameters for the hardware you have; for example, you cannot send a TRIG3 parameter if your hardware does not support TRIG3 . Sending the command for an output you do not have generates an error, “Hardware missing; Not available for this model number” Querying a non-existent output returns OFF Trig 2 Out Polarity does not appear in EXM or VXT
Preset	Unaffected by Preset, but set to POSitive by Restore Input/Output Defaults or Restore System Defaults->All
State Saved	Saved in instrument state

6.8.3 Trig 1 – 4 Out Device

Sets the output to the **Trig n Out** connector to trigger on either **ANALyzer** or **SOURce**.

Remote Command	<code>:TRIGger[1] 2 ... 4[:SEquence]:OUTPut:DIRection ANALyzer SOURce</code> <code>:TRIGger[1] 2 ... 4[:SEquence]:OUTPut:DIRection?</code>						
Example	<code>:TRIG1:OUTP:DIR ANAL</code>						
Dependencies	Only available on VXT models M9410A/11A/15A/16A and M9410E/11E/15E/16E						
Preset	Unaffected by Preset Restore Input/Output Defaults and Restore System Defaults->All preset the triggers as follows:						
	<table border="1"> <thead> <tr> <th>Trig n Out Device</th> <th>Preset</th> </tr> </thead> <tbody> <tr> <td>1, 3, 4</td> <td>ANALyzer</td> </tr> <tr> <td>2</td> <td>SOURce</td> </tr> </tbody> </table>	Trig n Out Device	Preset	1, 3, 4	ANALyzer	2	SOURce
Trig n Out Device	Preset						
1, 3, 4	ANALyzer						
2	SOURce						
State Saved	Saved in instrument state						

6.8.4 Src PXI Trig Out

Selects which signal will be routed to the backplane Source PXI Trigger Output Line.

Remote Command	<code>:TRIGger:PXIE:SOURce[:SEquence]:OUTPut S1Marker S2Marker S3Marker S4Marker PARB OFF</code> See " Option details " on page 2267 <code>:TRIGger:PXIE:SOURce[:SEquence]:OUTPut?</code>
Example	<code>:TRIG:PXIE:SOUR:OUTP S1M</code> <code>:TRIG:PXIE:SOUR:OUTP?</code>
Dependencies	Only appears in EXM, VXT and M941xE
Preset	OFF
State Saved	Saved in instrument state

Option details

Here are details of all Source PXI Trigger Output options:

Source	SCPI	Notes
Off	OFF	Selects no signal to be output to the Source PXI backplane line
Source Marker 1	S1Marker	Selects the Trigger Output at Marker 1 in the Waveform file that is currently playing to be output to the Source PXI backplane line
Source Marker 2	S2Marker	Selects the Trigger Output at Marker 2 in the Waveform file that is currently playing to be output to the Source PXI backplane line
Source Marker 3	S3Marker	Selects the Trigger Output at Marker 3 in the Waveform file that is currently playing to be output to the Source PXI backplane line
Source Marker 4	S4Marker	Selects the Trigger Output at Marker 4 in the Waveform file that is currently playing to be output to the Source PXI backplane line
PerArb	PARB	A synchronization trigger that is generated by the ARB at the beginning of each repetition of playing the signal. This selection causes the PerArb Trigger Output that is currently playing to be output to the Source PXI backplane line Only available in VXT Models M9410A/11A/15A/16A and M9410E/11E/15E/16E

6.8.5 Src Trig Out Polarity

Sets the output to the Source PXI backplane trigger line to trigger on either the positive or negative polarity.

Remote Command	<code>:TRIGger:PXIE:SOURce[:SEquence]:OUTPut:POLarity POSitive NEGative</code> <code>:TRIGger:PXIE:SOURce[:SEquence]:OUTPut:POLarity?</code>
Example	<code>:TRIG:PXIE:SOUR:OUTP:POL POS</code>
Dependencies	Only appears in EXM, VXT and M941xE
Preset	Unaffected by Preset, but set to POSitive by Restore Input/Output Defaults or Restore System Defaults->All
State Saved	Saved in instrument state

6.8.6 Select Src PXI Line

Controls which backplane trigger line `TRIG[0..7]` is used for the Source Trigger Output.

Remote Command	<code>:TRIGger:PXIE:SOURce[:SEquence]:OUTPut:LINE <line></code> <code>:TRIGger:PXIE:SOURce[:SEquence]:OUTPut:LINE?</code>
----------------	--

Example	<code>:TRIGger:PXIE:SOURce:OUTPut:LINE 0</code>
Dependencies	Only appears in EXM, VXT and M941xE
Preset	4
State Saved	Saved in instrument state
Range	[0,7]

6.8.7 Analyzer PXI Trig Out

Selects the signal that will be output from Analyzer PXI Trigger Line (Backplane Trigger Line 0~3).

Remote Command	<code>:TRIGger:PXIE:ANALyzer[:SEQuence]:OUTPut HSWP MEASuring MAIN GATE GTRigger OEVen OFF</code> See "Option Details" on page 2268 <code>:TRIGger:PXIE:ANALyzer[:SEQuence]:OUTPut?</code>
Example	<code>:TRIG:PXIE:ANAL:OUTP HSWP</code>
Dependencies	Only available on certain modular analyzers, such as CXA-m, VXT models M9410A/11A/15A/16A and M9410E/11E/15E/16E For VXT models M9410A/11A/15A/16A, only OFF , MEASuring and MAIN are available
Preset	Unaffected by Preset but is preset to OFF by Restore Input/Output Defaults or Restore System Defaults->All
State Saved	Saved in instrument state

Option Details

Here are details of all Analyzer PXI Trigger Output options:

Source	SCPI	Notes
Off	OFF	Selects no signal to be output to the Analyzer PXI backplane trigger line
Sweeping (HSWP)	HSWP	Selects the Sweeping Trigger signal to be output to the Analyzer PXI backplane trigger line when a measurement is made. This signal has historically been known as "HSWP" (High = Sweeping), and is 5 V TTL level with 50-ohm output impedance
Measuring	MEAS	Selects the Measuring trigger signal to be output to the Analyzer PXI backplane trigger line. This signal is true while the Measuring status bit is true
Main Trigger	MAIN	Selects the current instrument trigger signal to be output to the Analyzer PXI backplane trigger line
Gate Trigger	GTR	Selects the gate trigger signal to be output to the Analyzer PXI backplane trigger line. This is the source of the gate timing, not the actual gate signal
Gate	GATE	Selects the gate signal to be output to the Analyzer PXI backplane trigger line. The gate signal has been delayed and its length determined by delay and length settings. When the

6 Input/Output
6.8 Trigger Output

Source	SCPI	Notes
Odd/Even Trace Point	OEV	polarity is positive, a high on the Trig Out connector represents the time the gate is configured to pass the signal Selects either the odd or even trace points as the signal to be output to the Analyzer PXI backplane trigger line when performing swept spectrum analysis. When the polarity is positive, this output goes high during the time the instrument is sweeping past the first point (Point 0) and every other following trace point. The opposite is true if the polarity is negative

6.8.8 Analyzer Trig Out Polarity

Sets the output to the Analyzer PXI backplane trigger line to trigger on either the positive or negative polarity.

Remote Command	<code>:TRIGger:PXIE:ANALyzer[:SEQuence]:OUTPut:POLarity POSitive NEGative</code> <code>:TRIGger:PXIE:ANALyzer[:SEQuence]:OUTPut:POLarity?</code>
Example	<code>:TRIG:PXIE:ANAL:OUTP:POL POS</code>
Dependencies	Only available on certain modular analyzers, such as CXA-m, VXT models M9410A/11A/15A/16A and M9410E/11E/15E/16E
Preset	Unaffected by Preset, but set to POSitive by Restore Input/Output Defaults or Restore System Defaults->All POSitive
State Saved	Saved in instrument state

6.8.9 Select Analyzer PXI Line

Controls which `PXI_TRIG[0...3]` is used for the Analyzer Trigger Output.

Remote Command	<code>:TRIGger:PXIE:ANALyzer[:SEQuence]:OUTPut:LINE <line></code> <code>:TRIGger:PXIE:ANALyzer[:SEQuence]:OUTPut:LINE?</code>
Example	<code>:TRIGger:PXIE:ANALyzer:OUTPut:LINE 0</code>
Dependencies	Only available on certain modular analyzers, such as CXA-m, VXT models M9410A/11A/15A/16A and M9410E/11E/15E/16E
Preset	0
State Saved	Saved in instrument state
Range	[0,3]

6.8.10 Source Internal Trig Out

Selects the signal which will be output from Source Internal Trigger Line.

NOTE

In some software released in 2018 and 2019, the SCPI command for this function was as below:

```
:TRIGger:SOURce:INTernal[:SEquence]:OUTPut
S1Marker|S2Marker|S3Marker|S4Marker|OFF
```

It was necessary to change this SCPI in release A.24.00 due to internal conflicts in the software. User code written for the A.22.xx or A.23.xx instrument software which used the old form must be rewritten to use the form below.

Remote Command	<code>:TRIGger[:SEquence]:INTernal:SOURce:OUTPut S1Marker S2Marker S3Marker S4Marker PARB OFF</code> <code>:TRIGger[:SEquence]:INTernal:SOURce:OUTPut?</code>
Example	<code>:TRIG:INT:SOUR:OUTP S1M</code>
Notes	PARB (Per ARB) -A synchronization trigger that is generated by the ARB at the beginning of each repetition of playing the signal
Dependencies	Only available on VXT models M9420A, M9410A/11A/15A/16A and M9410E/11E/15E/16E
Preset	Unaffected by Preset but preset by Restore Input/Output Defaults or Restore System Defaults->All . The value is Mode-dependent: Power Amplifier Mode: S1Marker All other Modes: OFF
State Saved	Saved in instrument state

6.8.11 Source Internal Trig Out Polarity

Sets the output to the Source Internal trigger line to trigger on either the positive or negative polarity.

NOTE

In some software released in 2018 and 2019, the SCPI command for this function was as below:

```
:TRIGger:SOURce:INTernal[:SEquence]:OUTPut:POLarity
POSitive|NEGative
```

It was necessary to change this SCPI in release A.24.00 due to internal conflicts in the software. User code written for the A.22.xx or A.23.xx instrument software which used the old form must be rewritten to use the form below.

Remote Command	<code>:TRIGger[:SEquence]:INTernal:SOURce:OUTPut:POLarity POSitive NEGative</code> <code>:TRIGger[:SEquence]:INTernal:SOURce:OUTPut:POLarity?</code>
Example	<code>:TRIG:INT:SOUR:OUTP:POL POS</code>
Dependencies	Only available on VXT models and M9410E/11E/15E/16E
Preset	Unaffected by Preset , but set to POSitive by Restore Input/Output Defaults or Restore System

6 Input/Output
6.8 Trigger Output

Defaults->All	
State Saved	Saved in instrument state

6.9 Calibration

Lets you configure the Comb Calibrator. This tab only appears when an RCal license is installed. Settings associated with the Calibrator are configured here.

6.9.1 Configuration

Opens the dialog shown below. This is a full screen dialog. Configuring of Cals is done using this dialog. The table consists of rows of Cals and Columns of Cal settings. You can scroll or swipe vertically or horizontally to view Cals or settings not currently shown on the screen.

Dialog with Example Table entries:

? Close >

Cal Group

Cal Input

Calibrate Checked Rows

Apply Cal Group
 On
 Off

Copy From Cal Group

Copy

Select Calibrator

Serial #: SN1234567
Version 1.20

RCal Reference

Identify RCal Module

Cal Status >

Description

Go to Row Insert Row Below Use Current Meas Duplicate Row Delete Row Delete All

	Calibrate	Apply	Name	Last Cal	Applied	Type	Start Freq	Stop Fr
1	<input checked="" type="checkbox"/>	<input checked="" type="checkbox"/>	Entire Instrument	Jul 23 2019 03:32 PM	--	Magnitude	910.0 MHz	910.0 M
2	<input checked="" type="checkbox"/>	<input checked="" type="checkbox"/>	Switch Cal	May 14 2019 09:35 AM	--	Complex	1.000 GHz	2.000 G
3	<input checked="" type="checkbox"/>	<input checked="" type="checkbox"/>	Amp Cal	May 14 2019 09:35 AM	--	Magnitude	10 Hz	26.5 GH

Full Cal Group Table with Example entries:

6 Input/Output
6.9 Calibration

RCal Calibrations Table

Table will scroll vertically and horizontally

	Calibrate	Apply	Name	Last Cal	Applied	External Mixer	Cal Type
1	<input checked="" type="checkbox"/>	<input checked="" type="checkbox"/>	Entire Instrument	Aug 30 2018 03:32 PM	Yes	11970A : Normal	Vector
2	<input checked="" type="checkbox"/>	<input checked="" type="checkbox"/>	Wednesday with remote head	Sep 12 2018 02:27 PM	No	Custom : Normal	Vector
3	<input checked="" type="checkbox"/>	<input checked="" type="checkbox"/>	20190119 3:54pm	--	--	11970U : Normal	Vector
4	<input type="checkbox"/>	<input type="checkbox"/>	1 GHz – 3 GHz	--	--	11970V : Normal	Scalar
5	<input type="checkbox"/>	<input type="checkbox"/>	2 GHz – 4 GHz	--	--	K Band Single Harmonic No Doubler : Normal	Scalar
6	<input type="checkbox"/>	<input type="checkbox"/>	External Preamp	--	--	W Band Single Harmonic No Doubler : Normal	Scalar
7	<input type="checkbox"/>	<input type="checkbox"/>	(None)				
8	<input type="checkbox"/>	<input type="checkbox"/>	(None)				
9	<input type="checkbox"/>	<input type="checkbox"/>	(None)				
10	<input type="checkbox"/>	<input type="checkbox"/>	(None)				

Only shows when External Mixer is the selected Cal Input

Scalar
Vector

Start Freq	Stop Freq	Freq Step	Freq Points	Mech Atten	Mech Atten Start	Mech Atten Stop	Mech Atten Step	Elec Atten	Elec Atten Start
910.0 MHz	910.0 MHz	0 Hz	1	Step	0 dB	10 dB	2 dB	Step	0 dB
1.000 GHz	2.000 GHz	100.000 MHz	100	Reference	00 dB	00 dB	00 dB	Bypass	00 dB
10 Hz	26.5 GHz	0 Hz	3	All	00 dB	20 dB	2 dB	All	00 dB
1.000 GHz	3.000 GHz	100.00 MHz	20	Step	10 dB	50 dB	10 dB	Step	10 dB
2.000 GHz	4.000 GHz	10.000 MHz	200	Bypass	00 dB	20 dB	2 dB	All	00 dB
2.000 GHz	2.000 GHz	0 Hz	1	Reference	00 dB	00 dB	00 dB	Reference	00 dB

Step
All
Bypass

Step
All
Bypass

Elec Atten Stop	Elec Atten Step	Full Atten	Full Atten Start	Full Atten Stop	Freq Ext Atten	Freq Ext Atten Start	Freq Ext Atten Stop	IF Path
10 dB	5 dB	Step	0 dB	6 dB	Step	0 dB	6 dB	10 MHz
00 dB	00 dB	All	00 dB	00 dB	All	00 dB	00 dB	510 MHz
20 dB	9 dB	All	00 dB	20 dB	All	00 dB	200 dB	25 MHz
20 dB	2 dB	Step	6 dB	20 dB	Step	6 dB	20 dB	10 MHz
20 dB	9 dB	All	00 dB	20 dB	All	00 dB	200 dB	25 MHz
900 dB	00 dB	All	900 dB	900 dB	All	900 dB	900 dB	40 MHz

Step	Step	10 MHz
All	All	25 MHz
		40 MHz
		510 MHz
		1 GHz
		2 GHz
		4 GHz

6.9.1.1 Cal Group

This is the same as "Cal Group" on page 2307 in the Calibration tab.

6.9.1.2 Calibrate Checked Rows

Executes the Cals within the currently selected Cal Group that have the Calibrate box checked in the RCal Configuration Table.

Once selected, the following dialog box is displayed;

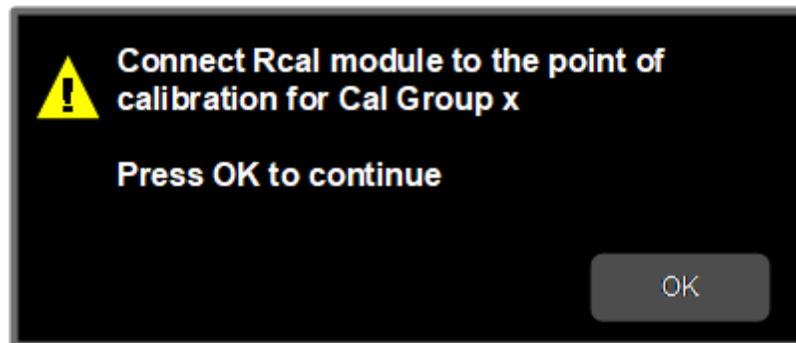

When you click OK, the following dialog is displayed;

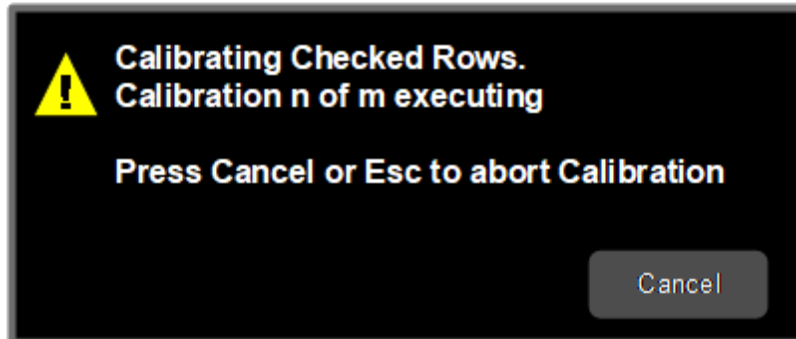

If there are multiple Cals being executed in a Cal Group, this dialog advises you when each Cal is complete. It also provides the ability to abort the Execute Cal Request. If you choose to abort, calibrations that have completed use the new Cal data and update the Last Cal field. Calibrations that have not completed retain the existing Cal data and Last Cal timestamp, or show “---” if the Cal had never been executed.

Remote Command	<code>:SYSTem:CALibration:INITiate:SElected</code>
Example	<code>:SYST:CAL:INIT:SEL</code>
Notes	Cals cannot be applied until they have been calibrated. Once a Cal has been calibrated, the Last Cal field in the table displays the date and time the Cal was last calibrated
Dependencies	Applied to the currently selected Cal Group
Couplings	Calibrate Selected is disabled if there are no Calibrate checkboxes checked. If the disabled control is selected, the advisory message “Check the Calibrate box for the Cals you want to calibrate” is displayed

6.9.1.3 Apply Cal Group

This is the same as ["Apply Cal Group" on page 2307](#) in the **Calibration** tab.

6.9.1.4 Abort Calibration

Aborts the Calibration routine of the currently selected Cal Group

Remote Command	<code>:SYSTem:CALibration:ABORt</code>
Example	<code>:SYST:CAL:ABOR</code>
Dependencies	Aborts the currently running calibration. The previously-run calibrations will still be available, but the current calibration is halted, and next calibrations selected are not executed. Once the calibration starts, the modal dialog appears, and the abort can be executed by selecting Cancel

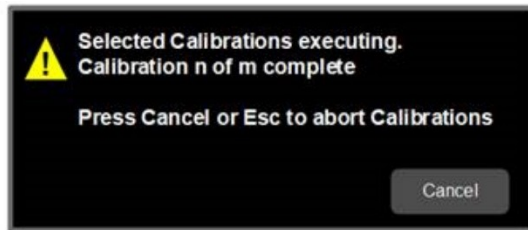

6.9.1.5 Copy From Cal Group

Determines the Cal Group from which existing rows are copied when using the "Copy" on page 2276 Group feature.

Remote Command	:SYSTem:CALibration:CGRoup:COPIY:FROM <integer>
Example	:SYST:CAL:CGR:COPIY:FROM 2 :SYST:CAL:CGR:COPIY:FROM?
Preset	1
Min	1
Max	100

6.9.1.6 Copy

Lets you copy the settings in the Cal Group specified by the **Copy From Cal Group** parameter.

All the rows in the table are copied to the selected Cal Group. The columns **Apply**, **Last Cal** and **Applied** are set to their default values.

The group level parameters are also copied, with the exception of **Apply Cal Group** and **Copy From Cal Group**.

Remote Command	:SYSTem:CALibration:CGRoup:COPIY
Example	:SYST:CAL:CGRoup:COPIY
Dependencies	Applied to the currently selected Cal Group
Couplings	Disabled if Copy From Cal Group is the same as the currently selected Cal Group. If the disabled control is selected, the advisory message "Unable to Copy from same Cal Group" is displayed, and the same message is returned remotely as a Settings Conflict If you attempt to copy from a Cal Group that is empty, the advisory message "Copy From Cal Group is empty" is displayed, and the same message is returned remotely as a Settings Conflict

6.9.1.7 Cal Input

Maps the currently selected Cal Group to a particular I/O port. This control allows any Input port (including External Mixing, the RF2 input, etc.) to be mapped to a specific Cal Group

Remote Command	<code>:SYSTem:CALibration:INPut RFIN RFIN2 EMIXer ERFIN</code> See " Option Details " on page 2277 <code>:SYSTem:CALibration:INPut?</code>
Example	<code>:SYST:CAL:INPut RFIN2</code>
Dependencies	<code>RFIN2</code> <code>EMIXer</code> are only available on C/E/M/P/UXA analyzers with the appropriate options loaded <code>ERFIN</code> is only available if a V3050A unit is connected
State Saved	Saved in State

Option Details

Note that the presence of these ports is highly hardware dependent.

Cal Input	SCPI	Notes
RF Input	<code>RFIN</code>	Main RF Port Not available on EXM with hardware M9431A
RF Input 2	<code>RFIN2</code>	Second RF Port, labeled RF Input 2 Only available on certain instruments
External Mixer	<code>EMIX</code>	Requires option EXM
External RF	<code>ERFIN</code>	Only available if a V3050A unit is connected

6.9.1.8 Freq Offset

Specifies any frequency offset that is to be applied to the currently selected Cal Group. This can be used when using an external mixer.

Remote Command	<code>:SYSTem:CALibration:FREQuency:OFFSet <freq></code> <code>:SYSTem:CALibration:FREQuency:OFFSet?</code>
Example	<code>:SYST:CAL:FREQ:OFFS 1e9</code>
Dependencies	The query applies to the currently selected Cal Group
Preset	All 0 Hz
State Saved	Saved in instrument state
Min	0 Hz
Max	100.0 GHz

6.9.1.9 Select Calibrator

Selects the calibrator for the currently selected Cal Group to use for executing the calibration when multiple modules are connected.

Remote Command	<code>:SYSTem:CALibration:MODule:SElect NONE RCM1 RCM2 RCM3 RCM4 RCM5 RCM6 RCM7 RCM8 RCM9 RCM10</code> <code>:SYSTem:CALibration:MODule:SElect?</code>
Example	<code>:SYST:CAL:MODule:SElect RCM1</code>
Notes	Details of the RCal module are displayed beneath the control. If there are no modules connected, the text states “No Modules Connected” For SCPI, if the parameter sent is for a module that is not currently connected to the instrument, the message “Selected RCal module not connected” is generated
Dependencies	The SCPI command is applied to the currently selected Cal Group
State Saved	Saved in instrument state
Range	All connected RCal modules

6.9.1.10 Identify RCal Module

Control to connect to the RCal module of the currently selected Cal Group and blink its identity light

6.9.1.11 RCal Module Serial Number (Remote Query Only)

Returns the serial number of the specified module

Remote Command	<code>:SYSTem:CALibration:MODule[1] 2 ... 10:SNUMber?</code>
Example	<code>:SYST:CAL:MOD:SNUM?</code>
Notes	If there is no module associated with the specified module number, returns an empty string

6.9.1.12 RCal Reference

Determines the reference type used by the RCal module of the currently selected Cal Group

Remote Command	<code>:SYSTem:CALibration:REFerence INTernal EXTernal</code> <code>:SYSTem:CALibration:REFerence?</code>
Example	<code>:SYST:CAL:REF EXT</code>
Dependencies	The SCPI command is applied to the currently selected Cal Group

Preset	EXternal
State Saved	Saved in instrument state
Range	Internal External

6.9.1.13 RCal Status

Opens a dialog that is used to provide the status of all active rows in all groups. Status can be one of the following: Calibrated, Applied, Calibration Failed or Apply Failed.

If a Calibration Fails, an error icon is shown in the **Calibrate** column of the row(s) that failed, with a message indicating the nature of the failure. If the failure cannot be addressed by the user, the error message “Calibration Failed. See Error Log” will be shown and details of the failure will be written to the SA Event Log.

Applying the Calibration can result in a warning if there is a mismatch between the currently executing instrument state and any of the following parameter settings;

- Cal Input
- Frequency
- IF Path
- IF Gain
- Phase Noise Optimization
- Preamp
- Coupling
- Mechanical Attenuator
- Electrical Attenuator
- Full Range Attenuator
- uW Path Control
- Mixing Mode
- External Mixer

When there is a mismatch a warning icon will be shown in the Applied column of the row(s) that had the mismatch with details in the format “<Parameter Name> does not match meas state”.

The Status dialog provides you with the group and row of a Calibration and its current state and any error details if the status is not OK.

RCal Status (Remote Query Only)

Returns a comma-separated list of the status of an individual row status in the format “Group”, “Row”, ‘Status’, “Details”

Remote Command	<code>:SYSTem:CALibration:ROW[1] 2 ... 100:STATus?</code>
Example	Return a comma-separated list for the status of an individual row, in the format “Group”, “Row”, ‘Status’, “Details”: <code>:SYST:CAL:ROW2:STAT?</code>
Dependencies	The SCPI command is applied to the currently selected Cal Group. The subopcode is used to identify the Cal row in the Cal Group If the subopcode does not reference an existing Cal row in the Cal Group, the error message “-221, Settings conflict; Subopcode does not reference an existing Cal row” is generated

All RCal Status (Remote Query Only)

Returns a comma-separated list of all entries in the Cal Status table in the format “Group”, “Row”, ‘Status’, “Details”, which is repeated for each row in the table. If there are no entries in the table, returns an empty string.

Remote Command	<code>:SYSTem:CALibration:STATus:ALL?</code>
Example	Return a comma-separated list of all entries in the Cal Status table in the format “Group”, “Row”, ‘Status’, “Details”, repeated for each row in the table: <code>:SYST:CAL:STAT:ALL?</code>

6.9.1.14 Go to Row

Sets the selected row in the Cal table for the currently selected Cal Group.

Notes	You can only go to a row that has already been added
Preset	1
State Saved	Saved in instrument state
Min	1
Max	32

6.9.1.15 Insert Row Below

Adds a new row to the currently selected Cal Group, under the currently selected row in the table or after the sub opcode used in the SCPI command. The default values for each of the settings in the row is used.

Remote Command	<code>:SYSTem:CALibration:ROW[1] 2 ... 100:INSert</code>
Example	<code>:SYST:CAL:ROW2:INSert</code>
Dependencies	The SCPI command is applied to the currently selected Cal Group. The subopcode is used to identify the Cal row in the Cal Group If the subopcode does not reference an existing Cal row in the Cal Group, the error message “-221, Settings conflict; Subopcode does not reference an existing Cal row” is generated

6.9.1.16 Description

Provides a description for the currently selected Cal Group from which the operator can easily identify the Cal Group.

Remote Command	<code>:SYSTem:CALibration:DESCription "Description"</code> <code>:SYSTem:CALibration:DESCription?</code>
Example	<code>:SYST:CAL:DESC "Description"</code>
Notes	Also shown on the Calibration menu panel, but limited to the first 18 characters
Dependencies	The SCPI command is applied to the currently selected Cal Group
State Saved	Saved in instrument state

6.9.1.17 Use Current Meas

Takes the settings from the current running measurement state to populate the Cal Row settings of the currently selected Cal Group.

Remote Command	<code>:SYSTem:CALibration:ROW[1] 2 ... 100:UCMeas</code>
Example	<code>:SYST:CAL:ROW2:UCM</code>
Dependencies	The SCPI command is applied to the currently selected Cal Group. The subopcode is used to identify the Cal row in the Cal Group If the group table is empty and subopcode is omitted or 1, a new row is created and populated using the current running measurement If the subopcode does not reference an existing Cal row in the Cal Group, the error message “-221,Settings conflict; Subopcode does not reference an existing Cal row” is generated Pressing the control or sending the SCPI command in measurements that do not support this parameter generates error -221, “Settings conflict; Feature not supported for this measurement”

6.9.1.18 Duplicate Row

Creates a new row the currently selected row, and populates the new row with the settings from the selected row of the currently selected Cal Group

Remote Command	<code>:SYSTem:CALibration:ROW[1] 2 ... 100:DUPLicate</code>
Example	<code>:SYST:CAL:ROW2:DUPL</code>
Dependencies	The SCPI command is applied to the currently selected Cal Group. The subopcode is used to identify the Cal row in the Cal Group If the subopcode does not reference an existing Cal row in the Cal Group, the error message “-221,Settings conflict; Subopcode does not reference an existing Cal row” is generated

6.9.1.19 Delete Row

Deletes the settings from the selected row of the currently selected Cal Group

Remote Command	<code>:SYSTem:CALibration:ROW[1] 2 ... 100:DELeTe</code>
Example	<code>:SYST:CAL:ROW2:DEL</code>
Notes	Disabled if the Cal Group contains no Cal rows
Dependencies	The SCPI command is applied to the currently selected Cal Group. The subopcode is used to identify the Cal row in the Cal Group If the subopcode does not reference an existing Cal row in the Cal Group, the error message “-221, Settings conflict; Subopcode does not reference an existing Cal row” is generated

6.9.1.20 Delete All

Deletes all the Cals in the currently selected Cal Group

Remote Command	<code>:SYSTem:CALibration:DELeTe:ALL</code>
Example	<code>:SYST:CAL:DEL:ALL</code>
Notes	Disabled if the Cal Group contains no Cal rows
Dependencies	The SCPI command is applied to the currently selected Cal Group

6.9.1.21 Calibrate

Determines whether the Cal row should be included when Calibrate Selected is executed.

Remote Command	<code>:SYSTem:CALibration:ROW[1] 2 ... 100:CALibrate:STATe ON OFF 1 0</code> <code>:SYSTem:CALibration:ROW[1] 2 ... 100:CALibrate:STATe?</code>
----------------	--

Example	<code>:SYST:CAL:ROW2:CAL:STAT ON</code> <code>:SYST:CAL:ROW2:CAL:STAT?</code>
Dependencies	The SCPI command is applied to the currently selected Cal Group. The subopcode is used to identify the Cal row in the Cal Group If the subopcode does not reference an existing Cal row in the Cal Group, the error message “-221, Settings conflict; Subopcode does not reference an existing Cal row” is generated
Preset	All OFF
State Saved	Saved in instrument state
Range	ON OFF

6.9.1.22 Apply

Determines the Cal that is applied.

Remote Command	<code>:SYSTem:CALibration:ROW[1] 2 ... 100:APPLY:STATe ON OFF 1 0</code> <code>:SYSTem:CALibration:ROW[1] 2 ... 100:APPLY:STATe?</code>
Example	<code>:SYST:CAL:ROW2:APPL:STAT ON</code> <code>:SYST:CAL:ROW2:APPL:STAT?</code>
Dependencies	The SCPI command is applied to the currently selected Cal Group. The subopcode is used to identify the Cal row in the Cal Group If the subopcode does not reference an existing Cal row in the Cal Group, the error message “-221, Settings conflict; Subopcode does not reference an existing Cal row” is generated You can only check the Apply checkbox for a Cal that has been executed. If you attempt to select the Apply checkbox for Cal's that have not been executed, the advisory message “Cal must be executed before it can be applied” is displayed If Apply Cal is ON , and you attempt to check the Apply checkbox for a Cal that is invalid for use with the current measurement state, the error “Cal invalid with current measurement settings is shown, and the checkbox remains unchecked
Couplings	When the Apply check box is checked, if the Apply Cal Group setting is OFF , it will be turned on. Calibrations are only applied when the Apply Cal Group is ON
Preset	All OFF
State Saved	Saved in instrument state
Range	ON OFF
Annotation	If <i>any</i> Cal check box in any group is checked and Apply Cal Group for that group is ON , RCal in the Meas Bar displays in amber to indicate Calibrations are in use

6.9.1.23 Name

Sets an ASCII text field allowing you to name the selected Cal

Remote Command	<code>:SYSTem:CALibration:ROW[1] 2 ... 100:NAME <string></code> <code>:SYSTem:CALibration:ROW[1] 2 ... 100:NAME?</code>
Example	<code>:SYST:CAL:ROW2:NAM "Monday AM Cal"</code>
Notes	45 chars max; may not fit on display if max chars used
Dependencies	The SCPI command is applied to the currently selected Cal Group. The subopcode is used to identify the Cal row in the Cal Group If the subopcode does not reference an existing Cal row in the Cal Group, the error message “-221, Settings conflict; Subopcode does not reference an existing Cal row” is generated
Preset	“Cal #”, where # is corresponding Cal number
State Saved	Saved in instrument state

6.9.1.24 Last Cal

Displays the date and time the selected Cal was last executed. Read only field.

Remote Command	<code>:SYSTem:CALibration:ROW[1] 2 ... 100:LAST?</code>
Example	Return data and time Cal 2 was last executed: <code>:SYST:CAL:ROW2:LAST?</code>
Notes	Returns a string containing the date and time the Cal was executed. If the Cal has never been executed, or any of the settings are changed, SCPI returns an empty string, and the front panel displays “---”
Dependencies	The SCPI query applies to the currently selected Cal Group If the subopcode does not reference an existing Cal row in the Cal Group, the error message “-221, Settings conflict; Subopcode does not reference an existing Cal row” is generated

6.9.1.25 Cal Applied

Displays the status of a Cal once it is applied. Is either Yes or No, depending on if the Cal was successfully applied or not. See RCalStatus for more details. If it is not being applied, the field shows “---”. Read-only field.

Remote Command	<code>:SYSTem:CALibration:ROW[1] 2 ... 100:CAPLied?</code>
Example	Return Cal Stats of Cal 2: <code>:SYST:CAL:ROW2:CAPP?</code>
Notes	Returns a string containing the date and time the Cal was executed. If the Cal has never been executed, or any of the settings are changed, SCPI returns an empty string, and the front panel displays “---”
Dependencies	The SCPI query applies to the currently selected Cal Group If the subopcode does not reference an existing Cal row in the Cal Group, the error message “-221, Settings conflict; Subopcode does not reference an existing Cal row” is generated

6.9.1.26 Cal Type

Specifies how the calibration is to be performed on the selected Cal. Options are;

- **MAGNitude**: A single CW tone is measured at the center of the screen for each frequency point
- **COMPLex**: A comb signal is measured across the full IF passband at each frequency point. Magnitude and Phase are measured

Remote Command	<code>:SYSTem:CALibration:ROW[1] 2 ... 100:TYPE MAGNitude COMPLex</code> <code>:SYSTem:CALibration:ROW[1] 2 ... 100:TYPE?</code>
Example	<code>:SYST:CAL:ROW2:TYPE COMP</code>
Dependencies	Only available if the selected RCal module has a license for complex calibrations. If it does not, this control is disabled The SCPI command applies to the currently selected Cal Group If the subopcode does not reference an existing Cal row in the Cal Group, the error message “-221, Settings conflict; Subopcode does not reference an existing Cal row” is generated
Preset	MAGNitude
State Saved	Saved in instrument state
Range	MAGNitude COMPLex

6.9.1.27 Start Freq

Specifies the start frequency of the selected Cal.

Remote Command	<code>:SYSTem:CALibration:ROW[1] 2 ... 100:FREQUENCY:START <freq></code> <code>:SYSTem:CALibration:ROW[1] 2 ... 100:FREQUENCY:START?</code>
Example	<code>:SYST:CAL:ROW2:FREQ:STAR 1e9</code>
Notes	Max values depend on Hardware Options (503, 507, 508, 513, 526)
Dependencies	The SCPI command applies to the currently selected Cal Group If the subopcode does not reference an existing Cal row in the Cal Group, the error message “-221, Settings conflict; Subopcode does not reference an existing Cal row” is generated By direct entry: You cannot set Start Frequency > Stop Frequency. You can set the Start frequency = Stop frequency. If you set Start Frequency = Stop Frequency, " Freq Step " on page 2287 is adjusted to 0, and " Freq Points " on page 2287 is adjusted to 1 With the knob or step keys: If you set Start Frequency = Stop Frequency, Freq Step is adjusted to 0, and Freq Points is adjusted to 1
Couplings	If you change the start frequency of the selected range to a value > the range's stop frequency, the

	<p>stop frequency of the previous range is changed to the same value. Freq Step is set to 0 Hz and Freq Points is set to 1</p> <p>If you change the start frequency \leq min frequency of the instrument, the start frequency of the selected range is set to the minimum frequency of the instrument</p> <p>If you change the start frequency \geq maximum frequency of the instrument, the start frequency of the selected range is set to the maximum frequency of the instrument and the stop frequency of selected range is set to the maximum frequency of the instrument. Freq Step is set to 0 Hz and Freq Points is set to 1</p>
Preset	Depends on the instrument maximum frequency
State Saved	Saved in instrument state
Min	If Scale Type is set to Lin, the min Start Frequency changes to -80 MHz
Max	Depends on the instrument maximum frequency – 10 Hz minimum span

6.9.1.28 Stop Freq

Specifies the stop frequency of the selected Cal.

Remote Command	<pre>:SYSTem:CALibration:ROW[1] 2 ... 100:FREQUENCY:STOP <freq> :SYSTem:CALibration:ROW[1] 2 ... 100:FREQUENCY:STOP?</pre>
Example	<pre>:SYST:CAL:ROW2:FREQ:STOP 1e9</pre>
Notes	Max values depend on Hardware Options
Dependencies	<p>The SCPI command applies to the currently selected Cal Group</p> <p>If the subopcode does not reference an existing Cal row in the Cal Group, the error message “-221, Settings conflict; Subopcode does not reference an existing Cal row” is generated</p> <p>By direct entry:</p> <p>You cannot set Stop frequency < Start frequency. You cannot set Start frequency = Stop frequency. You can set Start frequency = Stop frequency. If you set Start Frequency = Stop Frequency, "Freq Step" on page 2287 is adjusted to 0, and "Freq Points" on page 2287 is adjusted to 1</p> <p>With the knob or step keys:</p> <p>If you set Start Frequency = Stop Frequency, Freq Step is adjusted to 0, and Freq Points is adjusted to 1</p>
Couplings	<p>If you change the stop frequency of the selected range to a value < the range's start frequency the start frequency of the range is changed to the same value. Freq Step is set to 0 Hz and Freq Points is set to 1</p> <p>If you change the stop frequency \geq the maximum frequency of the instrument, the stop frequency of the selected range is set to the maximum frequency of the instrument</p> <p>If you change stop frequency \leq the minimum frequency of the instrument, the stop frequency of the selected range is set to the minimum frequency of the instrument and the start frequency of the selected range is set to the minimum frequency of the instrument. Freq Step is set to 0 Hz and Freq Points is set to 1</p>
Preset	Depends on the instrument maximum frequency

State Saved	Saved in instrument state
Min	If Scale Type is Lin, the min Stop Frequency is changed to -79.999990 MHz
Max	Depends on the instrument maximum frequency

6.9.1.29 Freq Step

Specifies the step frequency of the selected Cal. This determines the points between the start and stop frequencies to use for Calibration.

Remote Command	<code>:SYSTem:CALibration:ROW[1] 2 ... 100:FREQUENCY:STEP <freq></code> <code>:SYSTem:CALibration:ROW[1] 2 ... 100:FREQUENCY:STEP?</code>
Example	<code>:SYST:CAL:ROW2:FREQ:STEP 1e9</code>
Notes	Max values depend on Hardware Options
Dependencies	The SCPI command applies to the currently selected Cal Group If the subopcode does not reference an existing Cal row in the Cal Group, the error message “-221, Settings conflict; Subopcode does not reference an existing Cal row” is generated You cannot set Freq Step > Stop frequency - Start frequency Attempts to set Freq Step > Stop frequency - Start frequency results in Freq Step being set to Stop frequency - Start frequency
Couplings	Coupled to " Freq Points " on page 2287. Changing Freq Step adjusts Freq Points using $((\text{Stop Freq} - \text{Start Freq}) / \text{Freq Step} + 1)$ and clips to the next integer value, which may result in Freq Step being clipped too If Freq Step is set to a value > Stop Freq - Start Freq Stop Freq is increased, and Freq Points is set to 1
Preset	All 10 kHz
State Saved	Saved in instrument state
Min	1 Hz
Max	Depends on the instrument maximum frequency

6.9.1.30 Freq Points

Specifies the frequency points of the selected Cal. This determines the points between the start and stop frequencies to use for Calibration.

Remote Command	<code>:SYSTem:CALibration:ROW[1] 2 ... 100:FREQUENCY:POINTS</code> <code>:SYSTem:CALibration:ROW[1] 2 ... 100:FREQUENCY:POINTS?</code>
Example	<code>:SYST:CAL:ROW2:FREQ:POIN 100</code>
Couplings	Coupled to " Freq Step " on page 2287. Changing Freq Points adjusts Freq Step using $(\text{Stop Freq} - \text{Start Freq}) / (\text{Freq Points} - 1)$ and clips to the next integer value, which may result in Freq Step being clipped

Preset	1
Min	1
Max	100000

6.9.1.31 Mech Atten Type

Specifies the Mech Atten type to use:

- **STEP**: Use multiple Mech Atten states determined by Mech Atten Start, Mech Atten Stop and Mech Atten Step
- **ALL**: Use all the attenuator states
- **BYPass**: Bypasses the attenuator

Remote Command	<code>:SYSTem:CALibration:ROW[1] 2 ... 100:ATTenuation:TYPE STEP ALL BYPass</code> <code>:SYSTem:CALibration:ROW[1] 2 ... 100:ATTenuation:TYPE?</code>
Example	<code>:SYST:CAL:ROW3:ATT:TYPE STEP</code>
Dependencies	The SCPI command applies to the currently selected Cal Group If the subopcode does not reference an existing Cal row in the Cal Group, the error message “-221,Settings conflict; Subopcode does not reference an existing Cal row” is generated
Preset	STEP
State Saved	Saved in instrument state
Range	STEP ALL BYPass

6.9.1.32 Mech Atten Start

Determines the first Mechanical Attenuator to be used in the Calibration

Remote Command	<code>:SYSTem:CALibration:ROW[1] 2 ... 100:ATTenuation:START <rel_amp></code> <code>:SYSTem:CALibration:ROW[1] 2 ... 100:ATTenuation:START?</code>
Example	<code>:SYST:CAL:ROW3:ATT:START 20</code>
Dependencies	Disabled unless " Mech Atten Type " on page 2288 is STEP The SCPI command applies to the currently selected Cal Group If the subopcode does not reference an existing Cal row in the Cal Group, the error message “-221,Settings conflict; Subopcode does not reference an existing Cal row” is generated
Couplings	Coupled to " Mech Atten Stop " on page 2289. Mech Atten Start must be \leq Mech Atten Stop . If Mech Atten Start $>$ Mech Atten Stop , then Mech Atten Stop = Mech Atten Start
Preset	10 dB
State Saved	Saved in instrument state
Min	0 dB

6 Input/Output
6.9 Calibration

The attenuation set by this control cannot be decreased below 6 dB with the knob or step keys. To get to a value below 6 dB it must be directly entered from the keypad or via SCPI. This protects from adjusting the attenuation to a dangerously small value, which can put the instrument at risk of damage to input circuitry. However, if the current mechanical attenuation is below 6 dB it can be increased with the knob and step keys, but not decreased

Max	CXA Option 503 or 507: 50 dB EXA: 60 dB All other models: 70 dB Note that, in the single attenuator configuration, the total of ATT and EATT cannot exceed 50 dB, so if the EATT is set to 24 dB first, the main attenuation cannot be greater than 26 dB and is reduced accordingly; if the main attenuator is set to 40 dB first, EATT cannot be greater than 10 dB
-----	--

6.9.1.33 Mech Atten Stop

Determines the last Mechanical Attenuator to be used in the Calibration

Remote Command	<code>:SYSTem:CALibration:ROW[1] 2 ... 100:ATTenuation:STOP <rel_amp1></code> <code>:SYSTem:CALibration:ROW[1] 2 ... 100:ATTenuation:STOP?</code>	
Example	<code>:SYST:CAL:ROW3:ATT:STOP 30</code>	
Dependencies	Disabled unless " Mech Atten Type " on page 2288 is STEP The SCPI command applies to the currently selected Cal Group If the subopcode does not reference an existing Cal row in the Cal Group, the error message “-221,Settings conflict; Subopcode does not reference an existing Cal row” is generated	
Couplings	Coupled to " Mech Atten Start " on page 2288. Mech Atten Start must be \leq Mech Atten Stop . If Mech Atten Start $>$ Mech Atten Stop , then Mech Atten Stop = Mech Atten Start	
Preset	10 dB	
State Saved	Saved in instrument state	
Min	0 dB The attenuation set by this control cannot be decreased below 6 dB with the knob or step keys. To get to a value below 6 dB it must be directly entered from the keypad or via SCPI. This protects from adjusting the attenuation to a dangerously small value which can put the instrument at risk of damage to input circuitry. However, if the current mechanical attenuation is below 6 dB it can be increased with the knob and step keys, but not decreased	
Max	CXA Option 503 or 507	50 dB
	EXA	60 dB
	All other models	70 dB
	Note that, in the single attenuator configuration, the total of ATT and EATT cannot exceed 50 dB, so if the EATT is set to 24 dB first, the main attenuation cannot be greater than 26 dB and is reduced accordingly; if the main attenuator is set to 40 dB first, EATT cannot be greater than 10 dB	

6.9.1.34 Mech Atten Step

Determines the Mech Attenuation Step. This determines the points between the Mechanical Attenuation min and max to use for Calibration.

Remote Command	<code>:SYSTem:CALibration:ROW[1] 2 ... 100:ATTenuation:STEP <rel_amp1></code> <code>:SYSTem:CALibration:ROW[1] 2 ... 100:ATTenuation:STEP?</code>
Example	<code>:SYST:CAL:ROW2:ATT:STEP 2dB</code>
Dependencies	Disabled unless " Mech Atten Type " on page 2288 is STEP The SCPI command applies to the currently selected Cal Group If the subopcode does not reference an existing Cal row in the Cal Group, the error message "-221, Settings conflict; Subopcode does not reference an existing Cal row" is generated
Preset	2 dB
State Saved	Saved in instrument state
Min	2 dB
Max	10 dB

6.9.1.35 Elec Atten Type

Specifies the Elec Atten type to use:

- **STEP**: Use multiple Elec Atten states determined by Elec Atten Start, Elec Atten Stop and Elec Atten Step
- **ALL**: Use all the attenuator states
- **BYPass**: Bypasses the attenuator

Remote Command	<code>:SYSTem:CALibration:ROW[1] 2 ... 100:EATTenuation:TYPE STEP ALL BYPass</code> <code>:SYSTem:CALibration:ROW[1] 2 ... 100:EATTenuation:TYPE?</code>
Example	<code>:SYST:CAL:ROW3:EATT:TYPE STEP</code>
Dependencies	The SCPI command applies to the currently selected Cal Group If the subopcode does not reference an existing Cal row in the Cal Group, the error message "-221, Settings conflict; Subopcode does not reference an existing Cal row" is generated
Preset	STEP
State Saved	Saved in instrument state
Range	STEP ALL BYPass

6.9.1.36 Elec Atten Start

Determines the first Electronic Attenuator to be used in the Calibration

6 Input/Output
6.9 Calibration

Remote Command	<code>:SYSTem:CALibration:ROW[1] 2 ... 100:EATTenuation:START <rel_amp></code> <code>:SYSTem:CALibration:ROW[1] 2 ... 100:EATTenuation:START?</code>
Example	<code>:SYST:CAL:ROW3:EATT:START 0</code>
Dependencies	<p>Only appears in Dual Attenuator models with an Electronic Attenuator installed and licensed. It does not appear in models with the Single Attenuator configuration, as in the single attenuator configuration there is no “electronic attenuator” there is only a single integrated attenuator (which has both a mechanical and electronic stage)</p> <p>Disabled unless "Elec Atten Type" on page 2290 is STEP</p> <p>The electronic attenuator is unavailable above the low band (0-3.6 GHz, 0-3.4 GHz, or 0-3 GHz, depending on the model). If the low band ranges from 0-3.6 GHz, and Stop Frequency of the Calibration is > 3.6 GHz, then this parameter is grayed out</p> <p>If the Internal Preamp is on, meaning it is set to Low Band or Full, or the electronic attenuator is unavailable, then this parameter is grayed-out</p> <p>If either of the above is true, and if the SCPI command is sent, an error indicating that the electronic attenuator is unavailable is sent</p> <p>If both of the above are true, pressing the control generates error message -221, in other words, the frequency range lockout takes precedence</p> <p>The SCPI command applies to the currently selected Cal Group</p> <p>If the subopcode does not reference an existing Cal row in the Cal Group, the error message “-221, Settings conflict; Subopcode does not reference an existing Cal row” is generated</p>
Couplings	Coupled to Elec Atten Stop. Elec Atten Start must be <= Elec Atten Stop. If Elec Atten Start > Elec Atten Stop, Elec Atten Stop = Elec Atten Start
Preset	0 dB
State Saved	Saved in instrument state
Min	0 dB
Max	24 dB

6.9.1.37 Elec Atten Stop

Determines the last Electrical Attenuator to be used in the Calibration

Remote Command	<code>:SYSTem:CALibration:ROW[1] 2 ... 100:EATTenuation:STOP <rel_amp></code> <code>:SYSTem:CALibration:ROW[1] 2 ... 100:EATTenuation:STOP?</code>
Example	<code>:SYST:CAL:ROW3:EATT:STOP 10</code>
Dependencies	<p>Only appears in Dual Attenuator models with an Electronic Attenuator installed and licensed. It does not appear in models with the Single Attenuator configuration, as in the single attenuator configuration there is no “electronic attenuator” there is only a single integrated attenuator (which has both a mechanical and electronic stage)</p> <p>Disabled unless "Elec Atten Type" on page 2290 is STEP</p> <p>The electronic attenuator is unavailable above the low band (0-3.6 GHz, 0-3.4 GHz or 0-3 GHz, depending on the model). If the low band ranges from 0-3.6 GHz, and Stop Frequency of the</p>

	<p>Calibration is > 3.6 GHz, then this parameter is grayed out</p> <p>If the Internal Preamp is on, meaning it is set to Low Band or Full, the electronic attenuator is unavailable, then this parameter is grayed out</p> <p>If either of the above is true, and if the SCPI command is sent, an error indicating that the electronic attenuator is unavailable is sent</p> <p>If both of the above are true, pressing the control generates error message -221, in other words, the frequency range lockout takes precedence</p> <p>For SCPI, this query applies to the currently selected Cal Group</p> <p>If the subopcode does not reference an existing Cal row in the Cal Group, the error message “-221, Settings conflict; Subopcode does not reference an existing Cal row” is generated</p>
Couplings	Coupled to Elec Atten Start. Elec Atten Stop must be >= Elec Atten Start. If Elec Atten Stop < Elec Atten Start, Elec Atten Start = Elec Atten Stop
Preset	0 dB
State Saved	Saved in instrument state
Min	0 dB
Max	24 dB

6.9.1.38 Elec Atten Step

Determines the Elec Attenuation Step. This determines the points between the Electric Attenuation min and max to use for Calibration.

Remote Command	<pre>:SYSTem:CALibration:ROW[1] 2 ... 100:EATTenuation:STEP <rel_amp></pre> <pre>:SYSTem:CALibration:ROW[1] 2 ... 100:EATTenuation:STEP?</pre>
Example	<pre>:SYST:CAL:ROW2:EATT:STEP 2dB</pre>
Dependencies	<p>Disabled unless "Elec Atten Type" on page 2290 is STEP</p> <p>The SCPI command applies to the currently selected Cal Group</p> <p>If the subopcode does not reference an existing Cal row in the Cal Group, the error message “-221, Settings conflict; Subopcode does not reference an existing Cal row” is generated</p>
Preset	1 dB
State Saved	Saved in instrument state
Min	1 dB
Max	24 dB

6.9.1.39 Full Range Atten Type

Specifies the Full Range Atten type to use. The Full Range Attenuator adds a second input attenuator at the beginning of the RF Input 2, which enhances the protection and optimizes the performance of the extra internal mixers used by RF Input 2.

- **STEP**: Use multiple Full Range Atten states determined by Full Range Atten Start and Full Range Atten Stop
- **ALL**: Use all the attenuator states

Remote Command	<code>:SYSTem:CALibration:ROW[1] 2 ... 100:FATTenuation:TYPE STEP ALL </code> <code>:SYSTem:CALibration:ROW[1] 2 ... 100:FATTenuation:TYPE?</code>
Example	<code>:SYST:CAL:ROW3:FATT:TYPE STEP</code>
Dependencies	Only appears if input RF is selected, and RF Input Port 2 is selected, and the Full Range Attenuator exists The SCPI command applies to the currently selected Cal Group If the subopcode does not reference an existing Cal row in the Cal Group, the error message “-221, Settings conflict; Subopcode does not reference an existing Cal row” is generated
Preset	STEP
State Saved	Saved in instrument state
Range	STEP ALL

6.9.1.40 Full Range Atten Start

Determines the first Full Range Attenuator to be used in the Calibration

Remote Command	<code>:SYSTem:CALibration:ROW[1] 2 ... 100:FATTenuation:START <rel_amp></code> <code>:SYSTem:CALibration:ROW[1] 2 ... 100:FATTenuation:START?</code>
Example	<code>:SYST:CAL:ROW3:FATT:START 0</code>
Dependencies	Only appears in N9041B, when the RF input is selected, and the RF Input Port is set to RF Input 2, and the Full Range Attenuator is installed Disabled unless " Full Range Atten Type " on page 2292 is STEP The SCPI command applies to the currently selected Cal Group If the subopcode does not reference an existing Cal row in the Cal Group, the error message “-221, Settings conflict; Subopcode does not reference an existing Cal row” is generated
Couplings	Coupled to Full Range Atten Stop. Full Range Atten Start must be <= Full Range Atten Stop. If Full Range Atten Start > Full Range Atten Stop, Full Range Atten Stop = Full Range Atten Start
Preset	20 dB
State Saved	Saved in instrument state
Min	0 dB
Max	Only valid values are 0, 6, 14, 20 dB

6.9.1.41 Full Range Atten Stop

Determines the last Full Range Attenuator to be used in the Calibration

Remote Command	<code>:SYSTem:CALibration:ROW[1] 2 ... 100:FATTenuation:STOP <rel_amp1></code> <code>:SYSTem:CALibration:ROW[1] 2 ... 100:FATTenuation:STOP?</code>
Example	<code>:SYST:CAL:ROW3:FAT:PT:STOP 10</code>
Dependencies	Only appears in N9041B, when the RF input is selected, and the RF Input Port is set to RF Input 2, and the Full Range Attenuator is installed Disabled unless " Full Range Atten Type " on page 2292 is STEP The SCPI command applies to the currently selected Cal Group If the subopcode does not reference an existing Cal row in the Cal Group, the error message “-221, Settings conflict; Subopcode does not reference an existing Cal row” is generated
Couplings	Coupled to Full Range Atten Start. Full Range Atten Stop must be \geq Full Range Atten Start. If Full Atten Stop $<$ Full Range Atten Start, Full Range Atten Start = Full Range Atten Stop
Preset	20 dB
State Saved	Saved in instrument state
Min	0 dB
Max	Only valid values are 0, 6, 14, 20 dB

6.9.1.42 Frequency Extender Attenuation Type

Specifies the Frequency Extender Attenuation type to use. **Frequency Extender Attenuation** is applied to the frequency extender's high frequency input signal path (for example, with a V3050A frequency extender, the high frequency path is 50 GHz to 110 GHz).

- **STEP**: Use multiple Frequency Extender Attenuation states determined by Frequency Extender Attenuation Start and Frequency Extender Attenuation Stop
- **ALL**: Use all the attenuator states

Remote Command	<code>:SYSTem:CALibration:ROW[1] 2 ... 100:FEATtenuation:TYPE STEP ALL</code> <code>:SYSTem:CALibration:ROW[1] 2 ... 100:FEATtenuation:TYPE?</code>
Example	<code>:SYST:CAL:ROW3:FEAT:TYPE STEP</code>
Dependencies	Only applies, and is only visible, when the External RF (ERFIN) input is selected The SCPI command applies to the currently selected Cal Group If the subopcode does not reference an existing Cal row in the Cal Group, the error message “-221, Settings conflict; Subopcode does not reference an existing Cal row” is generated
Preset	STEP
State Saved	No
Range	STEP ALL REFERENCE

6.9.1.43 Frequency Extender Attenuation Start

Determines the first Frequency Extender Attenuator to be used in the Calibration.

Remote Command	<code>:SYSTem:CALibration:ROW[1] 2 ... 100:FEATtenuation:START <rel_amp1></code> <code>:SYSTem:CALibration:ROW[1] 2 ... 100:FEATtenuation:START?</code>
Example	<code>:SYST:CAL:ROW3:FEAT:START 0</code>
Dependencies	Only applies, and is only visible, when the External RF (ERFIN) input is selected Disabled unless " Frequency Extender Attenuation Type " on page 2294 is STEP The SCPI command applies to the currently selected Cal Group If the subopcode does not reference an existing Cal row in the Cal Group, the error message “-221, Settings conflict; Subopcode does not reference an existing Cal row” is generated
Couplings	Coupled to Frequency Extender Attenuation Stop. Frequency Extender Attenuation Start must be \leq Frequency Extender Attenuation Stop. If Frequency Extender Attenuation Start $>$ Frequency Extender Attenuation Stop, Frequency Extender Attenuation Stop = Frequency Extender Attenuation Start
Preset	0 dB
State Saved	Saved in instrument state
Min	0 dB
Max	V3050A: 26 dB

6.9.1.44 Frequency Extender Attenuation Stop

Determines the last Frequency Extender Attenuation to be used in the Calibration.

Remote Command	<code>:SYSTem:CALibration:ROW[1] 2 ... 100:FEATtenuation:STOP <rel_amp1></code> <code>:SYSTem:CALibration:ROW[1] 2 ... 100:FEATtenuation:STOP?</code>
Example	<code>:SYST:CAL:ROW3:FEAT:PT:STOP 26</code>
Dependencies	Only applies, and is only visible, when the External RF (ERFIN) input is selected Disabled unless " Frequency Extender Attenuation Type " on page 2294 is STEP The SCPI command applies to the currently selected Cal Group If the subopcode does not reference an existing Cal row in the Cal Group, the error message “-221, Settings conflict; Subopcode does not reference an existing Cal row” is generated
Couplings	Coupled to Frequency Extender Attenuation Start. Frequency Extender Attenuation Stop must be \geq Frequency Extender Attenuation Start. If Frequency Extender Attenuation Stop $<$ Frequency Extender Attenuation Start, Frequency Extender Attenuation Start = Frequency Extender Attenuation Stop
Preset	26 dB
State Saved	Saved in instrument state
Min	0 dB
Max	V3050A: 26 dB

6.9.1.45 Frequency Extender Atten Step

Determines the Frequency Extender Attenuation Step. This determines the points between the Frequency Extender Attenuation min and max to use for Calibration.

Remote Command	<code>:SYSTem:CALibration:ROW[1] 2 ... 100:FEATtenuation:STEP <rel_amp1></code> <code>:SYSTem:CALibration:ROW[1] 2 ... 100:FEATtenuation:STEP?</code>
Example	<code>:SYST:CAL:ROW2:FEAT:STEP 2dB</code>
Dependencies	Only applies, and is only visible, when the External RF (ERFIN) input is selected The SCPI command applies to the currently selected Cal Group If the subopcode does not reference an existing Cal row in the Cal Group, the error message “-221, Settings conflict; Subopcode does not reference an existing Cal row” is generated
Preset	1 dB
State Saved	No
Min	1 dB
Max	V3050A: 26 dB

6.9.1.46 IF Path

Determines the IF Path to be used in the Calibration.

Remote Command	<code>:SYSTem:CALibration:ROW[1] 2 ... 100:IF:PATH B10M B25M B40M B85M B125M B140M B160M B255M B510M B1G B1500M B2G B4G EXT</code> <code>:SYSTem:CALibration:ROW[1] 2 ... 100:IF:PATH?</code>																								
Example	<code>:SYST:CAL:ROW2:IF:PATH B25M</code>																								
Notes	<table border="1"> <tr><td>B10M</td><td>10 MHz</td></tr> <tr><td>B25M</td><td>25 MHz</td></tr> <tr><td>B40M</td><td>40 MHz</td></tr> <tr><td>B85M</td><td>85 MHz</td></tr> <tr><td>B125M</td><td>125 MHz</td></tr> <tr><td>B140M</td><td>140 MHz</td></tr> <tr><td>B160M</td><td>160 MHz</td></tr> <tr><td>B255M</td><td>255 MHz</td></tr> <tr><td>B510M</td><td>510 MHz</td></tr> <tr><td>B1G</td><td>1 GHz</td></tr> <tr><td>B1500M</td><td>1.5 GHz</td></tr> <tr><td>B2G</td><td>2 GHz</td></tr> </table>	B10M	10 MHz	B25M	25 MHz	B40M	40 MHz	B85M	85 MHz	B125M	125 MHz	B140M	140 MHz	B160M	160 MHz	B255M	255 MHz	B510M	510 MHz	B1G	1 GHz	B1500M	1.5 GHz	B2G	2 GHz
B10M	10 MHz																								
B25M	25 MHz																								
B40M	40 MHz																								
B85M	85 MHz																								
B125M	125 MHz																								
B140M	140 MHz																								
B160M	160 MHz																								
B255M	255 MHz																								
B510M	510 MHz																								
B1G	1 GHz																								
B1500M	1.5 GHz																								
B2G	2 GHz																								

6 Input/Output
6.9 Calibration

	B4G	4 GHz
	EXT	Depends on the hardware
	In cases where the path is not available but is selected via SCPI, generates error -241, "Hardware missing; Option not installed"	
Dependencies	Path	Availability requires Installation of:
	25 MHz	25 MHz or wider IF Bandwidth option
	40 MHz	40 MHz or wider IF Bandwidth option
	85 MHz	85 MHz or wider IF Bandwidth option
	125 MHz	125 MHz or wider IF Bandwidth option
	140 MHz	Option B1X
	160 MHz	Option B1Y. B1Y cannot be installed without B1X
	255 MHz	Option B2X or wider IF Bandwidth option
	510 MHz	Option B5Y or wider IF Bandwidth option
	1 GHz	Option H1G/B1G or wider IF Bandwidth option
	2 GHz	Option B2G(R20) or wider IF Bandwidth option
	4 GHz	Option B4G(R40) or wider IF Bandwidth option
	1.5 GHz	Option R15
	If Option B85 <i>and</i> either Option B1A or Option B1X are installed, the 85 MHz option does not appear, and B85M is disabled. Sending the command to select B85M in this case generates an error -221, "Settings Conflict; Use wider bandwidth selection"	
	If Option B1A <i>and</i> Option B1X are both installed, the 125 MHz option does not appear, and B125M is disabled. Sending the command to select B125M in this case generates an error -221, "Settings Conflict; Use wider bandwidth selection"	
	In cases where the path is not available, but is selected via SCPI, error -241, "Hardware missing; Option not installed" is generated	
	The preset value depends on the Digital IF BW setting of the default measurement	
Preset	If the 25 MHz path is not available, presets to 10 MHz	
State Saved	No	
Range	B10M B25M B40M B85M B125M B140M B160M B255M B510M B1G B1500M B2G B4G EXT	

6.9.1.47 IF Gain

Determines the IF Gain to be used in the Calibration

Remote Command	:SYSTem:CALibration:ROW[1] 2 ... 100:IF:GAIN[:STATE]AUTO HIGH LOW ALL :SYSTem:CALibration:ROW[1] 2 ... 100:IF:GAIN[:STATE]?
----------------	--

Example	<code>:SYST:CAL:ROW3:IF:GAIN ALL</code>
Dependencies	The SCPI command applies to the current selected Cal Group If the subopcode does not reference an existing Cal row in the Cal Group, the error message “-221, Settings conflict; Subopcode does not reference an existing Cal row” is generated
Preset	<code>AUTO</code>
State Saved	Saved in instrument state
Range	Auto High Gain Low Gain All

6.9.1.48 Preamp

Determines if the Preamp is to be used in the Calibration

Remote Command	<code>:SYSTem:CALibration:ROW[1] 2 ... 100:POWer[:RF]:GAIN:BAND OFF LOW FULL</code> <code>:SYSTem:CALibration:ROW[1] 2 ... 100:POWer:GAIN:BAND?</code>
Example	<code>:SYST:CAL:ROW2:POWer:GAIN:BAND OFF</code>
Dependencies	The SCPI command applies to the current selected Cal Group If the subopcode does not reference an existing Cal row in the Cal Group, the error message “-221, Settings conflict; Subopcode does not reference an existing Cal row” is generated
Preset	<code>OFF</code>
State Saved	Saved in instrument state
Range	<code>OFF LOW FULL</code>

6.9.1.49 Low Noise Amplifier (LNA)

Determines if the LNA is to be used in the Calibration.

Remote Command	<code>:SYSTem:CALibration:ROW[1] 2 ... 100:POWer[:RF]:GAIN:LNA[:STATe] ON OFF 1 0</code> <code>:SYSTem:CALibration:ROW[1] 2 ... 100:POWer[:RF]:GAIN:LNA[:STATe]?</code>
Example	<code>:SYST:CAL:ROW2:POW:GAIN:LNA ON</code> <code>:SYST:CAL:ROW2:POW:GAIN:LNA?</code>
Dependencies	The SCPI command is applied to the currently selected Cal Group. The subopcode is used to identify the Cal row in the Cal Group If the subopcode does not reference an existing Cal row in the Cal Group, the error message “-221, Settings conflict; Subopcode does not reference an existing Cal row” is generated
Preset	<code>OFF</code>
State Saved	No
Range	<code>ON OFF</code>

6.9.1.50 μ W Path Control

Determines the μ W Path Control to be used in the Calibration.

Option	SCPI
Standard Path	STD
Low Noise Path	LNPath
μ W Presel Bypass	MPBypass
Full Bypass	FULL

Remote Command	<code>:SYSTEM:CALibration:ROW[1] 2 ... 100:POWer[:RF]:MW:PATH STD LNPath MPBypass FULL</code> <code>:SYSTEM:CALibration:ROW[1] 2 ... 100:POWer[:RF]:MW:PATH?</code>
Example	<code>:SYST:CAL:ROW2:POW:MW:PATH FULL</code>
Dependencies	The SCPI command applies to the current selected Cal Group If the subopcode does not reference an existing Cal row in the Cal Group, the error message “-221, Settings conflict; Subopcode does not reference an existing Cal row” is generated This column is not shown in the table unless <i>either</i> Option MPB or Option LNB is present and licensed The Low Noise Path selection does not appear unless Option LNP is present and licensed The μ W Presel Bypass selection does not appear unless Option MPB is present and licensed The Full Bypass selection does not appear unless Options LNP, MPB and FBP are installed and licensed In any of these cases, if the required options are not present and the SCPI command is sent, error - 241, "Hardware missing; Option not installed" is generated
Preset	STD
State Saved	Saved in instrument state
Range	STD LNPath MPBypass FULL

6.9.1.51 Coupling

Determines the Coupling to be used in the Calibration

Remote Command	<code>:SYSTEM:CALibration:ROW[1] 2 ... 100:COUPling AC DC</code> <code>:SYSTEM:CALibration:ROW[1] 2 ... 100:COUPling?</code>
Example	<code>:SYST:CAL:ROW3:COUP AC</code>
Dependencies	The SCPI command applies to the current selected Cal Group If the subopcode does not reference an existing Cal row in the Cal Group, the error message “-221, Settings conflict; Subopcode does not reference an existing Cal row” is generated
Preset	AC

State Saved	Saved in instrument state
Range	AC DC

6.9.1.52 Phase Noise Optimization

Selects the LO (local oscillator) phase noise behavior for various desired operating conditions.

For full details, see "[Parameter Options & Installed Options](#)" on page 2300 below.

Remote Command	<code>:SYSTem:CALibration:ROW[1] 2 ... 100:FREQuency:SYNTHeSis[:STATe] 1 ... 5</code> For the meaning of each numeric option value, see " Parameter Options & Installed Options " on page 2300 below <code>:SYSTem:CALibration:ROW[1] 2 ... 100:FREQuency:SYNTHeSis[:STATe]?</code>
Example	Select optimization for best wide offset phase noise: <code>:SYST:CAL:ROW1:FREQ:SYNT 2</code>
Dependencies	The SCPI command applies to the current selected Cal Group If the subopcode does not reference an existing Cal row in the Cal Group, the error message “-221, Settings conflict; Subopcode does not reference an existing Cal row” is generated
Couplings	Coupled with " Phase Noise Optimization All Option " on page 2305 When Phase Noise Optimization All is ON , selects all available LO mappings, and Phase Noise Optimization parameter will display All in the Configuration table. SCPI Query is still available to determine which parameter will be displayed when Phase Noise Optimization All is OFF
Preset	2
State Saved	Yes
Range	See " Ranges " on page 2305 below
Min	1
Max	5

Parameter Options & Installed Options

The Phase Noise Optimization control lets you optimize the setup and behavior of the Local Oscillator (LO) depending on your specific measurement conditions. You may wish to trade off noise and speed, for example, to make a measurement faster without regard to noise or with optimum noise characteristics without regard to speed.

Parameter Values Summary

Option	#	Description
"Balanced" on page 2302	1	– In instruments with EPO, balances close-in phase noise with spur avoidance

Option	#	Description
		– In instruments without EPO optimizes phase noise for small frequency offsets from the carrier
"Best Wide-offset" on page 2302	2	Optimizes phase noise for wide frequency offsets from the carrier
"Fast Tuning" on page 2302	3	Optimizes LO for tuning speed
"Best Close-in" on page 2301	4 or 1*	– In instruments with EPO, emphasizes close-in phase noise performance without regard to spur avoidance – In instruments without EPO, this setting is accepted but no action is taken
"Best Spurs" on page 2302	5	– In instruments with EPO, emphasizes spur avoidance over close-in phase noise performance – In instruments without EPO, this setting is accepted but no action taken
Auto	-	Automatically selects LO (local oscillator) phase noise behavior to optimize dynamic range and speed for various instrument operating conditions

*Dependent on Option EPO installation. See "Best Close-in" on page 2301 below.

The actual behavior varies somewhat depending on model number and option; for example, you always get Fast Tuning by choosing Option #3, but in some models, "Fast Tuning" on page 2302 is identical in effect to "Best Close-in" on page 2301.

Best Close-in

Without option EPO

`:FREQ:SYNT 1`

The LO phase noise is optimized for smaller offsets from the carrier, at the expense of phase noise farther out.

The actual frequency offset within which noise is optimized is shown with in square brackets, as this can vary depending on the hardware set in use. For example, in some instruments this annotation appears as [offset < 20 kHz]

With option EPO

`:FREQ:SYNT 4`

In instruments with Option EPO, the LO is configured for the best possible close-in phase noise (offsets up to 600 kHz from the carrier), regardless of spurious products that occur with some center frequencies. Because this is generally less desirable for close-in measurements than the "Balanced" on page 2302 setting, parameter 1 selects "Balanced" on page 2302 in EPO instruments, in the interests of optimizing

code compatibility across the family. Parameter 4 selects "Best Close-in" on page 2301, which is usually not as good a choice as "Balanced" on page 2302.

Balanced

:FREQ:SYNT 1

In instruments with EPO, the LO is configured for the best possible phase noise at offsets up to 600 kHz from the carrier whenever there are no significant spurs within the span observed with an on-screen carrier. When there will be such a spur, the LO is reconfigured in a way that allows the phase noise to increase by 7 dB mostly within ± 1 octave around 400 kHz offset. The spurs will always be below -70 dBc.

Best Spurs

:FREQ:SYNT 5

In instruments with EPO, the LO is configured for better phase noise than the "Best Wide-offset" on page 2302 case close to the carrier, but the configuration has 11 dB worse phase noise than the "Best Close-in" on page 2301 case mostly within ± 1 octave around 300 kHz offset. Spurs are even lower than in the "Balanced" on page 2302 case at better than -90 dBc, whether or not the carrier is on-screen.

This setting is never selected when Phase Noise Optimization is in Auto, you must select it manually.

Best Wide-offset

:FREQ:SYNT 2

The LO phase noise is optimized for wider offsets from the carrier. Optimization is especially improved for offsets from 70 kHz to 300 kHz. Closer offsets are compromised and the throughput of measurements (especially remote measurements where the center frequency is changing rapidly), is reduced.

The actual frequency offset beyond which noise is optimized is shown with in square brackets, as this can vary depending on the hardware set in use. For example, in some instruments this annotation appears as [offset >30 kHz]

In instruments with Option EPO, the LO is configured for the best possible phase noise at offsets up to 600 kHz from the carrier whenever there are no significant spurs within the span observed with an on-screen carrier. When there will be such a spur, the LO is reconfigured in a way that allows the phase noise to increase by 7 dB mostly within ± 1 octave around 400 kHz offset. The spurs will always be below -70 dBc.

Fast Tuning

:FREQ:SYNT 3

In this mode, the LO behavior compromises phase noise at many offsets from the carrier in order to allow rapid measurement throughput when changing the center frequency or span. The term "[Fast Tuning" on page 2302](#) refers to the time it takes to move the local oscillator to the start frequency and begin a sweep; this setting does not impact the actual sweep time in any way.

In instruments with EP1, the LO behavior compromises phase noise at offsets below 4 MHz in order to improve measurement throughput. The throughput is especially affected when moving the LO more than 2.5 MHz and up to 10 MHz from the stop frequency to the next start frequency.

In instruments with Option EPO, this is the same configuration as "[Best Spurs" on page 2302](#). It is available with the "[Fast Tuning" on page 2302](#) label for convenience, and to make the user interface more consistent with other X-Series instrument family members.

(In models whose hardware does not provide for a "[Fast Tuning" on page 2302](#) option, the settings for "[Best Close-in" on page 2301](#) are used if "[Fast Tuning" on page 2302](#) is selected. This gives the fastest possible tuning for that hardware set.)

Auto

`:FREQ:SYNT:AUTO ON`

Selects the LO (local oscillator) phase noise behavior to optimize dynamic range and speed for various instrument operating conditions. The selection rules are as follows.

Auto Optimization Rules

X-Series instruments have several grades of LO, offering different configurations when in the Auto Mode. The rules for Auto selection are as follows:

Models with Option	Conditions	Selection
EPO	Center frequency is < 699.9 kHz	"Balanced" on page 2302
Models with option EPO have a two stage local oscillator, which switches to a single loop for fast tuning (available in UXA)	Span > 114.1 MHz, or	"Fast Tuning" on page 2302
	RBW > 800 kHz	"Fast Tuning" on page 2302
	RBW > 290 kHz, or	"Best Wide-offset" on page 2302
	Span > 4.2 MHz	"Best Wide-offset" on page 2302
	Other conditions	"Balanced" on page 2302
EP1	Span > 44.44 MHz, or	"Fast Tuning" on page 2302
Models with option EP1 have a two-	RBW > 1.9 MHz, or	"Fast Tuning" on page 2302

Models with Option	Conditions	Selection
loop local oscillator, which switches to a single loop for fast tuning (available in PXA)	Source Mode is set to "Tracking" Center frequency is < 195 kHz, <i>or</i> CF \geq 1 MHz <i>and</i> Span \leq 1.3 MHz <i>and</i> RBW \leq 75 kHz All other conditions	"Best Close-in" on page 2301 "Best Wide-offset" on page 2302
EP2 Models with option EP2 use a different loop bandwidth for the fast-tuning choice, which is a compromise between tuning speed and phase noise, giving good tuning speed at all offsets. Although not as good as for "Best Close-in" on page 2301; this is useful when you have to look across a wide range of spans (available, for example, in MXA for excellent phase noise)	CF < 130 kHz, <i>or</i> CF > 12 MHz <i>and</i> Span < 495 kHz <i>and</i> RBW < 40 kHz Span > 22 MHz, <i>or</i> RBW > 400 kHz, <i>or</i> CF \leq 12 MHz <i>and</i> Span < 495 kHz <i>and</i> RBW < 23 kHz All other conditions	"Best Close-in" on page 2301 "Fast Tuning" on page 2302 "Best Wide-offset" on page 2302
EP4 (available in CXA for improved phase noise)	Span > 101 MHz <i>or</i> RBW > 1.15 MHz <i>or</i> Source Mode is set to "Tracking" CF is < 109 kHz <i>or</i> CF \geq 4.95 MHz <i>and</i> Span \leq 666 kHz <i>and</i> RBW < 28 kHz All other conditions	"Fast Tuning" on page 2302 "Best Close-in" on page 2301 "Best Wide-offset" on page 2302
All Other Models Note that in these models, the hardware does not actually provide for an extra-fast tuning option, so the settings for "Fast Tuning" on page 2302 are actually the same as "Best Close-in" on page 2301, but the rules are implemented this way so that the user who doesn't care about phase noise but does care about tuning speed doesn't have to remember which of the other two settings gives faster tuning	Span > 12.34 MHz, <i>or</i> RBW > 250 kHz, <i>or</i> Source Mode is set to "Tracking" Center frequency is < 25 kHz, <i>or</i> CF \geq 1 MHz <i>and</i> Span \leq 141.4 kHz <i>and</i> RBW \leq 5 kHz All other conditions	"Fast Tuning" on page 2302 "Best Close-in" on page 2301 "Best Wide-offset" on page 2302

In all the above cases:

- The RBW to be used in the calculations is the equivalent -3 dB bandwidth of the current RBW filter
- The rules apply whether in swept spans, zero span, or FFT spans

Ranges

Option	Option #	Phase Noise Option	Range
No EPx Option	1	Best Close-in	[offset < 20 kHz]
	2	Best Wide-offset	[offset > 30 kHz]
	3	Fast Tuning	[same as Best Close-In]
EPO	4	Best Close-in	[offset < 600 kHz]
	1	Balanced	[offset < 600 kHz]
	5	Best Spurs	[offset < 600 kHz]
EP1	2	Best Wide-offset	[offset > 800 kHz]
	3	Fast Tuning	[same as Best Close-In]
	1	Best Close-in	[offset < 140 kHz]
EP2, EP3, EP5	2	Best Wide-offset	[offset > 160 kHz]
	3	Fast Tuning	[single loop]
	1	Best Close-in	[offset < 70 kHz]
EP4	2	Best Wide-offset	[offset > 100 kHz]
	3	Fast Tuning	[medium loop bw]
	1	Best Close-in	[offset < 90 kHz]
	2	Best Wide-offset	[offset > 130 kHz]
	3	Fast Tuning	[same as Best Close-In]

6.9.1.53 Phase Noise Optimization All Option

Selects all available LO settings

Remote Command	<code>:SYSTem:CALibration:ROW[1] 2 ... 100:FREQuency:SYNTHeSis:ALL[:STATe] ON OFF 1 0 :SYSTem:CALibration:ROW[1] 2 ... 100:FREQuency:SYNTHeSis:ALL[:STATe]?</code>
Example	<code>:SYST:CAL:ROW1:FREQ:SYNT:ALL ON</code>
Notes	When this parameter is ON , it overrides the Phase Noise Optimization parameter, and selects all available LO settings
Dependencies	The SCPI command applies to the current selected Cal Group If the subopcode does not reference an existing Cal row in the Cal Group, the error message “-221, Settings conflict; Subopcode does not reference an existing Cal row” is generated

Couplings	Coupled with " Phase Noise Optimization " on page 2300. When this parameter is ON , it selects all available LO mappings, and Phase Noise Optimization parameter displays All in the Configuration table. When this parameter is OFF , the Phase Noise Optimization parameter displays its previously set value in the Configuration table
Preset	OFF
State Saved	Saved in instrument state
Range	ON OFF

6.9.1.54 Mixing Mode

Determines the LO Mixing Mode to be used.

Remote Command	<code>:SYSTem:CALibration:ROW[1] 2 ... 100:LO:MMODE NORMa1 ALTErnate ALL</code> <code>:SYSTem:CALibration:ROW[1] 2 ... 100:LO:MMODE?</code>
Example	<code>:SYST:CAL:ROW3:LO:MMOD NORM</code>
Dependencies	The SCPI command applies to the current selected Cal Group If the subopcode does not reference an existing Cal row in the Cal Group, the error message “-221,Settings conflict; Subopcode does not reference an existing Cal row” is generated
Preset	NORMa1
State Saved	Saved in instrument state
Range	NORMa1 ALTErnate ALL

6.9.1.55 Match State

Determines if the Cal settings must match exactly when applying the correction. If not, the system may find the closest matching state or interpolate between states.

Remote Command	<code>:SYSTem:CALibration:ROW[1] 2 ... 100:MATCH[:STATE] ON OFF 1 0</code> <code>:SYSTem:CALibration:ROW[1] 2 ... 100:MATCH[:STATE]?</code>
Example	<code>:SYST:CAL4:MATC ON</code> <code>:SYST:CAL4:MATC?</code>
Dependencies	The SCPI command is applied to the currently selected Cal Group. The subopcode is used to identify the Cal row in the Cal Group If the subopcode does not reference an existing Cal row in the Cal Group, the error message “-221, Settings conflict; Subopcode does not reference an existing Cal row” is generated
Preset	All True
State Saved	Saved in instrument state
Range	True False

6.9.2 Cal Group

Specifies the selected Calibration Group. You can use different Cal Groups for different external hardware configurations. The Cal Group is also an important concept when sending SCPI commands to the Calibration System, because in each case the SCPI command is directed to the currently-selected Cal Group, which is the Cal Group that is modified by the SCPI command.

Remote Command	<code>:SYSTem:CALibration:CGRoup <integer></code> <code>:SYSTem:CALibration:CGRoup?</code>
Example	<code>:SYST:CAL:CGR 2</code> <code>:SYST:CAL:CGR?</code>
Preset	1
Min	1
Max	100

6.9.3 Apply Cal Group

Controls whether or not the checked **Apply** rows of the currently selected Cal Group are applied.

Remote Command	<code>:SYSTem:CALibration:CGRoup:APPLy <bool></code> <code>:SYSTem:CALibration:CGRoup:APPLy?</code>
Example	<code>:SYST:CAL:CGR:APPL ON</code> <code>:SYST:CAL:CGR:APPL?</code>
Dependencies	The SCPI command is applied to the currently selected Cal Group You can only turn on Apply Cal Group if at least one Cal for the currently selected group has been executed. If you attempt to select Apply Cal Group before any Cals have been executed, the advisory message "At least one Row must be calibrated before it can be applied" is displayed
Preset	OFF
State Saved	Saved in instrument state
Range	ON OFF
Annotation	If <i>any</i> Cal Group is ON , RCal in the Meas Bar displays in amber, to indicate that Calibrations are in use

6.9.4 All Apply Cal Group Off

Turns off **Apply Cal Group** for all groups.

Remote	<code>:SYSTem:CALibration:CGRoup:APPLy:AOff</code>
--------	--

Command

Example :SYST:CAL:CGR:APPL:AOFF

6.9.5 Connection

Opens the **Connection** dialog, which provides step-by-step instructions for its use.

6.10 Calibrator Control

Lets you select a calibrator and control the calibrator settings.

6.10.1 Select Cal Source

Lets you select the calibrator to control.

Remote Command	<code>:SYSTem:CALibration:TUNE[:SELEcted] NONE REF50 REF4800 TUNAb1e CALOUT RCM1 RCM2 RCM3 RCM4 RCM5 RCM6 RCM7 RCM8 RCM9 RCM10</code> <code>:SYSTem:CALibration:TUNE[:SELEcted]?</code>												
Example	<code>:SYST:CAL:TUNE:SEL TUNABLE</code> <code>:SYST:CAL:TUNE?</code>												
Notes	Options are: <table border="1"> <tr> <td><code>NONE</code></td> <td>No calibrator selected</td> </tr> <tr> <td><code>TUNAb1e</code></td> <td>Tunable internal calibrator present in N9042B</td> </tr> <tr> <td><code>CALOUT</code></td> <td>Tunable calibrator available through CALOUT front panel port in N9042B</td> </tr> <tr> <td><code>REF50</code></td> <td>50 MHz calibrator</td> </tr> <tr> <td><code>REF4800</code></td> <td>4.8 GHz calibrator</td> </tr> <tr> <td><code>RCM1 – RCM10</code></td> <td>RCal module</td> </tr> </table>	<code>NONE</code>	No calibrator selected	<code>TUNAb1e</code>	Tunable internal calibrator present in N9042B	<code>CALOUT</code>	Tunable calibrator available through CALOUT front panel port in N9042B	<code>REF50</code>	50 MHz calibrator	<code>REF4800</code>	4.8 GHz calibrator	<code>RCM1 – RCM10</code>	RCal module
<code>NONE</code>	No calibrator selected												
<code>TUNAb1e</code>	Tunable internal calibrator present in N9042B												
<code>CALOUT</code>	Tunable calibrator available through CALOUT front panel port in N9042B												
<code>REF50</code>	50 MHz calibrator												
<code>REF4800</code>	4.8 GHz calibrator												
<code>RCM1 – RCM10</code>	RCal module												
Dependencies	If the selected calibrator is not available, it does not appear in the dropdown. If you send SCPI to select a calibrator that is not available, the instrument generates an error												
Couplings	Selecting <code>REF50</code> sets the RF Calibrator to <code>REF50</code> Selecting <code>REF4800</code> sets the RF Calibrator to <code>REF4800</code> Selecting a calibrator source other than <code>REF50</code> or <code>REF4800</code> sets RF Calibrator to <code>OFF</code>												
Preset	Unaffected by Mode Preset . Set to <code>NONE</code> by Restore Input/Output Defaults or Restore System Defaults->All												

6.10.2 Cal Output

Lets you set the selected calibrator's RF power output state.

Remote Command	<code>:SYSTem:CALibration:TUNE:OUTput[:STATe] ON OFF 1 0</code> <code>:SYSTem:CALibration:TUNE:OUTput[:STATe]?</code>
Example	<code>:SYST:CAL:TUNE:OUTP ON</code> <code>:SYST:CAL:TUNE:OUTP?</code>

Preset	Unaffected by Mode Preset . Set to OFF by Restore Input/Output Defaults or Restore System Defaults->All
--------	--

6.10.3 Cal Frequency

Lets you set the selected calibrator's frequency.

Remote Command	<code>:SYSTem:CALibration:TUNE:FREQuency <freq></code> <code>:SYSTem:CALibration:TUNE:FREQuency?</code>
Example	Set source frequency to 150 MHz: <code>:SYST:CAL:TUNE:FREQ 150000000</code>
Preset	Unaffected by Mode Preset . Set to 1 GHz by Restore Input/Output Defaults or Restore System Defaults->All
Min/Max	Depend on the selected calibrator

6.10.4 Cal Signal Type

Lets you set the selected calibrator's signal type.

Remote Command	<code>:SYSTem:CALibration:TUNE:TYPE CW COMB</code> <code>:SYSTem:CALibration:TUNE:TYPE?</code>
Example	<code>:SYST:CAL:TUNE:TYPE CW</code> <code>:SYST:CAL:TUNE:TYPE?</code>
Dependencies	If the selected calibrator does not support a signal type, then that type is disabled in the dropdown Changing the signal type to a disabled option generates an error
Preset	Unaffected by Mode Preset . Set to CW by Restore Input/Output Defaults or Restore System Defaults->All

6.10.5 Cal Comb Spacing

Lets you set the calibrator's comb spacing, when the signal type is **COMB**.

Remote Command	<code>:SYSTem:CALibration:TUNE:SPACing <freq></code> <code>:SYSTem:CALibration:TUNE:SPACing?</code>
Example	Set comb spacing to 1 MHz: <code>:SYST:CAL:TUNE:SPAC 1000000</code>
Dependencies	Only appears when COMB is selected as "Cal Signal Type" on page 2310 If the selected calibrator does not support the Comb signal, attempting to set the spacing generates an error

6 Input/Output
6.10 Calibrator Control

Preset	Unaffected by Mode Preset . Set to 0 Hz by Restore Input/Output Defaults or Restore System Defaults->All
Min/Max	Dependent on the selected calibrator

6.10.6 Calibrator Reference

Determines the frequency reference type used by the RCal module of the currently selected Cal Group

Remote Command	<code>:SYSTem:CALibration:TUNE:REFerence INTERNAL EXTERNAL</code> <code>:SYSTem:CALibration:TUNE:REFerence?</code>
Example	Set the calibrator frequency reference to Internal: <code>:SYSTem:CALibration:TUNE:REFerence INTERNAL</code>
Dependencies	Only displayed when an RCal module is the selected calibrator
Preset	Unaffected by Mode Preset . Set to preset value by Restore Input/Output Defaults or Restore System Defaults->All
Range	<code>INTERNAL EXTERNAL</code>

6.11 Advanced

6.11.1 T/R Port High Power Attenuator

Controls whether additional attenuation is added at the T/R Port. The T/R port has two input paths, one that provides a 16 dB attenuator, and the other that bypasses this attenuator.

- When **ON**, the path includes the 16 dB attenuator, so the max input level for this path is +47 dBm (50 W)
- When **OFF**, the 16 dB attenuator is bypassed, so the max input level for this path is +33 dBm (2 W)

If the attenuator is turned off, the following warning message is displayed and confirmation that the attenuator is to be turned off is required;

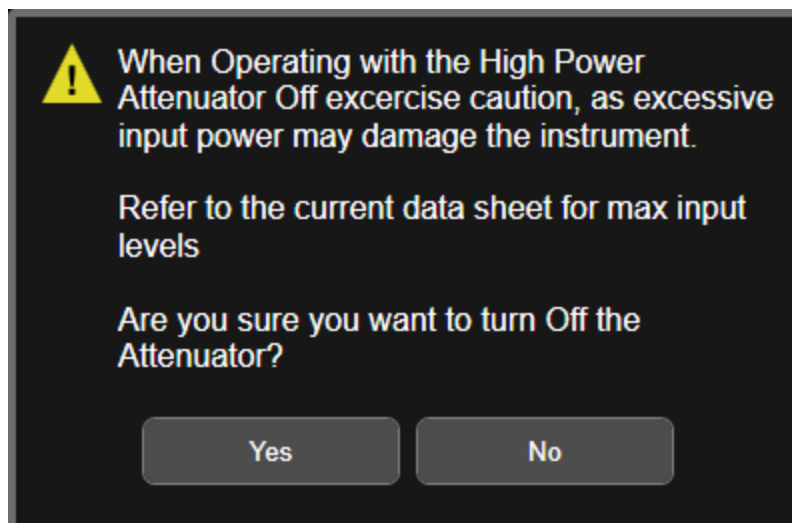

Whenever the attenuator is bypassed (**OFF**), a warning appears in the status bar: "Input caution; T/R unprotected"

In the case of an input overload at the T/R input, (>2 W with Attenuator off, or >50 W with attenuator on), or an over-temperature at the T/R input, the input is disconnected, and a dialog is displayed, stating:

"CAUTION! Excessive power has been detected at the T/R Port. The input has been disconnected. Remove the high signal power and press OK"

Or:

6 Input/Output
6.11 Advanced

“CAUTION! Over temperature has been detected at the T/R Port. The input has been disconnected. Remove the signal, allow to cool & press OK”

Until you press **OK**, the input remains disconnected, and no measurement can be made.

Remote Command	<code>[:SENSe]:FEED:RF:PORT:TR:HPOWer:ATTenuator[:STATe] ON OFF</code> <code>[:SENSe]:FEED:RF:PORT:TR:HPOWer:ATTenuator[:STATe]?</code>
Example	<code>:FEED:RF:PORT:TR:HPOW:ATT ON</code> <code>:FEED:RF:PORT:TR:HPOW:ATT?</code>
Dependencies	Only appears in modular analyzers, and only when the M9470A module is installed, such as in M8920A. Option HDX is required to enable the T/R port
Preset	<code>ON</code>
State Saved	Saved in instrument state

6.12 Aux I/O Control

This menu is only available with Option LSN, indicating that the LISN IO board is installed. It is used to control each of the eight control lines out of the rear panel connector independently. There are eight bits of control lines. The LISN Control (Mode setup) of the EMI Receiver application affects the **AUX I/O Control** settings. Whenever you change the LISN Control in Mode Setup, the corresponding AUX I/O Control data lines will also be changed. The selection at the AUX I/O Control does not affect the LISN Control (Mode Setup) setting.

6.12.1 Data 0 – Data 7

Sets the value for Data 0 through Data 7 respectively.

Remote Command	<code>:OUTPut:AUX:IO:DATA<n> OFF ON 0 1</code> where <n> in an integer 0 - 7
Example	<code>:OUTP:AUX:IO:DATA0 OFF</code>
Notes	Unaffected by Mode Preset , but Input/Output Preset presets the value to ON for all 8 data lines
Preset	ON
Range	OFF ON

6.12.2 Aux IO Control (Remote Command Only)

Sets/Queries the value for all 8 data lines.

Remote Command	<code>:OUTPut:AUX:IO <Value></code> <code>:OUTPut:AUX:IO?</code>
Example	<code>:OUTP:AUX:IO 31</code>
Notes	Unaffected by Mode Preset , but Input/Output Preset presets the value to ON for all 8 data lines
Couplings	The states of Data 0 to Data 7 under the AUX I/O Control panel (Input/Output menu) change according to the keyed-in AUX IO value
Preset	31
Min	0
Max	255
Backwards Compatibility SCPI	<code>:OUTPut:UPORt <Value></code>

7 Save/Recall/Print

This section describes the functions that can be accessed via the front panel **Save**, **Quick Save**, and **Recall** hardkeys, as well as via the controls in the front-panel folder icon, as shown below.

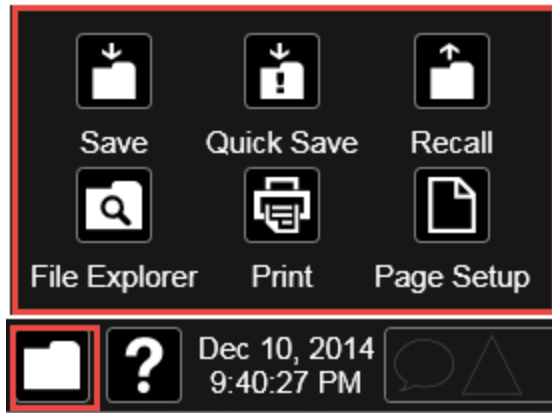

7.1 Quick Save

Quick Save repeats the previous Save at the touch of a single button. Whatever you saved before gets saved again to the same directory, and with a filename derived from the previous filename.

You access Quick Save by pressing the **Quick Save** hardkey, or by pressing the folder icon at the bottom of the display and then pressing the **Quick Save** icon. In addition, if you have a PC keyboard plugged in, the sequence **CTL-Q** will perform a Quick Save.

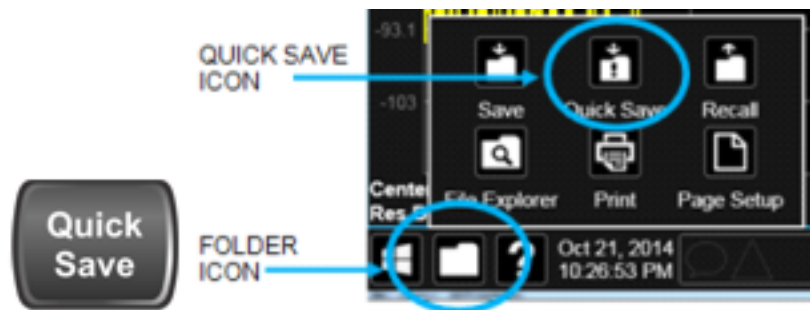

The **Quick Save** front-panel key repeats the most recent save that was performed from the **Save** menu, with the following exceptions:

- Register saves are not remembered as Saves for the purpose of the Quick Save function
- If the current measurement does not support the last non-register save that was performed, an informational message is generated, “File type not supported for this measurement”

Quick Save repeats the last type of qualified save (that is, a save qualified by the above criteria) in the last save directory by creating a unique filename using the Auto File Naming algorithm described below.

If the previous save was a Screen Image save, Quick Save saves a Screen Image when the Quick Save button is pressed. This image is *exactly* what is on the screen when the **Quick Save** button is pressed. Quick Save does *not* force a dialog exit or navigate in any way, it simply snaps the image on the screen and saves it. This lets you save images of dialogs and setup screens that would be impossible to save using the **Save** dialog.

NOTE

When **Quick Save** is pressed the display theme changes to the theme specified by the **Screen Image Theme** control in order to take the screen shot, and then changes back to the Display Theme, but no navigation is performed, and no dialogs are exited.

If **Quick Save** is pressed after startup and before any qualified Save has been performed, the Quick Save function performs a Screen Image save using the current settings for Screen Image saves (current theme, current directory), which then becomes the “last save” for the purpose of subsequent Quick Saves.

The Auto File Naming feature automatically generates a file name for use when saving a file. The filename consists of a prefix and suffix separated by a dot, as is standard for the Windows file system. A default prefix exists for each of the available file types:

Type	Default Prefix	Menu
State	State_	(Save/Recall)
Trace + State	State_	(Save/Recall)
Screen	Screen_	(Save/Recall)
Amplitude Corrections	Ampcor_	(Import/Export)
Traces	Trace_	(Import/Export)
Limit Lines	Limit_	(Import/Export)
Measurement Result	MeasR_	(Import/Export)
Capture Buffer	CapBuf_	(Import/Export)

A four-digit number is appended to the prefix to create a unique file name. The numbering sequence starts at 0000 within each Mode for each file type and updates incrementally to 9999, then wraps to 0000 again. It remembers where it was through a Mode Preset and when leaving and returning to the Mode. It is reset by Restore Misc Defaults and Restore System Defaults and subsequent running of the instrument application. So, for example, the first auto file name generated for State files is **State_0000.state**. The next is **State_0001**, and so forth.

One of the key features of Auto File Name is that we guarantee that the Auto File Name will never conflict with an existing file. The algorithm looks for the next available number. If it gets to 9999, then it looks for holes. If it find no holes, that is no more numbers are available, it gives an error.

For example, if when we get to State_0010.state there is already a State_0010.state file in the current directory, it advances the counter to State_0011.state to ensure that no conflict will exist (and then it verifies that State_0011.state also does not exist in the current directory and advances again if it does, and so forth).

If you enter a file name for a given file type, then the prefix becomes the filename you entered instead of the default prefix, followed by an underscore. The last four letters (the suffix) are the 4-digit number.

For example, if you save a measurement results file as “**fred.csv**”, then the next auto file name chosen for measurement results save will be **fred_0000.csv**.

NOTE

Although 0000 is used in the example above, the number that is used is actually the current number in the Meas Results sequence, that is, the number that would

have been used if you had not entered your own file name.

NOTE

If the filename you entered ends with `_dddd`, where `d`=any digit, making it look just like an auto file name, then the next auto file name picks up where you left off with the suffix being `dddd + 1`.

Quick Save Mode

Quick Save can be operated in the Normal mode and in a special “Prompt” mode. There is a switch on the User Interface page of the **System** menus that lets you control this.

When Quick Save Mode is in Normal (the default setting), the instrument does an immediate save of a new file of the same type and to the same directory as the previous Save action. When Quick Save Mode is in the Prompt state, instead of immediately performing a Save, the Alpha Keyboard pops up with the proposed auto-filename in the entry area. The user can then press Enter to accept the auto filename, or edit the name and press Enter. This allows you to easily save a file with a custom file name.

Notes

No remote command for this key specifically

7.2 Recall

The **Recall** dialog lets you recall previously saved states, traces and other items to the instrument from files on the instrument's internal storage, from removable devices, and from directories on the network. You access the Recall dialog by pressing the **Recall** hardkey, or by pressing the folder icon at the bottom of the display and then pressing the **Recall** icon.

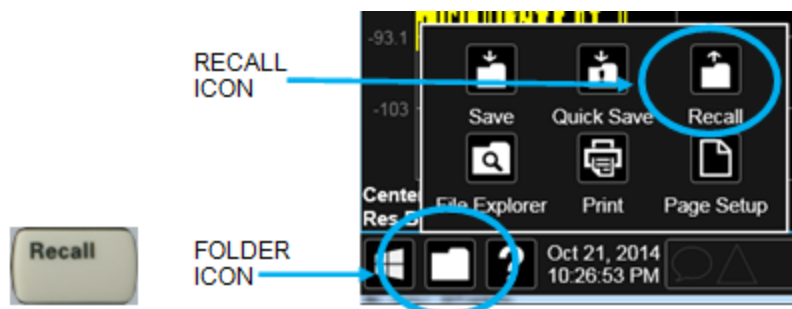

The dialog has section tabs running down the left side, which you use to specify what you want to recall, similar to the **Save** dialog. You choose the recall item and then complete the recall by choosing a register or file location from which to recall the item.

Notes No remote command for this key specifically, but **:MMEM:LOAD** is available for specific file types. For example: **:MMEM:LOAD:STATE <filename>**
If you try to recall a State file for a mode that is not licensed or not available in the instrument, an error message will occur and the state will not change

Backwards Compatibility Notes In legacy analyzers, it was possible to load a state without affecting the trace data, limit lines or correction data. Similarly (since User Preset is actually loading a state), it was possible to do a User Preset without affecting the trace data, limit lines or correction data
In the X-Series, "state" always includes all of this data; so, whenever state is loaded, all of the traces, limit lines and corrections are affected. Although this differs from previous behavior, it is desirable behavior, and should not cause adverse issues for users
Recall for the X-Series supports backward compatibility in the sense that you can recall a state file from any X-Series model number and any version of X-Series software. This is only possible if part of the recalling process goes through a limiting step after recalling the mode settings, at least for settings that may vary with version number, model number, option and license differences. If you try to recall a state file onto an instrument with less capability than what was available on the instrument during the save, the recall will ignore the state it doesn't support, and it will limit the recalled setting to what it allows
Example: if the saved state includes preamp ON, but the recalling instrument does not have a preamp; the preamp is limited to OFF. Conversely, if you save a state without a preamp, the preamp is OFF in the state file. When this saved file is recalled on an instrument with a licensed preamp, the preamp is changed to OFF. Another example is if the saved state has center frequency set to 20 GHz, but the instrument recalling the saved state is a different model and only supports 13.5 GHz. In this case, the

center frequency is limited along with any other frequency-based settings. Since the center frequency can't be preserved in this case, the recall limiting tries to at least preserve span to keep the measurement setup as intact as possible

Note that there is no state file compatibility outside of the X-Series. For example, you cannot recall a state file from ESA or PSA

7.2.1 Recall From File / Open

For every Recall type, a button appears called **Recall From File** or **Open**. “Recall From File” appears for recall types that also include registers (like State and Trace+State), and “Open” appears for all other recall types.

When you push the “Recall From File” or “Open” button, a dialog slides in from the right which allows you to see what files are saved in the current directory. See the “Save to File/Save As” section (3.1) for a depiction of this screen for the Save menu, which is similar to Recall.

The default directory is the internal directory for the current Mode and save type, on the D: drive. You may also change to another Mode's state directory by pressing the dropdown in the upper right corner labeled “Mode”. Once you have chosen a directory, the files in that directory whose extension matches the current data type (e.g., .state or .trace) are displayed in the right-hand window of the dialog. You can sort this list by name, date, file size or extension by tapping the Name, Date, Size, or Content header at the top of each column. A second tap toggles the sort order between Ascending and Descending.

Also displayed is a path depiction showing the path to the current directory. In the example shown, the path is D:\Users\Instrument\Documents\SA\screen. Tapping any element of this path lets you select an alternate route. Tapping the “Computer” arrow lets you select a different drive.



Tapping the “back” arrow navigates to the previously selected directory.

If you plug in a removable drive (e.g., a thumb drive), the browser immediately navigates to the root of that drive. Furthermore, if you had a thumb drive in and you were in a directory on the thumb, and then you exit the browser, when you come back in you are still in the same directory on that removable drive. If you remove the thumb drive, you return to the directory you had been in before the thumb drive was plugged in.

Note that for each data type there is a “current” directory, and it is the last directory used by either Save or Recall for that Mode. For example, if in SA Mode you save a Corrections file to a particular directory, then when you go to recall a Correction in SA Mode, you should be pointing at that directory. Or if in EMC Mode you recall a Limit from a particular directory then when in EMC Mode you go to save a Limit, it

should be pointing at that same directory. There is one “current” directory for each data type for each Mode (not one for Save and one for Recall).

The Filename field, just below the Path field, shows the filename that will be used. The **File Name** field is loaded with the name of the selected file. You may edit the filename by tapping it, which brings up the onscreen alpha keyboard. Press the “Done” button on this keyboard when you are done editing.

Select a file to load and press Recall. After a successful recall, a message "File <filename> recalled" or "State Register <register number> recalled" is displayed in an info box for a few seconds.

The **Files of Type** field shows the file suffix for the type of file you have selected to recall. This field only appears for files which have multiple file types that can be recalled. These file types are:

Amplitude Corrections:

- Amplitude Corrections (*.csv)
- Legacy Cable Corrections (*.cbl)
- Legacy User Corrections (*.amp)
- Legacy Other Corrections (*.oth)
- Legacy Antenna Corrections (*.ant)

Limits:

- Limit Data (*.csv)
- Legacy Limit Data (*.lim)

7.2.2 State

Lets you choose a register or file from which to recall the state.

See the Save State description for information on state files and their contents and the default paths. State files have the extension “.state”.

For rapid recall, the State menu lists 16 registers from which you can recall states. Pressing a Register button initiates the recall. You can also select a file from which to recall by pressing “Recall From File”.

Since each state file is only for one Mode, the settings for other Modes are unaffected when it is loaded. Recall State will cause a mode switch if the state being recalled is not from the current active mode.

NOTE

In products that run multiple simultaneous instances of the X-Series Application, all instances share the same registers and file directories, so make sure you know from what instance a file or register was saved before recalling it.

Remote Command	<code>:MMEMory:LOAD:STATe <filename></code>
Example	Load the state file data (on the default file directory path) into the instrument state: <code>:MMEM:LOAD:STAT "MyStateFile.state"</code>
Notes	<p>When you pick a file to recall, the instrument first verifies that the file is recallable in the current instrument by checking the software version and model number of the instrument. If there is a mismatch between the file and the instrument, the recall function tries to recall as much as possible. It may limit settings that differ based on model number, licensing or version number. In general, variables in the instrument which are not contained in the state file will be unaffected, and variables in the state file which are not contained in the instrument will be ignored</p> <p>The recall proceeds by aborting the currently running measurement, clearing any pending operations, and then loading the State from the saved state file. You can open state files from any Mode, so recalling a State file switches the instrument to the Mode that was active when the save occurred. After switching to the Mode of the saved state file, Mode settings and data (if any for the Mode) become those from the saved file. The active measurement becomes the measurement which was running when the state file was saved and the data relevant to the measurement (if there is any) is recalled</p> <p>After recalling the state, the Recall State function does the following:</p> <ul style="list-style-type: none">- Clears the input and output buffers- Status Byte is set to 0- Executes <code>*CLS</code> <p>If the file specified is empty an error is generated. If the specified file does not exist, another error is generated. If there is a mismatch between the file and the proper file type, an error is generated. If there is a mismatch between file version or model number or instrument version or model number, a warning is displayed. Then it returns to the State menu and File Open dialog goes away</p> <p>After the Recall, the instrument exits the Recall menu and returns to the previous menu</p>
Backwards Compatibility SCPI	<code>:MMEMory:LOAD:STATe 1,<filename></code> The "1" is simply ignored

7.2.3 Recall Type

If you have a built-in Source in your instrument, you may wish, when recalling State, to recall only the part of the State file that applies to the instrument, and leave the Source unaffected. Or you may wish to recall only the part of the State file that applies to the Source, and leave the instrument unaffected.

Lets you choose whether you wish to recall the entire Analyzer + Source state (**ALL**), just the Analyzer State (**ANALyzer**), or just the Source State (**SOURce**).

Remote Command	:MMEMory:LOAD:RTYPE ALL ANALyzer SOURce
Example	:MMEM:LOAD:RTYP ALL
Dependencies	Only available in models with a built-in source, such as VXT models
Preset	ALL
Range	ALL ANALyzer SOURce

7.2.4 Register 1 thru Register 16

Selecting any one of these register buttons causes the State to be recalled from the specified Register. The registers are provided for rapid saving and recalling, since you do not need to specify a filename or navigate to a file. Each of the register menu keys annotates whether it is empty or at what date and time it was last modified. In addition, you can edit any of the register names to enter custom names for any register.

Although these 16 registers are the only registers available from the front panel, there are 128 state registers available in the instrument. Registers 17-128 are only available from the SCPI interface, using the ***RCL** command.

There is one set of 128 state registers in the instrument, not one set for each Mode. When a state is saved, the Mode it was saved from is saved with it; then when it is recalled, the instrument switches to that Mode.

NOTE

In products that run multiple simultaneous instances of the X-Series Application, all instances share the same registers and file directories, so make sure you know from what instance a file or register was saved before recalling it.

The date displayed follows the format specified in the **Date Format** setting in the **Control Panel**. The time shows hours and minutes.

After the recall completes, the message "Register <register number> recalled" is displayed.

If you are in the Spectrum Analyzer Mode, and you are recalling a register that was saved in the Spectrum Analyzer Mode, then after the recall, you will still be in the Recall Register menu. If the Recall causes you to switch modes, then after the Recall, you will be in the Frequency menu.

If a requested register is empty an error is generated.

Example	*RCL 1
Range	1-16 from front panel, 1-128 from SCPI

7.2.5 Edit Register Names

You may enter a custom name on any of the **Register** keys, to help you remember what you are using that state to recall. To do this, press the **Name** field for the register you want to rename, which brings up the onscreen alpha keyboard. Press the **Done** button on this keyboard when you are done editing.

The maximum number of characters for a register name is 30. If you delete all the characters in the custom name, it restores the default (time and date).

For more information and the SCPI command, see ["Edit Register Names" on page 2360](#) under **Save, State**.

7.2.6 Trace+State

Lets you choose a register or file for recalling the state.

See [Save, "State" on page 2359](#) for information on state files and their contents and the default paths. State files have the extension **".state"**.

For rapid recall, the **Trace+State** menu lists 16 registers from which you can recall trace+state files. Pressing a **Register** control initiates the recall. You can also select a file from which to recall by pressing **Recall From File**.

Since each trace+state file is only for one Mode, the settings for other Modes are unaffected when it is loaded. **Recall Trace+State** will cause a mode switch if the trace+state being recalled is not from the current active Mode.

NOTE

In products that run multiple simultaneous instances of the X-Series Application, all instances share the same registers and file directories, so make sure you know from what instance a file or register was saved before recalling it.

Trace+State files have the extension **.trace**.

The Trace+State selection only appears for measurements that support trace saves. It is blanked for modes that do not support trace saves. Saving Trace is identical to saving State, except that a **.trace** extension is used on the file instead of **.state**, and internal flags are set in the file indicating which trace was saved.

Remote Command	<code>:MMEMory:LOAD:TRACe TRACE1 ... TRACE6,<filename></code>
Command	<code>:MMEMory:LOAD:TRACe:REGister TRACE1 ... TRACE6,<integer></code>
Example	Loads the trace file data (on the default file directory path) into the specified trace; if it is a "single trace" save file, that trace is loaded to trace 2, and is set to be not updating: <code>:MMEM:LOAD:TRAC TRACE2,"MyTraceFile.trace"</code> Restore the trace data in register 2 to Trace 1:

```
:MMEM:LOAD:TRAC:REG TRACE1,2
```

Notes

When you perform the recall, the recalling Trace function must first verify the file is recallable in this instrument by checking instrument software version and model number, since it includes State. If everything matches, a full recall proceeds by aborting the currently running measurement, and loading the state from the saved state file to as close as possible to the context in which the save occurred. You can open .trace files from any mode that supports them, so recalling a Trace file switches to the mode that was active when the save occurred. After switching to the mode of the saved state file, mode settings and data (if any for the mode) are loaded with values from the saved file and the saved measurement of the mode becomes the newly active measurement, and the data relevant to the measurement (if there is any) is recalled

Once the state is loaded, the trace data must be loaded. The internal flags are consulted to see which trace to load and the "To Trace" setting to see where to load it. Trace data is always loaded with the specified trace set to View, so that the data is visible and not updating (so as not to erase the recalled data). If the file is an "all trace" file, all traces are loaded with the saved data (to the original trace the data was saved from) and set to View. Traces whose data is not loaded are restored to the update state that existed when they were saved

After recall, the instrument exits the **Recall** menu and returns to the previous menu

Some Modes and measurements do not have 6 available traces. For example, Phase Noise Mode:

```
:MMEMory:LOAD:TRACe TRACE1|TRACE2|TRACE3,<filename>
```

Some Modes and measurements have more than 6 traces. For example, Realtime SA Mode:

```
:MMEMory:STORe:TRACe TRACE1 | TRACE2 | TRACE3 | TRACE4 | TRACE5 |  
TRACE6 | TRACE7 | TRACE8 | TRACE9 | TRACE10 | TRACE11 | TRACE12 |  
ALL,<filename>
```

7.2.7 Recall To Trace

Lets you select which Trace to recall to. Not all Modes have the same number of available traces. The default is the currently selected trace, selected in this or any other menu with **Trace** selection. If you have selected **ALL**, then that remains selected until you specifically change it to a single trace, regardless of the trace selected in the **Trace** menu.

If the .trace file is an "all trace" type, **To Trace** is ignored, and the traces each go back to the trace from which they were saved.

7.2.8 Register 1 thru Register 16

Selecting any one of these register buttons causes the specified trace(s) and the state of the currently active mode to be recalled from the specified Register. The registers are provided for rapid saving and recalling, since you do not need to specify a filename or navigate to a file. Each of the register menu keys annotates whether it is empty or at what date and time it was last modified. In addition, you can edit any of the register names to enter custom names for any register.

7 Save/Recall/Print
7.2 Recall

There is one set of 16 trace+state registers in the instrument, not one set for each Mode. When trace+state is saved, the Mode it was saved from is saved with it; then when it is recalled, the instrument switches to that Mode.

NOTE

In products that run multiple simultaneous instances of the X-Series Application, all instances share the same registers and file directories, so make sure you know from what instance a file or register was saved before recalling it.

The date displayed follows the format specified in the **Date Format** setting under the **Control Panel**. The time shows hours and minutes.

After the recall completes, the message **Register <register number> recalled** is displayed. If a requested register is empty, an error is generated.

Recalling state from a Register is the same as recalling state from a **Trace+State File**.

Example	<code>*RCL 1</code>
Range	1-16

7.2.9 Edit Register Names

You may enter a custom name on any of the **Register** keys, to help you remember what you are using that state to recall. To do this, press the **Name** field for the register you want to rename, which brings up the onscreen alpha keyboard. Press the **Done** button on this keyboard when you are done editing.

The maximum number of characters for a register name is 30. If you delete all the characters in the custom name, it restores the default (time and date).

For more information and the SCPI command, see "[Edit Register Names](#)" on page 2360 under **Save, State**.

7.2.10 Screen Config + State

Lets you load the complete configuration of all your screens from a file which you specify.

Note that recalling a screen config file wipes out your current screen configuration; you do not see a warning before it loads, but there is a note on the **Recall** page letting you know what is going to happen.

The filenames are of the form:

`State_0001.screen`

Remote	<code>:MMEMory:LOAD:SCONfig <filename></code>
--------	---

Command	
Example	Load the screen configuration from the file <code>MyScreenConfig.screen</code> in the default directory: <code>:MMEM:LOAD:SCON "myScreenConfig.screen"</code>

7.2.11 Measurement Data

Lets you specify a data type (for example, trace data) and choose a file from which to import the data.

Measurement Data files are comma-separated value (CSV) files, and contain the requested data in a form that can be imported into Excel or other spreadsheets, as well as header data that gives information on relevant instrument settings at the time the save occurred.

For more on **Measurement Data** files, see "[Measurement Data](#)" on page 2365 under **Save**.

Since the commonly exported data files are in CSV format, you can edit the data prior to importing it. This allows you to export a data file, manipulate the data in Excel (for example) and then import it.

7.2.12 Data Type

Lets you select the data type to recall.

Notes	There is no SCPI command for Data Type, as the type is implied in the SCPI command for each item
Dependencies	The Data Type menu for any given measurement only contains data types that are supported by that measurement. Data types that are not importable do not appear, even if they <i>do</i> appear in the corresponding Save menu

7.2.13 Trace

Allows you to import Trace files in the PC-readable CSV format.

Trace data files have the extension `.csv`. The trace file contains a "metadata" header which describes the state of the instrument when the file was saved. This metadata is compared to the current state of the instrument when the file is recalled; if it does not match the current state, the "invalid data indicator" (*) is displayed.

The metadata is detailed in Trace File Contents in the **Save** section.

Remote Command	<code>:MMEMory:LOAD:TRACe:DATA TRACE1 ... TRACE6,<filename></code>
Example	Import the 2nd trace from the file <code>myTrace2.csv</code> in the current path. For SA Mode, the default path

7 Save/Recall/Print
7.2 Recall

is:
`My Documents\SA\data\traces`
`:MMEM:LOAD:TRAC DATA TRACE2,"myTrace2.csv"`

Dependencies	For SA measurements, a trace cannot be recalled from a trace file that was exported with ALL traces selected A trace cannot be imported if the number of trace points in the file do not match the number of sweep points currently set for the measurement. If this happens, an error message is generated Errors are reported if the file is empty or missing, or if the file type does not match, or if there is a mismatch between the file type and the destination data type
Couplings	When a trace is imported, Trace Update is always turned OFF for that trace and Trace Display is always turned ON
Annotation	After recall is complete, an advisory is displayed in the message bar confirming which trace file was loaded
Status Bits/OPC dependencies	Sequential - aborts the current measurement

7.2.14 Limit

Lets you select a file from which to import the **Limit** data.

Limit files are CSV files, and contain the limit data in a form that can be imported into Excel or similar spreadsheets, as well as header data that provides information on the limit.

See the **Save Limit** description ("**Limit**" on page 2399) for information on Limit files and their contents and the default paths. **Limit** files have the extension **.csv**.

For backwards compatibility, older limit files with the extension **.lim** can be read into the instrument, but you can only save limits as **.csv** files.

A set of preloaded **Limits** files can be found in the directory:

`My Documents/EMC Limits and Ampcor/Limits`

Remote Command	<code>:MMEMory:LOAD:LIMit LLINE1 LLINE2 LLINE3 LLINE4 LLINE5 LLINE6,<-filename></code>
Example	Import the 2nd Limit Line from the file <code>myLimitLine2.csv</code> in the current path: <code>:MMEM:LOAD:LIM LLINE2,"myLimitLine2.csv"</code>
Dependencies	Errors are reported if the file is empty or missing, or if the file type does not match, or if there is a mismatch between the file type and the destination data type In the Log Plot measurement in Phase Noise Mode, there are only three Limit Lines, so the valid parameters are <code>LLINE1 LLINE2 LLINE3</code> This key only appears if you have the proper option installed in your instrument
Couplings	When a limit line is loaded from mass storage, it is automatically turned on. This allows the user to see it, thus confirming the load. The Margin settings will match those when the limit was saved

	The instrument cannot mix Limits domains (X Axis Unit must be Frequency or Time for both Limits). So, when a Limits file is loaded, the instrument sets the Limits domain (X Axis Unit) to match that of the file. If this changes the Limits domain from what it was before the file was loaded, all Limits data in all Limits sets is erased before the data loads. If this operation is over the remote interface, there is no warning if this occurs, so care should be taken to know the domain of the file you are loading
Annotation	After recall is complete, an advisory is displayed in the message bar confirming which limit file was loaded
Status Bits/OPC dependencies	Sequential - aborts the current measurement

7.2.15 Select Limit

Selects the Limit register into which the recalled **Limit** will be placed, for example, **Limit 1**.

Preset	Not part of Preset , but is reset to LLINE1 by Restore Mode Defaults Survives shutdown
--------	---

7.2.16 Correction

Allows you to import Amplitude Corrections files in the PC-readable CSV format.

Amplitude Correction files contain the correction data in a form that can be imported into Excel or similar spreadsheets, as well as header data that provides information on the correction.

For backwards compatibility, older limit files with the extensions **.amp**, **.cbl**, **.ant** and **.oth** can be read into the instrument.

A set of preloaded **Corrections** files can be found in the directory:

My Documents\EMC Limits and Ampcor\Ampcor

The default path for CSV files is:

My Documents\amplitudeCorrections

Antenna corrections are a particular kind of Amplitude Corrections – they are distinguished in the corrections file by having **Antenna Unit** set to a value other than **None**. When the Amplitude Correction is an Antenna correction and the **Antenna Unit** in the file is not **None**, the Y-Axis Unit setting changes to match the Antenna (Transducer) Unit in the file.

Remote Command	:MMEMory:LOAD:CORRection 1 ... 8, <filename>
Example	Recall the Amplitude Correction data from the file myAmpcor.csv in the current directory to the 2nd Amplitude Correction table, and turns on Correction 2:

7 Save/Recall/Print
7.2 Recall

	<code>:MME:LOAD:CORR 2, "myAmpcor.csv"</code>
Dependencies	<p>Only one Transducer units can be on at any given time. Note that this means that if a correction file with a Transducer Unit is loaded into a particular Correction, all other Corrections are set to that same Transducer unit</p> <p>Corrections are not supported by all Measurements. If in a Mode in which some Measurements support it, this key is grayed-out in measurements that do not. The key does not show at all if no measurements in the Mode support it</p> <p>Errors are reported if the file is empty or missing, or if the file type does not match, or if there is a mismatch between the file type and the destination data type</p> <p>This key does not appear unless you have the proper option installed in your instrument</p> <p>This command will generate an "Option not available" error unless you have the proper option installed in your instrument</p>
Couplings	When a correction file is loaded from mass storage, it is automatically turned on (CorrectionON) and Apply Corrections is set ON . This allows you to see its effect, thus confirming the load
Annotation	After recall is complete, an advisory is displayed in the message bar confirming which file was recalled
Backwards Compatibility SCPI	<code>:MME:LOAD:CORRection ANTenna CABLe OTHer USER, <filename></code>
	For backwards compatibility, ANTenna maps to 1, CABLe maps to 2, OTHer maps to 3 and USER maps to 4

7.2.17 Select Correction

Selects the register into which the recalled **Correction** will be placed, for example, **Correction 1**.

Preset	Not part of Preset , but reset to Correction 1 by Restore Input/Output Defaults Survives a shutdown
--------	---

7.2.18 Complex Correction

Imports **Complex Corrections** files in the PC-readable **.s2p** format.

Complex Correction files contain amplitude and phase correction data in a form that can be imported into Excel or similar spreadsheets, as well as header data that gives information on the correction.

The default path for Complex Corrections files is:

`My Documents\complexCorrections\`

Remote Command	<code>:MME:LOAD:CCORrection <integer>, <filename></code>
Example	<p>Recall the Complex Correction data from the file mycor.s2p in the current directory to the 2nd Complex Correction table, and turns on Complex Correction 2:</p> <p><code>:MME:LOAD:CCOR 2, "mycor.s2p"</code></p>

Dependencies	Not supported by all measurements. The tab does not appear at all if no measurements in the Mode support it Errors are reported if the file is empty or missing, or if the file type does not match, or if there is a mismatch between the file type and the destination data type
Couplings	When a complex correction file is loaded from mass storage, it is automatically turned ON and Apply Corrections is set ON . This allows you to see its effect, thus confirming the load
Annotation	After recall is complete, an advisory is displayed in the message bar confirming which file was recalled

7.2.19 Select Complex Correction

Selects the register into which the recalled **Complex Correction** will be placed, for example, **Complex Correction 1**.

Preset	Not part of Preset , but is reset to Correction 1 by Restore Input/Output Defaults Survives a shutdown
--------	---

7.2.20 Recall VDI CCD Correction

Imports VDI CCD External Mixer Correction files in the PC-readable CSV (.csv) format.

The default path for VDI CCD External Mixer Correction files is the instrument's **My Documents** folder.

Remote Command	<code>:MMEMory:LOAD:VCORrection <filename></code>
Example	<code>:MMEM:LOAD:VCOR "vdi_ccd_corr.csv"</code>
Dependencies	Requires the EXW (External Mixing Wide Bandwidth) and Ampcor (Amplitude Correction) licenses VDI CCD Corrections are not supported by all measurements. The tab does not appear at all if no measurements in the Mode support it Errors are reported if the file is empty or missing, or if the file type does not match, or if there is a mismatch between the file type and the destination data type If the file is empty, message -250 is reported. If the file does not exist, message -256 is reported. If there is a mismatch between the file and the destination data type, message -250 is reported
Couplings	When a VDI CCD correction file is loaded into memory, if the correction matches the current external mixer setup and " Select VDI CCD Correction " on page 2158 is NONE , the selected VDI CCD Correction is set to the serial number of the matching correction data
Annotation	After recall is complete, an advisory is displayed in the message bar confirming which file was recalled

7.2.21 Mask

The **Mask** data type is used to import and export Mask files for measurements that use masks, such as cellular comms and real-time measurements.

7.2.22 Sequence

These need to be brought over for the EXT and/or Sequence Analyzer when they are available in the Touch UI

7.2.23 Waveform

Recalls waveforms into the ARB memory of an Internal Source.

When you select the **Waveform** tab in the **Save** dialog,, a hint appears saying “Recalls files from Mass Storage to the ARB and lets you manage the ARB memory at the same time.”

You then tap **Recall From File** to display the **Recall Waveform** dialog.

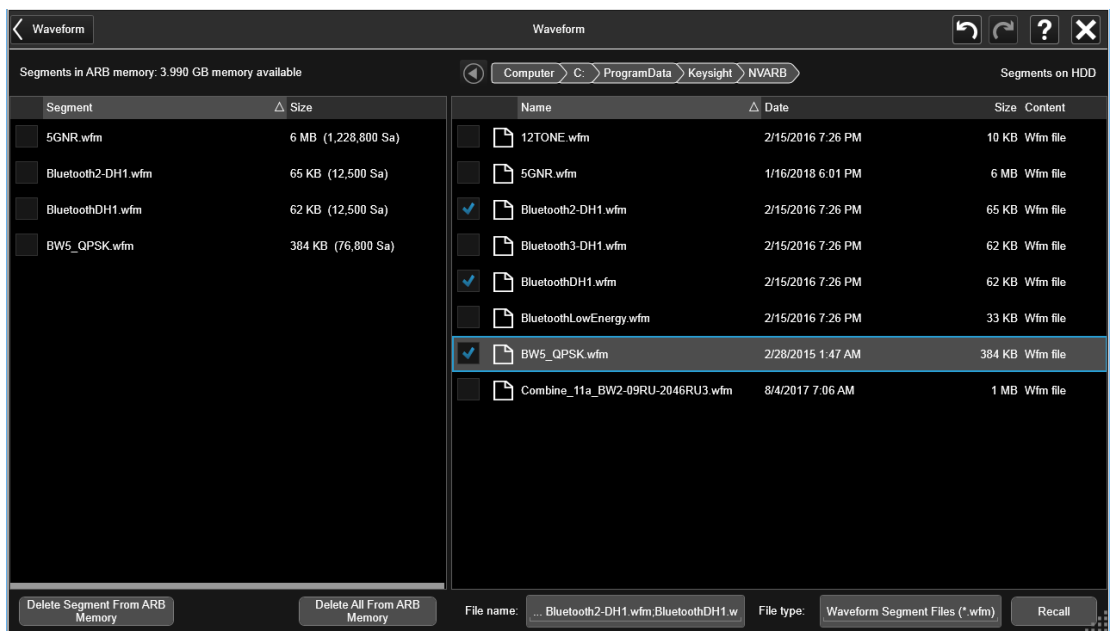

The left-hand window shows the files in ARB memory. The right-hand window shows the files on the hard drive.

You can select one or more waveform files in the right-hand window. Each file selected has a blue check box in it. To select a single file, tap that file's row. To select additional files, tap the check box in the row of the desired additional files.

When you have selected the file or files that you wish to recall, tap Recall. The file(s) are recalled into the ARB memory, and appear in the left-hand window.

If a file of the same name already exists within ARB memory, it is overwritten. If you wish to load two segments of the same name, you must rename one of the segments before loading it into ARB memory. To rename a segment, you can either use Windows File Explorer, or **:MMEMory:COPY**.

You can select one or more segments in the left-hand window and tap "Delete Segments from ARB memory" to delete the selected files. You can also delete all files in ARB memory by tapping "Delete All from ARB memory."

You can change the current directory by tapping on an element of the file path at the top of the screen and selecting the desired subdirectory in the list that appears, and repeating until you have the path you want. The current directory is used for manually loading waveform segments into ARB memory for playback, and as a search location for waveform segments that are required to be loaded into ARB memory for playback of a waveform sequence or a list sequence.

File Type allows you to specify a waveform format. The available file types are listed below:

Type	Extension	Notes
Waveform Files	.wfm	Keysight Signal Studio files
Binary Files	.bin	Interleaved IQ data files. They could be single precision or double precision customer created files. One-byte marker may be added
CSV Files	.csv	Comma-separated value file. Could be generated by Excel
Text Files	.txt	
Matlab Files	.mat	Should be Level 4, Level 5 or HDF5 MAT-files (only Level 5 Matlab file is supported in X24)

Waveforms in **.csv**, **.txt** and **.mat** formats are supported by models with a built-in source, such as VXT and EXM.

.txt files are formatted according to the following rules:

1. Text files only contain the IQ information. Data in the right column represents the amplitude of real(I) points, Data in the left column represents the amplitude of imaginary(Q) points
2. The amount of data should be multiple of two (IQ pairs)

7 Save/Recall/Print
7.2 Recall

3. The data range is from $-1e10$ to $1e10$, the data type should be `int`, `float` or `double`. 16 digits or fewer for every data is acceptable
4. The values are separated by comma or tab. Extra commas or tabs are ignored
5. Use **Enter** to separate IQ pairs

Example for text file data:

```
0.46425922, -0.57411048
0.47184454, -0.58435995
0.48107329, -0.59014958
0.49223323, -0.58998679
0.50419607, -0.58558843
0.51679158, -0.57721768
0.53005322, -0.56481976
0.54373011, -0.54879346
0.55759183, -0.52950807
0.57141409, -0.50732489
```

Rules 1–3 above also apply to `.csv` data.

Dependencies	Only appears if your hardware includes an Internal Source, such as in VXT
--------------	---

7.2.24 Load Segment to ARB Memory

Loads a single segment to ARB memory. Same as pressing the **Recall** button with a single waveform selected.

Remote Command	<code>:SOURCE:RADio:ARB:LOAD <string></code> <code><string></code> - specifies the path name of the file to load from the HDD into ARB memory. May be a <full path + filename>, or <"NVWFM" MSUS + colon + filename>
----------------	---

Example	<code>:SOUR:RAD:ARB:LOAD "D:\NVARB\testwaveform.bin"</code> or <code>:SOUR:RAD:ARB:LOAD "NVWFM:testwaveform.bin"</code>
---------	---

Notes	Because loading the file involves a delay of unpredictable length, this command should be followed by <code>*OPC?</code> , which holds off subsequent commands until the loading operating is complete If you specify a file over SCPI, but the file is not at the specified location, an error is generated If you try to load a waveform file but the file contains less than 500 IQ samples, an error is generated VXT models M9410A/11A/15A/16A and M9410E/11E/15E/16E: If you try to load a waveform file but the file contains less than 1024 IQ samples, an error is generated If you try to load a Signal Studio waveform <code>*.wfm</code> that contains invalid waveform header, an error is generated
-------	--

If the ARB is **ON** when you load a file to ARB memory or delete a file from ARB memory, the playing waveform segment may not keep phase continuity during the ARB memory operation. The waveform is replayed after the ARB operation is finished

ARB can be loaded into ARB memory even if required licenses are not present on the instrument. In this case, a GUI-only warning message -800, "Operation complete; Loaded <filename> successfully, but no license <required licenses> installed". You can install required licenses according to <required licenses> string to license it, or multi-pack license it

When in Sequence Analyzer Mode, and **Include Source** is **Yes**, an attempt to load a file to ARB memory is rejected with an error. When **Include Source** is **No**, and if there is insufficient free ARB memory to load the selected waveform, an error is generated

Remote Command	:SOURCE:RADio:ARB:LOAD:ALL <string> <string> specifies the directory on the HDD to load the files into ARB memory from
Example	:SOUR:RAD:ARB:LOAD:ALL "D:\nvarb"
Notes	<p>Loads all the segment files within the currently selected directory into ARB memory. If a file of the same name already exists within ARB memory, it is overwritten. If you wish to load two segments of the same name, you must rename one of the segments before loading it into ARB memory. To rename a segment, either use Windows File Explorer, or :MEMory:COpy</p> <p>If you specify a directory over SCPI, but the directory does not exist, an error is generated</p> <p>If the ARB is ON, and you then load or delete a file to ARB memory, the playing waveform segment may not keep phase continuity during the ARB memory operation. The waveform is replayed after the ARB operation is finished</p> <p>When in Sequence Analyzer Mode, and Include Source is Yes, an attempt to load all files from a directory to ARB memory is rejected with an error. When Include Source is No and there is insufficient free ARB memory to load all the waveforms, when the ARB memory is full, the copy ceases, and an error is generated</p>

7.2.25 Delete Segment From ARB Mem

Deletes a segment from ARB memory.

Remote Command	:SOURCE:RADio:ARB:DELeTe <string> <string> specifies the waveform to be deleted from the ARB playback memory
Example	:SOUR:RAD:ARB:DEL "testwaveform.bin"
Notes	<p>It is possible to delete files from within the ARB memory when the ARB is ON. However, if you attempt to delete the file that is currently playing an error is generated</p> <p>It is possible to delete a file from within the ARB memory when the sequencer state is ON, and the file is not being used by the List Sequencer. If you attempt to delete a file that is being used by the list sequencer, an error is generated</p> <p>When the Sequencer state of the List Sequencer is On, even if ARB state is On, the selected waveform will not be played. In this case, if the selected waveform is not used in List Sequence, it can be deleted, and the ARB state is turned Off</p> <p>If the ARB is ON and you load a file to ARB memory or delete a file from ARB memory, the playing</p>

waveform segment may not keep phase continuity during the ARB memory operation. The waveform is replayed after the ARB operation is finished

When in Sequence Analyzer Mode, and **Include Source** is **Yes**, an attempt to delete a file from ARB memory is rejected with an error. When **Include Source** is **No**, and you specify a file that does not exist within ARB memory, an error is generated

7.2.26 Delete All From ARB Memory

Removes all segments from ARB memory.

Remote Command	<code>:SOURce:RADio:ARB:DELeTe:ALL</code>
Example	<code>:SOUR:RAD:ARB:DELeTe:ALL</code>
Notes	<p>If you attempt to delete all files from ARB memory when there are waveform files used in the Sequencer function of the List Sequencer and the Sequencer state is ON, all files except the files currently being used in list sequencer are deleted, and an error is generated</p> <p>If the ARB is ON and you load a file to ARB memory or delete a file from ARB memory, the playing waveform segment may not keep phase continuity during the ARB memory operation. The waveform is replayed after the ARB operation is finished</p> <p>When in Sequence Analyzer Mode, and Include Source is Yes, an attempt to delete all files from ARB memory is rejected with an error. When Include Source is No, and you attempt to delete all files from ARB memory when the ARB is currently playing a file, all files except the one playing are deleted and an error is generated</p>

7.2.27 Set Default Directory (Remote Command Only)

Sets the default directory for loading ARB files from SCPI.

Remote Command	<code>:SOURce:RADio:ARB:DEFault:DIRectory <string></code> <code>:SOURce:RADio:ARB:DEFault:DIRectory?</code>
Example	<code>:SOUR:RAD:ARB:DEF:DIR "D:\ArbFiles"</code> <code>:SOUR:RAD:ARB:DEF:DIR?</code>
Notes	Sets the default directory to be used as a search location for waveform segments that are required to be loaded into ARB memory for playback of a waveform sequence, and as a search location for selecting waveforms using SCPI
State Saved	Persistent, survives a power cycle and a preset but not saved in the instrument state

7.2.28 Query ARB Memory File List (Remote Query Only)

Queries the instrument for the list of waveform segments in the ARB memory.

NOTE

Returns a string for waveform segment names in ARB memory. If you want a string list of waveform segments in the ARB memory, use "Query ARB Memory Full File List (Remote Query Only)" on page 2337.

Remote Command	:SOURce:RADio:ARB:CATalog?
Example	:SOUR:RAD:ARB:CATalog?
Notes	The return data is in the following format:
	<integer> memory used
	<integer> memory free
	<string>... comma separated list of waveform segments within ARB memory

7.2.29 Query ARB Memory Full File List (Remote Query Only)

Queries the instrument for the string list of waveform segments in the ARB memory. Returns a string list for waveform segment names in the ARB memory.

Remote Command	:SOURce:RADio:ARB:FCATalog?
Example	:SOUR:RAD:ARB:FCATalog?
Notes	The return data is in the following format:
	<integer> Memory used
	<integer> Memory free
	<integer> File count in ARB memory
	<string>,<string>, ... <string> Comma-separated string list of waveform segments within ARB memory
	Example: :SOUR:RAD:ARB:FCAT?
	EXT returns: 27499,2069653,3,"c2k.wfm","gsm.wfm","wcdma.wfm"

7.2.30 Demod Info

Recalls various **Demod Info** data types to help you setup your measurement. The available data types vary depending on which measurement you are in.

7.2.31 Data Type

There are several Demod Info Data Types available. You can specify the segment index to recall from and also choose which data type you want to recall.

7.2.32 Select Segment

Selects a segment for Demod Info recall.

Couplings	<p>When Data Type is Carrier Setting and Data Segment Index is 0, this key is grayed-out. Carrier Setting recall behavior depends on the number of data segments in the .scp file:</p> <ul style="list-style-type: none"> - One data segment in .scp file: apply to segment1 - Two or more data segments in .scp file: first data segment is applied to segment1, second data segment is applied to segment2, remaining data segments in .scp file are ignored
Preset	Segment1

7.2.33 Constellation State

Selects a file from which to import the constellation states data.

Constellation State files are ASCII comma-separated (CSV) text files, and have the extension **.csd** or **.txt**:

- **.csd** files contains the constellation state of all modulation formats
- **.txt** files contain only the constellation the state of the Custom IQ modulation format. This file format is the same as Signal Studio N7608C Custom IQ constellation file format. To use a recalled constellation, you will need to change the modulation format to Custom IQ

A preloaded **Constellation State** file can be found in the directory:

My Documents\VMA\data\DDEMOD\ConstInState

Remote Command	<code>:MMEMory:LOAD:DDEMod:SEGment1 ... 6:CONStIn:STATe <filename></code>
Example	<p>Import the constellation state from the file myConstInState.csd in the current path:</p> <pre>:MMEM:LOAD:DDEM:SEGM1:CONS:STAT "myConstInState.csd"</pre>
Dependencies	<p>Only appears in VMA Mode, in the Digital Demod measurement</p> <p>Errors are reported if the file is empty or missing, or if the file type does not match, or if there is a mismatch between the file type and the destination data type</p>
Annotation	After recall is complete, an advisory is displayed in the message bar confirming the constellation state was loaded

Status Bits/OPC dependencies	Sequential - aborts the current measurement
------------------------------	---

Backwards Compatibility SCPI	<code>:MMEMory:LOAD:CONStIn:STATe <filename></code>
------------------------------	---

7.2.34 Sync Pattern

Selects a file from which to import the sync pattern data.

Sync Pattern files are CSV files, and contain the sync pattern data in a form that can be imported into Excel or similar spreadsheets, as well as header data that gives information on the patterns.

Sync Pattern files have the extension `.csv`.

A set of preloaded **Sync Pattern** files can be found in the directory:

`My Documents\VMA\DDEMOD\SyncPattern`

This is also the default filepath.

Remote Command	<code>:MMEMory:LOAD:DDEMod:SYNC:PATtern <filename></code>
----------------	---

Example	Import the pattern string from the file <code>mySyncPattern.csv</code> in the current path: <code>:MMEM:LOAD:DDEM:SYNC:PATT "mySyncPattern.csv"</code>
---------	---

Dependencies	Only appears in VMA Mode, in the Digital Demod measurement Errors are reported if the file is empty or missing, or if the file type does not match, or if there is a mismatch between the file type and the destination data type
--------------	--

Annotation	After recall is complete, an advisory is displayed in the message bar confirming the sync pattern strings were loaded
------------	---

Status Bits/OPC dependencies	Sequential - aborts the current measurement
------------------------------	---

Backwards Compatibility SCPI	<code>:MMEMory:LOAD:SYNC:PATtern <filename></code>
------------------------------	--

7.2.35 Filter Coefficients

Selects a file from which to import the meas/ref filter coefficients data.

Filter Coefficients files are CSV files, and contain the filter coefficients data in a form that can be imported into Excel or similar spreadsheets, as well as header data that gives information on the filters.

You can specify whether you want the **Meas Filter** or **Reference Filter** coefficients by using the radio button that appears when **Filter Coefficients** is selected in the **Recall** menu.

Filter Coefficients files have the extension `.csv`, and the default path is:

My Documents\VMA\data\DDEMOD\FILTERCoef

Remote Command	<code>:MMEMory:LOAD:DDEMod:SEGment1 ... 6:FILTer:COEFFicient MEAS REF,<filename></code>
Example	Import the meas filter's coefficients for Digital Demod from the file <code>myFilterCoef.csv</code> in the current path: <code>:MMEM:LOAD:DDEM:SEGM1:FILT:COEF MEAS,"myFilterCoef.csv"</code>
Dependencies	Errors are reported if the file is empty or missing, or if the file type does not match, or if there is a mismatch between the file type and the destination data type
Annotation	After recall is complete, an advisory is displayed in the message bar confirming the filter's coefficients were loaded
Status Bits/OPC dependencies	Sequential - aborts the current measurement
Backwards Compatibility SCPI	<code>:MMEMory:LOAD:FILTer:COEFFicient MEAS REF,<filename></code>

7.2.36 Equalizer Coefficients

Selects a file from which to import the equalizer coefficients data.

Equalizer Coefficients files are CSV files, and contain the coefficients data in a form that can be imported into Excel or similar spreadsheets, as well as header data that gives information on the filters.

Equalizer Coefficients files have the extension `.csv`.

The default path for CSV files is:

My Documents\VMA\data\DDEMOD\EqCoef

The same directory contains a set of preloaded **Equalizer Coefficients** files.

Remote Command	<code>:MMEMory:LOAD:DDEMod:SEGment1 ... 6:EQUalizer:COEFFicient <filename></code>
Example	Import the equalizer filter's coefficients from the file <code>myEqualizerCoef.csv</code> in the current path for segment1 analysis: <code>:MMEM:LOAD:DDEM:SEGM1:EQU:COEF "myEqualizerCoef.csv"</code>
Dependencies	Errors are reported if the file is empty or missing, or if the file type does not match, or if there is a mismatch between the file type and the destination data type
Couplings	The Equalizer Length and Points / Symbol are updated, and Equalizer Hold is turned on after recall is complete. The equalizer runs in fixed-coefficients mode, unless the Equalizer Length, Points / Symbol or Equalizer Hold is changed after that
Annotation	After recall is complete, an advisory is displayed in the message bar confirming the equalizer's coefficients were loaded
Status Bits/OPC dependencies	Sequential - aborts the current measurement

7.2.37 Tx Pattern

Selects a file from which to import the bit pattern data for Tx BER measurement.

Tx Pattern files are CSV files, and contain the Tx bit pattern data in a form that can be imported into Excel or similar spreadsheets, as well as header data that gives information on the patterns.

Tx Pattern files have the extension **.csv**.

The default path for the CSV files is:

`My Documents\VMA\data\DDEMOD\TxPattern`

This directory also contains a set of preloaded **Tx Pattern** files.

Remote Command	<code>:MMEMory:LOAD:DDEMod:SEGment1 ... 6:TXBit:PATtern <filename></code>
Example	Import the pattern string from the file <code>myTxPattern.csv</code> in the current path: <code>:MMEM:LOAD:DDEM:SEGM1:TXB:PATT "myTxPattern.csv"</code>
Dependencies	Errors are reported if the file is empty or missing, or if the file type does not match, or if there is a mismatch between the file type and the destination data type
Annotation	After recall is complete, an advisory is displayed in the message bar confirming the sync pattern strings were loaded
Status Bits/OPC dependencies	Sequential - aborts the current measurement

7.2.38 Carrier Setting

Selects a **Carrier Setting** file from which to import signal configuration for demodulation, segment x ("**Data Segment Index**" on page 2342) in file is recalled and applied to segment y ("**Select Segment**" on page 2338) in Digital Demod measurement. When x is 0, y is ignored and up to 6 segments in file are recalled and applied. Note "**Select Segment**" on page 2338 is GUI only, so y needs to be specified in below SCPI.

The following file formats are supported:

- Signal Studio N7608C Setup Files (*.scp)
- PWSG Desktop Setup Files (*.pws)

Remote Command	<code>:MMEMory:LOAD:DDEMod:SEGment1 ... 6:SETup <filename></code>
Example	<code>:MMEM:LOAD:DDEM:SEGM1:SET "mySetup.scp"</code>
Dependencies	Errors are reported if the file is empty or missing, or if the file type does not match, or if signal configuration cannot be supported by Digital Demod measurement. Below is the supported format in Signal

7 Save/Recall/Print
7.2 Recall

	Studio N7608C: Custom Modulation = Custom IQ Custom IQ Type = ASK&PSK&QAM, FSK, SOQPSK Note: some Custom IQ Type + Filter combination is not supported yet and will cause recall error too
Couplings	When " Data Segment Index " on page 2342 is 0, SEGMENT in SCPI and Select Seg on GUI are ignored and up to 6 segments in file will be recalled and applied

7.2.39 Data Segment Index

Selects a data segment defined in a **Carrier Setting** file to recall, segment x in file is recalled and applied to segment y ("[Select Segment](#)" on page 2338) in Digital Demod measurement. When x is 0, y is ignored and up to 6 segments in file are recalled and applied. Note "[Select Segment](#)" on page 2338 is GUI-only, so y needs to be specified in "[Carrier Setting](#)" on page 2341 SCPI.

Remote Command	<code>:MMEORY:LOAD:DDEMOD:INDEX:SEGMENT <int></code>
Example	<code>:MMEORY:LOAD:DDEMOD:INDEX:SEGMENT?</code>
	<code>:MMEORY:LOAD:DDEMOD:INDEX:SEGMENT</code>
	<code>:MMEORY:LOAD:DDEMOD:INDEX:SEGMENT?</code>
Preset	0
State Saved	No
Min	0
Max	100

7.2.40 Data Type

There are several Demod Info Data Types available. You can specify to which component carrier you want to recall the **Demod Info** and also choose which data type you want to recall.

7.2.41 CC Setup

Selects a file from which to import the component carrier setup and demod settings to all component carrier or specified component carrier.

The following file formats are supported:

Format	Extension	Notes
xSA Setup Files	<code>.xml</code>	Export from Signal Studio N7608C
89601 VSA Setup Files	<code>.set</code> , <code>.setx</code>	
Signal Studio N7608C Setup Files	<code>.scp</code>	

xSA Setup Files

Extension: xml

xSA Setup Files created by Signal Studio N7608C (Custom Modulation) or N7630C (pre-5G) can be imported.

N7608C Setup Files

Extension: scp

Signal Studio N7608C (Custom Modulation) configuration file, when Custom Modulation type is Custom OFDM.

89601 VSA Setup Files

Extension: set, setx

The 89600 Vector Signal Analyzer Setup file created using the 89600 Vector Signal Analyzer Option BHF (Custom OFDM) can be imported. Note the resource map and resource modulation information recalled from 89601 VSA Setup files is not visible/editable under Meas Setup – Demod – Demod Settings – Resource Mapping.

Remote Command	<code>:MMEMory:LOAD:OFDM:SETup ALL CC0 CC1 CC2 CC3 CC4 CC5 CC6 CC7,<string></code>
Example	<code>:MMEM:LOAD:OFDM:SET CC0,"mySetup.setx"</code>
Dependencies	Only appears in VMA Mode, in the Custom OFDM measurement
Annotation	After recall is complete, an advisory is displayed in the message bar confirming the filter's coefficients were loaded
Status Bits/OPC dependencies	Sequential - aborts the current measurement

7.2.42 Pilot IQ Values

Selects a CSV file from which to import the **Pilot IQ Values**. Note the CSV file for MIMO contains IQ data for multiple layers, so the format is different than SISO.

Remote Command	<code>:MMEMory:LOAD:OFDM:IQPilot CC0 ... CC7,<filename></code>
Example	<code>:MMEM:LOAD:OFDM:IQP CC0,"pilotIQ.csv"</code>
Dependencies	Only appears in VMA Mode, in the Custom OFDM measurement
Status Bits/OPC dependencies	Sequential - aborts the current measurement

7.2.43 Preamble IQ Values

Selects a CSV file from which to import the **Preamble IQ Values**. Note the CSV file for MIMO contains IQ data for multiple layers, so the format is different than SISO.

7 Save/Recall/Print
7.2 Recall

Remote Command	<code>:MMEMory:LOAD:OFDM:IQPreamble CC0 ... CC7,<filename></code>
Example	<code>:MMEM:LOAD:OFDM:IQPR CC0,"pmb1Iq.csv"</code>
Dependencies	Only appears in VMA Mode, in the Custom OFDM measurement
Status Bits/OPC dependencies	Sequential - aborts the current measurement

7.2.44 Resource Map

Selects a CSV file from which to import the defined resource map.

Note the resource map information recalled from the CSV file is *not* visible/editable under **Meas Setup > Demod > Demod Settings > Resource Mapping**.

Remote Command	<code>:MMEMory:LOAD:OFDM:RMAP CC0 ... CC7,<filename></code>
Example	<code>:MMEM:LOAD:OFDM:RMAP CC0,"resourcemap.csv"</code>
Dependencies	Only appears in VMA Mode, in the Custom OFDM measurement
Status Bits/OPC dependencies	Sequential - waits for previous measurement to complete

7.2.45 Resource Modulation

Selects a CSV file from which to import the defined resource modulation.

Note the resource modulation information recalled from the CSV file is *not* visible/editable under **Meas Setup > Demod > Demod Settings > Resource Mapping**.

Remote Command	<code>:MMEMory:LOAD:OFDM:RMOdulation CC0 ... CC7,<filename></code>
Example	<code>:MMEM:LOAD:OFDM:RMOD CC0,"resourcemotion.csv"</code>
Dependencies	Only appears in VMA Mode, in the Custom OFDM measurement
Status Bits/OPC dependencies	Sequential - waits for previous measurement to complete

7.2.46 Filter Coefficients

Selects a file from which to import the Arbitrary filter coefficients data.

Filter Coefficients files are CSV files, and contain the filter coefficients data in a form that can be imported into Excel or similar spreadsheets, as well as header data that gives information on the filters.

Filter Coefficients files have the extension `.csv`, and the default path is:

`My Documents\VMA\data\CustomOFDM\FilterCoef`

Remote Command	<code>:MMEMory:LOAD:OFDM:FILTer:COEFFicient CC0 ... CC7,<filename></code>
Example	Import the meas filter's coefficients for Custom OFDM measurement from the file <code>myFilter-Coef.csv</code> in the current path: <code>:MMEM:LOAD:OFDM:FILT:COEF CC0,"myFilterCoef.csv"</code>
Dependencies	Errors are reported if the file is empty or missing, or if the file type does not match, or if there is a mismatch between the file type and the destination data type
Annotation	After recall is complete, an advisory is displayed in the message bar confirming the filter's coefficients were loaded
Status Bits/OPC dependencies	Sequential - aborts the current measurement

7.2.47 Power Sensor Cal Factor

Selects a file to which to export the Power Sensor Cal factor data.

Cal Factor files are XML files, and contain the cal factor data and header data that gives information on the power sensor.

The default path for **Cal Factor** Files is:

`My Documents\<mode name>\data\PSCF`

where `<mode name>` is the parameter used to select the mode with `:INST:SEL` (for example, `MRECEIVE` for Measuring Receiver Mode). Hence, a **Cal Factor** file from any measurement in the Measuring Receiver mode would be stored in:

`My Documents\MRECEIVE\data\PSCF`

Cal Factor files have the extension `.xml`. The default filename is `<Sensor Model>_<Sensor Serial Number>_0000.xml`, where the 4-digit number is the lowest number that does not conflict with any filename in the current directory. If the sensor model or serial number is blank, the default filename is `PSCF_0000.xml`.

Remote Command	<code>:MMEMory:STORe:PSCFactor <file_name></code>
Example	<code>:MMEM:STOR:PSCF "myPSCF.xml"</code>
Notes	If the save is initiated via SCPI, and the file already exists, the file will be overwritten Using the C: drive is strongly discouraged, since it runs the risk of being overwritten during an instrument software upgrade Both single and double quotes are supported for any filename parameter over SCPI
Dependencies	Only appears if you have the proper option installed in your instrument

7.2.48 Recording

Lets you specify a data type (for example, I/Q data) and select a file from which to import the data, then the data can be routed to the measurement engine as though

it were being acquired from the Input.

The recording and playback of signal data files is a multi-step process that involves controls in several menus.

The menus that are involved in Record/Playback are:

- **Save**, "[Recording](#)" on page 2420 (under the **Save** hardkey or the **Save** icon in the **File** panel)
- **Recall, Recording** (this menu)
- **Sweep, Recording** tab
- **Sweep, Playback** tab
- **Input/Output**, "[Data Source](#)" on page 2195 tab

NOTE

A complete tutorial for the Record/Playback functionality, including how to load and save Recording files, can be found under the **Data Source** tab in **Input/Output**.

Dependencies	Only available in the following modes and measurements: <ul style="list-style-type: none">- VMA (Digital Demod and Custom OFDM)- 5G NR (Modulation Analysis)- LTE (Modulation Analysis)- WLAN (Modulation Analysis, MIMO Modulation Analysis, Spectral Flatness)- Analog Demod- Bluetooth (Transmit Analysis)- IoT & SRComms (LoRa CSS Demod)
--------------	---

7.2.49 Data Type

Allows you to recall IQ data from the measurement using a specified file type ([CSV](#), [SDF](#), [TXT](#), [BIN](#), [BINX](#), [BINF](#), [ORB](#)). See "[Recording](#)" on page 2345 for details about the available file types.

Note that [BIN](#), [BINX](#) and [BINF](#) files do not include sampling rate information inside the file, so after recalling one of these file types you will need to set the Sample Rate in **Sweep, Playback**., based on your note of the Sample Rate that was displayed on the **Sweep, Recording** menu panel when you saved the file.

Example	<code>:MMEM:LOAD:RECORDing "C:\TEMP\MyIQData.csv"</code>
---------	--

7.2.50 Channel

Select data channels to recall. This is only supported in the 5G NR EVM, VMA Digital Demod, VMA Custom OFDM and WLAN MIMO EVM measurements.

The `<meas>` param in the command must be replaced with the node of the active measurement:

- `EVM` for 5G NR EVM
- `EVMM` for WLAN MIMO EVM
- `DDEM` for VMA Digital Demod
- `OFDM` for VMA Custom OFDM

Remote Command	<code>:MMEMory:LOAD:<meas>:RECORDing:CHANnel ALL CH1 CH2 CH3 CH4 CH5 CH6 CH7 CH8</code> <code>:MMEMory:LOAD:<meas>:RECORDing:CHANnel?</code>
Example	<code>:MMEM:LOAD:EVM:REC:CHAN CH1</code> <code>:MMEM:LOAD:EVM:REC:CHAN?</code>
Preset	<code>ALL</code>
State Saved	No
Range	<code>ALL CH1 CH2 CH3 CH4 CH5 CH6 CH7 CH8</code>

7.2.51 Reset

Clears all recalled data channels.

This is only supported by 5G NR EVM, VMA Digital Demod, VMA Custom OFDM and WLAN MIMO EVM measurements.

The `<meas>` param in the command must be replaced with the node of the active measurement:

- `EVM` for 5G NR EVM
- `EVMM` for WLAN MIMO EVM
- `DDEM` for VMA Digital Demod
- `OFDM` for VMA Custom OFDM

Remote Command	<code>:MMEMory:LOAD:<meas>:RECORDing:RESet</code>
----------------	---

Example `:MMEM:LOAD:EVM:REC:RES`

7.2.52 Recalled data channel table (Display only)

Displays recalled IQ data file for each channel in a table.

7.2.53 Recording + State

Recalls a snapshot file (`*.rssf`) that includes state and IQ recording.

Remote Command	<code>:MMEMory:LOAD:RState <filename></code>
Example	<code>:MMEM:LOAD:RST "snapshot1.rssf"</code>
Status Bits/OPC dependencies	Sequential - aborts the current measurement

7.2.54 CC Setup

You can recall a **Component Carrier Setup** file, which sets up the 5G NR Modulation Analysis measurement with the settings in the file.

Using the **Component Carrier** dropdown, you can specify which component carrier you wish to apply this setup to, or **ALL**.

The following file formats are supported:

Format	Extension
Signal Studio N7631C Setup	<code>.scp</code>
M9384B VXG 5G NR Setup	<code>.sgen</code>
PWSG Desktop Setup	<code>.pwsG</code>
89600 VSA 5G NR Setup	<code>.setx</code>
X-Series Measurement Application 5G NR Component Carrier Setup	<code>.nrcc</code>

Remote Command	<code>:MMEMory:LOAD:EVM:SETup ALL CC0 CC1 CC2 CC3 CC4 CC5 CC6 CC7 CC8 CC9 CC10 CC11 CC12 CC13 CC14 CC15,<string></code>
Example	<code>:MMEM:LOAD:EVM:SET CC0,"mySetup.scp"</code>
Status Bits/OPC dependencies	Sequential - aborts the current measurement

7.2.55 Frame Index (.scp and .pwsq only)

Signal Studio (N7631C) and PWSG desktop may have configuration for multiple frames. This parameter specifies which frame's configuration will be recalled in 5GNR Modulation Analysis measurement from a **.scp** or **.pwsq** file.

Remote Command	<code>:MMEMory:LOAD:EVM:FRAMe <int></code> <code>:MMEMory:LOAD:EVM:FRAMe?</code>
Example	<code>:MMEM:LOAD:EVM:FRAM 1</code> <code>:MMEM:LOAD:EVM:FRAM?</code>
Preset	0
State Saved	No
Min	0
Max	100

7.2.56 Close VSA after recall (.setx only)

Automatically launches VSA (VSA 2021 or later version with valid license is required) in the background, if it is needed to recall the specified **.setx** file. This provides recalled settings to the 5GNR EVM measurement through an internal API. This process will be slower and will consume more memory, because VSA is running in the background.

Lets you specify whether VSA will be closed after recalling the current **.setx** file:

- ON** Close VSA to improve performance and minimize memory usage
- OFF** Keep VSA running to allow faster recall of additional **.setx** files

Remote Command	<code>:MMEMory:LOAD:EVM:VSA:RELease 0 1 OFF ON</code> <code>:MMEMory:LOAD:EVM:VSA:RELease?</code>
Example	<code>:MMEM:LOAD:EVM:VSA:REL 1</code> <code>:MMEM:LOAD:EVM:VSA:REL?</code>
Preset	OFF
State Saved	No
Range	OFF ON

7.2.57 Custom IQ Constellation State

Selects a text (**.txt**) file from which to import the Constellation States definition for the Custom IQ modulation type. This file format is the same as Signal Studio

7 Save/Recall/Print
7.2 Recall

N7608C Custom IQ constellation file format and VMA Digital Demod measurement Custom IQ. To use a recalled constellation, change the PDSCH/PUSCH MCS to -1, then change the modulation format to Custom IQ.

A preloaded **Constellation State** file can be found under VMA directory:

`My Documents\VMA\data\DDEMOD\ConstInState`

Remote Command	<code>:MMEMory:LOAD:EVM:CONStIn:STATe <string></code>
Example	Import the constellation state from the file <code>myConstInState.txt</code> in the current path: <code>:MMEM:LOAD:EVM:CONS:STAT "myConstInState.txt"</code>
Dependencies	Only appears in 5GNR Mode, in the Modulation Analysis measurement Errors are reported if the file is empty or missing, or if the file type does not match, or if there is a mismatch between the file type and the destination data type
Annotation	After recall is complete, an advisory is displayed in the message bar confirming the constellation state was loaded

7.2.58 Memory Polynomial and Volterra Coefficients Files

This section includes details of:

- ["Sample file" on page 2350](#)
- ["Coefficient Lengths" on page 2352](#)
- ["How to apply the coefficients to signal" on page 2353](#)

7.2.59 Sample file

The following is a sample file for a Volterra coefficients file, with Memory order = 4, Nonlinear order = 9, Cross term order = 2, and Odd Order Only = True.

The file format is simple and explicit.

`DPD_ModelType,Volterra`

`DPD_MemoryOrder,4`

`DPD_NonlinearOrder,9`

`DPD_CrossTermOrder,2`

`DPD_OddOrderOnly,True`

`DPDScale` is average rms voltage of PA_Out waveform when extracting DPD model coefficients and can be used with 3 steps:

1. Calculate rms voltage ratio of PA_Out waveform to PA_In waveform which is normalized
2. Apply ratio got from step 1 on normalized PA_In waveform by multiplying calculation
3. Apply DPD model coefficients on waveform got from step 2 to get pre-distorted waveform which then to be normalized before downloading to signal generator

DPD_Scale,0.09999999999999086

DPD Model coefficients:

(1.00223 + 0.00970452i)

(-0.001965723 - 0.01462447i)

(-0.008369884 - 0.002737971i)

(0.01452063 + 0.01492864i)

(-0.006762785 - 0.006566553i)

(-0.01567868 - 0.01343224i)

(-0.141361 - 0.1372522i)

(0.1328902 + 0.1311074i)

(-0.05909718 - 0.07043044i)

(-0.001788079 + 0.01183834i)

(-1.562534 - 1.031141i)

(3.446798 + 4.501282i)

(-2.0815 - 3.004885i)

(0.06725498 + 0.8596171i)

(0.9134464 + 0.1463772i)

(35.86065 - 67.05225i)

(-80.63958 - 104.1732i)

(30.86995 + 55.34027i)

(5.221638 - 5.483259i)

(-18.13741 - 3.452169i)

(221.5443 - 2034.443i)

(657.9685 + 838.8614i)

(-199.259 - 441.7861i)

7 Save/Recall/Print
7.2 Recall

(-29.6007 + 17.26444i)
(103.4851 + 11.09599i)
(0.1350661 + 0.1316225i)
(-0.06501895 - 0.06489465i)
(5.014235 + 4.609146i)
(-0.8907772 - 0.668824i)
(-5.902434 - 8.141459i)
(1.636723 + 3.281262i)
(-46.47874 + 348.1572i)
(-6.124507 - 60.3042i)
(-33.16697 - 508.8666i)
(53.4192 + 129.6637i)
(100.1206 + 335.9822i)
(-35.58208 - 117.2356i)
(-2366.625 + 9791.407i)
(307.5222 - 554.9667i)
(4812.173 - 17976.19i)
(-880.0538 + 1257.174i)
(-3440.768 + 15373.81i)
(230.9595 - 1877.854i)
(308.9818 - 5781.878i)
(126.123 + 1276.467i)

7.2.60 Coefficient Lengths

The coefficient lengths depend on the following settings:

<code>ModelType</code>	Memory Polynomial (MP) Volterra
<code>MemoryOrder</code>	integer
<code>NonlinearOrder</code>	integer
<code>CrossTermOrder</code>	integer
<code>OddOrderOnly</code>	True/false

ModelType is MP

If **OddOrderOnly** is false, then $\text{CoeffsLength} = \text{NonlinearOrder} * (\text{MemoryOrder} + 1) + 1$, otherwise $\text{CoeffsLength} = \text{Int}((\text{NonlinearOrder} + 1)/2) * (\text{MemoryOrder} + 1)$

ModelType is Volterra

In the following formulae, $K = \text{integer value of } (\text{NonlinearOrder} + 1) / 2$

OddOrderOnly	NonlinearOrder Modulo 2	CoeffsLength
True	0	$\text{NonlinearOrder} * (\text{MemoryOrder} + 1) + \text{CrossTermOrder} * K * K$
True	Not 0	$\text{NonlinearOrder} * (\text{MemoryOrder} + 1) + \text{CrossTermOrder} * K * (K - 1)$
False	All	$K * (\text{MemoryOrder} + 1) + \text{CrossTermOrder} * K * (K - 1) / 2$

7.2.61 How to apply the coefficients to signal

The coefficient terms include three parts and $x(n)$ is the signal

The first $(M+1)$ terms are linear ones:

$$\sum_{m=0}^M A_m x(n - m)$$

1. The next $[(N-1)/2 * (M+1)]$ terms are nonlinear memory ones:

$$\sum_{m=0}^M \sum_{\substack{n=3 \\ \text{odd}}}^N B_{mn} x(n - m) |x(n - m)|^{n-1}$$

2. Cross terms

$$\sum_{\substack{i=3 \\ \text{odd}}}^N \sum_{\substack{k=2 \\ \text{even}}}^{i-1} \sum_{m=1}^{M_c} C_{ikm} x(n) |x(n)|^{i-k-1} |x(n - m)|^k$$

N is nonlinear order (odd number), M is memory order, M_c is cross term memory order

According to the sample file above, $N=9$, $M=4$, $M_c=2$ and $\text{OddOrderOnly} = \text{True}$, the length of coefficients = 45 including 5 for linear items and 20 nonlinear items and 20 cross items

The DPD model coefficients are as below:

$$Y(n) = \sum_{m=0}^M A_m \mathbf{x}(n-m) + \sum_{m=0}^M \sum_{n=3}^N B_{mn} \mathbf{x}(n-m) |\mathbf{x}(n-m)|^{n-1} + \sum_{i=3}^N \sum_{k=2}^{i-1} \sum_{m=1}^{Mc} C_{ikm} \mathbf{x}(n) |\mathbf{x}(n)|^{i-k-1} |\mathbf{x}(n-m)|^k$$

odd *even*

Y(n) is the predistorted signal, X(n) is the reference signal.

7.2.62 Loss Comp

Sets the import file type to Loss Compensation Before DUT Table or to Loss Compensation After DUT Table.

Mode	NFIGURE
Parameter Name	Recall Loss Comp
Control Path	Recall
Parameter Type	ImmediateAction
SCPI Command	:MMEMory:LOAD:LOSS BEFore AFTEr,<file_name>
SCPI Example	:MMEM:LOAD:LOSS BEF,"C:\LossBefore.csv" :MMEM:LOAD:LOSS AFT,"C:\LossAfter.csv"
Notes	Three file formats are supported: <ul style="list-style-type: none"> - Loss Compensation file (.csv) - Legacy Loss Compensation file (.loss) - S parameter file (.s2p)
Soft Key Label	Loss Comp
Backwards Compatibility SCPI	:MMEMory:LOAD:LOSS
Initial S/W Revision	A.04.00

For .s2p files, only the S21 component is used for the loss compensation.

The CSV format contains the following data:

File Type

Application Name: Measurement Name

Version and Model Number

Loss Comp Data

Below is an example of a valid CSV Loss Compensation file:

```
[Filetype LossCompensation]
```

```
[NF:NFIG]
```

```
Ver. ***, Model ***
```

```
10, 1.0000
```

20, 2.0000
30, 3.0000
40, 4.0000
50, 5.0000
60, 6.0000

7.2.63 Data Pattern

Lets you choose a file from which to import the data pattern for generating an NRZ waveform to be used by the Audio Generator ARB.

Data Pattern files are CSV files, containing the bit pattern data in a form that can be imported into Excel or similar spreadsheets.

Data Pattern files have the extension **.csv**.

Remote Command	<code>:MMEMory:LOAD:RTS:DATA:PATtern <filename></code>
Example	Import the data pattern from the file <code>myDataPattern.csv</code> in the current path: <code>:MMEM:LOAD:RTS:DATA:PATT "myDataPattern.csv"</code>
Dependencies	Errors are reported if the file is empty or missing, or if the file type does not match, or if there is a mismatch between the file type and the destination data type
Annotation	After recall is complete, an advisory is displayed in the message bar confirming the sync pattern strings were loaded
Status Bits/OPC dependencies	Sequential - aborts the current measurement

7.3 Save

The **Save** dialog lets you save states, traces, screen images and other items from the instrument to files on the instrument's internal storage, to removable devices, and to directories on the network. You access the dialog by pressing the **Save** hardkey, or by pressing the folder icon at the bottom of the display and then pressing the **Save** icon.

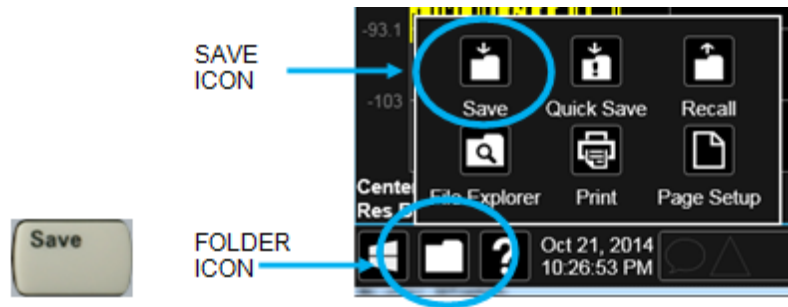

The dialog has tabs running down the left side, which you use to specify what you want to save.



You choose the save item and then complete the save by choosing a register or file location to which to save the item.

Notes

No remote command for this key specifically, but **:MMEM:STORE** is available for specific file types
 Example: **:MMEM:STOR:STATE <filename>**

7.3.1 Save to File / Save As

For every Save type, a control appears labeled **Save to File** or **Save As**. **Save to File** appears for save types that also include registers (like State and Trace+State), and **Save As** appears for all other save types.

When you press **Save to File** or **Save As**, a dialog slides in from the right that allows you to see what files are already saved in the current directory.

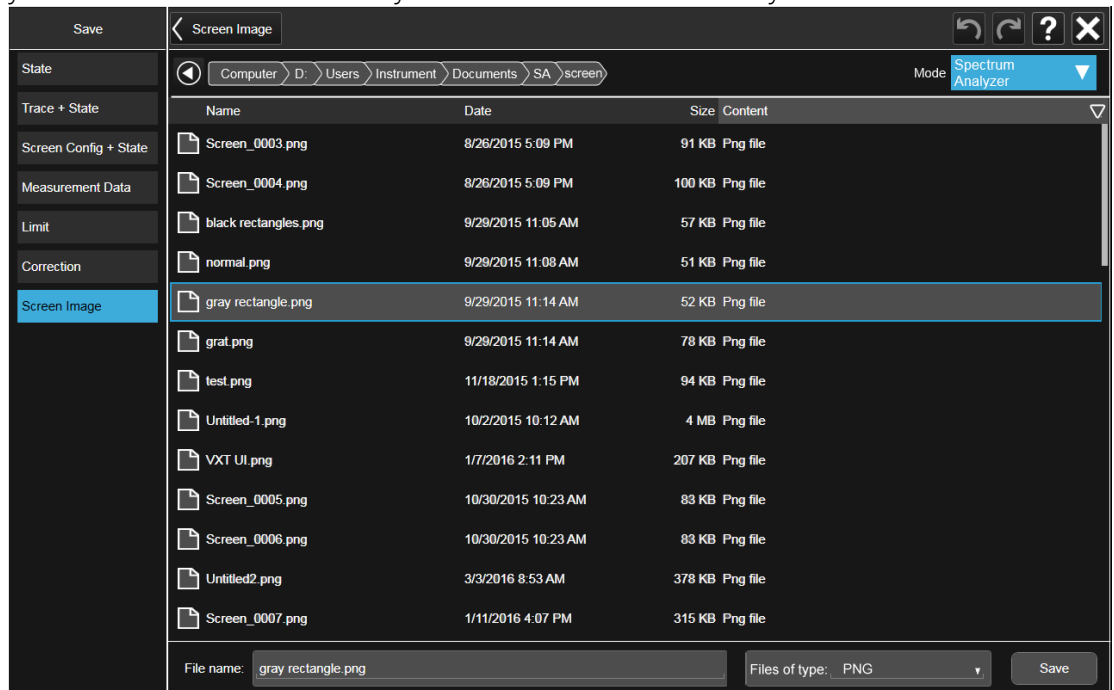

The default directory is the internal directory for the current Mode and save type, on

the **D:** drive. You may also change to another Mode's state directory by pressing the dropdown in the upper right corner labeled **Mode**. Once you have chosen a directory, the files in that directory whose extension matches the current data type (for example, **.state** or **.trace**) are displayed in the right-hand window of the dialog. You can sort this list by name, date, file size or extension by tapping the Name, Date, Size, or Content header at the top of each column. A second tap toggles the sort order between Ascending and Descending.

Also displayed is a path depiction showing the path to the current directory. In the example above, the path is **D:\Users\Instrument\Documents\SA\screen**. Tapping any element of this path lets you select an alternate route. Tapping the **Computer** arrow lets you select a different drive.



Tapping the "Back" arrow navigates to the previously selected directory.

Note: Using the C: drive is strongly discouraged, due to the risk of data being overwritten during an instrument software upgrade.

If you plug in a removable drive (for example, a thumb drive), the browser immediately navigates to the root of that drive. Furthermore, if you had a thumb drive in and you were in a directory on the thumb, and then you exit the browser, when you come back in you are still in the same directory on that removable drive. If you remove the thumb drive, you return to the directory you had been in before the thumb drive was plugged in.

Note that for each data type there is a "current" directory, and it is the last directory used by either Save or Recall for that Mode. For example, if in SA Mode you save a Corrections file to a particular directory, then when you go to recall a Correction in SA Mode, you should be pointing at that directory. Or if in EMC Mode you recall a Limit from a particular directory then when in EMC Mode you go to save a Limit, it should be pointing at that same directory. There is one "current" directory for each data type for each Mode (not one for Save and one for Recall).

The Filename field, just below the Path field, shows the filename that will be used. The **File Name** field is initially loaded with an automatically generated filename specific to the appropriate Save Type. The automatically generated filename is guaranteed not to conflict with any filename currently in the directory. You may edit the filename by tapping it, which brings up the onscreen alpha keyboard. Press the "Done" button on this keyboard when you are done editing.

Select a file to overwrite, type in a file name, or use the name suggested by the instrument (guaranteed not to conflict with any file in the current directory), and press Save. If the file specified already exists, a dialog will appear that allows you to replace the existing file by selecting **OK**, or you can Cancel the request.

After a successful save, a message "File <filename> saved" or "State Register <register number> saved" is displayed in an info box for a few seconds.

See ["Quick Save" on page 2316](#) for details of the automatic file naming algorithm.

7.3.2 State

Selects a register or file for saving the state.

State files contain essentially all the information required to return the instrument to the measurement and settings that were in effect at the time of the save. **State** files are in a proprietary binary form (for speed) and cannot be read or edited by PC software, but can be loaded back into the instrument to restore the state.

State files contain all the settings of the **Input/Output** system as well, even though **Input/Output** variables are outside of the Mode's state and unaffected by **Mode Preset**, because these are needed to restore the complete setup.

Persistent System settings (for example, GPIB address) are affected by neither **Mode Preset** nor **Restore Mode Defaults**, nor are they included in a saved **State** file.

For rapid saving, the **State** menu lists 16 registers to which you can save states. Pressing a **Register** button initiates the save. You can also select a file to which to save by pressing **Save to File**.

The default path for all **State** files is:

`My Documents\<<mode name>\state`

where `<mode name>` is the parameter used to select the Mode with `:INST:SEL` (for example, `SA` for Spectrum Analyzer Mode).

State files have the extension `.state`. The default filename is `State_0000.state`, where the 4-digit number is the lowest number that does not conflict with any filename in the current directory.

NOTE

In products that run multiple simultaneous instances of the X-Series Application, all instances share the same registers and file directories, so take care not to overwrite files and/or registers from one instance that were saved by another instance.

Remote Command	<code>:MMEMory:STORe:STATe <filename></code>
Example	Store the current instrument state data in the file <code>MyStateFile.state</code> in the default directory: <code>:MMEM:STOR:STATe "MyStateFile.state"</code>
Notes	Both single and double quotes are supported for any filename parameter over remote After saving to a register, that register's menu key is updated with the date the time, unless a custom label has been entered for that key After saving to a register, you remain in the Save State menu, so that you can see the Register key update. After saving to a file, the instrument automatically returns to the previous menu and any Save As dialog goes away

Backwards	:MMEMory:STORe:STATe 1,<filename>
Compatibility SCPI	The "1" is simply ignored. The command is sequential

7.3.3 Register 1 thru Register 16

Selecting any one of these register buttons causes the state of the currently active Mode to be saved to the specified **Register**. The registers are provided for rapid saving and recalling, since you do not need to specify a filename or navigate to a file. Each of the register menu keys annotates whether it is empty or at what date and time it was last modified. In addition, you can edit any of the register names to enter custom names for any register.

Although these 16 registers are the only registers available from the front panel, there are 128 state registers available in the instrument. Registers 17-128 are only available from the SCPI interface, using the ***SAV** command.

There is one set of 128 state registers in the instrument, not one set for each Mode. When a state is saved, the Mode it was saved from is saved with it; then when it is recalled, the instrument switches to that Mode.

NOTE

In products that run multiple simultaneous instances of the X-Series Application, all instances share the same registers and file directories, so take care not to overwrite files and/or registers from one instance that were saved by another instance.

The date displayed follows the format specified in the **Date Format** setting under the **Control Panel**. The time shows hours and minutes.

After the save completes, the corresponding register menu key annotation is updated with the date and time and the message **Register <register number> saved** is displayed.

Example	*SAV 1
Range	1-16 from front panel, 1-128 from SCPI

7.3.4 Edit Register Names

You may enter a custom name for any of the **Registers**, to help you remember what you are using that state to save. To do this, press the **Name** field for the register you want to rename, which displays the onscreen alpha keyboard. Press **Done** on this keyboard when you are done editing.

The maximum number of characters for a register name is 30. If you delete all the characters in the custom name, it restores the default (time and date).

The register names are stored within the state files, but they are not part of the instrument state; that is, once you have edited a register name, loading a new state will not change that register name. Another consequence of this is that the names will be persistent through a power cycle. Also, if a named state file is transferred to another instrument, it will bring its custom name along with it.

If you try to edit the name of an empty register, the instrument first saves the state to have a file to put the name in. If you load a named state file into an instrument with older firmware, it ignores the metadata.

The ***SAV** and ***RCL** commands are not affected by the custom register names, nor are the **:MMEM** commands.

Remote Command	:MMEMory:REGister:STATe:LABel <reg number>,"label"
Example	:MMEM:REG:STAT:LAB 1,"my label"
Notes	<p><reg number> is an integer from 1 to 16. If the SCPI specifies an invalid register number an error message is generated, -222, "Data out of range; Invalid register label number"</p> <p>"label" is a string from 0 to 30 characters in length. If a label exceeds 30 characters, an error message is generated, -150, "String data error; Label clipped to 30 characters"</p> <p>"label" of zero length erases the custom label and restores the default (time and date) label. For example, :MMEM:REG:STAT:LAB 1,""</p>
Preset	The names are unaffected by Preset or power cycle but are set to the default label (time and date) on Restore System Defaults>Misc

7.3.5 Trace+State

Selects a register or file for saving selected traces and the state.

Trace+State files contain essentially all the information required to return the instrument to the measurement and settings that were in effect at the time of the save, as well as the data for one or all traces. **Trace+State** files are in a proprietary binary form (for speed) and cannot be read or edited by PC software, but can be loaded back into the instrument to restore the state and trace(s).

Trace+State files contain all the settings of the **Input/Output** system as well, even though **Input/Output** variables are outside of the Mode's state and unaffected by **Mode Preset**, because these are needed to restore the complete setup.

Persistent **System** settings (for example, GPIB address) are affected by neither **Mode Preset** nor **Restore Mode Defaults**, nor are they included in a saved **Trace+State** file.

For rapid saving, the **Trace+State** menu lists 16 registers to which you can save trace+state files. The **Trace+State** registers are separate registers from the **State** registers. Pressing a **Register** button initiates the save. You can also select a file to which to save by pressing **Save to File**.

The default path for all **Trace+State** files is the same as that for **State** files:

7 Save/Recall/Print
7.3 Save

`My Documents\<mode name>\state`

where `<mode name>` is the parameter used to select the mode with `:INST:SEL` (for example, `BASIC` for IQ Analyzer Mode).

NOTE

In products that run multiple simultaneous instances of the X-Series Application, all instances share the same registers and file directories, so take care not to overwrite files and/or registers from one instance that were saved by another instance.

Trace+State files have the extension `.trace`. The default filename is `State_0000.trace`, where the 4-digit number is the lowest number that does not conflict with any filename in the current directory.

The **Trace+State** selection only appears for measurements that support trace saves. It is blanked for modes that do not support trace saves. Saving **Trace** is identical to saving **State** except a `.trace` extension is used on the file instead of `.state`, and internal flags are set in the file indicating which trace was saved.

See "[More Information](#)" on page 2363.

Remote Command	<code>:MMEMory:STORe:TRACe TRACE1 TRACE2 TRACE3 TRACE4 TRACE5 TRACE6 ALL,<filename></code> <code>:MMEMory:STORe:TRACe:REGister TRACE1 TRACE2 TRACE3 TRACE4 TRACE5 TRACE6 ALL,<integer></code>
----------------	--

Example	Save the file <code>myState.trace</code> on the default path and flags it as a "single trace" file with Trace 1 as the single trace (even though all of the traces are in fact stored): <code>:MMEM:STOR:TRAC TRACE1,"myState.trace"</code> Save the file <code>myState.trace</code> on the default path and flags it as an "all traces" file: <code>:MMEM:STOR:TRAC ALL,"myState.trace"</code> Store trace 1 data in trace register 2: <code>:MMEM:STOR:TRAC:REG TRACE1,2</code>
---------	--

Notes	This command actually performs a Save State , which in the Swept SA measurement includes the trace data. However, it flags it (in the file) as a "save trace" file of the specified trace (or all traces) Some Modes and measurements do not have available all 6 traces. The Phase Noise Mode command, for example, is: <code>:MMEMory:STORe:TRACe TRACE1 TRACE2 TRACE3 ALL,<filename></code> Some modes and measurements have more than 6 traces available. The Realtime SA Mode command, for example, is: <code>:MMEMory:STORe:TRACe TRACE1 TRACE2 TRACE3 TRACE4 TRACE5 TRACE6 TRACE7 TRACE8 TRACE9 TRACE10 TRACE11 TRACE12 ALL,<filename></code> The range for the register parameter is 1-5 When you initiate a save, if the file already exists, a dialog will appear that allows you to replace the existing file by selecting OK or you can cancel the request. If you select OK , the file will be overwritten. Using the C: drive is strongly discouraged, since it runs the risk of being overwritten during an instrument software upgrade
-------	--

Both single and double quotes are supported for any filename parameter over remote

After saving to a register, that register's menu key is updated with the date and time of the save

After saving to a register, you remain in the **Save Trace** menu, so that you can see the **Register** key update. After saving to a file, the instrument automatically returns to the previous menu and any **Save As** dialog goes away

More Information

In measurements that support saving **Traces**, for example, Swept SA, the **Trace** data is saved along with the **State** in the **State** file. When recalling the **State**, the **Trace** data is recalled as well. Traces are recalled exactly as they were stored, including the writing mode and update and display modes. If a Trace was updating and visible when the **State** was saved, it returns updating and visible, and its data will be rewritten right away. When you use **State** to save and recall traces, any trace whose data must be preserved should be placed in **View** or **Blank** mode before saving.

The following table describes the **Trace Save** and **Recall** possibilities:

You want to recall state and one trace's data, leaving other traces unaffected	Save Trace+State from 1 trace. Make sure that no other traces are updating (they should all be in View or Blank mode) when the save is performed	On recall, specify the trace you want to load the one trace's data into. This trace loads in view. All other traces' data will be unaffected, although their trace mode will be as it was when the state save was performed
You want to recall all traces	Save Trace+State from ALL traces	On recall, all traces come back in View (or Blank if they were in Blank or Background when saved)
You want all traces to load exactly as they were when saved	Save State	On recall, all traces' mode and data will be exactly as they were when saved. Any traces that were updating will have their data immediately overwritten

7.3.6 Save From Trace

Selects the trace to be saved. The default is the currently selected trace, selected in this this or any other menu with Trace selection. If you have chosen All then it remains chosen until you specifically change it to a single trace, regardless of the trace selected in the **Trace** menu.

When you select a trace, it makes that trace the current trace, so it displays on top of all of the other traces.

7.3.7 Register 1 thru Register 16

Selecting any one of these register buttons causes the specified trace(s) and the state of the currently active mode to be saved to the specified register. The registers are provided for rapid saving and recalling, since you do not need to specify a filename or navigate to a file. Each of the register menu keys annotates whether it is empty or at what date and time it was last modified. In addition, you can edit any of the register names to enter custom names for any register.

There is one set of 16 trace+state registers in the instrument, not one set for each Mode. When trace+state is saved, the Mode it was saved from is saved with it; then when it is recalled, the instrument switches to that Mode.

NOTE

In products that run multiple simultaneous instances of the X-Series Application, all instances share the same registers and file directories, so take care not to overwrite files and/or registers from one instance that were saved by another instance.

The date displayed follows the format specified in the **Date Format** setting in **Control Panel**. The time shows hours and minutes.

After the save completes, the corresponding register menu key annotation is updated with the date and time and the message **Register <register number> saved** is displayed.

Example	*SAV 1
Range	1-16

7.3.8 Edit Register Names

You may enter a custom name for any of the registers, to help you remember what you are using that trace+state to save. To do this, press the **Name** field for the register you want to rename, which displays the onscreen alpha keyboard. Press the **Done** button on this keyboard when you are done editing.

The maximum number of characters for a register name is 30. If you delete all the characters in the custom name, it restores the default (time and date).

The register names are stored within the trace+state files, but they are not part of the instrument state; that is, once you have edited a register name, loading a new state does not change that register name. Another consequence of this is that the names are persistent through a power cycle. Also, if a named state file is transferred to another instrument, it brings its custom name along with it.

If you try to edit the name of an empty register, the instrument will first save the trace+state to have a file to put the name in. If you load a named state file into an instrument with older firmware, it ignores the metadata.

Remote Command	<code>:MMEMory:REGister:TRACe:LABel <reg number>,"label"</code> <code>:MMEMory:REGister:TRACe:LABel? <reg number></code>
Example	<code>:MMEM:REG:TRAC:LAB 1,"my label"</code>
Notes	<code><reg number></code> is an integer from 1 to 16. If the SCPI specifies an invalid register number an error message is generated, -222, "Data out of range; Invalid register label number" <code>"label"</code> is a string from 0 to 30 characters in length. If a label exceeds 30 characters, an error message is generated, -150, "String data error; Label clipped to 30 characters" <code>"label"</code> of zero length erases the custom label and restores the default (time and date) label, e.g., <code>:MMEM:REG:TRAC:LAB 1,""</code>
Preset	The names are unaffected by Preset or power cycle but are set to the default label (time and date) on Restore System Defaults > Misc

7.3.9 Screen Config + State

Saves the complete configuration of all your screens to a file. You choose a file to which to export the data.

Remote Command	<code>:MMEMory:STORe:SCONfig <filename></code>
Example	Store the current screen configuration in the file <code>myScreenConfig.screen</code> in the default directory: <code>:MMEM:STOR:SCON "myScreenConfig.screen"</code>

7.3.10 Measurement Data

Specifies a data type (for example, trace data) and choose a file to which to export the data.

Measurement Data files are comma-separated Value (CSV) files, and contain the requested data in a form that can be imported into Excel or similar spreadsheets, as well as header data that gives information on relevant instrument settings at the time the save occurred.

The main application of **Measurement Data** files is for importing data to a PC for analysis, but in some cases **Measurement Data** files can also be imported back into the instrument to recreate the data object that existed at the time of the save. For example, most **Trace** data files can be imported back into the instrument.

The default path for **Measurement Data** Files is:

`My Documents\<mode name>\data`

7 Save/Recall/Print
7.3 Save

with the subdirectory reflecting the data type and where `<mode name>` is the parameter used to select the Mode with `:INST:SEL` (for example, `SA` for Spectrum Analyzer Mode) and `<measurement name>` is the parameter used to select the measurement with `:CONF` (for example, `SAN` for Swept SA). For example, a Peak Table file from Swept SA in SA Mode would be stored in:

`My Documents\SA\data\SAN\results`

Measurement Data files have extension `.csv`. The default filename is `Prefix_0000.csv`, where the 4-digit number is the lowest number that does not conflict with any filename in the current directory, and “Prefix” is dependent on the data type:

Type	Default Prefix
Traces	Trace_
Measurement Result	MeasR_
Capture Buffer	CapBuf_

For example, the default filename for a trace data file in an empty directory would be `Trace_0000.csv`

7.3.11 Save From

Selects the specific item to be saved, for example, if you are exporting trace data you may specify Trace 1, Trace 2, etc.

The default for traces is the currently selected trace, selected in this this or any other menu with Trace selection. If you have chosen **All** then it remains chosen until you specifically change it to a single trace, regardless of the trace selected in the Trace menu. The **All** selection saves all six traces in one CSV file with the x-axis data in the first column and the individual trace data in succeeding columns. The header data and x-axis data in this file reflect the current settings of the measurement. Note that any traces that are in **View** or **Blank** may have different x-axis data than the current measurement settings; but this different x-axis data is *not* output to the file.

Preset	Not part of Preset , but is reset to by Restore Mode Defaults Survives shutdown
--------	--

7.3.12 Data Type

You choose the data type to save by using the radio button selection box. Below are the specifications for Data files for each measurement.

Notes	There is no SCPI command for Data Type , as the type is implied in the SCPI command for each item
Dependencies	The Data Type menu for any given measurement only contains data types that are supported by that measurement

7.3.13 Meas Results

Meas Results files contain information that describes the current state of the instrument, as detailed in Meas Result File Contents below.

This command is only available in certain measurements, such as:

- PowerSuite: Channel Power, OBW, ACP, Spectrum Emissions Mask, Spurious Emissions, Power Stat CCDF, Transmit Power, Monitor Spectrum, IQ Waveform
- IQ Analyzer: Complex Spectrum
- Phase Noise: Log Plot and Spot Frequency
- WCDMA: Code Domain, Mod Accuracy, Power Control, and QPSK EVM
- Analog Demod: AM, FM, PM and FM Stereo
- Noise Figure
- Pulse

In general, the data in the Meas Results file matches the data which is returned to a measurement data query (`:FETCh?`, `:READ?`, `:MEASure?`). These queries and the results they return are documented for each measurement, and can be found in the Help for that measurement (or in the manual for that measurement) in the section titled **Remote Command Results**.

In the `MeasResults` file, you will see a column for each value of `n`. Each column contains the value for the corresponding value of `n` in the **Remote Command Results** table.

For example, Complex Spectrum allows values of `n` up to 17, and the `MeasResults` file for Complex Spectrum has 17 columns. So, the data returned when you send `:FETCh:SPECTrum1?` matches the data in the column labeled `MeasResult1` of the Meas Results file. See the example below:

Response to FETCh:SPECTrum1?

```
2.125444221E+01,6.487077992E+07,2.050000000E+02,6.004725051E+07,3.9215
68627E+04,2.370000000E+02,0.000000000E+00,1.000000000E-
07,1.000000000E+00,2.360000000E-05,2.500000000E+01
```

MeasResult1 column from Meas Results file

```
MeasResult1
-21.25444221
64870779.92
```

7 Save/Recall/Print
7.3 Save

205
60047250.51
39215.68627
237
0
1.00E-07
1
2.36E-05
25

In addition, examples of the Meas Results files are given for each data type in the Help below.

Remote Command	<code>:MMEemory:STORe:RESults <string></code>
Example	<code>:MMEem:STOR:RES "MeasR_0000.csv"</code>
Notes	<p>If the save is initiated via SCPI and the file already exists, the file will be overwritten</p> <p>The SCPI command exports measurement results to the file specified as the parameter in the current path. The default path is:</p> <p><code>My Documents\<current mode>\data\<measurement name>\results</code></p> <p>where <code><mode name></code> is the parameter used to select the mode with the <code>:INST:SEL</code> command (for example, <code>SA</code> for Spectrum Analyzer Mode) and <code><measurement name></code> is the parameter used to select the measurement with the <code>:CONF:</code> command (for example, <code>SAN</code> for the Swept SA measurement)</p> <p>Using the <code>C:</code> drive is strongly discouraged, since it runs the risk of being overwritten during an instrument software upgrade</p> <p>The SCPI parameter is a quoted string, which specifies the filename. Both single and double quotes are supported for any filename parameter over SCPI</p>
Annotation	After the save is complete, an advisory is displayed in the window so that the user can confirm which file was saved
Status Bits/OPC dependencies	Sequential – waits for the previous measurement to complete

7.3.14 CHP Meas Results File Contents

The file contains measurement results, preceded by the following header information.

- File ID string, which is `MeasResult`
- Mode ID: Measurement ID, for example, `SA:CHP`

- Firmware rev and model number
- Option string
- Auto Sweep Time Rules
- Average Mode
- Average Number
- Average State
- Center Frequency
- Detector
- Electrical Atten
- Electrical Atten State
- IFGain
- IFGainAuto
- Impedance
- Integ BW
- Internal Preamp
- Internal Preamp Band
- Mechanical Atten
- MechanicalAttenStepEnum
- PSD Unit
- Resolution Band Width
- Resolution Bandwidth Shape
- RRC Filter Alpha
- RRC Filter BW
- RRC Filter State
- Span

7 Save/Recall/Print
7.3 Save

- Sweep Points
- Sweep Time
- Sweep Time Auto
- TriggerSource
- Video Bandwidth
- Y Axis Unit

Following the header entries above is a line containing only **MeasResult1** and **MeasResult2**, which flags the start of the measurement results. Each subsequent line consists of two comma-separated values, the **MeasResult1** value and the **MeasResult2** value.

- **MeasResult1** contains the same results as `:MEAS|:READ|:FETCh:CHPower1`
- **MeasResult2** contains the same results as `:MEAS|:READ|:FETCh:CHPower2`

The exported file is in CSV format. When imported into Microsoft Excel or a similar spreadsheet application, a typical file appears as follows:

```

MeasResult
SA:CHP
A.10.53                                     N9030A
526 ALV ATP B1X B1Y B25 B40 BBA CR3 CRP DCF DDA DP2 DRD EA3 EDP      1
EMC EP1 ERC ESC ESP EXM FSA LFE LNP MAT MPB NFE NUL P26 PFR PNC
RTL RTS S40 SB1 SEC SM1 TVT YAS YAV
Auto Sweep Time Rules                       Normal
Average Mode                                Exponential
Average Number                               10
Average State                                TRUE
Center Frequency                             13255000000
Detector                                     Average
IFGain                                       FALSE
IFGainAuto                                  FALSE
Impedance                                    50
Integ BW                                    2000000
Internal Preamp                              FALSE
Internal Preamp Band                         Low
PSD Unit                                     DbmHz
Resolution Band Width                        27000

```

Resolution Bandwidth Shape	Gaussian
RRC Filter Alpha	0.22
RRC Filter BW	3840000
RRC Filter State	FALSE
Span	3000000
Sweep Points	1001
Sweep Time	0.004933333
Sweep Time Auto	TRUE
TriggerSource	Free
Video Bandwidth	270000
Y Axis Unit	DecibelMilliwatt
MeasResult1	MeasResult2
-76.8141133132837	-95.29174
-139.824413269924	-94.99601
	-94.95281
	-95.17146

7.3.15 OBW Meas Results File Contents

The first lines in the OBW Meas results file consist of header information, as follows.

- File ID string, which is "MeasResult"
- Measurement ID following Mode ID, which is "SA:OBW" for example.
- Firmware rev and model number
- Option string
- Auto Sweep Time Rules
- Average Mode
- Average Number
- Average State
- Center Frequency
- Detector
- Electrical Atten

7 Save/Recall/Print

7.3 Save

- Electrical Atten State
- IFGain
- IFGainAuto
- Internal Preamp
- Internal Preamp Band
- Limit
- Limit State
- Max Hold
- Mechanical Atten
- MechanicalAttenStepEnum
- OBW Percent Pwr
- Resolution Band Width
- Resolution Bandwidth Shape
- Span
- Sweep Points
- Sweep Time
- Sweep Time Auto
- TriggerSource
- Video Bandwidth
- x DB

The data above is followed in the file by a line containing “MeasResult1” and “MeasResult2”. This line forms a header for each set of measurement results, which appear in subsequent lines. Each line of Measurement Results consists of two comma-separated values, for MeasResult1 and MeasResult2 respectively.

The MeasResult1 set in the file corresponds to the data returned by `:MEAS|:READ|:FETCh:OBwidth1`, and the MeasResult2 set corresponds to the data returned by `:MEAS|:READ|:FETCh:OBwidth2`.

The exported file is in CSV format, with a `.csv` extension.

Meas Results File Example

When imported into Microsoft Excel, a typical Meas Results CSV file appears as shown in the example below.

MeasResult	
SA:OBW	
A.10.53	N9030A
526 ALV ATP B1X B1Y B25 B40 BBA CR3 CRP DCF DDA DP2 DRD EA3 EDP EMC EP1 ERC ESC ESP EXM FSA LFE LNP MAT MPB NFE NUL P26 PFR PNC RTL RTS S40 SB1 SEC SM1 TVT YAS YAV	1
Auto Sweep Time Rules	Normal
Average Mode	Exponential
Average Number	10
Average State	TRUE
Center Frequency	1.33E+10
Detector	Average
IFGain	FALSE
IFGainAuto	FALSE
Internal Preamp	FALSE
Internal Preamp Band	Low
Limit	5000000
Limit State	FALSE
Max Hold	FALSE
OBW Percent Pwr	99
Resolution Band Width	27000
Resolution Bandwidth Shape	Gaussian
Span	3000000
Sweep Points	1001
Sweep Time	0.004933
Sweep Time Auto	TRUE
TriggerSource	Free
Video Bandwidth	270000
x DB	-26
MeasResult1	MeasResult2
2971020.10835045	-94.3702543927405
-74.9741251886604	-94.1447790390963

7.3.16 ACP Meas Results File Contents

An ACP Meas Results File contains measurement results with the following header information, columns A and B unless otherwise stated:

- File ID string, which is **MeasResult**
- Mode ID: Measurement ID, for example, **SA:ACP**
- Firmware rev and model number
- Option string
- Auto Scaling
- Auto Sweep Time Rules
- Automatic Trigger Time
- Automatic Trigger Time State
- Average Mode
- Average Number
- Average State
- Bar Graph
- Carrier Coupling (columns A thru S, TRUE or FALSE)
- Carrier Pwr Present (columns A thru S, Yes or No)
- Carrier Spacing (columns A thru S, in Hz)
- Carriers
- Center Frequency
- Center Frequency Step
- Center Frequency Step State
- Detector Auto
- Detector Selection
- Electrical Atten

- Electrical Atten State
- External Array Trigger Delay (columns A thru E)
- External Array Trigger Delay State (columns A thru E)
- External Array Trigger Level (columns A thru E)
- External Array Trigger Slope (columns A thru E)
- Filter Alpha (columns A thru S)
- Filter BW
- Filter Type
- Internal Preamp
- Internal Preamp Band
- Limit Test
- Line Trigger Delay
- Line Trigger Delay State
- Line Trigger Slope
- Meas Method
- Meas Type
- Measurement Noise Bandwidth (columns A thru S, in Hz)
- Mechanical Atten
- MechanicalAttenStepEnum
- Method (columns A thru S)
- Noise Correction
- Offset Abs Limit (columns A thru G)
- Offset Fail (columns A thru G)
- Offset Filter Alpha
- Offset Filter BW (columns A thru G)

7 Save/Recall/Print

7.3 Save

- Offset Filter Type (columns A thru G)
- Offset Freq (columns A thru G)
- Offset Freq State (columns A thru G)
- Offset Integ BW (columns A thru G)
- Offset Method
- Offset Rel Lim (Car) (columns A thru G)
- Offset Rel Lim (PSD) (columns A thru G)
- Offset Res BW (columns A thru G)
- Offset Res BW Mode (columns A thru G)
- Offset Video BW (columns A thru G)
- Offset Video BW Mode (columns A thru G)
- Periodic Timer Period
- Periodic Timer Sync Source
- Periodic Timer Trigger Delay
- Periodic Timer Trigger Delay State
- Points
- Power Ref
- Power Ref State
- Preselector Adjust
- PSD Ref
- PSD Unit
- Ref Car Freq
- Ref Car Freq State
- Ref Carrier
- Ref Carrier Mode

- Ref Position
- Ref Value
- Res BW
- Res BW Mode
- RFBurst Trigger Delay
- RFBurst Trigger Delay State
- RFBurst Trigger Level Abs
- RFBurst Trigger Level Rel
- RFBurst Trigger Level Type
- RFBurst Trigger Slope
- Scale/Div
- Span
- Sweep Time
- Sweep Time Auto
- Trigger Holdoff
- Trigger Holdoff State
- Trigger Source
- Video BW
- Video BW Auto

The file contains this header, followed by a line containing **MeasResult1**, **MeasResult2**, and **MeasResult3**. This line flags the start of the measurement results. Each line of Measurement Results consists of three comma separated values, for **MeasResult1**, **MeasResult2**, and **MeasResult3**.

MeasResult1 contains the same result as **MEAS | READ | FETCH:ACPower1;**
MeasResult2, **MEAS | READ | FETCH:ACPower2;** **MeasResult3**,
MEAS | READ | FETCH:ACPower3.

The exported file is in CSV format, with a **.csv** extension. When imported into Microsoft Excel or a similar spreadsheet application, the *first three* columns of a typical file appear as follows:

7 Save/Recall/Print
7.3 Save

Column A	Column B	Additional columns (if any)
MeasResult		
SA:ACP		
A.10.53	N9030A	
526 ALV ATP B1X B1Y B25 B40 BBA CR3 CRP DCF DDA DP2 DRD EA3 EDP EMC EP1 ERC ESC ESP EXM FSA LFE LNP MAT MPB NFE NUL P26 PFR PNC RTL RTS S40 SB1 SEC SM1 TVT YAS YAV	01	
Auto Scaling	True	
Auto Sweep Time Rules	Accy	
Automatic Trigger Time	0.1	
Automatic Trigger Time State	False	
Average Mode	Exponential	
Average Number	10	
Average State	True	
Bar Graph	True	
Carrier Coupling	True	Columns A thru S: True/False
Carrier Pwr Present	Yes	Columns A thru S: Yes/No
Carrier Spacing	5000000	Columns A thru S: Hz
Carriers	1	
Center Frequency	13255000000	
Center Frequency Step	800000	
Center Frequency Step State	True	
Detector Auto	True	
Detector Selection	Average	
Electrical Atten	0	
Electrical Atten State	False	
External Array Trigger Delay	1E-06	Columns A thru E
External Array Trigger Delay State	False	Columns A thru E
External Array Trigger Level	1.2	Columns A thru E
External Array Trigger Slope	Positive	Columns A thru E
Filter Alpha	0.22	Columns A thru S
Filter BW	Minus3dB	
Filter Type	Gaussian	

Column A	Column B	Additional columns (if any)
Internal Preamp	False	
Internal Preamp Band	Low	
Limit Test	False	
Line Trigger Delay	1E-06	
Line Trigger Delay State	False	
Line Trigger Slope	Positive	
Meas Method	IbwSpeed	
Meas Type	TPRef	
Measurement Noise Bandwidth	2000000	Columns A thru S: Hz
Mechanical Atten	10	
MechanicalAttenStepEnum	S2dB	
Method	IBW	Columns A thru S
Noise Correction	False	
Offset Abs Limit	0	0
Offset Fail	Relative	Columns A thru G
Offset Filter Alpha	0.22	
Offset Filter BW	Minus3dB	Columns A thru G
Offset Filter Type	Gaussian	Columns A thru G
Offset Freq	3000000	Columns A thru G
Offset Freq State	True	Columns A thru G
Offset Integ BW	2000000	Columns A thru G
Offset Method	False	
Offset Rel Lim (Car)	-45	Columns A thru G
Offset Rel Lim (PSD)	-28.87	Columns A thru G
Offset Res BW	220000	Columns A thru G
Offset Res BW Mode	True	Columns A thru G
Offset Video BW	22000	Columns A thru G
Offset Video BW Mode	True	Columns A thru G
Periodic Timer Period	0.02	
Periodic Timer Sync Source	None	
Periodic Timer Trigger Delay	1E-06	
Periodic Timer Trigger Delay State	False	
Points	1001	
Power Ref	-76.81 dBm	

7 Save/Recall/Print
7.3 Save

Column A	Column B	Additional columns (if any)
Power Ref State	On	
Preselector Adjust	0	
PSD Ref	-139.82 dBm/Hz	
PSD Unit	DbmHz	
Ref Car Freq	13.255000000 GHz	
Ref Car Freq State	On	
Ref Carrier	1	
Ref Carrier Mode	On	
Ref Position	Top	
Ref Value	-30	
Res BW	220000	
Res BW Mode	False	
RFBurst Trigger Delay	1E-06	
RFBurst Trigger Delay State	False	
RFBurst Trigger Level Abs	-20	
RFBurst Trigger Level Rel	-6	
RFBurst Trigger Level Type	Absolute	
RFBurst Trigger Slope	Positive	
Scale/Div	10	
Span	8000000	
Sweep Time	0.02	
Sweep Time Auto	True	
Trigger Holdoff	0.1	
Trigger Holdoff State	False	
Trigger Source	Free	
Video BW	22000	
Video BW Auto	True	
MeasResult1	MeasResult2	MeasResult3
-76.8058517744559	0	1
0.084790019950006	-76.8058517744559	0
0.0283929128313787	-999	1
... and so on	-999	0
	-999	1

7.3.17 SPUR Meas Results File Contents

A Spurious Emissions Meas Results File contains measurement results with the following header information, columns A and B unless otherwise stated:

- File ID string, which is "MeasResult"
- Measurement ID following Mode ID, which is "SA:SPUR" for example.
- Firmware rev and model number
- Option string
- Abs Start Limit (columns A thru K)
- Abs Stop Limit (columns A thru K)
- Abs Stop Limit Mode (columns A thru K, TRUE or FALSE)
- Auto Scaling
- Auto Sweep Time Rules
- Automatic Trigger Time
- Automatic Trigger Time State
- Average Mode
- Average Number
- Average State
- Detector 1 (columns A thru K)
- Detector 2 (columns A thru K)
- Electrical Atten
- Electrical Atten State
- External Array Trigger Delay (columns A thru E)
- External Array Trigger Delay State (columns A thru E)
- External Array Trigger Level (columns A thru E)
- External Array Trigger Slope (columns A thru E)

7 Save/Recall/Print

7.3 Save

- Filter Type (columns A thru K)
- IF Gain Auto (columns A thru K, TRUE or FALSE)
- IF Gain State (columns A thru K, TRUE or FALSE)
- Internal Preamp
- Internal Preamp Band
- Line Trigger Delay
- Line Trigger Delay State
- Line Trigger Slope
- Meas Type
- Mechanical Atten
- MechanicalAttenStepEnum
- Peak Excursn (columns A thru K)
- Periodic Timer Period
- Periodic Timer Sync Source
- Periodic Timer Trigger Delay
- Periodic Timer Trigger Delay State
- Pk Threshold (columns A thru K)
- Points (columns A thru K)
- Points Mode (columns A thru K)
- Range State (columns A thru K)
- Ref Value
- Res BW (columns A thru K)
- Res BW Mode (columns A thru K)
- RFBurst Trigger Delay
- RFBurst Trigger Delay State

- RFBurst Trigger Level Abs
- RFBurst Trigger Level Rel
- RFBurst Trigger Level Type
- RFBurst Trigger Slope
- Scale/Div
- Spurious Report Mode
- SpurRangeStartFrequencyArray (columns A thru K)
- SpurRangeStopFrequencyArray (columns A thru K)
- Sweep Time (columns A thru K)
- Sweep Time Mode (columns A thru K)
- Trigger Holdoff
- Trigger Holdoff State
- TriggerSource
- Video BW (columns A thru K)
- Video BW Mode (columns A thru K)

The data above is followed in the file by a line containing “MeasResult1” to “MeasResult42”. This line forms a header for each set of measurement results, which appear in subsequent lines. Each line of Measurement Results consists of 42 comma-separated values, from the MeasResult1 value to the MeasResult42 value.

The MeasResult1 set in the file corresponds to the data returned by MEAS/READ/FETCH:SPURious1; the MeasResult2 set corresponds to the data returned by MEAS/READ/FETCH:SPURious2, and so on.

The exported file is in CSV format, with a .csv extension.

Meas Results File Example

When imported into Excel, a typical Meas Results file will show the header information above followed by the data. A sample of what the data rows look like appears below. Only the columns for Meas Result 1 through 6 are shown, due to lack of space:

MeasResult 1	MeasResult 2	MeasResult 3	MeasResult 4	MeasResult 5	MeasResult 6
19	-80.27209	-80.87862	-90.94577	-89.27086	-76.77856

MeasResult 1	MeasResult 2	MeasResult 3	MeasResult 4	MeasResult 5	MeasResult 6
1	-78.28497	-80.93996	-91.00485	-90.56063	-76.33968

7.3.18 SEM Meas Results File Contents

SEM Meas Results Files are CSV files, with a `.csv` extension. Each file contains sets of measurement results, preceded by a header section.

The header section items are as follows. They span columns A and B, unless otherwise stated:

- File ID string, which is `MeasResult`
- Mode ID: Measurement ID, for example, `SA:SEM`
- Firmware rev and model number
- Option string
- Automatic Trigger Time
- Automatic Trigger Time State
- Center Frequency
- ChanIntegBW
- ChannelDetector
- ChannelDetectorState
- ChanPwrRefAuto
- ChanResBW
- ChanResBWAuto
- ChanSpan
- ChanSweepTime
- ChanSweepTimeAuto
- ChanSweepTypeAuto
- ChanVbwRbwRatio

- ChanVbwRbwRatioAuto
- ChanVideoBW
- ChanVideoBWAuto
- Electrical Atten
- Electrical Atten Bypass
- Electrical Atten State
- External1 Trigger Delay
- External1 Trigger Delay State
- External1 Trigger Level
- External1 Trigger Slope
- External2 Trigger Delay
- External2 Trigger Delay State
- External2 Trigger Level
- External2 Trigger Slope
- FilterAlpha
- FrontEnd Gain
- FrontEnd Gain Mode
- Input Port
- Internal Preamp
- Internal Preamp Band
- Line Trigger Delay
- Line Trigger Delay State
- Line Trigger Slope
- LowNoiseAmplifier
- Measure Trace

7 Save/Recall/Print

7.3 Save

- Mechanical Atten
- Mechanical Atten Auto
- MergedTraceNumPoints
- OffsetAverageType
- OffsetDetector
- OffsetDetectorState
- OffsetLimit2ndFailMaskBTS
- OffsetLimit2ndFailMaskMS
- OffsetLimitAbs2ndStartBTS
- OffsetLimitAbs2ndStartMS
- OffsetLimitAbs2ndStopBTS
- OffsetLimitAbs2ndStopMS
- OffsetLimitAbsStartBTS
- OffsetLimitAbsStartMS
- OffsetLimitAbsStopBTS
- OffsetLimitAbsStopMS
- OffsetLimitFailMaskBTS
- OffsetLimitFailMaskMS
- OffsetLimitRelStartBTS
- OffsetLimitRelStartMS
- OffsetLimitRelStopBTS
- OffsetLimitRelStopMS
- OffsetMeasBWBTS
- OffsetMeasBWMS
- OffsetResolutionBWAUTOBTS

- OffsetResolutionBWAutoMS
- OffsetResolutionBWBTS
- OffsetResolutionBWMS
- OffsetSideBTS
- OffsetSideMS
- OffsetStartFrequencyBTS
- OffsetStartFrequencyMS
- OffsetStateBTS
- OffsetStateMS
- OffsetStopFrequencyBTS
- OffsetStopFrequencyMS
- OffsetSweepTimeAutoBTS
- OffsetSweepTimeAutoMS
- OffsetSweepTimeBTS
- OffsetSweepTimeMS
- OffsetSweepTypeAutoBTS
- OffsetSweepTypeAutoMS
- OffsetSweepTypeBTS
- OffsetSweepTypeMS
- OffsetVbwRbwRatioAutoBTS
- OffsetVbwRbwRatioAutoMS
- OffsetVbwRbwRatioBTS
- OffsetVbwRbwRatioMS
- OffsetVideoBWAutoBTS
- OffsetVideoBWAutoMS

7 Save/Recall/Print

7.3 Save

- OffsetVideoBWbTS
- OffsetVideoBWMS
- PeakReference
- Periodic Timer Period
- Periodic Timer Sync Source
- Periodic Timer Trigger Delay
- Periodic Timer Trigger Delay State
- PowerReference
- PSDReference
- Radio Device
- RefAverageType
- RFBurst Trigger Delay
- RFBurst Trigger Delay State
- RFBurst Trigger Level Abs
- RFBurst Trigger Level Rel
- RFBurst Trigger Level Type
- RFBurst Trigger Slope
- RrcFilter
- SemAverageNumber
- SemAverageState
- SemRbwShape
- Span
- Sweep Type
- TotalAtten
- Trace Display

- Trace Math Function
- Trace Math Log Offset
- Trace Math Log Reference
- Trace Math Operand 1
- Trace Math Operand 2
- Trace Update
- TraceTypeArray
- Trigger Holdoff
- Trigger Holdoff State
- TriggerSource
- Video Trigger Delay
- Video Trigger Delay State
- Video Trigger Level
- Video Trigger Slope
- ViewCenterFreq
- ViewSelection
- ViewSpan
- XScaleAuto
- XScalePerDiv
- XScaleRefFreq
- XScaleRefPos
- YAutoScaling
- YRefValue
- YScalePerDiv

The header section is followed by a line containing items **MeasResult1** to **MeasResult20**, which flags the start of the measurement results. Each line of

7 Save/Recall/Print
7.3 Save

Measurement Results consists of 20 comma-separated values, from **MeasResult1** through **MeasResult20**.

MeasResult1 contains the same results as **MEAS/READ/FETCH:SEMASK1**; **MeasResult2**, **MEAS/READ/FETCH:SEMASK2**; **MeasResult3**, **MEAS/READ/FETCH:SEMASK3**; and so on.

When imported into Microsoft Excel or a similar spreadsheet application, a typical Meas Results file displays the header information above, followed by the data section. A sample of the data rows appears below. Only the columns for **MeasResult1** through **MeasResult6** are shown, due to lack of space:

MeasResult1	MeasResult2	MeasResult3	MeasResult4	MeasResult5	MeasResult6	...etc.
-999	0	-13	999	15.59025	-999	
15.590253	0	-13	999	-999	-999	
59						

7.3.19 CCDF Meas Results File Contents

CCDF Meas Results Files are in CSV format, with a **.csv** extension. Each file contains sets of measurement results, preceded by a header section. The header section contains the following lines:

- File ID string, which is **MeasResult**
- Mode ID: Measurement ID, for example **SA:PST**
- Firmware rev and model number
- Option string
- Automatic Trigger Time
- Automatic Trigger Time State
- CcdfCurrentCounts
- Center Frequency
- Center Frequency Step
- Center Frequency Step State
- Counts
- Electrical Atten

- Electrical Atten State
- External Array Trigger Delay
- External Array Trigger Delay State
- External Array Trigger Level
- External Array Trigger Slope
- Gaussian Line
- IF Gain Auto
- IF Gain State
- Info BW
- Internal Preamp
- Internal Preamp Band
- Line Trigger Delay
- Line Trigger Delay State
- Line Trigger Slope
- Meas Cycles
- MeasInterval
- Mechanical Atten
- MechanicalAttenStepEnum
- Periodic Timer Period
- Periodic Timer Sync Source
- Periodic Timer Trigger Delay
- Periodic Timer Trigger Delay State
- Preselector Adjust
- Ref Trace
- RFBurst Trigger Delay

7 Save/Recall/Print
7.3 Save

- RFBurst Trigger Delay State
- RFBurst Trigger Level Abs
- RFBurst Trigger Level Rel
- RFBurst Trigger Level Type
- RFBurst Trigger Slope
- Scale/Div
- Trigger Holdoff
- Trigger Holdoff State
- TriggerSource

The header section is followed by a line containing items **MeasResult1** through **MeasResult4**. This line forms a header for each set of measurement results, which are listed in subsequent lines. Each line of Measurement Results consists of 4 comma-separated values, from the **MeasResult1** value to the **MeasResult4** value.

The **MeasResult1** set in the file corresponds to the data returned by **MEAS|READ|FETCh:PSTatistic1**; the **MeasResult2** set corresponds to the data returned by **MEAS|READ|FETCh:PSTatistic2**, and so on.

Meas Results File Example

When imported into Microsoft Excel or a similar spreadsheet application, a typical Meas Results file appears as shown in the example below.

MeasResult

SA:PST

A.10.53	N9030A
526 ALV ATP B1X B1Y B25	1
B40 BBA CR3 CRP DCF	
DDA DP2 DRD EA3 EDP	
EMC EP1 ERC ESC ESP EXM	
FSA LFE LNP MAT MPB NFE	
NUL P26 PFR PNC RTL RTS	
S40 SB1 SEC SM1 TVT YAS	
YAV	
Automatic Trigger Time	0.1
Automatic Trigger Time State	FALSE
CcdfCurrentCounts	6087500

Center Frequency	1.33E+10	
Center Frequency Step	5000000	
Center Frequency Step State	TRUE	
Counts	10000000	
Electrical Atten	0	
Electrical Atten State	FALSE	
External Array Trigger Delay	1.00E-06	1.00E-06
External Array Trigger Delay State	FALSE	FALSE
External Array Trigger Level	1.2	1.2
External Array Trigger Slope	Positive	Positive
Gaussian Line	TRUE	
IF Gain AUto	FALSE	
IF Gain State	FALSE	
Info BW	5000000	
Internal Preamp	FALSE	
Internal Preamp Band	Low	
Line Trigger Delay	1.00E-06	
Line Trigger Delay State	FALSE	
Line Trigger Slope	Positive	
Meas Cycles	1600	
MeasInterval	0.001	
Mechanical Atten	10	
MechanicalAttenStepEnum	S2dB	
Periodic Timer Period	0.02	
Periodic Timer Sync Source	None	
Periodic Timer Trigger Delay	1.00E-06	
Periodic Timer Trigger Delay State	FALSE	
Preselector Adjust	0	
Ref Trace	FALSE	
RFBurst Trigger Delay	1.00E-06	
RFBurst Trigger Delay State	FALSE	
RFBurst Trigger Level Abs	-20	
RFBurst Trigger Level Rel	-6	
RFBurst Trigger Level Type	Absolute	
RFBurst Trigger Slope	Positive	

7 Save/Recall/Print
7.3 Save

Scale/Div	2		
Trigger Holdoff	0.1		
Trigger Holdoff State	FALSE		
TriggerSource	Free		
MeasResult1	MeasResult2	MeasResult3	MeasResult4
-73.0651058869747	36.9712197125257	36.7879441171442	
36.9712197125257	36.8850431211499	36.7032368203129	

7.3.20 TXP Meas Results File Contents

A TXP Meas Results File contains measurement results with the following header information:

- File ID string, which is "MeasResult"
- Measurement ID following Mode ID, which is "SA:TXP" for example
- Firmware rev and model number
- Option string
- Center Frequency
- TXP_InfoBw
- TXP_Used_CaptureTime

The header data is followed by a line containing entries "MeasResult1" to "MeasResult4", which flags the start of the measurement results. Each line of Measurement Results consists of four comma separated-values, from the MeasResult1 value to the MeasResult4 value.

MeasResult1 contains the same results as **MEAS/READ/FETCh:TXPower|BPOwer1**; MeasResult2, **MEAS/READ/FETCh:TXPower|BPOwer2**; and so on.

The exported file has **.csv** extension. A typical Meas Results file, when imported into Excel, would appear as follows:

```
MeasResult
SA:TXP
A.10.53                               N9030A
526 ALV ATP B1X B1Y B25 B40 BBA      1
CR3 CRP DCF DDA DP2 DRD EA3
EDP EMC EP1 ERC ESC ESP EXM
FSA LFE LNP MAT MPB NFE NUL
P26 PFR PNC RTL RTS S40 SB1 SEC
```

```

SM1 TVT YAS YAV
Center Frequency          1.33E+10
TXP_InfoBw                3000000
TXP_Used_CaptureTime     0.00064
MeasResult1              MeasResult2      MeasResult3      MeasResult4
0
-999

```

7.3.21 IQ Waveform Meas Results File Contents

An IQ Waveform Meas Results File contains measurement results with the following header information:

- File ID string, which is "MeasResult"
- Measurement ID following Mode ID, for example, [WCDMA:WAV](#)
- Firmware rev and model number
- Option string
- Center Frequency
- Input Port
- Info BW
- Capture Time

The data above is followed in the file by a line containing [MeasResult0](#), [MeasResult1](#), and [MeasResult2](#). This line forms a header for each set of measurement results, which appear in subsequent lines. Each line of Measurement Results consists of 3 comma-separated values.

The [MeasResult0](#) set in the file corresponds to the data returned by [MEAS|READ|FETCH:WAVEform0](#); the [MeasResult1](#) set corresponds to the data returned by [:MEAS|READ|FETCH WAVEform1](#), and the [MeasResult2](#) set corresponds to the data returned by [:MEAS|READ|FETCH WAVEform2](#). See ["Remote Command Results" on page 673](#) for details.

The exported file is in CSV format, with a [.csv](#) extension.

Meas Results File Example

When imported into Microsoft Excel or a similar spreadsheet application, a typical Meas Results CSV file appears as shown in the example below.

7 Save/Recall/Print
7.3 Save

MeasResult

WCDMA:WAV

A.20.10_P0003 N9040B
503 508 513 526 AKT ALV ATP B1A B1X B1Y B25 B2X 1
B40 B85 CR3 CRP DP2 EA3 EDC EDP EMC EPO ERC
ESC ESP EXM FBP FP1 FP2 FS1 FS2 FSA FT2 LFE LNP
MPB NF2 NUL P26 PFR RBE RT2 RTL RTS TDS YAV
Center Frequency 1000000000
Input Port RF
WAV_InfoBw 100000
WAV_Used_CaptureTime 0.002

MeasResult0

MeasResult1

MeasResult2

3.24E-06	8.00E-06	-99.79862
7.28E-08	-96.51288923	-95.87017
2.43E-06	-96.51288923	-101.4529
-4.47E-06	251	-94.5003
7.65E-07	7.796300857	-95.8662
-2.56E-06	-88.71658837	-97.78934
4.79E-07	-125.5631137	-101.0861
5.94E-06		-97.72218
4.71E-06		-96.72934
1.93E-06		-100.7464
4.04E-07		-99.8119

(rows continue until all data is displayed)

7.3.22 Frequency Scan

See [PD - Mode - EMI Receiver.docx](#)

7.3.23 Header On/Off

See [PD - Mode - EMI Receiver.docx](#)

7.3.24 Title

See [PD - Mode - EMI Receiver.docx](#)

7.3.25 Client

See [PD - Mode - EMI Receiver.docx](#)

7.3.26 Operator

See [PD - Mode - EMI Receiver.docx](#)

7.3.27 Product Description

See [PD - Mode - EMI Receiver.docx](#)

7.3.28 Logo

See [PD - Mode - EMI Receiver.docx](#)

7.3.29 Browse

Lets you select an image that will be shown in the report if desired. Supported formats for images are: [.jpg](#), [.png](#) and [.bmp](#).

Remote Command	<code>:MMEMory:TRACe:LOGO:FILE "File Name"</code>
Example	<code>:MMEMory:TRACe:LOGO:FILE "C:\Temp\image.jpg"</code>
Dependencies	Grayed-out if the logo's state is off
State Saved	Saved in instrument state

7.3.30 Setting On/Off

See [PD - Mode - EMI Receiver.docx](#)

7.3.31 Trace Data On/Off

See [PD - Mode - EMI Receiver.docx](#)

7.3.32 Amplitude Correction Display

See [PD - Mode - EMI Receiver.docx](#)

7 Save/Recall/Print
7.3 Save

7.3.33 Limits Display State

See [PD - Mode - EMI Receiver.docx](#)

7.3.34 Screen State

See [PD - Mode - EMI Receiver.docx](#)

7.3.35 Scan Table On/Off

See [PD - Mode - EMI Receiver.docx](#)

7.3.36 Signal List On/Off

See [PD - Mode - EMI Receiver.docx](#)

7.3.37 Output Format

See [PD - Mode - EMI Receiver.docx](#)

7.3.38 Disturbance Analyzer

See [PD - Mode - EMI Receiver.docx](#)

7.3.39 Title

See [PD - Mode - EMI Receiver.docx](#)

7.3.40 Client

See [PD - Mode - EMI Receiver.docx](#)

7.3.41 Operator

See [PD - Mode - EMI Receiver.docx](#)

7.3.42 Product Description

See [PD - Mode - EMI Receiver.docx](#)

7.3.43 Comment

See [PD - Mode - EMI Receiver.docx](#)

7.3.44 Meas Setup On/Off

See [PD - Mode - EMI Receiver.docx](#)

7.3.45 Disturbance List On/Off

See [PD - Mode - EMI Receiver.docx](#)

7.3.46 Trace (All Traces) On/Off

See [PD - Mode - EMI Receiver.docx](#)

7.3.47 Channel On/Off

See [PD - Mode - EMI Receiver.docx](#)

7.3.48 Limit

Lets you choose a file to which to export the **Limit** data.

Limit files are CSV files, and contain the limit data in a form that can be imported into Excel or similar spreadsheets, as well as header data that gives information on the limit.

The default path for most Limits files is:

`My Documents\<mode name>\data\limits`

where `<mode name>` is the parameter used to select the mode with the `:INST:SEL` command (for example, `SA` for Spectrum Analyzer). Hence a **Limit** file from any measurement in Spectrum Analyzer Mode would be stored in:

`My Documents\SA\data\limits`

7 Save/Recall/Print
7.3 Save

The default path for **Limit** files from the Log Plot measurement in Phase Noise Mode is:

`My Documents\PNOISE\data\LPL\limits`

The default filename is `Limit_0000.csv`, where the 4-digit number is the lowest number that does not conflict with any filename in the current directory.

For backwards compatibility, older limit files with the extension `.lim` can be read into the instrument, but you can only save limits as `.csv` files.

Remote Command	<code>:MMEMory:STORe:LIMit LLINE1 ... LLINE6,<filename></code>
Example	Save the 2nd Limit Line to the file <code>myLimitLine2.csv</code> in the current path: <code>:MMEM:STOR:LIM LLINE2,"myLimitLine2.csv"</code>
Notes	If the save is initiated via SCPI, and the file already exists, the file will be overwritten Using the C: drive is strongly discouraged, since it runs the risk of being overwritten during an instrument software upgrade Both single and double quotes are supported for any filename parameter over SCPI
Dependencies	Only appears if you have the proper option installed in your instrument In the Log Plot measurement in Phase Noise Mode, there are only three Limit Lines, so the valid parameters are <code>LLINE1 LLINE2 LLINE3</code>
Preset	1 Not part of Preset , but reset by Restore Mode Defaults Survives power cycles
State Saved	The selected Limit number is saved in instrument state
Status Bits/OPC dependencies	Sequential - waits for previous measurement to complete

Limit File Contents

Limits may be exported into a data file with a `.csv` extension. They may be imported from that data file; they may also be imported from a legacy limit file with a `.lim` extension. The `.lim` files meet the specification for limit files contained in the EMI measurement guide, HP E7415A.

.csv file format

Except for information in quotes, limit line files are not case sensitive. Information in bold is required verbatim; other text is example text, and italic text is commentary which should not be present in the file.

The first five lines are system-required header lines, and must be in the correct order:

Limit	<i>Data file type name</i>
"FCC Part 15"	<i>File Description</i>
"Class B Radiated"	<i>Comment</i>
A.01.00.R0001,N9020A	<i>Instrument Version, Model Number</i>
P13 EA3 UK6 ,01	<i>Option List, File Format Version</i>

The next few lines describe the parameters; on export they will be in the order shown, on import they can be in any order. If some parameters are missing, they will revert to the default.

Type, Upper	<i>Upper Lower</i>
X Axis Unit, MHz	<i>MHz S; other units should be converted; this also specifies the domain</i>
Amplitude Unit, dBm	<i>dBm V; all other units should be converted appropriately</i>
Frequency Interpolation, Linear	<i>Logarithmic Linear</i>
Amplitude Interpolation, Logarithmic	<i>Logarithmic Linear</i>
X Control, Fixed	<i>Fixed Relative; on input we consider only the first three characters</i>
Y Control, Fixed	<i>Fixed Relative; on input we consider only the first three characters</i>
Margin, 0	<i>Always in dB. A 0 margin is equivalent to margin off</i>
X Offset, 10	<i>Expressed in the X axis units</i>
Y Offset, 5	<i>Expressed in the Amplitude units</i>

The Amplitude Unit line in the limits file may contain a transducer (formerly “antenna”) factor unit, for example:

Amplitude Unit=dBuV/m

Transducer factor units are dBuV/m, dBuA/m, dBpT, and dBG. In this case, the unit is treated exactly as though it were dBuV, meaning that all of the limits are interpreted to have units of dBuV. The box does NOT change Y Axis Units when such a limit is loaded in.

The X-Axis unit also specifies the domain (time or frequency). It is not possible to have both time-domain lines and frequency-domain lines at the same time; if a time-domain line is imported while the other lines are in the frequency domain (or vice-versa), all limit lines will be deleted prior to import.

If the sign of the margin is inappropriate for the limit type (for example a positive margin for an upper limit), the sign of the margin will be changed internally so that it is appropriate.

The remaining lines describe the data. Each line in the file represents an X-Y pair. The X values should be monotonically non-decreasing, although adjacent lines in the file can have the same X value as an aid to building a stair-stepped limit line. To specify a region over which there is no limit, use +1000 dBm for upper limits or – 1000 dBm for lower limits.

The data region begins with the keyword **DATA**:

DATA
200.000000,-10.00
300.000000,-10.00
300.000000,-20.00
500.000000,-20.00

.lim file format

This is a legacy format which allows files saved from older instruments to be loaded into the X-Series. *Design of files in this format is not recommended.*

7 Save/Recall/Print
7.3 Save

Except for name and description text (which is taken verbatim), limit line files are not case sensitive.

The file may optionally start with a description block, consisting of the single line **[DESCRIPTION]** followed by arbitrary text. If there is no Limit Line Name header, the description text will be used as the limit line description in the GUI. If there is a Limit Line Name header, the Limit Line Name will be used instead.

Arbitrary text

The header block begins with the single line **[HEADER]**, followed by some or all of the following fields, each with **<parameter name>=<parameter value>**. Excess white space around the “=” is ignored. If a field is not present or the data is invalid, the value is not changed when the limit line is loaded. Ordering of the fields is unimportant.

Limit Line Name="FCC Part 15;Class B Radiated"

Type =Upper	Upper Lower
Frequency Unit =MHz	For time domain limits, this should say "Time Unit"
Amplitude Unit=dBm	
Frequency Interpolation=Lin	Log Lin; on input we consider only the first three characters
Amplitude Interpolation=Log	Log Lin; on input we consider only the first three characters
Mode=Fixed	Fixed Relative
Margin=0	Always in dB. A 0 margin is equivalent to margin off
Domain=Frequency	Frequency Time
Delimiter=TAB	

The data block begins with the line **[DATA]**, and consists of any number of segments.

The Data lines represent segments – X1, Y1, X2, Y2. If the list of segments includes a gap in the middle on input, the space inside the gap will be set to ensure the limit does not fail: for upper limits maxtracevalue, for lower limits mintracevalue. If two segments overlap on input, the stricter of the two segments is used – for upper limits the lower segment, for lower limits the upper segment.

Thus, the following segments indicate into a –5 dB limit from 10 MHz to 20 MHz and 30 MHz to 40MHz:

10	-5	20	-5
30	-5	40	-5

If this was an upper limit, this would be translated into the following set of limit points:

10				-5	
20				-5	
20				maxtracevalue	
30				maxtracevalue	
30				-5	
40				-5	
	30	-29.5	88	-29.5	
	88	-33	216	-33	note that we are stair-stepping the line
	230	-35.6	960	-35.6	The gap between 216 MHz and 230 MHz will never fail
	960	-43.5	5000	-43.5	

7.3.49 Select Limit

Selects the specific Limit to be saved, for example, Limit 1.

Preset	Not part of Preset , but reset to LLINE1 by Restore Mode Defaults Survives shutdown
--------	---

7.3.50 Correction

Exports Amplitude Corrections files in the PC-readable **.csv** format.

Amplitude Correction files contain the correction data in a form that can be imported into Excel or similar spreadsheets, as well as header data that gives information on the correction.

The default filename is **Ampcor_0000.csv**, where the 4-digit number is the lowest number that does not conflict with any filename in the current directory.

The default path for Corrections files is:

My Documents\amplitudeCorrections

For backwards compatibility, older limit files with the extensions **.amp**, **.cbl**, **.ant** and **.oth** can be read into the instrument, but you can only save corrections as **.csv** files.

See "[Correction Data File](#)" on page 2404

Remote Command	:MEMory:STORe:CORRection 1 ... 8, <filename>
Example	Save Correction 2 to the file myAmpcor.csv on the current path: :MEM:STOR:CORR 2 "myAmpcor.csv"

7 Save/Recall/Print
7.3 Save

Notes	<p>If the save is initiated via SCPI, and the file already exists, the file will be overwritten</p> <p>Using the C: drive is strongly discouraged, since it runs the risk of being overwritten during an instrument software upgrade</p> <p>Both single and double quotes are supported for any filename parameter over SCPI</p>
Dependencies	<p>Corrections are not supported by all measurements. If in a Mode in which some measurements support it, this key is grayed-out in measurements that do not. Does not appear at all if no measurements in the Mode support it</p> <p>Does not appear unless you have the proper option installed in your instrument</p>
Annotation	After save is complete, an advisory is displayed in the message bar confirming which file was saved
Backwards Compatibility SCPI	<p>:MMEMory:STORE:CORRection ANTenna CABLe OTHeR USER, <filename></p> <p>For backwards compatibility, ANTenna maps to 1, CABLe maps to 2, OTHeR maps to 3 and USER maps to 4</p>

Correction Data File

A Correction Data File contains a copy of one of the instrument correction tables. Corrections provide a way to adjust the trace display for predetermined gain curves (such as for cable loss).

Corrections files are text files in **.csv** (Comma-Separated Values) form, to make them importable into Excel or other spreadsheet programs. The format for Corrections files is as follows:

Line #	Type of field	Example	Notes
1	File type, must be "Amplitude Correction"	Amplitude Correction	May not be omitted
2	File Description (in quotes)	"Correction Factors for 11966E"	60 characters max; may be empty but may not be omitted. If exceeds 60 characters, error -233 Too much data reported
3	Comment (in quotes)	"Class B Radiated"	60 characters max; may be empty but may not be omitted. . If exceeds 60 characters, error -233 Too much data reported
4	Instrument Version, Model #	A.02.06,N9020A	May be empty but may not be omitted
5	Option List, File Format Version	K03 LFE EXM ,01	May be empty but may not be omitted
6	Freq Unit to be used for all frequency values in the file	Frequency Unit, MHz	assumed to be Hz if omitted
7	Transducer Unit	Antenna Unit, None	If omitted leaves the Transducer unit

Line #	Type of field	Example	Notes
			unchanged. The amplitude unit in the Transducer Unit field is a conversion factor that is used to adjust the Y Axis Units of the current mode, if the mode supports Transducer Units. For more details on transducer correction data, refer to the Input/Output, Corrections key description. Allowable values: dBuV/m, dBuA/m, dBG, dBpT, None
8	Freq Interpolation	Frequency Interpolation, Linear	if omitted leaves the Freq Interpolation unchanged. Allowable values: Linear, Logarithmic
9	Bias value in mA	Bias,0.00	If omitted leaves the Bias value unchanged (added as of A.08.50)
10	Bias State	Bias State,On	If omitted leaves the Bias State unchanged. Allowable values: On, Off (added as of A.08.50)
11	Overlap, two values, Freq1 and Freq2, separated by commas	Overlap,33500,40000	Uses Freq Unit from line 6. Thus, in this example Freq1=33.5 GHz, Freq2= 40.0 GHz (see note below). If omitted leaves the overlap unchanged (added as of A.08.50)
12	DATA marker	DATA	Corrections data begins in the next line

Lines 2 through 5 can be empty but must appear in the file. Lines 6 through 11 are optional, the lines can be left out of the file altogether.

The Overlap row and the two Bias rows apply only to external mixing. Both are read-only, they are never written by the instrument. The only way to insert or modify these rows is to edit the file with a text editor or a spreadsheet editor. These rows are intended for use by mixer manufacturers, as they allow the manufacturer to insert data about how the mixer corrections were generated and how they should be applied. The Bias rows allow you to specify whether to turn Bias on or off when the Correction is turned on and to specify a Bias value (turning off the Correction does not change the Bias, but turning it back on again sets it to the value specified in the file). The Overlap row allows you to specify an overlap region in which two different corrections may be applied. It is expected that in the corrections data itself, there will be TWO corrections values exactly at Max Freq, otherwise Overlap is ignored. The way the overlap is processed is as follows: if at any given time the current instrument Start Freq is greater than Freq 1 and lower than Freq 2, and the current Stop Freq is greater than Freq 2, extend the first correction point at or above Freq 2 down to Freq 1, rather than using the correction data between Freq1 and Freq2.

7 Save/Recall/Print

7.3 Save

Only one Transducer units can be on at any given time. Note that this means that if a correction file with a Transducer Unit is loaded into a particular Correction, all other Corrections are set to that same Transducer unit. Note that the legacy term "Antenna Unit" is still used in the correction file, even though the more modern term "Transducer Unit" is used in the user interface.

Similarly, the Bias rows can only be used in Correction register 1, because there can only be one setting for Bias at any given time. If a Correction file with a Bias or Bias State row is loaded into any Correction register but 1, an error is generated: Mass storage error; Can only load Bias Settings into Correction 1

The data follows the DATA row, as comma separated X, Y pairs; one pair per line.

For example, suppose you have an Antenna to correct for on an N9020A version A.02.06 and the correction data is:

- 0 dB at 200 MHz
- 17 dB at 210 MHz
- 14.8 dB at 225 MHz

Then the file will look like:

- Amplitude Correction
- "Correction Factors for 11966E"
- "Class B Radiated"
- A.02.06,N9020A
- P13 EA3 UK6,01
- Frequency Unit, MHz
- Antenna Unit, dBuV/m
- Frequency Interpolation, Linear
- DATA
- 200.000000,0.00
- 210.000000,17.00
- 225.000000,14.80

The choices for the 1 of N fields in the metadata are as follows:

- Frequency Unit: Hz, kHz, MHz, GHz
- Antenna Unit: dBuV/m, dBuA/m, dBG, dBpT, None
- Frequency Interpolation: Logarithmic, Linear

7.3.51 Select Correction

Selects the specific Correction to be saved, for example, Correction 1.

Preset	Not part of a Preset , but reset to Correction 1 by Restore Input/Output Defaults Survives a shutdown
--------	---

7.3.52 Saving a SCPI Recording as a Python Script

To execute the generated Python script:

- Install the Python version required by PyVisa
- Download the PyVisa library from: <https://pypi.org/project/PyVISA/>
- Modify the connection string, to specify *your* instrument's connection string

Example Script

An example of the generated script is shown below.

```
#_install location: https://pypi.org/project/PyVISA/
import pyvisa
import re
# connected instrument
_inst = ""
# SCPI Recording commands and queries
# Add/Modify the instrument address to execute the script
_connectionString = 'your instrument connection string here'
#Example SCPI Recording Entries
_recordingEntries = ['Active Mode & Measurement|':INST:CONF:SA:SANalyzer',
'Query Operation Complete|'*OPC?',
'Active Mode & Measurement|':INST:CONF:SA:SANalyzer',
'Query Operation Complete|'*OPC?']
```

7 Save/Recall/Print
7.3 Save

```
'Center Frequency'|:SENSe:FREQuency:CENTer 12000000000',  
'Freq Offset'|:SENSe:FREQuency:OFFSet 10',  
'Ref Level'|:DISPlay:WINDow:TRACe:Y:SCALe:RLEVel 5']  
def ConnectToInstrument():  
    rm = pyvisa.ResourceManager()  
    _inst = rm.open_resource(_connectionString)  
    _inst.read_termination = '\n'  
    _inst.write_termination = '\n'  
    idn = _inst.query('IDN?')  
    print("Sending Recording Entries to: " + idn)  
def CheckError()  
    err = _inst.query('SYST:ERR?')  
    return err.lower.find("no error")  
def SendCommand(recordingEntry):  
    # split the recording entry into label and mnemonic  
    labelAndMnemonic = recordingEntry.split('|')  
    label = labelAndMnemonic[0]  
    mnemonic = labelAndMnemonic[1]  
    # check and see if this is OPC query  
    opcIndex = mnemonic.find('OPC?')  
    #if OPC query send the query and get OPC query value  
    if opcIndex >= 0:  
        opcQueryValue = _inst.query(mnemonic)  
        print(opcQueryValue)  
    else:  
        print(mnemonic)  
        _inst.write(mnemonic)  
    err = CheckError()  
    # publish any errors from the previous command  
    if err:
```

```

        print('Error for command ' + label + ': ' + err)
for entry in _recordingEntries
    SendCommand(entry)

```

7.3.53 Mask

The **Mask** data type is used to import and export Mask files for measurements that use masks, such as cellular comms and real-time measurements.

7.3.54 Waveform Sequence

Saves waveform sequences from the ARB memory of an Internal Source. When you open the Save **Waveform Sequence** dialog and press **Save**, the current waveform sequence is saved to the selected directory.

Notes	No remote command, front panel only
Dependencies	Only appears if your hardware includes an Internal Source, such as in VXT

7.3.55 Demod Info

Lets you save various Demod Info data types for later recall.

7.3.56 Data Type (Digital Demod Measurement)

There are several Demod Info Data Types available. You can specify which segment you want to save the **Demod Info** and also choose which data type you want to save.

7.3.57 Select Segment

Selects a segment for Demod Info recall.

Preset	Segment1
--------	----------

7.3.58 Constellation States

Selects a file to which to export the constellation state information.

Constellation State files have the extension **.csd** or **.txt**:

7 Save/Recall/Print
7.3 Save

- **.csd** files contains the constellation state of all modulation formats
- **.txt** files only contains the constellation state of Custom IQ modulation format, this file format is same as Signal Studio N7608C Custom IQ constellation file

The default path for **Constellation State** files is:

`My Documents\VMA\DDEMOD\ConstInState`

See "[.csv file format](#)" on page 2400

Remote Command	<code>:MMEemory:STORE:DDEMod:SEGMENT1 ... 6:CONStIn:STATe <filename></code>
Example	Save the constellation state data to the file <code>myConstInState2.csd</code> in the current path: <code>:MMEem:STOR:DDEM:SEGM1:CONS:STAT "myConstInState2.csd"</code>
Notes	If the save is initiated via SCPI, and the file already exists, the file will be overwritten Using the C: drive is strongly discouraged, since it runs the risk of being overwritten during an instrument software upgrade Both single and double quotes are supported for any filename parameter over SCPI
Status Bits/OPC dependencies	Sequential - waits for previous measurement to complete
Backwards Compatibility SCPI	<code>:MMEemory:STORE:CONStIn:STATe <filename></code>

.csd constellation state file format

```
!#
!# State definitions for 16 QAM
!#
!"S_16QAM_1","0011","0010","0001","0000"
!"S_16QAM_2","0111","0110","0101","0100"
!"S_16QAM_3","1011","1010","1001","1000"
!"S_16QAM_4","1111","1110","1101","1100"
```

.txt constellation state file format

This is the same as the N7608C Constellation Setting file format

```
0, -0.94868, 0.94868, 0
1, -0.31623, 0.94868, 1
2, 0.31623, 0.94868, 2
3, 0.94868, 0.94868, 3
4, -0.94868, 0.31623, 4
5, -0.31623, 0.31623, 5
6, 0.31623, 0.31623, 6
```

```
7,0.94868,0.31623,7
8,-0.94868,-0.31623,8
9,-0.31623,-0.31623,9
10,0.31623,-0.31623,A
11,0.94868,-0.31623,B
12,-0.94868,-0.94868,C
13,-0.31623,-0.94868,D
14,0.31623,-0.94868,E
15,0.94868,-0.94868,F
```

7.3.59 Sync Pattern

Selects a file to which to export the sync pattern string.

Sync Pattern files are CSV files, and contain the sync pattern string in a form that can be imported into Excel or similar spreadsheets, as well as header data that gives information on the sync pattern data.

The default path for **Sync Pattern** files is:

`My Documents\VMA\DDEMOD\SyncPattern`

Sync Pattern files have the extension `.csv`. The default filename is `SyncPattern_0000.csv`, where the 4-digit number is the lowest number that does not conflict with any filename in the current directory.

See [.csv sync pattern file format](#)

Remote Command	<code>:MMEMory:STORe:DDEMod:SYNC:PATTern <filename></code>
Example	Save the sync pattern data to the file <code>mySyncPattern2.csv</code> in the current path: <code>:MMEM:STOR:DDEM:SYNC:PATT "mySyncPattern2.csv"</code>
Notes	If the save is initiated via SCPI, and the file already exists, the file will be overwritten Using the C: drive is strongly discouraged, since it runs the risk of being overwritten during an instrument software upgrade Both single and double quotes are supported for any filename parameter over SCPI
Dependencies	Only appears in VMA Mode, in the Digital Demod measurement
Status Bits/OPC dependencies	Sequential - waits for previous measurement to complete
Backwards Compatibility SCPI	<code>:MMEMory:STORe:SYNC:PATTern <filename></code>

[.csv sync pattern file format](#)

Except for information in quotes, sync pattern files are not case sensitive. Information in bold is required verbatim; other text is example text, and italic text is commentary which should not be present in the file.

7 Save/Recall/Print
7.3 Save

The first five lines are system-required header lines, and must be in the correct order.

```
Sync Pattern                                Data file type name
"APCO-25 Phase 2"                          File Description
"It's for HPCM format"                     Comment
A.19.00.R0001, N9040B                      Instrument Version, Model Number
P13 EA3 UK6, 01                            Option List, File Format Version
```

The next line describes how many bits of each symbol contains.

```
BitsPerSymbol, 4                            0<integer<13
```

The data region begins with the keyword DATA. Each data line must be a string of 1s and 0s only.

```
DATA
"10101011101011001101"
```

7.3.60 Filter Coefficients

Selects a file to which to export the meas/ref filters' coefficients.

Filter Coefficients files are in CSV format and contain the filter coefficients data in a form that can be imported into Excel or similar spreadsheets, as well as header data that gives information on the filter's coefficients.

For Digital Demod, you can specify whether you want to save the Meas Filter or Reference Filter coefficients by using the radio button that appears when **Filter Coefficients** is selected in the **Save** menu:

Filter Coefficients files have the extension **.csv**. The default filename is **FilterCoef_0000.csv**, where the 4-digit number is the lowest number that does not conflict with any filename in the current directory.

For the Digital Demod measurement, the default path is:

```
My Documents\VMA\data\DDEMOD\FilterCoef
```

See [.csv filter coefficient file format](#)

Remote Command	<code>:MMEMory:STORe:DDEMod:SEGment1 ... 6:FILTer:COEFficient MEAS REF, <filename></code>
Example	Save the meas filter's coefficient data for Digital Demod to the file <code>myFilterCoef2.csv</code> in the current path: <code>:MMEM:STOR:DDEM:SEGM1:FILT:COEF MEAS, "myFilterCoef2.csv"</code>
Notes	If the save is initiated via SCPI, and the file already exists, the file will be overwritten Using the C: drive is strongly discouraged, since data may be overwritten during an instrument

	software upgrade
	Both single and double quotes are supported for any filename parameter over SCPI
Status Bits/OPC dependencies	Sequential - waits for previous measurement to complete
Backwards Compatibility SCPI	:MMEMory:STORe:FILTer:COEFFicient MEAS REF, <filename>

.csv filter coefficient file format

Except for information in quotes, filter coefficient files are not case sensitive. Information in bold is required verbatim; other text is example text, and italic text is commentary which should not be present in the file.

The first five lines are system-required header lines, and must be in the correct order:

Filter Coefficient	Data file type name
"APCO-25 Phase 2"	File Description
"It's for HPCM format"	Comment
A.19.00.R0001, N9040B	Instrument Version, Model Number
P13 EA3 UK6, 01	Option List, File Format Version

The next line describes the filter type that the coefficient data will be used for: Meas Filter or Ref Filter:

Type, MEAS	MEAS REF
-------------------	----------

The data region begins with the keyword **DATA**:

```
DATA
1.63559657308505e-20F
4.22313498473350e-06F
8.09719221631553e-06F
1.10388866034601e-05F
1.25623532739879e-05F
```

7.3.61 Equalizer Coefficients

Selects a file to which to export the equalizer's coefficients.

Equalizer Coefficients files are CSV files, and contain the coefficients data in a form that can be imported into Excel or similar spreadsheets, as well as header data that gives information on the equalizer's coefficients.

The default path for **Equalizer Coefficients** files is:

My Documents\VMA\DDEMOD\EqCoef

Equalizer Coefficients files have extension **.csv**. The default filename is **EqualizerCoef_0000.csv**, where the 4-digit number is the lowest number that does not conflict with any filename in the current directory.

See "[.csv equalizer coefficient file format](#)" on page 2414

Remote Command	:MMEMemory:STORE:DDEMod:SEGment1 ... 6:EQAlizer:COEFFicient <filename>
Example	Save the equalizer's coefficient data of segment1 to the file myEqualizerCoef2.csv in the current path: :MME:STOR:DDEM:SEGM1:EQU:COEF "myEqualizerCoef2.csv"
Notes	If the save is initiated via SCPI, and the file already exists, the file will be overwritten Using the C: drive is strongly discouraged, since it runs the risk of being overwritten during an instrument software upgrade Both single and double quotes are supported for any filename parameter over SCPI
Dependencies	Only appears in VMA Mode, in the Digital Demod measurement
Status Bits/OPC dependencies	Sequential - waits for previous measurement to complete

.csv equalizer coefficient file format

Except for information in quotes, equalizer coefficient files are not case sensitive. Information in bold is required verbatim; other text is example text, and italic text is commentary which should not be present in the file.

The first five lines are system-required header lines, and must be in the correct order:

Equalizer Coefficient	Data file type name
"add description here"	File Description
"add comments here"	Comment
A22.00.R0001, N9040B	Instrument Version, Model Number
P13 EA3 UK6, 01	Option List, File Format Version

The 5th and 6th lines describes how many points are displayed per symbol. The keyword is **PointsPerSymbol**:

PointsPerSymbol	
10	Points per symbol

The 7th and 8th lines describes how many symbols the equalizer length is. The keyword is **EQLengthInSymbol**:

EQLengthInSymbol	
21	Equalizer Length in symbol

The data region begins with the keyword **DATA**:

```
DATA
1.63559657308505e-20F
4.22313498473350e-06F
8.09719221631553e-06F
1.10388866034601e-05F
1.25623532739879e-05F
```

7.3.62 Tx Pattern

Selects a file to which to export the Tx pattern string.

Tx Pattern files are CSV files, which contain the Tx pattern string in a form that can be imported into Excel or similar spreadsheets, as well as header data that gives information on the Tx pattern data.

The default path for **Tx Pattern** files is:

`My Documents\VMA\DDEMOD\TxPattern`

Tx Pattern files have the extension `.csv`. The default filename is `TxPattern_0000.csv`, where the 4-digit number is the lowest number that does not conflict with any filename in the current directory.

See [CSV Tx pattern file format](#)

Remote Command	<code>:MMEMory:STORe:DDEMod:SEGment1 ... 6:TXBit:PATtern <filename></code>
Example	Save the Tx Pattern data to the file <code>myTxPattern2.csv</code> in the current path: <code>:MMEM:STOR:DDEM:SEGM1:TXB:PATT "myTxPattern2.csv"</code>
Notes	If the save is initiated via SCPI, and the file already exists, the file will be overwritten Using the C: drive is strongly discouraged, since data may be overwritten during an instrument software upgrade Both single and double quotes are supported for any filename parameter over SCPI
Dependencies	Only appears in VMA Mode, in the Digital Demod measurement
Status Bits/OPC dependencies	Sequential - waits for previous measurement to complete

CSV Tx pattern file format

Except for information in quotes, Tx pattern files are not case sensitive.

The first five lines are system-required header lines, and must be in the correct order.

<code>Tx Pattern</code>	Data file type name
<code>"APCO-25 Phase 2"</code>	File Description
<code>"It's for HPCM format"</code>	Comment

7 Save/Recall/Print
7.3 Save

A.25.00, N9040B

Instrument Version, Model Number

P13 EA3 UK6, 01

Option List, File Format Version

The data region begins with the keyword **DATA**. Each data line must be a 1 or 0 only.

DATA

1

0

7.3.63 Data Type (Custom OFDM Measurement)

There are several Demod Info Data Types available. You can specify which component carrier you want to save the **Demod Info** and also choose which data type you want to save.

7.3.64 Filter Coefficients

Selects a file to which to export the Arbitrary filters' coefficients.

Filter Coefficients files are in CSV format and contain the filter coefficients data in a form that can be imported into Excel or similar spreadsheets, as well as header data that gives information on the filter's coefficients.

Filter Coefficients files have the extension **.csv**. The default filename is **FilterCoef_0000.csv**, where the 4-digit number is the lowest number that does not conflict with any filename in the current directory.

For the Custom OFDM measurement, the default path is:

`My Documents\VMA\data\CustomOFDM\FilterCoef`

See [.csv filter coefficient file format](#)

Remote Command	<code>:MMEMory:STORe:OFDM:FILTer:COEFFicient CC0 ... CC7,<filename></code>
Example	Save the meas filter's coefficient data for Custom OFDM to the file <code>myFilterCoef2.csv</code> in the current path: <code>:MMEM:STOR:OFDM:FILT:COEF CC0,"filterCoff.csv"</code>
Notes	If the save is initiated via SCPI, and the file already exists, the file will be overwritten Using the C: drive is strongly discouraged, since it runs the risk of being overwritten during an instrument software upgrade Both single and double quotes are supported for any filename parameter over SCPI
Status Bits/OPC dependencies	Sequential - waits for previous measurement to complete
Backwards	<code>:MMEMory:STORe:FILTer:COEFFicient MEAS REF, <filename></code>

Compatibility SCPI	For Digital Demod only
-----------------------	------------------------

7.3.65 Pilot IQ Values

Selects a CSV file to export the pilot IQ values. Note the CSV file for MIMO contains IQ data for multiple layers so the format is different than SISO.

Remote Command	<code>:MMEMory:STORe:OFDM:IQPilot CC0 ... CC7,<filename></code>
Example	<code>:MMEM:STOR:OFDM:IQP CC0,"pilotIQ.csv"</code>
Notes	<p>If the save is initiated via SCPI, and the file already exists, the file will be overwritten</p> <p>Using the C: drive is strongly discouraged, since it runs the risk of being overwritten during an instrument software upgrade</p> <p>Both single and double quotes are supported for any filename parameter over SCPI</p>
Status Bits/OPC dependencies	Sequential - waits for previous measurement to complete

7.3.66 Preamble IQ Values

Selects a CSV file to export the preamble IQ values. Note the CSV file for MIMO contains IQ data for multiple layers so the format is different than SISO.

Remote Command	<code>:MMEMory:STORe:OFDM:IQPreable CC0 ... CC7,<filename></code>
Example	<code>:MMEM:STOR:OFDM:IQPR CC0,"pmbIq.csv"</code>
Notes	<p>If the save is initiated via SCPI, and the file already exists, the file will be overwritten</p> <p>Using the C: drive is strongly discouraged, since it runs the risk of being overwritten during an instrument software upgrade</p> <p>Both single and double quotes are supported for any filename parameter over SCPI</p>
Status Bits/OPC dependencies	Sequential - waits for previous measurement to complete

7.3.67 Screen Image

Selects a file for saving the contents of the display.

Screen Image files are PNG (Portable Network Graphics) files with the same resolution as the data display. They contain the image that was on the screen before you opened the **Save** dialog. When the **Screen Image** key is pressed, a "thumbnail"

of the captured image is displayed, with the note “This is the image that will be saved” below it.

After you have completed the save, a message “File image.png saved” (assuming `image.png` was the filename you used).

NOTE

As of firmware release A.17.50, sending `*CLS` (Clear Status) removes any message displayed on the screen. If you do not want to see the “File saved” message after sending `:MMEM:STOR:SCR` (described below), send the following sequence (substituting your file name for `filename.png`): `:MMEM:STOR:SCR “filename.png”;*CLS`

NOTE

As of firmware release A.19.50, saving a screen image removes any informational message displayed on the screen before it captures the screen. This is useful if you are sending “save image” commands in rapid sequence, as it keeps the “File saved” message from one screen capture from appearing in the next screen capture. Error messages are still captured.

If you send a succession of screen image commands *too* rapidly, the system may not have time to remove the previous message before the next screen capture. Sending screen image commands more rapidly than twice per second is not advised.

The default path for State Files is:

`My Documents\<mode name>\screen`

where `<mode name>` is the parameter used to select the mode with `:INST:SEL`, for example, `SA` for Spectrum Analyzer Mode.

Screen Image files have extension `.png`. The default filename is `Screen_0000.png`, where the 4-digit number is the lowest number that does not conflict with any filename in the current directory.

After you have completed the save, the **Quick Save** front-panel key lets you quickly repeat the last save performed, using an auto-named file, with new current screen data.

Remote Command	<code>:MMEMory:STORe:SCReen <filename></code>
----------------	---

Example	Store the current screen image in the file <code>MyScreenFile.png</code> in the default directory: <code>:MMEM:STOR:SCR "myScreen.png"</code>
---------	--

Backwards Compatibility SCPI	<code>:HCOpy:SDUMp:DATA?</code> returns the screen image in a <code><DEFINITE LENGTH ARBITRARY RESPONSE DATA></code> element. The response data is IEEE Block format; the controlling computer can strip the header and store the result as a <code>.png</code> file
------------------------------	---

Blocking Screen Capture (Remote Command Only)

This command works *only* when the measurement is in **Single** mode (see "[Sweep/Measure](#)" on page 1830). When the command is sent, it blocks the SCPI client, waits for the current refresh to complete, then captures the screen shot and saves it. In some instances, a single measurement is taken, and a screen shot of that measurement is captured.

This command ensures that the last-measured data is refreshed on the screen before it is captured, by blocking the command and waiting for refresh to complete. The command may time out, in which case it must be re-sent.

If timeout occurs, or if the active measurement is in **Continuous** mode, an error is returned.

Remote Command	<code>:MMEMory:STORe:SCReem:BLORked <filename></code>
Example	Wait for the current screen refresh to complete before capturing the screen shot, then store the current screen image in the file <code>MyScreenFile.png</code> in the default directory: <code>:MMEM:STOR:SCR:BLOR "myScreen.png"</code>

7.3.68 Theme

Accesses a menu of functions that enable you to choose the theme to be used when saving the screen image. You can choose between themes to be used when saving the screen image.

See "[More Information](#)" on page 2419 for examples of the themes.

Remote Command	<code>:MMEMory:STORe:SCReem:THEMe FILLed OUTLine</code> <code>:MMEMory:STORe:SCReem:THEMe?</code>
Example	<code>:MMEM:STOR:SCR:THEM OUTL</code>
Preset	FILLed ; not part of Preset , but reset by Restore Misc Defaults or Restore System Defaults All
Backwards Compatibility SCPI	<code>:MMEMory:STORe:SCReem:THEMe TDCOLOR TDMONochrome FCOLOR FMONochrome</code>
Backwards Compatibility Notes	To permit code compatibility with A-model X-Series Signal Analyzer instruments, the command parameters from the A-models are mapped as follows: TDCOLOR and TDMONochrome are both mapped to FILLed (exact full color representation of what is on the screen) FCOLOR and FMONochrome are both mapped to OUTLine (uses color for traces and other items, but most filled areas are white) There is no Monochrome theme in B-models, so the A-models monochrome commands yield color <code>:MMEM:STOR:SCR:THEM?</code> always returns FILLed or OUTLine , never FCOLOR , FMONochrome , TDCOLOR , or TDMONochrome There is no monochrome theme in the X-Series Touch UI More Information

- The **FILLed** theme is an exact representation of the information on the display
- The **OUTLine** theme eliminates most of the filled areas, in order to save ink when the image is printed. In addition, the yellow trace color is changed to be more orange, to improve visibility against a white background. Note that some objects remain filled. In particular, the selected marker remains filled with the green marker color, in order to distinguish it from the other markers. This is important, as it is the selected marker whose readout appears in the upper right corner of the display

7.3.69 Power Sensor Cal Factor

Selects a file to which to export the Power Sensor Cal factor data.

Cal Factor files are XML files, and contain the cal factor data and header data that gives information on the power sensor.

The default path for **Cal Factor** Files is:

`My Documents\<<mode name>\data\PSCF`

where `<mode name>` is the parameter used to select the mode with `:INST:SEL` (for example, `MRECEIVE` for Measuring Receiver Mode). Hence, a **Cal Factor** file from any measurement in the Measuring Receiver mode would be stored in:

`My Documents\MRECEIVE\data\PSCF`

Cal Factor files have the extension `.xml`. The default filename is `<Sensor Model>_<Sensor Serial Number>_0000.xml`, where the 4-digit number is the lowest number that does not conflict with any filename in the current directory. If the sensor model or serial number is blank, the default filename is `PSCF_0000.xml`.

Remote Command	<code>:MMEMory:STORE:PSCFactor <file_name></code>
Example	<code>:MMEM:STOR:PSCF "myPSCF.xml"</code>
Notes	If the save is initiated via SCPI, and the file already exists, the file will be overwritten Using the C: drive is strongly discouraged, since it runs the risk of being overwritten during an instrument software upgrade Both single and double quotes are supported for any filename parameter over SCPI
Dependencies	Only appears if you have the proper option installed in your instrument

7.3.70 Recording

Lets you save to a file data being acquired by the measurement, so that it can later be recalled and played back as though it were coming from the input.

You may specify a data type (for example, I/Q data) and choose a file to which to save the data.

The recording and playback of signal data files is a multi-step process that involves controls in several menus.

The menus that are involved in Record/Playback are:

- **Save, Recording** (this menu)
- **Recall, "Recording" on page 2345** (under the **Recall** hardkey or the **Recall** icon in the **File** panel)
- **Sweep, Recording** tab
- **Sweep, Playback** tab
- **Input/Output, "Data Source" on page 2195** tab

NOTE

A complete tutorial for the Record/Playback functionality, including how to load and save Recording files, can be found under the **Data Source** tab in **Input/Output**.

Dependencies	<p>Only available in the following Modes and measurements:</p> <ul style="list-style-type: none"> - VMA (Digital Demod and Custom OFDM) - 5G NR (Modulation Analysis) - LTE (Modulation Analysis) - WLAN (Modulation Analysis, MIMO Modulation Analysis, Spectral Flatness) - Analog Demod - Bluetooth (Transmit Analysis) - IoT & SRComms (LoRa CSS Demod)
--------------	--

7.3.71 Data Type

Lets you save IQ data from the measurement using a specified file type (**CSV**, **SDF**, **TXT**, **BIN**, **BINX**, **BINF**, **ORB**).

CSV	Comma-Separated Values. Excel compatible format. Plain text roughly three times the size of BINF
TXT	Text format. Plain text roughly three times the size of BINF
SDF	Format developed for Keysight 89600 VSA Software. Note that due to differences in the internal file structure, SDF files saved by X-Series are not guaranteed to work perfectly with 89600
BIN	Interleaved 16-bit Q15 signed IQ file, in Big Endian format. Q15 is a DSP format in which

7 Save/Recall/Print
7.3 Save

the most significant bit is the sign bit, followed by 15 bits of fraction. The Q15 number has a decimal range between -32768 and -32767. The data is scaled to fit within this decimal range

BIN files do not include sampling rate information inside the file, there will be associated txt file including sampling rate and scaling information

BINX Interleaved 16-bit Q15 signed IQ file, in Little Endian format. The data is scaled to fit within the decimal range

BINX files do not include sampling rate information inside the file, there will be associated txt file including sampling rate and scaling information

BINF 32-bit IEEE 754 floating-point number in Little Endian format. The data is raw IQ data

BINF files do not include sampling rate information inside the file, there will be associated txt file including sampling rate information

ORB Format developed for Keysight ORAN Studio. This format is only supported by 5G NR, LTEAFDD and LTEATDD Modulation Analysis measurements, LTEAFDD and LTEATDD CEVM measurements

Example `:MMEM:STOR:RECORDING "C:\TEMP\MyIQData.csv"`

7.3.72 Channel

Select data channels to save. This is only supported by 5G NR Mode's EVM, VMA Digital Demod, VMA Custom OFDM measurements, and by WLAN Mode's MIMO EVM measurement.

The `<meas>` param in the command must be replaced with the node of the active measurement:

Parameter	Mode	Measurement
EVM	5G NR	EVM
EVMM	WLAN	MIMO EVM
DDEM	VMA	Digital Demod
OFDM	VMA	Custom OFDM

Remote Command `:MMEMory:STOR: <meas>:RECORDING:CHANnel ALL | CH1 | CH2 | CH3 | CH4 | CH5 | CH6 | CH7 | CH8`
`:MMEMory:STOR: <meas>:RECORDING:CHANnel?`

Example `:MMEM:STOR:EVM:REC:CHAN CH1`
`:MMEM:STOR:EVM:REC:CHAN?`

Preset `ALL`

State Saved `No`

Range `ALL | CH1 | CH2 | CH3 | CH4 | CH5 | CH6 | CH7 | CH8`

7.3.73 Recording + State

You can save State and IQ recording into a snapshot file (*.rssf).

Remote Command	:MMEMory:STORe:RSTate <filename>
Example	:MMEM:STOR:RST "snapshot1.rssf"
Status Bits/OPC dependencies	Sequential - aborts the current measurement

7.3.74 Remote Only Commands

The following commands execute file system operations such as move, copy, and transfer data from a file.

7.3.75 Mass Storage Catalog (Remote Command Only)

Remote Command	:MMEMory:CATalog? [<directory_name>] The string <directory_name> must be a valid logical path. If no string then it uses the current directory
Example	:MMEM:CAT? "C:\"
Notes	Queries disk usage information (drive capacity, free space available) and obtains a list of files and directories in a specified directory in the following format: <numeric_value>,<numeric_value>,\{<file_entry>\} It returns two numeric parameters and as many strings as there are files and directories The first parameter indicates the total amount of storage currently used in bytes The second parameter indicates the total amount of storage available, also in bytes. <file_entry> is a string. Each <file_entry> indicates the name, type, and size of one file in the directory list: <file_name>,<file_type>,<file_size> As the Windows file system has an extension that indicates file type, <file_type> is always empty. <file_size> provides the size of the file in bytes. For directories, <file_entry> is surrounded by square brackets and both <file_type> and <file_size> are empty

7.3.76 Mass Storage Change Directory (Remote Command Only)

Remote Command	:MMEMory:CDIRectory [<directory_name>] <directory_name> must be a valid logical path :MMEMory:CDIRectory?
----------------	---

Example	<code>:MMEM:CDIR "C:\Program Files"</code>
Notes	<p>Changes the current directory for a mass memory file system. The <code><directory_name></code> parameter is a string. If no parameter is specified, the directory is set to the <code>*RST</code> value</p> <p>At <code>*RST</code>, this value is set to the default user data storage area, that is defined as <code>System.Environment.SpecialFolder.Personal</code></p> <p>Query returns full path of the current directory as a quoted string</p>

7.3.77 Mass Storage Copy (Remote Command Only)

Remote Command	<code>:MMEMory:COpy <string>,<string>[,<string>,<string>]</code> <code><string></code> must be a valid logical path
Example	<code>:MMEM:COpy "C:\TEMP\Screen_0000.png", "C:\\"</code>
Notes	<p>Copies an existing file to a new file or an existing directory to a new directory</p> <p>If no directory is specified, uses the current directory</p> <p>Two forms of parameters are allowed. The first form has two parameters. In this form, the first parameter specifies the source, and the second parameter specifies the destination</p> <p>The second form has four parameters. In this form, the first and third parameters specify the source. The second and fourth parameters specify the directories. The first pair of parameters specifies the source. The second pair specifies the destination. An error is generated if the source doesn't exist or the destination file already exists</p> <p>This command will generate an "access denied" error if the destination is a restricted folder (for example, <code>C:\Windows</code>) and you do not have Power User or Administrator privileges</p>

7.3.78 Mass Storage Device Copy (Remote Command Only)

Transfers data to/from a file and a peripheral device.

Remote Command	<code>:MMEMory:COpy:DEvice <source_string>,<dest_string></code> <code><source_string></code> and <code><dest_string></code> must be valid logical paths
Notes	<p>The strings must be a valid logical path or a valid device keyword. If <code>dest_string</code> is a device keyword, the data is copied from the source file to the device. If <code>source_string</code> is a device keyword, the data is copied to the source file from the device</p> <p>Valid device keywords are:</p> <p><code>SNS</code> (smart noise source)</p> <p>An error is generated if the file or device is not found</p>

7.3.79 Mass Storage Delete (Remote Command Only)

Remote	<code>:MMEMory:DElete <file_name>[,<directory_name>]</code>
--------	---

Command	<code><file_name></code> and <code><directory_name></code> must be valid logical paths
Example	<code>:MMEM:DEL "Screen_0000.png"</code>
Notes	If no directory is specified, uses the current directory Removes a file from the specified directory. <code><file_name></code> specifies the file name to be removed. This command generates an "access denied" error if the file is in a restricted folder (for example, <code>C:\Windows</code>) and you do not have Power User or Administrator privileges

7.3.80 Mass Storage Data (Remote Command Only)

Creates a file containing the specified data or queries the data from an existing file.

Remote Command	<code>:MMEMemory:DATA <file_name>, <data></code> <code><file_name></code> must be a valid logical path <code>:MMEMemory:DATA? <file_name></code>
Example	<code>:MMEM:DATA? "MyFile.txt"</code>
Notes	If no directory is specified, uses the current directory The command form <code>:MMEMemory:DATA <file_name>, <data></code> loads <code><data></code> into the file <code><file_name></code> . <code><data></code> is in 488.2 block format. <code><file_name></code> is string data The response to <code>:MMEMemory:DATA? <file_name></code> is the associated <code><data></code> in block format

7.3.81 Mass Storage Make Directory (Remote Command Only)

Remote Command	<code>:MMEMemory:MDIRectory <directory_name></code> <code><directory_name></code> must be a valid logical path
Example	<code>:MMEM:MDIR "C:\TEMP\NewDir"</code>
Notes	Creates a new directory. <code><directory_name></code> specifies the name to be created Generates an "access denied" error if the new directory would be in a restricted folder (for example, <code>C:\Windows</code>) and you do not have Power User or Administrator privileges

7.3.82 Mass Storage Move (Remote Command Only)

Remote Command	<code>:MMEMemory:MOVE <string>, <string>[, <string>, <string>]</code> <code><string></code> must be valid logical paths
Example	<code>:MMEM:MOVE "C:\TEMP\Screen_0000.png", "C:\\"</code>
Notes	Moves an existing file to a new file or an existing directory to a new directory Two forms of parameters are allowed. The first form has two parameters. In this form, the first parameter specifies the source, and the second parameter specifies the destination The second form has four parameters. In this form, the first and third parameters specify the source.

The second and fourth parameters specify the directories. The first pair of parameters specifies the source. The second pair specifies the destination. An error is generated if the source doesn't exist or the destination file already exists

This command generates an "access denied" error if the destination is a restricted folder (for example, [C:\Windows](#)) and you do not have Power User or Administrator privileges

7.3.83 Mass Storage Remove Directory (Remote Command Only)

Remote Command	<code>:MMEMory:RDIRectory <directory_name></code> <code><directory_name></code> must be a valid logical path
----------------	---

Example	<code>:MMEM:RDIR "C:\TEMP\NewDir"</code>
---------	--

Notes	Removes a directory. The <code><directory_name></code> parameter specifies the directory name to be removed. All files and directories under the specified directory will also be removed This command generates an "access denied" error if the folder is a restricted folder (for example, C:\Windows) or is in a restricted folder and you do not have Power User or Administrator privileges
-------	--

7.3.84 Mass Storage Determine Removable Media (Remote Query Only)

Used to determine whether any removable media devices are connected to the instrument. Primarily, these are USB memory devices plugged-in to the front panel or rear panel USB ports. On instruments with PC6 or PC7 CPUs, one SD card slot is available for removable media. The instrument's primary disk drive is *not* a removable media device.

Remote Command	<code>:MMEMory:RMEDia:LIST?</code>
----------------	------------------------------------

Example	<code>:MMEM:RMED:LIST?</code>
---------	-------------------------------

Notes	The return value is a string containing a list of partition identifiers, which are removable media devices. Each identifier will be separated by a comma. If no removable media is present, an empty string is returned
-------	---

Examples:

- One removable device present results in a return string of "F:"
- Two removable devices present results in a return string of "F:,G:"

No removable devices present results in a return string of ""

7.3.85 Mass Storage Determine Removable Media Label (Remote Command Only)

Used to set or query a removable media device's label.

Remote Command	:MMEMory:RMEDia:LABel <partition>,<string> :MMEMory:RMEDia:LABel? <partition>
Example	:MMEM:RMED:LAB "F:","My Device"
Notes	If the <partition> specified does not exist or is not a removable media device, the error -252, "Missing Media" is generated Setting the removable media label requires Administrative privileges. If the currently logged-in user does not have appropriate privileges, error "-221, Settings conflict; Administrator privileges required" is generated

7.3.86 Mass Storage Determine Removable Media Write-protect status (Remote Query Only)

Used to query a removable media device's write-protect status.

Remote Command	:MMEMory:RMEDia:WPRotect? <partition>
Example	:MMEM:RMED:WPR? "F:"
Notes	The return value is 1 if the device is write-protected, and 0 if the device is write-enabled If the <partition> specified does not exist or is not a removable media device the error -252, "Missing Media" is generated
Preset	The return value depends on the SD card installed

7.3.87 Mass Storage Determine Removable Media size (Remote Query Only)

Queries a removable media device's total memory size (not available memory size).

Remote Command	:MMEMory:RMEDia:SIZE? <partition>
Example	:MMEM:RMED:SIZE? "F:"
Notes	The return value is integer value in GBytes. Any device that is less than 1 GB returns 0 GB If the <partition> specified does not exist or is not a removable media device, the error -252, "Missing Media" is generated

7.3.88 :SYSTem:SET (Remote Command Only)

Obtains the state of the currently active mode in a form that can then be loaded back into the instrument quickly.

Remote Command	:SYSTem:SET <instrument state in IEEE Block> :SYSTem:SET?
----------------	--

7 Save/Recall/Print
7.3 Save

Notes

The query returns current instrument state of the active mode in IEEE Block data format. The state is in a machine-readable format only, as follows:

`<syst set preamble><state block data>`

Where:

`<syst set preamble>` is the format:

`#NMMM`

- `N` = number of digits that comprise `MMM`
- `MMM` = length in bytes of following data

`<state block data>` is machine readable state data

Example response: `#42016<state data>`

The state is recalled by sending the `:SYST:SET?` response data to the instrument. From example above: `:SYST:SET #42016<state data>`

7.4 Print

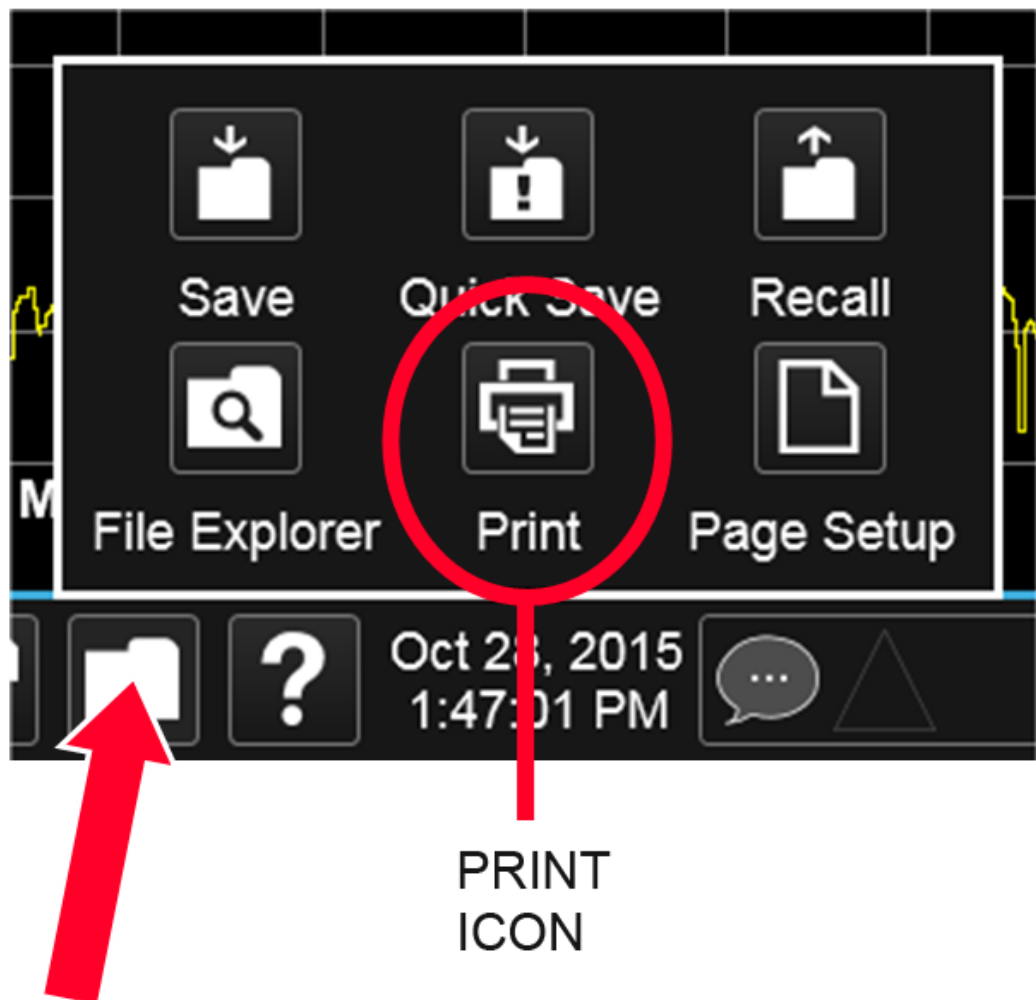

Opens a dialog for configuring printing (to the printer of your choice).

The `:HCOPY` command is equivalent to pressing the `PRINT` key.

Remote Command `:HCOPY[:IMMEDIATE]`

`:HCOPY:ABORT` can be used to abort a print that is already in progress. Sending `:HCOPY:ABORT` causes the instrument to stop sending data to the printer, although the printer may continue or even complete the print, depending on how much data was sent to the printer before you sent the `:ABORT` command.

Remote Command `:HCOPY:ABORT`

7.5 Page Setup

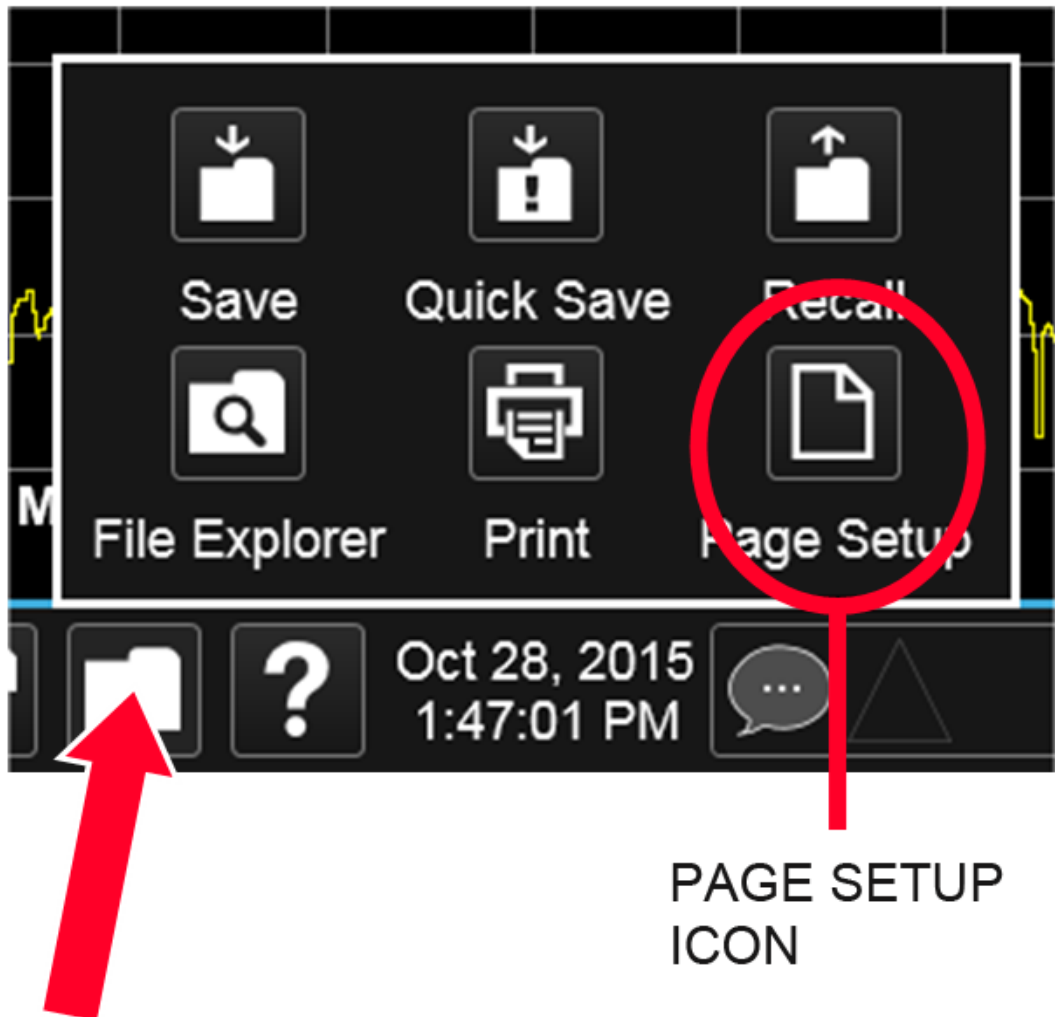

Opens a Windows Page Setup dialog that allows you to control aspects of the pages sent to the printer when the **PRINT** hardkey is pressed.

Depending on the abilities of the attached printer, paper size, paper source, page orientation and margins may all be set. There are no SCPI commands for controlling these parameters.

The dialog also has a dropdown control to let you select the Display Theme to use when printing. **Page Setup** themes are the same as those for **Screen Image** "Theme" on page 2419.

The **Theme** control has a corresponding SCPI command:

Remote Command	<code>:SYSTem:PRINt:THEMe FILLed OUTLine</code>
Command	<code>:SYSTem:PRINt:THEMe?</code>
Example	<code>:SYST:PRIN:THEM OUTL</code>
Preset	OUTL ; not part of Preset , but reset by Restore Misc Defaults or Restore System Defaults All and survives subsequent running of the modes
State Saved	No
Backwards Compatibility SCPI	<code>:SYSTem:PRINt:THEMe TDColor TDMonochrome FCOLor FMONochrome</code>
Backwards Compatibility Notes	<p>To permit code compatibility with A-model X-Series Signal Analyzer instruments, the command parameters from A-models are mapped as follows:</p> <p>TDColor and TDMonochrome are both mapped to FILLed: Exact full color representation of what is on the screen</p> <p>FCOLor and FMONochrome are both mapped to OUTLine: Uses color for traces and other items, but most filled areas are white</p> <p>There is no Monochrome theme in B-models, so the A-models' monochrome commands yield color</p> <p><code>:SYST:PRINt:THEM?</code> always returns FILLed or OUTLine; never FCOLor, FMONochrome, TDColor, or TDMonochrome</p>

8 Trigger

Controls the **Trigger** system of the instrument. In general, these are functions associated with internal triggers or trigger inputs. Trigger Output functions are configured under **Input/Output**.

Trigger functions are common across multiple Modes and Measurements, although some controls appear only in certain Modes and/or certain Measurements. Additionally, some of the tabs on the **Trigger** menu are only available in certain Modes.

Many of the Trigger functions can be set graphically using the Trigger Setting Diagram. For more information see: "[Trigger Optimization](#)" on page 2478

In general, each Measurement can have a different Trigger, and each Measurement remembers its previous-trigger setting.

8.1 Trigger

Contains controls that let you select the trigger source, and setup of each of the trigger sources. The instrument is designed to allow triggering from many sources, for example, Free Run, Video, External, RF Burst, etc.

In general, each Measurement can have a different Trigger Source, and each Measurement remembers its previous-Trigger Source.

8.1.1 Select Trig Source

Specifies the trigger source for the currently selected instrument input (RF or I/Q). If you change inputs, the new input remembers the trigger source it was last programmed to for the current measurement and uses that trigger source. When in External Mixing, the instrument uses the RF trigger source. You can directly set the trigger source for the RF Input and for the I/Q input using SCPI commands; see ["Trigger Source Presets" on page 2441](#), ["RF Trigger Source \(Remote Command Only\)" on page 2443](#), and ["I/Q Trigger Source \(Remote Command Only\)" on page 2445](#).

In general, each Measurement can have a different Trigger Source, and each Measurement remembers its previously-set Trigger Source. Not every Trigger Source is available for every Measurement, so the available choices for Select Trig Source may vary from Mode to Mode and Measurement to Measurement. The trigger sources that are available for each measurement are shown in the "List of Available Trigger sources" dropdown below.

Note that the controls available on the Trigger Tab change depending on which trigger source is selected. Tap each trigger source in the table in the "List of Available Trigger sources" dropdown to see what parameters are available for that trigger source.

Note that most measurements require the inclusion of a <measurement> parameter in the Trigger Source command. However, for the Swept SA measurement and RTSA this is not the case; for backwards compatibility, no <measurement> parameter is used when setting the Trigger Source for the Swept SA measurement or RTSA.

Waiting for Trigger

After you select a trigger source, the instrument will start its next measurement when that trigger source is satisfied. For example, if you choose External 1, the next measurement will start when the appropriate signal appears at the Trigger 1 In connector.

If the trigger source is not satisfied (for example, if no signal at the appropriate level appears at the Trigger 1 In connector), after approximately 2 seconds a popup

message will appear that says, "Waiting for trigger". The trigger annotation in the Meas Bar will also turn amber, as shown below:

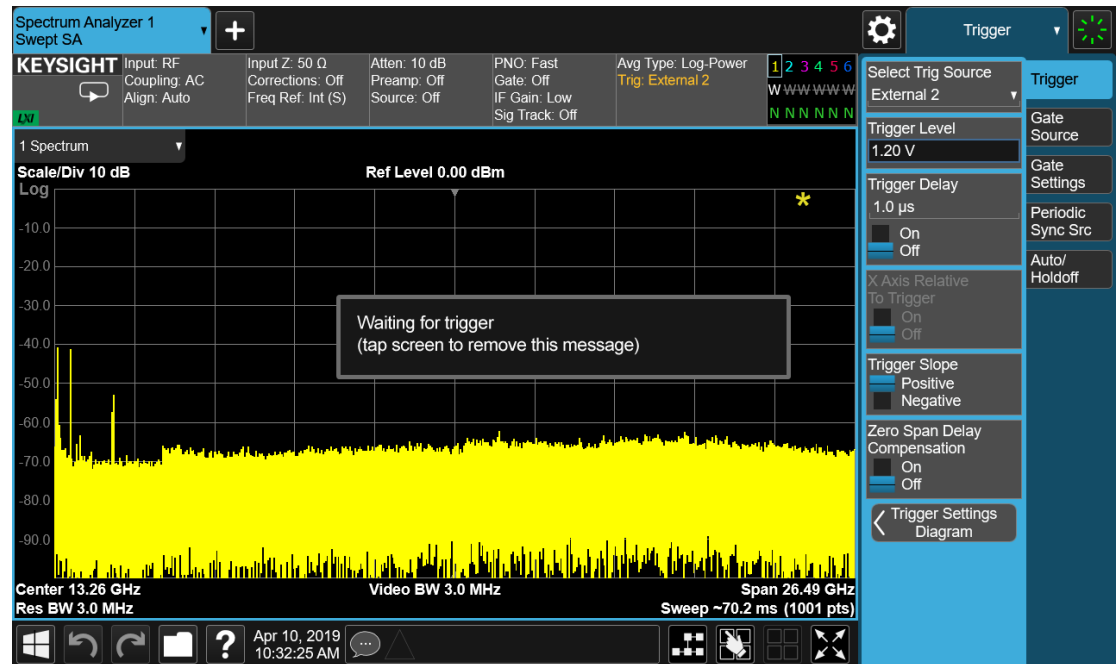

Tap anywhere on the screen (except on the message itself) to clear the popup. The annotation will remain amber until the trigger conditions are satisfied.

List of available Trigger sources

The tables show which Trigger sources are available for which Modes and Measurements, with the following exceptions:

- the Noise Figure Mode does not support Triggering at all
- the Disturbance Analyzer measurement in the EMI Mode does not support Triggering
- the Tx Band Spur measurement in the GSM/EDGE Mode does not support Triggering
- For some models (like N9042B) with ADC trigger: some IF Paths do not support Video trigger, instead they support ADC trigger

"Free Run" on page 2446

IMMediate

All Modes and measurements, except those measurements that support no triggers at all

"Video/ADC" on page 2446

VIDeo

All Modes except RTSA and Pulse

In Spectrum Analyzer Mode, all measurements except ACP and List Sweep
In WCDMA, MSR, Short Range Comms, VMA and LTE, all measurements

8 Trigger

8.1 Trigger

		except ACP
		In WLAN, all measurements
		In Phase Noise, all measurements except Log Plot and Spot Frequency
"ADC Trigger" on page 2447	ADC	All Modes and measurements supporting Video or Level, except Spectrum Analyzer mode
		Only supported in certain model's IF Paths
"Line" on page 2448	LINE	All Modes except EMI, Avionics and Analog Demod
		In Spectrum Analyzer, all measurements except List Sweep
		In WLAN and GSM/EDGE, all measurements except Power vs. Time
		In LTE and 5G NR, all measurements except Transmit On/Off Power
		In Short Range Comms, all measurements except Modulation Analysis
		In MSR, all measurements
Level [Mode: RTSA, PULSEX]	LEVe1	RTSA and Pulse Modes only
FMT [Mode: RTSA, PULSEX]	FMT	RTSA and Pulse Modes only
"External 1" on page 2448	EXTernal1	All Modes and measurements
"External 2" on page 2449	EXTernal2	All Modes and measurements
"External 3" on page 2450	EXTernal3	See "External 3 Support" on page 2436
"RF Burst" on page 2451	RFBurst	All Modes except EMI
		In Spectrum Analyzer, all measurements except List Sweep
"Periodic" on page 2452	FRAMe	All Modes except EMI
		In Spectrum Analyzer, all measurements except List Sweep
TV [Mode: SA]	TV	Spectrum Analyzer Mode only, and only in the Swept SA measurement

I/Q Triggers

"I/Q Mag" on page 2454	IQMag	All Modes except EMI, Avionics, RTSA, Analog Demod and Pulse In Spectrum Analyzer, only in Power Stat CCDF and Burst Power
"Input I" on page 2454	IINPut	In WCDMA, only in Power Stat CCDF and IQ Waveform
"Input Q" on page 2455	QINPut	In GSM/EDGE, only in EVM, GMSK Phase & Freq Error, Transmit Power and IQ Waveform In Phase Noise, only in IQ Waveform
"I (Demodulated)" on page 2455	IDEMod	In Bluetooth, only in Transmit Analysis In LTE, only in Power Stat CCDF, Modulation Analysis, Conformance EVM, and IQ Waveform
"Q (Demodulated)" on page 2456	QDEMod	In WLAN, only in Power Stat CCDF, Modulation Analysis, Spectral Flatness, and IQ Waveform In Short Range Comms, only in Power Stat CCDF and Modulation Analysis
"Aux I/Q Mag" on page 2456	AIQMag	In VMA, only in Power Stat CCDF, Digital Demod and IQ Waveform In CQM, only in Group Delay, Power Stat CCDF, and IQ Waveform
"PXI" on page 2457	PXI	All Modes and measurements (only found in modular analyzers)
"Internal" on page 2457	INTernal	All Modes and measurements (only found in modular analyzers)
"Audio External" on page 2451	AEXTernal	Via the TRIG IN connector on the M9260A Audio Analyzer module
"Prot Channel Detection" on page 2458	PRTChandet	Base Station Emulation; valid UL signal detected (PUSCH/PUCCH/PRACH/SRS)
"Prot Frame Aligned" on page 2458	PRTFrame	Base Station Emulation; periodic technology format radio frame with data frame aligned to the BSE timing
"Prot Event" on page 2459	PRTEvent	Base Station Emulation events

External 3 Support

Trigger Source **External 3** is available only in certain Modes and measurements, as follows:

5GNR	Transmit On Off, Modulation Analysis, Power Stat CCDF, and IQ Waveform measurements only
ADEMODO	Not supported
AVIONICS	Not supported
BT	Not supported
CQM	Group Delay, Power Stat CCDF, and IQ Waveform measurements only
EMI	Not supported
GSMEDGE	IQ Waveform and Transmit Power measurements only
LTEAFDD,	Power Stat CCDF, IQ Waveform, and Transmit On Off measurements only

8 Trigger

8.1 Trigger

LTEATDD	
MSR	Power Stat CCDF, and IQ Waveform measurements only
PA	Power Amplifier measurement
PNOISE	IQ Waveform measurement only
PULSEX	Pulse measurement only
SA	Power Stat CCDF and Burst Power measurements only
SRCOMMS	Modulation Analysis, Power Stat CCDF, and IQ Waveform measurements only
VMA	Digital Demod, Custom OFDM, IQ Waveform, and Power Stat CCDF measurements only
WCDMA	QPSK EVM, Power Stat CCDF, and IQ Waveform measurements only
WLAN	Spectral Flatness, Modulation Analysis, Power Vs Time, Power Stat CCDF, and IQ Waveform measurements only

Backwards Compatibility SCPI

The following SCPI commands are provided for Backwards Compatibility:

Backwards Compatibility SCPI	:TRIGger[:SEQuence]:SOURCe EXTernal For backward compatibility, the parameter EXTernal is mapped to EXTernal1 [:SENSe]:<measurement>:TRIGger:SOURce This backwards compatibility alias command is provided for ESA/PSA compatibility This backwards compatibility command does not apply to the Swept SA measurement, for that just use :TRIGger:SOURce This backwards compatibility command does not apply to the monitor spectrum, log plot and spot frequency measurements [:SENSe]:<measurement>:TRIGger:SOURce IF In earlier instruments, the parameter IF was used by apps for the video trigger, so using the IF parameter selects VIDeo triggering. Sending IF in the command causes VID to be returned to a query [:SENSe]:ACPR:TRIGger:SOURce This backwards Compatibility SCPI command is provided to support the same functionality as [:SENSe]:ACPr:TRIGger:SOURce (PSA W-CDMA, PSA cdma2000 and PSA 1xEVDO) due to the fact that the ACPr node conflicts with the ACPower node The legacy command: :TRIGger[:SEQuence]:RFBurst:FSElectivity[:STATe] OFF ON 0 1 is not supported in the X-Series, as the hardware to do Frequency Selective burst triggers does not exist in X-Series
------------------------------------	---

More Information

The **Trigger** menus let you select the trigger source and trigger settings for a sweep or measurement. In triggered operation (basically, any trigger source other than Free Run), the instrument will begin a sweep or measurement only when the

selected trigger conditions are met, generally when your trigger source signal meets the specified trigger level and polarity requirements. (In FFT measurements, the trigger controls when the data acquisition begins for FFT conversion.)

For each of the trigger sources, you may define a set of operational parameters or settings, which will be applied when that source is selected as the current trigger source. Examples of these settings are Trigger Level, Trigger Delay, and Trigger Slope. You may apply different settings for each source; so, for example, you could have a Trigger Level of 1v for External 1 trigger and -10 dBm for Video trigger.

Once you have established the settings for a given trigger source, they generally will remain unchanged for that trigger source as you go from measurement to measurement within a Mode (although the settings can change as you go from Mode to Mode). Furthermore, the trigger settings within a Mode are the same for the **Trigger** menu, the **Gate Source** menu, and the **Periodic Sync Src** menu. That is, if **Ext1** trigger level is set to 1v in the **Trigger** menu, it will appear as 1v in both the **Gate Source** and the **Periodic Sync Src** menus. For these reasons the trigger settings commands are not qualified with the measurement name, the way the trigger source commands are.

Trigger Setup Parameters:

The following examples show trigger setup parameters using an external trigger source.

Example 1 illustrates the trigger conditions with negative slope and no trigger occurs during trigger Holdoff time.

Example 2 illustrates the trigger conditions with positive slope, trigger delay, and auto trigger time.

8 Trigger
8.1 Trigger

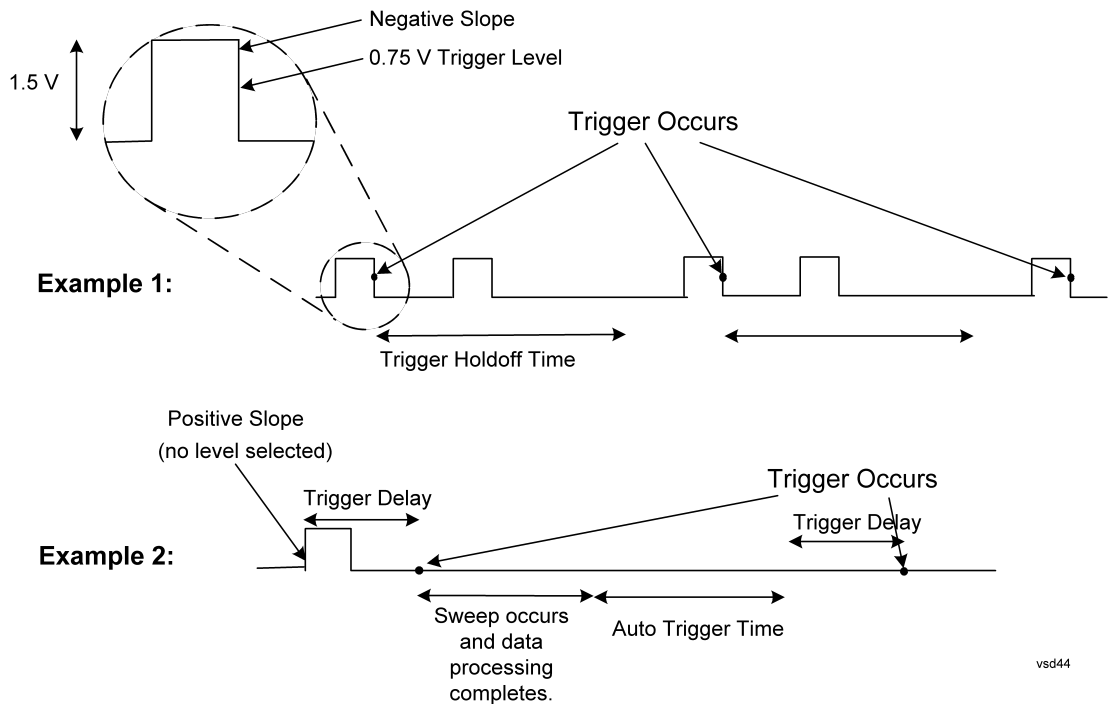

vsd44

Remote Command Swept SA and RTSA measurements:
`:TRIGger[:SEquence]:SOURce EXTERNAL1 | EXTERNAL2 | EXTERNAL3 | IMMEDIATE | LINE | FRAME | RFBURST | VIDEO | TV | PXI | INTERNAL`
`:TRIGger[:SEquence]:SOURce?`

All other measurements
`:TRIGger:<measurement>[:SEquence]:SOURce EXTERNAL1 | EXTERNAL2 | EXTERNAL3 | AEXTERNAL | IMMEDIATE | LEVEL | FMT | LINE | ADC | FRAME | RFBURST | VIDEO | IQMAG | IDEMOD | QDEMOD | IINPUT | QINPUT | AIQMAG | PXI | INTERNAL | PRTCHANDET | PRTFRAME | PRTEVENT`
`:TRIGger:<measurement>[:SEquence]:SOURce?`

Example The following commands set the External 1 trigger input for various measurements

Swept SA and RTSA measurements:

`:TRIG:SOUR EXT1`

Other Spectrum Analyzer Mode measurements:

Harmonics:

`:TRIG:HARM:SOUR EXT1`

Power Suite measurements (appear in many Modes):

Channel Power:

`:TRIG:CHP:SOUR EXT1`

Occupied BW, Output Spectrum BW:

`:TRIG:OBW:SOUR EXT1`

Notes	<p>For some of the trigger parameters, the tie-in to the parameter is not obvious. These are:</p> <ul style="list-style-type: none">IMMEDIATE, selects Free RunFRAME, selects Periodic TriggerFMT, selects Frequency Mask TriggerAEXTERNAL, selects Audio External trigger, using the TRIG IN connector on the M9260A Audio Analyzer module <p>For most measurements, the <measurement> keyword follows TRIGGER. For Swept SA and RTSA Modes, do <i>not</i> use the <measurement> keyword. Using the wrong command form will result in an Undefined Header error</p> <p>Other trigger-related commands are found in the :INITiate and :ABORT SCPI command subsystems</p> <p>*OPC should be used after requesting data. This will hold off any subsequent changes to the selected trigger source, until after the sweep is completed and the data is returned</p> <p>Available ranges and presets can vary from mode to mode</p> <p>FMT (Pulse and RTSA apps):</p> <p>The amplitude resolution of the Frequency Mask is coupled to the Scale/Division. There are 256 vertical points therefore the amplitude resolution is computed using the algorithm: (10 * Scale/Div) / # Vertical Points</p>
Dependencies	<p>Not all trigger sources are available for each input. See the "RF Trigger Source (Remote Command Only)" on page 2443 and "I/Q Trigger Source (Remote Command Only)" on page 2445 commands for detailed information on which trigger sources are available for each input</p> <p>In some models, there is no second External input. In these models, the External 2 selection is not shown and the EXTERNAL2 parameter will generate a "Hardware missing; Not available for this model number" message</p> <p>EXTERNAL3 is available only when Option H1G is installed</p> <p>For the E7760 the only available selections are: EXTERNAL1 IMMEDIATE INTERNAL RFBURST VIDEO</p> <p>For UXM the only available selections are: EXTERNAL1 IMMEDIATE PRTCHANDET PRTFRAME PRTEVENT</p> <p>In the Pulse app, when Option B2X and H1G are installed and Digital IF BW is greater than 255.176 MHz, only three trigger sources, IMMEDIATE, LEVEL, and EXTERNAL3 are available</p> <p>Level Trigger (Pulse and RTSA apps):</p> <p>Level trigger is allowed in average detector mode</p> <p>When Level Trigger is the selected Trigger Source in the Spectrum measurement, Spectrum minimum Acquisition Time is limited to the PVT minimum Acquisition Time. If the Spectrum Acquisition Time changed as a result of going into Level Trigger, a message is posted "Min Acq Time is 200 usec when Level Trigger is ON". When Level Trigger is no longer the selected Trigger Source, Spectrum minimum Acquisition Time is restored</p> <p>FMT (Pulse and RTSA apps):</p> <p>If you were not in Free Run when you entered the FMT Setup View, you can change Trigger Source to Free Run while in the editor. This will allow you to configure the mask with a continually updating trace. When exiting FMT Setup View, the Trigger Source will be changed back to FMT</p>

8 Trigger

8.1 Trigger

For Power Stat CCDF and IQ Waveform in 5G NR and LTEATDD, switching the radio direction changes this parameter to the preset value

In Transmit On|Off Power in 5G NR and LTEATDD, the value changes as follows

- If changed to uplink: Periodic
- If changed to downlink: External 1 except for models with the H1G option. With the H1G option, it changes as follows
 - External 1, when Info BW \leq 255 MHz
 - External 3, when Info BW \geq 256 MHz

Couplings	<p>FMT (Pulse and RTSA apps):</p> <p>A remote user can enter or access FMT data via <code>:TRIGger[:SEquence]:FMT[1] 2:DATA</code></p> <p>The upper and lower masks can have different freq/ampl pairs therefore subop code 1 is for the upper mask and subop code 2 is for the lower mask</p>
Preset	See "Trigger Source Presets" below
Status Bits/OPC dependencies	The Status Operation Register bit 5 "Waiting for Trigger" is set at the same time as the Sweeping or Measuring bit is set. It is cleared when the trigger actually occurs (that is, after the trigger event occurs and all the applicable trigger criteria have been met). A corresponding pop-up message ("Waiting for trigger") is generated if no trigger signal appears after approximately 2 sec. This message goes away when a trigger signal appears

Trigger Source Presets

The following Trigger Source presets are used for these measurements after a Mode Preset or Meas Preset:

Meas	Mode	Preset for RF	Preset for IQ
Swept SA	SA	IMM	IQ not supported
CHP	SA, WCDMA, MSR, SRCOMMS, 5GNR, WLAN	IMM	IQ not supported
OBW	SA, WCDMA, LTEAFDD, LTEATDD, BT, 5GNR, WLAN	1xEVDO: EXT1 Others: IMM	IQ not supported
Transmit Analysis	BT	RFB	IQM
Adjacent Channel Power	BT	IMM	IQ not supported
LE In-band Emissions	BT	IMM	IQ not supported
EDR In-band Spurious Emissions	BT	RF Burst	IQ not supported
CCDF	SA, WCDMA, LTEAFDD, LTEATDD, MSR, SRCOMMS, 5GNR, WLAN, CQM	LTEATDD:	LTEATDD: - BTS: EXT1

Meas	Mode	Preset for RF	Preset for IQ
		- BTS: External 1 - MS: Periodic Timer Others: IMM	- MS: FRAM Others: IMM
ACP	SA, WCDMA, LTEAFDD, LTEATDD, MSR, SRCOMMS, 5GNR	IMM	IQ not supported
Tx Power	SA, GSM	RFBurst	IMM
SPUR	SA, WCDMA, MSR, LTEAFDD, LTEATDD, 5GNR, WLAN	IMM	IQ not supported
SEM	SA, WCDMA, MSR, LTEAFDD, LTEATDD, SRCOMMS, 5G NR, WLAN	IMM	IQ not supported
CDP	WCDMA	IMM	IMM
RHO	WCDMA	IMM	IMM
PCON	WCDMA	IMM	IMM
QPSK	WCDMA	EXT1	IMM
MON	All except: SA, BASIC	IMM	IQ not supported
WAV	All except: SA	LTEATDD: - BTS: External 1 - MS: Periodic Timer GSM/EDGE: RFBurst All others: IMM	LTEATDD: - BTS: EXT1 - MS: FRAM GSM/EDGE: IQM All others: IMM
EVM	LTEAFDD, LTEATDD, SRCOMMS, 5GNR, WLAN	IMM	IMM
PVT	WLAN	RFB	IQ not supported
Spectral Flatness	WLAN	IMM	IMM
SPEC	BASIC	IMM	IMM
LOG Plot	PN	IMM	IQ not supported
Spot Freq	PN	IMM	IQ not supported
GMSK PVT	EDGE/GSM	RFB	IMM
GMSK PFER	EDGE/GSM	RFB	IQM
GMSK ORFS	EDGE/GSM	RFB	IQ not supported
EDGE PVT	EDGE/GSM	RFB	IMM

8 Trigger
8.1 Trigger

Meas	Mode	Preset for RF	Preset for IQ
EDGE EVM	EDGE/GSM	RFB	IQM
EDGE ORFS	EDGE/GSM	Periodic Timer	IQ not supported
Combined WCDMA	WCDMA	IMM	IQ not supported
Combined GSM	EDGE/GSM	RFB	IQ not supported
List Power Step	WCDMA, EDGE/GSM	IMM	IQ not supported
Transmit On/Off Power	LTETDD, LTEATDD, 5GNR	BTS: External 1 (External3 when IFBW \geq 256 MHz with H1G option) MS: Periodic Timer	BTS: EXT1 MS: FRAM
Transmit Analysis	BLUETOOTH	RFB	IQ not supported
Adjacent Channel Power	BLUETOOTH	IMM	IQ not supported
LE In-band Emissions	BLUETOOTH	IMM	IQ not supported
EDR In-band Spurious Emissions	BLUETOOTH	Periodic Timer	IQ not supported
Conformance EVM Spectrum & PVT	LTEAFDD, LTEATDD, MSR RTSA	IMM IMM	IMM IQ not supported
Pulse	PULSEX	IMM	IQ not supported
AM, FM, PM, FM Stereo	ADEMODO	IMM	IQ not supported
PAvT	SA, 5GNR, VMA	IMM	IMM
Group Delay	CQM	IMM	IMM

RF Trigger Source (Remote Command Only)

Selects the trigger to be used for the specified measurement when RF is the selected input. The RF trigger source can be queried and changed even while another input is selected, but it is inactive until RF becomes the selected input.

Note the inclusion of the <measurement> parameter in the command below. Because each measurement remembers its own Trigger Source, the command must be qualified with the measurement name. Note that for the Swept SA measurement

this is not the case; for backwards compatibility, no <measurement> parameter is used when setting the Trigger Source for the Swept SA measurement.

Remote Command `:TRIGger:<measurement>[:SEquence]:RF:SOURce EXTernal1 | EXTernal2 | IMMEDIATE | LEVel | FMT | LINE | FRAME | RFBurst | VIDEo | IF | TV | PXI | INTernal | PRTChandet | PRTFrame | PRTEvent`
 `:TRIGger:<measurement>[:SEquence]:RF:SOURce?`

Note that the available parameters are model number and hardware dependent

Example Select the external 1 trigger input for the ACP measurement and the RF input:
 `:TRIG:ACP:RF:SOUR EXT1`

Select video triggering for the **SANalyzer** measurement and the RF input. For **SAN**, do not use the <measurement> keyword:
 `:TRIG:RF:SOUR VID`

Notes Not all measurements have all the trigger sources available to them. Check the trigger source documentation for your specific measurement to see what sources are available

Note that not all trigger sources are available for each input, and that the available parameters are model number and hardware dependent

For the **RF Trigger Source**, the following trigger sources are available:

IMMEDIATE	free run triggering
VIDEo	triggers on the video signal level
LEVel	triggers on the video signal level with time qualified triggering
FMT	triggers on the amplitude spectrum with frequency mask triggering
LINE	triggers on the power line signal
EXTernal1 or EXTernal	triggers on an externally connected trigger source marked "Trigger 1 In" on the rear panel of standalone instruments, "Trigger 3" on the front panel of EXM and VXT model M9421A, and "Trigger 1" on the front panel of VXT models M9410A/11A/15A/16A
EXTernal2	triggers on an externally connected trigger source marked "Trigger 2 In" on the front panel of standalone instruments, and "Trigger 1" on the front panel of EXM and VXT model M9421A, and "Trigger 2" on the front panel of VXT models M9410A/11A/15A/16A. In some models, there is no second External input. In these models, the External 2 selection is not shown and the EXTernal2 parameter will generate a "Hardware missing; Not available for this model number" message
RFBurst	triggers on the bursted frame
FRAME	triggers on the periodic timer
IF (video)	same as video, for backwards compatibility only
PRTChandet	triggers on Base Station Emulation detecting a valid UL signal (PUSCH/PUCCH/PRACH/SRS)

8 Trigger
8.1 Trigger

PRTFrame	triggers on the Base Station Emulation periodic technology format radio frame with data frame aligned to the BSE timing
PRTEvent	triggers on the Base Station Emulation events
INTernal	triggers on the internal source trigger output, for models with an internal source such as VXT
PXI trigger	only supported in PXI (modular) instruments
<p>*OPC should be used after requesting data. This will hold off any subsequent changes to the selected trigger source, until after the sweep is completed and the data is returned</p> <p>Available ranges, and presets can vary from mode to mode</p>	

Dependencies	<p>The available choices for VXT are: Free Run, Video, Internal, External 1, External 2, RF Burst, Periodic and PXI</p> <p>In VXT, Internal is only in VXT models M9410A/11A/15A/16A, not in models M9420/21A, and Internal and Periodic are not available in Spectrum Analyzer Mode</p> <p>PXI is only found in VXT</p> <p>The available choices for EXM are Free Run, Video, Internal, External 1, External 2, RF Burst, and Periodic</p> <p>The available choices for UXM are Free Run, External 1, Prot Channel Detection, Prot Frame Aligned, and Prot Event</p> <p>Prot Channel Detection, Prot Frame Aligned, and Prot Event are only available in UXM</p> <p>The available choices for E7760 are Free Run, External 1, Internal, Video and RF Burst</p> <p>In some models, there is no second External input. In these models, the External 2 selection is not shown and the EXTernal12 parameter will generate a "Hardware missing; Not available for this model number" error</p>
--------------	---

Status Bits/OPC dependencies	<p>The Status Operation Register bit 5 "Waiting for Trigger" is set at the same time as the Sweeping or Measuring bit is set. It is cleared when the trigger actually occurs (that is, after the trigger event occurs and all the applicable trigger criteria have been met). A corresponding pop-up message ("Waiting for trigger") is generated if no trigger signal appears after approximately 2 seconds. This message goes away when a trigger signal appears</p>
------------------------------	--

I/Q Trigger Source (Remote Command Only)

Selects the trigger to be used for the specified measurement when I/Q (which requires option BBA) is the selected input. The I/Q trigger source can be queried and changed even while another input is selected, but it is inactive until I/Q becomes the selected input.

Remote Command	<pre>:TRIGger:<measurement>[:SEquence]:IQ:SOURce EXTernal1 EXTernal2 IMMEDIATE IQMag IDEMod QDEMod IINPut QINPut AIQMag</pre> <pre>:TRIGger:<measurement>[:SEquence]:IQ:SOURce?</pre>
----------------	---

Example	<pre>:TRIG:WAVEform:SOUR IQM</pre> <p>Selects I/Q magnitude triggering for the IQ Waveform measurement and the I/Q input</p>
---------	--

Notes	<p>Not all measurements have all the trigger sources available to them. Check the trigger source documentation for your specific measurement to see what sources are available</p> <p>Note that not all trigger sources are available for each input, and that the available parameters are model number and hardware dependent</p> <p>For the I/Q Trigger Source, the following trigger sources are available:</p> <table border="1"> <tr> <td>IMMediate</td> <td>free run triggering</td> </tr> <tr> <td>EXTernal1</td> <td>triggers on an externally connected trigger source on the rear panel or EXTernal</td> </tr> <tr> <td>EXTernal2</td> <td>triggers on an externally connected trigger source on the front panel</td> </tr> <tr> <td>IQMag</td> <td>triggers on the magnitude of the I/Q signal</td> </tr> <tr> <td>IDEMod</td> <td>triggers on the I/Q signal's demodulated I voltage</td> </tr> <tr> <td>QDEMod</td> <td>triggers on the I/Q signal's demodulated Q voltage</td> </tr> <tr> <td>IINPut</td> <td>triggers on the I channel's ADC voltage</td> </tr> <tr> <td>QINPut</td> <td>triggers on the Q channel's ADC voltage</td> </tr> <tr> <td>AIQMag</td> <td>triggers on the magnitude of the auxiliary receiver channel I/Q signal</td> </tr> </table> <p>*OPC should be used after requesting data. This will hold off any subsequent changes to the selected trigger source, until after the sweep is completed and the data is returned</p> <p>Available ranges, and from mode-to-mode presets can vary</p>	IMMediate	free run triggering	EXTernal1	triggers on an externally connected trigger source on the rear panel or EXTernal	EXTernal2	triggers on an externally connected trigger source on the front panel	IQMag	triggers on the magnitude of the I/Q signal	IDEMod	triggers on the I/Q signal's demodulated I voltage	QDEMod	triggers on the I/Q signal's demodulated Q voltage	IINPut	triggers on the I channel's ADC voltage	QINPut	triggers on the Q channel's ADC voltage	AIQMag	triggers on the magnitude of the auxiliary receiver channel I/Q signal
IMMediate	free run triggering																		
EXTernal1	triggers on an externally connected trigger source on the rear panel or EXTernal																		
EXTernal2	triggers on an externally connected trigger source on the front panel																		
IQMag	triggers on the magnitude of the I/Q signal																		
IDEMod	triggers on the I/Q signal's demodulated I voltage																		
QDEMod	triggers on the I/Q signal's demodulated Q voltage																		
IINPut	triggers on the I channel's ADC voltage																		
QINPut	triggers on the Q channel's ADC voltage																		
AIQMag	triggers on the magnitude of the auxiliary receiver channel I/Q signal																		
Status Bits/OPC dependencies	<p>The Status Operation Register bit 5 "Waiting for Trigger" is set at the same time as the Sweeping or Measuring bit is set. It is cleared when the trigger actually occurs (that is, after the trigger event occurs and all the applicable trigger criteria have been met). A corresponding pop-up message ("Waiting for trigger") is generated if no trigger signal appears after approximately 2 sec. This message goes away when a trigger signal appears</p>																		

8.1.1.1 Free Run

Free Run triggering occurs immediately after the sweep/measurement is initiated.

Example	<p>Swept SA measurement: :TRIG:SOUR IMM</p> <p>Measurements other than Swept SA: :TRIG:<meas>:SOUR IMM</p>
Annunciation	Free Run (in the Meas Bar)

8.1.1.2 Video/ADC

The Video trigger condition is met when the video signal at the left edge of the graticule (the filtered and detected version of the input signal, including both RBW and VBW filtering) crosses the video trigger level with the chosen slope.

8 Trigger

8.1 Trigger

The Video trigger level is shown as a labeled line on the display. The line is displayed as long as Video is the selected trigger source. The Trigger Level line can be adjusted using the step keys, knob, or numeric keypad. It can also be dragged on the display with your finger or with a mouse.

When the detector selected for all active traces is the average detector, the video signal for triggering does not include any VBW filtering.

Log Plot and Spot Frequency measurements, in the Phase Noise Mode, do not support Video Trigger.

The **Trigger** tab contains the following Trigger Source dependent controls when Video Trigger is selected:

- "Prot Frame Aligned" on page 2458
- "Trigger Delay" on page 2461
- "Trigger Slope" on page 2465

Additional controls are also present, which are not dependent on the selected Trigger Source.

Note that Video Trigger is a software trigger of the acquired trace for some measurements and a hardware trigger of the IF envelope for others. Most measurements support one method or the other, although some (like ACP) don't support Video Trigger at all. For those measurements that support Video Trigger as a software trigger, the Trigger Level units will be dependent on the current Y Axis Unit for the measurement; for those that support Video Trigger as an IF Envelope trigger, the units are typically in dBm.

Example	Swept SA measurement: :TRIG:SOUR VID
	Measurements other than Swept SA: :TRIG:<meas>:SOUR VID

Annunciation Video (in the Meas Bar)

8.1.1.3 ADC Trigger

Some IF Paths in certain models (like N9042B) in IQ Measurements have an ADC trigger. ADC is like the Video trigger, but with 2 limitations due to a lack of post-processing.

First, the trigger is not limited to the current measurement's setup IF BW. The trigger sees everything in the passband, so measurements like IQA Complex Spectrum can be triggered outside of the current Digital IF BW.

The final limitation is, due to lack of post-processing, the amplitude accuracy of the ADC trigger is less than the video trigger.

If ADC trigger is available for at least one IF Path on a model, then the ADC trigger will always be seen as a trigger option in IQ Measurements. However, it will only be available (not grayed out) to select when using IF Paths that support it.

If Video Trigger is selected and measurement setup (IF Path or IF BW) is changed to a path that only supports the ADC trigger instead, then ADC trigger will be selected and *vice versa*.

Example	Measurements other than Swept SA: :TRIG:<meas>:SOUR ADC
---------	--

Annunciation ADC (in the Meas Bar)

8.1.1.4 Line

When **Line** is selected, start of a new sweep/measurement will be synchronized with the next cycle of the line voltage.

Line trigger is not available when operating from a "dc power source", for example, when the instrument is powered from batteries.

Line trigger is not available when using modular instruments like the VXT.

The **Trigger** tab contains the following Trigger Source dependent controls when **Line** Trigger is selected:

- "Trigger Delay" on page 2461
- "Trigger Slope" on page 2465

Additional controls are also present that are not dependent on the selected Trigger Source.

Example	:TRIG:SOUR LINE Swept SA measurement :TRIG:<meas>:SOUR LINE Measurements other than Swept SA
---------	---

Annunciation LINE (in the Meas Bar)

8.1.1.5 External 1

When **External 1** is selected, a new sweep/measurement starts when the external trigger condition is met using the TRIGGER 1 IN input connector on the rear panel.

Grayed-out if Ext 1 is in use by Point Trigger in the Source Setup menu of Swept SA. Forced to "Free Run" on page 2446 if already selected and Point Trigger is set to External 1.

8 Trigger

8.1 Trigger

The **Trigger** tab contains the following Trigger Source dependent controls when External 1 Trigger is selected:

- ["Prot Frame Aligned" on page 2458](#)
- ["Trigger Delay" on page 2461](#)
- ["Trigger Slope" on page 2465](#)

Additional controls are also present that are not dependent on the selected Trigger Source.

Example	<code>:TRIG:SOUR EXT1</code> Swept SA measurement <code>:TRIG:<meas>:SOUR EXT1</code> Measurements other than Swept SA
---------	---

Annunciation	External 1 (in the Meas Bar)
--------------	------------------------------

8.1.1.6 External 2

When **External 2** is selected, a new sweep/measurement starts when the external trigger condition is met using the TRIGGER 2 IN input connector on the rear panel.

Grayed-out if Ext 2 is in use by Point Trigger in the Source Setup menu of Swept SA. Forced to ["Free Run" on page 2446](#) if already selected and Point Trigger is set to External 2.

The **Trigger** tab contains the following Trigger Source dependent controls when External 2 Trigger is selected:

- ["Prot Frame Aligned" on page 2458](#)
- ["Trigger Delay" on page 2461](#)
- ["Trigger Slope" on page 2465](#)

Additional controls are also present that are not dependent on the selected Trigger Source.

Example	<code>:TRIG:SOUR EXT2</code> Swept SA measurement <code>:TRIG:<meas>:SOUR EXT2</code> Measurements other than Swept SA
---------	---

Annunciation	External 2 (in the Meas Bar)
--------------	------------------------------

8.1.1.7 External 3

When **External 3** is selected, a new sweep/measurement starts when the external trigger condition is met using the TRIGGER 3 IN input connector on the rear panel.

This control only appears in certain instrument and option combinations, as follows.

- For N9042B, selects the Precision External Trigger, but available only when IF Path is 255 MHz or wider. The resolution will be within one sample count of the 4.8 GHz ADC sampling rate for 255 ~ 2 GHz IF Paths, and within one sample count of the 10.2 GHz sampling rate for the 4 GHz IF Path
- For all other instruments, available only if Option H1G is installed. It is only available when the 1 GHz path is chosen, either directly or indirectly; in all other paths it is visible but grayed-out. Direct and indirect selection of the 1 GHz path occurs as follows:
 - **Direct:** Measurements that directly support the 1 GHz path have a 1 GHz selection in the **IF Path** menu in **Meas Setup**
 - **Indirect:** Certain measurements, such as Power Statistics CCDF (**PST**), always choose the widest available path, and so will choose the 1 GHz path if it is available, even if there is no **IF Path** menu for the measurement. **External 3** will be visible when this results in the 1 GHz path being selected, even if there is no control or readout indicating that the 1 GHz path has been selected

For a full list of Modes and measurements that support **External 3**, see "[External 3 Support](#)" on page 2436 in the section "[Select Trig Source](#)" on page 2433.

When **External 3** is set, and then becomes disabled because you switched away from the 1 GHz path, the Trigger Source selection reverts to the default ("[Free Run](#)" on page 2446).

When **External 3** Trigger is selected, the **Trigger** tab displays the following Trigger Source dependent controls:

- "[Prot Frame Aligned](#)" on page 2458
- "[Trigger Delay](#)" on page 2461
- "[Trigger Slope](#)" on page 2465

Additional controls are also present that are not dependent on the selected Trigger Source.

Example	<code>:TRIG:SPEC:SOUR EXT3</code> Sets External 3 as the trigger source for the Complex Spectrum measurement
Annunciation	External 3 (in the Meas Bar)

8.1.1.8 Audio External

When **Audio External** is selected, a new sweep/measurement starts when the external trigger condition is met using the TRIG IN input connector on the front panel of the M9260A Audio Analyzer module. This is a TTL level input (not analog) that supports both rising edge and falling edge triggers.

Only appears in modular instruments, and only when the M9260A Audio Analyzer module is installed, such as in M8920A.

The **Trigger** tab contains the following Trigger Source dependent controls when Audio External Trigger is selected:

- "Trigger Delay" on page 2461
- "Trigger Slope" on page 2465

Additional controls are also present that are not dependent on the selected Trigger Source.

Example	<code>:TRIG:RTES:SOUR AEXT</code> Sets Audio External as the trigger source for the Radio Test measurement
Annunciation	Audio Ext (in the Meas Bar)

8.1.1.9 RF Burst

When **RF Burst** is selected, a new sweep/measurement starts when an RF burst envelope signal is identified from the signal at the RF Input connector.

In some models, a variety of burst trigger circuitry is available, resulting in various available burst trigger bandwidths. The instrument automatically chooses the appropriate trigger path based on the hardware configuration and other settings of the instrument.

The **Trigger** tab contains the following Trigger Source dependent controls when RF Burst is selected:

- "Trigger Level Absolute/Relative" on page 2466
- "Absolute Trigger Level" on page 2467
- "Relative Trigger Level" on page 2467
- "Trigger Delay" on page 2461
- "Trigger Slope" on page 2465

Additional controls are also present that are not dependent on the selected Trigger Source.

Example	<code>:TRIG:SOUR RFB</code> Swept SA measurement <code>:TRIG:<meas>:SOUR RFB</code> Measurements other than Swept SA
Annunciation	RF Burst (in the Meas Bar)

8.1.1.10 Periodic

When **Periodic** is selected, the instrument uses a built-in periodic timer signal as the trigger. Trigger occurrences are set by the **Periodic Timer** parameter, which is modified by the **Offset** and Periodic Sync Src.

Use this trigger when there is a periodic signal but no reliable signal on which to trigger. You can synchronize the periodic signal with outside events (using the Periodic Sync Src) to get closer to a reliable trigger signal (see ["More Information" on page 2453](#) below).

If you do not have a sync source selected (**OFF**), then the internal timer will not be synchronized with any external timing events.

The **Trigger** tab contains the following Trigger Source dependent controls when Periodic Trigger is selected:

- ["Period" on page 2469](#)
- ["Offset" on page 2470](#)
- ["Reset Offset Display" on page 2471](#)
- ["Sync Source" on page 2472](#)
- ["Trigger Delay" on page 2461](#)

Additional controls are also present that are not dependent on the selected Trigger Source.

Example	<code>:TRIG:SOUR FRAM</code> Swept SA measurement <code>:TRIG:<meas>:SOUR FRAM</code> Measurements other than Swept SA
Annunciation	Periodic (in the Meas Bar)

More Information

The graphic below shows the action of the periodic timer trigger.

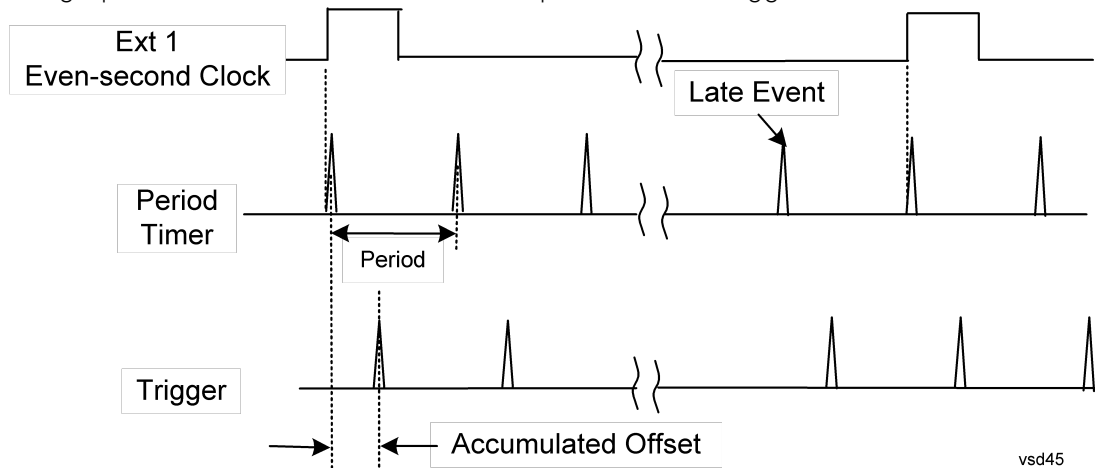

A common application is measuring periodic burst RF signals for which a trigger signal is not easily available. For example, we might be measuring a TDMA radio that bursts every 20 ms. Let's assume that the 20 ms period is very consistent. Let's also assume that we do not have an external trigger source available that is synchronized with the period, and that the signal-to-noise ratio of the signal is not high enough to provide a clean RF burst trigger at all of the analysis frequencies. For example, we might want to measure spurious transmissions at an offset from the carrier that is larger than the bandwidth of the RF burst trigger. In this application, we can set the Periodic Timer to a 20.00 ms period and adjust the offset from that timer to position our trigger just where we want it. If we find that the 20.00 ms is not exactly right, we can adjust the period slightly to minimize the drift between the period timer and the signal to be measured.

A second way to use this feature would be to use **Sync Source** temporarily, instead of **Offset**. In this case, we might tune to the signal in a narrow span and use the RF Burst trigger to synchronize the periodic timer. Then we would turn the sync source off so that it would not miss-trigger. Miss-triggering can occur when we are tuned so far away from the RF burst trigger that it is no longer reliable.

A third example would be to synchronize to a signal that has a reference time element of much longer period than the period of interest. In some CDMA applications, it is useful to look at signals with a short periodicity, by synchronizing that periodicity to the "even-second clock" edge that happens every two seconds. Thus, we could connect the even-second clock trigger to Ext1 and use then Ext1 as the sync source for the periodic timer.

The figure below illustrates this third example. The top trace represents the even-second clock. It causes the periodic timer to synchronize with the leading edge

shown. The instrument trigger occurs at a time delayed by the accumulated offset from the period trigger event. The periodic timer continues to run, and triggers continue to occur, with a periodicity determined by the instrument time base. The timer output (labeled "late event") will drift away from its ideal time due to imperfect matching between the time base of the signal being measured and the time base of the instrument, and also because of imperfect setting of the period parameter. But the synchronization is restored on the next even-second clock event. ("Accumulated offset" is described in the in the **Offset** function section.)

8.1.1.11 I/Q Mag

When **I/Q Mag** is selected, the trigger condition is met when the I/Q magnitude crosses the I/Q magnitude trigger level. The magnitude is measured at the output of the main I/Q digital receiver.

This trigger type is only valid for measurements that support the I/Q inputs.

The **Trigger** tab contains the following Trigger Source dependent controls when I/Q Mag Trigger is selected:

- "Prot Frame Aligned" on page 2458
- "Trigger Delay" on page 2461
- "Trigger Slope" on page 2465

Additional controls are also present that are not dependent on the selected Trigger Source.

Example	<code>:TRIG:<meas>:SOUR IQM</code>
Annunciation	I/Q Mag (in the Meas Bar)

8.1.1.12 Input I

When **Input I** is selected, the condition is met when the voltage at the I Input crosses the trigger level.

This trigger type is only valid for measurements that support the I/Q inputs.

The **Trigger** tab contains the following Trigger Source dependent controls when Input I Trigger is selected:

- "Prot Frame Aligned" on page 2458
- "Trigger Delay" on page 2461
- "Trigger Slope" on page 2465

8 Trigger
8.1 Trigger

Additional controls are also present that are not dependent on the selected Trigger Source.

Example	:TRIG:<meas>:SOUR IINP
---------	------------------------

Annunciation	Input I (in the Meas Bar)
--------------	---------------------------

8.1.1.13 Input Q

When **Input Q** is selected, the condition is met when the voltage at the I Input crosses the trigger level.

This trigger type is only valid for measurements that support the I/Q inputs.

The **Trigger** tab contains the following Trigger Source dependent controls when Input Q Trigger is selected:

- ["Prot Frame Aligned" on page 2458](#)
- ["Trigger Delay" on page 2461](#)
- ["Trigger Slope" on page 2465](#)

Additional controls are also present that are not dependent on the selected Trigger Source.

Example	:TRIG:<meas>:SOUR QINP
---------	------------------------

Annunciation	Input Q (in the Meas Bar)
--------------	---------------------------

8.1.1.14 I (Demodulated)

When **I (Demodulated)** is selected, the trigger condition is met when the I voltage crosses the I voltage trigger level.

This trigger type is only valid for measurements that support the I/Q inputs.

The **Trigger** tab contains the following Trigger Source dependent controls when I (Demodulated) Trigger is selected:

- ["Prot Frame Aligned" on page 2458](#)
- ["Trigger Delay" on page 2461](#)
- ["Trigger Slope" on page 2465](#)

Additional controls are also present that are not dependent on the selected Trigger Source.

Example	:TRIG:<meas>:SOUR IDEM
---------	------------------------

Annunciation	I (Demod) (in the Meas Bar)
--------------	-----------------------------

8.1.1.15 Q (Demodulated)

When **Q (Demodulated)** is selected, the trigger condition is met when the Q voltage crosses the Q voltage trigger level.

This trigger type is only valid for measurements that support the I/Q inputs.

The **Trigger** tab contains the following Trigger Source dependent controls when Q (Demodulated) Trigger is selected:

- ["Prot Frame Aligned" on page 2458](#)
- ["Trigger Delay" on page 2461](#)
- ["Trigger Slope" on page 2465](#)

Additional controls are also present that are not dependent on the selected Trigger Source.

Example	<code>:TRIG:<meas>:SOUR QDEM</code>
---------	---

Annunciation	Q (Demod) (in the Meas Bar)
--------------	-----------------------------

8.1.1.16 Aux I/Q Mag

When **Aux I/Q Mag** is selected, the trigger condition is met when the auxiliary receiver's I/Q magnitude output crosses the Auxiliary I/Q magnitude trigger level.

This trigger type is only valid for measurements that support the I/Q inputs.

The **Trigger** tab contains the following Trigger Source dependent controls when Aux I/Q Mag Trigger is selected:

- ["Prot Frame Aligned" on page 2458](#)
- ["Trigger Delay" on page 2461](#)
- ["Trigger Slope" on page 2465](#)
- ["Trigger Center Frequency" on page 2475](#)
- ["Trigger BW" on page 2475](#)

Additional controls are also present that are not dependent on the selected Trigger Source.

Example	<code>:TRIG:<meas>:SOUR AIQM</code>
---------	---

Annunciation	Aux I/Q Mag (in the Meas Bar)
--------------	-------------------------------

8.1.1.17 PXI

When **PXI** is selected, a new sweep/measurement will start when detecting the signal from the PXI backplane trigger line.

This trigger type is only found in the modular instrument products.

The **Trigger** tab contains the following Trigger Source dependent controls when PXI Trigger is selected:

- ["Select PXI Line" on page 2476](#)
- ["Trigger Delay" on page 2461](#)
- ["Trigger Slope" on page 2465](#)

Additional controls are also present that are not dependent on the selected Trigger Source.

Example	Swept SA measurement: :TRIG:SOUR PXI Measurements other than Swept SA: :TRIG:<meas>:SOUR PXI
---------	---

Annunciation	PXI (in the Meas Bar)
--------------	-----------------------

8.1.1.18 Internal

When **Internal** is selected, the trigger condition is met when detecting the signal from the internal RF Source module.

This trigger type is only found in the modular instrument products.

The **Trigger** tab contains the following Trigger Source dependent controls when Aux I/Q Mag Trigger is selected:

- ["Prot Frame Aligned" on page 2458](#)
- ["Trigger Delay" on page 2461](#)
- ["Trigger Slope" on page 2465](#)

Additional controls are also present that are not dependent on the selected Trigger Source.

For an Internal trigger to occur, there must be a trigger output from the internal RF source. This means that you must configure the Source Trigger Output before selecting Internal as the Trigger Source. To enable the Source Trigger Output,

output trigger should not be off if internal source works as list sequence mode and Trig 2 Out should not be off if internal source works as MXG mode. Otherwise, no trigger occurs, and measurement does not start.

Example	Swept SA measurement: :TRIG:SOUR INTernal Measurements other than Swept SA: :TRIG:<meas>:SOUR INTernal
Annunciation	Internal (in the Meas Bar)

8.1.1.19 Prot Channel Detection

Selects a protocol channel detection Base Station Emulation as the trigger. When Prot Channel Detection is selected, a new sweep/measurement will start when the protocol channel detection trigger condition is met.

Protocol Channel Detection Trigger is defined as the Base Station Emulation protocol channel detection event of PUSCH, PUCCH, PRACH or SRS. With this trigger, the IQ data, and therefore the measurement, is aligned at the beginning of the LTE sub-frame where the particular event was detected. Channel transmission is aligned to the sub-frame boundary; therefore, the measurement is aligned with its transmission with the exception of SRS, which might not start at the beginning of the sub-frame containing the SRS as it might have an offset from the start of the sub-frame base on the SRS configuration, In this case, the trigger and measurement are aligned to the beginning of the sub-frame containing SRS as defined by this trigger type (which is not the beginning of the SRS itself due to the offset).

This trigger type is only available in UXM.

Example	:TRIG:<meas>:SOUR PRTC
Annunciation	Prot Chan Det (in the Meas Bar)

8.1.1.20 Prot Frame Aligned

Selects a protocol frame aligned Base Station Emulation as the trigger. When Prot Frame Aligned is selected, a new sweep/measurement will start when the protocol frame aligned data trigger condition is met.

Prot Frame Aligned Trigger is aligned with the Base Station Emulation Protocol uplink frame timing boundary. It depends on the technology format of the base station call processing.

This trigger type is only available in UXM.

Example	:TRIG:<meas>:SOUR PRTF
Annunciation	Prot Frame (in the Meas Bar)

8.1.1.21 Prot Event

Selects a protocol frame aligned Base Station Emulation as the trigger. When Prot Frame Aligned is selected, a new sweep/measurement will start when the protocol frame aligned data trigger condition is met.

Prot Event Trigger is defined as the Base Station Emulation protocol internal event such as the starting of a predefined uplink pattern for a relative power control ramp. With this trigger, the IQ data, and therefore the measurement, is aligned with the start of the desired uplink pattern.

This trigger type is only available in UXM.

Example	<code>:TRIG:<meas>:SOUR PRTF</code>
Annunciation	Prot Frame (in the Meas Bar)

8.1.2 Trigger Level

Sets the amplitude level for Trigger and Gate sources that use level triggering. When the video signal crosses this level, with the chosen slope, the trigger occurs.

For any given Trigger, Gate, or Periodic Sync Src, the same Trigger Level is used for the Trigger source in the Trigger menu, for the Gate source in the Gate Source menu, and for the Periodic Sync source in the Periodic Sync Src menu.

If **Video** is the selected trigger source, the trigger level displays as a green horizontal line with the label TRIG LVL just above it on the right:



If the value of trigger level is off screen low this line displays along the bottom of the graticule. If the value of trigger level is off screen high this line displays above the graticule but no farther above than 1.5 % of the graticule height (the same as the trace itself). Note that the TRIG LVL label cannot display above the graticule so the label itself stops at the top of the graticule.

For the I/Q Triggers, the I/Q reference impedance is used for converting between power and voltage.

Trigger Level Parameters

Source	Example	Min	Max	Prese t	Resoluti on	Step Key Incr	Knob Incr
Video	<code>TRIG:VID:LEV -40 dBm</code>	-170 dBm	+30 dBm	-25 dBm	.01 dB	Scale/Div (Log), 1 dB (Lin)	Step/10, but never < 0.1 dB
Level	<code>TRIG:LEV:LEV -40 dBm</code>	-170 dBm	+30 dBm	-25 dBm	.01 dB	Scale/Div (Log), 1 dB (Lin)	Step/10, but never < 0.1 dB
External 1 2	<code>TRIG:EXT1:LEV 0.4 V</code>	-5 V VXT models M9410A/11A/15A /16A: 0 V	5 V VXT models M9410A/11A/15A /16A: 2.5 V	1.2 V	10 mV	0.5 V	0.1 V
I/Q Mag	<code>TRIG:IQM:LEV -30 dBm</code>	-200 dBm	100 dBm	-25 dBm	.1 dB	Scale/Div (Log), 1 dB (Lin)	Step/10, but never < 0.1 dB
I (Demod)	<code>TRIG:IDEM:LEV 0.5 V</code>	-1 V	1 V	0.25 V	4 significant digits	Scale/Div	Step/100, but never < 1 μV
Q (Demod)	<code>TRIG:QDEM:LEV 0.5 V</code>	-1 V	1 V	0.25 V	4 significant digits	Scale/Div	Step/100, but never < 1 μV
Input I	<code>TRIG:IINP:LEV 0.5 V</code>	-1 V	1 V	0.25 V	4 significant digits	Scale/Div	Step/100, but never < 1 μV
Input Q	<code>TRIG:QINP:LEV 0.5 V</code>	-1 V	1 V	0.25 V	4 significant digits	Scale/Div	Step/100, but never < 1 μV
Aux Chan I/Q Mag	<code>TRIG:AIQM:LEV -30 dBm</code>	-200 dBm	100 dBm	-25 dBm	.1 dB	Scale/Div (Log), 1 dB (Lin)	Step/10, but never < 0.1 dB
Internal	<code>TRIG:INT:LEV 1.2 V</code>	-5 V VXT models M9410A/11A/15A /16A: 0 V	5 V VXT models M9410A/11A/15A /16A: 2.5 V	1.2 V	10 mV	.5 V	.1 V
ADC	<code>TRIG:ADC:LEV -40 dBm</code>	-170 dBm	30 dBm	-25 dBm	.01 dB	Scale/Div	Step/10,

8 Trigger

8.1 Trigger

Source	Example	Min	Max	Prese t	Resoluti on	Step Key Incr	Knob Incr
	EV -30 dBm			dBm		iv (Log), 1 dB (Lin)	but never < 0.1 dB

More Information

For Video Trigger Level, when sweep type = FFT, the video trigger uses the amplitude envelope in a bandwidth wider than the FFT width as a trigger source. This can be useful but does not have the same relationship between the displayed trace and the trigger level as in swept triggering.

For Video Trigger Level the settable resolution of the function is 0.01 dB, even when the Y Axis Unit is linear. In Linear Y Axis Unit (for example, Volts) this requires 4 significant digits to display on the control.

For the Level trigger source, used in RTSA and other measurements, External Gain and Ref Level Offset modify the actual trace data as it is taken and are taken into account by Trig Level.

Remote Command	<pre>:TRIGger[:SEquence]:<trig_source>:LEVel <ampl> :TRIGger[:SEquence]:<trig_source>:LEVel?</pre> <p>where <trig_source> is one of:</p> <pre>EXTernal1 EXTernal2 EXTernal3 VIDEo ADC LEVel IQMag IDEMod QDEMod IINPut QINPut AIQMag INTernal</pre>
Example	<pre>:TRIG:VID:LEV -40 dBm</pre>
Dependencies	Only appears when Video, External 1 2, or an I/Q trigger is selected as the Trigger Source
State Saved	Saved in instrument state
Backwards	<pre>:TRIGger[:SEquence]:IF:LEVel</pre>
Compatibility SCPI	<p>taken as video trigger level</p> <pre>:TRIGger[:SEquence]:IF:LEVel?</pre> <p>taken as video trigger level query</p> <pre>:TRIGger[:SEquence]:EXTernal:LEVel</pre> <p>the parameter EXTernal is mapped to EXTernal1</p> <pre>:TRIGger[:SEquence]:FRAMe:EXTernal1:LEVel</pre>

8.1.3 Trigger Delay

Controls a time delay that the instrument will wait to begin a sweep after meeting the trigger criteria, for Trigger and Gate sources that support Trigger Delay.

For any given Trigger, Gate, or Periodic Sync source, the same Trigger Delay is used for the Trigger source in the Trigger menu, for the Gate source in the Gate Source menu, and for the Periodic Sync source in the Periodic Sync Src menu.

Negative trigger delays can be used. Negative trigger delay makes intuitive sense in time domain and works well in FFT mode where the bandwidth of the filter before the video trigger is about 1.25 span. You can use negative delay to pre-trigger the instrument in the time domain or FFT, but not in swept spans. Video trigger delay may be set to negative values, in time domain, FFT and even swept, but in swept spans, negative settings of Trig Delay are treated as a zero setting within the internal hardware and the advisory message "Neg. Trig Delay unavailable in Swept Mode, zero delay used." is generated when such a delay is set.

Remote Command	<pre>:TRIGger[:SEquence]:<trig_source>:DElay <time> :TRIGger[:SEquence]:<trig_source>:DElay?</pre> <p>where <trig_source> is one of: LINE EXTernal1 EXTernal2 EXTernal3 AEXTernal VIDeo ADC RFBurst FRAME LEVel FMT IQMag IDEMod QDEMod IINPut QINPut AIQMag PXI INTernal</p>
Example	<pre>:TRIG:VID:DEL:STAT ON :TRIG:VID:DEL 100 ms</pre>
Dependencies	Only appears when Video, Line, External 1 2, RF Burst, Periodic Timer or an I/Q trigger is selected as the Trigger Source
Couplings	When FMT Trigger Criteria is INSIDE or OUTSIDE , FMT Trigger Delay State is forced to OFF FMT Trigger Delay MaxValue is dependent on the current AcquisitionTime. The equation is: MaxValue = 2 ¹⁶ x AcqTime, but never to exceed 70 sec. Ex: In PVT View with a min PVT Acq Time of 200 us, this Trigger Delay MaxValue is 13.26 sec. In RT Spectrum and Spectrogram with a min Acq Time of 100 us, this Trigger Delay MaxValue is 6.55 sec. When the Acq Time is increased, this MaxValue also increases
State Saved	Saved in instrument state
Annotation	Trig Delay (in the Measurement Bar)
Backwards Compatibility Notes	<p>For backward compatibility with VSA/PSA comms apps</p> <pre>:TRIGger[:SEquence]:IF:DElay :TRIGger[:SEquence]:DElay</pre> <p>The legacy <code>:TRIGger[:SEquence]:DElay</code> command affects the delay for the VID, LINE, EXT1, EXT2, and RFB triggers</p> <p>Auto Function</p>
Remote Command	<pre>:TRIGger[:SEquence]:<trig_source>:DElay:STATe OFF ON 0 1 :TRIGger[:SEquence]:<trig_source>:DElay:STATe?</pre> <p>where <trig_source> is one of: LINE EXTernal1 EXTernal2 EXTernal3 AEXTernal VIDeo ADC RFBurst FRAME LEVel FMT IQMag IDEMod QDEMod IINPut QINPut AIQMag PXI INTernal</p>
Preset	OFF

Backwards Compatibility Commands

Example	<code>:TRIG:DEL 1 ms</code>
Preset	1 us
State Saved	Saved in instrument state
Backwards Compatibility	<code>:TRIGger[:SEquence]:DELay <time></code>
SCPI	<code>:TRIGger[:SEquence]:DELay?</code> <code>:TRIGger[:SEquence]:DELay:STATE OFF ON 0 1</code> <code>:TRIGger[:SEquence]:DELay:STATE?</code>

Example	<code>:TRIG:OFFS ON</code> <code>:TRIG:OFFS -100 ms</code>
---------	---

Notes
ESA commands for trigger offset, which allowed you to use a positive or negative delay when in zero span and in a Res BW \geq 1 kHz. For ESA compatibility, X-series instruments keep track of this offset and adds it to the Trigger Delay for VIDEO, LINE, EXTERNAL1 or EXTERNAL2 whenever the value is sent to the hardware, if in Zero Span and RBW \geq 1 kHz

Preset	Off, 0 s
State Saved	Saved in instrument state
Min	-11 s
Max	+11 s
Backwards Compatibility	<code>:TRIGger[:SEquence]:OFFSet <time></code>
SCPI	<code>:TRIGger[:SEquence]:OFFSet?</code>

Auto Function

Remote Command	<code>:TRIGger[:SEquence]:OFFSet:STATE OFF ON 0 1</code> <code>:TRIGger[:SEquence]:OFFSet:STATE?</code>
----------------	--

Preset	OFF
--------	-----

Trigger Delay Parameters

Note: in Swept SA, when transitioning from Zero Span to Swept spans, the trigger delay is clipped to -150 ms if it had been longer in Zero Span.

Source	Example	Preset	Min	Max	Resolution
Video	<code>TRIG:VID:DEL:STAT ON</code> <code>TRIG:VID:DEL 100 ms</code>	Off, 1 us	-150 ms (-10s in Swept SA Zero Span)	+500 ms	100 ns
Level	<code>TRIG:LEV:DEL:STAT ON</code>	Off, 30 ms	0 ms	70 sec (but	Multiple of Acq

Source	Example	Preset	Min	Max	Resolution
	TRIG:LEV:DEL 100 ms			dependent on Acq Time like FMT)	Time (as is FMT)
FMT	TRIG:FMT:DEL:STAT ON TRIG:FMT:DEL 100 ms	Off, 30 ms	0 ms	70 sec (but dependent on Acq Time like FMT)	Multiple of Acq Time (as is FMT)
External 1 2	TRIG:EXT1:DEL:STAT ON TRIG:EXT2:DEL 100 ms	Off, 1 us	-150 ms (-10s in Swept SA Zero Span)	+500 ms	100 ns
Line	TRIG:LINE:DEL:STAT ON TRIG:LINE:DEL 100 ms	Off, 1 us	-150 ms (-10s in Swept SA Zero Span)	+500 ms	100 ns
RF Burst	TRIG:RFB:DEL:STAT ON TRIG:RFB:DEL 100 ms	Off, 1 us	-150 ms (-10s in Swept SA Zero Span)	+500 ms	100 ns
Periodic Timer	TRIG:FRAM:DEL:STAT ON TRIG:FRAM:DEL 100 ms	Off, 1 us	-150 ms (-10s in Swept SA Zero Span)	+500 ms	100 ns
I/Q Mag	TRIG:IQM:DEL:STAT ON TRIG:IQM:DEL 10 ms	Off, 1 us	-2.5 s	+10 s	10 ns
I (Demod)	TRIG>IDEM:DEL:STAT ON TRIG>IDEM:DEL 10 ms	Off, 1 us	-2.5 s	+10 s	10 ns
Q (Demod)	TRIG:QDEM:DEL:STAT ON TRIG:QDEM:DEL 10 ms	Off, 1 us	-2.5 s	+10 s	10 ns
Input I	TRIG:IINP:DEL:STAT ON TRIG:IINP:DEL 10 ms	Off, 1 us	-2.5 s	+10 s	10 ns
Input Q	TRIG:QINP:DEL:STAT ON TRIG:QINP:DEL 10 ms	Off, 1 us	-2.5 s	+10 s	10 ns
Aux Chan I/Q Mag	TRIG:AIQM:DEL:STAT ON TRIG:AIQM:DEL 10 ms	Off, 1 us	-2.5 s	+10 s	10 ns
PXI	TRIG:PXI:DEL:STAT ON TRIG:PXI:DEL 10 ms	Off, 1 us	-150 ms	+500 ms	100 ns
Internal	TRIG:INT:DEL:STAT ON TRIG:INT:DEL 10 ms	Off, 1 us	-150 ms	+500 ms	100 ns
Prot Channel Detection	TRIG:PRTC:DEL:STAT ON TRIG:PRTC:DEL 1 ms	Off, 1 ms	-10 ms	+10 ms	100 ns

8 Trigger
8.1 Trigger

Source	Example	Preset	Min	Max	Resolution
Prot Frame Aligned	TRIG:PRTF:DEL:STAT ON TRIG:PRTF:DEL 1 ms	Off, 1 ms	-10 ms	+10 ms	100 ns
Prot Event	TRIG:PRTE:DEL:STAT ON TRIG:PRTE:DEL 1 ms	Off, 1 ms	-10 ms	+10 ms	100 ns

Note: in Bluetooth Mode, the preset value of Trigger Delay is always (On, -20us).

More Information

Here is the diagram for Frequency Mask Trigger (FMT) Trigger Delay:

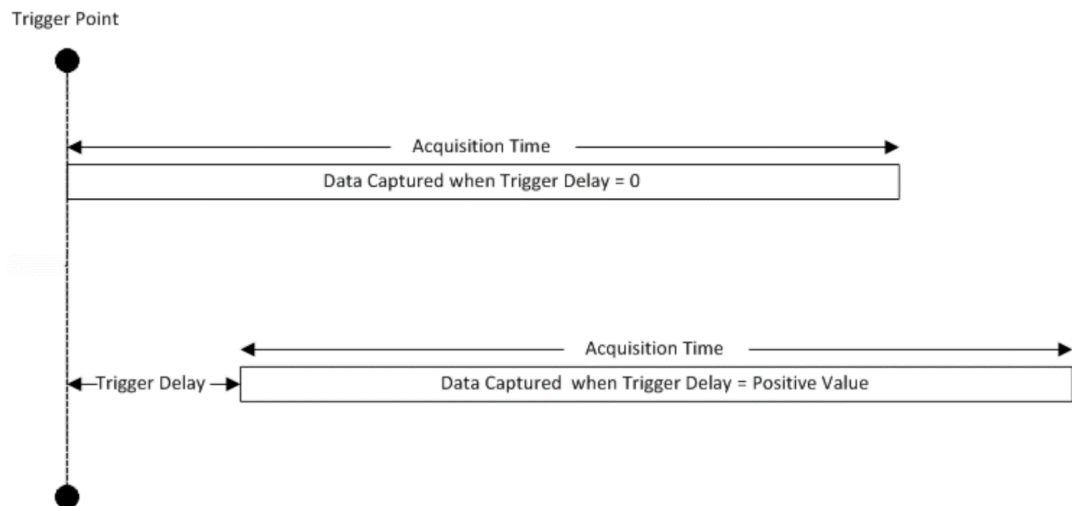

8.1.4 Trigger Slope

Sets the trigger polarity for Trigger and Gate sources that support Trigger Slope. It is set positive to trigger on a rising edge and negative to trigger on a falling edge.

For any given Trigger, Gate, or Periodic Sync source, the same Trigger Slope is used for the Trigger source in the Trigger menu, for the Gate source in the Gate Source menu, and for the Periodic Sync source in the Periodic Sync Src menu.

Remote Command :TRIGger[:SEquence]:<trig_source>:SLOPe POSitive | NEGative
 :TRIGger[:SEquence]:<trig_source>:SLOPe?

where <trig_source> is one of:

LINE | EXTernal1 | EXTernal2 | EXTernal3 | AEXTernal | VIDEo | ADC RFBurst |

	IQMag IDEMod QDEMod IINPut QINPut AIQMag PXI INternal
Example	:TRIG:VID:SLOP NEG :TRIG:VID:SLOP? :TRIG:EXT1: SLOP NEG
Dependencies	Only appears when Video, Line, External 1 2, RF Burst or an I/Q trigger is selected as the Trigger Source
Preset	POSitive
State Saved	Saved in instrument state
Backwards Compatibility SCPI	:TRIGger[:SEquence]:IF:SLOPe NEGative POSitive :TRIGger[:SEquence]:IF:SLOPe? For backward compatibility with VSA/PSA comms apps :TRIGger[:SEquence]:EXTernal:SLOPe For backward compatibility, the parameter EXTernal is mapped to EXTernal1 :TRIGger[:SEquence]:FRAMe:EXTernal1:SLOPe :TRIGger[:SEquence]:FRAMe:EXTernal2:SLOPe

Example	:TRIG:SLOP NEG
Preset	POSitive
State Saved	Saved in instrument state
Backwards Compatibility SCPI	:TRIGger[:SEquence]:SLOPe POSitive NEGative :TRIGger[:SEquence]:SLOPe?

Note: when transitioning from Zero Span to Swept spans, the trigger delay is clipped to -150 ms if it had been longer in Zero Span.

8.1.5 Trigger Level Absolute/Relative

Selects either Absolute or Relative Burst Triggering.

Remote Command	:TRIGger[:SEquence]:RFBurst:LEVel:TYPE ABSolute RELative :TRIGger[:SEquence]:RFBurst:LEVel:TYPE?
Example	Set the trigger level type of the RF burst trigger to Relative: :TRIG:RFB:LEV:TYPE REL
Dependencies	Only appears when RF Burst is selected as the Trigger Source
Preset	ABSolute
State Saved	Saved in instrument state

8.1.6 Absolute Trigger Level

Sets the absolute trigger level for the RF burst envelope.

NOTE

When using the External Mixing path, the Absolute Trigger Level is uncalibrated because the factory default was set to accommodate the expected IF levels for the RF path.

Remote Command	<code>:TRIGger[:SEquence]:RFBurst:LEVel:ABSolute <ampl></code> <code>:TRIGger[:SEquence]:RFBurst:LEVel:ABSolute?</code>
Example	Set the trigger level of the RF burst envelope signal to the absolute level of 10 dBm: <code>:TRIG:RFB:LEV:ABS 10 dBm</code>
Notes	Sending this command does not switch the setting from relative to absolute; to switch it you need to send <code>:TRIGger[:SEquence]:RFBurst:LEVel:TYPE</code> For Bluetooth Mode, the default value is -50 dBm
Dependencies	Only appears when RF Burst is selected as the Trigger, Gate or Periodic Sync Source
Couplings	This same level is used for the RF Burst trigger source in the Trigger menu, for the RF Burst selection in the Gate Source menu, and also for the RF Burst selection in the Periodic Sync Src menu
Preset	LTEA FDD/TDD modes: -40 dBm or -50 dBm depending on the hardware 5G NR mode: -40 dBm All other modes: -20 dBm
State Saved	Saved in instrument state
Min	-200 dBm
Max	100 dBm
Backwards Compatibility SCPI	<code>:TRIGger[:SEquence]:FRAMe:RFBurst:LEVel:ABSolute</code>

8.1.7 Relative Trigger Level

Sets the relative trigger level for the RF burst envelope.

In some models, the relative burst trigger function is implemented in hardware. In other models, without the advanced triggering hardware required, the relative burst trigger function is implemented in software in some measurements, and is unavailable in other measurements.

When implemented in software, the relative RF Burst trigger function is implemented as follows:

1. The measurement starts with the absolute RF Burst trigger setting. If it cannot get a trigger with that level, auto trigger fires and the acquisition starts anyway.

After the acquisition, the measurement searches for the peak in the acquired waveform and saves it

2. In the next cycle of the measurement, the measurement determines a new absolute RF Burst level based on the peak value from the first measurement and the Relative RF Burst Trigger Level (always 0 or negative dB) set by the user. The following formula is used: absolute RF Burst level = peak level of the previous acquisition + relative RF Burst level
3. If the new absolute RF Burst level differs from the previous by more than 0.5 dB, the new level is sent to the hardware; otherwise, it is not updated (to avoid slowing down the acquisition)

Steps 2 and 3 repeat for subsequent measurements.

Remote Command	<code>:TRIGger[:SEquence]:RFBurst:LEVel:RELative <rel_ampl></code> <code>:TRIGger[:SEquence]:RFBurst:LEVel:RELative?</code>
Example	Set the trigger level of the RF burst envelope signal to the relative level of -10 dB: <code>:TRIG:RFB:LEV:REL -10 dB</code>
Notes	Sending this command does not switch the setting from absolute to relative; to switch it you need to send <code>:TRIGger[:SEquence]:RFBurst:LEVel:TYPE</code> The relative trigger level is not available in some measurements. In those measurements the <code>RELative</code> parameter, and <code>:TRIGger[:SEquence]:RFBurst:LEVel:TYPE</code> generates an error if sent
Dependencies	This control is grayed-out and Absolute Trigger Level selected if the required hardware is not present in your instrument and the current measurement does not support Relative triggering Only appears when RF Burst is selected as the Trigger Source
Preset	-6 dB GSM: -25 dB
State Saved	Saved in instrument state
Min	-45 dB
Max	0 dB
Backwards Compatibility SCPI	<code>:TRIGger[:SEquence]:RFBurst:LEVel</code> This legacy command is aliased to <code>:TRIGger[:SEquence]:RFBurst:LEVel:RELative</code> because PSA had <i>only</i> relative burst triggering In some models, a variety of burst trigger circuitry is available, resulting in various available burst trigger bandwidths. The instrument automatically chooses the appropriate trigger path based on the hardware configuration and other settings of the instrument. Here is the RF Burst Trigger Bandwidth table for Swept SA Measurement in SA mode:

8 Trigger
8.1 Trigger

Model	Option	Span	Swp Type	FFT Width	Trigger BW, -10 dB	Notes
EXA	any	All	all	all	16 MHz	
MXA	w/o B25	All	all	all	16 MHz	
MXA	B25	Zero	N/A	N/A	16 MHz	
MXA	B25	All	Swept	N/A	16 MHz	
MXA	B25	< 8 MHz	FFT	all	16 MHz	
MXA	B25	≥ 8 MHz	FFT	25 MHz	30 MHz	
PXA	any	all	all	all	> 80 MHz	Exceptions(*)

(*) Exceptions: When the RF Burst Trigger Level Type is Absolute, the start frequency is below 300 MHz, and the sweep type is either Swept or FFT with an FFT width of less than 25 MHz, then the RF Burst Trigger Bandwidth is not >80 MHz. It would be 16 MHz except in the subcase of Sweep Type = FFT and FFT Width between 8 and 25 MHz inclusive, where it would be 30 MHz.

8.1.8 Period

Sets the period of the internal periodic timer clock. For digital communications signals, this is usually set to the frame period of your current input signal. In the case that sync source is not set to OFF, and the external sync source rate is changed for some reason, the periodic timer is synchronized at every external synchronization pulse by resetting the internal state of the timer circuit.

Remote Command	<code>:TRIGger[:SEquence]:FRAMe:PERiod <time></code> <code>:TRIGger[:SEquence]:FRAMe:PERiod?</code>
Example	<code>:TRIG:FRAM:PER 100 ms</code>
Dependencies	The invalid data indicator turns on when the period is changed, until the next sweep/measurement completes Only appears when Periodic Timer is selected as the Trigger or Gate Source
Couplings	The same period is used in the Gate Source selection of the period timer
Preset	20 ms unless noted below: GSM: 4.615383 ms 5G NR: 10 ms
State Saved	Saved in instrument state
Min	100.000 ns
Max	559.0000 ms

8.1.9 Offset

Adjusts the accumulated offset between the periodic timer events and the trigger event. Adjusting the accumulated offset is different than setting an offset and requires explanation.

The periodic timer is usually not synchronized with any external events, so the timing of its output events has no absolute meaning. Since the timing relative to external events (RF signals) is important, you need to be able to adjust (offset) it. However, you have no direct way to see when the periodic timer events occur. All that you can see is the trigger timing. When you want to adjust the trigger timing, you will be changing the internal offset between the periodic timer events and the trigger event. Because the absolute value of that internal offset is unknown, we will just call that the accumulated offset. Whenever the Offset parameter is changed, you are changing that accumulated offset. You can reset the displayed offset using Reset Offset Display. Changing the display does not change the value of the accumulated offset, and you can still make additional changes to accumulated offset.

To avoid ambiguity, we define that an increase in the "offset" parameter, either from the knob or the SCPI adjust command, serves to delay the timing of the trigger event.

Remote Command	<code>:TRIGger[:SEquence]:FRAMe:OFFSet <time></code> <code>:TRIGger[:SEquence]:FRAMe:OFFSet?</code>
Example	<code>:TRIG:FRAM:OFFS 1.2 ms</code>
Notes	<p>The front panel interface (for example, the knob), and this command, adjust the accumulated offset, which is shown on the control</p> <p>However, the actual amount sent to the hardware each time the offset is updated is the delta value, that is, the current accumulated offset value minus the previous accumulated offset value. Note that the accumulated offset value is essentially arbitrary; it represents the accumulated offset from the last time the offset was zeroed (with the Reset Offset Display key)</p> <p>Note that this command does not change the period of the trigger waveform. Note also that Offset is used only when the sync source is set to OFF, otherwise delay is used, see "Trigger Delay" on page 2461</p> <p>An increase in the "offset" parameter, either from the knob or the SCPI adjust command, serves to delay the timing of the trigger event</p> <p>When the SCPI command is sent the value shown on the control is updated with the new value. However, the actual amount sent to the hardware is the delta value, that is, the current accumulated offset value minus the previous accumulated offset value</p> <p>The SCPI query simply returns the value currently showing on the key</p>
Dependencies	<p>The invalid data indicator turns on when the offset is changed, until the next sweep/measurement completes</p> <p>Only appears when Periodic Timer is selected as the Trigger or Gate Source</p>

8 Trigger
8.1 Trigger

Couplings	The same offset is used in the Gate Source selection of the period timer
Preset	0 s
State Saved	Saved in instrument state
Min	-10.000 s
Max	10.000 s

8.1.10 Reset Offset Display

Resets the value of the periodic trigger offset display setting to 0.0 seconds. The current displayed trigger location may include an offset value defined with the **Offset** key. Pressing this control redefines the currently displayed trigger location as the new trigger point that is 0.0 s offset. The **Offset** control can then be used to add offset relative to this new timing.

Remote Command	<code>:TRIGger[:SEquence]:FRAMe:OFFSet:DISPlay:RESet</code>
Example	<code>:TRIG:FRAM:OFFS:DISP:RES</code>
Dependencies	Only appears when Periodic Timer is selected as the Trigger or Gate Source

8.1.11 Offset Adjust (Remote Command Only)

Lets you advance the phase of the frame trigger by the amount you specify. It does *not* work in the same way as the related front panel keys.

The command does not change the period of the trigger waveform. If the command is sent multiple times, it advances the phase of the frame trigger an additional amount each time it is sent. Negative numbers are permitted.

Remote Command	<code>:TRIGger[:SEquence]:FRAMe:ADJust <time></code>
Example	<code>:TRIG:FRAM:ADJ 1.2 ms</code>
Notes	<p>Note also that Offset is used only when the sync source is set to OFF, otherwise delay is used, see section "Trigger Delay" on page 2461</p> <p>An increase in the "offset" parameter, either from the knob or the SCPI adjust command, serves to delay the timing of the trigger event</p> <p>The front panel interface (for example, the knob) and the <code>:TRIG:FRAM:OFFS</code> command adjust the accumulated offset, which is shown on the active function display. However, the actual amount sent to the hardware is the delta value, that is, the current offset value minus the previous offset value</p> <p>When the SCPI command is sent the value shown on the control (and the Active Function, if this happens to be the active function) is updated by increasing it (or decreasing it if the value sent is negative) by the amount specified in the SCPI command</p> <p>This is no query for this command</p>
Dependencies	The invalid data indicator turns on when the offset is changed, until the next sweep/measurement

	completes
Couplings	The same offset is used in the Gate Source selection of the period timer
Preset	0 s
State Saved	Saved in instrument state
Min	-10.000 s
Max	10.000 s

8.1.12 Sync Source

For convenience, you can select the Periodic Timer Sync Source using this dropdown. You can also select it from the Periodic Sync Src tab, which also contains controls that let you configure the Sync Source.

Selects a signal source for you to synchronize your periodic timer trigger to, otherwise you might be triggering at some arbitrary location in the frame. Synchronization reduces the precision requirements on the setting of the period.

Example	<pre>:TRIG:FRAM:SYNC EXT1 :TRIG:FRAM:SYNC EXT2 :TRIG:FRAM:SYNC RFB :TRIG:FRAM:SYNC OFF</pre>
Dependencies	Only appears when Periodic Timer is selected as the Trigger or Gate Source
Preset	OFF
State Saved	Saved in instrument state

8.1.13 TV Line

Selects the **TV Line** number on which to trigger. Line number range is dependent on the settings of the **"Standard"** on page 2474 and **"Field"** on page 2473 menus within the TV trigger setup functions. When the line number is incremented beyond the upper limit, the value will change to the lower limit and continue incrementing from there. When the line number is decremented below the lower limit, the value will change to the upper limit and continue decrementing from there.

Remote Command	<pre>:TRIGger[:SEquence]:TV:LINE <integer> :TRIGger[:SEquence]:TV:LINE?</pre>
Example	<pre>:TRIG:TV:LINE 20 :TRIG:TV:LINE?</pre>
Dependencies	<p>Only available in the Swept SA measurement</p> <p>Only appears when TV is selected as the Trigger Source</p>

8 Trigger

8.1 Trigger

Preset	17
State Saved	Saved in instrument state
Min	1 The minimum value is the minimum line and rolls over to the maximum value. The minimum line number depends on which Field and standard are selected
Max	The maximum value is the maximum line and rolls over to the minimum value. The maximum line number depends on which Field and standard are selected Field 1 (ODD): <ul style="list-style-type: none"> Maximum line is 263 for formats NTSC-M, NTSC-Japan, NTSC-4.43, PAL-M and PAL-60 Maximum line is 313 for formats PAL-B, D, G, H, I, PAL-N, PAL-N Combin, and SECAM-L Field 2 (EVEN): <ul style="list-style-type: none"> The maximum line 262 for formats NTSC-M, NTSC-Japan, NTSC-4.43, PAL-M and PAL-60 The maximum line is 312 for formats PAL-B, D, G, H, I, PAL-N, PAL-N Combin, and SECAM-L Field = ENTire Frame: <ul style="list-style-type: none"> 525, for formats NTSC-M, NTSC-Japan, NTSC-4.43, PAL-M and PAL-60 625, for formats PAL-B, D, G, H, I, PAL-N, PAL-N Combin, and SECAM-L

8.1.14 Field

Selects the **Field** on which to trigger:

Entire Frame	ENTire	Causes the selected line number to be viewed as an offset into the entire frame starting with line 1, the first line in Field One
Field One	ODD	Causes the selected line number to be viewed as an offset into the first field starting with Line 1, the first line in Field One
Field Two	EVEN	Causes the selected line number to be viewed as an offset into the second field. If Line 1 is selected, it is the 264th line of the frame (NTSC-M, NTSC-Japan, NTSC-4.43, PAL-M, PAL-60) or the 314th line of the frame (PAL-B,D,G,H,I, PAL-N, PAL-N-Combin, SECAM-L)

Remote Command	<code>:TRIGger[:SEquence]:TV:FMODe ENTire ODD EVEN</code> <code>:TRIGger[:SEquence]:TV:FMODe?</code>
Example	<code>:TRIG:TV:FMOD ENT</code> <code>:TRIG:TV:FMOD EVEN</code> <code>:TRIG:TV:FMOD ODD</code>
Dependencies	Only available in the Swept SA measurement Only appears when TV is selected as the Trigger Source

	This command is available only when Option B7B (TV trigger) is installed
Preset	<code>ENTire</code>
Range	<code>ENTire ODD EVEN</code>

8.1.15 Standard

Accesses the **Standard** menu keys, which select from the following TV standards:

NTSC-M	<code>MNTSc</code>
NTSC-Japan	<code>JNTSc</code>
NTSC-4.43	<code>NTSC443</code>
PAL-M	<code>MPAL</code>
PAL-B,D,G,H,I	<code>BPAL</code>
PAL-N	<code>NPAL</code>
PAL-N-Combin	<code>CPAL</code>
PAL-60	<code>PAL60</code>
SECAM-L	<code>LSEC</code>

As the TV standard is changed, the current line value is clipped as necessary to keep it valid for the chosen standard and field mode. For example, line 600 is selected in Entire Frame mode in PAL-N; if NTSC-M is selected, the line number is clipped to 525. Or, if line 313 is selected in Field 1 mode in PAL-N and NTSC-M is selected, the line number is clipped to 263. Changing back to the PAL-N standard will leave the line number at 263.

Remote Command	<code>:TRIGger[:SEquence]:TV:STANdard MNTSc JNTSc NTSC443 MPAL BPAL NPAL CPAL PAL60 LSEC</code> <code>:TRIGger[:SEquence]:TV:STANdard?</code>
Example	Sets NTSC-M <code>:TRIG:TV:STAN MNTS</code> Queries Standard <code>:TRIG:TV:STAN?</code>
Dependencies	Only available in the Swept SA measurement Only appears when TV is selected as the Trigger Source
Preset	<code>MNTS</code>
State Saved	Saved in instrument state
Range	<code>MNTSc JNTSc NTSC443 MPAL BPAL NPAL CPAL PAL60 LSEC</code>

8.1.16 Trigger Center Frequency

Sets the center frequency to be used by the auxiliary receiver for the **Auxiliary Channel I/Q Magnitude** trigger.

Remote Command	<code>:TRIGger[:SEquence]:AIQMag:CENTer <freq></code> <code>:TRIGger[:SEquence]:AIQMag:CENTer?</code>
Example	<code>:TRIG:AIQM:CENT 10 MHz</code>
Notes	Trigger CF + 1/2 Trigger BW < Max Trigger CF - 1/2 Trigger BW > Min
Dependencies	Only appears when Aux Channel I/Q Mag is selected as the Trigger Source
Preset	0 Hz
State Saved	Saved in instrument state
Range	-40 MHz to 40 MHz
Min	-40 MHz
Max	40 MHz

8.1.17 Trigger BW

Sets the information bandwidth used by the auxiliary receiver for the Auxiliary Channel I/Q Magnitude trigger.

Remote Command	<code>:TRIGger[:SEquence]:AIQMag:BANDwidth <freq></code> <code>:TRIGger[:SEquence]:AIQMag:BANDwidth?</code>
Example	<code>:TRIG:AIQM:BAND 8 MHz</code>
Notes	The combined sample rate for the main and auxiliary receivers cannot exceed 100 MSa/sec. The bandwidth available to Trigger BW is limited to what is available after the main receiver's bandwidth (Info BW, sometimes pre-FFT BW) is set. Because of this limitation, the Max is not always achievable. The combination of " Trigger Center Frequency " on page 2475 and Trigger BW is also limited: <ul style="list-style-type: none"> - Trigger CF + 1/2 Trigger BW < Max - Trigger CF - 1/2 Trigger BW > Min
Dependencies	Only appears when Aux Channel I/Q Mag is selected as the Trigger Source
Preset	Bandwidth option dependent: <ul style="list-style-type: none"> - No Opt: 10 MHz - Opt B25: 25 MHz - Opt S40: 40 MHz

State Saved	Saved in instrument state
Range	10 Hz to Maximum
Min	10 Hz
Max	Bandwidth option & I/Q input path-dependent: <ul style="list-style-type: none"> - No Opt, I or Q Only: 10 MHz, I+jQ: 20 MHz - Opt B25, I or Q Only: 25 MHz, I+jQ: 50 MHz - Opt S40, I or Q Only: 40 MHz, I+jQ: 80 MHz

8.1.18 Zero Span Delay Compensation On/Off

In **Zero Span**, there is a natural delay in the signal path, which comes from the RBW filter. This is usually desirable, as it lets you trigger on events and also see those events, because the signal is delayed from the trigger event. However, in some cases it is desirable to eliminate this delay, so that trigger events line up exactly with the zero-time point in **Zero Span**. You can use the **Zero Span Delay Comp On/Off** feature to enable or disable zero span delay compensation.

Remote Command	<code>:TRIGger[:SEquence]:EXTernal1 EXTernal2 RFBurst:DELay:COMPensation OFF ON</code> <code> 0 1</code> <code>:TRIGger[:SEquence]:EXTernal1 EXTernal2 RFBurst:DELay:COMPensation?</code>
Example	<code>:TRIG:EXT1:DEL:COMP ON</code> <code>:TRIG:EXT1:DEL:COMP?</code> <code>:TRIG:EXT2:DEL:COMP ON</code> <code>:TRIG:RFB:DEL:COMP ON</code>
Dependencies	No effect except in zero-span, but not locked out in nonzero spans Zero Span Delay Compensation only appears in the Swept SA and List Power Step measurements. Only External and RF Burst triggers support it Does not appear in VXT If the SCPI command is sent when the control is not shown, an error is returned: -221, "Settings conflict; Feature not supported for this measurement" Only appears when External 1 2 or RF Burst is selected as the Trigger, Gate or Periodic Sync Source
Preset	<code>OFF</code>
State Saved	Saved in instrument state

8.1.19 Select PXI Line

Controls which `PXI_TRIG[0..7]` backplane line is used for the trigger source.
Only found in modular analyzer products.

8 Trigger

8.1 Trigger

Remote Command	<code>:TRIGger[:SEquence]:PXI:LINE <line></code> <code>:TRIGger[:SEquence]:PXI:LINE?</code>
Example	<code>:TRIG:PXI:LIN 2</code>
Preset	0
State Saved	Saved in instrument state
Range	[0,7]

8.1.20 Reset Sync Monitor

Lets you reset the status of Synchronization for **Periodic** trigger This control works together with bit 6 “Waiting for Periodic Sync Source” in the `:STATus:OPERation:CONDition` status register.

When you first switch to periodic trigger, RF Burst is the default Sync Source. The register will be set immediately. A “Periodic Trigger, Waiting for Sync Source” message will be generated after 2 seconds (if the instrument is not synchronized). The system is waiting for a RF Burst signal. You can tap the screen to remove the message.

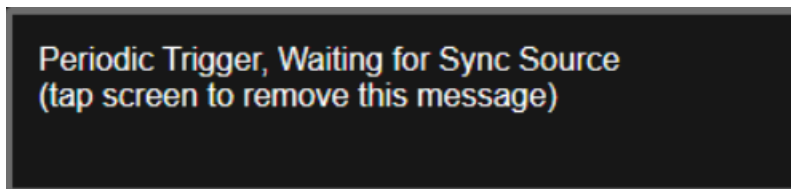

Once RF burst signal is provided and the hardware synchronized, the register will be cleared and a “Periodic Trigger Synchronized” message will be generated.

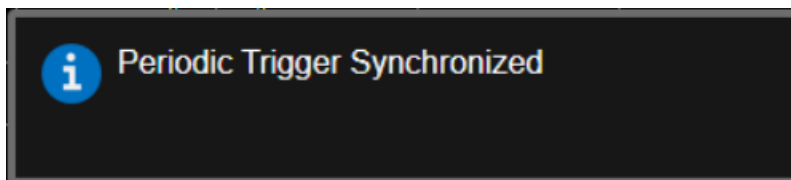

When change to a new Sync Source other than Off, take External1 as an example. You'll get the condition register set to 1 and a pop-up message again. There are the possible following conditions:

- External1 is provided: the register is cleared, message is updated.
- External1 is not provided, you set the Sync Source to Off: the register is cleared, message is cleared.
- External1 is not provided, you set the Sync Source to External2: the register and message keep the same.

- External1 is not provided, you set the Sync Source back to RF Burst: the register is cleared, message is also cleared. That’s because the instrument is synchronized to RF Burst already. If you want to make a new synchronization, you have to press “Reset Sync Monitor” you send SCPI command “:TRIG:FRAM:SMON:RES”.

Remote Command	:TRIGger[:SEquence]:FRAMe:SMONitor:RESet
Example	:TRIG:FRAM:SMON:RES
Notes	<p>This control works together with bit 1 “Waiting for Periodic Sync Source” in the :STATus:OPERation:INSTRument:CONDition status register</p> <p>A “Periodic Trigger, Waiting for Sync Source” message will be generated after pressing this control, and the status bit will be set</p> <p>A “Periodic Trigger Synchronized” message will be generated after successfully synchronizing to Sync Source, and the status bit will be cleared</p>
Dependencies	<p>Only functional when Periodic Trigger is selected as the Trigger or Gate Source, and Sync Source is not Off</p> <p>Only available in VXT models M9410A/11A/15A/16A</p>
Status Bits/OPC dependencies	Bit 6 of :STATus:OPERation:CONDition will be set after pressing this control

8.1.21 Trigger Optimization

Sets the trigger behavior for various desired operation conditions.

Remote Command	:TRIGger[:SEquence]:OPTimize:MODE NORMAL MJITter
	For option details, see " Options " on page 2478
	:TRIGger[:SEquence]:OPTimize:MODE?
Example	<p>Select trigger optimization for minimum jitter:</p> <p>:TRIG:OPT:MOD MJIT</p>
Dependencies	<p>Only appears in VXT models M9410A/11A/15A/16A</p> <p>Minimum jitter is functional only when digital IF BW is lower than 300 MHz. When Trigger Optimization is set to MJITter and it is not in effect, the following warning message appears in the status bar:</p> <p>Settings Alert; Minimum Jitter is not available</p>
Preset	NORMAL
State Saved	Yes
Range	NORMAL MJITter

Options

Trigger optimization options are:

8 Trigger

8.1 Trigger

Trigger Optimization	SCPI	Notes
Normal	<code>NORMa1</code>	No optimization
Minimum Jitter	<code>MJITter</code>	Optimizes trigger for minimum jitter. A software resample method is provided to reduce jitter, at the expense of some measurement speed The acquisition jitter depends on the digital IF BW, the jitter will be smaller when digital IF BW gets larger. For example, when the digital IF BW is 98.3 MHz in 5GNR, the jitter varies under 15ns. When set MJITter as trigger optimization type, the jitter will be reduced to 1ns This setting applies to all the Trigger Sources

8.1.22 Trigger Settings Diagram

Lets you configure the **Trigger** system using a visual utility.

First, select what you want to configure (the Trigger, Gate or Periodic Sync Source) by tapping the box for **Trigger**, **Gate** or **Periodic Sync Source**.

Next, tap any box in the gray row to choose a Trigger Source to connect to. For **Periodic Sync Source**, you can also tap **Off**.

The **Trigger Settings Diagram** changes depending on context. The Trigger Sources that are available change depending on which input you have selected.

8.2 Gate Source

Contains controls that let you select and configure Gate control signals.

This tab appears in the **Trigger** menu panel for measurements that support gating. In measurements that do not support gating, this tab does not appear.

The menus under the **Gate Source** tab are the same as those under the **Trigger** tab, with these exceptions:

A smaller set of sources is available for gating.

The Free Run and Video selections are not provided for Gate

- The Trig Delay controls are not present
- Relative RF Burst Triggering is not available, just Absolute
- There is an additional control, Sync Holdoff, under Gate Source

Any changes to the settings in the setup menus under each Gate Source selection (for example: Trigger Level, Trigger Delay, etc.) also affect the corresponding settings under the Trigger menu keys. The gate system uses the Trigger SCPI commands for the setup functions, since each setting affects both Gate and Trigger.

Example: to set the Trigger Level for External 1 Trigger you use the command `:TRIG:EXT1:LEV`; to set the Trigger Level for External 1 Gate you use the same command, `:TRIG:EXT1:LEV`. By the same token, once you set the External 1 Trigger Level to 1v, it is 1v whether External 1 is being used as a Gate Source or a Trigger Source.

If a command is sent to the **TRIG** node to set the functions that are omitted from the **Gate Source** menus (Auto Trig, Holdoff, Trig Delay), it is accepted and the values stored, but the values are not visible from the **Gate Source** menus.

8.2.1 Select Gate Source

Selects the source of the Gate signal for doing Gated Trigger measurements.

This version of the **Select Gate Source** function is used in all measurements except the Pulse measurement application.

For the selection of the gate source the SCPI node, `:TRIGger[:SEquence]:` is replaced by `[:SENSe]:SWEep:EGATe:` as shown in the remote command below. Because you can independently set the Gate Source and the Trigger Source, there is a separate SCPI command for the Gate Source.

Remote Command `[:SENSe]:SWEep:EGATe:SOURce EXTerna11 | EXTerna12 | LINE | FRAMe | RFBurst`

8 Trigger
8.2 Gate Source

	TV VIDEO PXI INTERNAL [:SENSE]:SWEp:EGATe:SOURce?
Example	:SWE:EGAT:SOUR EXT1 :SWE:EGAT:SOUR?
Dependencies	Available selections differ depending on models as below
	Benchtop Line, External 1, External 2, RF Burst, Periodic, TV (Swept SA only)
	VXT Video, Internal, External 1, External 2, RF Burst, Periodic, PXI Internal and Periodic are not available in Spectrum Analyzer Mode - Internal is available only in M9410A/11A/15A/16A and unavailable in M9420/21A
	EXM Video, Internal, External 1, External 2, RF Burst, Periodic Not available in E7760 In some models, there is no second External input. In these models, the External 2 selection is not shown and the EXTERNAL2 parameter will generate a "Hardware missing; Not available for this model number" error
Preset	GSM/EDGE, Phase Noise: FRAM MSR: EXT1 LTEATDD, 5G NR: - Direction is Downlink: EXT1 - Direction is Uplink: FRAM All Others: EXT1

8.2.2 Sync Holdoff

Applies only to the Periodic Timer. Specifies the duration that the sync source signal for the Periodic Timer must be kept false before the transition to true to be recognized as the sync timing. The periodic timer phase is aligned when the sync source signal becomes true, after the Holdoff time is satisfied.

A holdoff of 2 ms works with most WiMAX signals, but there may be cases where the burst off duration is less than 1 ms and this value will need to be changed.

Remote Command	:TRIGger[:SEquence]:FRAMe:SYNC:HOLDoff <time> :TRIGger[:SEquence]:FRAMe:SYNC:HOLDoff?
Example	:TRIG:FRAM:SYNC:HOLD 5 :TRIG:FRAM:SYNC:HOLD?
Dependencies	Only appears if Periodic is the selected Gate Source Does not appear in all Measurements. For example, does not appear in Swept SA

Preset	LTEATDD: ON, 1 ms 5G NR: ON, 250.0 us 1xEVDO: OFF, 0 ms (SCPI only) Other than above: OFF, 4 msec
State Saved	Saved in instrument state
Min	0 ms
Max	+500 ms
Auto Function	
Remote Command	<code>:TRIGger[:SEquence]:FRAMe:SYNC:HOLDoff:STATe OFF ON 0 1</code> <code>:TRIGger[:SEquence]:FRAMe:SYNC:HOLDoff:STATe?</code>
Preset	LTEATDD, 5G NR: ON Others: OFF

8.3 Gate Settings

Contains controls that let you control the gating function. The Gate functionality is used to view signals best viewed by qualifying them with other events.

This tab appears in the **Trigger** menu panel for measurements that support gating. In measurements that do not support gating, this tab does not appear.

In the Swept SA measurement, the Gate controls, and all SCPI under the `[:SENSe] :SWEep:EGATe` SCPI node are unavailable when Source Mode is set to Tracking. This is because the Gate circuitry is used to sync the external source. If the Tracking Source is turned on, the Gate is turned off.

Gate setup parameters are the same for all measurements – they do not change as you change measurements. Settings like these are called “Meas Global” and are unaffected by Meas Preset.

Note that Sweep Time auto coupling rules and annotation are changed when Gate is on.

8.3.1 Gate On/Off

Turns the gate function on or off.

When the Gate Function is **ON**, the selected Gate Method is used along with the gate settings and the signal at the gate source to control the sweep and video system with the gate signal. Not all measurements allow every type of Gate Methods.

If the Gate were to be turned **ON** without a gate signal present, Marker Count operation would be unreliable, so it is locked out whenever Gate is on for measurements that support Marker Count.

Remote Command	<code>[:SENSe] :SWEep:EGATe [:STATe] OFF ON 0 1</code> <code>[:SENSe] :SWEep:EGATe [:STATe] ?</code>
Example	<code>:SWE:EGAT ON</code> <code>:SWE:EGAT ?</code>
Dependencies	The function is unavailable (grayed-out) and OFF when: <ul style="list-style-type: none"> – Gate Method is LO or Video and FFT Sweep Type is manually selected – Gate Method is FFT, and Swept Sweep Type is manually selected – Marker Count is ON <p>The following are unavailable whenever Gate is on:</p> <ul style="list-style-type: none"> – FFT under Sweep Type when Method=LO or Video or Swept under Sweep Type when Method=FFT

- **Marker Count**

While Gate is on, the Auto Rules for Sweep Type are modified so that the choice agrees with the Gate Method: i.e., FFT for Method = FFT and Swept for Method = LO or Video

When in the ACP measurement:

- When Meas Method is RBW or FAST, this function is unavailable, and the control is grayed-out
- Whenever Gate is on, Meas Method, RBW, or FAST is unavailable and keys for those are grayed-out
- When Gate is on, Offset Res BW and Offset Video BW are ignored (if you set these values) and the measurement works as if all Offset Res BW and all Offset Video BW are coupled with the Res BW and the Video BW under the BW menu. When Gate is on, the Offset BW control in the Offset/Limit menu is grayed-out

Preset	LTEATDD Mode: ON Other modes: OFF
State Saved	Saved in instrument state
Range	OFF ON
Annunciation	Annunciated in the Meas Bar ; if Gate is on, the word "Gate:" followed by the gate type appears, where <ul style="list-style-type: none"> - LO = Gated LO - Vid = Gated Video - FFT = Gated FFT
Backwards Compatibility SCPI	[:SENSe] :SWEep :TIME :GATE [:STATE] Available in SA and SCPI LC Modes ESA compatibility
Backwards Compatibility Notes	In ESA, Trig Delay (On) and Gate (On) could not be active at the same time. This dependency does not exist in PSA or in the X-Series

8.3.2 Gate View On/Off

Turning on Gate View puts the instrument into Gate View. When in Gate View, the regular view of the current measurement traces and results are reduced vertically to about 70% of the regular height. The Zero Span window, showing the positions of the Gate, is shown between the Measurement Bar and the reduced measurement window. By reducing the height of the measurement window, some of the annotation on the Data Display may not fit and is not shown.

Remote Command	[:SENSe] :SWEep :EGATe :VIEW ON OFF 1 0 [:SENSe] :SWEep :EGATe :VIEW?
Example	Turn on the gate view:

8 Trigger

8.3 Gate Settings

:SWE:EGAT:VIEW ON	
Dependencies	<p>In the Swept SA measurement:</p> <p>In Gate View, the regular Sweep Time (or Acquisition Time) control is grayed out, to avoid confusing the user who wants to set Gate View Sweep Time. When pressed, the grayed-out control puts up the informational message "Use Gate View Sweep Time in the Gate menu"</p> <p>In other measurements:</p> <p>When you turn Gate View on, the lower window takes on the current state of the instrument. Upon leaving Gate View, the instrument takes on the state of the lower window</p> <p>When you turn Gate View on, the upper window Sweep Time (or Acquisition Time) is set to Gate View Sweep Time (or Gate View Acquisition Time)</p>
Couplings	<p>These couplings apply to the Swept SA measurement:</p> <ul style="list-style-type: none"> - When Gate View is turned on, the instrument is set to Zero Span - Gate View automatically turns off whenever a Span other than Zero is selected - Gate View automatically turns off if you press the Swept Span toggle under Freq while in Gate View, and the instrument returns to the Span it was in before entering Gate View (even if that is Zero Span) - When Gate View is turned on, the sweep time used is the Gate View Sweep Time. This is set according to the rules in "Gate View Sweep Time" on page 2491 - When Gate View is turned off, Sweep Time is set to the normal Swept SA measurement sweep time - If Gate View is on and Gate is off, then turning on Gate turns off Gate View
Preset	OFF
State Saved	Saved in instrument state
Range	ON OFF
Annunciation	<p>For Gate View to work properly, a gate signal must be present at the selected Gate Source. Therefore, in Gate View, any time more than 2 seconds passes with no gate signal, a pop-up message "Waiting for gate input" appears. This message goes away when a gate signal appears</p>

Turning Gate View off returns the instrument to the Normal measurement view.

In Swept SA, the normal measurement view is the single-window Swept SA view. When returning to this view, the Swept SA measurement returns to the Span it was in before entering **Gate View** (even if that is Zero Span).

The **Gate View** window is triggered from the Gate Source, with zero trigger delay. Also, when updating the **Gate View** window, the Gate itself must not operate. So, it is internally shut off while the gate view window is being updated. For the Swept SA measurement, this means that the Gate is internally shut off whenever the gate view window is displayed. The measurement bar and controls continue to show the Trigger source for the main sweep window and give no indication that the Gate is shut off or that the Gate View window is triggered from the Gate Source.

When in **Gate View**, vertical lines are displayed in the Gate View window as follows:

Green lines labeled GATE START and GATE STOP are displayed at the gate edges as follows: in Edge Gate, a line is shown for Delay and one for the end of the Gate period, defined by Length. In Level Gate a line is shown only for Delay. You can adjust the position of the green lines by adjusting the gate length and the gate delay or by dragging them with your finger or the mouse.. These lines update in the Gate View window as the active function changes, even if the window is not being updated. In Gated LO and Gated Video, these lines are positioned relative to the delay reference line (not relative to 0 time). In Gated FFT, their location is relative to the left edge of the screen.

A blue line is displayed showing the delay reference, that is, the reference point for the Gate Delay within the Zero Span window. The blue line represents where (in time) the effective location of the gate start would be if the gate were programmed to zero delay.

- A second blue line is displayed at the location that represents the boundary between "compensated IF" and "compensated LO" operating modes. The second blue line is labeled "MIN FAST" because it represents the minimum Gate Delay for fast Gated LO operation. This line is only displayed in Gated LO. You cannot scroll (knob) or decrement (down key) the Gate Delay to less than that represented by the position of this line, it can only be set below this position manually, although once there it can be moved freely with the knob while below the line.

A yellow line in the Gated Video case only, is displayed at B_{length} , where B_{length} is the display point (bucket) length for the swept trace, which is given by the Sweep Time (or Acquisition Time) for that trace divided by number of Points - 1. So, it is referenced to 0 time, not to the delay reference. This line is labeled NEXT PT (it is not shown in the figure above because the figure above is for Gated LO). The yellow line represents the edge of a display point (bucket). Normally in Gated Video, the bucket length must be selected so that it exceeds the off time of the burst. There is another way to use the instrument in Gated Video measurements, and that is to set the bucket width much shorter than the off time of the burst. Then use the Max Hold trace function to fill in "missing" buckets more slowly. This allows you to see some of the patterns of the Gated Video results earlier, though seeing a completely filled-in spectrum later.

8.3.3 Gate Delay

Controls the length of time from the time the gate condition goes True until the gate is turned on.

Remote Command	<code>[:SENSe] :SWEp :EGATe :DELay <time></code>
Example	<code>:SWE :EGAT :DELay 500ms</code> <code>:SWE :EGAT :DELay ?</code>

8 Trigger
8.3 Gate Settings

Notes	Units of time are required, or no units; otherwise, an invalid suffix error message is generated
Preset	WiMAX OFDMA: 71 us GSM/EDGE: 600 us WLAN: 500 us 5G NR: 5 ms Others: 57.7 us
State Saved	Saved in instrument state
Min	0.0 us
Max	100 s
Backwards Compatibility SCPI	<code>[:SENSe]:SWEep:TIME:GATE:DELay</code> <i>This backward compatibility command is available in SA and SCPI LC Modes</i> ESA compatibility

8.3.4 Gate Length

Controls the length of time that the gate is on after it opens.

Remote Command	<code>[:SENSe]:SWEep:EGATe:LENGth <time></code> <code>[:SENSe]:SWEep:EGATe:LENGth?</code>
Example	<code>:SWE:EGAT:LENG 1</code> <code>:SWE:EGAT:LENG?</code>
Notes	Units of time are required, or no units; otherwise, an invalid suffix error message is generated
Dependencies	Grayed-out when Gate Method is set to FFT , in which case the label changes to that shown below 
	The control is also grayed-out if Gate Control = LEVe1
Preset	WiMAX OFDMA: 50 us GSM/EDGE: 200 us WLAN: 1.54 ms Others: 461.6 us
State Saved	Saved in instrument state
Min	100 ns
Max	5 s
Backwards Compatibility SCPI	<code>[:SENSe]:SWEep:TIME:GATE:LENGth</code> <i>This backward compatibility command is available in SA and SCPI LC Modes</i>

 ESA compatibility

8.3.5 Gate Method

Lets you choose one of the three different types of gating. Not all types of gating are available for all measurements.

Remote Command	<code>[:SENSe] :SWEep :EGATe :METHod LO VIdEo FFT</code> For option details, see " "LO" on page 2488 ", " "Video" on page 2488 " or " "FFT" on page 2489 " <code>[:SENSe] :SWEep :EGATe :METHod?</code>
Example	<code>:SWE :EGAT :METH FFT</code>
Dependencies	This function is only available in the Swept SA measurement in Spectrum Analyzer Mode This control is unavailable when Gate is On and FFT Sweep Type manually selected When selected, Sweep Type is forced to Swept, and the FFT selection in Sweep Type is grayed-out Only the FFT method is supported in non-SA products Only the FFT method is supported by VXT models M9410A/11A/15A/16A
Preset	LO
State Saved	Saved in instrument state
Range	Video LO FFT
Annunciation	In Meas Bar

LO

In [LO](#) gating, when Gate is [ON](#), the LO sweeps whenever the gate conditions as specified in the Gate menu are satisfied by the signal at the Gate Source.

This form of gating is more sophisticated, and results in faster measurements. With Gated LO, the instrument only sweeps while the gate conditions are satisfied. This means that a sweep could take place over several gate events. It would start when the gate signal goes true and stop when it goes false, and then continue when it goes true again. But since the LO is sweeping as long as the gate conditions are satisfied, the sweep typically finishes much more quickly than with Gated Video.

When in zero span, there is no actual sweep performed. But data is only taken while the gate conditions are satisfied. So even though there is no sweep, the gate settings will impact when data is acquired.

Video

In [Video](#) gating, when Gate is [ON](#), the video signal is allowed to pass through whenever the gate conditions as specified in the Gate menu are satisfied by the

signal at the Gate Source.

This form of gating may be thought of as a simple switch, which connects the signal to the input of the spectrum analyzer. When the gate conditions are satisfied, the switch is closed, and when the gate conditions are not satisfied, the switch is open. So we only look at the signal while the gate conditions are satisfied.

With this type of gating, you usually set the instrument to sweep very slowly. In fact, a general rule is to sweep slowly enough that the gate is guaranteed to be closed at least once per data measurement interval (bucket). Then if the peak detector is used, each bucket will represent the peak signal as it looks with the gate closed.

FFT

In **FFT** gating, when Gate is **ON**, an FFT is performed whenever the gate conditions as specified in the Gate menu are satisfied by the signal at the Gate Source. This is an FFT measurement that begins when the gate conditions are satisfied. Since the time period of an FFT is approximately $1.83/\text{RBW}$, you get a measurement that starts under predefined conditions and takes place over a predefined period. So, in essence, this is a gated measurement. You have limited control over the gate length, but it works in FFT sweeps, which the other two methods do not.

Gated FFT is not possible in zero span since the instrument is not sweeping, so in zero span the Gated LO method is used. Data is still only taken while the gate conditions are satisfied, so the gate settings do impact when data is acquired.

The Gate Length will be $1.83/\text{RBW}$.

This is a convenient way to make a triggered FFT measurement under control of an external gating signal.

8.3.6 Control Edge/Level

Sets the method of controlling the gating function from the gating signal.

- EDGE** The gate opens (after the Delay) on the selected edge (for example, positive) of the gate signal and closes on the alternate edge (for example, negative)
- LEVe1** The gate opens (after the Delay) when the gate signal has achieved a certain level and stays open as long as that level is maintained

Remote Command `[:SENSe] :SWEp:EGATe:CONTRol EDGE | LEVe1`
`[:SENSe] :SWEp:EGATe:CONTRol?`

Example `:SWE:EGAT:CONT EDGE`

Dependencies If the Gate Method is **FFT**, this control is grayed-out and **EDGE** is selected
 If the Gate Source is TV, Frame, or Line, this control is grayed-out and **EDGE** is selected

Preset	EDGE
State Saved	Saved in instrument state
Backwards Compatibility SCPI	<p><code>[:SENSe] :SWEEp :EGATE :TYPE</code></p> <p>This backwards-compatibility command is available when the primary command is available</p> <p><code>[:SENSe] :SWEEp :TIME :GATE :TYPE</code></p> <p>This backwards-compatibility command is available in SA and SCPILC Modes</p> <p>ESA Compatibility</p>

8.3.7 Gate Holdoff

Lets you increase or decrease the wait time after a gate event ends before the instrument will respond to the next gate signal.

After any Gate event finishes, the instrument must wait for the sweep system to settle before it can respond to another Gate signal. The instrument calculates a "wait time," taking into account a number of factors, including RBW and Phase Noise Optimization settings. The goal is to achieve the same accuracy when gated as in ungated operation. The figure below illustrates this concept:

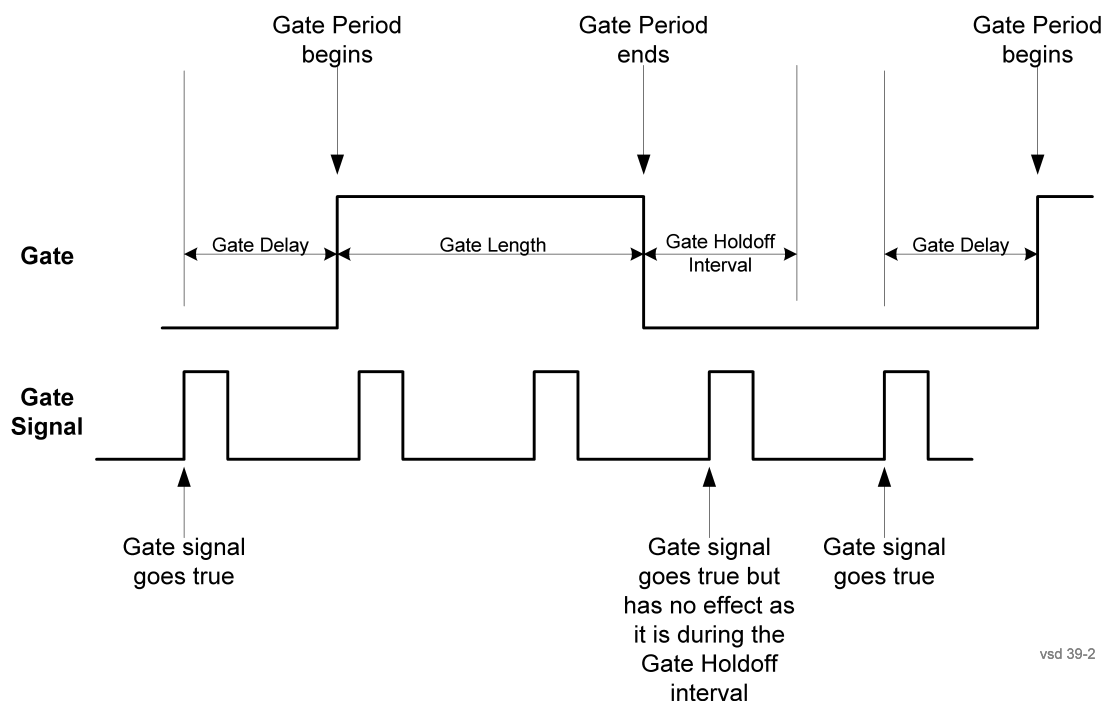

When **Gate Holdoff** is Auto, the wait time calculated by the instrument is used. When Gate Time is in Manual, the user may adjust the wait time, usually decreasing it in order to achieve greater speed, but at the risk of decreasing accuracy.

8 Trigger
8.3 Gate Settings

When the **Method** control is set to **Video** or **FFT**, the **Gate Holdoff** function has no effect.

In measurements that do not support "**Auto Function**" on page 2491, the value shown when Auto is selected is "---" and the manually set holdoff is returned to a query.

Remote Command	<code>[:SENSe]:SWEep:EGATe:HOLDoff <time></code> <code>[:SENSe]:SWEep:EGATe:HOLDoff?</code>
Example	<code>:SWE:EGAT:HOLD 0.0002</code> <code>:SWE:EGAT:HOLD?</code>
Couplings	When Gate Holdoff is Auto , the Gate Holdoff control shows the value calculated by the instrument for the wait time Pressing the Gate Holdoff control while it is in Auto and not selected, causes the control to become selected and allows the user to adjust the value. If the value is adjusted, the setting changes to Man Pressing the Gate Holdoff key, while it is in Auto and selected, does not change the value of Gate Holdoff , but causes the setting to change to Man . Now the user can adjust the value Pressing the control while it is in Man and selected, cause the value to change back to Auto Pressing the control while it is in Man and not selected, causes the control to become selected and allows the user to adjust the value When Method is set to Video or FFT , the Gate Holdoff function has no effect
Preset	Auto
State Saved	Saved in instrument state
Min	1 μsec
Max	1 sec

Auto Function

Remote Command	<code>[:SENSe]:SWEep:EGATe:HOLDoff:AUTO OFF ON 0 1</code> <code>[:SENSe]:SWEep:EGATe:HOLDoff:AUTO?</code>
Example	<code>:SWE:EGAT:HOLD:AUTO ON</code> <code>:SWE:EGAT:HOLD:AUTO?</code>
Preset	Auto/On
State Saved	Saved in instrument state
Range	Auto Man

8.3.8 Gate View Sweep Time

Controls the Sweep Time in the Gate View window. To provide an optimal view of the gate signal, the instrument initializes **Gate View Sweep Time** based on the current settings of Gate Delay and Gate Length.

NOTE Since **Gate View Sweep Time** is used to calculate Gate Delay and Gate Length increments, it is maintained even when not in **Gate View**.

NOTE In instruments without sweeping hardware such as some modular analyzers, this control may be labeled **Gate View Acquisition Time**

Remote Command	<code>[:SENSe] :SWEep:EGATe:TIME <time></code> <code>[:SENSe] :SWEep:EGATe:TIME?</code>
Example	<code>:SWE:EGAT:TIME 500 ms</code>
Dependencies	Gate View Sweep Time is initialized: <ul style="list-style-type: none"> - On Preset (after initializing delay and length) - Every time the Gate Method is set/changed <p>Additionally, in the Swept SA measurement, whenever you do a Preset, or leave Gate View, the instrument remembers the Gate Delay and Gate Length settings. Then, when returning to Gate View, if the current Gate Delay and/or Gate Length do not match the remembered values Gate View Sweep Time is re-initialized</p>
Preset	WiMAX OFDMA: 5 ms GSM/EDGE: 1 ms 5G NR: 10 ms Others: 800 μ s
State Saved	Saved in instrument state
Min	1 μ s
Max	6000 s
Annotation	The gate view Sweep Time is displayed in the lower-right corner of the gate view window

8.3.9 Gate View Start Time

Controls the time at the left edge of the Gate View.

Remote Command	<code>[:SENSe] :SWEep:EGATe:VIEW:STARt <time></code> <code>[:SENSe] :SWEep:EGATe:VIEW:STARt?</code>
Example	<code>:SWE:EGAT:VIEW:STAR 10ms</code>
Notes	Units of time are required or no units; otherwise, an invalid suffix error message is generated
Preset	0 ms
State Saved	Saved in instrument state
Min	0
Max	500 ms

8.3.10 Gate Delay Compensation

Allows you to select an RBW-dependent value by which to adjust the gate delay, to compensate for changes in the delay caused by RBW effects. You can select between uncompensated operation and two types of compensation:

Uncompensated	OFF
Delay Until RBW Settled	SETTled
Compensate for RBW Group Delay	GDElay

For full details of these options, see ["More Information" on page 2493](#)

Remote Command	<code>[:SENSe]:SWEep:EGATe:DELay:COMPensation:TYPE OFF SETTled GDElay</code> <code>[:SENSe]:SWEep:EGATe:DELay:COMPensation:TYPE?</code>
Example	<code>:SWE:EGAT:DEL:COMP:TYPE SETT</code> <code>:SWE:EGAT:DEL:COMP:TYPE?</code>
Notes	<p>Although this function is Meas Global, there are some measurements that do not support this function. In those measurements the control is not displayed, and the operation will be Uncompensated</p> <p>If some but not all measurements in a Mode support this function, then selecting a measurement that does not support it will not change the Meas Global selection; it will simply be “Uncompensated” while in that measurement. The SCPI command is still accepted while in that measurement</p> <p>If Gate Delay Compensation is not supported at all within a particular mode, the control is not displayed, and if the SCPI command is sent while in a measurement within that mode, an “Undefined Header” message is generated</p> <p>Note that, for modular products such as EXM and VXT, this function is not supported. In those products the control is not displayed and the SCPI is ignored, although it is accepted without error</p>
Preset	TD-SCDMA, LTEA FDD/TDD, 5G NR Modes: GDElay All other Modes: SETTled
State Saved	Saved in instrument state
Range	OFF SETTled GDElay

More Information

Selecting **Uncompensated** means that the actual gate delay is as you set it.

Selecting **Delay Until RBW Settled** causes the gate delay to be increased above the user setting by an amount equal to $3.06/\text{RBW}$. This compensated delay causes the GATE START and GATE STOP lines on the display to move by the compensation amount, and the actual hardware gate delay to be increased by the same amount. All the other gate lines (for example, MIN FAST) are unaffected. If the RBW subsequently changes, the compensation is readjusted for the new RBW. The value shown on the **Gate Delay** control does *not* change.

Delay Until RBW Settled allows excellent measurements of gated signals, by allowing the IF to settle following any transient that affects the burst. Excellent measurements also require that the analysis region not extend into the region affected by the falling edge of the burst. Thus, excellent measurements can only be made over a width that declines with narrowing RBWs, which is achieved by decreasing the gate length below the user setting by an amount equal to $2.53/\text{RBW}$. Therefore, for general purpose compensation, you will still want to change the gate length with changes in RBW even if the gate delay is compensated. The compensated Gate Length is limited by the instrument so that it will never go below 10% of the value shown on the Gate Length key, as otherwise the sweep times could get very long. Anytime the **Gate Length** and **RBW** values combine in such a way that this limiting takes place, a warning is displayed. For measurements that contain multiple sweeps with different RBW like SEM and SPUR, the smallest RBW is used for this limiting.

Selecting **Compensate for RBW Group Delay** causes the gate delay to be increased above the user setting by an amount equal to $1.81/\text{RBW}$. This compensated delay causes the GATE START, GATE STOP lines on the display to move by the compensation amount, and the actual hardware gate delay to be increased by the same amount. All the other gate lines (for example, MIN FAST) are unaffected. If the RBW subsequently changes, the compensation is readjusted for the new RBW. The value shown on the **Gate Delay** control does *not* change. **Compensate for RBW Group Delay** also includes gate length compensation; the gate length itself is adjusted as necessary to attempt to compensate for delay effects imposed by the RBW.

Compensate for RBW Group Delay is similar to **Delay Until RBW Settled** but compensates for the group delay of the RBW filter, rather than the filter settling time. As the RBW gets narrow, this can allow the settling tail of the RBW to affect the beginning part of the gated measurement and allow the beginning of the RBW settling transient to affect the end of the gated measurement. These two effects are symmetric because the RBW response is symmetric. Because the gate length is not automatically compensated, some users might find this compensation to be more intuitive than compensation for RBW settling.

8.3.11 Min Fast Position Query (Remote Query Only)

Queries the position of the MIN FAST line, relative to the delay reference (REF) line. See "[Gate View On/Off](#)" on page 2484. If this query is sent while not in Gate view, the MinFast calculation is performed based on the current values of the appropriate parameters and the result is returned. Reading this value lets you set an optimal gate delay value for the current measurement setup.

Example	<code>:SWE:EGAT:MIN?</code>
Backwards Compatibility SCPI	<code>[:SENSe] :SWEep:EGATe:MINFast?</code>

8.3.12 Gate Preset (Remote Command Only)

Presets the time-gated spectrum analysis capability.

This command sets gate parameter values to the ESA preset values, as follows:

- Gate trigger type = edge
- Gate polarity = positive
- Gate delay = 1 us
- Gate length = 1 us

Backwards Compatibility	<code>[:SENSe] :SWEp :TIME :GATE :PRESet</code>
SCPI	ESA Compatibility

8.3.13 Gate Level (Remote Command Only)

Sets the gate input transition point level for the external **TRIGGER** inputs on the front and rear panel. This is a legacy command for PSA compatibility. It is simply an alias to the equivalent trigger level command.

Notes	This command is simply an alias to <code>:TRIGger [:SEQuence] :EXTernal [1] 2 :LEVel</code>
Backwards Compatibility	<code>[:SENSe] :SWEp :EGATe :EXTernal [1] 2 :LEVel <voltage></code>
SCPI	<code>[:SENSe] :SWEp :EGATe :EXTernal [1] 2 :LEVel?</code>

8.3.14 Gate Polarity (Remote Command Only)

Sets the polarity for the gate signal. This setup is now done using the gate trigger's slope setting.

When **POSitive** is selected, a positive-going edge (Edge) or a high voltage (Level) will satisfy the gate condition, after the delay set with the Gate Delay key. When **NEGative** is selected, a negative-going edge (Edge) or a low voltage (Level) will satisfy the gate condition after the delay.

Example	<code>:SWE :EGAT :POL NEG</code> <code>:SWE :EGAT :POL ?</code>
---------	--

Preset	<code>POSitive</code>
--------	-----------------------

State Saved	Saved in instrument state
-------------	---------------------------

Backwards Compatibility SCPI	<pre>[:SENSe]:SWEep:EGATE:POLarity NEGative POSitive</pre> <pre>[:SENSe]:SWEep:EGATE:POLarity?</pre> <p>This backwards-compatibility command is available in Modes that support Gate Polarity parameter</p> <pre>[:SENSe]:SWEep:TIME:GATE:POLarity</pre> <p>This backwards-compatibility command is available in SA and SCPI LC Modes</p> <p>ESA compatibility</p>
---------------------------------	---

Preset	HIGH
--------	-------------

Backwards Compatibility SCPI	<pre>[:SENSe]:SWEep:TIME:GATE:LEVel HIGH LOW</pre> <pre>[:SENSe]:SWEep:TIME:GATE:LEVel?</pre> <p>ESA compatibility</p>
---------------------------------	--

8.4 Enables the hardware accelerated stepped FFT gating feature (Display only)

Enables or disables the hardware-accelerated stepped FFT gating feature:

- Enabling the Hardware Acceleration feature means that the Stepped FFT algorithm will run on the FPGA for configurations where speed improvements are possible
- Disabling the hardware-accelerated stepped FFT gating means the Stepped FFT software algorithm will always run on the CPU instead of the FPGA

When enabled it is only used when applicable and determined by the current sweep configuration.

The default value is **ON** and its value is power-on persistent.

Remote Command	<code>[:SENSe] :SWEep:EGATe:HACCeLerate:ENABle OFF ON 0 1</code>
Example	<code>:SWEep:EGATe:HACCeLerate:ENABle ON</code>
Notes	Value ON means the hardware accelerated stepped FFT gating is used intelligently Value OFF means the hardware accelerated stepped FFT gating is always disabled
Dependencies	Only valid in ACP, CHP and SEM measurements
State Saved	Saved in instrument state

8.5 Periodic Sync Src

Contains controls that let you select and configure the sync signal for the **Periodic Timer** Trigger.

For convenience controls for adjusting the level and slope of the selected sync source are provided here. Note that these settings match those in the **Trigger** and **Gate Source** menus; that is, each trigger source has only one value of level and slope, regardless of which menu it is accessed from.

8.5.1 Select Periodic Timer Sync Source

Selects a signal source for you to synchronize your periodic timer trigger to, otherwise you are triggering at some arbitrary location in the frame. Synchronization reduces the precision requirements on the setting of the period.

Note that, with Sync Source **OFF**, the timing will drift unless the signal source frequency is locked to the instrument frequency reference.

Remote Command	<code>:TRIGger[:SEquence]:FRAMe:SYNC EXTernal1 EXTernal2 RFBurst PXI INTernal OFF</code> <code>:TRIGger[:SEquence]:FRAMe:SYNC?</code>
Example	<code>:TRIG:FRAM:SYNC EXT1</code> <code>:TRIG:FRAM:SYNC EXT2</code> <code>:TRIG:FRAM:SYNC RFB</code> <code>:TRIG:FRAM:SYNC OFF</code>
Dependencies	PXI and INTernal triggers are only found in modular analyzers such as VXT Not available in E7760 or UXM In some models, there is no second External input. In these models, the External 2 selection is not shown, and the EXTernal2 parameter generates a “Hardware missing; Not available for this model number” message
Preset	OFF GSM/EDGE, LTE, LTETDD, 5G NR: RFBurst
State Saved	Saved in instrument state
Backwards Compatibility SCPI	<code>:TRIGger[:SEquence]:FRAMe:SYNC EXTernal</code> For backwards-compatibility, the parameter EXTernal is mapped to EXTernal1

8.6 Auto/Holdoff

Contains controls that let you adjust Auto Trigger and Trigger Holdoff parameters
This tab does not appear in Spectrum Analyzer Mode in VXT model M9421A.

8.6.1 Trig Holdoff

Sets the holdoff time between triggers. When the trigger condition is satisfied, the trigger occurs, the delay begins, and the holdoff time begins. New trigger conditions will be ignored until the holdoff time expires. For a free-running trigger, the holdoff value is the minimum time between triggers.

Remote Command	<code>:TRIGger[:SEquence]:HOLDoff <time></code> <code>:TRIGger[:SEquence]:HOLDoff?</code>
Example	<code>:TRIG:HOLD:STAT ON</code> <code>:TRIG:HOLD 100 ms</code>
Dependencies	Unavailable if the selected Input is BBIQ . If this is the case, the control is grayed-out if it is pressed the informational message "Feature not supported for this Input" is displayed. If the SCPI command is sent, the error "Settings conflict; Feature not supported for this Input" is generated
Preset	All modes except GSM/EDGE, LTEAFDD/TDD and 5G NR: 100 ms GSM/EDGE, Bluetooth: 10 μ s LTEATDD: 19 ms 5G NR: 4 ms
State Saved	Saved in instrument state
Min	0 s
Max	0.5 s VXT models M9410A/11A/15A/16A: 2.86 s
Auto Function	
Remote Command	<code>:TRIGger[:SEquence]:HOLDoff:STATe OFF ON 0 1</code> <code>:TRIGger[:SEquence]:HOLDoff:STATe?</code>
Preset	All modes but GSM/EDGE: OFF GSM/EDGE mode: ON

8.6.2 Auto Trig

Sets the time that the instrument will wait for the trigger conditions to be met. If they are not met after that much time, then the instrument is triggered anyway.

Remote Command	<code>:TRIGger[:SEquence]:ATRigger <time></code> <code>:TRIGger[:SEquence]:ATRigger?</code>
Example	<code>:TRIG:ATR:STAT ON</code> <code>:TRIG:ATR 100 ms</code>
Notes	The "time that the instrument will wait" starts when the instrument is ready for a trigger, which may be hundreds of ms after the data acquisition for a sweep is done. The "time" ends when the trigger condition is satisfied, not when the delay ends
Dependencies	Not available in Real Time Spectrum Analyzer Mode
Preset	Off, 100 ms
State Saved	Saved in instrument state
Min	1 ms
Max	100 s
Auto Function	
Remote Command	<code>:TRIGger[:SEquence]:ATRigger:STATe OFF ON 0 1</code> <code>:TRIGger[:SEquence]:ATRigger:STATe?</code>
Preset	OFF

8.6.3 Holdoff Type

Enables you to set the Trigger **Holdoff Type**.

NOTE

Holdoff Type is not supported by all measurements. If the current measurement does not support it, this control does not appear, and **Holdoff Type** is Normal. If **Holdoff Type** SCPI is sent while in such a measurement, the SCPI is accepted and the setting remembered, but it has no effect until a measurement is in force that supports **Holdoff Type**.

Trigger Holdoff Type functionality

- NORMAL** This is the "oscilloscope" type of trigger holdoff and is the setting when the **Holdoff Type** control does not appear. In this type of holdoff, no new trigger will be accepted until the holdoff interval has expired after the previous trigger
- ABOVE** If the trigger slope is positive, a trigger event is generated only if the signal characteristic of interest crosses the trigger threshold (with positive slope) and then remains above the threshold for at least the holdoff time. For negative slope, the trigger event is generated if the signal characteristic crosses the threshold (with negative slope) after having been above the threshold for at least the holdoff time. In either case, the trigger event is associated with the time the level was crossed
- BELow** If the trigger slope is positive, a trigger event is generated only if the signal characteristic of interest crosses the trigger threshold (with positive slope) after

8 Trigger
 8.6 Auto/Holdoff

having been below the threshold for at least the holdoff time. For negative slope, the trigger event is generated if the signal characteristic crosses the threshold (with negative slope) and then remains below the threshold for at least the holdoff time. In either case, the trigger event is associated with the time the level was crossed

Remote Command	:TRIGger[:SEquence]:HOLDoff:TYPE NORMa1 ABOVe BELow :TRIGger[:SEquence]:HOLDoff:TYPE?	
Example	:TRIG:HOLD:TYPE NORM	
Preset	Modes	Setting
	GSM/EDGE	BELow
	Bluetooth	
	All others	NORMa1
State Saved	Saved in instrument state	

9 Programming the Instrument

This section provides information about the instrument's SCPI programming interface. You can also operate the instrument remotely using some legacy programming languages by running the N9061C Remote Language Compatibility measurement application and the N9062C SCPI Language Compatibility measurement application.

9.1 List of Supported SCPI Commands

The SCPI commands available while using this application are listed below.

To find a command in the list, search according to its first alphanumeric character, ignoring any leading ":" or "[" characters. The sole exception to this is the asterisk [*] prefix, identifying IEEE 488.2 Common commands and queries; all these appear at the start of the list.

Note that most commands also have query forms. In cases where a command and its query are described in the same topic, the list below includes the command and query as a *single* item, with no suffix.

Suffix	Interpretation
No suffix	Command & Query, <i>or</i> Command only For details, click the link to view the command definition
?	Query only

*

*CAL
 *CAL
 *CLS
 *ESE
 *ESR?
 *IDN?
 *OPC
 *OPT?
 *RCL
 *RST
 *SAV
 *SRE
 *STB?
 *TRG
 *TST?
 *WAI

A

ABORt

C

CALCuLate[:<meas>]:MATH?

```

CALCulate:<meas>:MATH
CALCulate:<meas>:MTRace
CALCulate:<meas>:PLAY:MODE
CALCulate:<meas>:PLAY:SRATe
CALCulate:<meas>:PLAY:START
CALCulate:<meas>:PLAY:STEP:FORWard
CALCulate:<meas>:PLAY:STOP
CALCulate:ACPower:LIMit:STATe
CALCulate:ACPower:MARKer[1]|2|...|12:MAXimum
CALCulate:ACPower:MARKer[1]|2|...|12:MAXimum:LEFT
CALCulate:ACPower:MARKer[1]|2|...|12:MAXimum:NEXT
CALCulate:ACPower:MARKer[1]|2|...|12:MAXimum:RIGHT
CALCulate:ACPower:MARKer[1]|2|...|12:MINimum
CALCulate:ACPower:MARKer[1]|2|...|12:MODE
CALCulate:ACPower:MARKer[1]|2|...|12:PTPeak
CALCulate:ACPower:MARKer[1]|2|...|12:REFerence
CALCulate:ACPower:MARKer[1]|2|...|12:TRACe
CALCulate:ACPower:MARKer[1]|2|...|12:X
CALCulate:ACPower:MARKer[1]|2|...|12:X:POSition
CALCulate:ACPower:MARKer[1]|2|...|12:Y?
CALCulate:ACPower:MARKer:AOFF
CALCulate:ACPower:MARKer:COUPle[:STATe]
CALCulate:ACPower:OFFSet[1]|2[:OUTer]:LIST:LIMit:NEGative
[:UPPer]:DATA
CALCulate:ACPower:OFFSet[1]|2[:OUTer]:LIST:LIMit:POSitive
[:UPPer]:DATA
CALCulate:CHPower:LIMit:POWer
CALCulate:CHPower:LIMit:POWer:FAIL?
CALCulate:CHPower:LIMit:POWer:STATe
CALCulate:CHPower:LIMit:PSDensity
CALCulate:CHPower:LIMit:PSDensity:STATe
CALCulate:CHPower:LIMit:PSD:FAIL?
CALCulate:CHPower:MARKer[1]|2|...|12:MAXimum
CALCulate:CHPower:MARKer[1]|2|...|12:MODE
CALCulate:CHPower:MARKer[1]|2|...|12:REFerence
CALCulate:CHPower:MARKer[1]|2|...|12:TRACe
CALCulate:CHPower:MARKer[1]|2|...|12:X
CALCulate:CHPower:MARKer[1]|2|...|12:X:POSition
CALCulate:CHPower:MARKer[1]|2|...|12:Y?
CALCulate:CHPower:MARKer:AOFF
CALCulate:CLIMits:FAIL?
CALCulate:DATA<n>:COMPRESS?
CALCulate:DATA[1]|2|...|6:PEAKs?
CALCulate:DDEMod:LIMit:STATe
CALCulate:DDEMod:LLINE[1]|2|...|6:COMMENT
CALCulate:DDEMod:LLINE[1]|2|...|6:COPY
CALCulate:DDEMod:LLINE[1]|2|...|6:DELeTe
CALCulate:DDEMod:LLINE[1]|2|...|6:DESCRiption
CALCulate:DDEMod:LLINE[1]|2|...|6:DISPlay
CALCulate:DDEMod:LLINE[1]|2|...|6:FAIL?

```

9 Programming the Instrument
 9.1 List of Supported SCPI Commands

```

CALCulate:DDEMod:LLINe[1]|2|...|6:MARGin
CALCulate:DDEMod:LLINe[1]|2|...|6:MARGin:STATe
CALCulate:DDEMod:LLINe[1]|2|...|6:OFFSet:UPDate
CALCulate:DDEMod:LLINe[1]|2|...|6:OFFSet:X
CALCulate:DDEMod:LLINe[1]|2|...|6:OFFSet:Y
CALCulate:DDEMod:LLINe[1]|2|...|6:TYPE
CALCulate:DDEMod:LLINe[1]|2|...|6:WINDow
CALCulate:DDEMod:LLINe[1]|2|...|6:X[:DATA]
CALCulate:DDEMod:LLINe[1]|2|...|6:X:POINTs?
CALCulate:DDEMod:LLINe[1]|2|...|6:X:REFerence
CALCulate:DDEMod:LLINe[1]|2|...|6:X:UNIT
CALCulate:DDEMod:LLINe[1]|2|...|6:Y[:DATA]
CALCulate:DDEMod:LLINe[1]|2|...|6:Y:POINTs?
CALCulate:DDEMod:LLINe[1]|2|...|6:Y:UNIT
CALCulate:DDEMod:LLINe:ALL:DELeTe
CALCulate:DDEMod:MARKer[1]|2|...|12:FUNCTion
CALCulate:DDEMod:MARKer[1]|2|...|12:FUNCTion:BAND:LEFT
CALCulate:DDEMod:MARKer[1]|2|...|12:FUNCTion:BAND:RIGHT
CALCulate:DDEMod:MARKer[1]|2|...|12:FUNCTion:BAND:SPAN
CALCulate:DDEMod:MARKer[1]|2|...|12:MAXimum
CALCulate:DDEMod:MARKer[1]|2|...|12:MAXimum:LEFT
CALCulate:DDEMod:MARKer[1]|2|...|12:MAXimum:NEXT
CALCulate:DDEMod:MARKer[1]|2|...|12:MAXimum:PREVIOUS
CALCulate:DDEMod:MARKer[1]|2|...|12:MAXimum:RIGHT
CALCulate:DDEMod:MARKer[1]|2|...|12:MINimum
CALCulate:DDEMod:MARKer[1]|2|...|12:MODE
CALCulate:DDEMod:MARKer[1]|2|...|12:PTPeak
CALCulate:DDEMod:MARKer[1]|2|...|12:REFerence
CALCulate:DDEMod:MARKer[1]|2|...|12[:SET]:CENTer
CALCulate:DDEMod:MARKer[1]|2|...|12:WINDow
CALCulate:DDEMod:MARKer[1]|2|...|12:X
CALCulate:DDEMod:MARKer[1]|2|...|12:Y:IMAGinary
CALCulate:DDEMod:MARKer[1]|2|...|12:Y[:REAL]
CALCulate:DDEMod:MARKer:AOFF
CALCulate:DDEMod:MARKer:COUPlE[:STATe]
CALCulate:DDEMod:SEGMENT1|...|6:COMPensate:IQOFFset[:STATe]
CALCulate:DDEMod:SEGMENT1|...|6:FILTer:COEFFicient:MEASure[:DATA]
CALCulate:DDEMod:SEGMENT1|...|6:FILTer:COEFFicient:REFerence[:DATA]
CALCulate:DDEMod:SEGMENT1|...|6:IQRotation
CALCulate:DDEMod:SEGMENT1|...|6:LIMit:CERRor[:HERTZ]
CALCulate:DDEMod:SEGMENT1|...|6:LIMit:DEVIation:OFFSet
CALCulate:DDEMod:SEGMENT1|...|6:LIMit:EVM:RMS
CALCulate:DDEMod:SEGMENT1|...|6:LIMit:FERRor[:HERTZ]
CALCulate:DDEMod:SEGMENT1|...|6:LIMit:OEVM:RMS
CALCulate:DDEMod:SEGMENT1|...|6:LIMit:POWer
CALCulate:DDEMod:SEGMENT1|...|6:NORMalize
CALCulate:DDEMod:SEGMENT1|...|6:OQPSk:IQALign[:STATe]
CALCulate:DDEMod:SEGMENT1|...|6:PPSYmbol:COUPlE
CALCulate:DDEMod:TRACe:SEARCh:TIME:LENGTh
CALCulate:DDEMod:TRACe:SEARCh:TIME:OFFSet
  
```

CALCulate:DDEMod:TRACe:SEARCh:TIME:REFeRence
 CALCulate:DDEMod:WINDow[1]|2|...|6:FAIL?
 CALCulate:FPOWer:POWer[1,2,...,999]?
 CALCulate:FPOWer:POWer[1,2,...,999]:CONFIgure
 CALCulate:FPOWer:POWer[1,2,...,999]:DEFine?
 CALCulate:FPOWer:POWer[1,2,...,999]:FETCh?
 CALCulate:FPOWer:POWer[1,2,...,999]:INITiate
 CALCulate:FPOWer:POWer[1,2,...,999]:READ?
 CALCulate:FPOWer:POWer[1,2,...,999]:READ1?
 CALCulate:FPOWer:POWer[1,2,...,999]:READ2?
 CALCulate:FPOWer:POWer[1,2,...,999]:RESet
 CALCulate:MATH
 CALCulate:MONitor:MARKer[1]|2|...|12:FUNCTion
 CALCulate:MONitor:MARKer[1]|2|...|12:FUNCTion:BAND:LEFT
 CALCulate:MONitor:MARKer[1]|2|...|12:FUNCTion:BAND:RIGHT
 CALCulate:MONitor:MARKer[1]|2|...|12:FUNCTion:BAND:SPAN
 CALCulate:MONitor:MARKer[1]|2|...|12:MAXimum
 CALCulate:MONitor:MARKer[1]|2|...|12:MAXimum:NEXT
 CALCulate:MONitor:MARKer[1]|2|...|12:MODE
 CALCulate:MONitor:MARKer[1]|2|...|12:REFeRence
 CALCulate:MONitor:MARKer[1]|2|...|12:STATe
 CALCulate:MONitor:MARKer[1]|2|...|12:TRACe
 CALCulate:MONitor:MARKer[1]|2|...|12:X
 CALCulate:MONitor:MARKer[1]|2|...|12:X:POSition
 CALCulate:MONitor:MARKer[1]|2|...|12:Y?
 CALCulate:MONitor:MARKer:AOFF
 CALCulate:MONitor:MARKer:COUPle[:STATe]
 CALCulate:OBWidth:LIMit:FBLimit
 CALCulate:OBWidth:LIMit[:TEST]
 CALCulate:OBWidth:MARKer[1]|2|...|12:MAXimum
 CALCulate:OBWidth:MARKer[1]|2|...|12:MODE
 CALCulate:OBWidth:MARKer[1]|2|...|12:REFeRence
 CALCulate:OBWidth:MARKer[1]|2|...|12:TRACe
 CALCulate:OBWidth:MARKer[1]|2|...|12:X
 CALCulate:OBWidth:MARKer[1]|2|...|12:X:POSition
 CALCulate:OBWidth:MARKer[1]|2|...|12:Y?
 CALCulate:OBWidth:MARKer:AOFF
 CALCulate:OFDM:MARKer[1]|2|...|12:FUNCTion
 CALCulate:OFDM:MARKer[1]|2|...|12:FUNCTion:BAND:LEFT
 CALCulate:OFDM:MARKer[1]|2|...|12:FUNCTion:BAND:RIGHT
 CALCulate:OFDM:MARKer[1]|2|...|12:FUNCTion:BAND:SPAN
 CALCulate:OFDM:MARKer[1]|2|...|12:FUNCTion:INTerval:LEFT
 CALCulate:OFDM:MARKer[1]|2|...|12:FUNCTion:INTerval:RIGHT
 CALCulate:OFDM:MARKer[1]|2|...|12:FUNCTion:INTerval:SPAN
 CALCulate:OFDM:MARKer[1]|2|...|12:MAXimum
 CALCulate:OFDM:MARKer[1]|2|...|12:MAXimum:LEFT
 CALCulate:OFDM:MARKer[1]|2|...|12:MAXimum:NEXT
 CALCulate:OFDM:MARKer[1]|2|...|12:MAXimum:PREVious
 CALCulate:OFDM:MARKer[1]|2|...|12:MAXimum:RIGHT
 CALCulate:OFDM:MARKer[1]|2|...|12:MINimum
 CALCulate:OFDM:MARKer[1]|2|...|12:MODE

9 Programming the Instrument
9.1 List of Supported SCPI Commands

CALCulate:OFDM:MARKer[1]|2|...|12:PTPeak
CALCulate:OFDM:MARKer[1]|2|...|12:REfERENCE
CALCulate:OFDM:MARKer[1]|2|...|12[:SET]:CENTer
CALCulate:OFDM:MARKer[1]|2|...|12:WINDow
CALCulate:OFDM:MARKer[1]|2|...|12:X
CALCulate:OFDM:MARKer[1]|2|...|12:Y:IMAGinary
CALCulate:OFDM:MARKer[1]|2|...|12:Y[:REAL]
CALCulate:OFDM:MARKer[1]|2|...|12:Z
CALCulate:OFDM:MARKer:AOff
CALCulate:OFDM:MARKer:COUple[:STATe]
CALCulate:PSTatistic:MARKer[1]|2|...|12:MODE
CALCulate:PSTatistic:MARKer[1]|2|...|12:REfERENCE
CALCulate:PSTatistic:MARKer[1]|2|...|12:TRACe
CALCulate:PSTatistic:MARKer[1]|2|...|12:X
CALCulate:PSTatistic:MARKer[1]|2|...|12:Y?
CALCulate:PSTatistic:MARKer:AOff
CALCulate:PSTatistic:MARKer:COUple[:STATe]
CALCulate:PSTatistic:RANGe[:PROBability]:MINimum
CALCulate:PSTatistic:STORe:REfERENCE
CALCulate:SEMask:LLIne:STATe
CALCulate:SEMask:MARKer[1]|2|...|12:MODE
CALCulate:SEMask:MARKer[1]|2|...|12:TRACe
CALCulate:SEMask:MARKer[1]|2|...|12:X
CALCulate:SEMask:MARKer[1]|2|...|12:X:POSition
CALCulate:SEMask:MARKer[1]|2|...|12:Y?
CALCulate:SEMask:MARKer:AOff
CALCulate:SEMask:MARKer:COUple[:STATe]
CALCulate:SPURious:MARKer[1]|2|...|12:MAXimum
CALCulate:SPURious:MARKer[1]|2|...|12:MAXimum:LEFT
CALCulate:SPURious:MARKer[1]|2|...|12:MAXimum:NEXT
CALCulate:SPURious:MARKer[1]|2|...|12:MAXimum:RIGHT
CALCulate:SPURious:MARKer[1]|2|...|12:MINimum
CALCulate:SPURious:MARKer[1]|2|...|12:MODE
CALCulate:SPURious:MARKer[1]|2|...|12:PTPeak
CALCulate:SPURious:MARKer[1]|2|...|12:REfERENCE
CALCulate:SPURious:MARKer[1]|2|...|12:TRACe:ATTached
CALCulate:SPURious:MARKer[1]|2|...|12:X
CALCulate:SPURious:MARKer[1]|2|...|12:X:POSition
CALCulate:SPURious:MARKer[1]|2|...|12:Y?
CALCulate:SPURious:MARKer:AOff
CALCulate:SPURious:MARKer:COUple[:STATe]
CALCulate:SPURious[:RANGe][:LIST]:LIMit:ABSolute[:UPPer]:DATA
[:START]
CALCulate:SPURious[:RANGe][:LIST]:LIMit:ABSolute
[:UPPer]:DATA:STOP
CALCulate:SPURious[:RANGe][:LIST]:LIMit:ABSolute
[:UPPer]:DATA:STOP:AUTO
CALCulate:WAVEform:MARKer[1]|2|...|12:FUNCTion
CALCulate:WAVEform:MARKer[1]|2|...|12:FUNCTion:BAND:LEFT
CALCulate:WAVEform:MARKer[1]|2|...|12:FUNCTion:BAND:RIGHT

CALCulate:WAVEform:MARKer[1]|2|...|12:FUNCTion:BAND:SPAN
 CALCulate:WAVEform:MARKer[1]|2|...|12:MAXimum
 CALCulate:WAVEform:MARKer[1]|2|...|12:MAXimum:NEXT
 CALCulate:WAVEform:MARKer[1]|2|...|12:MINimum
 CALCulate:WAVEform:MARKer[1]|2|...|12:MODE
 CALCulate:WAVEform:MARKer[1]|2|...|12:REFerence
 CALCulate:WAVEform:MARKer[1]|2|...|12:TRACe
 CALCulate:WAVEform:MARKer[1]|2|...|12:X
 CALCulate:WAVEform:MARKer[1]|2|...|12:X:POSition
 CALCulate:WAVEform:MARKer[1]|2|...|12:Y?
 CALCulate:WAVEform:MARKer:AOFF
 CALCulate:WAVEform:MARKer:COUPle[:STATe]
 CALCulate:WAVEform:MARKer:PEAK:SEARch:RANGe
 CALCulate:WAVEform:MARKer:PEAK:SEARch:RANGe:STARt
 CALCulate:WAVEform:MARKer:PEAK:SEARch:RANGe:STOP
 CALibration[:ALL]
 CALibration[:ALL]:NPENding
 CALibration:AUTO
 CALibration:AUTO:ALERT
 CALibration:AUTO:MODE
 CALibration:AUTO:TIME:OFF?
 CALibration:DATA:BACKup
 CALibration:DATA:DEFault
 CALibration:DATA:INTernal:BACKup
 CALibration:DATA:INTernal:RESTore
 CALibration:DATA:RESTore
 CALibration:EMIXer
 CALibration:EXPIred
 CALibration:FREQuency:REFerence:COARse
 CALibration:FREQuency:REFerence:FINE
 CALibration:FREQuency:REFerence:MODE
 CALibration:INTernal:ASFRanges?
 CALibration:INTernal:ASFRanges:EXTend[:STATe]
 CALibration:INTernal:ASFRanges:FRANGes
 CALibration:INTernal:ASFRanges[:STATe]
 CALibration:INTernal:EMPath
 CALibration:INTernal:FAST[:ALL]
 CALibration:INTernal:HBAND[:ALL]
 CALibration:INTernal:LBAND[:ALL]
 CALibration:INTernal:LOLeakage
 CALibration:INTernal:RECeiver[:ALL]
 CALibration:INTernal:RRHead:AMPLitude
 CALibration:INTernal:RRHead:AMPLitude:FAST
 CALibration:INTernal:RRHead:IFCable
 CALibration:INTernal:RRHead:LOPower
 CALibration:INTernal:RRHead:LOSync
 CALibration:INTernal:SOURce[:ALL]
 CALibration:INTernal:SOURce[:ALL]:NPENding
 CALibration:INTernal:VXT:TRANsceiver
 CALibration:IQ:FLATness:I
 CALibration:IQ:FLATness:I|IBAR|Q|QBAR:TIME?

9 Programming the Instrument
9.1 List of Supported SCPI Commands

CALibration:IQ:FLATness:IBAR
CALibration:IQ:FLATness:Q
CALibration:IQ:FLATness:QBAR
CALibration:IQ:ISOLation
CALibration:IQ:ISOLation:TIME?
CALibration:IQ:PROBe:I
CALibration:IQ:PROBe:I|:TIME?
CALibration:IQ:PROBe:IBar
CALibration:IQ:PROBe:IBAR:TIME?
CALibration:IQ:PROBe:I:CLEar
CALibration:IQ:PROBe:Q
CALibration:IQ:PROBe:QBar
CALibration:IQ:PROBe:QBAR:TIME?
CALibration:IQ:PROBe:Q:CLEar
CALibration:IQ:PROBe:Q:TIME?
CALibration:NFLoor
CALibration:NRF
CALibration:NRF:NPending
CALibration:NRF:Selector
CALibration:PDElay:CORRection
CALibration:PDElay:SOURce
CALibration:PRESelector
CALibration:REFerence:CLOCK?
CALibration:REFerence:CLOCK:END?
CALibration:REFerence:CLOCK:INITialize?
CALibration:RF
CALibration:RF:NPending
CALibration:RF:Selector:ALERT
CALibration:RF:Selector:CONDUCTed
CALibration:RF:Selector:FULL
CALibration:RF:Selector:ONLY
CALibration:RF:Selector:RADiated
CALibration:RF:Selector:SCHeduler:RECurrence
CALibration:RF:Selector:SCHeduler:RECurrence:DAY
CALibration:RF:Selector:SCHeduler:RECurrence:WEEK
CALibration:RF:Selector:SCHeduler:STATE
CALibration:RF:Selector:SCHeduler:TASK
CALibration:RF:Selector:SCHeduler:TIME:NEXT?
CALibration:RF:Selector:SCHeduler:TIME:START
CALibration:TDS
CALibration:TEMPerature:AGO?
CALibration:TEMPerature:CURRent?
CALibration:TEMPerature:CURRent:RRHead?
CALibration:TEMPerature:CURRent:RRHead:LO?
CALibration:TEMPerature:INTernal:EMPath?
CALibration:TEMPerature:INTernal:FAST?
CALibration:TEMPerature:INTernal:HBAND?
CALibration:TEMPerature:INTernal:LBAND?
CALibration:TEMPerature:INTernal:LOLeakage?
CALibration:TEMPerature:INTernal:RECeiver?

CALibration:TEMPERature:INTernal:RRHead:AMPLitude?
CALibration:TEMPERature:INTernal:RRHead:AMPLitude:FAST?
CALibration:TEMPERature:INTernal:RRHead:IFCable?
CALibration:TEMPERature:INTernal:RRHead:LOPower?
CALibration:TEMPERature:INTernal:RRHead:LOSync?
CALibration:TEMPERature:INTernal:SOURce?
CALibration:TEMPERature:INTernal:VXT:TRANSceiver?
CALibration:TEMPERature:LALL?
CALibration:TEMPERature:LIF?
CALibration:TEMPERature:LPRselector?
CALibration:TEMPERature:LRF?
CALibration:TEMPERature:MAXimum?
CALibration:TEMPERature:MINimum?
CALibration:TEMPERature:NFLoor?
CALibration:TEMPERature:OLDest:SEConds?
CALibration:TEMPERature:OLDest[:TEMPERature]?
CALibration:TEMPERature:PDElay:SOURce?
CALibration:TEMPERature:RFPSelector:LCONducted?
CALibration:TEMPERature:RFPSelector:LRADiated?
CALibration:TEMPERature:UPDown:CONVerter?
CALibration:TIME:ELAPsed:NFLoor?
CALibration:TIME:INTernal:EMPath?
CALibration:TIME:INTernal:FAST?
CALibration:TIME:INTernal:HBAN?
CALibration:TIME:INTernal:LBANd?
CALibration:TIME:INTernal:LOLeakage?
CALibration:TIME:INTernal:RECeiver?
CALibration:TIME:INTernal:RRHead:AMPLitude?
CALibration:TIME:INTernal:RRHead:AMPLitude:FAST?
CALibration:TIME:INTernal:RRHead:IFCable?
CALibration:TIME:INTernal:RRHead:LOPower?
CALibration:TIME:INTernal:RRHead:LOSync?
CALibration:TIME:INTernal:SOURce?
CALibration:TIME:INTernal:VXT:TRANSceiver?
CALibration:TIME:LALL?
CALibration:TIME:LIF?
CALibration:TIME:LPRselector?
CALibration:TIME:LRF?
CALibration:TIME:NFLoor?
CALibration:TIME:PDElay:SOURce?
CALibration:TIME:REFerence:CLOCK?
CALibration:TIME:RFPSelector:LCONducted?
CALibration:TIME:RFPSelector:LRADiated?
CALibration:TIME:UPDown:CONVerter?
CALibration:UPDown:CONVerter
CALibration:YTF
CALibration:YTF:NPENding
CONFigure?
CONFigure?
CONFigure:<measurement>[:NDEFault]
CONFigure:ACPpower

9 Programming the Instrument
9.1 List of Supported SCPI Commands

CONFigure:ACPower
CONFigure:ACPower:NDEFault
CONFigure:CATalog?
CONFigure:CHPower
CONFigure:CHPower
CONFigure:CHPower:NDEFault
CONFigure:DDEMod
CONFigure:DDEMod
CONFigure:DDEMod:NDEFault
CONFigure:MONitor
CONFigure:MONitor
CONFigure:MONitor:NDEFault
CONFigure:OBWidth
CONFigure:OBWidth
CONFigure:OBWidth:NDEFault
CONFigure:OFDM
CONFigure:PAVTime
CONFigure:PAVTime
CONFigure:PAVTime:NDEFault
CONFigure:PStatistic
CONFigure:PStatistic
CONFigure:PStatistic:NDEFault
CONFigure:SEMask
CONFigure:SEMask
CONFigure:SEMask:NDEFault
CONFigure:SPURious
CONFigure:SPURious
CONFigure:SPURious:NDEFault
CONFigure:WAVEform
CONFigure:WAVEform
CONFigure:WAVEform:NDEFault
COUple

D

DISPlay:<meas>:WINDow[1]:TRACe:Y[:SCALe]:RANGe
DISPlay:ACPower:VIEW[1]:WINDow[1]:TRACe:X[:SCALe]:COUple
DISPlay:ACPower:VIEW:NSElect
DISPlay:ACPower:VIEW[:SElect]
DISPlay:ACPower:WINDow[1]:BGRaph
DISPlay:ACPower:WINDow[1]:TRACe:Y[:SCALe]:COUple
DISPlay:ACPower:WINDow[1]:TRACe:Y[:SCALe]:PDIVision
DISPlay:ACPower:WINDow[1]:TRACe:Y[:SCALe]:RLEVel
DISPlay:ACPower:WINDow[1]:TRACe:Y[:SCALe]:RPOStition
DISPlay:ACTivefunc[:STATe]
DISPlay:ANNotation:MBAR[:STATe]
DISPlay:ANNotation:SCReen[:STATe]
DISPlay:ANNotation:TRACe[:STATe]
DISPlay:BACKlight

DISPlay:CHPower:WINDow[1]:BGRaph
DISPlay:CHPower:WINDow[1]:TRACe:Y[:SCALe]:COUPlE
DISPlay:CHPower:WINDow[1]:TRACe:Y[:SCALe]:PDIvIson
DISPlay:CHPower:WINDow[1]:TRACe:Y[:SCALe]:RLEvEl
DISPlay:CHPower:WINDow[1]:TRACe:Y[:SCALe]:RPOSItion
DISPlay:DDEMod:BITS:FORMat
DISPlay:DDEMod:EYE:TRACe:INTerval
DISPlay:DDEMod:SYMBol:SHAPE
DISPlay:DDEMod:SYMBol:SIZE
DISPlay:DDEMod:TXBit:PATTern
DISPlay:DDEMod:VIEW[:SElect]
DISPlay:DDEMod:WINDow[1]|2|...|6:SEGment?
DISPlay:DDEMod:WINDow[1]|2|...|6[:TRACe]:DATA
DISPlay:DDEMod:WINDow[1]|2|...|6[:TRACe]:FORMat
DISPlay:DDEMod:WINDow[1]|2|...|6:X[:SCALe]:COUPlE
DISPlay:DDEMod:WINDow[1]|2|...|6:X[:SCALe]:RLEvEl
DISPlay:DDEMod:WINDow[1]|2|...|6:X[:SCALe]:RPOSItion
DISPlay:DDEMod:WINDow[1]|2|...|6:X[:SCALe]:UNIT:TIME
DISPlay:DDEMod:WINDow[1]|2|...|6:X[:SCALe]:WIDTH
DISPlay:DDEMod:WINDow[1]|2|...|6:Y[:SCALe]:AUTO:ONCE
DISPlay:DDEMod:WINDow[1]|2|...|6:Y[:SCALe]:PDIvIson
DISPlay:DDEMod:WINDow[1]|2|...|6:Y[:SCALe]:RLEvEl
DISPlay:DDEMod:WINDow[1]|2|...|6:Y[:SCALe]:RPOSItion
DISPlay:DDEMod:Y[:SCALe]:AUTO:REStArt
DISPlay:ENABle
DISPlay:FSCReen[:STATe]
DISPlay:GRATicule[:STATe]
DISPlay:MONitor:WINDow[1]:TRACe:Y[:SCALe]:COUPlE
DISPlay:MONitor:WINDow[1]:TRACe:Y[:SCALe]:PDIvIson
DISPlay:MONitor:WINDow[1]:TRACe:Y[:SCALe]:RANGe
DISPlay:MONitor:WINDow[1]:TRACe:Y[:SCALe]:RLEvEl
DISPlay:MONitor:WINDow[1]:TRACe:Y[:SCALe]:RPOSItion
DISPlay:OBWidth:VIEW:NSElect
DISPlay:OBWidth:VIEW[:SElect]
DISPlay:OBWidth:WINDow[1]:TRACe:Y[:SCALe]:COUPlE
DISPlay:OBWidth:WINDow[1]:TRACe:Y[:SCALe]:PDIvIson
DISPlay:OBWidth:WINDow[1]:TRACe:Y[:SCALe]:RLEvEl
DISPlay:OBWidth:WINDow[1]:TRACe:Y[:SCALe]:RPOSItion
DISPlay:OBWidth:WINDow[1]:XDB
DISPlay:OBWidth:WINDow2:BOUNDaries:FREQuency
DISPlay:OFDM:DATA:SUBCarrier
DISPlay:OFDM:EVM:PERCent
DISPlay:OFDM:NULL:SUBCarrier
DISPlay:OFDM:PIlot:SUBCarrier
DISPlay:OFDM:PREamble:SUBCarrier
DISPlay:OFDM:SYNC:CORRelation:PERCent
DISPlay:OFDM:VIEW[:SElect]
DISPlay:OFDM:WINDow[1]|2|...|6:CCARrier
DISPlay:OFDM:WINDow[1]|2|...|6[:TRACe]:DATA
DISPlay:OFDM:WINDow[1]|2|...|6[:TRACe]:FORMat
DISPlay:OFDM:WINDow[1]|2|...|6:X[:SCALe]:COUPlE

9 Programming the Instrument
 9.1 List of Supported SCPI Commands

DISPLAY:OFDM:WINDOW[1]|2|...|6:X[:SCALE]:RLEVEL
 DISPLAY:OFDM:WINDOW[1]|2|...|6:X[:SCALE]:RPOSITION
 DISPLAY:OFDM:WINDOW[1]|2|...|6:X[:SCALE]:WIDTH
 DISPLAY:OFDM:WINDOW[1]|2|...|6:Y[:SCALE]:AUTO:ONCE
 DISPLAY:OFDM:WINDOW[1]|2|...|6:Y[:SCALE]:PDIVISION
 DISPLAY:OFDM:WINDOW[1]|2|...|6:Y[:SCALE]:RLEVEL
 DISPLAY:OFDM:WINDOW[1]|2|...|6:Y[:SCALE]:RPOSITION
 DISPLAY:OFDM:Y[:SCALE]:AUTO:RESTART
 DISPLAY:PAVTIME:TYPE
 DISPLAY:PAVTIME:VIEW[1]:WINDOW[1]:TRACE:Y[:SCALE]
 DISPLAY:PAVTIME:VIEW[1]:WINDOW[1]:TRACE:Y
 [:SCALE]:AMPLITUDE:PDIVISION
 DISPLAY:PAVTIME:VIEW[1]:WINDOW[1]:TRACE:Y
 [:SCALE]:AMPLITUDE:RLEVEL
 DISPLAY:PAVTIME:VIEW[1]:WINDOW[1]:TRACE:Y
 [:SCALE]:AMPLITUDE:RPOSITION
 DISPLAY:PAVTIME:VIEW[1]:WINDOW[1]:TRACE:Y[:SCALE]:PHASE:PDIVISION
 DISPLAY:PAVTIME:VIEW[1]:WINDOW[1]:TRACE:Y[:SCALE]:PHASE:RLEVEL
 DISPLAY:PAVTIME:VIEW[1]:WINDOW[1]:TRACE:Y[:SCALE]:PHASE:RPOSITION
 DISPLAY:PSTATISTIC:GAUSSIAN[:STATE]
 DISPLAY:PSTATISTIC:RTRACE[:STATE]
 DISPLAY:PSTATISTIC:VIEW[1]:WINDOW2:TRACE:X[:SCALE]:PDIVISION
 DISPLAY:SEMASK:OFFSET:SABSOLUTE
 DISPLAY:SEMASK:VIEW:NSELECT
 DISPLAY:SEMASK:VIEW[:SELECT]
 DISPLAY:SEMASK:WINDOW[1]:TRACE:X[:SCALE]:COUPLE
 DISPLAY:SEMASK:WINDOW[1]:TRACE:X[:SCALE]:PDIVISION
 DISPLAY:SEMASK:WINDOW[1]:TRACE:X[:SCALE]:RLEVEL
 DISPLAY:SEMASK:WINDOW[1]:TRACE:X[:SCALE]:RPOSITION
 DISPLAY:SEMASK:WINDOW[1]:TRACE:Y[:SCALE]:COUPLE
 DISPLAY:SEMASK:WINDOW[1]:TRACE:Y[:SCALE]:PDIVISION
 DISPLAY:SEMASK:WINDOW[1]:TRACE:Y[:SCALE]:RLEVEL
 DISPLAY:SEMASK:WINDOW[1]:TRACE:Y[:SCALE]:RPOSITION
 DISPLAY:SPURIOUS:FREQUENCY:CENTER[:STATE]
 DISPLAY:SPURIOUS:VIEW:RANGE:TABLE:FMODE
 DISPLAY:SPURIOUS:VIEW[:SELECT]
 DISPLAY:SPURIOUS:WINDOW[1]:TRACE:Y[:SCALE]:COUPLE
 DISPLAY:SPURIOUS:WINDOW[1]:TRACE:Y[:SCALE]:PDIVISION
 DISPLAY:SPURIOUS:WINDOW[1]:TRACE:Y[:SCALE]:RLEVEL
 DISPLAY:THEME
 DISPLAY:UINTERFACE:CSize
 DISPLAY:UINTERFACE:HTABS
 DISPLAY:UINTERFACE:STAB
 DISPLAY:UINTERFACE:STFScreen
 DISPLAY:UINTERFACE:TYPE?
 DISPLAY:VIEW:ADVANCED:CATALOG?
 DISPLAY:VIEW:ADVANCED:DELETE
 DISPLAY:VIEW:ADVANCED:DELETE:ALL
 DISPLAY:VIEW:ADVANCED:NAME
 DISPLAY:VIEW:ADVANCED:RENAME

DISPlay:VIEW:ADVanced:SElect
DISPlay:VIEW:ADVanced:USER:CATalog?
DISPlay:WAVEform:VIEW[1]|2:WINDow[1]:TRACe:X[:SCALE]:COUple
DISPlay:WAVEform:VIEW[1]|2:WINDow[1]:TRACe:X[:SCALE]:PDIVision
DISPlay:WAVEform:VIEW[1]|2:WINDow[1]:TRACe:X[:SCALE]:RLEVel
DISPlay:WAVEform:VIEW[1]|2:WINDow[1]:TRACe:X[:SCALE]:RPOStion
DISPlay:WAVEform:VIEW[1]|2:WINDow[1]:TRACe:Y[:SCALE]:COUple
DISPlay:WAVEform:VIEW[1]:WINDow[1]:TRACe:Y[:SCALE]:PDIVision
DISPlay:WAVEform:VIEW[1]:WINDow[1]:TRACe:Y[:SCALE]:RANGE
DISPlay:WAVEform:VIEW[1]:WINDow[1]:TRACe:Y[:SCALE]:RLEVel
DISPlay:WAVEform:VIEW[1]:WINDow[1]:TRACe:Y[:SCALE]:RPOStion
DISPlay:WAVEform:VIEW2:WINDow[1]:TRACe:Y[:SCALE]:PDIVision
DISPlay:WAVEform:VIEW2:WINDow[1]:TRACe:Y[:SCALE]:RANGE
DISPlay:WAVEform:VIEW2:WINDow[1]:TRACe:Y[:SCALE]:RLEVel
DISPlay:WAVEform:VIEW2:WINDow[1]:TRACe:Y[:SCALE]:RPOStion
DISPlay:WAVEform:VIEW:NSElect
DISPlay:WAVEform:VIEW[:SElect]
DISPlay:WINDow[1]:ANNOtation[:ALL]

F

FETCh:<measurement>[n]?
FETCh:ACPower?
FETCh:CHPower:DENSity[n]?
FETCh:CHPower[n]?
FETCh:DDEMod?
FETCh:MONitor[n]?
FETCh:OBwidth:FERRor?
FETCh:OBwidth[n]?
FETCh:OBwidth:OBwidth?
FETCh:OBwidth:XDB?
FETCh:PAVTime[n]?
FETCh:PStatistic?
FETCh:SEMask[n]?
FETCh:SPURious[n]?
FETCh:WAVEform?
FORMat:BORDER
FORMat[:TRACe][:DATA]

H

HCOPy:ABORt
HCOPy[:IMMediate]

I

INITiate:<measurement>

9 Programming the Instrument
9.1 List of Supported SCPI Commands

INITiate:ACPower
INITiate:CHPower
INITiate:CONTinuous
INITiate:DDEMod
INITiate[:IMMediate]
INITiate:MONitor
INITiate:OBWidth
INITiate:PAUSE
INITiate:PAVTime
INITiate:PStatistic
INITiate:REStart
INITiate:RESume
INITiate:SEMask
INITiate:SPURious
INITiate:WAVEform
INPut[1]:IQ[:I]:IMPedance
INPut[1]:IQ:Q:IMPedance
INPut:COUPling
INPut:COUPling:I
INPut:COUPling:Q
INPut:FEXTender:CABLE:CORRection
INPut:IMPedance:REFerence
INPut:IQ[:I]:DIFFerential
INPut:IQ:MIRRored
INPut:IQ:Q:DIFFerential
INPut:OFFSet:I
INPut:OFFSet:Q
INSTrument:CATalog?
INSTrument:CONFigure:<mode_id>:<meas>
INSTrument:COUPlE:DEFault
INSTrument:COUPlE:EMC:STANdard
INSTrument:COUPlE:FREQuency:CENTer
INSTrument:COUPlE:SCREen:INPut
INSTrument:DEFault
INSTrument:NSElect
INSTrument:SCREen:CATalog?
INSTrument:SCREen:CREate
INSTrument:SCREen:DELeTe
INSTrument:SCREen:DELeTe:ALL
INSTrument:SCREen:MUlTiple?
INSTrument:SCREen:MUlTiple[:STATe]
INSTrument:SCREen:ORientation
INSTrument:SCREen:REName
INSTrument:SCREen:SElect
INSTrument:SCREen:STAB?
INSTrument[:SElect]
INSTrument[:SElect]
INSTrument[:SElect]
INSTrument[:SElect]
INSTrument[:SElect]

INSTRument[:SElect]
INSTRument[:SElect]
INSTRument:UNLoad

L

LXI:IDENtify[:STATe]

M

MEASure:<measurement>[n]?
MEASure:ACPower[n]?
MEASure:CHPower:DENSity[n]?
MEASure:CHPower[n]?
MEASure:DDEMod[n]?
MEASure:MONitor[n]?
MEASure:OBwidth:FERRor?
MEASure:OBwidth[n]?
MEASure:OBwidth:OBwidth?
MEASure:OBwidth:XDB?
MEASure:PAVTime[n]?
MEASure:PSTatistic[n]?
MEASure:SEMAsk[n]?
MEASure:SPURious[n]?
MEASure:WAVEform[n]?
MMEMemory:CATalog?
MMEMemory:CDIRectory
MMEMemory:COPIY
MMEMemory:COPIY:DEVIce
MMEMemory:DATA
MMEMemory:DELeTe
MMEMemory:HEADer:ID?
MMEMemory:LOAD:<meas>:RECOrding:CHANnel
MMEMemory:LOAD:<meas>:RECOrding:RESEt
MMEMemory:LOAD:CCORrection
MMEMemory:LOAD:CORREction
MMEMemory:LOAD:DDEMod:INDEx:SEGMENT
MMEMemory:LOAD:DDEMod:SEGMENT1|...|6:CONStIn:STATe
MMEMemory:LOAD:DDEMod:SEGMENT1|...|6:EQUalizer:COEFFicient
MMEMemory:LOAD:DDEMod:SEGMENT1|...|6:FILTer:COEFFicient
MMEMemory:LOAD:DDEMod:SEGMENT1|...|6:SETUp
MMEMemory:LOAD:DDEMod:SEGMENT1|...|6:TXBit:PATTERn
MMEMemory:LOAD:DDEMod:SYNC:PATTERn
MMEMemory:LOAD:LIMit
MMEMemory:LOAD:LOSS
MMEMemory:LOAD:OFDM:FILTer:COEFFicient
MMEMemory:LOAD:OFDM:IQPilot
MMEMemory:LOAD:OFDM:IQPReamble

9 Programming the Instrument
9.1 List of Supported SCPI Commands

MMEemory:LOAD:OFDM:RMAP
MMEemory:LOAD:OFDM:RMOdulation
MMEemory:LOAD:OFDM:SEtup
MMEemory:LOAD:RState
MMEemory:LOAD:RTS:DATA:PATtern
MMEemory:LOAD:RTYpe
MMEemory:LOAD:SCONfig
MMEemory:LOAD:STATe
MMEemory:LOAD:TRACe
MMEemory:LOAD:TRACe:DATA
MMEemory:LOAD:TRACe:REGister
MMEemory:LOAD:VCORrection
MMEemory:MDIRectory
MMEemory:MOVE
MMEemory:RDIRectory
MMEemory:REGister:STATe:LABel
MMEemory:REGister:TRACe:LABel
MMEemory:RMEDIA:LABel
MMEemory:RMEDIA:LIST?
MMEemory:RMEDIA:SIZE?
MMEemory:RMEDIA:WProtect?
MMEemory:STORe:<meas>:RECording:CHANnel
MMEemory:STORe:CORRection
MMEemory:STORe:DDEMod:SEGMENT1|...|6:CONStln:STATe
MMEemory:STORe:DDEMod:SEGMENT1|...|6:EQualizer:COEFFicient
MMEemory:STORe:DDEMod:SEGMENT1|...|6:FILTer:COEFFicient
MMEemory:STORe:DDEMod:SEGMENT1|...|6:TXBit:PATtern
MMEemory:STORe:DDEMod:SYNC:PATtern
MMEemory:STORe:LIMit
MMEemory:STORe:OFDM:FILTer:COEFFicient
MMEemory:STORe:OFDM:IQPilot
MMEemory:STORe:OFDM:IQPreamble
MMEemory:STORe:PSCFactor
MMEemory:STORe:PSCFactor
MMEemory:STORe:QSAVe
MMEemory:STORe:RESults
MMEemory:STORe:RState
MMEemory:STORe:SCONfig
MMEemory:STORe:SCReen
MMEemory:STORe:SCReen:BLOCKed
MMEemory:STORe:SCReen:THEMe
MMEemory:STORe:STATe
MMEemory:STORe:TRACe
MMEemory:STORe:TRACe:REGister

O

OUTPut:ANALog
OUTPut:ANALog:AUTO

OUTPut:ANALog:SVIDeo
OUTPut:AUX
OUTPut:AUX:AIF
OUTPut:AUX:IO
OUTPut:AUX:IO:DATA<n>
OUTPut:DBUS[1][:STATe]
OUTPut:DBUS2:DATA
OUTPut:DBUS2[:STATe]
OUTPut:EIF
OUTPut:EREFerence:OUTPut
OUTPut[:EXTErnal][:STATe]
OUTPut:IF2
OUTPut:IQ:OUTPut
OUTPut:MODulation[:STATe]
OUTPut:ROSCillator:LO:OUTPut

R

READ:<measurement>[n]?
READ:ACPower[n]?
READ:CHPower:DENSity[n]?
READ:CHPower[n]?
READ:DDEMod[n]?
READ:MONitor[n]?
READ:OBwidth:FERRor?
READ:OBwidth[n]?
READ:OBwidth:OBwidth?
READ:OBwidth:XDB?
READ:PAVTime[n]?
READ:PStatistic[n]?
READ:SEMask[n]?
READ:SPURious[n]?
READ:WAVEform[n]?

S

[:SENSe]:<meas>:POWer:IQ:REFerence:PLANE
[:SENSe]:<meas>:SwEep:ACQuisition:TIME
[:SENSe]:<meas>:SwEep:ACQuisition:TIME:AUTO
[:SENSe]:<meas>:SwEep:ETIME?
[:SENSe]:<meas>:SwEep:TIME
[:SENSe]:<meas>:SwEep:TIME:AUTO
[:SENSe]:<measurement>:PFILter[:STATe]
[:SENSe]:ACPower:AVERAge:COUNT
[:SENSe]:ACPower:AVERAge[:STATe]
[:SENSe]:ACPower:AVERAge:TCONTRol
[:SENSe]:ACPower:BANDwidth[:RESolution]
[:SENSe]:ACPower:BANDwidth[:RESolution]:AUTO

9 Programming the Instrument
 9.1 List of Supported SCPI Commands

```

[:SENSe]:ACPower:BANDwidth[:RESolution]:FPOwer:MODE
[:SENSe]:ACPower:BANDwidth:SHApe
[:SENSe]:ACPower:BANDwidth:TYPE
[:SENSe]:ACPower:BANDwidth:VIDeo
[:SENSe]:ACPower:BANDwidth:VIDeo:AUTO
[:SENSe]:ACPower:CARRier[1]|2:AUTO[:STATe]
[:SENSe]:ACPower:CARRier[1]|2:COUNT
[:SENSe]:ACPower:CARRier[1]|2:CPSD
[:SENSe]:ACPower:CARRier[1]|2:INDEX
[:SENSe]:ACPower:CARRier[1]|2:LIST:BANDwidth[:INTEgration]
[:SENSe]:ACPower:CARRier[1]|2:LIST:COUPlE
[:SENSe]:ACPower:CARRier[1]|2:LIST:FILTer:ALPHa
[:SENSe]:ACPower:CARRier[1]|2:LIST:FILTer[:RRC][:STATe]
[:SENSe]:ACPower:CARRier[1]|2:LIST:PPResent
[:SENSe]:ACPower:CARRier[1]|2:LIST:WIDTh
[:SENSe]:ACPower:CARRier[1]|2[:POwer]
[:SENSe]:ACPower:CARRier[1]|2:PREFerence:TYPE
[:SENSe]:ACPower:CARRier[1]|2:RCARRier
[:SENSe]:ACPower:CARRier[1]|2:RCARRier:AUTO
[:SENSe]:ACPower:CARRier[1]|2:RCARRier:ZBASE
[:SENSe]:ACPower:CARRier[1]|2:RCFRequency
[:SENSe]:ACPower:CARRier[1]|2:RCFRequency:AUTO
[:SENSe]:ACPower:CORRection:NOISe[:AUTO]
[:SENSe]:ACPower:DETEctor:AUTO
[:SENSe]:ACPower:DETEctor[:FUNction]
[:SENSe]:ACPower:FILTer:BANDwidth[:INTEgration]
[:SENSe]:ACPower:FREQuency:SPAN
[:SENSe]:ACPower:FREQuency:SYNThesis:AUTO[:STATe]
[:SENSe]:ACPower:FREQuency:SYNThesis[:STATe]
[:SENSe]:ACPower:IF:GAIN:FPOwer
[:SENSe]:ACPower:METHod
[:SENSe]:ACPower:OFFSet[1]|2[:OUTer]:LIST:ABSolute
[:SENSe]:ACPower:OFFSet[1]|2[:OUTer]:LIST:BANDwidth[:INTEgration]
[:SENSe]:ACPower:OFFSet[1]|2[:OUTer]:LIST:BANDwidth:RESolution
[:SENSe]:ACPower:OFFSet[1]|2
[:OUTer]:LIST:BANDwidth:RESolution:AUTO
[:SENSe]:ACPower:OFFSet[1]|2[:OUTer]:LIST:BANDwidth:SHApe
[:SENSe]:ACPower:OFFSet[1]|2[:OUTer]:LIST:BANDwidth:TYPE
[:SENSe]:ACPower:OFFSet[1]|2[:OUTer]:LIST:BANDwidth:VIDeo
[:SENSe]:ACPower:OFFSet[1]|2[:OUTer]:LIST:BANDwidth:VIDeo:AUTO
[:SENSe]:ACPower:OFFSet[1]|2[:OUTer]:LIST:FILTer:ALPHa
[:SENSe]:ACPower:OFFSet[1]|2[:OUTer]:LIST:FILTer[:RRC][:STATe]
[:SENSe]:ACPower:OFFSet[1]|2[:OUTer]:LIST[:FREQuency]
[:SENSe]:ACPower:OFFSet[1]|2[:OUTer]:LIST:RCARRier
[:SENSe]:ACPower:OFFSet[1]|2[:OUTer]:LIST:RPSDensity
[:SENSe]:ACPower:OFFSet[1]|2[:OUTer]:LIST:SIDE
[:SENSe]:ACPower:OFFSet[1]|2[:OUTer]:LIST:STATe
[:SENSe]:ACPower:OFFSet[1]|2[:OUTer]:LIST:TEST
[:SENSe]:ACPower:OFFSet[1]|2[:OUTer]:TYPE
[:SENSe]:ACPower:OFFSet:MAXNumber
  
```

```

[:SENSe]:ACPower:SAVoid[:STATe]
[:SENSe]:ACPower:SWEp:POINts
[:SENSe]:ACPower:SWEp:TIME:AUTO:RULes
[:SENSe]:ACPower:TYPE
[:SENSe]:AFINput[1]|2:COUPling
[:SENSe]:AFINput[1]|2:IMPedance
[:SENSe]:AFINput[1]|2:LOW
[:SENSe]:CCARrier0|...|7:OFDM:TIME:OFFSet?
[:SENSe]:CCORrection:CSET:COMMeNt
[:SENSe]:CCORrection:CSET:ALL:DELeTe
[:SENSe]:CCORrection:CSET:DATA
[:SENSe]:CCORrection:CSET:DELeTe
[:SENSe]:CCORrection:CSET:DESCRiption
[:SENSe]:CCORrection:CSET:DIRectiOn
[:SENSe]:CCORrection:CSET:PORT
[:SENSe]:CCORrection:CSET:SELeCt
[:SENSe]:CCORrection:CSET[:STATe]
[:SENSe]:CCORrection:CSET:X:SPACing
[:SENSe]:CCORrection:DATA?
[:SENSe]:CHPower:AVERage:COUNt
[:SENSe]:CHPower:AVERage[:STATe]
[:SENSe]:CHPower:AVERage:TCONtrol
[:SENSe]:CHPower:BANDwidth:INTegratiOn
[:SENSe]:CHPower:BANDwidth[:RESolution]
[:SENSe]:CHPower:BANDwidth[:RESolution]:AUTO
[:SENSe]:CHPower:BANDwidth:SHAPE
[:SENSe]:CHPower:BANDwidth:VIDeo
[:SENSe]:CHPower:BANDwidth:VIDeo:AUTO
[:SENSe]:CHPower:DETeCtor:AUTO
[:SENSe]:CHPower:DETeCtor[:FUNctiOn]
[:SENSe]:CHPower:FILTer[:RRC]:ALPHa
[:SENSe]:CHPower:FILTer[:RRC]:BANDwidth
[:SENSe]:CHPower:FILTer[:RRC][:STATe]
[:SENSe]:CHPower:FREQuency:SPAN
[:SENSe]:CHPower:FREQuency:SPAN:AUTO
[:SENSe]:CHPower:FREQuency:SPAN:FULL
[:SENSe]:CHPower:FREQuency:SYNThesis:AUTO[:STATe]
[:SENSe]:CHPower:FREQuency:SYNThesis[:STATe]
[:SENSe]:CHPower:IF:GAIN:AUTO[:STATe]
[:SENSe]:CHPower:IF:GAIN[:STATe]
[:SENSe]:CHPower:SAVoid[:STATe]
[:SENSe]:CHPower:SWEp:POINts
[:SENSe]:CHPower:SWEp:TIME:AUTO:RULes
[:SENSe]:CORRection:BTS[:RF]:GAIN
[:SENSe]:CORRection:CSET[1]|2|...|16:ANTenna[:UNIT]
[:SENSe]:CORRection:CSET[1]|2|...|16:COMMeNt
[:SENSe]:CORRection:CSET[1]|2|...|16:DATA
[:SENSe]:CORRection:CSET[1]|2|...|16:DATA:MERGe
[:SENSe]:CORRection:CSET[1]|2|...|16:DELeTe
[:SENSe]:CORRection:CSET[1]|2|...|16:DESCRiption
[:SENSe]:CORRection:CSET[1]|2|...|16:DIRectiOn
  
```

9 Programming the Instrument
 9.1 List of Supported SCPI Commands

```

[:SENSe]:CORRection:CSET[1]|2|...|16:RF:PORT
[:SENSe]:CORRection:CSET[1]|2|...|16[:STATe]
[:SENSe]:CORRection:CSET[1]|2|...|16:X:SPACing
[:SENSe]:CORRection:CSET:ALL:DELeTe
[:SENSe]:CORRection:CSET:ALL[:STATe]
[:SENSe]:CORRection:CSET:GRoUp[1]|2|...|10:DATA
[:SENSe]:CORRection:CSET:GRoUp:BReak
[:SENSe]:CORRection:CSET:GRoUp:COMMeNt
[:SENSe]:CORRection:CSET:GRoUp:DELeTe
[:SENSe]:CORRection:CSET:GRoUp:DESCRiption
[:SENSe]:CORRection:CSET:GRoUp:RELoAd
[:SENSe]:CORRection:CSET:GRoUp[:STATe]
[:SENSe]:CORRection:IMPedance[:INPut][:MAGNitude]
[:SENSe]:CORRection:IQ:I:ATTenuation
[:SENSe]:CORRection:IQ:I:ATTenuation:RATio
[:SENSe]:CORRection:IQ:I:GAIN
[:SENSe]:CORRection:IQ[:I]:SKEW
[:SENSe]:CORRection:IQ:Q:ATTenuation
[:SENSe]:CORRection:IQ:Q:ATTenuation:RATio
[:SENSe]:CORRection:IQ:Q:GAIN
[:SENSe]:CORRection:IQ:Q:GAIN:COUPlE
[:SENSe]:CORRection:IQ:Q:SKEW
[:SENSe]:CORRection:MS[:RF]:GAIN
[:SENSe]:CORRection:NOISe:FLOor
[:SENSe]:CORRection:NOISe:FLOor
[:SENSe]:CORRection:NOISe:FLOor
[:SENSe]:CORRection:NOISe:FLOor
[:SENSe]:CORRection:NOISe:FLOor:ADAPtive
[:SENSe]:CORRection:NOISe:FLOor:ADAPtive
[:SENSe]:CORRection:NOISe:FLOor:ADAPtive
[:SENSe]:CORRection:NOISe:FLOor:ADAPtive
[:SENSe]:CORRection:SA[:RF]:GAIN
[:SENSe]:DDEMod:AVERage:COUNT
[:SENSe]:DDEMod:AVERage[:STATe]
[:SENSe]:DDEMod:AVERage:TCONtrol
[:SENSe]:DDEMod:BANDwidth[:RESolution]
[:SENSe]:DDEMod:CCEVm[:ENABLE]
[:SENSe]:DDEMod:EQUalization:RESet
[:SENSe]:DDEMod:FREQUency:SYNThesis[:STATe]
[:SENSe]:DDEMod:IF:GAIN:AUTO[:STATe]
[:SENSe]:DDEMod:IF:GAIN:LEVeL
[:SENSe]:DDEMod:IF:GAIN:SELeCt
[:SENSe]:DDEMod:LO:DITHer[:STATe]
[:SENSe]:DDEMod:LO:MIXMode
[:SENSe]:DDEMod:MCHannel:CHANnel:INFO?
[:SENSe]:DDEMod:MCHannel:IPADdress1|2
[:SENSe]:DDEMod:MCHannel:IPADdress1|2
[:SENSe]:DDEMod:MCHannel:IPADdress1|2:LOCKed
[:SENSe]:DDEMod:OPTimize
  
```

```

[:SENSe]:DDEMod:OPTimize:ITERative:TARGet
[:SENSe]:DDEMod:OPTMethod
[:SENSe]:DDEMod:SAVoid:AUTO
[:SENSe]:DDEMod:SAVoid:FREQuency
[:SENSe]:DDEMod:SAVoid[:STATe]
[:SENSe]:DDEMod:SEGment1|...|6:APSK:R2Ratio
[:SENSe]:DDEMod:SEGment1|...|6:APSK:R3Ratio
[:SENSe]:DDEMod:SEGment1|...|6:BER:COUNT:BITS
[:SENSe]:DDEMod:SEGment1|...|6:BER:STATe
[:SENSe]:DDEMod:SEGment1|...|6:CADJust
[:SENSe]:DDEMod:SEGment1|...|6:CIQ:DIFFerential:STATe
[:SENSe]:DDEMod:SEGment1|...|6:CIQ:OFFSet:STATe
[:SENSe]:DDEMod:SEGment1|...|6:CIQ:PHASe:ROTation
[:SENSe]:DDEMod:SEGment1|...|6:CIQ:PHASe:ROTation:SODD
[:SENSe]:DDEMod:SEGment1|...|6:CIQ:PIlot
[:SENSe]:DDEMod:SEGment1|...|6:CIQ:PIlot:CYCLE
[:SENSe]:DDEMod:SEGment1|...|6:CIQ:PIlot:MODulation
[:SENSe]:DDEMod:SEGment1|...|6:CIQ:PIlot:PATTern
[:SENSe]:DDEMod:SEGment1|...|6:CIQ:PIlot:STARt
[:SENSe]:DDEMod:SEGment1|...|6:COMPensate:NREFerence
[:SENSe]:DDEMod:SEGment1|...|6:CONSTln:PERsistence
[:SENSe]:DDEMod:SEGment1|...|6:CPMindex
[:SENSe]:DDEMod:SEGment1|...|6:CPMindex:AUTO
[:SENSe]:DDEMod:SEGment1|...|6:EQualization:CONVergence
[:SENSe]:DDEMod:SEGment1|...|6:EQualization:FLenGth
[:SENSe]:DDEMod:SEGment1|...|6:EQualization:HOLD
[:SENSe]:DDEMod:SEGment1|...|6:EQualization:SOURce
[:SENSe]:DDEMod:SEGment1|...|6:EQualization:STATe
[:SENSe]:DDEMod:SEGment1|...|6:EVM:REPort:DB
[:SENSe]:DDEMod:SEGment1|...|6:FFT:WINDow:TYPE
[:SENSe]:DDEMod:SEGment1|...|6:FILTer:ALPHa
[:SENSe]:DDEMod:SEGment1|...|6:FILTer:BT
[:SENSe]:DDEMod:SEGment1|...|6:FILTer:MEASurement
[:SENSe]:DDEMod:SEGment1|...|6:FILTer:REFerence
[:SENSe]:DDEMod:SEGment1|...|6:FSK:DEViation:REFerence
[:SENSe]:DDEMod:SEGment1|...|6:FSK:TXFRequency:OFFSet
[:SENSe]:DDEMod:SEGment1|...|6:LSNR
[:SENSe]:DDEMod:SEGment1|...|6:MCfilter:BANdwidth
[:SENSe]:DDEMod:SEGment1|...|6:MODulation
[:SENSe]:DDEMod:SEGment1|...|6:MSK:DDECode:ANCHor
[:SENSe]:DDEMod:SEGment1|...|6:NAME
[:SENSe]:DDEMod:SEGment1|...|6:PPSYmbol
[:SENSe]:DDEMod:SEGment1|...|6:SPECTrum
[:SENSe]:DDEMod:SEGment1|...|6:SRATE
[:SENSe]:DDEMod:SEGment1|...|6:SWEEp:POINTs
[:SENSe]:DDEMod:SEGment1|...|6:TIME:OFFSet
[:SENSe]:DDEMod:SEGment1|...|6:TIME:OFFSet:REFerence
[:SENSe]:DDEMod:SEGment1|2:FSK:DEViation:REFerence:AUTO
[:SENSe]:DDEMod:SEGment1|2:MCfilter[:STATe]
[:SENSe]:DDEMod:SNUMber
[:SENSe]:DDEMod:STITching:SPECTrum[:STATe]
  
```

9 Programming the Instrument
9.1 List of Supported SCPI Commands

```
[ :SENSe ] :DDEMod:SYNC:BURSt[ :STATe ]  
[ :SENSe ] :DDEMod:SYNC:BURSt:THREshold  
[ :SENSe ] :DDEMod:SYNC:SLENgth  
[ :SENSe ] :DDEMod:SYNC:SLENgth:AUTO  
[ :SENSe ] :DDEMod:SYNC:SWORd:OFFSet  
[ :SENSe ] :DDEMod:SYNC:SWORd:PATTern  
[ :SENSe ] :DDEMod:SYNC:SWORd[ :STATe ]  
[ :SENSe ] :FEED  
[ :SENSe ] :FEED:AFALign  
[ :SENSe ] :FEED:AFINput:PORT  
[ :SENSe ] :FEED:AREFERENCE  
[ :SENSe ] :FEED:DATA  
[ :SENSe ] :FEED:DATA:STORe  
[ :SENSe ] :FEED:IQ:TYPE  
[ :SENSe ] :FEED[ :RF ]:PORT:INFORMATION?  
[ :SENSe ] :FEED[ :RF ]:PORT[ :INPut ]  
[ :SENSe ] :FEED:RF:PORT:OUTPut  
[ :SENSe ] :FEED:RF:PORT:TR:HPOWER:ATTenuator[ :STATe ]  
[ :SENSe ] :FREQuency:CENTer  
[ :SENSe ] :FREQuency:CENTer  
[ :SENSe ] :FREQuency:CENTer  
[ :SENSe ] :FREQuency:CENTer  
[ :SENSe ] :FREQuency:CENTer  
[ :SENSe ] :FREQuency:CENTer  
[ :SENSe ] :FREQuency:CENTer  
[ :SENSe ] :FREQuency:CENTer  
[ :SENSe ] :FREQuency:CENTer  
[ :SENSe ] :FREQuency:CENTer  
[ :SENSe ] :FREQuency:CENTer:AUTO  
[ :SENSe ] :FREQuency:CENTer:AUTO  
[ :SENSe ] :FREQuency:CENTer:AUTO  
[ :SENSe ] :FREQuency:CENTer:STEP:AUTO  
[ :SENSe ] :FREQuency:CENTer:STEP:AUTO  
[ :SENSe ] :FREQuency:CENTer:STEP:AUTO  
[ :SENSe ] :FREQuency:CENTer:STEP:AUTO  
[ :SENSe ] :FREQuency:CENTer:STEP:AUTO  
[ :SENSe ] :FREQuency:CENTer:STEP:AUTO  
[ :SENSe ] :FREQuency:CENTer:STEP:AUTO  
[ :SENSe ] :FREQuency:CENTer:STEP:AUTO  
[ :SENSe ] :FREQuency:CENTer:STEP:AUTO  
[ :SENSe ] :FREQuency:CENTer:STEP[ :INCRement ]  
[ :SENSe ] :FREQuency:CENTer:STEP[ :INCRement ]  
[ :SENSe ] :FREQuency:CENTer:STEP[ :INCRement ]  
[ :SENSe ] :FREQuency:CENTer:STEP[ :INCRement ]  
[ :SENSe ] :FREQuency:CENTer:STEP[ :INCRement ]  
[ :SENSe ] :FREQuency:CENTer:STEP[ :INCRement ]  
[ :SENSe ] :FREQuency:CENTer:STEP[ :INCRement ]  
[ :SENSe ] :FREQuency:CENTer:STEP[ :INCRement ]  
[ :SENSe ] :FREQuency:CENTer:STEP[ :INCRement ]
```

```
[ :SENSe ]:FREQuency:CENTer:STEP[ :INCRement ]  
[ :SENSe ]:FREQuency:EMIXer:CENTer  
[ :SENSe ]:FREQuency:EMIXer:CENTer  
[ :SENSe ]:FREQuency:EMIXer:CENTer  
[ :SENSe ]:FREQuency:EMIXer:CENTer  
[ :SENSe ]:FREQuency:EMIXer:CENTer  
[ :SENSe ]:FREQuency:EMIXer:CENTer  
[ :SENSe ]:FREQuency:EMIXer:CENTer  
[ :SENSe ]:FREQuency:EMIXer:CENTer  
[ :SENSe ]:FREQuency:EMIXer:CENTer  
[ :SENSe ]:FREQuency:EMIXer:CENTer  
[ :SENSe ]:FREQuency:IQ:CENTer  
[ :SENSe ]:FREQuency:IQ:CENTer  
[ :SENSe ]:FREQuency:IQ:CENTer  
[ :SENSe ]:FREQuency:IQ:CENTer  
[ :SENSe ]:FREQuency:IQ:CENTer  
[ :SENSe ]:FREQuency:IQ:CENTer  
[ :SENSe ]:FREQuency:IQ:CENTer  
[ :SENSe ]:FREQuency:IQ:CENTer  
[ :SENSe ]:FREQuency:IQ:CENTer  
[ :SENSe ]:FREQuency:OFFSet  
[ :SENSe ]:FREQuency:RF:CENTer  
[ :SENSe ]:FREQuency:RF:CENTer  
[ :SENSe ]:FREQuency:RF:CENTer  
[ :SENSe ]:FREQuency:RF:CENTer  
[ :SENSe ]:FREQuency:RF:CENTer  
[ :SENSe ]:FREQuency:RF:CENTer  
[ :SENSe ]:FREQuency:RF:CENTer  
[ :SENSe ]:FREQuency:RF:CENTer  
[ :SENSe ]:FREQuency:RF:CENTer  
[ :SENSe ]:FREQuency:RF:CENTer  
[ :SENSe ]:HDUPlex:PORT:INPut  
[ :SENSe ]:HDUPlex:PORT:OUTPut  
[ :SENSe ]:MIXer:BAND  
[ :SENSe ]:MIXer:BIAS  
[ :SENSe ]:MIXer:BIAS:STATe  
[ :SENSe ]:MIXer:CIFLoss  
[ :SENSe ]:MIXer:HARMonic  
[ :SENSe ]:MIXer:LODoubler  
[ :SENSe ]:MIXer:MPATH  
[ :SENSe ]:MIXer:TTPe  
[ :SENSe ]:MIXer:TTPe?  
[ :SENSe ]:MIXer:UIFFreq  
[ :SENSe ]:MONitor:AVERage:COUNT  
[ :SENSe ]:MONitor:AVERage[ :STATe ]  
[ :SENSe ]:MONitor:AVERage:TCONtrol  
[ :SENSe ]:MONitor:BANDwidth[ :RESolution ]  
[ :SENSe ]:MONitor:BANDwidth[ :RESolution ]:AUTO  
[ :SENSe ]:MONitor:BANDwidth:VIDeo  
[ :SENSe ]:MONitor:BANDwidth:VIDeo:AUTO  
[ :SENSe ]:MONitor:BANDwidth:VIDeo:RATio
```

9 Programming the Instrument
 9.1 List of Supported SCPI Commands

```

[:SENSe]:MONitor:BANDwidth:VIDeo:RATio:AUTO
[:SENSe]:MONitor:CONVersion:TYPE
[:SENSe]:MONitor:DETEctor:TRACe?
[:SENSe]:MONitor:DETEctor:TRACe[1]|2|3:AUTO
[:SENSe]:MONitor:DETEctor:TRACe[1]2|3
[:SENSe]:MONitor:FREQuency:SPAN
[:SENSe]:MONitor:FREQuency:SPAN:BANDwidth[:RESolution]:RATio
[:SENSe]:MONitor:FREQuency:SPAN:BANDwidth[:RESolution]:RATio:AUTO
[:SENSe]:MONitor:PNOise:OPTion
[:SENSe]:MONitor:SAVoid[:STATe]?
[:SENSe]:MONitor:SWEp:POINTs
[:SENSe]:OBwidth:AVERage:COUNT
[:SENSe]:OBwidth:AVERage[:STATe]
[:SENSe]:OBwidth:AVERage:TCONtrol
[:SENSe]:OBwidth:BANDwidth[:RESolution]
[:SENSe]:OBwidth:BANDwidth[:RESolution]:AUTO
[:SENSe]:OBwidth:BANDwidth:SHApe
[:SENSe]:OBwidth:BANDwidth:VIDeo
[:SENSe]:OBwidth:BANDwidth:VIDeo:AUTO
[:SENSe]:OBwidth:DETEctor:AUTO
[:SENSe]:OBwidth:DETEctor[:FUNction]
[:SENSe]:OBwidth:FREQuency:SPAN
[:SENSe]:OBwidth:FREQuency:SPAN:AUTO
[:SENSe]:OBwidth:FREQuency:SPAN:FULL
[:SENSe]:OBwidth:IF:GAIN:AUTO[:STATe]
[:SENSe]:OBwidth:IF:GAIN[:STATe]
[:SENSe]:OBwidth:INTegration[:METHod]
[:SENSe]:OBwidth:MAXHold
[:SENSe]:OBwidth:PERCent
[:SENSe]:OBwidth:PREFerence
[:SENSe]:OBwidth:SAVoid[:STATe]
[:SENSe]:OBwidth:SWEp:POINTs
[:SENSe]:OBwidth:SWEp:TIME:AUTO:RULes
[:SENSe]:OBwidth:XDB
[:SENSe]:OFDM:AVERage:COUNT
[:SENSe]:OFDM:AVERage[:STATe]
[:SENSe]:OFDM:AVERage:TCONtrol
[:SENSe]:OFDM:CCARrier<n>:FREQuency:OFFSet
[:SENSe]:OFDM:CCARrier0|...|7:BANDwidth
[:SENSe]:OFDM:CCARrier0|...|7:CoPY
[:SENSe]:OFDM:CCARrier0|...|7:DFTsPread
[:SENSe]:OFDM:CCARrier0|...|7:EFLoCk:RANGe
[:SENSe]:OFDM:CCARrier0|...|7:EFLoCk:RANGe:WIDTh
[:SENSe]:OFDM:CCARrier0|...|7:EQUalizer:AVERage:MoDE
[:SENSe]:OFDM:CCARrier0|...|7:EQUalizer:INITial:MoDE
[:SENSe]:OFDM:CCARrier0|...|7:EQUalizer:INITial:SYMBols
[:SENSe]:OFDM:CCARrier0|...|7:EQUalizer:USE:DATA
[:SENSe]:OFDM:CCARrier0|...|7:EQUalizer:USE:DCPilot
[:SENSe]:OFDM:CCARrier0|...|7:EQUalizer:USE:PILot
[:SENSe]:OFDM:CCARrier0|...|7:EQUalizer:USE:PREAmble
  
```



```

[:SENSe]:OFDM:CCARrier0 ... 7:EVMSNorm
[:SENSe]:OFDM:CCARrier0 ... 7:EVM:REPort:DB
[:SENSe]:OFDM:CCARrier0 ... 7:FFT:LENGth
[:SENSe]:OFDM:CCARrier0 ... 7:FILTer:PBAND
[:SENSe]:OFDM:CCARrier0 ... 7:FILTer:SRATio
[:SENSe]:OFDM:CCARrier0 ... 7:FILTer:TBAND
[:SENSe]:OFDM:CCARrier0 ... 7:FILTer:TYPE
[:SENSe]:OFDM:CCARrier0 ... 7:GUARd:INTerval
[:SENSe]:OFDM:CCARrier0 ... 7:GUARd:INTerval:RINDex
[:SENSe]:OFDM:CCARrier0 ... 7:GUARd:LOWer
[:SENSe]:OFDM:CCARrier0 ... 7:GUARd:UPPer
[:SENSe]:OFDM:CCARrier0 ... 7:HSCShift
[:SENSe]:OFDM:CCARrier0 ... 7:LO:MIXMode
[:SENSe]:OFDM:CCARrier0 ... 7LO:MIXMode:AUTO
[:SENSe]:OFDM:CCARrier0 ... 7:PHASe:COMPensation:FREQuency
[:SENSe]:OFDM:CCARrier0 ... 7:PHASe:COMPensation:MODE
[:SENSe]:OFDM:CCARrier0 ... 7:PILot:IQ
[:SENSe]:OFDM:CCARrier0 ... 7:PITDomain
[:SENSe]:OFDM:CCARrier0 ... 7:PREamble:IQ
[:SENSe]:OFDM:CCARrier0 ... 7:REMez:ATTenuation
[:SENSe]:OFDM:CCARrier0 ... 7:REMez:RIPple
[:SENSe]:OFDM:CCARrier0 ... 7:RMAP
[:SENSe]:OFDM:CCARrier0 ... 7:RMODulation
[:SENSe]:OFDM:CCARrier0 ... 7:SAMPlE:FREQuency?
[:SENSe]:OFDM:CCARrier0 ... 7:SAMPlE:FREQuency
[:SENSe]:OFDM:CCARrier0 ... 7:SAVoid:AUTO
[:SENSe]:OFDM:CCARrier0 ... 7:SAVoid:FREQuency
[:SENSe]:OFDM:CCARrier0 ... 7:SPEctrum
[:SENSe]:OFDM:CCARrier0 ... 7[:STATe]
[:SENSe]:OFDM:CCARrier0 ... 7:SYMBol:ADJust
[:SENSe]:OFDM:CCARrier0 ... 7:SYMBol:COMPensate:CERRor
[:SENSe]:OFDM:CCARrier0 ... 7:SYNChronize:MODE
[:SENSe]:OFDM:CCARrier0 ... 7:SYNChronize:REFeRence:INTerval
[:SENSe]:OFDM:CCARrier0 ... 7:SYNChronize:REFeRence:OFFSet
[:SENSe]:OFDM:CCARrier0 ... 7:SYNChronize:REGion:SELECTION
[:SENSe]:OFDM:CCARrier0 ... 7:SYNChronize:SEARch:INTerval
[:SENSe]:OFDM:CCARrier0 ... 7:SYNChronize:SEARch:OFFSet
[:SENSe]:OFDM:CCARrier0 ... 7:TGAP
[:SENSe]:OFDM:CCARrier0 ... 7:TGAP:RINDex
[:SENSe]:OFDM:CCARrier0 ... 7:TIME:BURSt[:STATe]
[:SENSe]:OFDM:CCARrier0 ... 7:TIME:BURSt:THReshold
[:SENSe]:OFDM:CCARrier0 ... 7:TIME:BURSt:THReshold:AUTO
[:SENSe]:OFDM:CCARrier0 ... 7:TIME:INTerval
[:SENSe]:OFDM:CCARrier0 ... 7:TIME:LENGth:RESUlt
[:SENSe]:OFDM:CCARrier0 ... 7:TIME:LENGth:RESUlt:AUTO
[:SENSe]:OFDM:CCARrier0 ... 7:TIME:LENGth:SEARch
[:SENSe]:OFDM:CCARrier0 ... 7:TIME:OFFSet
[:SENSe]:OFDM:CCARrier0 ... 7:TRACk:AMPLitude
[:SENSe]:OFDM:CCARrier0 ... 7:TRACk:DATA
[:SENSe]:OFDM:CCARrier0 ... 7:TRACk:PHASe
[:SENSe]:OFDM:CCARrier0 ... 7:TRACk:TIMing
  
```

9 Programming the Instrument
 9.1 List of Supported SCPI Commands

```

[:SENSe]:OFDM:CCARrier0|...|7:WSINc:LENGth
[:SENSe]:OFDM:CCARrier0|...|7:WSINc:LENGth:AUTO
[:SENSe]:OFDM:CCARrier0|...|7:WSINc:WINDow
[:SENSe]:OFDM:CCARrier[0]|1|...|7:RF:CHANnel1|...|8:ATTenuation
[:SENSe]:OFDM:CCARrier[0]|1|...|7:RF:CHANnel1|...|8:EATTenuation
[:SENSe]:OFDM:CCARrier[0]|1|...|7:RF:CHANnel1|...|8:GAIN:LNA
[:SENSe]:OFDM:CCARrier[0]|1|...|7:RF:CHANnel1|...|8:GAIN:PREamp
[:SENSe]:OFDM:CCARrier[0]|1|...|7:RF:CHANnel1|...|8:IF:GAIN:LEVel
[:SENSe]:OFDM:CCARrier[0]|1|...|7:RF:CHANnel1|...|8:IFPath
[:SENSe]:OFDM:CCARrier[0]|1|...|7:RF:CHANnel1|...|8:MW:PATH
[:SENSe]:OFDM:CCARrier:REFerence
[:SENSe]:OFDM:CCEVm[:ENABLE]
[:SENSe]:OFDM:FREQuency:SYNThesis[:STATe]
[:SENSe]:OFDM:IF:GAIN:AUTO[:STATe]
[:SENSe]:OFDM:IF:GAIN:LEVel
[:SENSe]:OFDM:IF:GAIN:REFerence:CCARrier
[:SENSe]:OFDM:IF:GAIN:SElect
[:SENSe]:OFDM:LO:DITHer[:STATe]
[:SENSe]:OFDM:MCHannel:CHANnel:INFO?
[:SENSe]:OFDM:MCHannel:IPADdress1|2
[:SENSe]:OFDM:MCHannel:IPADdress1|2:LOCKed
[:SENSe]:OFDM:MCHannel:IPADdress1|2:PORT
[:SENSe]:OFDM:MIMO:PARTially:SUBCount
[:SENSe]:OFDM:MIMO:PARTially:SYMCount
[:SENSe]:OFDM:MIMO[:STATe]
[:SENSe]:OFDM:MIMO:TXANTennas
[:SENSe]:OFDM:MIMO:TYPE
[:SENSe]:OFDM:OFDM:CCARrier0|...|7:TIME:LENGth:SEARCh?
[:SENSe]:OFDM:OPTimize
[:SENSe]:OFDM:OPTimize:ITERative:TARGet
[:SENSe]:OFDM:OPTMethod
[:SENSe]:OFDM:RADio:STANdard:PRESet
[:SENSe]:OFDM:RF:ACQuistion:ATABle
[:SENSe]:OFDM:RF:ACQuistion:ATABle:IFPath:AUTO
[:SENSe]:OFDM:SAVoid[:STATe]
[:SENSe]:OFDM:STITChing:SPECtrum[:STATe]
[:SENSe]:PAVTime:FERRor
[:SENSe]:PAVTime:FERRor:CORRection[:STATe]
[:SENSe]:PAVTime:FERRor:IMMediate
[:SENSe]:PAVTime:FERRor:TIME
[:SENSe]:PAVTime:IF:GAIN:AUTO[:STATe]
[:SENSe]:PAVTime:IF:GAIN[:STATe]
[:SENSe]:PAVTime:MTIME?
[:SENSe]:PAVTime:SEGMENTS
[:SENSe]:PAVTime:SEGMENTS:INTerval
[:SENSe]:PAVTime:SEGMENTS:OFFSet
[:SENSe]:PAVTime:SEGMENTS:TRANsient
[:SENSe]:PAVTime:SYNC
[:SENSe]:POWer:IQ[:I]:RANGE[:UPPer]
[:SENSe]:POWer:IQ:Q:RANGE[:UPPer]
  
```

```
[ :SENSe ]:POWer:IQ:RANGe:AUTO  
[ :SENSe ]:POWer[ :RF ]:ATTenuation  
[ :SENSe ]:POWer[ :RF ]:ATTenuation:AUTO  
[ :SENSe ]:POWer[ :RF ]:ATTenuation:STEP[ :INCRement ]  
[ :SENSe ]:POWer[ :RF ]:EATTenuation  
[ :SENSe ]:POWer[ :RF ]:EATTenuation:STATe  
[ :SENSe ]:POWer[ :RF ]:FRATten  
[ :SENSe ]:POWer[ :RF ]:GAIN:BAND  
[ :SENSe ]:POWer[ :RF ]:GAIN:LNA[ :STATe ]  
[ :SENSe ]:POWer[ :RF ]:GAIN[ :STATe ]  
[ :SENSe ]:POWer[ :RF ]:MW:PATH  
[ :SENSe ]:POWer[ :RF ]:MW:PATH:AUTO  
[ :SENSe ]:POWer[ :RF ]:MW:PATH:AUTO:FULL  
[ :SENSe ]:POWer[ :RF ]:PADJust  
[ :SENSe ]:POWer[ :RF ]:PCENter  
[ :SENSe ]:POWer[ :RF ]:RANGe  
[ :SENSe ]:POWer[ :RF ]:RANGe:MIXer:OFFSet  
[ :SENSe ]:POWer[ :RF ]:RANGe:OPTimize  
[ :SENSe ]:POWer[ :RF ]:RANGe:OPTimize  
[ :SENSe ]:POWer[ :RF ]:RANGe:OPTimize:ATTenuation  
[ :SENSe ]:POWer[ :RF ]:RANGe:OPTimize:ATTenuation  
[ :SENSe ]:POWer[ :RF ]:RANGe:OPTimize:TYPE  
[ :SENSe ]:POWer[ :RF ]:RANGe:PARatio  
[ :SENSe ]:POWer[ :RF ]:RFPSelector:NFIltEr[ :STATe ]  
[ :SENSe ]:POWer[ :RF ]:RFPSelector[ :STATe ]  
[ :SENSe ]:POWer[ :RF ]:SWPreSel  
[ :SENSe ]:POWer[ :RF ]:SWPreSel:BW  
[ :SENSe ]:POWer[ :RF ]:SWPreSel:STAT?  
[ :SENSe ]:POWer[ :RF ]:SWPreSel:STATe  
[ :SENSe ]:PStatistic:BANDwidth  
[ :SENSe ]:PStatistic:BANDwidth:AUTO  
[ :SENSe ]:PStatistic:COUNts  
[ :SENSe ]:PStatistic:IF:GAIN:AUTO[ :STATe ]  
[ :SENSe ]:PStatistic:IF:GAIN[ :STATe ]  
[ :SENSe ]:PStatistic:SWEp:CYCLes  
[ :SENSe ]:PStatistic:SWEp:TIME  
[ :SENSe ]:PStatistic:URATio  
[ :SENSe ]:RADio:STANdard:PRESet  
[ :SENSe ]:ROSCillator:BANDwidth  
[ :SENSe ]:ROSCillator:EXtErnal:FREQuency  
[ :SENSe ]:ROSCillator:EXtErnal:FREQuency:DEFault  
[ :SENSe ]:ROSCillator:LO:INPut  
[ :SENSe ]:ROSCillator:PXIReference:EXtErnal:FREQuency  
[ :SENSe ]:ROSCillator:PXIReference:EXtErnal:LOCK?  
[ :SENSe ]:ROSCillator:PXIReference:SElect  
[ :SENSe ]:ROSCillator:PXIReference:SOURce  
[ :SENSe ]:ROSCillator:SOURce?  
[ :SENSe ]:ROSCillator:SOURce:TYPE  
[ :SENSe ]:SEMask:AVERage:CARRier:TYPE  
[ :SENSe ]:SEMask:AVERage:COUNt  
[ :SENSe ]:SEMask:AVERage:OFFSet:TYPE
```

9 Programming the Instrument
 9.1 List of Supported SCPI Commands

```

[:SENSe]:SEMask:AVERAge[:STATe]
[:SENSe]:SEMask:BANDwidth[1]|2:INTEgration
[:SENSe]:SEMask:BANDwidth[1]|2[:RESolution]
[:SENSe]:SEMask:BANDwidth[1]|2[:RESolution]:AUTO
[:SENSe]:SEMask:BANDwidth[1]|2:VIDeo
[:SENSe]:SEMask:BANDwidth[1]|2:VIDeo:AUTO
[:SENSe]:SEMask:BANDwidth[1]|2:VIDeo:RATio
[:SENSe]:SEMask:BANDwidth[1]|2:VIDeo:RATio:AUTO
[:SENSe]:SEMask:BANDwidth:SHAPE
[:SENSe]:SEMask:CARRier:AUTO[:STATe]
[:SENSe]:SEMask:CARRier:CPSD
[:SENSe]:SEMask:CARRier:PEAK[:POWer]
[:SENSe]:SEMask:CARRier[:POWer]
[:SENSe]:SEMask:DETEctor:CARRier:AUTO
[:SENSe]:SEMask:DETEctor:CARRier[:FUNction]
[:SENSe]:SEMask:DETEctor:OFFSet:AUTO
[:SENSe]:SEMask:DETEctor:OFFSet[:FUNction]
[:SENSe]:SEMask:FILTer[:RRC]:ALPHA
[:SENSe]:SEMask:FILTer[:RRC][:STATe]
[:SENSe]:SEMask:FREQuency[1]|2:SPAN
[:SENSe]:SEMask:FREQuency[1]|2:SPAN:AUTO
[:SENSe]:SEMask:NCONtiguous:REGion
[:SENSe]:SEMask:OFFSet[1]|2:INNEr:CMASK:FREQuency:STOP
[:SENSe]:SEMask:OFFSet[1]|2:INNEr:CMASK[:STATe]
[:SENSe]:SEMask:OFFSet[1]|2:INNEr:LIST:BANDwidth:IMULti
[:SENSe]:SEMask:OFFSet[1]|2:INNEr:LIST:BANDwidth[:RESolution]
[:SENSe]:SEMask:OFFSet[1]|2:INNEr:LIST:BANDwidth
[:RESolution]:AUTO
[:SENSe]:SEMask:OFFSet[1]|2:INNEr:LIST:BANDwidth:VIDeo
[:SENSe]:SEMask:OFFSet[1]|2:INNEr:LIST:BANDwidth:VIDeo:AUTO
[:SENSe]:SEMask:OFFSet[1]|2:INNEr:LIST:FREQuency:START
[:SENSe]:SEMask:OFFSet[1]|2:INNEr:LIST:FREQuency:STOP
[:SENSe]:SEMask:OFFSet[1]|2:INNEr:LIST:SIDE
[:SENSe]:SEMask:OFFSet[1]|2:INNEr:LIST:START:ABSolute
[:SENSe]:SEMask:OFFSet[1]|2:INNEr:LIST:START:RCARRier
[:SENSe]:SEMask:OFFSet[1]|2:INNEr:LIST:START:SABSolute
[:SENSe]:SEMask:OFFSet[1]|2:INNEr:LIST:STATe
[:SENSe]:SEMask:OFFSet[1]|2:INNEr:LIST:STOP:ABSolute
[:SENSe]:SEMask:OFFSet[1]|2:INNEr:LIST:STOP:ABSolute:COUPlE
[:SENSe]:SEMask:OFFSet[1]|2:INNEr:LIST:STOP:RCARRier
[:SENSe]:SEMask:OFFSet[1]|2:INNEr:LIST:STOP:RCARRier:COUPlE
[:SENSe]:SEMask:OFFSet[1]|2:INNEr:LIST:STOP:SABSolute
[:SENSe]:SEMask:OFFSet[1]|2:INNEr:LIST:STOP:SABSolute:COUPlE
[:SENSe]:SEMask:OFFSet[1]|2:INNEr:LIST:SWEEp:ACQuisition:TIME
[:SENSe]:SEMask:OFFSet
[1]|2:INNEr:LIST:SWEEp:ACQuisition:TIME:AUTO
[:SENSe]:SEMask:OFFSet[1]|2:INNEr:LIST:SWEEp:ETIME?
[:SENSe]:SEMask:OFFSet[1]|2:INNEr:LIST:SWEEp:TIME
[:SENSe]:SEMask:OFFSet[1]|2:INNEr:LIST:SWEEp:TIME:AUTO
[:SENSe]:SEMask:OFFSet[1]|2:INNEr:LIST:SWEEp:TYPE

```

```

[:SENSe]:SEMask:OFFSet[1]|2:INNER:LIST:SWEEp:TYPE:AUTO
[:SENSe]:SEMask:OFFSet[1]|2:INNER:LIST:TEST
[:SENSe]:SEMask:OFFSet[1]|2:INNER:LIST:TEST:SABSolute
[:SENSe]:SEMask:OFFSet[1]|2:INNER:TYPE
[:SENSe]:SEMask:OFFSet[1]|2[:OUTer]:LIST:BANDwidth:IMULti
[:SENSe]:SEMask:OFFSet[1]|2[:OUTer]:LIST:BANDwidth[:RESolution]
[:SENSe]:SEMask:OFFSet[1]|2[:OUTer]:LIST:BANDwidth
[:RESolution]:AUTO
[:SENSe]:SEMask:OFFSet[1]|2[:OUTer]:LIST:BANDwidth:VIDeo
[:SENSe]:SEMask:OFFSet[1]|2[:OUTer]:LIST:BANDwidth:VIDeo:AUTO
[:SENSe]:SEMask:OFFSet[1]|2[:OUTer]:LIST:BANDwidth:VIDeo:RATio
[:SENSe]:SEMask:OFFSet[1]|2
[:OUTer]:LIST:BANDwidth:VIDeo:RATio:AUTO
[:SENSe]:SEMask:OFFSet[1]|2[:OUTer]:LIST:FREQuency:START
[:SENSe]:SEMask:OFFSet[1]|2[:OUTer]:LIST:FREQuency:STOP
[:SENSe]:SEMask:OFFSet[1]|2[:OUTer]:LIST:SIDE
[:SENSe]:SEMask:OFFSet[1]|2[:OUTer]:LIST:START:ABSolute
[:SENSe]:SEMask:OFFSet[1]|2[:OUTer]:LIST:START:RCARrier
[:SENSe]:SEMask:OFFSet[1]|2[:OUTer]:LIST:START:SABSolute
[:SENSe]:SEMask:OFFSet[1]|2[:OUTer]:LIST:STATE
[:SENSe]:SEMask:OFFSet[1]|2[:OUTer]:LIST:STOP:ABSolute
[:SENSe]:SEMask:OFFSet[1]|2[:OUTer]:LIST:STOP:ABSolute:COUPle
[:SENSe]:SEMask:OFFSet[1]|2[:OUTer]:LIST:STOP:RCARrier
[:SENSe]:SEMask:OFFSet[1]|2[:OUTer]:LIST:STOP:RCARrier:COUPle
[:SENSe]:SEMask:OFFSet[1]|2[:OUTer]:LIST:STOP:SABSolute
[:SENSe]:SEMask:OFFSet[1]|2[:OUTer]:LIST:STOP:SABSolute:COUPle
[:SENSe]:SEMask:OFFSet[1]|2[:OUTer]:LIST:SWEEp:ACQuisition:TIME
[:SENSe]:SEMask:OFFSet[1]|2
[:OUTer]:LIST:SWEEp:ACQuisition:TIME:AUTO
[:SENSe]:SEMask:OFFSet[1]|2[:OUTer]:LIST:SWEEp:ETIME?
[:SENSe]:SEMask:OFFSet[1]|2[:OUTer]:LIST:SWEEp:TIME
[:SENSe]:SEMask:OFFSet[1]|2[:OUTer]:LIST:SWEEp:TIME:AUTO
[:SENSe]:SEMask:OFFSet[1]|2[:OUTer]:LIST:SWEEp:TYPE
[:SENSe]:SEMask:OFFSet[1]|2[:OUTer]:LIST:SWEEp:TYPE:AUTO
[:SENSe]:SEMask:OFFSet[1]|2[:OUTer]:LIST:TEST
[:SENSe]:SEMask:OFFSet[1]|2[:OUTer]:LIST:TEST:SABSolute
[:SENSe]:SEMask:OFFSet[1]|2[:OUTer]:TYPE
[:SENSe]:SEMask:OFFSet[1]|2:TYPE
[:SENSe]:SEMask:SAVoid[:STATE]?
[:SENSe]:SEMask:SWEEp[1]|2:TIME
[:SENSe]:SEMask:SWEEp[1]|2:TIME:AUTO
[:SENSe]:SEMask:SWEEp[1]|2:TYPE
[:SENSe]:SEMask:SWEEp[1]|2:TYPE:AUTO
[:SENSe]:SEMask:SWEEp:ACQuisition:TIME
[:SENSe]:SEMask:SWEEp:ACQuisition:TIME:AUTO
[:SENSe]:SEMask:SWEEp:ETIME?
[:SENSe]:SEMask:SWEEp:POINts
[:SENSe]:SEMask:SWEEp:TYPE:AUTO:RULEs
[:SENSe]:SEMask:TYPE
[:SENSe]:SEMask:WBFFt:ENABle
  
```

9 Programming the Instrument
9.1 List of Supported SCPI Commands

```
[ :SENSe ] :SIDentify :MODE  
[ :SENSe ] :SIDentify [ :STATe ]  
[ :SENSe ] :SPECTrum :IF :FREQUency ?  
[ :SENSe ] :SPECTrum :LO :MIXMode :SIDE ?  
[ :SENSe ] :SPURious :AVERAge :COUNT  
[ :SENSe ] :SPURious :AVERAge [ :STATe ]  
[ :SENSe ] :SPURious :AVERAge :TCONtrol  
[ :SENSe ] :SPURious :AVERAge :TYPE  
[ :SENSe ] :SPURious :FSMeas  
[ :SENSe ] :SPURious :IF :GAIN :AUTO [ :STATe ]  
[ :SENSe ] :SPURious :IF :GAIN [ :STATe ]  
[ :SENSe ] :SPURious [ :RANGe ] :ALL :SWEp :TYPE :AUTO  
[ :SENSe ] :SPURious [ :RANGe ] [ :LIST ] :ATTenuation  
[ :SENSe ] :SPURious [ :RANGe ] [ :LIST ] :ATTenuation :AUTO  
[ :SENSe ] :SPURious [ :RANGe ] [ :LIST ] :BANDwidth :IMULTi  
[ :SENSe ] :SPURious [ :RANGe ] [ :LIST ] :BANDwidth [ :RESolution ]  
[ :SENSe ] :SPURious [ :RANGe ] [ :LIST ] :BANDwidth [ :RESolution ] :AUTO  
[ :SENSe ] :SPURious [ :RANGe ] [ :LIST ] :BANDwidth :SHAPE  
[ :SENSe ] :SPURious [ :RANGe ] [ :LIST ] :BANDwidth :VIDeo  
[ :SENSe ] :SPURious [ :RANGe ] [ :LIST ] :BANDwidth :VIDeo :AUTO  
[ :SENSe ] :SPURious [ :RANGe ] [ :LIST ] :DETEctor [ 1 ] [ :FUNCTION ]  
[ :SENSe ] :SPURious [ :RANGe ] [ :LIST ] :DETEctor2 [ :FUNCTION ]  
[ :SENSe ] :SPURious [ :RANGe ] [ :LIST ] :FREQUency :CENTer  
[ :SENSe ] :SPURious [ :RANGe ] [ :LIST ] :FREQUency :SPAN  
[ :SENSe ] :SPURious [ :RANGe ] [ :LIST ] :FREQUency :START  
[ :SENSe ] :SPURious [ :RANGe ] [ :LIST ] :FREQUency :STOP  
[ :SENSe ] :SPURious [ :RANGe ] [ :LIST ] :PEAK :EXCURsion  
[ :SENSe ] :SPURious [ :RANGe ] [ :LIST ] :PEAK :THReshold  
[ :SENSe ] :SPURious [ :RANGe ] [ :LIST ] :STATe  
[ :SENSe ] :SPURious [ :RANGe ] [ :LIST ] :SWEp :POINTs  
[ :SENSe ] :SPURious [ :RANGe ] [ :LIST ] :SWEp :POINTs :AUTO  
[ :SENSe ] :SPURious [ :RANGe ] [ :LIST ] :SWEp :TIME  
[ :SENSe ] :SPURious [ :RANGe ] [ :LIST ] :SWEp :TIME :AUTO  
[ :SENSe ] :SPURious :REPT :MODE  
[ :SENSe ] :SPURious :SPUR  
[ :SENSe ] :SPURious :SWEp :TIME :AUTO :RULEs  
[ :SENSe ] :SPURious :TYPE  
[ :SENSe ] :SWEp :EGATe :CONTRol  
[ :SENSe ] :SWEp :EGATe :DELay  
[ :SENSe ] :SWEp :EGATe :DELay :COMPensation :TYPE  
[ :SENSe ] :SWEp :EGATe :HACCElerate :ENABLE  
[ :SENSe ] :SWEp :EGATe :HOLDoff  
[ :SENSe ] :SWEp :EGATe :HOLDoff :AUTO  
[ :SENSe ] :SWEp :EGATe :LENGth  
[ :SENSe ] :SWEp :EGATe :METHod  
[ :SENSe ] :SWEp :EGATe :SOURce  
[ :SENSe ] :SWEp :EGATe [ :STATe ]  
[ :SENSe ] :SWEp :EGATe :TIME  
[ :SENSe ] :SWEp :EGATe :VIEW  
[ :SENSe ] :SWEp :EGATe :VIEW :START
```

```

[:SENSe]:SWEp:IF:DITHer
[:SENSe]:SWEp:IF:DITHer
[:SENSe]:SWEp:IMAGeprot
[:SENSe]:SWEp:IMAGeprot
[:SENSe]:VCORection:DELeTe
[:SENSe]:VCORection:SELeCt
[:SENSe]:VOLTagE|POWer:IQ:MIRROred
[:SENSe]:VOLTagE:IQ[:I]:RANGe[:UPPer]
[:SENSe]:VOLTagE:IQ:Q:RANGe[:UPPer]
[:SENSe]:VOLTagE:IQ:RANGe:AUTO
[:SENSe]:WAVeform:ADC:DITHer:AUTO[:STATe]
[:SENSe]:WAVeform:ADC:DITHer[:STATe]
[:SENSe]:WAVeform:APERture?
[:SENSe]:WAVeform:AVERAge:COUNT
[:SENSe]:WAVeform:AVERAge[:STATe]
[:SENSe]:WAVeform:AVERAge:TACount
[:SENSe]:WAVeform:AVERAge:TACount:AUTO
[:SENSe]:WAVeform:AVERAge:TCONtrol
[:SENSe]:WAVeform:AVERAge:TYPE
[:SENSe]:WAVeform:AVERAge:TYPE:AUTO
[:SENSe]:WAVeform:DIF:BANDwidth
[:SENSe]:WAVeform:DIF:BANDwidth:AUTO
[:SENSe]:WAVeform:DIF:FILTer:ALPHA
[:SENSe]:WAVeform:DIF:FILTer:BANDwidth
[:SENSe]:WAVeform:DIF:FILTer:BANDwidth:AUTO
[:SENSe]:WAVeform:DIF:FILTer:TYPE
[:SENSe]:WAVeform:FREQuency:SYNThesis:AUTO[:STATe]
[:SENSe]:WAVeform:FREQuency:SYNThesis[:STATe]
[:SENSe]:WAVeform:IF:FREQuency?
[:SENSe]:WAVeform:IF:GAIN:AUTO[:STATe]
[:SENSe]:WAVeform:IF:GAIN:LEVel
[:SENSe]:WAVeform:IF:GAIN:OFFSet
[:SENSe]:WAVeform:IF:GAIN[:STATe]
[:SENSe]:WAVeform:LO:DITHer[:STATe]
[:SENSe]:WAVeform:LO:MIXMode
[:SENSe]:WAVeform:LO:MIXMode:SIDE?
[:SENSe]:WAVeform:SAVoid[:STATe]
[:SENSe]:WAVeform:SPECTrum
[:SENSe]:WAVeform:SRATe
[:SENSe]:WAVeform:SWEp:TIME
SERvice[:PRoDUCTION]:SOURce:MCONtrol:MPLicense[:STATe]
SOURce:AM[:DEPTH][:LINear]
SOURce:AM:INTernal:FREQuency
SOURce:AM:INTernal:FREQuency:STEP[:INCRement]
SOURce:AM:STATe
SOURce:FM[:DEVIation]
SOURce:FM:INTernal:FREQuency
SOURce:FM:INTernal:FREQuency:STEP[:INCRement]
SOURce:FM:STATe
SOURce:FREQuency:CHANnELs:BAND
SOURce:FREQuency:CHANnELs:NUMBer

```

9 Programming the Instrument
9.1 List of Supported SCPI Commands

SOURce:FREQuency:COUPLing
SOURce:FREQuency:COUPLing:OFFSet
SOURce:FREQuency[:CW]
SOURce:FREQuency:OFFSet
SOURce:FREQuency:REFerence
SOURce:FREQuency:REFerence:SET
SOURce:FREQuency:REFerence:STATe
SOURce:FREQuency:STEP[:INCRement]
SOURce:LIST:INITiation:ARMed?
SOURce:LIST:NUMBer:STEPs
SOURce:LIST:REPetition:TYPE
SOURce:LIST:SETup:AMPLitude
SOURce:LIST:SETup:CLEar
SOURce:LIST:SETup:CNFRequency
SOURce:LIST:SETup:DURation:TYPE
SOURce:LIST:SETup:INPut:TRIGger
SOURce:LIST:SETup:OUTPut:TRIGger
SOURce:LIST:SETup:RADio:BAND
SOURce:LIST:SETup:RADio:BAND:LINK
SOURce:LIST:SETup:TOCount
SOURce:LIST:SETup:TRANSition:TIME
SOURce:LIST:SETup:WAVEform
SOURce:LIST[:STATe]
SOURce:LIST:STEP[1]|2|...|1000:SETup
SOURce:LIST:STEP[1]|2|...|1000:SETup:AMPLitude
SOURce:LIST:STEP[1]|2|...|1000:SETup:CNFRequency
SOURce:LIST:STEP[1]|2|...|1000:SETup:DURation:TCOUNT
SOURce:LIST:STEP[1]|2|...|1000:SETup:DURation:TCOUNT
SOURce:LIST:STEP[1]|2|...|1000:SETup:DURation:TYPE
SOURce:LIST:STEP[1]|2|...|1000:SETup:INPut:TRIGger
SOURce:LIST:STEP[1]|2|...|1000:SETup:OUTPut:TRIGger
SOURce:LIST:STEP[1]|2|...|1000:SETup:RADio:BAND
SOURce:LIST:STEP[1]|2|...|1000:SETup:RADio:BAND:LINK
SOURce:LIST:STEP[1]|2|...|1000:SETup:TRANSition:TIME
SOURce:LIST:STEP[1]|2|...|1000:SETup:WAVEform
SOURce:LIST:TRIGger[:IMMediate]
SOURce:LIST:TRIGger:INITiate[:IMMediate]
SOURce:LIST:TRIGger:OUTPut:TYPE
SOURce:LIST:TRIGger:OUTPut:TYPE:MARKer
SOURce:PM[:DEViation]
SOURce:PM:INTernal:FREQuency
SOURce:PM:INTernal:FREQuency:STEP[:INCRement]
SOURce:PM:STATe
SOURce:POWer[:LEVel][:IMMediate][:AMPLitude]
SOURce:POWer[:LEVel][:IMMediate][:AMPLitude]:UNIT
SOURce:POWer[:LEVel][:IMMediate]:OFFSet
SOURce:POWer:REFerence
SOURce:POWer:REFerence:STATe
SOURce:POWer:STEP[:INCRement]
SOURce:PRESet

SOURce:RADio:ARB:BASeband:FREQuency:OFFSet
SOURce:RADio:ARB:BASeband:POWer
SOURce:RADio:ARB:CATalog?
SOURce:RADio:ARB:CATalog?
SOURce:RADio:ARB:DEFault:DIRectory
SOURce:RADio:ARB:DELeTe
SOURce:RADio:ARB:DELeTe:ALL
SOURce:RADio:ARB:FCATalog?
SOURce:RADio:ARB:FCATalog?
SOURce:RADio:ARB:HEADer:CLEar
SOURce:RADio:ARB:HEADer:INFormation?
SOURce:RADio:ARB:HEADer:SAVE
SOURce:RADio:ARB:IQADjustment:DELay
SOURce:RADio:ARB:IQADjustment:GAIN
SOURce:RADio:ARB:IQADjustment:[STATe]
SOURce:RADio:ARB:LOAD
SOURce:RADio:ARB:LOAD:ALL
SOURce:RADio:ARB:MDEStination:ALCHold
SOURce:RADio:ARB:MDEStination:PULSe
SOURce:RADio:ARB:MPLicensed:NAME:LOCKed?
SOURce:RADio:ARB:MPLicensed:UID:LOCKed?
SOURce:RADio:ARB:MPOLarity:MARKer1|...|4
SOURce:RADio:ARB:NR5G:PHASe:FILTer:BANDwidth
SOURce:RADio:ARB:NR5G:PHASe:FILTer[:STATe]
SOURce:RADio:ARB:NR5G:PHASe:SCS
SOURce:RADio:ARB:NR5G:PHASe[:STATe]
SOURce:RADio:ARB:RETRigger
SOURce:RADio:ARB:RMS
SOURce:RADio:ARB:RMS:CALCulate
SOURce:RADio:ARB:RMS:CALCulation:MODE
SOURce:RADio:ARB:RSCaling
SOURce:RADio:ARB:SCLock:RATE
SOURce:RADio:ARB:SEQuence[:MWAveform]
SOURce:RADio:ARB:SEQuence:SYNC
SOURce:RADio:ARB[:STATe]
SOURce:RADio:ARB:TRIGger:INITiate
SOURce:RADio:ARB:TRIGger[:SOURce]
SOURce:RADio:ARB:TRIGger[:SOURce]:EXTErnal:DELay
SOURce:RADio:ARB:TRIGger[:SOURce]:EXTErnal:DELay:STATe
SOURce:RADio:ARB:TRIGger[:SOURce]:EXTErnal:SLOPe
SOURce:RADio:ARB:TRIGger[:SOURce]:PXI:DELay
SOURce:RADio:ARB:TRIGger[:SOURce]:PXI:DELay:STATe
SOURce:RADio:ARB:TRIGger[:SOURce]:PXI:LINE
SOURce:RADio:ARB:TRIGger[:SOURce]:PXI:SLOPe
SOURce:RADio:ARB:TRIGger:SYNC[:STATe]
SOURce:RADio:ARB:TRIGger:TYPE
SOURce:RADio:ARB:TRIGger:TYPE:CONTInuous[:TYPE]
SOURce:RADio:ARB:TRIGger:TYPE:SADVance[:TYPE]
SOURce:RADio:ARB:WAVEform
SOURce:RADio:BAND:LINK
SOURce:SYNC:CONFig

9 Programming the Instrument
9.1 List of Supported SCPI Commands

SOURce:SYNC:CONNeCTed?
SOURce:SYNC:REMOte:ADDReSS
SOURce:SYNC:REMOte:ADDReSS:ADD
SOURce:SYNC:REMOte:ADDReSS:DELeTe
SOURce:SYNC:REMOte:IPPort
SOURce:SYNC:REMOte:SEC<integer>?
SOURce:SYNC:REMOte:SECOndary<integer>
SOURce:SYNC:RTSetting:STATe
SOURce:SYNC:SETTings:ENABLe
SOURce:SYNC:SETTings:SEGMeNt2:ENABLe
SOURce:SYNC:SETTings:SEGMeNt2:FREQuency
SOURce:SYNC:STARt
SOURce:SYNC:STOP
SOURce:SYNC:TYPE
STATus:OPERation:CONDeNtion?
STATus:OPERation:ENABLe
STATus:OPERation:ENABLe
STATus:OPERation[:EVENT]?
STATus:OPERation:INSTRument:CONDeNtion?
STATus:OPERation:INSTRument:ENABLe
STATus:OPERation:INSTRument[:EVENT]?
STATus:OPERation:INSTRument:NTRansition
STATus:OPERation:INSTRument:PTRansition
STATus:OPERation:NTRansition
STATus:OPERation:PTRansition
STATus:PRESet
STATus:QUEStionable:CALibration:CONDeNtion?
STATus:QUEStionable:CALibration:ENABLe
STATus:QUEStionable:CALibration[:EVENT]?
STATus:QUEStionable:CALibration:EXTeNded:FAILure:CONDeNtion?
STATus:QUEStionable:CALibration:EXTeNded:FAILure:ENABLe
STATus:QUEStionable:CALibration:EXTeNded:FAILure[:EVENT]?
STATus:QUEStionable:CALibration:EXTeNded:FAILure:NTRansition
STATus:QUEStionable:CALibration:EXTeNded:FAILure:PTRansition
STATus:QUEStionable:CALibration:EXTeNded:NEEDed:CONDeNtion?
STATus:QUEStionable:CALibration:EXTeNded:NEEDed:ENABLe
STATus:QUEStionable:CALibration:EXTeNded:NEEDed[:EVENT]?
STATus:QUEStionable:CALibration:EXTeNded:NEEDed:NTRansition
STATus:QUEStionable:CALibration:EXTeNded:NEEDed:PTRansition
STATus:QUEStionable:CALibration:NTRansition
STATus:QUEStionable:CALibration:PTRansition
STATus:QUEStionable:CALibration:SKIPped:CONDeNtion?
STATus:QUEStionable:CALibration:SKIPped:ENABLe
STATus:QUEStionable:CALibration:SKIPped[:EVENT]?
STATus:QUEStionable:CALibration:SKIPped:NTRansition
STATus:QUEStionable:CALibration:SKIPped:PTRansition
STATus:QUEStionable:CONDeNtion?
STATus:QUEStionable:ENABLe
STATus:QUEStionable[:EVENT]?
STATus:QUEStionable:FREQuency:CONDeNtion?

STATus:QUESTionable:FREQuency:ENABle
STATus:QUESTionable:FREQuency[:EVENT]?
STATus:QUESTionable:FREQuency:NTRansition
STATus:QUESTionable:FREQuency:PTRansition
STATus:QUESTionable:INTEgrity:CONDition?
STATus:QUESTionable:INTEgrity:ENABle
STATus:QUESTionable:INTEgrity[:EVENT]?
STATus:QUESTionable:INTEgrity:NTRansition
STATus:QUESTionable:INTEgrity:OUTPut:CONDition?
STATus:QUESTionable:INTEgrity:OUTPut:ENABle
STATus:QUESTionable:INTEgrity:OUTPut[:EVENT]?
STATus:QUESTionable:INTEgrity:OUTPut:NTRansition
STATus:QUESTionable:INTEgrity:OUTPut:PTRansition
STATus:QUESTionable:INTEgrity:PTRansition
STATus:QUESTionable:INTEgrity:SIGNal:CONDition?
STATus:QUESTionable:INTEgrity:SIGNal:ENABle
STATus:QUESTionable:INTEgrity:SIGNal[:EVENT]?
STATus:QUESTionable:INTEgrity:SIGNal:NTRansition
STATus:QUESTionable:INTEgrity:SIGNal:PTRansition
STATus:QUESTionable:INTEgrity:UNCalibrated:CONDition?
STATus:QUESTionable:INTEgrity:UNCalibrated:ENABle
STATus:QUESTionable:INTEgrity:UNCalibrated[:EVENT]?
STATus:QUESTionable:INTEgrity:UNCalibrated:NTRansition
STATus:QUESTionable:INTEgrity:UNCalibrated:PTRansition
STATus:QUESTionable:NTRansition
STATus:QUESTionable:POWer:CONDition?
STATus:QUESTionable:POWer:ENABle
STATus:QUESTionable:POWer[:EVENT]?
STATus:QUESTionable:POWer:NTRansition
STATus:QUESTionable:POWer:PTRansition
STATus:QUESTionable:POWer:PTRansition?>
STATus:QUESTionable:PTRansition
STATus:QUESTionable:TEMPerature:CONDition?
STATus:QUESTionable:TEMPerature:ENABle
STATus:QUESTionable:TEMPerature[:EVENT]?
STATus:QUESTionable:TEMPerature:NTRansition
STATus:QUESTionable:TEMPerature:PTRansition
SYSTem:APPLication:CATalog[:NAME]?
SYSTem:APPLication:CATalog[:NAME]:COUNT?
SYSTem:APPLication:CATalog:OPTion?
SYSTem:APPLication:CATalog:REVision?
SYSTem:APPLication[:CURRent][:NAME]?
SYSTem:APPLication[:CURRent]:OPTion?
SYSTem:APPLication[:CURRent]:REVision?
SYSTem:APPLication:LOADed?
SYSTem:CALibration:ABORT
SYSTem:CALibration:CGRoup
SYSTem:CALibration:CGRoup:APPLY
SYSTem:CALibration:CGRoup:APPLY:AOFF
SYSTem:CALibration:CGRoup:COPY
SYSTem:CALibration:CGRoup:COPY:FROM

9 Programming the Instrument
 9.1 List of Supported SCPI Commands

SYSTem:CALibration:DELeTe:ALL
 SYSTem:CALibration:DESCRiption
 SYSTem:CALibration:FREQuency:OFFSet
 SYSTem:CALibration:INITiate:SELeCted
 SYSTem:CALibration:INPut
 SYSTem:CALibration:MODUle[1]|2|...|10:SNUMber?
 SYSTem:CALibration:MODUle:SELeCt
 SYSTem:CALibration:REFerence
 SYSTem:CALibration:ROW[1]|2|...|100:APPLy:STATe
 SYSTem:CALibration:ROW[1]|2|...|100:ATTenuation:START
 SYSTem:CALibration:ROW[1]|2|...|100:ATTenuation:STEP
 SYSTem:CALibration:ROW[1]|2|...|100:ATTenuation:STOP
 SYSTem:CALibration:ROW[1]|2|...|100:ATTenuation:TYPE
 SYSTem:CALibration:ROW[1]|2|...|100:CALibrate:STATe
 SYSTem:CALibration:ROW[1]|2|...|100:CAPPLIED?
 SYSTem:CALibration:ROW[1]|2|...|100:COUPLing
 SYSTem:CALibration:ROW[1]|2|...|100:DELeTe
 SYSTem:CALibration:ROW[1]|2|...|100:DUPLicate
 SYSTem:CALibration:ROW[1]|2|...|100:EATTenuation:START
 SYSTem:CALibration:ROW[1]|2|...|100:EATTenuation:STEP
 SYSTem:CALibration:ROW[1]|2|...|100:EATTenuation:STOP
 SYSTem:CALibration:ROW[1]|2|...|100:EATTenuation:TYPE
 SYSTem:CALibration:ROW[1]|2|...|100:FATTenuation:START
 SYSTem:CALibration:ROW[1]|2|...|100:FATTenuation:STOP
 SYSTem:CALibration:ROW[1]|2|...|100:FATTenuation:TYPE
 SYSTem:CALibration:ROW[1]|2|...|100:FEATTenuation:START
 SYSTem:CALibration:ROW[1]|2|...|100:FEATTenuation:STEP
 SYSTem:CALibration:ROW[1]|2|...|100:FEATTenuation:STOP
 SYSTem:CALibration:ROW[1]|2|...|100:FEATTenuation:TYPE
 SYSTem:CALibration:ROW[1]|2|...|100:FREQuency:POINts
 SYSTem:CALibration:ROW[1]|2|...|100:FREQuency:START
 SYSTem:CALibration:ROW[1]|2|...|100:FREQuency:STEP
 SYSTem:CALibration:ROW[1]|2|...|100:FREQuency:STOP
 SYSTem:CALibration:ROW[1]|2|...|100:FREQuency:SYNThesis:ALL[:STATe]
 SYSTem:CALibration:ROW[1]|2|...|100:FREQuency:SYNThesis[:STATe]
 SYSTem:CALibration:ROW[1]|2|...|100:IF:GAIN[:STATe]?
 SYSTem:CALibration:ROW[1]|2|...|100:IF:GAIN
 [:STATe]AUTO|HIGH|LOW|ALL
 SYSTem:CALibration:ROW[1]|2|...|100:IF:PATH
 SYSTem:CALibration:ROW[1]|2|...|100:INSert
 SYSTem:CALibration:ROW[1]|2|...|100:LAST?
 SYSTem:CALibration:ROW[1]|2|...|100:LO:MMODE
 SYSTem:CALibration:ROW[1]|2|...|100:MATCH[:STATe]
 SYSTem:CALibration:ROW[1]|2|...|100:NAME
 SYSTem:CALibration:ROW[1]|2|...|100:POWER:GAIN:BAND?
 SYSTem:CALibration:ROW[1]|2|...|100:POWER[:RF]:GAIN:BAND
 SYSTem:CALibration:ROW[1]|2|...|100:POWER[:RF]:GAIN:LNA[:STATe]
 SYSTem:CALibration:ROW[1]|2|...|100:POWER[:RF]:MW:PATH
 SYSTem:CALibration:ROW[1]|2|...|100:STATus?
 SYSTem:CALibration:ROW[1]|2|...|100:TYPE

SYSTem:CALibration:ROW[1]|2|...|100:UCMeas
SYSTem:CALibration:STATus:ALL?
SYSTem:CALibration:TUNE:FREQuency
SYSTem:CALibration:TUNE:OUTput[:STATe]
SYSTem:CALibration:TUNE:REFerence
SYSTem:CALibration:TUNE[:SElected]
SYSTem:CALibration:TUNE:SPACing
SYSTem:CALibration:TUNE:TYPE
SYSTem:COMMunicate:GPIB[1][:SELF]:ADDRes
SYSTem:COMMunicate:GPIB[1][:SELF]:CONTroller[:ENABle]
SYSTem:COMMunicate:LAN:INSTrument:PORT?
SYSTem:COMMunicate:LAN:IPV4:CONFig
SYSTem:COMMunicate:LAN:IPV6:CONFig
SYSTem:COMMunicate:LAN:MULTiple:NIC:ENABled?
SYSTem:COMMunicate:LAN:PHYSical:IPAdDress:LIST?
SYSTem:COMMunicate:LAN:SCPI:EOSession:DCLear:ENABle
SYSTem:COMMunicate:LAN:SCPI:HISLip:ENABle
SYSTem:COMMunicate:LAN:SCPI:SICL:ENABle
SYSTem:COMMunicate:LAN:SCPI:SOCKet:CONTRol?
SYSTem:COMMunicate:LAN:SCPI:SOCKet:ENABle
SYSTem:COMMunicate:LAN:SCPI:TELNet:ENABle
SYSTem:COMMunicate:USB:CONNection?
SYSTem:COMMunicate:USB:PACKets?
SYSTem:COMMunicate:USB:STATus?
SYSTem:CONFigure[:SYSTem]?
SYSTem:CSYSTem?
SYSTem:DATE
SYSTem:DEFault
SYSTem:DISPlay:BACKlight:INTensity
SYSTem:DISPlay:CFORmat
SYSTem:DISPlay:HINTs?
SYSTem:DISPlay:HINTs[:STATe]
SYSTem:DISPlay:LANGuage
SYSTem:DISPlay:MPPosition
SYSTem:DISPlay:MPTab
SYSTem:DISPlay:NEPimmediate
SYSTem:ERRor[:NEXT]?
SYSTem:ERRor:OVERload[:STATe]
SYSTem:ERRor:PUP?
SYSTem:ERRor:VERBose
SYSTem:HELP:HEADers?
SYSTem:HID?
SYSTem:IDN
SYSTem:IDN:CONFigure
SYSTem:KLOCK
SYSTem:LICense[:FPAck]:WAVEform:ADD
SYSTem:LICense[:FPAck]:WAVEform:CLEar
SYSTem:LICense[:FPAck]:WAVEform:FREE?
SYSTem:LICense[:FPAck]:WAVEform:LOCK
SYSTem:LICense[:FPAck]:WAVEform:NAME?
SYSTem:LICense[:FPAck]:WAVEform:REPLace

9 Programming the Instrument
9.1 List of Supported SCPI Commands

SYSTem:LIcense[:FPACK]:WAVeform:STATus?
SYSTem:LIcense[:FPACK]:WAVeform:UID?
SYSTem:LIcense[:FPACK]:WAVeform:USED?
SYSTem:LKEY
SYSTem:LKEY?
SYSTem:LKEY:BORRow
SYSTem:LKEY:BORRow:LIST?
SYSTem:LKEY:BORRow:NETWork:COU:ENABle
SYSTem:LKEY:BORRow:RETurn
SYSTem:LKEY:COU?
SYSTem:LKEY:COU:LIST?
SYSTem:LKEY:DELeTe
SYSTem:LKEY:LIST?
SYSTem:LKEY:SOFTware:SUPPort:EXPIration:DATE?
SYSTem:LKEY:WAVeform:ADD
SYSTem:LKEY:WAVeform:CLear
SYSTem:LKEY:WAVeform:FREE?
SYSTem:LKEY:WAVeform:LOCK
SYSTem:LKEY:WAVeform:NAME?
SYSTem:LKEY:WAVeform:REPLace
SYSTem:LKEY:WAVeform:STATus?
SYSTem:LKEY:WAVeform:UID?
SYSTem:LKEY:WAVeform:USED?
SYSTem:LOCK:NAME?
SYSTem:LOCK:OWNer?
SYSTem:LOCK:RELease
SYSTem:LOCK:REQUest?
SYSTem:LOFF
SYSTem:LWStation
SYSTem:METRics:FPANel?
SYSTem:METRics:SCPI?
SYSTem:METRics:STIME?
SYSTem:MRELay:COUnt?
SYSTem:OPTions?
SYSTem:PDOWN
SYSTem:PERSONa:DEFault
SYSTem:PERSONa:MANUFACTurer
SYSTem:PERSONa:MANUFACTurer:DEFault
SYSTem:PERSONa:MODEl
SYSTem:PERSONa:MODEl:DEFault
SYSTem:PON:APPLication:LLIST
SYSTem:PON:APPLication:VMEMory[:AVAILable]?
SYSTem:PON:APPLication:VMEMory:TOTAL?
SYSTem:PON:APPLication:VMEMory:USED?
SYSTem:PON:APPLication:VMEMory:USED:NAME?
SYSTem:PON:ETIME?
SYSTem:PON:FPGA:LOAD
SYSTem:PON:FPGA:PREFerence
SYSTem:PON:MODE
SYSTem:PON:TIME?

SYSTem:PON:TYPE
 SYSTem:PRESet
 SYSTem:PRESet:FULL
 SYSTem:PRESet:TYPE
 SYSTem:PRESet:USER
 SYSTem:PRESet:USER:ALL
 SYSTem:PRESet:USER:SAVE
 SYSTem:PRINt:THEMe
 SYSTem:PUP
 SYSTem:PUP:PROcEss
 SYSTem:SECurity:USB:WPRotect[:ENABle]
 SYSTem:SEQuencer
 SYSTem:SET
 SYSTem:SHOW
 SYSTem:SOFTware:VERSIon:DATE?
 SYSTem:TEMPerature:HEXTreme?
 SYSTem:TEMPerature:LEXTreme?
 SYSTem:TIME
 SYSTem:VERSIon?

T

TRACe[:<meas>]:CLEAr:ALL
 TRACe:<meas>:COPY
 TRACe:<meas>:EXCHange
 TRACe[:<meas>]:PRESet:ALL
 TRACe[1]|2|...|6:DISPly[:STATe]
 TRACe[1]|2|...|6:TYPE
 TRACe[1]|2|...|6:UPDate[:STATe]
 TRACe[1]|2|3:<meas>:DISPly[:STATe]
 TRACe[1]|2|3:<meas>:TYPE
 TRACe[1]|2|3:<meas>:UPDate[:STATe]
 TRACe:CLEAr
 TRACe:COPY
 TRACe[:DATA]
 TRACe:EXCHange
 TRACe:MONitor:CLEAr:ALL
 TRIGger:<measurement>[:SEQuence]:IQ:SOURce
 TRIGger:<measurement>[:SEQuence]:RF:SOURce
 TRIGger:<measurement>[:SEQuence]:SOURce
 TRIGger[1]|2|...|4[:SEQuence]:OUTPut
 TRIGger[1]|2|...|4[:SEQuence]:OUTPut:DIRectiOn
 TRIGger[1]|2|...|4[:SEQuence]:OUTPut:POLarity
 TRIGger:PXIE:ANALyzer[:SEQuence]:OUTPut
 TRIGger:PXIE:ANALyzer[:SEQuence]:OUTPut:LINE
 TRIGger:PXIE:ANALyzer[:SEQuence]:OUTPut:POLarity
 TRIGger:PXIE:SOURce[:SEQuence]:OUTPut
 TRIGger:PXIE:SOURce[:SEQuence]:OUTPut:LINE
 TRIGger:PXIE:SOURce[:SEQuence]:OUTPut:POLarity

9 Programming the Instrument
9.1 List of Supported SCPI Commands

TRIGger[:SEQuence]:<trig_source>:DELay
TRIGger[:SEQuence]:<trig_source>:DELay:STATe
TRIGger[:SEQuence]:<trig_source>:LEVel
TRIGger[:SEQuence]:<trig_source>:SLOPe
TRIGger[:SEQuence]:AIQMag:BANDwidth
TRIGger[:SEQuence]:AIQMag:CENTer
TRIGger[:SEQuence]:ATRigger
TRIGger[:SEQuence]:ATRigger:STATe
TRIGger[:SEQuence]:EXTErnal1|EXTErnal2|RFBurst:DELay:COMPensation
TRIGger[:SEQuence]:FRAMe:ADJust
TRIGger[:SEQuence]:FRAMe:OFFSet
TRIGger[:SEQuence]:FRAMe:OFFSet:DISPlay:RESet
TRIGger[:SEQuence]:FRAMe:PERiod
TRIGger[:SEQuence]:FRAMe:SMONitor:RESet
TRIGger[:SEQuence]:FRAMe:SYNC
TRIGger[:SEQuence]:FRAMe:SYNC:HOLDoff
TRIGger[:SEQuence]:FRAMe:SYNC:HOLDoff:STATe
TRIGger[:SEQuence]:HOLDoff
TRIGger[:SEQuence]:HOLDoff:STATe
TRIGger[:SEQuence]:HOLDoff:TYPE
TRIGger[:SEQuence]:INTernal:SOURce:OUTPut
TRIGger[:SEQuence]:INTernal:SOURce:OUTPut:POLarity
TRIGger[:SEQuence]:OFFSet:STATe
TRIGger[:SEQuence]:OPTimize:MODE
TRIGger[:SEQuence]:PXI:LINE
TRIGger[:SEQuence]:RFBurst:LEVel:ABSolute
TRIGger[:SEQuence]:RFBurst:LEVel:RELative
TRIGger[:SEQuence]:RFBurst:LEVel:TYPE
TRIGger[:SEQuence]:SOURce
TRIGger[:SEQuence]:TV:FMODe
TRIGger[:SEQuence]:TV:LINE
TRIGger[:SEQuence]:TV:STANdard

U

UNIT:ACPower:POWer:PSD
UNIT:CHPower:POWer:PSD

9.2 IEEE 488.2 Common Commands

The instrument supports the following subset of IEEE 488.2 Common Commands, as defined in Chapter 10 of [IEEE Standard 488.2-1992](#). As indicated below, some of these commands correspond directly to instrument front-panel functionality, while others are available only as remote commands.

- ["*CAL? - Calibration Query" on page 2542](#) (Align Now All equivalent)
- ["*CLS - Clear Status" on page 2543](#)
- ["*ESE - Standard Event Status Enable" on page 2543](#)
- ["*ESR? - Standard Event Status Register Query" on page 2544](#)
- ["*IDN? - Identification Query" on page 2544](#)
- ["*OPC? - Operation Complete" on page 2545](#)
- ["*OPT? - Query Instrument Options" on page 2546](#)
- ["*RCL - Recall Instrument State" on page 2546](#) (Recall State equivalent)
- ["*RST - Reset" on page 2546](#) (Mode Preset equivalent)
- ["*SAV - Save Instrument State" on page 2547](#) (Save State equivalent)
- ["*SRE - Service Request Enable" on page 2547](#)
- ["*STB? - Status Byte Query" on page 2548](#)
- ["*TRG - Trigger" on page 2548](#)
- ["*TST? - Self Test Query" on page 2548](#)
- ["*WAI - Wait-to-Continue" on page 2549](#)

9.2.1 *CAL? - Calibration Query

***CAL?** Performs a full alignment and returns a number indicating the success of the alignment. A zero is returned if the alignment is successful. A one is returned if any part of the alignment fails. The equivalent SCPI command is [:CALibrate\[:ALL\]?](#)

See ["Align Now All" on page 1902](#)

Remote Command

***CAL**

Example	*CAL? Runs a full alignment and returns 0 if no problems encountered
Status Bits/OPC dependencies	See "Align Now All" on page 1902

9.2.2 *CLS - Clear Status

Clears the ["Status Byte Register" on page 2579](#), by emptying the error queue and clearing all bits in all of the event registers, and consequently all bits in the Status Byte Register.

The Status Byte Register summarizes the states of the other registers. It is also responsible for generating service requests.

Remote Command	*CLS
Example	*CLS Clears the error queue and the Status Byte Register
Notes	For related commands, see :SYSTem:ERRor[:NEXT]? See also :STATus:PRESet and all commands in the "Status Register System & STATus Subsystem" on page 2570
Status Bits/OPC dependencies	Resets all bits in all event registers to 0, which resets all the status byte register bits to 0 also

9.2.3 *ESE - Standard Event Status Enable

Sets the desired bits in the Event Enable sub-register of the ["Standard Event Status Register" on page 2583](#), which enables the corresponding bits in the Standard Event Status Register. This register monitors I/O errors and synchronization conditions such as operation complete, request control, query error, device-dependent error, status execution error, command error, and power on. The selected bits are **ORed** to become a summary bit (bit 5) in the ["Status Byte Register" on page 2579](#), which can be queried.

The query returns the state of this register.

Numeric values for bit patterns can be entered using decimal or hexadecimal representations (0 to 32767, equivalent to [#H0](#) to [#H7FFF](#)).

Remote Command	*ESE <integer> *ESE?
Example	*ESE 36 Enables the Standard Event Status Register to monitor query and command errors (bits 2 and 5)

	*ESE?
	Returns a 36 indicating that the query and command status bits are enabled
Notes	For related commands, see the "Status Register System & STATus Subsystem" on page 2570 and :SYSTem:ERRor[:NEXT]?
Preset	255
State Saved	Not saved in state
Min	0
Max	255

9.2.4 *ESR? - Standard Event Status Register Query

Queries and clears the ["Standard Event Status Register" on page 2583](#). (This is a destructive read.) The value returned is a hexadecimal number that reflects the current state (0/1) of all the bits in the register.

Remote Command	*ESR?
Example	*ESR? Returns a 1 if there is either a query or command error, otherwise it returns a zero
Notes	For related commands, see "Status Register System & STATus Subsystem" on page 2570
Min/Max	0 / 255
Status Bits/OPC dependencies	Standard Event Status Register (bits 0 – 7)

9.2.5 *IDN? - Identification Query

Returns a string of instrument identification information. The string contains the model number, serial number, and firmware revision.

The response is organized into four fields separated by commas. The field definitions are as follows:

1. Manufacturer
2. Model
3. Serial number
4. Firmware version

Remote Command	*IDN?
----------------	--------------

Example	<p>*IDN?</p> <p>Returns instrument identification information, such as: Keysight Technologies,N9040B,US01020004,A.15.02</p> <p>Backwards Compatibility Command</p>
Example	<p>:ID?</p> <p>Returns model number, such as: N9040B</p>
Notes	<p>Provided for backwards compatibility: In Remote Language Compatibility Mode, ID? returns the model number of the emulated instrument In any other Mode, the returned model number is that of the actual instrument</p>
Backwards Compatibility SCPI	<p>:ID?</p>

9.2.6 *OPC? - Operation Complete

Sets bit 0 in the "Standard Event Status Register" on page 2583 (SESR) to "1" when pending operations have finished, that is when all overlapped commands are complete. It does not hold off subsequent operations. You can determine when the overlapped commands have completed either by polling the OPC bit in SESR, or by setting up the status system so that a service request (SRQ) is asserted when the OPC bit is set.

***OPC?** returns "1" after all the current overlapped commands are complete, so it holds off subsequent commands until the "1" is returned, then the program continues. This query can be used to synchronize events of other instruments on the external bus.

Remote Command	<p>*OPC</p> <p>*OPC?</p>
Example	<p>Select single sweeping: :INIT:CONT 0</p> <p>Initiate a sweep: :INIT:IMM</p> <p>Hold off any further commands until the sweep is complete: *OPC?</p>
Notes	<p>Not global to all remote ports or front panel. *OPC only affects operations that were initiated on the same port that the *OPC command was issued from</p> <p>*OPC is an overlapped command, but *OPC? is sequential</p> <p>*OPC? does <i>not</i> holdoff the completion of GUI update commands , such as :MMEM:LOAD:SCON "myScreenConfig.screen"</p>

9.2.7 *OPT? - Query Instrument Options

Returns a string of all installed instrument options. It is a comma-separated list, with quotes, for example:

`"550,B25,B40,BBA,CRP,CRW,EA3,EDP,ESC,EXM,FBP,LNP,MPB,NF2,RTS,EMC,FP2"`

Remote Command	<code>*OPT?</code>
----------------	--------------------

9.2.8 *RCL - Recall Instrument State

Recalls the instrument state from the specified instrument memory register.

- If the state being loaded has a newer firmware revision than the revision of the instrument, no state is recalled and an error is reported
- If the state being loaded has an equal firmware revision than the revision of the instrument, the state will be loaded
- If the state being loaded has an older firmware revision than the revision of the instrument, then the instrument will only load the parts of the state that apply to the older revision

Remote Command	<code>*RCL <register #></code>
Example	Recall the instrument state that is currently stored in register 7 (register 8 in the UI): <code>*RCL 7</code>
Notes	Registers 0 through 15 are accessible from the front panel in menu keys for Recall Registers. Register 0 corresponds to front panel Register 1
Min	0
Max	127
Status Bits/OPC dependencies	The command is sequential

9.2.9 *RST - Reset

`*RST` is equivalent to `:SYST:PRES;:INIT:CONT OFF`, which is a Mode Preset in the **Single** measurement state. This command is preferred over the Mode Preset command `:SYST:PRES`, because optimal remote programming occurs with the instrument in the **Single** measurement state.

`*RST` clears all pending OPC bits and sets the Status Byte to 0.

Remote Command	*RST
Notes	Sequential
Couplings	*RST causes the currently running measurement to be aborted and causes the default measurement to be active. *RST gets the mode to a consistent state, with all of the default couplings set
Status Bits/OPC dependencies	Clears all pending OPC bits. The " Status Byte Register " on page 2579 is set to 0

9.2.10 *SAV - Save Instrument State

Saves the current instrument state and mode to the specified instrument memory register.

Remote Command	*SAV <register #>
Example	Save the instrument state in register 9 (register 10 in the UI): *SAV 9
Notes	Registers 0 through 15 are accessible from the front panel in menu keys for Save Registers. Register 0 corresponds to the front panel Register 1
Min/Max	0 / 127
Status Bits/OPC dependencies	The command is sequential

9.2.11 *SRE - Service Request Enable

Enables the desired bits of the "[Service Request Enable Register](#)" on page 2582.

The query returns the value of the register, indicating which bits are currently enabled.

Numeric values for bit patterns can be entered using decimal or hexadecimal representations (0 to 32767, equivalent to **#H0** to **#H7FFF**).

Remote Command	*SRE <integer> *SRE?
Example	Enable bits 1, 2, and 4 in the service request enable register: *SRE 22
Notes	For related commands, see " Status Register System & STATus Subsystem " on page 2570 and :SYSTem:ERRor[:NEXT]?
Preset	0
Min/Max	0 / 255

Status Bits/OPC dependencies Service Request Enable Register (all bits, 0 – 7)

9.2.12 *STB? - Status Byte Query

Returns the value of the "Status Byte Register" on page 2579 without erasing its contents.

Remote Command	<code>*STB?</code>
Example	Return a decimal value for the bits in the Status Byte Register: <code>*STB?</code> For example, if 16 is returned, it indicates that bit 5 is set and one of the conditions monitored in the standard event status register is set
Notes	See related command " <code>*CLS - Clear Status</code> " on page 2543
Status Bits/OPC dependencies	Status Byte Register (all bits, 0 – 7)

9.2.13 *TRG - Trigger

Triggers the instrument. Use `:TRIGger[:SEquence]:SOURce` to select the trigger source.

Remote Command	<code>*TRG</code>
Example	Trigger the instrument to take a sweep or start a measurement, depending on the current instrument settings: <code>*TRG</code>
Notes	See related command <code>:INITiate:IMMediate</code>

9.2.14 *TST? - Self Test Query

Performs the internal self-test routines and returns a number indicating the success of the testing. The value returned is 0 if the test is successful, or 1 if it fails.

Remote Command	<code>*TST?</code>
Example	Run the self-test routines: <code>*TST?</code>

9.2.15 *WAI - Wait-to-Continue

Causes the instrument to wait until all overlapped commands are completed before executing any additional commands. There is no equivalent query.

Remote Command	<code>*WAI</code>
Example	Set the instrument to single sweep. Start a sweep, then wait for its completion: <code>:INIT:CONT OFF;INIT;*WAI</code>
Notes	<code>*WAI</code> does <i>not</i> wait for the completion of user-interface-related commands, such as <code>:MMEM:LOAD:SCON "myScreenConfig.screen"</code>
Status Bits/OPC dependencies	Not global to all remote ports or front panel. <code>*OPC</code> only considers operation that was initiated on the same port that the <code>*OPC</code> command was issued from

9.3 SCPI Operation and Results Query

You can use SCPI commands for remote control of measurements and querying of measurement results data. There are several alternative commands you can use to control the measurement, depending on how you wish to operate the instrument. There are also a number of queries that you can use to extract the measurement data.

In this section, “Mode” refers to a Measurement Application, for example, Spectrum Analyzer or 5G NR.

9.3.1 Mode Control

Use either `:INSTRument:SElect` or `:INSTRument:NSElect` to select the Mode. See “Mode” on page 91.

`:INSTRument:CONFigure` causes a Mode *and* Measurement switch at the same time. This results in faster overall switching than sending `:INSTRument:SElect` and `:CONFigure` separately, as described in “Mode” on page 91.

9.3.2 Measurement Control

This section describes the measurement control commands listed below, and their functions.

<code>"CONFigure"</code> on page 2551	Switches to the desired measurement. Presets all measurement settings to their defaults, <i>unless</i> <code>:NDEFault</code> is specified
<code>"INITiate"</code> on page 2552	Starts the measurement
<code>"FETCh"</code> on page 2552	Queries the data without starting the measurement. If a measurement is already in progress, waits for completion
<code>"READ"</code> on page 2553	Starts the measurement with the current settings and queries the data
<code>"MEASure"</code> on page 2554	Switches to the desired measurement, presets all measurement settings to their defaults, starts the measurement and queries the data

The relationship between the command forms is illustrated in the diagram below. `:FETCh`, `:READ` and `:MEASure` are queries that return measurement data.

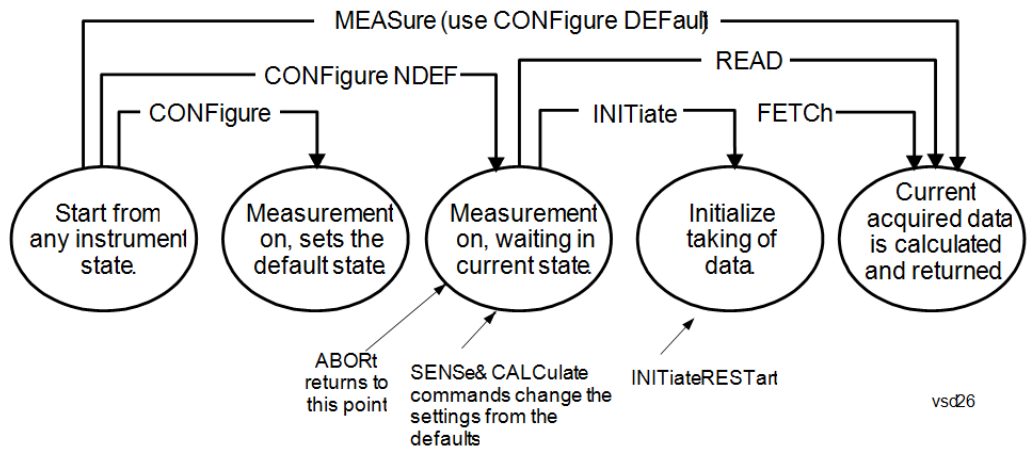

9.3.2.1 CONFigure

Stops the current measurement (if any) and sets up the instrument for the specified measurement using the measurement's default settings. Does not initiate the collection of measurement data unless `:INIT:CONT` is `ON`. If you change any measurement settings after using `:CONFigure`, "READ" on page 2553 can be used to initiate a measurement without changing the settings back to their defaults.

Normally `:CONFigure` presets the measurement after selecting it; but, if sent with the `NDEFault` parameter, it selects it without performing a Preset.

Remote Command	<code>:CONFigure:<measurement>[:NDEFault]</code> <code>:CONFigure?</code>
Example	Select and preset the Swept SA measurement: <code>:CONF:SAN</code> Select the Swept SA measurement <i>without</i> presetting: <code>:CONF:SAN:NDEF</code> Query the current measurement: <code>:CONF?</code>
Remote Command	<code>:CONFigure:CATalog?</code>
Example	<code>:CONF:CATalog?</code> returns a quoted string of all licensed measurement names in the current mode. For example, "SAN, CHP, OBW, ACP, PST, TXP, SPUR, SEM, LIST" for the Spectrum Analyzer mode

9.3.2.2 INITiate

Initiates a trigger cycle for the specified measurement, but does not output any data. You must then use `:FETCh<meas>` to return data. If a measurement other than the current one is specified, the instrument will switch to that measurement and then initiate it.

Remote Command `:INITiate:<measurement>`

Example Switch to the `SANalyzer` (Swept SA) measurement if not already there, then start the measurement:
`:INIT:SAN`

`:INITiate` does not change any of the measurement settings. For example, if you have already run the ACP measurement and you send `:INIT:ACP?` it initiates a new ACP measurement using the same instrument settings as the last time ACP was run.

If another measurement is running, `:INIT` switches to the specified measurement. For example, suppose you are running the channel power measurement. If you send `:INIT:ACP?` it changes from channel power to ACP and initiates an ACP measurement.

If your selected measurement is currently in the idle state, it restarts the measurement. Depending upon the measurement and the number of averages, there may be multiple data acquisitions, with multiple trigger events, for one full trigger cycle.

CAUTION

`:INIT` allows additional commands *while* the measurement is in progress.

Be aware that such additional commands may change measurement settings. They may cause the measurement in progress to be discarded, and a new measurement may start.

To wait for the completion of a measurement after sending `:INITiate`, send `"*WAI - Wait-to-Continue"` on page 2549, or `"*OPC? - Operation Complete"` on page 2545, or use `"FETCh"` on page 2552.

9.3.2.3 FETCh

Places selected data from the most recent measurement into the output buffer. Use `:FETCh` if you have already made a valid measurement and you want to retrieve data. You can issue `:FETCh` multiple times with differing `[n]` values without restarting or re-making the measurement, for example, both scalars and trace data from a single measurement.

Remote Command `:FETCh:<measurement>[n]?`

Example Fetch item 2 (Trace 2) from the **SAN** (Swept SA) measurement when the measurement completes. If not in the Swept SA measurement, returns an error:

:FETCh:SAN2?

:FETCh does not change any of the measurement settings, it simply reads the results of the current measurement. **:FETCh** may be used to return results other than those specified with the original **:READ** or **:MEASure** query that you sent.

You can only **:FETCh** results from the measurement that is currently active, it does not change to a different measurement. An error message is reported if a measurement other than the current one is specified.

If you need to get new measurement data, use **"READ"** on page 2553, which is equivalent to **"INITiate"** on page 2552 followed by **:FETCh**.

The measurement results for **n = 1** (usually the scalar result) will be returned if the optional **[n]** value is not included, or is set to 1. If the **[n]** value is set to a value other than 1, the selected data results will be returned. See each measurement for details of what types of scalar results or trace data results are available. The binary data formats should be used for handling large blocks of data since they are smaller and transfer faster than the ASCII format. See **"Format Data: Numeric Data (Remote Command Only)"** on page 2558.

Note that the data returned by **:FETCh?** uses the data setting specified by **"Format Data: Numeric Data (Remote Command Only)"** on page 2558 and **"Format Data: Byte Order (Remote Command Only)"** on page 2559 commands, and can return real or ASCII data. If the format is set to **INT, 32**, it returns **REAL, 32** data.

9.3.2.4 READ

Initiates a trigger cycle for the specified measurement and outputs the requested data. If a measurement other than the current one is specified, the instrument will switch to that measurement before it initiates the measurement and returns results.

Remote Command **:READ:<measurement>[n]?**

Example Switch to the **SANalyzer** (Swept SA) measurement if not already there, start the measurement, and return item 2 (Trace 2) from the measurement when the measurement completes:

:READ:SAN2?

:READ does not change any of the measurement settings. For example, if you have already run the ACP measurement and you send **:READ:ACP?**, it initiates a new ACP measurement using the same instrument settings as the last time ACP was run.

:READ switches to the specified measurement if the instrument is not already there. For example, suppose you have already run the ACP measurement but now you are running the Channel Power measurement. When you send **:READ:ACP?**, it changes

from Channel Power back to ACP and, using the previous ACP settings, initiates the measurement and return results.

The measurement results for $n = 1$ (usually the scalar result) will be returned if the optional `[n]` value is not included, or is set to 1. If the `[n]` value is set to a value other than 1, the selected data results will be returned. See each measurement for details of what types of scalar results or trace data results are available. The binary data formats should be used for handling large blocks of data since they are smaller and transfer faster than the ASCII format. See "[Format Data: Numeric Data \(Remote Command Only\)](#)" on page 2558.

Note that the data returned by `:READ?` uses the data setting specified by "[Format Data: Byte Order \(Remote Command Only\)](#)" on page 2559) and "[Format Data: Numeric Data \(Remote Command Only\)](#)" on page 2558, and can return real or ASCII data. If the format is set to `INT, 32` it returns `REAL, 32` data.

`:READ` blocks other SCPI communication, waiting until the measurement is complete before returning results.

For more details of how measurements proceed, see also "[INITiate](#)" on page 2552.

9.3.2.5 MEASure

Stops the current measurement (if any) and sets up the instrument for the specified measurement using the measurement's default settings, initiates a trigger cycle for the specified measurement, and outputs the requested data.

Remote Command	<code>:MEASure:<measurement>[n]?</code>
Example	<p>Switch to the <code>SANalyzer</code> (Swept SA) measurement, start the measurement, and read back item 2 (Trace 2) when the measurement completes</p> <pre><code>:MEAS:SAN2?</code></pre> <p>This is a fast single-command way to make a measurement using the measurement's default settings. These are the settings and units that conform to the Mode Setup settings (for example, Radio Standard) that you have currently selected.</p> <p>Stops the current measurement (if any) and sets up the instrument for the specified measurement using the measurement's defaults.</p> <p>Initiates the data acquisition for the measurement.</p> <p>Blocks other SCPI communication, waiting until the measurement is complete before returning results.</p> <p>Depending on the measurement and the number of averages, there may be multiple data acquisitions, with multiple trigger events.</p>

After the data is valid, returns the scalar results, or the trace data, for the specified measurement. The type of data returned may be defined by an `[n]` value that is sent with the command.

If the optional `[n]` value is not included, or is set to 1, scalar measurement results will be returned. If the `[n]` value is other than 1, the selected trace data results will be returned. See each command for details of which types of scalar results or trace data results are available.

The default format for data output is ASCII. (Older versions of Spectrum Analysis and Phase Noise mode measurements only use ASCII.) The binary data formats should be used for handling large blocks of data, because transfers are smaller and faster than when using the ASCII format. See ["Format Data: Numeric Data \(Remote Command Only\)" on page 2558](#) for more information.

If you need to change some of the measurement parameters from the measurement's default settings, you can set up the measurement with `:CONFigure`. Use the commands in the `:SENSe:<measurement>` and `:CALCulate:<measurement>` subsystems to change the settings, then you can use `:READ?` to initiate the measurement and query the results.

Measurement settings persist if you initiate a different measurement and then return to a previous one. Use `:READ?` if you want to use those persistent settings. If you want to go back to the default settings, use `:MEASure?`.

Note that the data returned to `:MEASure?` uses the data setting specified by ["Format Data: Byte Order \(Remote Command Only\)" on page 2559](#) and ["Format Data: Numeric Data \(Remote Command Only\)" on page 2558](#), and can return real or ASCII data. If the format is set to `INT, 32` it returns `REAL, 32` data.

9.3.3 Trace Formatting Commands

The following commands and queries are available to format and manipulate trace data.

9.3.3.1 Clear Trace (Remote Command Only)

Clears the selected trace (from the front panel) or the specified trace (from SCPI). Does not affect the state of any function or variable in the instrument. Loads `mintracevalue` into all of the points in the selected trace, unless the trace is in Min Hold in which case it loads `maxtracevalue`. This occurs even if `Update = Off`.

Remote Command	<code>:TRACe:CLEAr TRACE1 ... TRACE6</code>
Example	Clear Trace 1: <code>:TRAC:CLE TRACE1</code>

9.3.3.2 Send/Query Trace Data (Remote Command Only)

Allows trace data to be sent to the instrument or queried from the instrument. The response to the query is a list of the amplitude points which comprise the requested trace in the current Y Axis Unit of the instrument. The X Axis Unit is that of the destination trace (for send) or the source trace (for query).

See:

- ["Query Trace Data" on page 2556](#)
- ["More Information" on page 2557](#)

Remote Command	<code>:TRACe[:DATA] TRACE1 TRACE2 TRACE3 TRACE4 TRACE5 TRACE6, <data></code>
Notes	<p>The <code>TRACe[:DATA]</code> command is of the form: <code>:TRACe:DATA <trace>,<data></code></p> <p>where <code><trace></code> can be one of the following parameters: <code>TRACE1, TRACE2, TRACE3, TRACE4, TRACE5, TRACE6</code></p> <p>and where <code><data></code> can be</p> <ul style="list-style-type: none"> - ASCII data, which consists of a string of values separated by comma or - <code>REAL</code> or <code>INTEger</code> sent as a definite length block, with a header describing the data to follow
Couplings	<p>Sweep points will affect the amount of data</p> <p><code>:FORMat:DATA</code> describes the different types of data formats that can be used with trace data</p> <p>Use <code>:FORMat:BORDER</code> to set the byte order</p>

Query Trace Data

Remote Command	<code>:TRACe[:DATA]? TRACE1 TRACE2 TRACE3 TRACE4 TRACE5 TRACE6</code>
Example	<p>Send five points to Trace 1. Assuming that <code>:FORMat:DATA</code> is set to <code>ASCIi</code>, Y Axis Unit is set to dBm, and sweep points is set to 5, this will result in Trace 1 consisting of the five points -1 dBm, -2 dBm, -3 dBm, -4 dBm, and -5 dBm:</p> <p><code>:TRAC TRACE1, -1, -2, -3, -4, -5</code></p> <p>Query the instrument for the contents of trace 2:</p> <p><code>:TRAC? TRACE2</code></p>
Backwards Compatibility Notes	In X-Series, the legacy <code>RAWTRACE, LLINE1, LLINE2</code> parameters for trace data query are no longer available

More Information

The format and byte order of the sent or received data depend on "[Format Data: Numeric Data \(Remote Command Only\)](#)" on page 2558 and "[Format Data: Byte Order \(Remote Command Only\)](#)" on page 2559. **ASCII** data consists of a string of comma separated values. **REAL** or **INTEger** data is sent as a definite length block, with a header describing the data to follow.

For example, a four point trace might look like this if in ASCII (**FORMat:DATA ASCii**):

```
-5.87350E+01, -5.89110E+01, -5.87205E+01, -5.12345E+01<NL><END>
```

and like this if in **INTEger** with 4 bytes per point (**FORMat:DATA INT,32**):

```
#216<16 bytes of data><NL><END>
```

where the 2 in the #216 means "2 digits of numeric data to follow", and the 16 is the 2 digits and means "16 binary bytes to follow" (this is the definite length block format).

Note that the data is terminated with **<NL><END>**. (For GPIB this is newline, or linefeed, followed by EOI set true. For LAN, this is newline only.)

The data format set by "[Format Data: Numeric Data \(Remote Command Only\)](#)" on page 2558 and "[Format Data: Byte Order \(Remote Command Only\)](#)" on page 2559 is used both for sending data to the instrument and receiving data from the instrument.

When sending data to the instrument, the data block must contain exactly the number of points currently specified in **Sweep, Points** or an error message will be generated and there will be no change to the target trace.

No units terminator (for example, dB or V) is used when sending data; the data is taken as being in the current Y Axis Unit of the instrument.

When a trace is sent to the instrument, it immediately overwrites all of the data in the target trace. Consequently the trace should be inactive in order to achieve predictable results. If you send trace data while a trace is active, and particularly if a sweep or an **Average** or **Max/Min Hold** sequence is already in progress, you may end up with a trace that combines the data you sent with measurement data. Similarly, when querying trace data, it is best if the instrument is not sweeping during the query.

Therefore, it is generally advisable to be in **Single** sweep, or have the trace in **View**, when sending trace data to the instrument or querying trace data from the instrument.

9.3.3.3 Format Data: Numeric Data (Remote Command Only)

Specifies the format of the trace data input and output.

Specifies the formats used for trace data during data transfer across any remote port. Affects only the data format for setting and querying trace data for `:TRACe[:DATA]`, `:TRACe[:DATA]?`, `:CALCulate:DATA[n]?` and `:FETCh:SANalyzer[n]?`.

Remote Command	<code>:FORMat[:TRACe][:DATA] ASCii INTeger,32 REAL,32 REAL,64</code> <code>:FORMat[:TRACe][:DATA]?</code>
Notes	The query response is: <code>ASCii</code> : ASC,8 <code>REAL,32</code> : REAL,32 <code>REAL,64</code> : REAL,64 <code>INTeger,32</code> : INT,32 When the numeric data format is REAL or ASCii, data is output in the current Y Axis unit. When the data format is INTeger, data is output in units of m dBm (.001 dBm) The <code>INT,32</code> format returns binary 32-bit integer values in internal units (m dBm), in a definite length block
Dependencies	Sending a data format spec with an invalid number (for example, <code>INT,48</code>) generates no error. The instrument simply uses the default (8 for <code>ASCii</code> , 32 for <code>INTeger</code> , 32 for <code>REAL</code>) Sending data to the instrument which does not conform to the current <code>FORMat</code> specified, results in an error. Sending ASCII data when a definite block is expected generates message -161 "Invalid Block Data" and sending a definite block when ASCII data is expected generates message -121 "Invalid Character in Number"
Preset	<code>ASCii</code>
Backwards Compatibility Notes	Note that the <code>INT,32</code> format is only applicable to <code>:TRACe:DATA</code> . This preserves backwards compatibility for the Swept SA measurement. For all other commands/queries that honor <code>:FORMat:DATA</code> , if <code>INT,32</code> is sent the instrument will behave as though it were set to <code>REAL,32</code>

The specifications for each output type are:

ASCii Amplitude values are in ASCII, in the current Y Axis Unit, one ASCII character per digit, values separated by commas, each value in the form: `SX.YYYYYEsZZ`, where:
 S = sign (+ or -)
 X = one digit to left of decimal point
 Y = 5 digits to right of decimal point
 E = E, exponent header
 s = sign of exponent (+ or -)
 ZZ = two digit exponent

<code>REAL, 32</code>	Binary 32-bit real values in the current Y Axis Unit, in a definite length block
<code>REAL, 64</code>	Binary 64-bit real values in the current Y Axis Unit, in a definite length block

9.3.3.4 Format Data: Byte Order (Remote Command Only)

Selects the binary data byte order for data transfer and other queries.

Controls whether binary data is transferred in normal or swapped mode. Affects only the byte order for setting and querying trace data for `:TRACe[:DATA]`, `:TRACe[:DATA]?`, `:CALCulate:DATA[n]?` and `:FETCh:SANalyzer[n]?`.

By definition, any command that depends on this setting uses *any* format supported by `:FORMat:DATA`.

- **NORMal** order is a byte sequence that begins with the most significant byte (MSB) first, and ends with the least significant byte (LSB) last in the sequence: 1|2|3|4
- **SWAPped** order is when the byte sequence begins with the LSB first, and ends with the MSB last in the sequence: 4|3|2|1

Remote Command	<code>:FORMat:BOrDer NORMal SWAPped</code> <code>:FORMat:BOrDer?</code>
Preset	<code>NORMal</code>

9.3.3.5 Calculate/Compress Trace Data Query (Remote Command Only)

Returns compressed data for the currently selected measurement and sub-opcode `[n]`.

`n` = any valid sub-opcode for that measurement. See the `:MEASure:<measurement>?` query description of your specific measurement for information on the data that can be returned.

The data is returned in the current Y Axis Unit of the instrument. The command is used with a sub-opcode `<n>` (default = 1) to specify the trace. With trace queries, it is best if the instrument is not sweeping during the query. Therefore, it is generally advisable to be in **Single** sweep, or Update = Off.

This command is used to compress or decimate a long trace to extract and return only the desired data. A typical example would be to acquire N frames of GSM data and return the mean power of the first burst in each frame. The command can also be used to identify the best curve fit for the data.

Remote Command	<code>:CALCulate:DATA<n>:COMPress? BLOCK CFIT MAXimum MINimum MEAN DMEan RMS SAMPle SDEviation PPHase [,<soffset>[,<length>[,<roffset>[,<rlimit>]]]]</code>
----------------	---

Notes

The command supports 5 parameters, but the last 4 (`<soffset>`, `<length>`, `<roffset>`, `<rlimit>`) are optional. The optional parameters must be entered in the specified order. For example, if you want to specify `<length>`, then you must also specify `<soffset>`. See details below for a definition of each of these parameters

This command uses the data in the format specified by "[Format Data: Byte Order \(Remote Command Only\)](#)" on page 2559, returning either binary or ASCII data

As an example, to query the mean power of a set of GSM bursts:

- Supply a signal that is a set of GSM bursts
- Select the IQ Waveform measurement (in IQ Analyzer Mode)
- Set the sweep time to acquire at least one burst
- Set the triggers such that acquisition happens at a known position relative to a burst
- Query the mean burst levels using, `:CALC:DATA2:COMP? MEAN,24e-6,526e-6` (These parameter values correspond to GSM signals, where 526e-6 is the length of the burst in the slot and you just want 1 burst)

BLOCK or block data

Returns all the data points from the region of the trace data that you specify. For example, it could be used to return the data points of an input signal over several timeslots, excluding the portions of the trace data that you do not want. (This is x,y pairs for trace data and I,Q pairs for complex data.)

CFIT or curve fit

Applies curve fitting routines to the data. `<soffset>` and `<length>` are required to define the data that you want. `<roffset>` is an optional parameter for the desired order of the curve equation. The query will return the following values: the x-offset (in seconds) and the curve coefficients ((order + 1) values).

`MIN`, `MAX`, `MEAN`, `DME`, `RMS`, `SAMP`, `SDEV` and `PPH` return one data value for each specified region (or `<length>`) of trace data, for as many regions as possible until you run out of trace data (using `<roffset>` to specify regions), or they return the number of regions you specify (using `<rlimit>`) ignoring any data beyond that.

MINimum

Returns the minimum data point (y value) for the specified region(s) of trace data. For I/Q trace data, the minimum magnitude of the I/Q pairs is returned.

MAXimum

Returns the maximum data point (y value) for the specified region(s) of trace data. For I/Q trace data, the maximum magnitude of the I/Q pairs is returned.

MEAN

Returns a single value that is the arithmetic mean of the data point values (in dB/ dBm) for the specified region(s) of trace data. For I/Q trace data, the mean of the magnitudes of the I/Q pairs is returned. See the following equations.

NOTE

If the original trace data is in dB, this function returns the arithmetic mean of those log values, not log of the mean power which is a more useful value. The mean of the log is the better measurement technique when measuring CW signals in the presence of noise. The mean of the power, expressed in dB, is useful in power measurements such as Channel Power. To achieve the mean of the power, use the RMS option.

Equation 1: Mean Value of Data Points for Specified Region(s)

$$\text{MEAN} = \frac{1}{n} \sum_{X_i \in \text{region}(s)} X_i$$

where X_i is a data point value, and n is the number of data points in the specified region(s).

Equation 2: Mean Value of I/Q Data Pairs for Specified Region(s)

$$\text{MEAN} = \frac{1}{n} \sum_{X_i \in \text{region}(s)} |X_i|$$

where $|X_i|$ is the magnitude of an I/Q pair, and n is the number of I/Q pairs in the specified region(s).

DMEan

Returns a single value that is the mean power (in dB/ dBm) of the data point values for the specified region(s) of trace data. See the following equation:

Equation 3: DMEan Value of Data Points for Specified Region(s)

$$\text{DME} = 10 \times \log_{10} \left(\frac{1}{n} \sum_{X_i \in \text{region}(s)} 10^{\frac{X_i}{10}} \right)$$

RMS

Returns a single value that is the average power on a root-mean-squared voltage scale (arithmetic rms) of the data point values for the specified region(s) of trace

data. See the following equation.

Equation 4: RMS Value of Data Points for Specified Region(s)

$$\text{RMS} = \sqrt{\frac{1}{n} \sum_{X_i \in \text{region}(s)} X_i^2}$$

where X_i is a data point value, and n is the number of data points in the specified region(s).

For I/Q trace data, the rms of the magnitudes of the I/Q pairs is returned. See the following equation.

NOTE

This function is very useful for I/Q trace data. However, if the original trace data is in dB, this function returns the rms of the log values which is not usually needed.

Equation 5: RMS Value of I/Q Data Pairs for Specified Region(s)

$$\text{RMS} = \sqrt{\frac{1}{n} \sum_{X_i \in \text{region}(s)} X_i X_i^*}$$

where X_i is the complex value representation of an I/Q pair, X_i^* its conjugate complex number, and n is the number of I/Q pairs in the specified region(s).

Once you have the rms value for a region of trace data (linear or I/Q), you may want to calculate the mean power. You must convert this rms value (peak volts) to power in dBm:

$$10 \times \log[10 * (\text{rms value})^2]$$

SAMPLE

Returns the first data value (x,y pair) for the specified region(s) of trace data. For I/Q trace data, the first I/Q pair is returned.

SDEViation

Returns a single value that is the arithmetic standard deviation for the data point values for the specified region(s) of trace data. See the following equation.

Equation 6: Standard Deviation of Data Point Values for Specified Region(s)

$$SDEV = \sqrt{\frac{1}{n} \sum_{X_i \in \text{region}(s)} (X_i - \bar{X})^2}$$

where X_i is a data point value, \bar{X} is the arithmetic mean of the data point values for the specified region(s), and n is the number of data points in the specified region(s).

For I/Q trace data, the standard deviation of the magnitudes of the I/Q pairs is returned. See the following equation.

Equation 7: Standard Deviation of I/Q Data Pair Values for Specified Region(s)

$$SDEV = \sqrt{\frac{1}{n} \sum_{X_i \in \text{region}(s)} (|X_i| - \bar{X})^2}$$

where $|X_i|$ is the magnitude of an I/Q pair, \bar{X} is the mean of the magnitudes for the specified region(s), and n is the number of data points in the specified region(s).

PPHase

Returns the x,y pairs of both rms power (dBm) and arithmetic mean phase (radian) for every specified region and frequency offset (Hz). The number of pairs is defined by the specified number of regions. This parameter can be used for I/Q vector ($n=0$) in Waveform (time domain) measurement and all parameters are specified by data point in [PPHase](#).

The rms power of the specified region may be expressed as:

$$\text{Power} = 10 \times \log [10 \times (\text{RMS I/Q value})] + 10.$$

The RMS I/Q value (peak volts) is:

$$\sqrt{\frac{1}{n} \sum_{X_i \in \text{region}} X_i X_i^*}$$

where X_i is the complex value representation of an I/Q pair, X_i^* its conjugate complex number, and n is the number of I/Q pairs in the specified region.

The arithmetic mean phase of the specified region may be expressed as:

$$\frac{1}{n} \sum_{Y_i \in \text{region}} Y_i$$

where Y_i is the unwrapped phase of I/Q pair with applying frequency correction and n is the number of I/Q pairs in the specified region.

The frequency correction is made by the frequency offset calculated by the arithmetic mean of every specified region's frequency offset. Each frequency offset is calculated by the least square method against the unwrapped phase of I/Q pair.

Sample Trace Data - Constant Envelope

(See below for explanation of variables.)

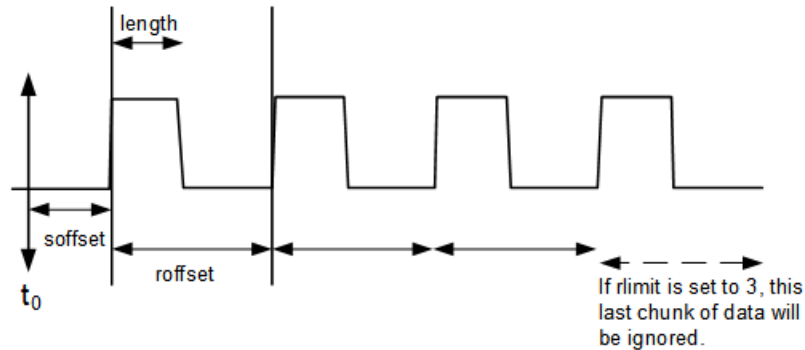

Sample Trace Data - Not Constant Envelope

(See below for explanation of variables.)

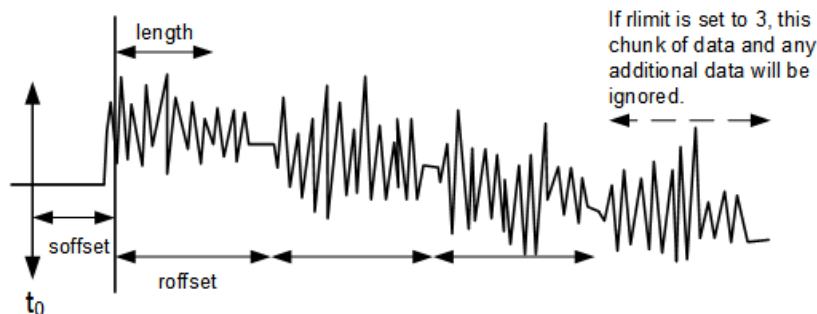

- <soffset> Optional real number, in seconds for time-domain traces, and is a dimensionless index 0 to Npoints - 1, for frequency-domain traces
 Specifies the amount of data at the beginning of the trace that will be ignored before the decimation process starts. It is the time or frequency change from the start of the trace to the point where you want to start using the data. The default value is zero
- <length> Optional real number, in seconds for time-domain traces, and is a dimensionless index 0 to Npoints - 1, for frequency-domain traces
 Defines how much data will be compressed into one value. This parameter has a default value equal to the current trace length
- <roffset> Optional real number, in seconds for time-domain traces, and is a dimensionless index 0 to Npoints - 1, for frequency-domain traces

Defines the beginning of the next field of trace elements to be compressed. This is relative to the beginning of the previous field. This parameter has a default value equal to the `<length>` variable. Note that this parameter is used for a completely different purpose when curve fitting (see "CFIT or curve fit" on page 2560 above)

`<rlimit>`

Optional integer

Specifies the number of data items that you want returned. Ignores any additional items beyond that number. You can use the Start offset and the Repeat limit to pick out exactly what part of the data you want to use. The default value is all the data

9.3.3.6 Calculate Peaks of Trace Data (Remote Command Only)

Returns a list of all the peaks for the currently selected measurement and sub-opcode `[n]`. The peaks must meet the requirements of the peak threshold and excursion values.

`n` = any valid sub-opcode for the current measurement. See the `:MEASure:<measurement>` command description of your specific measurement for information on the data that can be returned.

The command can only be used with specific sub-opcodes with measurement results that are trace data. Both real and complex traces can be searched, but complex traces are converted to magnitude in dBm. In many measurements the sub-opcode `n = 0`, is the raw trace data, which cannot be searched for peaks, and sub-opcode `n = 1`, is often calculated results values which also cannot be searched for peaks.

This command uses the data setting specified by "Format Data: Byte Order (Remote Command Only)" on page 2559 and "Format Data: Numeric Data (Remote Command Only)" on page 2558, and can return real or ASCII data. If the format is set to `INT, 32`, it returns `REAL, 32` data.

The command has four types of parameters:

1. Threshold (in dBm)
2. Excursion (in dB)
3. Sorting order (amplitude, frequency, time)
4. Optional in some measurements: Display line use (all, > display line, < display line)

Remote
Command

For Swept SA measurement:
`:CALCulate:DATA[1]|2|...|6:PEAKS? <threshold>,<excursion>[,AMPLitude |
FREQUENCY | TIME[,ALL | GTDLine | LTDLine]]`

For most other measurements:

```
:CALCulate:DATA[1]|2|...|6:PEAKs? <threshold>,<excursion>[,AMPLitude |
FREQuency | TIME]
```

Notes

Parameters:

<n>	The trace that will be used: [1] 2 ... 6
<threshold>	The level below which trace data peaks are ignored Note that the threshold value is required and is always used as a peak criterion. To effectively disable the threshold criterion for this command, provide a substantially low threshold value such as -200 dBm Note also that the threshold value used in this command is independent of and has no effect on the threshold value stored under the Peak Criteria menu
<excursion>	The minimum amplitude variation (rise and fall) required for a signal to be identified as peak Note that the excursion value is required and is always used as a peak criterion. To effectively disable the excursion criterion for this command, provide the minimum value of 0.0 dB Note also that the excursion value used in this command is independent of and has no effect on the excursion value stored under the Peak Criteria menu

Values must be provided for threshold and excursion. The sorting and display line parameters are optional (defaults are **AMPLitude** and **ALL**)

Note that there is always a Y-axis value for the display line, regardless of whether the display line state is on or off. It is the current Y-axis value of the display line which is used by this command to determine whether a peak should be reported

Sorting order:

AMPLitude	Lists the peaks in order of descending amplitude, with the highest peak first If this optional parameter not sent, this is the default
FREQuency	Lists the peaks in order of occurrence, left to right across the x-axis
TIME	Lists the peaks in order of occurrence, left to right across the x-axis

Peaks vs. Display Line:

ALL	Lists all of the peaks found (default if optional parameter not sent)
GTDLIne	Lists all of the peaks found above the display line Greater than display line
LTDLine	Lists all of the peaks found below the display line Less than display line

For example, for Swept SA measurement in Spectrum Analyzer Mode:

```
:CALC:DATA4:PEAK? -40,10,FREQ,GTDL
```

Identifies the peaks of trace 4 that are above -40 dBm, with excursions of at least 10 dB. The peaks are returned in order of increasing frequency, starting with the lowest frequency. Only the peaks that are above the display line are returned

Query Results:

If `:FORMat:DATA REAL, 32` is selected, returns a list of floating-point numbers. The first value in the list is the number of peak points that are in the following list. A peak point consists of two values: a peak amplitude followed by its corresponding frequency (or time)

If no peaks are found, the peak list consists of only the number of peaks, (0)

9.3.3.7 Smooth Trace Data (Remote Command Only)

Included for ESA compatibility. Not recommended for new designs. Use `:CALCulate:DATA:COMPRESS` instead.

Smooths the trace according to the number of points specified in `:TRACe:MATH:SMOoth:POINts`. There is no equivalent front panel function.

The purpose of this function is to perform a spatial video averaging, as compared to the temporal version supplied by the video-average command

`[:SENSe]:AVERage:TYPE VIDEo`. The functions of `:TRACe:MATH:SMOoth <trace>` and `[:SENSe]:AVERage:TYPE VIDEo | POWer` are not interchangeable.

Backwards Compatibility `:TRACe:MATH:SMOoth TRACE1 | ... | TRACE6`
SCPI

Each point value is replaced with the average of the values of the selected number of points, with half of those points located on each side of any particular point (when possible). Refer to the illustration below, which shows a 401 point trace with a smoothing number of 31. Think of the trace points as “buckets” of data. To smooth (arbitrary) point 273, the instrument averages buckets 258 through 288 and applies that value to point 273.

Increasing the number of points increases smoothing at the cost of decreasing resolution.

The amount of smoothing decreases at the end points. Because `:TRACe:MATH:SMOoth <trace>` averages values that occur before and after the data point in time, display irregularities can be caused at the start and stop frequencies. To avoid possible irregularities (signal distortion) at the ends of the trace, use small values for the smooth parameter.

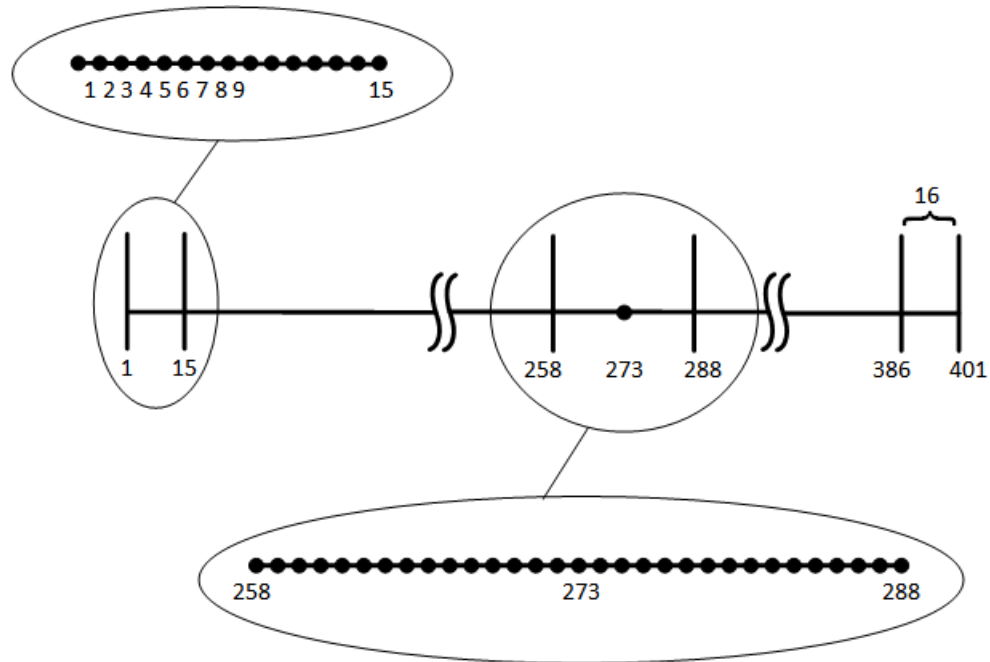

Smoothing With 401 Trace Points and 31 Smoothing Points

Refer to the illustration above for a discussion of this end-point smoothing phenomena. With 31 smoothing points and a 401 point trace, point 16 will be the first point to have full 31-bucket smoothing. Likewise, point 386 will be the last point with full 31-bucket smoothing. Under the conditions stated, points 2 through 15 will be smoothed as follows: Point 2 is derived from averaging buckets 1 through 3. Point 3 is derived from averaging buckets 1 through 5, Point 4 is derived from averaging buckets 1 through 7, and so forth until point 16 is reached. The quantity of buckets used for the smoothing running average increases at the rate of 2 buckets per point, from point 1 to point $(\lceil \text{smoothing number} + 1 \rceil / 2)$, at which time the full number of smoothing points is utilized. The same characteristic occurs at the completion of the trace, beginning at point 386, beyond which the number of averaging buckets begins to decrease until point 401 is reached.

By replacing the value of each point in a trace with the average of the values of a number of points centered about that point, any rapid variations in noise or signals are smoothed into more gradual variations. It thereby performs a function similar to reducing the video bandwidth without the corresponding changes in sweep time; as such, frequency resolution is decreased. Also, signal peaks are reduced with large smoothing values. This can cause the amplitude to appear to be less than its actual value.

9.3.3.8 Number of Points for Smoothing (Remote Command Only)

Included for ESA compatibility. Not recommended for new designs. Use `:CALCulate:DATA:COMPRESS` instead.

Specifies the number of points that will be smoothed. Increasing the number of points increases smoothing at the cost of decreasing resolution. If the number of points is an even number, then the number of points is increased by one. If the number of points is larger than the number of sweep points, then the number of sweep points is used, unless the number of sweep points is even, in which case the number of points will be the sweep points minus one. The number of points smoothed is always an odd number.

Example	<code>:TRAC:MATH:SMO:POIN 501</code>
Notes	<p>Only odd values are allowed</p> <p>If an even value of <code><integer></code> is specified, adds 1 unless <code><integer></code> = number of sweep points, in which case subtract 1</p> <p>Used with <code>TRACe:MATH:SMOoth</code></p>
Preset	11
Min	3
Max	Number of sweep points
Backwards Compatibility SCPI	<p><code>:TRACe:MATH:SMOoth:POINTs <integer></code></p> <p><code>:TRACe:MATH:SMOoth:POINTs?</code></p>

9.3.3.9 Mean Trace Data (Remote Command Only)

Included for ESA compatibility. Not recommended for new designs. Use `:CALCulate:DATA:COMPRESS` instead.

Returns the mean of the amplitudes of the trace amplitude elements in measurement units.

Example	<code>:TRAC:MATH:MEAN? TRACE2</code>
Backwards Compatibility SCPI	<code>:TRACe:MATH:MEAN? TRACE1 ... TRACE6</code>

9.4 Status Register System & STATus Subsystem

This section provides an overview of the X-Series SCPI status register system, and how to manage the registers. For detailed programming information on each status register, see "[Status Subsystem Registers and Commands](#)" on page 2579.

The SCPI **STATus** Subsystem allows you to monitor a number of status conditions within the instrument through the use of a hierarchy of status registers containing bits which go true or false depending on various conditions.

9.4.1 Status Register System Diagram

The diagram below provides a top-level overview of all the Status Registers and their interconnections.

To navigate to detailed information about each Register, click on a register name:

9 Programming the Instrument
 9.4 Status Register System & STATus Subsystem

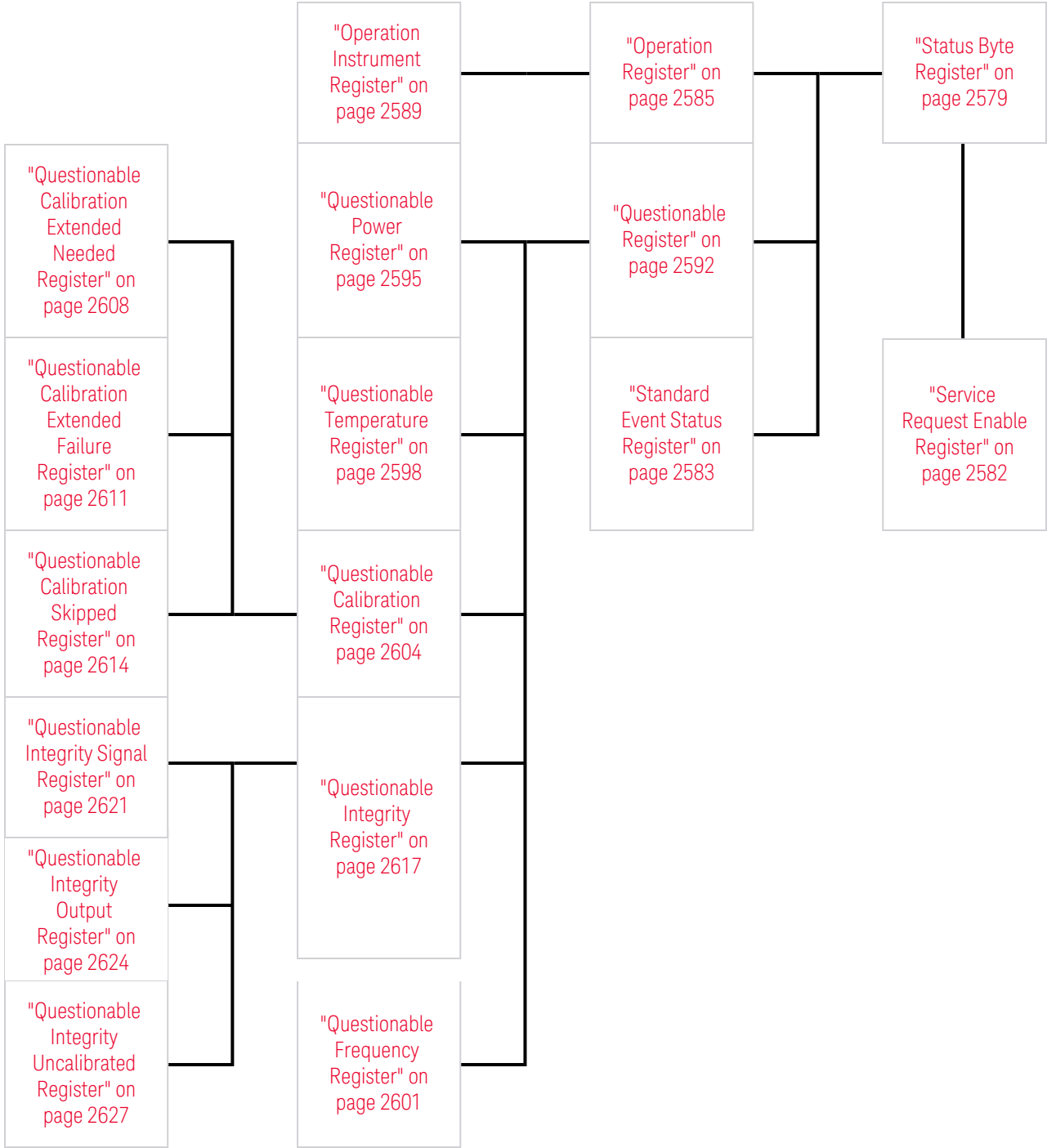

Detailed System Diagram

As from the **X-Apps 2023** update, the fully-detailed system diagram that previously appeared here is still available, but, for improved readability, it is now published as a separate high-resolution PDF. You can download the document from Keysight's web site at:

<http://literature.cdn.keysight.com/litweb/pdf/N9040-90056.pdf>

9.4.2 Status Register Hierarchy

The Status Register system contains multiple registers, arranged in a hierarchy. The lower-level registers propagate their data to the higher-level registers in the data structures by means of summary bits.

The "**Status Byte Register**" on page 2579 is at the top of the hierarchy and contains general status information for the instrument's events and conditions. All other individual registers are used to determine the specific events or conditions.

The "**Operation Register**" on page 2585 and "**Questionable Register**" on page 2592 are sets of registers that monitor the overall instrument condition. They are accessed using **:STATus:OPERation** and **:STATus:QUESTionable** commands in the **STATus** subsystem. Each composite status register set consists of five sub-registers:

1	Condition Register	Reports the real-time state of the signals monitored by this register set. There is no latching or buffering for a condition register
2	Positive Transition Register	Transition Filter Register Controls which signals will set a bit in the event register when the signal makes a low to high transition (when the condition bit changes from 0 to 1)
3	Negative Transition Register	Transition Filter Register Controls which signals will set a bit in the event register when the signal makes a high to low transition (when the condition bit changes from 1 to 0)
4	Event Register	Latches any signal state changes, in the way specified by the filter registers. Bits in the event register are never cleared by signal state changes. Event registers are cleared when read. They are also cleared by *CLS and by presetting the instrument
5	Event Enable Register	Controls which of the bits, being set in the event register, will be summarized as a single output for the register set. Summary bits are then used by the next higher register

Each status register produces a summary message bit.

The diagram below shows how the sub-registers relate to each other.

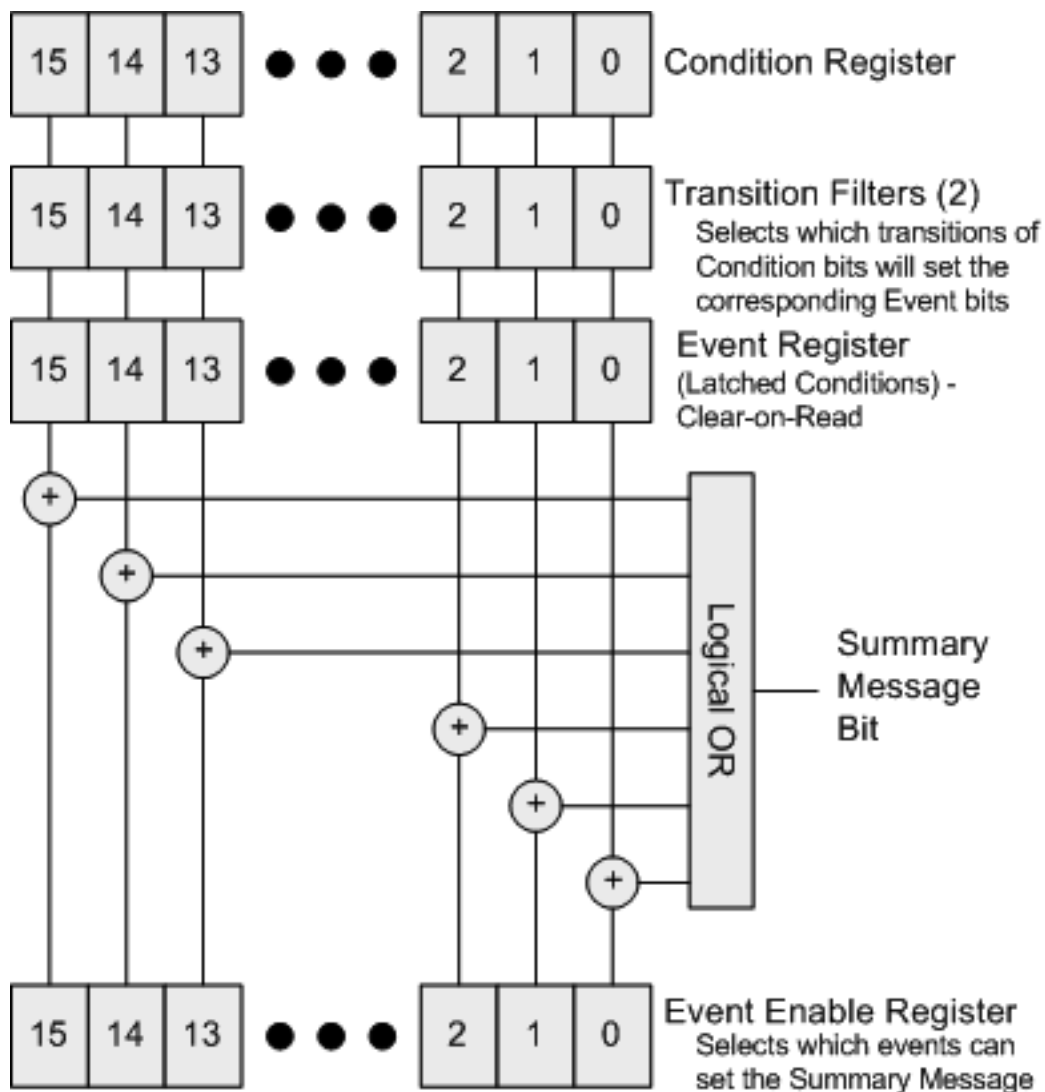

The settings of the Transition Filter registers determine whether or not a bit set in a Condition register ripples through to the Event register, as follows:

- If a bit is set in the Positive Transition register, then the corresponding bit in the Event register is set when the condition bit goes from low to high (false to true, off to on)
- Conversely, if a bit is set in the Negative Transition register then the Event register bit is set when the condition bit goes from high to low
- If *both* Transition Filter registers are set true, then the event bit for that condition is set whenever there is any change in the bit. If an event bit is set, the Event Enable register determines whether or not it will **OR** into the summary bit that is sent to the next level of register. If this bit is set, then the corresponding event bit will be included

Note that the Event register is "Clear-on-Read": when any bit is read, it is automatically cleared.

Questionable Registers

These registers report abnormal operating conditions. The status register hierarchy is:

- The summary outputs from the six [QUESTionable:<keyword>](#) detail registers are inputs to the ["Questionable Register" on page 2592](#)
- The summary output from the ["Questionable Register" on page 2592](#) is an input to the Status Byte Register
- The summary output from the is an input to the ["Operation Register" on page 2585](#). The inputs to the ["Operation Condition Query" on page 2586](#) Register indicate the real time state of the instrument. The ["Operation Event Query" on page 2587](#) Register summary output is an input to the Status Byte Register

Note that, in E4406A only, the ["Operation Enable" on page 2587](#) Register has an additional function. It is [ANDed](#) with the ["Operation Condition Query" on page 2586](#) Register to determine the instrument busy state, which is checked by ["*OPC? - Operation Complete" on page 2545](#) and ["*WAI - Wait-to-Continue" on page 2549](#). If the [ANDed](#) result is non-zero, the instrument is considered busy.

9.4.3 Status Register SCPI Commands

Monitoring of instrument conditions is done at the highest level using the following IEEE 488.2 common commands.

For complete command descriptions, see ["IEEE 488.2 Common Commands" on page 2542](#). Individual status registers can be set and queried using the commands described in ["Status Subsystem Registers and Commands" on page 2579](#).

*CLS	Clear Status	Clears the status byte by emptying the error queue and clearing all the event registers
*ESE	Event Status	Sets and queries the bits in the enable register part of the standard event status register
*ESE?	Enable	
*ESR?	Event Status Register	Queries and clears the event register part of the standard event status register
*OPC	Operation	Sets the standard event status register to monitor the completion of all commands. The query stops any new commands from being processed until the current processing is complete, then returns a '1'
*OPC?	Complete	
*PSC	Power-on	Sets the power-on state so that it clears the service request enable register and the event status enable register at power on
*PSC?	State Clear	

*SRE	Service Request Enable	Sets and queries the value of the service request enable register
*SRE?		
*STB?	Status Byte	Queries the value of the status byte register without erasing its contents

9.4.4 How to Use Status Registers

A program often needs to be able to detect and manage error conditions or changes in instrument status.

There are two methods you can use to programmatically access the information in status registers:

- The ["Polling Method" on page 2575](#)
- The ["Service Request \(SRQ\) Method" on page 2576](#)

The Polling Method works well if you do not need to know about changes the moment they occur. To detect a change using this method, the program must repeatedly read the registers.

The SRQ Method should be used if you must know immediately when a condition changes.

Either method allows you to monitor one or more conditions.

9.4.4.1 Polling Method

In this method, the instrument has a passive role. It only tells the controller that conditions have changed when the controller asks the right question.

Use this method when:

- your programming language/development environment does not support SRQ interrupts
- you want to write a simple, single-purpose program and don't want the added complexity of setting up an SRQ handler

To monitor a condition:

- Determine which register contains the bit that reports the condition
- Send the unique SCPI query to read that register
- Examine the bit to see if the condition has changed

Monitoring Options

You can monitor conditions in various ways:

- 1 Check the current instrument hardware and firmware status Do this by querying the condition registers, which continuously monitor status. These registers represent the current state of the instrument. Bits in a condition register are updated in real time
When the condition monitored by a particular bit becomes true, the bit is set to 1. When the condition becomes false, the bit is reset to 0
- 2 Monitor a particular condition (bit) You can enable a particular bit(s), using the ["Standard Event Status Enable Register" on page 2584](#). The instrument will then monitor that particular condition. If the bit becomes true (0 to 1 transition) in the Event Register, it will stay set until the Event Register is cleared. Querying the Event Register allows you to detect that this condition occurred, even if the condition no longer exists. The Event Register can only be cleared by querying it, or by sending `*CLS`
- 3 Monitor a particular type of change in a condition (bit) By default, the Transition Registers are set if the condition goes from 0 to 1 (false to true, or a positive transition), but you can change this behavior so the selected condition is detected if the bit goes from 1 to 0 (true to false, or a negative transition)
You can also detect *both* types of transitions, or neither
If both Transition Registers are set to 0 for a particular bit position, that bit is *not* set in the ["Standard Event Status Enable Register" on page 2584](#) for either type of change

9.4.4.2 Service Request (SRQ) Method

In this method, the instrument takes a more active role, by informing the controller when there has been a condition change, without the controller asking.

Use this method when:

- you need time-critical notification of changes
- you are monitoring more than one device which supports SRQs
- you need to have the controller do something else while waiting
- you can't afford the performance penalty inherent to polling

Using the Service Request (SRQ) Method

Your language, bus, and programming environment must be able to support SRQ interrupts, for example, BASIC used with VXI-11.3 (GPIB over LAN). When you monitor a condition with the SRQ method, you must:

- Determine which bit monitors the condition
- Determine how that bit reports to the request service (**RQS**) bit of the status byte
- Send SCPI commands to enable the bit that monitors the condition and to enable the summary bits that report the condition to the **RQS** bit
- Enable the controller to respond to service requests

When the condition changes, the instrument sets its **RQS** bit. The controller is informed of the change as soon as it occurs. As a result, the time the controller would otherwise have used to monitor the condition can be used to perform other tasks. Your program determines how the controller responds to the SRQ.

Bit 6 of the "Status Byte Register" on page 2579 is the request service (**RQS**) bit. Use ***SRE** to configure the **RQS** bit to report changes in instrument status. When such a change occurs, the **RQS** bit is set. It is cleared when the Status Byte Register is queried using ***SRE?** (with a serial poll.) It can be queried *without* erasing the contents by using ***STB?**.

When a register being set causes a summary bit in the status byte to change from 0 to 1, the instrument can initiate the service request (SRQ) process. However, the process is only initiated if *both* the following conditions are true:

The corresponding bit of the service request enable register is also set to 1

The instrument does not have a service request pending. (A service request is considered to be pending between the time the instrument's SRQ process is initiated and the time the controller reads the status byte register)

The SRQ process sets the SRQ true. It also sets the status byte's request service (**RQS**) bit to 1. Both actions are necessary to inform the controller that the instrument requires service. Setting the SRQ line *only* informs the controller that some device on the bus requires service. Setting the **RQS** bit allows the controller to determine which instrument requires service.

If your program enables the controller to detect and respond to service requests, it should instruct the controller to perform a serial poll when the SRQ is set true. Each device on the bus returns the contents of its Status Byte Register in response to this poll. The device whose **RQS** bit is set to 1 is the device that requested service.

NOTE

When you read the instrument's Status Byte Register using a serial poll, the **RQS bit is reset to 0. Other bits in the register are not affected.**

If the status register is configured to SRQ on end-of-measurement, and the measurement is in **Continuous** mode, then restarting a measurement (via **:INIT**) can cause the measuring bit to pulse low. This causes an SRQ even though you have not actually reached the "end-of-measurement" condition. To avoid this:

- Set `:INITiate:CONTinuous OFF`
- Set/enable the status registers
- Restart the measurement (send `:INIT`)

9.4.5 Status Register Bit Parameters

The diagram below shows a typical status register, in this case the "Operation Enable" on page 2587 Register. Each bit in a register is represented by a numerical value based on its location. When a command requires a bit pattern to be sent as its parameter, that can be entered as a numeric value using decimal or hexadecimal representations. (where 0 to 32767 is equivalent to `#H0` to `#H7FFF`). If you want to enable more than one bit, you send the sum of all the bits that you want to monitor.

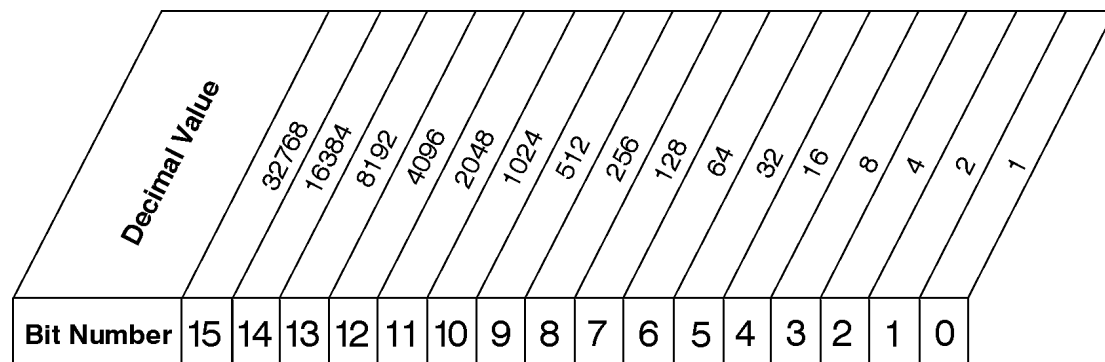

`STATus:OPERation:ENABLE <num>`
`STATus:OPERation:ENABLE?`

Standard Operation Event Enable Register

ck730a

NOTE Bit 15 is not used to report status.

Example 1

To enable bit 0 and bit 6 of standard event status register, you would send the command `*ESE 65` because $1 + 64 = 65$

The results of a query are evaluated in a similar way. If the `*STB?` command returns a decimal value of 140, ($140 = 128 + 8 + 4$) then bit 7 is true, bit 3 is true and bit 2 is true

Example 2

Suppose you want to know if an Auto-trigger Timeout occurs, but you only cared about that specific condition. So you would want to know what was happening with bit 10 in the Status Questionable Integrity register, and not about any other bits

It is usually a good idea to start by clearing all the status registers, using `*CLS`

Sending `:STAT:QUES:INT:ENAB 1024` lets you monitor only bit 10 events, instead of the default monitoring all the bits in the register. The register default is for positive transition events (0 to 1 transition), that is, when an auto-trigger timeout occurs. If instead, you want to know when the Auto-trigger timeout condition is cleared, then you set `:STAT:QUES:INT:PTR 0` and `:STAT:QUES:INT:NTR 32767`

Now, the only output from the "Questionable Integrity Register" on page 2617 will come from a bit 10 positive transition, and goes to the Integrity Sum bit 9 of the "Questionable Register" on page 2592

If you want only to monitor bit 9 of the same register, send `:STAT:QUES:ENAB 512`

The "Questionable Register" on page 2592 output goes to the "Status Questionable Summary" bit 3 of the "Status Byte Register" on page 2579. The output from this register can be enabled using `*SRE 8`.

Finally, you can use the serial polling functionality available for the particular bus/software that you are using to monitor the Status Byte Register, or you could use `*STB?` to poll the Status Byte Register.

9.4.6 Status Subsystem Registers and Commands

The Status Subsystem registers monitor various events and conditions in the instrument. Software written to control the instrument may need to monitor some of these events and conditions.

To set and query status registers, you can use the `STATus` subsystem SCPI commands and queries.

NOTE

All status register commands are sequential. You can send them in the middle of an ongoing overlapped command to get the current status. You can also send them following a sequential command. In this case, the status register command waits for the completion of the previously-sent sequential command before performing the action.

Most commands are sequential commands; only a few are overlapped.

If a command *is* overlapped, then that is explicitly stated in the command description.

See also the [Keysight X-Series Signal Analyzers Instrument Messages](#) manual for more detail on the instrument conditions that can cause these bits to be set.

9.4.6.1 Status Byte Register

Provides a one-byte overview of the entire `STATus` subsystem. All the other registers funnel into this register via summary bits, as shown in the "Status Register System

Diagram" on page 2570.

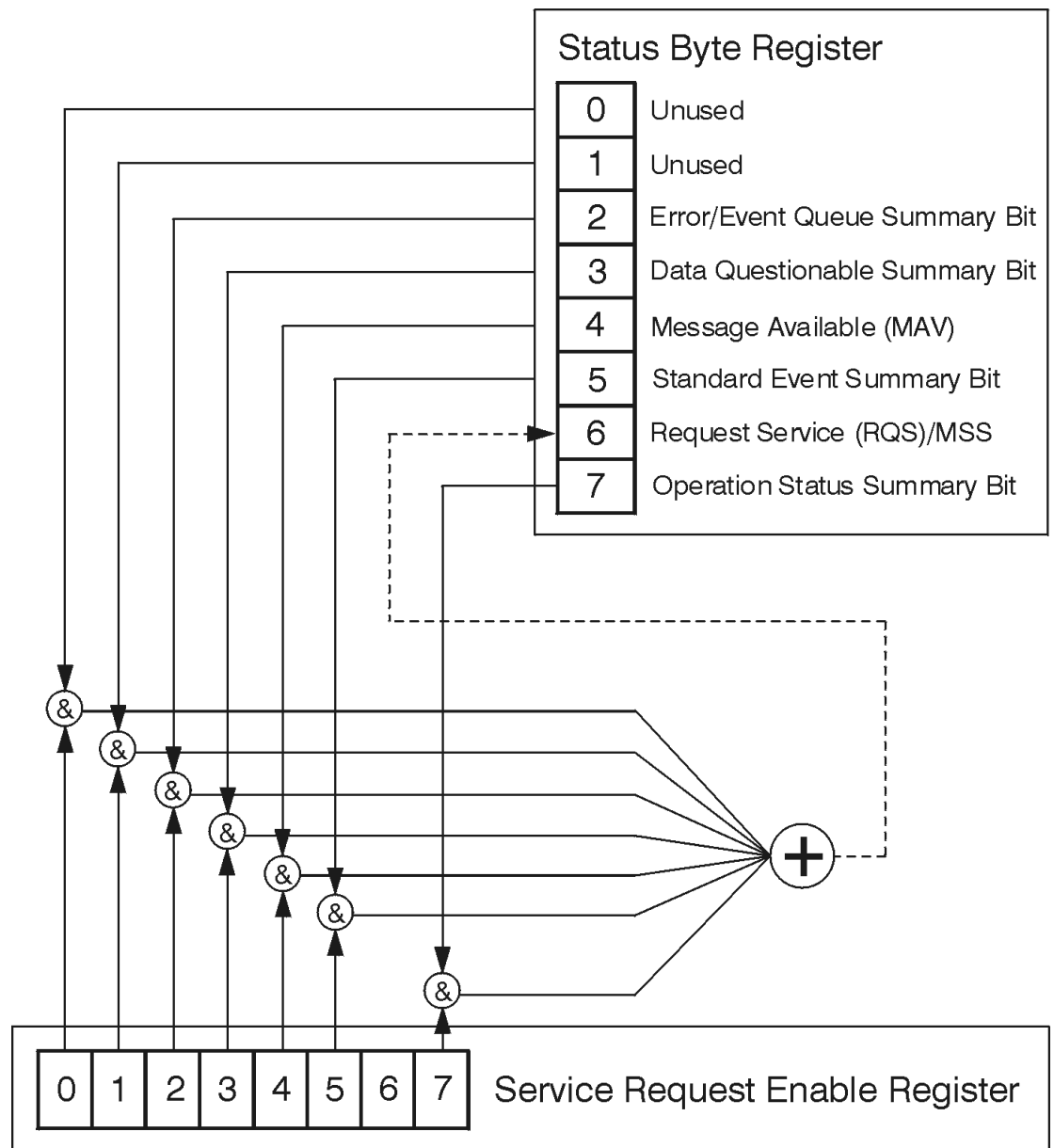

ck776a

Bit Number	7	6	5	4	3	2	1	0
Description	Standard Operation Status Summary Bit	Request Service (RQS) Summary Bit	Standard Event Status Summary Bit	Message Available (MAV)	Data Questionable Status Summary Bit	Error/Event Queue Summary Bit	Unused	Unused

*STB?

Status Byte Register

ck725a

Bit	Description
0, 1	These bits are always set to 0
2	A 1 in this bit position indicates that the SCPI error queue is not empty which means that it contains at least one error message
3	A 1 in this bit position indicates that the data questionable summary bit has been set. The data questionable event register can then be read to determine the specific condition that caused this bit to be set
4	A 1 in this bit position indicates that the instrument has data ready in the output queue. There are no lower status groups that provide input to this bit
5	A 1 in this bit position indicates that the standard event summary bit has been set. The standard event status register can then be read to determine the specific event that caused this bit to be set
6	A 1 in this bit position indicates that the instrument has at least one reason to report a status change. This bit is also called the master summary status bit (MSS)
7	A 1 in this bit position indicates that the standard operation summary bit has been set. The standard operation event register can then be read to determine the specific condition that caused this bit to be set

To query the Status Byte Register, send **"*STB? - Status Byte Query"** on page 2548. The response will be the decimal sum of the bits that are set to 1. For example, if bit number 7 and bit number 3 are set to 1, the decimal sum of the 2 bits is 128 plus 8, so the decimal value 136 is returned.

***STB** does *not* clear the status register.

The **RQS** bit is read and reset by a serial poll. The same bit position (**MSS**) is read non-destructively by ***STB?**. If you serial-poll bit 6, it is read as **RQS**, but if you send ***STB**, it reads bit 6 as **MSS**. For more information refer to Section 11 of: [IEEE Standard 488.2-1992](#)

In addition to the Status Byte Register, the status byte group also contains the "Service Request Enable Register" on page 2582, which lets you select which bits in the Status Byte Register will trigger a service request.

Service Request Enable Register

Enables the desired bits of the Service Request (SRQ) subsystem.

Send `*SRE <integer>`, where `<integer>` is the sum of the decimal values of the bits you want to enable plus the decimal value of bit 6. For example, assume that you want to enable bit 7 so that whenever the standard operation status register summary bit is set to 1 it will trigger a service request. Send the command `*SRE 192` (because $192 = 128 + 64$). You must always add 64 (the numeric value of RQS bit 6) to your numeric sum when you enable any bits for a service request.

`*SRE?` returns the decimal value of the sum of the bits previously enabled with `*SRE <integer>`.

This register presets to zeros (0).

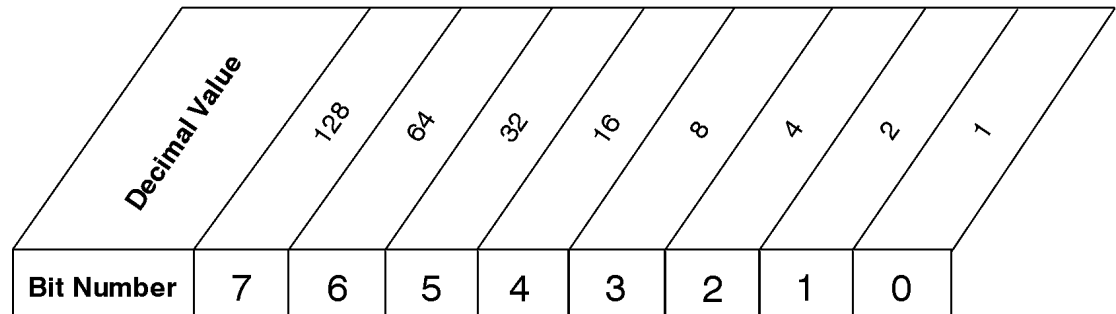

`*SRE <num>`
`*SRE?`

Service Request Enable Register

ck726a

See also "[*SRE - Service Request Enable](#)" on page 2547

Preset the Status Byte

Sets bits in most of the enable and transition registers to their default state.

- Presets:
- All Transition Filters
- All Enable Registers
- Error/Event Queue Enable

Has no effect on Event Registers, Error/Event QUEue, IEEE 488.2 ESE, and SRE Registers, as described in: [IEEE Standard 488.2-1992](#)

Remote Command :STATus:PRESet

Example :STAT:PRES

9.4.6.2 Standard Event Status Register

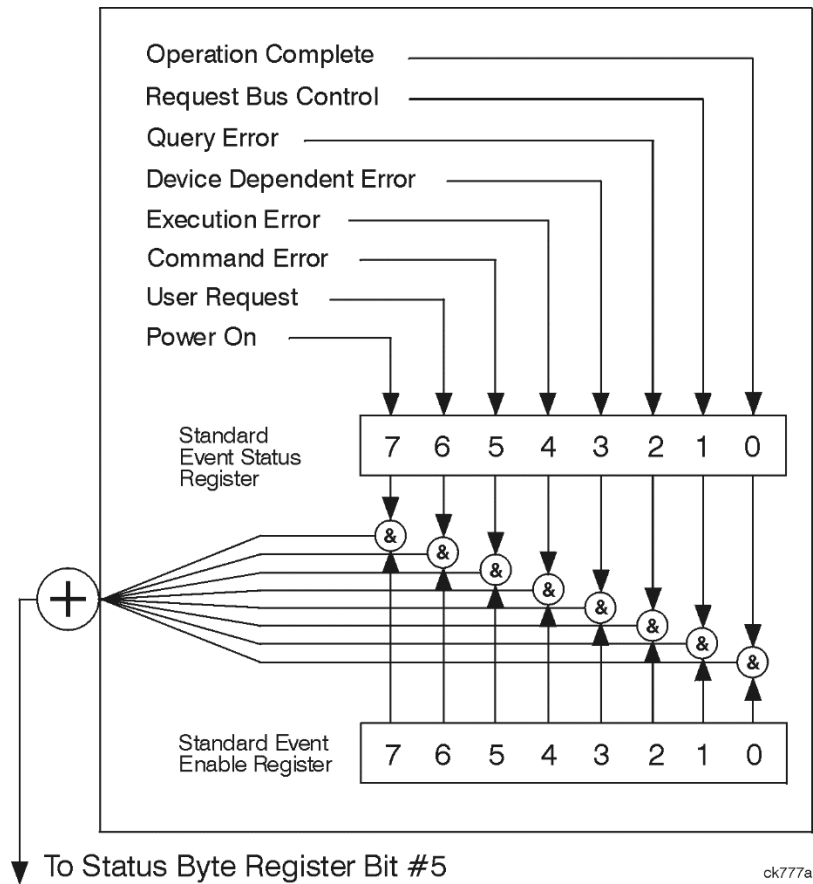

The standard event status register contains the following bits:

	Description	Power On	User Request Key (Local)	Command Error	Execution Error	Device Dependent Error	Query Error	Request Control	Operation Complete
Bit Number	7	6	5	4	3	2	1	0	

*ESR?

Standard Event Status Register

ck727a

Bit	Description
0	A 1 in this bit position indicates that all pending operations were completed following execution of the *OPC command
1	For GPIB handshaking to request control. Currently it is set to 0, because there are no implementations where the spectrum analyzer controls another instrument
2	A 1 in this bit position indicates that a query error has occurred. Query errors have SCPI error numbers from -499 to -400
3	A 1 in this bit position indicates that a device dependent error has occurred. Device dependent errors have SCPI error numbers from -399 to -300 and 1 to 32767
4	A 1 in this bit position indicates that an execution error has occurred. Execution errors have SCPI error numbers from -299 to -200
5	A 1 in this bit position indicates that a command error has occurred. Command errors have SCPI error numbers from -199 to -100
6	A 1 in this bit position indicates that the LOCAL key has been pressed. This is true even if the instrument is in local lockout mode
7	A 1 in this bit position indicates that the instrument has been turned off and then on

The Standard Event Status Register is used to determine the specific events that set bit 5 in the "Status Byte Register" on page 2579. To query this register, send *ESR?. The response will be the decimal sum of the bits that are enabled (set to 1). For example, if bit number 7 and bit number 3 are enabled, the decimal sum of the 2 bits is 128 plus 8, so the decimal value 136 is returned. See also "*ESR? - Standard Event Status Register Query" on page 2544

Standard Event Status Enable Register

In addition to the "Standard Event Status Register" on page 2583, the Standard Event status group also contains a Standard Event Status Enable Register. This

register lets you choose which bits in the standard event status register will set the summary bit (bit 5 of the status byte register) to 1. Send ***ESE <integer>**, where **<integer>** is the sum of the decimal values of the bits you want to enable. For example, to enable bit 7 and bit 6 so that whenever either of those bits is set to 1, the standard event status summary bit of the status byte register will be set to 1, send ***ESE 192** (128 + 64). ***ESE?** returns the decimal value of the sum of the bits previously enabled with ***ESE <integer>**.

The standard event status enable register presets to zeros (0).

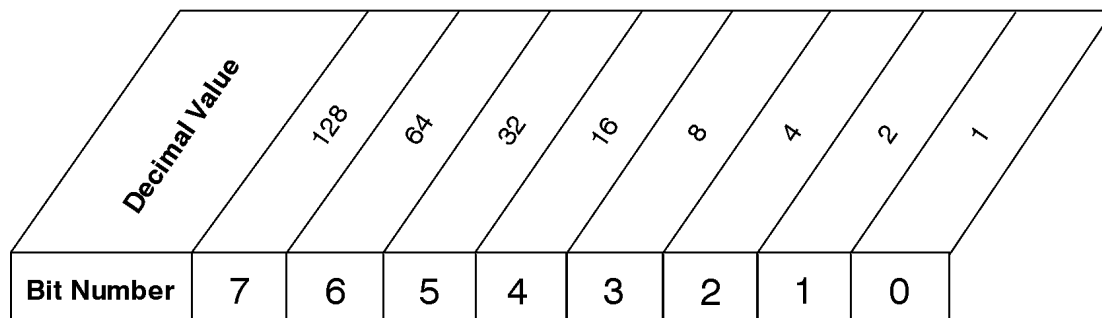

***ESE <num>**
***ESE?**

Standard Event Status Enable Register

ck728a

See also **"*ESE - Standard Event Status Enable"** on page 2543

9.4.6.3 Operation Register

This register and the **"Questionable Register"** on page 2592 are sets of registers that monitor the overall instrument condition. They are accessed using **:STATus:OPERation** and **:STATus:QUEStionable**.

This register monitors the current instrument measurement state and various instrument operations for a quick summary of what is happening within the instrument. It checks to see if the instrument is calibrating, sweeping, or waiting for a trigger (see also **"*OPC? - Operation Complete"** on page 2545).

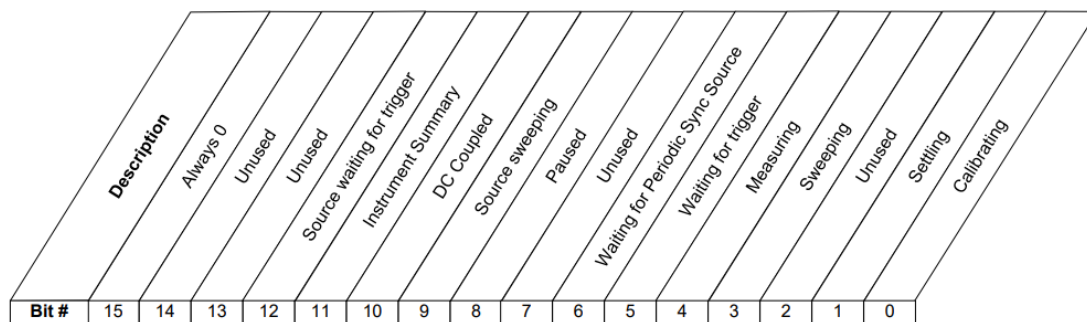

STATus:OPERation Register

Bit	Condition	Operation
0	Calibrating	The instrument is busy executing its Align Now process
1	Settling	The instrument circuitry is settling
3	Sweeping	The instrument is busy taking a sweep
4	Measuring	The instrument is busy making a measurement. Measurements often require multiple sweeps. They are initiated by user-interface keys or with the MEASure group of commands The bit is valid for most X-Series Modes
5	Waiting for trigger	The instrument is waiting for the trigger conditions to be met, then it will trigger a sweep or measurement
6	Waiting for Periodic Sync Source	The instrument is waiting for the Periodic trigger Sync Source conditions to be met, then the sweep or measurement period will be synchronized
8	Paused	The measurement is paused
9	Source Sweeping	The List Sequencer is running, or Freq Scan results are available The List Sequencer or Waveform Sequences are running, specifically, in VXT models: M9410A/11A/15A/16A, M9410E/11E/15E/16E, E6680A/80E/81A, S9110A/01A/06A/08A/15A/30A, M8920B
10	DC Coupled	The instrument is DC coupled
11	Instrument Summary	The summary bit for the " Operation Instrument Register " on page 2589
12	Source Waiting for Trigger	The built in source is waiting for a trigger

Filter Registers

- ["Operation Condition Query"](#) on page 2586
- ["Operation Enable"](#) on page 2587
- ["Operation Event Query"](#) on page 2587
- ["Operation Negative Transition"](#) on page 2588
- ["Operation Positive Transition"](#) on page 2588

Operation Condition Query

Returns the decimal value of the sum of the bits in the Status Operation Condition register.

NOTE

The data in this register is continuously updated and reflects the current conditions.

Remote Command	<code>:STATus:OPERation:CONDition?</code>
Example	<code>:STAT:OPER:COND?</code>
Preset	0
Status Bits/OPC dependencies	Sequential command

Operation Enable

Determines which bits in the "Operation Event Query" on page 2587 register will set the Operation Status Summary bit (bit 7) in the "Status Byte Register" on page 2579.

The variable `<integer>` is the sum of the decimal values of the bits you want to enable.

NOTE The preset condition is to have all bits in this enable register set to 0. To have any Operation Events reported to the Status Byte Register, one or more bits need to be set to 1.

Remote Command	<code>:STATus:OPERation:ENABle <integer></code> <code>:STATus:OPERation:ENABle?</code>
Example	<code>:STAT:OPER:ENAB 1</code> Sets the register so that Align Now events will be reported to the Status Byte Register
Preset	0
Min	0
Max	32767
Status Bits/OPC dependencies	Sequential command

Operation Event Query

Returns the decimal value of the sum of the bits in the Operation Event register.

NOTE The register requires that the associated PTRansition or NTRansition filters be set before a condition register bit can set a bit in the event register. The data in this register is latched until it is queried. Once queried, the register is cleared.

Remote Command	<code>:STATus:OPERation[:EVENT]?</code>
Example	<code>:STAT:OPER?</code>
Preset	0

Status Bits/OPC depend- Sequential command
 encies

Operation Negative Transition

Determines which bits in the "Operation Condition Query" on page 2586 register will set the corresponding bit in the "Operation Event Query" on page 2587 register when the condition register bit has a negative transition (1 to 0).

The variable `<integer>` is the sum of the decimal values of the bits that you want to enable.

Remote Command	<code>:STATus:OPERation:NTRansition <integer></code> <code>:STATus:OPERation:NTRansition?</code>
Example	<code>:STAT:OPER:NTR 1</code> Align Now operation complete will be reported to the Status Byte Register
Preset	0
Min	0
Max	32767
Status Bits/OPC dependencies	Sequential command

Operation Positive Transition

Determines which bits in the "Operation Condition Query" on page 2586 register will set the corresponding bit in the "Operation Event Query" on page 2587 register when the condition register bit has a positive transition (0 to 1).

The variable `<integer>` is the sum of the decimal values of the bits that you want to enable.

Remote Command	<code>:STATus:OPERation:PTRansition <integer></code> <code>:STATus:OPERation:PTRansition?</code>
Example	<code>:STAT:OPER:PTR 1</code> Align Now operation beginning will be reported to the Status Byte Register
Preset	32767
Min	0
Max	32767
Status Bits/OPC dependencies	Sequential command

9.4.6.4 Operation Instrument Register

Monitors instrument-related operations and summarizes them in bit 11 of the "Operation Register" on page 2585.

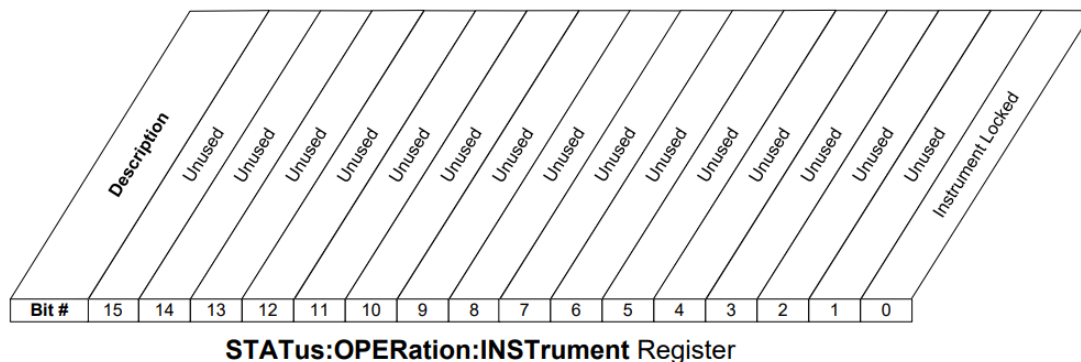

Bit	Condition	Operation
0	Instrument Locked	The instrument is locked

Filter Registers

- "Operation Instrument Condition" on page 2589
- "Operation Instrument Enable" on page 2590
- "Operation Instrument Event Query" on page 2590
- "Operation Instrument Negative Transition" on page 2591
- "Operation Instrument Positive Transition" on page 2591

Operation Instrument Condition

Returns the decimal value of the sum of the bits in the Status Operation Instrument Condition register.

NOTE The data in this register is continuously updated and reflects the current conditions.

Remote Command	:STATus:OPERation:INSTrument:CONDition?
Example	:STAT:OPER:INST:COND?
Preset	0
Status Bits/OPC dependencies	Sequential command

Operation Instrument Enable

Determines which bits in the "Operation Instrument Condition" on page 2589 Register will set bits in the "Operation Instrument Event Query" on page 2590 register, which also sets the Instrument Summary bit (bit 11) in the "Operation Instrument Register" on page 2589.

The variable `<integer>` is the sum of the decimal values of the bits you want to enable.

NOTE

The preset condition is to have all bits in this enable register set to 0. To have any Instrument Events reported to the Status Byte Register, one or more bits need to be set to 1.

Remote Command	<code>:STATus:OPERation:INSTrument:ENABle <integer></code>
Example	<code>:STAT:OPER:INST:ENAB 1</code> Sets the register so that Instrument Locked will be reported to the Status Byte Register
Preset	32767
Min	0
Max	32767
Status Bits/OPC dependencies	Sequential command

Operation Instrument Event Query

Returns the decimal value of the sum of the bits in the Operation Instrument Event register.

NOTE

The register requires that the associated PTRansition or NTRansition filters be set before a condition register bit can set a bit in the event register. The data in this register is latched until it is queried. Once queried, the register is cleared.

Remote Command	<code>:STATus:OPERation:INSTrument[:EVENT]?</code>
Example	<code>:STAT:OPER:INST?</code>
Preset	0
Status Bits/OPC dependencies	Sequential command

Operation Instrument Negative Transition

Determines which bits in the "Operation Condition Query" on page 2586 Register will set the corresponding bit in the "Operation Event Query" on page 2587 register when the condition register bit has a negative transition (1 to 0).

The variable `<integer>` is the sum of the decimal values of the bits that you want to enable.

Remote Command	<code>:STATus:OPERation:INSTrument:NTRansition <integer></code> <code>:STATus:OPERation:INSTrument:NTRansition?</code>
Example	<code>:STAT:OPER:INST:NTR 1</code> Instrument Locked being cleared will be reported to the Instrument Summary of the Status Operation register
Preset	0
Min	0
Max	32767
Status Bits/OPC dependencies	Sequential command

Operation Instrument Positive Transition

Determines which bits in the "Operation Condition Query" on page 2586 Register will set the corresponding bit in the "Operation Event Query" on page 2587 register when the condition register bit has a positive transition (0 to 1).

The variable `<integer>` is the sum of the decimal values of the bits that you want to enable.

Remote Command	<code>:STATus:OPERation:INSTrument:PTRansition <integer></code> <code>:STATus:OPERation:INSTrument:PTRansition?</code>
Example	<code>:STAT:OPER:INST:PTR 1</code> Instrument Locked being set will be reported to the Instrument Summary of the Status Operation register
Preset	32767
Min	0
Max	32767
Status Bits/OPC dependencies	Sequential command

9.4.6.5 Questionable Register

This register and the "Operation Register" on page 2585 monitor the overall instrument condition. They are accessed using :STATus:OPERation and :STATus:QUESTionable.

This register monitors the instrument's condition to see if anything questionable has happened. It detects anything that might cause an error or a bad measurement, such as a hardware problem, an out-of-calibration situation, or a unusual signal. All the bits are summary bits from lower-level event registers.

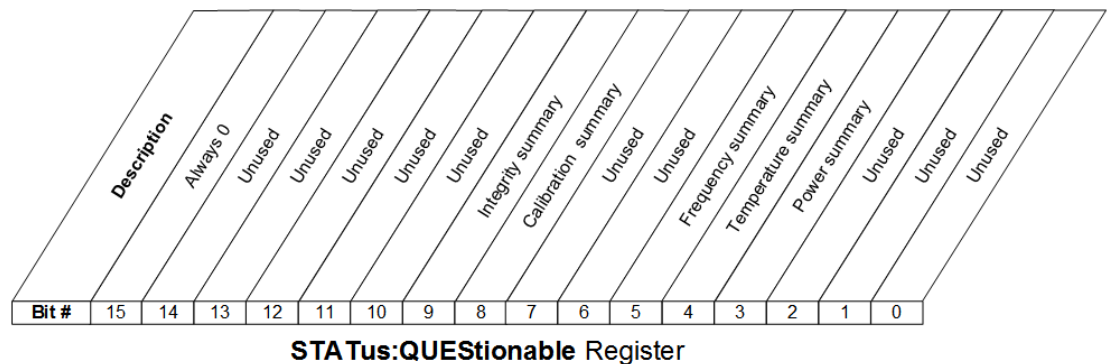

Bit	Condition	Operation
3	Power summary	Summary bit for "Questionable Power Register" on page 2595
4	Temperature summary	Summary bit for "Questionable Temperature Register" on page 2598
5	Frequency summary	Summary bit for "Questionable Frequency Register" on page 2601
8	Calibration summary	Summary bit for "Questionable Calibration Register" on page 2604
9	Integrity summary	Summary bit for "Questionable Integrity Register" on page 2617

Filter Registers

- "Questionable Condition" on page 2593
- "Questionable Enable" on page 2593
- "Questionable Event Query" on page 2594
- "Questionable Negative Transition" on page 2594
- "Questionable Positive Transition" on page 2594

Questionable Condition

Returns the decimal value of the sum of the bits in the Questionable Condition register.

NOTE

The data in this register is continuously updated and reflects current conditions.

Remote Command	:STATus:QUEStionable:CONDition?
Example	:STAT:QUES:COND?
Preset	0
Status Bits/OPC dependencies	Sequential command

Questionable Enable

Determines which bits in the "Questionable Event Query" on page 2594 Register will set the Questionable Status Summary bit (bit3) in the "Status Byte Register" on page 2579.

The variable `<integer>` is the sum of the decimal values of the bits you want to enable.

NOTE

The preset condition is all bits in this enable register set to 0. To report any Questionable Events to the Status Byte Register, one or more bits need to be set to 1. The "Standard Event Status Register" on page 2583 should be queried after each measurement to check the Questionable Status Summary (bit 3). If it is equal to 1, a condition during the test may have made the test results invalid. If it is equal to 0, this indicates that no hardware problem or measurement problem was detected by the analyzer.

Remote Command	:STATus:QUEStionable:ENABle <integer> :STATus:QUEStionable:ENABle? :STATus:OPERation:ENABle <integer> :STATus:OPERation:ENABle?
Example	:STAT:QUES:ENAB 16 Sets the register so that questionable temperature events will be reported to the Status Byte Register
Preset	0
Min	0
Max	32767

Status Bits/OPC dependencies Sequential command

Questionable Event Query

Returns the decimal value of the sum of the bits in the Questionable Event register.

NOTE

The register requires that the associated PTRansition or NTRansition filters be set before a condition register bit can set a bit in the event register. The data in this register is latched until it is queried. Once queried, the register is cleared.

Remote Command	<code>:STATus:QUESTionable[:EVENT]?</code>
Example	<code>:STAT:QUES?</code>
Preset	0
Status Bits/OPC dependencies	Sequential command

Questionable Negative Transition

Determines which bits in the "Questionable Condition" on page 2593 Register will set the corresponding bit in the "Questionable Event Query" on page 2594 Register when the condition register bit has a negative transition (1 to 0).

The variable `<integer>` is the sum of the decimal values of the bits that you want to enable.

Remote Command	<code>:STATus:QUESTionable:NTRansition <integer></code> <code>:STATus:QUESTionable:NTRansition?</code>
Example	<code>:STAT:QUES:NTR 16</code> Temperature summary 'questionable cleared' will be reported to the Status Byte Register
Preset	0
Min	0
Max	32767
Status Bits/OPC dependencies	Sequential command

Questionable Positive Transition

Determines which bits in the "Questionable Condition" on page 2593 Register will set the corresponding bit in the "Questionable Event Query" on page 2594 Register when the condition register bit has a positive transition (0 to 1).

The variable `<integer>` is the sum of the decimal values of the bits that you want to enable.

Remote Command	<code>:STATus:QUESTIONable:PTRansition <integer></code>
	<code>:STATus:QUESTIONable:PTRansition?</code>
Example	<code>:STAT:QUES:PTR 16</code> Temperature summary 'questionable asserted' will be reported to the Status Byte Register
Preset	32767
Min	0
Max	32767
Status Bits/OPC dependencies	Sequential command

9.4.6.6 Questionable Power Register

Monitors power-related conditions within the instrument and summarizes them in bit 3 of the "Questionable Register" on page 2592.

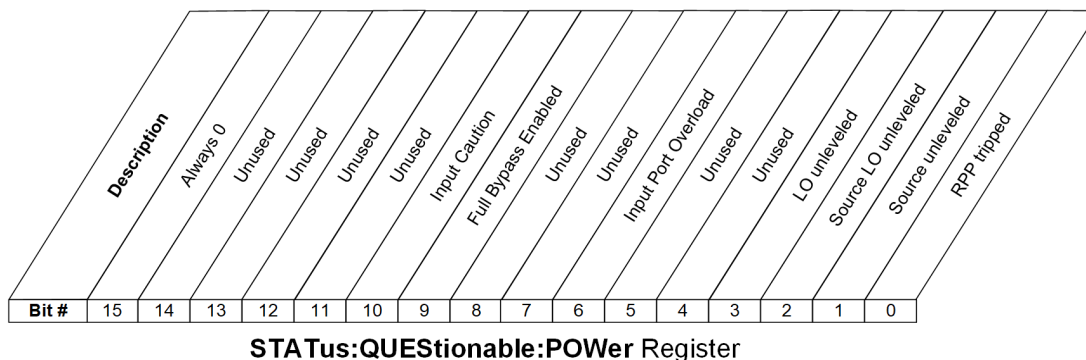

Bit	Condition	Operation
0	RPP tripped	(not currently in use)
1	Source Unlevelved	The built-in source is not properly leveled
2	Source LO Unlevelved	(not currently in use)
3	LO Unlevelved	(not currently in use)
6	Input Port Overload	A power overload condition exists at an input port
9	Full Bypass Enabled	Frontend circuitry is bypassed, use caution to protect the mixer
10	Input Caution	Input circuitry is configured such that care is required to prevent damage

Filter Registers

- "Questionable Power Condition" on page 2596
- "Questionable Power Enable" on page 2596
- "Questionable Power Event Query" on page 2597
- "Questionable Power Negative Transition" on page 2597
- "Questionable Power Positive Transition" on page 2597

Questionable Power Condition

Returns the decimal value of the sum of the bits in the Questionable Power Condition register.

NOTE

The data in this register is continuously updated and reflects the current conditions.

Remote Command	:STATus:QUESTionable:POWer:CONDition?
Example	:STAT:QUES:POW:COND?
Preset	0
Status Bits/OPC dependencies	Sequential command

Questionable Power Enable

Determines which bits in the "Questionable Power Condition" on page 2596 Register will set bits in the Questionable Power Event register, which also sets the Power Summary bit (bit 3) in the "Questionable Register" on page 2592.

The variable `<integer>` is the sum of the decimal values of the bits you want to enable.

Remote Command	:STATus:QUESTionable:POWer:ENABle <integer> :STATus:QUESTionable:POWer:ENABle?
Example	:STAT:QUES:POW:ENAB 2 Source Unlevelled will be reported to the Power Summary of the Status Questionable register
Preset	32767
Min	0
Max	32767
Status Bits/OPC dependencies	Sequential command

Questionable Power Event Query

Returns the decimal value of the sum of the bits in the Questionable Power Event Query register.

NOTE

The register requires that the associated PTRansition or NTRansition filters be set before a condition register bit can set a bit in the event register. The data in this register is latched until it is queried. Once queried, the register is cleared.

Remote Command	:STATus:QUESTionable:POWer[:EVENT]?
Example	:STAT:QUES:POW?
Preset	0
Status Bits/OPC dependencies	Sequential command

Questionable Power Negative Transition

Determines which bits in the "Questionable Power Condition" on page 2596 register will set the corresponding bit in the "Questionable Power Event Query" on page 2597 register when the condition register bit has a negative transition (1 to 0).

The variable <integer> is the sum of the decimal values of the bits that you want to enable.

Remote Command	:STATus:QUESTionable:POWer:NTRansition <integer> :STATus:QUESTionable:POWer:NTRansition?
Example	:STAT:QUES:POW:NTR 2 Source Unlevelled being cleared will be reported to the Power Summary of the Status Questionable register
Preset	0
Min	0
Max	32767
Status Bits/OPC dependencies	Sequential command

Questionable Power Positive Transition

Determines which bits in the "Questionable Power Condition" on page 2596 register will set the corresponding bit in the "Questionable Power Event Query" on page 2597 register when the condition register bit has a positive transition (0 to 1).

The variable `<integer>` is the sum of the decimal values of the bits that you want to enable.

Remote Command	<code>:STATus:QUESTionable:POWer:PTRansition <integer></code> <code>:STATus:QUESTionable:POWer:PTRansition?></code>
Example	<code>:STAT:QUES:POW:PTR 32</code> Source Unlevelled being set will be reported to the Power Summary of the Status Questionable register
Preset	32767
Min	0
Max	32767
Status Bits/OPC dependencies	Sequential command

9.4.6.7 Questionable Temperature Register

Monitors temperature-related conditions within the instrument and summarizes them in bit 4 of the "Questionable Register" on page 2592.

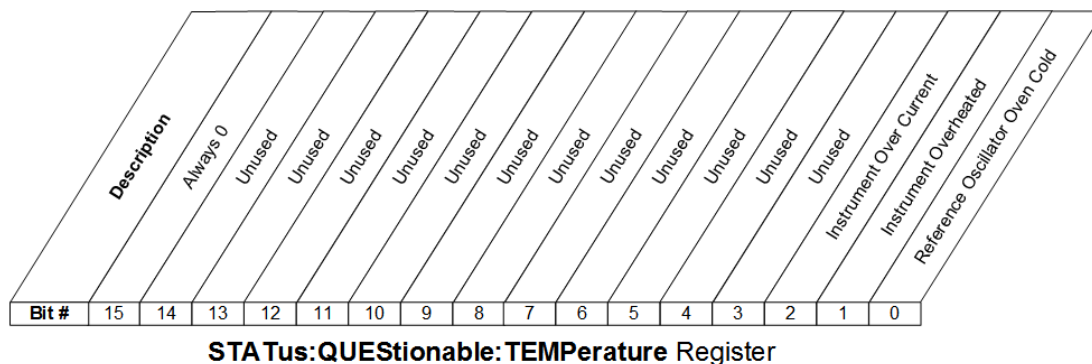

Bit	Condition	Operation
0	Reference Oscillator Oven Cold	(not currently in use)
1	Instrument overheated (over temperature)	Excessive heat has been detected in some part of the instrument
2	Instrument over current	Excessive heat has been detected in some part of the instrument, the instrument should be restarted

Filter Registers

- "Questionable Temperature Condition" on page 2599
- "Questionable Temperature Enable" on page 2599

- "Questionable Temperature Event Query" on page 2600
- "Questionable Temperature Negative Transition" on page 2600
- "Questionable Temperature Positive Transition" on page 2600

Questionable Temperature Condition

Returns the decimal value of the sum of the bits in the Questionable Temperature Condition register.

NOTE The data in this register is continuously updated and reflects the current conditions.

Remote Command	:STATus:QUEStionable:TEMPerature:CONDition?
Example	:STAT:QUES:TEMP:COND?
Preset	0
Status Bits/OPC dependencies	Sequential command

Questionable Temperature Enable

Determines which bits in the "Questionable Temperature Condition" on page 2599 Register will set bits in the "Questionable Temperature Event Query" on page 2600 register, which also sets the Temperature Summary bit (bit 4) in the "Questionable Register" on page 2592.

The variable `<integer>` is the sum of the decimal values of the bits you want to enable.

Remote Command	:STATus:QUEStionable:TEMPerature:ENABle <integer> :STATus:QUEStionable:TEMPerature:ENABle?
Example	:STAT:QUES:TEMP:ENAB 2 Instrument Overheated will be reported to the Temperature Summary of the Questionable Register
Preset	32767
Min	0
Max	32767
Status Bits/OPC dependencies	Sequential command

Questionable Temperature Event Query

Returns the decimal value of the sum of the bits in the Questionable Temperature Event register.

NOTE

The register requires that the associated PTRansition or NTRansition filters be set before a condition register bit can set a bit in the event register. The data in this register is latched until it is queried. Once queried, the register is cleared.

Remote Command	:STATus:QUESTionable:TEMPerature[:EVENT]?
Example	:STAT:QUES:TEMP?
Preset	0
Status Bits/OPC dependencies	Sequential command

Questionable Temperature Negative Transition

Determines which bits in the "Questionable Temperature Condition" on page 2599 Register will set bits in the "Questionable Temperature Event Query" on page 2600 register, when the condition register bit has a negative transition (1 to 0).

The variable <integer> is the sum of the decimal values of the bits that you want to enable.

Remote Command	:STATus:QUESTionable:TEMPerature:NTRansition <integer> :STATus:QUESTionable:TEMPerature:NTRansition?
Example	:STAT:QUES:TEMP:NTR 2 Instrument Overheated being cleared will be reported to the Temperature Summary of the Status Questionable register
Preset	0
Min	0
Max	32767
Status Bits/OPC dependencies	Sequential command

Questionable Temperature Positive Transition

Determines which bits in the "Questionable Temperature Condition" on page 2599 Register will set bits in the "Questionable Temperature Event Query" on page 2600 register, when the condition register bit has a positive transition (0 to 1).

The variable `<integer>` is the sum of the decimal values of the bits that you want to enable.

Remote Command	<code>:STATus:QUESTIONable:TEMPerature:PTRansition <integer></code>
	<code>:STATus:QUESTIONable:TEMPerature:PTRansition?</code>
Example	<code>:STAT:QUES:TEMP:PTR 2</code> Instrument Overheated being set will be reported to the Temperature Summary of the Questionable register
Preset	32767
Min	0
Max	32767
Status Bits/OPC dependencies	Sequential command

9.4.6.8 Questionable Frequency Register

Monitors frequency-related conditions within the instrument and summarizes them in bit 5 of the "Questionable Register" on page 2592.

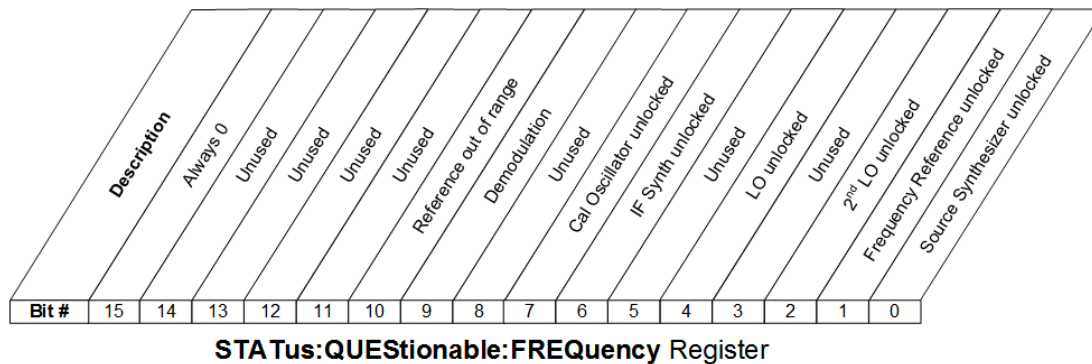

Bit	Condition	Operation
0	Source Synth Unlocked	The synthesizer in the built-in source is not locked
1	Frequency Reference Unlocked	The instrument's frequency reference is unlocked
2	2 nd LO Unlocked	The instrument's second LO (local oscillator) is unlocked
4	LO Unlocked	The instrument's main LO (local oscillator) is unlocked
6	IF Synth Unlocked	The synthesizer in the IF is not locked
7	Cal Osc Unlocked	The oscillator used for internal calibrations is not locked
9	Demodulation	Demodulation cannot be performed due to an out of range frequency

Bit	Condition	Operation
10	Reference missing or out of range	The signal being fed to a reference input is missing or too high or low in frequency for the reference to lock

Filter Registers

- "Questionable Frequency Condition" on page 2602
- "Questionable Frequency Enable" on page 2602
- "Questionable Frequency Event Query" on page 2603
- "Questionable Frequency Negative Transition" on page 2603
- "Questionable Frequency Positive Transition" on page 2604

Questionable Frequency Condition

Returns the decimal value of the sum of the bits in the Questionable Frequency Condition register.

NOTE The data in this register is continuously updated and reflects the current conditions.

Remote Command	:STATus:QUESTionable:FREQuency:CONDition?
Example	:STAT:QUES:FREQ:COND?
Preset	0
Status Bits/OPC dependencies	Sequential command

Questionable Frequency Enable

Determines which bits in the "Questionable Frequency Condition" on page 2602 Register will set bits in the "Questionable Temperature Event Query" on page 2600 register, which also sets the Frequency Summary bit (bit 5) in the "Questionable Register" on page 2592.

The variable <integer> is the sum of the decimal values of the bits you want to enable.

Remote Command	:STATus:QUESTionable:FREQuency:ENABle <integer>
Example	:STAT:QUES:FREQ:ENAB 2
	Frequency Reference Unlocked will be reported to the Frequency Summary of the Status

	Questionable register
Preset	32767
Min	0
Max	32767
Status Bits/OPC dependencies	Sequential command

Questionable Frequency Event Query

Returns the decimal value of the sum of the bits in the Questionable Frequency Event register.

NOTE The register requires that the associated PTRansition or NTRansition filters be set before a condition register bit can set a bit in the event register. The data in this register is latched until it is queried. Once queried, the register is cleared.

Remote Command	:STATus:QUESTionable:FREQuency[:EVENT]?
Example	:STAT:QUES:FREQ?
Preset	0
Status Bits/OPC dependencies	Sequential command

Questionable Frequency Negative Transition

Determines which bits in the "Questionable Frequency Condition" on page 2602 register will set the corresponding bit in the "Questionable Frequency Event Query" on page 2603 register when the condition register bit has a negative transition (1 to 0).

The variable <integer> is the sum of the decimal values of the bits that you want to enable.

Remote Command	:STATus:QUESTionable:FREQuency:NTRansition <integer> :STATus:QUESTionable:FREQuency:NTRansition?
Example	:STAT:QUES:FREQ:NTR 2 Frequency Reference 'regained lock' will be reported to the Frequency Summary of the Status Questionable register
Preset	0
Min	0
Max	32767

Status Bits/OPC dependencies Sequential command

Questionable Frequency Positive Transition

Determines which bits in the "Questionable Frequency Condition" on page 2602 register will set the corresponding bit in the "Questionable Frequency Event Query" on page 2603 register when the condition register bit has a positive transition (0 to 1).

The variable `<integer>` is the sum of the decimal values of the bits that you want to enable.

Remote Command	<code>:STATus:QUESTionable:FREQuency:PTRansition <integer></code> <code>:STATus:QUESTionable:FREQuency:PTRansition?</code>
Example	<code>:STAT:QUES:FREQ:PTR 2</code> Frequency Reference 'became unlocked' will be reported to the Frequency Summary of the Status Questionable register
Preset	32767
Min	0
Max	32767
Status Bits/OPC dependencies	Sequential command

9.4.6.9 Questionable Calibration Register

Monitors calibration-related conditions within the instrument and summarizes them in bit 8 of the "Questionable Register" on page 2592. Three of the bits are summary bits from lower-level event registers.

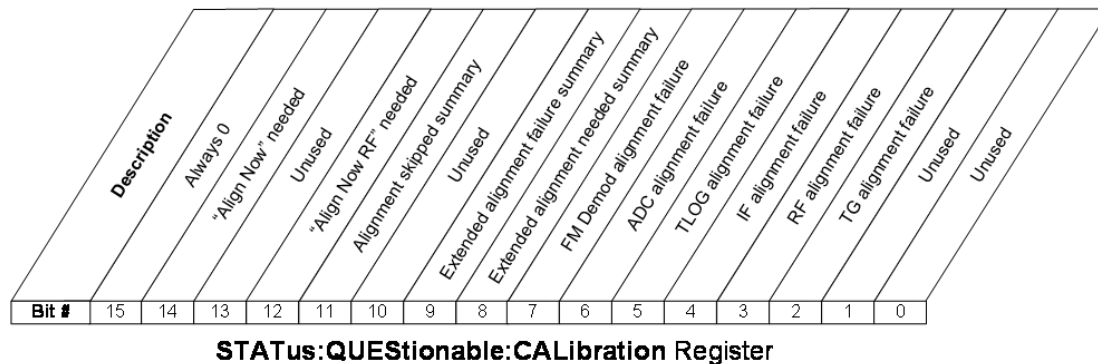

Bit	Condition	Operation
2	TG Alignment Failure	The Tracking Generator failed to align properly
3	RF Alignment Failure	The RF section (frontend) failed to align properly
4	IF Alignment Failure	The IF section failed to align properly
5	LO Alignment Failure	The LO (local oscillator) failed to align properly
6	ADC Alignment Failure	The ADC section failed to align properly
7	FM Demod Alignment Failure	The FM Demod section failed to align properly
8	Extended Align Needed Summary	Summary bit for "Questionable Calibration Extended Needed Register" on page 2608
9	Extended Align Failure Summary	Summary bit for "Questionable Calibration Extended Failure Register" on page 2611
11	Align Skipped Summary	Summary bit for "Questionable Calibration Skipped Register" on page 2614
12	"Align Now RF" required	Go to the System, Alignments, Align Now menu and perform an "Align Now RF"
14	"Align Now" required	Go to the System, Alignments, Align Now menu and perform an "Align Now All" or an "Align Now Expired"

Filter Registers

- "Questionable Calibration Condition" on page 2605
- "Questionable Calibration Enable" on page 2606
- "Questionable Calibration Event Query" on page 2606
- "Questionable Calibration Negative Transition" on page 2607
- "Questionable Calibration Positive Transition" on page 2607

Questionable Calibration Condition

Returns the decimal value of the sum of the bits in the Questionable Calibration Condition register.

NOTE

The data in this register is continuously updated and reflects the current conditions.

Remote Command	<code>:STATus:QUESTionable:CALibration:CONDition?</code>
Example	<code>:STAT:QUES:CAL:COND?</code>
Preset	0
Status Bits/OPC dependencies	Sequential command

Questionable Calibration Enable

Determines which bits in the "Questionable Calibration Condition" on page 2605 Register will set bits in the "Questionable Calibration Event Query" on page 2606 register, which also sets the Calibration Summary bit (bit 8) in the "Questionable Register" on page 2592.

The variable `<integer>` is the sum of the decimal values of the bits you want to enable.

Remote Command	<code>:STATus:QUESTionable:CALibration:ENABLE <integer></code> <code>:STATus:QUESTionable:CALibration:ENABLE?</code>
Example	<code>:STAT:QUES:CAL:ENAB 16384</code> Can be used to query if an alignment is needed, if you have turned off the automatic alignment process
Min	0
Max	32767
Status Bits/OPC dependencies	Sequential command

Questionable Calibration Event Query

Returns the decimal value of the sum of the bits in the Questionable Calibration Event register.

NOTE

The register requires that the associated PTRansition or NTRansition filters be set before a condition register bit can set a bit in the event register. The data in this register is latched until it is queried. Once queried, the register is cleared.

Remote Command	<code>:STATus:QUESTionable:CALibration[:EVENT]?</code>
Example	<code>:STAT:QUES:CAL?</code>
Preset	0
Status Bits/OPC dependencies	Sequential command

Questionable Calibration Negative Transition

Determines which bits in the "Questionable Calibration Condition" on page 2605 register will set the corresponding bit in the "Questionable Calibration Event Query" on page 2606 register when the condition register bit has a negative transition (1 to 0).

The variable `<integer>` is the sum of the decimal values of the bits that you want to enable.

Remote Command	<code>:STATus:QUESTIONable:CALibration:NTRansition <integer></code> <code>:STATus:QUESTIONable:CALibration:NTRansition?</code>
Example	<code>:STAT:QUES:CAL:NTR 16384</code> "Align All Now Needed" being cleared will be reported to the Calibration Summary of the Status Questionable register
Preset	0
Min	0
Max	32767
Status Bits/OPC dependencies	Sequential command

Questionable Calibration Positive Transition

Determines which bits in the "Questionable Calibration Condition" on page 2605 register will set the corresponding bit in the "Questionable Calibration Event Query" on page 2606 register when the condition register bit has a positive transition (0 to 1).

The variable `<integer>` is the sum of the decimal values of the bits that you want to enable.

Remote Command	<code>:STATus:QUESTIONable:CALibration:PTRansition <integer></code> <code>:STATus:QUESTIONable:CALibration:PTRansition?</code>
Example	<code>:STAT:QUES:CAL:PTR 16384</code> "Align All Now Needed" being set will be reported to the Calibration Summary of the Status Questionable register
Preset	32767
Min	0
Max	32767
Status Bits/OPC dependencies	Sequential command

9.4.6.10 Questionable Calibration Extended Needed Register

Monitors conditions that occur because a calibration or alignment is required to guarantee accurate measurements. It summarizes them in bit 8 of the "Questionable Calibration Register" on page 2604.

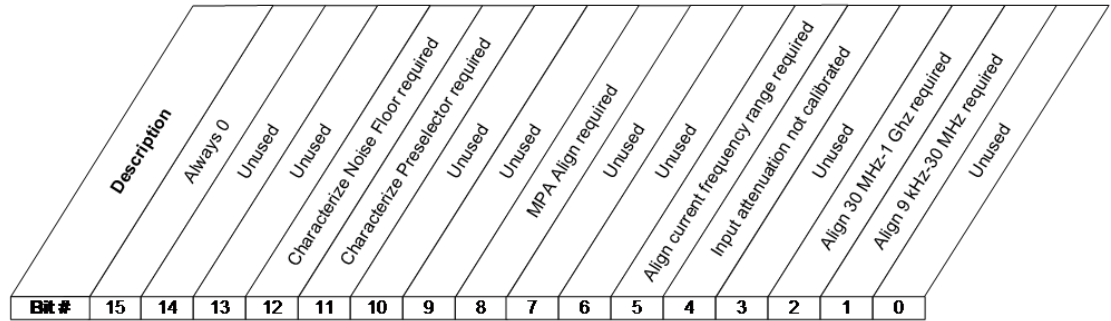

STATus:QUESTIONable:CALibration:EXTended:NEEDED Register

Bit	Condition	Operation
1	Align 9kHz-30MHz required	EMI receiver alignment required, 9kHz-30 MHz (conducted band)
2	Align 30MHz-1GHz required	EMI receiver alignment required, 30 MHz-1 GHz (radiated band)
4	Input Attenuation not calibrated	The input attenuator is uncalibrated
5	Align current frequency range required	Alignment for current set frequency range is needed. It is suggested to process Align Selected Freq Range for the frequency range in use
8	MPA Align required	The Multiport Adaptor must be calibrated (EXT only)
11	Characterize Preselector required	Go to the System, Alignments, Advanced menu and perform a "Characterize Preselector"
12	Characterize Noise Floor required	Go to the System, Alignments, Advanced menu and perform a "Characterize Noise Floor"

Filter Registers

- "Questionable Calibration Extended Needed Condition" on page 2609
- "Questionable Calibration Extended Needed Enable" on page 2609
- "Questionable Calibration Extended Needed Event Query" on page 2610

- "Questionable Calibration Extended Needed Negative Transition" on page 2610
- "Questionable Calibration Extended Needed Positive Transition" on page 2610

Questionable Calibration Extended Needed Condition

Returns the decimal value of the sum of the bits in the Questionable Calibration Extended Needed Condition register.

NOTE The data in this register is continuously updated and reflects the current conditions.

Remote Command	:STATus:QUESTionable:CALibration:EXTended:NEEDed:CONDition?
Example	:STAT:QUES:CAL:EXT:NEED:COND?
Preset	0
Status Bits/OPC dependencies	Sequential command

Questionable Calibration Extended Needed Enable

Determines which bits in the "Questionable Calibration Extended Needed Condition" on page 2609 will set bits in the "Questionable Calibration Extended Needed Event Query" on page 2610 register, which also sets bit 14 of the "Questionable Calibration Register" on page 2604.

The variable `<integer>` is the sum of the decimal values of the bits that you want to enable.

Remote Command	:STATus:QUESTionable:CALibration:EXTended:NEEDed:ENABle <integer> :STATus:QUESTionable:CALibration:EXTended:NEEDed:ENABle?
Example	:STAT:QUES:CAL:EXT:NEED:ENAB 2 Can be used to query if an EMI conducted alignment is needed
Preset	32767
Min	0
Max	32767
Status Bits/OPC dependencies	Sequential command

Questionable Calibration Extended Needed Event Query

Returns the decimal value of the sum of the bits in the Questionable Calibration Extended Needed Event register.

NOTE

The register requires that the associated PTRansition or NTRansition filters be set before a condition register bit can set a bit in the event register. The data in this register is latched until it is queried. Once queried, the register is cleared.

Remote Command	<code>:STATus:QUESTionable:CALibration:EXTended:NEEDed[:EVENT]?</code>
Example	<code>:STAT:QUES:CAL:EXT:NEED?</code>
Preset	0
Status Bits/OPC dependencies	Sequential command

Questionable Calibration Extended Needed Negative Transition

Determines which bits in the "Questionable Calibration Extended Needed Condition" on page 2609 register will set the corresponding bit in the "Questionable Calibration Extended Needed Event Query" on page 2610 register when the condition register bit has a negative transition (1 to 0).

The variable `<integer>` is the sum of the decimal values of the bits that you want to enable.

Remote Command	<code>:STATus:QUESTionable:CALibration:EXTended:NEEDed:NTRansition <integer></code> <code>:STATus:QUESTionable:CALibration:EXTended:NEEDed:NTRansition?</code>
Example	<code>:STAT:QUES:CAL:EXT:NEED:NTR 2</code> Conducted alignment required bit being cleared will be reported
Preset	0
Min	0
Max	32767
Status Bits/OPC dependencies	Sequential command

Questionable Calibration Extended Needed Positive Transition

Determines which bits in the "Questionable Calibration Extended Needed Condition" on page 2609 register will set the corresponding bit in the "Questionable Calibration

Extended Needed Event Query" on page 2610 register when the condition register bit has a positive transition (0 to 1).

The variable `<integer>` is the sum of the decimal values of the bits that you want to enable.

Remote Command	<code>:STATus:QUESTIONable:CALibration:EXTended:NEEded:PTRansition <integer></code>
Example	<code>:STAT:QUES:CAL:EXT:NEED:PTR 2</code> Conducted alignment required bit being set will be reported
Preset	32767
Min	0
Max	32767
Status Bits/OPC dependencies	Sequential command

9.4.6.11 Questionable Calibration Extended Failure Register

Monitors conditions that occur because a calibration or alignment has failed to complete properly. It summarizes them in bit 9 of the "Questionable Calibration Register" on page 2604.

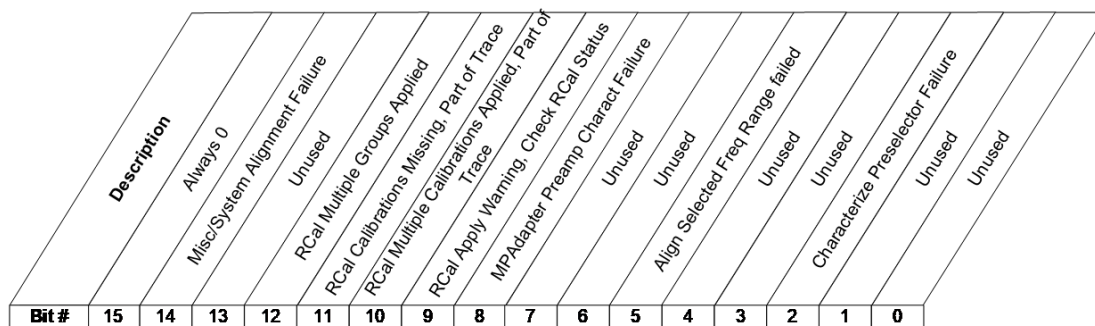

STATus:QUESTIONable:CALibration:EXTended:FAILURE Register

Bit	Condition	Operation
2	Characterize Preselector Failure	The preselector characterization failed
5	Align Selected Freq Range failed	The alignment for selected frequency range failed
8	MPAdapter Preamp Charact Failure	The Multiport Adaptor must be calibrated (EXT only)
9	RCal Apply Warning, Check RCal Status	The calibration request sent to the RCal module failed

Bit	Condition	Operation
10	RCal Multiple Calibrations Applied, Part of Trace	More than one calibration is being applied to part of the trace for current measurement
11	RCal Calibrations Missing, Part of Trace	The calibration being applied is not being applied to all of the trace for the current measurement
12	RCal Multiple Groups Applied	More than one calibrated rows are being applied to the current measurement
14	Misc/System Alignment Failure	Miscellaneous/System alignments have failed

Filter Registers

- ["Questionable Calibration Extended Failure Condition" on page 2612](#)
- ["Questionable Calibration Extended Failure Enable" on page 2612](#)
- ["Questionable Calibration Extended Failure Event Query" on page 2613](#)
- ["Questionable Calibration Extended Failure Negative Transition" on page 2613](#)
- ["Questionable Calibration Extended Failure Positive Transition" on page 2614](#)

Questionable Calibration Extended Failure Condition

Returns the decimal value of the sum of the bits in the Questionable Calibration Extended Failure Condition register.

NOTE

The data in this register is continuously updated and reflects the current conditions.

Remote Command	<code>:STATus:QUEStionable:CALibration:EXTended:FAILure:CONDition?</code>
Example	<code>:STAT:QUES:CAL:EXT:FAIL:COND?</code>
Preset	0
Status Bits/OPC dependencies	Sequential command

Questionable Calibration Extended Failure Enable

Determines which bits in the ["Questionable Calibration Extended Failure Condition" on page 2612](#) Register will set bits in the ["Questionable Calibration Extended Failure Event Query" on page 2613](#) register, which also sets bit 9 of the ["Questionable Calibration Register" on page 2604](#).

The variable `<integer>` is the sum of the decimal values of the bits that you want to enable.

Remote Command	<code>:STATus:QUESTIONable:CALibration:EXTended:FAILure:ENABle <integer></code>
	<code>:STATus:QUESTIONable:CALibration:EXTended:FAILure:ENABle?</code>
Example	<code>:STAT:QUES:CAL:EXT:FAIL:ENAB 1</code> Can be used to query if an EMI conducted alignment failed
Preset	32767
Min	0
Max	32767
Status Bits/OPC dependencies	Sequential command

Questionable Calibration Extended Failure Event Query

Returns the decimal value of the sum of the bits in the Questionable Calibration Extended Failure Event register.

NOTE

The register requires that the associated PTRansition or NTRansition filters be set before a condition register bit can set a bit in the event register. The data in this register is latched until it is queried. Once queried, the register is cleared.

Remote Command	<code>:STATus:QUESTIONable:CALibration:EXTended:FAILure[:EVENT]?</code>
Example	<code>:STAT:QUES:CAL:EXT:FAIL?</code>
Preset	0
Status Bits/OPC dependencies	Sequential command

Questionable Calibration Extended Failure Negative Transition

Determines which bits in the "Questionable Calibration Extended Failure Condition" on page 2612 register will set the corresponding bit in the "Questionable Calibration Extended Failure Event Query" on page 2613 register when the condition register bit has a negative transition (1 to 0).

The variable `<integer>` is the sum of the decimal values of the bits that you want to enable.

Remote Command	<code>:STATus:QUESTIONable:CALibration:EXTended:FAILure:NTRansition <integer></code>
	<code>:STATus:QUESTIONable:CALibration:EXTended:FAILure:NTRansition?</code>
Example	<code>:STAT:QUES:CAL:EXT:FAIL:NTR 1</code>

	Conducted alignment failed bit being cleared will be reported
Preset	0
Min	0
Max	32767
Status Bits/OPC dependencies	Sequential command

Questionable Calibration Extended Failure Positive Transition

Determines which bits in the "Questionable Calibration Extended Failure Condition" on page 2612 register will set the corresponding bit in the "Questionable Calibration Extended Failure Event Query" on page 2613 register when the condition register bit has a positive transition (0 to 1).

The variable `<integer>` is the sum of the decimal values of the bits that you want to enable.

Remote Command	<code>:STATus:QUEStionable:CALibration:EXTended:FAILure:PTRansition <integer></code> <code>:STATus:QUEStionable:CALibration:EXTended:FAILure:PTRansition?</code>
Example	<code>:STAT:QUES:CAL:EXT:FAIL:PTR 1</code> Conducted alignment failed bit being set will be reported
Preset	32767
Min	0
Max	32767
Status Bits/OPC dependencies	Sequential command

9.4.6.12 Questionable Calibration Skipped Register

Monitors conditions that occur because a calibration or alignment has been skipped due to various settings or conditions. It summarizes them in bit 11 of the "Questionable Calibration Register" on page 2604.

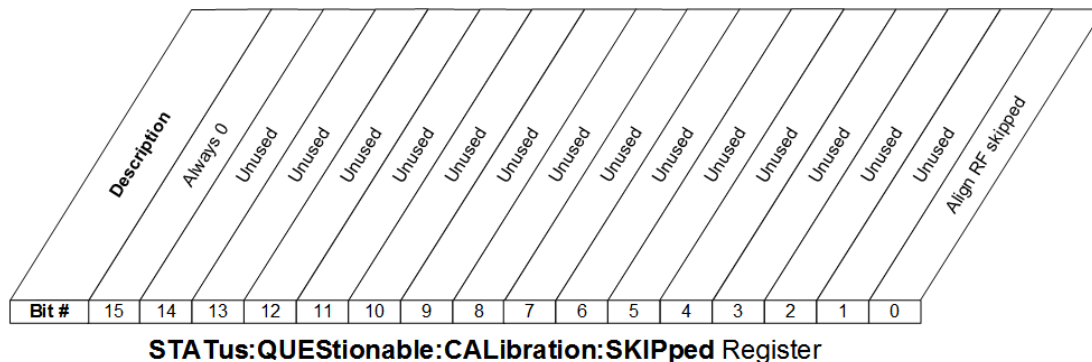

Bit	Condition	Operation
0	Align RF skipped	During an alignment, the calibration of the RF section (frontend) of the instrument was not performed. This can be caused by an interfering user signal present at the RF Input See "Align Now" on page 1900, "Align Now All" on page 1902

Filter Registers

- "Questionable Calibration Skipped Condition" on page 2615
- "Questionable Calibration Skipped Enable" on page 2616
- "Questionable Calibration Skipped Event Query" on page 2616
- "Questionable Calibration Skipped Negative Transition" on page 2616
- "Questionable Calibration Skipped Positive Transition" on page 2617

Questionable Calibration Skipped Condition

Returns the decimal value of the sum of the bits in the Questionable Calibration Skipped Condition register.

NOTE The data in this register is continuously updated and reflects the current conditions.

Remote Command	<code>:STATus:QUESTIONable:CALibration:SKIPPed:CONDition?</code>
Example	<code>:STAT:QUES:CAL:SKIP:COND?</code>
Preset	0
Status Bits/OPC dependencies	Sequential command

Questionable Calibration Skipped Enable

Determines which bits in the "Questionable Calibration Skipped Condition" on page 2615 Register will set bits in the "Questionable Calibration Skipped Event Query" on page 2616 register, which also sets bit 11 of the "Questionable Calibration Register" on page 2604.

The variable `<integer>` is the sum of the decimal values of the bits that you want to enable.

Remote Command	<code>:STATus:QUESTionable:CALibration:SKIPped:ENABle <integer></code>
	<code>:STATus:QUESTionable:CALibration:SKIPped:ENABle?</code>
Example	<code>:STAT:QUES:CAL:SKIP:ENAB 1</code>
	Can be used to query if an RF alignment skipped condition is detected
Preset	32767
Min	0
Max	32767
Status Bits/OPC dependencies	Sequential command

Questionable Calibration Skipped Event Query

Returns the decimal value of the sum of the bits in the Questionable Calibration Event register.

NOTE

The register requires that the associated PTRansition or NTRansition filters be set before a condition register bit can set a bit in the event register. The data in this register is latched until it is queried. Once queried, the register is cleared.

Remote Command	<code>:STATus:QUESTionable:CALibration:SKIPped[:EVENT]?</code>
Example	<code>:STAT:QUES:CAL:SKIP?</code>
Preset	0
Status Bits/OPC dependencies	Sequential command

Questionable Calibration Skipped Negative Transition

Determines which bits in the "Questionable Calibration Skipped Condition" on page 2615 register will set the corresponding bit in the "Questionable Calibration Skipped

[Event Query" on page 2616](#) register when the condition register bit has a negative transition (1 to 0).

The variable `<integer>` is the sum of the decimal values of the bits that you want to enable.

Remote Command	<code>:STATus:QUESTionable:CALibration:SKIPped:NTRansition <integer></code> <code>:STATus:QUESTionable:CALibration:SKIPped:NTRansition?</code>
Example	<code>:STAT:QUES:CAL:SKIP:NTR 1</code> RF Align Skipped bit being cleared will be reported
Preset	0
Min	0
Max	32767
Status Bits/OPC dependencies	Sequential command

Questionable Calibration Skipped Positive Transition

Determines which bits in the ["Questionable Calibration Skipped Condition" on page 2615](#) register will set the corresponding bit in the ["Questionable Calibration Skipped Event Query" on page 2616](#) register when the condition register bit has a positive transition (0 to 1).

The variable `<integer>` is the sum of the decimal values of the bits that you want to enable.

Remote Command	<code>:STATus:QUESTionable:CALibration:SKIPped:PTRansition <integer></code> <code>:STATus:QUESTionable:CALibration:SKIPped:PTRansition?</code>
Example	<code>:STAT:QUES:CAL:SKIP:PTR 1</code> RF Align Skipped bit being set will be reported
Preset	32767
Min	0
Max	32767
Status Bits/OPC dependencies	Sequential command

9.4.6.13 Questionable Integrity Register

Monitors measurement integrity-related conditions within the instrument and summarizes them in bit 9 of the ["Questionable Register" on page 2592](#). Two of the bits are summary bits from lower-level event registers.

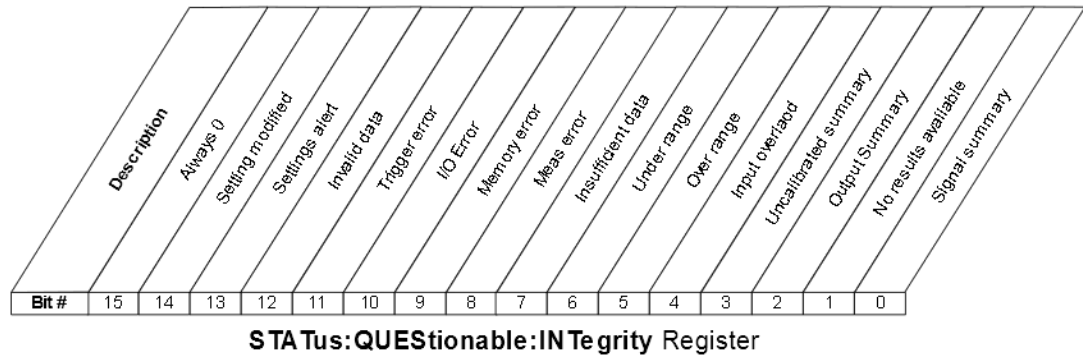

Bit	Condition	Operation
0	Signal Summary	The summary bit for the "Questionable Integrity Signal Register" on page 2621
1	No Result	The current measurement is incompatible with a setting or combination of settings, such as the selected Input, Radio Standard, etc.
2	Output Summary	The summary bit for the "Questionable Integrity Output Register" on page 2624
3	Uncalibrated Summary	The summary bit for the "Questionable Integrity Uncalibrated Register" on page 2627
4	Input Overload	A signal overload condition exists
5	Over Range	The signal at the input for this measurement is too high. You should increase the attenuation or decrease the signal level
6	Under Range	The signal at the input for this measurement is too low. You should decrease the attenuation or increase the signal level
7	Insufficient Data	Signal or settings conditions did not allow enough data to be taken during an acquisition for a valid measurement
8	Meas Error	(not currently in use)
9	Memory Error	There is not enough memory to perform the desired operation
10	I/O Error	I/O settings are preventing communication with an instrument or peripheral
11	Trigger Error	Signal or settings conditions did not allow enough data to be taken during an acquisition for a valid measurement
12	Invalid data	The Invalid Data indicator (* in upper right of display) is on, indicating that onscreen data may be stale and not match the current settings
13	Settings Alert	Settings are not right for a valid measurement, but the instrument is nonetheless allowing a measurement to be taken
14	Setting Modified	Settings are not right for a valid measurement, and the instrument is using different settings than the ones you entered in order to take a measurement

Filter Registers

- "Questionable Integrity Condition" on page 2619
- "Questionable Integrity Enable" on page 2619
- "Questionable Integrity Event Query" on page 2620
- "Questionable Integrity Negative Transition" on page 2620
- "Questionable Integrity Positive Transition" on page 2620

Questionable Integrity Condition

Returns the decimal value of the sum of the bits in the Questionable Integrity Condition register.

NOTE The data in this register is continuously updated and reflects the current conditions.

Remote Command	:STATus:QUESTionable:INTEgrity:CONDition?
Example	:STAT:QUES:INT:COND?
Preset	0
Status Bits/OPC dependencies	Sequential command

Questionable Integrity Enable

Determines which bits in the "Questionable Integrity Condition" on page 2619 Register will set bits in the "Questionable Integrity Event Query" on page 2620 register, which also sets the Integrity Summary bit (bit 9) in the "Questionable Register" on page 2592.

The variable `<integer>` is the sum of the decimal values of the bits that you want to enable.

Remote Command	:STATus:QUESTionable:INTEgrity:ENABle <integer> :STATus:QUESTionable:INTEgrity:ENABle?
Example	:STAT:QUES:INT:ENAB 8 Uncalibrated Summary will be reported to the Integrity Summary of the Status Questionable register
Preset	32767
Min	0
Max	32767
Status Bits/OPC dependencies	Sequential command

Questionable Integrity Event Query

Returns the decimal value of the sum of the bits in the Questionable Integrity Event register.

NOTE

The register requires that the associated PTRansition or NTRansition filters be set before a condition register bit can set a bit in the event register. The data in this register is latched until it is queried. Once queried, the register is cleared.

Remote Command	:STATus:QuesTionable:INTEgrity[:EVENT]?
Example	:STAT:QUES:INT?
Preset	0
Status Bits/OPC dependencies	Sequential command

Questionable Integrity Negative Transition

Determines which bits in the "Questionable Integrity Condition" on page 2619 register will set the corresponding bit in the "Questionable Integrity Event Query" on page 2620 register when the condition register bit has a negative transition (1 to 0).

The variable `<integer>` is the sum of the decimal values of the bits that you want to enable.

Remote Command	:STATus:QuesTionable:INTEgrity:NTRansition <integer> :STATus:QuesTionable:INTEgrity:NTRansition?
Example	:STAT:QUES:INT:NTR 8 Uncalibrated Summary being cleared will be reported to the Integrity Summary of the Status Questionable register
Preset	0
Min	0
Max	32767
Status Bits/OPC dependencies	Sequential command

Questionable Integrity Positive Transition

Determines which bits in the "Questionable Integrity Condition" on page 2619 register will set the corresponding bit in the "Questionable Integrity Event Query" on page 2620 register when the condition register bit has a positive transition (0 to 1).

The variable `<integer>` is the sum of the decimal values of the bits that you want to enable.

Remote Command	<code>:STATus:QUESTIONable:INTEgrity:PTRansition <integer></code> <code>:STATus:QUESTIONable:INTEgrity:PTRansition?</code>
Example	<code>:STAT:QUES:INT:PTR 8</code> Uncalibrated Summary being set will be reported to the Integrity Summary of the Status Questionable register
Preset	32767
Min	0
Max	32767
Status Bits/OPC dependencies	Sequential command

9.4.6.14 Questionable Integrity Signal Register

Monitors conditions that occur because a measurement may not be able to return an accurate or valid result due to signal conditions. It summarizes them in bit 0 of the "Questionable Integrity Register" on page 2617.

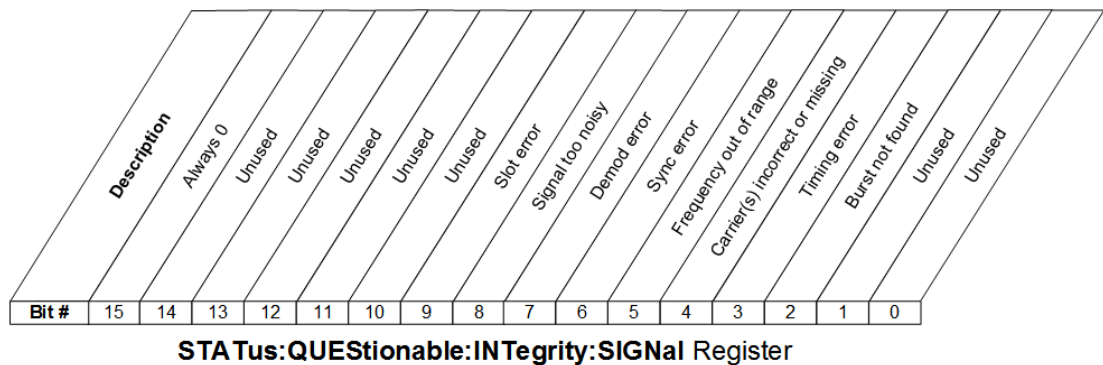

Bit	Condition	Operation
2	Burst not found	The instrument is expecting a bursted signal but such a signal cannot be detected because of inappropriate parameter settings or incorrect signal content
3	Timing Error	The instrument cannot establish appropriate timing from the signal
4	Carrier(s) incorrect or missing	The instrument cannot find the expected carrier(s) within the frequency ranges in which it is looking
5	Frequency out of range	One or more system or signal input frequencies are out of range
6	Sync error	The instrument cannot establish sync with the measured signal
7	Demod error	The instrument cannot demodulate the signal due to inappropriate

Bit	Condition	Operation
		signal or settings conditions
8	Signal Too Noisy	The instrument cannot measure the desired signal because it is too noisy
9	Slot Error	No valid signal slot found in captured data

Filter Registers

- ["Questionable Integrity Signal Condition" on page 2622](#)
- ["Questionable Integrity Signal Enable" on page 2622](#)
- ["Questionable Integrity Signal Event Query" on page 2623](#)
- ["Questionable Integrity Signal Negative Transition" on page 2623](#)
- ["Questionable Integrity Signal Positive Transition" on page 2624](#)

Questionable Integrity Signal Condition

Returns the decimal value of the sum of the bits in the Questionable Integrity Signal Condition register.

NOTE

The data in this register is continuously updated and reflects the current conditions.

Remote Command	<code>:STATus:QUEStionable:INTEgrity:SIGNal:CONDition?</code>
Example	<code>:STAT:QUES:INT:SIGN:COND?</code>
Preset	0
Status Bits/OPC dependencies	Sequential command

Questionable Integrity Signal Enable

Determines which bits in the ["Questionable Integrity Signal Condition" on page 2622](#) Register will set bits in the ["Questionable Integrity Signal Event Query" on page 2623](#) register, which also sets the Integrity Summary bit (bit 9) in the ["Questionable Register" on page 2592](#).

The variable `<integer>` is the sum of the decimal values of the bits that you want to enable.

Remote	<code>:STATus:QUEStionable:INTEgrity:SIGNal:ENABle <integer></code>
--------	---

Command	<code>:STATus:QUEStionable:INTEgrity:SIGNal:ENABle?</code>
Example	<code>:STAT:QUES:INT:SIGN:ENAB 4</code> Burst Not Found will be reported to the Integrity Summary of the Status Questionable register
Preset	32767
Min	0
Max	32767
Status Bits/OPC dependencies	Sequential command

Questionable Integrity Signal Event Query

Returns the decimal value of the sum of the bits in the Questionable Integrity Signal Event register.

NOTE

The register requires that the associated PTRansition or NTRansition filters be set before a condition register bit can set a bit in the event register. The data in this register is latched until it is queried. Once queried, the register is cleared.

Remote Command	<code>:STATus:QUEStionable:INTEgrity:SIGNal[:EVENT]?</code>
Example	<code>:STAT:QUES:INT:SIGN?</code>
Preset	0
Status Bits/OPC dependencies	Sequential command

Questionable Integrity Signal Negative Transition

Determines which bits in the "Questionable Integrity Signal Condition" on page 2622 register will set the corresponding bit in the "Questionable Integrity Signal Event Query" on page 2623 register when the condition register bit has a negative transition (1 to 0).

The variable `<integer>` is the sum of the decimal values of the bits that you want to enable.

Remote Command	<code>:STATus:QUEStionable:INTEgrity:SIGNal:NTRansition <integer></code> <code>:STATus:QUEStionable:INTEgrity:SIGNal:NTRansition?</code>
Example	<code>:STAT:QUES:INT:SIGN:NTR 4</code> Burst not found being cleared will be reported to the Integrity Summary of the Status Questionable register
Preset	0

Min	0
Max	32767
Status Bits/OPC dependencies	Sequential command

Questionable Integrity Signal Positive Transition

Determines which bits in the "Questionable Integrity Signal Condition" on page 2622 register will set the corresponding bit in the "Questionable Integrity Signal Event Query" on page 2623 register when the condition register bit has a positive transition (0 to 1).

The variable `<integer>` is the sum of the decimal values of the bits that you want to enable.

Remote Command	<code>:STATus:QUEStionable:INTEgrity:SIGNal:PTRansition <integer></code> <code>:STATus:QUEStionable:INTEgrity:SIGNal:PTRansition?</code>
Example	<code>:STAT:QUES:INT:SIGN:PTR 4</code> Burst not found being set will be reported to the Integrity Summary of the Status Questionable register
Preset	32767
Min	0
Max	32767
Status Bits/OPC dependencies	Sequential command

9.4.6.15 Questionable Integrity Output Register

Monitors conditions that occur in connection status currently limited to ODI streaming . It summarizes them in bit 2 of the "Questionable Integrity Register" on page 2617.

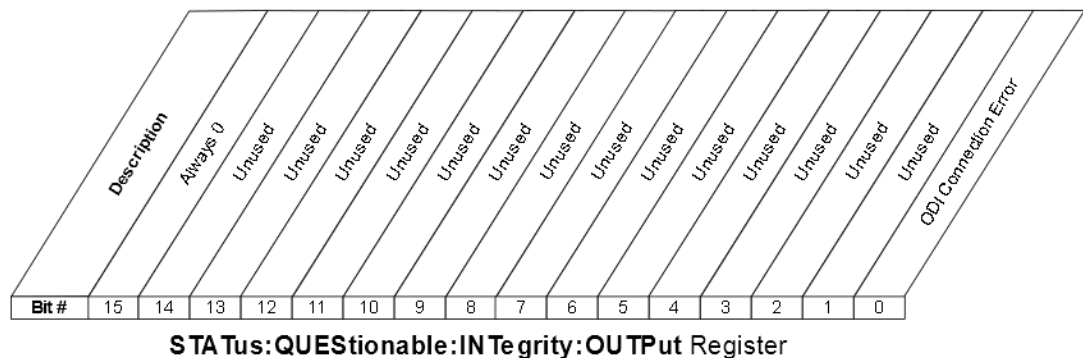

Bit	Condition	Operation
0	ODI Connection Error	ODI Connection Error This bit is never triggered, only its aliases are

Filter Registers

- "Questionable Integrity Output Condition" on page 2625
- "Questionable Integrity Output Enable" on page 2625
- "Questionable Integrity Output Event Query" on page 2626
- "Questionable Integrity Output Negative Transition" on page 2626
- "Questionable Integrity Output Positive Transition" on page 2627

Questionable Integrity Output Condition

Returns the decimal value of the sum of the bits in the Questionable Integrity Output Condition register.

NOTE The data in this register is continuously updated and reflects the current conditions.

Remote Command	<code>:STATus:QUEStionable:INTEgrity:OUTPut:CONDition?</code>
Example	<code>:STAT:QUES:INT:OUTP:COND?</code>
Preset	0
Status Bits/OPC dependencies	Sequential command

Questionable Integrity Output Enable

Determines which bits in the "Questionable Integrity Output Condition" on page 2625 register will set the corresponding bit in the "Questionable Integrity Output Event Query" on page 2626 register, which also sets the Data Output Summary bit (bit 2) in the "Questionable Integrity Register" on page 2617.

The variable `<integer>` is the sum of the decimal values of the bits that you want to enable.

Remote Command	<code>:STATus:QUEStionable:INTEgrity:OUTPut:ENABle</code> <code>:STATus:QUEStionable:INTEgrity:OUTPut:ENABle?</code>
Example	<code>:STAT:QUES:INT:OUTP:ENAB 1</code>

	Oversweep (Meas Uncal) is reported to the Integrity Summary of the Status Questionable register
Preset	32767
Min	0
Max	32767
Status Bits/OPC dependencies	Sequential command

Questionable Integrity Output Event Query

Returns the decimal value of the sum of the bits in the "Questionable Integrity Output Condition" on page 2625 register.

NOTE

The register requires that the associated PTRansition or NTRansition filters be set before a condition register bit can set a bit in the event register. The data in this register is latched until it is queried. Once queried, the register is cleared.

Remote Command	:STATus:QUESTionable:INTEgrity:OUTPut[:EVENT]?
Example	:STAT:QUES:INT:OUTP?
Preset	0
Status Bits/OPC dependencies	Sequential command

Questionable Integrity Output Negative Transition

Determines which bits in the "Questionable Integrity Output Condition" on page 2625 register will set the corresponding bit in the "Questionable Integrity Output Event Query" on page 2626 register when the condition register bit has a negative transition (1 to 0).

The variable <integer> is the sum of the decimal values of the bits that you want to enable.

Remote Command	:STATus:QUESTionable:INTEgrity:OUTPut:NTRansition <integer> :STATus:QUESTionable:INTEgrity:OUTPut:NTRansition?
Example	:STAT:QUES:INT:OUTP:NTR 1
	Oversweep cleared is reported to the Integrity Summary of the Status Questionable register
Preset	0
Min	0
Max	32767
Status Bits/OPC dependencies	Sequential command

Questionable Integrity Output Positive Transition

Determines which bits in the "Questionable Integrity Output Condition" on page 2625 register will set the corresponding bit in the "Questionable Integrity Output Event Query" on page 2626 register when the condition register bit has a positive transition (0 to 1).

The variable `<integer>` is the sum of the decimal values of the bits that you want to enable.

Remote Command	<code>:STATus:QUESTionable:INTEgrity:OUTPut:PTRansition <integer></code>
Example	<code>:STAT:QUES:INT:OUTP:PTR 1</code> Oversweep set is reported to the Integrity Summary of the Status Questionable register
Preset	32767
Min	0
Max	32767
Status Bits/OPC dependencies	Sequential command

9.4.6.16 Questionable Integrity Uncalibrated Register

Monitors conditions that occur because a measurement may not be able to return an accurate or valid result due to a mismatch between instrument settings and the signal, placing the instrument in an uncalibrated state for that signal. It summarizes them in bit 3 of the "Questionable Integrity Register" on page 2617.

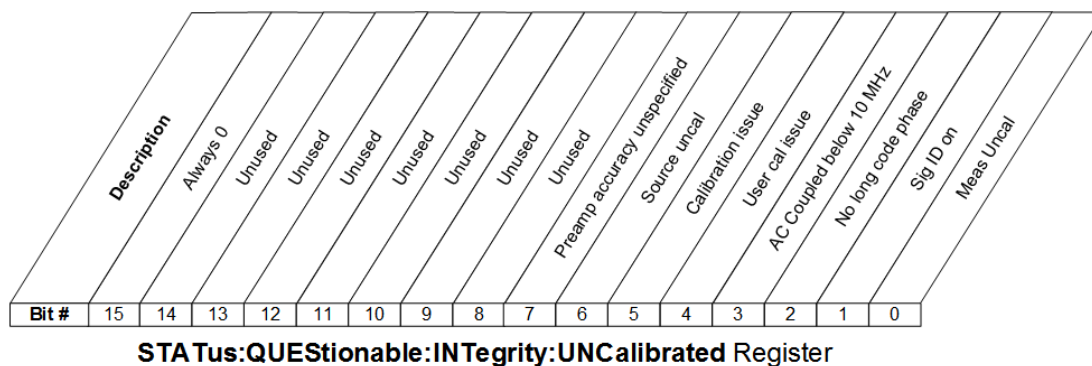

Bit	Condition	Operation
0	Meas Uncal	A Meas Uncal warning is being displayed; generally this means the sweep time must be reduced or the RBW increased
1	Signal ID on	In external mixing, the Sig ID function is on, which will impact the

Bit	Condition	Operation
		trace results
2	No Long Code Phase	The long code phase that identifies an access channel cannot be found (WCDMA)
3	AC coupled: Accy unspec'd <10 MHz	The instrument is AC coupled but is operating below 10 MHz, where the blocking capacitor will impact measurement accuracy
4	User cal issue	In noise figure measurements, the User Cal has not been performed or has been invalidated
5	Calibration issue	In noise figure measurements, one or more calibration or measurement frequency point exceeds the currently loaded Cal or Meas ENR Table frequency ranges
6	Source uncal	While using a Tracking Source, settings are putting it into an uncalibrated operational state
7	Preamplifier accuracy unspecified below XX MHz	The preamp is being used but is operating below frequencies for which its accuracy is specified

Filter Registers

- "Questionable Integrity Uncalibrated Condition" on page 2628
- "Questionable Integrity Uncalibrated Enable" on page 2629
- "Questionable Integrity Uncalibrated Event Query" on page 2629
- "Questionable Integrity Uncalibrated Negative Transition" on page 2629
- "Questionable Integrity Uncalibrated Positive Transition" on page 2630

Questionable Integrity Uncalibrated Condition

Returns the decimal value of the sum of the bits in the Questionable Integrity Uncalibrated Condition register.

NOTE The data in this register is continuously updated and reflects the current conditions.

Remote Command	:STAT:QUESTIONable:INTEgrity:UNCalibrated:CONDition?
Example	:STAT:QUES:INT:UNC:COND?
Preset	0
Status Bits/OPC dependencies	Sequential command

Questionable Integrity Uncalibrated Enable

Determines which bits in the "Questionable Integrity Uncalibrated Condition" on page 2628 Register will set bits in the "Questionable Integrity Uncalibrated Event Query" on page 2629 register, which also sets the Data Uncalibrated Summary bit (bit 3) in the "Questionable Integrity Register" on page 2617.

The variable `<integer>` is the sum of the decimal values of the bits that you want to enable.

Remote Command	<code>:STATus:QUESTionable:INTEgrity:UNCalibrated:ENABle</code>
Example	<code>:STAT:QUES:INT:UNC:ENAB 1</code> Oversweep (Meas Uncal) is reported to the Integrity Summary of the Status Questionable register
Preset	32767
Min	0
Max	32767
Status Bits/OPC dependencies	Sequential command

Questionable Integrity Uncalibrated Event Query

Returns the decimal value of the sum of the bits in the "Questionable Integrity Uncalibrated Condition" on page 2628 register.

NOTE The register requires that the associated PTRansition or NTRansition filters be set before a condition register bit can set a bit in the event register. The data in this register is latched until it is queried. Once queried, the register is cleared.

Remote Command	<code>:STATus:QUESTionable:INTEgrity:UNCalibrated[:EVENT]?</code>
Example	<code>:STAT:QUES:INT:UNC?</code>
Preset	0
Status Bits/OPC dependencies	Sequential command

Questionable Integrity Uncalibrated Negative Transition

Determines which bits in the "Questionable Integrity Uncalibrated Condition" on page 2628 register will set the corresponding bit in the "Questionable Integrity

"Uncalibrated Event Query" on page 2629 register when the condition register bit has a negative transition (1 to 0).

The variable `<integer>` is the sum of the decimal values of the bits that you want to enable.

Remote Command	<code>:STATus:QUESTIONable:INTEgrity:UNCalibrated:NTRansition <integer></code> <code>:STATus:QUESTIONable:INTEgrity:UNCalibrated:NTRansition?</code>
Example	<code>:STAT:QUES:INT:UNC:NTR 1</code> Oversweep cleared is reported to the Integrity Summary of the Status Questionable register
Preset	0
Min	0
Max	32767
Status Bits/OPC dependencies	Sequential command

Questionable Integrity Uncalibrated Positive Transition

Determines which bits in the "Questionable Integrity Uncalibrated Condition" on page 2628 register will set the corresponding bit in the "Questionable Integrity Uncalibrated Event Query" on page 2629 register when the condition register bit has a positive transition (0 to 1).

The variable `<integer>` is the sum of the decimal values of the bits that you want to enable.

Remote Command	<code>:STATus:QUESTIONable:INTEgrity:UNCalibrated:PTRansition <integer></code> <code>:STATus:QUESTIONable:INTEgrity:UNCalibrated:PTRansition?</code>
Example	<code>:STAT:QUES:INT:UNC:PTR 1</code> Oversweep set is reported to the Integrity Summary of the Status Questionable register
Preset	32767
Min	0
Max	32767
Status Bits/OPC dependencies	Sequential command

10 Hardware-Accelerated Fast Power Measurement (Remote Command Only)

The **Fast Power** option (FP2) enables very fast channel power measurements for instruments with the prerequisite hardware (DP2 and/or B40). It accomplishes this by performing real-time overlapped FFTs at the hardware layer, using software for basic post-processing before returning the result. The upshot of this approach is improved throughput for user applications that require many sequential power measurements.

The analysis bandwidth of FP2 may be limited by the licenses in the instrument.

NOTE

FP2 is remote-only, which means the instrument does not switch to any particular Mode or measurement. FP2 commands can be sent while another application is in use on the front panel.

Each Fast Power measurement can be predefined using an array index, and up to 1000 measurements can be stored. In the following documentation, instances of [1,2,...,999] can be substituted with a particular measurement index, for example, `:CALC:FPOW:POW1?`, `:CALC:FPOW:POW2?`, `:CALC:FPOW:POW134?`. In this way, power measurements can be defined one time in a batch, and then executed multiple times without having to redefine them, similar to “list mode” on other measurements.

In addition to basic channel power measurements, there are several other measurement “functions” for each channel, including peak power, peak frequency, and power spectral density.

10.1 Reset Fast Power Measurement (Remote Command Only)

Resets the measurement configuration to the defaults.

Remote Command	<code>:CALCulate:FPOWer:POWer[1,2,...,999]:RESet</code>
----------------	---

Example	<code>:CALC:FPOW:POW1:RES</code>
---------	----------------------------------

Notes	Option FP2 is required
-------	------------------------

10.2 Reset Fast Power Measurement (Remote Command Only)

Resets the measurement configuration to the defaults.

Remote Command	<code>:CALCulate:FPOW:POW[1,2,...,999]:RESet</code>
Example	<code>:CALC:FPOW:POW1:RES</code>
Notes	Option FP2 is required

10.2.1 Acquisition Time

Example	<code>:CALC:FPOW:POW1:DEF "AcquisitionTime=0.002"</code>
Notes	Sets the time in which the entire spectrum is measured. An increase in the acquisition time yields an improvement in measurement repeatability
Preset	0.001 s
Range	0 s to 1 s

10.2.2 Center Frequency

Example	<code>:CALC:FPOW:POW1:DEF "CenterFrequency=2e9"</code>
Notes	Sets the frequency in which the measurement is centered around. "Channel Offset Frequency Array" on page 2641 is calculated relative to the center frequency
Preset	1 GHz
Range	0 Hz to maximum instrument frequency

10.2.3 DC Coupled

Example	<code>:CALC:FPOW:POW1:DEF "DCCoupled=True"</code>				
Notes	Lets you specify whether the DC blocking capacitor is utilized. Set to True when measuring frequencies below 10 MHz				
Preset	False				
Range	<table border="0"> <tr> <td>True</td> <td>DC Coupled</td> </tr> <tr> <td>False</td> <td>AC Coupled</td> </tr> </table>	True	DC Coupled	False	AC Coupled
True	DC Coupled				
False	AC Coupled				

10.2.4 Detector Type

Example	<code>:CALC:FPOW:POW1:DEF "DetectorType=Peak"</code>
Notes	Option FP2 is required Lets you specify whether an RMS average or peak value is used during the measurement
Preset	<code>RmsAverage</code>
Range	<code>RmsAverage, Peak</code>

10.2.5 Do Noise Correction

Example	<code>:CALC:FPOW:POW1:DEF "DoNoiseCorrection=True"</code>
Notes	When noise correction is enabled, the linear noise power contributed by the instrument is subtracted from all measurements. This effectively lowers the noise floor of the instrument When noise correction is enabled, the first measurement for a given set of input parameters will take extra time. This is because the instrument takes an extra acquisition with the RF input disconnected from the instrument's front end to measure the noise of just the instrument. The measured noise floor is stored in a cache so the noise acquisition will occur only once for the same state settings. In other words, if noise correction was turned on and the instrument made an acquisition at frequency A, then frequency B, and back again to frequency A, the hidden initial noise floor acquisition would only occur for the first acquisition at frequency A and the cached noise floor would be used the second time frequency A was measured
Preset	<code>False</code>
Range	<code>True</code> Enable noise correction <code>False</code> Disable noise correction

10.2.6 Do Spur Suppression

Example	<code>:CALC:FPOW:POW1:DEF "DoSpurSuppression=True"</code>
Notes	When measuring very low-level signals, or when large out-of-band inputs are input into the instrument, sometimes unwanted spurs and residuals can appear in the measured spectrum. Spur suppression is a method to help minimize the levels of these internally generated spurs and residuals When spur suppression is enabled, the instrument will automatically take two acquisitions using two different internal analog LO frequencies. The FFT spectrums from both acquisitions are combined by taking the minimum power between both traces on a per FFT bin basis. External signals will have the same amplitude for both traces and therefore will return the expected amplitudes. However, low level spurs and residuals generated internally to the instrument tend to move to different FFT bins depending on the internal analog LO frequency used, and therefore tend to be suppressed using this spur suppression method

	Because two acquisitions, rather than a single acquisition, are made when spur suppression is enabled, the measurement time will always be slower when spur suppression is enabled	
Preset	False	
Range	True	Enable spur suppression
	False	Disable spur suppression

10.2.7 Electronic Attenuator Bypass

Example	:CALC:FPOW:POW1:DEF "ElecAttBypass =False"	
Notes	Lets you either utilize or bypass the electronic attenuator. The electronic attenuator is only available for frequencies up to 3.6 GHz. Set to True when using frequencies above 3.6 GHz. Set to False when using the preamp	
Preset	True	
Range	True	Bypass electronic attenuator
	False	Use electronic attenuator

10.2.8 Electronic Attenuation

Example	:CALC:FPOW:POW1:DEF "ElecAttenuation=10"	
Notes	Option EA3 is required The electronic attenuation value parameter sets the amount of electrical attenuation from 0 to 24 dB (1 dB steps) Set ElecAttBypass = False to make sure the electronic attenuator path is enabled	
Preset	0 dB	
Range	0 – 24 dB (1 dB steps)	

10.2.9 External Reference Frequency

Example	:CALC:FPOW:POW1:DEF "ExternalReferenceFrequency=10"	
Notes	This is the user-specified frequency of the external reference. Used when "Frequency Reference Source" on page 2636 is set to ExternalFrequencyReference, or AutoExternalFrequencyReference when the external source is present. Unused if FrequencyReferenceSource is set to InternalFrequencyReference	
Preset	10 MHz	

10.2.10 Frequency Reference Source

Example	<code>:CALC:FPOW:POW1:DEF "FrequencyReferenceSource= InternalFrequencyReference"</code>
Notes	Specifies which frequency reference source should be used for this request: <ul style="list-style-type: none">- If <code>ExternalFrequencyReference</code> is selected and no external reference is present, the frequency reference unlocks but the data acquisition will continue- If <code>AutoExternalFrequencyReference</code> is selected, the hardware senses whether an external source is present before starting the data acquisition. If no external source is present then the internal source is selected, and the data acquisition will continue
Preset	<code>InternalFrequencyReference</code>
Range	<code>InternalFrequencyReference, ExternalFrequencyReference, AutoExternalFrequencyReference</code>

10.2.11 IF Gain

Example	<code>:CALC:FPOW:POW1:DEF "IFGain=10"</code>
Notes	Lets you specify the gain at the IF stage anywhere from -6 to 16 dB (1 dB steps). This is an advanced feature; for most cases this should remain at its default value of 0 dB
Preset	0 dB
Range	-6 – 16 dB (1 dB steps)

10.2.12 IF Type

Example	<code>:CALC:FPOW:POW1:DEF "IFType=B25M"</code>
Notes	Lets you select between different IF paths. For example, if the signal is less than 25 MHz wide, then you can select the B25M path to take advantage of additional filtering on this analog IF path
Preset	<code>B40M</code>
Range	<code>B10M, B25M, B40M</code>

10.2.13 Include Power Spectrum

Example	<code>:CALC:FPOW:POW1:DEF "IncludePowerSpectrum=True"</code>
Notes	Lets you read data on the entire spectrum for diagnostic purposes. It is not recommended for production use For details of the binary format of the response, see "Diagnostic Binary Read Fast Power Measurement (Remote Command Only)" on page 2649

Preset	False	
Range	True	Returns both channel power and full power spectrum
	False	Returns only channel power

10.2.14 Mechanical Attenuation

Example	:CALC:FPOW:POW1:DEF "MechAttenuation=10"	
Notes	Sets the amount of mechanical attenuation anywhere from 0 to 70 dB (2 dB steps)	
Preset	0 dB	
Range	0 – 70 dB (2 dB steps)	

10.2.15 Preamp Mode

Example	:CALC:FPOW:POW1:DEF "PreAmpMode=Low"	
Notes	The license for the appropriate preamp is required Specifies whether the preamps are being utilized. Low allows any preamps up to 3.6 GHz, and Full allows all licensed preamps. Set ElecAttBypass = True to utilize any preamps (see " Electronic Attenuator Bypass " on page 2635)	
Preset	Off	
Range	Off, Low, Full	

10.2.16 Resolution Bandwidth Mode

Example	:CALC:FPOW:POW1:DEF "PreAmpMode=Low"	
Notes	Lets you specify whether the RBW filter is automatically or manually set. The BestSpeed value minimizes measurement time, while the Narrowest value minimizes RBW size (minimum of two FFT bins per RBW) To manually specify an RBW, set this parameter to Explicit , and set " Resolution Bandwidth " on page 2638 to the desired value	
Preset	BestSpeed	
Range	BestSpeed, Narrowest, Explicit	

10.2.17 Resolution Bandwidth

Example	<code>:CALC:FPOW:POW1:DEF "ResolutionBW=25e3"</code>
Notes	Sets the 3-dB bandwidth of the RBW filter. "Resolution Bandwidth Mode" on page 2637 must be set to Explicit to manually set the RBW
Preset	0 Hz

10.2.18 Trigger Delay

Example	<code>:CALC:FPOW:POW1:DEF "TriggerDelay=0.025"</code>
Notes	Sets the time after an external trigger is detected until the measurement is performed
Preset	0 s
Range	0 – 1 s

10.2.19 Trigger Level

Example	<code>:CALC:FPOW:POW1:DEF "TriggerLevel=2"</code>
Notes	Sets the voltage value at which an external trigger is detected
Preset	1.2 V
Range	-5 to 5 V

10.2.20 Trigger Slope

Example	<code>:CALC:FPOW:POW1:DEF "TriggerSlope=Negative"</code>
Notes	Specifies the direction of the edge trigger voltage for detection
Preset	Positive
Range	Positive, Negative

10.2.21 Trigger Source

Example	<code>:CALC:FPOW:POW1:DEF "TriggerSource=Ext1"</code>
Notes	Lets you select whether the measurement triggers freely, or is controlled by an external input Ext1 and Ext2 correspond to Trigger 1 In and Trigger 2 In, respectively
Preset	Free
Range	Free, Ext1, Ext2

10.2.22 Trigger Timeout

Example	<code>:CALC:FPOW:POW1:DEF "TriggerTimeout=0.1"</code>
Notes	Sets the time in which the instrument will wait for a trigger before automatically performing the measurement
Preset	1 s
Range	0 – 1 s

10.2.23 Signal Input

Example	<code>:CALC:FPOW:POW1:DEF "SignalInput=Fp50MHzCW"</code>
Notes	Lets you select between using the main RF input or the internal instrument reference CW signal of 50 MHz
Preset	<code>FpMainRf</code>
Range	<code>FpMainRf, Fp50MHzCW</code>

10.2.24 Use Preselector

Example	<code>:CALC:FPOW:POW1:DEF "UsePreSelector=True"</code>				
Notes	Lets you either utilize or bypass the front-end tunable filter at frequencies above 3.6 GHz. For frequencies below 3.6 GHz, the preselector is automatically bypassed, so you do not need to set this parameter to <code>False</code> in those cases				
Preset	<code>False</code>				
Range	<table border="0"> <tr> <td><code>True</code></td> <td>Use preselector above 3.6 GHz</td> </tr> <tr> <td><code>False</code></td> <td>Preselector bypassed</td> </tr> </table>	<code>True</code>	Use preselector above 3.6 GHz	<code>False</code>	Preselector bypassed
<code>True</code>	Use preselector above 3.6 GHz				
<code>False</code>	Preselector bypassed				

10.2.25 Channel Bandwidth Array

Example	<code>:CALC:FPOW:POW1:DEF "Bandwidth=[3.84e6, 5e6, 3.84e6]"</code>
Notes	Defines the bandwidth of each channel that will be measured All array parameters should have the same number of elements. Alternatively, if all the elements are the same value, a single number with no square brackets can be used to define the parameter
Preset	<code>[1e6]</code>
Range	0 to 40 MHz

10.2.26 Channel Filter Type Array

Example	<code>:CALC:FPOW:POW1:DEF "FilterType=[RRC, IBW, RRC]"</code>
Notes	Lets you select either an integration bandwidth (IBW) filter, or a root-raised-cosine (RRC) filter. The integration bandwidth filter weighs all frequencies within the bandwidth equally. The root-raised-cosine filter has an associated shape parameter, defined by the FilterAlpha parameter All array parameters should have the same number of elements. Alternatively, if all the elements are the same value, a single value with no square brackets can be used to define the parameter
Preset	<code>[IBW]</code>
Range	<code>IBW, RRC</code>

10.2.27 Channel Filter Alpha Array

Example	<code>:CALC:FPOW:POW1:DEF "FilterAlpha=[0.5, 0.0, 0.5]"</code>
Notes	Lets you adjust the alpha value associated with the root-raised-cosine (RRC) filter type. Set <code>FilterType</code> to <code>RRC</code> to utilize this parameter All array parameters should have the same number of elements. Alternatively, if all the elements are the same value, a single number with no square brackets can be used to define the parameter
Preset	<code>[0.22]</code>
Range	<code>0.0 - 1.0</code>

10.2.28 Channel Measurement Function Array

Example	<code>:CALC:FPOW:POW1:DEF "Function=[BandPower, PeakPower, BandPower]"</code>
Notes	Defines what measurement is being made for each individually-specified channel. For details, see "Parameter Options" on page 2640 All array parameters should have the same number of elements Alternatively, if all the elements are the same value, a single value with no square brackets can be used to define the parameter
Preset	<code>BandPower</code>
Range	<code>BandPower, BandDensity, PeakPower, PeakFrequency, XdBBandwidth, OccupiedBandwidth</code>

Parameter Options

Option	Description	Unit
<code>BandPower</code>	Total power within the specified bandwidth of the	<code>dBm</code>

Option	Description	Unit
	channel	
BandDensity	Total power density within the specified bandwidth of the channel	dBm/Hz
PeakPower	The peak power value within the specified bandwidth of the channel	dBm
PeakFrequency	The frequency that corresponds to the peak power value within the specified bandwidth of the channel. This frequency is relative to the center frequency	Hz
XdBBandwidth	The half power (-3.01 dB) bandwidth of the highest amplitude signal that resides within the channel dB is configurable using " Channel x-dB Bandwidth Array " on page 2642	Hz
OccupiedBandwidth	The bandwidth at which 99% of the total power resides within the channel Percentage is configurable using " Channel Occupied Bandwidth Percent Array " on page 2641	Hz

10.2.29 Channel Offset Frequency Array

Example	<code>:CALC:FPOW:POW1:DEF "OffsetFrequency=[-5e6, 0, 5e6]"</code>
Notes	Defines the difference between the center frequency to the center frequency of each channel All array parameters should have the same number of elements
Preset	[0]
Range	0 to 20 MHz

10.2.30 Channel Occupied Bandwidth Percent Array

Example	<code>:CALC:FPOW:POW1:DEF "OccupiedBandwidthPercent =[0.95, 0.95, 0.95]"</code>
Notes	Only applies to channels whose " Channel Measurement Function Array " on page 2640 is set to OccupiedBandwidth . The occupied bandwidth percent parameter specifies the percent of total power in these channels. The valid range for this parameter is 0.0 to 1.0, where 1.0 represents 100%. The default for this parameter is 0.99, which will return the bandwidth that contains 99% of the total channel power
Preset	[0.99]
Range	0 – 1.0

- 10 Hardware-Accelerated Fast Power Measurement (Remote Command Only)
- 10.2 Reset Fast Power Measurement (Remote Command Only)

10.2.31 Channel x-dB Bandwidth Array

Example	<code>:CALC:FPOW:POW1:DEF " XdBBandwidth =[-6.02, -3.01, -1.0]"</code>
Notes	Only applies to channels whose "Channel Measurement Function Array" on page 2640 is set to <code>XdBBandwidth</code> . The X dB bandwidth parameter is used to specify the power relative to the peak channel power over which the bandwidth is calculated. The parameter value must be a negative number
Preset	<code>[-3.01]</code>
Range	-200 to 0 dB

10.3 Define Fast Power Measurement Query (Remote Command Only)

Retrieves a list of all defined parameters in an ASCII string format

The following is an example of returned results:

```
"DCCoupled=False,ElecAttBypass=True,ElecAttenuation=0,IFGain=0,MechAttenuation=0,PreAmpMode=Off,PreSelectorOffset=0,UsePreSelector=False,ExternalReferenceFrequency=10000000,FrequencyReferenceSource=AutoExternalFrequencyReference,IFType=B40M,LOMode=SLW,SignalInput=FpMainRf,AcquisitionTime=0.001,CenterFrequency=100000000,ResolutionBW=0,ResolutionBWMode=BestSpeed,DetectorType=RmsAverage,Bandwidth=[1000000],OffsetFrequency=[0],Function=[BandPower],FilterType=[IBW],FilterAlpha=[0.22],OccupiedBandwidthPercent=[0.99],XdBBandwidth=[3.01],DoNoiseCorrection=False,DoSpurSuppression=False,MeasurementMethod=HardwareFFT,IncludePowerSpectrum=False,TriggerDelay=0,TriggerLevel=1.2,TriggerSlope=Positive,TriggerSource=Free,TriggerTimeout=1,Trigger1Output=Off,Trigger1OutputPolarity=Positive,Trigger2Output=Off,Trigger2OutputPolarity=Positive"
```

Remote Command	:CALCulate:FPOWer:POWer[1,2,...,999]:DEFine?
Example	:CALC:FPOW:POW1:DEF?
Notes	Retrieves a list of all defined parameters in an ASCII format

10.4 Configure Fast Power Measurement (Remote Command Only)

Begins hardware setup and returns immediately, with no acquisition made. This can be used in parallel with other hardware operations to effectively hide the hardware setup time.

Remote Command	<code>:CALCulate:FPOWer:POWer[1,2,...,999]:CONFigure</code>
Example	<code>:CALC:FPOW:POW1:CONF</code>
Notes	Option FP2 is required

10.5 Initiate Fast Power Measurement (Remote Command Only)

Begins an acquisition and returns immediately. The results of the measurement can be retrieved using `:FETCh`.

Remote Command	<code>:CALCulate:FPOWer:POWer[1,2,...,999]:INITiate</code>
Example	<code>:CALC:FPOW:POW1:INIT</code>
Notes	Option FP2 is required

10.6 Fetch Fast Power Measurement (Remote Command Only)

Used to retrieve the results of an acquisition initiated by `:INIT`. The returned results are in *ASCII string* format. The string begins and ends with quotation marks.

Remote Command	<code>:CALCulate:FPOWer:POWer[1,2,...,999]:FETCh?</code>
Example	<code>:CALC:FPOW:POW1:FETC?</code>
Notes	<p>Option FP2 is required</p> <p>Returns m comma-separated ASCII values, where m corresponds to the number of bandwidths defined</p> <ol style="list-style-type: none">1. Declared function return in the 1st specified channel2. Declared function return in the 2nd specified channel...m. Declared function return in the last specified channel <p>The <code>INIT</code> and <code>FETC?</code> command sequence has the same effect as a single <code>CALC:FPOW:POW[n]?</code> query. Units of the returned values depend on "Channel Measurement Function Array" on page 2640 for each channel</p>

10.7 Execute Fast Power Measurement (Remote Command Only)

Shorthand for `:INIT` immediately followed by `:FETC?`. The returned results are in *ASCII string* format. The string begins and ends with quotation marks.

Remote Command	<code>:CALCulate:FPOWer:POWer[1,2,...,999]?</code>
Example	<code>:CALC:FPOW:POW1?</code>
Notes	Option FP2 is required For return format, see notes for "Fetch Fast Power Measurement (Remote Command Only)" on page 2646

10.8 Binary Read Fast Power Measurement (Remote Command Only)

Shorthand for `:INIT` immediately followed by `:FETC?`. The returned results are in *binary format*.

Remote Command	<code>:CALCulate:FPOWer:POWer[1,2,...,999]:READ?</code> <code>:CALCulate:FPOWer:POWer[1,2,...,999]:READ1?</code>
Example	<code>:CALC:FPOW:POW1:READ?</code> <code>:CALC:FPOW:POW1:READ1?</code>
Notes	Option FP2 is required Returns m 4-byte floating point binary values (Little-Endian), where m corresponds to the number of bandwidths defined

10.9 Diagnostic Binary Read Fast Power Measurement (Remote Command Only)

Shorthand for `:INIT` immediately followed by `:FETC?`. The returned results are in *binary format*. This command is used primarily for diagnostic purposes, to test for ADC overloads and to visibly inspect the spectrum.

Remote Command	<code>:CALCulate:FPOwer:POWer[1,2,...,999]:READ2?</code>
----------------	--

Example	<code>:CALC:FPOW:POW1:READ2?</code>
---------	-------------------------------------

Notes	<p>Option FP2 is required</p> <p>Note that Spectrum data is only returned if <code>IncludePowerSpectrum</code> is set to <code>True</code> (see "Include Power Spectrum" on page 2636). If <code>IncludePowerSpectrum</code> is <code>False</code>, the number of spectrum points is zero (0)</p> <p>Units of the returned values are dependent on the <code>Function</code> parameter per channel (e.g. dBm for <code>BandPower</code>, Hz for <code>PeakFrequency</code>)</p> <p>Returns binary data (Little-Endian) that contains information on m amount of channels, along with ADC over range and full spectrum data</p> <p>The following is the binary format of the response</p> <p>Bandwidth Return Value</p> <ol style="list-style-type: none"> 1. Number of channels specified, m [4-byte int] 2. Declared function result for the 1st specified channel [4-byte float] 3. Declared function result for the 2nd specified channel [4-byte float] ... (m + 1). Declared function result for the last (mth) specified channel [4-byte float] <p>ADC Over Range</p> <ol style="list-style-type: none"> 1. ADC over-range occurred (1: true, 0: false) [2 byte short] <p>Spectrum Data</p> <ol style="list-style-type: none"> 1. Number of points in the spectrum data, k [4-byte int] 2. Start frequency of spectrum data (Hz) [8-byte double] 3. Step frequency of spectrum data (Hz) [8-byte double] 4. FFT bin at 1st point (dBm) [4-byte float] 5. FFT bin at 2nd point (dBm) [4-byte float] ... (k + 3). FFT bin at last (kth) point (dBm) [4-byte float]
-------	--

This information is subject to change
without notice.

© Keysight Technologies 2024

Edition 6, April 2024

N9054-90001

www.keysight.com

