X-Series Signal Analyzers

Bluetooth Mode

E6680A

M9410A M9411A M9415A M9416A

N9000B N9010B N9020B N9021B N9030B N9040B N9041B

N9042B



Notices

Copyright Notice

© Keysight Technologies 2023

No part of this manual may be reproduced in any form or by any means (including electronic storage and retrieval or translation into a foreign language) without prior agreement and written consent from Keysight Technologies, Inc. as governed by United States and international copyright laws.

Trademarks

WiMAX and Mobile WiMAX are US trademarks of the WiMAX Forum.

Manual Part Number

N9081-90004

Edition

Edition: 7, December 2023

Published in USA

Published by:

Keysight Technologies, Inc.
1400 Fountaingrove Parkway
Santa Rosa, CA 95403

Technology Licenses

The hardware and/or software described in this document are furnished under a license and may be used or copied only in accordance with the terms of such license.

U.S. Government Rights

The Software is "commercial computer software," as defined by Federal Acquisition Regulation ("FAR") 2.101. Pursuant to FAR 12.212 and 27.405-3 and Department of Defense FAR Supplement ("DFARS") 227.7202, the US government acquires commercial computer software under the same terms by which the software is customarily provided to the public. Accordingly, Keysight provides the Software to US government customers under its standard commercial license, which is embodied in its End User License Agreement (EULA), a copy of which can be found at

<http://www.keysight.com/find/sweula>. The license set forth in the EULA represents the exclusive authority by which the US government may use, modify, distribute, or disclose the Software. The EULA and the license set forth therein, does not require or permit, among other things, that Keysight: (1) Furnish technical information related to commercial computer software or commercial computer software documentation that is not customarily provided to the public; or (2) Relinquish to, or otherwise provide, the government rights in excess of these rights customarily provided to the public to use, modify, reproduce, release, perform, display, or disclose commercial computer software or commercial computer software documentation. No additional government requirements beyond those set forth in the EULA shall apply, except to the extent that those terms, rights, or licenses are explicitly required from all providers of commercial computer software pursuant to the FAR and the DFARS and are set forth specifically in writing elsewhere in the EULA. Keysight shall be under no obligation to update, revise or otherwise modify the Software. With respect to any technical data as defined by FAR 2.101, pursuant to FAR 12.211 and 27.404.2 and DFARS 227.7102, the US government acquires no greater than Limited Rights as defined in FAR 27.401 or DFAR 227.7103-5 (c), as applicable in any technical data.

Warranty

THE MATERIAL CONTAINED IN THIS DOCUMENT IS PROVIDED "AS IS," AND IS SUBJECT TO BEING CHANGED, WITHOUT NOTICE, IN FUTURE EDITIONS. FURTHER, TO THE MAXIMUM EXTENT PERMITTED BY APPLICABLE LAW, KEYSIGHT DISCLAIMS ALL WARRANTIES, EITHER EXPRESS OR IMPLIED, WITH REGARD TO THIS MANUAL AND ANY INFORMATION CONTAINED HEREIN, INCLUDING BUT NOT LIMITED TO THE IMPLIED WARRANTIES OF MERCHANTABILITY AND FITNESS FOR A PARTICULAR PURPOSE. KEYSIGHT SHALL NOT BE LIABLE FOR ERRORS OR FOR INCIDENTAL OR CONSEQUENTIAL DAMAGES IN CONNECTION WITH THE FURNISHING, USE, OR PERFORMANCE OF THIS DOCUMENT OR OF ANY INFORMATION CONTAINED HEREIN. SHOULD KEYSIGHT AND THE USER HAVE A SEPARATE WRITTEN AGREEMENT WITH WARRANTY TERMS COVERING THE MATERIAL IN THIS DOCUMENT THAT CONFLICT WITH THESE TERMS, THE WARRANTY TERMS IN THE SEPARATE AGREEMENT SHALL CONTROL.

Safety Information

CAUTION

A CAUTION notice denotes a hazard. It calls attention to an operating procedure, practice, or the like that, if not correctly performed or adhered to, could result in damage to the product or loss of important data. Do not proceed beyond a CAUTION notice until the indicated conditions are fully understood and met.

WARNING

A WARNING notice denotes a hazard. It calls attention to an operating procedure, practice, or the like that, if not correctly performed or adhered to, could result in personal injury or death. Do not proceed beyond a WARNING notice until the indicated conditions are fully understood and met.

Table Of Contents

Bluetooth Mode User's & Programmer's Reference	1
Table Of Contents	3
1 Documentation Roadmap	56
1.1 Products Covered by this Document	57
1.2 Additional Documentation	58
2 User Interface	60
2.1 Screen Tabs	61
2.1.1 Mode/Meas/View Dialog	62
2.1.1.1 Mode	63
2.1.1.2 Application Mode Remote Commands	66
Application Mode Catalog Query (Remote Command Only)	66
Current Application Model (Remote Command Only)	67
Current Application Revision (Remote Command Only)	67
Current Application Options (Remote Command Only)	68
Application Catalog Number of Entries (Remote Command Only)	68
Application Catalog Model Numbers (Remote Command Only)	68
Application Catalog Revision (Remote Command Only)	69
Application Catalog Options (Remote Command Only)	69
ESA SA compatibility command (Remote Command only)	69
GSM Mode compatibility command (Remote Command only)	70
SA compatibility command for EMC (Remote Command only)	70
Receiver compatibility command for EMC (Remote Command only)	70
APD compatibility command for EMC (Remote Command only)	70
IF Mode compatibility command for EMC (Remote Command only)	71
2.1.1.3 Measurement	71
2.1.1.4 View	71
2.1.1.5 Sequencer	73
2.1.1.6 Screen Name	76
2.1.1.7 Delete This Screen	77
2.1.1.8 Delete All But This Screen	77
2.1.1.9 89600 VSA	78
2.1.2 Add Screen	79
2.2 Meas Bar	81
2.3 Measurement Display	85

Table Of Contents

2.3.1 Window Title	85
2.3.2 Measurement Data	89
2.3.3 Annotation Hotspot	92
2.4 Menu Panel	94
2.4.1 Right-Click Menu	104
2.4.1.1 Add to User Menu	104
2.4.1.2 Help on this setting	104
2.4.2 User Menu	104
2.5 Cancel key	105
2.6 Onscreen Keyboard key	106
2.7 Touch On/Off Key	107
2.8 Tab key	108
2.9 Local Button	109
2.10 Control Bar	110
2.11 Windows	111
2.12 Undo/Redo	112
2.13 File Functions	116
2.13.1 File Explorer	116
2.14 Help	117
2.15 Status Bar	118
2.16 Block Diagram	126
2.17 View Editor	128
2.17.1 To Create a User View	132
2.17.2 To Resize or Rearrange Windows in a View	137
2.17.3 To Delete a Window from a View	140
2.17.4 To Save a User View	142
2.17.5 To Rename a User View	147
2.17.6 To Delete a User View	147
2.17.7 To Delete All User Views	147
2.17.8 Use Case: Displaying Marker and Peak Tables	147
2.17.9 View Editor Remote Commands	148
2.18 Multiscreen	149
2.18.1 Select Screen	151

2.18.2	Screen List (Remote only command)	152
2.19	Fullscreen	153
3	Bluetooth Mode	154
3.1	Measurement Commands	155
3.2	Transmit Analysis Measurement	156
3.2.1	Views	163
3.2.1.1	Quad	166
3.2.1.2	RF Envelope	166
3.2.1.3	Demod Waveform	166
3.2.1.4	RF Spectrum	166
3.2.1.5	Numeric Results	166
3.2.1.6	Channel Sounding Results	167
3.2.2	Windows	167
3.2.2.1	RF Envelope Graph	167
3.2.2.2	Demod Waveform Graph	167
3.2.2.3	RF Spectrum Graph	168
3.2.2.4	Metric Graph	168
3.2.2.5	Numeric Results Graph	172
3.2.2.6	Channel Sounding Metrics Graph	173
3.2.3	Amplitude	174
3.2.3.1	Y Scale	174
Ref Value		174
Scale/Div		175
Ref Position		176
Auto Scaling		177
3.2.3.2	Attenuation	178
Full Range Atten		180
Mech Atten		181
Elec Atten		183
Adjust Atten for Min Clipping		187
Adjust Atten		187
Pre-Adjust for Min Clipping		188
Mech Atten Step		192
3.2.3.3	Range (Baseband Input models)	193
Range Auto/Man		193
I Range		194
Q Range		196
Q Same as I		197

Table Of Contents

3.2.3.4 Range (Non-attenuator models)	197
Range	198
Adjust Range for Min Clipping	198
Pre-Adjust for Min Clipping	198
Peak-to-Average Ratio	199
Mixer Lvl Offset	200
3.2.3.5 Signal Path	200
Presel Center	201
Preselector Adjust	202
Internal Preamp	203
LNA	205
μ W Path Control	206
Software Preselection	215
SW Preselection Type	217
SW Preselection BW	217
High Freq Prefilter	218
3.2.4 BW	219
3.2.5 Display	219
3.2.5.1 View	220
View	220
User View	220
Restore Layout to Default	221
Save Layout as New View	221
Re-Save User View	221
Rename User View	221
Delete User View	222
Delete All User Views	222
View Editor Remote Commands	222
View Listing Query	223
User View Listing Query	223
3.2.5.2 Annotation	223
Graticule	224
Screen Annotation	224
Trace Annotation	225
Control Annotation	225
Meas Bar	225
Display Enable (Remote Command Only)	226
3.2.6 Frequency	227
3.2.6.1 Settings	227
Channel	227
Center Frequency	229
Span	234
LMH Channel	235
Geography	235
CF Step	236

3.2.7 Marker	237
3.2.7.1 Select Marker	237
3.2.7.2 Settings	238
Marker X-Axis Value	238
Marker Y-Axis Value (Remote Query Only)	238
Marker Mode	238
Delta Marker (Reset Delta)	239
Marker Settings Diagram	239
All Markers Off	239
Couple Markers	240
3.2.7.3 Peak Search	240
Marker X-Axis Value	240
Peak Search	240
Next Peak	241
Next Peak Right	241
Next Peak Left	242
Minimum Peak	242
Pk-Pk Search	242
Marker Delta	243
3.2.7.4 Properties	243
Marker X-Axis Value	243
Relative To	243
Marker Trace	244
Marker Settings Diagram	245
3.2.7.5 Marker Function	245
Marker X-Axis Value	245
Marker Function	245
Band Span	246
Band Left	246
Band Right	246
3.2.8 Meas Setup	247
3.2.8.1 Settings	247
Avg/Hold Num	247
Averaging On/Off	247
Average Type (SCPI Only)	248
Packet Type	248
Configure CS Packet	250
CS SYNC Access Address (32bits)	250
SYNC Sequence Type	250
SYNC Sounding Sequence Marker 1 Position	251
SYNC Sounding Sequence Marker 2 Position	251
SYNC Sounding Sequence Marker Value	252
SYNC Random Sequence Data Pattern	252
SYNC Random Sequence User Payload	252
Tone FFO Actuation Error	253

Table Of Contents

Tone Measurement Mode	253
Tone Time for Phase Measurement	253
Tone Time for Antenna Switch	254
Tone Number of Antenna Paths	254
IF Gain	255
Spur Avoidance	256
Auto Couple	257
Meas Preset	258
3.2.8.2 Radio	259
Radio Standard	259
LE PHY	259
Device	259
3.2.8.3 TX Power	260
Burst Sync	260
Output Power Start Marker	260
Output Power Stop Marker	261
GFSK Start Marker	261
GFSK Stop Marker	262
DPSK Start Marker	262
DPSK Stop Marker	262
3.2.8.4 Limits	263
Limit Test	263
Limits Setup	263
Output Power / Mod Character	263
Average Upper	263
Average Lower	264
Peak Upper	264
Relative Peak Upper	265
Average Output Power Limit Status (Remote Query only)	265
Peak Output Power Limit Status (Remote Query only)	265
$\Delta f1$ Average Upper	266
$\Delta f1$ Average Lower	266
$\Delta f2$ Max Lower	266
$\Delta f2$ Average / $\Delta f1$ Average Lower	267
Modulation Characteristics Limit Status (Remote Query only)	267
Modulation Characteristics $\Delta F1$ Average Limit Status (Remote Query only)	267
Modulation Characteristics $\Delta F2$ Maximum Limit Status (Remote Query only)	268
Modulation Characteristics $\Delta f2$ Average / $\Delta f1$ Average Ratio Limit Status (Remote Query only)	268
Carrier Drift / ICFT	268
DH1 Freq Drift Upper	268
DH1 Freq Drift Lower	269
DH1 Max Drift Rate Upper	269
DH1 Max Drift Rate Lower	269
DH3 Freq Drift Upper	270
DH3 Freq Drift Lower	270
DH3 Max Drift Rate Upper	270
DH3 Max Drift Rate Lower	270

DH5 Freq Drift Upper	271
CH5 Freq Drift Lower	271
CH5 Max Drift Rate Upper	271
DH5 Max Drift Rate Lower	272
LE Reference Freq Drift Upper	272
LE Reference Freq Drift Lower	272
LE Reference Initial Freq Drift Upper	273
LE Reference Initial Freq Drift Lower	273
LE Reference Max Drift Rate Upper	274
LE Reference Max Drift Rate Lower	274
Carrier Drift Limit Status (Remote Query only)	274
Freq Drift Limit Status (Remote Query only)	274
Max Drift Rate Limit Status (Remote Query only)	275
ICFT Upper	275
ICFT Lower	275
ICFT Limit Status (Remote Query only)	276
Relative TX Power	276
Relative Power Upper	276
Relative Power Lower	277
Relative Power Limit Status (Remote Query only)	277
Carrier Freq Stability	277
Initial Frequency Upper	277
Initial Frequency Lower	278
Block Frequency Upper	278
Block Frequency Lower	278
Total Frequency Upper	279
Total Frequency Lower	279
Mod Accuracy	279
RMS DEVM DQPSK Upper	279
RMS DEVM 8DPSK Upper	280
Peak DEVM DQPSK Upper	280
Peak DEVM 8DPSK Upper	280
99% DEVM DQPSK Upper	281
99% DEVM 8DPSK Upper	281
99% DEVM 8PSK Upper	282
99% DEVM QHS-P3 QPSK Upper	282
99% DEVM QHS-P2 QPSK Upper	282
Peak DEVM 8PSK Upper	283
Peak DEVM QHS-P3 QPSK Upper	283
Peak DEVM QHS-P2 QPSK Upper	283
RMS DEVM 8PSK Upper	284
RMS DEVM QHS-P3 QPSK Upper	284
RMS DEVM QHS-P2 QPSK Upper	284
Carrier Freq Stability and Modulation Accuracy Limit Status (Remote Query only)	285
Initial Freq Limit Status (Remote Query only)	285
Block Freq Limit Status (Remote Query only)	285
Total Freq Limit Status (Remote Query only)	286
DEVM Peak Limit Status (Remote Query only)	286
DEVM RMS Limit Status (Remote Query only)	286

Table Of Contents

99% DEVM Limit Status (Remote Query only)	287
3.2.8.5 Advanced	287
I/Q Offset Compensation	287
Hold Result	287
Power Reference Plane	288
3.2.9 Sweep	288
3.2.9.1 Sweep/Control	288
Acquisition Time	289
Sweep/Measure	289
Restart	291
Pause/Resume	293
3.2.9.2 X Scale	294
Ref Value	294
Scale/Division	295
Ref Position	295
Auto Scaling	296
3.2.9.3 Recording	297
3.2.9.4 Playback	298
Playback Mode	299
Playback Start	299
Playback Stop	301
Step Forward	301
Sample Rate	301
3.2.10 Trace	302
3.3 Adjacent Channel Power	303
3.3.1 Views	304
3.3.1.1 RF Envelope View	305
3.3.1.2 RF Spectrum View	305
3.3.2 Windows	305
3.3.3 Amplitude	307
3.3.3.1 Y Scale	307
Ref Value	307
Scale/Div	308
Ref Position	308
Auto Scaling	309
3.3.3.2 Attenuation	310
Full Range Atten	312
Mech Atten	313
Elec Atten	316
Adjust Atten for Min Clipping	319
Adjust Atten	319

Pre-Adjust for Min Clipping	320
Mech Atten Step	324
3.3.3.3 Range (Non-attenuator models)	325
Range	325
Adjust Range for Min Clipping	326
Pre-Adjust for Min Clipping	326
Peak-to-Average Ratio	327
Mixer Lvl Offset	328
3.3.3.4 Signal Path	328
Presel Center	328
Preselector Adjust	330
Internal Preamp	331
LNA	332
μ W Path Control	333
Software Preselection	343
SW Preselection Type	345
SW Preselection BW	345
High Freq Prefilter	346
3.3.4 BW	347
3.3.4.1 Settings	347
Res BW	348
Video BW	348
RBW Filter Type	348
3.3.5 Display	350
3.3.5.1 View	350
Views	350
User View	351
Restore Layout to Default	352
Save Layout as New View	352
Re-Save User View	352
Rename User View	353
Delete User View	353
Delete All User Views	353
View Editor Remote Commands	354
View Listing Query	354
User View Listing Query	354
3.3.5.2 Annotation	355
Graticule	355
Screen Annotation	355
Trace Annotation	356
Control Annotation	356
Meas Bar	356
Display Enable (Remote Command Only)	357
3.3.6 Freq	358
3.3.6.1 Settings	358

Table Of Contents

Channel	358
Center Frequency	360
Span	366
LMH Channel	367
Geography	367
CF Step	368
3.3.7 Marker	369
3.3.7.1 Select Marker	369
3.3.7.2 Settings	370
Marker X-Axis Value	370
Marker Y-Axis Value (Remote Command Only)	370
Marker Mode	371
Delta Marker (Reset Delta)	371
Marker Settings Diagram	371
All Markers Off	371
Couple Markers	372
3.3.7.3 Peak Search	372
Marker X-Axis Value	372
Peak Search	372
Next Peak	373
Next Peak Right	373
Next Peak Left	374
Minimum Peak	374
Pk-Pk Search	375
Marker Delta	376
3.3.7.4 Properties	376
Marker X-Axis Value	376
Relative To	376
Marker Trace	377
Marker Settings Diagram	377
3.3.7.5 Marker Function	378
Marker X-Axis Value	378
Marker Function	378
Band Span	378
Band Left	379
Band Right	379
3.3.8 Meas Setup	379
3.3.8.1 Settings	379
Meas Method	380
IF Gain	380
Spur Avoidance	381
Preset To Standard	382
Auto Couple	382
Meas Preset	384

3.3.8.2 Limits	384
Limit Test	384
Far Limit	385
Near Limit	385
3.3.8.3 Advanced	385
Noise Floor Extension	385
3.3.9 Sweep	386
3.3.9.1 Sweep/Control	386
Sweep Time	387
Acquisition Time	387
Sweep Number	387
Sweep/Measure	388
Restart	389
Pause/Resume	392
3.3.9.2 Sweep Config	392
Points	392
Points Auto State	393
3.3.9.3 X Scale	393
Ref Value	393
Scale/Division	394
Ref Position	394
Auto Scaling	395
3.3.10 Trace	396
3.3.10.1 Trace Control	396
Trace Type	396
Clear and Write Restart Averaging Restart Max/Min Hold	397
3.3.10.2 Detector	397
Detector	397
Detector Select Auto/Man	398
3.4 LE QHS In-band Emissions Measurement	399
3.4.1 Views	400
3.4.1.1 RF Envelope View	401
3.4.1.2 RF Spectrum View	401
3.4.2 Windows	401
3.4.3 Amplitude	403
3.4.3.1 Y Scale	403
Ref Value	403
Scale/Div	404
Ref Position	405
Auto Scaling	405
3.4.3.2 Attenuation	406

Table Of Contents

Full Range Atten	408
Mech Atten	409
Elec Atten	412
Adjust Atten for Min Clipping	415
Adjust Atten	416
Pre-Adjust for Min Clipping	416
Mech Atten Step	420
Max Mixer Level	421
Max Mixer Lvl Rules	422
3.4.3.3 Range (Non-attenuator models)	423
Range	423
Adjust Range for Min Clipping	423
Pre-Adjust for Min Clipping	424
Peak-to-Average Ratio	424
Mixer Lvl Offset	425
3.4.3.4 Signal Path	425
Presel Center	426
Preselector Adjust	427
Internal Preamp	428
LNA	430
μ W Path Control	431
Software Preselection	440
SW Preselection Type	442
SW Preselection BW	442
High Freq Prefilter	443
3.4.4 BW	444
3.4.4.1 Settings	444
Res BW	445
Video BW	445
RBW Filter Type	445
3.4.5 Display	447
3.4.5.1 View	447
Views	447
User View	448
Restore Layout to Default	449
Save Layout as New View	449
Re-Save User View	449
Rename User View	449
Delete User View	450
Delete All User Views	450
View Editor Remote Commands	450
View Listing Query	451
User View Listing Query	451
3.4.5.2 Annotation	451
Graticule	452

Screen Annotation	452
Trace Annotation	453
Control Annotation	453
Meas Bar	453
Display Enable (Remote Command Only)	454
3.4.6 Freq	455
3.4.6.1 Settings	455
Channel	455
Center Frequency	457
Span	463
LMH Channel	464
Geography	464
CF Step	465
3.4.7 Marker	466
3.4.7.1 Select Marker	466
3.4.7.2 Settings	467
Marker X-Axis Value	467
Marker Y (Remote Command Only)	467
Marker Mode	468
Delta Marker (Reset Delta)	468
Marker Settings Diagram	468
All Markers Off	468
Couple Markers	469
3.4.7.3 Peak Search	469
Marker X-Axis Value	469
Peak Search	469
Next Peak	470
Next Peak Right	470
Next Peak Left	471
Minimum Peak	471
Pk-Pk Search	471
Marker Delta	472
3.4.7.4 Properties	472
Marker X-Axis Value	472
Relative To	472
Marker Trace	473
Marker Settings Diagram	474
3.4.7.5 Marker Function	474
Marker X-Axis Value	474
Marker Function	474
Band Span	475
Band Left	475
Band Right	475
3.4.8 Meas Setup	476

Table Of Contents

3.4.8.1 Settings	476
Meas Method	476
IF Gain	476
Spur Avoidance	478
Preset To Standard	478
Auto Couple	479
Meas Preset	480
3.4.8.2 Radio	481
LE PHY	481
Radio Format	481
3.4.8.3 Limits	481
Limit Test	481
Far Limit	482
Freq Offset 2MHz	482
Freq Offset 4/5MHz	483
3.4.8.4 Advanced	483
Noise Floor Extension	483
3.4.9 Sweep	484
3.4.9.1 Sweep/Control	484
Sweep Time	484
Acquisition Time	485
Sweep Number	485
Sweep/Measure	485
Restart	487
Pause/Resume	490
3.4.9.2 Sweep Config	490
Points	490
Points Auto State	490
3.4.9.3 X Scale	491
Ref Value	491
Scale/Division	492
Ref Position	492
Auto Scaling	493
3.4.10 Trace	494
3.4.10.1 Trace Control	494
Trace Type	494
Clear and Write Restart Averaging Restart Max/Min Hold	494
3.4.10.2 Detector	495
Detector	495
Detector Select Auto/Man	496
3.5 EDR In-band Spur Emissions	497
3.5.1 Views	498

3.5.1.1 RF Envelope View	499
3.5.1.2 RF Spectrum View	499
3.5.2 Windows	499
3.5.3 Amplitude	502
3.5.3.1 Y Scale	502
Ref Value	502
Scale/Div	503
Ref Position	503
Auto Scaling	504
3.5.3.2 Attenuation	505
Full Range Atten	507
Mech Atten	508
Elec Atten	511
Adjust Atten for Min Clipping	514
Adjust Atten	515
Pre-Adjust for Min Clipping	515
Mech Atten Step	519
Max Mixer Level	520
Max Mixer Lvl Rules	521
3.5.3.3 Range (Non-attenuator models)	522
Range	522
Adjust Range for Min Clipping	522
Pre-Adjust for Min Clipping	523
Peak-to-Average Ratio	523
Mixer Lvl Offset	524
3.5.3.4 Signal Path	524
Presel Center	525
Preselector Adjust	526
Internal Preamp	527
LNA	529
μ W Path Control	530
Software Preselection	539
SW Preselection Type	541
SW Preselection BW	541
High Freq Prefilter	542
3.5.4 BW	543
3.5.4.1 Settings	543
Res BW	544
Video BW	544
3.5.5 Display	544
3.5.5.1 View	544
Views	545
User View	546

Table Of Contents

Restore Layout to Default	546
Save Layout as New View	547
Re-Save User View	547
Rename User View	547
Delete User View	548
Delete All User Views	548
View Editor Remote Commands	548
View Listing Query	549
User View Listing Query	549
3.5.5.2 Annotation	549
Graticule	549
Screen Annotation	550
Trace Annotation	550
Control Annotation	551
Meas Bar	551
Display Enable (Remote Command Only)	551
3.5.6 Freq	553
3.5.6.1 Settings	553
Channel	553
Center Frequency	555
Span	561
LMH Channel	562
Geography	562
CF Step	563
3.5.7 Marker	564
3.5.7.1 Select Marker	564
3.5.7.2 Settings	564
Marker X-Axis Value	564
Marker Y-Axis Value (Remote Command Only)	565
Marker Mode	565
Delta Marker (Reset Delta)	566
Marker Settings Diagram	566
All Markers Off	566
Couple Markers	566
3.5.7.3 Peak Search	567
Marker X-Axis Value	567
Peak Search	567
Next Peak	568
Next Peak Right	568
Next Peak Left	568
Minimum Peak	569
Pk-Pk Search	569
Marker Delta	570
3.5.7.4 Properties	570
Marker X-Axis Value	570

Relative To	570
Marker Trace	571
Marker Settings Diagram	571
3.5.7.5 Marker Function	572
Marker X-Axis Value	572
Marker Function	572
Band Span	572
Band Left	573
Band Right	573
3.5.8 Meas Setup	573
3.5.8.1 Settings	574
Meas Method	574
Guard Delay	574
IF Gain	574
Spur Avoidance	576
Preset To Standard	576
Auto Couple	577
Meas Preset	578
3.5.8.2 Limits	579
Limit Test	579
Far Limit	579
Near Limit	579
Relative Limit	580
3.5.8.3 Advanced	580
Noise Floor Extension	580
3.5.9 Sweep	581
3.5.9.1 Sweep/Control	581
Sweep Time	581
Acquisition Time	582
Sweep Number	582
Sweep/Measure	582
Restart	584
Pause/Resume	587
3.5.9.2 Sweep Config	587
Points	587
Points Auto State	587
3.5.9.3 X Scale	588
Ref Value	588
Scale/Division	589
Ref Position	589
Auto Scaling	590
3.5.10 Trace	591
3.5.10.1 Trace Control	591

Table Of Contents

Trace Type	591
Clear and Write Restart Averaging Restart Max/Min Hold	591
3.5.10.2 Detector	592
Detector	592
Detector Select Auto/Man	593
3.6 Monitor Spectrum Measurement	594
3.6.1 Views	594
3.6.1.1 Normal	594
3.6.2 Windows	595
3.6.2.1 Spectrum	595
3.6.3 Amplitude	597
3.6.3.1 Y Scale	597
Ref Value	597
Scale/Div	597
Scale Range	598
Ref Position	599
Auto Scaling	599
3.6.3.2 Attenuation	600
Full Range Atten	602
Mech Atten	603
Elec Atten	605
Adjust Atten for Min Clipping	609
Adjust Atten	609
Pre-Adjust for Min Clipping	610
Mech Atten Step	614
3.6.3.3 Range (Non-attenuator models)	615
Range	615
Adjust Range for Min Clipping	616
Pre-Adjust for Min Clipping	616
Peak-to-Average Ratio	617
Mixer Lvl Offset	618
3.6.3.4 Signal Path	618
Presel Center	618
Preselector Adjust	620
Internal Preamp	621
LNA	622
μ W Path Control	623
Software Preselection	633
SW Preselection Type	635
SW Preselection BW	635
High Freq Prefilter	636
3.6.4 BW	637

3.6.4.1 Settings	637
Res BW	638
Video BW	639
VBW:3dB RBW	640
Span:3dB RBW	643
3.6.5 Display	643
3.6.5.1 Meas Display	643
3.6.5.2 View	644
View	644
User View	644
Restore Layout to Default	645
Save Layout as New View	645
Re-Save User View	645
Rename User View	645
Delete User View	646
Delete All User Views	646
View Editor Remote Commands	646
View Listing Query	647
User View Listing Query	647
3.6.5.3 Annotation	647
Graticule	648
Screen Annotation	648
Trace Annotation	649
Control Annotation	649
Meas Bar	649
Display Enable (Remote Command Only)	650
3.6.6 Frequency	651
3.6.6.1 Settings	651
Channel	651
Center Frequency	653
Span	659
LMH Channel	662
Geography	662
CF Step	663
3.6.7 Marker	664
3.6.7.1 Select Marker	664
3.6.7.2 Settings	664
Marker Frequency	665
Marker Mode	666
Delta Marker (Reset Delta)	667
Marker Settings Diagram	667
All Markers Off	667
Couple Markers	667
3.6.7.3 Peak Search	668

Table Of Contents

Marker Frequency	668
Peak Search	668
Next Peak	669
Marker Delta	669
3.6.7.4 Properties	669
Marker Frequency	669
Relative To	670
Marker Trace	670
Marker Settings Diagram	671
3.6.7.5 Marker Function	671
Marker Frequency	672
Marker Function	672
Band Span	672
Band Left	673
Band Right	673
3.6.8 Meas Setup	673
3.6.8.1 Settings	673
Avg Hold Num	674
Averaging On/Off	674
Average Mode	674
Spur Avoidance	675
Meas Setup Summary Table	675
Auto Couple	675
Meas Preset	677
3.6.8.2 Radio	678
Radio Standard	678
LE PHY	678
Device	678
3.6.8.3 Global	679
Global Center Freq	679
Global EMC Std	680
Restore Defaults	680
3.6.9 Sweep	681
3.6.9.1 Sweep/Control	681
Sweep Time	681
Minimum Acquisition Time	683
Sweep/Measure	684
Restart	686
Pause/Resume	688
Abort (Remote Command Only)	689
Sweep Time Annotation (Remote Query Only)	689
3.6.9.2 Sweep Config	690
Points	690
3.6.10 Trace	691

3.6.10.1	Select Trace	692
3.6.10.2	Trace Control	692
	Trace Type	693
	Clear and Write Restart Averaging Restart Max/Min Hold	698
	View/Blank	698
	Trace Settings Table	701
	Clear All Traces	701
3.6.10.3	Detector	701
	Detector	701
	Detector Select Auto/Man	702
3.7	Occupied BW Measurement	704
3.7.1	Views	706
3.7.1.1	OBW Results	707
3.7.1.2	OBW Boundaries	708
3.7.1.3	Gate	708
3.7.2	Windows	708
3.7.2.1	Graph	708
3.7.2.2	Metrics - OBW Results	709
3.7.2.3	Metrics - OBW Boundaries	711
3.7.2.4	Gate	712
3.7.3	Amplitude	713
3.7.3.1	Y Scale	713
	Ref Value	713
	Scale/Div	713
	Scale Range	714
	Ref Position	715
	Auto Scaling	715
3.7.3.2	Attenuation	716
	Full Range Atten	718
	Mech Atten	719
	Elec Atten	721
	Adjust Atten for Min Clipping	725
	Adjust Atten	725
	Pre-Adjust for Min Clipping	726
	Mech Atten Step	730
3.7.3.3	Range (Non-attenuator models)	731
	Range	731
	Adjust Range for Min Clipping	732
	Pre-Adjust for Min Clipping	732
	Peak-to-Average Ratio	733
	Mixer Lvl Offset	734

Table Of Contents

3.7.3.4 Signal Path	734
Presel Center	734
Preselector Adjust	736
Internal Preamp	737
LNA	738
μ W Path Control	739
Software Preselection	749
SW Preselection Type	751
SW Preselection BW	751
High Freq Prefilter	752
3.7.4 BW	753
3.7.4.1 Settings	754
Res BW	754
Video BW	755
RBW Filter Type	756
3.7.5 Display	757
3.7.5.1 Meas Display	757
x dB BW Boundaries On/Off	757
Boundary Frequency	758
3.7.5.2 Annotation	758
Graticule	758
Screen Annotation	759
Trace Annotation	759
Control Annotation	760
Meas Bar	760
Display Enable (Remote Command Only)	760
3.7.5.3 View	762
View	762
User View	762
Restore Layout to Default	763
Save Layout as New View	763
Re-Save User View	763
Rename User View	764
Delete User View	764
Delete All User Views	764
View Editor Remote Commands	765
View Listing Query	765
User View Listing Query	765
3.7.6 Frequency	766
3.7.6.1 Settings	766
Channel	766
Center Frequency	767
Span	773
LMH Channel	774
Geography	775

CF Step	775
Full Span (Remote Command Only)	776
3.7.7 Marker	776
3.7.7.1 Select Marker	776
3.7.7.2 Settings	777
Marker Frequency	777
Marker Mode	778
Delta Marker (Reset Delta)	779
Marker Settings Diagram	780
All Markers Off	780
3.7.7.3 Peak Search	780
Marker Frequency	780
Peak Search	780
Marker Delta	781
3.7.7.4 Properties	781
Marker Frequency	781
Relative To	781
Marker Trace	782
Marker Settings Diagram	783
3.7.8 Meas Setup	783
3.7.8.1 Settings	783
Avg/Hold Num	783
Averaging On/Off	784
Average Mode	784
% of OBW Power	785
Power Ref	785
x dB	785
Power Integration Method	786
Spur Avoidance	786
Meas Setup Summary Table	787
Auto Couple	787
Meas Preset	789
Max Hold (Remote Command Only)	790
3.7.8.2 Limits	790
Limit	790
3.7.8.3 Radio	791
Radio Standard	791
LE PHY	792
Device	792
3.7.8.4 Advanced	792
Noise Floor Extension	793
IF Gain	798
3.7.8.5 Global	798

Table Of Contents

Global Center Freq	799
Global EMC Std	799
Restore Defaults	800
3.7.9 Sweep	800
3.7.9.1 Sweep/Control	800
Sweep Time	801
Minimum Acquisition Time	803
Sweep/Measure	804
Restart	806
Pause/Resume	808
Abort (Remote Command Only)	809
Sweep Time Annotation (Remote Query Only)	809
3.7.9.2 Sweep Config	810
Sweep Time Rules	810
Points	810
IF Dithering	812
Image Protection	812
3.7.10 Trace	813
3.7.10.1 Select Trace	819
3.7.10.2 Trace Control	819
Trace Type	820
Clear and Write Restart Averaging Restart Max/Min Hold	825
View/Blank	825
3.7.10.3 Math	828
Math Function	828
Operand 1 / Operand 2	834
Offset	835
Reference	835
3.7.10.4 Detector	835
Detector	835
Detector Select Auto/Man	837
3.7.10.5 Trace Function	837
From Trace	838
To Trace	838
Copy	838
Exchange	839
Preset All Traces	839
Clear All Traces	839
3.7.10.6 Advanced	840
Measure Trace	840
4 System	841
4.1 System	842

4.1.1 Show System	842
4.1.1.1 Show System contents (Remote Query Only)	843
4.1.1.2 Computer System description (Remote Query Only)	843
4.1.2 Show Hardware	843
4.1.3 Show LXI	843
4.1.4 Show Support Subscriptions	844
4.1.5 Show Support ID	844
4.1.6 Control Panel...	845
4.1.7 Web Browser	846
4.1.8 Application Controls	846
4.1.9 Sounds	846
4.2 I/O Config	848
4.2.1 GPIB	848
4.2.1.1 GPIB Address	848
4.2.1.2 GPIB Controller	848
4.2.2 SCPI LAN	849
4.2.2.1 SCPI Telnet	850
4.2.2.2 SCPI Socket	850
4.2.2.3 SICL Server	851
4.2.2.4 HiSLIP Server	852
4.2.2.5 Verbose SCPI On/Off	852
4.2.2.6 Device Clear on Disconnect	853
4.2.2.7 SCPI Socket Control Port (Remote Query Only)	854
4.2.2.8 SCPI Instrument Port (Remote Query Only)	854
4.2.3 Web Password Reset	854
4.2.4 System IDN Response	855
4.2.4.1 System IDN Response	855
4.2.4.2 User IDN	856
4.2.4.3 SYSTem:PERSONa (Remote Commands Only)	857
SYSTem:PERSONa:DEFault	857
SYSTem:PERSONa:MANufacturer	858
SYSTem:PERSONa:MANufacturer:DEFault	858
SYSTem:PERSONa:MODEl	858
SYSTem:PERSONa:MODEl:DEFault	859
4.2.5 LXI	859

Table Of Contents

4.2.5.1 LAN Reset	859
4.2.5.2 Device Identification (Remote Command Only)	859
4.2.6 Restore I/O Config Defaults	860
4.2.7 Query USB Connection (Remote Query Only)	860
4.2.8 USB Connection Status (Remote Query Only)	860
4.2.9 USB Packet Count (Remote Query Only)	861
4.2.10 Lock Remote I/O Session (Remote Command only)	861
4.2.10.1 Lock Remote I/O Request (Remote Query only)	863
4.2.10.2 Unlock Remote I/O Session (Remote Command only)	864
4.2.10.3 Remote I/O Session Lock Name (Remote Query only)	864
4.2.10.4 Remote I/O Session Lock Owner (Remote Query only)	865
4.2.11 Multiple Network Interface Card Configuration (Remote Commands Only)	865
4.2.11.1 Multiple Network Adapters Enabled (Remote Query Only)	866
4.2.11.2 Config IPV4 Address (Remote Command Only)	866
4.2.11.3 Config IPV6 Address (Remote Command Only)	867
4.2.11.4 List All Physical Network Adapter IP Addresses (Remote Query Only)	867
4.3 Preload / Unload Modes	868
4.3.1 Power-On Mode	868
4.3.2 Table of Modes	869
4.3.3 Preload: Select All, Preload: Deselect All	869
4.3.4 Move Up, Move Down	869
4.3.5 Unload	869
4.3.6 Loaded Modes (Remote Query Only)	870
4.3.7 User Interface	870
4.3.7.1 Menu Panel Position	870
4.3.7.2 Menu Panel Tabs	871
4.3.7.3 Annotations Local Settings/All Off	871
4.3.7.4 Display Theme	871
4.3.7.5 Backlight	872
4.3.7.6 Backlight Intensity	873
4.3.7.7 Hints	873

4.3.7.8	Numeric Entry Auto Open	873
4.3.7.9	Touch On/Off	874
4.3.7.10	Control Size	874
4.3.7.11	Quick Save Mode	874
4.3.7.12	Screen Tabs Left/Right	875
4.3.7.13	Hide Screen Tabs in Full Screen	876
4.3.7.14	2-Screen Orientation	877
4.3.7.15	Clock Format	878
4.3.7.16	Language	879
4.3.7.17	Restore User Interface Defaults	879
4.3.7.18	User Interface Type (Remote Query Only)	880
4.4	Power On	881
4.4.1	Power On State	881
4.4.2	Power On Application	883
4.4.3	FPGA Configuration	883
4.4.3.1	FPGA Load Preference	886
4.4.3.2	Load FPGA	887
4.4.4	Restore Power On Defaults	888
4.4.5	Configure Applications – Desktop application	888
4.4.6	Configure Applications - Instrument boot-up	891
4.4.7	Configure Applications - Remote Commands	891
4.4.7.1	Configuration list (Remote Command Only)	892
4.4.7.2	Configuration Memory Available (Remote Query Only)	892
4.4.7.3	Configuration Memory Total (Remote Query Only)	892
4.4.7.4	Configuration Memory Used (Remote Query Only)	893
4.4.7.5	Configuration Application Memory (Remote Query Only)	893
4.5	Restore Defaults	894
4.5.1	Input/Output	894
4.5.2	I/O Config	895
4.5.3	User Interface	895
4.5.4	Power On	895
4.5.5	Alignments	896
4.5.6	Misc	896

Table Of Contents

4.5.7 All	897
4.6 Alignments	899
4.6.1 Auto Align	899
4.6.1.1 Auto Align	899
4.6.1.2 All but RF	902
4.6.1.3 Alert	902
4.6.2 Align Now	904
4.6.2.1 Align Now All	906
4.6.2.2 Align Now All but RF	908
4.6.2.3 Align Now RF	910
4.6.2.4 Align Now Expired	911
4.6.2.5 Align Now Preselector	912
4.6.2.6 Align Now All but RF Preselector	913
4.6.2.7 Align Now RF Presel Only (20 Hz to 3.6 GHz)	913
4.6.2.8 Align Now External Mixer	914
4.6.2.9 Align Source	915
4.6.2.10 Align Receiver	916
4.6.2.11 Align Fast	916
4.6.2.12 Align LO Leakage	917
4.6.2.13 Align IF Cable	917
4.6.2.14 Align RRH Amplitude	917
4.6.2.15 Align Fast RRH Amplitude	918
4.6.2.16 Align RRH LO Power	918
4.6.2.17 Align LO Clock	918
4.6.2.18 Align VXT Transceiver	919
4.6.2.19 Align up down converter	919
4.6.2.20 Align Selected Freq Ranges	920
Enable Extended Freq Range	921
Frequency Range	921
Enable	923
4.6.2.21 Align External Mixer Path	923
4.6.2.22 Align Low Band	924
4.6.2.23 Align High Band	924
4.6.3 Path Delay Calibration	925

4.6.3.1	Source Path Delay Calibration	925
4.6.3.2	Path Delay Correction On/Off(Remote Command only)	927
4.6.4	Show Alignment Statistics	927
4.6.5	Timebase DAC	939
4.6.5.1	Timebase DAC	939
4.6.5.2	User Value	940
4.6.6	Advanced	941
4.6.6.1	Characterize Preselector	941
4.6.6.2	Characterize Reference Clock	943
4.6.6.3	Characterize Noise Floor	945
4.6.6.4	Calibration Temperature History	947
4.6.6.5	TDS Alignment	948
4.6.6.6	Backup or Restore Align Data...	949
Alignment Data Wizard (without Flash)		950
Perform Backup (without Flash) (Remote Command Only)		959
Perform Restore (without Flash) (Remote Command Only)		959
Alignment Data Wizard (with Flash)		960
Perform Backup (with Flash) (Remote Command Only)		965
Perform Restore (With Flash) (Remote Command Only)		965
Restore Alignment Defaults		965
4.6.6.7	oGRF Preselector	966
Align Now, 20 Hz to 30 MHz		966
Align Now, 30 MHz to 3.6 GHz		967
Align Now, 20 Hz to 3.6 GHz		968
Alert		969
4.6.6.8	Scheduler	970
Schedule Setup		970
Task		970
Date/Time		971
Hour		972
Minute		972
Recurrence		972
Number of Weeks		972
Day		973
4.7	Licensing	974
4.7.1	License Manager	974
4.7.2	System Software Version Date	974
4.7.3	Software Support Expiration Date	975
4.7.4	Network Licenses	975

Table Of Contents

4.7.4.1	Application Licenses	976
4.7.4.2	Instrument Software Options	976
4.7.4.3	License Checked Out Query (Remote Query Only)	976
4.7.4.4	List Licenses Checked Out (Remote Query Only)	977
4.7.4.5	Borrowed Network Licenses	977
4.7.4.6	Borrow a License	978
4.7.4.7	Listing Borrowed Licenses and Return a Borrowed License	979
	List Borrowed Licenses (Remote Query Only)	979
	Return a Borrowed License (Remote Command Only)	980
4.7.4.8	Enabling Network Checkouts While Borrowed	980
4.7.5	USB Portable Licenses	981
4.7.6	Configuring Network and USB Portable Licenses	981
4.7.7	Floating License Manager	981
4.7.8	Install License (Remote Command Only)	982
4.7.9	Remove License (Remote Command Only)	982
4.7.10	List Licenses (Remote Query Only)	983
4.7.11	Validate License (Remote Query Only)	984
4.7.12	Host ID Query (Remote Query Only)	984
4.8	Security	985
4.8.1	USB Write Protect	985
4.8.2	Restore Security Defaults	985
4.9	Diagnostics	986
4.9.1	Show Hardware Statistics	986
4.9.2	Pathwave Calibration Advisor...	986
4.9.3	Query the Mechanical Relay Cycle Count (Remote Query Only)	986
4.9.4	Query the Operating Temperature Extremes (Remote Query Only)	987
4.9.5	Query the Elapsed Time since 1st power on (Remote Query Only)	987
4.10	Service	988
4.11	System Remote Commands (Remote Commands Only)	989
4.11.1	List installed Options (Remote Query Only)	989
4.11.2	Lock the Front-panel keys (Remote Command Only)	990
4.11.3	Lock Workstation (Remote Command Only)	990
4.11.4	List SCPI Commands (Remote Query Only)	992

4.11.5 Front Panel activity history (Remote Query only)	992
4.11.6 SCPI activity history (Remote Query only)	993
4.11.7 Instrument start time (Remote Query only)	993
4.11.8 SCPI Version Query (Remote Query Only)	994
4.11.9 Date (Remote Command Only)	994
4.11.10 Time (Remote Command Only)	994
4.11.11 Input Overload Enable (Remote Command Only)	995
4.11.12 Power Up (Remote Query Only)	995
5 Preset	996
5.1 Preset Dropdown	999
5.2 Mode Preset	1000
5.3 Restore Mode Defaults	1002
5.4 Input/Output Preset	1003
5.5 Full Mode Preset	1004
5.6 User Preset	1005
5.7 Save User Preset	1007
5.8 User Preset All Modes	1008
5.9 Restore Defaults All Modes	1009
5.10 User Preset All Screens	1010
5.11 Save User Preset All Screens	1011
5.12 Restore Screen Defaults	1012
5.13 Preset Type (Remote Command Only)	1013
5.14 Restart Instrument (Shutdown)	1014
5.15 Restart Application (Application Shutdown)	1015
5.16 System Log Off (Remote Command Only)	1016
5.17 Power Standby (Instrument Shutdown)	1017
6 Input/Output	1018
6.1 RF Source	1019
6.1.1 RF Output	1019
6.1.2 RF Output Port	1019
6.1.3 Half Duplex Output Port	1021
6.1.4 RF Power	1022
6.1.5 T/R Port High Power Attenuator	1022

Table Of Contents

6.1.6 Amplitude Setup	1022
6.1.6.1 RF Power	1022
6.1.6.2 Set Reference Power	1026
6.1.6.3 Power Ref	1027
6.1.6.4 Power Unit	1027
6.1.6.5 Amptd Offset	1028
6.1.6.6 Amplitude Increment	1029
6.1.7 Frequency	1029
6.1.8 List Sequencer	1029
6.1.8.1 Sequencer	1030
6.1.8.2 Initiate Sequence	1030
6.1.8.3 Repetition	1031
6.1.8.4 Trig Out Type	1031
6.1.8.5 Select Data Marker	1031
6.1.8.6 Manual Trigger Now	1032
6.1.8.7 List Sequencer Setup	1032
Number of Steps	1032
Go To Step	1032
Insert Step Before	1033
Delete Step	1033
Clear List	1033
Step Trigger	1033
Transition Time	1034
Band	1035
Device	1039
Freq/Chan	1040
Power	1041
Waveform	1041
Waveform File	1042
Step Duration	1042
Duration Time	1043
Play Count	1044
Trig Out	1045
Step Configuration (Remote Command Only)	1045
Step Configuration of Step Trigger parameter list (Remote Command Only)	1047
Step Configuration of Transition Time parameter list (Remote Command Only)	1048
Step Configuration of Radio Band parameter list (Remote Command Only)	1048
Step Configuration of Radio Band Link parameter list (Remote Command Only)	1049
Step Configuration of Frequency/Channel Number parameter list (Remote Command Only)	1050
Step Configuration of Power parameter list (Remote Command Only)	1050

Step Configuration of Waveform parameter list (Remote Command Only)	1051
Step Configuration of Step Duration parameter list (Remote Command Only)	1052
Step Configuration of Duration Time or Play Count parameter list (Remote Command Only)	1052
Step Configuration of Output Trigger parameter list (Remote Command Only)	1053
Clear List (Remote Command Only)	1053
6.1.8.8 Remote Software Trigger (Remote command Only)	1054
6.1.8.9 Query List Sequence Initiation Armed Status (Remote Query Only)	1054
6.1.9 Frequency Setup	1054
6.1.9.1 Frequency	1054
6.1.9.2 Channel	1057
6.1.9.3 Radio Setup	1061
Radio Standard/Radio Band	1062
Radio Band Link	1066
6.1.9.4 Set Reference Frequency	1066
6.1.9.5 Freq Reference	1067
6.1.9.6 Freq Offset	1068
6.1.9.7 Freq Increment	1069
6.1.9.8 Rx/Tx Coupling	1070
6.1.9.9 Rx/Tx Offset	1071
6.1.10 Modulation	1071
6.1.11 Modulation Setup	1072
6.1.11.1 AM	1072
6.1.11.2 AM Mod Depth	1072
6.1.11.3 AM Rate	1072
6.1.11.4 AM Rate Increment	1073
6.1.11.5 FM	1073
6.1.11.6 FM Deviation	1074
6.1.11.7 FM Rate	1074
6.1.11.8 FM Rate Increment	1074
6.1.11.9 PM	1075
6.1.11.10 PM Deviation	1075
6.1.11.11 PM Rate	1075
6.1.11.12 PM Rate Increment	1076
6.1.11.13 ARB Setup	1076

Table Of Contents

Basic Control	1076
ARB State	1076
Sample Rate	1077
Run-Time Scaling	1081
Baseband Freq Offs	1081
Baseband Power	1082
Mkr 1-4 Polarity	1082
Pulse/RF Blank	1082
ALC Hold	1083
Trigger Type	1084
Continuous trigger	1084
Single trigger	1085
Segment Advance trigger	1086
Trigger Source	1086
Bus Trigger Command (Remote Command Only)	1087
Sync to Trigger Source	1087
External Trigger Delay	1088
External Trigger Polarity	1090
Select PXI Line	1091
PXI Trigger Delay	1091
PXI Trigger Polarity	1092
I/Q Adjustments	1092
I/Q Gain	1093
I/Q Delay	1093
RMS	1094
RMS Calculation Mode	1094
Calculate	1095
Use Header RMS	1095
Real-Time 5G NR Compensation	1096
SCS	1097
Filter	1097
Filter Bandwidth	1097
Select Waveform	1098
Segments in ARB Memory	1099
Recall Waveform	1099
Delete Segment From ARB Mem	1099
Delete All From ARB Memory	1099
Query ARB Memory File List (Remote Query Only)	1099
Query ARB Memory Full File List (Remote Query Only)	1100
Waveform Sequences	1100
Build New Sequence	1100
Segment	1101
Waveform	1101
Repetitions	1101
Marker 1 – Marker 4	1101
Sync Seq File	1101
Insert Waveform	1102
Segments in ARB Memory	1102
Delete Segment From ARB Mem	1103

Delete All From ARB Memory	1103
Delete Segment	1103
Save Sequence	1103
Build New Sequence (Remote Command Only)	1103
Edit Selected Sequence	1106
Segment	1106
Waveform	1106
Repetitions	1106
Marker 1 – Marker 4	1106
Sync Seq File	1107
Insert Waveform	1107
Segments in ARB Memory	1108
Delete Segment From ARB Mem	1108
Delete All From ARB Memory	1108
Delete Segment	1108
Waveform Utilities	1108
Add Waveform	1108
Replace Selected Waveform	1109
Clear Waveform from Slot	1110
Lock Waveform in Slot	1110
Slot Status Query (Remote Command Only)	1111
Slots Free Query (Remote Query Only)	1111
Slots Used Query (Remote Query Only)	1111
Slot Waveform Name Query (Remote Command Only)	1112
Slot Waveform Unique ID Query (Remote Command Only)	1112
Locked Waveform Name List Query (Remote Query Only)	1113
Locked Waveform Unique ID List Query (Remote Query Only)	1113
Multi-Pack License multi-module control state (Remote Command Only)	1113
Header Utilities	1114
Clear Header	1114
Save Header	1114
Query Waveform Unique ID (Remote Query Only)	1114
Query Selected Waveform Header info (Remote Query Only)	1115
6.1.12 Trigger Initiate	1116
6.1.13 Source Sync	1116
6.1.13.1 Sync Config	1116
6.1.13.2 Sync Type	1117
6.1.13.3 Sync Settings	1118
Secondary Module List	1118
Sync Settings	1119
Sync Segment 2	1120
Segment 2 Frequency	1120
IP Address	1121
SCPI Socket Port	1121
Add Secondary Module	1121
Delete Secondary Module	1121
Sync Runtime Settings (Remote Command Only)	1122

Table Of Contents

6.1.13.4 Sync Start	1122
6.1.13.5 Sync Stop	1122
6.1.13.6 Sync Connected (Remote Query Only)	1123
6.1.14 Source Preset	1123
6.2 Input	1124
6.2.1 Select Input	1124
6.2.2 RF Input Port	1133
6.2.3 SA Frequency Extender Firmware Update (Front Panel Only)	1143
6.2.4 SA Frequency Extender Cable Correction	1144
6.2.5 Half Duplex Input Port	1144
6.2.6 Port Information (Remote Command Only)	1145
6.2.7 RF Preselector	1145
6.2.8 Notch Filter	1147
6.2.9 RF Calibrator	1147
6.2.10 RF Coupling	1148
6.2.11 Input Z Correction	1150
6.2.12 All Screens Use Same Input	1151
6.2.13 External Mixer Setup	1151
6.2.13.1 Mixer Presets	1155
6.2.13.2 Mixer Bias	1160
6.2.13.3 Table Type	1161
6.2.13.4 Select VDI CCD Correction	1162
6.2.13.5 Delete All VDI CCD Corrections	1163
6.2.13.6 Harmonic	1163
6.2.13.7 LO Doubler	1164
6.2.13.8 Refresh USB Mixer Connection	1164
6.2.14 Mixer Path	1165
6.2.15 User IF Freq	1166
6.2.16 Signal ID On/Off	1166
6.2.17 Signal ID Mode	1167
6.2.18 Cable IF Loss	1168
6.2.19 I/Q Path	1169
6.2.20 Reference Z	1171

6.2.21 I/Q Setup	1171
6.2.21.1 I Setup	1171
Differential	1171
Input Z	1172
Skew	1173
Combined Differential/Input Z (Remote Command Only)	1174
6.2.21.2 I Probe	1174
Attenuation	1175
Offset	1176
Coupling	1176
Clear Calibration	1177
6.2.21.3 Calibrate	1177
I/Q Isolation Calibration	1178
I/Q Isolation Calibration Time (Remote Query Only)	1179
I Port	1179
I Port Probe Calibration Time (Remote Query Only)	1179
I-bar Port	1180
I-bar Port Probe Calibration Time (Remote Query Only)	1180
6.2.21.4 Q Setup	1180
Q Same as I	1180
Differential	1181
Input Z	1182
Skew	1183
6.2.21.5 Q Probe	1183
Attenuation	1183
Offset	1184
Coupling	1184
Clear Calibration	1185
6.2.21.6 Calibrate	1185
Q Port	1186
Q Port Probe Calibration Time (Remote Query Only)	1186
Q-bar Port	1186
Q-bar Port Probe Calibration Time (Remote Query Only)	1187
6.2.22 I/Q Cable Calibrate	1187
6.2.22.1 I Port	1188
6.2.22.2 I-bar Port	1188
6.2.22.3 Q Port	1189
6.2.22.4 Q-bar Port	1189
6.2.22.5 I/Q Cable Calibration Time (Remote Query Only)	1190
6.2.23 Audio Input Channel	1190
6.2.24 Audio Calibrator	1190

Table Of Contents

6.2.25 Audio Coupling	1190
6.2.26 Audio Input Ground	1191
6.2.27 Audio In Impedance	1191
6.2.28 Input/Output Preset	1191
6.3 External Gain	1193
6.3.1 External Preamp	1193
6.3.2 External Gain - MS	1195
6.3.3 External Gain - BTS	1196
6.3.4 I Ext Gain	1197
6.3.5 Q Ext Gain	1198
6.3.6 Q Gain in I+jQ	1198
6.4 Data Source	1199
6.4.1 Data Source	1209
6.4.2 Current Meas -> Capture Buffer	1210
6.5 Corrections	1211
6.5.1 Select Correction	1212
6.5.2 Correction On/Off	1213
6.5.3 Correction Port	1213
6.5.4 Correction Direction	1215
6.5.5 Edit Correction	1216
6.5.5.1 Select Correction	1217
6.5.5.2 Frequency	1217
6.5.5.3 Amplitude	1218
6.5.5.4 Go to Row	1218
6.5.5.5 Insert Row Below	1218
6.5.5.6 Delete Row	1218
6.5.5.7 Scale X Axis	1218
6.5.5.8 Delete Correction	1219
6.5.5.9 Correction Graph	1219
6.5.6 Edit Correction Settings	1220
6.5.6.1 Select Correction	1220
6.5.6.2 Freq Interpolation	1220
6.5.6.3 Transducer Unit	1222

6.5.6.4 Description	1223
6.5.6.5 Comment	1223
6.5.7 Complex Corrections	1224
6.5.7.1 Go To Row (Select Correction)	1225
6.5.7.2 Delete Row	1225
6.5.7.3 Delete All	1225
6.5.7.4 Correction On	1226
6.5.7.5 Correction Port	1226
6.5.7.6 Direction	1227
6.5.7.7 Description	1228
6.5.7.8 Comment	1228
6.5.7.9 File	1229
6.5.7.10 Freq Interpolation (Remote Command Only)	1229
6.5.7.11 Set Data (Remote Command Only)	1230
6.5.8 Apply Corrections	1230
6.5.9 Delete All Corrections	1231
6.5.10 Correction Group On/Off	1232
6.5.11 Break	1232
6.5.12 Reload Corrections From Files	1235
6.5.13 Edit Correction Group	1235
6.5.13.1 Go to Row	1235
6.5.13.2 Insert Row Below	1235
6.5.13.3 Delete Row	1236
6.5.13.4 Select File	1236
6.5.13.5 Specify File	1236
6.5.13.6 Remove File	1236
6.5.13.7 Correction Trace Display	1236
6.5.13.8 Description	1237
6.5.13.9 Comment	1237
6.5.13.10 Start Frequency	1237
6.5.13.11 Stop Frequency	1238
6.5.14 Merge Correction Data (Remote Command Only)	1238
6.5.15 Set (Replace) Data (Remote Command Only)	1239

Table Of Contents

6.5.16 Correction Group Range Data (Remote Command Only)	1239
6.5.17 Delete Correction Group Range (Remote Command Only)	1240
6.6 Freq Ref Input	1241
6.6.1 Freq Ref Input	1241
6.6.2 Ext Ref Freq	1246
6.6.3 Default External Ref Freq	1247
6.6.4 LO Ref Input	1247
6.6.5 Ref Lock BW	1248
6.6.6 Reference Oscillator On/Off (Remote Command Only)	1249
6.6.6.1 Select Ref	1249
6.6.6.2 Freq Ref In	1250
6.6.6.3 External Freq Ref	1250
6.6.6.4 Ext Ref Locked (Remote Query Only)	1250
6.7 Output	1252
6.7.1 Analog Out	1252
6.7.2 Screen Video Level	1256
6.7.3 Digital Bus Out	1257
6.7.4 Wideband Digital Bus	1257
6.7.5 Data Stream	1260
6.7.6 I/Q Cal Out	1260
6.7.7 Aux IF Out	1261
6.7.8 Arbitrary IF Freq	1263
6.7.9 Ext/Wide IF Out	1263
6.7.10 IF2 Out	1264
6.7.11 REF Out	1265
6.7.12 LO Ref Out	1265
6.8 Trigger Output	1267
6.8.1 Trig 1 – 4 Out	1267
6.8.2 Trig 1 – 4 Out Polarity	1269
6.8.3 Trig 1 – 4 Out Device	1270
6.8.4 Src PXI Trig Out	1270
6.8.5 Src Trig Out Polarity	1271
6.8.6 Select Src PXI Line	1271

6.8.7 Analyzer PXI Trig Out	1272
6.8.8 Analyzer Trig Out Polarity	1273
6.8.9 Select Analyzer PXI Line	1273
6.8.10 Source Internal Trig Out	1273
6.8.11 Source Internal Trig Out Polarity	1274
6.9 Calibration	1276
6.9.1 Configuration	1276
6.9.1.1 Cal Group	1278
6.9.1.2 Calibrate Checked Rows	1278
6.9.1.3 Apply Cal Group	1279
6.9.1.4 Abort Calibration	1279
6.9.1.5 Copy From Cal Group	1280
6.9.1.6 Copy	1280
6.9.1.7 Cal Input	1281
6.9.1.8 Freq Offset	1281
6.9.1.9 Select Calibrator	1282
6.9.1.10 Identify RCal Module	1282
6.9.1.11 RCal Module Serial Number (Remote Query Only)	1282
6.9.1.12 RCal Reference	1282
6.9.1.13 RCal Status	1283
RCal Status (Remote Query Only)	1284
All RCal Status (Remote Query Only)	1284
6.9.1.14 Go to Row	1284
6.9.1.15 Insert Row Below	1285
6.9.1.16 Description	1285
6.9.1.17 Use Current Meas	1285
6.9.1.18 Duplicate Row	1286
6.9.1.19 Delete Row	1286
6.9.1.20 Delete All	1286
6.9.1.21 Calibrate	1286
6.9.1.22 Apply	1287
6.9.1.23 Name	1287
6.9.1.24 Last Cal	1288
6.9.1.25 Cal Applied	1288

Table Of Contents

6.9.1.26	Cal Type	1289
6.9.1.27	Start Freq	1289
6.9.1.28	Stop Freq	1290
6.9.1.29	Freq Step	1291
6.9.1.30	Freq Points	1291
6.9.1.31	Mech Atten Type	1292
6.9.1.32	Mech Atten Start	1292
6.9.1.33	Mech Atten Stop	1293
6.9.1.34	Mech Atten Step	1294
6.9.1.35	Elec Atten Type	1294
6.9.1.36	Elec Atten Start	1294
6.9.1.37	Elec Atten Stop	1295
6.9.1.38	Elec Atten Step	1296
6.9.1.39	Full Range Atten Type	1296
6.9.1.40	Full Range Atten Start	1297
6.9.1.41	Full Range Atten Stop	1297
6.9.1.42	Frequency Extender Attenuation Type	1298
6.9.1.43	Frequency Extender Attenuation Start	1299
6.9.1.44	Frequency Extender Attenuation Stop	1299
6.9.1.45	Frequency Extender Atten Step	1300
6.9.1.46	IF Path	1300
6.9.1.47	IF Gain	1301
6.9.1.48	Preamp	1302
6.9.1.49	Low Noise Amplifier (LNA)	1302
6.9.1.50	μ W Path Control	1303
6.9.1.51	Coupling	1303
6.9.1.52	Phase Noise Optimization	1304
6.9.1.53	Phase Noise Optimization All Option	1309
6.9.1.54	Mixing Mode	1310
6.9.1.55	Match State	1310
6.9.2	Cal Group	1311
6.9.3	Apply Cal Group	1311
6.9.4	All Apply Cal Group Off	1311

6.9.5 Connection	1312
6.10 Calibrator Control	1313
6.10.1 Select Cal Source	1313
6.10.2 Cal Output	1313
6.10.3 Cal Frequency	1314
6.10.4 Cal Signal Type	1314
6.10.5 Cal Comb Spacing	1314
6.10.6 Calibrator Reference	1315
6.11 Advanced	1316
6.11.1 T/R Port High Power Attenuator	1316
6.12 Aux I/O Control	1318
6.12.1 Data 0 – Data 7	1318
6.12.2 Aux IO Control (Remote Command Only)	1318
7 Save/Recall/Print	1319
7.1 Quick Save	1320
7.2 Recall	1323
7.2.1 Recall From File / Open	1324
7.2.2 State	1325
7.2.2.1 Recall Type	1326
7.2.2.2 Register 1 thru Register 16	1327
7.2.2.3 Edit Register Names	1328
7.2.3 Trace+State	1328
7.2.3.1 Recall To Trace	1329
7.2.3.2 Register 1 thru Register 16	1329
7.2.3.3 Edit Register Names	1330
7.2.4 Screen Config + State	1330
7.2.5 Measurement Data	1331
7.2.5.1 Data Type	1331
Trace	1331
7.2.6 Limit	1332
7.2.6.1 Select Limit	1333
7.2.7 Correction	1333
7.2.7.1 Select Correction	1334

Table Of Contents

7.2.8 Complex Correction	1334
7.2.8.1 Select Complex Correction	1335
7.2.9 Recall VDI CCD Correction	1335
7.2.10 Mask	1335
7.2.11 Sequence	1336
7.2.12 Waveform	1336
7.2.12.1 Load Segment to ARB Memory	1338
7.2.12.2 Delete Segment From ARB Mem	1339
7.2.12.3 Delete All From ARB Memory	1339
7.2.12.4 Set Default Directory (Remote Command Only)	1340
7.2.12.5 Query ARB Memory File List (Remote Query Only)	1340
7.2.12.6 Query ARB Memory Full File List (Remote Query Only)	1341
7.2.13 Power Sensor Cal Factor	1341
7.2.14 Recording	1342
7.2.14.1 Data Type	1343
7.2.14.2 Channel	1343
7.2.14.3 Reset	1343
7.2.14.4 Recalled data channel table (Display only)	1344
7.2.15 Loss Comp	1344
7.3 Save	1346
7.3.1 Save to File / Save As	1347
7.3.2 State	1349
7.3.2.1 Register 1 thru Register 16	1350
7.3.2.2 Edit Register Names	1350
7.3.3 Trace+State	1351
7.3.3.1 Save From Trace	1353
7.3.3.2 Register 1 thru Register 16	1354
7.3.3.3 Edit Register Names	1354
7.3.4 Screen Config + State	1355
7.3.5 Measurement Data	1355
7.3.5.1 Save From	1356
7.3.5.2 Data Type	1356
Meas Results	1357

7.3.6 Limit	1358
7.3.6.1 Select Limit	1362
7.3.7 Correction	1362
7.3.7.1 Select Correction	1366
7.3.8 Mask	1366
7.3.9 Waveform Sequence	1366
7.3.10 Screen Image	1366
7.3.10.1 Theme	1368
7.3.11 Power Sensor Cal Factor	1369
7.3.12 Recording	1369
7.3.12.1 Data Type	1370
7.3.12.2 Channel	1371
7.3.13 Remote Only Commands	1371
7.3.13.1 Mass Storage Catalog (Remote Command Only)	1372
7.3.13.2 Mass Storage Change Directory (Remote Command Only)	1372
7.3.13.3 Mass Storage Copy (Remote Command Only)	1372
7.3.13.4 Mass Storage Device Copy (Remote Command Only)	1373
7.3.13.5 Mass Storage Delete (Remote Command Only)	1373
7.3.13.6 Mass Storage Data (Remote Command Only)	1373
7.3.13.7 Mass Storage Make Directory (Remote Command Only)	1374
7.3.13.8 Mass Storage Move (Remote Command Only)	1374
7.3.13.9 Mass Storage Remove Directory (Remote Command Only)	1374
7.3.13.10 Mass Storage Determine Removable Media (Remote Query Only)	1375
7.3.13.11 Mass Storage Determine Removable Media Label (Remote Command Only)	1375
7.3.13.12 Mass Storage Determine Removable Media Write-protect status (Remote Query Only)	1375
7.3.13.13 Mass Storage Determine Removable Media size (Remote Query Only)	1376
7.3.13.14 :SYSTem:SET (Remote Command Only)	1376
7.4 Print	1377
7.5 Page Setup	1378
8 Trigger	1380

Table Of Contents

8.1 Trigger	1381
8.1.1 Select Trig Source	1381
8.1.1.1 Free Run	1394
8.1.1.2 Video/ADC	1394
8.1.1.3 ADC Trigger	1395
8.1.1.4 Line	1396
8.1.1.5 External 1	1396
8.1.1.6 External 2	1397
8.1.1.7 External 3	1398
8.1.1.8 Audio External	1399
8.1.1.9 RF Burst	1399
8.1.1.10 Periodic	1400
8.1.1.11 I/Q Mag	1402
8.1.1.12 Input I	1402
8.1.1.13 Input Q	1403
8.1.1.14 I (Demodulated)	1403
8.1.1.15 Q (Demodulated)	1404
8.1.1.16 Aux I/Q Mag	1404
8.1.1.17 PXI	1405
8.1.1.18 Internal	1405
8.1.1.19 Prot Channel Detection	1406
8.1.1.20 Prot Frame Aligned	1406
8.1.1.21 Prot Event	1407
8.1.2 Trigger Level	1407
8.1.3 Trigger Delay	1409
8.1.4 Trigger Slope	1413
8.1.5 Trigger Level Absolute/Relative	1414
8.1.6 Absolute Trigger Level	1415
8.1.7 Relative Trigger Level	1415
8.1.8 Period	1417
8.1.9 Offset	1418
8.1.10 Reset Offset Display	1419
8.1.11 Offset Adjust (Remote Command Only)	1419

8.1.12 Sync Source	1420
8.1.13 TV Line	1420
8.1.14 Field	1421
8.1.15 Standard	1422
8.1.16 Trigger Center Frequency	1423
8.1.17 Trigger BW	1423
8.1.18 Zero Span Delay Compensation On/Off	1424
8.1.19 Select PXI Line	1424
8.1.20 Reset Sync Monitor	1425
8.1.21 Trigger Optimization	1426
8.1.22 Trigger Settings Diagram	1427
8.2 Gate Source	1428
8.2.1 Select Gate Source	1428
8.2.2 Sync Holdoff	1429
8.3 Gate Settings	1431
8.3.1 Gate On/Off	1431
8.3.2 Gate View On/Off	1432
8.3.3 Gate Delay	1434
8.3.4 Gate Length	1435
8.3.5 Gate Method	1436
8.3.6 Control Edge/Level	1437
8.3.7 Gate Holdoff	1438
8.3.8 Gate View Sweep Time	1439
8.3.9 Gate View Start Time	1440
8.3.10 Gate Delay Compensation	1441
8.3.11 Min Fast Position Query (Remote Query Only)	1442
8.3.12 Gate Preset (Remote Command Only)	1443
8.3.13 Gate Level (Remote Command Only)	1443
8.3.14 Gate Polarity (Remote Command Only)	1443
8.4 Enables the hardware accelerated stepped FFT gating feature (Display only)	1445
8.5 Periodic Sync Src	1446
8.5.1 Select Periodic Timer Sync Source	1446

Table Of Contents

8.6 Auto/Holdoff	1447
8.6.1 Trig Holdoff	1447
8.6.2 Auto Trig	1447
8.6.3 Holdoff Type	1448
9 Programming the Instrument	1450
9.1 List of Supported SCPI Commands	1451
*	1451
A	1451
C	1451
D	1459
F	1460
H	1461
I	1461
L	1462
M	1462
O	1463
R	1463
S	1464
T	1477
9.2 IEEE 488.2 Common Commands	1479
9.2.1 *CAL? - Calibration Query	1479
9.2.2 *CLS - Clear Status	1480
9.2.3 *ESE - Standard Event Status Enable	1480
9.2.4 *ESR? - Standard Event Status Register Query	1481
9.2.5 *IDN? - Identification Query	1481
9.2.6 *OPC? - Operation Complete	1482
9.2.7 *OPT? - Query Instrument Options	1483
9.2.8 *RCL - Recall Instrument State	1483
9.2.9 *RST - Reset	1483
9.2.10 *SAV - Save Instrument State	1484
9.2.11 *SRE - Service Request Enable	1484
9.2.12 *STB? - Status Byte Query	1485
9.2.13 *TRG - Trigger	1485

9.2.14 *TST? - Self Test Query	1485
9.2.15 *WAI - Wait-to-Continue	1486
9.3 SCPI Operation and Results Query	1487
9.3.1 Mode Control	1487
9.3.2 Measurement Control	1487
9.3.2.1 CONFigure	1488
9.3.2.2 INITiate	1489
9.3.2.3 FETCh	1489
9.3.2.4 READ	1490
9.3.2.5 MEASure	1491
9.3.3 Trace Formatting Commands	1492
9.3.3.1 Clear Trace (Remote Command Only)	1492
9.3.3.2 Send/Query Trace Data (Remote Command Only)	1493
9.3.3.3 Format Data: Numeric Data (Remote Command Only)	1495
9.3.3.4 Format Data: Byte Order (Remote Command Only)	1496
9.3.3.5 Calculate/Compress Trace Data Query (Remote Command Only)	1496
9.3.3.6 Calculate Peaks of Trace Data (Remote Command Only)	1502
9.3.3.7 Smooth Trace Data (Remote Command Only)	1504
9.3.3.8 Number of Points for Smoothing (Remote Command Only)	1505
9.3.3.9 Mean Trace Data (Remote Command Only)	1506
9.4 Status Register System & STATus Subsystem	1507
9.4.1 Status Register System Diagram	1507
9.4.2 Status Register Hierarchy	1509
9.4.3 Status Register SCPI Commands	1511
9.4.4 How to Use Status Registers	1512
9.4.4.1 Polling Method	1512
Monitoring Options	1513
9.4.4.2 Service Request (SRQ) Method	1513
Using the Service Request (SRQ) Method	1513
9.4.5 Status Register Bit Parameters	1515
9.4.6 Status Subsystem Registers and Commands	1516
9.4.6.1 Status Byte Register	1516
Service Request Enable Register	1519

Table Of Contents

Preset the Status Byte	1519
9.4.6.2 Standard Event Status Register	1520
Standard Event Status Enable Register	1521
9.4.6.3 Operation Register	1522
Operation Condition Query	1523
Operation Enable	1524
Operation Event Query	1524
Operation Negative Transition	1525
Operation Positive Transition	1525
9.4.6.4 Operation Instrument Register	1526
Operation Instrument Condition	1526
Operation Instrument Enable	1527
Operation Instrument Event Query	1527
Operation Instrument Negative Transition	1528
Operation Instrument Positive Transition	1528
9.4.6.5 Questionable Register	1529
Questionable Condition	1530
Questionable Enable	1530
Questionable Event Query	1531
Questionable Negative Transition	1531
Questionable Positive Transition	1531
9.4.6.6 Questionable Power Register	1532
Questionable Power Condition	1533
Questionable Power Enable	1533
Questionable Power Event Query	1534
Questionable Power Negative Transition	1534
Questionable Power Positive Transition	1534
9.4.6.7 Questionable Temperature Register	1535
Questionable Temperature Condition	1536
Questionable Temperature Enable	1536
Questionable Temperature Event Query	1537
Questionable Temperature Negative Transition	1537
Questionable Temperature Positive Transition	1537
9.4.6.8 Questionable Frequency Register	1538
Questionable Frequency Condition	1539
Questionable Frequency Enable	1539
Questionable Frequency Event Query	1540
Questionable Frequency Negative Transition	1540
Questionable Frequency Positive Transition	1541
9.4.6.9 Questionable Calibration Register	1541
Questionable Calibration Condition	1542
Questionable Calibration Enable	1543
Questionable Calibration Event Query	1543
Questionable Calibration Negative Transition	1544
Questionable Calibration Positive Transition	1544

9.4.6.10	Questionable Calibration Extended Needed Register	1545
	Questionable Calibration Extended Needed Condition	1546
	Questionable Calibration Extended Needed Enable	1546
	Questionable Calibration Extended Needed Event Query	1547
	Questionable Calibration Extended Needed Negative Transition	1547
	Questionable Calibration Extended Needed Positive Transition	1547
9.4.6.11	Questionable Calibration Extended Failure Register	1548
	Questionable Calibration Extended Failure Condition	1549
	Questionable Calibration Extended Failure Enable	1549
	Questionable Calibration Extended Failure Event Query	1550
	Questionable Calibration Extended Failure Negative Transition	1550
	Questionable Calibration Extended Failure Positive Transition	1551
9.4.6.12	Questionable Calibration Skipped Register	1551
	Questionable Calibration Skipped Condition	1552
	Questionable Calibration Skipped Enable	1553
	Questionable Calibration Skipped Event Query	1553
	Questionable Calibration Skipped Negative Transition	1553
	Questionable Calibration Skipped Positive Transition	1554
9.4.6.13	Questionable Integrity Register	1554
	Questionable Integrity Condition	1556
	Questionable Integrity Enable	1556
	Questionable Integrity Event Query	1557
	Questionable Integrity Negative Transition	1557
	Questionable Integrity Positive Transition	1557
9.4.6.14	Questionable Integrity Signal Register	1558
	Questionable Integrity Signal Condition	1559
	Questionable Integrity Signal Enable	1559
	Questionable Integrity Signal Event Query	1560
	Questionable Integrity Signal Negative Transition	1560
	Questionable Integrity Signal Positive Transition	1561
9.4.6.15	Questionable Integrity Output Register	1561
	Questionable Integrity Output Condition	1562
	Questionable Integrity Output Enable	1562
	Questionable Integrity Output Event Query	1563
	Questionable Integrity Output Negative Transition	1563
	Questionable Integrity Output Positive Transition	1564
9.4.6.16	Questionable Integrity Uncalibrated Register	1564
	Questionable Integrity Uncalibrated Condition	1565
	Questionable Integrity Uncalibrated Enable	1566
	Questionable Integrity Uncalibrated Event Query	1566
	Questionable Integrity Uncalibrated Negative Transition	1566
	Questionable Integrity Uncalibrated Positive Transition	1567
	10 Hardware-Accelerated Fast Power Measurement (Remote Command Only)	1568

Table Of Contents

10.1	Reset Fast Power Measurement (Remote Command Only)	1569
10.2	Reset Fast Power Measurement (Remote Command Only)	1570
10.2.1	Acquisition Time	1570
10.2.2	Center Frequency	1570
10.2.3	DC Coupled	1570
10.2.4	Detector Type	1570
10.2.5	Do Noise Correction	1571
10.2.6	Do Spur Suppression	1571
10.2.7	Electronic Attenuator Bypass	1572
10.2.8	Electronic Attenuation	1572
10.2.9	External Reference Frequency	1572
10.2.10	Frequency Reference Source	1572
10.2.11	IF Gain	1573
10.2.12	IF Type	1573
10.2.13	Include Power Spectrum	1573
10.2.14	Mechanical Attenuation	1573
10.2.15	Preamplifier Mode	1574
10.2.16	Resolution Bandwidth Mode	1574
10.2.17	Resolution Bandwidth	1574
10.2.18	Trigger Delay	1574
10.2.19	Trigger Level	1575
10.2.20	Trigger Slope	1575
10.2.21	Trigger Source	1575
10.2.22	Trigger Timeout	1575
10.2.23	Signal Input	1575
10.2.24	Use Preselector	1576
10.2.25	Channel Bandwidth Array	1576
10.2.26	Channel Filter Type Array	1576
10.2.27	Channel Filter Alpha Array	1576
10.2.28	Channel Measurement Function Array	1577
10.2.29	Channel Offset Frequency Array	1577
10.2.30	Channel Occupied Bandwidth Percent Array	1578
10.2.31	Channel x-dB Bandwidth Array	1578

10.3 Define Fast Power Measurement Query (Remote Command Only)	1579
10.4 Configure Fast Power Measurement (Remote Command Only)	1580
10.5 Initiate Fast Power Measurement (Remote Command Only)	1581
10.6 Fetch Fast Power Measurement (Remote Command Only)	1582
10.7 Execute Fast Power Measurement (Remote Command Only)	1583
10.8 Binary Read Fast Power Measurement (Remote Command Only)	1584
10.9 Diagnostic Binary Read Fast Power Measurement (Remote Command Only)	1585

1 Documentation Roadmap

This section describes the Keysight products covered by this document, and provides links to related documentation.

- ["Products Covered by this Document" on page 57](#)
- ["Additional Documentation" on page 58](#)

- 1 Documentation Roadmap
- 1.1 Products Covered by this Document

1.1 Products Covered by this Document

For the full list of instrument models covered by this documentation, see the title page: ["Bluetooth Mode User's & Programmer's Reference" on page 1](#).

1.2 Additional Documentation

If your instrument or computer has an internet connection, then you can access the latest editions of all relevant X-Series documentation via the links below.

This document is available in 3 formats:

- **Embedded Help**, in the instrument
- **Online Help**, at Keysight's web site

For information on this Mode, browse to:

<http://rfmw.em.keysight.com/wireless/helpfiles/BLUETOOTHMode/FlexUI.htm>

- **Users & Programmers Reference**, in downloadable PDF format

For information on this Mode, download from:

<http://literature.cdn.keysight.com/litweb/pdf/N9081-90004.pdf>

The following documents are available online at keysight.com:

[X-Series Messages Guide](#)

The following documents are in downloadable PDF format:

Getting Started Guides, Instrument Messages & Security

- [N90x0B Getting Started & Troubleshooting Guide](#)
- [N9041B Getting Started & Troubleshooting Guide](#)
- [X-Series Status Register System Diagram](#)
- [Security Features & Statement of Volatility](#)

Specifications Guides

- [N9000B CXA Specifications Guide](#)
- [N9010B EXA Specifications Guide](#)
- [N9020B MXA Specifications Guide](#)
- [N9030B PXA Specifications Guide](#)
- [N9040B UXA Specifications Guide](#)

- 1 Documentation Roadmap
- 1.2 Additional Documentation

- [N9041B UXA Specifications Guide](#)

Measurement Guides

- [Spectrum Analyzer Mode Measurement Guide](#)
- [Real-Time Spectrum Analyzer Measurement Guide](#)
- [Noise Figure Measurement Guide](#)
- [Analog Demod Measurement Application Measurement Guide](#)
- [Phase Noise Measurement Application Measurement Guide](#)
- [EMI Measurement Application Measurement Guide](#)
- [M9484C VXG Signal Generator and X-Series Signal Analyzers Measurement Guide](#)

Service Guides

- [N9010B EXA Service Guide](#)
- [N9020B MXA Service Guide](#)
- [N9030B PXA Service Guide](#)
- [N9040B UXA Service Guide](#)

2 User Interface

Here are the basic elements of the Multitouch User Interface. For more information, tap a topic.

Included in this section are also topics for several front panel keys not described in other topics. Tap one of these topics for more information.



"Cancel key" on
page 105



"Onscreen Keyboard key" on
page 106



"Touch On/Off Key" on
page 107



"Tab key" on
page 108

2.1 Screen Tabs

In the X-Series Multitouch User Interface (or Multitouch UI), you can run many different Measurement Applications, or “Modes”. Examples are Spectrum Analyzer Mode, LTE-A FDD Mode, IQ Analyzer Mode, and Real Time Spectrum Analyzer Mode. Each Mode has its own set of controls, windows and SCPI commands.

Each Mode runs within a “Screen”. The Multitouch UI supports multiple “Screens” (see ["Multiscreen" on page 149](#) for more information). Each screen displays one Measurement in one Mode. The set of configured screens is shown across the top of the display as a set of Screen Tabs, with a + tab at the right for adding new Screens:



You can see up to six tabs at a time on the UXA, and 4 at a time on the CXA, EXA, MXA and PXA. If there are more Screens configured than this, arrows appear to the left and right of the Screen Tabs; pressing the arrows scrolls the Screen Tabs to the left or right. A scroll bar also appears at the bottom of the Screen Tabs, indicating that you can scroll the tabs by dragging them with your finger; you can also scroll them by dragging the scroll bar.

Pressing a Screen Tab selects that screen for operation. Pressing the blue (selected) Screen Tab is the same as pressing the Mode/Meas front panel key.



Both actions open the ["Mode/Meas/View Dialog" on page 62](#). In addition, if you have a PC keyboard plugged in, the sequence CTL-SHIFT-M will open up this dialog.

The + tab at the right of the Screen Tabs bar adds a new Screen by cloning the current screen. The new Screen has the identical setup and settings as the current Screen. You can then change the Mode, Measurement and/or settings of the new Screen.

You can define up to 16 screens at once.

Example Multiscreen View

The example below shows a four-screen display in Multiscreen view.

The Screen called “Real-Time SA 2” is selected, as indicated by its blue tab. Touching any other screen or tab selects the screen for that tab and brings it to the foreground.

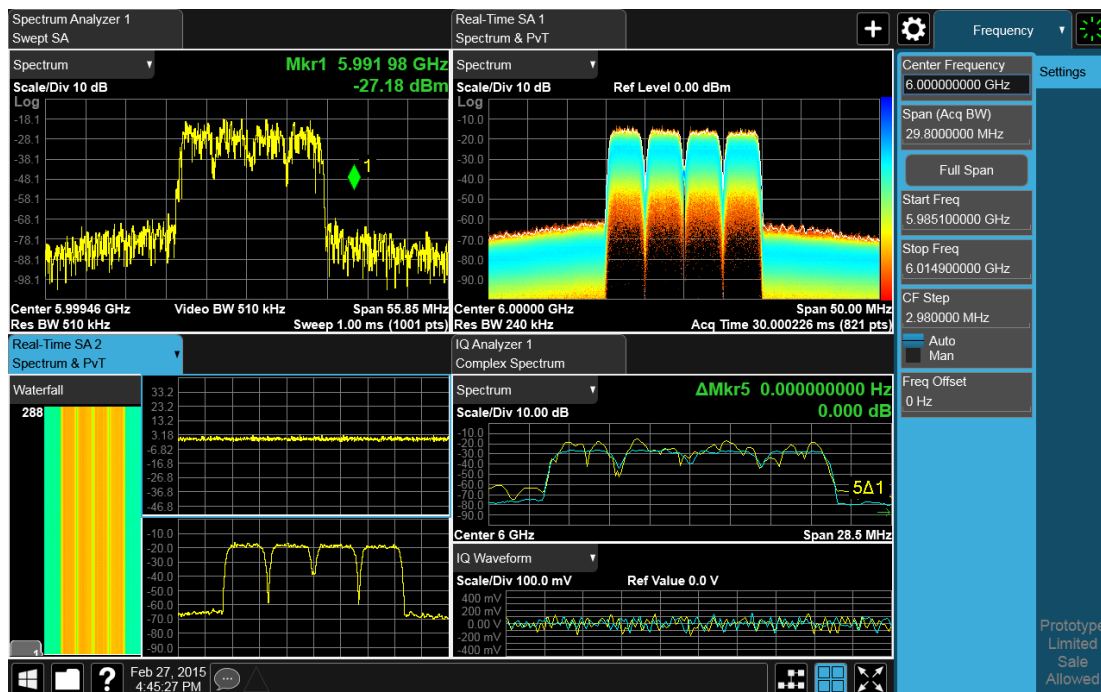

The following topics provide more information:

- "Mode/Meas/View Dialog" on page 62
- "Add Screen" on page 79
- "Multiscreen" on page 149

2.1.1 Mode/Meas/View Dialog

The Mode/Meas/View dialog opens when you press the selected (blue) Screen tab (see "Screen Tabs" on page 61) or the **Mode/Meas** front panel key.

This dialog displays lists of available Modes, Measurements and Views, as well as the "Sequencer" on page 73 control for configuring Screens.

2 User Interface

2.1 Screen Tabs

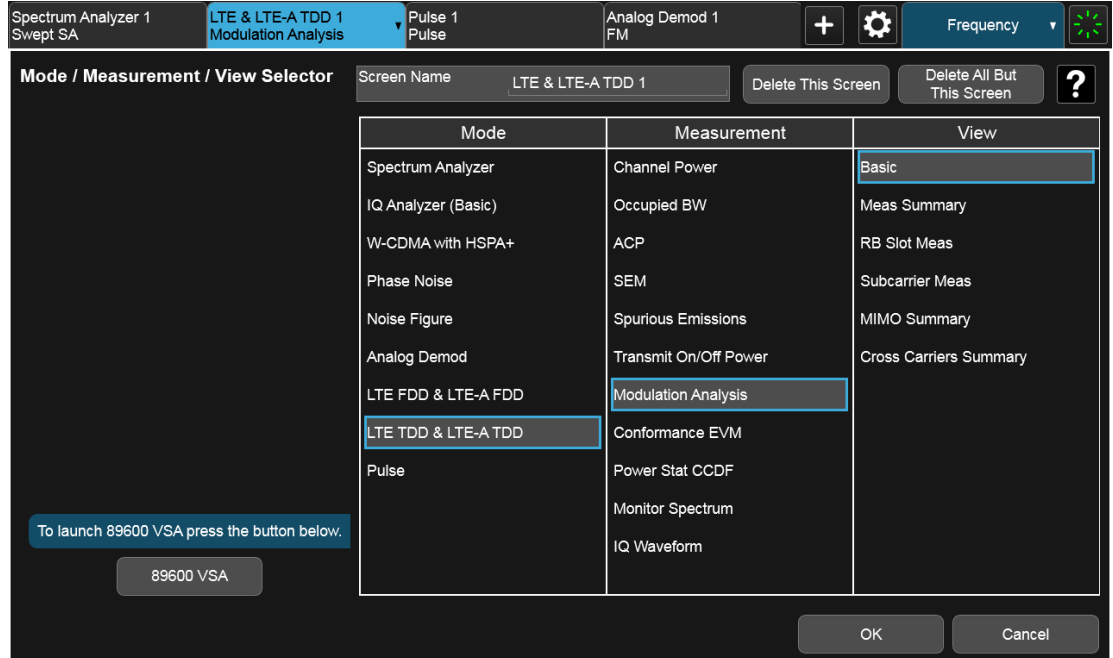

2.1.1.1 Mode

The first column in the Mode/Meas/View dialog allows you to select the desired Mode from those currently licensed in your instrument.

Modes, also known as “measurement applications”, are collections of measurement capabilities packaged together to provide you with an instrument personality specific to your measurement needs. Each Mode is ordered separately by Model Number and must be licensed in order for it to be available in the instrument.

You select the Mode you want to run using the Mode/Meas/View dialog. Once a Mode is selected, only the commands that are valid for that mode can be executed

For more information on Modes, preloading Modes, and memory requirements for Modes, see ["More Information" on page 66](#)

The `:INSTRument[:SElect]` command is used to remotely select a Mode by sending the instrument a parameter which represents the name of the desired Mode. The Mode Names may be found in the table under ["Index to Modes" on page 65](#).

The `:INSTRument:NSElect` command is used to remotely select a Mode by sending the Mode Number of the desired Mode. See ["Instrument Number Select" on page 64](#). The Mode Numbers may be found in the table under ["Index to Modes" on page 65](#).

The `:INSTRument:CONFigure` command causes a Mode and Measurement switch at the same time. This generally results in faster overall switching than sending the

`:INSTRument:SElect` and `CONFigure` commands separately. See "Mode and Measurement Select" on page 64.

Remote Command	<code>:INSTRument[:SElect] <mode_id></code> where <code><mode_id></code> is one of the values listed in "Index to Modes" on page 65 below <code>:INSTRument[:SElect]?</code>
Example	<code>:INST SA</code>
Notes	A list of the valid mode choices is returned by the <code>:INST:CAT?</code> query
Preset	The default Mode is set to <code>SA</code> on Restore System Defaults->All , unless noted below: For N8973B, N8974B, N8975B, or N8976B: <code>NFIG</code>
State Saved	Saved in instrument state
Annunciation	Application Title is in the Screen Tab

Instrument Number Select

Remote Command	<code>:INSTRument:NSElect <integer></code> <code>:INSTRument:NSElect?</code>
Example	<code>:INST:NSEL 1</code>
Notes	The Mode Numbers may be found in the table under "Index to Modes" on page 65 SA mode is number 1 The command is sequential: that is, continued parsing of commands cannot proceed until the instrument select is complete and the resultant SCPI trees are available
Preset	The default Mode is set to <code>1</code> by Restore System Defaults->All , unless noted in the table above
State Saved	Saved in instrument state

Mode and Measurement Select

Remote Command	<code>:INSTRument:CONFigure:<mode_id>:<meas></code> where <code><mode_id></code> is a valid parameter for the <code>:INST:SEL</code> command and <code><meas></code> is a valid parameter for the <code>:CONF</code> command in the Mode specified by <code><mode></code>
Example	<code>:INST:CONF:SA:SAN</code> selects the Spectrum Analyzer mode and the Swept SA measurement <code>:INST:CONF:WCDMA:RHO</code> selects the WCDMA mode and the Mod Accuracy measurement
Notes	The available parameters for <code><mode_id></code> are dependent upon installed and licensed applications resident in the instrument. The available parameters for <code><meas></code> are dependent on the <code><mode_id></code> parameter and the valid measurements available for that mode, which can depend on model numbers and installed options In general this command will execute more quickly than sending the equivalent separate <code>:INST:SEL</code>

and `:CONF` commands

Index to Modes

The Mode Number in the table below is the parameter for use with the `:INSTrument:NSElect` command. The Mode Parameter is the parameter for use with the `:INSTrument[:SElect]` command. Your actual choices will depend upon which applications are installed in your instrument.

Mode	Mode Number	Mode Parameter <mode_id>
5G NR	109	NR5G
89601 VSA	101	VSA89601
Analog Demod	234	ADEM0D
Avionics	232	AVIONIC
Bluetooth	228	BT00th
Channel Quality / Group Delay	161	CQM
EMI Receiver	141	EMI
GSM/EDGE/EDGE Evo	13	EDGE GSM
I/Q Analyzer (Basic)	8	BASIC
LTE FDD & LTE-A FDD	107	LTEAFDD
LTE TDD & LTE-A TDD	108	LTEATDD
Measuring Receiver	233	MRECEIVE
MSR	106	MSR
Noise Figure	219	NFIGure
Phase Noise	14	PNOISE
Power Amplifier	81	PA
Pulse	151	PULSEX
Radio Test	300	RTS
Real Time Spectrum Analyzer	2	RTSA
Remote Language Compatibility	266	RLC
SCPI Language Compatibility	270	SCPILC
Sequence Analyzer	123	SEQAN
Short Range Comms	218	SRCOMMS
Spectrum Analyzer	1	SA
Vector Modulation Analyzer	200	VMA
WCDMA with HSPA+	9	WCDMA
WLAN	217	WLAN

More Information

The Mode name appears on the Screen Tab, followed by a number identifying which instance of the Mode appears on that screen. Each Screen contains one Mode. For example, in the image below, there is one Real-Time Spectrum Analyzer screen, and two Spectrum Analyzer screens. The current Screen contains **Real-Time SA 1**.

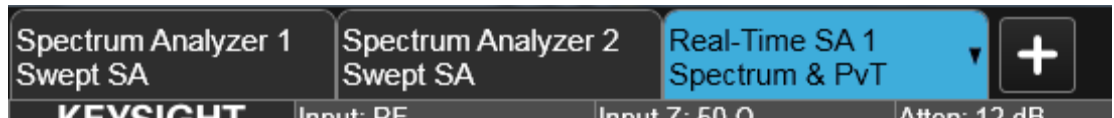

It is possible to specify the order in which the Modes appear in the Mode menu, using the **Configure Applications** utility on the Desktop. Using the same utility, it is also possible to specify a subset of the available applications to load into memory at startup time, which can decrease the startup time of the instrument and the amount of memory consumed.

Each application (Mode) that runs in an X-Series instrument consumes virtual memory. The various applications consume varying amounts of virtual memory, and as more applications run, the memory consumption increases. Keysight characterizes each Mode and assigns a memory usage quantity based on a conservative estimate. The **Configure Applications** utility shows an estimate for how much memory each Mode will consume.

You can still run a Mode even if it is not preloaded into memory – during runtime, the first time an application that is not loaded into memory is selected (either by pressing that application's **Mode** key or by sending that application's **:INST:SEL** command), the Application will be loaded, but this takes a few seconds. The instrument will pause while loading the application while displaying a message box that says “Loading application, please wait...” Preloading the application eliminates this wait time *but* consumes additional memory.

2.1.1.2 Application Mode Remote Commands

This section contains a number of remote commands that are provided for programming convenience and remote compatibility.

Application Mode Catalog Query (Remote Command Only)

Returns a string containing a comma-separated list of names of all the installed and licensed measurement modes (applications). These names can only be used with **:INSTrument[:SElect]**.

Remote Command **:INSTrument:CATalog?**

Example	<code>:INST:CAT?</code>
Notes	Query returns a quoted string of the installed and licensed modes separated with a comma. Example: <code>"SA,PNOISE,WCDMA"</code>
Backwards Compatibility Notes	VSA (E4406A): <code>:INSTrument:CATalog?</code> returned a list of installed <code>INSTrument:SELECT</code> items as a comma separated list of string values, for example: <code>"BASIC", "GSM", "EDGE GSM", "CDMA", "SERVICE"</code> X-Series uses the ESA/PSA compatible query of a string contain comma separated values: <code>"SA,PNOISE,NFIG,BASIC"</code>

Current Application Model (Remote Command Only)

Returns a string that is the Model Number of the currently selected application (mode). This information is also displayed in the **Show System** screen.

Remote Command	<code>:SYSTem:APPLication[:CURRent][:NAME]?</code>
Example	<code>:SYST:APPL?</code>
Notes	Query returns a quoted string that is the Model Number of the currently selected application (Mode). Example: <code>"N9060A"</code> String length between 6 to 9 characters.
Preset	Not affected by Preset
State Saved	Not saved in state, the value will be the selected application when a Save is done.

Current Application Revision (Remote Command Only)

Returns a string that is the Revision of the currently selected application (mode). This information is also displayed in the Show System screen

Remote Command	<code>:SYSTem:APPLication[:CURREnt]:REVIision?</code>
Example	<code>:SYST:APPL:REV?</code>
Notes	Query returns a quoted string that is the Revision of the currently selected application (Mode). Example: <code>"1.0.0.0"</code> String length is a maximum of 23 characters. (each numeral can be an integer + 3 decimal points) The format is Major.Minor.Build.Compile, where Major must correspond to the Integer portion of the Version in the license file for the application.
Preset	Not affected by a Preset
State Saved	Not saved in state, the value will be the selected application when a Save is done.

Current Application Options (Remote Command Only)

Returns a string that is the Options list of the currently selected application (Mode). This information is also displayed in the Show System screen

Remote Command	<code>:SYSTem:APPLication[:CURRent]:OPTion?</code>
Example	<code>:SYST:APPL:OPT?</code>
Notes	Query returns a quoted string that is the Option list of the currently selected application (Mode). The format is the name as the *OPT? or SYSTem:OPTion command: a comma separated list of option identifiers. Example: "1FP,2FP" String length is a maximum of 255 characters.
Preset	Not affected by a Preset
State Saved	Not saved in state per se, the value will be the selected application when a Save is invoked.

Application Catalog Number of Entries (Remote Command Only)

Returns the number of installed and licensed applications (Modes).

Remote Command	<code>:SYSTem:APPLication:CATalog[:NAME]:COUNT?</code>
Example	<code>:SYST:APPL:CAT:COUN?</code>
Preset	Not affected by Preset
State Saved	Not saved in instrument state.

Application Catalog Model Numbers (Remote Command Only)

Returns a list of Model Numbers for the installed and licensed applications (Modes).

Remote Command	<code>:SYSTem:APPLication:CATalog[:NAME]?</code>
Example	<code>:SYST:APPL:CAT?</code>
Notes	Returned value is a quoted string of a comma separated list of Model Numbers. Example, if SAMS and Phase Noise are installed and licensed: "N9060A,N9068A" String length varies based on licenses. Licenses are between 6 and 9 characters. So the string length will be between $COUNT * 7 - 1$ and $COUNT * 10 - 1$. (7 & 10 = Model Number length + 1 for comma. -1 = no comma for the 1st entry.)
Preset	Not affected by a Preset
State Saved	Not saved in instrument state.

Application Catalog Revision (Remote Command Only)

Returns the Revision of the provided Model Number.

Remote Command	<code>:SYSTem:APPLication:CATalog:REVision? <model></code>
Example	<code>:SYST:APPL:CAT:REV? 'N9060A'</code>
Notes	Returned value is a quoted string of revision for the provided Model Number. The revision will be a null-string ("") if the provided Model Number is not installed, licensed, and loaded. Example, if SAMS is installed and licensed: "1.0.0.0" String length is a maximum of 23 characters. (each numeral can be an integer + 3 decimal points)
Preset	Not affected by a Preset.
State Saved	Not saved in instrument state.

Application Catalog Options (Remote Command Only)

Returns a list of Options for the provided Model Number

Remote Command	<code>:SYSTem:APPLication:CATalog:OPTion? <model></code>
Example	<code>:SYST:APPL:CAT:OPT? 'N9060A'</code>
Notes	Returned value is a quoted string of a comma separated list of Options, in the same format as *OPT? or :SYSTem:OPTion?. If the provided Model Number is not installed and licensed a null-string ("") will be returned. Example, if SAMS is installed and licensed: "2FP" String length is a maximum of 255 characters.
Preset	Not affected by a Preset
State Saved	Not saved in instrument state.

ESA SA compatibility command (Remote Command only)

Provided for backwards compatibility with ESA. When this command is received, the analyzer aliases it to the appropriate Mode.

Remote Command	<code>:INSTrument[:SElect] 'SA' 'PNOISE' 'EDGE' 'GSM' 'BASIC'</code>
Example	<code>:INST 'SA'</code>
Notes	The query is not a quoted string. It is an enumeration as indicated in the Instrument Select table above

GSM Mode compatibility command (Remote Command only)

Provided for backwards compatibility. When this command is received, the analyzer aliases it to the following:

```
:INST:SEL EDGEGSM
```

Remote Command	:INSTrument[:SElect] GSM
----------------	--------------------------

Example	:INST GSM
---------	-----------

SA compatibility command for EMC (Remote Command only)

Provided for ESU compatibility. When this command is received, the analyzer aliases it to the following:

```
:INST:SEL SCPI LC
```

This results in the analyzer being placed in SCPI Language Compatibility Mode, in order to emulate the ESU Spectrum Analyzer Mode.

Remote Command	:INSTrument[:SElect] SANalyzer
----------------	--------------------------------

Example	:INST SAN
---------	-----------

Receiver compatibility command for EMC (Remote Command only)

Provided for ESU compatibility. When this command is received, the instrument aliases it to the following:

```
:INST:SEL EMI
```

```
:CONF FSC
```

This results in the instrument being placed in the EMI Receiver Mode, running the Frequency Scan measurement, in order to emulate the ESU Receiver Mode.

Remote Command	:INSTrument[:SElect] REceiver
----------------	-------------------------------

Example	:INST REC
---------	-----------

APD compatibility command for EMC (Remote Command only)

Provided for ESU compatibility. When this command is received, the analyzer aliases it to the following:

```
:INST:SEL EMI
```

```
:CONF APD
```

2 User Interface
2.1 Screen Tabs

This results in the analyzer being placed in the EMI Receiver Mode, running the APD measurement, in order to emulate the ESU APD Mode.

Remote Command	<code>:INSTrument[:SElect] APDistribution</code>
----------------	--

Example	<code>:INST APD</code>
---------	------------------------

IF Mode compatibility command for EMC (Remote Command only)

Provided for ESU compatibility. When this command is received, the analyzer aliases it to the following:

`:INST:SEL EMI`

`:CONF MON`

This results in the analyzer being placed in the EMI Receiver Mode, running the Monitor Spectrum measurement, in order to emulate the ESU IF Mode.

Remote Command	<code>:INSTrument[:SElect] IFANalyzer</code>
----------------	--

Example	<code>:INST IFAN</code>
---------	-------------------------

2.1.1.3 Measurement

The Measurement column of the Mode/Meas/View dialog shows all the Measurements available for the Mode which is selected in the first column. Select a Measurement in the second column and the View column will show all the Views available for that measurement. Once you have the Mode, Measurement and View selected, press OK to change the current Screen to that Mode, Measurement and View.

2.1.1.4 View

A View is a collection of Result Windows. The View column of the "Mode/Meas/View Dialog" on page 62 shows all the Views available for the Measurement which is selected in the second column. Once you have the Mode, Measurement and View selected, press OK to change the current Screen to that Mode, Measurement and View.

The View may also be set by using the View tab on the Display menu. The View tab is the last tab on the Display menu for every measurement. The Views are the same as those listed in the "Mode/Meas/View Dialog" on page 62.

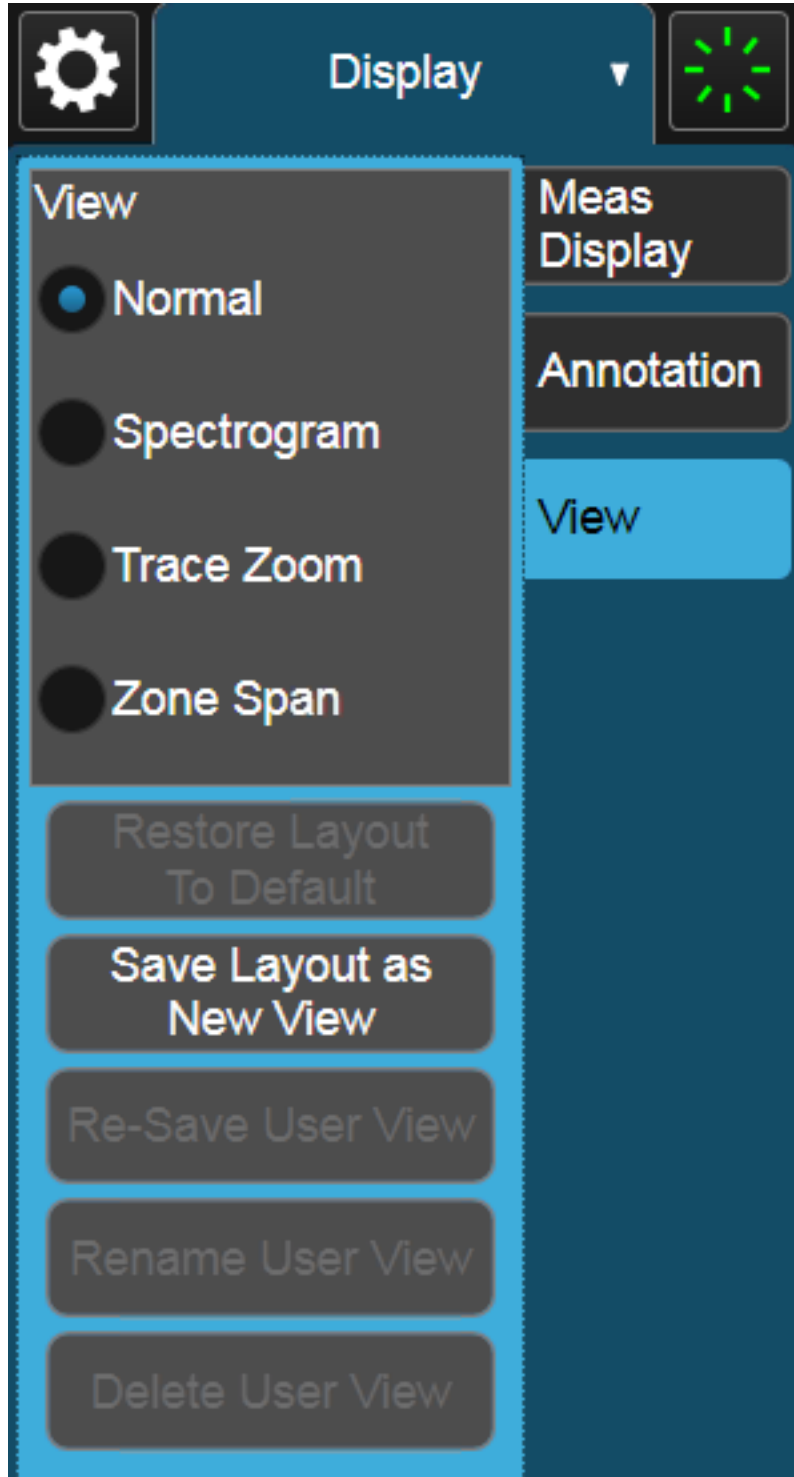

2.1.1.5 Sequencer

Allows multiple Screens to update sequentially while in "Multiscreen" on page 149 display mode. Each Screen updates in sequence, and when all have updated, the sequence will start again.

To start the Sequencer, you must have more than one Screen defined, and you must have Multiscreen selected (see "Screen Tabs" on page 61).

If you want each Screen to use a different input, you must turn off **All Screens Use Same Input** under **Input/Output**, **Input**.

CAUTION Differences in hardware settings between the Screens may cause switches and/or attenuators to cycle as you go from one Screen to another. This could potentially reduce the life of these components. To avoid this, make sure **Attenuation**, **µW Path Control** and other switch settings are the same in each Screen.

NOTE When the Sequencer is running, the destination of remote commands is unpredictable, so you should stop the Sequencer before sending any measurement-related commands. Once the Sequencer has stopped, select a specific Screen using `:INSTrument:SCReen:SElect`, before sending any further commands. See "Select Screen" on page 151

NOTE When the Sequencer is running, Auto alignment is temporarily disabled. A pending auto alignment might be executed when the sequencer is stopped.

See "More Information" on page 73

Remote Command	<code>:SYSTem:SEQuencer ON OFF 1 0</code> <code>:SYSTem:SEQuencer?</code>
Example	<code>:SYST:SEQ ON</code>
Notes	If the display is disabled (via <code>:DISP:ENAB OFF</code>) then the error message "-221, Settings conflict; Screen SCPI cannot be used when Display is disabled" is generated
Dependencies	To start the Sequencer, you must have more than one Screen defined and you must have Multiscreen selected
Preset	<code>OFF</code>

More Information

To start the Sequencer, tap the current (blue) Screen tab to go into the Mode/Meas/View Dialog:

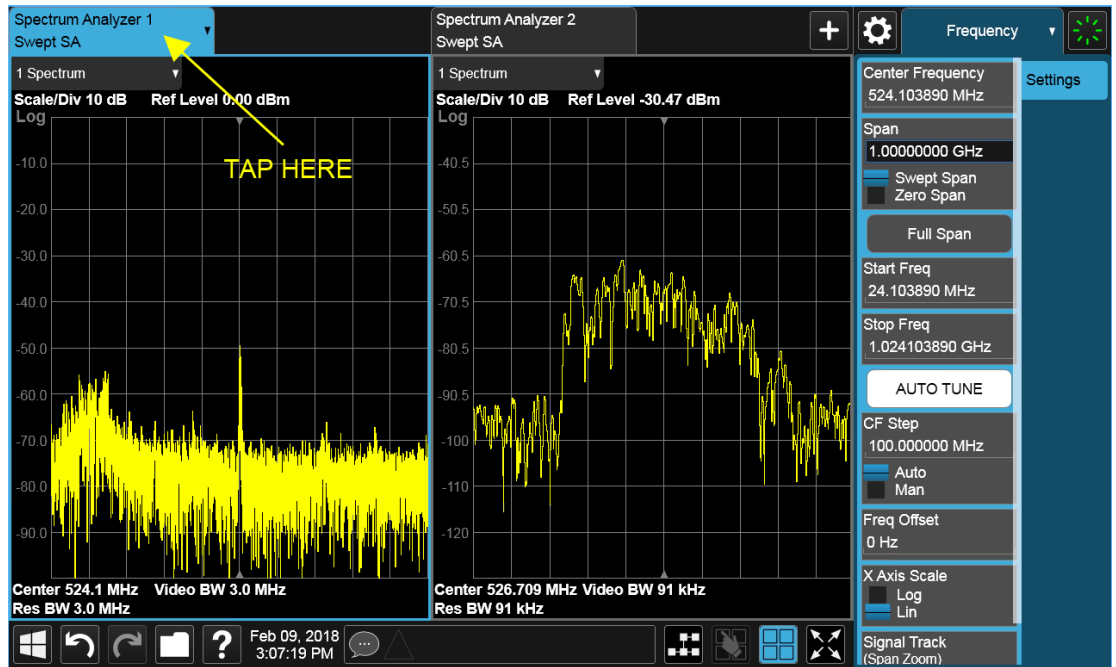

In the Sequencer block in the upper left hand corner, tap the Sequencing switch to turn it On:

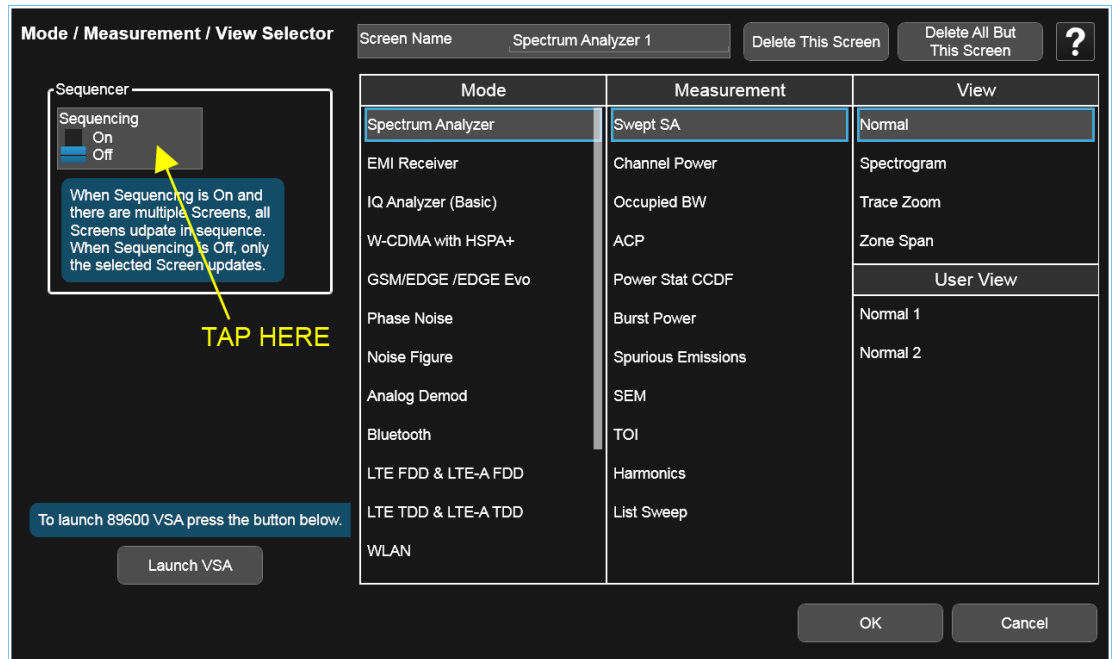

2 User Interface
2.1 Screen Tabs

The instrument will immediately exit the Mode/Meas/View Dialog and begin making measurements in each of the screens, one after the other. When a measurement is being made in a particular Screen, that Screen's tab will be blue.

Measurement being made in Screen 1:



Measurement being made in Screen 2:

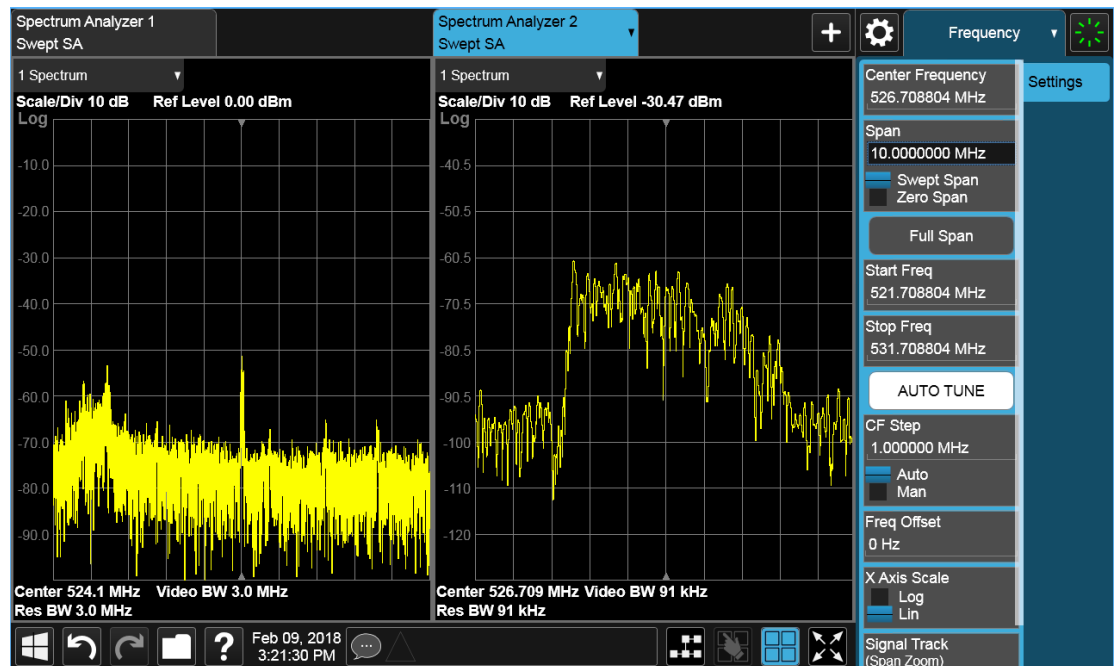

Touching any key or control on the display will cause the Sequencer to stop, so that you can make desired changes. When this happens, the message “Sequencer stopped” is displayed.

When the Sequencer is running, the screens update in the order in which they were created.

Each Screen takes one measurement then passes control to the next Screen. Each Screen updates as though it were in Single Sweep or Single Measurement mode. Thus, if Averaging is on, a Screen may take multiple sweeps before moving on to the next Screen.

2.1.1.6 Screen Name

By default, the screen name is the Mode (Application) name followed by a number indicating the instance of the application.

You may change the name displayed on the Screen Tab of any screen. The control to do this appears in the ["Mode/Meas/View Dialog" on page 62](#):

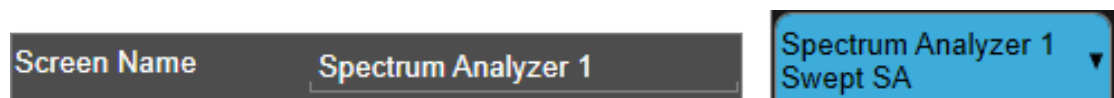

When you touch this control an onscreen keyboard appears, allowing you to change the name. Whatever you change it to appears on the Tab, even if you subsequently change the screen to a different Mode.



To reset the name, delete the screen name entirely.

Each Screen Name must be unique; you cannot give the same name to more than one screen.

Remote Command	<code>:INSTrument:SCReen:REName <alphanumeric></code>
Example	<code>:INST:SCR:REN "Baseband"</code>
Notes	<p>The currently active screen is renamed.</p> <p>If the <code><alphanumeric></code> specifying the new name is already present in the list of screen names, the error message “-224, Illegal parameter value; New name <name> already exists” appears</p> <p>If the display is disabled (via <code>:DISP:ENAB OFF</code>) then the error message “-221, Settings conflict; Screen SCPI cannot be used when Display is disabled” appears</p>

2.1.1.7 Delete This Screen

Pressing this button deletes the current Screen (the one with the blue tab). Deleting a screen removes it from view and selects the next lower screen in the list of screens. If only one screen is configured, it cannot be deleted.

If you press the **Delete This Screen** button, a prompt appears:

“This function will delete the current screen and its settings. This action cannot be undone. Do you want to proceed?”

Pressing **OK** or Enter deletes the screen, pressing **Cancel** or **ESC** does not.

Remote Command	<code>:INSTrument:SCReen:DELeTe</code>
Example	<code>:INST:SCR:DEL</code>
Notes	<p>The currently active screen is deleted</p> <p>If the screen you are attempting to delete is the only configured screen, the error message “-221, Settings conflict; Last screen cannot be deleted” is displayed</p> <p>If the display is disabled (via <code>:DISP:ENAB OFF</code>) then the error message “-221, Settings conflict; Screen SCPI cannot be used when Display is disabled” is generated</p>

2.1.1.8 Delete All But This Screen

Pressing this control deletes all the Screens except the current Screen (the one with the blue tab).

If you press the **Delete All But This Screen** button, a prompt appears:

“This function will delete all defined screens and their settings, except for the current screen. This action cannot be undone. Do you want to proceed?”

Pressing **OK** or Enter deletes the screen, pressing **Cancel** or ESC does not.

Remote Command	<code>:INSTrument:SCReen:DELeTe:ALL</code>
Example	<code>:INST:SCR:DEL:ALL</code>
Notes	<p>You can reset the instrument to the power-on configuration by invoking <code>:INST:SCR:DEL:ALL</code> followed by <code>:SYSTem:DEFault ALL</code></p> <p>If the display is disabled (via <code>:DISP:ENAB OFF</code>) then the error message “-221, Settings conflict; Screen SCPI cannot be used when Display is disabled” appears</p>

2.1.1.9 89600 VSA

Pressing this button launches the 89600 VSA software. The 89600 VSA software is powerful, PC-based software, offering the industry's most sophisticated general purpose and standards specific signal evaluation and troubleshooting tools for R&D engineers. Even for proprietary and non-standard signals in SATCOM or MILCOM applications, you can make signal quality measurements with customized IQ constellation.

The 89600 VSA software offers the following features:

- Over 35 general-purpose analog and digital demodulators ranging from 2FSK to 4096QAM
- Flexible and custom IQ and OFDM signal analysis for single carrier
- Standards specific modulation analysis including:
 - Cellular: GSM/EDGE, cdma2000, W-CDMA, TD-SCDMA, LTE(FDD/TDD),
 - LTE-Advanced and more
 - Wireless networking: 802.11a/b/g, 802.11n, 802.ac, 802.16 WiMAX (fixed/mobile), WiSUN (MR-FSK PHY)
 - RFID
 - Digital satellite video and other satellite signals, radar, LMDS
- Up to 400K bin FFT, for the highest resolution spectrum analysis
- A full suite of time domain analysis tools, including signal capture and playback, time gating, and CCDF measurements
- 20 simultaneous trace displays and the industry's most complete set of marker

functions

- Easy-to-use Microsoft Windows graphical user interface

For more information see the Keysight 89600 Series VSA web site at www.keysight.com/find/89600vsa

To learn more about how to use the 89600 VSA in the instrument, start the 89600 VSA software, then open the 89600 VSA Help and navigate to the topic "About Keysight X-Series Signal Analyzer with 89600 VSA Software".

Example `:INST:SEL VSA89601`
 `:INST:NSEL 101`

2.1.2 Add Screen

On X-Series analyzers you can configure up to 16 different Screens at one time. Each Screen contains one Mode, each Mode contains one Measurement, and each Measurement contains a number of Windows.

You can add screens by pressing the “+” icon in the "Screen Tabs" on page 61 panel. The icon is shown below:



Every time you add a Screen, the instrument “clones” or “copies” the current Screen into the new Screen. If desired, you can then use the "Mode/Meas/View Dialog" on page 62 to change the Mode, Measurement and/or View of the new Screen, or simply operate a second copy of your previous Screen, thus preserving the settings of your previous Screen.

When you have defined the maximum number of Screens (16), the “+” icon disappears.

For more information about operating the instrument with multiple screens configured, see "Multiscreen" on page 149.

Remote Command `:INSTrument:SCReen:CREate`

Example `:INST:SCR:CRE`

Notes The maximum number of screens is 16. If an attempt to add a screen occurs when the maximum have been defined, the error message “-221, Settings conflict; Screen limit reached” appears
When you create a new screen the Screen Name is the current Mode name followed by a number indicating the instance of the Mode.

If the display is disabled (via `:DISP:ENAB OFF`) then the error message “-221, Settings conflict; Screen SCPI cannot be used when Display is disabled” appears

2.2 Meas Bar

The Meas Bar is used to display annotation for the current measurement. There are three primary uses for the Meas Bar:

1. To show annotation for the most important parameters in the measurement so you can see them at a glance
2. To show the annotation that you will most want to have recorded in a screen dump
3. To give you quick access to settings.

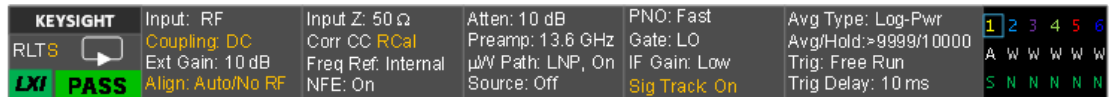

The Meas Bar is made up of a number of annotation panels, each of which, when pressed, opens up a dialog below it which contains controls for those settings.

For example, here is what the display looks like when you touch one of the regions of the Meas Bar:

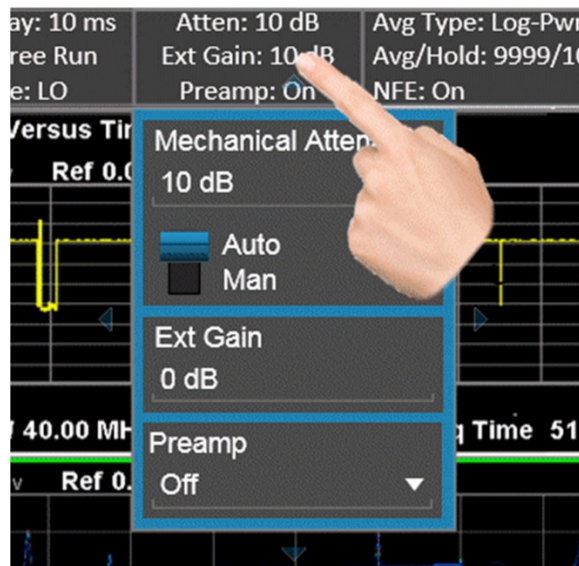

Touching anywhere off the hotspot panel or pressing any hardkey except **Save** or **Quick Save** closes the hotspot panel.

In a hotspot panel, the control in black with the blue border is the active function. Each panel may have its own default active function.

Settings that are colored amber are those that you need to be particularly aware of; for example, if Alignments are off, this is shown in amber, so you will know that you may not be meeting spec. Similarly, if DC coupling is on, this is shown amber, to alert you to be careful what voltage you put on the input.

You can turn the Meas Bar on and off with a switch on the Annotation tab of the Display menu.

System Control Panel

The leftmost panel holds the GPIB/Remote annunciators, the Single/Continuous symbol/control, the LXI indicator and the PASS/FAIL indicator. Tapping this panel drops down controls for Single/Continuous, Pause/Resume and restart.



GPIB/Remote annunciators

The GPIB/Remote annunciators are shown as the letters **KRLTS**. Each letter is shown if the state is true and is not shown if the state is false, as follows:

K	Keylock indicator	This is shown when the instrument is in the Keylock state (turned on and off by the SYST:KLOCK command)
R	Remote annunciator	Shown when the instrument is in the remote state, as when being controlled via the IEEE-488 bus (GPIB) or TCP/IP connections
L	GPIB Listen annunciator	Shown when addressed to listen via GPIB or TCP/IP
T	GPIB Talk annunciator	Shown when addressed to talk via GPIB or TCP/IP
S	GPIB SRQ annunciator	Shown when the instrument is asserting SRQ on GPIB. This annunciator is an amber color

Single/Continuous symbol/control

This annunciator shows as an arrow on an oval line when in Continuous, or an arrow on a straight line when in Single.

LXI indicator

This indicator displays in green when LAN is connected, in white when LAN is not connected, and in red when LAN is connected but has a connection problem.

PASS/FAIL indicator

This annunciator displays when Limits are turned on. It is green if all Limits are passing, and a red FAIL if any limit is not passing.

The following command queries the status of the current measurement limit testing. It returns a 0 if the measured results pass when compared with the current limits. It returns a 1 if the measured results fail any limit tests.

Remote Command `:CALCulate:CLIMits:FAIL?`

Example `:CALC:CLIM:FAIL?`

queries the current measurement to see if it fails the defined limits
Returns a 0 or 1: 0 it passes, 1 it fails

Trace Detector Settings Panel

In the Swept SA and some other measurements, there is a special panel summarizing the settings for the traces in the measurement:



There is one column for each trace. The rows are as follows:

- The top row shows the Trace Number, in the trace color.
- The second row shows the Trace Type for each trace (W=Clear/Write, A=Trace Average, M=Max Hold, m=Min Hold); this letter is in white if the trace is Active, in gray if the trace is inactive; there is a bar through the letter if the trace is not being displayed
- The third row shows the detector for each trace (N=Normal, S=Sample, A=Average, P=peak, p=negative peak, Q=Quasi Peak, E=EMI Average, R=RMS Average, f=math function)

In the example above, trace 1 is active, visible, and in Average using the Sample detector, the other traces are inactive, blanked and in Clear/Write using the Normal detector.

Tapping this panel drops down controls for the Traces.

2.3 Measurement Display

The Measurement Display contains one or more data windows displaying the result of the current measurement. These may be graphical or textual windows.

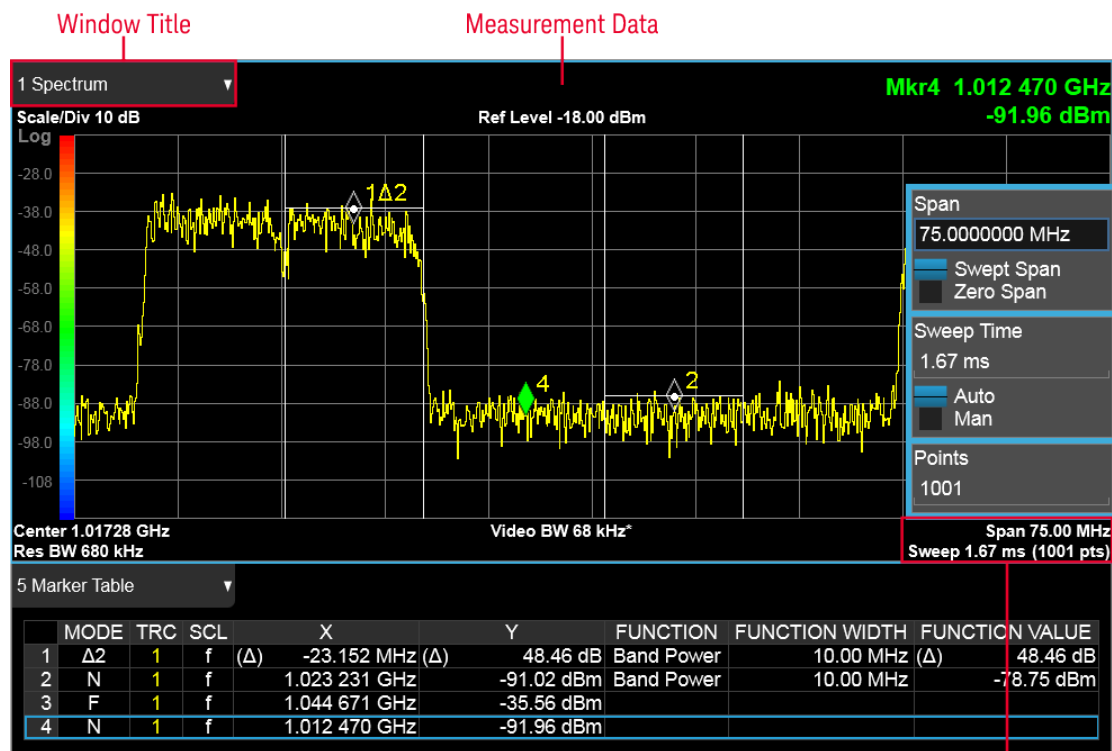

Each window in the Measurement display contains a "Window Title" on page 85, "Measurement Data" on page 89, and graphical windows also may contain "Annotation Hotspot" on page 92.

The selected window in the Measurement Display is indicated by a blue border. Window-dependent controls in the menu panel always refer to the selected window.

2.3.1 Window Title

The Window Title appears in the upper left hand corner of the window, and includes a title describing the measurement data currently being displayed in the window. The title may also contain additional information about the data in the window, for example in the LTE measurement supplication, the component carrier being displayed in the window will be indicated (e.g., "CC0").

Measurements that support User Views (see "View Editor" on page 128) also display the Window Number in the Window Title, to enable window addressing from SCPI. The number is the number that will be used in the SCPI command to address that window, for example, in the WCDMA Mod Accuracy measurement, Code Domain Power is assigned window number 6, so you address it with the following SCPI command:

```
:DISP:RHO:WIND6:TRAC:Y:RLEV 0.0
```

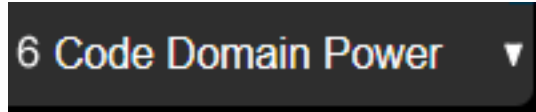

Note the arrow pointing down on the right side of the Window Title. This indicates that touching the Window Title will display a dropdown, which enables you to select the Measurement Data to be displayed in the window.

For example, if we wish to assign the results of the upper window in the display below to the Marker Table, we would touch the window title and then the "Data" control that is revealed, as shown:

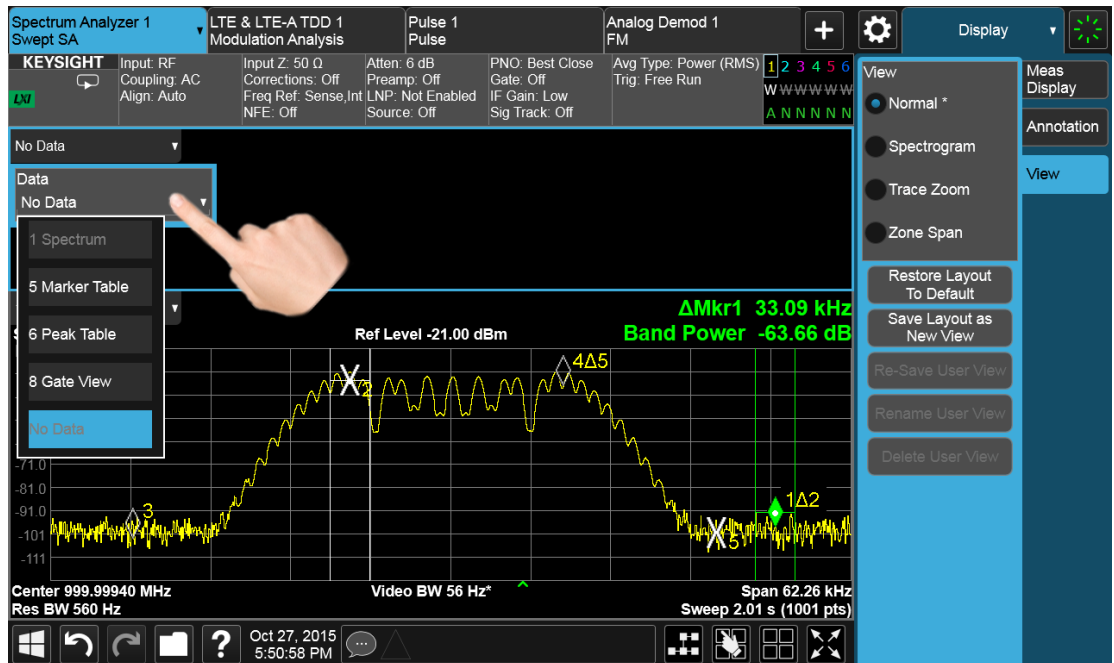

And then select Marker Table, yielding the result below:

2 User Interface
 2.3 Measurement Display

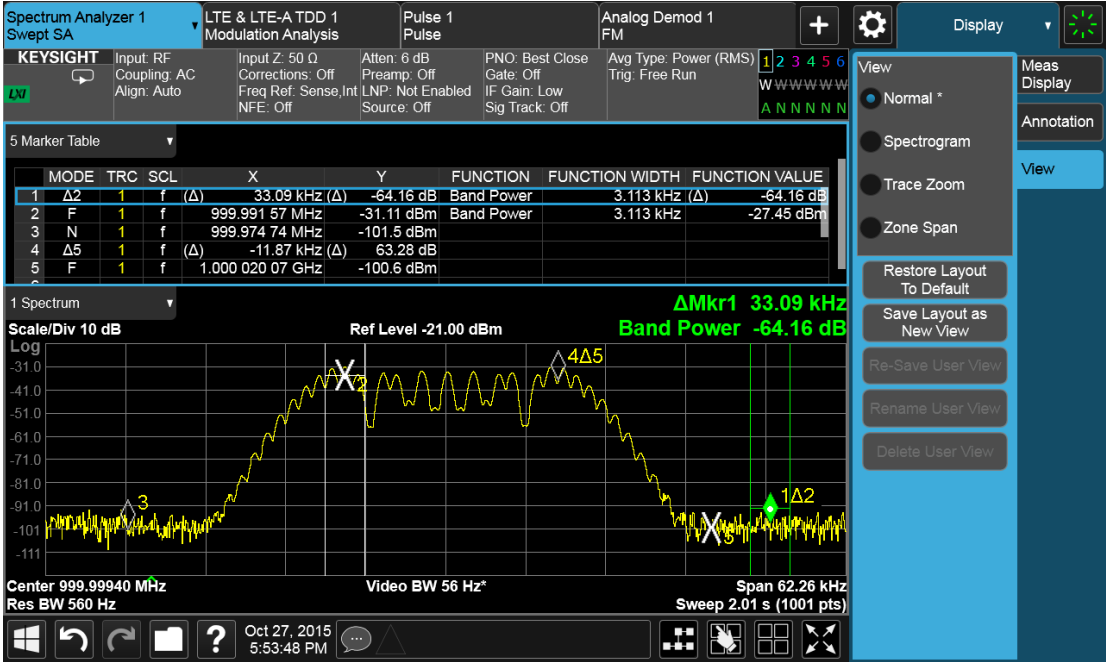

Note also that the Window Data dropdown can be a cascaded list, if the number of available results requires categorization to hold them all:

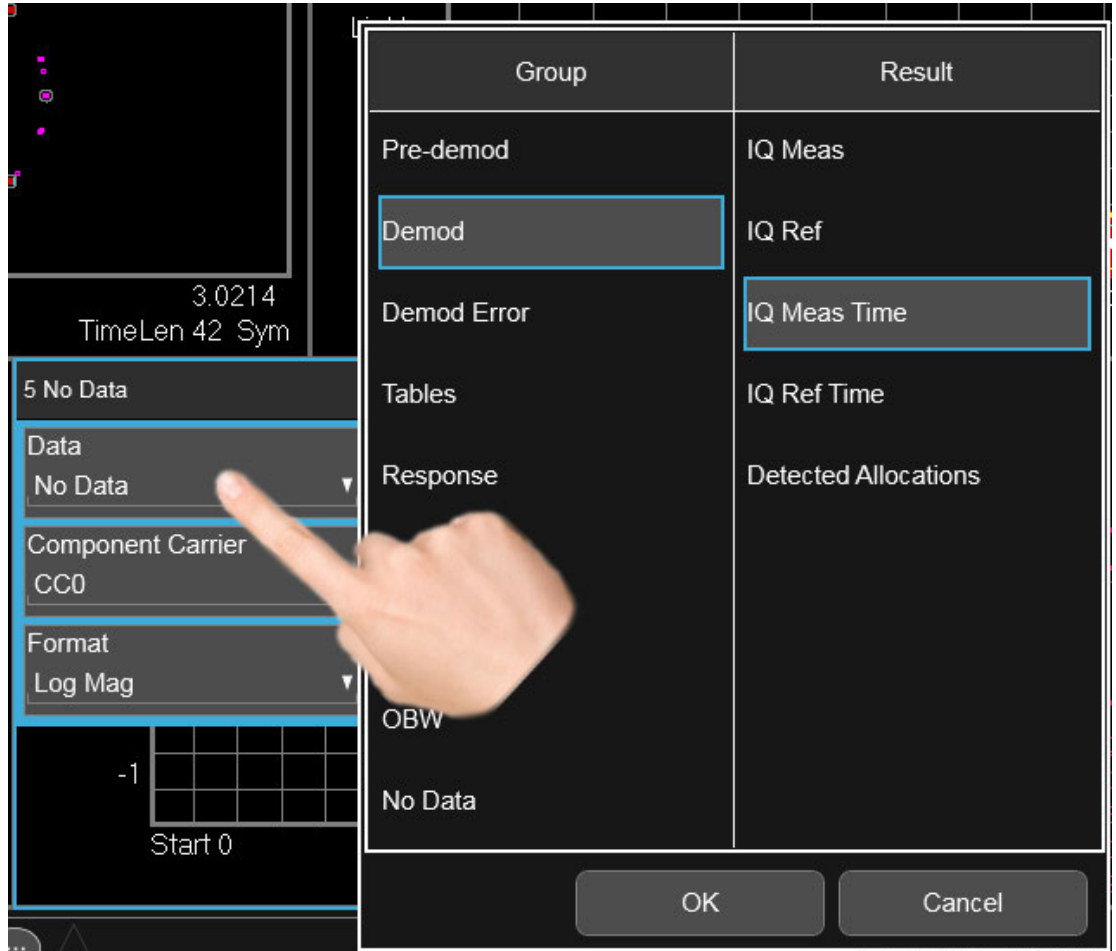

Note also that the Window Data dropdown sometimes includes controls for further configuring the window, for example, in LTE choosing the desired Component Carrier and Data format.

2 User Interface
 2.3 Measurement Display

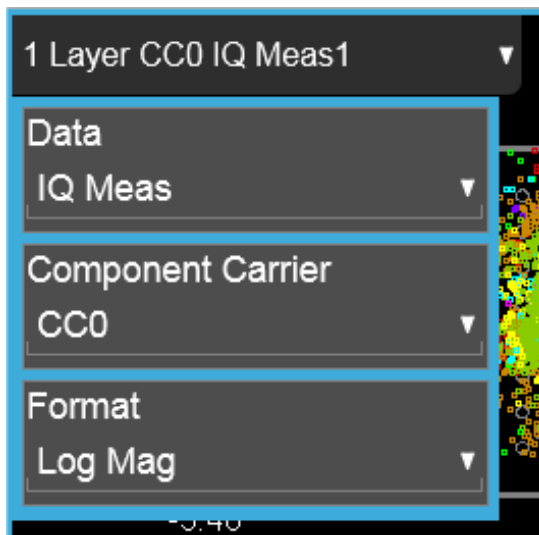

Touching a window's title dropdown also selects the window.

2.3.2 Measurement Data

The Measurement Data region shows graphical or textual data for the Data selected in the Window Title Data control. Below you can see examples of both graphical and textual windows in a four-window display.



There are many gestures which you can use to interact with a measurement display window. They are detailed below.

Swipe

There are several swipe actions, as listed below. One of the most important actions is swiping a spectrum window to the left or right, or up or down, to adjust the frequency and level of the spectrum, as shown below.

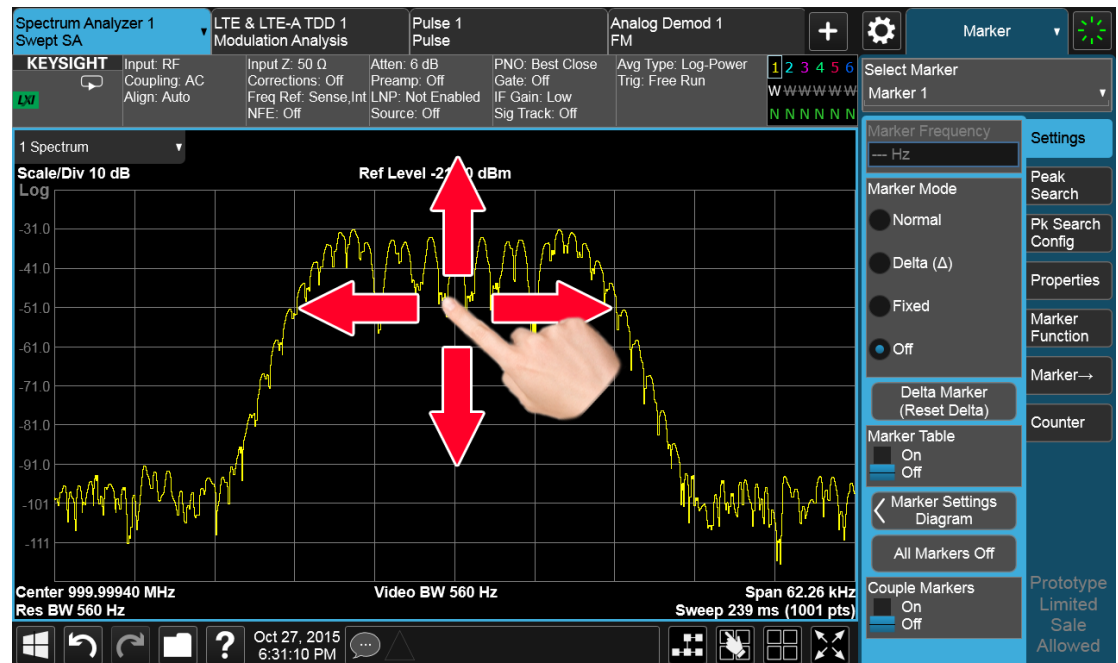

Swipe actions are summarized in the table below. Not all of these may be available, depending on the measurement.

Object	Action
Spectrum Trace Left/Right	Drag trace (change Center Frequency)
Spectrum Trace up/down	Drag trace (change Ref Level)
Marker Left/Right	Drag marker along trace
Fixed Marker Left/Right/Up/Down	Drag marker in space
Scrollable area	Scroll vertically or horizontally. Scrollable areas include the Menu Panel (if overfull), tables and lists. A scrollable area is indicated by a vertical or horizontal translucent white bar which can also be dragged by a mouse When scrolling a table: <ul style="list-style-type: none"> – Row headers remain in place when the table is scrolled horizontally, and scroll with the table when the table is scrolled vertically – Column headers remain in place when the table is scrolled vertically, and scroll with the table when the table is scrolled horizontally

2 User Interface
 2.3 Measurement Display

Object	Action
Toggle control	Toggle in that direction

Pinch

You can also pinch in or out either horizontally or vertically to zoom in the x-axis or y-axis dimension. For example, a pinch horizontally lets you adjust the Span of the Spectrum window. Also, pinching on the wings of a Band Power or other Band Function allows you to widen or narrow that Band Function.

Pinching may sometimes be easier if you use the index finger of each hand, rather than pinching with one hand.

Touch-and-Hold

You can also touch-and-hold the display, that is, touch it and hold your finger on the display. A circle is drawn, and when the drawing completes, a right-click gesture is performed that depends on the screen feature touched, as listed in the table below.

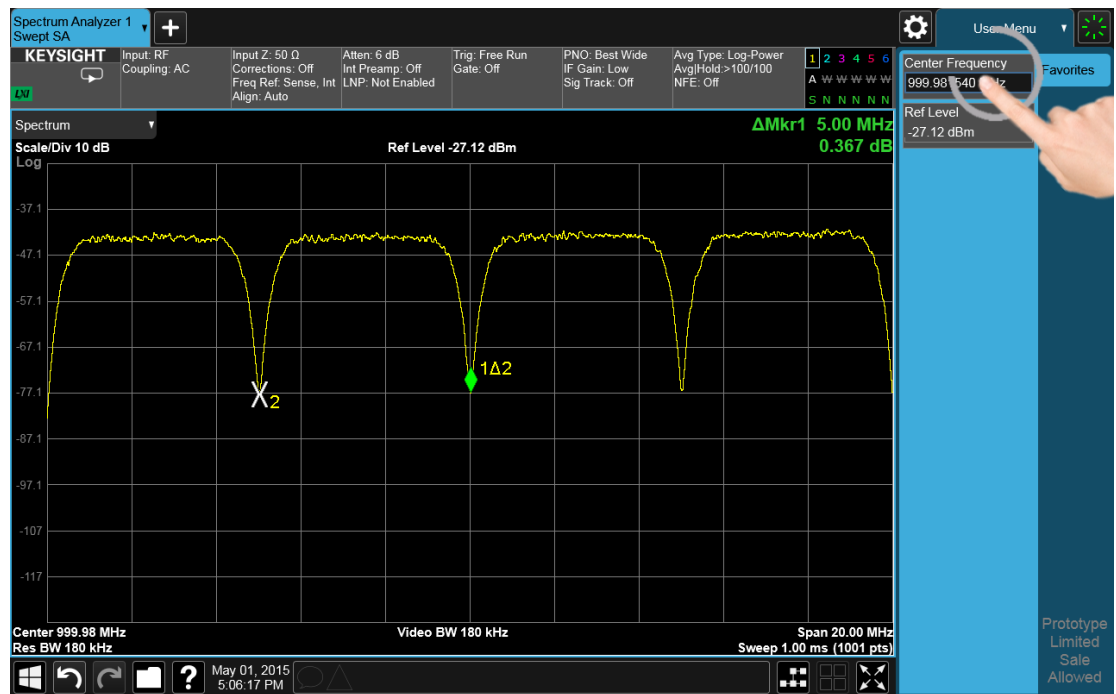

Right Click on a Trace	Peak Search, Trace Type (Clear/Write, Trace Average, Max Hold, Min Hold), Trace View/Blank (Active, View, Blank, Background). Not all of these may be available, depending on the measurement
Right Click on a Marker	Marker Mode (Normal, Delta, Fixed, Off), Peak Search, Next Peak, Next Pk Right, Next Pk Left). Not all of these may be available, depending on the measurement

Right Click on the Background	Lets you select Help
Right Click on a Menu Panel control	Lets you add or remove that control from the User Menu or get Help on that control

Tap

Tapping an object causes the actions defined in the table below:

Object	Action
Marker	Select
Marker (repeated taps on stacked)	Cycle through stacked markers
Trace	Select. In addition if Marker is the active function, move the selected marker to the point where you tapped
Trace (repeated taps on stacked)	Cycle through stacked traces
Window	Select if unselected
Screen	Select if unselected

Double Tap

Double-tapping an object causes the actions defined in the table below:

Object	Action
Window	Zoom/Unzoom

2.3.3 Annotation Hotspot

You can tap on a graticule annotation to modify one of the fields in that annotation. For example if you tap on the region with Center Freq and Res BW in it, a menu panel pops up with just those settings on it.

2 User Interface
2.3 Measurement Display

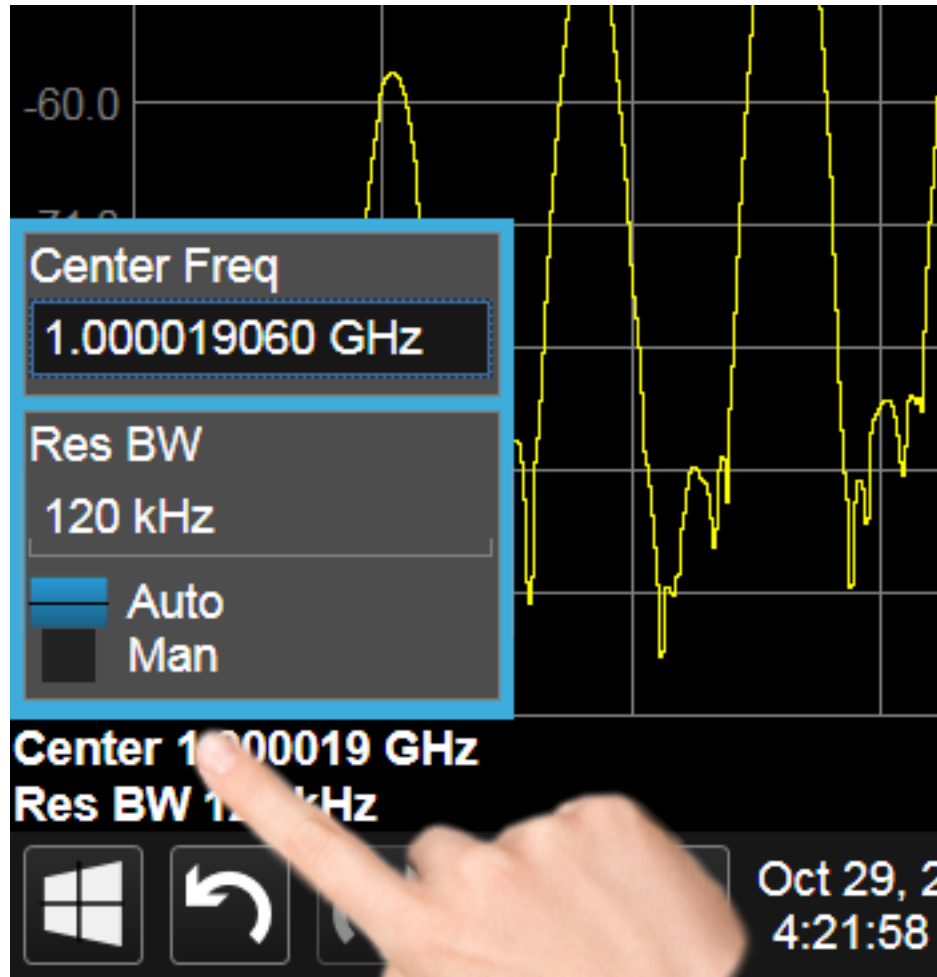

Touching anywhere off the hotspot panel or pressing any hardkey except **Save** or **Quick Save** closes the hotspot panel.

Annotation which is not currently able to be adjusted is not grayed out on the display, but the control in the hotspot that drops down or pops up is grayed out.

In a hotspot panel, the control in black with the blue border is the active function. Each panel may have its own default active function

2.4 Menu Panel

The menu panel is the main focus of the X-Series Multitouch user interface. The controls include active functions, dropdowns, action buttons, radio buttons and toggles.

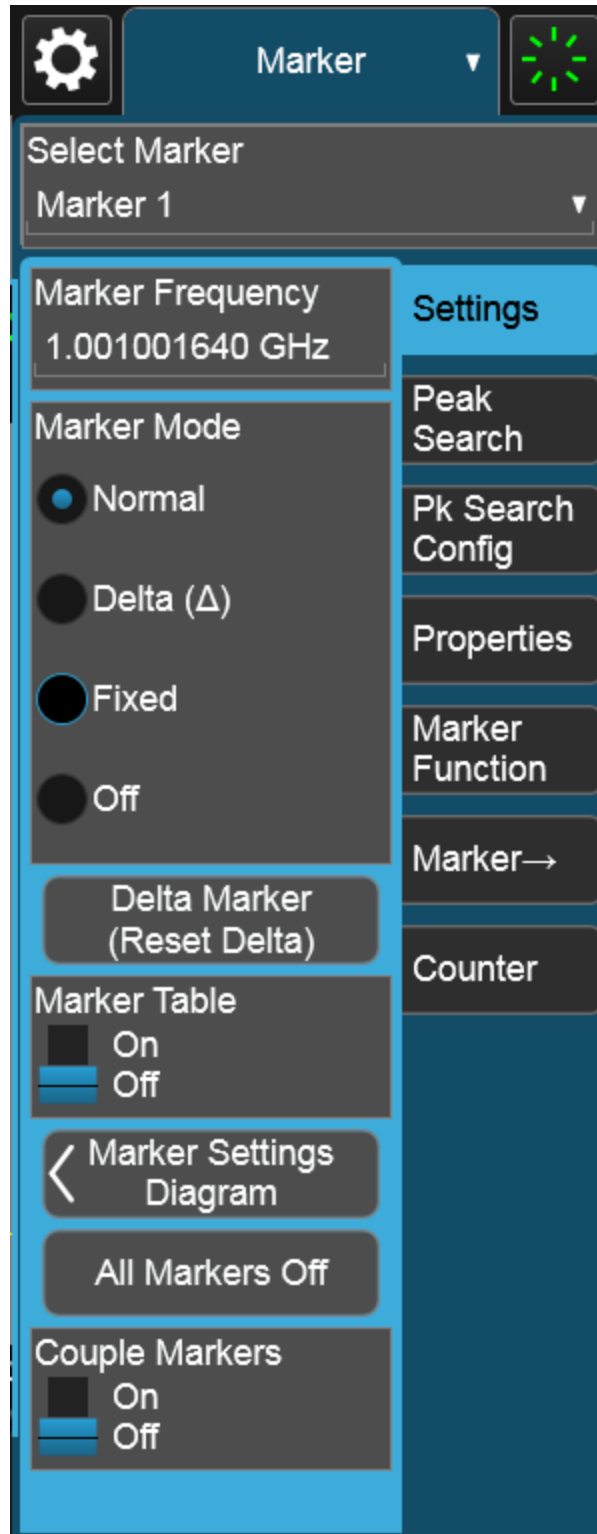

The menu panel normally appears on the right side of the display and consists of a rectangular panel with multiple “sub-panels” lying on top of each other, each sub-panel being accessed by a tab on the right.

You press a front panel key (or “hardkey”) to access a particular menu. On the front panel there are twelve “measurement hardkeys” (the ones in the shaded region in the figures below) – these are the hardkeys that open up menus in the menu panel.

With a menu open, tap a tab to access the controls on its sub-panel. Whenever you press the front panel key associated with a menu, the default (top) tab is selected.

If the number of controls on a panel exceeds the height of the panel, scrolling is enabled, which is indicated by a white bar on the left that fades away after a few seconds. You swipe up or down with your finger to scroll the panel, or you can grab the white bar with a mouse.

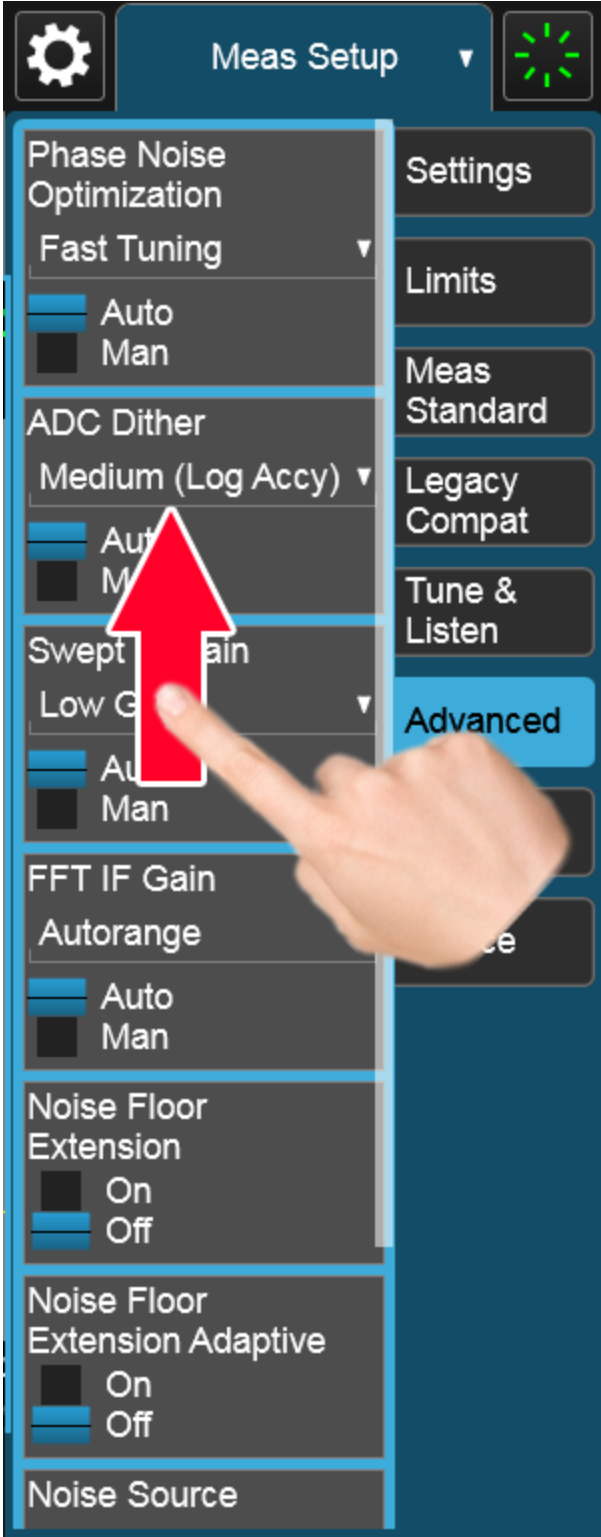

If you move to a different menu panel or sub-panel and then come back to a previous panel, the previous panel is always reset to be scrolled all the way back to the top.

Accessing Menus Without Using Front-Panel Keys

You can access the menu panels without using the front panel keys, as you would need to do if you were operating the instrument using Remote Desktop. Touch or click on the menu title, as shown below. A dropdown containing the twelve measurement hardkeys appears. Selecting a hardkey from the dropdown displays the corresponding menu, and the dropdown disappears.



Entering Numeric Values

Many controls on the menu panel allow you to enter numeric values. These are called “active functions.” An active function control displays a number and a suffix,

2 User Interface

2.4 Menu Panel

for example 13.255 GHz, as in the example below:

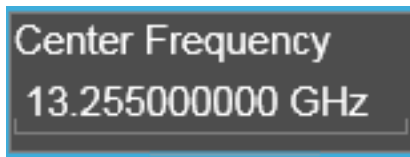

An active function is “active” if the numeric value is surrounded by a black background with a blue border, as below. In this state, it is ready to receive numeric input from the number pad on the front panel, the knob, or the step keys.

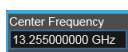

When an active function is in the active state, you can start typing or pressing the number keys on the front panel, which causes the Numeric Entry Panel to appear, as shown below. The Numeric Entry Panel displays the typed value, and the terminators to complete the entry.

Here we see a UXA with an active function control in the active state. Although no Numeric Entry Panel is displayed, you can just touch the “2” key:



This causes the Numeric Entry Panel to pop up to receive the numbers you are typing:



Type in as many digits as required, then touch one of the unit terminator buttons in the Numeric Entry Panel to complete the entry. In this case, 2 GHz was the desired entry, so you just touch the “GHz” terminator:

2 User Interface
2.4 Menu Panel



The Numeric Entry Panel disappears and, in the example, the active function value becomes 2 GHz.



It is important to note that you can always pop up the Numeric Entry Panel by touching an active function control while it is active; for example, if you were to touch it in the figure above, the Numeric Entry Panel would pop up right next to the control:

2 User Interface
2.4 Menu Panel



You can display the Numeric Entry Panel by touching any active function control while it is active, but you don't have to pop up the Numeric Entry Panel first, you can just start typing and it will pop up on its own, thus saving you a keystroke.

You can also adjust a value without displaying the Numeric Entry panel by turning the knob or using the step keys while an active function is active. If you turn the knob or use the step keys while the Numeric Entry Panel is displayed, it disappears, allowing you to see the entire screen while you are making the adjustment.

You can also drag the Numeric Entry Panel to another part of the display if it is covering something that you wish to see while it is on the screen.

2.4.1 Right-Click Menu

If you click with the right mouse button on any of the menus in measurements, a popup menu appears, which includes:

The items in this menu are:

- ["Add to User Menu" on page 104](#)
- ["Help on this setting" on page 104](#)

2.4.1.1 Add to User Menu

For details, see ["User Menu" on page 104](#).

2.4.1.2 Help on this setting

For details, see ["Help" on page 117](#).

2.4.2 User Menu

Lets you create your own menu, to include controls that you frequently use. You can have one **User Menu** for each measurement, and all User Menus survive a power cycle.

You add a control to the User Menu for the current measurement by right-clicking on the control, then selecting ["Add to User Menu" on page 104](#). You can also remove the control from the User Menu using the same right-click menu item.

User Menu appears at the bottom of the menu drop-down panel.

2.5 Cancel key



This front-panel key has the same functions as the Windows **Esc** (Escape) key. It does the following:

- Cancels dialogs
- Cancels active functions (unless there is an entry in progress, in which case it cancels that, and reverts to the previous value)
- Resets input overloads
- Aborts print operations
- Cancels certain other operations (such as alignments)
- Returns you to Local Control (if in Remote)
- If the backlight is off, turns on the backlight, and does nothing else

Most of this functionality is the same as earlier X-Series models and similar to ESA and PSA operation.

When the instrument is in Remote, any hardkey that is pressed on the front panel displays this message:

Analyzer is in Remote. Press ESC to return to Local

The exception is the **Cancel (ESC)** key, which takes the instrument out of Remote.

When the instrument is also in the LLO (local lockout state), the **Local** key is locked out as well. When this is the case, and the **Local** key is pressed, this message is displayed:

Local key is locked out by remote computer. Cancel Local Lockout on computer or release remote control

When you see this message, you should disconnect the remote computer, or use it to take the instrument out of the Local Lockout state.

2.6 Onscreen Keyboard key



This key turns the onscreen alpha keyboard (OSK) on and off.

There are two onscreen keyboards:

- The Multitouch OSK, which pops up automatically if, while using the analyzer application, a text field becomes the active function
- The Windows OSK, which you must open manually when a text field must be entered while interacting with Windows or other apps

2.7 Touch On/Off Key



This front-panel key turns the display touch functionality on and off. If off, you can turn it back on using the front panel **Touch On/Off** key. When the touch functionality is off, you can still use a mouse as a pointer.

When toggled, a dialog box appears midscreen that confirms “Touchscreen On” or “Touchscreen Off”.

This function remains in effect until it is turned off or until the app shuts down. The app always starts up with Touch enabled.

2.8 Tab key



This key has the same function as the **Tab** key on a PC keyboard. You can use this key to display the Windows Taskbar, as follows.

- Alt-Tab to the Desktop
- Touch the desktop
- Touch **TAB**
- The Taskbar appears

2.9 Local Button

Appears in the Menu Panel when the instrument is in remote, and can be brought back to local via the **Local (ESC)** Key. See also "[Cancel key](#)" on page 105.

2.10 Control Bar

The Control Bar contains controls and readouts that let you control instrument functions independent of the current measurement.

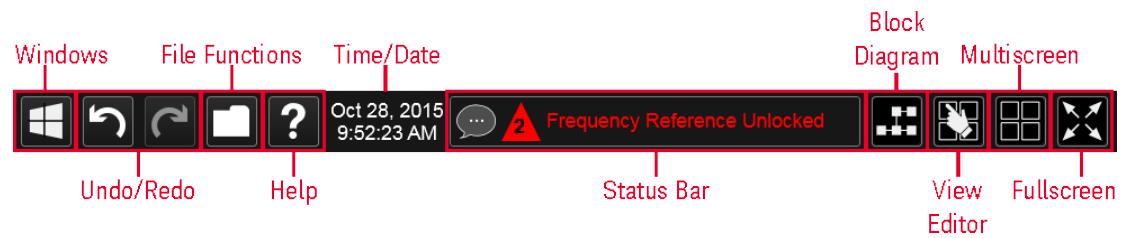

2.11 Windows

Pressing the Windows icon on the "Control Bar" on page 110 has the same effect as pressing the Windows icon on the Windows taskbar. It displays the Windows taskbar and Start Menu, which allows you to launch Windows programs and access features such as the Control Panel.

2.12 Undo/Redo

The Undo button in the "Control Bar" on page 110,



and the Undo front panel key,

Ctrl=Redo



are used to undo the most recently executed function.

If you Undo a function, and then decide you should not have done so, you can use the **Redo** button in the "Control Bar" on page 110 to put it back the way it was. The Redo function may also be executed by pressing **Ctrl+Undo** (holding the **Ctrl** key down while pressing the **Undo** front panel key).



Undo allows you to restore a setting, which you had previously set, back to its value before you changed it. When you press the Undo button or front panel key, the last setting you changed is "undone", that is, its previous setting is restored. You are notified of this fact with an advisory pop up message; for example, if the Center Frequency had been 300 MHz, and you changed it to 1 GHz and then pressed **Undo**, the message would show:

UNDO: Center Freq 1 GHz -> 300 MHz

The instrument can store 5 levels of action for Undo.

To truly understand Undo and Redo, it helps to think of two "stacks", an Undo stack and a Redo stack,

UNDO stack

REDO stack

Whenever you perform an action, it is placed on the Undo stack. So for example, if you set the Center Frequency to 1 GHz, then set the RBW to 1 MHz, then set the Detector to Peak, each of these actions gets "pushed" onto the Undo stack:

UNDO stack	REDO stack
Det = Peak RBW = 1MHz CF = 1 GHz	

When you press **Undo**, the top item on the Undo stack is removed, the action represented by that item is undone, and the item is placed on the Redo stack. So pressing **Undo** once in the above case would undo the setting of the peak detector, and the stacks would look like this:

UNDO stack	REDO stack
RBW = 1MHz CF = 1 GHz	Det = Peak

Now pressing **Undo** again would undo the RBW = 1 MHz action, and the stacks would look like this:

UNDO stack	REDO stack
CF = 1 GHz	RBW = 1MHz Det = Peak

Now pressing Redo would Redo the RBW = 1 MHz action, and the stacks would again look like this:

UNDO stack	REDO stack
RBW = 1MHz CF = 1 GHz	Det = Peak

Also, whenever you set a value, the Redo stack is cleared; you can't redo an action once you have interrupted the original flow of actions. Think of the Undo stack as the past, and the Redo stack as the future; if you have items in both stacks it means you have gone back to a time in the past; if you then *do* something you have changed the future, so the old future (the Redo stack) gets cleared.

For example, in the example above, if you now were to change another setting, such as VBW = 1 kHz, the Redo stack gets cleared, and the stacks would look like this:

UNDO stack	REDO stack
VBW = 1 kHz	
RBW = 1MHz	
CF = 1 GHz	

Undo can undo changes you make with the knob or step keys, however all contiguous events that affect the same parameter are aggregated into one event for the sake of Undo. For example, if CF is the active function and is 1 GHz, and you turn the knob back and forth, then enter a value, then use the step keys, when you press **Undo**, the instrument returns to CF = 1 GHz.

Actions that Cannot be Undone

There are some actions that cannot be undone, because these clear the Undo/Redo stack:

- Restore Mode Defaults clears the stack for that Mode in that Screen
- Sending SCPI commands clears the stack for that Mode in that Screen
- Loading a state file (including User Preset) clears the stack for that Mode in that Screen
- Deleting a Screen clears all the stacks in that screen
- Changing Views

Undo/Redo works within the context of a Mode. Each Mode in each Screen keeps its own record. Settings in the Control Panel or System Settings menus are not undoable.

There are several actions that may change many parameters. Among these are Auto Tune, and Adjust Atten for Min Clipping. After executing such a function, Undo sets all parameters back to their value before the function was selected. Auto Tune appears to be a single action, even though the instrument executes it in several steps.

Redo reverses the effect of the last Undo action, assuming that no other settings have been changed since the last Undo. Changing a setting after an Undo clears memory of all settings after that Undo, that is, it clears the Redo stack, as explained above.

2 User Interface

2.12 Undo/Redo

When you press the **Redo** icon or **Ctl** and the **Undo** hardkey, you are notified with an advisory popup message; for example, if the Center Frequency had been 300 MHz, and you changed it to 1 GHz and then pressed **Undo**, the message would say:

UNDO: Center Freq 1 GHz -> 300 MHz

If you then press **Redo**, the message will say:

REDO: Center Freq 300 MHz -> 1 GHz

Neither **Undo** nor **Redo** perform any navigation, and have no effect on which menu panel is displayed nor which function is active.

2.13 File Functions

The File Functions popup contains controls for executing Save, Recall, File and Print operations. You display the File Functions popup by tapping the File Functions icon in the "Control Bar" on page 110.

For more information on a control, tap an icon in the image below.

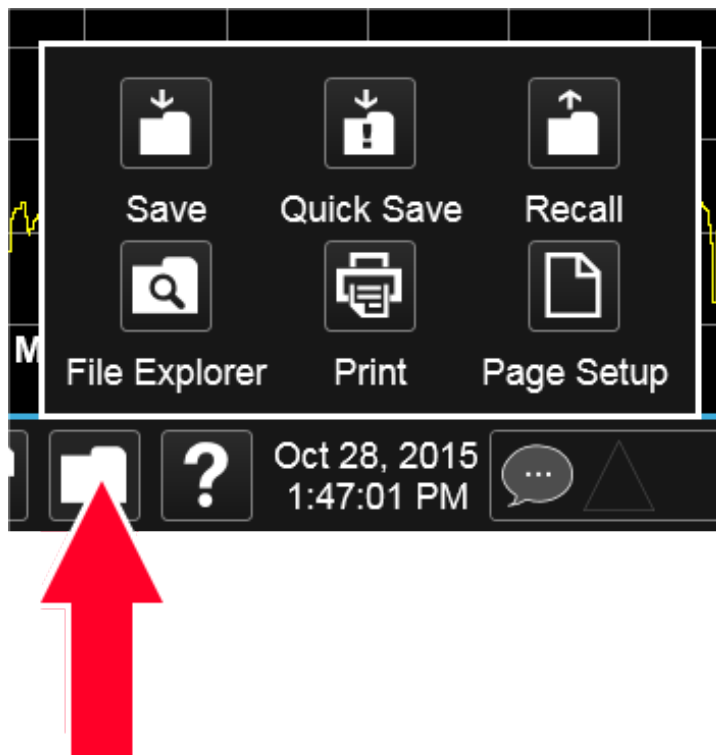

Tapping this folder icon displays the File Functions popup

2.13.1 File Explorer

Pressing the File Explorer button in the "File Functions" on page 116 dialog opens the Windows File Explorer, which allows you to perform operating system file functions such as Move, Copy and Delete.

File Explorer also allows you to map network drives to drive letters on your PC or intranet, in order to more easily save screen images, states and other data, and load them back into the instrument.

2.14 Help



Pressing the **Help** button in the "[Control Bar](#)" on page 110, the **Help** front panel key, or the **F1** key if you have a PC keyboard connected, opens the context-sensitive help system. The **Help** button appears in the "[Control Bar](#)" on page 110 and in the banner of full-screen dialogs

You can also use the Help window's Contents pane to navigate to Help for any function in the instrument

You can also touch-and-hold a specific control to display a "right-click" menu, in which one of the choices is **Help on this setting**

2.15 Status Bar

The Status Panel (or Status Bar) appears at the bottom of the display and contains three fields:

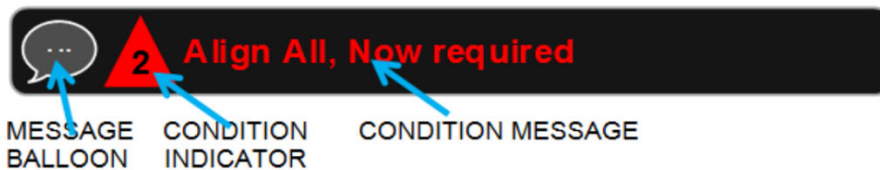

The Message Balloon appears on the left side of the Status Panel and lets you know when there is an unread message in the queue.



No unread messages

Unread messages

The Message Balloon has a gray outline and no fill if there are no unread messages; it has a gray fill and a white outline and displays a white ellipsis in the middle if there are unread messages.

The Condition Indicator appears to the right of the Message Balloon and shows the current number of open conditions. Below are some examples of what the Condition Indicator can look like:



The triangle is unfilled if there are no open conditions, filled with yellow if all open conditions are warnings, and filled with red if at least one open condition is an error. The number displayed is the total number of open conditions.

Touching the Condition Indicator opens up the Show Status dialog (see below) with the Current Conditions tab selected. Touching anywhere else on the Status Bar opens up the Show Status dialog with the History tab selected.

The Condition Message appears to the right of the Condition Indicator. In the example below, the Condition Message is “Align All, Now required”:

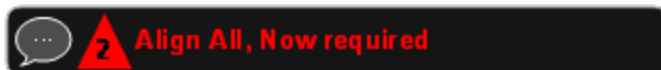

Warning condition messages display in yellow, error condition messages display in red.

If there is more than 1 open condition, the Condition Message cycles through the display of all of the open conditions, one at a time. Each message is displayed for 2 seconds, then the next for 2 seconds, and so on.

Show Status Dialog

The Show Status dialog appears if you tap anywhere in the Status Bar. Touching the Condition Indicator (the triangle in the Status Bar) opens up the Show Status dialog with the Current Conditions tab selected. Touching anywhere else on the Status Bar opens up the Show Status dialog with the History tab selected.

Status	History				?	X	
History	Type	ID	Message	Repeats	Time		
Current Conditions	✓	1064	Align Now All required - CLEARED		6:37:49 PM 2/24/2015		
Settings	✓	1301	Meas Uncal - CLEARED		6:37:37 PM 2/24/2015		
	✗	64	Align Now All required - DETECTED		6:36:59 PM 2/24/2015		
	⚠	301	Meas Uncal - DETECTED		6:33:27 PM 2/24/2015		
	✓	1301	Meas Uncal - CLEARED		6:31:27 PM 2/24/2015		
	⚠	301	Meas Uncal - DETECTED		6:33:27 PM 2/24/2015		
	✓	1141	Input Overload - CLEARED,ADC over range	47	1:07:56 PM 2/24/2015		
	✗	141	Input Overload - DETECTED,ADC over range	47	1:07:56 PM 2/24/2015		
	✗	780	No Peak Found		1:03:55 PM 2/24/2015		
	<div style="display: flex; justify-content: space-between; align-items: center;"> Informational Warning Error Press any row for more info about that Message Clear Message Queue </div>						

If the display fills up, scrolling is enabled just as in other X-Series Multi-touch UI displays.

The Status dialog automatically refreshes as new messages and conditions occur.

At the bottom of the screen is a Clear Message Queue button. This button clears all errors in all error queues.

Note the following:

- Clear Message Queue does not affect the current status conditions
- Mode Preset does not clear the message queue
- Restore System Defaults (Super Preset) will clear all message queues
- *CLS only clears the queue if it is sent remotely and *RST does not affect any error queue
- Switching Modes does not affect any error queues

See "[More Information](#)" on page 121

Remote Command `:SYSTem:ERRor[:NEXT]?`

Example `:SYST:ERR?`

Notes The return string has the format:

<Error Number>, <Error>

Where <Error Number> and <Error> are those shown on the Show Errors screen

Backwards
Compatibility
Notes

In some legacy analyzers, the Repeat field shows the number of times the message has repeated since the last time the error queue was cleared. In the X-Series, the Repeat field shows the number of times the error has repeated since the last intervening error. So the count may very well be different than in the past even for identical signal conditions

Unlike previous analyzers, in the X-Series all errors are reported through the Message or Status lines and are logged to the event queue. They never appear as text in the graticule area (as they sometimes do in previous analyzers) and they are never displayed in the settings panel at the top of the screen (as they sometimes do, by changing color, in previous analyzers)

As a consequence of the above, the user can only see one status condition (the most recently generated) without looking at the queue. In the past, at least in the Spectrum Analyzer, multiple status conditions might display on the right side of the graticule

In general, there is no backwards compatibility specified or guaranteed between the error numbers in the X-Series and those of earlier products. Error, event, and status processing code in customers' software will probably need to be rewritten to work with X-Series





In the legacy analyzers, some conditions report as errors and others simply turn on status bits. Conditions that report as errors often report over and over as long as the condition exists. In the X-series, all conditions report as start and stop events. Consequently, software that repeatedly queries for a condition error until it stops reporting will have to be rewritten for the X-series



More Information

The Status Dialog has two screens, selectable by the tabs on the right: **History** and **Current Conditions**:

History

History brings up a screen displaying the front panel message queue in chronological order, with the newest event at the top. Remember that the front panel queue contains all of the events generated by front panel actions as well as error events from all of the SCPI queues. A typical History display appears below:

Status	History				?	X
History	Type	ID	Message	Repeats	Time	
Current Conditions		301	Meas Uncal - DETECTED		5:36:35 PM 2/24/2015	
Settings		1141	Input Overload - CLEARED,ADC over range	49	1:07:56 PM 2/24/2015	
		141	Input Overload - DETECTED,ADC over range	49	1:07:56 PM 2/24/2015	
		1141	Input Overload - CLEARED,ADC over range		1:07:53 PM 2/24/2015	

 Informational
  Warning
  Error

Press any row for more info about that Message

Clear Message Queue

The fields on the History display are:

Type	Displays the icon identifying the event or condition as an error or warning
ID	Displays the error number
Message	Displays the message text
Repeat (RPT)	<p>This field shows the number of consecutive instances of the event, uninterrupted by other events. In other words, if an event occurs 5 times with no other intervening event, the value of repeat will be 5</p> <p>If the value of Repeat is 1 the field does not display. If the value of Repeat is >1, the time and date shown are those of the most recent occurrence. If the value of repeat reaches 999,999 it stops there. The Repeat field can run into some pretty large numbers when apps (like the GSM app) report things like “GSM sync burst not found” as events rather than conditions, which is actually fairly common</p> <p>Note that the repeat count is unavailable over SCPI</p>
Time	Shows the most recent time (including the date) at which the event occurred. Time is displayed to the second

To understand the History dialog, and to properly program the instrument's messaging system, remember that there are two types of occurrences, events and conditions:

- An event is an occurrence of zero duration. Events generate messages which are displayed in the center of the display for a period of time and then fade away. These may be of an advisory nature or may represent errors, for example “No

peak found”

- A condition is an occurrence of finite duration, that is, it has a start and an end. Conditions are states of the analyzer characterized by some combination of settings or some kind of failure that the user needs to be told about while it is happening, but then can stop being told once it goes away; for example “Input overload; ADC over range”

The error queue contains error events as well as the DETECTED and CLEARED events for condition errors, as seen in the figure above.

DETECTED events have numbers less than 1000 and CLEARED events have the same number plus 1000. For example,

301, Meas Uncal – DETECTED

and later

1301, Meas Uncal – CLEARED

To detect a condition error over SCPI, you should read the error queue and note any DETECTED error which is not followed eventually by an associated CLEARED error. This means the condition is still in effect. It is not sufficient to simply read the error queue until you get “No Errors” back. You may still have the condition error; the condition may still be in effect, and if that is the case, all you have done by clearing the error queue is to remove the first event (the DETECTED event) from the queue. For a condition error, you have to read the error queue until you see the CLEARED event for that condition. THEN you know that the condition is gone.

Current Conditions

The **Current Conditions** display shows all of the open conditions in the instrument. An open condition is a condition error or warning for which a start (detected) event has occurred but for which no corresponding stop (cleared) event has occurred.

An example of the Current Conditions screen appears below:

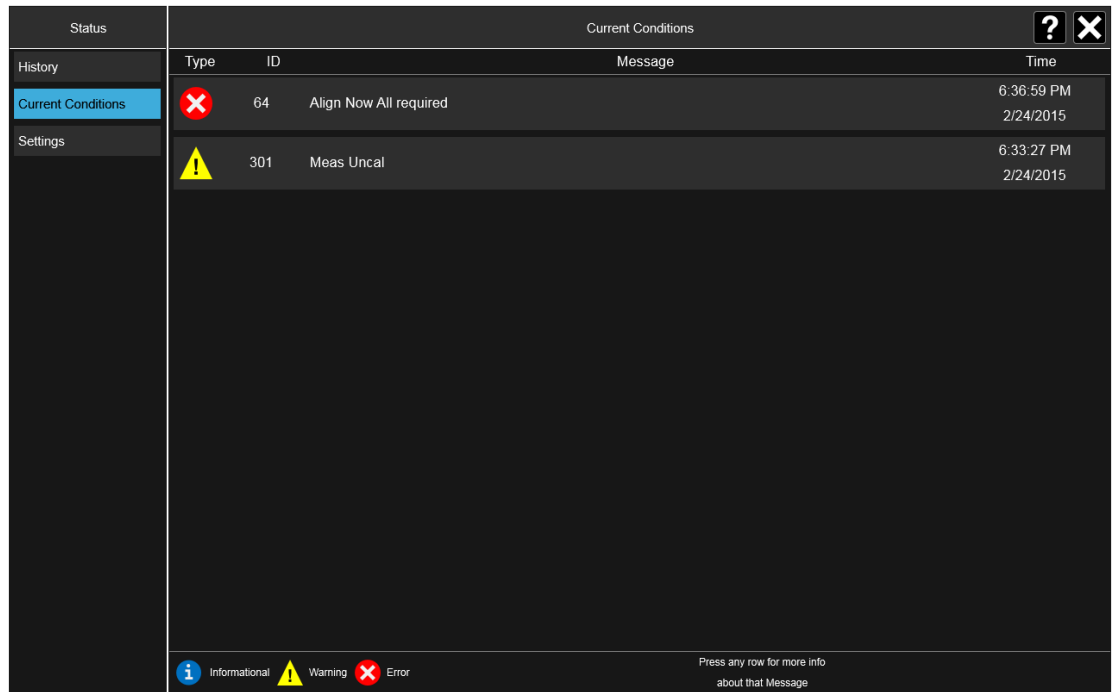

The fields on the Current Conditions display are:

- Type** Displays the icon identifying the event or condition as an error or warning or informational
- ID** Displays the error number
- Message** Displays the message text
- Time** Shows the most recent time (including the date) at which the event occurred. Time is displayed to the second

Touching a condition message expands the display of that message. Touching again collapses it. The description is the same as the one that appears on the message dialog. An example of this is shown in the History section, below.

When there are no open conditions, the display is as shown below:

2 User Interface
2.15 Status Bar



2.16 Block Diagram

When you press the Block Diagram button in the "Control Bar" on page 110, the display changes to a stylized pictorial representation of the current internal hardware setup and signal processing path. When you touch one of the blocks on the Block Diagram, the corresponding menu panel opens.



When you press the Block Diagram button, the display changes to a stylized pictorial representation of the current internal hardware setup and signal processing path. When you touch one of the blocks on the Block Diagram, the corresponding menu panel opens.

While in the Block Diagram display, the button is blue colored, as:



To exit the Block Diagram display, tap the button again.

The Block Diagram display is not meant to be a completely accurate representation, but one which can show differences as you change the hardware setup. For example, here is the basic RF Block Diagram:

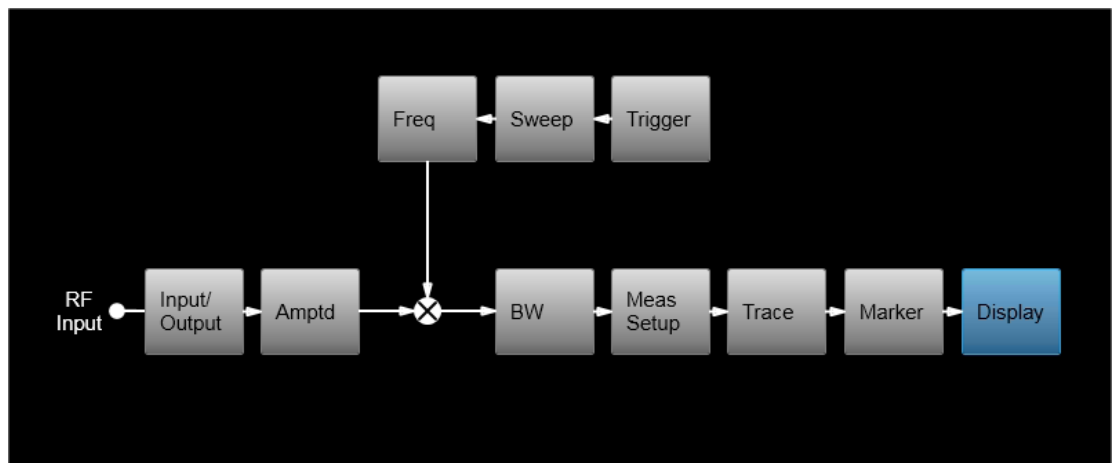

And here is the Block Diagram when External Mixing is selected:

2 User Interface
2.16 Block Diagram

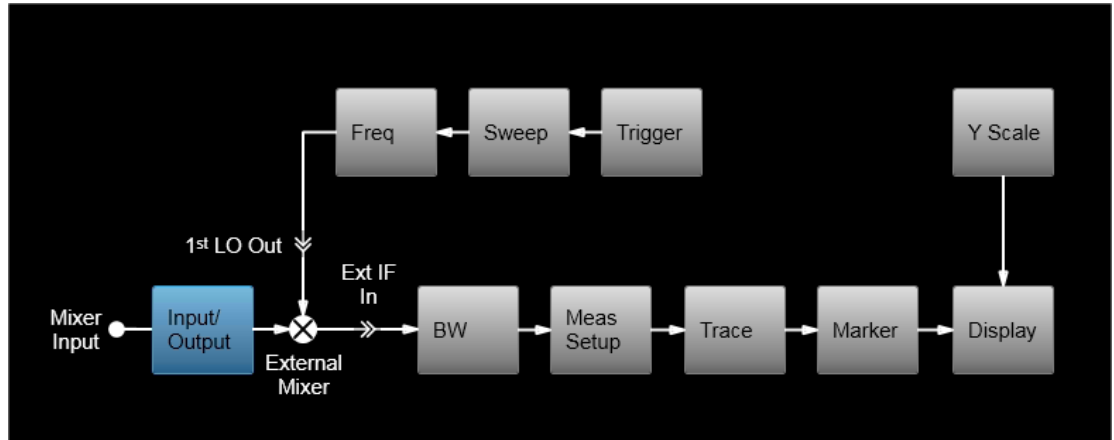

And here is the Block Diagram when the I/Q inputs are selected:

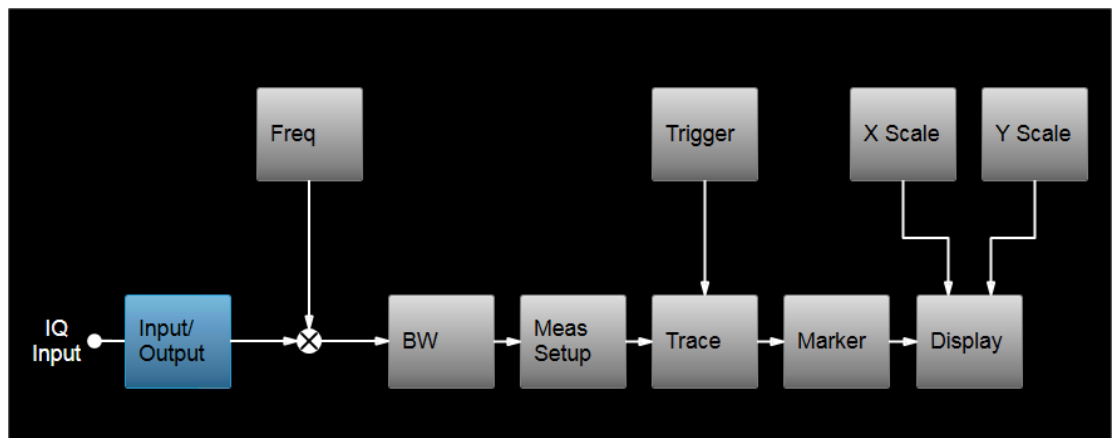

2.17 View Editor

This section describes the use of the View Editor, which allows you to:

- Add windows to and delete windows from the current measurement
- Resize and rearrange windows
- Create User Views

User Views are custom Views that you create by adding, deleting, rearranging, resizing, or changing the contents of the windows in an existing View, and then saving the edited View as a new View. The instrument lists the current User Views for a measurement after the Predefined Views, in the Mode/Meas dialog and on the View menu panel under Display:

ent	View
	Basic Meas Summary RB Slot Meas Subcarrier Meas MIMO Summary Cross Carriers Summary
	User View
	My New View

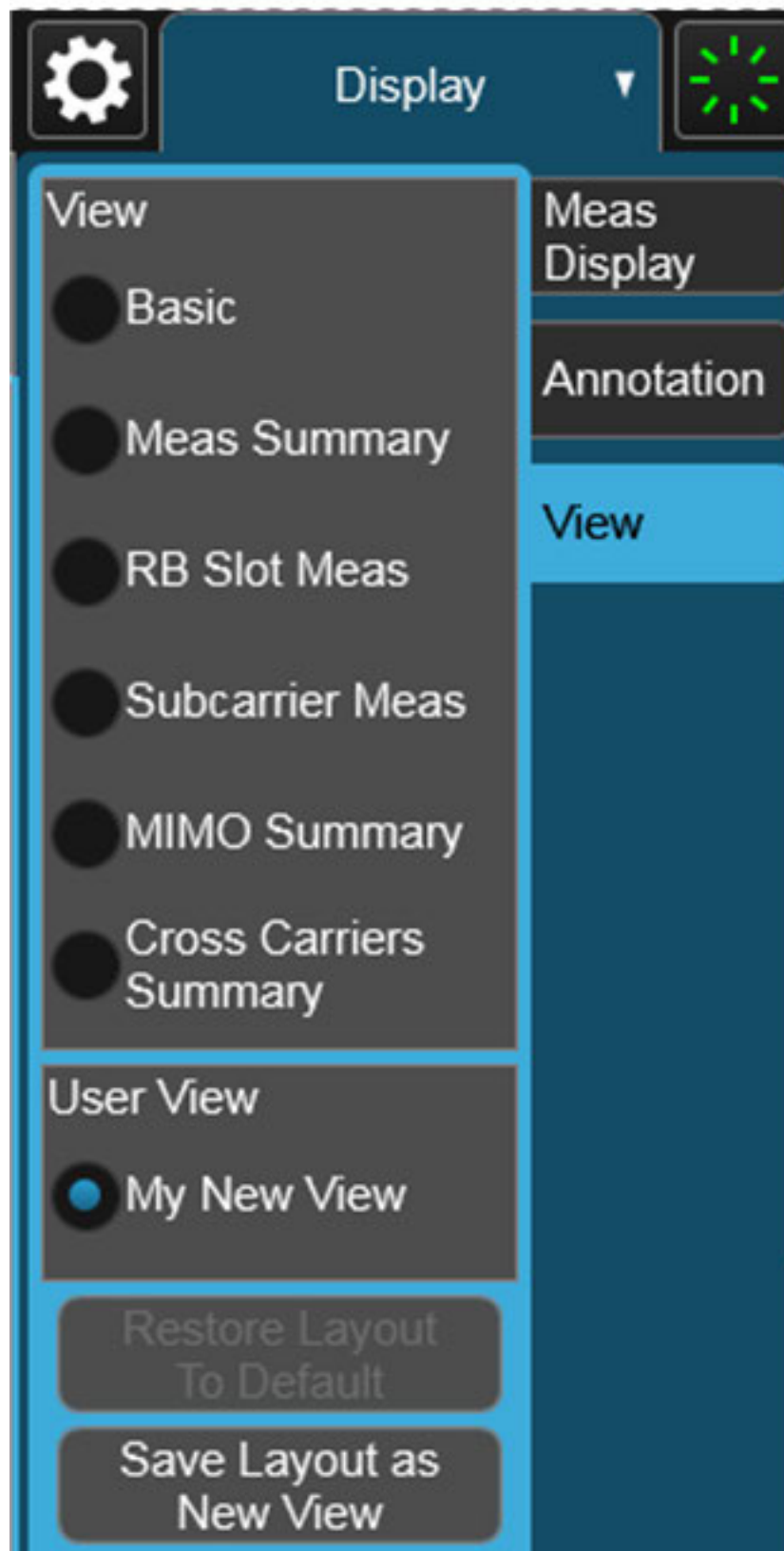

You can save an edited View using the **Save Layout as New View** control in the View menu (see ["To Save a User View" on page 142](#)).

On occasion, the instrument may automatically save an edited View for you. If you have edited a View, so that the * is displaying next to the View name, you must save that View as a User View before you save State or switch measurements. If you forget that you have made changes to a View, then to keep from losing your edited View when you switch measurements, the instrument will save it for you. If you have an edited View that has not been saved and you try to do any of the following:

- Enter the "Save" menu
- Switch Measurements
- Switch Modes
- Switch Screens

the edited view will be saved for you with the name "Autosaved". When this happens, you will receive the following message:

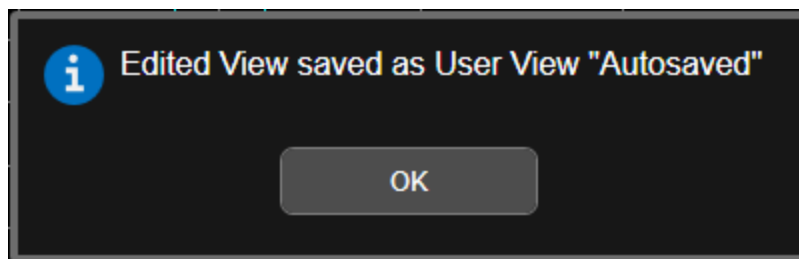

If an Autosaved User View already exists, the User View called "Autosaved" will be overwritten with the currently edited view. If you have multiple edited views, the selected edited view will be Autosaved. If there is not an edited view selected the last selected edited view will be Autosaved.

To Open the View Editor



Pressing the View Editor button (shown above) in the ["Control Bar" on page 110](#), at the bottom right of the screen, opens the View Editor.

While in the View Editor, the icon is blue colored, as:



Pressing the View Editor button again exits the View Editor.

To Close the View Editor

Tap the View Editor button again.

The user chooses the desired View through the use of the Mode/Meas/View dialog (see ["Mode/Meas/View Dialog" on page 62](#)) or the View menu (a tab under the **Display** key). The View menu allows the user to browse the views in the current measurement. The View menu contains a list of Predefined Views for you to use. If you wish to modify a Predefined View or create your own, new View, you use the View Editor.

User Views & Predefined Views

A User View is any View that is not in the list of predefined Views for the current measurement. For example, the Swept SA measurement has four predefined Views: Normal, Spectrogram, Zone Span, and Trace Zoom.

User Views allow you to add, delete, change and rearrange the windows of a predefined View, creating a new custom view.

2.17.1 To Create a User View

Whenever you add or delete a window to/from a predefined View, or change what is being displayed in a Predefined View's window, the Predefined View is marked with an asterisk (*), to show that it has been modified.

For example, to edit the View shown below, you press the Edit View icon.

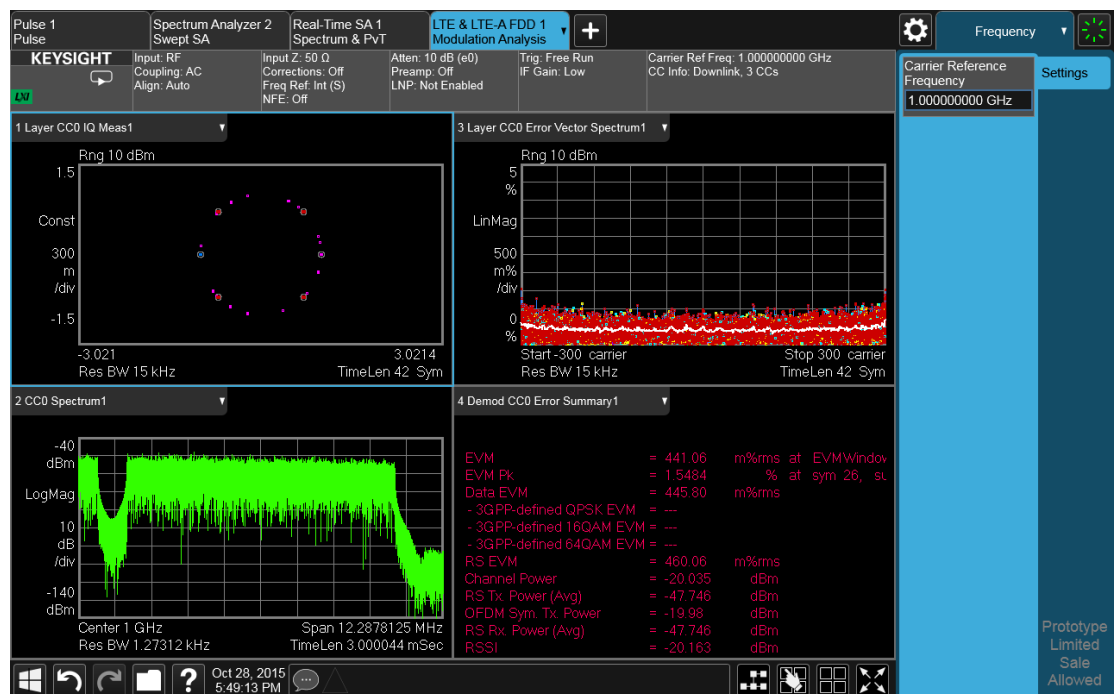

2 User Interface

2.17 View Editor

When you do this, you get the View Editor screen, which appears as below. The menu panel switches to the View menu. Here we see that we are in the Predefined View called “Basic”.

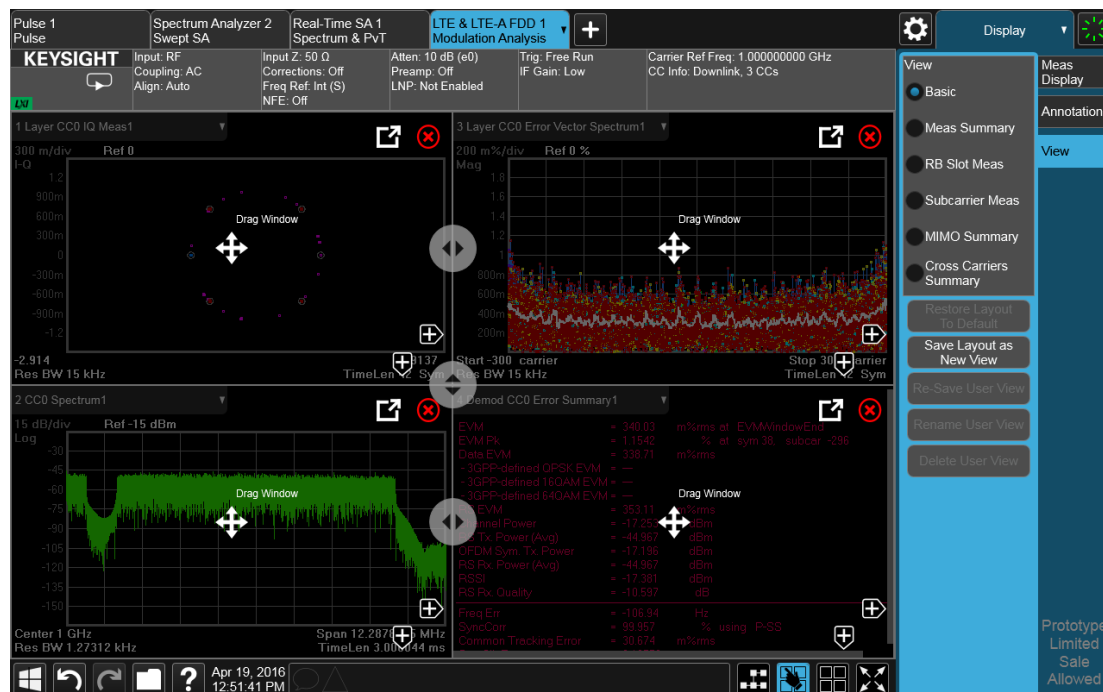

Each window has two arrows containing + signs. Pressing either of the “+” symbols adds a new window on that side. For example, let’s say you press the + symbol on the right of the lower left window:

You would then see this:



A fifth window has been added, and is automatically assigned the number 5. (The window number, which is displayed in the Window Title region, is used when sending SCPI commands to that window).

Note the * that now appears next to Basic in the View menu, indicating that you are now in the **modified** Basic View. You see the * if you add, delete or rearrange windows, but simply resizing windows does not display the *. The * means you are in a modified View, which must be saved as a User View before you leave the measurement (if you don't save it, the instrument will save it for you).

Note also that the Restore Layout to Default control is no longer grayed out. If you press this control it restores the Basic View to its default state. Restore Layout to Default becomes available when you add, delete or rearrange windows **and** when you resize them; otherwise it is grayed out.

You can add more windows with the “+” arrow symbols. Note that the “+” arrow symbols only appear if the current measurement has more windows available to display. If you are already displaying all the measurement's windows, the “+” symbols disappear.

You can exit the View Editor by again tapping the Edit View icon.

You can specify which result you want to see in the new window by tapping its title region.

2 User Interface

2.17 View Editor

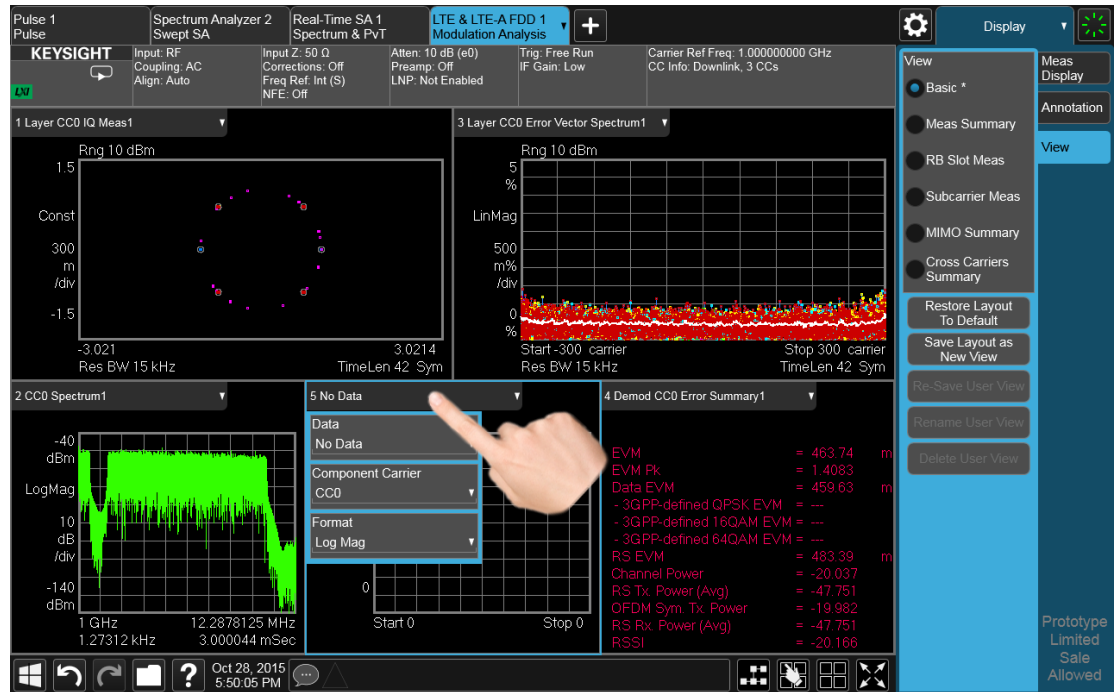

A panel drops down, containing a Data control for specifying window results. Some measurements, such as LTE-A in this example, also provide controls on this dropdown for specifying other window parameters, such as the Component Carrier and Data Format. Tap the Data control and you will see a list of available results for the window. In some cases, as in LTE-A, this will be a cascading list, due to the number of results available:

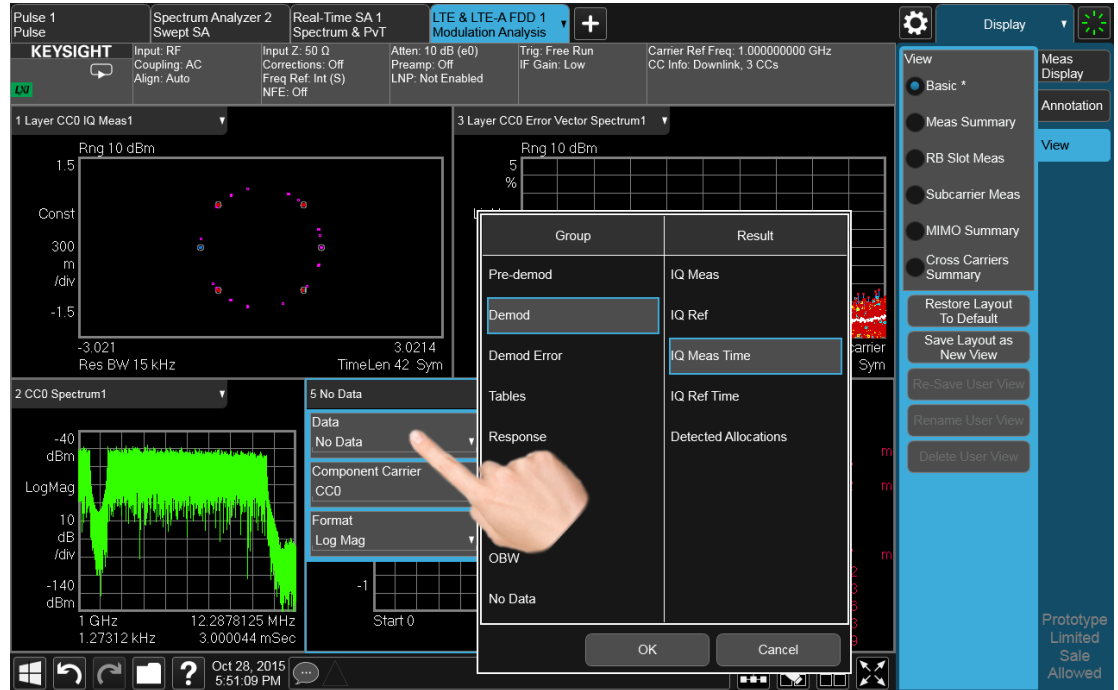

Choose the result you want and tap OK. Here we have chosen IQ Meas Time from the Demod group:



Your new, edited User View is now ready to use.

2.17.2 To Resize or Rearrange Windows in a View

Sometimes you may wish to resize a window. To do this go back into the View Editor and note the large, translucent white circles along the edges of the draggable borders. These are the “resize handles”. You can resize the windows by dragging these handles. Note that in their quiescent state they are slightly translucent; when you touch one it turns solid white, indicating that it is draggable. If you touch and drag one of them it moves the axis to which it is attached.

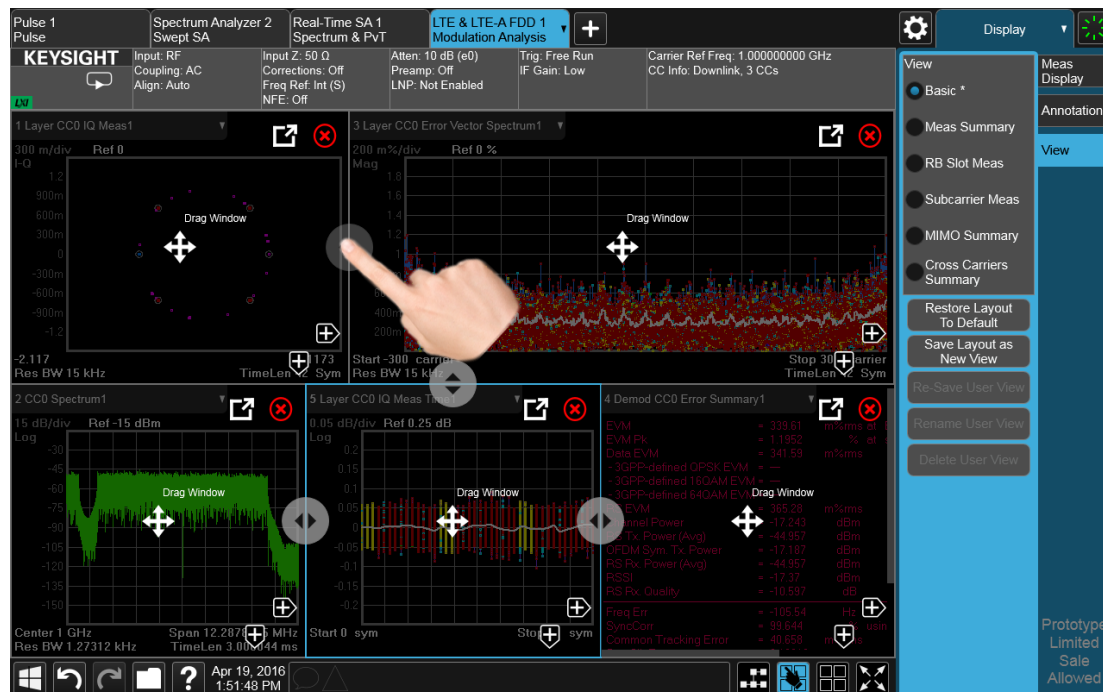

Another feature that comes with the View Editor is the ability to move windows around. You do this by dragging the four-arrow objects in the center of the window; the whole window goes along. Actually you can touch and drag anywhere in the window (except on one of the arrows or the delete circle) and it will drag, but the four-arrow objects give you an indication and a convenient finger target.



The outline of the window appears as it is being dragged. When you start to drag a window, target symbols appear in the other windows:



If you drop a window on one of the targets, it swaps positions with the target window. If you drag a window's center into another window, green stripes appear on the edges to show you where the window will go when you release it:

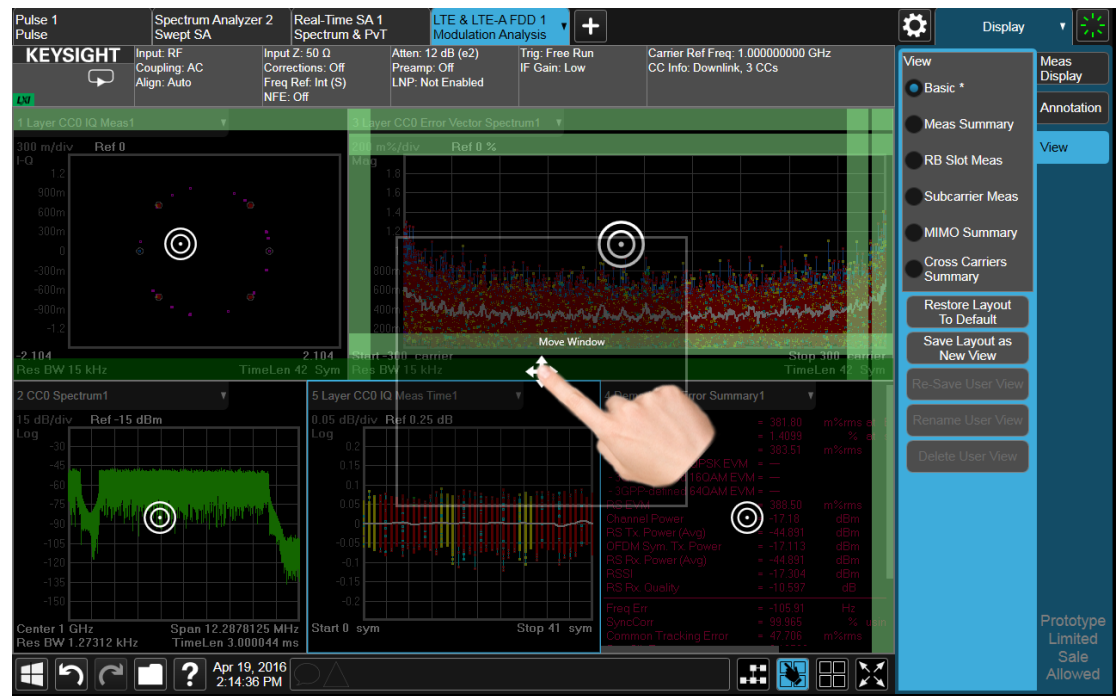

2 User Interface

2.17 View Editor

When you hover over one of the stripes it gets dimmer, to show the position the window being dragged will take on. If you release a window over an inner stripe, the window you are dragging and the window over which you were hovering resize to share the space the target window originally occupied. If you release a window over an outer stripe, as shown below, the window you are dragging takes on a new position outside the array of other windows:

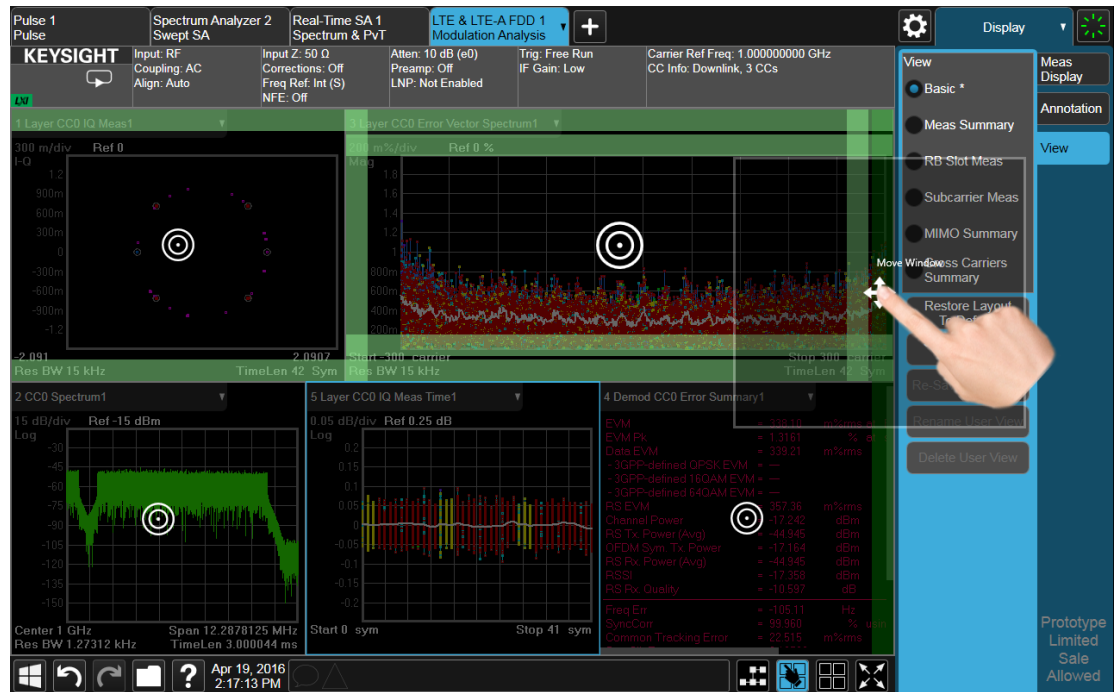

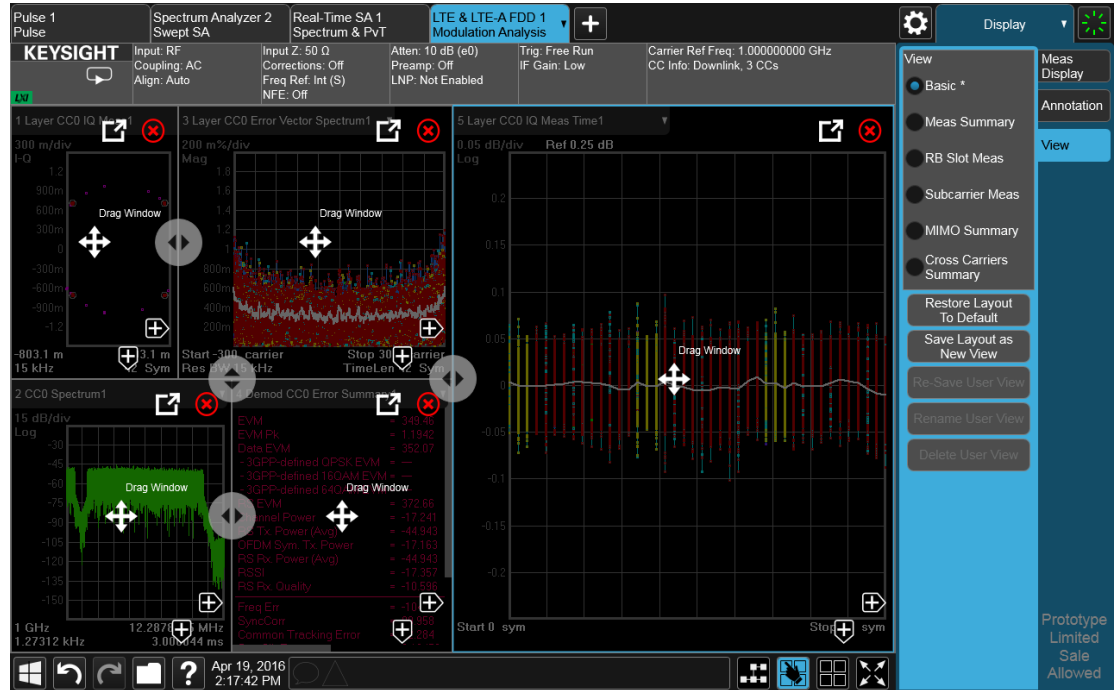

In either case, one or more of the remaining windows resize to occupy the space formerly occupied by the window you were dragging.

2.17.3 To Delete a Window from a View

The View Editor also lets you delete a window. To do this, tap one of the circled red X's, as shown below.

There has to be more than one window for you to see the circled red Xs.

2 User Interface

2.17 View Editor

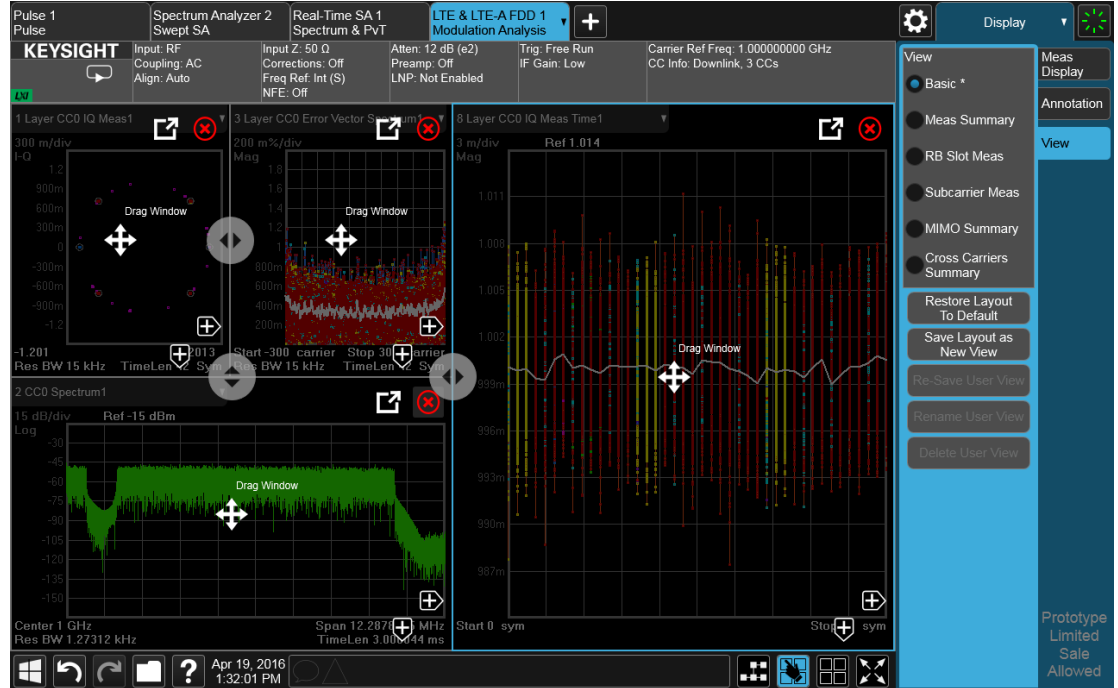

Now press the View Editor button (the blue hand) to exit the View Editor. At this point, you have an edited Predefined View, as shown by the * next to Basic:

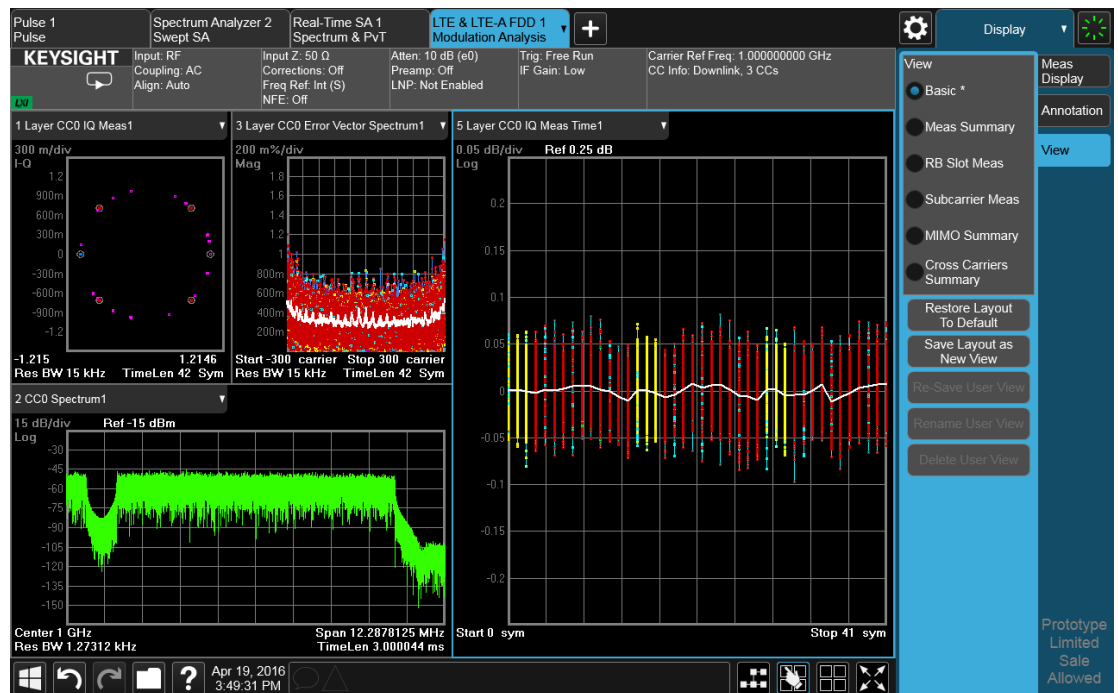

When you are finished with it, you can restore the Layout to the default for Basic by pressing “Restore Layout to Default”. Or you can save your edited View as a “User

View” (if you exit the measurement without saving the edited View, the instrument will save it for you as a User View called “Autosaved”).

If you clone the current Screen by pressing the “+” tab, the modified Predefined View will be saved as a User View called “Autosaved”, and it will be available in the new Screen.

2.17.4 To Save a User View

See also "[Transferring User Views Between Instruments](#)" on page 144

To save your new View as a User View, tap the “Save Layout as New View” control. You will get an alpha keyboard that lets you name your new View; the default is the old View name with a number. Below, we have typed in “My New View”:

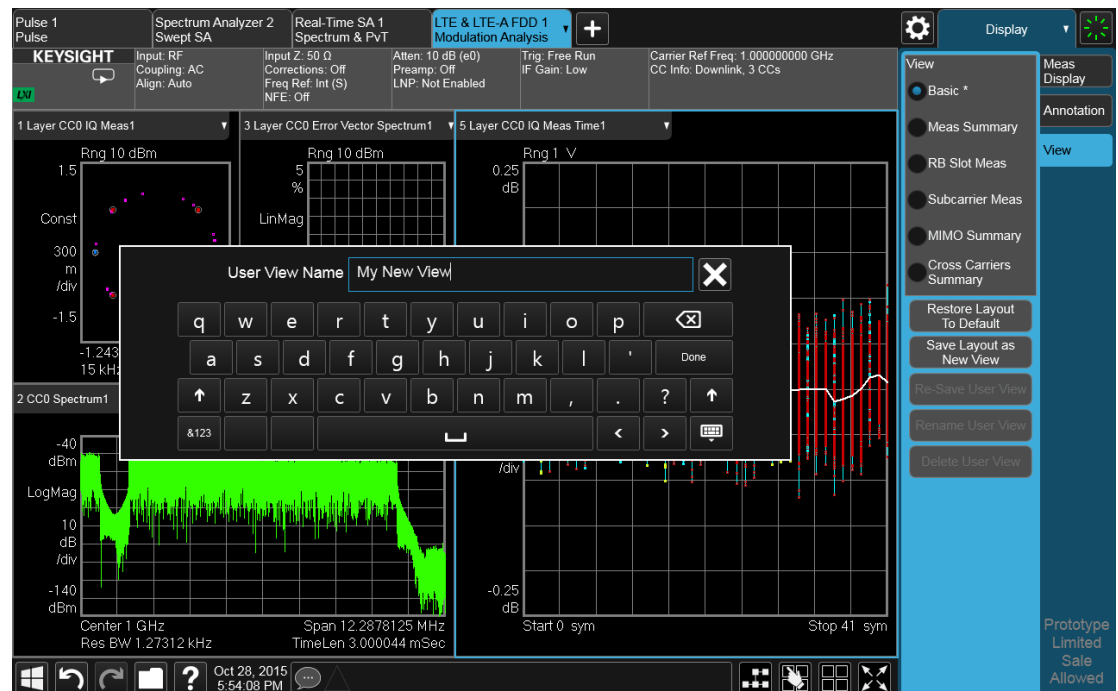

When you tap “Done”, the View is saved:

2 User Interface

2.17 View Editor

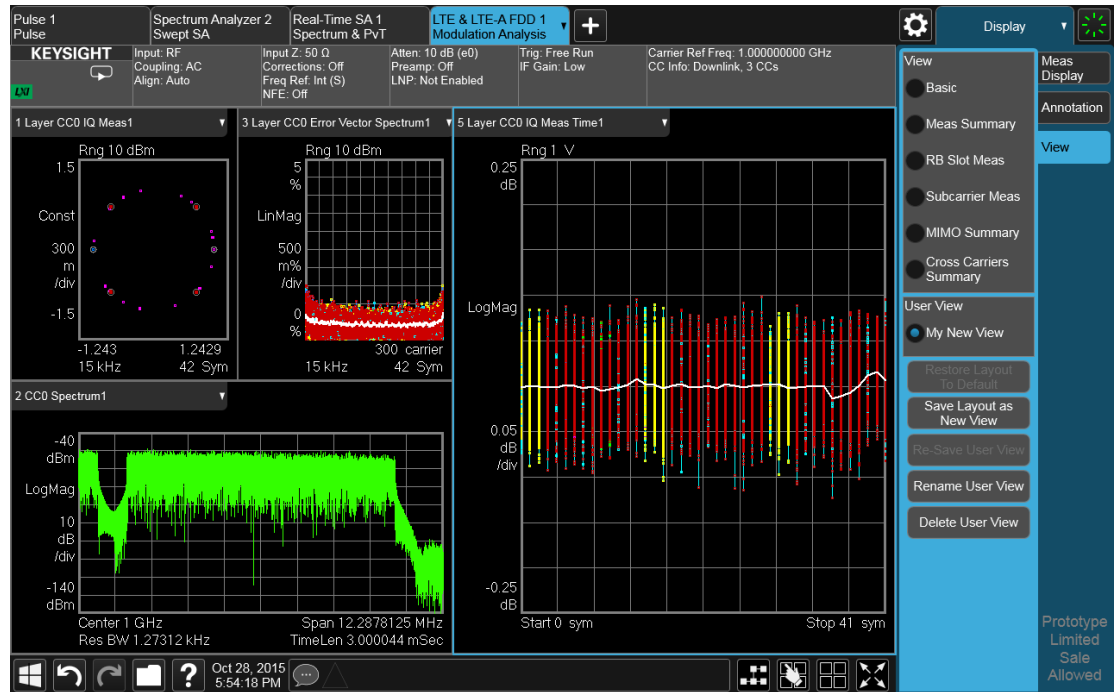

Notice the User View region which has appeared on the menu panel above, with the new User View called “My New View. Notice also that “Basic” has returned to its original, unedited state and the * is gone from its name. Note also that “Restore Layout to Default” is grayed out. Note also that if you go to the Mode/Meas dialog, you will see the User View there as well:

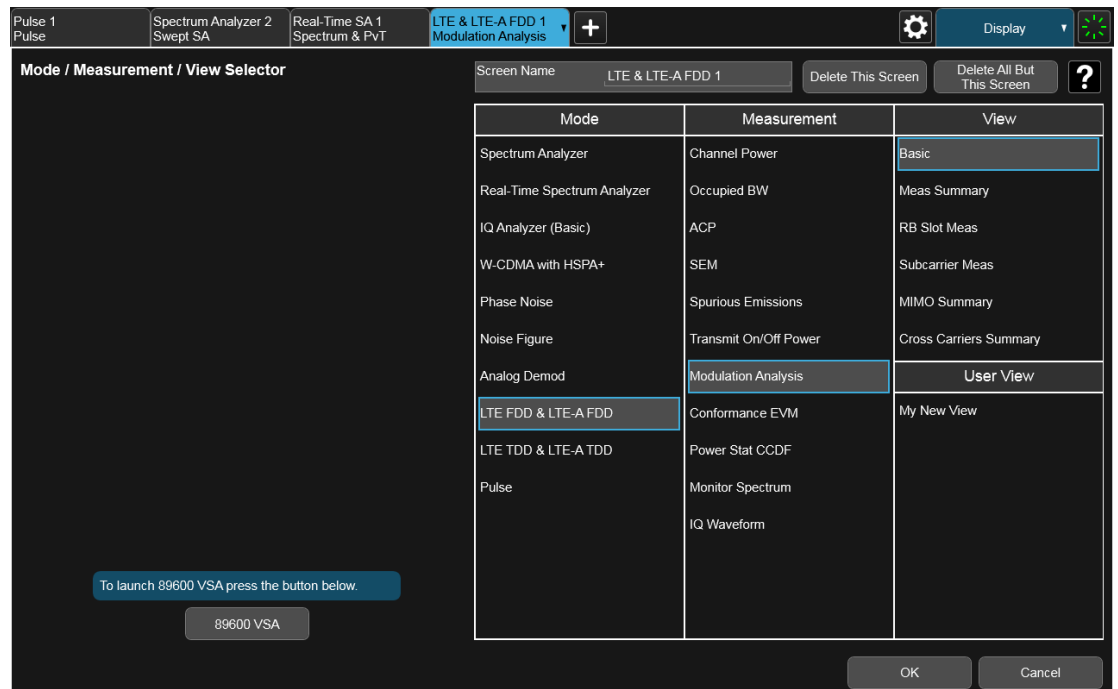

When naming a new View, you must choose a name that is not already in use for any User View in any measurement; this is because User Views get written to permanent memory and are available to all instances of the Measurement in any screen. They survive a Mode Preset and also survive shutdown and restart of the application.

Transferring User Views Between Instruments

To transfer a User View to another instrument, you must copy the desired file to a portable drive or to your network and then copy it to the target instrument.

When you save a User View, a file is created (or updated if it already exists) containing all the User Views for the current measurement. All of these files are saved on the D: drive in the instrument, in the folder:

`D:\Users\Instrument\My Documents\UserViews`

(assuming you are logged in as Instrument, which is the default).

Look for the file for your measurement. The file naming convention is:

`ModeName.MeasName.layout`

Where **ModeName** is the long-form SCPI parameter for the `:INST:SEL` command for your Mode, and **MeasName** is the long-form SCPI parameter for the `:CONF` command for your Measurement.

For a full list of all **ModeName** parameters, see **Index to Modes** in "Mode" on page 63.

The following is a full list of all **MeasName** parameters.

Measurement Name	SCPI ID
ACP, Adjacent Channel Power	<code>ACPower</code>
AM	<code>AM</code>
AM Depth	<code>AMD</code>
Amplitude Probability Distribution	<code>APD</code>
Audio Distortion	<code>AUDDist</code>
Audio Frequency	<code>AUDFreq</code>
Audio Level	<code>AUDLevel</code>
Audio SINAD	<code>AUDSinad</code>
Automatic Direction Finder	<code>ADF</code>
Channel Power	<code>CHPower</code>
Code Domain	<code>CDPower</code>
Combined GSM	<code>CGSM</code>
Combined WCDMA	<code>CWCDma</code>
Complex Spectrum	<code>SPECTrum</code>
Conformance EVM	<code>CEVM</code>
Custom OFDM	<code>OFDM</code>

2 User Interface
 2.17 View Editor

Measurement Name	SCPI ID
Digital Demod	DDEMod
Disturbance Analyzer	DANalyzer
EDR In-band Spurious Emissions	IBSPurious
EVM	EEVM
Fast Capture	FCAPture
Fast Spectrum	FSPectrum
FM	FM
FM Deviation	FMDeviation
FM Stereo	FMStereo
Frequency Counter	FCOunter
Frequency Scan	FSCan
GMSK Phase & Freq Error	PFERror
Group Delay	GDELay
Harmonics	HARMonics
HRP UWB Demodulation	HUWB
Instrument Landing System	ILS
IQ Waveform	WAVEform
LE In-band Emissions	IBEMissions
List Power Step	LPSTep
List Sequencer	LSEQuencer
List Sweep	LIST
Log Plot	LPLot
LoRa (CSS) Demodulation	LORA
Marker Beacon	MBE
Mod Accuracy	RHO
Modulation Analysis	EVM
Modulation Distortion	MODDist
Modulation Rate	MODRate
Modulation SINAD	MODSinad
Monitor Spectrum	MONitor
Noise Figure	NFIGure
Occupied BW /	OBWidth
Output Spectrum BW	
Output RF Spectrum	EORFspectr
Phase and Amplitude vs Time	PAVTime

Measurement Name	SCPI ID
PM	PM
PM Deviation	PMDeviation
Power Amplifier	PAMplifier
Power Control	PCONtrol
Power Stat CCDF	PStatistic
Power vs Time	EPVTime
Pulse	PULSe
QPSK EVM	EVMQpsk
Real Time Scan	RTSC
RF Power	RFPower
SEM	SEMAsk
Spectral Flatness	FLATness
Spectrum & PVT	RTSA
Spot Frequency	SFRequency
Spurious Emissions	SPURious
Streaming	STReaming
Strip Chart	SCHart
Swept SA	SANalyzer
TOI	TOI
Transmit Analysis	TX
Transmit On/Off Power	PVTime
Transmit Power (Burst Power)	TXPower
Tuned RF Level	TRFLevel
Tuned RF Level with Tracking	TTRF
Tx Band Spur	ETSPur
VHF Omni-Directional Range	VOR

Examples:

- The User View file for the Swept SA measurement is [SA.SANalyzer.layout](#)
- The User View file for the ACP measurement in the WCDMA mode is [WCDMA.ACPower.layout](#)

Copy the desired file to a thumb drive or to your network. Then go to the target instrument and copy the file into the [D:\Users\Instrument\My Documents\UserViews](#) directory on that instrument (again, assuming you are logged in as Instrument).

Note that copying this file to another instrument will overwrite the file already in that instrument, if any, and will destroy any User Views that might have been created on that instrument.

Note that when you delete the last User View for a measurement, the file is removed.

2.17.5 To Rename a User View

You can rename a User View by selecting that View and tapping “Rename User View.” You can also re-edit a User View; if you do this, an asterisk will appear next to the User View’s name. You can then tap “Re-Save User View to save it back to its existing name, or “Save Layout as New View” to add another, new User View.

2.17.6 To Delete a User View

You can delete a User View by doing the following:

1. From the **"Mode/Meas/View Dialog"** on page 62, or from the **View** menu, select the User View that you want to delete
2. Switch to the **Display** menu
3. Select the **View** tab
4. Tap **Delete User View**

2.17.7 To Delete All User Views

You can delete all User Views by tapping “Delete All User Views.” The default view becomes the current view for the Measurement if a User View was the current view when this control was pressed.

2.17.8 Use Case: Displaying Marker and Peak Tables

One common application for User Views is to create a View that allows the Spectrum Analyzer to display both a Marker Table and a Peak Table at the same time. To do this, simply add a Marker Table Window and a Peak Table window to the Spectrum window of the Swept SA measurement. The result is shown below; note that the new View has been named “Marker Table & Peak Table”:

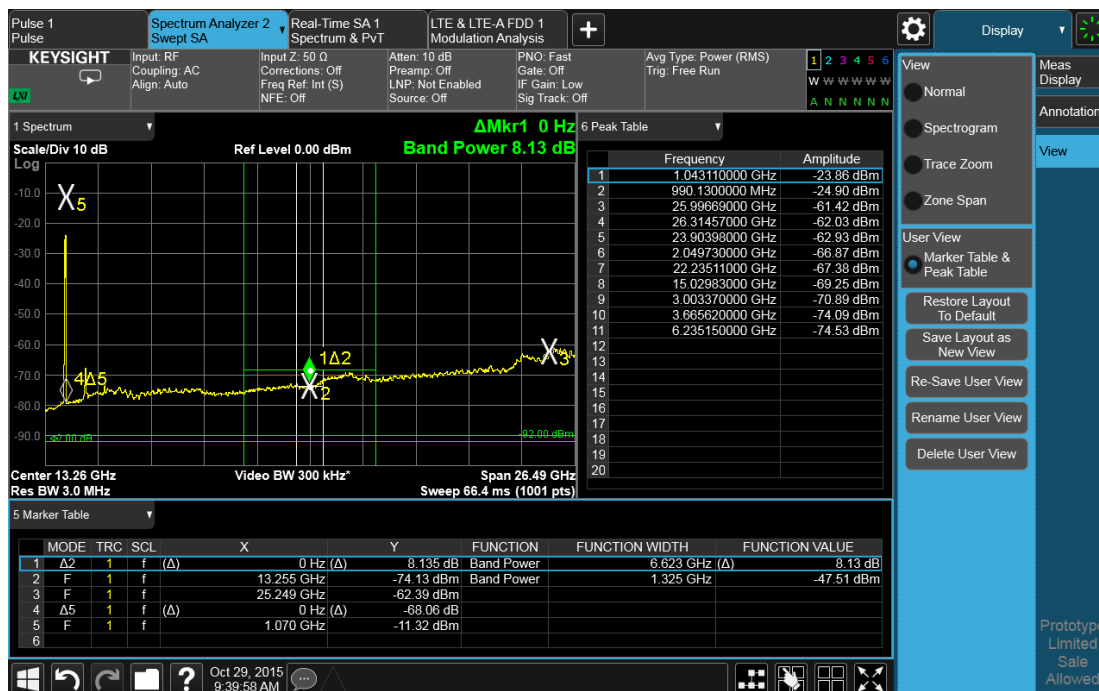

NOTE: There are legacy displays like Marker Table, Peak Table, Measure at Marker and Gate View, which are not Views but special display modes. These are retained for backwards compatibility, however they are turned on and off with switches and do not use the View system. Turning on one of these switches does not create a modified View, it merely adds the specified window to the current View; turning the switch back off removes the window. While the switch is on, NO View shows as selected in the View menu. These switches are grayed out if you are in a modified View or a User View. Since only one of these switches can be on at a time, and because these switches turn off on a Preset, User Views offer a superior way of adding windows than using the switches.

Some measurements do not support User Views; these do not allow adding, deleting or rearranging windows, however they do allow resizing windows. In these measurements you can get into the View Editor but the Add icons, Delete icons and Move icons will not appear. You can still resize the windows and in some cases (e.g. Noise Figure) you can still change window contents.

2.17.9 View Editor Remote Commands

Remote Commands for User Views can be found in the documentation for the Display, View tab.

2.18 Multiscreen

You can configure up to 16 different Screens at a time. Normally, you only see one Screen, and the set of configured screens is shown across the top of the display in a series of "Screen Tabs" on page 61. Touching any screen's tab brings it to the foreground, makes it the current Screen and starts it updating.

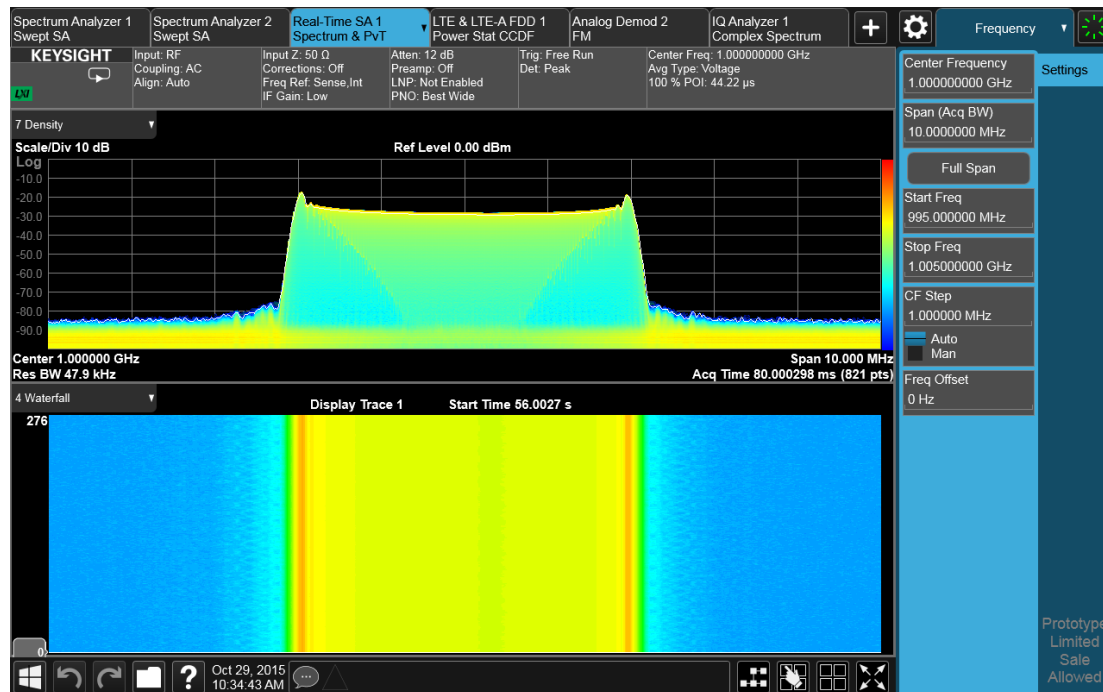

Multiscreen view lets you display all of the configured Screens at once.

You can switch to Multiscreen View by pressing this button in the "Control Bar" on page 110 at the bottom right of the screen:



Multiscreen View looks like this:

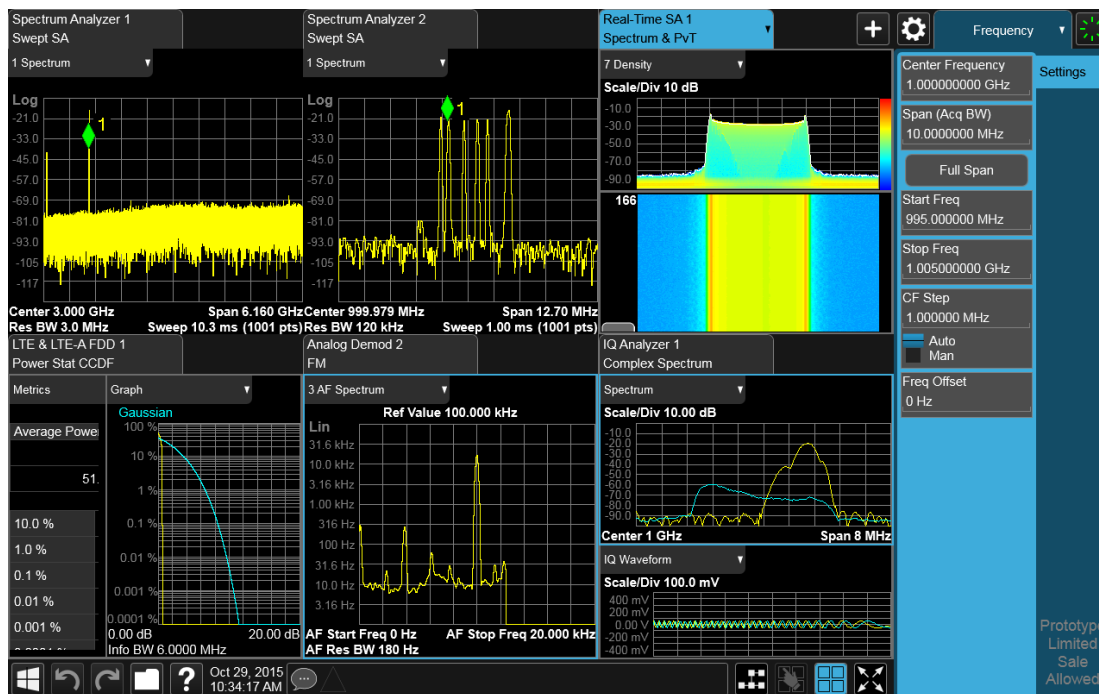

While in Multiscreen View, the button changes from a black background to a blue background:



To exit Multiscreen view, tap the button again.

Multiscreen View cannot be activated if only one screen is configured.

Each Screen contains one Mode, each Mode contains one Measurement, and each Measurement contains a number of Windows arranged in Views. You can configure multiple instances of the same Mode along with any combination of other Modes.

In Multiscreen View, just as in Single Screen View, only one screen is active.

You switch Screens by tapping the Screen Tab you want, or when in Multiscreen View, you can tap the Screen itself. When you switch Screens, the current Screen's state and measurement results are preserved, the new Screen's previous state and data are loaded, and the new Screen starts running its Mode.

In Multiscreen View:

- The Meas Bar does not display
- The Screens are presented in an array of equal size boxes, except where the number of Screens means some have to be different sizes (as when you have 3 Screens, 5 Screens, etc.).

- Each Screen has a tab that contains the name of the Mode and Measurement in the box and a number associated with the instance of that Mode. You can enter a custom Screen name that replaces the Mode name, by going into the Mode/Meas dialog
- There is always one and only one selected Screen. It is indicated by a blue tab. Only the selected Screen is actually running a measurement and updating its display
- The selected window in the selected screen is the context for the current menus. It is the only window on the display with a blue border
- As you go from screen to screen, each screen remembers the last menu that was active in that screen and restores it as the active menu

In Multiscreen View, as in Single Screen View, tapping the blue tab or pressing the Mode/Meas front panel key opens the ["Mode/Meas/View Dialog" on page 62](#) which allows you to change the Mode (or Measurement or View) being displayed in that Screen.

Remote Command	<code>:INSTRument:SCReen:MULTiple[:STATe] OFF ON 0 1</code> <code>:INSTRument:SCReen:MULTiple?</code>
Example	<code>:INST:SCR:MULT ON</code>
Notes	If only one screen is configured, attempting to set Multi-Screen ON generates the error “-221, Settings conflict; Multi-Screen requires >1 screen”
Preset	OFF
	For more information, see the following: <ul style="list-style-type: none"> – "Select Screen" on page 151 – "Screen List (Remote only command)" on page 152

2.18.1 Select Screen

You can select a screen by touching its tab or, in ["Multiscreen" on page 149](#) mode, touching the screen itself. Selecting the Screen activates the screen and suspends the previously selected screen (if any).

Remote Command	<code>:INSTRument:SCReen:SElect <screen name></code> <code>:INSTRument:SCReen:SElect?</code>
Example	<code>:INST:SCR:SEL "Baseband"</code>
Notes	If the <screen name> is specified but not found in the list of Screens, the error message “-224, Illegal parameter value; Screen Name not found” is generated If the display is disabled (via <code>:DISP:ENAB OFF</code>) then the error message “-221, Settings conflict; Screen SCPI cannot be used when Display is disabled” is generated

Preset	Returns the name of the active screen
--------	---------------------------------------

2.18.2 Screen List (Remote only command)

You can obtain a list of currently configured Screens. This permits your remote program to manage screens for selection, renaming, or deletion.

Remote Command	<code>:INSTrument:SCReen:CATalog?</code>
----------------	--

Example	<code>:INST:SCR:CAT?</code>
---------	-----------------------------

Notes	<p>The query response is a comma separated list of Screen Names. If only 1 Screen is configured, there is no trailing comma</p> <p>For R&S compatibility, the following query is also available:</p> <p><code>:INSTrument:SCReen:LIST?</code></p>
-------	---

Preset	Returns list of currently configured Screens
--------	--

2.19 Fullscreen

The Fullscreen button is in the "Control Bar" on page 110, at the lower right corner of the display.



When **Full Screen** is pressed the measurement window expands horizontally over the entire instrument display. The screen graticule area expands to fill the available display area.

It turns off the display of the menu panel, however the controls that drop down from the Meas Bar and on-screen annotation are still available, and you can still drag the trace and markers and perform a pinch zoom, so you can still operate the instrument.

Pressing **Full Screen** again while Full Screen is in effect cancels Full Screen.

You can get even more screen area for your data display by turning off the Meas Bar using the Annotation tab of the Display menu)

Full Screen is canceled by the **Preset** key.

Remote Command	<code>:DISPlay:FSCReen[:STATe] OFF ON 0 1</code> <code>:DISPlay:FSCReen[:STATe]?</code>
Notes	This was set to Off by :SYST:DEF MISC in MXA1, but not by Preset. It is no longer set Off by :SYST:DEF MISC, since it is now meas global instead of mode global
Preset	Unaffected by Preset but set to Off by Restore Misc Defaults or shutdown and restart
State Saved	Not saved in instrument state
Backwards Compatibility SCPI	<code>:DISPlay:MENU[:STATe] OFF ON 0 1</code> This emulates ESA full screen functionality, which is the same as the FSCReen command in PSA except that the sense of on/off is reversed (that is, OFF means the menus are OFF, so Fullscreen is ON) and the default is ON (meaning Fullscreen is OFF)
Backwards Compatibility Notes	In ESA/PSA, Full Screen was turned on with a softkey, so pressing any other key turned Full Screen off. In the X-Series, because a hardkey is provided to turn this function on and off, pressing any other key no longer turns off Full Screen

3 Bluetooth Mode

Bluetooth Mode provides embedded transmitter test application on X-Series platforms to achieve R&D test solutions.

The following Radio Standards are supported:

- Basic Bluetooth (BT)
- EDR (Enhanced Data Rate), which offers enhanced data rates by using Phase Modulation (DPSK) as well as Frequency Modulation (GFSK)
- Low Energy(LE), which is based on Basic Bluetooth but uses less power

Example	<code>:INST:SEL BT</code> <code>:INST:NSEL 228</code>
Dependencies	The mode must be installed and licensed in your instrument before it is available for use
Status Bits/OPC dependencies	Changing modes resets all SCPI status registers and mask registers to their power-on defaults. Therefore, event or condition register masks must be re-established after a mode change

3.1 Measurement Commands

The commands for selecting each measurement are shown below. The commands relating to the Views and Windows for each measurement are described in the documentation for each measurement.

Example	<p><code>:CONFigure:ACPower</code></p> <p>Selects Adjacent Channel Power measurement. This is a special Bluetooth version of Adjacent Channel Power, not the same as the ACP Power Suite measurement</p> <p><code>:CONFigure:OBWidth</code></p> <p>Selects Output Spectrum BW (OBW). This measurement is the same as the OBW measurement in the Power Suite, which appears in several Modes</p> <p><code>:CONFigure:MONitor</code></p> <p>Selects Monitor Spectrum measurement from the Power Suite</p> <p><code>:CONFigure:TX</code></p> <p>Selects Transmit Analysis measurement</p> <p><code>:CONFigure:IBEM</code></p> <p>Selects LE In-band Emissions measurement</p> <p><code>:CONFigure:IBSP</code></p> <p>Selects EDR In-band Spurious Emissions measurement</p>
Preset	<code>TX</code>
State Saved	Instrument State

3.2 Transmit Analysis Measurement

Transmit Analysis is a measurement that combines multiple measurements in a single package. If Radio Std is Basic or Low Energy, it includes Output Power, Modulation Characteristics and ICFT (Initial Carrier Frequency Tolerance). If Radio Std is EDR, it includes Relative Transmit Power, Differential Phase Decoding, Carrier Frequency Stability and Mod Accuracy.

The goal of this measurement is to provide all necessary measurement results at once in the fastest time.

Measurement Commands

The general functionality of ["CONFigure" on page 1488](#), ["INITiate" on page 1489](#), ["FETCh" on page 1489](#), ["MEASure" on page 1491](#), and ["READ" on page 1490](#) are described in the section **SCPI Operation and Results Query** in the topic **Programming the Instrument**.

The following measurement commands and queries are used to configure the measurement:

<code>:INITiate:TX</code>	Initiates a trigger cycle for the TX measurement, but does not return any data. You must then use <code>:FETC:TX[n]?</code> to retrieve data Does not change any measurement settings
<code>:CONFigure?</code>	Returns the long form name of current measurement, in this case, TX
<code>:CONFigure:TX</code>	Selects TX measurement with Meas Setup settings in preset state – same as "Meas Preset" on page 258
<code>:CONFigure:TX:NDEFault</code>	Selects TX measurement <i>without</i> affecting settings

The following queries are used to retrieve the results (see ["Remote Command Results" on page 156](#)):

<code>:FETCh:TX?</code>	Retrieves the data specified by n
<code>:MEASure:TX [n]?</code>	Switches to TX measurement, restores default values, starts the measurement, then retrieves the data specified by n
<code>:READ:TX[n]?</code>	Starts the measurement, then retrieves the data specified by n

Remote Command Results

All scalar results for this measurement are contained in one table, and there is one equivalent subopcode for the remote results. Remote users can use this equivalence by visually inspecting the corresponding summary trace on the display, or by using

3 Bluetooth Mode
3.2 Transmit Analysis Measurement

:CALC:DATA queries, which programmatically describe the corresponding summary traces.

The following table describes the results returned by the **:FETCh**, **:MEASure**, and **:READ** queries listed above, according to the index value **n**.

n	Return Value
0	The captured raw data
1	Returns 27 comma-separated scalar results <ul style="list-style-type: none"> - Results 1 - 12 apply to Basic or Low Energy packets - Results 13 - 24 apply to EDR packets - Results 1-2 and 14-19 apply to QHS packets - Results 26 - 27 are the common results

As the packet type is auto-determined, the results for the signal being analyzed will be computed. Any results that are not available return 9.91E+37 (**NaN**)

Results are returned in the following order:

#	Item	Unit, if any
1	GFSK Avg Power/Avg Packet Power	dBm
2	GFSK Peak Power/Peak Packet Power	dBm
3	$\Delta f1$ Avg	Hz
4	$\Delta f2$ Avg	Hz
5	Min $\Delta f1$ Max	Hz
6	Max $\Delta f1$ Max	Hz
7	Min $\Delta f2$ Max	Hz
8	Max $\Delta f2$ Max	Hz
9	$\Delta f2 > 115$ kHz	
10	$\Delta f2$ Avg/ $\Delta f1$ Avg	
11	ICFT for Basic Freq offset for LE	Hz
12	Max Frequency Drift	Hz
13	Max Drift Rate	Hz
14	Freq Offset ω_i	Hz
15	Freq Offset ω_o	Hz
16	Freq Offset $\omega_i + \omega_o$	Hz
17	RMS DEVM	%

n Return Value

#	Item	Unit, if any
18	Peak DEVM	%
19	99% DEVM for EDR/QHS modulation	%
20	GFSK Avg Power	dBm
21	DPSK Avg Power	dBm
22	Relative Power (DPSK Avg Power - GFSK Avg Power)	dB
23	BER	%
24	Bit Errors	
25	Guard Interval	s
26	Packet Type*	
27	Payload Length	bits

- 2 Demod Waveform trace/ Demod IQ trace
- 3 Block frequency error trace
- 4 Block RMS DEVM trace
- 5 Block Peak DEVM trace
- 6 Returns comma-separated scalar results for Basic or Low Energy packets

Results are returned in the following order:

#	Item	Unit, if any
1	Packet Type*	
2	Payload Length	bits
3	Max GFSK Avg Power	dBm
4	Min GFSK Avg Power	dBm
5	Avg GFSK Avg Power	dBm
6	Max GFSK Peak Power	dBm
7	Min GFSK Peak Power	dBm
8	Avg GFSK Peak Power	dBm
9	Max $\Delta f1$ Avg	Hz
10	Min $\Delta f1$ Avg	Hz
11	Avg $\Delta f1$ Avg	Hz
12	Max $\Delta f2$ Avg	Hz
13	Min $\Delta f2$ Avg	Hz
14	Avg $\Delta f2$ Avg	Hz
15	Max $\Delta f1$ Max	Hz
16	Min $\Delta f1$ Max	Hz

3 Bluetooth Mode
3.2 Transmit Analysis Measurement

n	Return Value		
#	Item	Unit, if any	
17	Max Δf_2 Max	Hz	
18	Min Δf_2 Max	Hz	
19	Max value of $\Delta f_2 > 115$ kHz		
20	Min value $\Delta f_2 > 115$ kHz		
21	Avg value $\Delta f_2 > 115$ kHz		
22	Max value of Δf_2 Avg/ Δf_1 Avg		
23	Min value of Δf_2 Avg/ Δf_1 Avg		
24	Avg value of Δf_2 Avg/ Δf_1 Avg		
25	Max ICFT for Basic Max Freq offset for LE	Hz	
26	Min ICFT for Basic Min Freq offset for LE	Hz	
27	Avg ICFT for Basic Avg Freq offset for LE	Hz	
28	Max value of Max Frequency Drift	Hz	
29	Min value of Max Frequency Drift	Hz	
30	Avg value of Max Frequency Drift	Hz	
31	Max value of Frequency Drift Rate	Hz	
32	Min value of Frequency Drift Rate	Hz	
33	Avg value of Frequency Drift Rate	Hz	
34	Coding Scheme for LE 1M coded signal 0.0 means S=8, 1.0 means S= 2		
35	Coding Scheme for LE 1M coded 0.0 means S=8, 1.0 means S=2		
36	Max value of Initial Frequency Drift	Hz	
37	Min value of Initial Frequency Drift	Hz	
38	37. Avg value of Initial Frequency Drift	Hz	

7 Returns comma-separated scalar results for EDR packets
Results are returned in the following order:

#	Item	Unit, if any
1	Packet Type*	
2	Payload Length	bits
3	99% DEVM value	%

n	Return Value		
	#	Item	Unit, if any
	4	99% DEVM rate	%
	5	Max Freq Offset ω_i	Hz
	6	Min Freq Offset ω_i	Hz
	7	Avg Freq Offset ω_i	Hz
	8	Max Freq Offset ω_o	Hz
	9	Min Freq Offset ω_o	Hz
	10	Avg Freq Offset ω_o	Hz
	11	Max Freq Offset $\omega_i + \omega_o$	Hz
	12	Min Freq Offset $\omega_i + \omega_o$	Hz
	13	Avg Freq Offset $\omega_i + \omega_o$	Hz
	14	Max RMS DEVM	%
	15	Min RMS DEVM	%
	16	Avg RMS DEVM	%
	17	Max Peak DEVM	%
	18	Min Peak DEVM	%
	19	Avg Peak DEVM	%
	20	Max GFSK Avg Power	dBm
	21	Min GFSK Avg Power	dBm
	22	Avg GFSK Avg Power	dBm
	23	Max DPSK Avg Power	dBm
	24	Min DPSK Avg Power	dBm
	25	Avg DPSK Avg Power	dBm
	26	Max Relative Power (DPSK Avg Power - GFSK Avg Power)	dB
	27	Min Relative Power (DPSK Avg Power - GFSK Avg Power)	dB
	28	Avg Relative Power (DPSK Avg Power - GFSK Avg Power)	dB
	29	Max BER	%
	30	Min BER	%
	31	Avg BER	%
	32	Max Bit Errors	
	33	Min Bit Errors	
	34	Avg Bit Errors	
	35	Max Guard Interval	s
	36	Min Guard Interval	s
	37	Avg Guard Interval	s
8		For Basic or LE packet, returns full packet demod bits	

3 Bluetooth Mode
3.2 Transmit Analysis Measurement

n	Return Value																																																																														
	For other packets, returns -999.0																																																																														
9	For LE primary Advertising channel PDU, returns 64 float data 1~48 is AdvA, 49~64 is PDU header (LSB first) For other packets. returns -999.0																																																																														
10	For LE reference signal with CTE filed, returns CTE info bits (8 float values, LSB first) For other packets. returns -999.0																																																																														
11	Returns 25 comma-separated scalar results for QHS packets If no result is available, NaN (9.91E+37) is returned Results are returned in the following order:																																																																														
	<table border="1"> <thead> <tr> <th>#</th> <th>Item</th> <th>Unit, if any</th> </tr> </thead> <tbody> <tr><td>1</td><td>Packet Type*</td><td></td></tr> <tr><td>2</td><td>Payload Length</td><td>bits</td></tr> <tr><td>3</td><td>99% DEVM value</td><td>%</td></tr> <tr><td>4</td><td>99% DEVM rate</td><td>%</td></tr> <tr><td>5</td><td>Max Avg Packet Power</td><td>dBm</td></tr> <tr><td>6</td><td>Min Avg Packet Power</td><td>dBm</td></tr> <tr><td>7</td><td>Avg Avg Packet Power</td><td>dBm</td></tr> <tr><td>8</td><td>Max Peak Packet Power</td><td>dBm</td></tr> <tr><td>9</td><td>Min Peak Packet Power</td><td>dBm</td></tr> <tr><td>10</td><td>Avg Peak Packet Power</td><td>dBm</td></tr> <tr><td>11</td><td>Max Freq Offset ω_i</td><td>Hz</td></tr> <tr><td>12</td><td>Min Freq Offset ω_i</td><td>Hz</td></tr> <tr><td>13</td><td>Avg Freq Offset ω_i</td><td>Hz</td></tr> <tr><td>14</td><td>Max Freq Offset ω_o</td><td>Hz</td></tr> <tr><td>15</td><td>Min Freq Offset ω_o</td><td>Hz</td></tr> <tr><td>16</td><td>Avg Freq Offset ω_o</td><td>Hz</td></tr> <tr><td>17</td><td>Max Freq Offset $\omega_i+\omega_o$</td><td>Hz</td></tr> <tr><td>18</td><td>Min Freq Offset $\omega_i+\omega_o$</td><td>Hz</td></tr> <tr><td>19</td><td>Avg Freq Offset $\omega_i+\omega_o$</td><td>Hz</td></tr> <tr><td>20</td><td>Max RMS DEVM</td><td>%</td></tr> <tr><td>21</td><td>Min RMS DEVM</td><td>%</td></tr> <tr><td>22</td><td>Avg RMS DEVM</td><td>%</td></tr> <tr><td>23</td><td>Max Peak DEVM</td><td>%</td></tr> <tr><td>24</td><td>Min Peak DEVM</td><td>%</td></tr> <tr><td>25</td><td>Avg Peak DEVM</td><td>%</td></tr> </tbody> </table>	#	Item	Unit, if any	1	Packet Type*		2	Payload Length	bits	3	99% DEVM value	%	4	99% DEVM rate	%	5	Max Avg Packet Power	dBm	6	Min Avg Packet Power	dBm	7	Avg Avg Packet Power	dBm	8	Max Peak Packet Power	dBm	9	Min Peak Packet Power	dBm	10	Avg Peak Packet Power	dBm	11	Max Freq Offset ω_i	Hz	12	Min Freq Offset ω_i	Hz	13	Avg Freq Offset ω_i	Hz	14	Max Freq Offset ω_o	Hz	15	Min Freq Offset ω_o	Hz	16	Avg Freq Offset ω_o	Hz	17	Max Freq Offset $\omega_i+\omega_o$	Hz	18	Min Freq Offset $\omega_i+\omega_o$	Hz	19	Avg Freq Offset $\omega_i+\omega_o$	Hz	20	Max RMS DEVM	%	21	Min RMS DEVM	%	22	Avg RMS DEVM	%	23	Max Peak DEVM	%	24	Min Peak DEVM	%	25	Avg Peak DEVM	%
#	Item	Unit, if any																																																																													
1	Packet Type*																																																																														
2	Payload Length	bits																																																																													
3	99% DEVM value	%																																																																													
4	99% DEVM rate	%																																																																													
5	Max Avg Packet Power	dBm																																																																													
6	Min Avg Packet Power	dBm																																																																													
7	Avg Avg Packet Power	dBm																																																																													
8	Max Peak Packet Power	dBm																																																																													
9	Min Peak Packet Power	dBm																																																																													
10	Avg Peak Packet Power	dBm																																																																													
11	Max Freq Offset ω_i	Hz																																																																													
12	Min Freq Offset ω_i	Hz																																																																													
13	Avg Freq Offset ω_i	Hz																																																																													
14	Max Freq Offset ω_o	Hz																																																																													
15	Min Freq Offset ω_o	Hz																																																																													
16	Avg Freq Offset ω_o	Hz																																																																													
17	Max Freq Offset $\omega_i+\omega_o$	Hz																																																																													
18	Min Freq Offset $\omega_i+\omega_o$	Hz																																																																													
19	Avg Freq Offset $\omega_i+\omega_o$	Hz																																																																													
20	Max RMS DEVM	%																																																																													
21	Min RMS DEVM	%																																																																													
22	Avg RMS DEVM	%																																																																													
23	Max Peak DEVM	%																																																																													
24	Min Peak DEVM	%																																																																													
25	Avg Peak DEVM	%																																																																													
12	Returns 14 comma-separated scalar results for Channel Sounding packet																																																																														

n Return Value

If no result is available, NaN (9.91E+37) / -999 is returned

Results are returned in the following order:

- 1 Avg CS SYNC Packet Power (dBm)
- 2 Peak CS SYNC Packet Power (dBm)
- 3 CS SYNC Freq Offset (Hz)
- 4 Fractional Timing Error (ns)
- 5 Reference Power Level (dBm)
- 6 SS PCT1 (rad)
- 7 SS PCT2 (rad)
- 8 Access Address Quality:
 - 0: No error
 - 1: Bit errors
 - 2: Not found
- 9 Number of payload bit errors
- 10 CS Tone Freq Offset (Hz)
- 11 Fractional Freq Offset (ppm)
- 12 Phase Correction Term I
- 13 Phase Correction Term Q
- 14 Stable Phase (degrees)

*Packet type is returned as an integer number, as listed in the table below:

Packet Type Value	Packet Type Description
-1	Invalid
0	Null
1	Poll
2	FHS
3	DM1
4	DH1
5	HV1
6	HV2
7	HV3
8	DV
9	AUX1
10	DM3

Packet Type Value	Packet Type Description
11	DH3
14	DM5
15	DH5
20	EDR2DH1
22	EDR2EV3
23	EDR3EV3
24	EDR3DH1
26	EDR2DH3
27	EDR3DH3
28	EDR2EV5
29	EDR3EV5
30	EDR2DH5
31	EDR3DH5
33	ULPReference
34	LE 2M Reference
35	LE Coded
36 ~ 42	LE primary advertising channel PDU
43	CS SYNC
44	CS Tone
45	CS SYNC + CS Tone
46	CS Tone + CS SYNC
49	QHS-P2
50	QHS-P3
51	QHS-P4
52	QHS-P5
53	QHS-P6

3.2.1 Views

The Transmit Analysis measurement has four predefined views, as follows.

Some of these are multiple-window views. When in a multiple-window view, you select a window by touching it. The menu controls may sometimes change depending on which window is selected.

Whenever the view changes, the default menu is **Frequency**, unless otherwise specified in the view description.

View	Windows
"Quad" on page 166	"RF Envelope Graph" on page 167 "Demod Waveform Graph" on page 167 "RF Spectrum Graph" on page 168 "Metric Graph" on page 168
"RF Envelope" on page 166	"RF Envelope Graph" on page 167 "Metric Graph" on page 168
"Demod Waveform" on page 166	"Demod Waveform Graph" on page 167 "Metric Graph" on page 168
"RF Spectrum" on page 166	"RF Spectrum Graph" on page 168 "Metric Graph" on page 168
"Numeric Results" on page 166	"Numeric Results Graph" on page 172
"Channel Sounding Results" on page 167	"RF Envelope Graph" on page 167 "Demod Waveform Graph" on page 167 "RF Spectrum Graph" on page 168 "Channel Sounding Metrics Graph" on page 173

View Selection

Selects the desired measurement view from the selections listed in the table below. There are two available commands, allowing you to select the view using either the ID string or a numeric ID value. For more details of the commands, see:

- "View Selection by Name" on page 165
- "View Selection by Number" on page 165

In the following table:

- The Enumerated ID is used with the SCPI Command `:DISP:TX:VIEW[:SEL]`.
- The Numeric ID is used with the SCPI Command `:DISP:TX:VIEW:NSEL`.

Enumerated ID	Numeric ID	View Name & Details
QUAD	1	"Quad" on page 166 Provides a combination view of RF Envelope graph, Demod Waveform graph, RF Spectrum graph and the summary data
RFENvelope	2	"RF Envelope" on page 166 Provides a combination view of RF Envelope graph and the summary data
DWAVEform	3	"Demod Waveform" on page 166

3 Bluetooth Mode

3.2 Transmit Analysis Measurement

Enumerated ID	Numeric ID	View Name & Details
RFSpectrum	4	Provides a combination view of Demod Waveform graph and the summary data "RF Spectrum" on page 166
NRESults	5	Provides a combination view of RF Spectrum graph and the summary data "Numeric Results" on page 166
CSResults	6	Provides a view of the summary data plus the corresponding Limit values "Channel Sounding Results" on page 167
		Quad view: RF Envelope graph, Demod Waveform graph, RF Spectrum graph and Channel Sounding metrics

View Selection by Name

Remote Command	<code>:DISPlay:TX:VIEW[:SElect] QUAD RFENvelope DWAVEform RFSpectrum NRESults CSResults</code> <code>:DISPlay:TX:VIEW[:SElect]?</code>
Example	<code>:DISP:TX:VIEW:SEL RFSP</code> <code>:DISP:TX:VIEW:SEL?</code>
Couplings	If Radio Std is EDR, DWAVEform(3) will be Constellation View
Preset	QUAD
State Saved	Yes
Range	Quad View RF Envelope Demod Waveform RF Spectrum Numeric results Channel Sounding Results

View Selection by Number

Displays the numeric values of the measurement results.

For a complete list of Numeric ID values for use with this command, see ["View Selection" on page 164](#) above.

Remote Command	<code>:DISPlay:TX:VIEW:NSElect <integer></code> <code>:DISPlay:TX:VIEW:NSElect?</code>
Example	<code>:DISP:TX:VIEW:NSEL 1</code> <code>:DISP:TX:VIEW:NSEL?</code>
Preset	1
State Saved	Yes
Min	1
Max	6

3.2.1.1 Quad

Windows: "RF Envelope Graph" on page 167, "Demod Waveform Graph" on page 167, "RF Spectrum Graph" on page 168, "Metric Graph" on page 168

Combination view of the RF Envelope, Demod Waveform, RF Spectrum, and the summary data using the above 4 windows.

Example `:DISP:TX:VIEW QUAD`

3.2.1.2 RF Envelope

Windows: "RF Envelope Graph" on page 167, "Metric Graph" on page 168

Dual window view of the RF Envelope and Summary metrics.

Example `:DISP:TX:VIEW RFENvelope`

3.2.1.3 Demod Waveform

Windows: "Demod Waveform Graph" on page 167, "Metric Graph" on page 168

Dual window view of the Demod Waveform and Summary metrics.

Example `:DISP:TX:VIEW DWAVEform`

3.2.1.4 RF Spectrum

Windows: "RF Spectrum Graph" on page 168, "Metric Graph" on page 168

Dual window view of the RF Spectrum and Summary metrics.

Example `:DISP:TX:VIEW RFSpectrum`

3.2.1.5 Numeric Results

Windows: "Metric Graph" on page 168

Example `:DISP:TX:VIEW NRESults`

3.2.1.6 Channel Sounding Results

Windows: "RF Envelope Graph" on page 167, "Demod Waveform Graph" on page 167, "RF Spectrum Graph" on page 168, Channel Sounding Metrics Graph

Combination view of the RF Envelope, Demod Waveform, RF Spectrum, and the Channel Sounding Metrics using the above 4 windows.

Example `:DISP:TX:VIEW CSResults`

3.2.2 Windows

This section describes the Windows that are available in the Transmit Analysis measurement.

Window #	Name
1	"RF Envelope Graph" on page 167
2	"Demod Waveform Graph" on page 167
3	"RF Spectrum Graph" on page 168
4	"Metric Graph" on page 168
5	"Numeric Results Graph" on page 172
6	"Channel Sounding Metrics Graph" on page 173

3.2.2.1 RF Envelope Graph

Window #1

Displays amplitude envelope information for total acquisition time. The actual IF BW information is displayed in the bottom left corner of the window and actual sample interval is also displayed in the bottom right corner of the window.

The RF Envelope window appears in two views, as follows:

View	Size	Position
"Quad" on page 166	Half, half width	Upper left
"RF Envelope" on page 166	Half, full width	Top

3.2.2.2 Demod Waveform Graph

Window #2

The Demod Waveform window appears in two views, as follows:

View	Size	Position
"Quad" on page 166	Half, half width	Upper right
"Demod Waveform" on page 166	Half, full width	Top

3.2.2.3 RF Spectrum Graph

Window #3

The RF Spectrum window displays Amplitude versus frequency information. The spectrum is calculated by FFT with 10kHz RBW.

The RF Spectrum window appears in two views, as follows:

View	Size	Position
"Quad" on page 166	Half, half width	Lower left
"Demod Waveform" on page 166	Half, full width	Top

3.2.2.4 Metric Graph

Window #4

CTE Info results (CTE Time, RFU, CTE Type) are displayed in metrics window.

This window appears in the following views:

View	Size	Position
"Quad" on page 166	Half, half width	Lower right
"RF Envelope" on page 166	Half, full width	Bottom
"Demod Waveform" on page 166	Half, full width	Bottom
"RF Spectrum" on page 166	Half, full width	Bottom
"Numeric Results" on page 166	Full	

Radio Standard: Basic or Low Energy

Name	Corresponding Results	Explanation
Packet Type	n=6 1st Packet Type	
Payload	No scpi result Payload Type	
Payload Length	n=6 2nd Payload Length	nnn bits
Average Power	n=6 3rd (max) n=6 4th (min)	-nnn.nn dBm

3 Bluetooth Mode
 3.2 Transmit Analysis Measurement

Name	Corresponding Results	Explanation
Peak Power	n=6 5th (avg) GFSK Average Power	-nnn.nn dBm
	n=6 6th (max)	
	n=6 7th (min)	
	n=6 8th (avg) GFSK Peak Power	
Δf1 Avg	n=6 9th (max)	-nnn.n Hz
	n=6 10th (min)	
	n=6 11st (avg) Δf1 Avg	
Δf2 Avg	n=6 12nd (max)	-nnn.n Hz
	n=6 13rd (min)	
	n=6 14th (avg) Δf2 Avg	
Δf1 Max	n=6 15th (max)	-nn.n Hz
	n=6 16th (min) Δf1 Max	
Δf2 Max	n=6 17th (max)	-nn.n Hz
	n=6 18th (min) Δf2 Max	
Δf2 > 115 kHz	n=6 19th (max)	nnn%
	n=6 20th (min)	
	n=6 21st (avg) Δf2 > 115 kHz	
	n=6 22nd (max)	
Δf2 Avg/ Δf1 Avg	n=6 23rd (min)	-nnn.nn
	n=6 24th (avg) Δf2 Avg/Δf1 Avg	
	n=6 28th (max)	
Max Frequency Drift	n=6 29th (min)	-nnn Hz
	n=6 30th (avg) Max Frequency Drift	
	n=6 31st (max)	
Frequency Drift Rate	n=6 32nd (min)	-nnn Hz/50 μs
	n=6 33rd (avg) Frequency Drift Rate	
	n=6 35th (max)	
ICFT		-nnn.n Hz

Name	Corresponding Results	Explanation
	n=6 36th (min) n=6 37th (avg) Initial Carrier Freq Tolerance	
CTE Time	n=10	nn μ s
RFU	n=10	0/1
CTE Type	n=10	AoA AOD with 1 μ s slot AOD with 2 μ s slot Reserved

Radio Standard: EDR

Name	Corresponding Results	Explanation
Packet Type	n=7 1st Packet Type	
Payload	No scpi result Payload Type	
Payload Length	n=7 2nd Payload Length	nnn bits
99% DEVM value	n=7 3rd 99% DEVM value	nnn.nn %
99% DEVM rate	n=7 4th GFSK Peak Power	nnn.nn %
Freq Offset ω_i	n=7 5th (max) n=7 6th(min) n=7 7th (avg) Freq Offset ω_i	-nnn.n Hz
Freq Offset ω_o	n=7 8th (max) n=7 9th(min) n=7 10th (avg) Freq Offset ω_o	-nnn.n Hz
$\omega_i + \omega_o$	n=7 11st (max) n=7 12nd (min) n=7 13rd (avg) Freq Offset $\omega_i + \omega_o$	-nnn Hz
DEVMrms	n=7 14th (max) n=7 15th (min)	nnn.nn %

3 Bluetooth Mode
3.2 Transmit Analysis Measurement

Name	Corresponding Results	Explanation
DEVM _{peak}	n=7 16th (avg) RMS DEVM	nnn.nn %
	n=7 17th (max)	
	n=7 18th (min)	
	n=7 19th (avg) Peak DEVM	
GFSK Avg Pwr	n=7 20th (max)	-nnn.nn dBm
	n=7 21st (min)	
	n=7 22nd (avg) GFSK Avg Power	
	n=7 23rd (max)	
DPSK Avg Pwr	n=7 24th (min)	-nnn.nn dBm
	n=7 25th (avg) DPSK Avg Power	
	n=7 26th (max)	
	n=7 27th (min)	
Rel. Avg Pwr	n=7 28th (avg) Relative Avg Power (DPSK Avg Power - GFSK Avg Power)	-nnn.nn dB
	n=7 29th (max)	
	n=7 30th (min)	
	n=7 31st (avg) Bit Error Rate	
BER	n=7 32nd (max)	nnn.nn%
	n=7 33rd (min)	
	n=7 34th (avg) Bit Error	
	n=7 35th (max)	
Bit Errors	n=7 36th (min)	nnn
	n=7 37th (avg) Guard Interval	
	n=7 38th (max)	
	n=7 39th (min)	
Guard Interval	n=7 40th (avg) Guard Interval	nnn.nn s
	n=7 41th (max)	
	n=7 42th (min)	
	n=7 43th (avg)	

Radio Standard: QHS

Name	Corresponding Results	Explanation
Packet Type	n=11 1st Packet Type	
Payload Length	n=11 2nd Payload Length	nnn bits

Name	Corresponding Results	Explanation
99% DEVM value	n=11 3rd 99% DEVM value	nnn.nn %
99% DEVM rate	n=11 4th GFSK Peak Power	nnn.nn %
Average Power	n=11 5th (max) n=11 6th (min) n=11 7th (avg) Average Packet Power	-nnn.nn dBm
Peak Power	n=11 8th (max) n=11 9th (min) n=11 10th (avg) Peak Packet Power	-nnn.nn dBm
Freq Offset ω_i	n=11 11th (max) n=11 12th(min) n=11 13th (avg) Freq Offset ω_i	-nnn.n Hz
Freq Offset ω_o	n=11 14th (max) n=11 15th(min) n=11 16th (avg) Freq Offset ω_o	-nnn.n Hz
$\omega_i + \omega_o$	n=11 17st (max) n=11 18th (min) n=11 19th (avg) Freq Offset $\omega_i + \omega_o$	-nnn Hz
DEVM _{rms}	n=11 20th (max) n=11 21st (min) n=11 22nd (avg) RMS DEVM	nnn.nn %
DEVM _{peak}	n=11 23rd (max) n=11 24th (min) n=11 25th (avg) Peak DEVM	nnn.nn %

3.2.2.5 Numeric Results Graph

Window #5

3.2.2.6 Channel Sounding Metrics Graph

Window #6

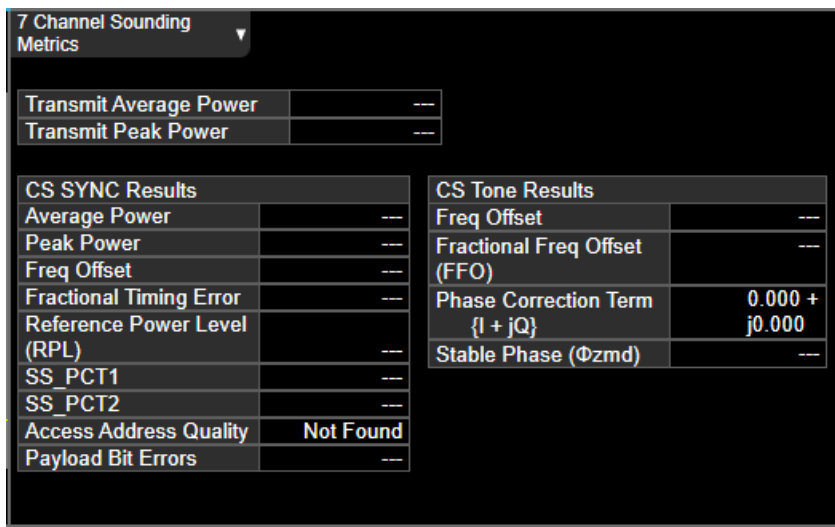

Appears in the following Views:

View	Size	Position
Channel Sounding Results View	Half, half width	Lower right

Packet Type: CS SYNC | CS Tone | CS SYNC + CS Tone | CS Tone + CS SYNC

Name	Corresponding Results	Explanation
Average Power	n=12 1st CS SYNC Average Power	-nnn.nn dBm
Peak Power	n=12 2nd CS SYNC Peak Power	-nnn.nn dBm
Freq Offset	n=12 3rd CS SYNC Frequency Offset	-nnn.n Hz
Fractional Timing Error	n=12 4th Fractional Timing Component of CS SYNC packet	nnn.nn ns
Reference Power Level (RPL)	n=12 5th Sidelobe power of sounding sequence payload	-nnn.nn dBm
SS_PCT1	n=12 6th PCT1 of Sounding Sequence	-n.nnn rad

Name	Corresponding Results	Explanation
SS_PCT2	n=12 7th PCT2 of Sounding Sequence	-n.nnn rad
Access Address Quality	n=12 8th Access Address Quality	n
Payload Bit Errors	n=12 9th Number of payload bit errors	nn
Freq Offset	n=12 10th CS Tone Frequency Offset	-nnn.n Hz
Fractional Freq Offset (FFO)	n=12 11th Fractional Freq Offset	-nn.nn ppm
Phase Correction Term $\sqrt{I+jQ}$	n=12 12th (I) n=12 13th (J) IQ value of Phase Correction Term of CS Tone	-n.nnnnn
Stable Phase	n=12 14th zero-mean, de-trended phase vector	nn.nnn degrees

3.2.3 Amplitude

Activates the **Amplitude** menu and selects **Reference Level** or **Reference Value** as the active function, depending on the measurement.

Some features in this menu apply to multiple measurements. Some other features apply only to specific measurements and their controls are blanked or grayed-out in measurements that do not support the feature.

3.2.3.1 Y Scale

Contains controls that pertain to the Y axis parameters of the measurement. These parameters control how data on the vertical (Y) axis is displayed and control instrument settings that affect the vertical axis.

Ref Value

Controls the Y value of the selected trace at the Reference Position. The functionality depends on the selected window.

Remote Command
:DISPlay:TX:WINDow[1]|2|3:TRACe:Y[:SCALe]:RLEVe1 <real>
:DISPlay:TX:WINDow[1]|2|3:TRACe:Y[:SCALe]:RLEVe1?

For Window numbers, see ["Backwards Compatibility SCPI" on page 175](#)

3 Bluetooth Mode

3.2 Transmit Analysis Measurement

Example	#1 – RF Envelope Window: :DISP:TX:WIND:TRAC:Y:RLEV 0.0	
Couplings	When Auto Scaling is On (default), this value is automatically determined by the measurement result. When you set a value manually, Auto Scaling changes to Off	
Preset	0.00 dBm (1-RF Envelope 3-RF Spectrum) 0 Hz (2-Demod Waveform)	
State Saved	Yes	
Min/Max	1-RF Envelope	-100.00 dBm / 30.00 dBm
	2-Demod Waveform	-10 GHz/10 GHz
	3-RF Spectrum	-100.00 dBm / 30.00 dBm

Backwards Compatibility SCPI

Window Numbers used to be a combination of View and Window. Now the **VIEW** parameter is not used and removed. For backwards compatibility the old View and Window numbers are supported as below:

#	Window	Old SCPI Command	New SCPI Command
1	RF Envelope	DISP:TX:VIEW[1]:WIND[1]:TRAC:Y:RLEV 0.0	DISP:TX:WIND:TRAC:Y:RLEV 0.0
2	Demod Waveform	DISP:TX:VIEW2:WIND[1]:TRAC:Y:RLEV 0.0	DISP:TX:WIND2:TRAC:Y:RLEV 0.0
3	RF Spectrum	DISP:TX:VIEW3:WIND[1]:TRAC:Y:RLEV 0.0	DISP:TX:WIND3:TRAC:Y:RLEV 0.0

Scale/Div

Controls the Y value of the selected trace at the Reference Position. The functionality depends on the selected window.

Remote Command	:DISPlay:TX:WINDow[1] 2 3:TRACe:Y[:SCALe]:PDIVision <real> :DISPlay:TX:WINDow[1] 2 3:TRACe:Y[:SCALe]:PDIVision?	
	For Window numbers, see " Backwards Compatibility SCPI " on page 176	
Example	:DISP:TX:WIND:TRAC:Y:PDIV 0.0 1 – RF Envelope Window	
Couplings	When Auto Scaling is On (default), this value is automatically determined by the measurement result. When you set a value manually, Auto Scaling changes to Off	
Preset	1-RF Envelope	10.0 dB

	2-Demod Waveform	50.000 kHz
	3-RF Spectrum	10.0 dB
State Saved	Yes	
Min/Max	1-RF Envelope	0.1dB / 30.0 dB
	2-Demod Waveform	1.0 Hz/10 GHz
	3-RF Spectrum	0.1dB / 30.0 dB

Backwards Compatibility SCPI

Window Numbers used to be a combination of View and Window. Now the **VIEW** parameter is not used and removed. For backwards compatibility the old View and Window numbers are supported as below:

#	Window	Old SCPI Command	New SCPI Command
1	RF Envelope	<code>DISP:TX:VIEW[1]:WIND[1]:TRAC:Y:PDIV 0.0</code>	<code>DISP:TX:WIND:TRAC:Y:PDIV 0.0</code>
2	Demod Waveform	<code>DISP:TX:VIEW2:WIND[1]:TRAC:Y:PDIV 0.0</code>	<code>DISP:TX:WIND2:TRAC:Y:PDIV 0.0</code>
3	RF Spectrum	<code>DISP:TX:VIEW3:WIND[1]:TRAC:Y:PDIV 0.0</code>	<code>DISP:TX:WIND3:TRAC:Y:PDIV 0.0</code>

Ref Position

Controls the Y ref position of the selected trace. The functionality depends on the selected window.

Remote Command	<code>:DISPlay:TX:WINDow[1] 2 3:TRACe:Y[:SCALe]:RPOSition TOP CENTer BOTTom</code> <code>:DISPlay:TX:WINDow[1] 2 3:TRACe:Y[:SCALe]:RPOSition?</code> For Window numbers, see " Backwards Compatibility SCPI " on page 177
Example	<code>:DISP:TX:WIND:TRAC:Y:PROS CENT</code> 1 – RF Envelope Window
Preset	TOP (1-RF Envelope 3-RF Spectrum) CENTER (2-Demod Waveform)
State Saved	Saved in instrument state
Range	Top Ctr Bot

Backwards Compatibility SCPI

Window Numbers used to be a combination of View and Window. Now the **VIEW** parameter is not used and removed. For backwards compatibility the old View and Window numbers are supported as below:

#	Window	Old SCPI Command	New SCPI Command
1	RF Envelope	<code>DISP:TX:VIEW[1]:WIND[1]:TRAC:Y:RPOS 0.0</code>	<code>DISP:TX:WIND:TRAC:Y:RPOS 0.0</code>
2	Demod Waveform	<code>DISP:TX:VIEW2:WIND[1]:TRAC:Y:RPOS 0.0</code>	<code>DISP:TX:WIND2:TRAC:Y:RPOS 0.0</code>
3	RF Spectrum	<code>DISP:TX:VIEW3:WIND[1]:TRAC:Y:RPOS 0.0</code>	<code>DISP:TX:WIND3:TRAC:Y:RPOS 0.0</code>

Auto Scaling

Toggles this function On or Off. The functionality depends on the selected window.

Remote Command	<code>:DISPlay:TX:WINDow[1] 2 3:TRACe:Y[:SCALe]:COUPle 0 1 OFF ON</code> <code>:DISPlay:TX:WINDow[1] 2 3:TRACe:Y[:SCALe]:COUPle?</code>
Example	1 – RF Envelope Window: <code>:DISP:TX:WIND:TRAC:Y:COUP ON</code>
Couplings	When Auto Scaling is On, and you press the Restart front-panel key, this function automatically determines the scale per division and reference values based on the measurement results. When you manually set a value for the Y Rel Value or Y Scale/Div , this parameter is automatically set to Off
Preset	ON
State Saved	Saved in instrument state
Range	On Off

Backwards Compatibility SCPI

Window Numbers used to be a combination of View and Window, now the VIEW parameter is not used and removed. For backwards compatibility the old View and Window numbers are honored as below:

#	Window	Old SCPI Command	New SCPI Command
1	RF Envelope	<code>DISP:TX:VIEW[1]:WIND[1]:TRAC:Y:COUP 0.0</code>	<code>DISP:TX:WIND:TRAC:Y:COUP 0.0</code>
2	Demod Waveform	<code>DISP:TX:VIEW2:WIND[1]:TRAC:Y:COUP 0.0</code>	<code>DISP:TX:WIND2:TRAC:Y:COUP 0.0</code>
3	RF Spectrum	<code>DISP:TX:VIEW3:WIND[1]:TRAC:Y:COUP 0.0</code>	<code>DISP:TX:WIND3:TRAC:Y:COUP 0.0</code>

3.2.3.2 Attenuation

Controls the attenuator functions and interactions between the attenuation system components.

There are two attenuator configurations in the X-Series. One is a Dual-Attenuator configuration consisting of a mechanical attenuator and an optional electronic attenuator. The other configuration uses a single attenuator with combined mechanical and electronic sections that controls all the attenuation functions. Different models in the X-Series come with different configurations.

- See ["Dual-Attenuator Configurations"](#) on page 178
- See ["Single-Attenuator Configuration"](#) on page 179

Most attenuation settings are the same for all measurements – they do not change as you change measurements. Settings like these are called “Meas Global” and are unaffected by **Meas Preset**.

Only available when the hardware set includes an input attenuator, which is typically only the case for Keysight’s benchtop instruments. For example, this tab does *not* appear in VXT models M9421A/10A/11A, nor in UXM. In UXM, all **Attenuation** and **Range** settings are disabled, as the expected input power level is handled by the Call Processing App that drives the DUT power control.

Dependencies In measurements that support the I/Q inputs, unavailable when I/Q is the selected input. Replaced by the **Range** tab in that case

Dual-Attenuator Configurations

Configuration 1: Mechanical attenuator + optional electronic attenuator

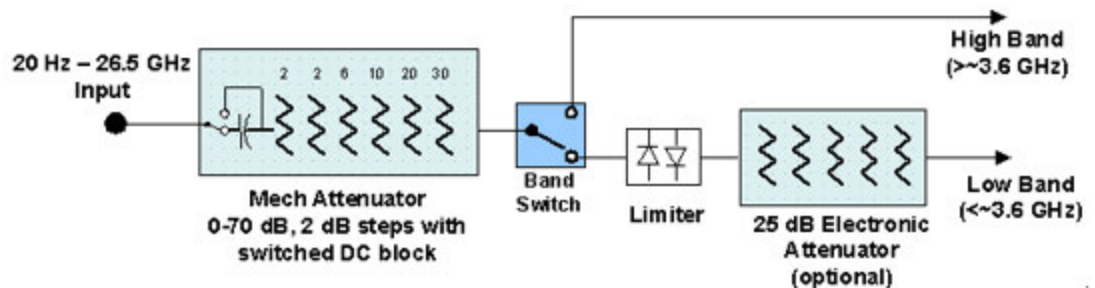

Configuration 2: Mechanical attenuator, no optional electronic attenuator

3 Bluetooth Mode
 3.2 Transmit Analysis Measurement

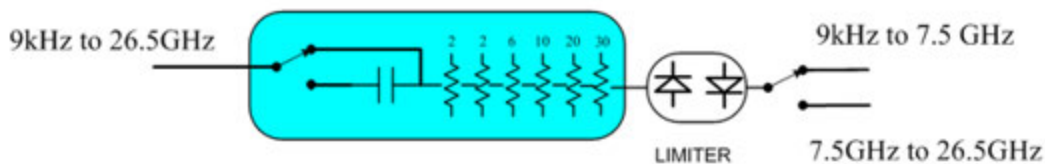

Note that Configuration 2 is not strictly speaking a dual-section attenuator, since there is no electronic section available. However, it behaves exactly like Configuration 1 without the Electronic Attenuator Option EA3, therefore for the sake of this document it is grouped into the “Dual-Attenuator” configuration.

Single-Attenuator Configuration

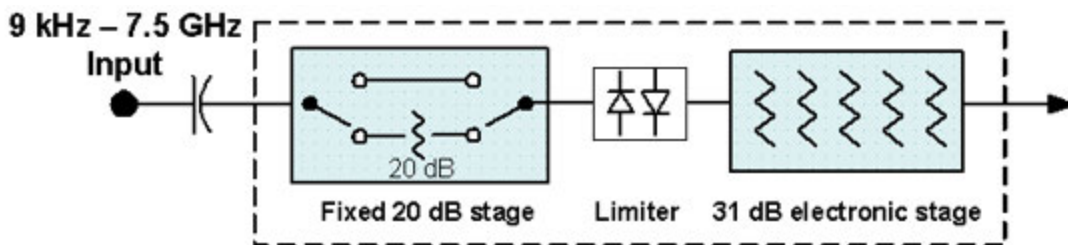

You can tell which attenuator configuration you have by pressing the Attenuation tab, which (in most Modes) opens the Attenuation menu. If the first control in the Attenuation menu says **Mech Atten** you have the Dual-Attenuator configuration. If the first control says **Atten** you have the Single-Attenuator configuration.

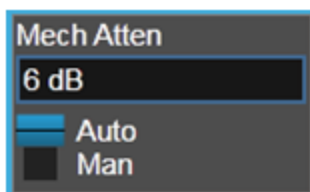

Dual Attenuator

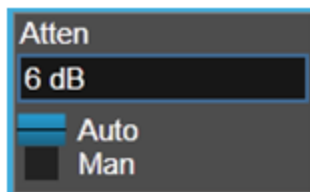

Single Attenuator

(Note that depending on the measurement, there may be no Auto/Man functionality on the Mech Atten control.)

In the Single-Attenuator configuration, you control the attenuation with a single control, as the fixed stage has only two states. In the Dual-Attenuator configuration, both stages have significant range, so you are given separate control of the mechanical and electronic attenuator stages.

When you have the Dual-Attenuator configuration, you may still have only a Single-Attenuator, because unless Option EA3 (the Electronic Attenuator option) is available, and you purchase it, you will have only the mechanical attenuator.

Full Range Atten

This control and **Attenuator Summary** only appear in N9041B, when the RF input is selected, the RF Input Port is set to RF Input 2, and the Full Range Attenuator is installed. The Full Range Attenuator adds a second input attenuator in front of RF Input 2, which enhances the protection and optimizes the performance of the extra internal mixers used by RF Input 2.

Remote Command	<code>[:SENSe]:POWer[:RF]:FRATten <rel_ampl></code> <code>[:SENSe]:POWer[:RF]:FRATten?</code>
Example	<code>:POW:FRAT 14</code> <code>:POW:FRAT?</code>
Notes	When you enter an amplitude value that falls between valid values, the value will be incremented to the next smallest valid value
Dependencies	Only appears if input RF is selected, RF Input Port 2 is selected, and the Full Range Attenuator exists
Couplings	This value is never changed by any coupling, but other couplings use this value. See Reference Level and " Mech Atten " on page 719 command descriptions
Preset	20 dB
State Saved	Saved in instrument state
Min	0 dB
Max	Only valid values are 0, 6, 14, 20 dB
Annotation	<p>When the Input is RF, and the Input Port is RF Input 2, and the Full Range Attenuator is installed: On the Meas Bar, the field "Atten" displays as follows:</p> <ul style="list-style-type: none"> - If the sweep is entirely < 50 GHz, the value shown after "Atten:" is equal to Mech Atten + Elec Atten + Full Range Atten - If the sweep is entirely > 50 GHz, the value shown after "Atten:" is equal to Full Range Atten - If the sweep straddles 50 GHz, the value shown after "Atten:" is preceded by the symbol ">=" and is equal to Full Range Atten <p>In the Amplitude, "Y Scale" on page 597 menu, and the Atten Meas Bar dropdown menu panel, a summary is displayed as follows:</p> <p>"Total Atten below 50 GHz" followed by the value of Full Range Atten + Mech Atten + Elec Atten "Total Atten above 50 GHz" followed by the value of Full Range Atten</p> <p>For example, if Mech Atten = 6 dB, Elec Atten = 4 dB, and Full Range Atten = 20 dB, the summary below is shown:</p> <ul style="list-style-type: none"> - Attenuator summary: - Total Atten below 50 GHz: 30 dB - Total Atten above 50 GHz: 20 dB

Mech Atten

Labeled **Mech Atten** in Dual-Attenuator models and **Atten** in Single-Attenuator models. In the Dual-Attenuator configuration, this control only affects the mechanical attenuator.

Lets you modify the attenuation applied to the RF input signal path. This value is normally auto-coupled to the Ref Level, the Internal Preamp Gain, any External Gain that is entered, and the Max Mixer Level, as described in the table below.

See "[Attenuator Configurations and Auto/Man](#)" on page 183

Remote Command	<pre>[:SENSe]:POWer[:RF]:ATTenuation <rel_amp1> [:SENSe]:POWer[:RF]:ATTenuation? [:SENSe]:POWer[:RF]:ATTenuation:AUTO OFF ON 0 1 [:SENSe]:POWer[:RF]:ATTenuation:AUTO?</pre>
Example	<pre>:POW:ATT 20</pre> <p>Dual-Attenuator configuration: sets the mechanical attenuator to 20 dB Single-Attenuator mode: sets the main attenuation to 20 dB (see below for definition of "main" attenuation) In either case, if the attenuator was in Auto, it is set to Manual <pre>:POW:ATT:AUTO ON</pre> Turn Auto Mech Atten ON</p>
Dependencies	<p>Some measurements do not support Auto setting of "Mech Atten" on page 181. In these measurements, the Auto/Man selection is not available, and the Auto/Man toggle function is not available</p> <p>In Dual-Attenuator configurations, when the electronic attenuator is enabled, the mechanical attenuator has no auto setting, and the Auto/Man toggle function is not available. The state of Auto/Man is remembered and restored when the electronic attenuator is once again disabled. This is described in more detail in "Elec Atten" on page 721</p> <p>See "Attenuator Configurations and Auto/Man" on page 183 for more information on the Auto/Man functionality</p> <p>:POW:ATT:AUTO is only available in measurements that support Mech Atten Auto, such as Swept SA</p>
Couplings	<p>If the RF Input Port is the RF Input:</p> <ul style="list-style-type: none"> - If the USB Preamp is connected to USB, use 0 dB for Mech Atten - Otherwise compute the auto-selected value of Mech Atten based on Reference Level, Int Preamp, External Gain, Ref Level Offset, Max Mixer Level, μW Path Control and IF Gain settings. Limit this value to be no less than 6 dB (total attenuation below 6 dB can never be chosen by Auto) - In the N9041B, if the RF Input Port is RF Input 2, use the formula above and subtract the Full Range Atten value from the result to determine the Mech Atten. Limit the value so that it is never lower than 0 dB and so that total attenuation, including Full Range Atten, is never less than 6 dB

(total attenuation, including Full Range Atten below 6 dB, can never be chosen by Auto)

In External Mixing and BBIQ, where the Attenuator is not in the signal path, the Attenuator setting changes as described above when "Mech Atten" on page 181 is in Auto, but no changes are made to the actual attenuator hardware setting until the input is changed back to the RF Input

For CXA-m with option FSA (Fine-Step Attenuator or 2 dB steps), the FSA-like behavior is only available when the frequency setting is ≤ 7.5 GHz. So, when the frequency is changed from below 7.5 GHz to above 7.5 GHz, the attenuation setting will be changed to a multiple of 10 dB which will be no smaller than the previous setting. For example, 4 dB attenuation will be changed to 10 dB

Preset	<p>The preset for Mech Attenuation is "Auto"</p> <p>The Auto value of attenuation is 10 dB</p> <p>ON</p>
State Saved	Saved in instrument state
Min	<p>0 dB</p> <p>The attenuation set by this control cannot be decreased below 6 dB with the knob or step keys. Values below 6 dB must be directly entered from the keypad or via SCPI. This protects against setting a dangerously small attenuation value, which can put the instrument at risk of damage to input circuitry. If the current mechanical attenuation is below 6 dB, it can be increased with the knob and step keys, but not decreased</p>
Max	<p>CXA Option 503 or 507: 50 dB</p> <p>EXA: 60 dB</p> <p>All other models: 70 dB</p> <p>Note that in the Single-Attenuator configuration, the total of ATT and EATT cannot exceed 50 dB. So, if the EATT is set to 24 dB first, the main attenuation cannot be greater than 26 dB and will be reduced accordingly; if the main attenuator is set to 40 dB first, EATT cannot be greater than 10 dB</p>
Annotation	<p>The current value for Total Atten is displayed in the Measurement Bar at the top of the display. A value appears for Electronic Attenuation only if the Electronic Attenuator is enabled. The annotation appears as</p> <p>Atten: <total> dB (e<elec>)</p> <p>The e letter is in amber in Single-Attenuator configurations</p> <p>For example:</p> <p>Dual-Attenuator configuration:</p> <p>Atten: 24 dB (e14)</p> <p>Indicating the total attenuation is at 24 dB and the electronic attenuation is at 14 dB</p> <p>Single-Attenuator configuration:</p> <p>A: 24 dB (e14)</p> <p>Indicating the total attenuation is at 24 dB and the "soft" attenuation is at 14 dB (see below for definition of "soft" attenuation)</p> <p>When in Manual, a # sign appears in front of Atten in the annotation</p>

Attenuator Configurations and Auto/Man

As described under "Y Scale" on page 597, there are two distinct attenuator configurations available in the X-Series, the single attenuator and Dual-Attenuator configurations. In Dual-Attenuator configurations, we have the mechanical attenuation and the electronic attenuation, and the current total attenuation is the sum of the electronic + mechanical attenuation. In Single-Attenuator configurations, we refer to the attenuation set using "Mech Atten" on page 181 (or `:POW:ATT`) as the "main" attenuation; and the attenuation that is set by `:POW:EATT` as the "soft" attenuation (`:POW:EATT` is honored even in the Single-Attenuator configuration, for compatibility purposes). Then the current total attenuation is the sum of the main + soft attenuation.

See "Elec Atten" on page 721 for more about "soft" attenuation.

NOTE

In some measurements, the **Mech Atten** control has an Auto/Man function. In these measurements, an Auto/Man switch is shown on the **Mech Atten** control:

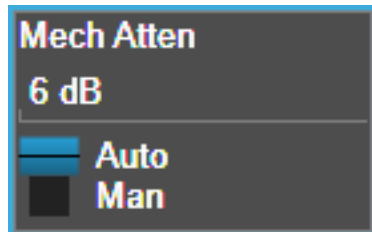

Note that in configurations that include an Electronic Attenuator, this switch is only shown when the Electronic Attenuator is disabled.

In other measurements, **Mech Atten** has no Auto/Man function. In these measurements, no switch is shown on the **Mech Atten** control:

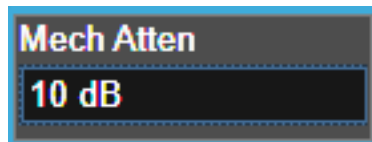

Mech Atten also appears with no switch, as above, in configurations that include an Electronic Attenuator but when the Electronic Attenuator is enabled.

Elec Atten

Controls the Electronic Attenuator in Dual-Attenuator configurations. Does not appear in Single-Attenuator configurations, because the control of both the mechanical and electronic stages of the Single-Attenuator is integrated into the single **Atten** control.

This control includes an **Enable/Disable** toggle switch; it is only possible to enter a value for the Electronic Attenuator when this switch is in the **Enable** position.

For more details about the Electronic Attenuator, see ["More Information" on page 185](#)

Remote Command	<pre>[:SENSe]:POWer[:RF]:EATTenuation <rel_amp1> [:SENSe]:POWer[:RF]:EATTenuation? [:SENSe]:POWer[:RF]:EATTenuation:STATE OFF ON 0 1 [:SENSe]:POWer[:RF]:EATTenuation:STATE?</pre>
Example	<pre>:POW:EATT 10 :POW:EATT? :POW:EATT:STAT ON :POW:EATT:STAT?</pre>
Notes	Electronic Attenuation's specification is defined only when Mechanical Attenuation is 6 dB
Dependencies	<p>Only appears in Dual-Attenuator models with an Electronic Attenuator installed and licensed. Does not appear in models with the Single-Attenuator configuration, because in the Single-Attenuator configuration there is no "electronic attenuator"; there is only a single integrated attenuator (which has both a mechanical and electronic stage). However, in the Single-Attenuator configuration, EATT SCPI commands are accepted for compatibility with other X-series instruments, and set a "soft" attenuation. The "soft" attenuation is treated as an addition to the "main" attenuation value set by the Attenuation control or :POW:ATT, and affects the total attenuation displayed on the Attenuation control and the Meas Bar</p> <p>The electronic attenuator, and the "soft" attenuation function provided in Single-Attenuator configurations, are unavailable above the low band (0-3.6 GHz, 0-3.4 GHz, 0-3 GHz, depending on the model). If the low band range is from 0-3.6 GHz, and Stop Frequency of the instrument is > 3.6 GHz, then the Enabled/Disabled section of the Elec Atten control will be OFF and grayed-out</p> <p>If "Internal Preamp" on page 737 is ON (that is, set to Low Band or Full), the electronic attenuator (and the "soft" attenuation function provided in Single-Attenuator configurations) is unavailable. In this case the Enabled/Disabled section of the Elec Atten control will be OFF and grayed-out</p> <p>If either of the above is true, and the SCPI command is sent, an error indicating that the electronic attenuator is unavailable is returned</p> <p>If both the above are true, pressing the control generates error message -221, in other words, the frequency range lockout takes precedence</p> <p>If the electronic/soft Attenuator is enabled, then the Stop Freq of the instrument is limited to 3.6 GHz and Internal Preamp is unavailable</p> <p>If "LNA" on page 738 is ON, the electronic attenuator (and the "soft" attenuation function provided in Single-Attenuator configurations) is unavailable. In this case the Enabled/Disabled section of the Elec Atten control will be OFF and grayed-out. This coupling works in the following modes/measurements:</p> <ul style="list-style-type: none"> - Channel Power, Occupied BW, ACP, SEM, Spurious Emissions, Power Stat CCDF measurements in all Modes - Transmit On Off Power measurement in 5GNR Mode - Power vs. Time and Transmit Power measurement in GSM/EDGE Mode - Burst Power measurement in Spectrum Analyzer Mode

	The SCPI-only “soft” electronic attenuation for the single-attenuator configuration is not available in all measurements; in particular, it is not available in the Swept SA measurement
Couplings	Enabling and disabling the Electronic Attenuator affects the setting of the Mechanical Attenuator (in Dual-Attenuator configurations). This is described in more detail below and in "Mechanical Attenuator Transition Rules" on page 185
Preset	0 dB OFF (Disabled) for Swept SA measurement ON (Enabled) for all other measurements that support the electronic attenuator
State Saved	Saved in instrument state
Min	0 dB
Max	Dual-Attenuator configuration: 24 dB Single-Attenuator configuration: the total of ATT and EATT cannot exceed 50 dB. So, if the EATT is set to 24 dB first, the main attenuation cannot be greater than 26 dB and will be reduced accordingly; if the main attenuator is set to 40 dB first, EATT cannot be greater than 10 dB
Annotation	See Annotation under the Mech Atten control description

More Information

The electronic attenuator offers finer steps than the mechanical attenuator, has no acoustical noise, is faster, and is less subject to wear. These advantages primarily aid in remote operation and are negligible for front panel use. See ["Using the Electronic Attenuator: Pros and Cons" on page 186](#) for a detailed discussion of the pros and cons of using the electronic attenuator.

For the Single-Attenuator configuration, for SCPI backwards compatibility, the “soft” attenuation feature replaces the Dual-Attenuator configuration’s electronic attenuator. All the same couplings and limitations apply. See ["Attenuator Configurations and Auto/Man" on page 721](#)

Mechanical Attenuator Transition Rules

When the Electronic Attenuator is enabled, the Mechanical Attenuator transitions to a state that has no Auto function. Below are the rules for transitioning the Mechanical Attenuator. Note that the information below *only* applies to the Dual-Attenuator configurations, and *only* when the Electronic Attenuator is installed:

When the Electronic Attenuation is enabled from a disabled state:

- The Mechanical Attenuator is initialized to 10 dB (this is its optimal performance setting). You can then set it as desired with SCPI, numeric keypad, step keys, or knob, and it behaves as it normally would in manual mode
- The Auto/Man state of (Mech) Atten is saved

- The Auto/Man toggle on the (Mech) Atten control disappears, and the auto rules are disabled
- The Electronic Attenuator is set to 10 dB less than the previous value of the Mechanical Attenuator, within the limitation that it must stay within the range of 0 to 24 dB of attenuation

Examples in the Dual-Attenuator configuration:

- Mech Atten at 20 dB. Elec Atten enabled, Mech Atten set to 10 dB, and Elec Atten set to 10 dB. New total attenuation equals the value before Elec Atten enabled
- Mech Atten at 0 dB. Elec Atten enabled, Mech Atten set to 10 dB, and Elec Atten set to 0 dB. New total attenuation does not equal the value before Elec Atten enabled
- Mech Atten at 40 dB. Elec Atten enabled, Mech Atten set to 10 dB, and Elec Atten set to 24 dB. New total attenuation does not equal the value before Elec Atten enabled

When the Electronic Attenuation is disabled from an enabled state:

- The Elec Atten control is grayed out
- The Auto/Man state of (Mech) Atten is restored
- If now in Auto, (Mech) Atten recouples
- If now in Man, (Mech) Atten is set to the value of total attenuation that existed before the Elec Atten was disabled. The resulting value is rounded up to the smallest value possible given the (Mech) Atten Step setting - (That is, 57 dB changes to 58 dB when (Mech) Atten Step is 2 dB)

Using the Electronic Attenuator: Pros and Cons

The electronic attenuator offers finer steps than the mechanical attenuator, has no acoustical noise, is faster, and is less subject to wear.

The “finer steps” advantage of the electronic attenuator is beneficial in optimizing the alignment of the instrument dynamic range to the signal power in the front panel as well as remote use. Thus, you can achieve improved relative signal measurement accuracy. Compared to a mechanical attenuator with 2 dB steps, the 1 dB resolution of the electronic attenuator only gives better resolution when the odd-decibel steps are used. Those odd-decibel steps are less accurately calibrated than the even-decibel steps, so one tradeoff for this superior relative accuracy is reduced absolute amplitude accuracy.

Another disadvantage of the electronic attenuator is that the spectrum analyzer loses its “Auto” setting, making operation less convenient.

Also, the relationship between the dynamic range specifications (TOI, SHI, compression, and noise) and instrument performance are less well-known with the electrical attenuator. With the mechanical attenuator, TOI, SHI, and compression threshold levels increase dB-for-dB with increasing attenuation, and the noise floor does as well. With the electronic attenuator, there is an excess attenuation of about 1 to 3 dB between 0 and 3.6 GHz, making the effective TOI, SHI, and so forth, less well known. Excess attenuation is the actual attenuation relative to stated attenuation. Excess attenuation is accounted for in the instrument calibration.

Adjust Atten for Min Clipping

Sets the combination of mechanical and electronic attenuation and gain based on the current measured signal level so that clipping will be at a minimum.

This is an immediate action function, that is, it executes once, when the control is pressed.

The algorithms that are used for the adjustment are documented under ["Pre-Adjust for Min Clipping" on page 726](#).

Remote Command	<code>[:SENSe]:POWer[:RF]:RANGe:OPTimize IMMEDIATE</code>
Example	<code>:POW:RANG:OPT IMM</code>
Notes	Executing Adjust Atten for Min Clipping initiates the measurement
Dependencies	Does not appear in the Swept SA, RTSA, Monitor Spectrum and Complex Spectrum measurements Appears in the Waveform measurement in 5G NR Mode only

Adjust Atten

Allows you to select;

- Electric attenuator only
- Combination of Electric attenuator and Mechanical attenuator

when `[:SENSe]:POWer[:RF]:RANGe:OPTimize IMMEDIATE` is executed.

Remote Command	<code>[:SENSe]:POWer[:RF]:RANGe:OPTimize:TYPE EONLY COMBined</code> <code>[:SENSe]:POWer[:RF]:RANGe:OPTimize:TYPE?</code>
Example	<code>:POW:RANG:OPT:TYPE EONL</code> <code>:POW:RANG:OPT:TYPE?</code>
Dependencies	Does not appear in the Swept SA, RTSA, Monitor Spectrum and Complex Spectrum measurements Appears in the Waveform measurement in 5G NR Mode only
Preset	<code>COMBined</code>
State Saved	Saved in instrument state

Pre-Adjust for Min Clipping

If this function is **ON**, it applies the adjustment described under "[Adjust Atten for Min Clipping](#)" on page 725 each time a measurement restarts. Therefore, in Continuous measurement mode, it only executes before the first measurement.

In Dual-Attenuator models, you can set **Elec+Mech Atten**, in which case both attenuators participate in the autoranging, or **Elec Atten Only**, in which case the mechanical attenuator does not participate in the autoranging. This latter case results in less wear on the mechanical attenuator and is usually faster.

See "[Adjustment Algorithm](#)" on page 189

Selection	SCPI	Note
Off	OFF	This is the default setting
On	ON	Available in Single-Attenuator instruments. For compatibility with models that do not have an input attenuator, the ON parameter is supported and mapped to COMBined
Elec Atten Only	ELECTrical	Selects only the electric attenuator to participate in auto ranging. This offers less wear on the mechanical attenuator and is usually faster
Elec+Mech Atten	COMBined	In Dual-Attenuator models, this selects both attenuators to participate in the autoranging

Remote Command	<code>[:SENSe]:POWer[:RF]:RANGe:OPTimize:ATTenuation OFF ON ELECTrical COMBined</code> <code>[:SENSe]:POWer[:RF]:RANGe:OPTimize:ATTenuation?</code>
Example	<code>:POW:RANG:OPT:ATT OFF</code> <code>:POW:RANG:OPT:ATT?</code>
Notes	The parameter option ELECTrical sets this function to ON in Single-Attenuator models The parameter option COMBined is mapped to ELECTrical in Single-Attenuator models. If you send COMBined , it sets the function to ON and returns ELEC to a query For SCPI compatibility with models that do not have an input attenuator, the ON parameter is honored and mapped to COMBined
Dependencies	Only appears in Dual-Attenuator models with an Electronic Attenuator installed In instruments with Dual-Attenuator model, when " Elec Atten " on page 721 is OFF or grayed-out, " Pre-Adjust for Min Clipping " on page 188 is grayed-out Does not appear in the Swept SA, RTSA, Monitor Spectrum and Complex Spectrum measurements For the Waveform measurement, available only in 5G NR Mode
Preset	OFF when Elec Atten is Disabled at preset, otherwise ELEC
State Saved	Saved in instrument state
Range	Dual-Attenuator models:

3 Bluetooth Mode
 3.2 Transmit Analysis Measurement

	Off Elec Atten Only Mech + Elec Atten Single-Attenuator models: Off On
Notes	ON aliases to "Elec Atten Only" (:POW:RANG:OPT:ATT ELEC) OFF aliases to "Off" (:POW:RANG:OPT:ATT OFF) :POW:RANG:AUTO? returns true if :POW:RANG:OPT:ATT is not OFF
Backwards Compatibility SCPI	[:SENSe]:POWer[:RF]:RANGe:AUTO ON OFF 1 0 [:SENSe]:POWer[:RF]:RANGe:AUTO?

Adjustment Algorithm

The algorithms for the adjustment are documented below:

Single-Attenuator Models

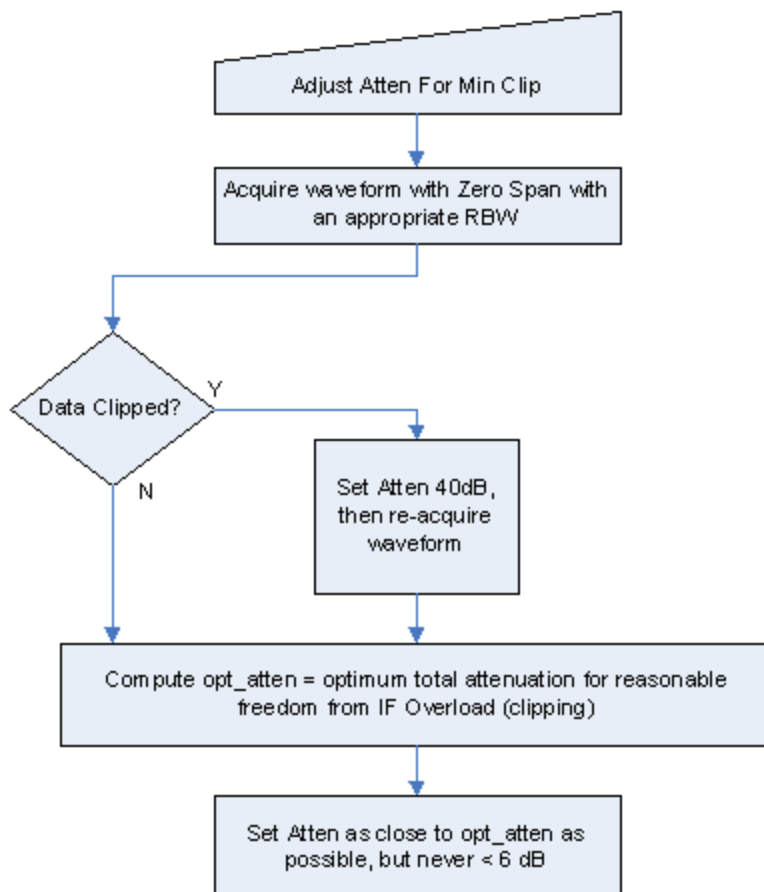

Dual-Attenuator models

"Adjust Atten for Min Clipping" on page 725 or "Pre-Adjust for Min Clipping" on page 188 selection is Mech + Elec Atten:

3 Bluetooth Mode
 3.2 Transmit Analysis Measurement

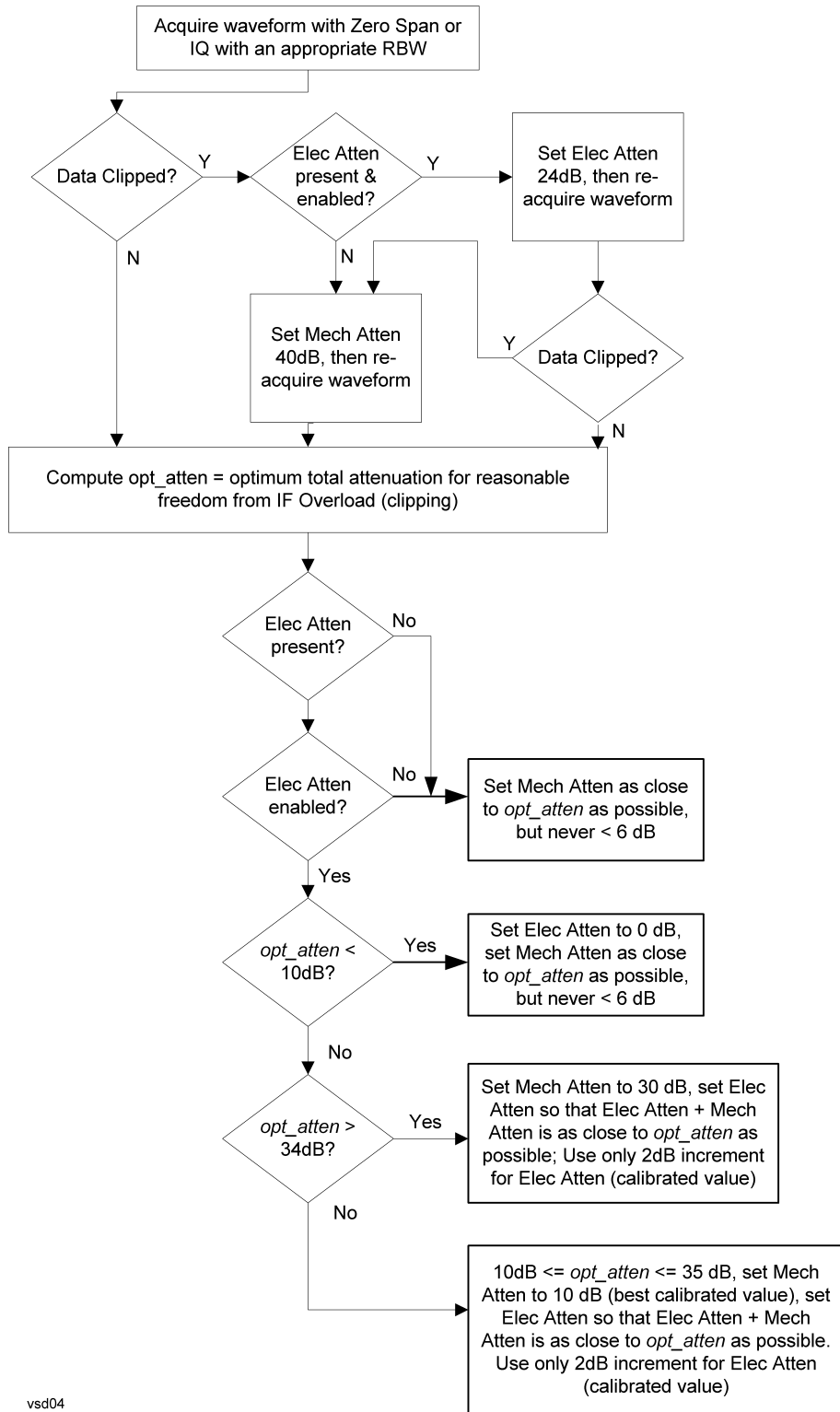

vsd04

"Pre-Adjust for Min Clipping" on page 188 selection is Elec Only.

Note that the **Mech Atten** value is not adjusted, and the value previously set is used. Therefore, there is a case that IF Overload is still observed depending on the input signal level and the Mech Atten setting.

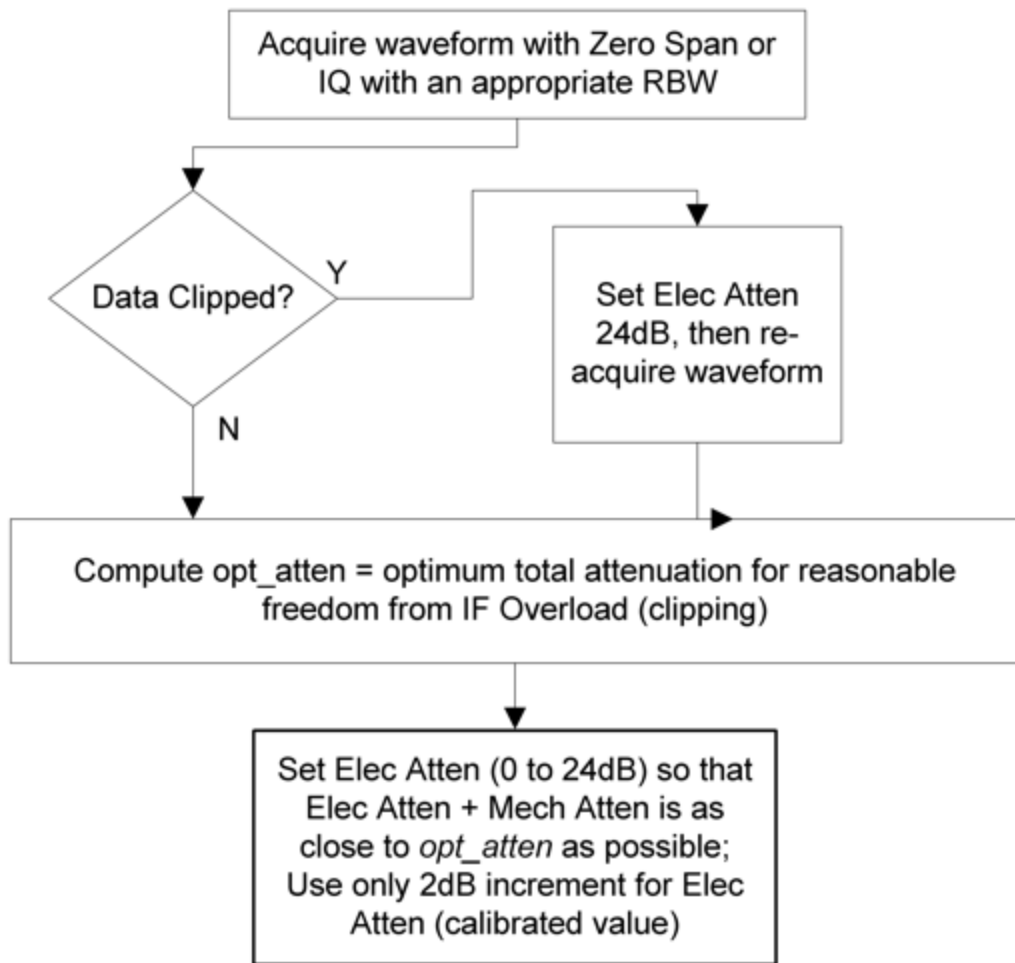

Mech Atten Step

Controls the step size used when making adjustments to the input attenuation.

Labeled **Mech Atten Step** in Dual-Attenuator models and **Atten Step** in Single-Attenuator models. In the Dual-Attenuator configuration, only affects the step size of the mechanical attenuator.

Remote Command `[:SENSe]:POWer[:RF]:ATTenuation:STEP[:INCRement] 10 dB | 2 dB`

	<code>[:SENSe]:POWer[:RF]:ATTenuation:STEP[:INCRement]?</code>
Example	<code>:POW:ATT:STEP 2</code> <code>:POW:ATT:STEP?</code>
Notes	Has a toggle control on the front panel, but takes a specific value (in dB) when used remotely. The only valid values are 2 and 10
Dependencies	Blanked in EXA, CXA and CXA-m if option FSA (2 dB steps) is not present. If blanked, attempts to set it via SCPI yield an error
Couplings	When the attenuation step size changes, the current mechanical attenuation value is adjusted (if necessary) to be quantized to the new step size. That is, if step is set to 10 dB, mech atten is increased if necessary so it is a multiple of 10 dB
Preset	EXA, CXA and CXA-m: 10 dB (2 dB with option FSA) All other models: 2 dB
State Saved	Saved in instrument state

3.2.3.3 Range (Baseband Input models)

Only available when Option BBA is present (I/Q Baseband Inputs), the current measurement supports option BBA, and I/Q is the selected input. In these cases, replaces the **Attenuation** tab.

Each input channel (I and Q) has four internal gain ranges. The maximum allowed voltage in each gain range is slightly more than the nominal value, so the break point between ranges is a few millivolts higher than the nominal (setting a peak voltage of 0.502 mV will still map to the 0.5 V Peak range).

Gain Setting	Volts RMS	Volts Peak	Volts Peak - Peak	dBm (50Ω)	Break Point
0 dB	0.7071	1.0	2.0	10	n/a
6 dB	0.3536	0.5	1.0	4	0.502 V Peak
12 dB	0.1768	0.25	0.5	-2	0.252 V Peak
18 dB	0.0884	0.125	0.25	-8	0.127 V Peak

Dependencies	Available only when the selected input is I/Q. If the current measurement does not support baseband inputs, an error will be displayed: "No result; Meas invalid with I/Q inputs"
State Saved	No

Range Auto/Man

The **Auto** setting for **Range** causes the range to be set based on the Y Scale settings. When **Range** is **Auto**, the I & Q Range are set based on the top of the Y Scale when the Y scale is in dB units (for example, power), or to the max(abs(top), abs(bottom)) when the Y scale reference is not at the top of the screen.

Not all measurements support **Range Auto/Man**. If **Auto** is not supported in the current measurement, this control is grayed-out, displaying **Man**, and **MAN** is returned to a SCPI query, but this does *not* change the Auto/Man setting for **Range**. When you switch to a measurement that supports **Auto**, it goes back to **Auto** if it was previously in **Auto** mode.

Remote Command	<code>[:SENSe]:VOLTage:IQ:RANGe:AUTO OFF ON 0 1</code> <code>[:SENSe]:VOLTage:IQ:RANGe:AUTO?</code>
Example	Put the I Range and Q Range in manual <code>:VOLT:IQ:RANG:AUTO OFF</code> <code>:VOLT:IQ:RANG:AUTO?</code>
Dependencies	If Auto is not supported, sending the SCPI command generates an error
Couplings	When in Auto , both I Range and Q Range are set to the same value, computed as follows: Maximum absolute value is computed for the Y Scale. The top and bottom of the graph are computed based on Ref Value, Scale/Div, and Ref Position. Formula: $Y_{Max} = \max(\text{abs}(\text{top}), \text{abs}(\text{bottom}))$ The I Range and Q Range are then set to YMax
Preset	ON
State Saved	Saved in instrument state
Annotation	When in Man, the Range annotation is preceded by "#" This is an alternate form of the command to match the POWer form of the I Range and Q Range SCPI.
Remote Command	<code>[:SENSe]:POWer:IQ:RANGe:AUTO OFF ON 0 1</code> <code>[:SENSe]:POWer:IQ:RANGe:AUTO?</code>
Example	Put the I Range and Q Range in manual <code>:POW:IQ:RANG:AUTO OFF</code> <code>:POW:IQ:RANG:AUTO?</code>
Notes	<code>:POW:IQ:RANG:AUTO</code> is an alternate form of <code>:VOLT:IQ:RANG:AUTO</code> , to maintain consistency with I Range and Q Range, which support both the POWer and VOLTage forms of the command
Preset	ON
Range	Auto Man

I Range

The internal gain range for the I channel when the Input Path is I Only or I and I/Q. Used for both the I and Q channels when the Input Path is I+jQ.

Remote Command	<code>[:SENSe]:VOLTage:IQ[:I]:RANGe[:UPPer] <voltage></code> <code>[:SENSe]:VOLTage:IQ[:I]:RANGe[:UPPer]?</code>
Example	Set the I Range to 0.5 V Peak <code>:VOLT:IQ:RANG 0.5 V</code>

3 Bluetooth Mode
3.2 Transmit Analysis Measurement

:VOLT:IQ:RANG?	
Notes	The numeric entries are mapped to the smallest gain range whose break point is greater than or equal to the value, or 1 V Peak if the value is greater than 1 V
Couplings	When " Q Same as I " on page 197 is On, the I Range value will be copied to " Q Range " on page 196 Changing the value also sets Range = Man
Preset	Complex SPECTrum Measurement: 0.5 V Peak All others: 1 V Peak
State Saved	Saved in instrument state
Range	1 V Peak (10 dBm @ 50 Ω) 0.5 V Peak (4 dBm @ 50Ω) 0.25 V Peak (-2 dBm @ 50Ω) 0.125 V Peak (-8 dBm @ 50Ω)
Min	0.125 V
Max	1 V
Annotation	The Range annotation replaces the RF Input context's "Atten" annotation "Rng: <I Range>". When Range = Man the annotation is preceded by "#" The I Range is not annotated in Input Path Q Only. When I Range and Q Range are the same, the annotation is "Rng: <Range>". When I Range and Q Range are different and the Input Path is Ind I/Q, the annotation is "Rng: <I Range>, <Q Range>" and "Peak" is removed from the text. Examples: "Rng: 1 V Peak" the I Range is 1 V Peak "Rng: 1 V, 0.5 V " the I Range is 1 V Peak and the Q Range is 0.5 V Peak This is an alternate form of the command to allow entry as a power.
Remote Command	[:SENSe]:POWer:IQ[:I]:RANGe[:UPPer] <amp;lt;math>[:SENSe]:POWer:IQ[:I]:RANGe[:UPPer]?
Example	Set the I Range to 0.5 V Peak when Reference Z is 50 Ω, and to 1.0 V Peak when Reference Z is 75 Ω :POW:IQ:RANG 4 dBm :POW:IQ:RANG?
Notes	The POWer form of the command is provided for convenience. It maps to the same underlying gain range parameter as the VOLTage form The Reference Z (not the I channel Input Z) is used to convert the power to peak voltage, which is then used to set the I Range as with the VOLTage form of the command. The power values of the 4 range states (1V Peak, 0.5V Peak, 0.25V Peak, and 0.125V Peak) will vary with Reference Z. Here are some examples: 50 Ω: 10, 4, -2, -8 75 Ω: 8.2, 2.2, -3.8, -9.8 600 Ω: -0.8, -6.8, -12.8, -18.9
Preset	10.0 dBm
Range	-20 dBm to 10 dBm
Min	-20 dBm
Max	10 dBm

Q Range

The internal gain range for the Q channel. **Q Range** only applies to Input Path Q Only and Ind I/Q. For input I+jQ "**I Range**" on page 194 determines both I and Q channel range settings.

Remote Command	<code>[:SENSe]:VOLTage:IQ:Q:RANGe[:UPPer] <voltage></code> <code>[:SENSe]:VOLTage:IQ:Q:RANGe[:UPPer]?</code>
Example	Set the Q Range to 0.5 V Peak: <code>:VOLT:IQ:Q:RANG 0.5 V</code> <code>:VOLT:IQ:Q:RANG?</code>
Notes	The numeric entries are mapped to the smallest gain range whose break point is greater than or equal to the value, or 1 V Peak if the value is greater than 1 V Q Range is only used for Input Path Q Only and Ind I/Q. For input I+jQ, " I Range " on page 194 determines both I and Q channel range settings
Couplings	When " Q Same as I " on page 197 is On, the " I Range " on page 194 value is copied to Q Range and the range value keys are disabled Changing the value also sets Range = Man
Preset	1 V Peak
State Saved	Saved in instrument state
Range	1 V Peak (10 dBm @ 50Ω) 0.5 V Peak (4 dBm @ 50Ω) 0.25 V Peak (-2 dBm @ 50Ω) 0.125 V Peak (-8 dBm @ 50Ω)
Min	0.125 V
Max	1 V
Annotation	The Range annotation replaces the RF Input context's "Atten" annotation "Rng: <Q Range>". When Range = Man the annotation is preceded by "#" The Q Range is not annotated in Input Path I Only or I+jQ. When I Range and Q Range are the same, the annotation is "Rng: <Range>". When I Range and Q Range are different and the Input Path is Ind I/Q, the annotation is "Rng: <I Range>, <Q Range>" and "Peak" is removed from the text. Examples: "Rng: 1 V Peak" the Q Range is 1 V Peak "Rng: 1 V, 0.5 V " the I Range is 1 V Peak and the Q Range is 0.5 V Peak This is an alternate form of the command to allow entry as a power.
Remote Command	<code>[:SENSe]:POWer:IQ:Q:RANGe[:UPPer] <amp;gt;</code> <code>[:SENSe]:POWer:IQ:Q:RANGe[:UPPer]?</code>
Example	Sets the Q Range to 0.5 V Peak when Reference Z is 50 Ω, and to 1.0 V Peak when Reference Z is 75 Ω: <code>:POW:IQ:Q:RANG 4 dBm</code> <code>:POW:IQ:Q:RANG?</code>
Notes	The POWer form of the command is provided for convenience. It maps to the same underlying gain range parameter as the VOLTage form of the command

The Reference Z (not the Q channel Input Z) is used to convert the power to peak voltage, which is then used to set the Q Range as with the **VOLTage** form of the command. The power values of the 4 range states (1V Peak, 0.5V Peak, 0.25V Peak, and 0.125V Peak) will vary with Reference Z. Here are some examples:

50 Ω : 10, 4, -2, -8

75 Ω : 8.2, 2.2, -3.8, -9.8

600 Ω : -0.8, -6.8, -12.8, -18.9

Preset	10.0 dBm
Range	-20 dBm to 10 dBm
Min	-20 dBm
Max	10 dBm

Q Same as I

Many, but not all, usages require the I and Q channels to have an identical setup. To simplify channel setup, **Q Same as I** causes the Q channel range to be mirrored from the I channel. That way, you only need to set up one channel (the I channel). The I channel values are copied to the Q channel, so at the time **Q Same as I** is Off, the I and Q channel setups will be identical.

Remote Command	<code>[:SENSe]:VOLTage POWer:IQ:MIRRed OFF ON 0 1</code> <code>[:SENSe]:VOLTage POWer:IQ:MIRRed?</code>
Example	Turn off the mirroring of I Range to Q Range <code>:VOLT:IQ:MIRR OFF</code> <code>:POW:IQ:MIRR OFF</code>
Couplings	When ON , the " I Range " on page 194 value is mirrored (copied) to the " Q Range " on page 196
Preset	ON
State Saved	Saved in instrument state
Range	OFF ON

3.2.3.4 Range (Non-attenuator models)

Only available for Keysight's modular signal analyzers and certain other Keysight products, such as VXT

State Saved	No
-------------	----

Range

Represents the amplitude of the largest sinusoidal signal that could be present within the IF without being clipped by the ADC. For signals with high peak-to-average ratios, the range may need to exceed the rms signal power by a significant amount to avoid clipping.

This is a measurement global setting.

Remote Command	<code>[:SENSe]:POWer[:RF]:RANGe <real></code> <code>[:SENSe]:POWer[:RF]:RANGe?</code>
Example	<code>:POW:RANG 10 dBm</code> <code>:POW:RANG?</code>
Notes	The MIN and MAX values are affected by the External Gain parameters, and by the Center Frequency . The hardware compensates for frequency response and alters the Range setting.
Preset	0 dBm
State Saved	Yes
Min	-100
Max	100
Annotation	Meas Bar

Adjust Range for Min Clipping

Sets the combination of attenuation and gain based on the current measured signal level so that clipping will be at a minimum.

This is an "immediate action" function, that is, it executes once, when the key is pressed.

This key does not appear in measurements that do not support this functionality.

Remote Command	<code>[:SENSe]:POWer[:RF]:RANGe:OPTimize IMMEDIATE</code>
Notes	Executing Adjust Range for Min Clipping initiates the measurement.
Dependencies	Does not appear in the Swept SA and Monitor Spectrum measurements.

Pre-Adjust for Min Clipping

If this function is **ON**, it applies the adjustment described under Adjust Range For Min Clipping each time a measurement restarts. Therefore, in Continuous measurement mode, it only executes before the first measurement.

Remote Command	<code>[:SENSe]:POWer[:RF]:RANGe:OPTimize:ATTenuation OFF ON ELECTRICAL </code>
----------------	--

	COMBined <code>[:SENSe]:POWer[:RF]:RANGe:OPTimize:ATTenuation?</code>
Notes	Because there is no attenuator control available in these models, the control displays only ON and OFF choices. However, for SCPI compatibility with other platforms, all three parameters (ELECTrical , COMBined , and ON) are honored and all are mapped to ELECTrical , so if any of these three parameters is sent, a subsequent query will return ELEC
Dependencies	Does not appear in the Swept SA and Monitor Spectrum measurements
Preset	OFF for Swept SA measurement; ON for all other measurements that support Pre-Adjust for Min Clipping
State Saved	Saved in instrument state

Adjustment Algorithm

The algorithm for the adjustment is documented below:

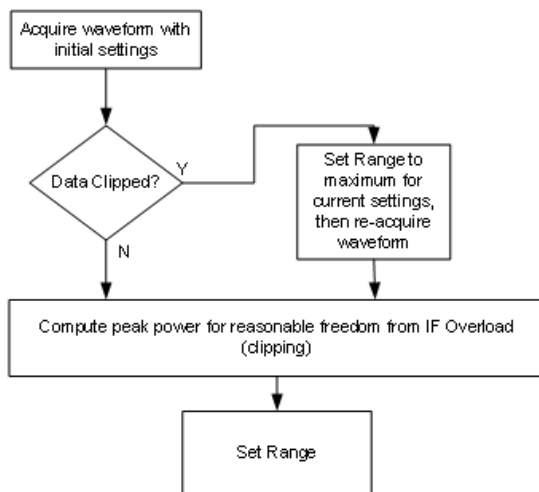

Peak-to-Average Ratio

Used with "**Range (Non-attenuator models)**" on page 731 to optimize the level control in the instrument. The value is the ratio, in dB, of the peak power to the average power of the signal to be measured. A ratio of 0 should be used for sinusoidal signals; for 802.11g OFDM signals use 9 dB.

All Modes show the current value of Peak-to-Average ratio on the control. However, some Modes do not permit changing the value. In these situations, the control is grayed-out.

Remote Command	<code>[:SENSe]:POWer[:RF]:RANGe:PARatio <real></code> <code>[:SENSe]:POWer[:RF]:RANGe:PARatio?</code>
----------------	--

Example	<code>:POW:RANG:PAR 12 dB</code>
Notes	In some Modes, this parameter is read-only; meaning the value will appear on the control and query via SCPI, but is not changeable. In such applications the control is grayed-out. Attempting to change the value via SCPI will be ignored but no error message will be generated
Dependencies	Does not appear in Spectrum Analyzer Mode
Preset	10 dB VXT Models M9410A/11A: 0 dB
State Saved	Saved in instrument state
Min	0 dB
Max	20 dB VXT Models M9410A/11A: 50 dB

Mixer Lvl Offset

This is an advanced setting to adjust target Range at the input mixer, which in turn affects the signal level in the instrument's IF. This setting can be used when additional optimization is needed after setting "[Peak-to-Average Ratio](#)" on page 733. Positive values of offset optimize noise performance over distortion, negative values optimize distortion performance over noise.

Remote Command	<code>[:SENSe] :POWer [:RF] :RANGe :MIXer :OFFSet <real></code> <code>[:SENSe] :POWer [:RF] :RANGe :MIXer :OFFSet?</code>
Example	<code>:POW:RANG:MIX:OFFS -5 dB</code>
Preset	0 dB
State Saved	Saved in instrument state
Min	-35 dB VXT Models M9410A/11A: -34 dB
Max	30 dB

3.2.3.5 Signal Path

Contains controls that pertain to the routing of the signal through the frontend of the instrument.

In general, only appears in instruments whose hardware supports this signal routing. For example, this tab does not appear in many of the modular instrument products, including VXT Model M9421A, or UXM.

This tab *does* appear in VXT Models M9410A/11A, because "[Software Preselection](#)" on page 749 is under this tab, and VXT Models M9410A/11A implement a version of Software Preselection.

Presel Center

Adjusts the centering of the preselector filter to optimize the amplitude accuracy at the frequency of the selected marker. If the selected marker is not on when **Presel Center** is pressed, the instrument turns on the selected marker, performs a peak search, and then performs centering on the marker's center frequency. If the selected marker is already on and between the start and stop frequencies of the instrument, the instrument performs the preselector calibration on that marker's frequency. If the selected marker is already on, but outside the frequency range between **Start Freq** and **Stop Freq**, the instrument first performs a peak search, and then performs centering on the marker's center frequency.

The value displayed on "**Preselector Adjust**" on page 736 changes to reflect the new preselector tuning.

Certain considerations should be observed to ensure proper operation, as detailed in "**Proper Preselector Operation**" on page 202.

Remote Command	<code>[:SENSe] :POWer[:RF] :PCENter</code>
Example	<code>:POW:PCEN</code>
Notes	The rules outlined above under the control description apply for the remote command as well as the key. The result of the command depends on marker position, etc. Any message generated by the control press is also generated in response to the remote command
Dependencies	Does not appear in CXA-m, nor in VXT Models M9410A/11A Grayed-out if the microwave preselector is off <ul style="list-style-type: none"> - If the selected marker's frequency is below Band 1, an advisory message is generated "Preselector not used in this frequency range" and no action is taken - Grayed-out if entirely in Band 0, that is, if Stop Freq is below about 3.6 GHz Grayed-out if entirely above 50 GHz, that is, if Start Freq is above 50 GHz - Blanked in models that do not include a preselector, such as Option 503. If the remote command is sent in these instruments, accepted without error, and the query always returns 0 - Grayed-out in the Spectrogram View
Couplings	The active marker position determines where the centering will be attempted If the instrument is in a measurement such as averaging when centering is initiated, the act of centering the preselector restarts averaging, but the first average trace will not be taken until the centering is completed The offset applied to do the centering appears in " Preselector Adjust " on page 736
Status Bits/OPC dependencies	When centering the preselector, *OPC does not return true until the process is complete and a subsequent measurement has completed, nor are results returned in response to <code>:READ</code> or <code>:MEASure</code> queries The Measuring bit remains set (true) while this command is operating, and does not go false until the subsequent sweep/measurement has completed

Proper Preselector Operation

Certain considerations should be observed to ensure proper operation:

1. If the selected marker is **Off**, the instrument turns on a marker, performs a peak search, and adjusts the preselector using the selected marker's frequency. It uses the "highest peak" peak search method unqualified by threshold or excursion, so that there is no chance of a 'no peak found' error. It continues with that peak, even if it is the peak of just noise. Therefore, for this operation to work properly, there should be a signal on-screen in a preselected range for the peak search to find
2. If the selected marker is already **On**, the instrument attempts the centering at that marker's frequency. There is no preselector for signals below about 3.6 GHz, so if the marker is on a signal below 3.6 GHz, no centering is attempted, and an advisory message is generated
3. In some models, the preselector can be bypassed. If it is bypassed, no centering is attempted in that range and a message is generated

Preselector Adjust

Lets you manually adjust the preselector filter frequency to optimize its response to the signal of interest. Only available when **"Presel Center"** on page 734 is available.

For general purpose signal analysis, using **Presel Center** is recommended. Centering the filter minimizes the impact of long-term preselector drift. **Preselector Adjust** can be used instead to manually optimize the preselector. One application of manual optimization would be to peak the preselector response, which both optimizes the signal-to-noise ratio and minimizes amplitude variations due to small (short-term) preselector drifting.

When **Presel Center** is performed, the offset applied to do the centering becomes the new value of **Preselector Adjust**.

Remote Command	<code>[:SENSe]:POWer[:RF]:PADJust <freq></code> <code>[:SENSe]:POWer[:RF]:PADJust?</code>
Example	<code>:POW:PADJ 100KHz</code> <code>:POW:PADJ?</code>
Notes	The value on the control is displayed to 0.1 MHz resolution
Dependencies	<ul style="list-style-type: none"> - Does not appear in CXA-m - Does not appear in VXT Models M9410A/11A - Grayed-out if microwave preselector is off - Grayed-out if entirely in Band 0, that is, if Stop Freq is lower than about 3.6 GHz

3 Bluetooth Mode

3.2 Transmit Analysis Measurement

	<ul style="list-style-type: none"> - Grayed-out if entirely above 50 GHz, that is, if Start Freq is higher than 50 GHz - Blank in models that do not include a preselector, such as Option 503. If the command is sent in these instruments, it is accepted without error, and the query always returns 0 - Grayed-out in the Spectrogram View
Preset	0 MHz
State Saved	The Preselector Adjust value set by " Presel Center " on page 734, or by manually adjusting Preselector Adjust Not saved in instrument state, and does not survive a Preset or power cycle
Min	-500 MHz
Max	500 MHz
Backwards Compatibility SCPI	<code>[:SENSe]:POWer[:RF]:MW:PADJust</code> <code>[:SENSe]:POWer[:RF]:MMW:PADJust</code>
Notes	The command has no effect, and the query always returns <code>MWAVE</code>
Backwards Compatibility SCPI	<code>[:SENSe]:POWer[:RF]:PADJust:PRESelector MWAVE MMWave EXTERNAL</code> <code>[:SENSe]:POWer[:RF]:PADJust:PRESelector?</code>

Internal Preamp

Accesses a menu of controls for the internal preamps. Turning on the preamp gives a better noise figure, but a poorer inter-modulation distortion (TOI) to noise floor dynamic range. You can optimize this setting for your measurement.

The instrument takes the preamp gain into account as it sweeps. If you sweep outside of the range of the preamp, the instrument will also account for that. The displayed result always reflects the correct gain.

For some measurements, when the preamp is on and any part of the displayed frequency range is below the lowest frequency for which the preamp has specifications, a warning condition message appears in the status line. For example, for a preamp with a 9 kHz lowest specified frequency: "Preamp: Accy unspec'd below 9 kHz".

Selection	Example	Note
Off	<code>:POW:GAIN OFF</code>	
Low Band	<code>:POW:GAIN ON</code> <code>:POW:GAIN:BAND LOW</code>	Sets the internal preamp to use only the low band. The frequency range of the installed (optional) low-band preamp is displayed in square brackets on the Low Band selection in the dropdown
Full Range	<code>:POW:GAIN ON</code> <code>:POW:GAIN:BAND</code>	Sets the internal preamp to use its full range. The low band (0-3.6 GHz, 0-3.4 GHz, 0-3 GHz, depending on the

Selection	Example	Note
	FULL	<p>model) is supplied by the low band preamp and the frequencies above low band are supplied by the high band preamp</p> <p>The frequency range of the installed (optional) low-band preamp is displayed in square brackets on the Full Range selection in the dropdown. If the high band option is not installed the Full Range selection does not appear</p>

NOTE

The maximum **Center Frequency** for Low Band, displayed in square brackets, can change based on the selected IFBW for measurements that support IFBW (for example, Waveform measurement across all Modes that support it). In certain models (such as N9042B & N9032B), IFBW values ≤ 40 MHz have a maximum Low Band frequency of 3.6 GHz, while $40 \text{ MHz} < \text{IFBW} \leq 1 \text{ GHz}$ have a maximum of 3.3 GHz, and $1 \text{ GHz} < \text{IFBW} \leq 1.5 \text{ GHz}$ have a maximum of 3.5 GHz. IFBW values $> 1.5 \text{ GHz}$ do not support a **Center Frequency** that can reach the Low Band maximum frequency. In these cases, **N/A** is displayed in the square brackets for Low Band.

Remote Command	<pre>[:SENSe]:POWer[:RF]:GAIN:BAND LOW FULL [:SENSe]:POWer[:RF]:GAIN:BAND? [:SENSe]:POWer[:RF]:GAIN[:STATe] OFF ON 0 1 [:SENSe]:POWer[:RF]:GAIN[:STATe]?</pre>
Example	<pre>:POW:GAIN:BAND LOW :POW:GAIN:BAND? :POW:GAIN OFF :POW:GAIN?</pre>
Dependencies	<p>Not available on all hardware platforms. If the preamp is not present or is unlicensed, this control is not shown</p> <p>Does not appear in VXT Models M9410A/11A/15A/16A</p> <p>If :POW:GAIN:BAND FULL is sent when a low band preamp is available, the preamp band parameter is set to LOW instead of FULL, and an "Option not installed" message is generated</p> <p>Not available when the electronic/soft attenuator is enabled</p>
Preset	<pre>LOW OFF</pre>
State Saved	Saved in instrument state
Annotation	<p>When the USB Preamp is not connected to USB, the Preamp annotation in the Meas Bar says "Off" if the preamp is off and displays the frequency range of the low band or full range preamp depending on the setting. For example, if the Preamp is set to Low Band and the Low Band is 3.6 GHz the annotation says "3.6 GHz". If it is a 13.6 GHz preamp and it is set to Full Range the annotation says "13.6 GHz"</p>

When the USB Preamp is connected to USB, the Preamp annotation says “Preamp: USB” if the internal preamp is off or “Preamp: USB, Int” if the internal preamp is on (only for measurements that support the USB preamp)

LNA

Lets you turn the Low Noise Amplifier (**LNA**) on or off.

LNA is an additional preamplifier that provides superior DANL and frequency range compared to "**Internal Preamp**" on page 737. LNA provides lower system noise figure, especially at frequencies above 100 MHz, and can be operated up to the full range of 50 GHz instruments.

For best possible sensitivity, **LNA** can be turned on *together* with "**Internal Preamp**" on page 737, although if you operate both preamps together, note that the TOI (distortion) specifications are impacted. The sensitivity improvement of this combination is substantial when operating in high band (frequencies above 3.6 GHz).

For more details about annotation, see "**More Information**" on page 205

Remote Command	<code>[:SENSe]:POWer[:RF]:GAIN:LNA[:STATe] OFF ON 0 1</code> <code>[:SENSe]:POWer[:RF]:GAIN:LNA[:STATe]?</code>
Example	<code>:POW:GAIN:LNA ON</code>
Dependencies	Requires Option LNA, except for VXT models M9415A/16A Does not appear in VXT models M9421A/10A/11A May not appear in some measurements LNA is not available when the electronic/soft attenuator is enabled
Preset	OFF
State Saved	Saved in State

More Information

When **LNA** is installed, the preamp annotation changes to show the state of both **LNA** and **Internal Preamp**. Below is an example:

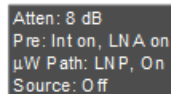

```
Atten: 8 dB
Pre: Int on, LNA on
μW Path: LNP, On
Source: Off
```

Note that when operating entirely in the low band (below about 3.6 GHz), if **LNA** is on, **Internal Preamp** is switched off (even if you have its switch set to **ON**). This is because the noise performance is actually degraded in low band if both preamps are on. In this case, the annotation reflects the actual state of the two preamps, but the

Internal Preamp annotation displays in amber, to warn you that the actual state of **Internal Preamp** does not match its switch control display:

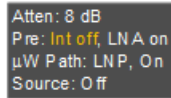

μW Path Control

Options for this control include **μW Preselector Bypass** (Option MPB), **Low Noise Path** (Option LNP) and **Full Bypass Enable** in the High Band path circuits.

When the μW Preselector is bypassed, flatness is improved, but will be subject to spurs from out of band interfering signals. When **Low Noise Path Enable** is selected, the instrument automatically bypasses certain circuitry in the high frequency bands that can contribute to noise, when it is appropriate based on other instrument settings.

For most applications, the preset state is **Standard Path**, which provides the best remote-control throughput, minimizes acoustic noise from switching and minimizes the risk of wear in the hardware switches, particularly in remote test scenarios where both low band and high band setups will follow in rapid succession. In this path, the bypass of the low band/high band switch and microwave preamp is never activated, which can cause some noise degradation but preserves the life of the bypass switch.

For applications that utilize the wideband IF paths, the preset state is **μW Preselector Bypass**, if option MPB is present. This is because, when using a wideband IF such as the 140 MHz IF, the μW Preselector's bandwidth can be narrower than the available IF bandwidth, causing degraded amplitude flatness and phase linearity, so it is desirable to bypass the preselector in the default case.

You may choose **Low Noise Path Enable** for a lower noise floor, especially in the 21–26.5 GHz region, though without improving many measures of dynamic range, and without giving the best possible noise floor. The preamp, if purchased and used, gives better noise floor than does **Low Noise Path Enable**, but the preamp's compression threshold and third-order intercept are much poorer than that of **Low Noise Path Enable**.

A fourth choice is **Full Bypass Enable**, which combines **μW Preselector Bypass** and **Low Noise Path Enable**. Because this can bypass most of the circuitry between the input and the first mixer, care should be taken when using this setting to avoid damaging the mixer. **Full Bypass Enable** is only available if both options LNP and MPB are present, as well as option FBP.

Path	Example	Note
Standard Path	:POW:MW:PATH STD	Normal setting for most measurements. μW Preselector in circuit, Low Noise Path disabled

3 Bluetooth Mode
 3.2 Transmit Analysis Measurement

Path	Example	Note
Low Noise Path Enable	:POW:MW:PATH LNP	See " Low Noise Path Enable " on page 210
μW Preselector Bypass	:POW:MW:PATH MPB	See " μW Preselector Bypass " on page 212
Full Bypass Enable	:POW:MW:PATH FULL	See " Full Bypass Enable " on page 213

Remote Command `[:SENSE]:POWer[:RF]:MW:PATH STD | LNPath | MPBypass | FULL`
`[:SENSe]:POWer[:RF]:MW:PATH?`

Example `:POW:MW:PATH LNP`
 Enables the Low Noise path
`:POW:MW:PATH?`

Notes If "[Presel Center](#)" on page 734 is performed, the instrument will momentarily switch to the Standard Path, regardless of the setting of **μW Path Control**
 The DC Block will always be switched in when the low noise path is switched in, to protect succeeding circuitry from DC. Note that this does not mean "when the low noise path is enabled" but when, based on the Low Noise Path rules, the path is actually switched in. This can happen when the selection is **Low Noise Path Enable** or **Full Bypass Enable**. In the case where the DC Block is switched in the instrument is now AC coupled. However, if you selected DC coupling, the UI would still behave as though it were DC coupled, including all annunciation, warnings, status bits, and responses to SCPI queries. This is because, based on other settings, the instrument could switch out the low noise path at any time and hence go back to being DC coupled
 Alignment switching ignores the settings in this menu, and restores them when finished

Dependencies Does not appear in CXA-m, VXT Models M9410A/11A, nor in BBIQ and External Mixing

- The **Low Noise Path Enable** selection does not appear unless Option LNP is present and licensed
- The **μW Preselector Bypass** selection does not appear unless Option MPB is present and licensed
- The **Full Bypass Enable** selection does not appear unless options LNP and MPB are both present as well as option FBP

In any of these cases, if the required options are not present and the SCPI command is sent, error - 241, "Hardware missing; Option not installed" is generated
Low Noise Path Enable and **Full Bypass Enable** are grayed-out if the current measurement does not support them
Low Noise Path Enable and **Full Bypass Enable** are not supported in Avionics and MMR Modes (non-modulation measurements). In any of these cases (that is, the feature is not supported in either measurement or Mode), if the SCPI command is sent, the following error is generated: -221, "Setting Conflict; Feature not supported for this measurement"

Preset	Mode	Value
	IQ Analyzer	MPB option present and licensed: MPB
	Pulse	MPB option not present and licensed: STD

Mode	Value
Avionics	
All other Modes	STD
State Saved	Save in instrument state
Range	Standard Path Low Noise Path Enable μ W Presel Bypass Full Bypass Enable
Annotation	<p>In the Meas Bar, if the Standard path is chosen: μW Path: Standard</p> <p>If Low Noise Path is enabled but the LNP switch is not thrown: μW Path: LNP,Off</p> <p>If the Low Noise Path is enabled and the LNP switch is thrown: μW Path: LNP,On</p> <p>If the preselector is bypassed: μW Path: Bypass</p> <p>If Full Bypass Enable is selected but the LNP switch is not thrown: μW Path: FByp,Off</p> <p>If Full Bypass Enable is selected and the LNP switch is thrown: μW Path: FByp,On</p>

μ W Path Control Auto

In VMA, WLAN, 5G NR, CQM Modes, an **Auto/Man** switch is added to μ W Path Control:



This allows the function to automatically switch based on certain Auto Rules as shown below:

VMA Mode

Measurement	When μ W Path Control is in Auto
Digital Demod	Use Standard Path unless tuned frequency > 3.6 GHz and IFBW > 15 MHz, in which case choose Preselector Bypass
Monitor Spectrum	Always Presel Bypass
IQ Waveform	Use Standard Path unless tuned frequency > 3.6 GHz and IFBW > 15 MHz, in which case choose Preselector Bypass
Custom OFDM	Use Standard Path unless tuned frequency > 3.6 GHz and IFBW > 15 MHz, in

3 Bluetooth Mode

3.2 Transmit Analysis Measurement

Measurement	When μ W Path Control is in Auto
	which case choose Preselector Bypass
Channel Power	Always Presel Bypass
Occupied BW	Always Presel Bypass
CCDF	Use Standard Path unless tuned frequency > 3.6 GHz and IFBW > 15 MHz, in which case choose Preselector Bypass
ACP	Always Presel Bypass
SEM	Always Presel Bypass
Spurious Emissions	Always Standard Path

WLAN Mode

Measurement	When μ W Path Control is in Auto
Modulation Analysis	Always Presel Bypass
Spectral Flatness	Always Presel Bypass
Power vs Time	Always Presel Bypass
Monitor Spectrum	Always Presel Bypass
IQ Waveform	Always Presel Bypass
Channel Power	Always Presel Bypass
Occupied BW	Always Presel Bypass
CCDF	Always Presel Bypass
SEM	For 11be 320M, when 'Enabled Wideband IF for FFT' is OFF or 'Sweep Type Rule' is Best Dynamic Range, auto μ W path is standard For other cases, auto μ W path is presel bypass if presel bypass is enabled, auto μ W path is standard if presel bypass is not enabled
Spurious Emissions	Always Standard Path

5G NR Mode

Measurement	When μ W Path Control is in Auto
Modulation Analysis	Use Standard Path unless tuned frequency > 3.6 GHz and IFBW > 15 MHz, in which case choose Full Bypass if conditions warrant(FBP Option is available and "Allow Full Bypass in Auto" is On), otherwise choose Preselector Bypass
Monitor Spectrum	Always Standard Path
IQ Waveform	Use Standard Path unless tuned frequency > 3.6 GHz and IFBW > 15 MHz, in which case choose Full Bypass if conditions warrant(FBP Option is available and "Allow Full Bypass in Auto" is On), otherwise choose Preselector Bypass
Channel Power	Always Standard Path

Measurement	When μ W Path Control is in Auto
Occupied BW	Always Standard Path
CCDF	Use Standard Path unless tuned frequency > 3.6 GHz and IFBW > 15 MHz, in which case choose Preselector Bypass
ACP	Always Standard Path
SEM	Always Standard Path
Spurious Emissions	Always Standard Path
Transmit On Off Power	Use Standard Path unless tuned frequency > 3.6 GHz and Info BW > 15 MHz, in which case choose Preselector Bypass

Channel Quality Mode

Measurement	When μ W Path Control is in Auto
Group Delay	Use Standard Path unless tuned frequency > 3.6 GHz and IFBW > 15 MHz, in which case choose Full Bypass if conditions warrant(FBP Option is available and "Allow Full Bypass in Auto" is On), otherwise choose Preselector Bypass
Monitor Spectrum	Always Standard Path
IQ Waveform	Use Standard Path unless tuned frequency > 3.6 GHz and IFBW > 15 MHz, in which case choose Preselector Bypass
CCDF	Use Standard Path unless tuned frequency > 3.6 GHz and IFBW > 15 MHz, in which case choose Preselector Bypass

Remote Command	<code>[:SENSe]:POWer[:RF]:MW:PATH:AUTO ON OFF 1 0</code> <code>[:SENSe]:POWer[:RF]:MW:PATH:AUTO?</code>
Example	<code>:POW:MW:PATH:AUTO ON</code> <code>:POW:MW:PATH:AUTO?</code>
Dependencies	Only appears in VMA, WLAN, 5G NR and CQM Modes
Couplings	See the tables above
Preset	<code>ON</code>
Range	<code>ON OFF</code>

Low Noise Path Enable

Low Noise Path Enable provides a lower noise floor under some circumstances, particularly when operating in the 21–26.5 GHz region. With the Low Noise Path enabled, the low band/high band switch and microwave preamp are bypassed whenever *all* the following are true:

- The instrument is not in the Low Band, meaning:
- the start frequency is above 3.5 GHz and

3 Bluetooth Mode

3.2 Transmit Analysis Measurement

- the stop frequency is above 3.6 GHz
- The internal preamp is not installed, or if installed, is set to **Off** or **Low Band**

Note that this means that, when any part of a sweep is done in Low Band, the Low Noise Path is not used, whether or not the **Low Noise Path Enable** is selected in the user interface. Also, if the preamp is turned on, the Low Noise Path is not used, whether or not the **Low Noise Path Enable** is selected in the user interface. The only time the Low Noise Path is used is when **Low Noise Path Enable** is selected, the sweep is completely in High Band (> 3.6 GHz) and no preamp is in use.

For measurements that use IQ acquisition, the low noise path is used when **Center Frequency** is in High Band (> 3.6 GHz) and no preamp is in use. In other words, the rules above are modified to use only the center frequency to qualify which path to switch in. This is not the case for FFTs in the Swept SA measurement; they use the same rules as swept measurements.

Note that the Low Noise Path, while giving improved DANL, has the disadvantage of decreased TOI performance and decreased gain compression performance relative to the standard path.

Note also that the bypass switch is a mechanical switch and has finite life, so if the **Low Noise Path Enable** is selected, it is possible to cause frequent cycling of this switch by frequently changing instrument settings such that the above conditions hold true only some of the time. A user making tests of this nature should consider opting for the **Standard Path**, which will never throw the bypass switch, at the expense of some degraded noise performance.

The low noise path is useful for situations where the signal level is so low that the instrument performance is dominated by noise even with 0 dB attenuation, but still high enough that the preamp option would have excessive third-order intermodulation or compression. The preamp, if purchased and used, gives better noise floor than does the “Low Noise Path.” However, its compression threshold and third-order intercept are much poorer than that of the non-preamp path.

There are some applications, typically for signals around –30 dBm, for which the third-order dynamic range of the standard path is good enough, but the noise floor is not low enough even with 0 dB input attenuation. When the third-order dynamic range of the preamp path is too little and the noise floor of the standard path is too high, the Low Noise Path can provide the best dynamic range

The graph below illustrates the concept. It shows, in red, the performance of an instrument at different attenuation settings, both with the preamp on and off, in a measurement that is affected by both instrument noise and instrument TOI. The green shows the best available dynamic range, offset by 0.5 dB for clarity. The blue shows how the best available dynamic range improves for moderate signal levels with the low noise path switched in. In this illustration, the preamp improves the

noise floor by 15 dB while degrading the third-order intercept by 30 dB, and the low noise path reduces loss by 8 dB. The attenuator step size is 2 dB.

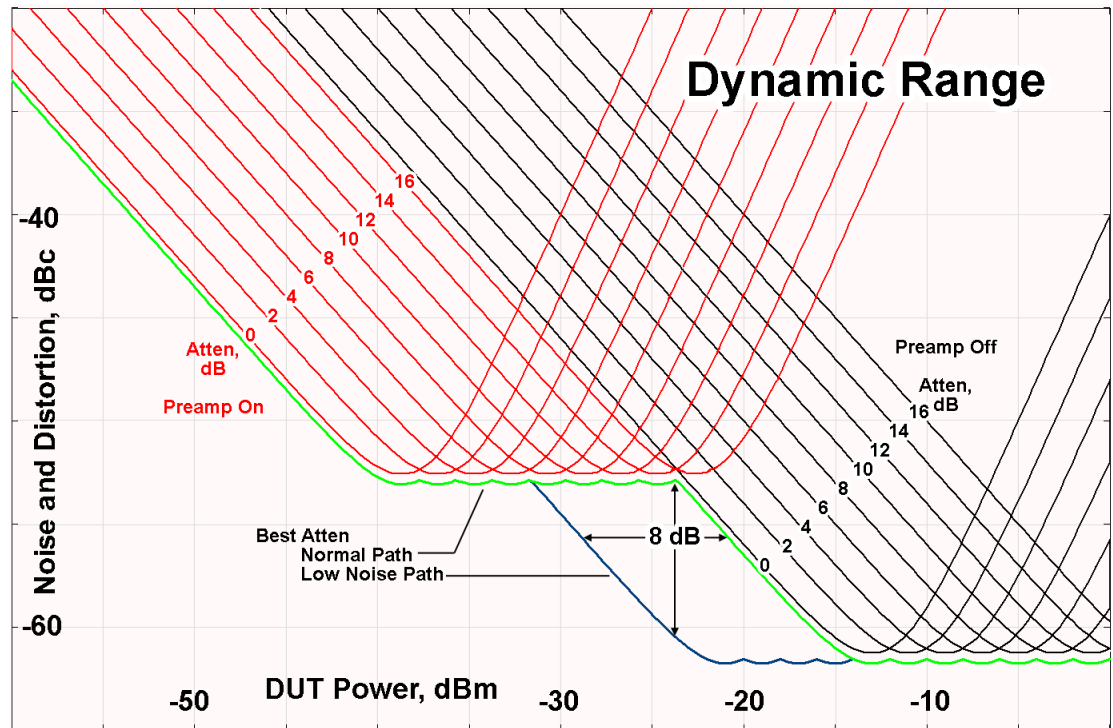

There are other times where selecting the low noise path improves performance, too. Compression-limited measurements such as finding the nulls in a pulsed-RF spectrum can profit from the low noise path in a way similar to the TOI-limited measurement illustrated. Accuracy can be improved when the low noise path allows the optimum attenuation to increase from a small amount like 0, 2 or 4 dB to a larger amount, giving better return loss at the instrument input. Harmonic measurements, such as second and third harmonic levels, are much improved using the low noise path because of the superiority of that path for harmonic (though not intermodulation) distortion performance.

µW Preselector Bypass

Toggles the preselector bypass switch for band 1 and higher. When the microwave preselector is on, the signal path is preselected. When the microwave preselector is off, the signal path is not preselected. The preselected path is the normal path for the instrument.

The preselector is a tunable bandpass filter which prevents signals away from the frequency of interest from combining in the mixer to generate in-band spurious signals (images). The consequences of using a preselector filter are its limited

bandwidth, the amplitude and phase ripple in its passband, and any amplitude and phase instability due to center frequency drift.

Option MPB or pre-selector bypass provides an unpreselected input mixer path for certain X-Series signal analyzers with frequency ranges above 3.6 GHz. This signal path allows a wider bandwidth and less amplitude variability, which is an advantage when doing modulation analysis and broadband signal analysis. The disadvantage is that, without the preselector, image signals will be displayed. Another disadvantage of bypassing the preselector is increased LO emission levels at the front panel input port.

Image responses are separated from the real signal by twice the 1st IF. For IF Paths of 10 MHz and 25 MHz, the 1st IF is 322.5 MHz, so the image response and the real signal will be separated by 645 MHz. The 1st IF will be different for other IF Path settings. When viewing a real signal and its corresponding image response in internal mixing, the image response will be to the left of the real signal.

Also, the image response and the real signal typically have the same amplitude and exhibit the same shape factor.

However, if Option FS1 (Fast Sweep Capability) is enabled, the image response in the Swept SA measurement appears lower in amplitude and has a much wider shape factor compared to the real signal.

Full Bypass Enable

With **Full Bypass Enable** selected, the microwave preselector is bypassed. In addition, the low band/high band switch and microwave preamp are bypassed whenever *all* the following are true:

- The instrument is not in the Low Band, meaning:
- the start frequency is above 3.5 GHz and
- the stop frequency is above 3.6 GHz.
- the internal preamp is not installed or if installed, is set to **Off** or **Low Band**

Note that this means that, when any part of a sweep is done in Low Band, the Low Noise Path is not used, whether or not the **Full Bypass Enable** is selected in the user interface. Also, if the preamp is turned on, the Low Noise Path is not used, whether or not the **Full Bypass Enable** is selected in the user interface. The only time the Low Noise Path is used is when **Full Bypass Enable** is selected, the sweep is completely in High Band (> 3.6 GHz) and no preamp is in use.

CAUTION

When **Full Bypass Enable** is selected, and "**Y Scale**" on page 597 is set to 0 dB, there will be a direct AC connection between the input and the first converter

when the Low Noise Path switches in (when Start Freq >3.6 GHz and the Preamp is either not licensed, set to Low Band, or Off). This puts the first converter at considerable risk to be damaged by high AC power. Consequently, whenever **Full Bypass Enable** is selected, a warning message appears in the status bar:

“Full Bypass Enabled, maximum safe input power reduced”

Microwave Preselector Bypass Backwards Compatibility

Example	<code>:POW:MW:PRES OFF</code> Bypasses the microwave preselector
Notes	Included for Microwave Preselector Bypass backwards compatibility The ON parameter sets the STD path (<code>:POW:MW:PATH STD</code>) The OFF parameter sets path MPB (<code>:POW:MW:PATH MPB</code>)
Preset	ON
Backwards Compatibility SCPI	<code>[:SENSe]:POWer[:RF]:MW:PRESelector[:STATe] ON OFF 0 1</code> <code>[:SENSe]:POWer[:RF]:MW:PRESelector[:STATe]?</code>

Frequency Extender Preselection Bypass

Only applies to the high frequency path of the Frequency Extender, and only if the Frequency Extender allows it. For example, the V3050A high frequency path is 50 – 110 GHz and *does* allow control of the preselector bypass.

When the Frequency Extender’s preselection is bypassed, flatness is improved, but will be subject to spurs from out-of-band interfering signals. For bandwidths greater than 2.5 [GHz], it is recommended that the signal bypass the Frequency Extender Preselector since the max bandwidth of the Preselector can be as narrow as 2.5 [GHz].

For most applications, the preset state is **OFF**, which gives the best remote-control throughput, minimizes acoustic noise from switching, minimizes out of band spurs, and minimizes the risk of wear in the hardware switches.

Preselector and Bandwidth Conflict

When the Frequency Extender Preselector is applied and the signal bandwidth is greater than 2.5 [GHz], then a settings alert message will show to warn the user that the signal may be distorted due to the limitation of the Frequency Extender Preselector bandwidth.

An example of the settings alert message is shown below.

Settings Alert message in the Status Bar at the bottom of the display.



Settings Alert message in the error queue

Type	ID	
	159	Settings Alert - DETECTED; Presel/Meas BW conflict

Software Preselection

Provided in some instruments, either to compensate for issues with provided hardware preselection or to provide the preselection function when there is no hardware preselector.

N9041B

Software Preselection compensates for the frequency range limit of the microwave preselector. Since the microwave preselector only goes up to 50 GHz, software preselection must be used to suppress and separate images above 50 GHz. The specific algorithm used for software preselection is specified by the SW Preselection Type selection – Normal or Advanced.

In N9041B, **Software Preselection** only applies for frequencies above 50 GHz, therefore it is only used for RF Input 2. Even if turned on, it is not used for other inputs, and never for frequencies below 50 GHz. This is why the label of this control contains the parenthetical note “(>~50 GHz)”.

Note that in N9041B, in Swept SA measurement, **Software Preselection** works even if the measurement is using an FFT Sweep Type. In measurements other than Swept SA, Software Preselection is not used if the measurement is using an FFT sweep type.

N9042B+V3050A

Software Preselection compensates for the frequency range limit of the microwave preselector. Since the microwave preselector only goes up to 50 GHz, software preselection must be used to suppress and separate images above 50 GHz. The specific algorithm used for software preselection is specified by the SW Preselection Type selection – Normal or Advanced.

For N9042B+V3050A, Software Preselection only applies for frequencies above 50 GHz, therefore it is only used for External RF. Even if it is turned on, it will not be used for other inputs and never for frequencies below 50 GHz. This is why the label of this control contains the parenthetical note “(>~50 GHz)”.

Note that for N9042B+V3050A, in the Swept SA measurement, Software Preselection works even if the measurement is using an FFT Sweep Type. In measurements other than Swept SA, Software Preselection is not used if the measurement is using an FFT Sweep Type.

VXT models M9410A/11A

Software Preselection is used to provide the preselection function, as there is no hardware preselector in these models. Two background traces are taken and compared point by point, and the point with the lowest amplitude from the two traces is used. This provides a method to reduce spurs that are internally generated within the VXT, but you should note the following when using Software Preselection:

- There is some speed cost due to the need to take multiple captures
- Taking the point with the lowest amplitude in each trace will make the average noise level lower at all points that do not have a spur. This can reduce the accuracy of the measurement of noise and noise-like signals

Because of the difficulty in identifying spurs manually, you are recommended to leave Software Preselection **ON** at all times in VXT models M9410A/11A. If you turn it off in order to speed up your measurement or improve noise accuracy, be aware of unwanted onscreen spurs.

Remote Command	<code>[:SENSe]:POWer[:RF]:SWPreSel:STATe 0 1 ON OFF</code>	
	<code>[:SENSe]:POWer[:RF]:SWPreSel:STAT?</code>	
Example	<code>:POW:SWPR:STAT 1</code>	
	<code>:POW:SWPR:STAT?</code>	
Dependencies	Only appears in N9041B, N9042B+V2050A, and VXT models M9410A/11A. Does not appear in all measurements	
Couplings	Affects Sweep Time Auto Tune supports Software Preselection , so Auto Tune should be performed after setting the Software Preselection state	
Preset	N9041B	OFF
	N9042B+V3050A	ON
	M9410A/11A	ON
State Saved	Saved in instrument state	

SW Preselection Type

Specifies the algorithm used for software preselection.

Two hidden sweeps occur in succession. The second sweep is offset in LO frequency by $2 * IF / N$. For each point in each trace, the smaller amplitude from the two traces is taken and placed in that point in the selected trace. The Peak detector is auto-selected to improve the image suppression effectiveness. Responses of each trace that lie on top of one another will remain and are valid signals. Other signals are images, which are suppressed. The action of taking the smaller of the two traces will make the average noise level lower in all points that do not have an image, thus reducing the accuracy of the measurement of noise and noise-like signals.

- **NORMa1** - mathematically removes all image and multiple responses of signals present at the input
- **ADVanced** - any trace processing (such as “max hold” or trace averaging) is performed on the points of both candidate traces before the “select minimum” operation occurs. This form of processing works better for non-stationary signals, such as pulsed-RF signals

Remote Command	<code>[:SENSe]:POWer[:RF]:SWPreSel NORMa1 ADVanced</code> <code>[:SENSe]:POWer[:RF]:SWPreSel?</code>
Example	<code>:POW:SWPR NORM</code> <code>:POW:SWPR?</code>
Dependencies	Only appears in N9041B and N9042B+V3050A. Only appears in measurements that use the Swept method Grayed-out when "Software Preselection" on page 749 is OFF. The grayout message is “Unavailable unless SW Presel enabled”
Preset	N9041B ADVanced N9042B+V3050A NORMa1
State Saved	Saved in instrument state

SW Preselection BW

Specifies the effective bandwidth to be used for Software Preselection.

The options are:

- **NORMa1** – when making Swept measurements, a software preselection algorithm is used which takes up to 4 background acquisitions, then post-processes the result. This algorithm can remove images from signals with an occupied

bandwidth up to around 3 GHz. (Default/Preset setting). When making FFT measurements, this algorithm is not used, instead the same algorithm is used as for **NARRow** (below)

- **NARRow**– a software preselection algorithm is used which takes two background acquisitions, then post-processes the result to detect and remove images from wideband signals with occupied bandwidths up to 2 GHz. This increases the risk of images failing to be rejected, but improves the measurement speed

Remote Command	<code>[:SENSe]:POWer[:RF]:SWPResel:BW NORMa1 NARRow</code> <code>[:SENSe]:POWer[:RF]:SWPResel:BW?</code>
Example	<code>:POW:SWPR:BW NARR</code>
Dependencies	Only appears in N9041B and N9042B+V3050A. Only appears in measurements that use the Swept method Grayed-out when " Software Preselection " on page 749 is OFF . The grayout message is "Unavailable unless SW Presel enabled" For N9042B+V3050A, the parameter is SCPI-only, and always set to NARRow when Software Preselection is enabled
Preset	N9041B NORMa1 N9042B+V3050A NARRow
State Saved	Saved in instrument state

High Freq Prefilter

Lets you set the state of Prefilter for center frequencies above 1310 MHz.

In VXT Models M9410A/11A, the Receiver RF path has a bank of filters that come after the RF Attenuator in the signal path. Since this bank of filters precedes the mixer they are known as the "Prefilter" bank. Their purpose is to eliminate unwanted in-band mixing products by filtering out all but the desired frequencies before the signals get to the mixer. There are 13 prefilter bands to cover the frequencies between 9 kHz and 6000 MHz. The Prefilter provides the necessary rejection of the unwanted signal.

Remote Command	<code>[:SENSe]:<measurement>:PFILter[:STATe] ON OFF 1 0</code> <code>[:SENSe]:<measurement>:PFILter[:STATe]?</code>
Example	Enable High Freq Prefilter for the Complex Spectrum Measurement in BASIC Mode: <code>:SPEC:PFIL ON</code> Enable High Freq Prefilter for the IQ Waveform Measurement, in multiple Modes: <code>:WAV:PFIL ON</code> Enable High Freq Prefilter for the Swept SA Measurement in SA Mode:

3 Bluetooth Mode
3.2 Transmit Analysis Measurement

	:SAN:PFIL ON
Dependencies	Only appears in VXT models M9410A/11A with center frequency above 1310 MHz
Preset	See "Prefilter Presets" on page 219 below
State Saved	Saved in instrument state

Prefilter Presets

Meas	Mode	Preset
SPEC	BASIC	OFF
WAV	BASIC, WCDMA, WLAN, LTEAFDD, LTEATDD, 5GNR, VMA	OFF
MON	WCDMA, WLAN, LTEAFDD, LTEATDD, 5GNR, VMA	OFF
RHO	WCDMA	OFF
CDP	WCDMA	OFF
PCON	WCDMA	OFF
EVMQ	WCDMA	OFF
CHP	WCDMA, WLAN, LTEAFDD, LTEATDD, 5GNR, VMA, SA	OFF
OBW	WCDMA, WLAN, LTEAFDD, LTEATDD, 5GNR, VMA, SA	OFF
ACP	WCDMA, LTEAFDD, LTEATDD, 5GNR, VMA, SA	OFF
SEM	WCDMA, WLAN, LTEAFDD, LTEATDD, 5GNR, VMA, SA	OFF
PST	WCDMA, WLAN, LTEAFDD, LTEATDD, 5GNR, VMA, SA	OFF
PVT	WLAN, LTEAFDD, LTEATDD, 5GNR	OFF
EVM	WLAN, LTEAFDD, LTEATDD, 5GNR	OFF
FLAT	WLAN	OFF
EVMM	WLAN	OFF
CEVM	LTEAFDD, LTEATDD	OFF
PAVT	5GNR, VMA	OFF
DDEM	VMA	OFF
OFDM	VMA	OFF
SAN	SA	ON
HARM	SA	ON

3.2.4 BW

Not supported in this measurement.

3.2.5 Display

Opens the **Display** menu, which lets you configure display items for the current Mode, Measurement, View, or Window.

3.2.5.1 View

Contains controls for selecting the current **View**, and for editing User Views.

View

See "Views" on page 163.

User View

Lets you choose a View from the saved User Views for the current measurement. This panel only appears if a User View exists for the current measurement.

Remote Command	<code>:DISPlay:VIEW:ADVanced:SElect <alphanumeric></code> <code>:DISPlay:VIEW:ADVanced:SElect?</code>
Example	Select Baseband as the current View <code>:DISP:VIEW:ADV:SEL "Baseband"</code>
Notes	<p>You must be in the measurement whose View you are trying to set to send the command. You can only set Views for the current measurement using this command</p> <p>For predefined views, the parameter is derived from the view name that is shown in the View list in the user interface. For example, if you are trying to select the Trace Zoom view in the Swept SA measurement, you send:</p> <pre>:DISP:VIEW:ADV:SEL "Trace Zoom"</pre> <p>because "Trace Zoom" is the name of the View as seen in the Mode/Meas dialog or in the Display, View menu</p> <p>You <i>cannot</i> use the legacy View parameter (which in this case would be <code>TZOOM</code>) with</p> <pre>:DISP:VIEW:ADV:SEL</pre> <p><code><alphanumeric></code> is case insensitive; you can specify mixed case, however the name will be evaluated on a single case. Thus, both of the following forms work:</p> <pre>:DISP:VIEW:ADV:SEL "Trace Zoom"</pre> <pre>:DISP:VIEW:ADV:SEL "TRACE ZOOM"</pre> <p>If the specified view is not a valid View, the query returns the error message "-224, Illegal parameter value; View with the name <alphanumeric> does not exist"</p> <p>If the display is disabled (via <code>:DISP:ENAB OFF</code>) then the error message "-221, Settings conflict; View SCPI cannot be used while Display is disabled" is generated</p>
Backwards Compatibility SCPI	<p>The legacy node</p> <pre>:DISPlay:VIEW[:SElect]</pre> <p>is retained for backwards compatibility, but it only supports predefined views</p>

Restore Layout to Default

Restores the Layout to the default for Basic.

Modified Views are very temporary; if you exit the current measurement they are discarded, and they are not saved in State. To retain this View for later use, and to be able to return easily to your original Basic View, you can save your edited View as a “User View”.

Save Layout as New View

Saves your new View as a User View. An alpha keyboard appears, which lets you name your new View; the default is the old View name plus a number.

Remote Command	<code>:DISPlay:VIEW:ADVanced:NAME <alphanumeric></code>
Example	<code>:DISP:VIEW:ADV:NAME "Baseband"</code> Creates a new View named Baseband from the current View, and selects it as the current View
Notes	<code><alphanumeric></code> is case insensitive; you can specify mixed case, however the name will be evaluated on a single case If <code><alphanumeric></code> name already exists as a View, the error message “-224, Illegal parameter value; View <alphanumeric> already exists” is generated If the display is disabled (via <code>:DISP:ENAB OFF</code>) then the error message “-221, Settings conflict; User View SCPI cannot be used while Display is disabled” is generated

Re-Save User View

You can re-edit a User View; if you make changes, then an asterisk will appear next to the User View’s name. You can then tap **Re-Save User View** to save it back to its existing name, or **Save Layout as New View** to add another, new User View.

This is a front panel function only, there is no remote command available to perform this function. To do this remotely, you must first perform **Save Layout as New View**, then delete the old User View and rename the new one with the name of the View you just deleted.

Rename User View

You can rename the current View by giving it a new unique name. Only User Views can be renamed, if the current View is a Predefined View, an error occurs.

Remote Command	<code>:DISPlay:VIEW:ADVanced:REName <alphanumeric></code>
----------------	---

Example	<code>:DISP:VIEW:ADV:REN "Baseband"</code>
Notes	<p><code><alphanumeric></code> is case insensitive; you can specify mixed case, however the name will be evaluated on a single case</p> <p>If the <code><alphanumeric></code> specifying the new name is already present in the list of View names, the error message "-224, Illegal parameter value; View <alphanumeric> already exists" is generated</p> <p>If the current View is a Predefined View, the error message "-224, Illegal parameter value; Cannot rename a Predefined View" is generated</p> <p>If the display is disabled (via <code>:DISP:ENAB OFF</code>) then the error message "-221, Settings conflict; View SCPI cannot be used while Display is disabled" is generated</p>

Delete User View

You can delete the current View if it is a User View. The default view becomes the current view for the Measurement.

Remote Command	<code>:DISPlay:VIEW:ADVanced:DElete</code>
Example	<code>:DISP:VIEW:ADV:DEL</code>
Notes	<p><code><alphanumeric></code> is case insensitive; you can specify mixed case, however the name will be evaluated on a single case</p> <p>If the <code><alphanumeric></code> is not present in the list of View names, the error message "-224, Illegal parameter value; View <alphanumeric> does not exist" is generated</p> <p>If the current View is a Predefined View, the error message "-224, Illegal parameter value; Cannot delete a Predefined View" is generated</p> <p>If the display is disabled (via <code>:DISP:ENAB OFF</code>) then the error message "-221, Settings conflict; View SCPI cannot be used while Display is disabled" is generated</p>

Delete All User Views

Deletes all previously saved User Views. The default view becomes the current view for the Measurement if a User View was the current view when this command was executed.

Remote Command	<code>:DISPlay:VIEW:ADVanced:DElete:ALL</code>
Example	<code>:DISP:VIEW:ADV:DEL:ALL</code>
Notes	Disabled if there are no User Views

View Editor Remote Commands

The following remote commands help you manage Views and User Views. Note that the SCPI node for User Views handles both Predefined and User Views. The legacy

nodes, `:DISPlay:VIEW[:SElect]` and `:DISPlay:VIEW:NSEL`, are retained for backwards compatibility, but they only support predefined views.

View Listing Query

Returns a string containing a comma-separated list of names for *all* the Views, including User Views, available for the current Measurement.

Remote Command	<code>:DISPlay:VIEW:ADVanced:CATalog?</code>
Example	<code>:DISP:VIEW:ADV:CAT?</code>
Notes	Returns a quoted string of the available Views for the current measurement, separated by commas. The list includes names for <i>all</i> the Views, including User Views, available for the current Measurement Example: <code>"Normal,Trace Zoom,Spectrogram,Baseband,myView1,yourView1"</code> No distinction is made between Predefined and User Views If you switch measurements with the display disabled (via <code>:DISP:ENAB OFF</code>), then query the list of available Views, the result is undefined

User View Listing Query

Returns a string containing a comma-separated list of names for *only* the User Views available for the current Measurement.

Remote Command	<code>:DISPlay:VIEW:ADVanced:USER:CATalog?</code>
Example	<code>:DISP:VIEW:ADV:USER:CAT?</code>
Notes	Returns a quoted string of the available User Views for the current measurement, separated by commas. Example: <code>"Baseband,myView1,yourView1"</code> If you switch measurements with the display disabled (see "Display Enable (Remote Command Only)" on page 760), then query the list of available Views, the result is undefined

3.2.5.2 Annotation

Contains controls for setting up the annotation for the current Mode or Measurement.

Graticule

Turns the display graticule On or Off for all windows with graticules in all measurements in the current Mode. Also turns the graticule Y-Axis annotation on and off.

Remote Command	<code>:DISPlay:GRATicule[:STATe] OFF ON 0 1</code> <code>:DISPlay:GRATicule[:STATe]?</code>
Example	<code>:DISP:GRAT OFF</code>
Notes	The graticule is the set of horizontal and vertical lines that make up the grid/divisions for the X-Axis and Y-Axis
Preset	ON
State Saved	Saved in instrument state
Backwards Compatibility SCPI	<code>:DISPlay:WINDow[1]:TRACe:GRATicule:GRID[:STATe] OFF ON 0 1</code> <code>:DISPlay:WINDow[1]:TRACe:GRATicule:GRID[:STATe]?</code> This command is accepted for backwards compatibility with older instruments, but the WINDow , TRACe and GRID parameters are ignored

Screen Annotation

Controls the display of the annunciation and annotation around the graticule, including any annotation on lines (such as the display line, the threshold line, etc.) and the Y-Axis annotation, for all windows with screen annotation in all measurements in the current Mode.

This does *not* include marker annotation (or the N dB result). When **OFF**, the graticule expands to fill the entire graticule area, leaving only the 1.5% gap above the graticule, as described in the **Trace** section.

Remote Command	<code>:DISPlay:ANNotation:SCReen[:STATe] OFF ON 0 1</code> <code>:DISPlay:ANNotation:SCReen[:STATe]?</code>
Example	<code>:DISP:ANN:SCR OFF</code>
Dependencies	Grayed-out and forced to OFF when System Display Settings, Annotation is OFF
Preset	ON This remains OFF through a Preset when System Display Settings, Annotation is set to OFF
State Saved	Saved in instrument state

Trace Annotation

Turns on and off the labels on the traces, showing their detector (or their Math Mode) as described in the **Trace** section, for all windows in all measurements in the current Mode for which Trace Annotation on/off is supported.

If Trace Math is being performed on a trace, then the Trace Math annotation replaces the detector annotation.

For measurements that support limit lines, this key also turns on and off the labels on the Limit Lines. The label is the Limit number annotation and Limit Comment displayed on the graph. If the length of the comment is greater than 20 characters, the first 8 characters and the last 8 characters are displayed, joined with

Remote Command	<code>:DISPlay:ANNotation:TRACe[:STATe] ON OFF 1 0</code> <code>:DISPlay:ANNotation:TRACe[:STATe]?</code>
Example	<code>:DISP:ANN:TRAC OFF</code>
Preset	<code>OFF</code>
State Saved	Saved in instrument state

Control Annotation

Turns on and off the display of values on the Active Function controls for all measurements in the current Mode. This is a security feature.

Remote Command	<code>:DISPlay:ACTivefunc[:STATe] ON OFF 1 0</code> <code>:DISPlay:ACTivefunc[:STATe]?</code>
Example	<code>:DISP:ACT OFF</code>
Dependencies	Grayed out and forced to <code>OFF</code> when System Display Settings, Annotation is <code>OFF</code>
Preset	<code>ON</code> This remains <code>OFF</code> through a Preset when System Display Settings, Annotation is set to <code>OFF</code>
State Saved	Saved in instrument state

Meas Bar

Turns the Measurement Bar at the top of the screen on and off for all measurements in the current Mode. When `OFF`, the graticule area expands to fill the area formerly occupied by the Measurement Bar.

Remote Command	<code>:DISPlay:ANNotation:MBAR[:STATe] OFF ON 0 1</code> <code>:DISPlay:ANNotation:MBAR[:STATe]?</code>
----------------	--

Example	<code>:DISP:ANN:MBAR OFF</code>
Dependencies	Grayed out and forced to OFF when System Display Settings, Annotation is OFF
Preset	ON This remains OFF through a Preset when System Display Settings, Annotation is set to OFF
State Saved	Saved in instrument state

Display Enable (Remote Command Only)

Turns the display on/off, including the display drive circuitry. The backlight stays lit to confirm that the instrument is on. The display enable setting is mode global. There are three reasons for turning the display off:

1. To increase speed as much as possible by freeing the instrument from having to update the display
2. To reduce emissions from the display, drive circuitry
3. For security purposes

If you have turned off the display:

- and you are in local operation, the display can be turned back on by pressing any key or by sending `:SYSTEM:DEFAULTS MISC` or `:DISPLAY:ENABLE ON` (neither `*RST` nor `:SYSTEM:PRESET` enable the display)
- and you are in remote operation, the display can be turned back on by pressing the **Local** or **Esc** keys, or by sending `:SYSTEM:DEFAULTS MISC` or `:DISPLAY:ENABLE ON` (neither `*RST` nor `:SYSTEM:PRESET` enable the display)
- and you are using either the `:SYSTEM:KLOCK` command or GPIB local lockout, then *no* front-panel key press will turn the display back on. You must turn it back on remotely.

If the display is **OFF**, many SCPI commands related to User Views and Multiscreen functionality do not work, and return the error messages “-221, Settings conflict; Screen SCPI cannot be used when Display is disabled” or “221, Settings conflict; View SCPI cannot be used while Display is disabled”. These commands include:

Name	Command
Select User View	<code>:DISPLAY:VIEW:ADVANCED:SELECT</code>
Rename User View	<code>:DISPLAY:VIEW:ADVANCED:RENAME</code>
Delete User View	<code>:DISPLAY:VIEW:ADVANCED:DELETE</code>
Create User View	<code>:DISPLAY:VIEW:ADVANCED:NAME</code>
Select Screen	<code>:INSTRUMENT:SCREEN:SELECT</code>
Delete Screen	<code>:INSTRUMENT:SCREEN:DELETE</code>

3 Bluetooth Mode

3.2 Transmit Analysis Measurement

Name	Command
Delete All But This Screen	:INSTrument:SCReen:DELeTe:ALL
Add Screen	:INSTrument:SCReen:CREate
Rename Screen	:INSTrument:SCReen:REName
Sequencer On/Off	:SYSTem:SEQuencer

Remote Command	:DISPlay:ENABle OFF ON 0 1
Example	:DISP:ENAB OFF
Couplings	:DISP:ENAB OFF turns Backlight OFF and :DISP:ENAB ON turns Backlight ON, but changing Backlight settings does <i>not</i> change the state of :DISP:ENAB
Preset	ON Set by :SYST:DEF MISC, but not affected by *RST or :SYSTem:PRESet
State Saved	Not saved in instrument state
Backwards Compatibility Notes	:SYST:PRES no longer turns on :DISPlay:ENABle as it did in legacy analyzers

3.2.6 Frequency

Opens the **Frequency** menu, which contains controls that allow you to control the frequency and channel parameters of the instrument.

Some features in the **Frequency** menu are the same for all measurements in the current Mode – they do not change as you change measurements. Settings like these are called “Meas Global” and are unaffected by Meas Preset.

3.2.6.1 Settings

Contains controls that pertain to the X axis parameters of the measurement. These parameters control how data on the vertical (X) axis is displayed and control instrument settings that affect the horizontal axis.

Channel

Selects which Bluetooth channel will be measured.

Channel number is common for all the measurements. The coupling of Channel and Center Frequency apply to the following Measurements:

- Transmit Analysis
- Output Spectrum BW
- Monitor Spectrum

For other measurements, center frequency does not depend on channel. If center frequency is changed in other measurements but channel isn't changed, center frequency still can return to the old value only if the measurement is switched to the upward measurements.

Remote Command	<code>[:SENSe]:CHANnel[:NUMBer] <integer></code> <code>[:SENSe]:CHANnel[:NUMBer]?</code>
Example	<code>:CHAN 22</code> <code>:CHAN?</code>

Couplings
The coupling of channel and center frequency is only applied to the following measurements:

- Transmit Analysis
- Output Spectrum BW
- Monitor Spectrum

For other measurements, center frequency does not depend on channel. Following is the coupling of channel and center frequency

If Radio Stand is Basic or EDR:

$$\text{Channel} = (\text{CF} - 2.402\text{E9}) / 1.0\text{e6}$$

If the Center Frequency is set to a value between channels, the channel key should display > prior to the previous channel number if the CF is < 500 kHz above the previous channel and < prior to the next channel number if the CF is > = 500 kHz above the previous channel

For example, if Channel = 3.4, the channel key will display >3. If Channel = 3.5, the channel key will display <4. If Channel < 0, the channel key will display <0. If Channel > 78(22), the channel key display will display >78(22)

If Radio Stand is Low Energy:

$$\text{Channel} = (\text{CF} - 2.402\text{E9}) / 2.0\text{e6}$$

The max value of channel is 39. The range of channel is 0-39

If the Center Frequency is set to a value between channels, the channel key should display > prior to the previous channel number if the CF is < 1 MHz above the previous channel and < prior to the next channel number if the CF is > = 1 MHz above the previous channel

For example, if Channel = 3.4, the channel key will display >3. If Channel = 3.5, the channel key will display <4. If Channel < 0, the channel key will display <0. If Channel > 78(22), the channel key display will display >78(22)

If Geography is France :

- Channel Number: 0...22
- If Center Frequency < 2.454 GHz, the channel key should display < 0

-
- If Center Frequency > 2.476 GHz, the channel key should display > 22

If Geography is Others:

- Channel Number: 0...78
- If Center Frequency < 2.402 GHz, the channel key should display < 0
- If Center Frequency > 2.480 GHz, the channel key should display > 78

Preset	0
State Saved	Yes
Range	0 – 78
Min/Max	0 / 78

Center Frequency

Sets the frequency that corresponds to the horizontal center of the graticule (when frequency Scale Type is set to linear). While adjusting **Center Frequency**, **Span** is held constant, which means that both **Start Freq** and **Stop Freq** will change.

In measurements that also have **Start Freq** and **Stop Freq** controls, pressing **Center Frequency** sets the frequency entry mode to Center/Span. In Center/Span mode, the center frequency and span values are displayed below the graticule, and the default active function in the **Frequency** menu is **Center Frequency**. In the Start/Stop annotation mode, **Start Freq** and **Stop Freq** are displayed below the graticule instead of **Center Frequency** and **Span**.

Pressing **Center Frequency** also sets the frequency entry mode to Center/Span. In Center/Span mode, the center frequency and span values are displayed below the graticule, and the default active function in the **Frequency** menu is **Center Frequency**.

When **Display Scale Type** is set to **LOG**, pressing **Center Frequency** sets the frequency that corresponds to the arithmetic mean of the start frequency and stop frequency, which is not at the horizontal center of the graticule.

The center frequency setting is the same for all measurements within a Mode, that is, it is Meas Global. Some Modes are also able to share a Mode Global center frequency value. If this is the case, the Mode has a **Global** tab in its **Meas Setup** menu.

Center Frequency sets (and queries) the center frequency for the currently selected input. If your instrument has multiple inputs, and you select another input, **Center Frequency** changes to the value for that input. SCPI commands are available to directly set **Center Frequency** for a specific input (see "**RF Center Frequency**" on page 233 and "**Ext Mix Center Freq**" on page 234).

Center Frequency is remembered as you go from input to input. Thus you can set a **Center Frequency** of 10 GHz with the RF Input selected, change to BBIQ and set a **Center Frequency** of 20 MHz, then switch to External Mixing and set a **Center Frequency** of 60 GHz. When you return to the RF Input, **Center Frequency** reverts to 10 GHz; back to BBIQ and it is 20 MHz; back to External Mixing and it is 60 GHz.

Remote Command	<code>[:SENSe] :FREQuency :CENTer <freq></code> <code>[:SENSe] :FREQuency :CENTer ?</code>
Example	Set Center Frequency to 50 MHz: <code>:FREQ:CENT 50 MHz</code> Increment Center Frequency by the value of CF Step : <code>:FREQ:CENT UP</code> Return the current value of Center Frequency : <code>:FREQ:CENT ?</code>
Notes	Sets the RF, External Mixing or I/Q Center Frequency depending on the selected input: <ul style="list-style-type: none"> – For RF input it is equivalent to <code>:FREQ:RF :CENT</code> – For I/Q input it is equivalent to <code>:FREQ:IQ :CENT</code> – For External Mixer it is equivalent to <code>:FREQ:EMIX :CENT</code> Preset and Max values depend on Hardware Options If no terminator (for example, MHz) is sent, the terminator Hz is used. If a terminator with unit other than frequency is used, an invalid suffix error message is generated
Dependencies	Center Frequency can be limited by Start Freq or Stop Freq limits, if Span is so large that start or stop reach their limits
Couplings	When operating in “swept span”, any value of Center Frequency or Span that is within the frequency range of the instrument is allowed, <i>if</i> the value is being set through the front panel numeric key pad or the SCPI command. The other parameter is forced to a different value if needed, to keep Start and Stop Frequencies within the instrument’s frequency range Coupling between center frequency and span: numeric (keypad) entries are treated differently than changing the value using the step keys (Up/Down Arrows) or the knob. Similarly, for remote operation, sending a numeric frequency value is treated differently than the UP DOWN keywords: <ul style="list-style-type: none"> – Numeric entries (keypad or remote): Any value of Center Frequency or Span (within the frequency range of the instrument) is allowed. The other parameter is changed, as necessary, to keep the Start Freq and Stop Freq within the instrument frequency range – Knob or Step keys (up/down arrows) or UP DOWN keywords: The value of the parameter being changed (Center Frequency or Span) is limited so the other parameter is not forced to a new value. Thus, if only the step keys and knob are used, you can return to the initial Center Frequency and Span by changing only the current parameter Note that, since out-of-range Start Freq and Stop Freq are never allowed, markers and trace math work correctly without requiring any special handling for out-of-range conditions
Preset	Depends on instrument maximum frequency, mode, measurement, and selected input

3 Bluetooth Mode
3.2 Transmit Analysis Measurement

	See "Center Frequency Presets" on page 231 and "Ext Mix Center Freq" on page 234
State Saved	Saved in instrument state
Min/Max	Depends on instrument maximum frequency, mode, measurement, and selected input See "Center Frequency Presets" on page 231 and "Ext Mix Center Freq" on page 234
Annotation	Center <value> appears in the lower left corner of the display
Status Bits/OPC dependencies	Non-overlapped

Center Frequency Presets

The following table provides the Center Frequency Presets for the Spectrum Analyzer mode, and the Max Freq, for the various frequency options:

Freq Option	CF after Mode Preset	Stop Freq after Mode Preset	Max Freq (can't tune above)
503 (all but CXA)	1.805 GHz	3.6 GHz	3.7 GHz
503 (CXA)	1.505 GHz	3.0 GHz	3.08 GHz
507 (all but CXA)	3.505 GHz	7.0 GHz	7.1 GHz
507 (CXA)	3.755 GHz	7.5 GHz	7.58 GHz
508 (all but MXE)	1.805 GHz	3.6 GHz	8.5 GHz
508 (MXE)	4.205 GHz	8.4 GHz	8.5 GHz
513	6.805 GHz	13.6 GHz	13.8 GHz
526 (except CXA and MXE)	13.255 GHz	26.5 GHz	27.0 GHz*
526 (CXA)	13.255 GHz	26.5 GHz	26.55 GHz
526 (MXE)	1.805 GHz	3.6 GHz	27.0 GHz
532	16.005 GHz	32.0 GHz	32.5 GHz
540	20.005 GHz	40.0 GHz	40.5 GHz
543	21.505 GHz	43.0 GHz	43.0 GHz
544	22.005 GHz	44.0 GHz	45.0 GHz
550	25.005 GHz	50.0 GHz	52 GHz
F03 (CXA-m)	1.505 GHz	3.0 GHz	3.08 GHz
F07 (CXA-m)	3.755 GHz	7.5 GHz	7.575 GHz
F13 (CXA-m)	6.805 GHz	13.6 GHz	13.8 GHz
F26 (CXA-m)	13.255 GHz	26.5 GHz	26.55 GHz
504 (M9421A, M8920A)	2.145 GHz	3.88GHz	3.88 GHz
506 (M9421A, M8920A)	3.245 GHz	6.08GHz	6.08 GHz
F06 (M9410A/11A)	1.0 GHz	6.08 GHz	6.08 GHz
F06 (M9415A)	1 GHz	1.08 GHz	6.6 GHz

Freq Option	CF after Mode Preset	Stop Freq after Mode Preset	Max Freq (can't tune above)
F08 (M9415A)	1 GHz	1.08 GHz	8.6 GHz
F12 (M9415A)	1 GHz	1.08 GHz	12.9 GHz

*For option 526, the Max CF in RTSA is 26.999999995 GHz.

N9041B Center Freq Presets

Input	CF after Mode Preset	Stop Freq after Mode Preset	Max Freq (can't tune above)
Input 1, all models	25.005 GHz	50.0 GHz	52 GHz
Input 2, opt 585	42.505 GHz	85.0 GHz	86 GHz
Input 2, opt 590	45.005 GHz	90.0 GHz	92 GHz
Input 2, opt 5CX	55.005 GHz	110.0 GHz	110 GHz

Input 2, CXA and MXE

Model	CF after Mode Preset	Stop Freq after Mode Preset	Max Freq (can't tune above)
CXA opt C75	0.7505 GHz	1.5 GHz	1.58 GHz
MXE	505 MHz	1 GHz	1.000025 GHz

Tracking Generator Frequency Limits (CXA only)

Tracking Generator Option	Min Freq (clips to this freq when turn TG on and can't tune below while TG on)	If above this Freq, Stop Freq clipped to this Freq when TG turned on	Max Freq (can't tune above) while TG on
T03	9 kHz	3.0 GHz	3.08 GHz
T06	9 kHz	6.0 GHz	6.05 GHz

Tracking Generator Frequency Limits(CXA-m only)

Tracking Generator Option	Min Freq (clips to this freq when turn TG on and can't tune below while TG on)	If above this Freq, Stop Freq clipped to this Freq when TG turned on	Max Freq (can't tune above) while TG on
T03	2 MHz	3.08 GHz	3.08 GHz
T07	2 MHz	7.575 GHz	7.575 GHz
T13	2 MHz	13.8 GHz	13.8 GHz
T26	2 MHz	26.55 GHz	26.55 GHz

RF Center Frequency

Specifies the RF Center Frequency. Sets the center frequency to use when the RF input is selected, even if the RF input is not the input that is selected at the time the command is sent. Note that **Center Frequency** in the **Frequency** menu on the front panel always applies to the currently selected input.

Remote Command	[:SENSe]:FREQuency:RF:CENTer <freq> [:SENSe]:FREQuency:RF:CENTer?	
Example	:FREQ:RF:CENT 30 MHz :FREQ:RF:CENT?	
Notes	This command is the same in all Modes, but the parameter is Measurement Global. So, the value is independent in each Mode and common across all the measurements in the Mode	
Dependencies	If the electronic/soft attenuator is enabled, any attempt to set Center Frequency such that the Stop Frequency would be >3.6 GHz fails and results in an advisory message. If the equivalent SCPI command is sent, this same message is generated as part of a “-221, Settings conflict” warning If Source Mode is set to Tracking, and the Max or Min Center Frequency is therefore limited by the limits of the source, a warning message is generated, “Data out of range; clipped to source max/min” if these limits are exceeded. Note that for an external source, these limits can be affected by the settings of Source Numerator, Source Denominator, and Power Sweep	
Preset	See " Center Frequency Presets " on page 231	
State Saved	Saved in instrument state	
Min	Instrument Types	Value
	VXT model M9421A	55.000005 MHz
	VXT models M9410A/11A	6.505 kHz with Option LFE 330.000005 MHz without Option LFE 330.000005 MHz
	VXT model M9415A	330.000005 MHz
	M8920A	80.005 kHz
	All other instruments	-79.999995 MHz
	<i>Unless Source Mode is set to Tracking, in which case it is limited by the minimum frequency of the Source</i>	
Max	See table above. Basically, instrument maximum frequency – 5 Hz. Note that, if the Source Mode is set to Tracking, the effective instrument maximum frequency may be limited by the source maximum frequency If the knob or step keys are being used, also depends on the value of the other three interdependent parameters: Span , Start Frequency and Stop Frequency	

Ext Mix Center Freq

Specifies the External Mixer Center Frequency. Sets the center frequency to use when the External Mixer is selected, even if the External Mixer input is not the input which is selected at the time the command is sent. Note that the **Center Frequency** function in the **Frequency** menu on the front panel always applies to the currently selected input.

Remote Command	<code>[:SENSe] :FREQuency:EMIXer:CENTer <freq></code> <code>[:SENSe] :FREQuency:EMIXer:CENTer?</code>
Example	<code>:FREQ:EMIX:CENT 60 GHz</code> <code>:FREQ:EMIX:CENT?</code>
Notes	This command is the same in all Modes, but the parameter is Measurement Global. So, the value is independent in each Mode and common across all the measurements in the Mode
Couplings	When you return to External Mixing after using one of the other inputs (for example, RF), you return to the settings that you had when you left External Mixing. So, you return to the band you were in with the Center Frequency that you had. However, Span is <i>not</i> an input-dependent parameter, so it does not change. Therefore, the instrument comes back with the Span from the previous input, limited as necessary by the current mixer setup
Preset	When Mode Preset is performed while in External Mixing, the start frequency of the current Mode is set to the nominal Min frequency of the lowest harmonic range in the Harmonic Table for the current mixer setup. Similarly, the stop frequency of the current Mode is set to the nominal Max frequency of the highest harmonic range in the Harmonic Table. Center Frequency thus presets to the point arithmetically equidistant from these two frequencies Note that, if the current measurement has a limited Span available to it, and cannot achieve the span shown in the table (Span = Stop Freq – Start Freq), the instrument uses the maximum span that the measurement allows, and still sets Center Frequency to the midpoint of the Start Freq and Stop Freq values in the Harmonic Table When Restore Input/Output Defaults is performed, the mixer presets to the 11970A, whose Start and Stop frequencies are 26.5 and 40 GHz respectively. The center of these two frequencies is 33.25 GHz. Therefore, after Restore Input/Output Defaults , if you switch to External Mixing and do a Mode Preset while in the Spectrum Analyzer Mode, the resulting Center Frequency is 33.25 GHz
State Saved	Yes
Min	The minimum frequency in the currently selected mixer band + 5 Hz
Max	The maximum frequency in the currently selected mixer band - 5 Hz If the knob or step keys are being used, also depends on the value of the other three interdependent parameters Span , Start Freq and Stop Freq

Span

Sets the span of the RF Spectrum view, facilitating zoom in/out functionality. The maximum span is limited to the sample rate.

Remote	<code>[:SENSe] :TX:FREQuency:SPAN <freq></code>
--------	---

3 Bluetooth Mode

3.2 Transmit Analysis Measurement

Command	<code>[:SENSe] :TX:FREQuency:SPAN?</code>
Example	<code>:TX:FREQ:SPAN 2MHz</code> <code>:TX:FREQ:SPAN?</code>
Couplings	The key associated with this parameter is only enabled when RF Spectrum Window is selected in Quad View, or when in RF Spectrum view. It is empty when any other view is selected The info BW used for data capture is always 4 MHz, so max value of Span is limited to 4 MHz
Preset	4.000000 MHz
State Saved	Yes
Min/Max	10 Hz/ 4.000000 MHz
Annotation	Bottom right of RF Spectrum graph

LMH Channel

Enables quick selection from a subset of the available channel numbers for the Low (channel 0), Middle (channel 39), or High (channel 78) channels.

Remote Command	<code>[:SENSe] :CHANne1:LMH LOW MID HIGH</code> <code>[:SENSe] :CHANne1:LMH?</code>
Example	<code>:FREQ:LMH MID</code> <code>:FREQ:LMH?</code>
Couplings	If Radio Stand is Basic or EDR, the soft key label is Low(0), Mid(39), High(78) If Radio Stand is Low Energy, the soft key label is Low(0), Mid(20), High(39) If geography is France, this key will be grayed-out
Preset	LOW
State Saved	Yes
Range	LOW MID HIGH
Backwards Compatibility SCPI	<code>[:SENSe] :FREQuency:LMH LOW MID HIGH</code> <code>[:SENSe] :FREQuency:LMH?</code>

Geography

Selects the desired country. The selection defines the frequency range and the available channel numbers for the transmit channel.

Remote Command	<code>[:SENSe] :FREQuency:GEOGraphy FRANce OTHERs</code> <code>[:SENSe] :FREQuency:GEOGraphy?</code>
Example	<code>:FREQ:GEOG FRAN</code> <code>:FREQ:GEOG?</code>

Couplings	France: <ul style="list-style-type: none"> - Center Frequency 2454 MHz + (0...22) MHz - Channel Number: 0...22 Others: <ul style="list-style-type: none"> - Center Frequency 2402 MHz + (0...78) MHz - Channel Number: 0...78
Preset	OTHers
State Saved	Yes
Range	FRANce OTHers

CF Step

Changes the step size for the center frequency and start and stop frequency functions. Once a step size has been selected and the center frequency function is active, the step keys (and the UP|DOWN parameters for Center Frequency from remote commands) change the center frequency by the step-size value. The step size function is useful for finding harmonics and sidebands beyond the current frequency span of the instrument.

Note that the start and stop frequencies also step by the CF Step value.

Remote Command	<pre>[:SENSe]:FREQuency:CENTer:STEP[:INCRement] <freq> [:SENSe]:FREQuency:CENTer:STEP[:INCRement]? [:SENSe]:FREQuency:CENTer:STEP:AUTO OFF ON 0 1 [:SENSe]:FREQuency:CENTer:STEP:AUTO?</pre>
Example	<pre>:FREQ:CENT:STEP 500 MHz :FREQ:CENT UP</pre> <p>Increases the current center frequency value by 500 MHz</p> <pre>:FREQ:CENT:STEP? :FREQ:CENT:STEP:AUTO ON :FREQ:CENT:STEP:AUTO?</pre>
Notes	Preset and Max values are dependent on Hardware Options
Dependencies	Not available in MSR, LTEAFDD/LTEATDD, 5GNR and Channel Quality Modes If the electronic/soft attenuator is enabled, any attempt to change the value of the center frequency >3.6 GHz by pressing the Up-arrow key, fails and results in an advisory message. If the equivalent SCPI command is sent, this same message is generated as part of a "-221, Settings conflict" warning
Couplings	When auto-coupled, the center frequency step size is set to 10% of the span
Preset	Auto

	ON
State Saved	Saved in instrument state
Min	– (the maximum frequency of the instrument). That is, 27 GHz max freq instrument has a CF step range of +/- 27 GHz. Note that this is the maximum frequency given the current settings of the instrument, so in External Mixing, for example, it is the maximum frequency of the current mixer band
Max	The maximum frequency of the instrument. That is, 27 GHz max freq instrument has a CF step range of +/- 27 GHz. Note that this is the maximum frequency given the current settings of the instrument, so in External Mixing, for example, it is the maximum frequency of the current mixer band
Status Bits/OPC dependencies	non-overlapped

3.2.7 Marker

Accesses the **Marker** menu. A marker can be placed on a trace to allow the value of the trace at the marker point to be determined precisely. The functions in this menu include a 1-of-N selection of the control mode **Normal**, **Delta**, or **Off** for the selected marker. If the selected marker is **Off**, pressing **Marker** sets it to **Normal** and places it at the center of the screen on the trace determined by the Marker Trace rules.

Markers may also be used in pairs to read the difference (or delta) between two data points. They can be used in Marker Functions to do advanced data processing, or to specify operating points in functions like Signal Track and N dB Points.

3.2.7.1 Select Marker

Specifies the selected marker. The term “selected marker” is used throughout this document to specify which marker will be affected when you change marker settings, perform a Peak Search, etc.

The **Select Marker** control appears above the menu panel, indicating that it applies to all controls in the **Marker** menu panels. **Select Marker** is blanked if you select a tab whose controls do *not* depend on the selected marker (e.g., **Counter**).

For any menu that includes **Select Marker**, the first control is always **Marker Frequency | Time**.

Notes	The selected marker is remembered even when not in the Marker menu, and is used if a search is done, or a Band Function is turned on, or for Signal Track or Continuous Peak
Preset	Marker 1
State Saved	The number of the selected marker is saved in instrument state
Annunciation	Appears in the marker results block label for Normal and Delta markers

3.2.7.2 Settings

The controls on this tab include the **Marker** active function and a radio button selection of the marker control mode (**Normal**, **Delta** or **Off**) for the selected marker, as well as additional functions that help you use markers.

Marker X-Axis Value

Sets or queries a marker's X-Axis value in frequency or time.

Remote Command	<code>:CALCulate:TX:MARKer[1] 2 ... 12:X <real></code> <code>:CALCulate:TX:MARKer[1] 2 ... 12:X?</code>
Example	<code>:CALC:TX:MARK:X 2.402E+9</code> <code>:CALC:TX:MARK:X?</code>
Notes	The query is returned in the fundamental units for the current marker X Axis scale This command (not the query) causes the specified marker to become selected
Dependencies	The Marker X-Axis unit depends on the currently selected window <ul style="list-style-type: none"> - For RF Envelope and Demod Waveform the units are ns us ms s ks - For RF Spectrum the units are Hz kHz MHz GHz
Preset	After a preset, all markers are turned OFF , so Marker X-Axis Value query returns Not a Number (NAN). When Marker is ON , default value of Marker X-Axis Value is the center of the appropriate window
State Saved	Yes
Min/Max	-/+9.91E+37

Marker Y-Axis Value (Remote Query Only)

Queries a marker's Y-Axis value only.

Remote Command	<code>:CALCulate:TX:MARKer[1] 2 ... 12:Y?</code>
Example	<code>:CALC:TX:MARK:Y?</code>
Preset	Since the result value is always calculated from acquisition data, the default value is arbitrary. Although the Preset/Default values are defined
Min/Max	-/+9.91E+37

Marker Mode

Sets the marker control mode to **Normal** (**POSition**), **Delta**, or **Off**. All interactions and dependencies detailed under the control description are enforced when the

3 Bluetooth Mode

3.2 Transmit Analysis Measurement

remote command is sent. If the selected marker is **Off**, pressing **Marker** sets it to **Normal** and places it at the center of the screen on the trace determined by the Marker Trace rules. At the same time, Marker X-Axis Value appears on the Active Function area.

The default active function is the active function for the currently selected marker control mode. If the current control mode is **Off**, there is no active function, and the active function is turned off.

Remote Command	<code>:CALCulate:TX:MARKer[1] 2 ... 12:MODE POSition DELTa OFF</code> <code>:CALCulate:TX:MARKer[1] 2 ... 12:MODE?</code>
Example	<code>:CALC:TX:MARK:MODE POS</code> <code>:CALC:TX:MARK:MODE?</code>
Notes	This command (not the query) causes the specified marker to become selected
Couplings	If a marker's mode is changed to Delta , the Marker Trace setting of the Delta marker will be that of the reference marker If a Delta marker has a reference marker in a different window, the Delta marker's mode changes to Normal
Preset	OFF All markers

Delta Marker (Reset Delta)

Pressing this button has the same effect as pressing **Delta** in "**Marker Mode**" on page 238. The selected marker becomes a **Delta** marker. If the selected marker is already a **Delta** marker, the reference marker is moved to the current position of the selected marker, thus resetting the delta to zero.

Marker Settings Diagram

Lets you configure the **Marker** system using a visual utility.

All Markers Off

Turns off all markers.

Remote Command	<code>:CALCulate:TX:MARKer:AOFF</code>
Example	<code>:CALC:TX:MARK:AOFF</code>

Couple Markers

When this function is On, moving any marker causes an equal X Axis movement of every other marker which is not Fixed or Off. By “equal X Axis movement” we mean that we preserve the difference between each marker’s X Axis value (in the fundamental x-axis units of the trace that marker is on), and the X Axis value of the marker being moved (in the same fundamental x-axis units).

This may result in markers going off screen.

Remote Command	<code>:CALCulate:TX:MARKer:COUPlE[:STATe] ON OFF 1 0</code> <code>:CALCulate:TX:MARKer:COUPlE[:STATe]?</code>
Example	<code>:CALC:TX:MARK:COUP ON</code> <code>:CALC:TX:MARK:COUP?</code>
Preset	OFF Preset by Mode Preset and All Markers Off
State Saved	Saved in instrument state

3.2.7.3 Peak Search

The controls on this tab allow you to move the marker to selected peaks of the signal, giving you enormous analysis capabilities, particularly when combined with the **Delta** marker function.

NOTE

Pressing the **Peak Search** hardkey automatically moves you to the **Peak Search** page of the **Marker** menu *and* performs a peak search.

Pressing the **Peak Search** tab once you are already *in* the **Marker** menu does *not* perform a peak search.

Marker X-Axis Value

This is the fundamental control that you use to move a marker around on the trace. It is the same as the "**Marker X-Axis Value**" on page 238 control on the **Settings** tab.

Peak Search

Moves the selected marker to the trace point that has the maximum y-axis value for that marker’s trace.

NOTE

Pressing the **Peak Search** hardkey automatically moves you to the **Peak Search** page of the **Marker** menu *and* performs a peak search.

Remote Command	<code>:CALCulate:TX:MARKer[1] 2 ... 12:MAXimum</code>
Example	<code>:CALC:TX:MARK2:MAX</code> <code>:SYST:ERR?</code> Can be used to query the errors to determine if a peak is found. The message “No peak found” will be returned after an unsuccessful search
Notes	Sending this command selects the subopcoded marker This command has no effect when the selected marker is located on the polar trace. In this case, the command is ignored

Next Peak

Moves the selected marker to the peak that is next lower in amplitude than the current marker value. Only peaks which meet all enabled peak criteria are considered. If there is no valid peak lower than the current marker position, a “No peak found” message is generated, and the marker is not moved.

If the selected marker was off, then it is turned on as a **Normal** marker and a peak search is performed.

Remote Command	<code>:CALCulate:TX:MARKer[1] 2 ... 12:MAXimum:NEXT</code>
Example	<code>:CALC:TX:MARK2:MAX:NEXT</code>
Notes	Sending this command selects the subopcoded marker
State Saved	Not part of saved state

Next Peak Right

Moves the selected marker to the nearest peak right of the current marker that meets all enabled peak criteria. If there is no valid peak to the right of the current marker position, a “No peak found” message is generated, and the marker is not moved. If the selected marker was off, then it is turned on as a **Normal** marker and a peak search is performed.

Remote Command	<code>:CALCulate:TX:MARKer[1] 2 ... 12:MAXimum:RIGHT</code>
Example	<code>:CALC:TX:MARK2:MAX:RIGH</code>
Notes	Sending this command selects the subopcoded marker
State Saved	Not part of saved state

Next Peak Left

Moves the selected marker to the nearest peak left of the current marker that meets all enabled peak criteria. If there is no valid peak to the left of the current marker position, a “No peak found” message is generated, and the marker is not moved. If the selected marker was **Off**, then it is turned on as a **Normal** marker and a peak search is performed.

Pressing this control moves the selected marker to the nearest active channel left of the current marker when Marker Trace is Code Domain Power. In other cases, moves the selected marker to the highest peak left of the current marker.

Remote Command	<code>:CALCulate:TX:MARKer[1] 2 ... 12:MAXimum:LEFT</code>
Example	<code>:CALC:TX:MARK2:MAX:LEFT</code>
State Saved	Not part of saved state

Minimum Peak

Moves the selected marker to the minimum y-axis value on the current trace. Minimum (negative) peak searches do not have to meet the peak search criteria. It just looks for the lowest y-axis value. If the selected marker is **Off**, it is turned on before the minimum search is performed.

Remote Command	<code>:CALCulate:TX:MARKer[1] 2 ... 12:MINimum</code>
Example	<code>:CALC:TX:MARK:MIN</code>
Notes	Sending this command selects the subopcoded marker
State Saved	Not part of saved state

Pk-Pk Search

Finds and displays the amplitude and frequency (or time, if in zero span) differences between the highest and lowest y-axis value. It places the selected marker on the minimum value on its selected trace. And it places that marker's reference marker on the peak of its selected trace.

This function turns on the reference marker and sets its mode to Normal if it is not already on. (These markers may be on two different traces.)

The rules for finding the maximum peak are exactly the same as for Peak Search, including the use of the peak criteria rules. However, the minimum trace value is not required to meet any criteria other than being the minimum y-axis value in the trace.

If the selected marker is off, a delta type marker is turned on and the peak-to-peak search is done. If the selected marker is on, but it is not a delta marker, then it is

changed to delta which turns on the reference marker if needed, and then it performs the peak-to-peak function.

Remote Command	:CALCulate:TX:MARKer[1] 2 ... 12:PTPeak
Example	:CALC:TX:MARK:PTP
Notes	Turns on the Marker D active function Sending this command selects the subopcoded marker
Dependencies	Pk-Pk Search is not available when Coupled Markers is on
Couplings	The selected marker becomes a delta marker if not already in delta mode
State Saved	Not part of saved state

Marker Delta

Pressing this button has the same effect as pressing **Delta** in "[Marker Mode](#)" on [page 238](#). The selected marker becomes a **Delta** marker. If the selected marker is already a **Delta** marker, the reference marker is moved to the current position of the selected marker, thus resetting the delta to zero.

The control is duplicated here to allow you to conveniently perform a peak search and change the marker's control mode to **Delta** without having to access two separate menus.

3.2.7.4 Properties

The controls on this tab are used to set certain properties of the selected marker.

Marker X-Axis Value

This is the fundamental control that you use to move a marker around on the trace. It is the same as the "[Marker X-Axis Value](#)" on [page 238](#) control on the **Settings** tab.

Relative To

Selects the marker to which the selected marker is relative (its reference marker).

Every marker has another marker to which it is relative. This marker is referred to as the "reference marker" for that marker. This attribute is set by the Marker, Properties, Relative To control. The marker must be a Delta marker to make this attribute relevant. If it is a Delta marker, the reference marker determines how the marker is controlled and how its value is displayed. A marker cannot be relative to itself.

Remote	:CALCulate:TX:MARKer[1] 2 ... 12:REference <integer>
--------	--

Command	<code>:CALCulate:TX:MARKer[1] 2 ... 12:REFerence?</code>
Example	<code>:CALC:TX:MARK:REF 5</code> <code>:CALC:TX:MARK:REF?</code>
Notes	This command causes the marker specified with the subopcode to become selected Range (for SCPI command): 1 to 12. If the range is exceeded the value is clipped A marker cannot be relative to itself so that choice is not available, and if sent from SCPI generates error -221: "Settings conflict; marker cannot be relative to itself" When queried a single value is returned (the specified marker numbers relative marker)
Couplings	The act of specifying the selected marker's reference marker makes the selected marker a Delta marker If the reference marker is off it is turned on in Normal mode at the delta marker location
Preset	The preset default Relative To marker (reference marker) is the next higher numbered marker (current marker +1). For example, if marker 2 is selected, then it's default reference marker is marker 3. The exception is marker 12, which has a default reference of marker 1 Set to default by Restore Mode Defaults . Not reset by Marker Off , All Markers Off , or Preset
State Saved	Saved in instrument state. Not affected by Marker Off and hence not affected by Preset or power cycle
Min	1
Max	12
Annunciation	Appears in the marker label of a Delta marker

Marker Trace

Selects the trace on which to place the marker. A marker is associated with one and only one trace. This trace is used to determine the placement, result, and X Axis Scale of the marker. All markers have an associated trace. It is from that trace that they determine their attributes and behaviors, and it is to that trace that they go when they become Normal or Delta markers.

In Transmit Analysis measurement there are three named traces, RF Envelope, Demod Waveform and RF Spectrum.

If the marker is not Off, it moves the marker from the trace it was on to the new trace. If the marker changes windows, it retains its relative horizontal positions in the new window.

If the marker is off it stays off, but is now associated with the specified trace.

Remote Command	<code>:CALCulate:TX:MARKer[1] 2 ... 12:TRACe RFENvelope DWAVeform RFSpectrum</code> <code>:CALCulate:TX:MARKer[1] 2 ... 12:TRACe?</code>
Example	<code>:CALC:TX:MARK2:TRAC RFEN</code> <code>:CALC:TX:MARK:TRACE?</code>
Couplings	Sending the remote command causes the addressed marker to become selected If ever a delta marker has a reference marker in a different window, the delta marker's mode changes to

	Pos(for example, it becomes a normal marker)
Preset	RFSpectrum Preset by Preset or All Markers Off
State Saved	Yes

Marker Settings Diagram

Lets you configure the Marker system using a visual utility. It is the same as "[Marker Settings Diagram](#)" on page 239 on the **Settings** tab.

3.2.7.5 Marker Function

The controls on this tab allow you to control the marker functions of the instrument. Marker functions perform post-processing operations on marker data.

Marker X-Axis Value

This is the fundamental control that you use to move a marker around on the trace. It is the same as "[Marker X-Axis Value](#)" on page 238 on the **Settings** tab.

Marker Function

Sets the marker control function type to one of:

Marker Noise	NOISe
Band/Interval Power	BPOWer
Band Interval Density	BDENsity
Marker Function Off	OFF

All interactions and dependencies detailed under the key description are enforced when the remote command is sent.

Remote Command	<code>:CALCulate:TX:MARKer[1] 2 ... 12:FUNCTION NOISe BPOWer BDENsity =OFF</code> <code>:CALCulate:TX:MARKer[1] 2 ... 12:FUNCTION?</code>
Example	<code>:CALC:TX:MARK:FUNC NOIS</code> <code>:CALC:TX:MARK:FUNC?</code>
Preset	OFF
State Saved	Yes
Range	Marker Noise Band/Interval Power Band Interval Density Marker Function Off
Annotation	Mkr # <X value> and <Marker value> upper right on graph

Band Span

Sets the width of the frequency span for the selected marker.

Remote Command	<code>:CALCulate:TX:MARKer[1] 2 ... 12:FUNCTION:BAND:SPAN <freq></code> <code>:CALCulate:TX:MARKer[1] 2 ... 12:FUNCTION:BAND:SPAN?</code>
Example	<code>:CALC:TX:MARK12:FUNC:BAND:SPAN 20 MHz</code> <code>:CALC:TX:MARK12:FUNC:BAND:SPAN?</code>
Couplings	Changing the Band Span necessarily changes the Band Left and Band/Interval Right values
Preset	1.0 MHz
State Saved	Yes
Min/Max	100.0 kHz/200.0 MHz

Band Left

Sets the left edge frequency for the band of the selected marker.

Remote Command	<code>:CALCulate:TX:MARKer[1] 2 ... 12:FUNCTION:BAND:LEFT <freq></code> <code>:CALCulate:TX:MARKer[1] 2 ... 12:FUNCTION:BAND:LEFT?</code>
Example	<code>:CALC:TX:MARK12:FUNC:BAND:LEFT 20 MHz</code> <code>:CALC:TX:MARK12:FUNC:BAND:LEFT?</code>
Couplings	Changing the Band Left necessarily changes the Band Span and Band Right values
Preset	Depends on X axis range of selected Trace
State Saved	Yes
Min/Max	-9.91E+37 / 9.91E+37

Band Right

Sets the right edge frequency for the band of the selected marker.

Remote Command	<code>:CALCulate:TX:MARKer[1] 2 ... 12:FUNCTION:BAND:RIGHT <freq></code> <code>:CALCulate:TX:MARKer[1] 2 ... 12:FUNCTION:BAND:RIGHT?</code>
Example	<code>:CALC:TX:MARK12:FUNC:BAND:RIGH 20 MHz</code> <code>:CALC:TX:MARK12:FUNC:BAND:RIGH?</code>
Couplings	Changing the Band Right necessarily changes the Band Left and Band Span values
Preset	Depends on X axis range of selected Trace
State Saved	Yes
Min/Max	-9.91E+37 / 9.91E+37

3.2.8 Meas Setup

Contains functions for setting up the measurement parameters.

3.2.8.1 Settings

Lets you set measurement parameters.

Avg/Hold Num

Used to specify the number of data acquisitions that will be averaged. After the specified number of average counts, ["Averaging On/Off" on page 247](#) determines the averaging action.

On - Sets measurement averaging on.

Off - Sets measurement averaging off.

Remote Command	<code>[:SENSe]:TX:AVERage:COUNT <integer></code> <code>[:SENSe]:TX:AVERage:COUNT?</code>
Example	<code>:TX:AVER:COUN 10</code> <code>:TX:AVER:COUN?</code>
Preset	10
State Saved	Yes
Min/Max	1/10000

Averaging On/Off

Averaging Mode. Turns averaging on or off.

Remote Command	<code>[:SENSe]:TX:AVERage[:STATe]OFF ON 0 1</code> <code>[:SENSe]:TX:AVERage[:STATe]?</code>
Example	<code>:TX:AVER:STAT OFF</code> <code>:TX:AVER:STAT?</code>
Preset	ON
State Saved	Yes
Range	On Off

Average Type (SCPI Only)

Used to specify the type of average. There are three average types:

Option	For Average Number N:
SCALar	Results = $(A_1 + A_2 + A_3 + \dots + A_N)/N$
MAX	Results = Max $(A_1, A_2, A_3 \dots A_N)$
MIN	Results = Min $(A_1, A_2, A_3 \dots A_N)$

Remote Command	<code>[:SENSe]:TX:AVERAge:TYPE SCALar MIN MAX</code> <code>[:SENSe]:TX:AVERAge:TYPE?</code>
Example	<code>:TX:AVER:TYPE MAX</code> <code>:TX:AVER:TYPE?</code>
Preset	SCALar
State Saved	Yes
Range	Scalar Min Max

Packet Type

Accesses a menu that lets you specify the packet type and select the auto/manual detection mode. For a poor signal, you can select packet type detect mode manual, to improve the accuracy of the demodulated signal. For a good signal, you can select packet type detect mode auto, which is convenient when the signal is changing.

For signals configured with CSSYNC | CSTone | CSSTone | CSTSYNC packet types, you can only select packet type manually. Auto-detected mode is not supported for testing these kinds of signals.

Remote Command	<code>[:SENSe]:TX:PACKet:TYPE AUTO DH1 DH3 DH5 DM1 DM3 DM5 E2DH1 E2DH3 E2DH5 E2EV3 E2EV5 E3DH1 E3DH3 E3DH5 E3EV3 E3EV5 LREference L2MRefere LCReference CSSync CSTone CSSTone CSTSync QHSP2 QHSP3 QHSP4 QHSP5 QHSP6</code> <code>[:SENSe]:TX:PACKet:TYPE?</code>
Example	<code>:TX:PACK:TYPE DH1</code> <code>:TX:PACK:TYPE?</code>
Notes	If the auto detected type is not a valid type, the read back will be invalid If the packet type is AUTO , the packet type auto state will be ON . If the Packet Type Auto State is ON , the packet type is AUTO At present, auto-detected mode is not supported for CSSYNC CSTone CSSTone CSTSYNC packet types
Dependencies	See " Packet Type Dependencies " on page 249 below

3 Bluetooth Mode
3.2 Transmit Analysis Measurement

Preset	There is no defined preset value. It depends on the signal type when the default packet type is auto
State Saved	Yes
Range	AUTO DH1 DH3 DH5 DM1 DM3 DM5 EDR 2-EV3 EDR 2-EV5 EDR 2-DH1 EDR 2-DH3 EDR 2-DH5 EDR 3-EV3 EDR 3-EV5 EDR 3-DH1 EDR 3-DH3 EDR 3-DH5 LReference L2MRefere LCReference CS SYNC CS Tone CS SYNC + CS Tone CS Tone + CS SYNC QHS-P2 QHS-P3 QHS-P4 QHS-P5 QHS-P6
	Auto Function
Remote Command	<code>[:SENSe]:TX:PACKet:AUTO ON OFF 1 0</code> <code>[:SENSe]:TX:PACKet:AUTO?</code>
Example	<code>:TX:PACK:AUTO OFF</code> <code>:TX:PACK:AUTO?</code>
Preset	ON

Packet Type Dependencies

Packet Type	Effect
DH1, DH3, DH5, DM1, DM3, DM5	Radio Std is set to Basic Trigger Holdoff Type is set to Below
EDR 2-EV3, EDR 2-EV5, EDR 2-DH1, EDR 2-DH3, EDR 2-DH5, EDR 3-EV3, EDR 3-EV5, EDR 3-DH1, EDR 3-DH3, EDR 3-DH5	Radio Std is set to EDR Trigger Holdoff Type is set to Below
LE 1MHz Reference	Radio Std is set to Low Energy LE PHY is set to LE 1M
LE 2MHz Reference	Radio Std is set to Low Energy LE PHY is set to LE 2M
LE Coded Reference	Radio Std is set to Low Energy LE PHY is set to LE Coded
CSSYNC, CSTone, CSSTone, CSTSYNC	Radio Std is set to Low Energy

Packet Type	Effect
QHS-P2, QHS-P3, QHS-P4, QHS-P5, QHS-P6	LE PHY is set to LE 1M Radio Std is set to QHS Trigger Holdoff Type is set to Below

Configure CS Packet

The dialog contains the settings for configuring channel sounding packet.

CS SYNC Access Address (32bits)

Sets a 32-bit access address in hexadecimal format for Channel Sounding SYNC packet.

Remote Command	<code>[:SENSe]:TX:CS:SYNC:ADDRess <string></code> <code>[:SENSe]:TX:CS:SYNC:ADDRess?</code>
Example	<code>:TX:CS:SYNC:ADDR '12123456'</code> <code>:TX:CS:SYNC:ADDR?</code>
Couplings	Available when packet type contains CS SYNC Must be a 4-character string, entered in hexadecimal format. If the string length is not 4, it is truncated or padded with 0. If a non-hexadecimal character is included, that character is replaced by 0
Preset	<code>71764129</code>
State Saved	Saved in instrument state

SYNC Sequence Type

Sets Sequence Type of payload for Channel Sounding SYNC packet.

Remote Command	<code>[:SENSe]:TX:CS:SYNC:SEQuence:TYPE NONE SS32 SS96 RS32 RS64 RS96 RS128</code> <code>[:SENSe]:TX:CS:SYNC:SEQuence:TYPE?</code>
Example	<code>:TX:CS:SYNC:SEQ:TYPE RS32</code> <code>:TX:CS:SYNC:SEQ:TYPE?</code>
Couplings	Available when packet type contains CS SYNC
State Saved	Saved in instrument state
Range	No Sequence 32-bit Sounding Sequence 96-bit Sounding Sequence 32-bit Random Sequence 64-bit Random Sequence 96-bit Random Sequence 128-bit Random Sequence

SYNC Sounding Sequence Marker 1 Position

Sets the bit start number of the first marker in the sounding sequence payload of CS SYNC packet.

Remote Command	<code>[:SENSe]:TX:CS:SYNC:SSMPosition:MARKer1 <integer></code> <code>[:SENSe]:TX:CS:SYNC:SSMPosition:MARKer1?</code>
Example	<code>:TX:CS:SYNC:SSMP:MARK1 2</code> <code>:TX:CS:SYNC:SSMP:MARK1?</code>
Couplings	Available when packet type contains CS SYNC and Sequence Type is Sounding Sequence The Marker positions for each sounding sequence packet is determined by the value of SS_Marker1_Position and SS_Marker2_Position parameters For 32-bit sounding sequence, the range of 1 st marker is $\{1\sim 29\}$ and the default value is 1 For 96-bit sounding sequence, the range of 1 st marker is $\{1\sim 64\}$ and the default value is 1
Preset	1
State Saved	Yes
Min/Max	1/64

SYNC Sounding Sequence Marker 2 Position

Sets the bit start number of the second marker in the 96-bit sounding sequence payload of CS SYNC packet.

Remote Command	<code>[:SENSe]:TX:CS:SYNC:SSMPosition:MARKer2 <integer></code> <code>[:SENSe]:TX:CS:SYNC:SSMPosition:MARKer2?</code>
Example	<code>:TX:CS:SYNC:SSMP:MARK2 72</code> <code>:TX:CS:SYNC:SSMP:MARK2?</code>
Couplings	Available when packet type contains CS SYNC and Sequence Type is 96-bit Sounding Sequence The Marker positions for each sounding sequence packet is determined by the value of SS_Marker1_Position and SS_Marker2_Position parameters For 32-bit sounding sequence, the 2 nd marker is not available For 96-bit sounding sequence, the 2 nd marker is available, and its range of 2 nd marker is $\{68\sim 142\}$ and the default value is 68
Preset	68
State Saved	Yes
Min/Max	68/142

SYNC Sounding Sequence Marker Value

Sets mark value of sounding sequence payload for CS SYNC packet.

Remote Command	<code>[:SENSe]:TX:CS:SYNC:SSMValue B0011 B1100</code> <code>[:SENSe]:TX:CS:SYNC:SSMValue?</code>
Example	<code>:TX:CS:SYNC:SSMV B1100</code> <code>:TX:CS:SYNC:SSMV?</code>
Couplings	Available when packet type contains CS SYNC and Sequence Type is Sounding Sequence
Preset	<code>B0011</code>
State Saved	Saved in instrument state
Range	<code>0b0011 0b1100</code>

SYNC Random Sequence Data Pattern

Sets data pattern in random sequence payload of CS SYNC packet.

Remote Command	<code>[:SENSe]:TX:CS:SYNC:RSDPattern PN9 XF0 XAA PN15 XFF X00 X0F X55</code> <code> UDEFined</code> <code>[:SENSe]:TX:CS:SYNC:RSDPattern?</code>
Example	<code>:TX:CS:SYNC:RSDP X00</code> <code>:TX:CS:SYNC:RSDP?</code>
Couplings	Available when packet type contains CS SYNC and Sequence Type is Random Sequence
Preset	<code>PN9</code>
State Saved	Saved in instrument state
Range	<code>PN9 11110000 10101010 PN15 11111111 00000000 00001111 01010101 User Payload</code>

SYNC Random Sequence User Payload

Sets user payload in hexadecimal format for random sequence payload of CS SYNC packet when Data Pattern is user defined.

Remote Command	<code>[:SENSe]:TX:CS:SYNC:RSDData <string></code> <code>[:SENSe]:TX:CS:SYNC:RSDData?</code>
Example	<code>:TX:CS:SYNC:RSD '3456'</code> <code>:TX:CS:SYNC:RSD?</code>
Couplings	Available when packet type contains CS SYNC and Sequence Type is Random Sequence and Data Pattern is User Defined 32-character string, entered in hexadecimal format. If the string length is not enough, it is padded with

3 Bluetooth Mode
3.2 Transmit Analysis Measurement

0. If a non-hexadecimal character is included, that character is replaced by 0
The least significant bit corresponds to the most significant bit of the CS Payload. When the sequence is less than 16 octets, the least significant octets shall be padded with zeros accordingly

Preset	00000000000000000000000000000000
State Saved	Saved in instrument state

Tone FFO Actuation Error

Sets the FFO actuation error value which is applicable to the phase measurement over CS Tone packet.

Remote Command	<code>[:SENSe]:TX:CS:TONE:FAERror <real></code> <code>[:SENSe]:TX:CS:TONE:FAERror?</code>
Example	<code>:TX:CS:TONE:FAER 1</code> <code>:TX:CS:TONE:FAER?</code>
Couplings	Available when packet type is CS Tone, CS SYNC + CS Tone, CS Tone + CS SYNC
Preset	0
State Saved	Yes
Min/Max	-4 ppm / 3.96875ppm

Tone Measurement Mode

Sets the measurement type to do over CS Tone packet.

Remote Command	<code>[:SENSe]:TX:CS:TONE:MMODe FREQuency PHASe</code> <code>[:SENSe]:TX:CS:TONE:MMODe?</code>
Example	<code>:TX:CS:TONE:MMOD PHAS</code> <code>:TX:CS:TONE:MMOD?</code>
Couplings	Available when packet type is CS Tone, CS SYNC + CS Tone, CS Tone + CS SYNC
Preset	FREQ
State Saved	Saved in instrument state
Range	FREQuency Measurement PHASe Measurement

Tone Time for Phase Measurement

Sets time for phase measurement over CS Tone packet.

Remote Command	<code>[:SENSe]:TX:CS:TONE:PMTime T10 T20 T40</code> <code>[:SENSe]:TX:CS:TONE:PMTime?</code>
----------------	---

Example	<code>:TX:CS:TONE:PMT T0</code> <code>:TX:CS:TONE:PMT?</code>
Couplings	Available when packet type is CS Tone, CS SYNC + CS Tone, CS Tone + CS SYNC and Meas Mode is Phase Measurement
Preset	<code>T10</code>
State Saved	Saved in instrument state
Range	10 us 20 us 40 us

Tone Time for Antenna Switch

Sets Time for Antenna Switch in the phase measurement over CS Tone packet.

Remote Command	<code>[:SENSe]:TX:CS:TONE:ASTime T0 T1 T2 T4 T10</code> <code>[:SENSe]:TX:CS:TONE:ASTime?</code>
Example	<code>:TX:CS:TONE:AST T2</code> <code>:TX:CS:TONE:AST?</code>
Couplings	Available when packet type is CS Tone, CS SYNC + CS Tone, CS Tone + CS SYNC and Meas Mode is Phase Measurement
Preset	<code>T0</code>
State Saved	Saved in instrument state
Range	0 us 1 us 2 us 4 us 10 us

Tone Number of Antenna Paths

Sets number of antenna paths used in the phase measurement over CS Tone packet.

Remote Command	<code>[:SENSe]:TX:CS:TONE:APNumber <integer></code> <code>[:SENSe]:TX:CS:TONE:APNumber?</code>
Example	<code>:TX:CS:TONE:APN 2</code> <code>:TX:CS:TONE:APN?</code>
Couplings	Available when packet type is CS Tone, CS SYNC + CS Tone, CS Tone + CS SYNC and Meas Mode is Phase Measurement
Preset	1
State Saved	Saved in instrument state
Min	1
Max	4

IF Gain

Lets you control an internally switched IF amplifier with approximately 10 dB of gain. This amplifier takes full advantage of the RF dynamic range of the analyzer. When it can be turned on without an overload, the dynamic range is always better when the amplifier is set to On, than when it is set to Off. The control “IF Gain” can be used to set the IF Gain function to Auto, or to On (the extra 10 dB) or Off. These settings affect sensitivity and IF overloads.

This only applies to the RF input. It does not apply to baseband I/Q input.

IF Gain Auto

Activates the auto rules for IF Gain.

Remote Command	<code>[:SENSe]:TX:IF:GAIN:AUTO[:STATe] OFF ON 0 1</code> <code>[:SENSe]:TX:IF:GAIN:AUTO[:STATe]?</code>
Example	<code>:TX:IF:GAIN:AUTO OFF</code> <code>:TX:IF:GAIN:AUTO?</code>
Notes	Only applies to the RF input. It does not apply to baseband I/Q input
Dependencies	Does not appear in VXT models M9421A/10A/11A, or UXM
Couplings	When either the auto attenuation works (for example, with the electrical attenuator) or optimize mechanical attenuator range is requested, the IF Gain setting is changed according to the following rule 'Auto' sets IF Gain to 'High Gain' under any of the following conditions: the input attenuator is set to 0 dB, the preamp is turned on, or the Max Mixer Level is -20 dBm or lower. For other settings, 'Auto' sets IF Gain to 'Low Gain'
Preset	OFF
State Saved	Yes
Range	Auto Man

IF Gain State

Selects the range of IF gain:

ON	High gain
OFF	Low gain

Remote Command	<code>[:SENSe]:TX:IF:GAIN[:STATe] ON OFF 1 0</code> <code>[:SENSe]:TX:IF:GAIN[:STATe]?</code>
Example	<code>:TX:IF:GAIN OFF</code> <code>:TX:IF:GAIN?</code>

Notes	Only applies to the RF input. It does not apply to baseband I/Q input
Dependencies	Does not appear in VXT models M9421A/10A/11A, or UXM
Couplings	When either the auto attenuation works (for example, with the electrical attenuator) or optimize mechanical attenuator range is requested, the IF Gain setting is changed according to the following rule 'Auto' sets IF Gain to 'High Gain' under any of the following conditions: the input attenuator is set to 0 dB, the preamp is turned on, or the Max Mixer Level is -20 dBm or lower. For other settings, 'Auto' sets IF Gain to 'Low Gain'
Preset	OFF
State Saved	Yes
Range	Low Gain High Gain

Spur Avoidance

Because VXT models M9410A/11A/15A/16A are direct-conversion (zero-IF) receivers, feedthrough leakage from the local oscillator appears as a spurious signal (spur) at the center frequency. The Spur Avoidance function is provided to eliminate this spur, at the expense of some measurement speed.

When **Spur Avoidance** is enabled (the default), the analyzer uses a software algorithm to remove this spur from the displayed measurement data, but the algorithm only operates under certain conditions. Specifically, it only operates when the $BW \leq \max BW / 2.5$.

You can disable this function to speed up your measurement. When **Spur Avoidance** is Off, a warning message will appear in the status bar as "Settings Alert; Spur Avoidance Off". This is to alert you that measurement accuracy might be impacted because you have defeated the spur avoidance algorithm.

Remote Command	<code>[:SENSe]:TX:SAVoid[:STATe] ON OFF 0 1</code> <code>[:SENSe]:TX:SAVoid[:STATe]?</code>
Example	<code>:TX:SAV ON</code> <code>:TX:SAV?</code>
Dependencies	Only appears in VXT models M9410A/11A/15A/16A
Preset	ON
State Saved	Saved in instrument state
Range	ON OFF

Auto Couple

Immediately puts all **Auto/Man** functions into **Auto**. **Auto Couple** is confined to the current measurement only. It does not affect other measurements in the Mode.

In the **Auto** state, **Auto/Man** functions are said to be “coupled”, meaning their values change as you make changes to other values in the measurement. This helps ensure accurate measurements and optimum dynamic range. **Auto Couple** is an immediate action function, and when it is executed, all the **Auto/Man** controls for the current measurement are set to **Auto**, and all measurement settings coupled to the **Auto/Man** parameters are automatically set to their optimal values.

For further details of measurement-specific settings (if any), see "[Measurement-Specific Details](#)" on page 258 below.

Remote Command	:COUPle ALL
Example	:COUP ALL
Backwards Compatibility SCPI	:COUPLE ALL NONE
Backwards Compatibility Notes	: COUP :NONE puts all Auto/Man parameters in manual mode, decoupling all the coupled instrument parameters. It is retained for backwards compatibility and is <i>not</i> recommended for making measurements or new designs

All **Auto/Man** parameter couplings in the measurement are set to **Auto**. This includes couplings that may be unavailable or grayed-out due to the current state. For example, in the Swept SA measurement, there is no **Auto/Man** coupling for **RBW** while in Zero Span. Nonetheless, if **Auto Couple** were executed while in Zero Span, it would set **RBW** to Auto "behind the scenes" so that, on exit from Zero Span, it would be in **Auto**.

Any **Auto/Man** selection specific (local) to the other measurements in the current Mode are not affected by **Auto Couple**. Any functions that are *not* coupled with other instrument parameters, such as ranging or leveling variables, such as **AutoRange** or **AutoScale**, are not affected.

Executing **Auto Couple** generates the informational message, "All Auto/Man functions have been set to Auto".

Each parameter, upon being set to **Auto**, selects and sets the appropriate auto-coupled value based on that parameter's coupling rules. The Dependency Resolver orchestrates the couplings for parameters that depend on one or more other parameters. The coupling and dependency rules for each parameter are defined in the section describing that parameter.

Executing **Auto Couple** does not affect markers, marker functions, trace or display attributes, or any other instrument setting other than those specifically mentioned above.

Measurement-Specific Details

TOI (SA Mode only)

Parameters affected by **Auto Couple** are:

- Center Frequency Step
- Resolution Bandwidth
- Span/RBW Ratio
- Sweep Time
- Video BANDwidth VBW/RBW ratio
- Upper and Lower Tone (set to Sense)
- Zero span measurement Resolution Bandwidth
- Zero span measurement Dwell Time

Harmonics (SA Mode only)

Parameters affected by **Auto Couple** are:

- Resolution Bandwidth
- Fundamental Frequency
- Dwell Time
- Range Table Resolution Bandwidths
- Range Table Dwell Times

Meas Preset

Restores all measurement parameters to their default values.

Remote Command	:CONFigure:TX
Example	:CONF:TX
Couplings	Restores all measurement parameters to these default values

3.2.8.2 Radio

Contains controls to select Radio Standard and device type. It appears in the Transmit Analysis, LE In-band Emissions, Monitor Spectrum, and Output Spectrum Bandwidth measurements

Radio Standard

Allows the user to select the Radio Standard of the expected Bluetooth Signal being measured.

Remote Command	<code>[:SENSe]:RADio:STANdard BASic EDR LENergy QHS</code> <code>[:SENSe]:RADio:STANdard?</code>
Example	<code>:RAD:STAN EDR</code> <code>:RAD:STAN?</code>
Couplings	The Basic EDR Low Energy value can be available when 9081EM0E/OD license is installed The QHS value can be available when 9081SP1E license is installed
Preset	<code>BASic</code>
State Saved	Yes
Range	Basic EDR Low Energy QHS

LE PHY

Sets LE PHY type.

Remote Command	<code>[:SENSe]:RADio:LE:PHY LE1M LE2M LECoded</code> <code>[:SENSe]:RADio:LE:PHY?</code>
Example	<code>:RAD:LE:PHY LE1M</code> <code>:RAD:LE:PHY?</code>
Couplings	Grayed-out if radio standard is not LE and measurement is not LE In-band Emission
Preset	LE1M

Device

Allows the user to select the expected Power Class.

Remote Command	<code>[:SENSe]:RADio:DEVice PC1 PC2 PC3</code> <code>[:SENSe]:RADio:DEVice?</code>
Example	<code>:RAD:DEV PC1</code>

	<code>:RAD:DEV?</code>
Couplings	It determines the default limit value of Output Power Grayed-out if Radio standard is Not Basic
Preset	PC1
State Saved	Yes
Range	Power Class1 Power Class2 Power Class3

3.2.8.3 TX Power

Lets you set transmit power parameters.

Burst Sync

Used to select how the measurement will synchronize with the correct part of the burst. Possible values are:

Option	SCPI	Effect
Preamble	<code>PREamble</code>	Uses p0 to define the start of the burst
RF Amptd	<code>RAMPtd</code>	Defines the duration of the burst as the time between the leading and trailing 3 dB points compared to the average power
None	<code>NONE</code>	No synchronization process

Bust Sync is only applied to the measurement Output Power.

Remote Command	<code>[:SENSe]:TX:BSYNc PREamble RAMPtd NONE</code> <code>[:SENSe]:TX:BSYNc?</code>
Example	<code>:TX:BSYN NONE</code> <code>:TX:BSYN?</code>
Preset	<code>PREamble</code>
State Saved	Yes
Range	Preamble RF Amptd None

Output Power Start Marker

Used to determine the point at which averaging of the power should begin. Defined as a percentage of the burst length, relative to a specific start point. The difference between the output power stop and start marker must be at least 1%.

Remote Command	<code>[:SENSe]:TX:OPower:MARKer:START <real></code> <code>[:SENSe]:TX:OPower:MARKer:START?</code>
----------------	--

3 Bluetooth Mode

3.2 Transmit Analysis Measurement

Example	<code>:TX:OPOW:MARK:STAR 50</code> <code>:TX:OPOW:MARK:STAR?</code>
Couplings	Grayed-out when radio standard is EDR
Preset	20.0
State Saved	Yes
Min/Max	0.0/99.0

Output Power Stop Marker

Used to determine the point at which averaging of the power should stop. Defined as a percentage of the burst length, relative to a specific start point. The difference between the output power stop and start marker must be at least 1%.

Remote Command	<code>[:SENSe]:TX:OPower:MARKer:STOP <real></code> <code>[:SENSe]:TX:OPower:MARKer:STOP?</code>
Example	<code>:TX:OPOW:MARK:STOP 50</code> <code>:TX:OPOW:MARK:STOP?</code>
Couplings	Grayed-out when radio standard is EDR
Preset	80.0
State Saved	Yes
Min/Max	1.0/100.0

GFSK Start Marker

Used to determine the point at which averaging of the power should begin. Defined as a percentage of the EDR GFSK length, relative to a specific start point. The difference between the EDR GFSK average power stop and start marker must be at least 1%.

Remote Command	<code>[:SENSe]:TX:GFSK:MARKer:STARt <real></code> <code>[:SENSe]:TX:GFSK:MARKer:STARt?</code>
Example	<code>:TX:GFSK:MARK:STAR 50</code> <code>:TX:GFSK:MARK:STAR?</code>
Couplings	Grayed-out when radio standard is <i>not</i> EDR
Preset	20.0
State Saved	Yes
Min/Max	0.0/99.0

GFSK Stop Marker

Used to determine the point at which averaging of the power should stop. Defined as a percentage of the EDR GFSK length, relative to a specific start point. The difference between the EDR GFSK average power stop and start marker must be at least 1%.

Remote Command	<code>[:SENSe]:TX:GFSK:MARKer:STOP <real></code> <code>[:SENSe]:TX:GFSK:MARKer:STOP?</code>
Example	<code>:TX:GFSK:MARK:STOP 50</code> <code>:TX:GFSK:MARK:STOP?</code>
Couplings	Grayed-out when radio standard is <i>not</i> EDR
Preset	80.0
State Saved	Yes
Min/Max	1.0/100.0

DPSK Start Marker

Used to determine the point at which averaging of the power should begin. Defined as a percentage of the EDR DPSK length, relative to a specific start point. The difference between the EDR DPSK average power stop and start marker must be at least 1%.

Remote Command	<code>[:SENSe]:TX:DPSK:MARKer:START <real></code> <code>[:SENSe]:TX:DPSK:MARKer:START?</code>
Example	<code>:TX:DPSK:MARK:STAR 50</code> <code>:TX:DPSK:MARK:STAR?</code>
Couplings	Grayed-out when radio standard is <i>not</i> EDR
Preset	20.0
State Saved	Yes
Min/Max	0.0/99.0

DPSK Stop Marker

Used to determine the point at which averaging of the power should stop. Defined as a percentage of the EDR DPSK length, relative to a specific start point. The difference between the EDR DPSK average power stop and start marker must be at least 1%.

Remote Command	<code>[:SENSe]:TX:DPSK:MARKer:STOP <real></code>
----------------	---

3 Bluetooth Mode
 3.2 Transmit Analysis Measurement

	<code>[:SENSe] :TX:DPSK:MARKer:STOP?</code>
Example	<code>:TX:DPSK:MARK:STOP 50</code> <code>:TX:DPSK:MARK:STOP?</code>
Couplings	Grayed-out when radio standard is <i>not</i> EDR
Preset	80.0
State Saved	Yes
Min/Max	1.0/100.0

3.2.8.4 Limits

Lets you set Limits parameters.

Limit Test

Turns limit checking on or off.

Remote Command	<code>:CALCulate:TX:LIMit:STATe OFF ON 0 1</code> <code>:CALCulate:TX:LIMit:STATe?</code>
Example	<code>:CALC:TX:LIM:STAT 1</code> <code>:CALC:TX:LIM:STAT?</code>
Preset	ON
State Saved	Yes
Range	On Off

Limits Setup

Displays a dialog for advanced sync parameters.

Output Power / Mod Character

Average Upper

Sets the upper limit used when testing the Average Output Power metric.

Remote Command	<code>:CALCulate:TX:OPower:LIMit:AVERage:UPPer <ampl></code> <code>:CALCulate:TX:OPower:LIMit:AVERage:UPPer?</code>
Example	<code>:CALC:TX:OPow:LIM:AVER:UPP 4</code> <code>:CALC:TX:OPow:LIM:AVER:UPP?</code>

Couplings	The Preset value depends on device power class and Radio Std: <ul style="list-style-type: none"> - Power Class1: 20.0 dBm - Power Class2: 4.0 dBm - Power Class3: 0.0 dBm - Radio Std Low Energy: 10.0 dBm
Preset	20.00 dBm
State Saved	Yes
Min/Max	-100 dBm / 100 dBm

Average Lower

Sets the lower limit used when testing the Average Output Power metric.

Remote Command	<code>:CALCulate:TX:OPower:LIMit:AVERage:LOWer <amp1></code> <code>:CALCulate:TX:OPower:LIMit:AVERage:LOWer?</code>
Example	<code>:CALC:TX:OPow:LIM:AVER:LOW -6</code> <code>:CALC:TX:OPow:LIM:AVER:LOW?</code>
Couplings	The Preset value depend on device power class and Radio Std <ul style="list-style-type: none"> - Power Class1: 0.0 dBm - Power Class2: -6.0 dBm - Power Class3: -100.0 dBm - Radio Std Low Energy: -20.0 dBm
Preset	0.00 dBm
State Saved	Yes
Min/Max	-100 dBm / 100 dBm

Peak Upper

Sets the upper limit used when testing the Peak Output Power metric.

Remote Command	<code>:CALCulate:TX:OPower:LIMit:PEAK:UPPer <amp1></code> <code>:CALCulate:TX:OPower:LIMit:PEAK:UPPer?</code>
Example	<code>:CALC:TX:OPow:LIM:PEAK:UPP 23</code> <code>:CALC:TX:OPow:LIM:PEAK:UPP?</code>
Couplings	Only available when radio standard is Basic

3 Bluetooth Mode
3.2 Transmit Analysis Measurement

Preset	23.00 dBm
State Saved	Yes
Min/Max	-100 dBm / 100 dBm

Relative Peak Upper

Sets the relative upper limit for Peak Output Power. It is the relative value between peak power and average power.

Remote Command	<code>:CALCulate:TX:OPower:LIMit:PEAK:RELative:PAverage <rel_amp1></code>
Example	<code>:CALC:TX:OPow:LIM:PEAK:REL:PAV 3</code> <code>:CALC:TX:OPow:LIM:PEAK:REL:PAV?</code>
Couplings	Only available when radio standard is LE
Preset	3.00 dB
State Saved	Yes
Min/Max	-100 dB / 100 dB

Average Output Power Limit Status (Remote Query only)

Determines the Pass/Fail status for Average Output Power.

Remote Command	<code>:CALCulate:TX:OPower:LIMit:AVERage:FAIL?</code>
Example	<code>:CALC:TX:OPow:LIM:AVER:FAIL?</code>
Notes	1 (one) is returned if any of the test results were outside the specified limits. Otherwise, 0 (zero) is returned to indicate that a failure has not occurred
State Saved	Yes

Peak Output Power Limit Status (Remote Query only)

Determines the Pass/Fail status for Peak Output Power

Remote Command	<code>:CALCulate:TX:OPower:LIMit:PEAK:FAIL?</code>
Example	<code>:CALC:TX:OPow:LIM:PEAK:FAIL?</code>
Notes	1 (one) is returned if the test results were outside the specified limits. Otherwise, 0 (zero) is returned to indicate that a failure has not occurred
State Saved	Yes

$\Delta f1$ Average Upper

Sets the upper limit used when testing the $\Delta f1$ Avg metric.

Remote Command	:CALCulate:TX:MCHar:LIMit:DF1:AVERage:UPPer <freq> :CALCulate:TX:MCHar:LIMit:DF1:AVERage:UPPer?
Example	:CALC:TX:MCH:LIM:DF1:AVER:UPP 175 kHz :CALC:TX:MCH:LIM:DF1:AVER:UPP?
Couplings	Preset value depends on the Radio Std: <ul style="list-style-type: none"> - Basic: 175 kHz - LE 1M or LE Coded: 275 kHz - LE 2M: 550kHz
Preset	175 kHz
State Saved	Yes
Min/Max	-600 kHz / 600 kHz

$\Delta f1$ Average Lower

Sets the lower limit used when testing the $\Delta f1$ Avg metric.

Remote Command	:CALCulate:TX:MCHar:LIMit:DF1:AVERage:LOWer <freq> :CALCulate:TX:MCHar:LIMit:DF1:AVERage:LOWer?
Example	:CALC:TX:MCH:LIM:DF1:AVER:LOW 140 kHz :CALC:TX:MCH:LIM:DF1:AVER:LOW?
Couplings	Preset Value depend on Radio Std: <ul style="list-style-type: none"> - Basic: 140 kHz - LE 1M or LE Coded: 225 kHz - LE 2M: 450 kHz
Preset	140 kHz
State Saved	Yes
Min/Max	-600 kHz / 600 kHz

$\Delta f2$ Max Lower

Sets the lower limit used when testing the $\Delta f2$ Max metric.

3 Bluetooth Mode
3.2 Transmit Analysis Measurement

Remote Command	<code>:CALCulate:TX:MCHar:LIMit:DF2:MAX:LOWer <freq></code> <code>:CALCulate:TX:MCHar:LIMit:DF2:MAX:LOWer?</code>
Example	<code>:CALC:TX:MCH:LIM:DF2:MAX:LOW 115 kHz</code> <code>:CALC:TX:MCH:LIM:DF2:MAX:LOW?</code>
Couplings	Preset value depend on Radio Std: <ul style="list-style-type: none"> - Basic: 115 kHz - Low Energy 1M: 185 kHz - Low Energy 2M: 370 kHz
Preset	115 kHz
State Saved	Yes
Min/Max	-500 kHz / 500 kHz

Δf_2 Average / Δf_1 Average Lower

Sets the lower limit used when testing the Δf_2 Average / Δf_1 Average metric.

Remote Command	<code>:CALCulate:TX:MCHar:LIMit:RATio:LOWer <real></code> <code>:CALCulate:TX:MCHar:LIMit:RATio:LOWer?</code>
Example	<code>:CALC:TX:MCH:LIM:RAT:LOW 0.8</code> <code>:CALC:TX:MCH:LIM:RAT:LOW?</code>
Preset	0.8
State Saved	Yes
Min/Max	0 / 1

Modulation Characteristics Limit Status (Remote Query only)

Determines the Pass/Fail status for Modulation Characteristics.

Remote Command	<code>:CALCulate:TX:MCHar:LIMit:FAIL?</code>
Example	<code>:CALC:TX:MCH:LIM:FAIL?</code>
Notes	1 (one) is returned if any of the test results were outside the specified limits. Otherwise, 0 (zero) is returned to indicate that a failure has not occurred
State Saved	Yes

Modulation Characteristics ΔF_1 Average Limit Status (Remote Query only)

Determines the Pass/Fail status for Modulation Characteristics.

Remote Command	<code>:CALCulate:TX:MCHar:LIMit:DF1:AVERage:FAIL?</code>
Example	<code>:CALC:TX:MCH:LIM:DF1:AVER:FAIL?</code>
Notes	1 (one) is returned if any of the test results were outside the specified limits. Otherwise, 0 (zero) is returned to indicate that a failure has not occurred
State Saved	Yes

Modulation Characteristics $\Delta F2$ Maximum Limit Status (Remote Query only)

Determines the Pass/Fail status for Modulation Characteristics.

Remote Command	<code>:CALCulate:TX:MCHar:LIMit:DF2:MAX:FAIL?</code>
Example	<code>:CALC:TX:MCH:LIM:DF2:MAX:FAIL?</code>
Notes	1 (one) is returned if the test results were outside the specified limits. Otherwise, 0 (zero) is returned to indicate that a failure has not occurred
State Saved	Yes

Modulation Characteristics $\Delta f2$ Average / $\Delta f1$ Average Ratio Limit Status (Remote Query only)

Determines the Pass/Fail status for Modulation Characteristics.

Remote Command	<code>:CALCulate:TX:MCHar:LIMit:RATio:FAIL?</code>
Example	<code>:CALC:TX:MCH:LIM:RAT:FAIL?</code>
Notes	1 (one) is returned if the test results were outside the specified limits. Otherwise, 0 (zero) is returned to indicate that a failure has not occurred
State Saved	Yes

Carrier Drift / ICFT

DH1 Freq Drift Upper

Sets the upper limit used when testing the Freq Drift metric for DH1 packets.

Remote Command	<code>:CALCulate:TX:CFDRift:LIMit:DH1:DRIFt:UPPer <freq></code> <code>:CALCulate:TX:CFDRift:LIMit:DH1:DRIFt:UPPer?</code>
Example	<code>:CALC:TX:CFDR:LIM:DH1:DRIF:UPP 25 kHz</code> <code>:CALC:TX:CFDR:LIM:DH1:DRIF:UPP?</code>

Preset	25 kHz
State Saved	Yes
Min/Max	-/+500 kHz

DH1 Freq Drift Lower

Sets the lower limit used when testing the Freq Drift metric for DH1 packets.

Remote Command	<code>:CALCulate:TX:CFDRift:LIMit:DH1:DRIFt:LOWer <freq></code> <code>:CALCulate:TX:CFDRift:LIMit:DH1:DRIFt:LOWer?</code>
Example	<code>:CALC:TX:CFDR:LIM:DH1:DRIF:LOW -25 kHz</code> <code>:CALC:TX:CFDR:LIM:DH1:DRIF:LOW?</code>
Preset	-25 kHz
State Saved	Yes
Min/Max	-/+500 kHz

DH1 Max Drift Rate Upper

Sets the upper limit used when testing the Max Drift Rate metric for DH1 packets.

Remote Command	<code>:CALCulate:TX:CFDRift:LIMit:DH1:RATE:UPPer <freq></code> <code>:CALCulate:TX:CFDRift:LIMit:DH1:RATE:UPPer?</code>
Example	<code>:CALC:TX:CFDR:LIM:DH1:RATE:UPP 20 kHz</code> <code>:CALC:TX:CFDR:LIM:DH1:RATE:UPP?</code>
Preset	20 kHz
State Saved	Yes
Min/Max	-/+500 kHz

DH1 Max Drift Rate Lower

Sets the lower limit used when testing the Max Drift Rate metric for DH1 packets.

Remote Command	<code>:CALCulate:TX:CFDRift:LIMit:DH1:RATE:LOWer <freq></code> <code>:CALCulate:TX:CFDRift:LIMit:DH1:RATE:LOWer?</code>
Example	<code>:CALC:TX:CFDR:LIM:DH1:RATE:LOW -20 kHz</code> <code>:CALC:TX:CFDR:LIM:DH1:RATE:LOW?</code>
Preset	-20 kHz
State Saved	Yes
Min/Max	-/+500 kHz

DH3 Freq Drift Upper

Sets the upper limit used when testing the Freq Drift metric for DH3 packets.

Remote Command	:CALCulate:TX:CFDRift:LIMit:DH3:DRIFt:UPPer <freq> :CALCulate:TX:CFDRift:LIMit:DH3:DRIFt:UPPer?
Example	:CALC:TX:CFDR:LIM:DH3:DRIF:UPP 40 kHz :CALC:TX:CFDR:LIM:DH3:DRIF:UPP?
Preset	40 kHz
State Saved	Yes
Min/Max	-/+500 kHz

DH3 Freq Drift Lower

Sets the lower limit used when testing the Freq Drift metric for DH3 packets.

Remote Command	:CALCulate:TX:CFDRift:LIMit:DH3:DRIFt:LOWer <freq> :CALCulate:TX:CFDRift:LIMit:DH3:DRIFt:LOWer?
Example	:CALC:TX:CFDR:LIM:DH3:DRIF:LOW -40 kHz :CALC:TX:CFDR:LIM:DH3:DRIF:LOW?
Preset	-40 kHz
State Saved	Yes
Min/Max	-/+500 kHz

DH3 Max Drift Rate Upper

Sets the upper limit used when testing the Max Drift Rate metric for DH3 packets.

Remote Command	:CALCulate:TX:CFDRift:LIMit:DH3:RATE:UPPer <freq> :CALCulate:TX:CFDRift:LIMit:DH3:RATE:UPPer?
Example	:CALC:TX:CFDR:LIM:DH3:RATE:UPP 20 kHz :CALC:TX:CFDR:LIM:DH3:RATE:UPP?
Preset	20 kHz
State Saved	Yes
Min/Max	-/+500 kHz

DH3 Max Drift Rate Lower

Sets the lower limit used when testing the Max Drift Rate metric for DH3 packets.

3 Bluetooth Mode
3.2 Transmit Analysis Measurement

Remote Command	:CALCulate:TX:CFDRift:LIMit:DH3:RATE:LOWer <freq> :CALCulate:TX:CFDRift:LIMit:DH3:RATE:LOWer?
Example	:CALC:TX:CFDR:LIM:DH3:RATE:LOW -20 kHz :CALC:TX:CFDR:LIM:DH3:RATE:LOW?
Preset	-20 kHz
State Saved	Yes
Min/Max	-/+500 kHz

DH5 Freq Drift Upper

Sets the upper limit used when testing the Freq Drift metric for DH5 packets.

Remote Command	:CALCulate:TX:CFDRift:LIMit:DH5:DRIFt:UPPer <freq> :CALCulate:TX:CFDRift:LIMit:DH5:DRIFt:UPPer?
Example	:CALC:TX:CFDR:LIM:DH5:DRIF:UPP 40 kHz :CALC:TX:CFDR:LIM:DH5:DRIF:UPP?
Preset	40 kHz
State Saved	Yes
Min/Max	-/+500 kHz

CH5 Freq Drift Lower

Sets the lower limit used when testing the Freq Drift metric for DH5 packets.

Remote Command	:CALCulate:TX:CFDRift:LIMit:DH5:DRIFt:LOWer <freq> :CALCulate:TX:CFDRift:LIMit:DH5:DRIFt:LOWer?
Example	:CALC:TX:CFDR:LIM:DH5:DRIF:LOW -40 kHz :CALC:TX:CFDR:LIM:DH5:DRIF:LOW?
Preset	-40 kHz
State Saved	Yes
Min/Max	-/+500 kHz

CH5 Max Drift Rate Upper

Sets the upper limit used when testing the Max Drift Rate metric for DH5 packets.

Remote Command	:CALCulate:TX:CFDRift:LIMit:DH5:RATE:UPPer <freq> :CALCulate:TX:CFDRift:LIMit:DH5:RATE:UPPer?
Example	:CALC:TX:CFDR:LIM:DH5:RATE:UPP 20 kHz

	<code>:CALC:TX:CFDR:LIM:DH5:RATE:UPP?</code>
Preset	20 kHz
State Saved	Yes
Min/Max	-/+500 kHz

DH5 Max Drift Rate Lower

Sets the lower limit used when testing the Max Drift Rate metric for DH5 packets.

Remote Command	<code>:CALCulate:TX:CFDRift:LIMit:DH5:RATE:LOWer <freq></code>
	<code>:CALCulate:TX:CFDRift:LIMit:DH5:RATE:LOWer?</code>
Example	<code>:CALC:TX:CFDR:LIM:DH5:RATE:LOW -20 kHz</code>
	<code>:CALC:TX:CFDR:LIM:DH5:RATE:LOW?</code>
Preset	-20 kHz
State Saved	Yes
Min/Max	-/+500 kHz

LE Reference Freq Drift Upper

Sets the upper limit used when testing the Freq Drift metric for LE Reference packets.

Remote Command	<code>:CALCulate:TX:CFDRift:LIMit:LREference:DRIFt:UPPer <freq></code>
	<code>:CALCulate:TX:CFDRift:LIMit:LREference:DRIFt:UPPer?</code>
Example	<code>:CALC:TX:CFDR:LIM:LREF:DRIF:UPP 40 kHz</code>
	<code>:CALC:TX:CFDR:LIM:LREF:DRIF:UPP?</code>
Preset	50 kHz
State Saved	Yes
Min/Max	-/+500 kHz

LE Reference Freq Drift Lower

Sets the lower limit used when testing the Freq Drift metric for LE Reference packets.

Remote Command	<code>:CALCulate:TX:CFDRift:LIMit:LREference:DRIFt:LOWer <freq></code>
	<code>:CALCulate:TX:CFDRift:LIMit:LREference:DRIFt:LOWer?</code>
Example	<code>:CALC:TX:CFDR:LIM:LREF:DRIF:LOW -40 kHz</code>
	<code>:CALC:TX:CFDR:LIM:LREF:DRIF:LOW?</code>

3 Bluetooth Mode
3.2 Transmit Analysis Measurement

Preset	-50 kHz
State Saved	Yes
Min/Max	-/+500 kHz

LE Reference Initial Freq Drift Upper

Sets the upper limit used when testing the Initial Freq Drift metric for LE Reference packets.

For LE uncoded data, this is the limit for $f_1 - f_0$.

For LE coded data, this is the limit for $f_3 - f_0$.

Remote Command	<code>:CALCulate:TX:CFDRift:LIMit:LREference:INITial:DRIFt:UPPer <freq></code> <code>:CALCulate:TX:CFDRift:LIMit:LREference:INITial:DRIFt:UPPer?</code>
Example	<code>:CALC:TX:CFDR:LIM:LREF:INIT:DRIF:UPP 40 kHz</code> <code>:CALC:TX:CFDR:LIM:LREF:INIT:DRIF:UPP?</code>
Preset	23 kHz
State Saved	Yes
Min/Max	-/+500 kHz

LE Reference Initial Freq Drift Lower

Sets the lower limit used when testing the Initial Freq Drift metric for LE Reference packets.

For LE uncoded data, this is the limit for $f_1 - f_0$.

For LE coded data, this is the limit for $f_3 - f_0$.

Remote Command	<code>:CALCulate:TX:CFDRift:LIMit:LREference:INITial:DRIFt:LOWer <freq></code> <code>:CALCulate:TX:CFDRift:LIMit:LREference:INITial:DRIFt:LOWer?</code>
Example	<code>:CALC:TX:CFDR:LIM:LREF:INIT:DRIF:LOW -40 kHz</code> <code>:CALC:TX:CFDR:LIM:LREF:INIT:DRIF:LOW?</code>
Preset	-23 kHz
State Saved	Yes
Min/Max	-/+500 kHz

LE Reference Max Drift Rate Upper

Sets the upper limit used when testing the Max Drift Rate metric for LE Reference packets.

Remote Command	<code>:CALCulate:TX:CFDRift:LIMit:LREference:RATE:UPPer <freq></code> <code>:CALCulate:TX:CFDRift:LIMit:LREference:RATE:UPPer?</code>
Example	<code>:CALC:TX:CFDR:LIM:LREF:RATE:UPP 20 kHz</code> <code>:CALC:TX:CFDR:LIM:LREF:RATE:UPP?</code>
Preset	20 kHz
State Saved	Yes
Min/Max	-/+500 kHz

LE Reference Max Drift Rate Lower

Sets the lower limit used when testing the Max Drift Rate metric for LE Reference packets.

Remote Command	<code>:CALCulate:TX:CFDRift:LIMit:LREference:RATE:LOWer <freq></code> <code>:CALCulate:TX:CFDRift:LIMit:LREference:RATE:LOWer?</code>
Example	<code>:CALC:TX:CFDR:LIM:LREF:RATE:LOW -20 kHz</code> <code>:CALC:TX:CFDR:LIM:LREF:RATE:LOW?</code>
Preset	-20 kHz
State Saved	Yes
Min/Max	-/+500 kHz

Carrier Drift Limit Status (Remote Query only)

Determines the Pass/Fail status for Carrier Drift.

Remote Command	<code>:CALCulate:TX:CFDRift:LIMit:FAIL?</code>
Example	<code>:CALC:TX:CFDR:LIM:FAIL?</code>
Notes	1 (one) is returned if any of the test results were outside the specified limits. Otherwise, 0 (zero) is returned to indicate that a failure has not occurred
State Saved	Yes

Freq Drift Limit Status (Remote Query only)

Determines the Pass/Fail status for Freq Drift.

3 Bluetooth Mode
3.2 Transmit Analysis Measurement

Remote Command	:CALCulate:TX:CFDRift:LIMit:DRIFt:FAIL?
Example	:CALC:TX:CFDR:LIM:DRIF:FAIL?
Notes	1 (one) is returned if any of the test results were outside the specified limits. Otherwise, 0 (zero) is returned to indicate that a failure has not occurred
State Saved	Yes

Max Drift Rate Limit Status (Remote Query only)

Determines the Pass/Fail status for Max Drift Rate.

Remote Command	:CALCulate:TX:CFDRift:LIMit:RATE:FAIL?
Example	:CALC:TX:CFDR:LIM:RATE:FAIL?
Notes	1 (one) is returned if any of the test results were outside the specified limits. Otherwise, 0 (zero) is returned to indicate that a failure has not occurred
State Saved	Yes

ICFT Upper

Sets the upper limit used when testing the ICFT metric.

Remote Command	:CALCulate:TX:ICFT:LIMit:UPPer <freq> :CALCulate:TX:ICFT:LIMit:UPPer?
Example	:CALC:TX:ICFT:LIM:UPP 75 kHz :CALC:TX:ICFT:LIM:UPP?
Couplings	Preset value depends on the Radio Std: <ul style="list-style-type: none"> - Basic: 75 kHz - Low Energy: 150 kHz When radio std is LE, this control name is Freq Offset Upper
Preset	75 kHz
State Saved	Yes
Min/Max	-/+500 kHz

ICFT Lower

Sets the lower limit used when testing the ICFT metric.

Remote Command	<code>:CALCulate:TX:ICFT:LIMit:LOWer <freq></code> <code>:CALCulate:TX:ICFT:LIMit:LOWer?</code>
Example	<code>:CALC:TX:ICFT:LIM:LOW 75 kHz</code> <code>:CALC:TX:ICFT:LIM:LOW?</code>
Couplings	Preset value depends on the Radio Std: <ul style="list-style-type: none"> - Basic: -75 kHz - Low Energy: -150 kHz <p>When radio std is LE, this control name is Freq Offset Lower</p>
Preset	-75 kHz
State Saved	Yes
Min/Max	-/+500 kHz

ICFT Limit Status (Remote Query only)

Determines the Pass/Fail status for ICFT.

Remote Command	<code>:CALCulate:TX:ICFT:LIMit:FAIL?</code>
Example	<code>:CALC:TX:ICFT:LIM:FAIL?</code>
Notes	1 (one) is returned if any of the test results were outside the specified limits. Otherwise, 0 (zero) is returned to indicate that a failure has not occurred
State Saved	Yes

Relative TX Power

Relative Power Upper

Sets the upper limit (y) used in the formula $x < PDPSK - PGFSK < y$ when testing the Relative Power metric.

Remote Command	<code>:CALCulate:TX:RPOWer:LIMit:UPPer <rel_amp1></code> <code>:CALCulate:TX:RPOWer:LIMit:UPPer?</code>
Example	<code>:CALC:TX:RPOW:LIM:UPP 4</code> <code>:CALC:TX:RPOW:LIM:UPP?</code>
Preset	1.00 dB
State Saved	Yes
Min/Max	-100 dB / 100 dB

Relative Power Lower

Sets the lower limit x used in the formula $x < \text{PDPSK} - \text{PGFSK} < y$ when testing the Relative Power metric.

Remote Command	<code>:CALCulate:TX:RPOwer:LIMit:LOWer <rel_amp1></code>
Example	<code>:CALC:TX:RPOW:LIM:LOW -1</code> <code>:CALC:TX:RPOW:LIM:LOW?</code>
Preset	-4.00 dB
State Saved	Yes
Min/Max	-100 dB / 100 dB

Relative Power Limit Status (Remote Query only)

Determines the Pass/Fail status for the Relative Power.

Remote Command	<code>:CALCulate:TX:RPOwer:LIMit:FAIL?</code>
Example	<code>:CALC:TX:RPOW:LIM:FAIL?</code>
Notes	1 (one) is returned if any of the test results were outside the specified limits. Otherwise, 0 (zero) is returned to indicate that a failure has not occurred
State Saved	Yes

Carrier Freq Stability

Initial Frequency Upper

Sets the upper limit used when testing the Initial Frequency Offset (ω_i) metric.

Remote Command	<code>:CALCulate:TX:FSMaccuracy:LIMit:FERRor:INITial:UPPer <freq></code>
Example	<code>:CALC:TX:FSM:LIM:FERR:INIT:UPP 75 kHz</code> <code>:CALC:TX:FSM:LIM:FERR:INIT:UPP?</code>
Notes	Available for EDR and QHS radio standard
Preset	QHS:150kHz Others:75 kHz
State Saved	Yes
Min/Max	-/+500 kHz

Initial Frequency Lower

Sets the lower limit used when testing the Initial Frequency Offset (ω_i) metric.

Remote Command	<code>:CALCulate:TX:FSMaccuracy:LIMit:FERRor:INITial:LOWer <freq></code> <code>:CALCulate:TX:FSMaccuracy:LIMit:FERRor:INITial:LOWer?</code>
Example	<code>:CALC:TX:FSM:LIM:FERR:INIT:LOW -75 kHz</code> <code>:CALC:TX:FSM:LIM:FERR:INIT:LOW?</code>
Notes	Available for EDR and QHS radio standard
Preset	QHS:-150kHz Others:-75 kHz
State Saved	Yes
Min/Max	-500 kHz/500 kHz

Block Frequency Upper

Sets the upper limit used when testing the Block Frequency Offset (ω_o) metric.

Remote Command	<code>:CALCulate:TX:FSMaccuracy:LIMit:FERRor:BLOCK:UPPer <freq></code> <code>:CALCulate:TX:FSMaccuracy:LIMit:FERRor:BLOCK:UPPer?</code>
Example	<code>:CALC:TX:FSM:LIM:FERR:BLOCK:UPP 10 kHz</code> <code>:CALC:TX:FSM:LIM:FERR:BLOCK:UPP?</code>
Preset	10 kHz
State Saved	Yes
Min/Max	-/+500 kHz

Block Frequency Lower

Sets the lower limit used when testing the Block Frequency Offset (ω_o) metric.

Remote Command	<code>:CALCulate:TX:FSMaccuracy:LIMit:FERRor:BLOCK:LOWer <freq></code> <code>:CALCulate:TX:FSMaccuracy:LIMit:FERRor:BLOCK:LOWer?</code>
Example	<code>:CALC:TX:FSM:LIM:FERR:BLOCK:LOW -10 kHz</code> <code>:CALC:TX:FSM:LIM:FERR:BLOCK:LOW?</code>
Preset	-10 kHz
State Saved	Yes
Min/Max	-/+500 kHz

Total Frequency Upper

Sets the upper limit used when testing the Total Frequency Offset ($\omega_i + \omega_o$) metric.

Remote Command	:CALCulate:TX:FSMaccuracy:LIMit:FERRor:TOTal:UPPer <freq> :CALCulate:TX:FSMaccuracy:LIMit:FERRor:TOTal:UPPer?
Example	:CALC:TX:FSM:LIM:FERR:TOT:UPP 75 kHz :CALC:TX:FSM:LIM:FERR:TOT:UPP?
Notes	Available for EDR and QHS radio standard
Preset	QHS:150kHz Other:75 kHz
State Saved	Yes
Min/Max	-/+500 kHz

Total Frequency Lower

Sets the lower limit used when testing the Total Frequency Offset ($\omega_i + \omega_o$) metric.

Remote Command	:CALCulate:TX:FSMaccuracy:LIMit:FERRor:TOTal:LOWer <freq> :CALCulate:TX:FSMaccuracy:LIMit:FERRor:TOTal:LOWer?
Example	:CALC:TX:FSM:LIM:FERR:TOT:LOW -75 kHz :CALC:TX:FSM:LIM:FERR:TOT:LOW?
Notes	Available for EDR and QHS radio standard
Preset	QHS:-150kHz Others:-75 kHz
State Saved	Yes
Min/Max	-/+500 kHz

Mod Accuracy

RMS DEVM DQPSK Upper

Sets the upper limit used when testing the RMS DEVM metric for $\pi/4$ -DQPSK blocks.

Remote Command	:CALCulate:TX:FSMaccuracy:LIMit:DEVM:RMS:DQPSk:UPPer <percent> :CALCulate:TX:FSMaccuracy:LIMit:DEVM:RMS:DQPSk:UPPer?
Example	:CALC:TX:FSM:LIM:DEVM:RMS:DQPS:UPP 13.00

	:CALC:TX:FSM:LIM:DEVM:RMS:DQPS:UPP?
Notes	Available for EDR and QHS radio standard
Preset	QHS:8.00 Others:20.00
State Saved	Yes
Min/Max	0.0 / 100.00

RMS DEVM 8DPSK Upper

Sets the upper limit used when testing the RMS DEVM metric for 8DPSK blocks.

Remote Command	:CALCulate:TX:FSMaccuracy:LIMit:DEVM:RMS:DPSK:UPPer <percent> :CALCulate:TX:FSMaccuracy:LIMit:DEVM:RMS:DPSK:UPPer?
Example	:CALC:TX:FSM:LIM:DEVM:RMS:DPSK:UPP 13.00 :CALC:TX:FSM:LIM:DEVM:RMS:DPSK:UPP?
Notes	Available for EDR and QHS radio standard
Preset	QHS:8.00 Others:13.00
State Saved	Yes
Min/Max	0.00/100.00

Peak DEVM DQPSK Upper

Sets the upper limit used when testing the Peak DEVM metric for $\pi/4$ -DQPSK symbols.

Remote Command	:CALCulate:TX:FSMaccuracy:LIMit:DEVM:PEAK:DQPSk:UPPer <percent> :CALCulate:TX:FSMaccuracy:LIMit:DEVM:PEAK:DQPSk:UPPer?
Example	:CALC:TX:FSM:LIM:DEVM:PEAK:DQPS:UPP 35.00 :CALC:TX:FSM:LIM:DEVM:PEAK:DQPS:UPP?
Notes	Available for EDR and QHS radio standard
Preset	QHS:22.00 Others:35.00
State Saved	Yes
Min/Max	0.0 / 100.00

Peak DEVM 8DPSK Upper

Sets the upper limit used when testing the Peak DEVM metric for 8DPSK symbols.

3 Bluetooth Mode
3.2 Transmit Analysis Measurement

Remote Command	:CALCulate:TX:FSMaccuracy:LIMit:DEVM:PEAK:DPSK:UPPer <percent> :CALCulate:TX:FSMaccuracy:LIMit:DEVM:PEAK:DPSK:UPPer?
Example	:CALC:TX:FSM:LIM:DEVM:PEAK:DPSK:UPP 25.00 :CALC:TX:FSM:LIM:DEVM:PEAK:DPSK:UPP?
Notes	Available for EDR and QHS radio standard
Preset	QHS:20.00 Others:25.00
State Saved	Yes
Min/Max	0.0 / 100.00

99% DEVM DQPSK Upper

Sets the upper limit used when testing the 99% DEVM metric for $\pi/4$ -DQPSK symbols.

Remote Command	:CALCulate:TX:FSMaccuracy:LIMit:DEVM:NNPercentile:DQPSk:UPPer <percent> :CALCulate:TX:FSMaccuracy:LIMit:DEVM:NNPercentile:DQPSk:UPPer?
Example	:CALC:TX:FSM:LIM:DEVM:NNP:DQPS:UPP 30.00 :CALC:TX:FSM:LIM:DEVM:NNP:DQPS:UPP?
Notes	Available for EDR and QHS radio standard
Preset	QHS:17.50 Others:30.00
State Saved	Yes
Min/Max	0.0 / 100.00

99% DEVM 8DPSK Upper

Sets the upper limit used when testing the 99% DEVM metric for 8DPSK symbols.

Remote Command	:CALCulate:TX:FSMaccuracy:LIMit:DEVM:NNPercentile:DPSK:UPPer <percent> :CALCulate:TX:FSMaccuracy:LIMit:DEVM:NNPercentile:DPSK:UPPer?
Example	:CALC:TX:FSM:LIM:DEVM:NNP:DPSK:UPP 20.00 :CALC:TX:FSM:LIM:DEVM:NNP:DPSK:UPP?
Notes	Available for EDR and QHS radio standard
Preset	QHS:17.50 Others:20.00
State Saved	Yes
Min/Max	0.0 / 100.00

99% DEVM 8PSK Upper

Sets the upper limit used when testing the 99% DEVM metric for 8PSK symbols.

Remote Command	:CALCulate:TX:FSMaccuracy:LIMit:DEVM:NNPercentile:PSK:UPPer <percent> :CALCulate:TX:FSMaccuracy:LIMit:DEVM:NNPercentile:PSK:UPPer?
Example	:CALC:TX:FSM:LIM:DEVM:NNP:PSK:UPP 30.00 :CALC:TX:FSM:LIM:DEVM:NNP:PSK:UPP?
Notes	Available for QHS radio standard
Preset	17.50
State Saved	Yes
Min/Max	0.0 / 100.00

99% DEVM QHS-P3 QPSK Upper

Sets the upper limit used when testing the 99% DEVM metric for High Speed Link $\pi/4$ -QPSK Symbols at 3Mbps.

Remote Command	:CALCulate:TX:FSMaccuracy:LIMit:DEVM:NNPercentile:QPSK:P3:UPPer <percent> :CALCulate:TX:FSMaccuracy:LIMit:DEVM:NNPercentile:QPSK:P3:UPPer?
Example	:CALC:TX:FSM:LIM:DEVM:NNP:QPSK:P3:UPP 20.00 :CALC:TX:FSM:LIM:DEVM:NNP:QPSK:P3:UPP?
Notes	Available for QHS radio standard
Preset	20.00
State Saved	Yes
Min/Max	0.0 / 100.00

99% DEVM QHS-P2 QPSK Upper

Sets the upper limit used when testing the 99% DEVM metric for High Speed Link $\pi/4$ -QPSK Symbols at 2Mbps.

Remote Command	:CALCulate:TX:FSMaccuracy:LIMit:DEVM:NNPercentile:QPSK:P2:UPPer <percent> :CALCulate:TX:FSMaccuracy:LIMit:DEVM:NNPercentile:QPSK:P2:UPPer?
Example	:CALC:TX:FSM:LIM:DEVM:NNP:QPSK:P2:UPP 20.00 :CALC:TX:FSM:LIM:DEVM:NNP:QPSK:P2:UPP?
Notes	Available for QHS radio standard
Preset	23.00
State Saved	Yes

Min/Max 0.0 / 100.00

Peak DEVM 8PSK Upper

Sets the upper limit used when testing the Peak DEVM metric for 8PSK symbols.

Remote Command :CALCulate:TX:FSMaccuracy:LIMit:DEVM:PEAK:PSK:UPPer <percent>
 :CALCulate:TX:FSMaccuracy:LIMit:DEVM:PEAK:PSK:UPPer?

Example :CALC:TX:FSM:LIM:DEVM:PEAK:PSK:UPP 35.00
 :CALC:TX:FSM:LIM:DEVM:PEAK:PSK:UPP?

Notes Available for QHS radio standard

Preset 20.00

State Saved Yes

Min/Max 0.0 / 100.00

Peak DEVM QHS-P3 QPSK Upper

Sets the upper limit used when testing the Peak DEVM metric for High Speed Link $\pi/4$ -QPSK Symbols at 3Mbps.

Remote Command :CALCulate:TX:FSMaccuracy:LIMit:DEVM:PEAK:QPSK:P3:UPPer <percent>
 :CALCulate:TX:FSMaccuracy:LIMit:DEVM:PEAK:QPSK:P3:UPPer?

Example :CALC:TX:FSM:LIM:DEVM:PEAK:QPSK:P3:UPP 25.00
 :CALC:TX:FSM:LIM:DEVM:PEAK:QPSK:P3:UPP?

Notes Available for QHS radio standard

Preset 30.00

State Saved Yes

Min/Max 0.0 / 100.00

Peak DEVM QHS-P2 QPSK Upper

Sets the upper limit used when testing the Peak DEVM metric for High Speed Link $\pi/4$ -QPSK Symbols at 2Mbps.

Remote Command :CALCulate:TX:FSMaccuracy:LIMit:DEVM:PEAK:QPSK:P2:UPPer <percent>
 :CALCulate:TX:FSMaccuracy:LIMit:DEVM:PEAK:QPSK:P2:UPPer?

Example :CALC:TX:FSM:LIM:DEVM:PEAK:QPSK:P2:UPP 25.00
 :CALC:TX:FSM:LIM:DEVM:PEAK:QPSK:P2:UPP?

Notes Available for QHS radio standard

Preset	35.00
State Saved	Yes
Min/Max	0.0 / 100.00

RMS DEVM 8PSK Upper

Sets the upper limit used when testing the RMS DEVM metric for 8PSK blocks.

Remote Command	<code>:CALCulate:TX:FSMaccuracy:LIMit:DEVM:RMS:PSK:UPPer <percent></code> <code>:CALCulate:TX:FSMaccuracy:LIMit:DEVM:RMS:PSK:UPPer?</code>
Example	<code>:CALC:TX:FSM:LIM:DEVM:RMS:PSK:UPP 13.00</code> <code>:CALC:TX:FSM:LIM:DEVM:RMS:PSK:UPP?</code>
Notes	Available for QHS radio standard
Preset	8
State Saved	Yes
Min/Max	0.0 / 100.00

RMS DEVM QHS-P3 QPSK Upper

Sets the upper limit used when testing the RMS DEVM metric for High Speed Link $\pi/4$ -QPSK blocks at 3Mbps.

Remote Command	<code>:CALCulate:TX:FSMaccuracy:LIMit:DEVM:RMS:QPSK:P3:UPPer <percent></code> <code>:CALCulate:TX:FSMaccuracy:LIMit:DEVM:RMS:QPSK:P3:UPPer?</code>
Example	<code>:CALC:TX:FSM:LIM:DEVM:RMS:QPSK:P3:UPP 13.00</code> <code>:CALC:TX:FSM:LIM:DEVM:RMS:QPSK:P3:UPP?</code>
Notes	Available for QHS radio standard
Preset	10.00
State Saved	Yes
Min/Max	0.0 / 100.00

RMS DEVM QHS-P2 QPSK Upper

Sets the upper limit used when testing the RMS DEVM metric for High Speed Link $\pi/4$ -QPSK blocks at 2Mbps.

Remote Command	<code>:CALCulate:TX:FSMaccuracy:LIMit:DEVM:RMS:QPSK:P2:UPPer <percent></code> <code>:CALCulate:TX:FSMaccuracy:LIMit:DEVM:RMS:QPSK:P2:UPPer?</code>
Example	<code>:CALC:TX:FSM:LIM:DEVM:RMS:QPSK:P2:UPP 13.00</code>

3 Bluetooth Mode
3.2 Transmit Analysis Measurement

	<code>:CALC:TX:FSM:LIM:DEVM:RMS:QPSK:P2:UPP?</code>
Notes	Available for QHS radio standard
Preset	12.00
State Saved	Yes
Min/Max	0.0 / 100.00

Carrier Freq Stability and Modulation Accuracy Limit Status (Remote Query only)

Determines the Pass/Fail status for the Carrier Freq Stability and Modulation Accuracy.

Remote Command	<code>:CALCulate:TX:FSMaccuracy:LIMit:FAIL?</code>
Example	<code>:CALC:TX:FSM:LIM:FAIL?</code>
Notes	1 (one) is returned if any of the test results were outside the specified limits. Otherwise, 0 (zero) is returned to indicate that a failure has not occurred
State Saved	Yes

Initial Freq Limit Status (Remote Query only)

Determines the Pass/Fail status for the Initial Freq.

Remote Command	<code>:CALCulate:TX:FSMaccuracy:LIMit:FERRor:INITial:FAIL?</code>
Example	<code>:CALC:TX:FSM:LIM:FERR:INIT:FAIL?</code>
Notes	1 (one) is returned if any of the test results were outside the specified limits. Otherwise, 0 (zero) is returned to indicate that a failure has not occurred
State Saved	Yes

Block Freq Limit Status (Remote Query only)

Determines the Pass/Fail status for the Block Freq.

Remote Command	<code>:CALCulate:TX:FSMaccuracy:LIMit:FERRor:BLOCK:FAIL?</code>
Example	<code>:CALC:TX:FSM:LIM:FERR:BLOC:FAIL?</code>
Notes	1 (one) is returned if any of the test results were outside the specified limits. Otherwise, 0 (zero) is returned to indicate that a failure has not occurred
State Saved	Yes

Total Freq Limit Status (Remote Query only)

Determines the Pass/Fail status for the Total Initial Freq.

Remote Command	<code>:CALCulate:TX:FSMaccuracy:LIMit:FERRor:TOTal:FAIL?</code>
Example	<code>:CALC:TX:FSM:LIM:FERR:TOT:FAIL?</code>
Notes	1 (one) is returned if any of the test results were outside the specified limits. Otherwise, 0 (zero) is returned to indicate that a failure has not occurred
State Saved	Yes

DEVM Peak Limit Status (Remote Query only)

Determines the Pass/Fail status for the DEVM Peak.

Remote Command	<code>:CALCulate:TX:FSMaccuracy:LIMit:DEVM:PEAK:FAIL?</code>
Example	<code>:CALC:TX:FSM:LIM:DEVM:PEAK:FAIL?</code>
Notes	1 (one) is returned if the test results were outside the specified limits. Otherwise, 0 (zero) is returned to indicate that a failure has not occurred
State Saved	Yes
Backwards Compatibility SCPI	<code>:CALCulate:TX:LIMit:DEVM:PEAK:FAIL?</code>

DEVM RMS Limit Status (Remote Query only)

Determines the Pass/Fail status for the DEVM RMS.

Remote Command	<code>:CALCulate:TX:FSMaccuracy:LIMit:DEVM:RMS:FAIL?</code>
Example	<code>:CALC:TX:FSMaccuracy:LIM:DEVM:RMS:FAIL?</code>
Notes	1 (one) is returned if the test results were outside the specified limits. Otherwise, 0 (zero) is returned to indicate that a failure has not occurred
State Saved	Yes
Backwards Compatibility SCPI	<code>:CALCulate:TX:LIMit:DEVM:RMS:FAIL?</code>

99% DEVM Limit Status (Remote Query only)

Determines the Pass/Fail status for the 99% DEVM.

Remote Command	:CALCulate:TX:FSMaccuracy:LIMit:DEVM:NNPercentile:FAIL?
Example	:CALC:TX:FSMaccuracy:LIM:DEVM:NNP:FAIL?
Notes	1 (one) is returned if the test results were outside the specified limits. Otherwise, 0 (zero) is returned to indicate that a failure has not occurred
State Saved	Yes
Backwards Compatibility SCPI	:CALCulate:TX:LIMit:DEVM:NNPercentile:FAIL?

3.2.8.5 Advanced

Lets you set Advanced parameters.

I/Q Offset Compensation

Turns I/Q Offset Compensation on or off:

- On: The computation of EVM excludes I/Q Offset
- Off: The computation of EVM includes I/Q Offset

Remote Command	:CALCulate:TX:IQOFfset[:STATe] OFF ON 0 1 :CALCulate:TX:IQOFfset[:STATe] ?
Example	:CALC:TX:IQOF 1 :CALC:TX:IQOF?
Couplings	If Radio Standard is other than EDR, I/Q Offset Compensation is disabled
Preset	ON
State Saved	Yes
Range	On Off

Hold Result

Store the measurement result for either $\Delta f1$ Avg or $\Delta f2$ Avg, depending on which result has been measured.

Remote Command	<code>:CALCulate:TX:HRESult OFF DF1 DF2</code> <code>:CALCulate:TX:HRESult?</code>
Example	<code>:CALC:TX:HRES OFF</code> <code>:CALC:TX:HRES?</code>
Couplings	The $\Delta f2$ Avg / $\Delta f1$ Avg ratio will be computed once valid results for both $\Delta f1$ Avg and $\Delta f2$ Avg are available If Hold Result $\Delta f1$ Avg is selected, $\Delta f1$ Avg will not be updated until Hold Result Off has been selected If Hold Result $\Delta f2$ Avg is selected, $\Delta f2$ Avg will not be updated until Hold Result Off has been selected
Preset	OFF
State Saved	Yes
Range	Off $\Delta f1$ Avg $\Delta f2$ Avg
Backwards Compatibility SCPI	<code>[:SENSe]:TX:HRESult =OFF DF1 DF2</code> <code>[:SENSe]:TX:HRESult?</code>

Power Reference Plane

Increases the power by 3 dB only for Baseband I+jQ measurements.

Remote Command	<code>[:SENSe]:TX:POWer:IQ:REFerence:PLANE RF BASEband</code> <code>[:SENSe]:TX:POWer:IQ:REFerence:PLANE?</code>
Example	<code>:TX:POW:IQ:REF:PLAN BAS</code> <code>:TX:POW:IQ:REF:PLAN?</code>
Dependencies	Only available if the I/Q input exists Enabled when input is I/Q and I/Q Path is I+jQ Disabled for all other conditions
Preset	RF
State Saved	Saved in instrument state

3.2.9 Sweep

Contains controls that allow you to control the sweep and measurement functions of the analyzer, such as the sweep or measurement time and whether in **Single** sweep/measure or **Continuous** sweep/measure mode.

3.2.9.1 Sweep/Control

Accesses controls that let you operate the sweep and control functions of the instrument, such as **Sweep Time** and **Continuous/Single**.

Acquisition Time

Controls the time the instrument takes to capture a single packet.

Remote Command	<code>[:SENSe]:ACQuisition:TIME <time></code> <code>[:SENSe]:ACQuisition:TIME?</code>
Example	<code>:ACQ:TIME 700uS</code> <code>:ACQ:TIME?</code>
Couplings	Acquisition Time may be clipped by the instrument if the specified acquisition time cannot be performed
Preset	3.0 ms
State Saved	Yes
Min/Max	100 us/100.0 s

Sweep/Measure

Lets you toggle between **Continuous** and **Single** sweep or measurement operation. The single/continuous state is Meas Global, so the setting affects all measurements.

The front-panel key **Single/Cont** performs exactly the same function

See "[More Information](#)" on page 290

Remote Command	<code>:INITiate:CONTinuous OFF ON 0 1</code> <code>:INITiate:CONTinuous?</code>
Example	Put instrument into Single measurement operation: <code>:INIT:CONT 0</code> <code>:INIT:CONT OFF</code> Put instrument into Continuous measurement operation: <code>:INIT:CONT 1</code> <code>:INIT:CONT ON</code>
Preset	ON Note that <code>:SYST:PRES</code> sets <code>:INIT:CONT</code> to ON , but <code>*RST</code> sets <code>:INIT:CONT</code> to OFF
State Saved	Saved in instrument state
Annunciation	The Single/Continuous icon in the Meas Bar changes depending on the setting: <ul style="list-style-type: none"> - A line with an arrow is Single - A loop with an arrow is Continuous
Backwards Compatibility Notes	X-Series A-models had Single and Cont hardkeys in place of the SweepSingleCont softkey. In the X-Series A-models, if in single measurement, the Cont hardkey (and <code>INIT:CONT ON</code>) switched to continuous measurement, but never restarted a measurement and never reset a sweep

X-Series B-models have a **Cont/Single** toggle control instead of **Single** and **Cont** hardkeys, but it is still true that, if in single measurement, the **Cont/Single** toggle control never restarts a measurement and never resets a sweep

More Information

Continuous Mode	<p>The instrument takes repetitive sweeps, averages, measurements, etc., when in continuous mode. If in average or Max/Min Hold, and the average/hold count reaches the Average/Hold Num, the count stops incrementing, but the instrument keeps sweeping</p> <p>See the Trace key description under Trace Average for the averaging formula used both before and after the Average/Hold Num is reached. The trigger condition must be met prior to each sweep</p> <p>The type of trace processing for multiple sweeps is set under the Trace key, with choices of Trace Average, Max Hold, or Min Hold</p>
Single Mode	<p>The instrument takes a single sweep when in Single mode, or if in average or Max/Min Hold, or if there is a Waterfall window displayed, it takes multiple sweeps until the average/hold count reaches the Average/Hold Num, then the count stops incrementing, and the instrument stops sweeping</p> <p>See the Trace key description under Trace Average for the averaging formula used. The trigger condition must be met prior to the sweep</p> <p>The type of trace processing for multiple sweeps is set under the Trace key, with choices of Trace Average, Max Hold, or Min Hold</p>

If the instrument is in **Single** measurement mode, pressing the **Cont/Single** toggle control does not zero the count and does not cause the sweep to be reset; the only action is to put the instrument into Continuous measurement operation.

If the instrument is already in **Continuous** sweep:

- **:INIT:CONT 1** has no effect
- **:INIT:CONT 0** places the instrument in Single Sweep but has no effect on the current sequence until $k = N$, at which point the current sequence will stop and the instrument will go to the idle state

See "**Restart**" on page 806 for details of **:INIT:IMMEDIATE**.

If the instrument is already in **Single** sweep, **:INIT:CONT OFF** has no effect.

If the instrument is already in **Single** sweep, then pressing **Cont/Single** in the middle of a sweep does not restart the sweep or sequence. Similarly, pressing **Cont/Single** does not restart the sweep or sequence if the sweep is not in the idle state (for example, if you are taking a very slow sweep, or the instrument is waiting for a trigger). Even though pressing **Cont/Single** in the middle of a sweep does not restart the sweep, sending **:INIT:IMM** does reset it.

If the instrument is in **Single** sweep, and *not* Averaging/Holding, and you want to take one more sweep, press **Restart**.

If the instrument is in **Single** sweep, *and* Averaging/Holding, and you want to take one more sweep without resetting the Average trace or count, go to **Meas Setup** and increment the average count by 1 by pressing the **Step-Up** key while **Average/Hold Num** is the active function. You can also do this by sending **:CALC: AVER: TCON UP**.

Restart

Restarts the current sweep, or measurement, or set of averaged/held sweeps or measurements. If you are Paused, pressing **Restart** performs a Resume.

The front-panel key **Restart** performs exactly the same function.

The **Restart** function is accessed in several ways:

- Pressing the **Restart** key
- Sending **:INIT: IMM**
- Sending **:INIT: REST**

See "[More Information](#)" on page 292

Remote Command	:INITiate[: IMMEDIATE] :INITiate: RESTart
Example	:INIT: IMM :INIT: REST
Notes	:INIT: REST and :INIT: IMM perform exactly the same function
Couplings	Resets average/hold count k. For the first sweep overwrites all active (update = on) traces with new current data. For application modes, it resets other parameters as required by the measurement
Status Bits/OPC dependencies	This is an Overlapped command The STATus: OPERation register bits 0 through 8 are cleared , <i>except</i> bit 6 (Waiting for Periodic Sync). Initiating a measurement and Waiting for Periodic Sync could be asynchronous The STATus: QUESTionable register bit 9 (INTegrity sum) is cleared The SWEEPING bit is set The MEASURING bit is set
Backwards Compatibility Notes	For Spectrum Analysis Mode in ESA and PSA, the Restart hardkey and the :INIT: REST command restarted trace averages (displayed average count reset to 1) for a trace in Clear Write , but did not restart Max Hold and Min Hold In X-Series, the Restart hardkey and the :INIT: REST command restart not only Trace Average , but MaxHold and MinHold traces as well

More Information

The **Restart** function first aborts the current sweep or measurement as quickly as possible. It then resets the sweep and trigger systems, sets up the measurement and initiates a new data measurement sequence with a new data acquisition (sweep) taken once the trigger condition is met.

If the instrument is in the process of aligning when a **Restart** is executed, the alignment finishes before the restart function is performed.

Even when set for **Single** operation, multiple sweeps may be taken when **Restart** is pressed (for example, when averaging/holding is on). Thus, when we say that **Restart** "restarts a measurement", depending on the current settings, we may mean that it:

- Restarts the current sweep
- Restarts the current measurement
- Restarts the current set of sweeps if any trace is in Trace Average, Max Hold or Min Hold
- Restarts the current set of measurements if Averaging, or Max Hold, or Min Hold is on for the measurement

If there is no Average or Max/Min Hold function (no trace in Trace Average or Hold, or **Average/Hold Num** set to 1), and no **Waterfall** window is being displayed, a single sweep is equivalent to a single measurement. A single sweep is taken after the trigger condition is met; and the instrument stops sweeping once that sweep has completed. However, with **Average/Hold Num** >1, and at least one trace set to Trace Average, Max Hold, or Min Hold, or a **Waterfall** window being displayed, multiple sweeps/data acquisitions are taken for a single measurement. The trigger condition must be met prior to each sweep. The sweep is stopped when the average count k equals the number N set for **Average/Hold Num**.

Once the full set of sweeps has been taken, the instrument goes to the idle state. To take one more sweep without resetting the average count, increment the average count by 1, by pressing the **Step-Up** key while **Average/Hold Number** is the active function, or by sending the remote command `:CALC:AVER:TCON UP`.

Trace Update

The numeric results are not blanked at any time during the restart cycle.

For slow sweeps (see **Trace Update** section in **Trace/Detector**), the traces are updated real-time during the sweep. There may be a special circumstance in

application mode measurements where an exception is made and the traces and/or results need to be blanked before displaying the new results.

To summarize, the following list shows what happens to the trace data on various events:

Event	Trace Effect
Clear/Write pressed (even if already in Clear/Write)	Set to mintracevalue
Max Hold pressed (even if already in Max Hold)	Set to mintracevalue
Min Hold pressed (even if already in Min Hold)	Set to maxtracevalue
Trace Average pressed (even if already in Trace Average)	Trace data unaffected but start new sweep/avg/hold
Restart pressed	Trace data unaffected but start new sweep/avg/hold
Parameter requiring restart changed (e.g., RBW)	Trace data unaffected but start new sweep/avg/hold

Sweep and Trigger Reset

Resetting the sweep system resets the average/hold count k to 0. It also resets the set point counter to 0. Resetting the trigger system resets the internal auto trig timer to the value set by the **Auto Trig** control.

Averaging

The weighting factor used for averaging is k . This k is also the average/hold count for how many valid sweeps (data acquisitions) have been done. This k is used for comparisons with N , as those comparisons always needs to be based on valid completed sweeps.

The displayed average/hold, K , shows the count for the sweep (data acquisition) in progress. $K = k + 1$, with a limit of N . The displayed value K changes from its previous value to 1 as soon as the trigger condition for the first data acquisition (sweep) is met.

Pause/Resume

Pauses a measurement after the current data acquisition is complete.

When paused, the label on the control changes to **Resume**. Pressing **Resume** unpauses the measurement. When paused, pressing **Restart** performs a Resume.

Remote Command **:INITiate:PAUSE**
 :INITiate:RESume

Example	<code>:INIT:PAUS</code> <code>:INIT:RES</code>
Dependencies	Not displayed in Modes that do not support pausing
Annotation	Only on control

3.2.9.2 X Scale

Accesses controls that let you set the horizontal scale parameters.

Ref Value

Sets the X-axis reference level (start time) for the RF Envelope graph or Demod Waveform graph, allowing smaller sections of the RF Envelope or Demod Waveform to be viewed in greater detail.

Remote Command	<code>:DISPlay:TX:WINDow[1] 2:TRACe:X[:SCALE]:RLEVel <time></code> <code>:DISPlay:TX:WINDow[1] 2:TRACe:X[:SCALE]:RLEVel?</code> For Window numbers, see "Backwards Compatibility SCPI" on page 294
Example	<code>:DISP:TX:WIND:TRAC:X:RLEV 100us</code> <code>:DISP:TX:WIND:TRAC:X:RLEV?</code>
Couplings	Max value is coupled to acquisition time and X scale/division (see below) The key associated with this parameter is only enabled when window 1 is selected in Quad View, or when in RF Envelope view or Demod Waveform view. It is empty when RF Spectrum view is selected
Preset	0.000 s
State Saved	Yes
Range	0 – (acquisition time – (X scale/division * 10))
Min/Max	0 s/ (acquisition time – (X scale/division * 10))

Backwards Compatibility SCPI

Window Numbers used to be a combination of View and Window. Now the **VIEW** parameter is not used and removed. For backwards compatibility the old View and Window numbers are supported as below:

#	Window	Old SCPI Command	New SCPI Command
1	RF Envelope	<code>DISP:TX:VIEW[1]:WIND[1]:TRAC:X:RLEV 0.0</code>	<code>DISP:TX:WIND:TRAC:X:RLEV 0.0</code>
2	Demod Waveform	<code>DISP:TX:VIEW2:WIND[1]:TRAC:X:RLEV 0.0</code>	<code>DISP:TX:WIND2:TRAC:X:RLEV 0.0</code>

Scale/Division

Sets the X-axis scale per division for the RF Envelope graph or Demod Waveform graph, allowing smaller sections of the RF Envelope graph or Demod Waveform graph to be viewed in greater detail.

Remote Command	<code>:DISPlay:TX:WINDow[1] 2:TRACe:X[:SCALE]:PDIVision <time></code> <code>:DISPlay:TX:WINDow[1] 2:TRACe:X[:SCALE]:PDIVision?</code>
	For Window numbers, see " Backwards Compatibility SCPI " on page 295
Example	<code>:DISP:TX:WIND:TRAC:X:PDIV 10us</code> <code>:DISP:TX:WIND:TRAC:X:PDIV?</code>
Couplings	Min is coupled to sample time, but maintains at least two points at any time Max value is coupled to X reference value and acquisition time The key associated with this parameter is only enabled when window 1 is selected in Quad View, or when in RF Envelope view or Demod Waveform view. It is empty when RF Spectrum view is selected
Preset	0.3 ms
State Saved	Yes
Range	Hardware Dependent
Min/Max	$(2 * \text{Acquisition Time}) / (10 * \text{Number of points in RF Envelope})$! min value $(\text{Acquisition Time} - \text{Ref Level}) / 10$! max value

Backwards Compatibility SCPI

Window Numbers used to be a combination of View and Window. Now the **VIEW** parameter is not used and removed. For backwards compatibility the old View and Window numbers are supported as below:

#	Window	Old SCPI Command	New SCPI Command
1	RF Envelope	<code>DISP:TX:VIEW[1]:WIND[1]:TRAC:X:PDIV 10us</code>	<code>DISP:TX:WIND:TRAC:X:PDIV 10us</code>
2	Demod Waveform	<code>DISP:TX:VIEW2:WIND[1]:TRAC:X:PDIV 10us</code>	<code>DISP:TX:WIND2:TRAC:X:PDIV 10us</code>

Ref Position

Sets the X-axis ref position for the RF Envelope graph or Demod Waveform graph, allowing smaller sections of the RF Envelope graph or Demod Waveform graph to be viewed in greater detail.

Remote Command	<code>:DISPlay:TX:WINDow[1] 2:TRACe:X[:SCALE]:RPOsition LEFT CENTer RIGHT</code> <code>:DISPlay:TX:WINDow[1] 2:TRACe:X[:SCALE]:RPOsition?</code>
----------------	---

	For Window numbers, see " Backwards Compatibility SCPI " on page 296
Example	<code>:DISP:TX:WIND:TRAC:X:RPOS RIGH</code> <code>:DISP:TX:WIND:TRAC:X:RPOS?</code>
Preset	LEFT
State Saved	Yes
Range	Left Ctr Right

Backwards Compatibility SCPI

Window Numbers used to be a combination of View and Window. Now the **VIEW** parameter is not used and removed. For backwards compatibility the old View and Window numbers are supported as below:

#	Window	Old SCPI Command	New SCPI Command
1	RF Envelope	<code>DISP:TX:VIEW[1]:WIND[1]:TRAC:X:RPOS RIGH</code>	<code>DISP:TX:WIND:TRAC:X:RPOS RIGH</code>
2	Demod Waveform	<code>DISP:TX:VIEW2:WIND[1]:TRAC:X:RPOS RIGH</code>	<code>DISP:TX:WIND2:TRAC:X:RPOS RIGH</code>

Auto Scaling

Sets the X-axis auto scaling for the RF Envelope graph or Demod Waveform graph.

Remote Command	<code>:DISP:lay:TX:WINDow[1] 2:TRACe:X[:SCALe]:COUPle OFF ON 0 1</code> For Window numbers, see " Backwards Compatibility SCPI " on page 296 <code>:DISP:lay:TX:WINDow[1] 2:TRACe:X[:SCALe]:COUPle?</code>
Example	<code>:DISP:TX:WIND:TRAC:X:COUP ON</code> <code>:DISP:TX:WIND:TRAC:X:COUP?</code>
Couplings	When Auto Scaling is On, and you press the Restart front-panel key, this function automatically determines the scale per division and reference values based on the measurement results. When you manually set a value for X Ref Value or X Scale/Div , this parameter is automatically set to Off
Preset	ON
State Saved	Yes
Range	On Off

Backwards Compatibility SCPI

Window Numbers used to be a combination of View and Window. Now the **VIEW** parameter is not used and removed. For backwards compatibility the old View and Window numbers are supported as below:

#	Window	Old SCPI Command	New SCPI Command
1	RF Envelope	DISP:TX:VIEW[1]:WIND[1]:TRAC:X:COUP ON	DISP:TX:WIND:TRAC:X:COUP ON
2	Demod Waveform	DISP:TX:VIEW2:WIND[1]:TRAC:X:COUP ON	DISP:TX:WIND2:TRAC:X:COUP ON

3.2.9.3 Recording

Displays the Sample Rate, Sample Points and Sample Time of the saved IQ data file.

Recording and playback of signal data files is a multi-step process that involves controls in several menus:

- **Save, Recording** (under the **Save** hardkey or the **Save** icon in the **File** panel)
- **Recall, Recording** (under the **Recall** hardkey or the **Recall** icon in the **File** panel)
- **Sweep, Recording** (this tab)
- **Sweep, "Playback"** on page 298
- **Input/Output, "Data Source"** on page 1199

NOTE

A complete tutorial for **Record/Playback** functionality, including how to load and save recording files, can be found in the help for the tab **"Data Source"** on page 1199 under **Input/Output**.

This menu includes the following display-only fields:

Sample Rate

Displays the sample rate of the saved IQ data file. If you have not saved an IQ data file, the value is 0.

Sample Points

Displays the total number of sample points in the saved IQ data file. If you have not saved an IQ data file, the value is 0.

Sampling Time

Displays the total sample time of the saved IQ data file. If you have not saved an IQ data file, the value is 0.

Saved Channels [Mode: 5GNR, VMA, WLAN]

Displays the channel index/number of the saved IQ data file. If you have not saved an IQ data file, no value is displayed.

This control is designed for multi-channel I/Q data recording and playback.

3.2.9.4 Playback

Contains parameters for playback of saved recording files recalled to the instrument.

Recording and playback of signal data files is a multi-step process that involves controls in several menus:

- **Save, Recording** (under the **Save** hardkey or the **Save** icon in the **File** panel)
- **Recall, Recording** (under the **Recall** hardkey or the **Recall** icon in the **File** panel)
- **Sweep, "Recording"** on page 297
- **Sweep, Playback** (this tab)
- **Input/Output, "Data Source"** on page 1199

NOTE

A complete tutorial for **Record/Playback** functionality, including how to load and save recording files, can be found in the help for the tab **"Data Source"** on page 1199 under the **Input/Output** menu.

This menu includes the following display-only fields:

Sample Points

Displays the total number of sample points in the recalled IQ data file. If you have not recalled an IQ data file, the value is 0.

Sampling Time

Displays the total sample time of the recalled IQ data file. If you have not recalled an IQ data file, the value is 0.

Input Channels [Mode: 5G NR, VMA, WLAN]

Displays the input channel number of the recalled IQ data file. If you have not recalled an IQ data file, the default value of 1 is displayed.

This control is designed for multi-channel I/Q data recording and playback.

Playback Mode

Specifies the mode of IQ data to be played back and analyzed:

- Fixed: Playback Stop value is ignored. Measurement will analyze the first chunk of IQ data start from Playback Start repeatedly
- Iterative: Measurement will analyze the IQ data chunk by chunk between Playback Start and Playback Stop, if the last chunk is not complete it will be ignored and start from the first chunk again

Remote Command	<code>:CALCulate:<meas>:PLAY:MODE FIXed ITERative</code> <code>:CALCulate:<meas>:PLAY:MODE?</code>
Example	Where <code><meas></code> is the mnemonic for the current measurement, for example, <code>EVM</code> For EVM measurement in 5G NR Mode: <code>:CALC:EVM:PLAY:MODE CONT</code> <code>:CALC:EVM:PLAY:MODE?</code>
Preset	<code>FIX</code>
State Saved	Saved in instrument state
Range	Fixed Iterative

Playback Start

Once you have loaded an IQ data file using **Recall, Recording**, this control enables you to specify the start position of the IQ data playback range to be analyzed. If its value is less than zero, an additional zero is inserted at the beginning of the IQ data.

To go to a specific location in the recalled I/Q data, enter the desired **Playback Start** point.

You can use this control to examine the data you recalled from the recording file. How you proceed depends on whether you are in **Continuous** or **Single** mode. To determine which mode you are in, look at the first panel on the left in the **Meas Bar** above the data display.

If the panel looks like this, you are in **Continuous** mode:



If the panel looks like this, you are in **Single** mode:

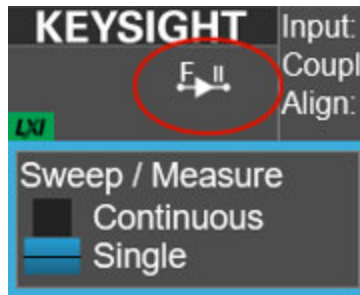

The **F** indicates that the instrument is using data from a file (if you wish to return to looking at data at the analyzer input, change the **Data Source** control in the **Input/Output, Data Source** menu from **File** back to **Input**.)

To examine the data you loaded:

Continuous mode

In this mode, turn the knob or use the **Up/Down** keys on the front panel to move through records in the recording. You will see **Playback Start** change from 0 to successively higher values as you move deeper into the data.

Single mode

In this mode, you can only look at one record. Set the **Playback Start** time to the desired offset from zero, then press **Restart**. A single record will be displayed. Note that until you press **Restart**, the “invalid data” indicator (yellow asterisk) is displayed in each window. After you press **Restart**, the invalid data indicator disappears.

Remote Command	<code>:CALCulate:<meas>:PLAY:START <time></code> <code>:CALCulate:<meas>:PLAY:START?</code>
	Where <code><meas></code> is the mnemonic for the current measurement, for example, <code>EVM</code>
Example	For EVM measurement in 5G NR Mode: <code>:CALC:EVM:PLAY:STAR 0.01 s</code> <code>:CALC:EVM:PLAY:STAR?</code>
Preset	0
State Saved	Saved in instrument state
Min/Max	-/+Sample Points in IQ file / Sample Rate in IQ file

Playback Stop

Specifies the stop position of the IQ data playback range to be analyzed, when "Playback Mode" is iterative.

Remote Command	<code>:CALCulate:<meas>:PLAY:STOP <time></code> <code>:CALCulate:<meas>:PLAY:STOP?</code>
	Where <code><meas></code> is the mnemonic for the current measurement, for example, <code>EVM</code>
Example	For EVM measurement in 5G NR Mode: <code>:CALC:EVM:PLAY:STOP 0.01 s</code> <code>:CALC:EVM:PLAY:STOP?</code>
Preset	0
State Saved	No
Min	0
Max	Sample Points in IQ file x Sample Rate

Step Forward

Move to next chunk of IQ data when "Playback Mode" on page 299 is iterative.

Remote Command	<code>:CALCulate:<meas>:PLAY:STEP:FORward</code>
	Where <code><meas></code> is the mnemonic for the current measurement, for example, <code>EVM</code>
Example	For EVM measurement in 5G NR Mode: <code>:CALC:EVM:PLAY:STEP:FORW</code>
State Saved	Saved in instrument state

Sample Rate

Displays the sample rate of the recalled IQ data file if the recalled file format contains sampling rate information (`.csv`, `.sdf`, `.txt`). In this case, the *control* is grayed-out.

`BIN` and `BINX` files do not include sampling rate information inside the file, so after recalling one of these files, you must set **Sample Rate** manually. When you save a file in these formats, you must specify the sample rate, as displayed under **Sweep, Recording**.

Remote Command	<code>:CALCulate:<meas>:PLAY:SRATe <freq></code> <code>:CALCulate:<meas>:PLAY:SRATe?</code>
	Where <code><meas></code> is the mnemonic for the current measurement, for example, <code>EVM</code>

Example	For EVM measurement in 5G NR Mode: <code>:CALC:EVM:PLAY:SRAT 122.88MHz</code> <code>:CALC:EVM:PLAY:SRAT?</code>
Couplings	Displays only after recalling <code>.csv</code> , <code>.sdf</code> , or <code>.txt</code> files Settable after recalling <code>.bin</code> or <code>.binx</code> files
Preset	0
State Saved	No
Min	0

3.2.10 Trace

Not supported in this Measurement.

3.3 Adjacent Channel Power

The Adjacent Channel Power measurement is performed to verify that the emissions levels within the operating frequency range conform to the limits. The power measurements covered by this test are total peak power for adjacent channels.

Measurement Commands

All scalar results for this measurement are contained in one table and there is one equivalent subopcode for the remote results. You can use this equivalence by visually inspecting the corresponding summary trace on the display, or by using `:CALC:DATA` queries, which programmatically describe the corresponding summary trace.

```
:CONFigure:ACPower  
:CONFigure:ACPower:NDEFault  
:FETCh:ACPower[n]?  
:INITiate:ACPower  
:MEASure:ACPower[n]?  
:READ:ACPower[n]?
```

Remote Command Results

ACP provides 79 scalar values for the Tx power per channel. The number of meaningful results depend on the Span, with the meaningful values at the head of the array.

The following table lists the results returned by the `(FETCh|MEASure|READ):ACP` queries, indexed by subopcode `n`:

n	Return Value
0	Returns <code>NaN</code> (9.91E+37)
1	Returns 79 comma-separated scalar values for the Tx power per channel. The number of the meaningful results depends on the Span, with the meaningful values at the head of the array
2	1. TxRefIndex 2. TxRefPower 3. AdjChanPowerUpper 4. AdjChanPowerLower 5. NumberofExceptions

3.3.1 Views

The ACP measurement has two views, the RF Spectrum View and the RF Envelope View.

These Views are multiple-window Views. When in a multiple window View, you select a window by touching it. The menu controls may sometimes change depending on which window is selected.

Whenever the View changes, the default menu is Frequency, unless otherwise specified in the View description.

View Selection Remote Commands

Allows you to select the desired measurement view.

The Enumerated ID is used with the SCPI Command `:DISP:ACP:VIEW[:SEL]` ("[View Selection by Name](#)" on page 304)

The Numeric ID is used with the SCPI Command `:DISP:ACP:VIEW:NSEL` ("[View Selection by Number \(Remote Command only\)](#)" on page 305)

Enumerated ID	Numeric ID	View Name & Details
RFENvelope	1	Provides a combination view of RF Envelope graph and the summary data as shown below
RFSPpectrum	2	Provides a combination view of RF Spectrum graph and the summary data as shown below

View Selection by Name

Allows you to specify the view via its enumerated ID string.

Remote Command	<code>:DISPlay:ACPower:VIEW[:SElect] RFENvelope RFSPpectrum</code> <code>:DISPlay:ACPower:VIEW[:SElect]?</code>
Example	<code>:DISP:ACP:VIEW:SEL RFSP</code> <code>:DISP:ACP:VIEW:SEL?</code>
Preset	RFSPpectrum
State Saved	Yes
Range	RF Envelope RF Spectrum

View Selection by Number (Remote Command only)

Allows you to specify the view via its numeric ID value.

Remote Command	<code>:DISPlay:ACPower:VIEW:NSElect <integer></code> <code>:DISPlay:ACPower:VIEW:NSElect?</code>
Example	<code>:DISP:ACP:VIEW:NSEL 1</code> <code>:DISP:ACP:VIEW:NSEL?</code>
Preset	1
State Saved	Yes
Min/Max	1/2

3.3.1.1 RF Envelope View

Windows: "RF Envelope Graph" on page 305, "Metrics" on page 306

Example	<code>:DISP:ACP:VIEW RFEN</code>
---------	----------------------------------

3.3.1.2 RF Spectrum View

Windows: "RF Spectrum Graph" on page 306, "Metrics" on page 306

Example	<code>:DISP:ACP:VIEW RFSP</code>
---------	----------------------------------

3.3.2 Windows

This section describes the Windows that are available in the ACP measurement.

RF Envelope Graph

The RF Envelope Graph window is used to display the RF Envelope being measured by the ACP measurement.

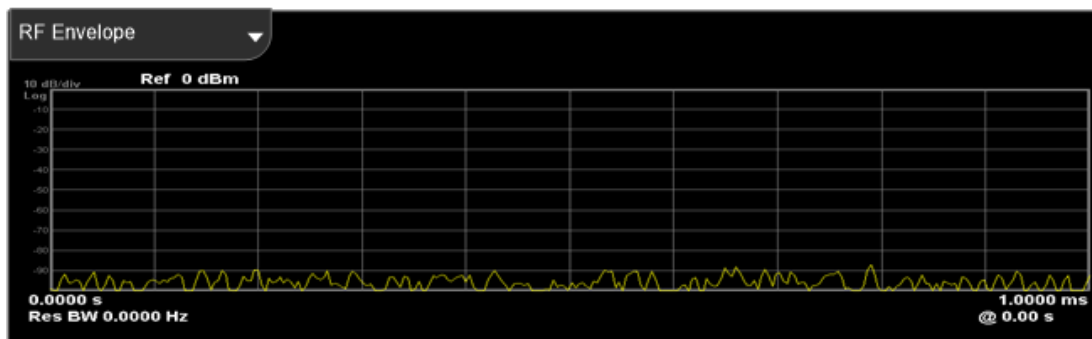

RF Spectrum Graph

The RF Spectrum Graph window is used to display the RF Spectrum being measured by the ACP measurement.

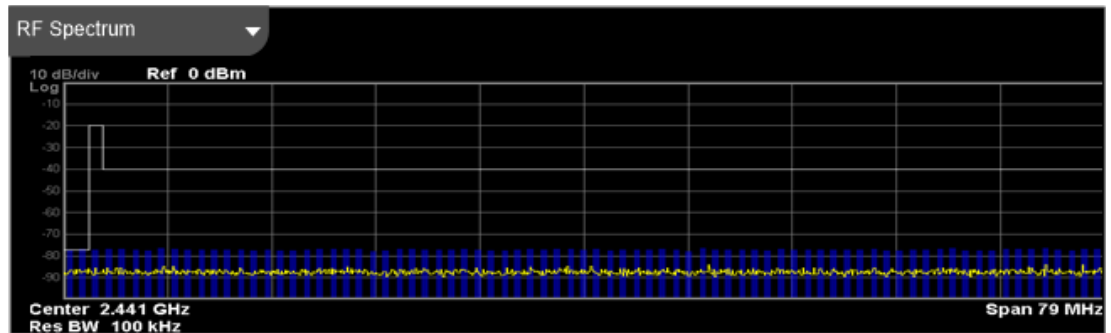

Metrics

The Metrics window displays the following results:

Tx Chan

It refers to the channel of the Transmit signal.

Tx Chan Power

It refers to the power of the Transmit channel.

Adj Chan Lower

The adjacent channel power between 500 kHz and 1.5 MHz from the carrier and it is located at the carrier's left part.

Adj Chan Upper

The adjacent channel power between 500 kHz and 1.5 MHz from the carrier and it is located at the carrier's right part.

Number of Exceptions

The number of the channel that channel power goes beyond its limit value.

Result Table

Each channel results are listed in the results table, which includes channel number, channel power, limits value and pass/fail status for every channel.

Gate

Turning on Gate View shows the Gate Window, which allows you to see your Gating signal at the same time as the measured data. See the description under Gate View in the Trigger, Gate Settings section.

3.3.3 Amplitude

The Amplitude front-panel key activates the Amplitude menu and selects Reference Value as the active function.

3.3.3.1 Y Scale

Contains controls that pertain to the Y axis parameters of the measurement. These parameters control how data on the vertical (Y) axis is displayed and control instrument settings that affect the vertical axis.

Ref Value

Controls the Y value of the selected trace at the Reference Position. The functionality depends on the selected window.

Remote Command	<code>:DISPlay:ACPower:WINDow[1] 2:TRACe:Y[:SCALe]:RLEVel <real></code> <code>:DISPlay:ACPower:WINDow[1] 2:TRACe:Y[:SCALe]:RLEVel?</code>
	Window numbers are as follows: RF Envelope: 1 RF Spectrum: 2
Example	<code>:DISP:ACP:WIND:TRAC:Y:RLEV 0.0</code> 1 – RF Envelope Window <code>:DISP:ACP:WIND2:TRAC:Y:RLEV 0.0</code> 2 – RF Spectrum Window
Couplings	When Auto Scaling is On (default), this value is automatically determined by the measurement result. When you set a value manually, Auto Scaling changes to Off
Preset	0.00dBm
State Saved	Yes
Min/Max	-100.00 dBm / 30.00 dBm

Backwards Compatibility SCPI

Window Numbers used to be a combination of View and Window, now the VIEW parameter is not used and removed. For backwards compatibility the old View and Window numbers are honored as below:

Window	Old SCPI Command	New SCPI Command
--------	------------------	------------------

RF Envelope	<code>DISP:ACP:VIEW:WIND:TRAC:Y:RLEV 0.0</code>	<code>DISP:ACP:WIND:TRAC:Y:RLEV 0.0</code>
RF Spectrum	<code>DISP:ACP:VIEW2:WIND:TRAC:Y:RLEV 0.0</code>	<code>DISP:ACP:WIND2:TRAC:Y:RLEV 0.0</code>

Scale/Div

Controls the Y scale per division of the selected trace. The functionality depends on the selected window.

Remote Command	<code>:DISPlay:ACP:Power:WINDow[1] 2:TRACe:Y[:SCALe]:PDIVision <rel_amp1></code> <code>:DISPlay:ACP:Power:WINDow[1] 2:TRACe:Y[:SCALe]:PDIVision?</code>
	Window numbers are as follows: RF Envelope: 1 RF Spectrum: 2
Example	<code>:DISP:ACP:WIND:TRAC:Y:PDIV 0.0</code> 1 – RF Envelope Window <code>:DISP:ACP:WIND2:TRAC:Y:PDIV 0.0</code> 2 – RF Spectrum Window
Couplings	When Auto Scaling is On (default), this value is automatically determined by the measurement result. When you set a value manually, Auto Scaling changes to Off
Preset	10.0 dB
State Saved	Yes
Min/Max	0.1 dB / 30.00 dB

Backwards Compatibility SCPI

Window Numbers used to be a combination of View and Window, now the VIEW parameter is not used and removed. For backwards compatibility the old View and Window numbers are honored as below:

Window	Old SCPI Command	New SCPI Command
RF Envelope	<code>DISP:ACP:VIEW:WIND:TRAC:Y:PDIV 0.0</code>	<code>DISP:ACP:WIND:TRAC:Y:PDIV 0.0</code>
RF Spectrum	<code>DISP:ACP:VIEW2:WIND:TRAC:Y:PDIV 0.0</code>	<code>DISP:ACP:WIND2:TRAC:Y:PDIV 0.0</code>

Ref Position

Controls the Y ref position of the selected trace. The functionality depends on the selected window.

Remote	<code>:DISPlay:ACP:Power:WINDow[1] 2:TRACe:Y[:SCALe]:RPOsition TOP CENTer BOTTom</code>
--------	---

3 Bluetooth Mode
3.3 Adjacent Channel Power

Command	<code>:DISPlay:ACPower:WINDow[1] 2:TRACe:Y[:SCALe]:RPOSition?</code> Window numbers are as follows: RF Envelope: 1 RF Spectrum: 2
Example	<code>:DISP:ACP:WIND:TRAC:Y:RPOS CENT</code> 1 – RF Envelope window <code>:DISP:ACP:WIND2:TRAC:Y:RPOS CENT</code> 2 – RF Spectrum Window
Preset	TOP
State Saved	Saved in instrument state
Range	Top Ctr Bot

Backwards Compatibility SCPI

Window Numbers used to be a combination of View and Window, now the VIEW parameter is not used and removed. For backwards compatibility the old View and Window numbers are honored as below:

Window	Old SCPI Command	New SCPI Command
RF Envelope	<code>DISP:ACP:VIEW:WIND:TRAC:Y:RPOS CENT</code>	<code>DISP:ACP:WIND:TRAC:Y:RPOS CENT</code>
RF Spectrum	<code>DISP:ACP:VIEW2:WIND:TRAC:Y:RPOS CENT</code>	<code>DISP:ACP:WIND2:TRAC:Y:RPOS CENT</code>

Auto Scaling

Toggles the Auto Scaling function between On and Off. The functionality depends on the selected window.

Remote Command	<code>:DISPlay:ACPower:WINDow[1] 2:TRACe:Y[:SCALe]:COUPle 0 1 OFF ON</code> <code>:DISPlay:ACPower:WINDow[1] 2:TRACe:Y[:SCALe]:COUPle?</code> Window numbers are as follows: RF Envelope: 1 RF Spectrum: 2
Example	<code>:DISP:ACP:WIND:TRAC:Y:COUP ON</code> 1 – RF Envelope window <code>:DISP:ACP:WIND2:TRAC:Y:COUP ON</code> 2 – RF Spectrum Window
Couplings	When Auto Scaling is On, and you press the Restart front-panel key, this function automatically determines the scale per division and reference values based on the measurement results. When you manually set a value for the Y Rel Value or Y Scale/Div, this parameter is automatically set to Off

Preset	ON
State Saved	Saved in instrument state
Range	On Off

Backwards Compatibility SCPI

Window Numbers used to be a combination of View and Window, now the VIEW parameter is not used and removed. For backwards compatibility the old View and Window numbers are honored as below:

Window	Old SCPI Command	New SCPI Command
RF Envelope	DISP:ACP:VIEW:WIND:TRAC:Y:COUPl e CENT	DISP:ACP:WIND:TRAC:Y:COUPl e CENT
RF Spectrum	DISP:ACP:VIEW2:WIND:TRAC:Y:COUPl e CENT	DISP:ACP:WIND2:TRAC:Y:COUPl e CENT

3.3.3.2 Attenuation

Controls the attenuator functions and interactions between the attenuation system components.

There are two attenuator configurations in the X-Series. One is a Dual-Attenuator configuration consisting of a mechanical attenuator and an optional electronic attenuator. The other configuration uses a single attenuator with combined mechanical and electronic sections that controls all the attenuation functions. Different models in the X-Series come with different configurations.

- See "[Dual-Attenuator Configurations](#)" on page 310
- See "[Single-Attenuator Configuration](#)" on page 311

Most attenuation settings are the same for all measurements – they do not change as you change measurements. Settings like these are called “Meas Global” and are unaffected by **Meas Preset**.

Only available when the hardware set includes an input attenuator, which is typically only the case for Keysight’s benchtop instruments. For example, this tab does *not* appear in VXT models M9421A/10A/11A, nor in UXM. In UXM, all **Attenuation** and **Range** settings are disabled, as the expected input power level is handled by the Call Processing App that drives the DUT power control.

Dependencies	In measurements that support the I/Q inputs, unavailable when I/Q is the selected input. Replaced by the Range tab in that case
--------------	--

Dual-Attenuator Configurations

Configuration 1: Mechanical attenuator + optional electronic attenuator

3 Bluetooth Mode
 3.3 Adjacent Channel Power

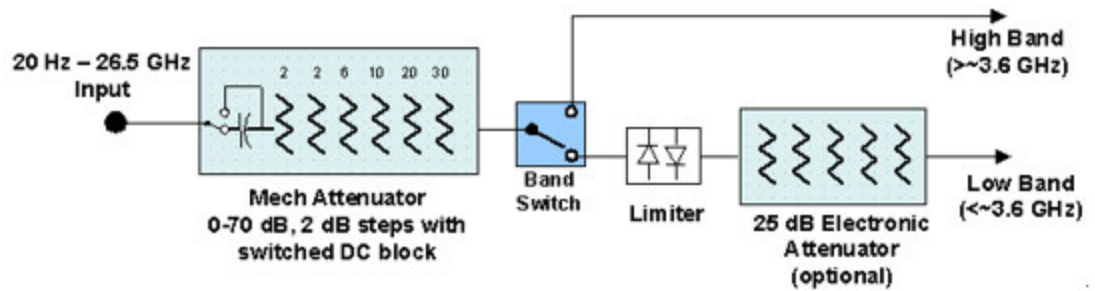

Configuration 2: Mechanical attenuator, no optional electronic attenuator

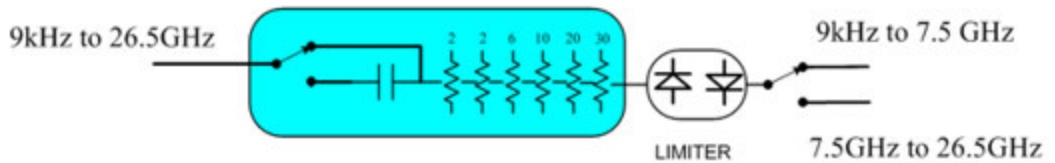

Note that Configuration 2 is not strictly speaking a dual-section attenuator, since there is no electronic section available. However, it behaves exactly like Configuration 1 without the Electronic Attenuator Option EA3, therefore for the sake of this document it is grouped into the “Dual-Attenuator” configuration.

Single-Attenuator Configuration

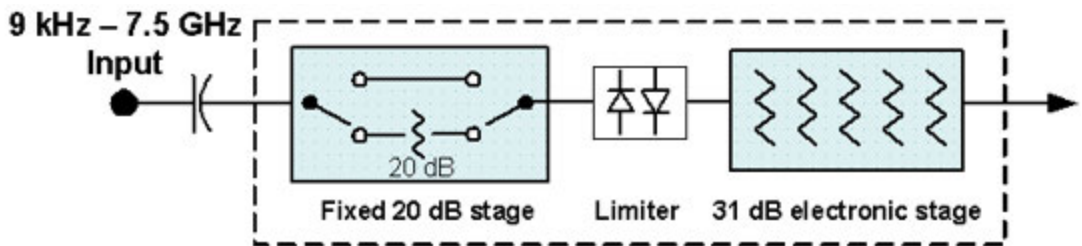

You can tell which attenuator configuration you have by pressing the Attenuation tab, which (in most Modes) opens the Attenuation menu. If the first control in the Attenuation menu says **Mech Atten** you have the Dual-Attenuator configuration. If the first control says **Atten** you have the Single-Attenuator configuration.

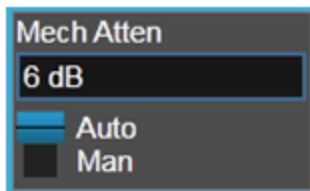

Dual Attenuator

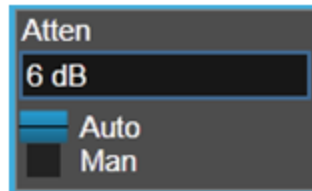

Single Attenuator

(Note that depending on the measurement, there may be no Auto/Man functionality on the Mech Atten control.)

In the Single-Attenuator configuration, you control the attenuation with a single control, as the fixed stage has only two states. In the Dual-Attenuator configuration, both stages have significant range, so you are given separate control of the mechanical and electronic attenuator stages.

When you have the Dual-Attenuator configuration, you may still have only a Single-Attenuator, because unless Option EA3 (the Electronic Attenuator option) is available, and you purchase it, you will have only the mechanical attenuator.

Full Range Atten

This control and **Attenuator Summary** only appear in N9041B, when the RF input is selected, the RF Input Port is set to RF Input 2, and the Full Range Attenuator is installed. The Full Range Attenuator adds a second input attenuator in front of RF Input 2, which enhances the protection and optimizes the performance of the extra internal mixers used by RF Input 2.

Remote Command	<code>[:SENSe]:POWer[:RF]:FRATten <rel_amp1></code> <code>[:SENSe]:POWer[:RF]:FRATten?</code>
Example	<code>:POW:FRAT 14</code> <code>:POW:FRAT?</code>
Notes	When you enter an amplitude value that falls between valid values, the value will be incremented to the next smallest valid value
Dependencies	Only appears if input RF is selected, RF Input Port 2 is selected, and the Full Range Attenuator exists
Couplings	This value is never changed by any coupling, but other couplings use this value. See Reference Level and " Mech Atten " on page 719 command descriptions
Preset	20 dB
State Saved	Saved in instrument state
Min	0 dB
Max	Only valid values are 0, 6, 14, 20 dB
Annotation	When the Input is RF , and the Input Port is RF Input 2 , and the Full Range Attenuator is installed: On the Meas Bar, the field "Atten" displays as follows: <ul style="list-style-type: none"> - If the sweep is entirely < 50 GHz, the value shown after "Atten:" is equal to Mech Atten + Elec Atten + Full Range Atten - If the sweep is entirely > 50 GHz, the value shown after "Atten:" is equal to Full Range Atten - If the sweep straddles 50 GHz, the value shown after "Atten:" is preceded by the symbol ">=" and is equal to Full Range Atten

In the **Amplitude**, "**Y Scale**" on page 597 menu, and the Atten **Meas Bar** dropdown menu panel, a summary is displayed as follows:

"Total Atten below 50 GHz" followed by the value of Full Range Atten + Mech Atten + Elec Atten

"Total Atten above 50 GHz" followed by the value of Full Range Atten

For example, if Mech Atten = 6 dB, Elec Atten = 4 dB, and Full Range Atten = 20 dB, the summary below is shown:

- Attenuator summary:
- Total Atten below 50 GHz: 30 dB
- Total Atten above 50 GHz: 20 dB

Mech Atten

Labeled **Mech Atten** in Dual-Attenuator models and **Atten** in Single-Attenuator models. In the Dual-Attenuator configuration, this control only affects the mechanical attenuator.

Lets you modify the attenuation applied to the RF input signal path. This value is normally auto-coupled to the Ref Level, the Internal Preamp Gain, any External Gain that is entered, and the Max Mixer Level, as described in the table below.

See "[Attenuator Configurations and Auto/Man](#)" on page 315

Remote Command	<pre>[:SENSe]:POWer[:RF]:ATTenuation <rel_amp1> [:SENSe]:POWer[:RF]:ATTenuation? [:SENSe]:POWer[:RF]:ATTenuation:AUTO OFF ON 0 1 [:SENSe]:POWer[:RF]:ATTenuation:AUTO?</pre>
Example	<pre>:POW:ATT 20</pre> <p>Dual-Attenuator configuration: sets the mechanical attenuator to 20 dB Single-Attenuator mode: sets the main attenuation to 20 dB (see below for definition of "main" attenuation) In either case, if the attenuator was in Auto, it is set to Manual <pre>:POW:ATT:AUTO ON</pre> Turn Auto Mech Atten ON</p>
Dependencies	<p>Some measurements do not support Auto setting of "Mech Atten" on page 313. In these measurements, the Auto/Man selection is not available, and the Auto/Man toggle function is not available</p> <p>In Dual-Attenuator configurations, when the electronic attenuator is enabled, the mechanical attenuator has no auto setting, and the Auto/Man toggle function is not available. The state of Auto/Man is remembered and restored when the electronic attenuator is once again disabled. This is described in more detail in "Elec Atten" on page 721</p> <p>See "Attenuator Configurations and Auto/Man" on page 315 for more information on the Auto/Man</p>

	<p>functionality</p> <p>:POW:ATT:AUTO is only available in measurements that support Mech Atten Auto, such as Swept SA</p>
Couplings	<p>If the RF Input Port is the RF Input:</p> <ul style="list-style-type: none"> - If the USB Preamp is connected to USB, use 0 dB for Mech Atten - Otherwise compute the auto-selected value of Mech Atten based on Reference Level, Int Preamp, External Gain, Ref Level Offset, Max Mixer Level, μW Path Control and IF Gain settings. Limit this value to be no less than 6 dB (total attenuation below 6 dB can never be chosen by Auto) - In the N9041B, if the RF Input Port is RF Input 2, use the formula above and subtract the Full Range Atten value from the result to determine the Mech Atten. Limit the value so that it is never lower than 0 dB and so that total attenuation, including Full Range Atten, is never less than 6 dB (total attenuation, including Full Range Atten below 6 dB, can never be chosen by Auto) <p>In External Mixing and BBIQ, where the Attenuator is not in the signal path, the Attenuator setting changes as described above when "Mech Atten" on page 313 is in Auto, but no changes are made to the actual attenuator hardware setting until the input is changed back to the RF Input</p> <p>For CXA-m with option FSA (Fine-Step Attenuator or 2 dB steps), the FSA-like behavior is only available when the frequency setting is ≤ 7.5 GHz. So, when the frequency is changed from below 7.5 GHz to above 7.5 GHz, the attenuation setting will be changed to a multiple of 10 dB which will be no smaller than the previous setting. For example, 4 dB attenuation will be changed to 10 dB</p>
Preset	<p>The preset for Mech Attenuation is "Auto"</p> <p>The Auto value of attenuation is 10 dB</p> <p>ON</p>
State Saved	Saved in instrument state
Min	<p>0 dB</p> <p>The attenuation set by this control cannot be decreased below 6 dB with the knob or step keys. Values below 6 dB must be directly entered from the keypad or via SCPI. This protects against setting a dangerously small attenuation value, which can put the instrument at risk of damage to input circuitry. If the current mechanical attenuation is below 6 dB, it can be increased with the knob and step keys, but not decreased</p>
Max	<p>CXA Option 503 or 507: 50 dB</p> <p>EXA: 60 dB</p> <p>All other models: 70 dB</p> <p>Note that in the Single-Attenuator configuration, the total of ATT and EATT cannot exceed 50 dB. So, if the EATT is set to 24 dB first, the main attenuation cannot be greater than 26 dB and will be reduced accordingly; if the main attenuator is set to 40 dB first, EATT cannot be greater than 10 dB</p>
Annotation	<p>The current value for Total Atten is displayed in the Measurement Bar at the top of the display. A value appears for Electronic Attenuation only if the Electronic Attenuator is enabled. The annotation appears as</p> <p>Atten: <total> dB (e<elec>)</p> <p>The e letter is in amber in Single-Attenuator configurations</p> <p>For example:</p>

Dual-Attenuator configuration:

Atten: 24 dB (e14)

Indicating the total attenuation is at 24 dB and the electronic attenuation is at 14 dB

Single-Attenuator configuration:

A: 24 dB (e14)

Indicating the total attenuation is at 24 dB and the “soft” attenuation is at 14 dB (see below for definition of “soft” attenuation)

When in Manual, a # sign appears in front of Atten in the annotation

Attenuator Configurations and Auto/Man

As described under "[Y Scale](#)" on page 597, there are two distinct attenuator configurations available in the X-Series, the single attenuator and Dual-Attenuator configurations. In Dual-Attenuator configurations, we have the mechanical attenuation and the electronic attenuation, and the current total attenuation is the sum of the electronic + mechanical attenuation. In Single-Attenuator configurations, we refer to the attenuation set using "[Mech Atten](#)" on page 313 (or `:POW:ATT`) as the “main” attenuation; and the attenuation that is set by `:POW:EATT` as the “soft” attenuation (`:POW:EATT` is honored even in the Single-Attenuator configuration, for compatibility purposes). Then the current total attenuation is the sum of the main + soft attenuation.

See "[Elec Atten](#)" on page 721 for more about “soft” attenuation.

NOTE

In some measurements, the **Mech Atten** control has an Auto/Man function. In these measurements, an Auto/Man switch is shown on the **Mech Atten** control:

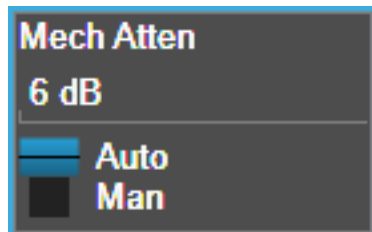

Note that in configurations that include an Electronic Attenuator, this switch is only shown when the Electronic Attenuator is disabled.

In other measurements, **Mech Atten** has no Auto/Man function. In these measurements, no switch is shown on the **Mech Atten** control:

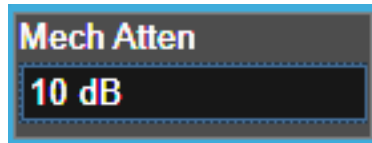

Mech Atten also appears with no switch, as above, in configurations that include an Electronic Attenuator but when the Electronic Attenuator is enabled.

Elec Atten

Controls the Electronic Attenuator in Dual-Attenuator configurations. Does not appear in Single-Attenuator configurations, because the control of both the mechanical and electronic stages of the Single-Attenuator is integrated into the single **Atten** control.

This control includes an **Enable/Disable** toggle switch; it is only possible to enter a value for the Electronic Attenuator when this switch is in the **Enable** position.

For more details about the Electronic Attenuator, see ["More Information" on page 317](#)

Remote Command	<pre>[:SENSe]:POWer[:RF]:EATTenuation <rel_ampl> [:SENSe]:POWer[:RF]:EATTenuation? [:SENSe]:POWer[:RF]:EATTenuation:STATe OFF ON 0 1 [:SENSe]:POWer[:RF]:EATTenuation:STATe?</pre>
Example	<pre>:POW:EATT 10 :POW:EATT? :POW:EATT:STAT ON :POW:EATT:STAT?</pre>
Notes	Electronic Attenuation's specification is defined only when Mechanical Attenuation is 6 dB
Dependencies	<p>Only appears in Dual-Attenuator models with an Electronic Attenuator installed and licensed. Does not appear in models with the Single-Attenuator configuration, because in the Single-Attenuator configuration there is no "electronic attenuator"; there is only a single integrated attenuator (which has both a mechanical and electronic stage). However, in the Single-Attenuator configuration, EATT SCPI commands are accepted for compatibility with other X-series instruments, and set a "soft" attenuation. The "soft" attenuation is treated as an addition to the "main" attenuation value set by the Attenuation control or <code>:POW:ATT</code>, and affects the total attenuation displayed on the Attenuation control and the Meas Bar</p> <p>The electronic attenuator, and the "soft" attenuation function provided in Single-Attenuator configurations, are unavailable above the low band (0-3.6 GHz, 0-3.4 GHz, 0-3 GHz, depending on the model). If the low band range is from 0-3.6 GHz, and Stop Frequency of the instrument is > 3.6 GHz, then the Enabled/Disabled section of the Elec Atten control will be OFF and grayed-out</p> <p>If "Internal Preamp" on page 737 is ON (that is, set to Low Band or Full), the electronic attenuator (and the "soft" attenuation function provided in Single-Attenuator configurations) is unavailable. In this case the Enabled/Disabled section of the Elec Atten control will be OFF and grayed-out</p> <p>If either of the above is true, and the SCPI command is sent, an error indicating that the electronic attenuator is unavailable is returned</p> <p>If both the above are true, pressing the control generates error message -221, in other words, the frequency range lockout takes precedence</p> <p>If the electronic/soft Attenuator is enabled, then the Stop Freq of the instrument is limited to 3.6 GHz and Internal Preamp is unavailable</p>

3 Bluetooth Mode

3.3 Adjacent Channel Power

If "LNA" on page 738 is ON, the electronic attenuator (and the "soft" attenuation function provided in Single-Attenuator configurations) is unavailable. In this case the **Enabled/Disabled** section of the **Elec Atten** control will be OFF and grayed-out. This coupling works in the following modes/measurements:

- Channel Power, Occupied BW, ACP, SEM, Spurious Emissions, Power Stat CCDF measurements in all Modes
- Transmit On|Off Power measurement in 5GNR Mode
- Power vs. Time and Transmit Power measurement in GSM/EDGE Mode
- Burst Power measurement in Spectrum Analyzer Mode

The SCPI-only "soft" electronic attenuation for the single-attenuator configuration is not available in all measurements; in particular, it is not available in the Swept SA measurement

Couplings	Enabling and disabling the Electronic Attenuator affects the setting of the Mechanical Attenuator (in Dual-Attenuator configurations). This is described in more detail below and in " Mechanical Attenuator Transition Rules " on page 317
Preset	0 dB OFF (Disabled) for Swept SA measurement ON (Enabled) for all other measurements that support the electronic attenuator
State Saved	Saved in instrument state
Min	0 dB
Max	Dual-Attenuator configuration: 24 dB Single-Attenuator configuration: the total of ATT and EATT cannot exceed 50 dB. So, if the EATT is set to 24 dB first, the main attenuation cannot be greater than 26 dB and will be reduced accordingly; if the main attenuator is set to 40 dB first, EATT cannot be greater than 10 dB
Annotation	See Annotation under the Mech Atten control description

More Information

The electronic attenuator offers finer steps than the mechanical attenuator, has no acoustical noise, is faster, and is less subject to wear. These advantages primarily aid in remote operation and are negligible for front panel use. See "[Using the Electronic Attenuator: Pros and Cons](#)" on page 318 for a detailed discussion of the pros and cons of using the electronic attenuator.

For the Single-Attenuator configuration, for SCPI backwards compatibility, the "soft" attenuation feature replaces the Dual-Attenuator configuration's electronic attenuator. All the same couplings and limitations apply. See "[Attenuator Configurations and Auto/Man](#)" on page 721

Mechanical Attenuator Transition Rules

When the Electronic Attenuator is enabled, the Mechanical Attenuator transitions to a state that has no Auto function. Below are the rules for transitioning the Mechanical Attenuator. Note that the information below *only* applies to the Dual-

Attenuator configurations, and *only* when the Electronic Attenuator is installed:

When the Electronic Attenuation is enabled from a disabled state:

- The Mechanical Attenuator is initialized to 10 dB (this is its optimal performance setting). You can then set it as desired with SCPI, numeric keypad, step keys, or knob, and it behaves as it normally would in manual mode
- The Auto/Man state of (Mech) Atten is saved
- The Auto/Man toggle on the (Mech) Atten control disappears, and the auto rules are disabled
- The Electronic Attenuator is set to 10 dB less than the previous value of the Mechanical Attenuator, within the limitation that it must stay within the range of 0 to 24 dB of attenuation

Examples in the Dual-Attenuator configuration:

- Mech Atten at 20 dB. Elec Atten enabled, Mech Atten set to 10 dB, and Elec Atten set to 10 dB. New total attenuation equals the value before Elec Atten enabled
- Mech Atten at 0 dB. Elec Atten enabled, Mech Atten set to 10 dB, and Elec Atten set to 0 dB. New total attenuation does not equal the value before Elec Atten enabled
- Mech Atten at 40 dB. Elec Atten enabled, Mech Atten set to 10 dB, and Elec Atten set to 24 dB. New total attenuation does not equal the value before Elec Atten enabled

When the Electronic Attenuation is disabled from an enabled state:

- The Elec Atten control is grayed out
- The Auto/Man state of (Mech) Atten is restored
- If now in Auto, (Mech) Atten recouples
- If now in Man, (Mech) Atten is set to the value of total attenuation that existed before the Elec Atten was disabled. The resulting value is rounded up to the smallest value possible given the (Mech) Atten Step setting - (That is, 57 dB changes to 58 dB when (Mech) Atten Step is 2 dB)

Using the Electronic Attenuator: Pros and Cons

The electronic attenuator offers finer steps than the mechanical attenuator, has no acoustical noise, is faster, and is less subject to wear.

The “finer steps” advantage of the electronic attenuator is beneficial in optimizing the alignment of the instrument dynamic range to the signal power in the front panel as well as remote use. Thus, you can achieve improved relative signal measurement accuracy. Compared to a mechanical attenuator with 2 dB steps, the 1 dB resolution of the electronic attenuator only gives better resolution when the odd-decibel steps are used. Those odd-decibel steps are less accurately calibrated than the even-decibel steps, so one tradeoff for this superior relative accuracy is reduced absolute amplitude accuracy.

Another disadvantage of the electronic attenuator is that the spectrum analyzer loses its “Auto” setting, making operation less convenient.

Also, the relationship between the dynamic range specifications (TOI, SHI, compression, and noise) and instrument performance are less well-known with the electrical attenuator. With the mechanical attenuator, TOI, SHI, and compression threshold levels increase dB-for-dB with increasing attenuation, and the noise floor does as well. With the electronic attenuator, there is an excess attenuation of about 1 to 3 dB between 0 and 3.6 GHz, making the effective TOI, SHI, and so forth, less well known. Excess attenuation is the actual attenuation relative to stated attenuation. Excess attenuation is accounted for in the instrument calibration.

Adjust Atten for Min Clipping

Sets the combination of mechanical and electronic attenuation and gain based on the current measured signal level so that clipping will be at a minimum.

This is an immediate action function, that is, it executes once, when the control is pressed.

The algorithms that are used for the adjustment are documented under ["Pre-Adjust for Min Clipping" on page 726](#).

Remote Command	<code>[:SENSe]:POWer[:RF]:RANGe:OPTimize IMMEDIATE</code>
Example	<code>:POW:RANG:OPT IMM</code>
Notes	Executing Adjust Atten for Min Clipping initiates the measurement
Dependencies	Does not appear in the Swept SA, RTSA, Monitor Spectrum and Complex Spectrum measurements Appears in the Waveform measurement in 5G NR Mode only

Adjust Atten

Allows you to select;

- Electric attenuator only
- Combination of Electric attenuator and Mechanical attenuator

when `[:SENSe]:POWer[:RF]:RANGe:OPTimize IMMEDIATE` is executed.

Remote Command	<code>[:SENSe]:POWer[:RF]:RANGe:OPTimize:TYPE EONLY COMBined</code> <code>[:SENSe]:POWer[:RF]:RANGe:OPTimize:TYPE?</code>
Example	<code>:POW:RANG:OPT:TYPE EONL</code> <code>:POW:RANG:OPT:TYPE?</code>
Dependencies	Does not appear in the Swept SA, RTSA, Monitor Spectrum and Complex Spectrum measurements Appears in the Waveform measurement in 5G NR Mode only
Preset	<code>COMBined</code>
State Saved	Saved in instrument state

Pre-Adjust for Min Clipping

If this function is **ON**, it applies the adjustment described under "[Adjust Atten for Min Clipping](#)" on page 725 each time a measurement restarts. Therefore, in Continuous measurement mode, it only executes before the first measurement.

In Dual-Attenuator models, you can set **Elec+Mech Atten**, in which case both attenuators participate in the autoranging, or **Elec Atten Only**, in which case the mechanical attenuator does not participate in the autoranging. This latter case results in less wear on the mechanical attenuator and is usually faster.

See "[Adjustment Algorithm](#)" on page 321

Selection	SCPI	Note
Off	<code>OFF</code>	This is the default setting
On	<code>ON</code>	Available in Single-Attenuator instruments. For compatibility with models that do not have an input attenuator, the <code>ON</code> parameter is supported and mapped to <code>COMBined</code>
Elec Atten Only	<code>ELECTrical</code>	Selects only the electric attenuator to participate in auto ranging. This offers less wear on the mechanical attenuator and is usually faster
Elec+Mech Atten	<code>COMBined</code>	In Dual-Attenuator models, this selects both attenuators to participate in the autoranging

Remote Command	<code>[:SENSe]:POWer[:RF]:RANGe:OPTimize:ATTenuation OFF ON ELECTrical COMBined</code> <code>[:SENSe]:POWer[:RF]:RANGe:OPTimize:ATTenuation?</code>
Example	<code>:POW:RANG:OPT:ATT OFF</code> <code>:POW:RANG:OPT:ATT?</code>
Notes	The parameter option <code>ELECTrical</code> sets this function to <code>ON</code> in Single-Attenuator models The parameter option <code>COMBined</code> is mapped to <code>ELECTrical</code> in Single-Attenuator models. If you send <code>COMBined</code> , it sets the function to <code>ON</code> and returns <code>ELEC</code> to a query

3 Bluetooth Mode
 3.3 Adjacent Channel Power

	For SCPI compatibility with models that do not have an input attenuator, the ON parameter is honored and mapped to COMBined
Dependencies	Only appears in Dual-Attenuator models with an Electronic Attenuator installed In instruments with Dual-Attenuator model, when " Elec Atten " on page 721 is OFF or grayed-out, " Pre-Adjust for Min Clipping " on page 320 is grayed-out Does not appear in the Swept SA, RTSA, Monitor Spectrum and Complex Spectrum measurements For the Waveform measurement, available only in 5G NR Mode
Preset	OFF when Elec Atten is Disabled at preset, otherwise ELEC
State Saved	Saved in instrument state
Range	Dual-Attenuator models: Off Elec Atten Only Mech + Elec Atten Single-Attenuator models: Off On
Notes	ON aliases to "Elec Atten Only" (:POW:RANG:OPT:ATT ELEC) OFF aliases to "Off" (:POW:RANG:OPT:ATT OFF) :POW:RANG:AUTO? returns true if :POW:RANG:OPT:ATT is not OFF
Backwards Compatibility SCPI	[:SENSe]:POWer[:RF]:RANGe:AUTO ON OFF 1 0 [:SENSe]:POWer[:RF]:RANGe:AUTO?

Adjustment Algorithm

The algorithms for the adjustment are documented below:

Single-Attenuator Models

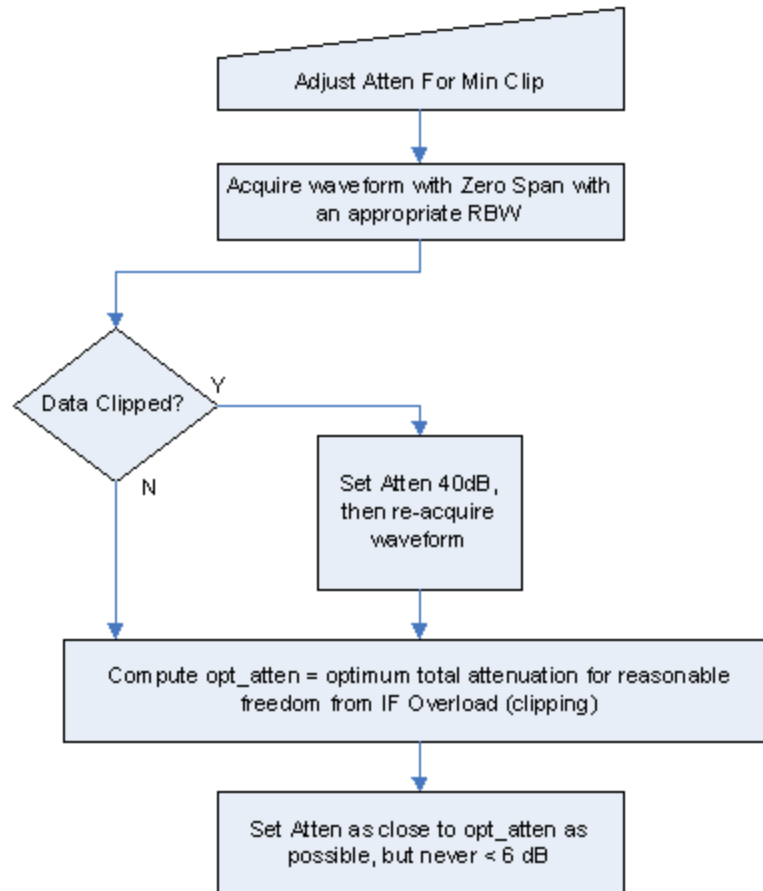

Dual-Attenuator models

"Adjust Atten for Min Clipping" on page 725 or "Pre-Adjust for Min Clipping" on page 320 selection is Mech + Elec Atten:

3 Bluetooth Mode
 3.3 Adjacent Channel Power

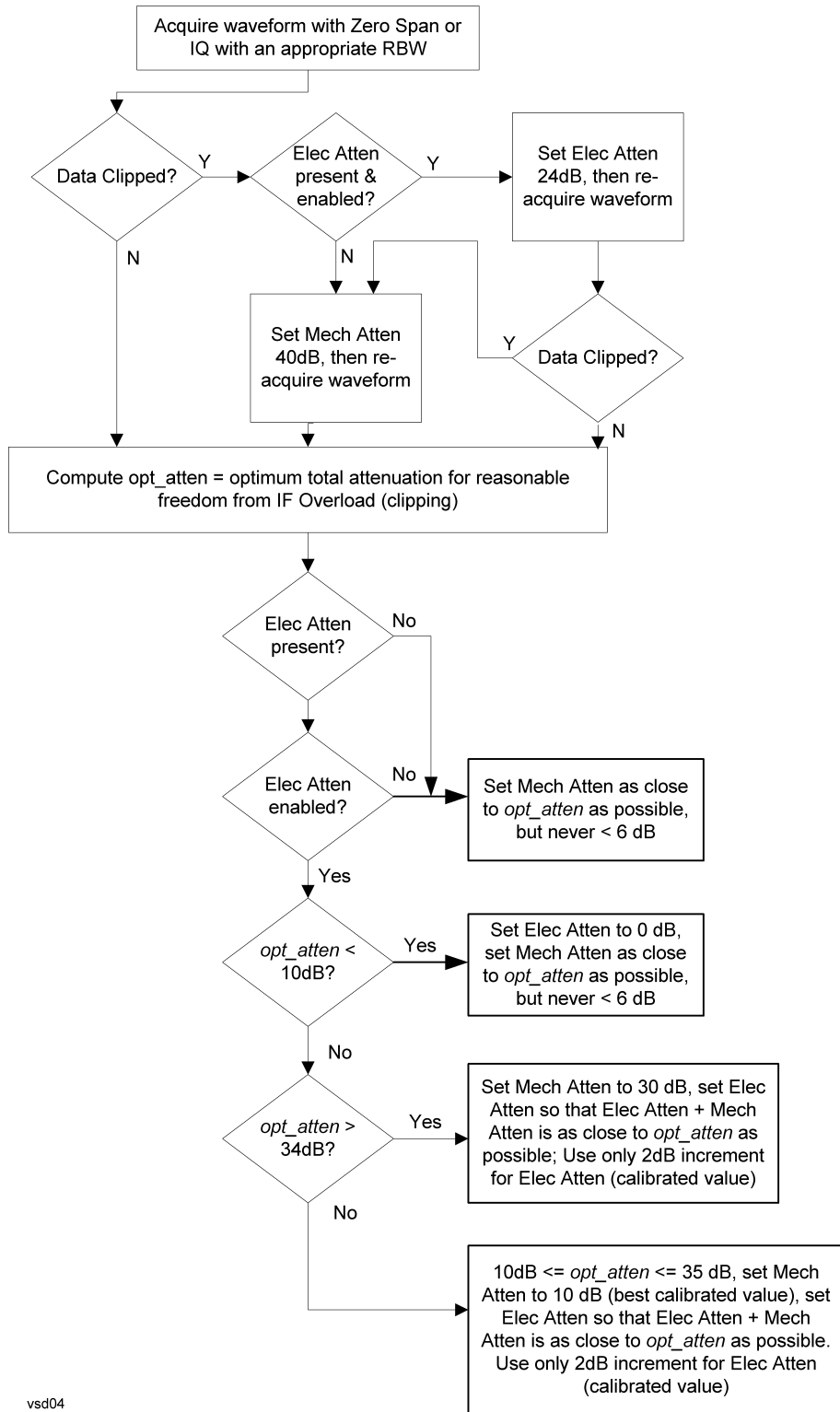

vsd04

"Pre-Adjust for Min Clipping" on page 320 selection is Elec Only.

Note that the **Mech Atten** value is not adjusted, and the value previously set is used. Therefore, there is a case that IF Overload is still observed depending on the input signal level and the Mech Atten setting.

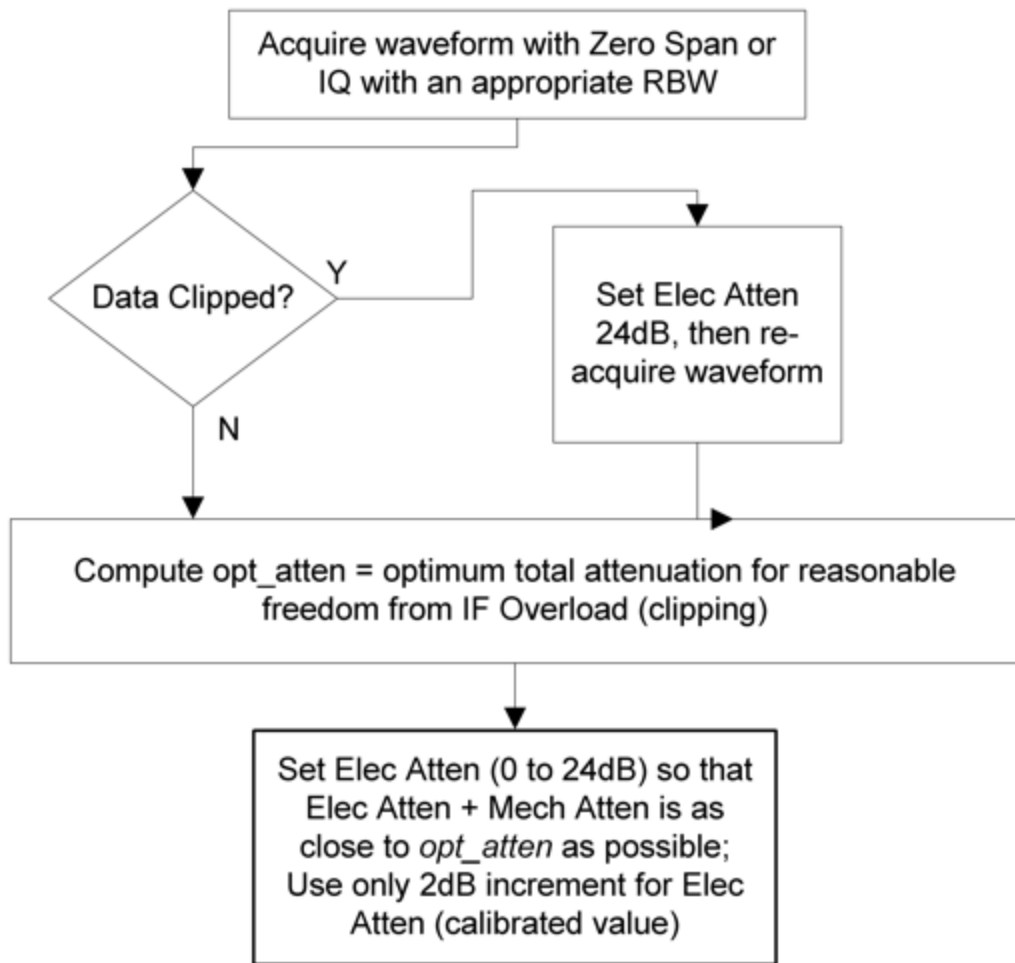

Mech Atten Step

Controls the step size used when making adjustments to the input attenuation.

Labeled **Mech Atten Step** in Dual-Attenuator models and **Atten Step** in Single-Attenuator models. In the Dual-Attenuator configuration, only affects the step size of the mechanical attenuator.

Remote Command `[:SENSe]:POWer[:RF]:ATTenuation:STEP[:INCRement] 10 dB | 2 dB`

3 Bluetooth Mode
3.3 Adjacent Channel Power

	<code>[:SENSe]:POWer[:RF]:ATTenuation:STEP[:INCRement]?</code>
Example	<code>:POW:ATT:STEP 2</code> <code>:POW:ATT:STEP?</code>
Notes	Has a toggle control on the front panel, but takes a specific value (in dB) when used remotely. The only valid values are 2 and 10
Dependencies	Blanked in EXA, CXA and CXA-m if option FSA (2 dB steps) is not present. If blanked, attempts to set it via SCPI yield an error
Couplings	When the attenuation step size changes, the current mechanical attenuation value is adjusted (if necessary) to be quantized to the new step size. That is, if step is set to 10 dB, mech atten is increased if necessary so it is a multiple of 10 dB
Preset	EXA, CXA and CXA-m: 10 dB (2 dB with option FSA) All other models: 2 dB
State Saved	Saved in instrument state

3.3.3.3 Range (Non-attenuator models)

Only available for Keysight's modular signal analyzers and certain other Keysight products, such as VXT

State Saved	No
-------------	----

Range

Represents the amplitude of the largest sinusoidal signal that could be present within the IF without being clipped by the ADC. For signals with high peak-to-average ratios, the range may need to exceed the rms signal power by a significant amount to avoid clipping.

This is a measurement global setting.

Remote Command	<code>[:SENSe]:POWer[:RF]:RANGe <real></code> <code>[:SENSe]:POWer[:RF]:RANGe?</code>
Example	<code>:POW:RANG 10 dBm</code> <code>:POW:RANG?</code>
Notes	The MIN and MAX values are affected by the External Gain parameters, and by the Center Frequency The hardware compensates for frequency response and alters the Range setting
Preset	0 dBm
State Saved	Yes
Min	-100
Max	100
Annotation	Meas Bar

Adjust Range for Min Clipping

Sets the combination of attenuation and gain based on the current measured signal level so that clipping will be at a minimum.

This is an "immediate action" function, that is, it executes once, when the key is pressed.

This key does not appear in measurements that do not support this functionality.

Remote Command	<code>[:SENSe]:POWer[:RF]:RANGe:OPTimize IMMEDIATE</code>
Notes	Executing Adjust Range for Min Clipping initiates the measurement
Dependencies	Does not appear in the Swept SA and Monitor Spectrum measurements

Pre-Adjust for Min Clipping

If this function is **ON**, it applies the adjustment described under Adjust Range For Min Clipping each time a measurement restarts. Therefore, in Continuous measurement mode, it only executes before the first measurement.

Remote Command	<code>[:SENSe]:POWer[:RF]:RANGe:OPTimize:ATTenuation OFF ON ELECTrical COMBined</code> <code>[:SENSe]:POWer[:RF]:RANGe:OPTimize:ATTenuation?</code>
Notes	Because there is no attenuator control available in these models, the control displays only ON and OFF choices. However, for SCPI compatibility with other platforms, all three parameters (ELECTrical , COMBined , and ON) are honored and all are mapped to ELECTrical , so if any of these three parameters is sent, a subsequent query will return ELEC
Dependencies	Does not appear in the Swept SA and Monitor Spectrum measurements
Preset	OFF for Swept SA measurement; ON for all other measurements that support Pre-Adjust for Min Clipping
State Saved	Saved in instrument state

Adjustment Algorithm

The algorithm for the adjustment is documented below:

3 Bluetooth Mode
3.3 Adjacent Channel Power

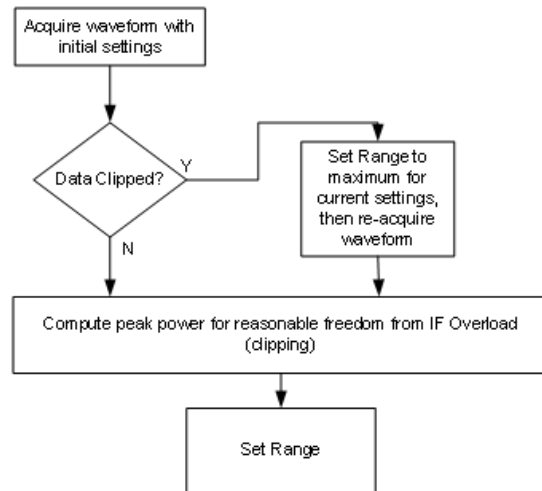

Peak-to-Average Ratio

Used with "[Range \(Non-attenuator models\)](#)" on page 731 to optimize the level control in the instrument. The value is the ratio, in dB, of the peak power to the average power of the signal to be measured. A ratio of 0 should be used for sinusoidal signals; for 802.11g OFDM signals use 9 dB.

All Modes show the current value of Peak-to-Average ratio on the control. However, some Modes do not permit changing the value. In these situations, the control is grayed-out.

Remote Command	<code>[:SENSe]:POWer[:RF]:RANGe:PARatio <real></code> <code>[:SENSe]:POWer[:RF]:RANGe:PARatio?</code>
Example	<code>:POW:RANG:PAR 12 dB</code>
Notes	In some Modes, this parameter is read-only; meaning the value will appear on the control and query via SCPI, but is not changeable. In such applications the control is grayed-out. Attempting to change the value via SCPI will be ignored but no error message will be generated
Dependencies	Does not appear in Spectrum Analyzer Mode
Preset	10 dB VXT Models M9410A/11A: 0 dB
State Saved	Saved in instrument state
Min	0 dB
Max	20 dB VXT Models M9410A/11A: 50 dB

Mixer Lvl Offset

This is an advanced setting to adjust target Range at the input mixer, which in turn affects the signal level in the instrument's IF. This setting can be used when additional optimization is needed after setting "[Peak-to-Average Ratio](#)" on page 733. Positive values of offset optimize noise performance over distortion, negative values optimize distortion performance over noise.

Remote Command	<code>[:SENSe] :POWer [:RF] :RANGe :MIXer :OFFSet <real></code> <code>[:SENSe] :POWer [:RF] :RANGe :MIXer :OFFSet?</code>
Example	<code>:POW:RANG:MIX:OFFS -5 dB</code>
Preset	0 dB
State Saved	Saved in instrument state
Min	-35 dB VXT Models M9410A/11A: -34 dB
Max	30 dB

3.3.3.4 Signal Path

Contains controls that pertain to the routing of the signal through the frontend of the instrument.

In general, only appears in instruments whose hardware supports this signal routing. For example, this tab does not appear in many of the modular instrument products, including VXT Model M9421A, or UXM.

This tab *does* appear in VXT Models M9410A/11A, because "[Software Preselection](#)" on page 749 is under this tab, and VXT Models M9410A/11A implement a version of Software Preselection.

Presel Center

Adjusts the centering of the preselector filter to optimize the amplitude accuracy at the frequency of the selected marker. If the selected marker is not on when **Presel Center** is pressed, the instrument turns on the selected marker, performs a peak search, and then performs centering on the marker's center frequency. If the selected marker is already on and between the start and stop frequencies of the instrument, the instrument performs the preselector calibration on that marker's frequency. If the selected marker is already on, but outside the frequency range between **Start Freq** and **Stop Freq**, the instrument first performs a peak search, and then performs centering on the marker's center frequency.

3 Bluetooth Mode
3.3 Adjacent Channel Power

The value displayed on "[Preselector Adjust](#)" on page 736 changes to reflect the new preselector tuning.

Certain considerations should be observed to ensure proper operation, as detailed in "[Proper Preselector Operation](#)" on page 329.

Remote Command	<code>[:SENSe] :POWer [:RF] :PCENter</code>
Example	<code>:POW:PCEN</code>
Notes	The rules outlined above under the control description apply for the remote command as well as the key. The result of the command depends on marker position, etc. Any message generated by the control press is also generated in response to the remote command
Dependencies	Does not appear in CXA-m, nor in VXT Models M9410A/11A Grayed-out if the microwave preselector is off <ul style="list-style-type: none"> - If the selected marker's frequency is below Band 1, an advisory message is generated "Preselector not used in this frequency range" and no action is taken - Grayed-out if entirely in Band 0, that is, if Stop Freq is below about 3.6 GHz Grayed-out if entirely above 50 GHz, that is, if Start Freq is above 50 GHz - Blanked in models that do not include a preselector, such as Option 503. If the remote command is sent in these instruments, accepted without error, and the query always returns 0 - Grayed-out in the Spectrogram View
Couplings	The active marker position determines where the centering will be attempted If the instrument is in a measurement such as averaging when centering is initiated, the act of centering the preselector restarts averaging, but the first average trace will not be taken until the centering is completed The offset applied to do the centering appears in " Preselector Adjust " on page 736
Status Bits/OPC dependencies	When centering the preselector, *OPC does not return true until the process is complete and a subsequent measurement has completed, nor are results returned in response to <code>:READ</code> or <code>:MEASure</code> queries The Measuring bit remains set (true) while this command is operating, and does not go false until the subsequent sweep/measurement has completed

Proper Preselector Operation

Certain considerations should be observed to ensure proper operation:

1. If the selected marker is **Off**, the instrument turns on a marker, performs a peak search, and adjusts the preselector using the selected marker's frequency. It uses the "highest peak" peak search method unqualified by threshold or excursion, so that there is no chance of a 'no peak found' error. It continues with that peak, even if it is the peak of just noise. Therefore, for this operation to work properly, there should be a signal on-screen in a preselected range for the peak search to find

2. If the selected marker is already **On**, the instrument attempts the centering at that marker's frequency. There is no preselector for signals below about 3.6 GHz, so if the marker is on a signal below 3.6 GHz, no centering is attempted, and an advisory message is generated
3. In some models, the preselector can be bypassed. If it is bypassed, no centering is attempted in that range and a message is generated

Preselector Adjust

Lets you manually adjust the preselector filter frequency to optimize its response to the signal of interest. Only available when "**Presel Center**" on page 734 is available.

For general purpose signal analysis, using **Presel Center** is recommended. Centering the filter minimizes the impact of long-term preselector drift. **Preselector Adjust** can be used instead to manually optimize the preselector. One application of manual optimization would be to peak the preselector response, which both optimizes the signal-to-noise ratio and minimizes amplitude variations due to small (short-term) preselector drifting.

When **Presel Center** is performed, the offset applied to do the centering becomes the new value of **Preselector Adjust**.

Remote Command	<code>[:SENSe]:POWer[:RF]:PADJust <freq></code> <code>[:SENSe]:POWer[:RF]:PADJust?</code>
Example	<code>:POW:PADJ 100KHz</code> <code>:POW:PADJ?</code>
Notes	The value on the control is displayed to 0.1 MHz resolution
Dependencies	<ul style="list-style-type: none"> - Does not appear in CXA-m - Does not appear in VXT Models M9410A/11A - Grayed-out if microwave preselector is off - Grayed-out if entirely in Band 0, that is, if Stop Freq is lower than about 3.6 GHz - Grayed-out if entirely above 50 GHz, that is, if Start Freq is higher than 50 GHz - Blank in models that do not include a preselector, such as Option 503. If the command is sent in these instruments, it is accepted without error, and the query always returns 0 - Grayed-out in the Spectrogram View
Preset	0 MHz
State Saved	The Preselector Adjust value set by " Presel Center " on page 734, or by manually adjusting Preselector Adjust Not saved in instrument state, and does not survive a Preset or power cycle

3 Bluetooth Mode

3.3 Adjacent Channel Power

Min	-500 MHz
Max	500 MHz
Backwards Compatibility SCPI	<code>[:SENSe]:POWer[:RF]:MW:PADJust</code> <code>[:SENSe]:POWer[:RF]:MMW:PADJust</code>
Notes	The command has no effect, and the query always returns MWAVE
Backwards Compatibility SCPI	<code>[:SENSe]:POWer[:RF]:PADJust:PRESelector MWAVE MMWave EXternal</code> <code>[:SENSe]:POWer[:RF]:PADJust:PRESelector?</code>

Internal Preamp

Accesses a menu of controls for the internal preamps. Turning on the preamp gives a better noise figure, but a poorer inter-modulation distortion (TOI) to noise floor dynamic range. You can optimize this setting for your measurement.

The instrument takes the preamp gain into account as it sweeps. If you sweep outside of the range of the preamp, the instrument will also account for that. The displayed result always reflects the correct gain.

For some measurements, when the preamp is on and any part of the displayed frequency range is below the lowest frequency for which the preamp has specifications, a warning condition message appears in the status line. For example, for a preamp with a 9 kHz lowest specified frequency: "Preamp: Accy unspec'd below 9 kHz".

Selection	Example	Note
Off	<code>:POW:GAIN OFF</code>	
Low Band	<code>:POW:GAIN ON</code> <code>:POW:GAIN:BAND LOW</code>	Sets the internal preamp to use only the low band. The frequency range of the installed (optional) low-band preamp is displayed in square brackets on the Low Band selection in the dropdown
Full Range	<code>:POW:GAIN ON</code> <code>:POW:GAIN:BAND FULL</code>	Sets the internal preamp to use its full range. The low band (0-3.6 GHz, 0-3.4 GHz, 0-3 GHz, depending on the model) is supplied by the low band preamp and the frequencies above low band are supplied by the high band preamp The frequency range of the installed (optional) low-band preamp is displayed in square brackets on the Full Range selection in the dropdown. If the high band option is not installed the Full Range selection does not appear

NOTE

The maximum **Center Frequency** for Low Band, displayed in square brackets, can change based on the selected IFBW for measurements that support IFBW (for example, Waveform measurement across all Modes that support it). In certain models (such as N9042B & N9032B), IFBW values ≤ 40 MHz have a maximum Low Band frequency of 3.6 GHz, while $40 \text{ MHz} < \text{IFBW} \leq 1 \text{ GHz}$ have a maximum of 3.3 GHz, and $1 \text{ GHz} < \text{IFBW} \leq 1.5 \text{ GHz}$ have a maximum of 3.5 GHz. IFBW values $> 1.5 \text{ GHz}$ do not support a **Center Frequency** that can reach the Low Band maximum frequency. In these cases, **N/A** is displayed in the square brackets for Low Band.

Remote Command	<pre>[:SENSe]:POWer[:RF]:GAIN:BAND LOW FULL [:SENSe]:POWer[:RF]:GAIN:BAND? [:SENSe]:POWer[:RF]:GAIN[:STATe] OFF ON 0 1 [:SENSe]:POWer[:RF]:GAIN[:STATe]?</pre>
Example	<pre>:POW:GAIN:BAND LOW :POW:GAIN:BAND? :POW:GAIN OFF :POW:GAIN?</pre>
Dependencies	<p>Not available on all hardware platforms. If the preamp is not present or is unlicensed, this control is not shown</p> <p>Does not appear in VXT Models M9410A/11A/15A/16A</p> <p>If <code>:POW:GAIN:BAND FULL</code> is sent when a low band preamp is available, the preamp band parameter is set to <code>LOW</code> instead of <code>FULL</code>, and an "Option not installed" message is generated</p> <p>Not available when the electronic/soft attenuator is enabled</p>
Preset	<pre>LOW OFF</pre>
State Saved	Saved in instrument state
Annotation	<p>When the USB Preamp is not connected to USB, the Preamp annotation in the Meas Bar says "Off" if the preamp is off and displays the frequency range of the low band or full range preamp depending on the setting. For example, if the Preamp is set to Low Band and the Low Band is 3.6 GHz the annotation says "3.6 GHz". If it is a 13.6 GHz preamp and it is set to Full Range the annotation says "13.6 GHz"</p> <p>When the USB Preamp is connected to USB, the Preamp annotation says "Preamp: USB" if the internal preamp is off or "Preamp: USB, Int" if the internal preamp is on (only for measurements that support the USB preamp)</p>

LNA

Lets you turn the Low Noise Amplifier (**LNA**) on or off.

LNA is an additional preamplifier that provides superior DANL and frequency range compared to **"Internal Preamp" on page 737**. LNA provides lower system noise

3 Bluetooth Mode

3.3 Adjacent Channel Power

figure, especially at frequencies above 100 MHz, and can be operated up to the full range of 50 GHz instruments.

For best possible sensitivity, **LNA** can be turned on *together* with "**Internal Preamp**" on page 737, although if you operate both preamps together, note that the TOI (distortion) specifications are impacted. The sensitivity improvement of this combination is substantial when operating in high band (frequencies above 3.6 GHz).

For more details about annotation, see "**More Information**" on page 333

Remote Command	<code>[:SENSe]:POWer[:RF]:GAIN:LNA[:STATe] OFF ON 0 1</code> <code>[:SENSe]:POWer[:RF]:GAIN:LNA[:STATe]?</code>
Example	<code>:POW:GAIN:LNA ON</code>
Dependencies	Requires Option LNA, except for VXT models M9415A/16A Does not appear in VXT models M9421A/10A/11A May not appear in some measurements LNA is not available when the electronic/soft attenuator is enabled
Preset	OFF
State Saved	Saved in State

More Information

When **LNA** is installed, the preamp annotation changes to show the state of both **LNA** and **Internal Preamp**. Below is an example:

```
Atten: 8 dB
Pre: Int on, LNA on
µW Path: LNP, On
Source: Off
```

Note that when operating entirely in the low band (below about 3.6 GHz), if **LNA** is on, **Internal Preamp** is switched off (even if you have its switch set to **ON**). This is because the noise performance is actually degraded in low band if both preamps are on. In this case, the annotation reflects the actual state of the two preamps, but the **Internal Preamp** annotation displays in amber, to warn you that the actual state of **Internal Preamp** does not match its switch control display:

```
Atten: 8 dB
Pre: Int off, LNA on
µW Path: LNP, On
Source: Off
```

µW Path Control

Options for this control include **µW Preselector Bypass** (Option MPB), **Low Noise Path** (Option LNP) and **Full Bypass Enable** in the High Band path circuits.

When the μ W Preselector is bypassed, flatness is improved, but will be subject to spurs from out of band interfering signals. When **Low Noise Path Enable** is selected, the instrument automatically bypasses certain circuitry in the high frequency bands that can contribute to noise, when it is appropriate based on other instrument settings.

For most applications, the preset state is **Standard Path**, which provides the best remote-control throughput, minimizes acoustic noise from switching and minimizes the risk of wear in the hardware switches, particularly in remote test scenarios where both low band and high band setups will follow in rapid succession. In this path, the bypass of the low band/high band switch and microwave preamp is never activated, which can cause some noise degradation but preserves the life of the bypass switch.

For applications that utilize the wideband IF paths, the preset state is **μ W Preselector Bypass**, if option MPB is present. This is because, when using a wideband IF such as the 140 MHz IF, the μ W Preselector's bandwidth can be narrower than the available IF bandwidth, causing degraded amplitude flatness and phase linearity, so it is desirable to bypass the preselector in the default case.

You may choose **Low Noise Path Enable** for a lower noise floor, especially in the 21–26.5 GHz region, though without improving many measures of dynamic range, and without giving the best possible noise floor. The preamp, if purchased and used, gives better noise floor than does **Low Noise Path Enable**, but the preamp's compression threshold and third-order intercept are much poorer than that of **Low Noise Path Enable**.

A fourth choice is **Full Bypass Enable**, which combines **μ W Preselector Bypass** and **Low Noise Path Enable**. Because this can bypass most of the circuitry between the input and the first mixer, care should be taken when using this setting to avoid damaging the mixer. **Full Bypass Enable** is only available if both options LNP and MPB are present, as well as option FBP.

Path	Example	Note
Standard Path	:POW:MW:PATH STD	Normal setting for most measurements. μ W Preselector in circuit, Low Noise Path disabled
Low Noise Path Enable	:POW:MW:PATH LNP	See " Low Noise Path Enable " on page 338
μ W Preselector Bypass	:POW:MW:PATH MPB	See " μW Preselector Bypass " on page 340
Full Bypass Enable	:POW:MW:PATH FULL	See " Full Bypass Enable " on page 341

Remote Command [:SENSe]:POWer[:RF]:MW:PATH STD | LNPath | MPBypass | FULL
[:SENSe]:POWer[:RF]:MW:PATH?

Example :POW:MW:PATH LNP
Enables the Low Noise path

3 Bluetooth Mode
3.3 Adjacent Channel Power

: POW: MW: PATH?											
Notes	<p>If "Presel Center" on page 734 is performed, the instrument will momentarily switch to the Standard Path, regardless of the setting of μW Path Control</p> <p>The DC Block will always be switched in when the low noise path is switched in, to protect succeeding circuitry from DC. Note that this does not mean "when the low noise path is enabled" but when, based on the Low Noise Path rules, the path is actually switched in. This can happen when the selection is Low Noise Path Enable or Full Bypass Enable. In the case where the DC Block is switched in the instrument is now AC coupled. However, if you selected DC coupling, the UI would still behave as though it were DC coupled, including all annunciation, warnings, status bits, and responses to SCPI queries. This is because, based on other settings, the instrument could switch out the low noise path at any time and hence go back to being DC coupled</p> <p>Alignment switching ignores the settings in this menu, and restores them when finished</p>										
Dependencies	<p>Does not appear in CXA-m, VXT Models M9410A/11A, nor in BBIQ and External Mixing</p> <ul style="list-style-type: none"> - The Low Noise Path Enable selection does not appear unless Option LNP is present and licensed - The μW Preselector Bypass selection does not appear unless Option MPB is present and licensed - The Full Bypass Enable selection does not appear unless options LNP and MPB are both present as well as option FBP <p>In any of these cases, if the required options are not present and the SCPI command is sent, error - 241, "Hardware missing; Option not installed" is generated</p> <p>Low Noise Path Enable and Full Bypass Enable are grayed-out if the current measurement does not support them</p> <p>Low Noise Path Enable and Full Bypass Enable are not supported in Avionics and MMR Modes (non-modulation measurements). In any of these cases (that is, the feature is not supported in either measurement or Mode), if the SCPI command is sent, the following error is generated: -221, "Setting Conflict; Feature not supported for this measurement"</p>										
Preset	<table border="1" style="width: 100%; border-collapse: collapse;"> <thead> <tr> <th style="text-align: left;">Mode</th> <th style="text-align: left;">Value</th> </tr> </thead> <tbody> <tr> <td>IQ Analyzer</td> <td>MPB option present and licensed: MPB</td> </tr> <tr> <td>Pulse</td> <td>MPB option not present and licensed: STD</td> </tr> <tr> <td>Avionics</td> <td></td> </tr> <tr> <td>All other Modes</td> <td>STD</td> </tr> </tbody> </table>	Mode	Value	IQ Analyzer	MPB option present and licensed: MPB	Pulse	MPB option not present and licensed: STD	Avionics		All other Modes	STD
Mode	Value										
IQ Analyzer	MPB option present and licensed: MPB										
Pulse	MPB option not present and licensed: STD										
Avionics											
All other Modes	STD										
State Saved	Save in instrument state										
Range	Standard Path Low Noise Path Enable μW Presel Bypass Full Bypass Enable										
Annotation	<p>In the Meas Bar, if the Standard path is chosen: μW Path: Standard</p> <p>If Low Noise Path is enabled but the LNP switch is not thrown: μW Path: LNP,Off</p> <p>If the Low Noise Path is enabled and the LNP switch is thrown: μW Path: LNP,On</p> <p>If the preselector is bypassed:</p>										

μ W Path: Bypass

If Full Bypass Enable is selected but the LNP switch is not thrown:

μ W Path: FByP,Off

If Full Bypass Enable is selected and the LNP switch is thrown:

μ W Path: FByP,On

μ W Path Control Auto

In VMA, WLAN, 5G NR, CQM Modes, an **Auto/Man** switch is added to μ W Path Control:



This allows the function to automatically switch based on certain Auto Rules as shown below:

VMA Mode

Measurement	When μ W Path Control is in Auto
Digital Demod	Use Standard Path unless tuned frequency > 3.6 GHz and IFBW > 15 MHz, in which case choose Preselector Bypass
Monitor Spectrum	Always Presel Bypass
IQ Waveform	Use Standard Path unless tuned frequency > 3.6 GHz and IFBW > 15 MHz, in which case choose Preselector Bypass
Custom OFDM	Use Standard Path unless tuned frequency > 3.6 GHz and IFBW > 15 MHz, in which case choose Preselector Bypass
Channel Power	Always Presel Bypass
Occupied BW	Always Presel Bypass
CCDF	Use Standard Path unless tuned frequency > 3.6 GHz and IFBW > 15 MHz, in which case choose Preselector Bypass
ACP	Always Presel Bypass
SEM	Always Presel Bypass
Spurious Emissions	Always Standard Path

WLAN Mode

Measurement	When μ W Path Control is in Auto
Modulation	Always Presel Bypass

3 Bluetooth Mode

3.3 Adjacent Channel Power

Measurement	When μ W Path Control is in Auto
Analysis	
Spectral Flatness	Always Presel Bypass
Power vs Time	Always Presel Bypass
Monitor Spectrum	Always Presel Bypass
IQ Waveform	Always Presel Bypass
Channel Power	Always Presel Bypass
Occupied BW	Always Presel Bypass
CCDF	Always Presel Bypass
SEM	For 11be 320M, when 'Enabled Wideband IF for FFT' is OFF or 'Sweep Type Rule' is Best Dynamic Range, auto μ W path is standard For other cases, auto μ W path is presel bypass if presel bypass is enabled, auto μ W path is standard if presel bypass is not enabled
Spurious Emissions	Always Standard Path

5G NR Mode

Measurement	When μ W Path Control is in Auto
Modulation Analysis	Use Standard Path unless tuned frequency > 3.6 GHz and IFBW > 15 MHz, in which case choose Full Bypass if conditions warrant(FBP Option is available and "Allow Full Bypass in Auto" is On), otherwise choose Preselector Bypass
Monitor Spectrum	Always Standard Path
IQ Waveform	Use Standard Path unless tuned frequency > 3.6 GHz and IFBW > 15 MHz, in which case choose Full Bypass if conditions warrant(FBP Option is available and "Allow Full Bypass in Auto" is On), otherwise choose Preselector Bypass
Channel Power	Always Standard Path
Occupied BW	Always Standard Path
CCDF	Use Standard Path unless tuned frequency > 3.6 GHz and IFBW > 15 MHz, in which case choose Preselector Bypass
ACP	Always Standard Path
SEM	Always Standard Path
Spurious Emissions	Always Standard Path
Transmit On Off Power	Use Standard Path unless tuned frequency > 3.6 GHz and Info BW > 15 MHz, in which case choose Preselector Bypass

Channel Quality Mode

Measurement	When μ W Path Control is in Auto
Group Delay	Use Standard Path unless tuned frequency > 3.6 GHz and IFBW > 15 MHz, in which case choose Full Bypass if conditions warrant(FBP Option is available and

Measurement	When μ W Path Control is in Auto
Monitor Spectrum	“Allow Full Bypass in Auto” is On), otherwise choose Preselector Bypass
IQ Waveform	Always Standard Path
CCDF	Use Standard Path unless tuned frequency > 3.6 GHz and IFBW > 15 MHz, in which case choose Preselector Bypass
Remote Command	<code>[:SENSe] :POWer [:RF] :MW:PATH:AUTO ON OFF 1 0</code> <code>[:SENSe] :POWer [:RF] :MW:PATH:AUTO?</code>
Example	<code>:POW:MW:PATH:AUTO ON</code> <code>:POW:MW:PATH:AUTO?</code>
Dependencies	Only appears in VMA, WLAN, 5G NR and CQM Modes
Couplings	See the tables above
Preset	ON
Range	ON OFF

Low Noise Path Enable

Low Noise Path Enable provides a lower noise floor under some circumstances, particularly when operating in the 21–26.5 GHz region. With the Low Noise Path enabled, the low band/high band switch and microwave preamp are bypassed whenever *all* the following are true:

- The instrument is not in the Low Band, meaning:
- the start frequency is above 3.5 GHz and
- the stop frequency is above 3.6 GHz
- The internal preamp is not installed, or if installed, is set to **Off** or **Low Band**

Note that this means that, when any part of a sweep is done in Low Band, the Low Noise Path is not used, whether or not the **Low Noise Path Enable** is selected in the user interface. Also, if the preamp is turned on, the Low Noise Path is not used, whether or not the **Low Noise Path Enable** is selected in the user interface. The only time the Low Noise Path is used is when **Low Noise Path Enable** is selected, the sweep is completely in High Band (> 3.6 GHz) and no preamp is in use.

For measurements that use IQ acquisition, the low noise path is used when **Center Frequency** is in High Band (> 3.6 GHz) and no preamp is in use. In other words, the rules above are modified to use only the center frequency to qualify which path to switch in. This is not the case for FFTs in the Swept SA measurement; they use the same rules as swept measurements.

3 Bluetooth Mode

3.3 Adjacent Channel Power

Note that the Low Noise Path, while giving improved DANL, has the disadvantage of decreased TOI performance and decreased gain compression performance relative to the standard path.

Note also that the bypass switch is a mechanical switch and has finite life, so if the **Low Noise Path Enable** is selected, it is possible to cause frequent cycling of this switch by frequently changing instrument settings such that the above conditions hold true only some of the time. A user making tests of this nature should consider opting for the **Standard Path**, which will never throw the bypass switch, at the expense of some degraded noise performance.

The low noise path is useful for situations where the signal level is so low that the instrument performance is dominated by noise even with 0 dB attenuation, but still high enough that the preamp option would have excessive third-order intermodulation or compression. The preamp, if purchased and used, gives better noise floor than does the “Low Noise Path.” However, its compression threshold and third-order intercept are much poorer than that of the non-preamp path.

There are some applications, typically for signals around -30 dBm, for which the third-order dynamic range of the standard path is good enough, but the noise floor is not low enough even with 0 dB input attenuation. When the third-order dynamic range of the preamp path is too little and the noise floor of the standard path is too high, the Low Noise Path can provide the best dynamic range

The graph below illustrates the concept. It shows, in red, the performance of an instrument at different attenuation settings, both with the preamp on and off, in a measurement that is affected by both instrument noise and instrument TOI. The green shows the best available dynamic range, offset by 0.5 dB for clarity. The blue shows how the best available dynamic range improves for moderate signal levels with the low noise path switched in. In this illustration, the preamp improves the noise floor by 15 dB while degrading the third-order intercept by 30 dB, and the low noise path reduces loss by 8 dB. The attenuator step size is 2 dB.

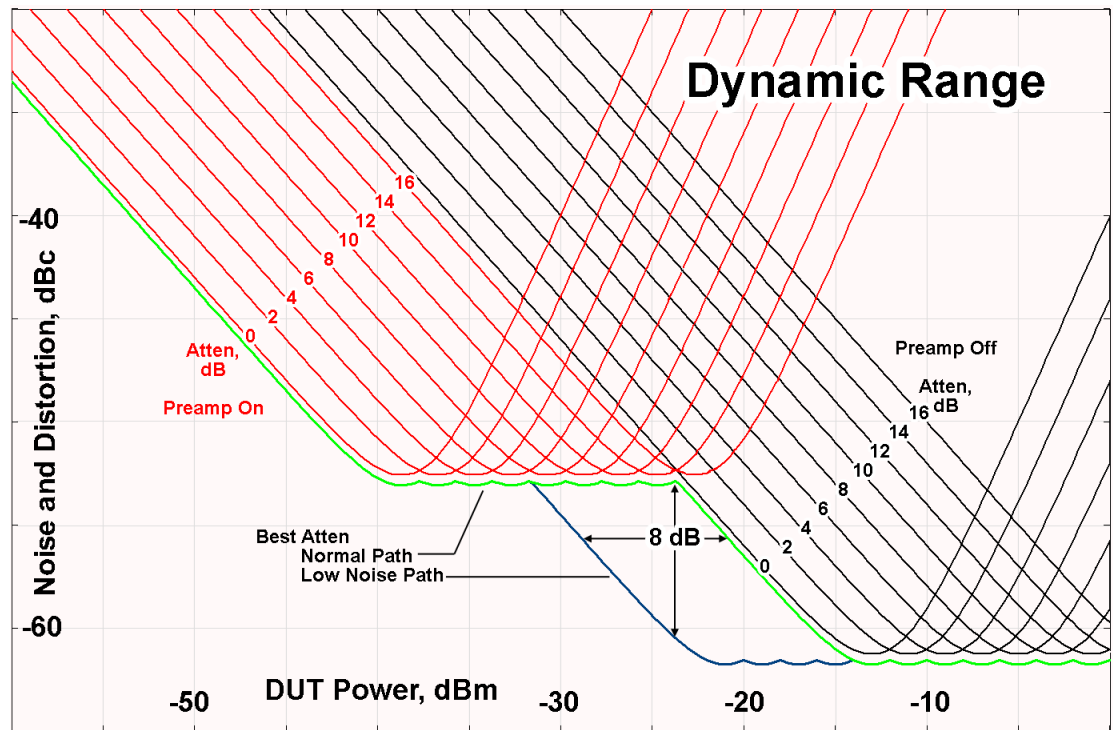

There are other times where selecting the low noise path improves performance, too. Compression-limited measurements such as finding the nulls in a pulsed-RF spectrum can profit from the low noise path in a way similar to the TOI-limited measurement illustrated. Accuracy can be improved when the low noise path allows the optimum attenuation to increase from a small amount like 0, 2 or 4 dB to a larger amount, giving better return loss at the instrument input. Harmonic measurements, such as second and third harmonic levels, are much improved using the low noise path because of the superiority of that path for harmonic (though not intermodulation) distortion performance.

μ W Preselector Bypass

Toggles the preselector bypass switch for band 1 and higher. When the microwave preselector is on, the signal path is preselected. When the microwave preselector is off, the signal path is not preselected. The preselected path is the normal path for the instrument.

The preselector is a tunable bandpass filter which prevents signals away from the frequency of interest from combining in the mixer to generate in-band spurious signals (images). The consequences of using a preselector filter are its limited bandwidth, the amplitude and phase ripple in its passband, and any amplitude and phase instability due to center frequency drift.

Option MPB or pre-selector bypass provides an unpreselected input mixer path for certain X-Series signal analyzers with frequency ranges above 3.6 GHz. This signal path allows a wider bandwidth and less amplitude variability, which is an advantage when doing modulation analysis and broadband signal analysis. The disadvantage is that, without the preselector, image signals will be displayed. Another disadvantage of bypassing the preselector is increased LO emission levels at the front panel input port.

Image responses are separated from the real signal by twice the 1st IF. For IF Paths of 10 MHz and 25 MHz, the 1st IF is 322.5 MHz, so the image response and the real signal will be separated by 645 MHz. The 1st IF will be different for other IF Path settings. When viewing a real signal and its corresponding image response in internal mixing, the image response will be to the left of the real signal.

Also, the image response and the real signal typically have the same amplitude and exhibit the same shape factor.

However, if Option FS1 (Fast Sweep Capability) is enabled, the image response in the Swept SA measurement appears lower in amplitude and has a much wider shape factor compared to the real signal.

Full Bypass Enable

With **Full Bypass Enable** selected, the microwave preselector is bypassed. In addition, the low band/high band switch and microwave preamp are bypassed whenever *all* the following are true:

- The instrument is not in the Low Band, meaning:
- the start frequency is above 3.5 GHz and
- the stop frequency is above 3.6 GHz.
- the internal preamp is not installed or if installed, is set to **Off** or **Low Band**

Note that this means that, when any part of a sweep is done in Low Band, the Low Noise Path is not used, whether or not the **Full Bypass Enable** is selected in the user interface. Also, if the preamp is turned on, the Low Noise Path is not used, whether or not the **Full Bypass Enable** is selected in the user interface. The only time the Low Noise Path is used is when **Full Bypass Enable** is selected, the sweep is completely in High Band (> 3.6 GHz) and no preamp is in use.

CAUTION

When **Full Bypass Enable** is selected, and "**Y Scale**" on page 597 is set to 0 dB, there will be a direct AC connection between the input and the first converter when the Low Noise Path switches in (when Start Freq >3.6 GHz and the Preamp is either not licensed, set to Low Band, or Off). This puts the first converter at considerable risk to be damaged by high AC power. Consequently,

whenever **Full Bypass Enable** is selected, a warning message appears in the status bar:

“Full Bypass Enabled, maximum safe input power reduced”

Microwave Preselector Bypass Backwards Compatibility

Example	<code>:POW:MW:PRES OFF</code> Bypasses the microwave preselector
Notes	Included for Microwave Preselector Bypass backwards compatibility The ON parameter sets the STD path (<code>:POW:MW:PATH STD</code>) The OFF parameter sets path MPB (<code>:POW:MW:PATH MPB</code>)
Preset	ON
Backwards Compatibility SCPI	<code>[:SENSe]:POWer[:RF]:MW:PRESelector[:STATe] ON OFF 0 1</code> <code>[:SENSe]:POWer[:RF]:MW:PRESelector[:STATe]?</code>

Frequency Extender Preselection Bypass

Only applies to the high frequency path of the Frequency Extender, and only if the Frequency Extender allows it. For example, the V3050A high frequency path is 50 – 110 GHz and *does* allow control of the preselector bypass.

When the Frequency Extender’s preselection is bypassed, flatness is improved, but will be subject to spurs from out-of-band interfering signals. For bandwidths greater than 2.5 [GHz], it is recommended that the signal bypass the Frequency Extender Preselector since the max bandwidth of the Preselector can be as narrow as 2.5 [GHz].

For most applications, the preset state is **OFF**, which gives the best remote-control throughput, minimizes acoustic noise from switching, minimizes out of band spurs, and minimizes the risk of wear in the hardware switches.

Preselector and Bandwidth Conflict

When the Frequency Extender Preselector is applied and the signal bandwidth is greater than 2.5 [GHz], then a settings alert message will show to warn the user that the signal may be distorted due to the limitation of the Frequency Extender Preselector bandwidth.

An example of the settings alert message is shown below.

Settings Alert message in the Status Bar at the bottom of the display.



Settings Alert message in the error queue

Type	ID	
	159	Settings Alert - DETECTED; Presel/Meas BW conflict

Software Preselection

Provided in some instruments, either to compensate for issues with provided hardware preselection or to provide the preselection function when there is no hardware preselector.

N9041B

Software Preselection compensates for the frequency range limit of the microwave preselector. Since the microwave preselector only goes up to 50 GHz, software preselection must be used to suppress and separate images above 50 GHz. The specific algorithm used for software preselection is specified by the SW Preselection Type selection – Normal or Advanced.

In N9041B, **Software Preselection** only applies for frequencies above 50 GHz, therefore it is only used for RF Input 2. Even if turned on, it is not used for other inputs, and never for frequencies below 50 GHz. This is why the label of this control contains the parenthetical note “(>~50 GHz)”.

Note that in N9041B, in Swept SA measurement, **Software Preselection** works even if the measurement is using an FFT Sweep Type. In measurements other than Swept SA, Software Preselection is not used if the measurement is using an FFT sweep type.

N9042B+V3050A

Software Preselection compensates for the frequency range limit of the microwave preselector. Since the microwave preselector only goes up to 50 GHz, software preselection must be used to suppress and separate images above 50 GHz. The specific algorithm used for software preselection is specified by the SW Preselection Type selection – Normal or Advanced.

For N9042B+V3050A, Software Preselection only applies for frequencies above 50 GHz, therefore it is only used for External RF. Even if it is turned on, it will not be used for other inputs and never for frequencies below 50 GHz. This is why the label of this control contains the parenthetical note “(>~50 GHz)”.

Note that for N9042B+V3050A, in the Swept SA measurement, Software Preselection works even if the measurement is using an FFT Sweep Type. In measurements other than Swept SA, Software Preselection is not used if the measurement is using an FFT Sweep Type.

VXT models M9410A/11A

Software Preselection is used to provide the preselection function, as there is no hardware preselector in these models. Two background traces are taken and compared point by point, and the point with the lowest amplitude from the two traces is used. This provides a method to reduce spurs that are internally generated within the VXT, but you should note the following when using Software Preselection:

- There is some speed cost due to the need to take multiple captures
- Taking the point with the lowest amplitude in each trace will make the average noise level lower at all points that do not have a spur. This can reduce the accuracy of the measurement of noise and noise-like signals

Because of the difficulty in identifying spurs manually, you are recommended to leave Software Preselection **ON** at all times in VXT models M9410A/11A. If you turn it off in order to speed up your measurement or improve noise accuracy, be aware of unwanted onscreen spurs.

Remote Command	<code>[:SENSe] : POWer [:RF] : SWPreSel : STATe 0 1 ON OFF</code>	
	<code>[:SENSe] : POWer [:RF] : SWPreSel : STAT?</code>	
Example	<code>: POW : SWPR : STAT 1</code>	
	<code>: POW : SWPR : STAT?</code>	
Dependencies	Only appears in N9041B, N9042B+V2050A, and VXT models M9410A/11A. Does not appear in all measurements	
Couplings	Affects Sweep Time Auto Tune supports Software Preselection , so Auto Tune should be performed after setting the Software Preselection state	
Preset	N9041B	OFF
	N9042B+V3050A	ON
	M9410A/11A	ON
State Saved	Saved in instrument state	

SW Preselection Type

Specifies the algorithm used for software preselection.

Two hidden sweeps occur in succession. The second sweep is offset in LO frequency by $2 * IF / N$. For each point in each trace, the smaller amplitude from the two traces is taken and placed in that point in the selected trace. The Peak detector is auto-selected to improve the image suppression effectiveness. Responses of each trace that lie on top of one another will remain and are valid signals. Other signals are images, which are suppressed. The action of taking the smaller of the two traces will make the average noise level lower in all points that do not have an image, thus reducing the accuracy of the measurement of noise and noise-like signals.

- **NORMa1** - mathematically removes all image and multiple responses of signals present at the input
- **ADVanced** - any trace processing (such as “max hold” or trace averaging) is performed on the points of both candidate traces before the “select minimum” operation occurs. This form of processing works better for non-stationary signals, such as pulsed-RF signals

Remote Command	<code>[:SENSe]:POWer[:RF]:SWPResel NORMa1 ADVanced</code> <code>[:SENSe]:POWer[:RF]:SWPResel?</code>
Example	<code>:POW:SWPR NORM</code> <code>:POW:SWPR?</code>
Dependencies	Only appears in N9041B and N9042B+V3050A. Only appears in measurements that use the Swept method Grayed-out when "Software Preselection" on page 749 is OFF. The grayout message is “Unavailable unless SW Presel enabled”
Preset	N9041B ADVanced N9042B+V3050A NORMa1
State Saved	Saved in instrument state

SW Preselection BW

Specifies the effective bandwidth to be used for Software Preselection.

The options are:

- **NORMa1** – when making Swept measurements, a software preselection algorithm is used which takes up to 4 background acquisitions, then post-processes the result. This algorithm can remove images from signals with an occupied

bandwidth up to around 3 GHz. (Default/Preset setting). When making FFT measurements, this algorithm is not used, instead the same algorithm is used as for **NARRow** (below)

- **NARRow**– a software preselection algorithm is used which takes two background acquisitions, then post-processes the result to detect and remove images from wideband signals with occupied bandwidths up to 2 GHz. This increases the risk of images failing to be rejected, but improves the measurement speed

Remote Command	<code>[:SENSe]:POWer[:RF]:SWPResel:BW NORMal NARRow</code> <code>[:SENSe]:POWer[:RF]:SWPResel:BW?</code>
Example	<code>:POW:SWPR:BW NARR</code>
Dependencies	Only appears in N9041B and N9042B+V3050A. Only appears in measurements that use the Swept method Grayed-out when " Software Preselection " on page 749 is OFF . The grayout message is "Unavailable unless SW Presel enabled" For N9042B+V3050A, the parameter is SCPI-only, and always set to NARRow when Software Preselection is enabled
Preset	N9041B NORMal N9042B+V3050A NARRow
State Saved	Saved in instrument state

High Freq Prefilter

Lets you set the state of Prefilter for center frequencies above 1310 MHz.

In VXT Models M9410A/11A, the Receiver RF path has a bank of filters that come after the RF Attenuator in the signal path. Since this bank of filters precedes the mixer they are known as the "Prefilter" bank. Their purpose is to eliminate unwanted in-band mixing products by filtering out all but the desired frequencies before the signals get to the mixer. There are 13 prefilter bands to cover the frequencies between 9 kHz and 6000 MHz. The Prefilter provides the necessary rejection of the unwanted signal.

Remote Command	<code>[:SENSe]:<measurement>:PFILter[:STATe] ON OFF 1 0</code> <code>[:SENSe]:<measurement>:PFILter[:STATe]?</code>
Example	Enable High Freq Prefilter for the Complex Spectrum Measurement in BASIC Mode: <code>:SPEC:PFIL ON</code> Enable High Freq Prefilter for the IQ Waveform Measurement, in multiple Modes: <code>:WAV:PFIL ON</code> Enable High Freq Prefilter for the Swept SA Measurement in SA Mode:

3 Bluetooth Mode
3.3 Adjacent Channel Power

	:SAN:PFIL ON
Dependencies	Only appears in VXT models M9410A/11A with center frequency above 1310 MHz
Preset	See "Prefilter Presets" on page 347 below
State Saved	Saved in instrument state

Prefilter Presets

Meas	Mode	Preset
SPEC	BASIC	OFF
WAV	BASIC, WCDMA, WLAN, LTEAFDD, LTEATDD, 5GNR, VMA	OFF
MON	WCDMA, WLAN, LTEAFDD, LTEATDD, 5GNR, VMA	OFF
RHO	WCDMA	OFF
CDP	WCDMA	OFF
PCON	WCDMA	OFF
EVMQ	WCDMA	OFF
CHP	WCDMA, WLAN, LTEAFDD, LTEATDD, 5GNR, VMA, SA	OFF
OBW	WCDMA, WLAN, LTEAFDD, LTEATDD, 5GNR, VMA, SA	OFF
ACP	WCDMA, LTEAFDD, LTEATDD, 5GNR, VMA, SA	OFF
SEM	WCDMA, WLAN, LTEAFDD, LTEATDD, 5GNR, VMA, SA	OFF
PST	WCDMA, WLAN, LTEAFDD, LTEATDD, 5GNR, VMA, SA	OFF
PVT	WLAN, LTEAFDD, LTEATDD, 5GNR	OFF
EVM	WLAN, LTEAFDD, LTEATDD, 5GNR	OFF
FLAT	WLAN	OFF
EVMM	WLAN	OFF
CEVM	LTEAFDD, LTEATDD	OFF
PAVT	5GNR, VMA	OFF
DDEM	VMA	OFF
OFDM	VMA	OFF
SAN	SA	ON
HARM	SA	ON

3.3.4 BW

The BW key opens the bandwidth menu, which contains controls for bandwidth parameters of the instrument.

3.3.4.1 Settings

The Settings Tab contains the basic Bandwidth functions.

Res BW

Enables you to set the Resolution Bandwidth of the analyzer.

Remote Command	<code>[:SENSe]:ACPower:BANDwidth BWIDth[:RESolution] <freq></code> <code>[:SENSe]:ACPower:BANDwidth BWIDth[:RESolution]?</code>
Example	<code>:ACP:BAND 100 kHz</code> <code>:ACP:BAND?</code>
Dependencies	If meas method is FFT, this control will be grayed out
Preset	100.00 kHz
State Saved	Yes
Min/Max	1Hz/8MHz

Video BW

Enables you to set the Video Bandwidth of the analyzer.

Remote Command	<code>[:SENSe]:ACPower:BANDwidth BWIDth:VIDeo <freq></code> <code>[:SENSe]:ACPower:BANDwidth BWIDth:VIDeo?</code>
Example	<code>:ACP:BAND:VID 200 kHz</code> <code>:ACP:BAND:VID?</code>
Notes	Setting VBW = 100 kHz and Detector = Sample gets the same results as that of setting VBW = 300 kHz and Detector = Average
Dependencies	If meas method is FFT, this key will be grayed out
Preset	100.00 kHz
State Saved	Yes
Min/Max	1 Hz/50 MHz

RBW Filter Type

Selects the type for the resolution bandwidth filters. Historically, the Res BW filters in HP/Agilent/Keysight spectrum analyzers were Gaussian filters, specified using the -3 dB bandwidth of the filter. That is, a 10 MHz Res BW filter was a Gaussian shape with its -3 dB points 10 MHz apart. In the X-Series, the **RBW Filter BW** menu lets you choose between a Gaussian and Flat Top filter shape, for varying measurement conditions.

Filter Type	SCPI Example	Notes
Gaussian	<code>BAND:SHAP GAUS</code>	
Flattop	<code>BAND:SHAP FLAT</code>	

See "[More Information](#)" on page 349

Remote Command	<code>[:SENSe]:ACPower:BANDwidth:SHAPE GAUSSian FLATtop</code> <code>[:SENSe]:ACPower:BANDwidth:SHAPE?</code>
Example	<code>:ACP:BAND:SHAP GAUS</code> <code>:ACP:BAND:SHAP?</code>
Notes	GAUSSian= Gaussian FLATtop = Flattop We use SHAPe instead of TYPE (even though the control name uses Type) because TYPE is used for (below) for backwards compatibility
Preset	GAUSSian
State Saved	Saved in instrument state

More Information

Gaussian filters

When the Gaussian filter type is chosen, a set of 160 RBW filters are available whose shape is approximately Gaussian. The actual bandwidths used to realize the X-Series' Gaussian filters are chosen to come as close as possible, within the limitations of the digital IF, to a 24 step per decade series from 1 Hz through 3 MHz, plus the 4, 5, 6 and 8 MHz settings.

For Gaussian filters, the annotation at the bottom of the screen shows the filter bandwidth type (unless it is Normal) parenthetically between the words "Res BW" and the value, for example:

Res BW 10.0 Hz (Normal bandwidth)

Res BW (Impulse) 14.8 Hz (Impulse bandwidth)

Flattop filters

When the Flattop filter type is chosen, a new set of 134 RBW hardware settings are available. These settings realize filters that are approximately rectangular in shape. When this shape is chosen the filter bandwidth options are irrelevant and therefore unavailable.

The annotation at the bottom of the screen shows that the Flattop shape is being used, for example:

Res BW (Flattop) 10 Hz

3.3.5 Display

The Display key opens the Display Menu, which lets you configure display items for the current Mode, Measurement View or Window.

3.3.5.1 View

Contains controls for selecting the current **View**, and for editing User Views.

Views

The ACP measurement has two views, the RF Spectrum View and the RF Envelope View.

These Views are multiple-window Views. When in a multiple window View, you select a window by touching it. The menu controls may sometimes change depending on which window is selected.

Whenever the View changes, the default menu is Frequency, unless otherwise specified in the View description.

View Selection Remote Commands

Allows you to select the desired measurement view.

The Enumerated ID is used with the SCPI Command `:DISP:ACP:VIEW[:SEL]` ("[View Selection by Name](#)" on page 350)

The Numeric ID is used with the SCPI Command `:DISP:ACP:VIEW:NSEL` ("[View Selection by Number \(Remote Command only\)](#)" on page 351)

Enumerated ID	Numeric ID	View Name & Details
RFENvelope	1	Provides a combination view of RF Envelope graph and the summary data as shown below
RFSPectrum	2	Provides a combination view of RF Spectrum graph and the summary data as shown below

View Selection by Name

Allows you to specify the view via its enumerated ID string.

Remote Command `:DISPlay:ACPower:VIEW[:SElect] RFENvelope | RFSPectrum`

3 Bluetooth Mode

3.3 Adjacent Channel Power

	<code>:DISPlay:ACPower:VIEW[:SElect]?</code>
Example	<code>:DISP:ACP:VIEW:SEL RFSP</code> <code>:DISP:ACP:VIEW:SEL?</code>
Preset	RFSPpectrum
State Saved	Yes
Range	RF Envelope RF Spectrum

View Selection by Number (Remote Command only)

Allows you to specify the view via its numeric ID value.

Remote Command	<code>:DISPlay:ACPower:VIEW:NSElect <integer></code> <code>:DISPlay:ACPower:VIEW:NSElect?</code>
Example	<code>:DISP:ACP:VIEW:NSEL 1</code> <code>:DISP:ACP:VIEW:NSEL?</code>
Preset	1
State Saved	Yes
Min/Max	1/2

User View

Lets you choose a View from the saved User Views for the current measurement. This panel only appears if a User View exists for the current measurement.

Remote Command	<code>:DISPlay:VIEW:ADVanced:SElect <alphanumeric></code> <code>:DISPlay:VIEW:ADVanced:SElect?</code>
Example	Select Baseband as the current View <code>:DISP:VIEW:ADV:SEL "Baseband"</code>
Notes	<p>You must be in the measurement whose View you are trying to set to send the command. You can only set Views for the current measurement using this command</p> <p>For predefined views, the parameter is derived from the view name that is shown in the View list in the user interface. For example, if you are trying to select the Trace Zoom view in the Swept SA measurement, you send:</p> <pre><code>:DISP:VIEW:ADV:SEL "Trace Zoom"</code></pre> <p>because "Trace Zoom" is the name of the View as seen in the Mode/Meas dialog or in the Display, View menu</p> <p>You <i>cannot</i> use the legacy View parameter (which in this case would be <code>TZOom</code>) with</p> <pre><code>:DISP:VIEW:ADV:SEL</code></pre> <p><code><alphanumeric></code> is case insensitive; you can specify mixed case, however the name will be</p>

evaluated on a single case. Thus, both of the following forms work:

```
:DISP:VIEW:ADV:SEL "Trace Zoom"
```

```
:DISP:VIEW:ADV:SEL "TRACE ZOOM"
```

If the specified view is not a valid View, the query returns the error message “-224, Illegal parameter value; View with the name <alphanumeric> does not exist”

If the display is disabled (via `:DISP:ENAB OFF`) then the error message “-221, Settings conflict; View SCPI cannot be used while Display is disabled” is generated

Backwards Compatibility SCPI	The legacy node <code>:DISPlay:VIEW[:SElect]</code> is retained for backwards compatibility, but it only supports predefined views
------------------------------	--

Restore Layout to Default

Restores the Layout to the default for Basic.

Modified Views are very temporary; if you exit the current measurement they are discarded, and they are not saved in State. To retain this View for later use, and to be able to return easily to your original Basic View, you can save your edited View as a “User View”.

Save Layout as New View

Saves your new View as a User View. An alpha keyboard appears, which lets you name your new View; the default is the old View name plus a number.

Remote Command	<code>:DISPlay:VIEW:ADVanced:NAME <alphanumeric></code>
----------------	---

Example	<code>:DISP:VIEW:ADV:NAME "Baseband"</code>
---------	---

Creates a new View named **Baseband** from the current View, and selects it as the current View

Notes	<p><alphanumeric> is case insensitive; you can specify mixed case, however the name will be evaluated on a single case</p> <p>If <alphanumeric> name already exists as a View, the error message “-224, Illegal parameter value; View <alphanumeric> already exists” is generated</p> <p>If the display is disabled (via <code>:DISP:ENAB OFF</code>) then the error message “-221, Settings conflict; User View SCPI cannot be used while Display is disabled” is generated</p>
-------	--

Re-Save User View

You can re-edit a User View; if you make changes, then an asterisk will appear next to the User View’s name. You can then tap **Re-Save User View** to save it back to its existing name, or **Save Layout as New View** to add another, new User View.

3 Bluetooth Mode

3.3 Adjacent Channel Power

This is a front panel function only, there is no remote command available to perform this function. To do this remotely, you must first perform **Save Layout as New View**, then delete the old User View and rename the new one with the name of the View you just deleted.

Rename User View

You can rename the current View by giving it a new unique name. Only User Views can be renamed, if the current View is a Predefined View, an error occurs.

Remote Command	<code>:DISPlay:VIEW:ADVanced:REName <alphanumeric></code>
Example	<code>:DISP:VIEW:ADV:REN "Baseband"</code>
Notes	<p><code><alphanumeric></code> is case insensitive; you can specify mixed case, however the name will be evaluated on a single case</p> <p>If the <code><alphanumeric></code> specifying the new name is already present in the list of View names, the error message "-224, Illegal parameter value; View <alphanumeric> already exists" is generated</p> <p>If the current View is a Predefined View, the error message "-224, Illegal parameter value; Cannot rename a Predefined View" is generated</p> <p>If the display is disabled (via <code>:DISP:ENAB OFF</code>) then the error message "-221, Settings conflict; View SCPI cannot be used while Display is disabled" is generated</p>

Delete User View

You can delete the current View if it is a User View. The default view becomes the current view for the Measurement.

Remote Command	<code>:DISPlay:VIEW:ADVanced:DELeTe</code>
Example	<code>:DISP:VIEW:ADV:DEL</code>
Notes	<p><code><alphanumeric></code> is case insensitive; you can specify mixed case, however the name will be evaluated on a single case</p> <p>If the <code><alphanumeric></code> is not present in the list of View names, the error message "-224, Illegal parameter value; View <alphanumeric> does not exist" is generated</p> <p>If the current View is a Predefined View, the error message "-224, Illegal parameter value; Cannot delete a Predefined View" is generated</p> <p>If the display is disabled (via <code>:DISP:ENAB OFF</code>) then the error message "-221, Settings conflict; View SCPI cannot be used while Display is disabled" is generated</p>

Delete All User Views

Deletes all previously saved User Views. The default view becomes the current view for the Measurement if a User View was the current view when this command was

executed.

Remote Command	<code>:DISPlay:VIEW:ADVanced:DELeTe:ALL</code>
Example	<code>:DISP:VIEW:ADV:DEL:ALL</code>
Notes	Disabled if there are no User Views

View Editor Remote Commands

The following remote commands help you manage Views and User Views. Note that the SCPI node for User Views handles both Predefined and User Views. The legacy nodes, `:DISPlay:VIEW[:SElect]` and `:DISPlay:VIEW:NSEL`, are retained for backwards compatibility, but they only support predefined views.

View Listing Query

Returns a string containing a comma-separated list of names for *all* the Views, including User Views, available for the current Measurement.

Remote Command	<code>:DISPlay:VIEW:ADVanced:CATalog?</code>
Example	<code>:DISP:VIEW:ADV:CAT?</code>
Notes	Returns a quoted string of the available Views for the current measurement, separated by commas. The list includes names for <i>all</i> the Views, including User Views, available for the current Measurement Example: <code>"Normal,Trace Zoom,Spectrogram,Baseband,myView1,yourView1"</code> No distinction is made between Predefined and User Views If you switch measurements with the display disabled (via <code>:DISP:ENAB OFF</code>), then query the list of available Views, the result is undefined

User View Listing Query

Returns a string containing a comma-separated list of names for *only* the User Views available for the current Measurement.

Remote Command	<code>:DISPlay:VIEW:ADVanced:USER:CATalog?</code>
Example	<code>:DISP:VIEW:ADV:USER:CAT?</code>
Notes	Returns a quoted string of the available User Views for the current measurement, separated by commas. Example: <code>"Baseband,myView1,yourView1"</code>

If you switch measurements with the display disabled (see "[Display Enable \(Remote Command Only\)](#)" on page 760), then query the list of available Views, the result is undefined

3.3.5.2 Annotation

Contains controls for setting up the annotation for the current Mode or Measurement.

Graticule

Turns the display graticule On or Off for all windows with graticules in all measurements in the current Mode. Also turns the graticule Y-Axis annotation on and off.

Remote Command	<code>:DISPlay:GRATicule[:STATe] OFF ON 0 1</code> <code>:DISPlay:GRATicule[:STATe]?</code>
Example	<code>:DISP:GRAT OFF</code>
Notes	The graticule is the set of horizontal and vertical lines that make up the grid/divisions for the X-Axis and Y-Axis
Preset	<code>ON</code>
State Saved	Saved in instrument state
Backwards Compatibility SCPI	<code>:DISPlay:WINDow[1]:TRACe:GRATicule:GRID[:STATe] OFF ON 0 1</code> <code>:DISPlay:WINDow[1]:TRACe:GRATicule:GRID[:STATe]?</code> This command is accepted for backwards compatibility with older instruments, but the <code>WINDow</code> , <code>TRACe</code> and <code>GRID</code> parameters are ignored

Screen Annotation

Controls the display of the annunciation and annotation around the graticule, including any annotation on lines (such as the display line, the threshold line, etc.) and the Y-Axis annotation, for all windows with screen annotation in all measurements in the current Mode.

This does *not* include marker annotation (or the N dB result). When `OFF`, the graticule expands to fill the entire graticule area, leaving only the 1.5% gap above the graticule, as described in the **Trace** section.

Remote Command	<code>:DISPlay:ANNotation:SCReen[:STATe] OFF ON 0 1</code> <code>:DISPlay:ANNotation:SCReen[:STATe]?</code>
Example	<code>:DISP:ANN:SCR OFF</code>
Dependencies	Grayed-out and forced to <code>OFF</code> when System Display Settings, Annotation is <code>OFF</code>

Preset	ON This remains OFF through a Preset when System Display Settings, Annotation is set to OFF
State Saved	Saved in instrument state

Trace Annotation

Turns on and off the labels on the traces, showing their detector (or their Math Mode) as described in the **Trace** section, for all windows in all measurements in the current Mode for which Trace Annotation on/off is supported.

If Trace Math is being performed on a trace, then the Trace Math annotation replaces the detector annotation.

For measurements that support limit lines, this key also turns on and off the labels on the Limit Lines. The label is the Limit number annotation and Limit Comment displayed on the graph. If the length of the comment is greater than 20 characters, the first 8 characters and the last 8 characters are displayed, joined with

Remote Command	<code>:DISPlay:ANNotation:TRACe[:STATe] ON OFF 1 0</code> <code>:DISPlay:ANNotation:TRACe[:STATe]?</code>
Example	<code>:DISP:ANN:TRAC OFF</code>
Preset	OFF
State Saved	Saved in instrument state

Control Annotation

Turns on and off the display of values on the Active Function controls for all measurements in the current Mode. This is a security feature.

Remote Command	<code>:DISPlay:ACTivefunc[:STATe] ON OFF 1 0</code> <code>:DISPlay:ACTivefunc[:STATe]?</code>
Example	<code>:DISP:ACT OFF</code>
Dependencies	Grayed out and forced to OFF when System Display Settings, Annotation is OFF
Preset	ON This remains OFF through a Preset when System Display Settings, Annotation is set to OFF
State Saved	Saved in instrument state

Meas Bar

Turns the Measurement Bar at the top of the screen on and off for all measurements in the current Mode. When **OFF**, the graticule area expands to fill the area formerly

occupied by the Measurement Bar.

Remote Command	<code>:DISPlay:ANNotation:MBAR[:STATe] OFF ON 0 1</code> <code>:DISPlay:ANNotation:MBAR[:STATe]?</code>
Example	<code>:DISP:ANN:MBAR OFF</code>
Dependencies	Grayed out and forced to OFF when System Display Settings, Annotation is OFF
Preset	ON This remains OFF through a Preset when System Display Settings, Annotation is set to OFF
State Saved	Saved in instrument state

Display Enable (Remote Command Only)

Turns the display on/off, including the display drive circuitry. The backlight stays lit to confirm that the instrument is on. The display enable setting is mode global. There are three reasons for turning the display off:

1. To increase speed as much as possible by freeing the instrument from having to update the display
2. To reduce emissions from the display, drive circuitry
3. For security purposes

If you have turned off the display:

- and you are in local operation, the display can be turned back on by pressing any key or by sending `:SYSTem:DEFaults MISC` or `:DISPlay:ENABle ON` (neither `*RST` nor `:SYSTem:PRESet` enable the display)
- and you are in remote operation, the display can be turned back on by pressing the **Local** or **Esc** keys, or by sending `:SYSTem:DEFaults MISC` or `:DISPlay:ENABle ON` (neither `*RST` nor `:SYSTem:PRESet` enable the display)
- and you are using either the `:SYSTem:KLOCK` command or GPIB local lockout, then *no* front-panel key press will turn the display back on. You must turn it back on remotely.

If the display is **OFF**, many SCPI commands related to User Views and Multiscreen functionality do not work, and return the error messages “-221, Settings conflict; Screen SCPI cannot be used when Display is disabled” or “221, Settings conflict; View SCPI cannot be used while Display is disabled”. These commands include:

Name	Command
Select User View	<code>:DISPlay:VIEW:ADVanced:SElect</code>
Rename User View	<code>:DISPlay:VIEW:ADVanced:REName</code>
Delete User View	<code>:DISPlay:VIEW:ADVanced:DElete</code>

Name	Command
Create User View	:DISPlay:VIEW:ADVanced:NAME
Select Screen	:INSTrument:SCReen:SElect
Delete Screen	:INSTrument:SCReen:DELeTe
Delete All But This Screen	:INSTrument:SCReen:DELeTe:ALL
Add Screen	:INSTrument:SCReen:CREate
Rename Screen	:INSTrument:SCReen:REName
Sequencer On/Off	:SYSTem:SEQuencer

Remote Command	:DISPlay:ENABle OFF ON 0 1
Example	:DISP:ENAB OFF
Couplings	:DISP:ENAB OFF turns Backlight OFF and :DISP:ENAB ON turns Backlight ON, but changing Backlight settings does <i>not</i> change the state of :DISP:ENAB
Preset	ON Set by :SYST:DEF MISC, but not affected by *RST or :SYSTem:PRESet
State Saved	Not saved in instrument state
Backwards Compatibility Notes	:SYST:PRES no longer turns on :DISPlay:ENABle as it did in legacy analyzers

3.3.6 Freq

The Freq key opens the Frequency menu, which contains controls that allow you to control the Frequency and Channel parameters of the instrument.

Some features in the Frequency menu are the same for all measurements in the current Mode – they do not change as you change measurements. Settings like these are called “Meas Global” and are unaffected by Meas Preset.

3.3.6.1 Settings

The Settings Tab contains controls that pertain to the X axis parameters of the measurement. These parameters control how data on the vertical (X) axis is displayed and control instrument settings that affect the horizontal axis.

Channel

Selects which Bluetooth channel will be measured.

3 Bluetooth Mode
 3.3 Adjacent Channel Power

Channel number is common for all the measurements. The coupling of Channel and Center Frequency apply to the following Measurements:

- Transmit Analysis
- Output Spectrum BW
- Monitor Spectrum

For other measurements, center frequency does not dependent on channel. If center frequency is changed in other measurements but channel isn't changed, center frequency still can return to the old value only if the measurement is switched to the upward measurements.

Remote Command	<code>[:SENSe]:CHANnel[:NUMBer] <integer></code> <code>[:SENSe]:CHANnel[:NUMBer]?</code>
Example	<code>:CHAN 22</code> <code>:CHAN?</code>

Couplings	The coupling of channel and center frequency is only applied to the following measurements: <ul style="list-style-type: none"> - Transmit Analysis - Output Spectrum BW - Monitor Spectrum
-----------	---

For other measurements, center frequency does not depend on channel. Following is the coupling of channel and center frequency

If Radio Stand is Basic or EDR:

$$\text{Channel} = (\text{CF} - 2.402\text{E}9) / 1.0\text{e}6$$

If the Center Frequency is set to a value between channels, the channel key should display > prior to the previous channel number if the CF is < 500 kHz above the previous channel and < prior to the next channel number if the CF is > = 500 kHz above the previous channel

For example, if Channel = 3.4, the channel key will display >3. If Channel = 3.5, the channel key will display <4. If Channel < 0, the channel key will display <0. If Channel > 78(22), the channel key display will display >78(22)

If Radio Stand is Low Energy:

$$\text{Channel} = (\text{CF} - 2.402\text{E}9) / 2.0\text{e}6$$

The max value of channel is 39. The range of channel is 0-39

If the Center Frequency is set to a value between channels, the channel key should display > prior to the previous channel number if the CF is < 1 MHz above the previous channel and < prior to the next channel number if the CF is > = 1 MHz above the previous channel

For example, if Channel = 3.4, the channel key will display >3. If Channel = 3.5, the channel key will display <4. If Channel < 0, the channel key will display <0. If Channel > 78(22), the channel key display will display >78(22)

If Geography is France :

- Channel Number: 0...22

-
- If Center Frequency < 2.454 GHz, the channel key should display < 0
 - If Center Frequency > 2.476 GHz, the channel key should display > 22

If Geography is Others:

- Channel Number: 0...78
- If Center Frequency < 2.402 GHz, the channel key should display < 0
- If Center Frequency > 2.480 GHz, the channel key should display > 78

Preset	0
State Saved	Yes
Range	0 - 78
Min/Max	0 / 78

Center Frequency

Sets the frequency that corresponds to the horizontal center of the graticule. While adjusting the Center Frequency the Span is held constant.

The center frequency setting is the same for all measurements within a mode, that is, it is Meas Global. Some modes are also able to share a Mode Global center frequency value. If this is the case, the Mode will have a **Global** tab in its **Meas Setup** menu.

The **Center Freq** function sets (and queries) the Center Frequency for the currently selected input. If your instrument has multiple inputs, and you select another input, the Center Freq changes to the value for that input. SCPI commands are available to directly set the Center Freq for a specific input.

Center Freq is remembered as you go from input to input. Thus, you can set a Center Freq of 10 GHz with the RF Input selected, change to BBIQ, and set a Center Freq of 20 MHz, then switch to External Mixing and set a Center Freq of 60 GHz, and when you go back to the RF Input the Center Freq will go back to 10 GHz; back to BBIQ and it is 20 MHz; back to External Mixing and it is 60 GHz.

See:

- ["Center Frequency Presets" on page 363](#)
- ["VXT Models with Radio Heads/CIU Frequency Range" on page 364](#)
- ["RF Center Freq" on page 365](#)
- ["Ext Mix Center Freq" on page 365](#)
- ["I/Q Center Freq" on page 366](#)

3 Bluetooth Mode

3.3 Adjacent Channel Power

Remote Command	<pre>[:SENSe]:FREQuency:CENTer <freq></pre> <pre>[:SENSe]:FREQuency:CENTer?</pre>
Example	<pre>:FREQ:CENT 50 MHz</pre> <p>Sets Center Frequency to 50 MHz</p> <pre>:FREQ:CENT UP</pre> <p>Increments the Center Frequency by the value of CF Step</p> <pre>:FREQ:CENT?</pre> <p>Returns the current value of Center Frequency</p>
Notes	<p>Sets the RF, External Mixing or I/Q Center Frequency depending on the selected input:</p> <ul style="list-style-type: none"> – For RF input it is equivalent to <code>:FREQ:RF:CENT</code> – For I/Q input it is equivalent to <code>:FREQ:IQ:CENT</code> – For External Mixer it is equivalent to <code>:FREQ:EMIX:CENT</code> <p>Preset and Max values are dependent on Hardware Options (5xx)</p> <p>If no terminator (for example, MHz) is sent, the terminator Hz is used. If a terminator with unit other than Frequency is used, an invalid suffix error message is generated</p>
Couplings	<p>In LTEAFDD/LTEATDD and 5GNR Modes:</p> <p>Center Frequency, Center Frequency Offset and Carrier Reference Frequency are coupled with the following equation:</p> $\text{Center Frequency} = \text{Carrier Reference Frequency} + \text{Center Frequency Offset}$ <p>If the following conditions are satisfied at the same time:</p> <ul style="list-style-type: none"> – the Num Component Carrier equals to 1 – the Center Frequency Offset equals to 0 Hz – the mode of the Center Frequency is Auto <p>The Center Frequency is equivalent to Carrier Reference Frequency</p> <p>The major purpose of this coupling is to keep BWCC with legacy LTE, in which <code>:SENSe:FREQuency:CENTer</code> is used to set up the Frequency of the measurement</p> <p>Otherwise, the Center Frequency Offset is changed following the Center Frequency and the Carrier Reference Frequency keeps intact</p> <p>In MSR, Center Freq, Center Freq Offset and Carrier Ref Freq are coupled with the equation, $\text{Center Freq} = \text{Carrier Ref Freq} + \text{Center Freq Offset}$. When Center Freq is changed, Center Freq Offset is updated and Carrier Ref Freq is not changed</p> <p>When auto, Center Freq Offset remains the same value. Thus, Center Freq changes the same amount of Carrier Ref Freq change when Carrier Ref Freq is changed. The auto state changes to manual when either Center Freq is changed</p> <p>In Bluetooth Mode:</p> <p>Center Frequency is coupled to Channel and Geography</p> <ul style="list-style-type: none"> – If Geography is France: Center Frequency 2454 MHz + (channel number* channel space) MHz

- If Geography is Others: Center Frequency 2402 MHz + (channel number* channel space) MHz
- If Radio Stand is Basic or EDR, channel space is 1 MHz
- If Radio Stand is Low Energy, channel space is 2 MHz

In other modes:
Any value of the Center Frequency or Span that keeps start frequency and stop frequency within the frequency range of the instrument is allowed when the value is being set through the front panel numeric keypad or the SCPI command. Other frequency parameters are forced to different values if needed, to keep the start and stop frequencies within the instrument's frequency range

Preset	Depends on instrument maximum frequency, mode, measurement, and selected input See "Center Frequency Presets" on page 363, "RF Center Freq" on page 365, "Ext Mix Center Freq" on page 365, "I/Q Center Freq" on page 366 and "VXT Models with Radio Heads/CIU Frequency Range" on page 364
State Saved	Saved in instrument state
Min/Max	Depends on instrument maximum frequency, mode, measurement, and selected input See "Center Frequency Presets" on page 363, "RF Center Freq" on page 365, "Ext Mix Center Freq" on page 365, "I/Q Center Freq" on page 366 and "VXT Models with Radio Heads/CIU Frequency Range" on page 364
Annotation	Center <value> appears in the lower left corner of the display
Status Bits/OPC dependencies	Non-overlapped

Center Frequency Auto State

Remote Command	<code>[:SENSe] :FREQuency :CENTer :AUTO ON OFF 1 0</code> <code>[:SENSe] :FREQuency :CENTer :AUTO?</code>
Example	<code>:FREQ:CENT:AUTO OFF</code> <code>:FREQ:CENT:AUTO?</code>
Dependencies	This is only available in MSR, LTEAFDD/LTEATDD and 5GNR Modes
Couplings	When the Center Frequency is changed, the state is automatically changed to Manual Center Frequency, Center Frequency Offset and Carrier Reference Frequency are coupled. When Carrier Reference Frequency changes: <ul style="list-style-type: none"> - Center Frequency : Auto Center Frequency = Carrier Reference Frequency + Center Frequency Offset (fixed) - Center Frequency : Man Center Frequency (fixed) = Carrier Reference Frequency + Center Frequency Offset
Preset	ON
State Saved	Saved in instrument state
Range	Auto Man

Center Frequency Presets

The following table provides the Center Frequency Presets for the Spectrum Analyzer mode, and the Max Freq, for the various frequency options:

Freq Option	CF after Mode Preset	Stop Freq after Mode Preset	Max Freq (can't tune above)
503 (all but CXA)	1.805 GHz	3.6 GHz	3.7 GHz
503 (CXA)	1.505 GHz	3.0 GHz	3.08 GHz
507 (all but CXA)	3.505 GHz	7.0 GHz	7.1 GHz
507 (CXA)	3.755 GHz	7.5 GHz	7.58 GHz
508 (all but MXE)	1.805 GHz	3.6 GHz	8.5 GHz
508 (MXE)	4.205 GHz	8.4 GHz	8.5 GHz
513	6.805 GHz	13.6 GHz	13.8 GHz
526 (except CXA and MXE)	13.255 GHz	26.5 GHz	27.0 GHz*
526 (CXA)	13.255 GHz	26.5 GHz	26.55 GHz
526 (MXE)	1.805 GHz	3.6 GHz	27.0 GHz
532	16.005 GHz	32.0 GHz	32.5 GHz
540	20.005 GHz	40.0 GHz	40.5 GHz
543	21.505 GHz	43.0 GHz	43.0 GHz
544	22.005 GHz	44.0 GHz	45.0 GHz
550	25.005 GHz	50.0 GHz	52 GHz
F03 (CXA-m)	1.505 GHz	3.0 GHz	3.08 GHz
F07 (CXA-m)	3.755 GHz	7.5 GHz	7.575 GHz
F13 (CXA-m)	6.805 GHz	13.6 GHz	13.8 GHz
F26 (CXA-m)	13.255 GHz	26.5 GHz	26.55 GHz
504 (M9421A, M8920A)	2.145 GHz	3.88GHz	3.88 GHz
506 (M9421A, M8920A)	3.245 GHz	6.08GHz	6.08 GHz
F06 (M9410A/11A)	1.0 GHz	6.08 GHz	6.08 GHz
F06 (M9415A)	1 GHz	1.08 GHz	6.6 GHz
F08 (M9415A)	1 GHz	1.08 GHz	8.6 GHz
F12 (M9415A)	1 GHz	1.08 GHz	12.9 GHz

*For option 526, the Max CF in RTSA is 26.999999995 GHz.

N9041B Center Freq Presets

Input	CF after Mode Preset	Stop Freq after Mode Preset	Max Freq (can't tune above)
Input 1, all models	25.005 GHz	50.0 GHz	52 GHz

Input	CF after Mode Preset	Stop Freq after Mode Preset	Max Freq (can't tune above)
Input 2, opt 585	42.505 GHz	85.0 GHz	86 GHz
Input 2, opt 590	45.005 GHz	90.0 GHz	92 GHz
Input 2, opt 5CX	55.005 GHz	110.0 GHz	110 GHz

Input 2, CXA and MXE

Model	CF after Mode Preset	Stop Freq after Mode Preset	Max Freq (can't tune above)
CXA opt C75	0.7505 GHz	1.5 GHz	1.58 GHz
MXE	505 MHz	1 GHz	1.000025 GHz

Tracking Generator Frequency Limits (CXA only)

Tracking Generator Option	Min Freq (clips to this freq when turn TG on and can't tune below while TG on)	If above this Freq, Stop Freq clipped to this Freq when TG turned on	Max Freq (can't tune above) while TG on
T03	9 kHz	3.0 GHz	3.08 GHz
T06	9 kHz	6.0 GHz	6.05 GHz

Tracking Generator Frequency Limits(CXA-m only)

Tracking Generator Option	Min Freq (clips to this freq when turn TG on and can't tune below while TG on)	If above this Freq, Stop Freq clipped to this Freq when TG turned on	Max Freq (can't tune above) while TG on
T03	2 MHz	3.08 GHz	3.08 GHz
T07	2 MHz	7.575 GHz	7.575 GHz
T13	2 MHz	13.8 GHz	13.8 GHz
T26	2 MHz	26.55 GHz	26.55 GHz

VXT Models with Radio Heads/CIU Frequency Range

The following table shows the Center Frequency Presets and Range for VXT modes with Radio Heads/CIU.

Products with Radio Heads/CIU	Preset	Start frequency	Stop frequency
M9421A + CIU	6 GHz	5.9 GHz	12 GHz
M9410A + CIU	6 GHz	5.9 GHz	12 GHz
M9410A + CIU + RRH	25 GHz	24.25 GHz	43.5 GHz

RF Center Freq

Specifies the RF Center Frequency. This command sets the Center Frequency to be used when the RF input is selected, even if the RF input is not the input that is selected at the time the command is sent. Note that **"Center Frequency" on page 360** in the **Frequency** menu on the front panel always applies to the currently selected input.

Remote Command	<code>[:SENSe] :FREQuency:RF:CENTer <freq></code> <code>[:SENSe] :FREQuency:RF:CENTer?</code>
Example	<code>:FREQ:RF:CENT 30 MHz</code> <code>:FREQ:RF:CENT?</code>
Notes	This command is the same in all Modes, but the parameter is Measurement Global, so the value is independent in each Mode and common across all the measurements in the Mode
Dependencies	If the electronic/soft attenuator is enabled, any attempt to set Center Frequency such that the Stop Frequency would be >3.6 GHz fails and results in an advisory message. If the equivalent SCPI command is sent, this same message is generated as part of a "-221, Settings conflict" warning
Preset	See "Center Frequency Presets" on page 363 above
State Saved	Saved in instrument state
Min	-79.999995 MHz
Max	See table above. Basically, instrument maximum frequency - 5 Hz If the knob or step keys are being used, also depends on the value of Span

Ext Mix Center Freq

Specifies the External Mixer Center Frequency. This command sets the Center Frequency to be used when the External Mixer is selected, even if the External Mixer input is not the input that is selected at the time the command is sent. Note that **"Center Frequency" on page 360** in the **Frequency** menu on the front panel always applies to the currently selected input.

Remote Command	<code>[:SENSe] :FREQuency:EMIXer:CENTer <freq></code> <code>[:SENSe] :FREQuency:EMIXer:CENTer?</code>
Example	<code>:FREQ:EMIX:CENT 60 GHz</code> <code>:FREQ:EMIX:CENT?</code>
Notes	This command is the same in all Modes, but the parameter is Measurement Global, so the value is independent in each Mode and common across all the measurements in the Mode
Couplings	When returning to External Mixing after having been switched to one of the other inputs (e.g., RF), you will come back into the settings that you had when you left External Mixing. So, you will come back to the band you were in with the Center Frequency that you had. However, Span is not an input-dependent parameter, therefore you will bring the span over from the other input. Therefore, the instrument comes back with the span from the previous input, limited as necessary by the current mixer setup
Preset	When a Mode Preset is performed while in External Mixing, the Start frequency of the current Mode is

set to the nominal Min Freq of the lowest harmonic range in the Harmonic Table for the current mixer setup. Similarly, the Stop frequency of the current Mode is set to the nominal Max Freq of the highest harmonic range in the Harmonic Table. The Center Freq thus presets to the point arithmetically equidistant from these two frequencies

Note that, if the current measurement has a limited Span available to it, and cannot achieve the Span shown in the table (Span=Stop Freq – Start Freq), the instrument uses the maximum Span the measurement allows, and still sets the Center Freq to the midpoint of the Start and Stop Freq values in the Harmonic Table

When Restore Input/Output Defaults is performed, the mixer presets to the 11970A, whose Start and Stop frequencies are 26.5 and 40 GHz respectively. The center of these two frequencies is 33.25 GHz. Therefore, after a Restore Input/Output Defaults, if you go into External Mixing and do a Mode Preset while in the Spectrum Analyzer Mode, the resulting Center Freq is 33.25 GHz

State Saved	Yes
Min	The minimum frequency in the currently selected mixer band + 5 Hz If the knob or step keys are being used, also depends on Span
Max	The maximum frequency in the currently selected mixer band - 5 Hz If the knob or step keys are being used, also depends on Span

I/Q Center Freq

Specifies the I/Q Center Frequency. This command sets the Center Frequency to be used when the I/Q input is selected, even if the I/Q input is not the input that is selected at the time the command is sent. Note that **"Center Frequency" on page 360** in the **Frequency** menu on the front panel always applies to the currently selected input.

Remote Command	<code>[:SENSe] :FREQuency :IQ :CENTer <freq></code> <code>[:SENSe] :FREQuency :IQ :CENTer?</code>
Example	<code>:FREQ:IQ:CENT 30 MHz</code>
Notes	This command is the same in all Modes, but the parameter is Measurement Global, so the value is independent in each Mode and common across all the measurements in the Mode
Preset	0 Hz
State Saved	Saved in instrument state
Min	-40.049995 MHz
Max	40.049995 MHz

Span

Changes the displayed frequency range symmetrically about the center frequency.

NOTE

Entered values of Span must be odd numbers of MHz.

3 Bluetooth Mode

3.3 Adjacent Channel Power

Remote Command	<code>[:SENSe] :ACPower:FREQuency:SPAN <freq></code> <code>[:SENSe] :ACPower:FREQuency:SPAN?</code>
Example	<code>:ACP:FREQ:SPAN 25MHz</code> <code>:ACP:FREQ:SPAN?</code>
Couplings	If Meas Method is FFT, the maximum value of Span couples to the MAX IFBW of the instrument
Preset	79 MHz
State Saved	Saved in instrument state
Min/Max	1.0 MHz/ 79.000 MHz
Annotation	Bottom right of RF Spectrum graph

LMH Channel

Enables quick selection from a subset of the available channel numbers for the Low (channel 0), Middle (channel 39), or High (channel 78) channels.

Remote Command	<code>[:SENSe] :CHANne1:LMH LOW MID HIGH</code> <code>[:SENSe] :CHANne1:LMH?</code>
Example	<code>:FREQ:LMH MID</code> <code>:FREQ:LMH?</code>
Couplings	If Radio Stand is Basic or EDR, the soft key label is Low(0), Mid(39), High(78) If Radio Stand is Low Energy, the soft key label is Low(0), Mid(20), High(39) If geography is France, this key will be grayed-out
Preset	LOW
State Saved	Yes
Range	LOW MID HIGH
Backwards Compatibility SCPI	<code>[:SENSe] :FREQuency:LMH LOW MID HIGH</code> <code>[:SENSe] :FREQuency:LMH?</code>

Geography

Selects the desired country. The selection defines the frequency range and the available channel numbers for the transmit channel.

Remote Command	<code>[:SENSe] :FREQuency:GEOGraphy FRANce OTHERs</code> <code>[:SENSe] :FREQuency:GEOGraphy?</code>
Example	<code>:FREQ:GEOG FRAN</code> <code>:FREQ:GEOG?</code>
Couplings	France:

	<ul style="list-style-type: none"> - Center Frequency 2454 MHz + (0...22) MHz - Channel Number: 0...22 <p>Others:</p> <ul style="list-style-type: none"> - Center Frequency 2402 MHz + (0...78) MHz - Channel Number: 0...78
Preset	OTHers
State Saved	Yes
Range	FRANce OTHers

CF Step

Changes the step size for the center frequency and start and stop frequency functions. Once a step size has been selected and the center frequency function is active, the step keys (and the UP|DOWN parameters for Center Frequency from remote commands) change the center frequency by the step-size value. The step size function is useful for finding harmonics and sidebands beyond the current frequency span of the instrument.

Note that the start and stop frequencies also step by the CF Step value.

Remote Command	<pre>[:SENSe]:FREQuency:CENTer:STEP[:INCRement] <freq> [:SENSe]:FREQuency:CENTer:STEP[:INCRement]? [:SENSe]:FREQuency:CENTer:STEP:AUTO OFF ON 0 1 [:SENSe]:FREQuency:CENTer:STEP:AUTO?</pre>
Example	<pre>:FREQ:CENT:STEP 500 MHz :FREQ:CENT UP</pre> <p>Increases the current center frequency value by 500 MHz</p> <pre>:FREQ:CENT:STEP? :FREQ:CENT:STEP:AUTO ON :FREQ:CENT:STEP:AUTO?</pre>
Notes	Preset and Max values are dependent on Hardware Options
Dependencies	Not available in MSR, LTEAFDD/LTEATDD, 5GNR and Channel Quality Modes If the electronic/soft attenuator is enabled, any attempt to change the value of the center frequency >3.6 GHz by pressing the Up-arrow key, fails and results in an advisory message. If the equivalent SCPI command is sent, this same message is generated as part of a "-221, Settings conflict" warning
Couplings	When auto-coupled, the center frequency step size is set to 10% of the span
Preset	Auto ON

State Saved	Saved in instrument state
Min	– (the maximum frequency of the instrument). That is, 27 GHz max freq instrument has a CF step range of +/- 27 GHz. Note that this is the maximum frequency given the current settings of the instrument, so in External Mixing, for example, it is the maximum frequency of the current mixer band
Max	The maximum frequency of the instrument. That is, 27 GHz max freq instrument has a CF step range of +/- 27 GHz. Note that this is the maximum frequency given the current settings of the instrument, so in External Mixing, for example, it is the maximum frequency of the current mixer band
Status Bits/OPC dependencies	non-overlapped

3.3.7 Marker

The Marker key accesses the Marker menu. A marker can be placed on a trace to allow the value of the trace at the marker point to be determined precisely. The functions in this menu include a 1-of-N selection of the control mode Normal, Delta, or Off for the selected marker. If the selected marker is Off, pressing Marker sets it to Normal and places it at the center of the screen on the trace determined by the Marker Trace rules.

Markers may also be used in pairs to read the difference (or delta) between two data points. They can be used in Marker Functions to do advanced data processing, or to specify operating points in functions like Signal Track and N dB Points.

3.3.7.1 Select Marker

Specifies the selected marker. The term “selected marker” is used throughout this document to specify which marker will be affected when you change marker settings, perform a Peak Search, etc.

The Select Marker control appears above the menu panel, indicating that it applies to all controls in the Marker menu panels. Select Marker is blanked if you select a tab whose controls do NOT depend on the selected marker (e.g., Counter).

On any menu tab for which Select Marker displays, the first control is always Marker Frequency|Time.

Notes	The selected marker is remembered even when not in the Marker menu and is used if a Search is done or a Band Function is turned on or for Signal Track or Continuous Peak
Preset	Marker 1
State Saved	The number of the selected marker is saved in instrument state
Annunciation	Appears in the marker results block label for Normal and Delta markers

3.3.7.2 Settings

The controls on the Settings tab include the Marker active function and a radio button selection of the marker control mode (Normal, Delta or Off) for the selected marker, as well as additional functions that help you use markers.

Marker X-Axis Value

The command below sets and queries a marker's X-Axis value in frequency or time.

Remote Command	<code>:CALCulate:ACPower:MARKer[1] 2 ... 12:X <real></code> <code>:CALCulate:ACPower:MARKer[1] 2 ... 12:X?</code>
Example	<code>:CALC:ACP:MARK:X 2.402E+9</code> <code>:CALC:ACP:MARK:X?</code>
Notes	The query is returned in the fundamental units for the current marker X-Axis scale. This command (not the query) causes the specified marker to become selected
Dependencies	The Marker X-Axis unit is dependent on the currently selected window For RF Envelope the units will be ns us ms s ks For RF Spectrum the units will be Hz kHz MHz GHz
Preset	After a preset, all Markers are turned OFF, so Marker X-Axis Value query will return not a number (NAN). When Marker is On, default value of Marker X-Axis value is the center of the appropriate window
State Saved	Yes
Min	-9.91E+37
Max	9.91E+37

Marker Y-Axis Value (Remote Command Only)

The command below queries a marker's Y-Axis value only.

Remote Command	<code>:CALCulate:ACPower:MARKer[1] 2 ... 12:Y?</code>
Example	<code>:CALC:ACP:MARK:Y?</code>
Preset	Since the result value is always calculated from acquisition data, the default value is arbitrary. Although the Preset/Default values are defined
Min	-9.91E+37
Max	9.91E+37

Marker Mode

Sets the marker control mode to **Normal**, **Delta**, or **Off**. All interactions and dependencies detailed under the control description are enforced when the remote command is sent. If the selected marker is **Off**, pressing Marker sets it to **Normal** and places it at the center of the screen on the trace determined by the Marker Trace rules. At the same time, Marker X Axis Value appears on the Active Function area.

The default active function is the active function for the currently selected marker control mode. If the current control mode is **Off**, there is no active function and the active function is turned off.

Remote Command	<code>:CALCulate:ACP:MARKer[1] 2 ... 12:MODE POSition DELTa OFF</code> <code>:CALCulate:ACP:MARKer[1] 2 ... 12:MODE?</code>
Example	<code>:CALC:ACP:MARK:MODE POS</code> <code>:CALC:ACP:MARK:MODE?</code>
Notes	This command (not the query) causes the specified marker to become selected
Couplings	If a marker has the mode changed to delta, the Marker Trace setting of the delta marker will be that of the reference marker If a delta marker has a reference marker in a different window, the delta marker's mode changes to normal
Preset	OFF (all markers)

Delta Marker (Reset Delta)

Pressing this button is exactly the same as pressing the “Delta” selection on the Marker Mode radio button. The selected marker becomes a Delta Marker. If the selected marker is already a Delta marker, the reference marker is moved to the current position of the selected marker, thus resetting the Delta to zero.

Marker Settings Diagram

The Marker Settings Diagram lets you configure the Marker system using a visual utility.

All Markers Off

Turns off all markers.

Remote Command	<code>:CALCulate:ACPower:MARKer:AOFF</code>
Example	<code>:CALC:ACP:MARK:AOFF</code>

Couple Markers

When this function is On, moving any marker causes an equal X Axis movement of every other marker which is not Fixed or Off. By “equal X Axis movement” we mean that we preserve the difference between each marker’s X Axis value (in the fundamental x-axis units of the trace that marker is on) and the X Axis value of the marker being moved (in the same fundamental x-axis units).

This may result in markers going off screen.

Remote Command	:CALCulate:ACPower:MARKer:COUPle[:STATe] ON OFF 1 0 :CALCulate:ACPower:MARKer:COUPle[:STATe]?
Example	:CALC:ACP:MARK:COUP ON :CALC:ACP:MARK:COUP?
Preset	OFF, presets on Mode Preset and All Markers Off
State Saved	Saved in instrument state

3.3.7.3 Peak Search

The controls on the Peak Search tab allow you to move the marker to selected peaks of the signal, giving you enormous analysis capabilities, particularly when combined with the Delta Marker function.

NOTE

Pressing the Peak Search hardkey automatically moves you to the Peak Search page of the Marker menu AND performs a Peak Search.

Pressing the Peak Search tab once you are already IN the Marker menu does NOT perform a Peak Search.

Marker X-Axis Value

The Marker X-Axis Value control is the fundamental control that you use to move a marker around on the trace. This is the same as the "[Marker X-Axis Value](#)" on page 370 control on the Settings tab.

Peak Search

Pressing the Peak Search control moves the selected marker to the trace point which has the maximum y-axis value for that marker’s trace..

NOTE

Pressing the Peak Search hardkey automatically moves you to the Peak Search page of the Marker menu AND performs a Peak Search.

Remote Command	<code>:CALCulate:ACPower:MARKer[1] 2 ... 12:MAXimum</code>
Example	<code>:CALC:ACP:MARK2:MAX</code> <code>:SYST:ERR?</code> Can be used to query the errors to determine if a peak is found. The message "No peak found" (-200) will be returned after an unsuccessful search
Notes	Sending this command selects the subopcoded marker This command does not work when the selected marker is located on the polar trace. In this case, the command is ignored

Next Peak

Pressing Next Peak moves the selected marker to the peak that is next lower in amplitude than the current marker value. Only peaks which meet all enabled peak criteria are considered. If there is no valid peak lower than the current marker position, a "No peak found" message is generated and the marker is not moved.

If the selected marker was off, then it is turned on as a normal marker and a peak search is performed.

Remote Command	<code>:CALCulate:ACPower:MARKer[1] 2 ... 12:MAXimum:NEXT</code>
Example	<code>:CALC:ACP:MARK2:MAX:NEXT</code>
Notes	Sending this command selects the subopcoded marker
State Saved	Not part of saved state

Next Peak Right

Pressing Next Pk Right moves the selected marker to the nearest peak right of the current marker that meets all enabled peak criteria. If there is no valid peak to the right of the current marker position, a "No peak found" message is generated and the marker is not moved.

If the selected marker was off, then it is turned on as a normal marker and a peak search is performed.

Parameter Name	Next Peak Search on the Right
Control Path	Marker, Peak Search
Control Type	Immediate Action

SCPI Command	<code>:CALCulate:ACPower:MARKer[1] 2 ... 12:MAXimum:RIGHT</code>
SCPI Example	<code>:CALC:ACP:MARK2:MAX:RIGH</code>
Notes	Sending this command selects the subopcoded marker
State Saved	Not part of saved state
Initial S/W Revision	Prior to A.02.00
Help Map ID	470288

Next Peak Left

Pressing Next Pk Left moves the selected marker to the nearest peak left of the current marker that meets all enabled peak criteria. If there is no valid peak to the left of the current marker position, a “No peak found” message is generated and the marker is not moved.

If the selected marker was off, then it is turned on as a normal marker and a peak search is performed.

Pressing this control moves the selected marker to the nearest active channel left of the current marker when Marker Trace is Code Domain Power. In other cases, moves the selected marker to the highest peak left of the current marker.

Parameter Name	Next Peak Search on the Left
Control Path	Marker, Peak Search
Control Type	Immediate Action
SCPI Command	<code>:CALCulate:ACPower:MARKer[1] 2 ... 12:MAXimum:LEFT</code>
SCPI Example	<code>:CALC:ACP:MARK2:MAX:LEFT</code>
State Saved	Not part of saved state
Initial S/W Revision	Prior to A.02.00
Help Map ID	470289

Minimum Peak

Moves the selected marker to the minimum y-axis value on the current trace. Minimum (negative) peak searches do not have to meet the peak search criteria. It just looks for the lowest y-axis value. If the selected marker is Off, it is turned on before the minimum search is performed.

Parameter Name	Minimum Peak Search
Control Path	Marker, Peak Search
Control Type	Immediate Action
SCPI Command	<code>:CALCulate:ACPower:MARKer[1] 2 ... 12:MINimum</code>

3 Bluetooth Mode
 3.3 Adjacent Channel Power

SCPI Example	<code>:CALC:ACP:MARK:MIN</code>
Notes	Sending this command selects the subopcoded marker
State Saved	Not part of saved state
Initial S/W Revision	Prior to A.02.00
Modified at S/W Revision	A.03.00
Help Map ID	470290

Pk-Pk Search

Finds and displays the amplitude and frequency (or time, if in zero span) differences between the highest and lowest y-axis value. It places the selected marker on the minimum value on its selected trace. And it places that marker's reference marker on the peak of its selected trace.

This function turns on the reference marker and sets its mode to **Normal** if it is not already on. (These markers may be on two different traces.)

The rules for finding the maximum peak are exactly the same as for Peak Search , including the use of the peak criteria rules. However, the minimum trace value is not required to meet any criteria other than being the minimum y-axis value in the trace.

If the selected marker is off, a delta type marker is turned on and the peak-to-peak search is done. If the selected marker is on, but it is not a delta marker, then it is changed to delta which turns on the reference marker if needed, and then it performs the peak-to-peak function.

Parameter Name	Pk-Pk Search
Control Path	Marker, Peak Search
Control Type	Immediate Action
SCPI Command	<code>:CALCulate:ACPower:MARKer[1] 2 ... 12:PTPeak</code>
SCPI Example	<code>:CALC:ACP:MARK:PTP</code>
Notes	Turns on the Marker D active function Sending this command selects the subopcoded marker
Dependencies	Pk-Pk Search is not available when Coupled Markers is on
Couplings	The selected marker becomes a delta marker if not already in delta mode
Preset	n/a
State Saved	Not part of saved state
Initial S/W Revision	Prior to A.02.00
Help Map ID	470291

Marker Delta

Pressing this button is exactly the same as pressing the “Delta” selection on the Marker Mode radio button on the Settings tab. The selected marker becomes a Delta Marker. If the selected marker is already a Delta marker, the reference marker is moved to the current position of the selected marker, thus resetting the Delta to zero.

The control is duplicated here in the Peak Search Menu to allow you to conveniently perform a peak search and change the marker’s control mode to Delta without having to access two separate menus.

3.3.7.4 Properties

The controls on the Properties tab are used to set certain properties of the selected marker.

Marker X-Axis Value

The Marker X-Axis Value control is the fundamental control that you use to move a marker around on the trace. This is the same as the "[Marker X-Axis Value](#)" on page 370 control on the Settings tab.

Relative To

Selects the marker to which the selected marker is relative (its *reference marker*).

Every marker has another marker to which it is relative. This marker is referred to as the “reference marker” for that marker. This attribute is set by the **Marker, Properties, Relative To** key. The marker must be a **Delta** marker to make this attribute relevant. If it is a **Delta** marker, the reference marker determines how the marker is controlled and how its value is displayed. A marker cannot be relative to itself.

Remote Command `:CALCulate:ACPower:MARKer[1]|2|...|12:REference <integer>`

Command `:CALCulate:ACPower:MARKer[1]|2|...|12:REference?`

Example `:CALC:ACP:MARK:REF 5`

`:CALC:ACP:MARK:REF?`

Notes This command causes the marker specified with the subopcode to become selected

Range (for SCPI command): 1 to 12. If the range is exceeded the value is clipped

A marker cannot be relative to itself so that choice is not available, and if sent from SCPI generates error -221: “Settings conflict; marker cannot be relative to itself”

3 Bluetooth Mode
3.3 Adjacent Channel Power

	When queried a single value is returned (the specified marker numbers relative marker)
Couplings	The act of specifying the selected marker's reference marker makes the selected marker a Delta marker If the reference marker is off it is turned on in Normal mode at the delta marker location
Preset	The preset default "Relative To" marker (reference marker) is the next higher numbered marker (current marker +1). For example, if marker 2 is selected, then it's default reference marker is marker 3. The exception is marker 12, which has a default reference of marker 1 Set to the defaults by using Restore Mode Defaults . This is not reset by Marker Off , All Markers Off , or Preset
State Saved	Saved in instrument state. Not affected by Marker Off and hence not affected by Preset or power cycle
Min	1
Max	12
Annunciation	Appears in the marker label of a Delta marker

Marker Trace

Selects the trace on which to place the marker. A marker is associated with one and only one trace. This trace is used to determine the placement, result, and X Axis Scale of the marker. All markers have an associated trace. It is from that trace that they determine their attributes and behaviors, and it is to that trace that they go when they become Normal or Delta markers.

If the marker is not **Off**, it moves the marker from the trace it was on to the new trace. If the marker changes windows, it retains its relative horizontal positions in the new window.

If the marker is **off** it stays off, but is now associated with the specified trace.

Remote Command	<code>:CALCulate:ACPower:MARKer[1] 2 ... 12:TRACe RFENvelope RFSpectrum</code> <code>:CALCulate:ACPower:MARKer[1] 2 ... 12:TRACe?</code>
Example	<code>:CALC:ACP:MARK2:TRAC RFEN</code> <code>:CALC:ACP:MARK:TRACE?</code>
Couplings	Sending the remote command causes the addressed marker to become selected If ever a delta marker has a reference marker in a different window, the delta marker's mode changes to Pos(for example, it becomes a normal marker)
Preset	RF Spectrum Presets on Preset or All Markers Off
State Saved	Yes

Marker Settings Diagram

The Marker Settings Diagram lets you configure the Marker system using a visual utility. This is the same as the "[Marker Settings Diagram](#)" on page 371 control on the

Settings tab.

3.3.7.5 Marker Function

The controls on the Marker Function tab allow you to control the Marker Functions of the instrument. Marker Functions perform post-processing operations on marker data.

Marker X-Axis Value

The Marker X-Axis Value control is the fundamental control that you use to move a marker around on the trace. This is the same as the "Marker X-Axis Value" on page 370 control on the Settings tab.

Marker Function

Sets the marker control function type to, Marker Noise, Band/Interval Power, Band Interval Density, or Marker Function Off.

All interactions and dependencies detailed under the key description are enforced when the remote command is sent.

Remote Command	<code>:CALCulate:ACPower:MARKer[1] 2 ... 12:FUNCtion NOISe BPOwer BDENsity =OFF</code> <code>:CALCulate:ACPower:MARKer[1] 2 ... 12:FUNCtion?</code>
Example	<code>:CALC:ACP:MARK:FUNC NOIS</code> <code>:CALC:ACP:MARK:FUNC?</code>
Dependencies	Only RF Spectrum Trace has Marker Function
Preset	OFF
State Saved	Yes
Range	Marker Noise Band/Interval Power Band Interval Density Marker Function Off
Annotation	Mkr # <X value> and <Marker value> upper right on graph

Band Span

Sets the width of the frequency span for the selected marker.

Remote Command	<code>:CALCulate:ACPower:MARKer[1] 2 ... 12:FUNCtion:BAND:SPAN <freq></code> <code>:CALCulate:ACPower:MARKer[1] 2 ... 12:FUNCtion:BAND:SPAN?</code>
Example	<code>:CALC:ACP:MARK12:FUNC:BAND:SPAN 20 MHz</code> <code>:CALC:ACP:MARK12:FUNC:BAND:SPAN?</code>

3 Bluetooth Mode
3.3 Adjacent Channel Power

Couplings	Changing the Band Span necessarily changes the Band Left and Band/Interval Right values
Preset	0
State Saved	Yes
Min/Max	100.0 kHz/200.0 MHz

Band Left

Sets the left edge frequency for the band of the selected marker.

Remote Command	<code>:CALCulate:ACPower:MARKer[1] 2 ... 12:FUNCTION:BAND:LEFT <freq></code> <code>:CALCulate:ACPower:MARKer[1] 2 ... 12:FUNCTION:BAND:LEFT?</code>
Example	<code>:CALC:ACP:MARK12:FUNC:BAND:LEFT 20 MHz</code> <code>:CALC:ACP:MARK12:FUNC:BAND:LEFT?</code>
Couplings	Changing the Band Left necessarily changes the Band Span and Band Right values
Preset	Depends on X axis range of selected Trace
State Saved	Yes
Min/Max	-9.91E+37/9.91E+37

Band Right

Sets the right edge frequency for the band of the selected marker.

Remote Command	<code>:CALCulate:ACPower:MARKer[1] 2 ... 12:FUNCTION:BAND:RIGHT <freq></code> <code>:CALCulate:ACPower:MARKer[1] 2 ... 12:FUNCTION:BAND:RIGHT?</code>
Example	<code>:CALC:ACP:MARK12:FUNC:BAND:RIGH 20 MHz</code> <code>:CALC:ACP:MARK12:FUNC:BAND:RIGH?</code>
Couplings	Changing the Band Right necessarily changes the Band Left and Band Span values
Preset	Depends on X axis range of selected Trace
State Saved	Yes
Min/Max	-9.91E+37/9.91E+37

3.3.8 Meas Setup

The Meas Setup menu panel contains functions for setting up the measurement parameters.

3.3.8.1 Settings

This tab enables you to set measurement parameters.

Meas Method

Sweep means each 100 kHz bin's data capture mode is by Sweep.

Remote Command	<code>[:SENSe] :ACPower:METhod SWEEp FFT</code> <code>[:SENSe] :ACPower:METhod?</code>
Example	<code>:ACP:METh SWEE</code> <code>:ACP:METh?</code>
Preset	SWEEp
State Saved	Yes
Range	Sweep FFT

IF Gain

Enables you to control an internally switched IF amplifier with approximately 10 dB of gain. This amplifier takes full advantage of the RF dynamic range of the analyzer. When it can be turned on without an overload, the dynamic range is always better when the amplifier is set to On, than when it is set to Off. The control "IF Gain" can be used to set the IF Gain function to Auto, or to On (the extra 10 dB) or Off. These settings affect sensitivity and IF overloads.

This only applies to the RF input. It does not apply to baseband I/Q input.

IF Gain Auto

Activates the auto rules for IF Gain.

Remote Command	<code>[:SENSe] :ACP:IF:GAIN:AUTO[:STATe] OFF ON 0 1</code> <code>[:SENSe] :ACP:IF:GAIN:AUTO[:STATe]?</code>
Example	<code>:ACP:IF:GAIN:AUTO OFF</code> <code>:ACP:IF:GAIN:AUTO?</code>
Notes	This only applies to the RF input. It does not apply to baseband I/Q input
Dependencies	This control does not appear in VXT models M9421A/10A/11A, or UXM
Couplings	When either the auto attenuation works (for example, with the electrical attenuator) or optimize mechanical attenuator range is requested, the IF Gain setting is changed according to the following rule 'Auto' sets IF Gain to 'High Gain' under any of the following conditions: the input attenuator is set to 0 dB, the preamp is turned on, or the Max Mixer Level is -20 dBm or lower. For other settings, 'Auto' sets IF Gain to 'Low Gain'
Preset	OFF

State Saved	Yes
Range	Auto Man
IF Gain State	
Selects the range of IF gain.	
Remote Command	<code>[:SENSe]:ACP:IF:GAIN[:STATe] ON OFF 1 0</code> <code>[:SENSe]:ACP:IF:GAIN[:STATe]?</code>
Example	<code>:ACP:IF:GAIN OFF</code> <code>:ACP:IF:GAIN?</code>
Notes	Where ON = high gain OFF = low gain This only applies to the RF input. It does not apply to baseband I/Q input
Dependencies	This control does not appear in VXT models M9421A/10A/11A, M9393A, M9391A, or UXM
Couplings	When either the auto attenuation works (for example, with the electrical attenuator) or optimize mechanical attenuator range is requested, the IF Gain setting is changed according to the following rule 'Auto' sets IF Gain to 'High Gain' under any of the following conditions: the input attenuator is set to 0 dB, the preamp is turned on, or the Max Mixer Level is -20 dBm or lower. For other settings, 'Auto' sets IF Gain to 'Low Gain'
Preset	OFF
State Saved	Yes
Range	Low Gain High Gain

Spur Avoidance

Because the VXT models M9410A/11A/15A are direct-conversion (zero-IF) receivers, feedthrough leakage from the local oscillator appears as a spurious signal (spur) at the center frequency. The **Spur Avoidance** function is provided to eliminate this spur, at the expense of some measurement speed.

When **Spur Avoidance** is enabled (the default), the analyzer uses a software algorithm to remove this spur from the displayed measurement data, but the algorithm only operates under certain conditions. Specifically, it only operates in multiple capture case.

You can disable this function to speed up your measurement by setting Spur Avoidance to "Disabled."

Note that when Spur Avoidance is not in effect, either because you have disabled it or because you are not in multiple capture, the following warning message appears in the status bar:

Settings Alert;Spur Avoidance Off

This is to alert you that measurement accuracy might be impacted by the fact that Spur Avoidance is not in effect.

Remote Command	<code>[:SENSe]:ACPower:SAVoid[:STATe] ON OFF 0 1</code> <code>[:SENSe]:ACPower:SAVoid[:STATe]?</code>
Example	<code>:ACP:SAV ON</code> <code>:ACP:SAV?</code>
Dependencies	This control only appears in VXT models M9410A/11A/15A
Preset	OFF
State Saved	Saved in instrument state
Range	ON OFF

Preset To Standard

This is immediate. It enables the setting to comply with the standard requirement.

Remote Command	<code>[:SENSe]:ACPower:PRESet:STANdard</code>
Example	<code>:ACP:PRES:STAN</code>
Couplings	When this key is pressed, following settings are changed: Meas Method, RBW, VBW, Detector type, Trace Type, Sweep Number, Sweep Time, Sweep Points, Center Freq, and Span

Auto Couple

Immediately puts all **Auto/Man** functions into **Auto**. **Auto Couple** is confined to the current measurement only. It does not affect other measurements in the Mode.

In the **Auto** state, **Auto/Man** functions are said to be “coupled”, meaning their values change as you make changes to other values in the measurement. This helps ensure accurate measurements and optimum dynamic range. **Auto Couple** is an immediate action function, and when it is executed, all the **Auto/Man** controls for the current measurement are set to **Auto**, and all measurement settings coupled to the **Auto/Man** parameters are automatically set to their optimal values.

For further details of measurement-specific settings (if any), see "[Measurement-Specific Details](#)" on page 383 below.

Remote Command	<code>:COUPle ALL</code>
Example	<code>:COUP ALL</code>
Backwards Compatibility SCPI	<code>:COUPLE ALL NONE</code>

Backwards
Compatibility
Notes

:COUP:NONE puts all Auto/Man parameters in manual mode, decoupling all the coupled instrument parameters. It is retained for backwards compatibility and is *not* recommended for making measurements or new designs

All **Auto/Man** parameter couplings in the measurement are set to **Auto**. This includes couplings that may be unavailable or grayed-out due to the current state. For example, in the Swept SA measurement, there is no **Auto/Man** coupling for **RBW** while in Zero Span. Nonetheless, if **Auto Couple** were executed while in Zero Span, it would set **RBW** to Auto "behind the scenes" so that, on exit from Zero Span, it would be in **Auto**.

Any **Auto/Man** selection specific (local) to the other measurements in the current Mode are not affected by **Auto Couple**. Any functions that are *not* coupled with other instrument parameters, such as ranging or leveling variables, such as **AutoRange** or **AutoScale**, are not affected.

Executing **Auto Couple** generates the informational message, "All Auto/Man functions have been set to Auto".

Each parameter, upon being set to **Auto**, selects and sets the appropriate auto-coupled value based on that parameter's coupling rules. The Dependency Resolver orchestrates the couplings for parameters that depend on one or more other parameters. The coupling and dependency rules for each parameter are defined in the section describing that parameter.

Executing **Auto Couple** does *not* affect markers, marker functions, trace or display attributes, or any other instrument setting other than those specifically mentioned above.

Measurement-Specific Details

TOI (SA Mode only)

Parameters affected by **Auto Couple** are:

- Center Frequency Step
- Resolution Bandwidth
- Span/RBW Ratio
- Sweep Time
- Video BANDwidth VBW/RBW ratio
- Upper and Lower Tone (set to Sense)

- Zero span measurement Resolution Bandwidth
- Zero span measurement Dwell Time

Harmonics (SA Mode only)

Parameters affected by **Auto Couple** are:

- Resolution Bandwidth
- Fundamental Frequency
- Dwell Time
- Range Table Resolution Bandwidths
- Range Table Dwell Times

Meas Preset

Restores all the measurement parameters to their default values.

Remote Command	:CONFigure:ACPower
----------------	--------------------

Example	:CONF:ACP
---------	-----------

Couplings	Selecting Meas Preset restores all measurement parameters to these default values
-----------	---

3.3.8.2 Limits

This tab enables you to set Limit parameters.

Limit Test

Enables you to turn on or off limit checking at the specified frequency.

For each operating frequency exceptions in up to three bands of 1 MHz width centered on a frequency which is an integer multiple of 1 MHz are allowed. They must however comply with an absolute value of –20 dBm.

Remote Command	:CALCulate:ACPower:LIMit:STATe OFF ON 0 1
	:CALCulate:ACPower:LIMit:STATe?

Example	:CALC:ACP:LIM:STAT 1
	:CALC:ACP:LIM:STAT?

3 Bluetooth Mode
3.3 Adjacent Channel Power

Preset	ON
State Saved	Yes
Range	On Off

Far Limit

Sets the far limit, in dBm for Adjacent channel power $|M-N| \geq 3$.

Remote Command	<code>:CALCulate:ACPower:LIMit:FAR:UPPer[:DATA] <ampl></code> <code>:CALCulate:ACPower:LIMit:FAR:UPPer[:DATA]?</code>
Example	<code>:CALC:ACP:LIM:FAR:UPP -30.0</code> <code>:CALC:ACP:LIM:FAR:UPP?</code>
Preset	-40.0 dBm
State Saved	Yes
Min/Max	-90 dBm/30.0 dBm

Near Limit

Sets the near limit, in dBm for Adjacent channel power $|M-N| = 2$.

Remote Command	<code>:CALCulate:ACPower:LIMit:NEAR:UPPer[:DATA] <ampl></code> <code>:CALCulate:ACPower:LIMit:NEAR:UPPer[:DATA]?</code>
Example	<code>:CALC:ACP:LIM:NEAR:UPP -30.0</code> <code>:CALC:ACP:LIM:NEAR:UPP?</code>
Preset	-20.0 dBm
State Saved	Yes
Min/Max	-90.0 dBm/30.0 dBm

3.3.8.3 Advanced

The Advanced tab contains controls for setting advanced functions of the analyzer.
This tab does not appear in EXM or VXT.

Noise Floor Extension

Allows you to turn on/configure the Noise Floor Extension (NFE) function.

When ON, the expected noise power of the analyzer (derived from a factory calibration) is subtracted from the trace data. This will usually reduce the apparent noise level by about 10 dB in low band, and 8 dB in high band (>~3.6 GHz).

NFE works with any RBW, VBW, detector, any setting of Average Type, any amount of trace averaging, and any signal type. It is ineffective when the trace is not smoothed (smoothing processes include narrow VBWs, trace averaging, and long sweep times with the detector set to Average or Peak). It works best with extreme amounts of smoothing, and with the average detector, with the Average Type set to Power.

In those cases where the cancellation is ineffective, it nonetheless has no undesirable side-effects. There is no significant speed impact to having Noise Floor Extension on.

The best accuracy is achieved when substantial smoothing occurs in each point before trace averaging. Thus, when using the average detector, results are better with long sweep times and fewer trace averages. When using the sample detector, the VBW filter should be set narrow with less trace averaging, instead of a wide VBW filter with more trace averaging.

Remote Command	<code>[:SENSe]:CORRection:NOISe:FLOor ON OFF 1 0</code> <code>[:SENSe]:CORRection:NOISe:FLOor?</code>
Example	<code>:CORR:NOIS:FLO ON</code>
Dependencies	This control only appears in instruments with the NFE or NF2 license installed. In all others, the control does not appear, however the SCPI command will be accepted without error (but will have no effect)
Couplings	When NFE is enabled in any mode manually, a prompt will be displayed reminding you to perform the Characterize Noise Floor operation if it is needed. If NFE is enabled through SCPI and a Characterize Noise Floor operation is needed, an error will be entered in the system error queue
Preset	Unaffected by Mode Preset. Turned OFF at startup and by Restore Mode Defaults in Modes that do not support Adaptive
State Saved	No

3.3.9 Sweep

The Sweep key contains controls which allow you to control the sweep and measurement functions of the analyzer, such as the sweep or measurement time and whether in Single sweep/measure or Continuous sweep/measure mode.

3.3.9.1 Sweep/Control

Accesses controls that let you operate the sweep and control functions of the instrument, such as **Sweep Time** and **Continuous/Single**.

Sweep Time

Sets the sweep time for every 100 kHz bin. It doesn't represent the whole sweep time, and it only represent the sweep time for each 100 kHz bin.

Remote Command	<code>[:SENSe]:ACPower:SWEEp:TIME <time></code> <code>[:SENSe]:ACPower:SWEEp:TIME?</code>
Example	<code>:ACP:SWE:TIME 1.4ms</code> <code>:ACP:SWE:TIME?</code>
Dependencies	If Meas Method isn't Sweep, this key will be grayed out
Preset	100.0 ms
State Saved	Yes
Min/Max	100 us/120ms

Acquisition Time

Controls the time the instrument takes to capture a single packet.

Remote Command	<code>[:SENSe]:ACquisition:TIME <time></code> <code>[:SENSe]:ACquisition:TIME?</code>
Example	<code>:ACQ:TIME 700uS</code> <code>:ACQ:TIME?</code>
Couplings	Acquisition Time may be clipped by the instrument if the specified acquisition time cannot be performed
Preset	3.0 ms
State Saved	Yes
Min/Max	100 us/100.0 s

Sweep Number

Accesses a menu that enables you to set the number of sweeps.

Remote Command	<code>[:SENSe]:SWEEp:NUMBer <integer></code> <code>[:SENSe]:SWEEp:NUMBer?</code>
Example	<code>:SWE:NUMB 10</code> <code>:SWE:NUMB?</code>
Preset	10
State Saved	Yes
Min/Max	1/10000

Sweep/Measure

Lets you toggle between **Continuous** and **Single** sweep or measurement operation. The single/continuous state is Meas Global, so the setting affects all measurements.

The front-panel key **Single/Cont** performs exactly the same function

See "[More Information](#)" on page 388

Remote Command	<code>:INITiate:CONTinuous OFF ON 0 1</code> <code>:INITiate:CONTinuous?</code>
Example	Put instrument into Single measurement operation: <code>:INIT:CONT 0</code> <code>:INIT:CONT OFF</code> Put instrument into Continuous measurement operation: <code>:INIT:CONT 1</code> <code>:INIT:CONT ON</code>
Preset	ON Note that <code>:SYST:PRES</code> sets <code>:INIT:CONT</code> to ON , but <code>*RST</code> sets <code>:INIT:CONT</code> to OFF
State Saved	Saved in instrument state
Annunciation	The Single/Continuous icon in the Meas Bar changes depending on the setting: <ul style="list-style-type: none"> - A line with an arrow is Single - A loop with an arrow is Continuous
Backwards Compatibility Notes	X-Series A-models had Single and Cont hardkeys in place of the SweepSingleCont softkey. In the X-Series A-models, if in single measurement, the Cont hardkey (and <code>INIT:CONT ON</code>) switched to continuous measurement, but never restarted a measurement and never reset a sweep X-Series B-models have a Cont/Single toggle control instead of Single and Cont hardkeys, but it is still true that, if in single measurement, the Cont/Single toggle control never restarts a measurement and never resets a sweep

More Information

Continuous Mode	The instrument takes repetitive sweeps, averages, measurements, etc., when in continuous mode. If in average or Max/Min Hold, and the average/hold count reaches the Average/Hold Num , the count stops incrementing, but the instrument keeps sweeping See the Trace key description under Trace Average for the averaging formula used both before and after the Average/Hold Num is reached. The trigger condition must be met prior to each sweep The type of trace processing for multiple sweeps is set under the Trace key, with choices of Trace Average , Max Hold , or Min Hold
-----------------	---

3 Bluetooth Mode

3.3 Adjacent Channel Power

Single Mode The instrument takes a single sweep when in **Single** mode, or if in average or Max/Min Hold, or if there is a **Waterfall** window displayed, it takes multiple sweeps until the average/hold count reaches the **Average/Hold Num**, then the count stops incrementing, and the instrument stops sweeping

See the **Trace** key description under **Trace Average** for the averaging formula used. The trigger condition must be met prior to the sweep

The type of trace processing for multiple sweeps is set under the **Trace** key, with choices of **Trace Average**, **Max Hold**, or **Min Hold**

If the instrument is in **Single** measurement mode, pressing the **Cont/Single** toggle control does not zero the count and does not cause the sweep to be reset; the only action is to put the instrument into Continuous measurement operation.

If the instrument is already in **Continuous** sweep:

- **:INIT:CONT 1** has no effect
- **:INIT:CONT 0** places the instrument in Single Sweep but has no effect on the current sequence until $k = N$, at which point the current sequence will stop and the instrument will go to the idle state

See "**Restart**" on page 806 for details of **:INIT:IMMEDIATE**.

If the instrument is already in **Single** sweep, **:INIT:CONT OFF** has no effect.

If the instrument is already in **Single** sweep, then pressing **Cont/Single** in the middle of a sweep does not restart the sweep or sequence. Similarly, pressing **Cont/Single** does not restart the sweep or sequence if the sweep is not in the idle state (for example, if you are taking a very slow sweep, or the instrument is waiting for a trigger). Even though pressing **Cont/Single** in the middle of a sweep does not restart the sweep, sending **:INIT:IMM** does reset it.

If the instrument is in **Single** sweep, and *not* Averaging/Holding, and you want to take one more sweep, press **Restart**.

If the instrument is in **Single** sweep, *and* Averaging/Holding, and you want to take one more sweep without resetting the Average trace or count, go to **Meas Setup** and increment the average count by 1 by pressing the **Step-Up** key while **Average/Hold Num** is the active function. You can also do this by sending **:CALC:AVER:TCON UP**.

Restart

Restarts the current sweep, or measurement, or set of averaged/held sweeps or measurements. If you are Paused, pressing **Restart** performs a Resume.

The front-panel key **Restart** performs exactly the same function.

The **Restart** function is accessed in several ways:

- Pressing the **Restart** key
- Sending `:INIT:IMM`
- Sending `:INIT:REST`

See "[More Information](#)" on page 390

Remote Command	<code>:INITiate[:IMMediate]</code> <code>:INITiate:REStart</code>
Example	<code>:INIT:IMM</code> <code>:INIT:REST</code>
Notes	<code>:INIT:REST</code> and <code>:INIT:IMM</code> perform exactly the same function
Couplings	Resets average/hold count k. For the first sweep overwrites all active (update = on) traces with new current data. For application modes, it resets other parameters as required by the measurement
Status Bits/OPC dependencies	This is an Overlapped command The <code>STATUS:OPERation</code> register bits 0 through 8 are cleared , <i>except</i> bit 6 (Waiting for Periodic Sync). Initiating a measurement and Waiting for Periodic Sync could be asynchronous The <code>STATUS:QUEStionable</code> register bit 9 (<code>INTEgrity</code> sum) is cleared The <code>SWEEPING</code> bit is set The <code>MEASURING</code> bit is set
Backwards Compatibility Notes	For Spectrum Analysis Mode in ESA and PSA, the Restart hardkey and the <code>:INIT:REST</code> command restarted trace averages (displayed average count reset to 1) for a trace in Clear Write , but did not restart Max Hold and Min Hold In X-Series, the Restart hardkey and the <code>:INIT:REST</code> command restart not only Trace Average , but MaxHold and MinHold traces as well

More Information

The **Restart** function first aborts the current sweep or measurement as quickly as possible. It then resets the sweep and trigger systems, sets up the measurement and initiates a new data measurement sequence with a new data acquisition (sweep) taken once the trigger condition is met.

If the instrument is in the process of aligning when a **Restart** is executed, the alignment finishes before the restart function is performed.

Even when set for **Single** operation, multiple sweeps may be taken when **Restart** is pressed (for example, when averaging/holding is on). Thus, when we say that **Restart** "restarts a measurement", depending on the current settings, we may mean that it:

3 Bluetooth Mode

3.3 Adjacent Channel Power

- Restarts the current sweep
- Restarts the current measurement
- Restarts the current set of sweeps if any trace is in Trace Average, Max Hold or Min Hold
- Restarts the current set of measurements if Averaging, or Max Hold, or Min Hold is on for the measurement

If there is no Average or Max/Min Hold function (no trace in Trace Average or Hold, or **Average/Hold Num** set to 1), and no **Waterfall** window is being displayed, a single sweep is equivalent to a single measurement. A single sweep is taken after the trigger condition is met; and the instrument stops sweeping once that sweep has completed. However, with **Average/Hold Num** >1, and at least one trace set to Trace Average, Max Hold, or Min Hold, or a **Waterfall** window being displayed, multiple sweeps/data acquisitions are taken for a single measurement. The trigger condition must be met prior to each sweep. The sweep is stopped when the average count k equals the number N set for **Average/Hold Num**.

Once the full set of sweeps has been taken, the instrument goes to the idle state. To take one more sweep without resetting the average count, increment the average count by 1, by pressing the **Step-Up** key while **Average/Hold Number** is the active function, or by sending the remote command **:CALC:AVER:TCON UP**.

Trace Update

The numeric results are not blanked at any time during the restart cycle.

For slow sweeps (see **Trace Update** section in **Trace/Detector**), the traces are updated real-time during the sweep. There may be a special circumstance in application mode measurements where an exception is made and the traces and/or results need to be blanked before displaying the new results.

To summarize, the following list shows what happens to the trace data on various events:

Event	Trace Effect
Clear/Write pressed (even if already in Clear/Write)	Set to mintracevalue
Max Hold pressed (even if already in Max Hold)	Set to mintracevalue
Min Hold pressed (even if already in Min Hold)	Set to maxtracevalue
Trace Average pressed (even if already in Trace Average)	Trace data unaffected but start new sweep/avg/hold
Restart pressed	Trace data unaffected but start new sweep/avg/hold
Parameter requiring restart changed (e.g., RBW)	Trace data unaffected but start new sweep/avg/hold

Sweep and Trigger Reset

Resetting the sweep system resets the average/hold count k to 0. It also resets the set point counter to 0. Resetting the trigger system resets the internal auto trig timer to the value set by the **Auto Trig** control.

Averaging

The weighting factor used for averaging is k . This k is also the average/hold count for how many valid sweeps (data acquisitions) have been done. This k is used for comparisons with N , as those comparisons always needs to be based on valid completed sweeps.

The displayed average/hold, K , shows the count for the sweep (data acquisition) in progress. $K = k + 1$, with a limit of N . The displayed value K changes from its previous value to 1 as soon as the trigger condition for the first data acquisition (sweep) is met.

Pause/Resume

Pauses a measurement after the current data acquisition is complete.

When paused, the label on the control changes to **Resume**. Pressing **Resume** unpauses the measurement. When paused, pressing **Restart** performs a Resume.

Remote Command	<code>:INITiate:PAUSE</code> <code>:INITiate:RESume</code>
Example	<code>:INIT:PAUS</code> <code>:INIT:RES</code>
Dependencies	Not displayed in Modes that do not support pausing
Annotation	Only on control

3.3.9.2 Sweep Config

This tab accesses controls that enable you to configure the Sweep and Control functions of the analyzer, such as Sweep Rules.

Points

Sets the number of points for each 100KHz bin from 1 to 40001. Points is couple to Sweep Time, so changing sweep time may change the sweep Points.

3 Bluetooth Mode
3.3 Adjacent Channel Power

Remote Command	<code>[:SENSe]:ACPower:SWEEp:POINTs <integer></code> <code>[:SENSe]:ACPower:SWEEp:POINTs?</code>
Example	<code>:ACP:SWE:POIN 500</code> <code>:ACP:SWE:POIN?</code>
Couplings	Gray out if Meas Method is FFT
Preset	1001
State Saved	Yes
Min/Max	1/40001

Points Auto State

Remote Command	<code>[:SENSe]:ACPower:SWEEp:POINTs:AUTO OFF ON 0 1</code> <code>[:SENSe]:ACPower:SWEEp:POINTs:AUTO?</code>
Example	<code>:ACP:SWE:PION:AUTO OFF</code> <code>:ACP:SWE: PION:AUTO?</code>
Couplings	If point auto state is auto, Point value will be coupled with sweep time. Point = sweep time / 3.5us
Preset	ON

3.3.9.3 X Scale

This tab accesses controls that enable you to set the horizontal scale parameters.

Ref Value

Sets the X-axis reference level (start time) for the RF Envelope graph, allowing smaller sections of the RF Envelope trace to be viewed in greater detail.

Remote Command	<code>:DISP:ACPower:WINDow[1]:TRACe:X[:SCALE]:RLEVel <time></code> <code>:DISP:ACPower:WINDow[1]:TRACe:X[:SCALE]:RLEVel?</code>
Example	<code>:DISP:ACP:WIND:TRAC:X:RLEV 100us</code> <code>:DISP:ACP:WIND:TRAC:X:RLEV?</code>
Dependencies	This parameter is only available when RF Envelope View is selected
Couplings	Max value is coupled to Sweep time and X scale/division (see below)
Preset	0.000 s
State Saved	Yes
Range	0 – (Sweep time – (X scale/division * 10))
Min/Max	0 s/ (Sweep time – (X scale/division * 10))

Backwards Compatibility SCPI

Window Numbers used to be a combination of View and Window, now only Window number is sent. For backwards compatibility the old View and Window numbers are honored as below:

Window	Old SCPI Command	New SCPI Command
RF Envelope	<code>:DISP:ACP:VIEW1:WIND1:TRAC:X:RLEV 100us</code>	<code>:DISP:ACP:WIND1:TRAC:X:RLEV 100us</code>

Scale/Division

Sets the X-axis scale per division for the RF Envelope graph, allowing smaller sections of the RF Envelope trace to be viewed in greater detail.

Remote Command	<code>:DISPlay:ACPower:WINDow[1]:TRACe:X[:SCALe]:PDIVision <time></code> <code>:DISPlay:ACPower:WINDow[1]:TRACe:X[:SCALe]:PDIVision?</code>
Example	<code>:DISP:ACP:WIND:TRAC:X:PDIV 5us</code> <code>:DISP:ACP:WIND:TRAC:X:PDIV?</code>
Dependencies	This parameter is only available when RF Envelope View is selected
Couplings	Min is coupled to sample time, but maintains at least two points at any time Max value is coupled to X reference value and Sweep time
Preset	10.0 ms
State Saved	Yes
Range	Hardware Dependent
Min/Max	$(2 * \text{Sweep Time}) / (10 * \text{Number of points in RF Envelope}) / (\text{Sweep Time} - \text{Ref Level}) / 10$

Backwards Compatibility SCPI

Window Numbers used to be a combination of View and Window, now only Window number is sent. For backwards compatibility the old View and Window numbers are honored as below:

Window	Old SCPI Command	New SCPI Command
RF Envelope	<code>DISP:ACP:VIEW1:WIND1:TRAC:X:PDIV 5us</code>	<code>DISP:ACP:WIND1:TRAC:X:PDIV 5us</code>

Ref Position

Sets the X-axis reference position for the RF Envelope graph, allowing smaller sections of the RF Envelope trace to be viewed in greater detail.

Remote Command	<code>:DISPlay:ACPower:WINDow[1]:TRACe:X[:SCALe]:RPOSition LEFT CENTER RIGHT</code>
----------------	---

3 Bluetooth Mode
3.3 Adjacent Channel Power

	<code>:DISPlay:ACPower:WINDow[1]:TRACe:X[:SCALe]:RPOSition?</code>
	Window numbers are as follows: RF Envelope: 1
Example	<code>:DISP:ACP:WIND:TRAC:X:RPOS CENT</code> <code>:DISP:ACP:WIND:TRAC:X:RPOS?</code>
Dependencies	This parameter is only available when RF Envelope View is selected
Preset	<code>LEFT</code>
State Saved	Yes
Range	Left Ctr Right

Backwards Compatibility SCPI

Window Numbers used to be a combination of View and Window, now only Window number is sent. For backwards compatibility the old View and Window numbers are honored as below:

Window	Old SCPI Command	New SCPI Command
RF Envelope	<code>DISP:ACP:VIEW1:WIND1:TRAC:X:RPOS CENT</code>	<code>DISP:ACP:WIND1:TRAC:X:RPOS CENT</code>

Auto Scaling

Sets the X-axis auto scaling for the RF Envelope graph.

Remote Command	<code>:DisPlay:ACPower:WINDow[1]:TRACe:X[:SCALe]:COUPle OFF ON 0 1</code> <code>:DisPlay:ACPower:WINDow[1]:TRACe:X[:SCALe]:COUPle?</code>
Example	<code>:DISP:ACP:WIND:TRAC:X:COUP ON</code> <code>:DISP:ACP:WIND:TRAC:X:COUP?</code>
Dependencies	This parameter is only available when RF Envelope View is selected.
Couplings	When Auto Scaling is On, and you press the Restart front-panel key, this function automatically determines the scale per division and reference values based on the measurement results. When you manually set a value for the X Rel Value or X Scale/Div, this parameter is automatically set to Off
Preset	<code>ON</code>
State Saved	Yes
Range	On Off

Backwards Compatibility SCPI

Window Numbers used to be a combination of View and Window, now only Window number is sent. For backwards compatibility the old View and Window numbers are honored as below:

Window	Old SCPI Command	New SCPI Command
RF Envelope	<code>DISP:ACP:VIEW1:WIND1:TRAC:X:COUP ON</code>	<code>DISP:ACP:WIND1:TRAC:X:COUP ON</code>

3.3.10 Trace

The Trace key contains controls which allow you to control the traces.

3.3.10.1 Trace Control

The controls on the Trace Control tab allow you to set the type of the Trace and its update mode.

There are four trace Types: **Clear/Write**, **Trace Average**, **Max Hold** and **Min Hold**. Each type handles data in a different way.

Trace Type

Allows you to select the type of trace you want to you use for the current measurement.

There are four trace Types: Clear/Write, Trace Average, Max Hold and Min Hold.

Remote Command	<code>:TRACe:ACPower:TYPE WRITe AVERAge MAXHold MINHold</code> <code>:TRACe:ACPower:TYPE?</code>
Example	<code>:TRAC:ACP:TYPE WRIT</code> <code>:TRAC:ACP:TYPE?</code>
Notes	WRITe = Clear Write AVERAge = Average MAXHold = Maximum Hold MINHold = Minimum Hold
Preset	MAXHold
State Saved	Yes
Range	<code>ClearWrite Average MaxHold MinHold</code>

Clear and Write | Restart Averaging | Restart Max/Min Hold

A button is provided whose function is to start the trace writing as though the trace type had just been selected. Pressing this button is exactly like selecting the current trace type again – the button is provided because to many users it may not be obvious that re-selecting the current selection from a radio button menu will take an action.

This button takes on different labels depending on the Trace Type:

Clear/Write: Clear and Write

Trace Average: Restart Averaging

Max Hold: Restart Max Hold

Min Hold: Restart Min Hold

3.3.10.2 Detector

The Detector tab lets you choose and configure detectors for the selected trace.

Detector

Accesses a menu of functions that enables you to control the detectors for the current measurement. The following choices are available:

Auto - the detector selected depends on marker functions, trace functions, average type, and the trace averaging function.

Normal -the detector determines the peak of the CW-like signals, and it yields alternating maximums and minimums of noise-like signals. This is also referred to as Rosenfell detection.

Average -the detector determines the average of the signal within the sweep points. The averaging method depends upon the Average Type selection (voltage, power, or log scales).

Peak (Positive) -the detector determines the maximum of the signal within the sweep points.

Sample -the detector indicates the instantaneous level of the signal at the center of the sweep points represented by each display point.

Negative Peak -the detector determines the minimum of the signal within the sweep points.

When the detector choice is Auto, the analyzer selects the detector. The selected detector depends on marker functions, trace functions, and trace averaging functions for the current measurement.

Remote Command	<code>[:SENSe]:ACPower:DETECTOR[:FUNCTION] NORMal AVERage POSitive SAMPLe NEGative</code> <code>[:SENSe]:ACPower:DETECTOR[:FUNCTION]?</code>
Example	<code>:ACP:DET NORM</code> <code>:ACP:DET?</code>
Notes	When you manually select a detector (instead of selecting Auto), that detector is used regardless of other analyzer settings The detector choices are: The Normal detector determines the peak of CW-like signals, and it yields alternating maximums and minimums of noise-like signals. This is also referred to as Rosenfell detection The Average detector determines the average of the signal within the sweep points. The averaging method is Power Average (RMS) The Peak detector determines the maximum of the signal within the sweep points The Sample detector indicates the instantaneous level of the signal at the center of the sweep points represented by each display point The Negative Peak detector determines the minimum of the signal within the sweep points
Preset	SAMPLe
State Saved	Yes
Range	Normal Average Peak Sample Negative Peak

Detector Select Auto/Man

This toggle sets the Detector mode to Auto or Manual. In Auto, the proper detector is chosen based on rules that take into account the measurement settings and other analyzer settings.

When any detector is selected by the user, this toggles automatically set to Man (manual).

Remote Command	<code>[:SENSe]:ACPower:DETECTOR:AUTO ON OFF 1 0</code> <code>[:SENSe]:ACPower:DETECTOR:AUTO?</code>
Example	<code>:ACP:DET:AUTO ON</code> <code>:ACP:DET:AUTO?</code>
Couplings	when Detector setting is "Auto", Detector is set to Sample
Preset	ON
State Saved	Yes

3.4 LE|QHS In-band Emissions Measurement

The LE|QHS In-band Emissions measurement is performed to verify the emissions levels within the operating frequency range conform to the limits. The power measurements covered by this test are total peak power for adjacent channels.

Measurement Commands

All scalar results for this measurement are contained in one table and there is one equivalent subopcode for the remote results. You can use this equivalence by visually inspecting the corresponding summary trace on the display, or by using `:CALC:DATA` queries, which programmatically describe the corresponding summary trace.

`:CONFigure:IBEMissions`

`:CONFigure:IBEMissions:NDEFault`

`:FETCh:IBEMissions[n]?`

`:INITiate:IBEMissions`

`:MEASure:IBEMissions[n]?`

`:READ:IBEMissions[n]?`

Remote Command Results

LE|QHS In-band Emissions provides 80 scalar values for the Tx power per channel. The number of meaningful results depends on the Span, with the meaningful values at the head of the array.

The following table displays the returned results from the `(FETCh|MEASure|READ):IBEM` commands, indexed by subopcode `n`:

n	Return Value
0	Returns NaN (9.91E+37)
1	Returns 80 comma-separated scalar values for the Tx power per channel. The number of the meaningful results depends on the IBW, with the meaningful values at the head of the array
2	TxRefIndex TxRefPower AdjChanPowerUpper AdjChanPowerLower NumberofExceptions

3.4.1 Views

The table below shows the Views and Windows used for this Measurement:

These Views are multiple-window Views. When in a multiple window View, you select a window by touching it. The menu controls may sometimes change depending on which window is selected.

Whenever the View changes, the default menu is Frequency, unless otherwise specified in the View description.

View	Result
RF Envelope	RF Envelope Graph Metrics
RF Spectrum	RF Spectrum Graph Metric

View Selection by Name

Allows you to specify the view via its enumerated ID string.

Remote Command	<code>:DISPlay: IBEMissions:VIEW[:SElect] RFENvelope RFSpectrum</code> <code>:DISPlay:IBEMissions:VIEW[:SElect]?</code>
Example	<code>:DISP:IBEM:VIEW:SEL RFSP</code> <code>:DISP:IBEM:VIEW:SEL?</code>
Preset	RFSPpectrum
State Saved	Yes
Range	RF Envelope RF Spectrum

View Selection by Number (Remote Command only)

Allows you to specify the view via its numeric ID value.

Remote Command	<code>:DISPlay: IBEMissions:VIEW:NSElect <integer></code> <code>:DISPlay:IBEMissions:VIEW:NSElect?</code>
Example	<code>:DISP:IBEM:VIEW:NSEL 1</code> <code>:DISP:IBEM:VIEW:NSEL?</code>
Preset	1
State Saved	Yes
Min/Max	1/2

3.4.1.1 RF Envelope View

Provides a combination view of the RF Envelope graph and the Metrics data as shown below.

Windows: "RF Envelope Graph" on page 401, "Metrics" on page 402

Example `:DISP:IBEM:VIEW RFEN`

3.4.1.2 RF Spectrum View

Provides a combination view of the RF Envelope graph and the Metrics data as shown below.

Windows: "RF Spectrum Graph" on page 402, "Metrics" on page 402

Example `:DISP:IBEM:VIEW RFSP`

3.4.2 Windows

Each window has an associated number which appears in the window title dropdown for that window.

Window	Number
RF Envelope	1
RF Spectrum	2
Metrics	3

RF Envelope Graph

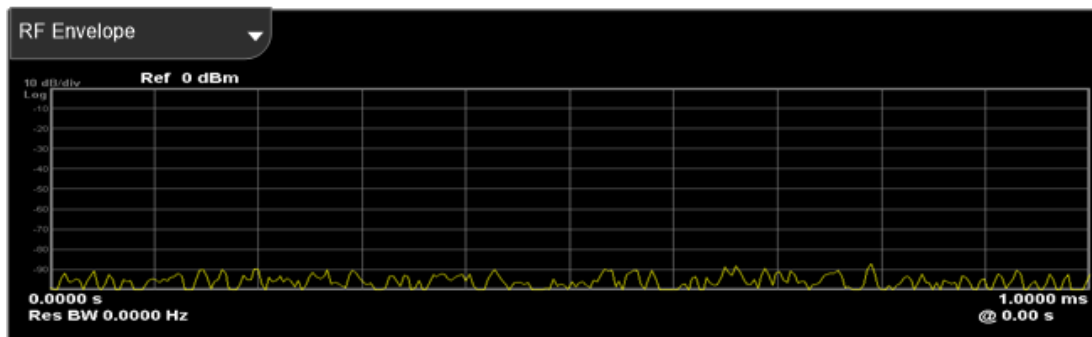

This Graph window appears in the following View:

View	Size	Position
RF Envelope	Half, full width	Top

RF Spectrum Graph

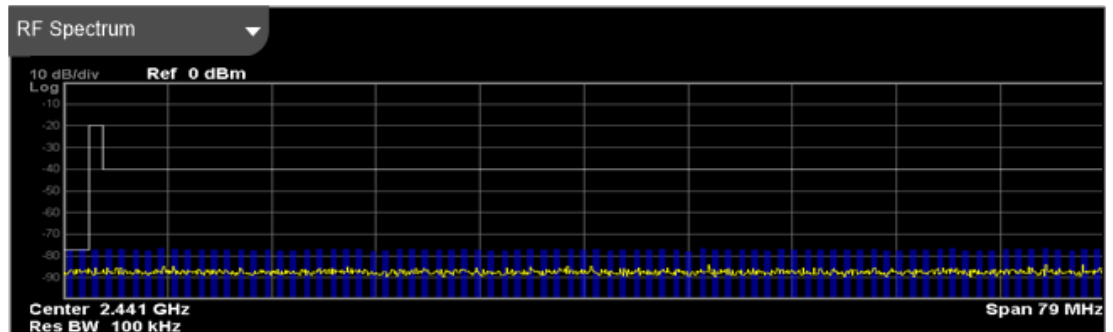

This Graph window appears in the following View:

View	Size	Position
RF Spectrum	Half, full width	Top

Metrics

The Metrics window appears in the following View:

View	Size	Position
RF Envelope	Half, full width	Top
RF Spectrum	Half, full width	Top

The text window displays the following results:

Tx Chan

It refers to the channel of the Transmit signal.

Tx Chan Power

It refers to the power of the Transmit channel.

Adj Chan Lower

The adjacent channel power between 500 kHz and 1.5 MHz from the carrier and it is located at the carrier's left part.

Adj Chan Upper

The adjacent channel power between 500 kHz and 1.5 MHz from the carrier and it is located at the carrier's right part.

Number of Exceptions

The number of the channel that channel power goes beyond its limit value.

Result Table

Each channel results are listed in the results table, which includes channel number, channel power, limits value and pass/fail status for every channel.

3.4.3 Amplitude

The Amplitude front-panel key activates the Amplitude menu and selects Reference Value as the active function.

3.4.3.1 Y Scale

Contains controls that pertain to the Y axis parameters of the measurement. These parameters control how data on the vertical (Y) axis is displayed and control instrument settings that affect the vertical axis.

Ref Value

Controls the Y value of the selected trace at the Reference Position. The functionality depends on the selected window.

Remote Command	<code>:DISPlay:IBEMissions:WINDow[1] 2:TRACe:Y[:SCALE]:RLEVel <real></code> <code>:DISPlay:IBEMissions:WINDow[1] 2:TRACe:Y[:SCALE]:RLEVel?</code>
	Window numbers are as follows: RF Envelope: 1 RF Spectrum: 2
Example	<code>:DISP:IBEM:WIND:TRAC:Y:RLEV 0.0</code> 1 – RF Envelope Window <code>:DISP:IBEM:WIND2:TRAC:Y:RLEV 0.0</code> 2 – RF Spectrum Window
Couplings	When Auto Scaling is On (default), this value is automatically determined by the measurement result. When you set a value manually, Auto Scaling changes to Off
Preset	0.00dBm
State Saved	Yes
Min/Max	-100.00 dBm / 30.00 dBm

Backwards Compatibility SCPI

Window Numbers used to be a combination of View and Window, now the VIEW parameter is not used and removed. For backwards compatibility the old View and Window numbers are honored as below:

Window	Old SCPI Command	New SCPI Command
RF Envelope	<code>DISP:IBEM:VIEW:WIND:TRAC:Y:RLEV 0.0</code>	<code>DISP:IBEM:WIND:TRAC:Y:RLEV 0.0</code>
RF Spectrum	<code>DISP:IBEM:VIEW2:WIND:TRAC:Y:RLEV 0.0</code>	<code>DISP:IBEM:WIND2:TRAC:Y:RLEV 0.0</code>

Scale/Div

Controls the Y scale per division of the selected trace. The functionality depends on the selected window.

Remote Command	<code>:DISPlay:IBEMissions:WINDow[1] 2:TRACe:Y[:SCALe]:PDIVision <rel_ampl></code> <code>:DISPlay:IBEMissions:WINDow[1] 2:TRACe:Y[:SCALe]:PDIVision?</code> Window numbers are as follows: RF Envelope: 1 RF Spectrum: 2
Example	<code>:DISP:IBEM:WIND:TRAC:Y:PDIV 0.0</code> 1 – RF Envelope Window <code>:DISP:IBEM:WIND2:TRAC:Y:PDIV 0.0</code> 2 – RF Spectrum Window
Couplings	When Auto Scaling is On (default), this value is automatically determined by the measurement result. When you set a value manually, Auto Scaling changes to Off
Preset	10.0 dB
State Saved	Yes
Min/Max	0.1 dB / 30.00 dB

Backwards Compatibility SCPI

Window Numbers used to be a combination of View and Window, now the VIEW parameter is not used and removed. For backwards compatibility the old View and Window numbers are honored as below:

Window	Old SCPI Command	New SCPI Command
RF Envelope	<code>DISP:IBEM:VIEW:WIND:TRAC:Y:PDIV 0.0</code>	<code>DISP:IBEM:WIND:TRAC:Y:PDIV 0.0</code>
RF Spectrum	<code>DISP:IBEM:VIEW2:WIND:TRAC:Y:PDIV 0.0</code>	<code>DISP:IBEM:WIND2:TRAC:Y:PDIV 0.0</code>

Ref Position

Controls the Y ref position of the selected trace. The functionality depends on the selected window.

Remote Command	<pre>:DISPlay:IBEMissions:WINDow[1] 2:TRACe:Y[:SCALe]:RPOSition TOP CENTer BOTTom</pre> <pre>:DISPlay:IBEMissions:WINDow[1] 2:TRACe:Y[:SCALe]:RPOSition?</pre> <p>Window numbers are as follows: RF Envelope: 1 RF Spectrum: 2</p>
Example	<pre>:DISP:IBEM:WIND:TRAC:Y:RPOS CENT</pre> <p>1 – RF Envelope window</p> <pre>:DISP:IBEM:WIND2:TRAC:Y:RPOS CENT</pre> <p>2 – RF Spectrum Window</p>
Preset	TOP
State Saved	Saved in instrument state
Range	Top Ctr Bot

Backwards Compatibility SCPI

Window Numbers used to be a combination of View and Window, now the VIEW parameter is not used and removed. For backwards compatibility the old View and Window numbers are honored as below:

Window	Old SCPI Command	New SCPI Command
RF Envelope	DISP:IBEM:VIEW:WIND:TRAC:Y:RPOS CENT	DISP:IBEM:WIND:TRAC:Y:RPOS CENT
RF Spectrum	DISP:IBEM:VIEW2:WIND:TRAC:Y:RPOS CENT	DISP:IBEM:WIND2:TRAC:Y:RPOS CENT

Auto Scaling

Toggles the Auto Scaling function between On and Off. The functionality depends on the selected window.

Remote Command	<pre>:DISPlay:IBEMissions:WINDow[1] 2:TRACe:Y[:SCALe]:COUPle 0 1 OFF ON</pre> <pre>:DISPlay:IBEMissions:WINDow[1] 2:TRACe:Y[:SCALe]:COUPle?</pre> <p>Window numbers are as follows: RF Envelope: 1 RF Spectrum: 2</p>
----------------	---

Example	<code>:DISP:IBEM:WIND:TRAC:Y:COUP ON</code> 1 – RF Envelope window <code>:DISP:IBEM:WIND2:TRAC:Y:COUP ON</code> 2 – RF Spectrum Window
Couplings	When Auto Scaling is On, and you press the Restart front-panel key, this function automatically determines the scale per division and reference values based on the measurement results. When you manually set a value for the Y Rel Value or Y Scale/Div, this parameter is automatically set to Off
Preset	<code>ON</code>
State Saved	Saved in instrument state
Range	On Off

Backwards Compatibility SCPI

Window Numbers used to be a combination of View and Window, now the VIEW parameter is not used and removed. For backwards compatibility the old View and Window numbers are honored as below:

Window	Old SCPI Command	New SCPI Command
RF Envelope	<code>DISP:IBEM:VIEW:WIND:TRAC:Y:COUPl e CENT</code>	<code>DISP:IBEM:WIND:TRAC:Y:COUPl e CENT</code>
RF Spectrum	<code>DISP:IBEM:VIEW2:WIND:TRAC:Y:COUPl e CENT</code>	<code>DISP:IBEM:WIND2:TRAC:Y:COUPl e CENT</code>

3.4.3.2 Attenuation

Controls the attenuator functions and interactions between the attenuation system components.

There are two attenuator configurations in the X-Series. One is a Dual-Attenuator configuration consisting of a mechanical attenuator and an optional electronic attenuator. The other configuration uses a single attenuator with combined mechanical and electronic sections that controls all the attenuation functions. Different models in the X-Series come with different configurations.

- See ["Dual-Attenuator Configurations" on page 407](#)
- See ["Single-Attenuator Configuration" on page 407](#)

Most attenuation settings are the same for all measurements – they do not change as you change measurements. Settings like these are called “Meas Global” and are unaffected by **Meas Preset**.

Only available when the hardware set includes an input attenuator, which is typically only the case for Keysight’s benchtop instruments. For example, this tab does *not* appear in VXT models M9421A/10A/11A, nor in UXM. In UXM, all

Attenuation and **Range** settings are disabled, as the expected input power level is handled by the Call Processing App that drives the DUT power control.

Dependencies In measurements that support the I/Q inputs, unavailable when I/Q is the selected input. Replaced by the **Range** tab in that case

Dual-Attenuator Configurations

Configuration 1: Mechanical attenuator + optional electronic attenuator

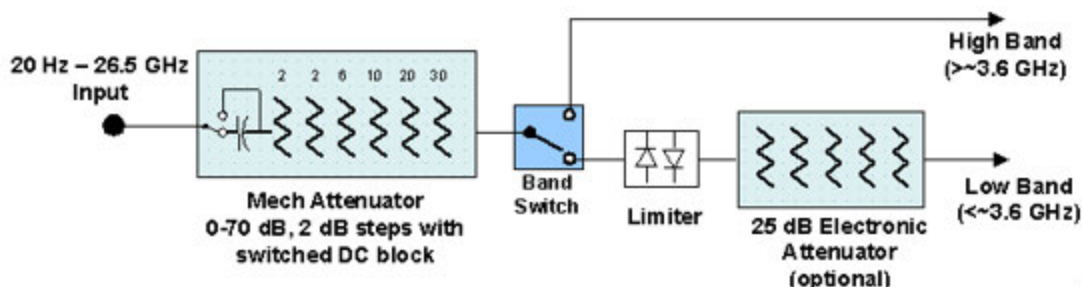

Configuration 2: Mechanical attenuator, no optional electronic attenuator

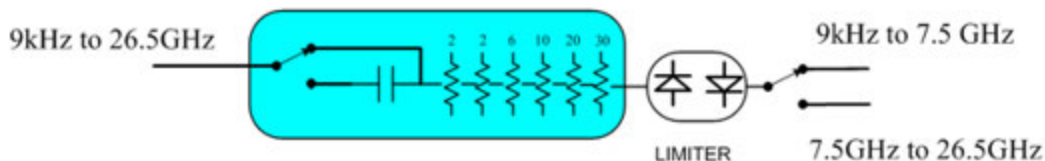

Note that Configuration 2 is not strictly speaking a dual-section attenuator, since there is no electronic section available. However, it behaves exactly like Configuration 1 without the Electronic Attenuator Option EA3, therefore for the sake of this document it is grouped into the “Dual-Attenuator” configuration.

Single-Attenuator Configuration

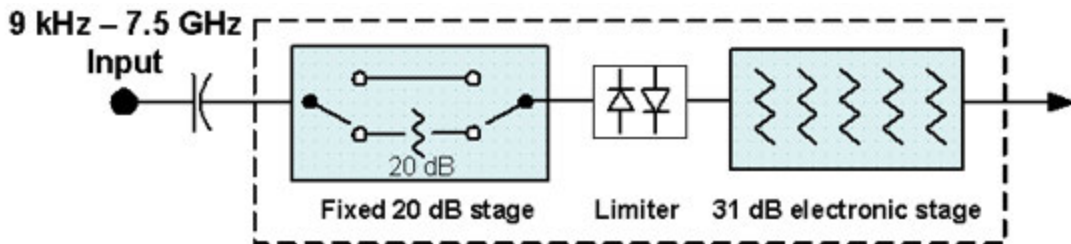

You can tell which attenuator configuration you have by pressing the Attenuation tab, which (in most Modes) opens the Attenuation menu. If the first control in the Attenuation menu says **Mech Atten** you have the Dual-Attenuator configuration. If the first control says **Atten** you have the Single-Attenuator configuration.



(Note that depending on the measurement, there may be no Auto/Man functionality on the Mech Atten control.)

In the Single-Attenuator configuration, you control the attenuation with a single control, as the fixed stage has only two states. In the Dual-Attenuator configuration, both stages have significant range, so you are given separate control of the mechanical and electronic attenuator stages.

When you have the Dual-Attenuator configuration, you may still have only a Single-Attenuator, because unless Option EA3 (the Electronic Attenuator option) is available, and you purchase it, you will have only the mechanical attenuator.

Full Range Atten

This control and **Attenuator Summary** only appear in N9041B, when the RF input is selected, the RF Input Port is set to RF Input 2, and the Full Range Attenuator is installed. The Full Range Attenuator adds a second input attenuator in front of RF Input 2, which enhances the protection and optimizes the performance of the extra internal mixers used by RF Input 2.

Remote Command	<code>[:SENSe] :POWer [:RF] :FRATten <rel_ampl></code> <code>[:SENSe] :POWer [:RF] :FRATten?</code>
Example	<code>:POW:FRAT 14</code> <code>:POW:FRAT?</code>
Notes	When you enter an amplitude value that falls between valid values, the value will be incremented to the next smallest valid value
Dependencies	Only appears if input RF is selected, RF Input Port 2 is selected, and the Full Range Attenuator exists
Couplings	This value is never changed by any coupling, but other couplings use this value. See Reference Level and "Mech Atten" on page 719 command descriptions
Preset	20 dB
State Saved	Saved in instrument state
Min	0 dB
Max	Only valid values are 0, 6, 14, 20 dB
Annotation	When the Input is RF , and the Input Port is RF Input 2 , and the Full Range Attenuator is installed:

3 Bluetooth Mode

3.4 LE|QHS In-band Emissions Measurement

On the Meas Bar, the field “Atten” displays as follows:

- If the sweep is entirely < 50 GHz, the value shown after “Atten:” is equal to Mech Atten + Elec Atten + Full Range Atten
- If the sweep is entirely > 50 GHz, the value shown after “Atten:” is equal to Full Range Atten
- If the sweep straddles 50 GHz, the value shown after “Atten:” is preceded by the symbol “>=” and is equal to Full Range Atten

In the **Amplitude**, **"Y Scale"** on page 597 menu, and the Atten **Meas Bar** dropdown menu panel, a summary is displayed as follows:

“Total Atten below 50 GHz” followed by the value of Full Range Atten + Mech Atten + Elec Atten

“Total Atten above 50 GHz” followed by the value of Full Range Atten

For example, if Mech Atten = 6 dB, Elec Atten = 4 dB, and Full Range Atten = 20 dB, the summary below is shown:

- Attenuator summary:
- Total Atten below 50 GHz: 30 dB
- Total Atten above 50 GHz: 20 dB

Mech Atten

Labeled **Mech Atten** in Dual-Attenuator models and **Atten** in Single-Attenuator models. In the Dual-Attenuator configuration, this control only affects the mechanical attenuator.

Lets you modify the attenuation applied to the RF input signal path. This value is normally auto-coupled to the Ref Level, the Internal Preamp Gain, any External Gain that is entered, and the Max Mixer Level, as described in the table below.

See **"Attenuator Configurations and Auto/Man"** on page 411

Remote Command	<code>[:SENSe]:POWer[:RF]:ATTenuation <rel_amp1></code> <code>[:SENSe]:POWer[:RF]:ATTenuation?</code> <code>[:SENSe]:POWer[:RF]:ATTenuation:AUTO OFF ON 0 1</code> <code>[:SENSe]:POWer[:RF]:ATTenuation:AUTO?</code>
----------------	--

Example	<code>:POW:ATT 20</code>
---------	--------------------------

Dual-Attenuator configuration: sets the mechanical attenuator to 20 dB

Single-Attenuator mode: sets the main attenuation to 20 dB (see below for definition of “main” attenuation)

In either case, if the attenuator was in Auto, it is set to Manual

`:POW:ATT:AUTO ON`

Turn Auto Mech Atten **ON**

Dependencies	<p>Some measurements do not support Auto setting of "Mech Atten" on page 409. In these measurements, the Auto/Man selection is not available, and the Auto/Man toggle function is not available</p> <p>In Dual-Attenuator configurations, when the electronic attenuator is enabled, the mechanical attenuator has no auto setting, and the Auto/Man toggle function is not available. The state of Auto/Man is remembered and restored when the electronic attenuator is once again disabled. This is described in more detail in "Elec Atten" on page 721</p> <p>See "Attenuator Configurations and Auto/Man" on page 411 for more information on the Auto/Man functionality</p> <p>:POW:ATT:AUTO is only available in measurements that support Mech Atten Auto, such as Swept SA</p>
Couplings	<p>If the RF Input Port is the RF Input:</p> <ul style="list-style-type: none"> - If the USB Preamp is connected to USB, use 0 dB for Mech Atten - Otherwise compute the auto-selected value of Mech Atten based on Reference Level, Int Preamp, External Gain, Ref Level Offset, Max Mixer Level, μW Path Control and IF Gain settings. Limit this value to be no less than 6 dB (total attenuation below 6 dB can never be chosen by Auto) - In the N9041B, if the RF Input Port is RF Input 2, use the formula above and subtract the Full Range Atten value from the result to determine the Mech Atten. Limit the value so that it is never lower than 0 dB and so that total attenuation, including Full Range Atten, is never less than 6 dB (total attenuation, including Full Range Atten below 6 dB, can never be chosen by Auto) <p>In External Mixing and BBIQ, where the Attenuator is not in the signal path, the Attenuator setting changes as described above when "Mech Atten" on page 409 is in Auto, but no changes are made to the actual attenuator hardware setting until the input is changed back to the RF Input</p> <p>For CXA-m with option FSA (Fine-Step Attenuator or 2 dB steps), the FSA-like behavior is only available when the frequency setting is ≤ 7.5 GHz. So, when the frequency is changed from below 7.5 GHz to above 7.5 GHz, the attenuation setting will be changed to a multiple of 10 dB which will be no smaller than the previous setting. For example, 4 dB attenuation will be changed to 10 dB</p>
Preset	<p>The preset for Mech Attenuation is "Auto"</p> <p>The Auto value of attenuation is 10 dB</p> <p>ON</p>
State Saved	<p>Saved in instrument state</p>
Min	<p>0 dB</p> <p>The attenuation set by this control cannot be decreased below 6 dB with the knob or step keys. Values below 6 dB must be directly entered from the keypad or via SCPI. This protects against setting a dangerously small attenuation value, which can put the instrument at risk of damage to input circuitry. If the current mechanical attenuation is below 6 dB, it can be increased with the knob and step keys, but not decreased</p>
Max	<p>CXA Option 503 or 507: 50 dB</p> <p>EXA: 60 dB</p> <p>All other models: 70 dB</p> <p>Note that in the Single-Attenuator configuration, the total of ATT and EATT cannot exceed 50 dB. So, if the EATT is set to 24 dB first, the main attenuation cannot be greater than 26 dB and will be reduced</p>

accordingly; if the main attenuator is set to 40 dB first, EATT cannot be greater than 10 dB

Annotation The current value for Total Atten is displayed in the Measurement Bar at the top of the display. A value appears for Electronic Attenuation only if the Electronic Attenuator is enabled. The annotation appears as

Atten: <total> dB (e<elec>)

The e letter is in amber in Single-Attenuator configurations

For example:

Dual-Attenuator configuration:
Atten: 24 dB (e14)

Indicating the total attenuation is at 24 dB and the electronic attenuation is at 14 dB

Single-Attenuator configuration:
A: 24 dB (e14)

Indicating the total attenuation is at 24 dB and the “soft” attenuation is at 14 dB (see below for definition of “soft” attenuation)

When in Manual, a # sign appears in front of Atten in the annotation

Attenuator Configurations and Auto/Man

As described under ["Y Scale" on page 597](#), there are two distinct attenuator configurations available in the X-Series, the single attenuator and Dual-Attenuator configurations. In Dual-Attenuator configurations, we have the mechanical attenuation and the electronic attenuation, and the current total attenuation is the sum of the electronic + mechanical attenuation. In Single-Attenuator configurations, we refer to the attenuation set using ["Mech Atten" on page 409](#) (or `:POW:ATT`) as the “main” attenuation; and the attenuation that is set by `:POW:EATT` as the “soft” attenuation (`:POW:EATT` is honored even in the Single-Attenuator configuration, for compatibility purposes). Then the current total attenuation is the sum of the main + soft attenuation.

See ["Elec Atten" on page 721](#) for more about “soft” attenuation.

NOTE

In some measurements, the **Mech Atten** control has an Auto/Man function. In these measurements, an Auto/Man switch is shown on the **Mech Atten** control:

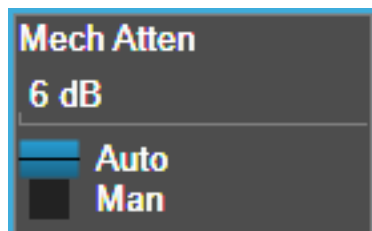

Note that in configurations that include an Electronic Attenuator, this switch is only shown when the Electronic Attenuator is disabled.

In other measurements, **Mech Atten** has no Auto/Man function. In these measurements, no switch is shown on the **Mech Atten** control:



Mech Atten also appears with no switch, as above, in configurations that include an Electronic Attenuator but when the Electronic Attenuator is enabled.

Elec Atten

Controls the Electronic Attenuator in Dual-Attenuator configurations. Does not appear in Single-Attenuator configurations, because the control of both the mechanical and electronic stages of the Single-Attenuator is integrated into the single **Atten** control.

This control includes an **Enable/Disable** toggle switch; it is only possible to enter a value for the Electronic Attenuator when this switch is in the **Enable** position.

For more details about the Electronic Attenuator, see ["More Information" on page 413](#)

Remote Command	<pre>[:SENSe]:POWer[:RF]:EATTenuation <rel_amp> [:SENSe]:POWer[:RF]:EATTenuation? [:SENSe]:POWer[:RF]:EATTenuation:STATe OFF ON 0 1 [:SENSe]:POWer[:RF]:EATTenuation:STATe?</pre>
Example	<pre>:POW:EATT 10 :POW:EATT? :POW:EATT:STAT ON :POW:EATT:STAT?</pre>
Notes	Electronic Attenuation's specification is defined only when Mechanical Attenuation is 6 dB
Dependencies	<p>Only appears in Dual-Attenuator models with an Electronic Attenuator installed and licensed. Does not appear in models with the Single-Attenuator configuration, because in the Single-Attenuator configuration there is no "electronic attenuator"; there is only a single integrated attenuator (which has both a mechanical and electronic stage). However, in the Single-Attenuator configuration, EATT SCPI commands are accepted for compatibility with other X-series instruments, and set a "soft" attenuation. The "soft" attenuation is treated as an addition to the "main" attenuation value set by the Attenuation control or :POW:ATT, and affects the total attenuation displayed on the Attenuation control and the Meas Bar</p> <p>The electronic attenuator, and the "soft" attenuation function provided in Single-Attenuator configurations, are unavailable above the low band (0-3.6 GHz, 0-3.4 GHz, 0-3 GHz, depending on the</p>

3 Bluetooth Mode
 3.4 LE|QHS In-band Emissions Measurement

model). If the low band range is from 0-3.6 GHz, and Stop Frequency of the instrument is > 3.6 GHz, then the **Enabled/Disabled** section of the **Elec Atten** control will be **OFF** and grayed-out

If "**Internal Preamp**" on page 737 is **ON** (that is, set to Low Band or Full), the electronic attenuator (and the "soft" attenuation function provided in Single-Attenuator configurations) is unavailable. In this case the **Enabled/Disabled** section of the **Elec Atten** control will be **OFF** and grayed-out

If either of the above is true, and the SCPI command is sent, an error indicating that the electronic attenuator is unavailable is returned

If both the above are true, pressing the control generates error message -221, in other words, the frequency range lockout takes precedence

If the electronic/soft Attenuator is enabled, then the **Stop Freq** of the instrument is limited to 3.6 GHz and **Internal Preamp** is unavailable

If "**LNA**" on page 738 is **ON**, the electronic attenuator (and the "soft" attenuation function provided in Single-Attenuator configurations) is unavailable. In this case the **Enabled/Disabled** section of the **Elec Atten** control will be **OFF** and grayed-out. This coupling works in the following modes/measurements:

- Channel Power, Occupied BW, ACP, SEM, Spurious Emissions, Power Stat CCDF measurements in all Modes
- Transmit On|Off Power measurement in 5G NR Mode
- Power vs. Time and Transmit Power measurement in GSM/EDGE Mode
- Burst Power measurement in Spectrum Analyzer Mode

The SCPI-only "soft" electronic attenuation for the single-attenuator configuration is not available in all measurements; in particular, it is not available in the Swept SA measurement

Couplings	Enabling and disabling the Electronic Attenuator affects the setting of the Mechanical Attenuator (in Dual-Attenuator configurations). This is described in more detail below and in " Mechanical Attenuator Transition Rules " on page 414
Preset	0 dB OFF (Disabled) for Swept SA measurement ON (Enabled) for all other measurements that support the electronic attenuator
State Saved	Saved in instrument state
Min	0 dB
Max	Dual-Attenuator configuration: 24 dB Single-Attenuator configuration: the total of ATT and EATT cannot exceed 50 dB. So, if the EATT is set to 24 dB first, the main attenuation cannot be greater than 26 dB and will be reduced accordingly; if the main attenuator is set to 40 dB first, EATT cannot be greater than 10 dB
Annotation	See Annotation under the Mech Atten control description

More Information

The electronic attenuator offers finer steps than the mechanical attenuator, has no acoustical noise, is faster, and is less subject to wear. These advantages primarily aid in remote operation and are negligible for front panel use. See "**Using the Electronic Attenuator: Pros and Cons**" on page 415 for a detailed discussion of the

pros and cons of using the electronic attenuator.

For the Single-Attenuator configuration, for SCPI backwards compatibility, the “soft” attenuation feature replaces the Dual-Attenuator configuration’s electronic attenuator. All the same couplings and limitations apply. See "[Attenuator Configurations and Auto/Man](#)" on page 721

Mechanical Attenuator Transition Rules

When the Electronic Attenuator is enabled, the Mechanical Attenuator transitions to a state that has no Auto function. Below are the rules for transitioning the Mechanical Attenuator. Note that the information below *only* applies to the Dual-Attenuator configurations, and *only* when the Electronic Attenuator is installed:

When the Electronic Attenuation is enabled from a disabled state:

- The Mechanical Attenuator is initialized to 10 dB (this is its optimal performance setting). You can then set it as desired with SCPI, numeric keypad, step keys, or knob, and it behaves as it normally would in manual mode
- The Auto/Man state of (Mech) Atten is saved
- The Auto/Man toggle on the (Mech) Atten control disappears, and the auto rules are disabled
- The Electronic Attenuator is set to 10 dB less than the previous value of the Mechanical Attenuator, within the limitation that it must stay within the range of 0 to 24 dB of attenuation

Examples in the Dual-Attenuator configuration:

- Mech Atten at 20 dB. Elec Atten enabled, Mech Atten set to 10 dB, and Elec Atten set to 10 dB. New total attenuation equals the value before Elec Atten enabled
- Mech Atten at 0 dB. Elec Atten enabled, Mech Atten set to 10 dB, and Elec Atten set to 0 dB. New total attenuation does not equal the value before Elec Atten enabled
- Mech Atten at 40 dB. Elec Atten enabled, Mech Atten set to 10 dB, and Elec Atten set to 24 dB. New total attenuation does not equal the value before Elec Atten enabled

When the Electronic Attenuation is disabled from an enabled state:

- The Elec Atten control is grayed out
- The Auto/Man state of (Mech) Atten is restored
- If now in Auto, (Mech) Atten recouples

3 Bluetooth Mode

3.4 LEIQHS In-band Emissions Measurement

- If now in Man, (Mech) Atten is set to the value of total attenuation that existed before the Elec Atten was disabled. The resulting value is rounded up to the smallest value possible given the (Mech) Atten Step setting - (That is, 57 dB changes to 58 dB when (Mech) Atten Step is 2 dB)

Using the Electronic Attenuator: Pros and Cons

The electronic attenuator offers finer steps than the mechanical attenuator, has no acoustical noise, is faster, and is less subject to wear.

The “finer steps” advantage of the electronic attenuator is beneficial in optimizing the alignment of the instrument dynamic range to the signal power in the front panel as well as remote use. Thus, you can achieve improved relative signal measurement accuracy. Compared to a mechanical attenuator with 2 dB steps, the 1 dB resolution of the electronic attenuator only gives better resolution when the odd-decibel steps are used. Those odd-decibel steps are less accurately calibrated than the even-decibel steps, so one tradeoff for this superior relative accuracy is reduced absolute amplitude accuracy.

Another disadvantage of the electronic attenuator is that the spectrum analyzer loses its “Auto” setting, making operation less convenient.

Also, the relationship between the dynamic range specifications (TOI, SHI, compression, and noise) and instrument performance are less well-known with the electrical attenuator. With the mechanical attenuator, TOI, SHI, and compression threshold levels increase dB-for-dB with increasing attenuation, and the noise floor does as well. With the electronic attenuator, there is an excess attenuation of about 1 to 3 dB between 0 and 3.6 GHz, making the effective TOI, SHI, and so forth, less well known. Excess attenuation is the actual attenuation relative to stated attenuation. Excess attenuation is accounted for in the instrument calibration.

Adjust Atten for Min Clipping

Sets the combination of mechanical and electronic attenuation and gain based on the current measured signal level so that clipping will be at a minimum.

This is an immediate action function, that is, it executes once, when the control is pressed.

The algorithms that are used for the adjustment are documented under ["Pre-Adjust for Min Clipping" on page 726](#).

Remote Command	<code>[:SENSe]:POWer[:RF]:RANGe:OPTimize IMMEDIATE</code>
Example	<code>:POW:RANG:OPT IMM</code>
Notes	Executing Adjust Atten for Min Clipping initiates the measurement
Dependencies	Does not appear in the Swept SA, RTSA, Monitor Spectrum and Complex Spectrum measurements Appears in the Waveform measurement in 5G NR Mode only

Adjust Atten

Allows you to select;

- Electric attenuator only
- Combination of Electric attenuator and Mechanical attenuator

when `[:SENSe]:POWer[:RF]:RANge:OPTimize IMMEDIATE` is executed.

Remote Command	<code>[:SENSe]:POWer[:RF]:RANge:OPTimize:TYPE EONLY COMBined</code> <code>[:SENSe]:POWer[:RF]:RANge:OPTimize:TYPE?</code>
Example	<code>:POW:RANG:OPT:TYPE EONL</code> <code>:POW:RANG:OPT:TYPE?</code>
Dependencies	Does not appear in the Swept SA, RTSA, Monitor Spectrum and Complex Spectrum measurements Appears in the Waveform measurement in 5G NR Mode only
Preset	<code>COMBined</code>
State Saved	Saved in instrument state

Pre-Adjust for Min Clipping

If this function is **ON**, it applies the adjustment described under "[Adjust Atten for Min Clipping](#)" on page 725 each time a measurement restarts. Therefore, in Continuous measurement mode, it only executes before the first measurement.

In Dual-Attenuator models, you can set **Elec+Mech Atten**, in which case both attenuators participate in the autoranging, or **Elec Atten Only**, in which case the mechanical attenuator does not participate in the autoranging. This latter case results in less wear on the mechanical attenuator and is usually faster.

See "[Adjustment Algorithm](#)" on page 417

Selection	SCPI	Note
Off	<code>OFF</code>	This is the default setting
On	<code>ON</code>	Available in Single-Attenuator instruments. For compatibility with models that do not have an input attenuator, the <code>ON</code> parameter is supported and mapped to <code>COMBined</code>
Elec Atten Only	<code>ELECTrical</code>	Selects only the electric attenuator to participate in auto ranging. This offers less wear on the mechanical attenuator and is usually faster
Elec+Mech Atten	<code>COMBined</code>	In Dual-Attenuator models, this selects both attenuators to participate in the autoranging

3 Bluetooth Mode

3.4 LEIQHS In-band Emissions Measurement

Remote Command	<code>[:SENSe]:POWer[:RF]:RANGe:OPTimize:ATTenuation OFF ON ELECtrical COMBined</code> <code>[:SENSe]:POWer[:RF]:RANGe:OPTimize:ATTenuation?</code>
Example	<code>:POW:RANG:OPT:ATT OFF</code> <code>:POW:RANG:OPT:ATT?</code>
Notes	The parameter option ELECtrical sets this function to ON in Single-Attenuator models The parameter option COMBined is mapped to ELECtrical in Single-Attenuator models. If you send COMBined , it sets the function to ON and returns ELEC to a query For SCPI compatibility with models that do not have an input attenuator, the ON parameter is honored and mapped to COMBined
Dependencies	Only appears in Dual-Attenuator models with an Electronic Attenuator installed In instruments with Dual-Attenuator model, when " Elec Atten " on page 721 is OFF or grayed-out, " Pre-Adjust for Min Clipping " on page 416 is grayed-out Does not appear in the Swept SA, RTSA, Monitor Spectrum and Complex Spectrum measurements For the Waveform measurement, available only in 5G NR Mode
Preset	OFF when Elec Atten is Disabled at preset, otherwise ELEC
State Saved	Saved in instrument state
Range	Dual-Attenuator models: Off Elec Atten Only Mech + Elec Atten Single-Attenuator models: Off On
Notes	ON aliases to "Elec Atten Only" (<code>:POW:RANG:OPT:ATT ELEC</code>) OFF aliases to "Off" (<code>:POW:RANG:OPT:ATT OFF</code>) <code>:POW:RANG:AUTO?</code> returns true if <code>:POW:RANG:OPT:ATT</code> is not OFF
Backwards Compatibility SCPI	<code>[:SENSe]:POWer[:RF]:RANGe:AUTO ON OFF 1 0</code> <code>[:SENSe]:POWer[:RF]:RANGe:AUTO?</code>

Adjustment Algorithm

The algorithms for the adjustment are documented below:

Single-Attenuator Models

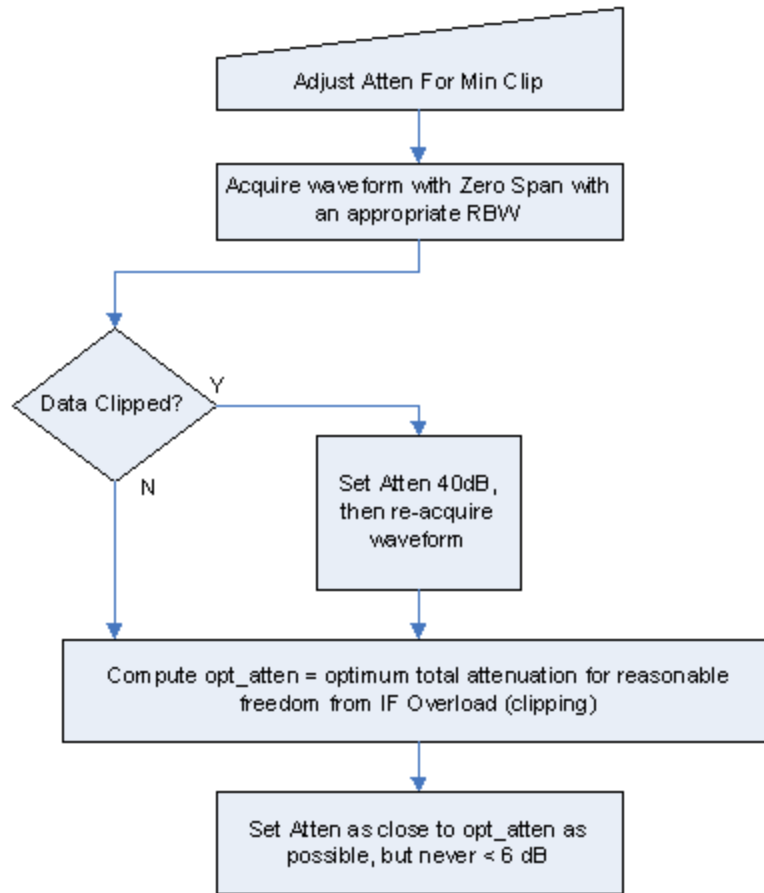

Dual-Attenuator models

"Adjust Atten for Min Clipping" on page 725 or "Pre-Adjust for Min Clipping" on page 416 selection is Mech + Elec Atten:

3 Bluetooth Mode
 3.4 LEIQHS In-band Emissions Measurement

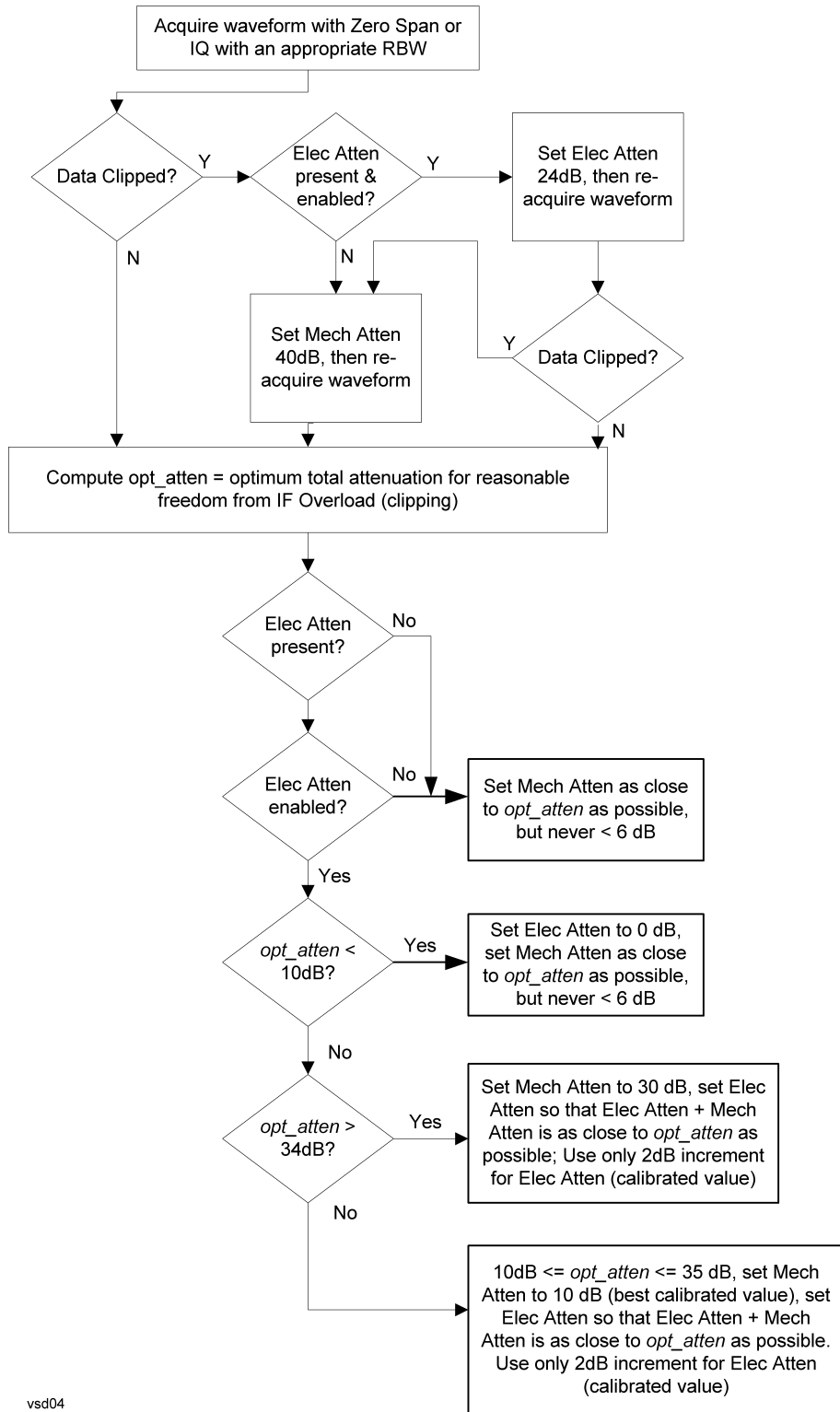

vsd04

"Pre-Adjust for Min Clipping" on page 416 selection is Elec Only.

Note that the **Mech Atten** value is not adjusted, and the value previously set is used. Therefore, there is a case that IF Overload is still observed depending on the input signal level and the Mech Atten setting.

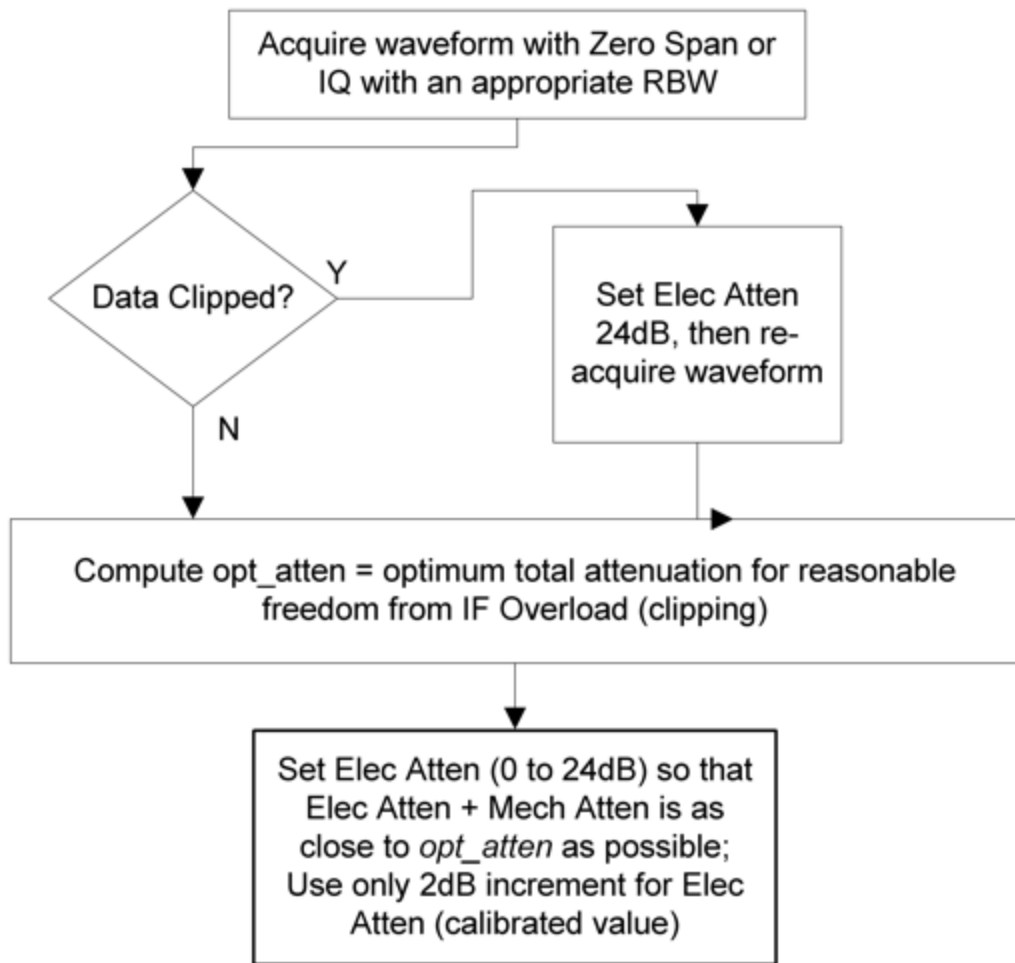

Mech Atten Step

Controls the step size used when making adjustments to the input attenuation.

Labeled **Mech Atten Step** in Dual-Attenuator models and **Atten Step** in Single-Attenuator models. In the Dual-Attenuator configuration, only affects the step size of the mechanical attenuator.

Remote Command `[:SENSe]:POWer[:RF]:ATTenuation:STEP[:INCRement] 10 dB | 2 dB`

3 Bluetooth Mode
 3.4 LE|QHS In-band Emissions Measurement

	<code>[:SENSe]:POWer[:RF]:ATTenuation:STEP[:INCRement]?</code>
Example	<code>:POW:ATT:STEP 2</code> <code>:POW:ATT:STEP?</code>
Notes	Has a toggle control on the front panel, but takes a specific value (in dB) when used remotely. The only valid values are 2 and 10
Dependencies	Blanked in EXA, CXA and CXA-m if option FSA (2 dB steps) is not present. If blanked, attempts to set it via SCPI yield an error
Couplings	When the attenuation step size changes, the current mechanical attenuation value is adjusted (if necessary) to be quantized to the new step size. That is, if step is set to 10 dB, mech atten is increased if necessary so it is a multiple of 10 dB
Preset	EXA, CXA and CXA-m: 10 dB (2 dB with option FSA) All other models: 2 dB
State Saved	Saved in instrument state

Max Mixer Level

Allows you to set the maximum level to be applied to the mixer for a signal at the top of the screen. By setting this value up or down you can allow more or less signal through the system.

The major impact of changes to **Max Mixer Level** is seen in changes to the value to which **Reference Level** is limited. Max Ref Level depends on Max Mixer Level and Attenuation, and therefore a higher Max Mixer Level may let you set Ref Level higher. However, changing this value can impact your TOI, compression, or dynamic range. The preset value of this function is best for most measurements.

See also "[Max Mixer Lvl Rules](#)" on page 521.

Remote Command	<code>[:SENSe]:POWer[:RF]:MIXer:RANGe[:UPPer] <real></code> <code>[:SENSe]:POWer[:RF]:MIXer:RANGe[:UPPer]?</code>
Example	<code>:POW:MIX:RANG -15 dBm</code> <code>:POW:MIX:RANG?</code>
Dependencies	Only appears in Swept SA and RTSA measurements
Preset	-10 dBm
State Saved	Saved in instrument state
Min	-50 dBm
Max	0 dBm

Max Mixer Lvl Rules

Allows you to optimize the Max Mixer Level setting for certain kinds of measurements.

- NORMal** The historical, and thus backwards compatible, setting range (-50 to 0 dBm) and default setting (-10 dBm). The instrument has been designed so that, at the default setting, any signal below the Reference Level is extremely unlikely to create ADC overloads. At this mixer level the scale fidelity will be within specifications, thus compression will be negligible
- TOI** Allows a range of settings of the "Max Mixer Level" on page 520, -50 to -10 dBm, that can be optimum for measurements limited by the instrument third-order dynamic range. The default setting, -25 dBm, is commonly appropriate but RBW affects this. A good setting for Max Mixer Level would be higher than the optimum mixer level by half of the attenuator step size
- COMPression** Allows a range of settings of the Max Mixer Level, -10 to +10 dBm or more, that can be optimum for measurements limited by the tradeoffs between instrument accuracy due to compression, and dynamic range due to the noise floor. The default setting, -3 dBm, is commonly appropriate, representing mixer drive levels that cause 1 dB or less compression at most carrier frequencies

Typical measurements that would be optimized by this setting are the measurement of low sideband levels, including nulls, in angle-modulated signals (FM and PM). Also pulsed-RF measurements, including finding nulls to estimate pulse width, which are often best done with significant overdrive (compression) of the front end

Setting Name (readback)	Setting Name (verbose)	Max Mixer Level Preset Value, dBm	Max Mixer Level minimum value, dBm	Max Mixer Level maximum value, dBm
NORMal	Normal – balance TOI, noise, and compression	-10	-50	0
TOI	TOI-limited dynamic range	-25	-50	-10
COMPression	Compression-limited dynamic range	-3	-10	+30

Remote Command	<code>[:SENSe]:POWer[:RF]:MIXer:RULEs NORMal TOI COMPression</code> <code>[:SENSe]:POWer[:RF]:MIXer:RULEs?</code>
Example	<code>:POW:MIX:RULE:COMP</code>
Dependencies	Only appears in the Swept SA and RTSA measurements
Preset	NORM

3.4.3.3 Range (Non-attenuator models)

Only available for Keysight's modular signal analyzers and certain other Keysight products, such as VXT

State Saved No

Range

Represents the amplitude of the largest sinusoidal signal that could be present within the IF without being clipped by the ADC. For signals with high peak-to-average ratios, the range may need to exceed the rms signal power by a significant amount to avoid clipping.

This is a measurement global setting.

Remote Command	<code>[:SENSe]:POWer[:RF]:RANGe <real></code> <code>[:SENSe]:POWer[:RF]:RANGe?</code>
Example	<code>:POW:RANG 10 dBm</code> <code>:POW:RANG?</code>
Notes	The MIN and MAX values are affected by the External Gain parameters, and by the Center Frequency . The hardware compensates for frequency response and alters the Range setting.
Preset	0 dBm
State Saved	Yes
Min	-100
Max	100
Annotation	Meas Bar

Adjust Range for Min Clipping

Sets the combination of attenuation and gain based on the current measured signal level so that clipping will be at a minimum.

This is an "immediate action" function, that is, it executes once, when the key is pressed.

This key does not appear in measurements that do not support this functionality.

Remote Command	<code>[:SENSe]:POWer[:RF]:RANGe:OPTimize IMMEDIATE</code>
Notes	Executing Adjust Range for Min Clipping initiates the measurement
Dependencies	Does not appear in the Swept SA and Monitor Spectrum measurements

Pre-Adjust for Min Clipping

If this function is **ON**, it applies the adjustment described under Adjust Range For Min Clipping each time a measurement restarts. Therefore, in Continuous measurement mode, it only executes before the first measurement.

Remote Command	<code>[:SENSe]:POWer[:RF]:RANGe:OPTimize:ATTenuation OFF ON ELECTrical COMBined</code> <code>[:SENSe]:POWer[:RF]:RANGe:OPTimize:ATTenuation?</code>
Notes	Because there is no attenuator control available in these models, the control displays only ON and OFF choices. However, for SCPI compatibility with other platforms, all three parameters (ELECTrical , COMBined , and ON) are honored and all are mapped to ELECTrical , so if any of these three parameters is sent, a subsequent query will return ELEC
Dependencies	Does not appear in the Swept SA and Monitor Spectrum measurements
Preset	OFF for Swept SA measurement; ON for all other measurements that support Pre-Adjust for Min Clipping
State Saved	Saved in instrument state

Adjustment Algorithm

The algorithm for the adjustment is documented below:

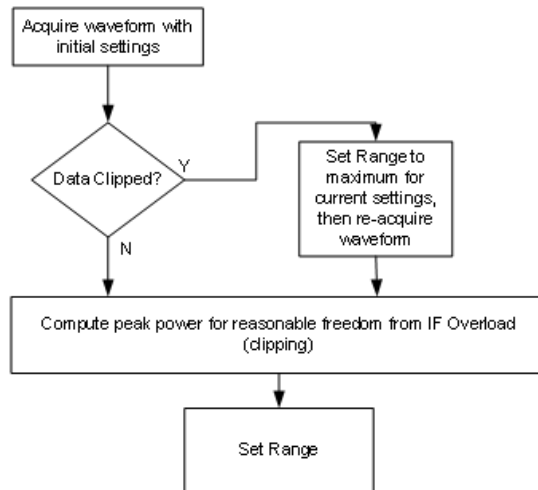

Peak-to-Average Ratio

Used with "[Range \(Non-attenuator models\)](#)" on page 731 to optimize the level control in the instrument. The value is the ratio, in dB, of the peak power to the average power of the signal to be measured. A ratio of 0 should be used for sinusoidal signals; for 802.11g OFDM signals use 9 dB.

3 Bluetooth Mode

3.4 LEIQHS In-band Emissions Measurement

All Modes show the current value of Peak-to-Average ratio on the control. However, some Modes do not permit changing the value. In these situations, the control is grayed-out.

Remote Command	<code>[:SENSe]:POWer[:RF]:RANGe:PARatio <real></code> <code>[:SENSe]:POWer[:RF]:RANGe:PARatio?</code>
Example	<code>:POW:RANG:PAR 12 dB</code>
Notes	In some Modes, this parameter is read-only; meaning the value will appear on the control and query via SCPI, but is not changeable. In such applications the control is grayed-out. Attempting to change the value via SCPI will be ignored but no error message will be generated
Dependencies	Does not appear in Spectrum Analyzer Mode
Preset	10 dB VXT Models M9410A/11A: 0 dB
State Saved	Saved in instrument state
Min	0 dB
Max	20 dB VXT Models M9410A/11A: 50 dB

Mixer Lvl Offset

This is an advanced setting to adjust target Range at the input mixer, which in turn affects the signal level in the instrument's IF. This setting can be used when additional optimization is needed after setting "[Peak-to-Average Ratio](#)" on page 733. Positive values of offset optimize noise performance over distortion, negative values optimize distortion performance over noise.

Remote Command	<code>[:SENSe]:POWer[:RF]:RANGe:MIXer:OFFSet <real></code> <code>[:SENSe]:POWer[:RF]:RANGe:MIXer:OFFSet?</code>
Example	<code>:POW:RANG:MIX:OFFS -5 dB</code>
Preset	0 dB
State Saved	Saved in instrument state
Min	-35 dB VXT Models M9410A/11A: -34 dB
Max	30 dB

3.4.3.4 Signal Path

Contains controls that pertain to the routing of the signal through the frontend of the instrument.

In general, only appears in instruments whose hardware supports this signal routing. For example, this tab does not appear in many of the modular instrument products, including VXT Model M9421A, or UXM.

This tab *does* appear in VXT Models M9410A/11A, because ["Software Preselection" on page 749](#) is under this tab, and VXT Models M9410A/11A implement a version of Software Preselection.

Presel Center

Adjusts the centering of the preselector filter to optimize the amplitude accuracy at the frequency of the selected marker. If the selected marker is not on when **Presel Center** is pressed, the instrument turns on the selected marker, performs a peak search, and then performs centering on the marker's center frequency. If the selected marker is already on and between the start and stop frequencies of the instrument, the instrument performs the preselector calibration on that marker's frequency. If the selected marker is already on, but outside the frequency range between **Start Freq** and **Stop Freq**, the instrument first performs a peak search, and then performs centering on the marker's center frequency.

The value displayed on ["Preselector Adjust" on page 736](#) changes to reflect the new preselector tuning.

Certain considerations should be observed to ensure proper operation, as detailed in ["Proper Preselector Operation" on page 427](#).

Remote Command	<code>[:SENSe] :POWer [:RF] :PCENter</code>
Example	<code>:POW:PCEN</code>
Notes	The rules outlined above under the control description apply for the remote command as well as the key. The result of the command depends on marker position, etc. Any message generated by the control press is also generated in response to the remote command
Dependencies	Does not appear in CXA-m, nor in VXT Models M9410A/11A Grayed-out if the microwave preselector is off <ul style="list-style-type: none"> - If the selected marker's frequency is below Band 1, an advisory message is generated "Preselector not used in this frequency range" and no action is taken - Grayed-out if entirely in Band 0, that is, if Stop Freq is below about 3.6 GHz Grayed-out if entirely above 50 GHz, that is, if Start Freq is above 50 GHz - Blanked in models that do not include a preselector, such as Option 503. If the remote command is sent in these instruments, accepted without error, and the query always returns 0 - Grayed-out in the Spectrogram View
Couplings	The active marker position determines where the centering will be attempted If the instrument is in a measurement such as averaging when centering is initiated, the act of centering the preselector restarts averaging, but the first average trace will not be taken until the centering is completed

Status Bits/OPC dependencies	<p>The offset applied to do the centering appears in "Preselector Adjust" on page 736</p> <hr/> <p>When centering the preselector, *OPC does not return true until the process is complete and a subsequent measurement has completed, nor are results returned in response to :READ or :MEASure queries</p> <p>The Measuring bit remains set (true) while this command is operating, and does not go false until the subsequent sweep/measurement has completed</p>
------------------------------	--

Proper Preselector Operation

Certain considerations should be observed to ensure proper operation:

1. If the selected marker is **Off**, the instrument turns on a marker, performs a peak search, and adjusts the preselector using the selected marker's frequency. It uses the "highest peak" peak search method unqualified by threshold or excursion, so that there is no chance of a 'no peak found' error. It continues with that peak, even if it is the peak of just noise. Therefore, for this operation to work properly, there should be a signal on-screen in a preselected range for the peak search to find
2. If the selected marker is already **On**, the instrument attempts the centering at that marker's frequency. There is no preselector for signals below about 3.6 GHz, so if the marker is on a signal below 3.6 GHz, no centering is attempted, and an advisory message is generated
3. In some models, the preselector can be bypassed. If it is bypassed, no centering is attempted in that range and a message is generated

Preselector Adjust

Lets you manually adjust the preselector filter frequency to optimize its response to the signal of interest. Only available when ["Presel Center" on page 734](#) is available.

For general purpose signal analysis, using **Presel Center** is recommended. Centering the filter minimizes the impact of long-term preselector drift. **Preselector Adjust** can be used instead to manually optimize the preselector. One application of manual optimization would be to peak the preselector response, which both optimizes the signal-to-noise ratio and minimizes amplitude variations due to small (short-term) preselector drifting.

When **Presel Center** is performed, the offset applied to do the centering becomes the new value of **Preselector Adjust**.

Remote Command	<pre>[:SENSe]:POWer[:RF]:PADJust <freq> [:SENSe]:POWer[:RF]:PADJust?</pre>
Example	<pre>:POW:PADJ 100KHz :POW:PADJ?</pre>

Notes	The value on the control is displayed to 0.1 MHz resolution
Dependencies	<ul style="list-style-type: none"> - Does not appear in CXA-m - Does not appear in VXT Models M9410A/11A - Grayed-out if microwave preselector is off - Grayed-out if entirely in Band 0, that is, if Stop Freq is lower than about 3.6 GHz - Grayed-out if entirely above 50 GHz, that is, if Start Freq is higher than 50 GHz - Blank in models that do not include a preselector, such as Option 503. If the command is sent in these instruments, it is accepted without error, and the query always returns 0 - Grayed-out in the Spectrogram View
Preset	0 MHz
State Saved	The Preselector Adjust value set by " Presel Center " on page 734, or by manually adjusting Preselector Adjust Not saved in instrument state, and does not survive a Preset or power cycle
Min	-500 MHz
Max	500 MHz
Backwards Compatibility SCPI	<code>[:SENSe]:POWer[:RF]:MW:PADJust</code> <code>[:SENSe]:POWer[:RF]:MMW:PADJust</code>
Notes	The command has no effect, and the query always returns MWAVE
Backwards Compatibility SCPI	<code>[:SENSe]:POWer[:RF]:PADJust:PRESelector MWAVE MMWave EXTernal</code> <code>[:SENSe]:POWer[:RF]:PADJust:PRESelector?</code>

Internal Preamp

Accesses a menu of controls for the internal preamps. Turning on the preamp gives a better noise figure, but a poorer inter-modulation distortion (TOI) to noise floor dynamic range. You can optimize this setting for your measurement.

The instrument takes the preamp gain into account as it sweeps. If you sweep outside of the range of the preamp, the instrument will also account for that. The displayed result always reflects the correct gain.

For some measurements, when the preamp is on and any part of the displayed frequency range is below the lowest frequency for which the preamp has specifications, a warning condition message appears in the status line. For example, for a preamp with a 9 kHz lowest specified frequency: "Preamp: Accy unspec'd below 9 kHz".

3 Bluetooth Mode
 3.4 LE|QHS In-band Emissions Measurement

Selection	Example	Note
Off	:POW:GAIN OFF	
Low Band	:POW:GAIN ON :POW:GAIN:BAND LOW	Sets the internal preamp to use only the low band. The frequency range of the installed (optional) low-band preamp is displayed in square brackets on the Low Band selection in the dropdown
Full Range	:POW:GAIN ON :POW:GAIN:BAND FULL	Sets the internal preamp to use its full range. The low band (0-3.6 GHz, 0-3.4 GHz, 0-3 GHz, depending on the model) is supplied by the low band preamp and the frequencies above low band are supplied by the high band preamp The frequency range of the installed (optional) low-band preamp is displayed in square brackets on the Full Range selection in the dropdown. If the high band option is not installed the Full Range selection does not appear

NOTE

The maximum **Center Frequency** for Low Band, displayed in square brackets, can change based on the selected IFBW for measurements that support IFBW (for example, Waveform measurement across all Modes that support it). In certain models (such as N9042B & N9032B), IFBW values ≤ 40 MHz have a maximum Low Band frequency of 3.6 GHz, while $40 \text{ MHz} < \text{IFBW} \leq 1 \text{ GHz}$ have a maximum of 3.3 GHz, and $1 \text{ GHz} < \text{IFBW} \leq 1.5 \text{ GHz}$ have a maximum of 3.5 GHz. IFBW values $> 1.5 \text{ GHz}$ do not support a **Center Frequency** that can reach the Low Band maximum frequency. In these cases, **N/A** is displayed in the square brackets for Low Band.

Remote Command	:SENSe]:POWer[:RF]:GAIN:BAND LOW FULL :SENSe]:POWer[:RF]:GAIN:BAND? :SENSe]:POWer[:RF]:GAIN[:STATe] OFF ON 0 1 :SENSe]:POWer[:RF]:GAIN[:STATe]?
Example	:POW:GAIN:BAND LOW :POW:GAIN:BAND? :POW:GAIN OFF :POW:GAIN?
Dependencies	Not available on all hardware platforms. If the preamp is not present or is unlicensed, this control is not shown Does not appear in VXT Models M9410A/11A/15A/16A If :POW:GAIN:BAND FULL is sent when a low band preamp is available, the preamp band parameter is set to LOW instead of FULL, and an "Option not installed" message is generated Not available when the electronic/soft attenuator is enabled
Preset	LOW

	OFF
State Saved	Saved in instrument state
Annotation	<p>When the USB Preamp is not connected to USB, the Preamp annotation in the Meas Bar says “Off” if the preamp is off and displays the frequency range of the low band or full range preamp depending on the setting. For example, if the Preamp is set to Low Band and the Low Band is 3.6 GHz the annotation says “3.6 GHz”. If it is a 13.6 GHz preamp and it is set to Full Range the annotation says “13.6 GHz”</p> <p>When the USB Preamp is connected to USB, the Preamp annotation says “Preamp: USB” if the internal preamp is off or “Preamp: USB, Int” if the internal preamp is on (only for measurements that support the USB preamp)</p>

LNA

Lets you turn the Low Noise Amplifier (**LNA**) on or off.

LNA is an additional preamplifier that provides superior DANL and frequency range compared to "**Internal Preamp**" on page 737. LNA provides lower system noise figure, especially at frequencies above 100 MHz, and can be operated up to the full range of 50 GHz instruments.

For best possible sensitivity, **LNA** can be turned on *together* with "**Internal Preamp**" on page 737, although if you operate both preamps together, note that the TOI (distortion) specifications are impacted. The sensitivity improvement of this combination is substantial when operating in high band (frequencies above 3.6 GHz).

For more details about annotation, see "**More Information**" on page 430

Remote Command	<code>[:SENSe]:POWer[:RF]:GAIN:LNA[:STATe] OFF ON 0 1</code> <code>[:SENSe]:POWer[:RF]:GAIN:LNA[:STATe]?</code>
Example	<code>:POW:GAIN:LNA ON</code>
Dependencies	<p>Requires Option LNA, except for VXT models M9415A/16A</p> <p>Does not appear in VXT models M9421A/10A/11A</p> <p>May not appear in some measurements</p> <p>LNA is not available when the electronic/soft attenuator is enabled</p>
Preset	OFF
State Saved	Saved in State

More Information

When **LNA** is installed, the preamp annotation changes to show the state of both **LNA** and **Internal Preamp**. Below is an example:

3 Bluetooth Mode

3.4 LEIQHS In-band Emissions Measurement

```
Atten: 8 dB
Pre: Int on, LNA on
μW Path: LNP, On
Source: Off
```

Note that when operating entirely in the low band (below about 3.6 GHz), if **LNA** is on, **Internal Preamp** is switched off (even if you have its switch set to **ON**). This is because the noise performance is actually degraded in low band if both preamps are on. In this case, the annotation reflects the actual state of the two preamps, but the **Internal Preamp** annotation displays in amber, to warn you that the actual state of **Internal Preamp** does not match its switch control display:

```
Atten: 8 dB
Pre: Int off, LNA on
μW Path: LNP, On
Source: Off
```

μW Path Control

Options for this control include **μW Preselector Bypass** (Option MPB), **Low Noise Path** (Option LNP) and **Full Bypass Enable** in the High Band path circuits.

When the **μW Preselector** is bypassed, flatness is improved, but will be subject to spurs from out of band interfering signals. When **Low Noise Path Enable** is selected, the instrument automatically bypasses certain circuitry in the high frequency bands that can contribute to noise, when it is appropriate based on other instrument settings.

For most applications, the preset state is **Standard Path**, which provides the best remote-control throughput, minimizes acoustic noise from switching and minimizes the risk of wear in the hardware switches, particularly in remote test scenarios where both low band and high band setups will follow in rapid succession. In this path, the bypass of the low band/high band switch and microwave preamp is never activated, which can cause some noise degradation but preserves the life of the bypass switch.

For applications that utilize the wideband IF paths, the preset state is **μW Preselector Bypass**, if option MPB is present. This is because, when using a wideband IF such as the 140 MHz IF, the **μW Preselector's** bandwidth can be narrower than the available IF bandwidth, causing degraded amplitude flatness and phase linearity, so it is desirable to bypass the preselector in the default case.

You may choose **Low Noise Path Enable** for a lower noise floor, especially in the 21–26.5 GHz region, though without improving many measures of dynamic range, and without giving the best possible noise floor. The preamp, if purchased and used, gives better noise floor than does **Low Noise Path Enable**, but the preamp's compression threshold and third-order intercept are much poorer than that of **Low Noise Path Enable**.

A fourth choice is **Full Bypass Enable**, which combines **μW Preselector Bypass** and **Low Noise Path Enable**. Because this can bypass most of the circuitry between the input and the first mixer, care should be taken when using this setting to avoid

damaging the mixer. **Full Bypass Enable** is only available if both options LNP and MPB are present, as well as option FBP.

Path	Example	Note
Standard Path	:POW:MW:PATH STD	Normal setting for most measurements. μ W Preselector in circuit, Low Noise Path disabled
Low Noise Path Enable	:POW:MW:PATH LNP	See " Low Noise Path Enable " on page 435
μ W Preselector Bypass	:POW:MW:PATH MPB	See " μW Preselector Bypass " on page 437
Full Bypass Enable	:POW:MW:PATH FULL	See " Full Bypass Enable " on page 438

Remote Command	[:SENSe] :POWer [:RF] :MW:PATH STD LNPath MPBypass FULL [:SENSe] :POWer [:RF] :MW:PATH?
Example	:POW:MW:PATH LNP Enables the Low Noise path :POW:MW:PATH?
Notes	If " Presel Center " on page 734 is performed, the instrument will momentarily switch to the Standard Path, regardless of the setting of μW Path Control The DC Block will always be switched in when the low noise path is switched in, to protect succeeding circuitry from DC. Note that this does not mean "when the low noise path is enabled" but when, based on the Low Noise Path rules, the path is actually switched in. This can happen when the selection is Low Noise Path Enable or Full Bypass Enable . In the case where the DC Block is switched in the instrument is now AC coupled. However, if you selected DC coupling, the UI would still behave as though it were DC coupled, including all annunciation, warnings, status bits, and responses to SCPI queries. This is because, based on other settings, the instrument could switch out the low noise path at any time and hence go back to being DC coupled Alignment switching ignores the settings in this menu, and restores them when finished
Dependencies	Does not appear in CXA-m, VXT Models M9410A/11A, nor in BBIQ and External Mixing <ul style="list-style-type: none"> - The Low Noise Path Enable selection does not appear unless Option LNP is present and licensed - The μW Preselector Bypass selection does not appear unless Option MPB is present and licensed - The Full Bypass Enable selection does not appear unless options LNP and MPB are both present as well as option FBP <p>In any of these cases, if the required options are not present and the SCPI command is sent, error -241, "Hardware missing; Option not installed" is generated</p> <p>Low Noise Path Enable and Full Bypass Enable are grayed-out if the current measurement does not support them</p> <p>Low Noise Path Enable and Full Bypass Enable are not supported in Avionics and MMR Modes (non-modulation measurements). In any of these cases (that is, the feature is not supported in either measurement or Mode), if the SCPI command is sent, the following error is generated: -221, "Setting Conflict; Feature not supported for this measurement"</p>

3 Bluetooth Mode
 3.4 LEIQHS In-band Emissions Measurement

Preset	Mode	Value
	IQ Analyzer	MPB option present and licensed: MPB
	Pulse	MPB option not present and licensed: STD
	Avionics	
	All other Modes	STD
State Saved	Save in instrument state	
Range	Standard Path Low Noise Path Enable μ W Presel Bypass Full Bypass Enable	

Annotation

In the Meas Bar, if the Standard path is chosen:
 μ W Path: Standard
 If Low Noise Path is enabled but the LNP switch is not thrown:
 μ W Path: LNP,Off
 If the Low Noise Path is enabled and the LNP switch is thrown:
 μ W Path: LNP,On
 If the preselector is bypassed:
 μ W Path: Bypass
 If Full Bypass Enable is selected but the LNP switch is not thrown:
 μ W Path: FBy,Off
 If Full Bypass Enable is selected and the LNP switch is thrown:
 μ W Path: FBy,On

μ W Path Control Auto

In VMA, WLAN, 5G NR, CQM Modes, an **Auto/Man** switch is added to **μ W Path Control**:



This allows the function to automatically switch based on certain Auto Rules as shown below:

VMA Mode

Measurement	When μ W Path Control is in Auto
Digital Demod	Use Standard Path unless tuned frequency > 3.6 GHz and IFBW > 15 MHz, in which case choose Preselector Bypass
Monitor Spectrum	Always Presel Bypass

Measurement	When μ W Path Control is in Auto
IQ Waveform	Use Standard Path unless tuned frequency > 3.6 GHz and IFBW > 15 MHz, in which case choose Preselector Bypass
Custom OFDM	Use Standard Path unless tuned frequency > 3.6 GHz and IFBW > 15 MHz, in which case choose Preselector Bypass
Channel Power	Always Presel Bypass
Occupied BW	Always Presel Bypass
CCDF	Use Standard Path unless tuned frequency > 3.6 GHz and IFBW > 15 MHz, in which case choose Preselector Bypass
ACP	Always Presel Bypass
SEM	Always Presel Bypass
Spurious Emissions	Always Standard Path

WLAN Mode

Measurement	When μ W Path Control is in Auto
Modulation Analysis	Always Presel Bypass
Spectral Flatness	Always Presel Bypass
Power vs Time	Always Presel Bypass
Monitor Spectrum	Always Presel Bypass
IQ Waveform	Always Presel Bypass
Channel Power	Always Presel Bypass
Occupied BW	Always Presel Bypass
CCDF	Always Presel Bypass
SEM	For 11be 320M, when 'Enabled Wideband IF for FFT' is OFF or 'Sweep Type Rule' is Best Dynamic Range, auto μ W path is standard For other cases, auto μ W path is presel bypass if presel bypass is enabled, auto μ W path is standard if presel bypass is not enabled
Spurious Emissions	Always Standard Path

5G NR Mode

Measurement	When μ W Path Control is in Auto
Modulation Analysis	Use Standard Path unless tuned frequency > 3.6 GHz and IFBW > 15 MHz, in which case choose Full Bypass if conditions warrant(FBP Option is available and "Allow Full Bypass in Auto" is On), otherwise choose Preselector Bypass
Monitor Spectrum	Always Standard Path
IQ Waveform	Use Standard Path unless tuned frequency > 3.6 GHz and IFBW > 15 MHz, in which case choose Full Bypass if conditions warrant(FBP Option is available

3 Bluetooth Mode
 3.4 LE|QHS In-band Emissions Measurement

Measurement	When μ W Path Control is in Auto
	and “Allow Full Bypass in Auto” is On), otherwise choose Preselector Bypass
Channel Power	Always Standard Path
Occupied BW	Always Standard Path
CCDF	Use Standard Path unless tuned frequency > 3.6 GHz and IFBW > 15 MHz, in which case choose Preselector Bypass
ACP	Always Standard Path
SEM	Always Standard Path
Spurious Emissions	Always Standard Path
Transmit On Off Power	Use Standard Path unless tuned frequency > 3.6 GHz and Info BW > 15 MHz, in which case choose Preselector Bypass

Channel Quality Mode

Measurement	When μ W Path Control is in Auto
Group Delay	Use Standard Path unless tuned frequency > 3.6 GHz and IFBW > 15 MHz, in which case choose Full Bypass if conditions warrant(FBP Option is available and “Allow Full Bypass in Auto” is On), otherwise choose Preselector Bypass
Monitor Spectrum	Always Standard Path
IQ Waveform	Use Standard Path unless tuned frequency > 3.6 GHz and IFBW > 15 MHz, in which case choose Preselector Bypass
CCDF	Use Standard Path unless tuned frequency > 3.6 GHz and IFBW > 15 MHz, in which case choose Preselector Bypass

Remote Command	<code>[:SENSe]:POWer[:RF]:MW:PATH:AUTO ON OFF 1 0</code> <code>[:SENSe]:POWer[:RF]:MW:PATH:AUTO?</code>
Example	<code>:POW:MW:PATH:AUTO ON</code> <code>:POW:MW:PATH:AUTO?</code>
Dependencies	Only appears in VMA, WLAN, 5G NR and CQM Modes
Couplings	See the tables above
Preset	<code>ON</code>
Range	<code>ON OFF</code>

Low Noise Path Enable

Low Noise Path Enable provides a lower noise floor under some circumstances, particularly when operating in the 21–26.5 GHz region. With the Low Noise Path enabled, the low band/high band switch and microwave preamp are bypassed whenever *all* the following are true:

- The instrument is not in the Low Band, meaning:
- the start frequency is above 3.5 GHz and
- the stop frequency is above 3.6 GHz
- The internal preamp is not installed, or if installed, is set to **Off** or **Low Band**

Note that this means that, when any part of a sweep is done in Low Band, the Low Noise Path is not used, whether or not the **Low Noise Path Enable** is selected in the user interface. Also, if the preamp is turned on, the Low Noise Path is not used, whether or not the **Low Noise Path Enable** is selected in the user interface. The only time the Low Noise Path is used is when **Low Noise Path Enable** is selected, the sweep is completely in High Band (> 3.6 GHz) and no preamp is in use.

For measurements that use IQ acquisition, the low noise path is used when **Center Frequency** is in High Band (> 3.6 GHz) and no preamp is in use. In other words, the rules above are modified to use only the center frequency to qualify which path to switch in. This is not the case for FFTs in the Swept SA measurement; they use the same rules as swept measurements.

Note that the Low Noise Path, while giving improved DANL, has the disadvantage of decreased TOI performance and decreased gain compression performance relative to the standard path.

Note also that the bypass switch is a mechanical switch and has finite life, so if the **Low Noise Path Enable** is selected, it is possible to cause frequent cycling of this switch by frequently changing instrument settings such that the above conditions hold true only some of the time. A user making tests of this nature should consider opting for the **Standard Path**, which will never throw the bypass switch, at the expense of some degraded noise performance.

The low noise path is useful for situations where the signal level is so low that the instrument performance is dominated by noise even with 0 dB attenuation, but still high enough that the preamp option would have excessive third-order intermodulation or compression. The preamp, if purchased and used, gives better noise floor than does the “Low Noise Path.” However, its compression threshold and third-order intercept are much poorer than that of the non-preamp path.

There are some applications, typically for signals around –30 dBm, for which the third-order dynamic range of the standard path is good enough, but the noise floor is not low enough even with 0 dB input attenuation. When the third-order dynamic range of the preamp path is too little and the noise floor of the standard path is too high, the Low Noise Path can provide the best dynamic range

The graph below illustrates the concept. It shows, in red, the performance of an instrument at different attenuation settings, both with the preamp on and off, in a measurement that is affected by both instrument noise and instrument TOI. The green shows the best available dynamic range, offset by 0.5 dB for clarity. The blue

shows how the best available dynamic range improves for moderate signal levels with the low noise path switched in. In this illustration, the preamp improves the noise floor by 15 dB while degrading the third-order intercept by 30 dB, and the low noise path reduces loss by 8 dB. The attenuator step size is 2 dB.

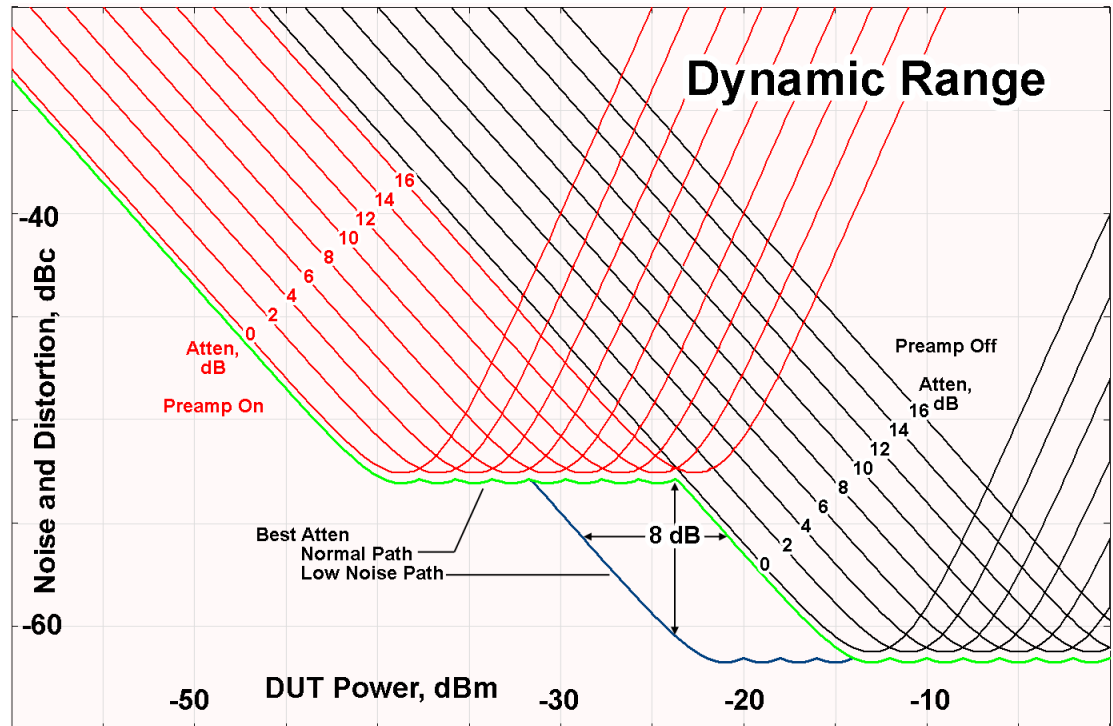

There are other times where selecting the low noise path improves performance, too. Compression-limited measurements such as finding the nulls in a pulsed-RF spectrum can profit from the low noise path in a way similar to the TOI-limited measurement illustrated. Accuracy can be improved when the low noise path allows the optimum attenuation to increase from a small amount like 0, 2 or 4 dB to a larger amount, giving better return loss at the instrument input. Harmonic measurements, such as second and third harmonic levels, are much improved using the low noise path because of the superiority of that path for harmonic (though not intermodulation) distortion performance.

μW Preselector Bypass

Toggles the preselector bypass switch for band 1 and higher. When the microwave preselector is on, the signal path is preselected. When the microwave preselector is off, the signal path is not preselected. The preselected path is the normal path for the instrument.

The preselector is a tunable bandpass filter which prevents signals away from the frequency of interest from combining in the mixer to generate in-band spurious

signals (images). The consequences of using a preselector filter are its limited bandwidth, the amplitude and phase ripple in its passband, and any amplitude and phase instability due to center frequency drift.

Option MPB or pre-selector bypass provides an unpreselected input mixer path for certain X-Series signal analyzers with frequency ranges above 3.6 GHz. This signal path allows a wider bandwidth and less amplitude variability, which is an advantage when doing modulation analysis and broadband signal analysis. The disadvantage is that, without the preselector, image signals will be displayed. Another disadvantage of bypassing the preselector is increased LO emission levels at the front panel input port.

Image responses are separated from the real signal by twice the 1st IF. For IF Paths of 10 MHz and 25 MHz, the 1st IF is 322.5 MHz, so the image response and the real signal will be separated by 645 MHz. The 1st IF will be different for other IF Path settings. When viewing a real signal and its corresponding image response in internal mixing, the image response will be to the left of the real signal.

Also, the image response and the real signal typically have the same amplitude and exhibit the same shape factor.

However, if Option FS1 (Fast Sweep Capability) is enabled, the image response in the Swept SA measurement appears lower in amplitude and has a much wider shape factor compared to the real signal.

Full Bypass Enable

With **Full Bypass Enable** selected, the microwave preselector is bypassed. In addition, the low band/high band switch and microwave preamp are bypassed whenever *all* the following are true:

- The instrument is not in the Low Band, meaning:
- the start frequency is above 3.5 GHz and
- the stop frequency is above 3.6 GHz.
- the internal preamp is not installed or if installed, is set to **Off** or **Low Band**

Note that this means that, when any part of a sweep is done in Low Band, the Low Noise Path is not used, whether or not the **Full Bypass Enable** is selected in the user interface. Also, if the preamp is turned on, the Low Noise Path is not used, whether or not the **Full Bypass Enable** is selected in the user interface. The only time the Low Noise Path is used is when **Full Bypass Enable** is selected, the sweep is completely in High Band (> 3.6 GHz) and no preamp is in use.

CAUTION

When **Full Bypass Enable** is selected, and "**Y Scale**" on page 597 is set to 0 dB, there will be a direct AC connection between the input and the first converter when the Low Noise Path switches in (when Start Freq >3.6 GHz and the Preamp is either not licensed, set to Low Band, or Off). This puts the first converter at considerable risk to be damaged by high AC power. Consequently, whenever **Full Bypass Enable** is selected, a warning message appears in the status bar:

"Full Bypass Enabled, maximum safe input power reduced"

Microwave Preselector Bypass Backwards Compatibility

Example	<code>:POW:MW:PRES OFF</code> Bypasses the microwave preselector
Notes	Included for Microwave Preselector Bypass backwards compatibility The ON parameter sets the STD path (<code>:POW:MW:PATH STD</code>) The OFF parameter sets path MPB (<code>:POW:MW:PATH MPB</code>)
Preset	ON
Backwards Compatibility SCPI	<code>[:SENSe]:POWer[:RF]:MW:PRESelector[:STATe] ON OFF 0 1</code> <code>[:SENSe]:POWer[:RF]:MW:PRESelector[:STATe]?</code>

Frequency Extender Preselection Bypass

Only applies to the high frequency path of the Frequency Extender, and only if the Frequency Extender allows it. For example, the V3050A high frequency path is 50 – 110 GHz and *does* allow control of the preselector bypass.

When the Frequency Extender's preselection is bypassed, flatness is improved, but will be subject to spurs from out-of-band interfering signals. For bandwidths greater than 2.5 [GHz], it is recommended that the signal bypass the Frequency Extender Preselector since the max bandwidth of the Preselector can be as narrow as 2.5 [GHz].

For most applications, the preset state is **OFF**, which gives the best remote-control throughput, minimizes acoustic noise from switching, minimizes out of band spurs, and minimizes the risk of wear in the hardware switches.

Preselector and Bandwidth Conflict

When the Frequency Extender Preselector is applied and the signal bandwidth is greater than 2.5 [GHz], then a settings alert message will show to warn the user that the signal may be distorted due to the limitation of the Frequency Extender Preselector bandwidth.

An example of the settings alert message is shown below.

Settings Alert message in the Status Bar at the bottom of the display.



Settings Alert message in the error queue

Type	ID	
	159	Settings Alert - DETECTED; Presel/Meas BW conflict

Software Preselection

Provided in some instruments, either to compensate for issues with provided hardware preselection or to provide the preselection function when there is no hardware preselector.

N9041B

Software Preselection compensates for the frequency range limit of the microwave preselector. Since the microwave preselector only goes up to 50 GHz, software preselection must be used to suppress and separate images above 50 GHz. The specific algorithm used for software preselection is specified by the SW Preselection Type selection – Normal or Advanced.

In N9041B, **Software Preselection** only applies for frequencies above 50 GHz, therefore it is only used for RF Input 2. Even if turned on, it is not used for other inputs, and never for frequencies below 50 GHz. This is why the label of this control contains the parenthetical note “(>~50 GHz)”.

Note that in N9041B, in Swept SA measurement, **Software Preselection** works even if the measurement is using an FFT Sweep Type. In measurements other than Swept SA, Software Preselection is not used if the measurement is using an FFT sweep type.

N9042B+V3050A

Software Preselection compensates for the frequency range limit of the microwave preselector. Since the microwave preselector only goes up to 50 GHz, software preselection must be used to suppress and separate images above 50 GHz. The specific algorithm used for software preselection is specified by the SW Preselection

3 Bluetooth Mode

3.4 LE|QHS In-band Emissions Measurement

Type selection – Normal or Advanced.

For N9042B+V3050A, Software Preselection only applies for frequencies above 50 GHz, therefore it is only used for External RF. Even if it is turned on, it will not be used for other inputs and never for frequencies below 50 GHz. This is why the label of this control contains the parenthetical note “(>~50 GHz)”.

Note that for N9042B+V3050A, in the Swept SA measurement, Software Preselection works even if the measurement is using an FFT Sweep Type. In measurements other than Swept SA, Software Preselection is not used if the measurement is using an FFT Sweep Type.

VXT models M9410A/11A

Software Preselection is used to provide the preselection function, as there is no hardware preselector in these models. Two background traces are taken and compared point by point, and the point with the lowest amplitude from the two traces is used. This provides a method to reduce spurs that are internally generated within the VXT, but you should note the following when using Software Preselection:

- There is some speed cost due to the need to take multiple captures
- Taking the point with the lowest amplitude in each trace will make the average noise level lower at all points that do not have a spur. This can reduce the accuracy of the measurement of noise and noise-like signals

Because of the difficulty in identifying spurs manually, you are recommended to leave Software Preselection **ON** at all times in VXT models M9410A/11A. If you turn it off in order to speed up your measurement or improve noise accuracy, be aware of unwanted onscreen spurs.

Remote Command	<code>[:SENSe]:POWer[:RF]:SWPrese1:STATe 0 1 ON OFF</code> <code>[:SENSe]:POWer[:RF]:SWPrese1:STAT?</code>
Example	<code>:POW:SWPR:STAT 1</code> <code>:POW:SWPR:STAT?</code>
Dependencies	Only appears in N9041B, N9042B+V2050A, and VXT models M9410A/11A. Does not appear in all measurements
Couplings	Affects Sweep Time Auto Tune supports Software Preselection , so Auto Tune should be performed after setting the Software Preselection state
Preset	N9041B OFF N9042B+V3050A ON M9410A/11A ON
State Saved	Saved in instrument state

SW Preselection Type

Specifies the algorithm used for software preselection.

Two hidden sweeps occur in succession. The second sweep is offset in LO frequency by $2 * IF / N$. For each point in each trace, the smaller amplitude from the two traces is taken and placed in that point in the selected trace. The Peak detector is auto-selected to improve the image suppression effectiveness. Responses of each trace that lie on top of one another will remain and are valid signals. Other signals are images, which are suppressed. The action of taking the smaller of the two traces will make the average noise level lower in all points that do not have an image, thus reducing the accuracy of the measurement of noise and noise-like signals.

- **NORMa1** - mathematically removes all image and multiple responses of signals present at the input
- **ADVanced** - any trace processing (such as “max hold” or trace averaging) is performed on the points of both candidate traces before the “select minimum” operation occurs. This form of processing works better for non-stationary signals, such as pulsed-RF signals

Remote Command	<code>[:SENSe]:POWer[:RF]:SWPreSel NORMa1 ADVanced</code> <code>[:SENSe]:POWer[:RF]:SWPreSel?</code>
Example	<code>:POW:SWPR NORM</code> <code>:POW:SWPR?</code>
Dependencies	Only appears in N9041B and N9042B+V3050A. Only appears in measurements that use the Swept method Grayed-out when "Software Preselection" on page 749 is OFF. The grayout message is “Unavailable unless SW Presel enabled”
Preset	N9041B ADVanced N9042B+V3050A NORMa1
State Saved	Saved in instrument state

SW Preselection BW

Specifies the effective bandwidth to be used for Software Preselection.

The options are:

- **NORMa1** – when making Swept measurements, a software preselection algorithm is used which takes up to 4 background acquisitions, then post-processes the result. This algorithm can remove images from signals with an occupied

3 Bluetooth Mode
 3.4 LE|QHS In-band Emissions Measurement

bandwidth up to around 3 GHz. (Default/Preset setting). When making FFT measurements, this algorithm is not used, instead the same algorithm is used as for **NARRow** (below)

- **NARRow**– a software preselection algorithm is used which takes two background acquisitions, then post-processes the result to detect and remove images from wideband signals with occupied bandwidths up to 2 GHz. This increases the risk of images failing to be rejected, but improves the measurement speed

Remote Command	<code>[:SENSe]:POWer[:RF]:SWPreSel:BW NORMa1 NARRow</code> <code>[:SENSe]:POWer[:RF]:SWPreSel:BW?</code>
Example	<code>:POW:SWPR:BW NARR</code>
Dependencies	Only appears in N9041B and N9042B+V3050A. Only appears in measurements that use the Swept method Grayed-out when " Software Preselection " on page 749 is OFF . The grayout message is "Unavailable unless SW Presel enabled" For N9042B+V3050A, the parameter is SCPI-only, and always set to NARRow when Software Preselection is enabled
Preset	N9041B NORMa1 N9042B+V3050A NARRow
State Saved	Saved in instrument state

High Freq Prefilter

Lets you set the state of Prefilter for center frequencies above 1310 MHz.

In VXT Models M9410A/11A, the Receiver RF path has a bank of filters that come after the RF Attenuator in the signal path. Since this bank of filters precedes the mixer they are known as the "Prefilter" bank. Their purpose is to eliminate unwanted in-band mixing products by filtering out all but the desired frequencies before the signals get to the mixer. There are 13 prefilter bands to cover the frequencies between 9 kHz and 6000 MHz. The Prefilter provides the necessary rejection of the unwanted signal.

Remote Command	<code>[:SENSe]:<measurement>:PFILter[:STATe] ON OFF 1 0</code> <code>[:SENSe]:<measurement>:PFILter[:STATe]?</code>
Example	Enable High Freq Prefilter for the Complex Spectrum Measurement in BASIC Mode: <code>:SPEC:PFIL ON</code> Enable High Freq Prefilter for the IQ Waveform Measurement, in multiple Modes: <code>:WAV:PFIL ON</code> Enable High Freq Prefilter for the Swept SA Measurement in SA Mode:

	:SAN:PFIL ON
Dependencies	Only appears in VXT models M9410A/11A with center frequency above 1310 MHz
Preset	See "Prefilter Presets" on page 444 below
State Saved	Saved in instrument state

Prefilter Presets

Meas	Mode	Preset
SPEC	BASIC	OFF
WAV	BASIC, WCDMA, WLAN, LTEAFDD, LTEATDD, 5GNR, VMA	OFF
MON	WCDMA, WLAN, LTEAFDD, LTEATDD, 5GNR, VMA	OFF
RHO	WCDMA	OFF
CDP	WCDMA	OFF
PCON	WCDMA	OFF
EVMQ	WCDMA	OFF
CHP	WCDMA, WLAN, LTEAFDD, LTEATDD, 5GNR, VMA, SA	OFF
OBW	WCDMA, WLAN, LTEAFDD, LTEATDD, 5GNR, VMA, SA	OFF
ACP	WCDMA, LTEAFDD, LTEATDD, 5GNR, VMA, SA	OFF
SEM	WCDMA, WLAN, LTEAFDD, LTEATDD, 5GNR, VMA, SA	OFF
PST	WCDMA, WLAN, LTEAFDD, LTEATDD, 5GNR, VMA, SA	OFF
PVT	WLAN, LTEAFDD, LTEATDD, 5GNR	OFF
EVM	WLAN, LTEAFDD, LTEATDD, 5GNR	OFF
FLAT	WLAN	OFF
EVMM	WLAN	OFF
CEVM	LTEAFDD, LTEATDD	OFF
PAVT	5GNR, VMA	OFF
DDEM	VMA	OFF
OFDM	VMA	OFF
SAN	SA	ON
HARM	SA	ON

3.4.4 BW

The BW key opens the bandwidth menu, which contains the Res BW, Video BW, and RBW Filter Type controls.

3.4.4.1 Settings

The Settings tab contains the basic Bandwidth functions.

Res BW

Enables you to set the Resolution Bandwidth of the analyzer.

Remote Command	<code>[:SENSe]:IBEMissions:BANDwidth BWIDth[:RESolution] <freq></code> <code>[:SENSe]:IBEMissions:BANDwidth BWIDth[:RESolution]?</code>
Example	<code>:IBEM:BAND 100 kHz</code> <code>:IBEM:BAND?</code>
Dependencies	If meas method is FFT, This control will be grayed out
Preset	100.00 kHz
State Saved	Yes
Min/Max	1Hz/8MHz

Video BW

Enables you to set the Video Bandwidth of the analyzer.

Remote Command	<code>[:SENSe]:IBEMissions:BANDwidth BWIDth:VIDeo <freq></code> <code>[:SENSe]:IBEMissions:BANDwidth BWIDth:VIDeo?</code>
Example	<code>:IBEM:BAND:VID 200 kHz</code> <code>:IBEM:BAND:VID?</code>
Notes	Setting VBW = 100 kHz and Detector = Sample gets the same results as that of setting VBW = 300 kHz and Detector = Average
Dependencies	If meas method is FFT, This key will be grayed out
Preset	100.00 kHz
State Saved	Yes
Min/Max	1 Hz/50 MHz

RBW Filter Type

Selects the type for the resolution bandwidth filters. Historically, the Res BW filters in HP/Agilent/Keysight spectrum analyzers were Gaussian filters, specified using the –3 dB bandwidth of the filter. That is, a 10 MHz Res BW filter was a Gaussian shape with its –3 dB points 10 MHz apart. In the X-Series, the **RBW Filter BW** menu lets you choose between a Gaussian and Flat Top filter shape, for varying measurement conditions.

Filter Type	SCPI Example	Notes
Gaussian	<code>BAND:SHAP GAUS</code>	
Flattop	<code>BAND:SHAP FLAT</code>	

See ["More Information" on page 446](#)

Remote Command	<code>[:SENSe]:IBEMissions:BANDwidth:SHAPE GAUSSian FLATtop</code>
Example	<code>:IBEM:BAND:SHAP GAUS</code> <code>:IBEM:BAND:SHAP?</code>
Notes	GAUSSian= Gaussian FLATtop = Flattop We use SHAPE instead of TYPE (even though the control name uses Type) because TYPE is used for (below) for backwards compatibility
Preset	GAUSSian
State Saved	Saved in instrument state

More Information

Gaussian filters

When the Gaussian filter type is chosen, a set of 160 RBW filters are available whose shape is approximately Gaussian. The actual bandwidths used to realize the X-Series' Gaussian filters are chosen to come as close as possible, within the limitations of the digital IF, to a 24 step per decade series from 1 Hz through 3 MHz, plus the 4, 5, 6 and 8 MHz settings.

For Gaussian filters, the annotation at the bottom of the screen shows the filter bandwidth type (unless it is Normal) parenthetically between the words "Res BW" and the value, for example

Res BW 10.0 Hz (Normal bandwidth)

Res BW (Impulse) 14.8 Hz (Impulse bandwidth)

Flattop filters

When the Flattop filter type is chosen, a new set of 134 RBW hardware settings are available. These settings realize filters that are approximately rectangular in shape. When this shape is chosen the filter bandwidth options are irrelevant and therefore unavailable.

The annotation at the bottom of the screen shows that the Flattop shape is being used, for example:

Res BW (Flattop) 10 Hz

3.4.5 Display

The Display key opens the Display Menu, which lets you configure display items for the current Mode, Measurement View or Window.

3.4.5.1 View

Contains controls for selecting the current **View**, and for editing User Views.

Views

The table below shows the Views and Windows used for this Measurement:

These Views are multiple-window Views. When in a multiple window View, you select a window by touching it. The menu controls may sometimes change depending on which window is selected.

Whenever the View changes, the default menu is Frequency, unless otherwise specified in the View description.

View	Result
RF Envelope	RF Envelope Graph Metrics
RF Spectrum	RF Spectrum Graph Metric

View Selection by Name

Allows you to specify the view via its enumerated ID string.

Remote Command	<code>:DISPlay: IBEMissions:VIEW[:SElect] RFENvelope RFSpectrum</code> <code>:DISPlay:IBEMissions:VIEW[:SElect]?</code>
Example	<code>:DISP:IBEM:VIEW:SEL RFSP</code> <code>:DISP:IBEM:VIEW:SEL?</code>
Preset	RFSPpectrum
State Saved	Yes
Range	RF Envelope RF Spectrum

View Selection by Number (Remote Command only)

Allows you to specify the view via its numeric ID value.

Remote Command	<code>:DISPlay: IBEMissions:VIEW:NSElect <integer></code> <code>:DISPlay:IBEMissions:VIEW:NSElect?</code>
Example	<code>:DISP:IBEM:VIEW:NSEL 1</code> <code>:DISP:IBEM:VIEW:NSEL?</code>
Preset	1
State Saved	Yes
Min/Max	1/2

User View

Lets you choose a View from the saved User Views for the current measurement. This panel only appears if a User View exists for the current measurement.

Remote Command	<code>:DISPlay:VIEW:ADVanced:SElect <alphanumeric></code> <code>:DISPlay:VIEW:ADVanced:SElect?</code>
Example	Select Baseband as the current View <code>:DISP:VIEW:ADV:SEL "Baseband"</code>
Notes	<p>You must be in the measurement whose View you are trying to set to send the command. You can only set Views for the current measurement using this command</p> <p>For predefined views, the parameter is derived from the view name that is shown in the View list in the user interface. For example, if you are trying to select the Trace Zoom view in the Swept SA measurement, you send:</p> <pre><code>:DISP:VIEW:ADV:SEL "Trace Zoom"</code></pre> <p>because "Trace Zoom" is the name of the View as seen in the Mode/Meas dialog or in the Display, View menu</p> <p>You <i>cannot</i> use the legacy View parameter (which in this case would be <code>TZOOM</code>) with</p> <pre><code>:DISP:VIEW:ADV:SEL</code></pre> <p><code><alphanumeric></code> is case insensitive; you can specify mixed case, however the name will be evaluated on a single case. Thus, both of the following forms work:</p> <pre><code>:DISP:VIEW:ADV:SEL "Trace Zoom"</code> <code>:DISP:VIEW:ADV:SEL "TRACE ZOOM"</code></pre> <p>If the specified view is not a valid View, the query returns the error message "-224, Illegal parameter value; View with the name <alphanumeric> does not exist"</p> <p>If the display is disabled (via <code>:DISP:ENAB OFF</code>) then the error message "-221, Settings conflict; View SCPI cannot be used while Display is disabled" is generated</p>
Backwards Compatibility SCPI	The legacy node <code>:DISPlay:VIEW[:SElect]</code> is retained for backwards compatibility, but it only supports predefined views

Restore Layout to Default

Restores the Layout to the default for Basic.

Modified Views are very temporary; if you exit the current measurement they are discarded, and they are not saved in State. To retain this View for later use, and to be able to return easily to your original Basic View, you can save your edited View as a “User View”.

Save Layout as New View

Saves your new View as a User View. An alpha keyboard appears, which lets you name your new View; the default is the old View name plus a number.

Remote Command	<code>:DISPlay:VIEW:ADVanced:NAME <alphanumeric></code>
Example	<code>:DISP:VIEW:ADV:NAME "Baseband"</code> Creates a new View named Baseband from the current View, and selects it as the current View
Notes	<code><alphanumeric></code> is case insensitive; you can specify mixed case, however the name will be evaluated on a single case If <code><alphanumeric></code> name already exists as a View, the error message “-224, Illegal parameter value; View <alphanumeric> already exists” is generated If the display is disabled (via <code>:DISP:ENAB OFF</code>) then the error message “-221, Settings conflict; User View SCPI cannot be used while Display is disabled” is generated

Re-Save User View

You can re-edit a User View; if you make changes, then an asterisk will appear next to the User View’s name. You can then tap **Re-Save User View** to save it back to its existing name, or **Save Layout as New View** to add another, new User View.

This is a front panel function only, there is no remote command available to perform this function. To do this remotely, you must first perform **Save Layout as New View**, then delete the old User View and rename the new one with the name of the View you just deleted.

Rename User View

You can rename the current View by giving it a new unique name. Only User Views can be renamed, if the current View is a Predefined View, an error occurs.

Remote Command	<code>:DISPlay:VIEW:ADVanced:REName <alphanumeric></code>
----------------	---

Example	<code>:DISP:VIEW:ADV:REN "Baseband"</code>
Notes	<p><code><alphanumeric></code> is case insensitive; you can specify mixed case, however the name will be evaluated on a single case</p> <p>If the <code><alphanumeric></code> specifying the new name is already present in the list of View names, the error message "-224, Illegal parameter value; View <alphanumeric> already exists" is generated</p> <p>If the current View is a Predefined View, the error message "-224, Illegal parameter value; Cannot rename a Predefined View" is generated</p> <p>If the display is disabled (via <code>:DISP:ENAB OFF</code>) then the error message "-221, Settings conflict; View SCPI cannot be used while Display is disabled" is generated</p>

Delete User View

You can delete the current View if it is a User View. The default view becomes the current view for the Measurement.

Remote Command	<code>:DISPlay:VIEW:ADVanced:DElete</code>
Example	<code>:DISP:VIEW:ADV:DEL</code>
Notes	<p><code><alphanumeric></code> is case insensitive; you can specify mixed case, however the name will be evaluated on a single case</p> <p>If the <code><alphanumeric></code> is not present in the list of View names, the error message "-224, Illegal parameter value; View <alphanumeric> does not exist" is generated</p> <p>If the current View is a Predefined View, the error message "-224, Illegal parameter value; Cannot delete a Predefined View" is generated</p> <p>If the display is disabled (via <code>:DISP:ENAB OFF</code>) then the error message "-221, Settings conflict; View SCPI cannot be used while Display is disabled" is generated</p>

Delete All User Views

Deletes all previously saved User Views. The default view becomes the current view for the Measurement if a User View was the current view when this command was executed.

Remote Command	<code>:DISPlay:VIEW:ADVanced:DElete:ALL</code>
Example	<code>:DISP:VIEW:ADV:DEL:ALL</code>
Notes	Disabled if there are no User Views

View Editor Remote Commands

The following remote commands help you manage Views and User Views. Note that the SCPI node for User Views handles both Predefined and User Views. The legacy

3 Bluetooth Mode
3.4 LEIQHS In-band Emissions Measurement

nodes, `:DISPlay:VIEW[:SElect]` and `:DISPlay:VIEW:NSEL`, are retained for backwards compatibility, but they only support predefined views.

View Listing Query

Returns a string containing a comma-separated list of names for *all* the Views, including User Views, available for the current Measurement.

Remote Command	<code>:DISPlay:VIEW:ADVanced:CATalog?</code>
Example	<code>:DISP:VIEW:ADV:CAT?</code>
Notes	Returns a quoted string of the available Views for the current measurement, separated by commas. The list includes names for <i>all</i> the Views, including User Views, available for the current Measurement Example: <code>"Normal,Trace Zoom,Spectrogram,Baseband,myView1,yourView1"</code> No distinction is made between Predefined and User Views If you switch measurements with the display disabled (via <code>:DISP:ENAB OFF</code>), then query the list of available Views, the result is undefined

User View Listing Query

Returns a string containing a comma-separated list of names for *only* the User Views available for the current Measurement.

Remote Command	<code>:DISPlay:VIEW:ADVanced:USER:CATalog?</code>
Example	<code>:DISP:VIEW:ADV:USER:CAT?</code>
Notes	Returns a quoted string of the available User Views for the current measurement, separated by commas. Example: <code>"Baseband,myView1,yourView1"</code> If you switch measurements with the display disabled (see "Display Enable (Remote Command Only)" on page 760), then query the list of available Views, the result is undefined

3.4.5.2 Annotation

Contains controls for setting up the annotation for the current Mode or Measurement.

Graticule

Turns the display graticule On or Off for all windows with graticules in all measurements in the current Mode. Also turns the graticule Y-Axis annotation on and off.

Remote Command	<code>:DISPlay:GRATicule[:STATe] OFF ON 0 1</code> <code>:DISPlay:GRATicule[:STATe]?</code>
Example	<code>:DISP:GRAT OFF</code>
Notes	The graticule is the set of horizontal and vertical lines that make up the grid/divisions for the X-Axis and Y-Axis
Preset	ON
State Saved	Saved in instrument state
Backwards Compatibility SCPI	<code>:DISPlay:WINDow[1]:TRACe:GRATicule:GRID[:STATe] OFF ON 0 1</code> <code>:DISPlay:WINDow[1]:TRACe:GRATicule:GRID[:STATe]?</code> This command is accepted for backwards compatibility with older instruments, but the WINDow , TRACe and GRID parameters are ignored

Screen Annotation

Controls the display of the annunciation and annotation around the graticule, including any annotation on lines (such as the display line, the threshold line, etc.) and the Y-Axis annotation, for all windows with screen annotation in all measurements in the current Mode.

This does *not* include marker annotation (or the N dB result). When **OFF**, the graticule expands to fill the entire graticule area, leaving only the 1.5% gap above the graticule, as described in the **Trace** section.

Remote Command	<code>:DISPlay:ANNotation:SCReen[:STATe] OFF ON 0 1</code> <code>:DISPlay:ANNotation:SCReen[:STATe]?</code>
Example	<code>:DISP:ANN:SCR OFF</code>
Dependencies	Grayed-out and forced to OFF when System Display Settings, Annotation is OFF
Preset	ON This remains OFF through a Preset when System Display Settings, Annotation is set to OFF
State Saved	Saved in instrument state

Trace Annotation

Turns on and off the labels on the traces, showing their detector (or their Math Mode) as described in the **Trace** section, for all windows in all measurements in the current Mode for which Trace Annotation on/off is supported.

If Trace Math is being performed on a trace, then the Trace Math annotation replaces the detector annotation.

For measurements that support limit lines, this key also turns on and off the labels on the Limit Lines. The label is the Limit number annotation and Limit Comment displayed on the graph. If the length of the comment is greater than 20 characters, the first 8 characters and the last 8 characters are displayed, joined with

Remote Command	<code>:DISPlay:ANNotation:TRACe[:STATe] ON OFF 1 0</code> <code>:DISPlay:ANNotation:TRACe[:STATe]?</code>
Example	<code>:DISP:ANN:TRAC OFF</code>
Preset	<code>OFF</code>
State Saved	Saved in instrument state

Control Annotation

Turns on and off the display of values on the Active Function controls for all measurements in the current Mode. This is a security feature.

Remote Command	<code>:DISPlay:ACTivefunc[:STATe] ON OFF 1 0</code> <code>:DISPlay:ACTivefunc[:STATe]?</code>
Example	<code>:DISP:ACT OFF</code>
Dependencies	Grayed out and forced to <code>OFF</code> when System Display Settings, Annotation is <code>OFF</code>
Preset	<code>ON</code> This remains <code>OFF</code> through a Preset when System Display Settings, Annotation is set to <code>OFF</code>
State Saved	Saved in instrument state

Meas Bar

Turns the Measurement Bar at the top of the screen on and off for all measurements in the current Mode. When `OFF`, the graticule area expands to fill the area formerly occupied by the Measurement Bar.

Remote Command	<code>:DISPlay:ANNotation:MBAR[:STATe] OFF ON 0 1</code> <code>:DISPlay:ANNotation:MBAR[:STATe]?</code>
----------------	--

Example	<code>:DISP:ANN:MBAR OFF</code>
Dependencies	Grayed out and forced to OFF when System Display Settings, Annotation is OFF
Preset	ON This remains OFF through a Preset when System Display Settings, Annotation is set to OFF
State Saved	Saved in instrument state

Display Enable (Remote Command Only)

Turns the display on/off, including the display drive circuitry. The backlight stays lit to confirm that the instrument is on. The display enable setting is mode global. There are three reasons for turning the display off:

1. To increase speed as much as possible by freeing the instrument from having to update the display
2. To reduce emissions from the display, drive circuitry
3. For security purposes

If you have turned off the display:

- and you are in local operation, the display can be turned back on by pressing any key or by sending `:SYSTEM:DEFAULTS MISC` or `:DISPLAY:ENABLE ON` (neither `*RST` nor `:SYSTEM:PRESET` enable the display)
- and you are in remote operation, the display can be turned back on by pressing the **Local** or **Esc** keys, or by sending `:SYSTEM:DEFAULTS MISC` or `:DISPLAY:ENABLE ON` (neither `*RST` nor `:SYSTEM:PRESET` enable the display)
- and you are using either the `:SYSTEM:KLOCK` command or GPIB local lockout, then *no* front-panel key press will turn the display back on. You must turn it back on remotely.

If the display is **OFF**, many SCPI commands related to User Views and Multiscreen functionality do not work, and return the error messages “-221, Settings conflict; Screen SCPI cannot be used when Display is disabled” or “221, Settings conflict; View SCPI cannot be used while Display is disabled”. These commands include:

Name	Command
Select User View	<code>:DISPLAY:VIEW:ADVANCED:SELECT</code>
Rename User View	<code>:DISPLAY:VIEW:ADVANCED:RENAME</code>
Delete User View	<code>:DISPLAY:VIEW:ADVANCED:DELETE</code>
Create User View	<code>:DISPLAY:VIEW:ADVANCED:NAME</code>
Select Screen	<code>:INSTRUMENT:SCREEN:SELECT</code>
Delete Screen	<code>:INSTRUMENT:SCREEN:DELETE</code>

3 Bluetooth Mode

3.4 LEIQHS In-band Emissions Measurement

Name	Command
Delete All But This Screen	:INSTrument:SCReen:DELeTe:ALL
Add Screen	:INSTrument:SCReen:CREate
Rename Screen	:INSTrument:SCReen:REName
Sequencer On/Off	:SYSTem:SEQuencer

Remote Command	:DISPlay:ENABle OFF ON 0 1
Example	:DISP:ENAB OFF
Couplings	:DISP:ENAB OFF turns Backlight OFF and :DISP:ENAB ON turns Backlight ON, but changing Backlight settings does <i>not</i> change the state of :DISP:ENAB
Preset	ON Set by :SYST:DEF MISC, but not affected by *RST or :SYSTem:PRESet
State Saved	Not saved in instrument state
Backwards Compatibility Notes	:SYST:PRES no longer turns on :DISPlay:ENABle as it did in legacy analyzers

3.4.6 Freq

The Freq key opens the Frequency menu, which contains controls that allow you to control the Frequency and Channel parameters of the instrument.

Some features in the Frequency menu are the same for all measurements in the current Mode – they do not change as you change measurements. Settings like these are called “Meas Global” and are unaffected by Meas Preset.

3.4.6.1 Settings

The Settings Tab contains controls that pertain to the X axis parameters of the measurement. These parameters control how data on the vertical (X) axis is displayed and control instrument settings that affect the horizontal axis.

Channel

Selects which Bluetooth channel will be measured.

Channel number is common for all the measurements. The coupling of Channel and Center Frequency apply to the following Measurements:

- Transmit Analysis
- Output Spectrum BW
- Monitor Spectrum

For other measurements, center frequency does not depend on channel. If center frequency is changed in other measurements but channel isn't changed, center frequency still can return to the old value only if the measurement is switched to the upward measurements.

Remote Command	<code>[:SENSe]:CHANnel[:NUMBer] <integer></code> <code>[:SENSe]:CHANnel[:NUMBer]?</code>
Example	<code>:CHAN 22</code> <code>:CHAN?</code>

Couplings

The coupling of channel and center frequency is only applied to the following measurements:

- Transmit Analysis
- Output Spectrum BW
- Monitor Spectrum

For other measurements, center frequency does not depend on channel. Following is the coupling of channel and center frequency

If Radio Stand is Basic or EDR:

$$\text{Channel} = (\text{CF} - 2.402\text{E9}) / 1.0\text{e6}$$

If the Center Frequency is set to a value between channels, the channel key should display > prior to the previous channel number if the CF is < 500 kHz above the previous channel and < prior to the next channel number if the CF is > = 500 kHz above the previous channel

For example, if Channel = 3.4, the channel key will display >3. If Channel = 3.5, the channel key will display <4. If Channel < 0, the channel key will display <0. If Channel > 78(22), the channel key display will display >78(22)

If Radio Stand is Low Energy:

$$\text{Channel} = (\text{CF} - 2.402\text{E9}) / 2.0\text{e6}$$

The max value of channel is 39. The range of channel is 0-39

If the Center Frequency is set to a value between channels, the channel key should display > prior to the previous channel number if the CF is < 1 MHz above the previous channel and < prior to the next channel number if the CF is > = 1 MHz above the previous channel

For example, if Channel = 3.4, the channel key will display >3. If Channel = 3.5, the channel key will display <4. If Channel < 0, the channel key will display <0. If Channel > 78(22), the channel key display will display >78(22)

If Geography is France :

- Channel Number: 0...22
- If Center Frequency < 2.454 GHz, the channel key should display < 0

-
- If Center Frequency > 2.476 GHz, the channel key should display > 22

If Geography is Others:

- Channel Number: 0..78
- If Center Frequency < 2.402 GHz, the channel key should display < 0
- If Center Frequency > 2.480 GHz, the channel key should display > 78

Preset	0
State Saved	Yes
Range	0 – 78
Min/Max	0 / 78

Center Frequency

Sets the frequency that corresponds to the horizontal center of the graticule. While adjusting the Center Frequency the Span is held constant.

The center frequency setting is the same for all measurements within a mode, that is, it is Meas Global. Some modes are also able to share a Mode Global center frequency value. If this is the case, the Mode will have a **Global** tab in its **Meas Setup** menu.

The **Center Freq** function sets (and queries) the Center Frequency for the currently selected input. If your instrument has multiple inputs, and you select another input, the Center Freq changes to the value for that input. SCPI commands are available to directly set the Center Freq for a specific input.

Center Freq is remembered as you go from input to input. Thus, you can set a Center Freq of 10 GHz with the RF Input selected, change to BBIQ, and set a Center Freq of 20 MHz, then switch to External Mixing and set a Center Freq of 60 GHz, and when you go back to the RF Input the Center Freq will go back to 10 GHz; back to BBIQ and it is 20 MHz; back to External Mixing and it is 60 GHz.

See:

- ["Center Frequency Presets" on page 460](#)
- ["VXT Models with Radio Heads/CIU Frequency Range" on page 461](#)
- ["RF Center Freq" on page 462](#)
- ["Ext Mix Center Freq" on page 462](#)
- ["I/Q Center Freq" on page 463](#)

Remote [\[:SENSe\]:FREQuency:CENTer <freq>](#)

Command	<code>[:SENSe] :FREQuency :CENTer?</code>
Example	<p><code>:FREQ:CENT 50 MHz</code></p> <p>Sets Center Frequency to 50 MHz</p> <p><code>:FREQ:CENT UP</code></p> <p>Increments the Center Frequency by the value of CF Step</p> <p><code>:FREQ:CENT?</code></p> <p>Returns the current value of Center Frequency</p>
Notes	<p>Sets the RF, External Mixing or I/Q Center Frequency depending on the selected input:</p> <ul style="list-style-type: none"> - For RF input it is equivalent to <code>:FREQ:RF :CENT</code> - For I/Q input it is equivalent to <code>:FREQ:IQ :CENT</code> - For External Mixer it is equivalent to <code>:FREQ:EMIX :CENT</code> <p>Preset and Max values are dependent on Hardware Options (5xx)</p> <p>If no terminator (for example, MHz) is sent, the terminator Hz is used. If a terminator with unit other than Frequency is used, an invalid suffix error message is generated</p>
Couplings	<p>In LTEAFDD/LTEATDD and 5GNR Modes:</p> <p>Center Frequency, Center Frequency Offset and Carrier Reference Frequency are coupled with the following equation:</p> $\text{Center Frequency} = \text{Carrier Reference Frequency} + \text{Center Frequency Offset}$ <p>If the following conditions are satisfied at the same time:</p> <ul style="list-style-type: none"> - the Num Component Carrier equals to 1 - the Center Frequency Offset equals to 0 Hz - the mode of the Center Frequency is Auto <p>The Center Frequency is equivalent to Carrier Reference Frequency</p> <p>The major purpose of this coupling is to keep BWCC with legacy LTE, in which <code>:SENSe :FREQuency :CENTer</code> is used to set up the Frequency of the measurement</p> <p>Otherwise, the Center Frequency Offset is changed following the Center Frequency and the Carrier Reference Frequency keeps intact</p> <p>In MSR, Center Freq, Center Freq Offset and Carrier Ref Freq are coupled with the equation, $\text{Center Freq} = \text{Carrier Ref Freq} + \text{Center Freq Offset}$. When Center Freq is changed, Center Freq Offset is updated and Carrier Ref Freq is not changed</p> <p>When auto, Center Freq Offset remains the same value. Thus, Center Freq changes the same amount of Carrier Ref Freq change when Carrier Ref Freq is changed. The auto state changes to manual when either Center Freq is changed</p> <p>In Bluetooth Mode:</p> <p>Center Frequency is coupled to Channel and Geography</p> <ul style="list-style-type: none"> - If Geography is France: Center Frequency 2454 MHz + (channel number* channel space) MHz

3 Bluetooth Mode

3.4 LEIQHS In-band Emissions Measurement

- If Geography is Others: Center Frequency 2402 MHz + (channel number* channel space) MHz
- If Radio Stand is Basic or EDR, channel space is 1 MHz
- If Radio Stand is Low Energy, channel space is 2 MHz

In other modes:

Any value of the Center Frequency or Span that keeps start frequency and stop frequency within the frequency range of the instrument is allowed when the value is being set through the front panel numeric keypad or the SCPI command. Other frequency parameters are forced to different values if needed, to keep the start and stop frequencies within the instrument's frequency range

Presets	Depends on instrument maximum frequency, mode, measurement, and selected input See " Center Frequency Presets " on page 460, " RF Center Freq " on page 462, " Ext Mix Center Freq " on page 462, " I/Q Center Freq " on page 463 and " VXT Models with Radio Heads/CIU Frequency Range " on page 461
State Saved	Saved in instrument state
Min/Max	Depends on instrument maximum frequency, mode, measurement, and selected input See " Center Frequency Presets " on page 460, " RF Center Freq " on page 462, " Ext Mix Center Freq " on page 462, " I/Q Center Freq " on page 463 and " VXT Models with Radio Heads/CIU Frequency Range " on page 461
Annotation	Center <value> appears in the lower left corner of the display
Status Bits/OPC dependencies	Non-overlapped

Center Frequency Auto State

Remote Command	<code>[:SENSe] :FREQuency:CENTer:AUTO ON OFF 1 0</code> <code>[:SENSe] :FREQuency:CENTer:AUTO?</code>
Example	<code>:FREQ:CENT:AUTO OFF</code> <code>:FREQ:CENT:AUTO?</code>
Dependencies	This is only available in MSR, LTEAFDD/LTEATDD and 5GNR Modes
Couplings	When the Center Frequency is changed, the state is automatically changed to Manual Center Frequency , Center Frequency Offset and Carrier Reference Frequency are coupled. When Carrier Reference Frequency changes: <ul style="list-style-type: none"> - Center Frequency : Auto Center Frequency = Carrier Reference Frequency + Center Frequency Offset (fixed) - Center Frequency : Man Center Frequency (fixed) = Carrier Reference Frequency + Center Frequency Offset
Presets	ON
State Saved	Saved in instrument state
Range	Auto Man

Center Frequency Presets

The following table provides the Center Frequency Presets for the Spectrum Analyzer mode, and the Max Freq, for the various frequency options:

Freq Option	CF after Mode Preset	Stop Freq after Mode Preset	Max Freq (can't tune above)
503 (all but CXA)	1.805 GHz	3.6 GHz	3.7 GHz
503 (CXA)	1.505 GHz	3.0 GHz	3.08 GHz
507 (all but CXA)	3.505 GHz	7.0 GHz	7.1 GHz
507 (CXA)	3.755 GHz	7.5 GHz	7.58 GHz
508 (all but MXE)	1.805 GHz	3.6 GHz	8.5 GHz
508 (MXE)	4.205 GHz	8.4 GHz	8.5 GHz
513	6.805 GHz	13.6 GHz	13.8 GHz
526 (except CXA and MXE)	13.255 GHz	26.5 GHz	27.0 GHz*
526 (CXA)	13.255 GHz	26.5 GHz	26.55 GHz
526 (MXE)	1.805 GHz	3.6 GHz	27.0 GHz
532	16.005 GHz	32.0 GHz	32.5 GHz
540	20.005 GHz	40.0 GHz	40.5 GHz
543	21.505 GHz	43.0 GHz	43.0 GHz
544	22.005 GHz	44.0 GHz	45.0 GHz
550	25.005 GHz	50.0 GHz	52 GHz
F03 (CXA-m)	1.505 GHz	3.0 GHz	3.08 GHz
F07 (CXA-m)	3.755 GHz	7.5 GHz	7.575 GHz
F13 (CXA-m)	6.805 GHz	13.6 GHz	13.8 GHz
F26 (CXA-m)	13.255 GHz	26.5 GHz	26.55 GHz
504 (M9421A, M8920A)	2.145 GHz	3.88GHz	3.88 GHz
506 (M9421A, M8920A)	3.245 GHz	6.08GHz	6.08 GHz
F06 (M9410A/11A)	1.0 GHz	6.08 GHz	6.08 GHz
F06 (M9415A)	1 GHz	1.08 GHz	6.6 GHz
F08 (M9415A)	1 GHz	1.08 GHz	8.6 GHz
F12 (M9415A)	1 GHz	1.08 GHz	12.9 GHz

*For option 526, the Max CF in RTSA is 26.999999995 GHz.

N9041B Center Freq Presets

3 Bluetooth Mode
 3.4 LEIQHS In-band Emissions Measurement

Input	CF after Mode Preset	Stop Freq after Mode Preset	Max Freq (can't tune above)
Input 1, all models	25.005 GHz	50.0 GHz	52 GHz
Input 2, opt 585	42.505 GHz	85.0 GHz	86 GHz
Input 2, opt 590	45.005 GHz	90.0 GHz	92 GHz
Input 2, opt 5CX	55.005 GHz	110.0 GHz	110 GHz

Input 2, CXA and MXE

Model	CF after Mode Preset	Stop Freq after Mode Preset	Max Freq (can't tune above)
CXA opt C75	0.7505 GHz	1.5 GHz	1.58 GHz
MXE	505 MHz	1 GHz	1.000025 GHz

Tracking Generator Frequency Limits (CXA only)

Tracking Generator Option	Min Freq (clips to this freq when turn TG on and can't tune below while TG on)	If above this Freq, Stop Freq clipped to this Freq when TG turned on	Max Freq (can't tune above) while TG on
T03	9 kHz	3.0 GHz	3.08 GHz
T06	9 kHz	6.0 GHz	6.05 GHz

Tracking Generator Frequency Limits(CXA-m only)

Tracking Generator Option	Min Freq (clips to this freq when turn TG on and can't tune below while TG on)	If above this Freq, Stop Freq clipped to this Freq when TG turned on	Max Freq (can't tune above) while TG on
T03	2 MHz	3.08 GHz	3.08 GHz
T07	2 MHz	7.575 GHz	7.575 GHz
T13	2 MHz	13.8 GHz	13.8 GHz
T26	2 MHz	26.55 GHz	26.55 GHz

VXT Models with Radio Heads/CIU Frequency Range

The following table shows the Center Frequency Presets and Range for VXT modes with Radio Heads/CIU.

Products with Radio Heads/CIU	Preset	Start frequency	Stop frequency
M9421A + CIU	6 GHz	5.9 GHz	12 GHz
M9410A + CIU	6 GHz	5.9 GHz	12 GHz
M9410A + CIU + RRH	25 GHz	24.25 GHz	43.5 GHz

RF Center Freq

Specifies the RF Center Frequency. This command sets the Center Frequency to be used when the RF input is selected, even if the RF input is not the input that is selected at the time the command is sent. Note that **"Center Frequency" on page 457** in the **Frequency** menu on the front panel always applies to the currently selected input.

Remote Command	<code>[:SENSe] :FREQuency:RF:CENTer <freq></code> <code>[:SENSe] :FREQuency:RF:CENTer?</code>
Example	<code>:FREQ:RF:CENT 30 MHz</code> <code>:FREQ:RF:CENT?</code>
Notes	This command is the same in all Modes, but the parameter is Measurement Global, so the value is independent in each Mode and common across all the measurements in the Mode
Dependencies	If the electronic/soft attenuator is enabled, any attempt to set Center Frequency such that the Stop Frequency would be >3.6 GHz fails and results in an advisory message. If the equivalent SCPI command is sent, this same message is generated as part of a "-221, Settings conflict" warning
Preset	See "Center Frequency Presets" on page 460 above
State Saved	Saved in instrument state
Min	-79.999995 MHz
Max	See table above. Basically, instrument maximum frequency - 5 Hz If the knob or step keys are being used, also depends on the value of Span

Ext Mix Center Freq

Specifies the External Mixer Center Frequency. This command sets the Center Frequency to be used when the External Mixer is selected, even if the External Mixer input is not the input that is selected at the time the command is sent. Note that **"Center Frequency" on page 457** in the **Frequency** menu on the front panel always applies to the currently selected input.

Remote Command	<code>[:SENSe] :FREQuency:EMIXer:CENTer <freq></code> <code>[:SENSe] :FREQuency:EMIXer:CENTer?</code>
Example	<code>:FREQ:EMIX:CENT 60 GHz</code> <code>:FREQ:EMIX:CENT?</code>
Notes	This command is the same in all Modes, but the parameter is Measurement Global, so the value is independent in each Mode and common across all the measurements in the Mode
Couplings	When returning to External Mixing after having been switched to one of the other inputs (e.g., RF), you will come back into the settings that you had when you left External Mixing. So, you will come back to the band you were in with the Center Frequency that you had. However, Span is not an input-dependent parameter, therefore you will bring the span over from the other input. Therefore, the instrument comes back with the span from the previous input, limited as necessary by the current mixer setup

3 Bluetooth Mode

3.4 LEIQHS In-band Emissions Measurement

Preset	<p>When a Mode Preset is performed while in External Mixing, the Start frequency of the current Mode is set to the nominal Min Freq of the lowest harmonic range in the Harmonic Table for the current mixer setup. Similarly, the Stop frequency of the current Mode is set to the nominal Max Freq of the highest harmonic range in the Harmonic Table. The Center Freq thus presets to the point arithmetically equidistant from these two frequencies</p> <p>Note that, if the current measurement has a limited Span available to it, and cannot achieve the Span shown in the table (Span=Stop Freq – Start Freq), the instrument uses the maximum Span the measurement allows, and still sets the Center Freq to the midpoint of the Start and Stop Freq values in the Harmonic Table</p> <p>When Restore Input/Output Defaults is performed, the mixer presets to the 11970A, whose Start and Stop frequencies are 26.5 and 40 GHz respectively. The center of these two frequencies is 33.25 GHz. Therefore, after a Restore Input/Output Defaults, if you go into External Mixing and do a Mode Preset while in the Spectrum Analyzer Mode, the resulting Center Freq is 33.25 GHz</p>
State Saved	Yes
Min	<p>The minimum frequency in the currently selected mixer band + 5 Hz</p> <p>If the knob or step keys are being used, also depends on Span</p>
Max	<p>The maximum frequency in the currently selected mixer band - 5 Hz</p> <p>If the knob or step keys are being used, also depends on Span</p>
<h3>I/Q Center Freq</h3> <p>Specifies the I/Q Center Frequency. This command sets the Center Frequency to be used when the I/Q input is selected, even if the I/Q input is not the input that is selected at the time the command is sent. Note that "Center Frequency" on page 457 in the Frequency menu on the front panel always applies to the currently selected input.</p>	
Remote Command	<pre>[:SENSe]:FREQuency:IQ:CENTer <freq></pre> <pre>[:SENSe]:FREQuency:IQ:CENTer?</pre>
Example	<pre>:FREQ:IQ:CENT 30 MHz</pre>
Notes	This command is the same in all Modes, but the parameter is Measurement Global, so the value is independent in each Mode and common across all the measurements in the Mode
Preset	0 Hz
State Saved	Saved in instrument state
Min	-40.049995 MHz
Max	40.049995 MHz

Span

Changes the displayed frequency range symmetrically about the center frequency.

NOTE Entered values of Span must be odd numbers of MHz.

Remote Command	<code>[:SENSe]:IBEMissions:FREQuency:SPAN <freq></code> <code>[:SENSe]:IBEMissions:FREQuency:SPAN?</code>
Example	<code>:IBEM:FREQ:SPAN 25MHz</code> <code>:IBEM:FREQ:SPAN?</code>
Couplings	If Meas Method is FFT, the maximum value of Span couples to the MAX IFBW of the instrument
Preset	81 MHz
State Saved	Yes
Min/Max	1.0 MHz/ 81 MHz
Annotation	Bottom right of RF Spectrum graph

LMH Channel

Enables quick selection from a subset of the available channel numbers for the Low (channel 0), Middle (channel 39), or High (channel 78) channels.

Remote Command	<code>[:SENSe]:CHANne1:LMH LOW MID HIGH</code> <code>[:SENSe]:CHANne1:LMH?</code>
Example	<code>:FREQ:LMH MID</code> <code>:FREQ:LMH?</code>
Couplings	If Radio Stand is Basic or EDR, the soft key label is Low(0), Mid(39), High(78) If Radio Stand is Low Energy, the soft key label is Low(0), Mid(20), High(39) If geography is France, this key will be grayed-out
Preset	<code>LOW</code>
State Saved	Yes
Range	<code>LOW MID HIGH</code>
Backwards Compatibility SCPI	<code>[:SENSe]:FREQuency:LMH LOW MID HIGH</code> <code>[:SENSe]:FREQuency:LMH?</code>

Geography

Selects the desired country. The selection defines the frequency range and the available channel numbers for the transmit channel.

Remote Command	<code>[:SENSe]:FREQuency:GEOGraphy FRANce OTHers</code> <code>[:SENSe]:FREQuency:GEOGraphy?</code>
Example	<code>:FREQ:GEOG FRAN</code>

3 Bluetooth Mode
 3.4 LE|QHS In-band Emissions Measurement

	:FREQ:GEOG?
Couplings	France: <ul style="list-style-type: none"> - Center Frequency 2454 MHz + (0...22) MHz - Channel Number: 0...22 Others: <ul style="list-style-type: none"> - Center Frequency 2402 MHz + (0...78) MHz - Channel Number: 0...78
Preset	OTHers
State Saved	Yes
Range	FRANce OTHers

CF Step

Changes the step size for the center frequency and start and stop frequency functions. Once a step size has been selected and the center frequency function is active, the step keys (and the UP|DOWN parameters for Center Frequency from remote commands) change the center frequency by the step-size value. The step size function is useful for finding harmonics and sidebands beyond the current frequency span of the instrument.

Note that the start and stop frequencies also step by the CF Step value.

Remote Command	[:SENSe]:FREQuency:CENTer:STEP[:INCRement] <freq> [:SENSe]:FREQuency:CENTer:STEP[:INCRement]? [:SENSe]:FREQuency:CENTer:STEP:AUTO OFF ON 0 1 [:SENSe]:FREQuency:CENTer:STEP:AUTO?
Example	:FREQ:CENT:STEP 500 MHz :FREQ:CENT UP Increases the current center frequency value by 500 MHz :FREQ:CENT:STEP? :FREQ:CENT:STEP:AUTO ON :FREQ:CENT:STEP:AUTO?
Notes	Preset and Max values are dependent on Hardware Options
Dependencies	Not available in MSR, LTEAFDD/LTEATDD, 5GNR and Channel Quality Modes If the electronic/soft attenuator is enabled, any attempt to change the value of the center frequency >3.6 GHz by pressing the Up-arrow key, fails and results in an advisory message. If the equivalent SCPI command is sent, this same message is generated as part of a "-221, Settings conflict" warning
Couplings	When auto-coupled, the center frequency step size is set to 10% of the span

Preset	Auto ON
State Saved	Saved in instrument state
Min	– (the maximum frequency of the instrument). That is, 27 GHz max freq instrument has a CF step range of +/- 27 GHz. Note that this is the maximum frequency given the current settings of the instrument, so in External Mixing, for example, it is the maximum frequency of the current mixer band
Max	The maximum frequency of the instrument. That is, 27 GHz max freq instrument has a CF step range of +/- 27 GHz. Note that this is the maximum frequency given the current settings of the instrument, so in External Mixing, for example, it is the maximum frequency of the current mixer band
Status Bits/OPC dependencies	non-overlapped

3.4.7 Marker

The Marker key accesses the Marker menu. A marker can be placed on a trace to allow the value of the trace at the marker point to be determined precisely. The functions in this menu include a 1-of-N selection of the control mode Normal, Delta, or Off for the selected marker. If the selected marker is Off, pressing Marker sets it to Normal and places it at the center of the screen on the trace determined by the Marker Trace rules.

Markers may also be used in pairs to read the difference (or delta) between two data points. They can be used in Marker Functions to do advanced data processing, or to specify operating points in functions like Signal Track and N dB Points.

3.4.7.1 Select Marker

Specifies the selected marker. The term “selected marker” is used throughout this document to specify which marker will be affected when you change marker settings, perform a Peak Search, etc.

The Select Marker control appears above the menu panel, indicating that it applies to all controls in the Marker menu panels. Select Marker is blanked if you select a tab whose controls do NOT depend on the selected marker (e.g., Counter).

On any menu tab for which Select Marker displays, the first control is always Marker Frequency|Time.

Notes	The selected marker is remembered even when not in the Marker menu and is used if a Search is done or a Band Function is turned on or for Signal Track or Continuous Peak
Preset	Marker 1
State Saved	The number of the selected marker is saved in instrument state
Annunciation	Appears in the marker results block label for Normal and Delta markers

3.4.7.2 Settings

The controls on the Settings tab include the Marker active function and a radio button selection of the marker control mode (Normal, Delta, or Off) for the selected marker, as well as additional functions that help you use markers.

Marker X-Axis Value

The command below sets and queries a marker's X-Axis value.

Remote Command	<code>:CALCulate:IBEMissions:MARKer[1] 2 ... 12:X <real></code> <code>:CALCulate:IBEMissions:MARKer[1] 2 ... 12:X?</code>
Example	<code>:CALC:IBEM:MARK:X 2.402E+9</code> <code>:CALC:IBEM:MARK:X?</code>
Notes	The query is returned in the fundamental units for the current marker X-Axis scale. This command (not the query) causes the specified marker to become selected
Dependencies	The Marker X unit is dependent on the currently selected window For RF Envelope the units will be ns us ms s ks For RF Spectrum the units will be Hz kHz MHz GHz
Preset	After a preset, all Markers are turned OFF, so Marker X-Axis Value query will return not a number (NaN). When Marker is On, default value of Marker X-Axis value is the center of the appropriate window
State Saved	Yes
Min	-9.91E+37
Max	9.91E+37

Marker Y (Remote Command Only)

The command below queries a marker's Y axis value only.

Remote Command	<code>:CALCulate:IBEMissions:MARKer[1] 2 ... 12:Y?</code>
Example	<code>:CALC:IBEM:MARK:Y?</code>
Preset	Since the result value is always calculated from acquisition data, the default value is arbitrary. Although the Preset/Default values are defined
Min	-9.91E+37
Max	9.91E+37

Marker Mode

Sets the marker control mode to Normal, Delta, or Off. All interactions and dependencies detailed under the control description are enforced when the remote command is sent. If the selected marker is Off, pressing Marker sets it to Normal and places it at the center of the screen on the trace determined by the Marker Trace rules. At the same time, Marker X Axis Value appears on the Active Function area.

The default active function is the active function for the currently selected marker control mode. If the current control mode is Off, there is no active function and the active function is turned off.

Remote Command	<code>:CALCulate:IBEMissions:MARKer[1] 2 ... 12:MODE POSITION DELTa =OFF</code> <code>:CALCulate:IBEMissions:MARKer[1] 2 ... 12:MODE?</code>
Example	<code>:CALC:IBEM:MARK:MODE POS</code> <code>:CALC:IBEM:MARK:MODE?</code>
Notes	This command (not the query) causes the specified marker to become selected
Couplings	If a marker has the mode changed to delta, the Marker Trace setting of the delta marker will be that of the reference marker If a delta marker has a reference marker in a different window, the delta marker's mode changes to normal
Preset	OFF (all markers)

Delta Marker (Reset Delta)

Pressing this button is exactly the same as pressing the “Delta” selection on the Marker Mode radio button. The selected marker becomes a Delta Marker. If the selected marker is already a Delta marker, the reference marker is moved to the current position of the selected marker, thus resetting the Delta to zero.

Marker Settings Diagram

The Marker Settings Diagram lets you configure the Marker system using a visual utility.

All Markers Off

Turns off all markers.

Remote Command	<code>:CALCulate:IBEMissions:MARKer:AOFF</code>
Example	<code>:CALC:IBEM:MARK:AOFF</code>

Couple Markers

When this function is On, moving any marker causes an equal X Axis movement of every other marker which is not Fixed or Off. By “equal X Axis movement” we mean that we preserve the difference between each marker’s X Axis value (in the fundamental x-axis units of the trace that marker is on) and the X Axis value of the marker being moved (in the same fundamental x-axis units).

This may result in markers going off screen.

Remote Command	:CALCulate:IBEMissions:MARKer:COUPlE[:STATe] ON OFF 1 0
Example	:CALC:IBEM:MARK:COUP ON :CALC:IBEM:MARK:COUP?
Preset	OFF, presets on Mode Preset and All Markers Off
State Saved	Saved in instrument state

3.4.7.3 Peak Search

The controls on the Peak Search tab allow you to move the marker to selected peaks of the signal, giving you enormous analysis capabilities, particularly when combined with the Delta Marker function.

NOTE

Pressing the **Peak Search** hardkey automatically moves you to the **Peak Search** page of the **Marker** menu **AND** performs a **Peak Search**.

Pressing the **Peak Search** tab once you are already **IN** the **Marker** menu does **NOT** perform a **Peak Search**.

Marker X-Axis Value

The Marker X-Axis Value control is the fundamental control that you use to move a marker around on the trace. This is the same as the "[Marker X-Axis Value](#)" on [page 467](#) control on the Settings tab.

Peak Search

Pressing the **Peak Search** control moves the selected marker to the trace point which has the maximum y-axis value for that marker’s trace.

NOTE

Pressing the Peak Search hardkey automatically moves you to the Peak Search page of the Marker menu AND performs a Peak Search.

Remote Command	<code>:CALCulate:IBEMissions:MARKer[1] 2 ... 12:MAXimum</code>
Example	<code>:CALC:IBEM:MARK2:MAX</code> <code>:SYST:ERR?</code> Can be used to query the errors to determine if a peak is found. The message “No peak found” will be returned after an unsuccessful search
Notes	Sending this command selects the subopcoded marker This command does not work when the selected marker is located on the polar trace. In this case, the command is ignored

Next Peak

Pressing Next Peak moves the selected marker to the peak that is next lower in amplitude than the current marker value. Only peaks which meet all enabled peak criteria are considered. If there is no valid peak lower than the current marker position, a “No peak found” message is generated and the marker is not moved.

If the selected marker was off, then it is turned on as a normal marker and a peak search is performed.

Remote Command	<code>:CALCulate:IBEMissions:MARKer[1] 2 ... 12:MAXimum:NEXT</code>
Example	<code>:CALC:IBEM:MARK2:MAX:NEXT</code>
Notes	Sending this command selects the subopcoded marker
State Saved	Not part of saved state

Next Peak Right

Pressing **Next Pk Right** moves the selected marker to the nearest peak right of the current marker that meets all enabled peak criteria. If there is no valid peak to the right of the current marker position, a “No peak found” message is generated and the marker is not moved.

If the selected marker was off, then it is turned on as a normal marker and a peak search is performed.

Remote Command	<code>:CALCulate:IBEMissions:MARKer[1] 2 ... 12:MAXimum:RIGHT</code>
Example	<code>:CALC:IBEM:MARK2:MAX:RIGH</code>
Notes	Sending this command selects the subopcoded marker
State Saved	Not part of saved state

Next Peak Left

Pressing **Next Pk Left** moves the selected marker to the nearest peak left of the current marker that meets all enabled peak criteria. If there is no valid peak to the left of the current marker position, a “No peak found” message is generated and the marker is not moved.

If the selected marker was off, then it is turned on as a normal marker and a peak search is performed.

Pressing this control moves the selected marker to the nearest active channel left of the current marker when Marker Trace is Code Domain Power. In other cases, moves the selected marker to the highest peak left of the current marker.

Remote Command	<code>:CALCulate:IBEMissions:MARKer[1] 2 ... 12:MAXimum:LEFT</code>
Example	<code>:CALC:IBEM:MARK2:MAX:LEFT</code>
State Saved	Not part of saved state

Minimum Peak

Moves the selected marker to the minimum y-axis value on the current trace. Minimum (negative) peak searches do not have to meet the peak search criteria. It just looks for the lowest y-axis value. If the selected marker is Off, it is turned on before the minimum search is performed.

Remote Command	<code>:CALCulate:IBEMissions:MARKer[1] 2 ... 12:MINimum</code>
Example	<code>:CALC:IBEM:MARK:MIN</code>
Notes	Sending this command selects the subopcoded marker
State Saved	Not part of saved state

Pk-Pk Search

Finds and displays the amplitude and frequency (or time, if in zero span) differences between the highest and lowest y-axis value. It places the selected marker on the minimum value on its selected trace. And it places that marker's reference marker on the peak of its selected trace.

This function turns on the reference marker and sets its mode to **Normal** if it is not already on. (These markers may be on two different traces.)

The rules for finding the maximum peak are exactly the same as for Peak Search, including the use of the peak criteria rules. However, the minimum trace value is not required to meet any criteria other than being the minimum y-axis value in the trace.

If the selected marker is off, a delta type marker is turned on and the peak-to-peak search is done. If the selected marker is on, but it is not a delta marker, then it is changed to delta which turns on the reference marker if needed, and then it performs the peak-to-peak function.

Remote Command	<code>:CALCulate:IBEMissions:MARKer[1] 2 ... 12:PTPeak</code>
Example	<code>:CALC:IBEM:MARK:PTP</code>
Notes	Turns on the Marker D active function Sending this command selects the subopcoded marker
Dependencies	Pk-Pk Search is not available when Coupled Markers is on
Couplings	The selected marker becomes a delta marker if not already in delta mode
State Saved	Not part of saved state

Marker Delta

Pressing this button is exactly the same as pressing the “Delta” selection on the Marker Mode radio button on the Settings tab. The selected marker becomes a Delta Marker. If the selected marker is already a Delta marker, the reference marker is moved to the current position of the selected marker, thus resetting the Delta to zero.

The control is duplicated here in the Peak Search Menu to allow you to conveniently perform a peak search and change the marker’s control mode to Delta without having to access two separate menus.

3.4.7.4 Properties

The controls on the Properties tab are used to set certain properties of the selected marker.

Marker X-Axis Value

The Marker X-Axis Value control is the fundamental control that you use to move a marker around on the trace. This is the same as the ["Marker X-Axis Value" on page 467](#) control on the Settings tab.

Relative To

Selects the marker to which the selected marker is relative (its reference marker).

Every marker has another marker to which it is relative. This marker is referred to as the “reference marker” for that marker. This attribute is set by the Marker, Properties, Relative To control. The marker must be a Delta marker to make this

3 Bluetooth Mode
 3.4 LE|QHS In-band Emissions Measurement

attribute relevant. If it is a Delta marker, the reference marker determines how the marker is controlled and how its value is displayed. A marker cannot be relative to itself.

Remote Command	<code>:CALCulate:IBEMissions:MARKer[1] 2 ... 12:REFerence <integer></code> <code>:CALCulate:IBEMissions:MARKer[1] 2 ... 12:REFerence?</code>
Example	<code>:CALC:IBEM:MARK:REF 5</code> <code>:CALC:IBEM:MARK:REF?</code>
Notes	This command causes the marker specified with the subopcode to become selected Range (for SCPI command): 1 to 12. If the range is exceeded the value is clipped A marker cannot be relative to itself so that choice is not available, and if sent from SCPI generates error -221: "Settings conflict; marker cannot be relative to itself" When queried a single value is returned (the specified marker numbers relative marker)
Couplings	The act of specifying the selected marker's reference marker makes the selected marker a Delta marker If the reference marker is off it is turned on in Normal mode at the delta marker location
Preset	The preset default "Relative To" marker (reference marker) is the next higher numbered marker (current marker +1). For example, if marker 2 is selected, then it's default reference marker is marker 3. The exception is marker 12, which has a default reference of marker 1 Set to the defaults by using Restore Mode Defaults . This is not reset by Marker Off , All Markers Off , or Preset
State Saved	Saved in instrument state. Not affected by Marker Off and hence not affected by Preset or power cycle
Min	1
Max	12
Annunciation	Appears in the marker label of a Delta marker

Marker Trace

Selects the trace on which to place the marker. A marker is associated with one and only one trace. This trace is used to determine the placement, result, and X Axis Scale of the marker. All markers have an associated trace. It is from that trace that they determine their attributes and behaviors, and it is to that trace that they go when they become Normal or Delta markers.

If the marker is not **Off**, it moves the marker from the trace it was on to the new trace. If the marker changes windows, it retains its relative horizontal positions in the new window.

If the marker is **off** it stays off, but is now associated with the specified trace.

Remote Command	<code>:CALCulate:IBEMissions:MARKer[1] 2 ... 12:TRACe RFENvelope RFSpectrum</code> <code>:CALCulate:IBEMissions:MARKer[1] 2 ... 12:TRACe?</code>
Example	<code>:CALC:IBEM:MARK2:TRAC RFEN</code> <code>:CALC:IBEM:MARK:TRACE?</code>

Couplings	Sending the remote command causes the addressed marker to become selected If ever a delta marker has a reference marker in a different window, the delta marker's mode changes to Pos(for example, it becomes a normal marker)
Preset	RF Spectrum Presets on Preset or All Markers Off
State Saved	Yes

Marker Settings Diagram

The Marker Settings Diagram lets you configure the Marker system using a visual utility. This is the same as the "[Marker Settings Diagram](#)" on page 468 control on the Settings tab.

3.4.7.5 Marker Function

The controls on the Marker Function tab allow you to control the Marker Functions of the instrument. Marker Functions perform post-processing operations on marker data.

Marker X-Axis Value

The Marker X-Axis Value control is the fundamental control that you use to move a marker around on the trace. This is the same as the "[Marker X-Axis Value](#)" on page 467 control on the Settings tab.

Marker Function

Sets the marker control function type to, Marker Noise, Band/Interval Power, Band Interval Density, or Marker Function Off.

All interactions and dependencies detailed under the key description are enforced when the remote command is sent.

Remote Command	<code>:CALCulate:IBEMissions:MARKer[1] 2 ... 12:FUNCTION NOISe BPOWer BDENsity =OFF</code> <code>:CALCulate:IBEMissions:MARKer[1] 2 ... 12:FUNCTION?</code>
Example	<code>:CALC:IBEM:MARK:FUNC NOIS</code> <code>:CALC:IBEM:MARK:FUNC?</code>
Dependencies	Only RF Spectrum Trace has Marker Function
Preset	OFF
State Saved	Yes
Range	Marker Noise Band/Interval Power Band Interval Density Marker Function Off
Annotation	Mkr # <X value> and <Marker value> upper right on graph

Band Span

Sets the width of the frequency span for the selected marker.

Remote Command	<code>:CALCulate:IBEMissions:MARKer[1] 2 ... 12:FUNCtion:BAND:SPAN <freq></code> <code>:CALCulate:IBEMissions:MARKer[1] 2 ... 12:FUNCtion:BAND:SPAN?</code>
Example	<code>:CALC:IBEM:MARK12:FUNC:BAND:SPAN 20 MHz</code> <code>:CALC:IBEM:MARK12:FUNC:BAND:SPAN?</code>
Couplings	Changing the Band Span necessarily changes the Band Left and Band/Interval Right values
Preset	0
State Saved	Yes
Min/Max	100.0 kHz/200.0 MHz

Band Left

Sets the left edge frequency for the band of the selected marker.

Remote Command	<code>:CALCulate:IBEMissions:MARKer[1] 2 ... 12:FUNCtion:BAND:LEFT <freq></code> <code>:CALCulate:IBEMissions:MARKer[1] 2 ... 12:FUNCtion:BAND:LEFT?</code>
Example	<code>:CALC:IBEM:MARK12:FUNC:BAND:LEFT 20 MHz</code> <code>:CALC:IBEM:MARK12:FUNC:BAND:LEFT?</code>
Couplings	Changing the Band Left necessarily changes the Band Span and Band Right values
Preset	Depends on X axis range of selected Trace
State Saved	Yes
Min/Max	-9.91E+37/9.91E+37

Band Right

Sets the right edge frequency for the band of the selected marker.

Remote Command	<code>:CALCulate:IBEMissions:MARKer[1] 2 ... 12:FUNCtion:BAND:RIGHT <freq></code> <code>:CALCulate:IBEMissions:MARKer[1] 2 ... 12:FUNCtion:BAND:RIGHT?</code>
Example	<code>:CALC:IBEM:MARK12:FUNC:BAND:RIGH 20 MHz</code> <code>:CALC:IBEM:MARK12:FUNC:BAND:RIGH?</code>
Couplings	Changing the Band Right necessarily changes the Band Left and Band Span values
Preset	Depends on X axis range of selected Trace
State Saved	Yes
Min/Max	-9.91E+37/9.91E+37

3.4.8 Meas Setup

The Meas Setup menu panel contains functions for setting up the measurement parameters.

3.4.8.1 Settings

This tab enables you to set measurement parameters.

Meas Method

Selects the measurement method.

Sweep means each 100 kHz bin's data capture mode is Sweep.

Remote Command	<code>[:SENSe]:IBEMissions:METhod SWEEp FFT</code> <code>[:SENSe]:IBEMissions:METhod?</code>
Example	<code>:IBEM:METh SWE</code> <code>:IBEM:METh?</code>
Preset	SWEEp
State Saved	Yes
Range	Sweep FFT

IF Gain

Enables you to control an internally switched IF amplifier with approximately 10 dB of gain. This amplifier takes full advantage of the RF dynamic range of the analyzer. When it can be turned on without an overload, the dynamic range is always better when the amplifier is set to On, than when it is set to Off. The control "IF Gain" can be used to set the IF Gain function to Auto, or to On (the extra 10 dB) or Off. These settings affect sensitivity and IF overloads.

This only applies to the RF input. It does not apply to baseband I/Q input.

IF Gain Auto State

Activates the auto rules for IF Gain.

Remote Command	<code>[:SENSe]:IBEMissions:IF:GAIN:AUTO[:STATE] OFF ON 0 1</code>
----------------	---

3 Bluetooth Mode
 3.4 LE|QHS In-band Emissions Measurement

	<code>[:SENSe]:IBEMissions:IF:GAIN:AUTO[:STATe]?</code>
Example	<code>:IBEM:IF:GAIN:AUTO OFF</code> <code>:IBEM:IF:GAIN:AUTO?</code>
Notes	This only applies to the RF input. It does not apply to baseband I/Q input
Dependencies	This control does not appear in VXT models M9421A/10A/11A, or UXM
Couplings	When either the auto attenuation works (for example, with the electrical attenuator) or optimize mechanical attenuator range is requested, the IF Gain setting is changed according to the following rule 'Auto' sets IF Gain to 'High Gain' under any of the following conditions: the input attenuator is set to 0 dB, the preamp is turned on, or the Max Mixer Level is -20 dBm or lower. For other settings, 'Auto' sets IF Gain to 'Low Gain'
Preset	OFF
State Saved	Yes
Range	Auto Man

IF Gain State

Selects the range of IF gain.

Remote Command	<code>[:SENSe]:IBEMissions:IF:GAIN[:STATe] ON OFF 1 0</code> <code>[:SENSe]:IBEMissions:IF:GAIN[:STATe]?</code>
Example	<code>:IBEM:IF:GAIN OFF</code> <code>:IBEM:IF:GAIN?</code>
Notes	Where ON = high gain OFF = low gain This only applies to the RF input. It does not apply to baseband I/Q input
Dependencies	This control does not appear in VXT models M9421A/10A/11A, or UXM
Couplings	When either the auto attenuation works (for example, with the electrical attenuator) or optimize mechanical attenuator range is requested, the IF Gain setting is changed according to the following rule 'Auto' sets IF Gain to 'High Gain' under any of the following conditions: the input attenuator is set to 0 dB, the preamp is turned on, or the Max Mixer Level is -20 dBm or lower. For other settings, 'Auto' sets IF Gain to 'Low Gain'
Preset	OFF
State Saved	Yes
Range	Low Gain High Gain

Spur Avoidance

Because the VXT models M9410A/11A/15A are direct-conversion (zero-IF) receivers, feedthrough leakage from the local oscillator appears as a spurious signal (spur) at the center frequency. The **Spur Avoidance** function is provided to eliminate this spur, at the expense of some measurement speed.

When **Spur Avoidance** is enabled (the default), the analyzer uses a software algorithm to remove this spur from the displayed measurement data, but the algorithm only operates under certain conditions. Specifically, it only operates in multiple capture case.

You can disable this function to speed up your measurement by setting Spur Avoidance to “Disabled.”

Note that when Spur Avoidance is not in effect, either because you have disabled it or because you are not in multiple capture, the following warning message appears in the status bar:

Settings Alert;Spur Avoidance Off

This is to alert you that measurement accuracy might be impacted by the fact that Spur Avoidance is not in effect.

Remote Command	<code>[:SENSe]:IBEMissions:SAVoid[:STATe] ON OFF 0 1</code> <code>[:SENSe]:IBEMissions:SAVoid[:STATe]?</code>
Example	<code>:IBEM:SAV ON</code> <code>:IBEM:SAV?</code>
Dependencies	This control only appears in VXT models M9410A/11A/15A
Preset	<code>ON</code>
State Saved	Saved in instrument state
Range	<code>ON OFF</code>

Preset To Standard

This is an immediate action. It enables the setting to comply with the standard requirement.

Remote Command	<code>[:SENSe]: IBEMissions:PRESet:STANdard</code>
Example	<code>:IBEM:PRES:STAN</code>
Couplings	When this control is pressed, following settings will be changed: Meas Method, RBW, VBW, Detector type, Trace Type, Sweep Number, Sweep Time, Sweep Points, Center Freq, and Span

Auto Couple

Immediately puts all **Auto/Man** functions into **Auto**. **Auto Couple** is confined to the current measurement only. It does not affect other measurements in the Mode.

In the **Auto** state, **Auto/Man** functions are said to be “coupled”, meaning their values change as you make changes to other values in the measurement. This helps ensure accurate measurements and optimum dynamic range. **Auto Couple** is an immediate action function, and when it is executed, all the **Auto/Man** controls for the current measurement are set to **Auto**, and all measurement settings coupled to the **Auto/Man** parameters are automatically set to their optimal values.

For further details of measurement-specific settings (if any), see "[Measurement-Specific Details](#)" on page 480 below.

Remote Command	:COUPle ALL
Example	:COUP ALL
Backwards Compatibility SCPI	:COUPLE ALL NONE
Backwards Compatibility Notes	:COUP:NONE puts all Auto/Man parameters in manual mode, decoupling all the coupled instrument parameters. It is retained for backwards compatibility and is <i>not</i> recommended for making measurements or new designs

All **Auto/Man** parameter couplings in the measurement are set to **Auto**. This includes couplings that may be unavailable or grayed-out due to the current state. For example, in the Swept SA measurement, there is no **Auto/Man** coupling for **RBW** while in Zero Span. Nonetheless, if **Auto Couple** were executed while in Zero Span, it would set **RBW** to Auto "behind the scenes" so that, on exit from Zero Span, it would be in **Auto**.

Any **Auto/Man** selection specific (local) to the other measurements in the current Mode are not affected by **Auto Couple**. Any functions that are *not* coupled with other instrument parameters, such as ranging or leveling variables, such as **AutoRange** or **AutoScale**, are not affected.

Executing **Auto Couple** generates the informational message, "All Auto/Man functions have been set to Auto".

Each parameter, upon being set to **Auto**, selects and sets the appropriate auto-coupled value based on that parameter's coupling rules. The Dependency Resolver orchestrates the couplings for parameters that depend on one or more other parameters. The coupling and dependency rules for each parameter are defined in the section describing that parameter.

Executing **Auto Couple** does not affect markers, marker functions, trace or display attributes, or any other instrument setting other than those specifically mentioned above.

Measurement-Specific Details

TOI (SA Mode only)

Parameters affected by **Auto Couple** are:

- Center Frequency Step
- Resolution Bandwidth
- Span/RBW Ratio
- Sweep Time
- Video BANDwidth VBW/RBW ratio
- Upper and Lower Tone (set to Sense)
- Zero span measurement Resolution Bandwidth
- Zero span measurement Dwell Time

Harmonics (SA Mode only)

Parameters affected by **Auto Couple** are:

- Resolution Bandwidth
- Fundamental Frequency
- Dwell Time
- Range Table Resolution Bandwidths
- Range Table Dwell Times

Meas Preset

Restores all the measurement parameters to their default values.

Remote Command [:CONFigure:IBEMissions](#)

Example	<code>:CONF:IBEM</code>
Couplings	Selecting Meas Preset restores all measurement parameters to these default values

3.4.8.2 Radio

Contains controls to select Radio Standard and device type. It appears in the Transmit Analysis, LE In-band Emissions, Monitor Spectrum, and Output Spectrum Bandwidth measurements

LE PHY

Sets LE PHY type.

Remote Command	<code>[:SENSe]:RADio:LE:PHY LE1M LE2M LECoded</code> <code>[:SENSe]:RADio:LE:PHY?</code>
Example	<code>:RAD:LE:PHY LE1M</code> <code>:RAD:LE:PHY?</code>
Couplings	Grayed-out if radio standard is not LE and measurement is not LE In-band Emission
Preset	LE1M

Radio Format

Select radio format to do in-band emission measurement.

Remote Command	<code>[:SENSe]:IBEM:RADio:FORMat LE QHS</code> <code>[:SENSe]:IBEM:RADio:FORMat?</code>
Example	<code>IBEM:RAD:FORM QHS</code>
Couplings	The setting can be available when 9081SP1E license is installed; Based on this, if 9081EM0E/OD license isn't installed, the Low Energy value can't be available
Preset	LE
State Saved	Yes
Range	Lower Energy QHS

3.4.8.3 Limits

This tab enables you to set Limit parameters.

Limit Test

Enables you to turn on or off limit checking at the specified frequency.

For each operating frequency exceptions in up to three bands of 1 MHz width centered on a frequency which is an integer multiple of 1 MHz are allowed. They must however comply with an absolute value of -20 dBm.

Remote Command	<code>:CALCulate: IBEMissions:LIMit:STATe OFF ON 0 1</code> <code>:CALCulate: IBEMissions:LIMit:STATe?</code>
Example	<code>:CALC:IBEM:LIM:STAT 1</code> <code>:CALC:IBEM:LIM:STAT?</code>
Preset	ON
State Saved	Yes
Range	On Off

Far Limit

Sets the far limit, in dBm for Adjacent channel power $|M-N| \geq 3$.

Remote Command	<code>:CALCulate: IBEMissions:LIMit:FAR:UPPer[:DATA] <ampl></code> <code>:CALCulate: IBEMissions:LIMit:FAR:UPPer[:DATA]?</code>
Example	<code>:CALC:IBEM:LIM:FAR:UPP -30.0</code> <code>:CALC:IBEM:LIM:FAR:UPP?</code>
Preset	-30.0 dBm
State Saved	Yes
Min/Max	-90 dBm/30.0 dBm

Freq Offset 2MHz

Sets the near limit in dBm for adjacent channel power, which is 2MHz from the carrier. This control is only available when LE PHY is LE 1M or LE Coded.

Remote Command	<code>:CALCulate:IBEMissions:LIMit:NEAR[:FO2M]:UPPer[:DATA] <ampl></code> <code>:CALCulate:IBEMissions:LIMit:NEAR[:FO2M]:UPPer[:DATA]?</code>
Example	<code>:CALC:IBEM:LIM:NEAR:UPP -30.0</code> <code>:CALC:IBEM:LIM:NEAR:UPP?</code>
Couplings	It is only available when LE PHY is LE 1M or LE Coded
Preset	-20.0 dBm
State Saved	Yes
Min/Max	-90.0 dBm/30.0 dBm

Freq Offset 4/5MHz

Sets the near limit in dBm for adjacent channel power, which is either 4MHz or 5MHz from the carrier. This control is only available when LE PHY is LE 2M.

Remote Command	<code>:CALCulate:IBEMissions:LIMit:NEAR:FO<freq>:UPPer[:DATA] <amp;1></code> <code>:CALCulate:IBEMissions:LIMit:NEAR:FO<freq>:UPPer[:DATA]?</code> Where <freq> is 4M 5M
Example	<code>:CALC:IBEM:LIM:NEAR:F04M:UPP -30.0</code> <code>:CALC:IBEM:LIM:NEAR:F05M:UPP?</code>
Couplings	It is only available when LE PHY is LE 2M
Preset	-20.0 dBm
State Saved	Yes
Min/Max	-90.0 dBm/30.0dBm

3.4.8.4 Advanced

The Advanced tab contains controls for setting advanced functions of the analyzer. This tab does not appear in EXM or VXT.

Noise Floor Extension

Allows you to turn on/configure the Noise Floor Extension (NFE) function.

When ON, the expected noise power of the analyzer (derived from a factory calibration) is subtracted from the trace data. This will usually reduce the apparent noise level by about 10 dB in low band, and 8 dB in high band (>~3.6 GHz).

NFE works with any RBW, VBW, detector, any setting of Average Type, any amount of trace averaging, and any signal type. It is ineffective when the trace is not smoothed (smoothing processes include narrow VBWs, trace averaging, and long sweep times with the detector set to Average or Peak). It works best with extreme amounts of smoothing, and with the average detector, with the Average Type set to Power.

In those cases where the cancellation is ineffective, it nonetheless has no undesirable side-effects. There is no significant speed impact to having Noise Floor Extension on.

The best accuracy is achieved when substantial smoothing occurs in each point before trace averaging. Thus, when using the average detector, results are better with long sweep times and fewer trace averages. When using the sample detector,

the VBW filter should be set narrow with less trace averaging, instead of a wide VBW filter with more trace averaging.

Remote Command	<code>[:SENSe]:CORRection:NOISe:FLOor ON OFF 1 0</code> <code>[:SENSe]:CORRection:NOISe:FLOor?</code>
Example	<code>:CORR:NOIS:FLO ON</code>
Dependencies	This control only appears in instruments with the NFE or NF2 license installed. In all others, the control does not appear, however the SCPI command will be accepted without error (but will have no effect)
Couplings	When NFE is enabled in any mode manually, a prompt will be displayed reminding you to perform the Characterize Noise Floor operation if it is needed. If NFE is enabled through SCPI and a Characterize Noise Floor operation is needed, an error will be entered in the system error queue
Preset	Unaffected by Mode Preset. Turned OFF at startup and by Restore Mode Defaults in Modes that do not support Adaptive
State Saved	No

3.4.9 Sweep

The Sweep key contains controls which allow you to control the sweep and measurement functions of the analyzer, such as the sweep or measurement time and whether in Single sweep/measure or Continuous sweep/measure mode.

3.4.9.1 Sweep/Control

Accesses controls that let you operate the sweep and control functions of the instrument, such as **Sweep Time** and **Continuous/Single**.

Sweep Time

Sets the sweep time for every 100 kHz bin. It doesn't represent the whole sweep time, and it only represent the sweep time for each 100 kHz bin.

Remote Command	<code>[:SENSe]:IBEMissions:SWEep:TIME <time></code> <code>[:SENSe]:IBEMissions:SWEep:TIME?</code>
Example	<code>:IBEM:SWE:TIME 1.4ms</code> <code>:IBEM:SWE:TIME?</code>
Dependencies	If Meas Method isn't Sweep, this key will be grayed out
Preset	100.0 ms
State Saved	Yes
Min/Max	100 us/120ms

Acquisition Time

Controls the time the instrument takes to capture a single packet.

Remote Command	<code>[:SENSe]:ACQuisition:TIME <time></code> <code>[:SENSe]:ACQuisition:TIME?</code>
Example	<code>:ACQ:TIME 700uS</code> <code>:ACQ:TIME?</code>
Couplings	Acquisition Time may be clipped by the instrument if the specified acquisition time cannot be performed
Preset	3.0 ms
State Saved	Yes
Min/Max	100 us/100.0 s

Sweep Number

Accesses a menu that enables you to set the number of sweeps.

Remote Command	<code>[:SENSe]:SWEep:NUMBer <integer></code> <code>[:SENSe]:SWEep:NUMBer?</code>
Example	<code>:SWE:NUMB 10</code> <code>:SWE:NUMB?</code>
Preset	10
State Saved	Yes
Min/Max	1/10000

Sweep/Measure

Lets you toggle between **Continuous** and **Single** sweep or measurement operation. The single/continuous state is Meas Global, so the setting affects all measurements.

The front-panel key **Single/Cont** performs exactly the same function

See "[More Information](#)" on page 486

Remote Command	<code>:INITiate:CONTinuous OFF ON 0 1</code> <code>:INITiate:CONTinuous?</code>
Example	Put instrument into Single measurement operation: <code>:INIT:CONT 0</code> <code>:INIT:CONT OFF</code> Put instrument into Continuous measurement operation:

	<code>:INIT:CONT 1</code>
	<code>:INIT:CONT ON</code>
Preset	ON Note that <code>:SYST:PRES</code> sets <code>:INIT:CONT</code> to ON , but <code>*RST</code> sets <code>:INIT:CONT</code> to OFF
State Saved	Saved in instrument state
Annunciation	The Single/Continuous icon in the Meas Bar changes depending on the setting: <ul style="list-style-type: none"> - A line with an arrow is Single - A loop with an arrow is Continuous
Backwards Compatibility Notes	X-Series A-models had Single and Cont hardkeys in place of the SweepSingleCont softkey. In the X-Series A-models, if in single measurement, the Cont hardkey (and <code>INIT:CONT ON</code>) switched to continuous measurement, but never restarted a measurement and never reset a sweep X-Series B-models have a Cont/Single toggle control instead of Single and Cont hardkeys, but it is still true that, if in single measurement, the Cont/Single toggle control never restarts a measurement and never resets a sweep

More Information

Continuous Mode	<p>The instrument takes repetitive sweeps, averages, measurements, etc., when in continuous mode. If in average or Max/Min Hold, and the average/hold count reaches the Average/Hold Num, the count stops incrementing, but the instrument keeps sweeping</p> <p>See the Trace key description under Trace Average for the averaging formula used both before and after the Average/Hold Num is reached. The trigger condition must be met prior to each sweep</p> <p>The type of trace processing for multiple sweeps is set under the Trace key, with choices of Trace Average, Max Hold, or Min Hold</p>
Single Mode	<p>The instrument takes a single sweep when in Single mode, or if in average or Max/Min Hold, or if there is a Waterfall window displayed, it takes multiple sweeps until the average/hold count reaches the Average/Hold Num, then the count stops incrementing, and the instrument stops sweeping</p> <p>See the Trace key description under Trace Average for the averaging formula used. The trigger condition must be met prior to the sweep</p> <p>The type of trace processing for multiple sweeps is set under the Trace key, with choices of Trace Average, Max Hold, or Min Hold</p>

If the instrument is in **Single** measurement mode, pressing the **Cont/Single** toggle control does not zero the count and does not cause the sweep to be reset; the only action is to put the instrument into Continuous measurement operation.

If the instrument is already in **Continuous** sweep:

- `:INIT:CONT 1` has no effect
- `:INIT:CONT 0` places the instrument in Single Sweep but has no effect on the current sequence until $k = N$, at which point the current sequence will stop and the instrument will go to the idle state

See "Restart" on page 806 for details of `:INIT:IMMEDIATE`.

If the instrument is already in **Single** sweep, `:INIT:CONT OFF` has no effect.

If the instrument is already in **Single** sweep, then pressing **Cont/Single** in the middle of a sweep does not restart the sweep or sequence. Similarly, pressing **Cont/Single** does not restart the sweep or sequence if the sweep is not in the idle state (for example, if you are taking a very slow sweep, or the instrument is waiting for a trigger). Even though pressing **Cont/Single** in the middle of a sweep does not restart the sweep, sending `:INIT:IMM` does reset it.

If the instrument is in **Single** sweep, and *not* Averaging/Holding, and you want to take one more sweep, press **Restart**.

If the instrument is in **Single** sweep, *and* Averaging/Holding, and you want to take one more sweep without resetting the Average trace or count, go to **Meas Setup** and increment the average count by 1 by pressing the **Step-Up** key while **Average/Hold Num** is the active function. You can also do this by sending `:CALC:AVER:TCON UP`.

Restart

Restarts the current sweep, or measurement, or set of averaged/held sweeps or measurements. If you are Paused, pressing **Restart** performs a Resume.

The front-panel key **Restart** performs exactly the same function.

The **Restart** function is accessed in several ways:

- Pressing the **Restart** key
- Sending `:INIT:IMM`
- Sending `:INIT:REST`

See "More Information" on page 488

Remote Command	<code>:INITiate[:IMMEDIATE]</code>
Example	<code>:INIT:IMM</code> <code>:INIT:REST</code>
Notes	<code>:INIT:REST</code> and <code>:INIT:IMM</code> perform exactly the same function

Couplings	Resets average/hold count k. For the first sweep overwrites all active (update = on) traces with new current data. For application modes, it resets other parameters as required by the measurement
Status Bits/OPC dependencies	This is an Overlapped command The STATUS:OPERation register bits 0 through 8 are cleared , <i>except</i> bit 6 (Waiting for Periodic Sync). Initiating a measurement and Waiting for Periodic Sync could be asynchronous The STATUS:QUESTionable register bit 9 (INTEgrity sum) is cleared The SWEEPING bit is set The MEASURING bit is set
Backwards Compatibility Notes	For Spectrum Analysis Mode in ESA and PSA, the Restart hardkey and the :INIT:REST command restarted trace averages (displayed average count reset to 1) for a trace in Clear Write , but did not restart Max Hold and Min Hold In X-Series, the Restart hardkey and the :INIT:REST command restart not only Trace Average , but MaxHold and MinHold traces as well

More Information

The **Restart** function first aborts the current sweep or measurement as quickly as possible. It then resets the sweep and trigger systems, sets up the measurement and initiates a new data measurement sequence with a new data acquisition (sweep) taken once the trigger condition is met.

If the instrument is in the process of aligning when a **Restart** is executed, the alignment finishes before the restart function is performed.

Even when set for **Single** operation, multiple sweeps may be taken when **Restart** is pressed (for example, when averaging/holding is on). Thus, when we say that **Restart** "restarts a measurement", depending on the current settings, we may mean that it:

- Restarts the current sweep
- Restarts the current measurement
- Restarts the current set of sweeps if any trace is in Trace Average, Max Hold or Min Hold
- Restarts the current set of measurements if Averaging, or Max Hold, or Min Hold is on for the measurement

If there is no Average or Max/Min Hold function (no trace in Trace Average or Hold, or **Average/Hold Num** set to 1), and no **Waterfall** window is being displayed, a single sweep is equivalent to a single measurement. A single sweep is taken after the trigger condition is met; and the instrument stops sweeping once that sweep has completed. However, with **Average/Hold Num** >1, and at least one trace set to Trace Average, Max Hold, or Min Hold, or a **Waterfall** window being displayed, multiple sweeps/data acquisitions are taken for a single measurement. The trigger

condition must be met prior to each sweep. The sweep is stopped when the average count k equals the number N set for **Average/Hold Num**.

Once the full set of sweeps has been taken, the instrument goes to the idle state. To take one more sweep without resetting the average count, increment the average count by 1, by pressing the **Step-Up** key while **Average/Hold Number** is the active function, or by sending the remote command `:CALC:AVER:TCON UP`.

Trace Update

The numeric results are not blanked at any time during the restart cycle.

For slow sweeps (see **Trace Update** section in **Trace/Detector**), the traces are updated real-time during the sweep. There may be a special circumstance in application mode measurements where an exception is made and the traces and/or results need to be blanked before displaying the new results.

To summarize, the following list shows what happens to the trace data on various events:

Event	Trace Effect
Clear/Write pressed (even if already in Clear/Write)	Set to mintracevalue
Max Hold pressed (even if already in Max Hold)	Set to mintracevalue
Min Hold pressed (even if already in Min Hold)	Set to maxtracevalue
Trace Average pressed (even if already in Trace Average)	Trace data unaffected but start new sweep/avg/hold
Restart pressed	Trace data unaffected but start new sweep/avg/hold
Parameter requiring restart changed (e.g., RBW)	Trace data unaffected but start new sweep/avg/hold

Sweep and Trigger Reset

Resetting the sweep system resets the average/hold count k to 0. It also resets the set point counter to 0. Resetting the trigger system resets the internal auto trig timer to the value set by the **Auto Trig** control.

Averaging

The weighting factor used for averaging is k . This k is also the average/hold count for how many valid sweeps (data acquisitions) have been done. This k is used for comparisons with N , as those comparisons always needs to be based on valid completed sweeps.

The displayed average/hold, **K**, shows the count for the sweep (data acquisition) in progress. $K = k + 1$, with a limit of **N**. The displayed value **K** changes from its previous value to 1 as soon as the trigger condition for the first data acquisition (sweep) is met.

Pause/Resume

Pauses a measurement after the current data acquisition is complete.

When paused, the label on the control changes to **Resume**. Pressing **Resume** unpauses the measurement. When paused, pressing **Restart** performs a Resume.

Remote Command	<code>:INITiate:PAUSE</code> <code>:INITiate:RESume</code>
Example	<code>:INIT:PAUS</code> <code>:INIT:RES</code>
Dependencies	Not displayed in Modes that do not support pausing
Annotation	Only on control

3.4.9.2 Sweep Config

This tab accesses controls that enable you to configure the Sweep and Control functions of the analyzer, such as Sweep Rules.

Points

Sets the number of points for each 100kHz bin from 1 to 40001. Points is couple to Sweep Time, so changing sweep time may change the sweep Points.

Remote Command	<code>[:SENSe]:IBEMissions:SWEEp:POINts <integer></code> <code>[:SENSe]:IBEMissions:SWEEp:POINts?</code>
Example	<code>:IBEM:SWE:POIN 500</code> <code>:IBEM:SWE:POIN?</code>
Couplings	Gray out if Meas Method is FFT
Preset	1001
State Saved	Yes
Min/Max	1/40001

Points Auto State

Enables the auto state for Sweep Points.

3 Bluetooth Mode
3.4 LE|QHS In-band Emissions Measurement

Remote Command	<code>[:SENSe]:IBEMissions:SWEEp:POINTs:AUTO OFF ON 0 1</code> <code>[:SENSe]:IBEMissions:SWEEp:POINTs:AUTO?</code>
Example	<code>:IBEM:SWE:PION:AUTO OFF</code> <code>:IBEM:SWE: PION:AUTO?</code>
Couplings	If point auto state is auto, Point value will be coupled with sweep time. Point = sweep time / 10 / 3.5us
Preset	ON

3.4.9.3 X Scale

This tab accesses controls that enable you to set the horizontal scale parameters.

Ref Value

Sets the X-axis reference level (start time) for the RF Envelope graph, allowing smaller sections of the RF Envelope trace to be viewed in greater detail.

Remote Command	<code>:DISPlay:IBEMissions:WINDow[1]:TRACe:X[:SCALE]:RLEVel <time></code> <code>:DISPlay:IBEMissions:WINDow[1]:TRACe:X[:SCALE]:RLEVel?</code>
Example	<code>:DISP:IBEM:WIND:TRAC:X:RLEV 100us</code> <code>:DISP:IBEM:WIND:TRAC:X:RLEV?</code>
Dependencies	This parameter is only available when RF Envelope View is selected
Couplings	Max value is coupled to Sweep time and X scale/division (see below)
Preset	0.000 s
State Saved	Yes
Range	0 – (Sweep time – (X scale/division * 10))
Min/Max	0 s/ (Sweep time – (X scale/division * 10))

Backwards Compatibility SCPI

Window Numbers used to be a combination of View and Window, now only Window number is sent. For backwards compatibility the old View and Window numbers are honored as below:

Window	Old SCPI Command	New SCPI Command
RF Envelope	<code>:DISP:IBEM:VIEW1:WIND1:TRAC:X:RLEV 100us</code>	<code>:DISP:IBEM:WIND1:TRAC:X:RLEV 100us</code>

Scale/Division

Sets the X-axis scale per division for the RF Envelope graph, allowing smaller sections of the RF Envelope trace to be viewed in greater detail.

Remote Command	<code>:DISPlay:IBEMissions:WINDow[1]:TRACe:X[:SCALe]:PDIVision <time></code> <code>:DISPlay:IBEMissions:WINDow[1]:TRACe:X[:SCALe]:PDIVision?</code>
Example	<code>:DISP:IBEM:WIND:TRAC:X:PDIV 5us</code> <code>:DISP:IBEM:WIND:TRAC:X:PDIV?</code>
Dependencies	This parameter is only available when RF Envelope View is selected
Couplings	Min is coupled to sample time, but maintains at least two points at any time Max value is coupled to X reference value and Sweep time
Preset	10.0 ms
State Saved	Yes
Range	Hardware Dependent
Min/Max	$(2 * \text{Sweep Time}) / (10 * \text{Number of points in RF Envelope}) / (\text{Sweep Time} - \text{Ref Level}) / 10$

Backwards Compatibility SCPI

Window Numbers used to be a combination of View and Window, now only Window number is sent. For backwards compatibility the old View and Window numbers are honored as below:

Window	Old SCPI Command	New SCPI Command
RF Envelope	<code>DISP:IBEM:VIEW1:WIND1:TRAC:X:PDIV 5us</code>	<code>DISP:IBEM:WIND1:TRAC:X:PDIV 5us</code>

Ref Position

Sets the X-axis reference position for the RF Envelope graph, allowing smaller sections of the RF Envelope trace to be viewed in greater detail.

Remote Command	<code>:DISPlay:IBEMissions:WINDow[1]:TRACe:X[:SCALe]:RPOSition LEFT CENTER RIGHT</code> <code>:DISPlay:IBEMissions:WINDow[1]:TRACe:X[:SCALe]:RPOSition?</code>
Example	<code>:DISP:IBEM:WIND:TRAC:X:RPOS CENT</code> <code>:DISP:IBEM:WIND:TRAC:X:RPOS?</code>
Dependencies	This parameter is only available when RF Envelope View is selected
Preset	LEFT

State Saved	Yes
Range	Left Ctrl Right

Backwards Compatibility SCPI

Window Numbers used to be a combination of View and Window, now only Window number is sent. For backwards compatibility the old View and Window numbers are honored as below:

Window	Old SCPI Command	New SCPI Command
RF Envelope	<code>DISP:IBEM:VIEW1:WIND1:TRAC:X:RPOS CENT</code>	<code>DISP:IBEM:WIND1:TRAC:X:RPOS CENT</code>

Auto Scaling

Sets the X-axis auto scaling for the RF Envelope graph.

Remote Command	<code>:Display:IBEMissions:WINDow[1]:TRACE:X[:SCALE]:COUPle OFF ON 0 1</code> <code>:Display:IBEMissions:WINDow[1]:TRACE:X[:SCALE]:COUPle?</code>
Example	<code>:DISP:IBEM:WIND:TRAC:X:COUP ON</code> <code>:DISP:IBEM:WIND:TRAC:X:COUP?</code>
Dependencies	This parameter is only available when RF Envelope View is selected
Couplings	When Auto Scaling is On, and you press the Restart front-panel key, this function automatically determines the scale per division and reference values based on the measurement results. When you manually set a value for the X Rel Value or X Scale/Div, this parameter is automatically set to Off
Preset	ON
State Saved	Yes
Range	On Off

Backwards Compatibility SCPI

Window Numbers used to be a combination of View and Window, now only Window number is sent. For backwards compatibility the old View and Window numbers are honored as below:

Window	Old SCPI Command	New SCPI Command
RF Envelope	<code>DISP:IBEM:VIEW1:WIND1:TRAC:X:COUP ON</code>	<code>DISP:IBEM:WIND1:TRAC:X:COUP ON</code>

3.4.10 Trace

The Trace key contains controls that allow you to control the traces.

3.4.10.1 Trace Control

The controls on the Trace Control tab allow you to set the type of the Trace and its update mode.

There are four trace Types: **Clear/Write**, **Trace Average**, **Max Hold** and **Min Hold**. Each type handles data in a different way.

Trace Type

Allows you to select the type of trace you want to you use for the current measurement.

There are four trace Types: **Clear/Write**, **Trace Average**, **Max Hold** and **Min Hold**.

Remote Command	<code>:TRACe:IBEMissions:TYPE WRITe AVERAge MAXHold MINHold</code> <code>:TRACe:IBEMissions:TYPE?</code>
Example	<code>:TRAC:IBEM:TYPE WRIT</code> <code>:TRAC:IBEM:TYPE?</code>
Notes	WRITe = Clear Write AVERAge = Average MAXHold = Maximum Hold MINHold = Minimum Hold
Preset	MAXHold
State Saved	Yes
Range	<code>ClearWrite Average MaxHold MinHold</code>

Clear and Write | Restart Averaging | Restart Max/Min Hold

A button is provided whose function is to start the trace writing as though the trace type had just been selected. Pressing this button is exactly like selecting the current trace type again – the button is provided because to many users it may not be obvious that re-selecting the current selection from a radio button menu will take an action.

This button takes on different labels depending on the Trace Type:

Clear/Write: Clear and Write

Trace Average: Restart Averaging

Max Hold: Restart Max Hold

Min Hold: Restart Min Hold

3.4.10.2 Detector

The Detector tab lets you choose and configure detectors for the selected trace.

Detector

Accesses a menu of functions that enables you to control the detectors for the current measurement. The following choices are available:

Auto - the detector selected depends on marker functions, trace functions, average type, and the trace averaging function.

Normal - the detector determines the peak of the CW-like signals, and it yields alternating maximums and minimums of noise-like signals. This is also referred to as Rosenfell detection.

Average - the detector determines the average of the signal within the sweep points. The averaging method depends upon the Average Type selection (voltage, power, or log scales).

Peak (Positive) - the detector determines the maximum of the signal within the sweep points.

Sample - the detector indicates the instantaneous level of the signal at the center of the sweep points represented by each display point.

Negative Peak - the detector determines the minimum of the signal within the sweep points.

When the detector choice is Auto, the analyzer selects the detector. The selected detector depends on marker functions, trace functions, and trace averaging functions for the current measurement.

Remote Command	<code>[:SENSe]:IBEMissions:DETEctor[:FUNction] NORMAl AVERAge POSitive SAMPlE NEGative</code> <code>[:SENSe]:IBEMissions:DETEctor[:FUNction]?</code>
Example	<code>:IBEM:DET NORM</code> <code>:IBEM:DET?</code>
Notes	When you manually select a detector (instead of selecting Auto), that detector is used regardless of other analyzer settings The detector choices are: The Normal detector determines the peak of CW-like signals, and it yields alternating maximums and

minimums of noise-like signals. This is also referred to as Rosenfell detection

The Average detector determines the average of the signal within the sweep points. The averaging method is Power Average (RMS)

The Peak detector determines the maximum of the signal within the sweep points

The Sample detector indicates the instantaneous level of the signal at the center of the sweep points represented by each display point

The Negative Peak detector determines the minimum of the signal within the sweep points

Preset	SAMPlE
State Saved	Yes
Range	Normal Average Peak Sample Negative Peak

Detector Select Auto/Man

This toggle sets the Detector mode to Auto or Manual. In Auto, the proper detector is chosen based on rules that take the measurement settings and other analyzer settings into account.

When any detector is selected by the user, this toggles automatically set to Man (manual).

Remote Command	<code>[:SENSe]:IBEMissions:DETECTOR:AUTO ON OFF 1 0</code>
Example	<code>:IBEM:DET:AUTO ON</code> <code>:IBEM:DET:AUTO?</code>
Couplings	When Detector setting is "Auto", Detector is set to Sample
Preset	ON
State Saved	Yes

3.5 EDR In-band Spur Emissions

The EDR In-band Spurious Emissions measurement is a low cost test for Bluetooth + EDR devices to verify the level of unwanted signals within the used frequency band lies below the required level, as defined in the following standard:

Compliance with Bluetooth + EDR Ver2.1 TRM/CA/13/C (EDR – In-band Spurious Emissions) RF test specifications.

Measurement Commands

All scalar results for this measurement are contained in one table and there is one equivalent subopcode for the remote results. The remote user can use this equivalence by visually inspecting the corresponding summary trace on the display, or by using `:CALC:DATA` queries, which programmatically describes the corresponding summary trace.

`:CONFigure:IBSPurious`

`:CONFigure:IBSPurious:NDEFault`

`:FETCh:IBSPurious[n]?`

`:INITiate:IBSPurious`

`:MEASure:IBSPurious[n]?`

`:READ:IBSPurious[n]?`

Remote Command Results

EDR In-band Spurious Emissions provides 79 scalar values for the Tx power per channel. The number of meaningful results depends on the Span, with the meaningful values at the head of the array.

The following table lists the results returned by the `(FETCh|MEASure|READ):IBSP` queries, indexed by subopcode `n`:

<code>n</code>	Return Value
<code>0</code>	Returns NaN (9.91E+37)
<code>1</code>	Returns 79 comma-separated scalar values for the Tx power per channel. The number of the meaningful results depends on the IBW. Meaningful values are placed the head of the array
<code>2</code>	1. TxRefIndex 2. TxRefPower 3. Adj500kHzPowerUpper 4. Adj500kHzPowerLower

5. NumberofExceptions

3.5.1 Views

This measurement has two views, the RF Spectrum View and the RF Envelope View.

These Views are multiple-window Views. When in a multiple window View, you select a window by touching it. The menu controls may sometimes change depending on which window is selected.

Whenever the View changes, the default menu is Frequency, unless otherwise specified in the View description.

View Selection Remote Commands

Allows you to select the desired measurement view.

The Enumerated ID is used with the SCPI Command `:DISP:IBSP:VIEW[:SEL]`

The Numeric ID is used with the SCPI Command `:DISP:IBSP:VIEW:NSEL`

Enumerated ID	Numeric ID	View Name & Details
<code>RFENvelope</code>	1	Provides a combination view of RF Envelope graph and the summary data as shown below
<code>RFSPpectrum</code>	2	Provides a combination view of RF Spectrum graph and the summary data as shown below

View Selection by Name

Allows you to specify the view via its enumerated ID string.

Remote Command	<code>:DISPlay: IBSPurious:VIEW[:SElect] RFENvelope RFSPpectrum</code> <code>:DISPlay:IBSPurious:VIEW[:SElect]?</code>
Example	<code>:DISP:IBSP:VIEW:SEL RFSP</code> <code>:DISP:IBSP:VIEW:SEL?</code>
Preset	<code>RFSPpectrum</code>
State Saved	Yes
Range	RF Envelope RF Spectrum

View Selection by Number (Remote Command only)

Allows you to specify the view via its numeric ID value.

Remote Command	<code>:DISPlay:IBSPurious:VIEW:NSElect <integer></code>
	<code>:DISPlay:IBSPurious:VIEW:NSElect?</code>
Example	<code>:DISP:IBSP:VIEW:NSEL 1</code> <code>:DISP:IBSP:VIEW:NSEL?</code>
Preset	1
State Saved	Yes
Min/Max	1/2

3.5.1.1 RF Envelope View

Windows: "RF Envelope Graph" on page 499, "Metrics" on page 501

Example `:DISP:IBSP:VIEW RFEN`

3.5.1.2 RF Spectrum View

Windows: "RF Spectrum Graph" on page 500, "Metrics" on page 501

Example `:DISP:IBSP:VIEW RFSP`

3.5.2 Windows

This section describes the Windows that are available in the ACP measurement.

Window	Number
RF Envelope	1
RF Spectrum	2
Metrics	3

RF Envelope Graph

The RF Envelope Graph window is used to display the RF Envelope being measured by the measurement.

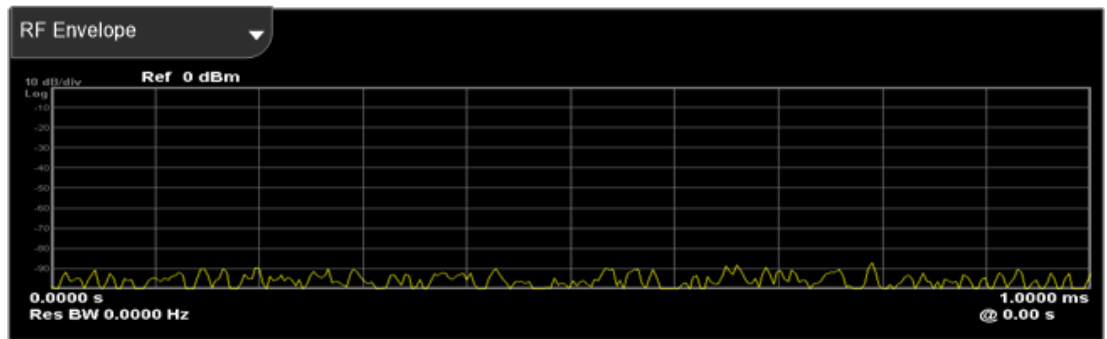

This Graph window appears in the following View:

View	Size	Position
RF Envelope	Half, full width	Top

Marker Operation	Yes
Corresponding Trace	RFEnvelope

RF Spectrum Graph

The RF Spectrum Graph window is used to display the RF Spectrum being measured by the measurement.

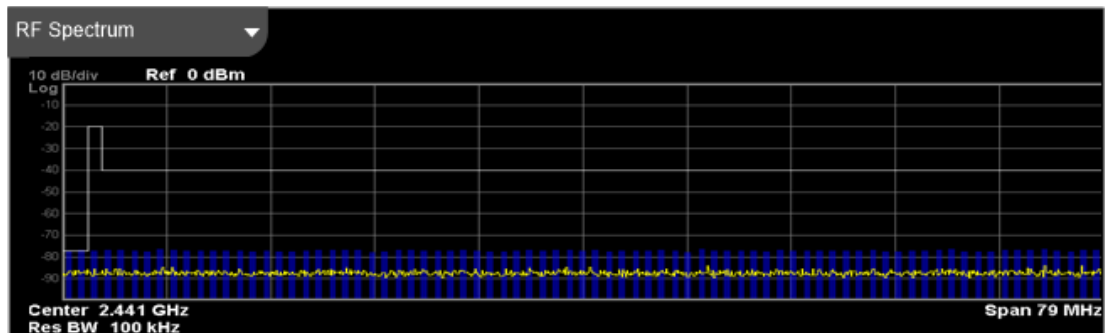

This Graph window appears in the following View:

View	Size	Position
RF Spectrum	Half, full width	Top

Marker Operation	Yes
Corresponding Trace	RFSPpectrum

Metrics

The Metrics window appears in the following Views:

View	Size	Position
RF Envelope	Half, full width	Top
RF Spectrum	Half, full width	Top

The text window displays the following results:

Tx Chan

It refers to the channel number of the transmit signal.

Tx Chan Power

It refers to the power of the transmit Signal.

Adj Channel Lower

The adjacent channel power between 1 MHz and 1.5 MHz from the carrier and it is located at the carrier's left part. Its unit is dBc, it is the difference relative to reference channel.

Adj Channel Upper

The adjacent channel power between 1 MHz and 1.5 MHz from the carrier and it is located at the carrier's right part. Its unit is dBc, it is the difference relative to reference channel.

Number of Exceptions

The number of the channel that channel power goes beyond its limit value.

Guard Position

The Guard start point relative to the burst rising point.

Time Offset

It is the burst rising edge relative to the first capture point.

Meas Time

It include the guard period, the DPSK portion of the packet and the power down ramp.

Result Table

Each channel results are listed in the results table, which includes channel number, channel power, limits value and pass/fail status for every channel.

3.5.3 Amplitude

The Amplitude front-panel key activates the Amplitude menu and selects Reference Value as the active function.

3.5.3.1 Y Scale

Contains controls that pertain to the Y axis parameters of the measurement. These parameters control how data on the vertical (Y) axis is displayed and control instrument settings that affect the vertical axis.

Ref Value

Controls the Y value of the selected trace at the Reference Position. The functionality depends on the selected window.

Remote Command	<code>:DISPlay:IBSPurious:WINDow[1] 2:TRACe:Y[:SCALe]:RLEVel <real></code> <code>:DISPlay:IBSPurious:WINDow[1] 2:TRACe:Y[:SCALe]:RLEVel?</code> Window numbers are as follows: RF Envelope: 1 RF Spectrum: 2
Example	<code>:DISP:IBSP:WIND:TRAC:Y:RLEV 0.0</code> 1 – RF Envelope Window <code>:DISP:IBSP:WIND2:TRAC:Y:RLEV 0.0</code> 2 – RF Spectrum Window
Couplings	When Auto Scaling is On (default), this value is automatically determined by the measurement result. When you set a value manually, Auto Scaling changes to Off
Preset	0.00dBm
State Saved	Yes
Min/Max	-100.00 dBm / 30.00 dBm

Backwards Compatibility SCPI

Window Numbers used to be a combination of View and Window, now the VIEW parameter is not used and removed. For backwards compatibility the old View and Window numbers are honored as below:

Window	Old SCPI Command	New SCPI Command
--------	------------------	------------------

3 Bluetooth Mode
3.5 EDR In-band Spur Emissions

RF Envelope	<code>DISP:IBSP:VIEW:WIND:TRAC:Y:RLEV 0.0</code>	<code>DISP:IBSP:WIND:TRAC:Y:RLEV 0.0</code>
RF Spectrum	<code>DISP:IBSP:VIEW2:WIND:TRAC:Y:RLEV 0.0</code>	<code>DISP:IBSP:WIND2:TRAC:Y:RLEV 0.0</code>

Scale/Div

Controls the Y scale per division of the selected trace. The functionality depends on the selected window.

Remote Command	<code>:DISPlay:IBSPurious:WINDow[1] 2:TRACe:Y[:SCALE]:PDIVision <rel_amp1></code> <code>:DISPlay:IBSPurious:WINDow[1] 2:TRACe:Y[:SCALE]:PDIVision?</code> Window numbers are as follows: RF Envelope: 1 RF Spectrum: 2
Example	<code>:DISP:IBSP:WIND:TRAC:Y:PDIV 0.0</code> 1 – RF Envelope Window <code>:DISP:IBSP:WIND2:TRAC:Y:PDIV 0.0</code> 2 – RF Spectrum Window
Couplings	When Auto Scaling is On (default), this value is automatically determined by the measurement result. When you set a value manually, Auto Scaling changes to Off
Preset	10.0 dB
State Saved	Yes
Min/Max	0.1 dB / 30.00 dB

Backwards Compatibility SCPI

Window Numbers used to be a combination of View and Window, now the VIEW parameter is not used and removed. For backwards compatibility the old View and Window numbers are honored as below:

Window	Old SCPI Command	New SCPI Command
RF Envelope	<code>DISP:IBSP:VIEW:WIND:TRAC:Y:PDIV 0.0</code>	<code>DISP:IBSP:WIND:TRAC:Y:PDIV 0.0</code>
RF Spectrum	<code>DISP:IBSP:VIEW2:WIND:TRAC:Y:PDIV 0.0</code>	<code>DISP:IBSP:WIND2:TRAC:Y:PDIV 0.0</code>

Ref Position

Controls the Y ref position of the selected trace. The functionality depends on the selected window.

Remote	<code>:DISPlay:IBSPurious:WINDow[1] 2:TRACe:Y[:SCALE]:RPOSition TOP CENTER </code>
--------	---

Command	BOTTom :DISPlay:IBSPurious:WINDow[1] 2:TRACe:Y[:SCALe]:RPOSition? Window numbers are as follows: RF Envelope: 1 RF Spectrum: 2
Example	:DISP:IBSP:WIND:TRAC:Y:RPOS CENT 1 – RF Envelope window :DISP:IBSP:WIND2:TRAC:Y:RPOS CENT 2 – RF Spectrum Window
Preset	TOP
State Saved	Saved in instrument state
Range	Top Ctr Bot

Backwards Compatibility SCPI

Window Numbers used to be a combination of View and Window, now the VIEW parameter is not used and removed. For backwards compatibility the old View and Window numbers are honored as below:

Window	Old SCPI Command	New SCPI Command
RF Envelope	DISP:IBSP:VIEW:WIND:TRAC:Y:RPOS CENT	DISP:IBSP:WIND:TRAC:Y:RPOS CENT
RF Spectrum	DISP:IBSP:VIEW2:WIND:TRAC:Y:RPOS CENT	DISP:IBSP:WIND2:TRAC:Y:RPOS CENT

Auto Scaling

Toggles the Auto Scaling function between On and Off. The functionality depends on the selected window.

Remote Command	:DISPlay:IBSPurious:WINDow[1] 2:TRACe:Y[:SCALe]:COUPle 0 1 OFF ON :DISPlay:IBSPurious:WINDow[1] 2:TRACe:Y[:SCALe]:COUPle? Window numbers are as follows: RF Envelope: 1 RF Spectrum: 2
Example	:DISP:IBSP:WIND:TRAC:Y:COUP ON 1 – RF Envelope window :DISP:IBSP:WIND2:TRAC:Y:COUP ON 2 – RF Spectrum Window

Couplings	When Auto Scaling is On, and you press the Restart front-panel key, this function automatically determines the scale per division and reference values based on the measurement results. When you manually set a value for the Y Rel Value or Y Scale/Div, this parameter is automatically set to Off
Preset	ON
State Saved	Saved in instrument state
Range	On Off

Backwards Compatibility SCPI

Window Numbers used to be a combination of View and Window, now the VIEW parameter is not used and removed. For backwards compatibility the old View and Window numbers are honored as below:

Window	Old SCPI Command	New SCPI Command
RF Envelope	DISP:IBSP:VIEW:WIND:TRAC:Y:COUPl e CENT	DISP:IBSP:WIND:TRAC:Y:COUPl e CENT
RF Spectrum	DISP:IBSP:VIEW2:WIND:TRAC:Y:COUPl e CENT	DISP:IBSP:WIND2:TRAC:Y:COUPl e CENT

3.5.3.2 Attenuation

Controls the attenuator functions and interactions between the attenuation system components.

There are two attenuator configurations in the X-Series. One is a Dual-Attenuator configuration consisting of a mechanical attenuator and an optional electronic attenuator. The other configuration uses a single attenuator with combined mechanical and electronic sections that controls all the attenuation functions. Different models in the X-Series come with different configurations.

- See "[Dual-Attenuator Configurations](#)" on page 506
- See "[Single-Attenuator Configuration](#)" on page 506

Most attenuation settings are the same for all measurements – they do not change as you change measurements. Settings like these are called “Meas Global” and are unaffected by **Meas Preset**.

Only available when the hardware set includes an input attenuator, which is typically only the case for Keysight’s benchtop instruments. For example, this tab does *not* appear in VXT models M9421A/10A/11A, nor in UXM. In UXM, all **Attenuation** and **Range** settings are disabled, as the expected input power level is handled by the Call Processing App that drives the DUT power control.

Dependencies	In measurements that support the I/Q inputs, unavailable when I/Q is the selected input. Replaced by the Range tab in that case
--------------	--

Dual-Attenuator Configurations

Configuration 1: Mechanical attenuator + optional electronic attenuator

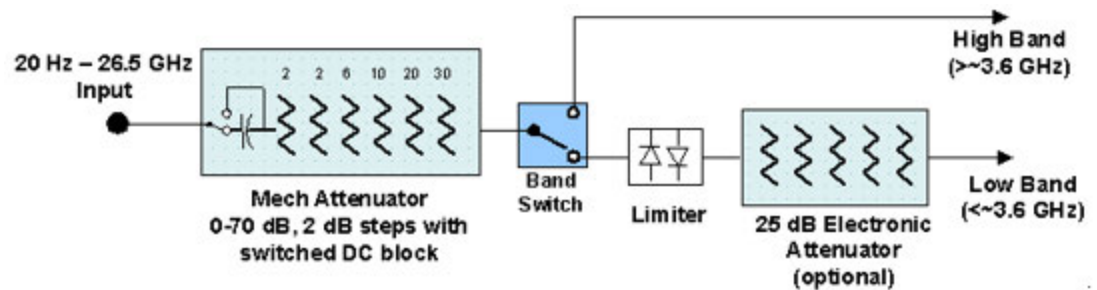

Configuration 2: Mechanical attenuator, no optional electronic attenuator

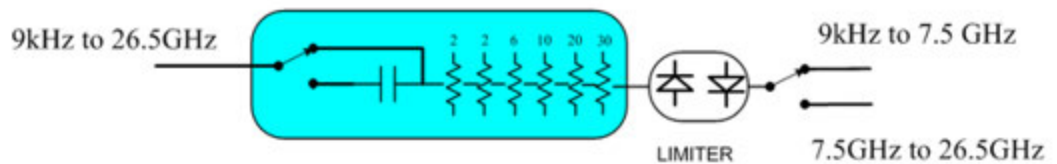

Note that Configuration 2 is not strictly speaking a dual-section attenuator, since there is no electronic section available. However, it behaves exactly like Configuration 1 without the Electronic Attenuator Option EA3, therefore for the sake of this document it is grouped into the “Dual-Attenuator” configuration.

Single-Attenuator Configuration

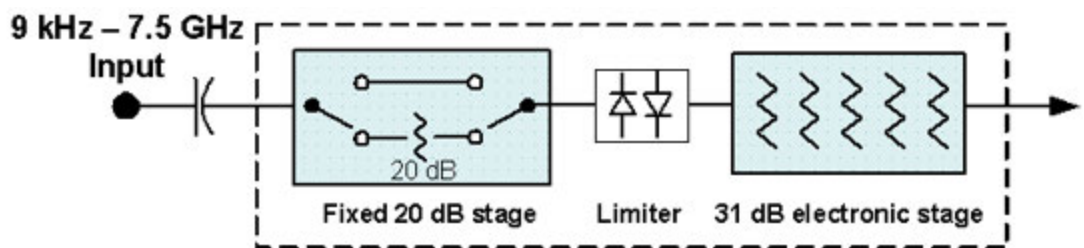

You can tell which attenuator configuration you have by pressing the Attenuation tab, which (in most Modes) opens the Attenuation menu. If the first control in the Attenuation menu says **Mech Atten** you have the Dual-Attenuator configuration. If the first control says **Atten** you have the Single-Attenuator configuration.



(Note that depending on the measurement, there may be no Auto/Man functionality on the Mech Atten control.)

In the Single-Attenuator configuration, you control the attenuation with a single control, as the fixed stage has only two states. In the Dual-Attenuator configuration, both stages have significant range, so you are given separate control of the mechanical and electronic attenuator stages.

When you have the Dual-Attenuator configuration, you may still have only a Single-Attenuator, because unless Option EA3 (the Electronic Attenuator option) is available, and you purchase it, you will have only the mechanical attenuator.

Full Range Atten

This control and **Attenuator Summary** only appear in N9041B, when the RF input is selected, the RF Input Port is set to RF Input 2, and the Full Range Attenuator is installed. The Full Range Attenuator adds a second input attenuator in front of RF Input 2, which enhances the protection and optimizes the performance of the extra internal mixers used by RF Input 2.

Remote Command	<code>[:SENSe]:POWer[:RF]:FRATten <rel_ampl></code> <code>[:SENSe]:POWer[:RF]:FRATten?</code>
Example	<code>:POW:FRAT 14</code> <code>:POW:FRAT?</code>
Notes	When you enter an amplitude value that falls between valid values, the value will be incremented to the next smallest valid value
Dependencies	Only appears if input RF is selected, RF Input Port 2 is selected, and the Full Range Attenuator exists
Couplings	This value is never changed by any coupling, but other couplings use this value. See Reference Level and " Mech Atten " on page 719 command descriptions
Preset	20 dB
State Saved	Saved in instrument state
Min	0 dB
Max	Only valid values are 0, 6, 14, 20 dB
Annotation	When the Input is RF, and the Input Port is RF Input 2, and the Full Range Attenuator is installed:

On the Meas Bar, the field “Atten” displays as follows:

- If the sweep is entirely < 50 GHz, the value shown after “Atten:” is equal to Mech Atten + Elec Atten + Full Range Atten
- If the sweep is entirely > 50 GHz, the value shown after “Atten:” is equal to Full Range Atten
- If the sweep straddles 50 GHz, the value shown after “Atten:” is preceded by the symbol “>=” and is equal to Full Range Atten

In the **Amplitude**, **"Y Scale"** on page 597 menu, and the Atten **Meas Bar** dropdown menu panel, a summary is displayed as follows:

“Total Atten below 50 GHz” followed by the value of Full Range Atten + Mech Atten + Elec Atten

“Total Atten above 50 GHz” followed by the value of Full Range Atten

For example, if Mech Atten = 6 dB, Elec Atten = 4 dB, and Full Range Atten = 20 dB, the summary below is shown:

- Attenuator summary:
- Total Atten below 50 GHz: 30 dB
- Total Atten above 50 GHz: 20 dB

Mech Atten

Labeled **Mech Atten** in Dual-Attenuator models and **Atten** in Single-Attenuator models. In the Dual-Attenuator configuration, this control only affects the mechanical attenuator.

Lets you modify the attenuation applied to the RF input signal path. This value is normally auto-coupled to the Ref Level, the Internal Preamp Gain, any External Gain that is entered, and the Max Mixer Level, as described in the table below.

See **"Attenuator Configurations and Auto/Man"** on page 510

Remote Command	<pre>[:SENSe]:POWer[:RF]:ATTenuation <rel_ampl> [:SENSe]:POWer[:RF]:ATTenuation? [:SENSe]:POWer[:RF]:ATTenuation:AUTO OFF ON 0 1 [:SENSe]:POWer[:RF]:ATTenuation:AUTO?</pre>
----------------	--

Example	<pre>:POW:ATT 20</pre> <p>Dual-Attenuator configuration: sets the mechanical attenuator to 20 dB Single-Attenuator mode: sets the main attenuation to 20 dB (see below for definition of “main” attenuation) In either case, if the attenuator was in Auto, it is set to Manual <pre>:POW:ATT:AUTO ON</pre> Turn Auto Mech Atten ON</p>
---------	--

3 Bluetooth Mode

3.5 EDR In-band Spur Emissions

Dependencies	<p>Some measurements do not support Auto setting of "Mech Atten" on page 508. In these measurements, the Auto/Man selection is not available, and the Auto/Man toggle function is not available</p> <p>In Dual-Attenuator configurations, when the electronic attenuator is enabled, the mechanical attenuator has no auto setting, and the Auto/Man toggle function is not available. The state of Auto/Man is remembered and restored when the electronic attenuator is once again disabled. This is described in more detail in "Elec Atten" on page 721</p> <p>See "Attenuator Configurations and Auto/Man" on page 510 for more information on the Auto/Man functionality</p> <p>:POW:ATT:AUTO is only available in measurements that support Mech Atten Auto, such as Swept SA</p>
Couplings	<p>If the RF Input Port is the RF Input:</p> <ul style="list-style-type: none"> - If the USB Preamp is connected to USB, use 0 dB for Mech Atten - Otherwise compute the auto-selected value of Mech Atten based on Reference Level, Int Preamp, External Gain, Ref Level Offset, Max Mixer Level, μW Path Control and IF Gain settings. Limit this value to be no less than 6 dB (total attenuation below 6 dB can never be chosen by Auto) - In the N9041B, if the RF Input Port is RF Input 2, use the formula above and subtract the Full Range Atten value from the result to determine the Mech Atten. Limit the value so that it is never lower than 0 dB and so that total attenuation, including Full Range Atten, is never less than 6 dB (total attenuation, including Full Range Atten below 6 dB, can never be chosen by Auto) <p>In External Mixing and BBIQ, where the Attenuator is not in the signal path, the Attenuator setting changes as described above when "Mech Atten" on page 508 is in Auto, but no changes are made to the actual attenuator hardware setting until the input is changed back to the RF Input</p> <p>For CXA-m with option FSA (Fine-Step Attenuator or 2 dB steps), the FSA-like behavior is only available when the frequency setting is ≤ 7.5 GHz. So, when the frequency is changed from below 7.5 GHz to above 7.5 GHz, the attenuation setting will be changed to a multiple of 10 dB which will be no smaller than the previous setting. For example, 4 dB attenuation will be changed to 10 dB</p>
Preset	<p>The preset for Mech Attenuation is "Auto"</p> <p>The Auto value of attenuation is 10 dB</p> <p>ON</p>
State Saved	<p>Saved in instrument state</p>
Min	<p>0 dB</p> <p>The attenuation set by this control cannot be decreased below 6 dB with the knob or step keys. Values below 6 dB must be directly entered from the keypad or via SCPI. This protects against setting a dangerously small attenuation value, which can put the instrument at risk of damage to input circuitry. If the current mechanical attenuation is below 6 dB, it can be increased with the knob and step keys, but not decreased</p>
Max	<p>CXA Option 503 or 507: 50 dB</p> <p>EXA: 60 dB</p> <p>All other models: 70 dB</p> <p>Note that in the Single-Attenuator configuration, the total of ATT and EATT cannot exceed 50 dB. So, if the EATT is set to 24 dB first, the main attenuation cannot be greater than 26 dB and will be reduced</p>

accordingly; if the main attenuator is set to 40 dB first, EATT cannot be greater than 10 dB

Annotation The current value for Total Atten is displayed in the Measurement Bar at the top of the display. A value appears for Electronic Attenuation only if the Electronic Attenuator is enabled. The annotation appears as

Atten: <total> dB (e<elec>)

The e letter is in amber in Single-Attenuator configurations

For example:

Dual-Attenuator configuration:
Atten: 24 dB (e14)

Indicating the total attenuation is at 24 dB and the electronic attenuation is at 14 dB

Single-Attenuator configuration:
A: 24 dB (e14)

Indicating the total attenuation is at 24 dB and the “soft” attenuation is at 14 dB (see below for definition of “soft” attenuation)

When in Manual, a # sign appears in front of Atten in the annotation

Attenuator Configurations and Auto/Man

As described under ["Y Scale" on page 597](#), there are two distinct attenuator configurations available in the X-Series, the single attenuator and Dual-Attenuator configurations. In Dual-Attenuator configurations, we have the mechanical attenuation and the electronic attenuation, and the current total attenuation is the sum of the electronic + mechanical attenuation. In Single-Attenuator configurations, we refer to the attenuation set using ["Mech Atten" on page 508](#) (or `:POW:ATT`) as the “main” attenuation; and the attenuation that is set by `:POW:EATT` as the “soft” attenuation (`:POW:EATT` is honored even in the Single-Attenuator configuration, for compatibility purposes). Then the current total attenuation is the sum of the main + soft attenuation.

See ["Elec Atten" on page 721](#) for more about “soft” attenuation.

NOTE

In some measurements, the **Mech Atten** control has an Auto/Man function. In these measurements, an Auto/Man switch is shown on the **Mech Atten** control:

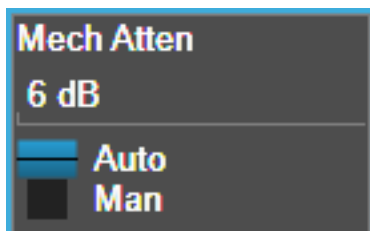

Note that in configurations that include an Electronic Attenuator, this switch is only shown when the Electronic Attenuator is disabled.

In other measurements, **Mech Atten** has no Auto/Man function. In these measurements, no switch is shown on the **Mech Atten** control:



Mech Atten also appears with no switch, as above, in configurations that include an Electronic Attenuator but when the Electronic Attenuator is enabled.

Elec Atten

Controls the Electronic Attenuator in Dual-Attenuator configurations. Does not appear in Single-Attenuator configurations, because the control of both the mechanical and electronic stages of the Single-Attenuator is integrated into the single **Atten** control.

This control includes an **Enable/Disable** toggle switch; it is only possible to enter a value for the Electronic Attenuator when this switch is in the **Enable** position.

For more details about the Electronic Attenuator, see ["More Information" on page 512](#)

Remote Command	<pre>[:SENSe]:POWer[:RF]:EATTenuation <rel_amp1> [:SENSe]:POWer[:RF]:EATTenuation? [:SENSe]:POWer[:RF]:EATTenuation:STATe OFF ON 0 1 [:SENSe]:POWer[:RF]:EATTenuation:STATe?</pre>
Example	<pre>:POW:EATT 10 :POW:EATT? :POW:EATT:STAT ON :POW:EATT:STAT?</pre>
Notes	Electronic Attenuation's specification is defined only when Mechanical Attenuation is 6 dB
Dependencies	<p>Only appears in Dual-Attenuator models with an Electronic Attenuator installed and licensed. Does not appear in models with the Single-Attenuator configuration, because in the Single-Attenuator configuration there is no "electronic attenuator"; there is only a single integrated attenuator (which has both a mechanical and electronic stage). However, in the Single-Attenuator configuration, EATT SCPI commands are accepted for compatibility with other X-series instruments, and set a "soft" attenuation. The "soft" attenuation is treated as an addition to the "main" attenuation value set by the Attenuation control or :POW:ATT, and affects the total attenuation displayed on the Attenuation control and the Meas Bar</p> <p>The electronic attenuator, and the "soft" attenuation function provided in Single-Attenuator configurations, are unavailable above the low band (0-3.6 GHz, 0-3.4 GHz, 0-3 GHz, depending on the</p>

model). If the low band range is from 0-3.6 GHz, and Stop Frequency of the instrument is > 3.6 GHz, then the **Enabled/Disabled** section of the **Elec Atten** control will be **OFF** and grayed-out

If "**Internal Preamp**" on page 737 is **ON** (that is, set to Low Band or Full), the electronic attenuator (and the "soft" attenuation function provided in Single-Attenuator configurations) is unavailable. In this case the **Enabled/Disabled** section of the **Elec Atten** control will be **OFF** and grayed-out

If either of the above is true, and the SCPI command is sent, an error indicating that the electronic attenuator is unavailable is returned

If both the above are true, pressing the control generates error message -221, in other words, the frequency range lockout takes precedence

If the electronic/soft Attenuator is enabled, then the **Stop Freq** of the instrument is limited to 3.6 GHz and **Internal Preamp** is unavailable

If "**LNA**" on page 738 is **ON**, the electronic attenuator (and the "soft" attenuation function provided in Single-Attenuator configurations) is unavailable. In this case the **Enabled/Disabled** section of the **Elec Atten** control will be **OFF** and grayed-out. This coupling works in the following modes/measurements:

- Channel Power, Occupied BW, ACP, SEM, Spurious Emissions, Power Stat CCDF measurements in all Modes
- Transmit On|Off Power measurement in 5GNR Mode
- Power vs. Time and Transmit Power measurement in GSM/EDGE Mode
- Burst Power measurement in Spectrum Analyzer Mode

The SCPI-only "soft" electronic attenuation for the single-attenuator configuration is not available in all measurements; in particular, it is not available in the Swept SA measurement

Couplings	Enabling and disabling the Electronic Attenuator affects the setting of the Mechanical Attenuator (in Dual-Attenuator configurations). This is described in more detail below and in " Mechanical Attenuator Transition Rules " on page 513
Preset	0 dB OFF (Disabled) for Swept SA measurement ON (Enabled) for all other measurements that support the electronic attenuator
State Saved	Saved in instrument state
Min	0 dB
Max	Dual-Attenuator configuration: 24 dB Single-Attenuator configuration: the total of ATT and EATT cannot exceed 50 dB. So, if the EATT is set to 24 dB first, the main attenuation cannot be greater than 26 dB and will be reduced accordingly; if the main attenuator is set to 40 dB first, EATT cannot be greater than 10 dB
Annotation	See Annotation under the Mech Atten control description

More Information

The electronic attenuator offers finer steps than the mechanical attenuator, has no acoustical noise, is faster, and is less subject to wear. These advantages primarily aid in remote operation and are negligible for front panel use. See "**Using the Electronic Attenuator: Pros and Cons**" on page 514 for a detailed discussion of the

pros and cons of using the electronic attenuator.

For the Single-Attenuator configuration, for SCPI backwards compatibility, the “soft” attenuation feature replaces the Dual-Attenuator configuration’s electronic attenuator. All the same couplings and limitations apply. See ["Attenuator Configurations and Auto/Man" on page 721](#)

Mechanical Attenuator Transition Rules

When the Electronic Attenuator is enabled, the Mechanical Attenuator transitions to a state that has no Auto function. Below are the rules for transitioning the Mechanical Attenuator. Note that the information below *only* applies to the Dual-Attenuator configurations, and *only* when the Electronic Attenuator is installed:

When the Electronic Attenuation is enabled from a disabled state:

- The Mechanical Attenuator is initialized to 10 dB (this is its optimal performance setting). You can then set it as desired with SCPI, numeric keypad, step keys, or knob, and it behaves as it normally would in manual mode
- The Auto/Man state of (Mech) Atten is saved
- The Auto/Man toggle on the (Mech) Atten control disappears, and the auto rules are disabled
- The Electronic Attenuator is set to 10 dB less than the previous value of the Mechanical Attenuator, within the limitation that it must stay within the range of 0 to 24 dB of attenuation

Examples in the Dual-Attenuator configuration:

- Mech Atten at 20 dB. Elec Atten enabled, Mech Atten set to 10 dB, and Elec Atten set to 10 dB. New total attenuation equals the value before Elec Atten enabled
- Mech Atten at 0 dB. Elec Atten enabled, Mech Atten set to 10 dB, and Elec Atten set to 0 dB. New total attenuation does not equal the value before Elec Atten enabled
- Mech Atten at 40 dB. Elec Atten enabled, Mech Atten set to 10 dB, and Elec Atten set to 24 dB. New total attenuation does not equal the value before Elec Atten enabled

When the Electronic Attenuation is disabled from an enabled state:

- The Elec Atten control is grayed out
- The Auto/Man state of (Mech) Atten is restored

- If now in Auto, (Mech) Atten recouples
- If now in Man, (Mech) Atten is set to the value of total attenuation that existed before the Elec Atten was disabled. The resulting value is rounded up to the smallest value possible given the (Mech) Atten Step setting - (That is, 57 dB changes to 58 dB when (Mech) Atten Step is 2 dB)

Using the Electronic Attenuator: Pros and Cons

The electronic attenuator offers finer steps than the mechanical attenuator, has no acoustical noise, is faster, and is less subject to wear.

The “finer steps” advantage of the electronic attenuator is beneficial in optimizing the alignment of the instrument dynamic range to the signal power in the front panel as well as remote use. Thus, you can achieve improved relative signal measurement accuracy. Compared to a mechanical attenuator with 2 dB steps, the 1 dB resolution of the electronic attenuator only gives better resolution when the odd-decibel steps are used. Those odd-decibel steps are less accurately calibrated than the even-decibel steps, so one tradeoff for this superior relative accuracy is reduced absolute amplitude accuracy.

Another disadvantage of the electronic attenuator is that the spectrum analyzer loses its “Auto” setting, making operation less convenient.

Also, the relationship between the dynamic range specifications (TOI, SHI, compression, and noise) and instrument performance are less well-known with the electrical attenuator. With the mechanical attenuator, TOI, SHI, and compression threshold levels increase dB-for-dB with increasing attenuation, and the noise floor does as well. With the electronic attenuator, there is an excess attenuation of about 1 to 3 dB between 0 and 3.6 GHz, making the effective TOI, SHI, and so forth, less well known. Excess attenuation is the actual attenuation relative to stated attenuation. Excess attenuation is accounted for in the instrument calibration.

Adjust Atten for Min Clipping

Sets the combination of mechanical and electronic attenuation and gain based on the current measured signal level so that clipping will be at a minimum.

This is an immediate action function, that is, it executes once, when the control is pressed.

The algorithms that are used for the adjustment are documented under ["Pre-Adjust for Min Clipping" on page 726](#).

Remote Command	<code>[:SENSe]:POWer[:RF]:RANGe:OPTimize IMMEDIATE</code>
Example	<code>:POW:RANG:OPT IMM</code>
Notes	Executing Adjust Atten for Min Clipping initiates the measurement

Dependencies	Does not appear in the Swept SA, RTSA, Monitor Spectrum and Complex Spectrum measurements Appears in the Waveform measurement in 5G NR Mode only
--------------	---

Adjust Atten

Allows you to select;

- Electric attenuator only
- Combination of Electric attenuator and Mechanical attenuator

when `[:SENSe]:POWer[:RF]:RANGe:OPTimize IMMEDIATE` is executed.

Remote Command	<code>[:SENSe]:POWer[:RF]:RANGe:OPTimize:TYPE EONLY COMBined</code> <code>[:SENSe]:POWer[:RF]:RANGe:OPTimize:TYPE?</code>
Example	<code>:POW:RANG:OPT:TYPE EONL</code> <code>:POW:RANG:OPT:TYPE?</code>
Dependencies	Does not appear in the Swept SA, RTSA, Monitor Spectrum and Complex Spectrum measurements Appears in the Waveform measurement in 5G NR Mode only
Preset	<code>COMBined</code>
State Saved	Saved in instrument state

Pre-Adjust for Min Clipping

If this function is `ON`, it applies the adjustment described under "[Adjust Atten for Min Clipping](#)" on page 725 each time a measurement restarts. Therefore, in Continuous measurement mode, it only executes before the first measurement.

In Dual-Attenuator models, you can set `Elec+Mech Atten`, in which case both attenuators participate in the autoranging, or `Elec Atten Only`, in which case the mechanical attenuator does not participate in the autoranging. This latter case results in less wear on the mechanical attenuator and is usually faster.

See "[Adjustment Algorithm](#)" on page 516

Selection	SCPI	Note
Off	<code>OFF</code>	This is the default setting
On	<code>ON</code>	Available in Single-Attenuator instruments. For compatibility with models that do not have an input attenuator, the <code>ON</code> parameter is supported and mapped to <code>COMBined</code>
Elec Atten Only	<code>ELECTrical</code>	Selects only the electric attenuator to participate in auto ranging. This offers less wear on the mechanical attenuator and is usually faster

	Selection	SCPI	Note
	Elec+Mech Atten	COMBined	In Dual-Attenuator models, this selects both attenuators to participate in the autoranging
Remote Command		<code>[:SENSe]:POWer[:RF]:RANGe:OPTimize:ATTenuation OFF ON ELECTrical COMBined</code> <code>[:SENSe]:POWer[:RF]:RANGe:OPTimize:ATTenuation?</code>	
Example		<code>:POW:RANG:OPT:ATT OFF</code> <code>:POW:RANG:OPT:ATT?</code>	
Notes		The parameter option ELECTrical sets this function to ON in Single-Attenuator models The parameter option COMBined is mapped to ELECTrical in Single-Attenuator models. If you send COMBined , it sets the function to ON and returns ELEC to a query For SCPI compatibility with models that do not have an input attenuator, the ON parameter is honored and mapped to COMBined	
Dependencies		Only appears in Dual-Attenuator models with an Electronic Attenuator installed In instruments with Dual-Attenuator model, when " Elec Atten " on page 721 is OFF or grayed-out, " Pre-Adjust for Min Clipping " on page 515 is grayed-out Does not appear in the Swept SA, RTSA, Monitor Spectrum and Complex Spectrum measurements For the Waveform measurement, available only in 5G NR Mode	
Preset		OFF when Elec Atten is Disabled at preset, otherwise ELEC	
State Saved		Saved in instrument state	
Range		Dual-Attenuator models: Off Elec Atten Only Mech + Elec Atten Single-Attenuator models: Off On	
Notes		ON aliases to "Elec Atten Only" (<code>:POW:RANG:OPT:ATT ELEC</code>) OFF aliases to "Off" (<code>:POW:RANG:OPT:ATT OFF</code>) <code>:POW:RANG:AUTO?</code> returns true if <code>:POW:RANG:OPT:ATT</code> is not OFF	
Backwards Compatibility SCPI		<code>[:SENSe]:POWer[:RF]:RANGe:AUTO ON OFF 1 0</code> <code>[:SENSe]:POWer[:RF]:RANGe:AUTO?</code>	

Adjustment Algorithm

The algorithms for the adjustment are documented below:

Single-Attenuator Models

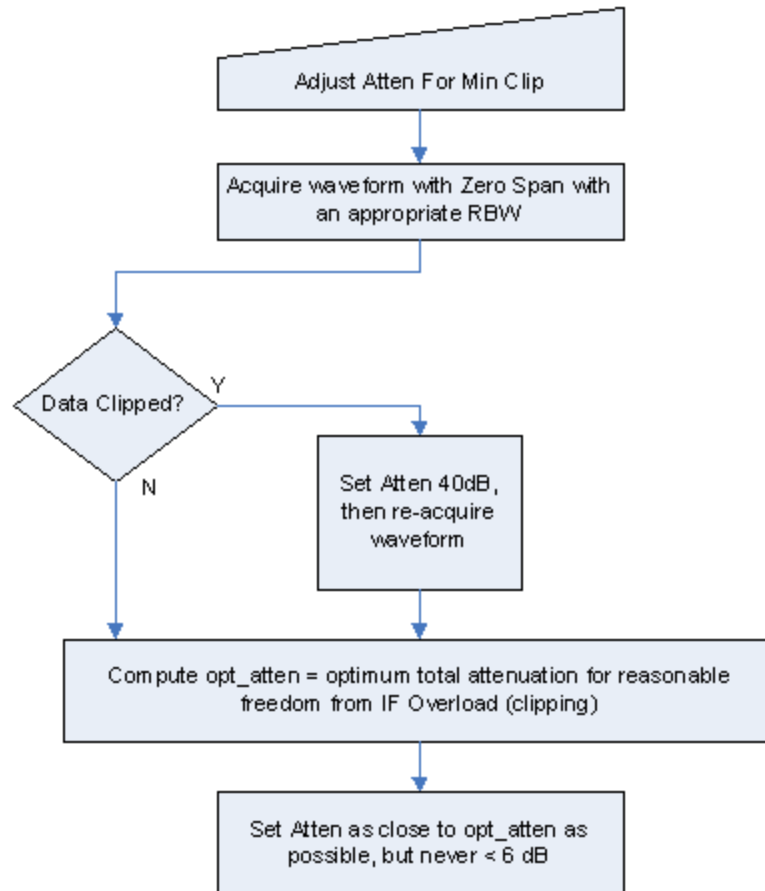

Dual-Attenuator models

"Adjust Atten for Min Clipping" on page 725 or "Pre-Adjust for Min Clipping" on page 515 selection is Mech + Elec Atten:

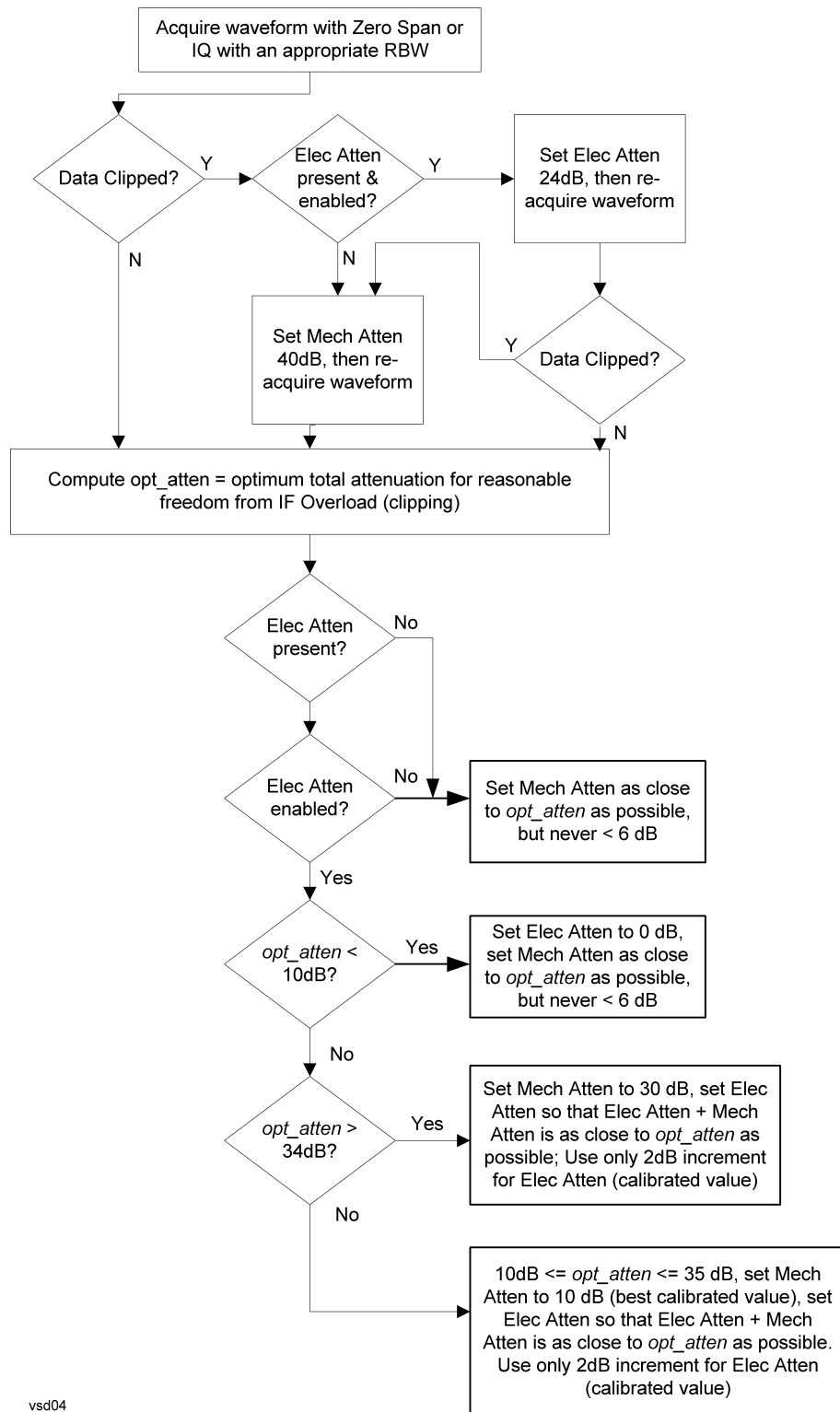

vsd04

"Pre-Adjust for Min Clipping" on page 515 selection is Elec Only.

Note that the **Mech Atten** value is not adjusted, and the value previously set is used. Therefore, there is a case that IF Overload is still observed depending on the input signal level and the Mech Atten setting.

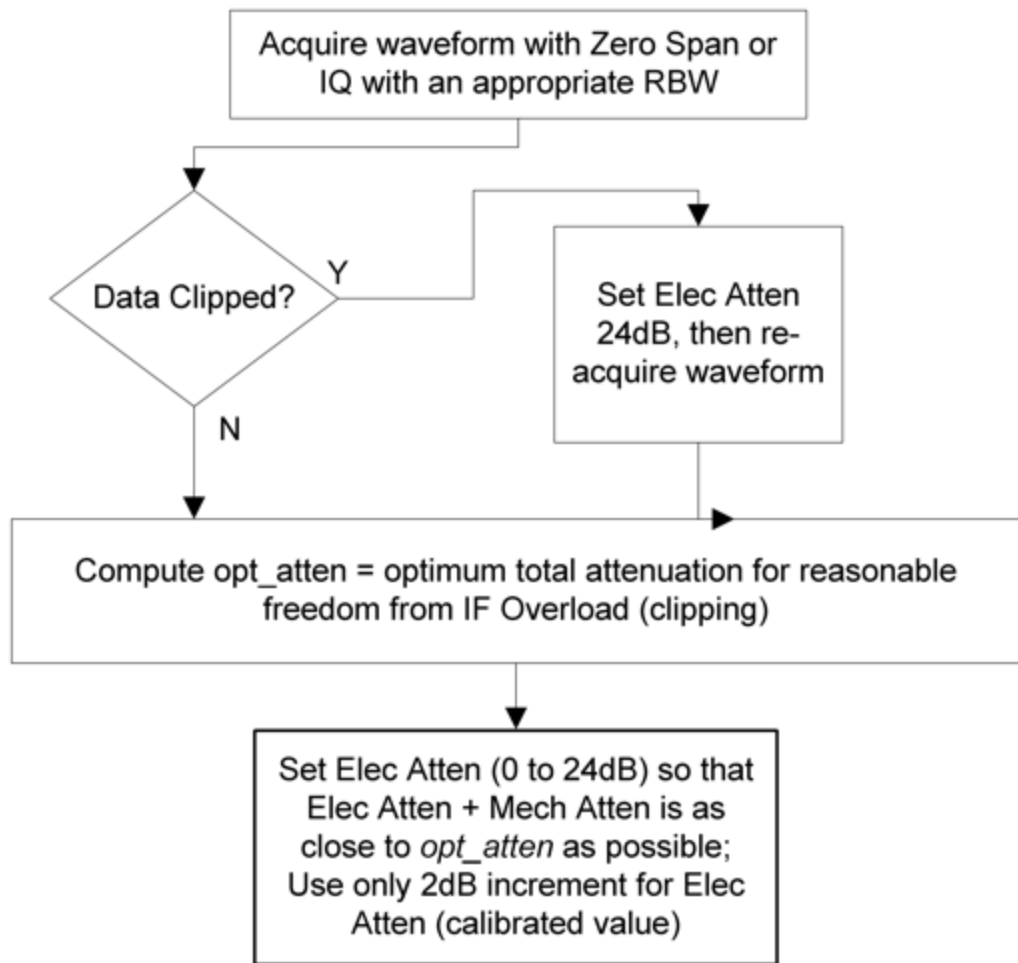

Mech Atten Step

Controls the step size used when making adjustments to the input attenuation.

Labeled **Mech Atten Step** in Dual-Attenuator models and **Atten Step** in Single-Attenuator models. In the Dual-Attenuator configuration, only affects the step size of the mechanical attenuator.

Remote Command `[:SENSe]:POWer[:RF]:ATTenuation:STEP[:INCRement] 10 dB | 2 dB`

	<code>[:SENSe]:POWer[:RF]:ATTenuation:STEP[:INCRement]?</code>
Example	<code>:POW:ATT:STEP 2</code> <code>:POW:ATT:STEP?</code>
Notes	Has a toggle control on the front panel, but takes a specific value (in dB) when used remotely. The only valid values are 2 and 10
Dependencies	Blanked in EXA, CXA and CXA-m if option FSA (2 dB steps) is not present. If blanked, attempts to set it via SCPI yield an error
Couplings	When the attenuation step size changes, the current mechanical attenuation value is adjusted (if necessary) to be quantized to the new step size. That is, if step is set to 10 dB, mech atten is increased if necessary so it is a multiple of 10 dB
Preset	EXA, CXA and CXA-m: 10 dB (2 dB with option FSA) All other models: 2 dB
State Saved	Saved in instrument state

Max Mixer Level

Allows you to set the maximum level to be applied to the mixer for a signal at the top of the screen. By setting this value up or down you can allow more or less signal through the system.

The major impact of changes to **Max Mixer Level** is seen in changes to the value to which **Reference Level** is limited. Max Ref Level depends on Max Mixer Level and Attenuation, and therefore a higher Max Mixer Level may let you set Ref Level higher. However, changing this value can impact your TOI, compression, or dynamic range. The preset value of this function is best for most measurements.

See also "[Max Mixer Lvl Rules](#)" on page 521.

Remote Command	<code>[:SENSe]:POWer[:RF]:MIXer:RANGe[:UPPer] <real></code> <code>[:SENSe]:POWer[:RF]:MIXer:RANGe[:UPPer]?</code>
Example	<code>:POW:MIX:RANG -15 dBm</code> <code>:POW:MIX:RANG?</code>
Dependencies	Only appears in Swept SA and RTSA measurements
Preset	-10 dBm
State Saved	Saved in instrument state
Min	-50 dBm
Max	0 dBm

Max Mixer Lvl Rules

Allows you to optimize the Max Mixer Level setting for certain kinds of measurements.

- NORMa1** The historical, and thus backwards compatible, setting range (–50 to 0 dBm) and default setting (–10 dBm). The instrument has been designed so that, at the default setting, any signal below the Reference Level is extremely unlikely to create ADC overloads. At this mixer level the scale fidelity will be within specifications, thus compression will be negligible
- TOI** Allows a range of settings of the "Max Mixer Level" on page 520, –50 to –10 dBm, that can be optimum for measurements limited by the instrument third-order dynamic range. The default setting, –25 dBm, is commonly appropriate but RBW affects this. A good setting for Max Mixer Level would be higher than the optimum mixer level by half of the attenuator step size
- COMPression** Allows a range of settings of the Max Mixer Level, –10 to +10 dBm or more, that can be optimum for measurements limited by the tradeoffs between instrument accuracy due to compression, and dynamic range due to the noise floor. The default setting, –3 dBm, is commonly appropriate, representing mixer drive levels that cause 1 dB or less compression at most carrier frequencies

 Typical measurements that would be optimized by this setting are the measurement of low sideband levels, including nulls, in angle-modulated signals (FM and PM). Also pulsed-RF measurements, including finding nulls to estimate pulse width, which are often best done with significant overdrive (compression) of the front end

Setting Name (readback)	Setting Name (verbose)	Max Mixer Level Preset Value, dBm	Max Mixer Level minimum value, dBm	Max Mixer Level maximum value, dBm
NORMa1	Normal – balance TOI, noise, and compression	–10	–50	0
TOI	TOI-limited dynamic range	–25	–50	–10
COMPression	Compression-limited dynamic range	–3	–10	+30

Remote Command	<code>[:SENSe]:POWer[:RF]:MIXer:RULEs NORMa1 TOI COMPression</code> <code>[:SENSe]:POWer[:RF]:MIXer:RULEs?</code>
Example	<code>:POW:MIX:RULE:COMP</code>
Dependencies	Only appears in the Swept SA and RTSA measurements
Preset	NORM

3.5.3.3 Range (Non-attenuator models)

Only available for Keysight's modular signal analyzers and certain other Keysight products, such as VXT

State Saved No

Range

Represents the amplitude of the largest sinusoidal signal that could be present within the IF without being clipped by the ADC. For signals with high peak-to-average ratios, the range may need to exceed the rms signal power by a significant amount to avoid clipping.

This is a measurement global setting.

Remote Command `[:SENSe]:POWer[:RF]:RANGe <real>`

Command `[:SENSe]:POWer[:RF]:RANGe?`

Example `:POW:RANG 10 dBm`

`:POW:RANG?`

Notes The MIN and MAX values are affected by the External Gain parameters, and by the **Center Frequency**. The hardware compensates for frequency response and alters the Range setting

Preset 0 dBm

State Saved Yes

Min -100

Max 100

Annotation Meas Bar

Adjust Range for Min Clipping

Sets the combination of attenuation and gain based on the current measured signal level so that clipping will be at a minimum.

This is an "immediate action" function, that is, it executes once, when the key is pressed.

This key does not appear in measurements that do not support this functionality.

Remote Command `[:SENSe]:POWer[:RF]:RANGe:OPTimize IMMEDIATE`

Notes Executing Adjust Range for Min Clipping initiates the measurement

Dependencies Does not appear in the Swept SA and Monitor Spectrum measurements

Pre-Adjust for Min Clipping

If this function is **ON**, it applies the adjustment described under Adjust Range For Min Clipping each time a measurement restarts. Therefore, in Continuous measurement mode, it only executes before the first measurement.

Remote Command	<code>[:SENSe]:POWer[:RF]:RANGe:OPTimize:ATTenuation OFF ON ELECTrical COMBined</code> <code>[:SENSe]:POWer[:RF]:RANGe:OPTimize:ATTenuation?</code>
Notes	Because there is no attenuator control available in these models, the control displays only ON and OFF choices. However, for SCPI compatibility with other platforms, all three parameters (ELECTrical , COMBined , and ON) are honored and all are mapped to ELECTrical , so if any of these three parameters is sent, a subsequent query will return ELEC
Dependencies	Does not appear in the Swept SA and Monitor Spectrum measurements
Preset	OFF for Swept SA measurement; ON for all other measurements that support Pre-Adjust for Min Clipping
State Saved	Saved in instrument state

Adjustment Algorithm

The algorithm for the adjustment is documented below:

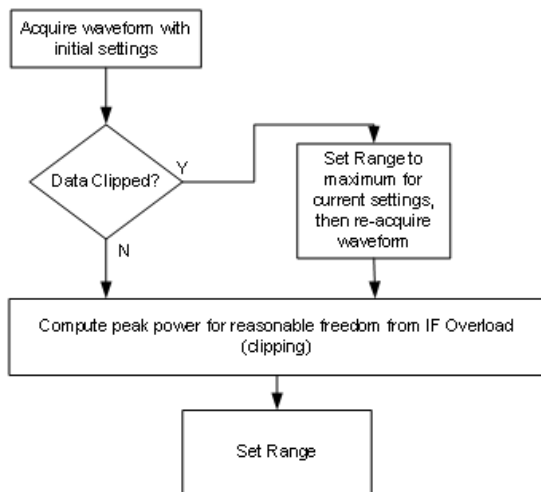

Peak-to-Average Ratio

Used with "**Range (Non-attenuator models)**" on page 731 to optimize the level control in the instrument. The value is the ratio, in dB, of the peak power to the average power of the signal to be measured. A ratio of 0 should be used for sinusoidal signals; for 802.11g OFDM signals use 9 dB.

All Modes show the current value of Peak-to-Average ratio on the control. However, some Modes do not permit changing the value. In these situations, the control is grayed-out.

Remote Command	<code>[:SENSe]:POWer[:RF]:RANGe:PARatio <real></code> <code>[:SENSe]:POWer[:RF]:RANGe:PARatio?</code>
Example	<code>:POW:RANG:PAR 12 dB</code>
Notes	In some Modes, this parameter is read-only; meaning the value will appear on the control and query via SCPI, but is not changeable. In such applications the control is grayed-out. Attempting to change the value via SCPI will be ignored but no error message will be generated
Dependencies	Does not appear in Spectrum Analyzer Mode
Preset	10 dB VXT Models M9410A/11A: 0 dB
State Saved	Saved in instrument state
Min	0 dB
Max	20 dB VXT Models M9410A/11A: 50 dB

Mixer Lvl Offset

This is an advanced setting to adjust target Range at the input mixer, which in turn affects the signal level in the instrument's IF. This setting can be used when additional optimization is needed after setting "[Peak-to-Average Ratio](#)" on page 733. Positive values of offset optimize noise performance over distortion, negative values optimize distortion performance over noise.

Remote Command	<code>[:SENSe]:POWer[:RF]:RANGe:MIXer:OFFSet <real></code> <code>[:SENSe]:POWer[:RF]:RANGe:MIXer:OFFSet?</code>
Example	<code>:POW:RANG:MIX:OFFS -5 dB</code>
Preset	0 dB
State Saved	Saved in instrument state
Min	-35 dB VXT Models M9410A/11A: -34 dB
Max	30 dB

3.5.3.4 Signal Path

Contains controls that pertain to the routing of the signal through the frontend of the instrument.

In general, only appears in instruments whose hardware supports this signal routing. For example, this tab does not appear in many of the modular instrument products, including VXT Model M9421A, or UXM.

This tab *does* appear in VXT Models M9410A/11A, because "[Software Preselection](#)" on page 749 is under this tab, and VXT Models M9410A/11A implement a version of Software Preselection.

Presel Center

Adjusts the centering of the preselector filter to optimize the amplitude accuracy at the frequency of the selected marker. If the selected marker is not on when **Presel Center** is pressed, the instrument turns on the selected marker, performs a peak search, and then performs centering on the marker's center frequency. If the selected marker is already on and between the start and stop frequencies of the instrument, the instrument performs the preselector calibration on that marker's frequency. If the selected marker is already on, but outside the frequency range between **Start Freq** and **Stop Freq**, the instrument first performs a peak search, and then performs centering on the marker's center frequency.

The value displayed on "[Preselector Adjust](#)" on page 736 changes to reflect the new preselector tuning.

Certain considerations should be observed to ensure proper operation, as detailed in "[Proper Preselector Operation](#)" on page 526.

Remote Command	<code>[:SENSe] :POWer [:RF] :PCENter</code>
Example	<code>:POW:PCEN</code>
Notes	The rules outlined above under the control description apply for the remote command as well as the key. The result of the command depends on marker position, etc. Any message generated by the control press is also generated in response to the remote command
Dependencies	Does not appear in CXA-m, nor in VXT Models M9410A/11A Grayed-out if the microwave preselector is off <ul style="list-style-type: none"> - If the selected marker's frequency is below Band 1, an advisory message is generated "Preselector not used in this frequency range" and no action is taken - Grayed-out if entirely in Band 0, that is, if Stop Freq is below about 3.6 GHz Grayed-out if entirely above 50 GHz, that is, if Start Freq is above 50 GHz - Blanked in models that do not include a preselector, such as Option 503. If the remote command is sent in these instruments, accepted without error, and the query always returns 0 - Grayed-out in the Spectrogram View
Couplings	The active marker position determines where the centering will be attempted If the instrument is in a measurement such as averaging when centering is initiated, the act of centering the preselector restarts averaging, but the first average trace will not be taken until the centering is completed

Status Bits/OPC dependencies	<p>The offset applied to do the centering appears in "Preselector Adjust" on page 736</p> <hr/> <p>When centering the preselector, *OPC does not return true until the process is complete and a subsequent measurement has completed, nor are results returned in response to :READ or :MEASure queries</p> <p>The Measuring bit remains set (true) while this command is operating, and does not go false until the subsequent sweep/measurement has completed</p>
------------------------------	--

Proper Preselector Operation

Certain considerations should be observed to ensure proper operation:

1. If the selected marker is **Off**, the instrument turns on a marker, performs a peak search, and adjusts the preselector using the selected marker's frequency. It uses the "highest peak" peak search method unqualified by threshold or excursion, so that there is no chance of a 'no peak found' error. It continues with that peak, even if it is the peak of just noise. Therefore, for this operation to work properly, there should be a signal on-screen in a preselected range for the peak search to find
2. If the selected marker is already **On**, the instrument attempts the centering at that marker's frequency. There is no preselector for signals below about 3.6 GHz, so if the marker is on a signal below 3.6 GHz, no centering is attempted, and an advisory message is generated
3. In some models, the preselector can be bypassed. If it is bypassed, no centering is attempted in that range and a message is generated

Preselector Adjust

Lets you manually adjust the preselector filter frequency to optimize its response to the signal of interest. Only available when ["Presel Center" on page 734](#) is available.

For general purpose signal analysis, using **Presel Center** is recommended. Centering the filter minimizes the impact of long-term preselector drift. **Preselector Adjust** can be used instead to manually optimize the preselector. One application of manual optimization would be to peak the preselector response, which both optimizes the signal-to-noise ratio and minimizes amplitude variations due to small (short-term) preselector drifting.

When **Presel Center** is performed, the offset applied to do the centering becomes the new value of **Preselector Adjust**.

Remote Command	<pre>[:SENSe]:POWer[:RF]:PADJust <freq> [:SENSe]:POWer[:RF]:PADJust?</pre>
Example	<pre>:POW:PADJ 100KHz :POW:PADJ?</pre>

3 Bluetooth Mode
 3.5 EDR In-band Spur Emissions

Notes	The value on the control is displayed to 0.1 MHz resolution
Dependencies	<ul style="list-style-type: none"> - Does not appear in CXA-m - Does not appear in VXT Models M9410A/11A - Grayed-out if microwave preselector is off - Grayed-out if entirely in Band 0, that is, if Stop Freq is lower than about 3.6 GHz - Grayed-out if entirely above 50 GHz, that is, if Start Freq is higher than 50 GHz - Blank in models that do not include a preselector, such as Option 503. If the command is sent in these instruments, it is accepted without error, and the query always returns 0 - Grayed-out in the Spectrogram View
Preset	0 MHz
State Saved	The Preselector Adjust value set by " Presel Center " on page 734, or by manually adjusting Preselector Adjust Not saved in instrument state, and does not survive a Preset or power cycle
Min	-500 MHz
Max	500 MHz
Backwards Compatibility SCPI	<code>[:SENSe]:POWer[:RF]:MW:PADJust</code> <code>[:SENSe]:POWer[:RF]:MMW:PADJust</code>
Notes	The command has no effect, and the query always returns MWAVE
Backwards Compatibility SCPI	<code>[:SENSe]:POWer[:RF]:PADJust:PRESelector MWAVE MMWave EXTERNAL</code> <code>[:SENSe]:POWer[:RF]:PADJust:PRESelector?</code>

Internal Preamp

Accesses a menu of controls for the internal preamps. Turning on the preamp gives a better noise figure, but a poorer inter-modulation distortion (TOI) to noise floor dynamic range. You can optimize this setting for your measurement.

The instrument takes the preamp gain into account as it sweeps. If you sweep outside of the range of the preamp, the instrument will also account for that. The displayed result always reflects the correct gain.

For some measurements, when the preamp is on and any part of the displayed frequency range is below the lowest frequency for which the preamp has specifications, a warning condition message appears in the status line. For example, for a preamp with a 9 kHz lowest specified frequency: "Preamp: Accy unspec'd below 9 kHz".

Selection	Example	Note
Off	<code>:POW:GAIN OFF</code>	
Low Band	<code>:POW:GAIN ON</code> <code>:POW:GAIN:BAND LOW</code>	Sets the internal preamp to use only the low band. The frequency range of the installed (optional) low-band preamp is displayed in square brackets on the Low Band selection in the dropdown
Full Range	<code>:POW:GAIN ON</code> <code>:POW:GAIN:BAND FULL</code>	Sets the internal preamp to use its full range. The low band (0-3.6 GHz, 0-3.4 GHz, 0-3 GHz, depending on the model) is supplied by the low band preamp and the frequencies above low band are supplied by the high band preamp The frequency range of the installed (optional) low-band preamp is displayed in square brackets on the Full Range selection in the dropdown. If the high band option is not installed the Full Range selection does not appear

NOTE

The maximum **Center Frequency** for Low Band, displayed in square brackets, can change based on the selected IFBW for measurements that support IFBW (for example, Waveform measurement across all Modes that support it). In certain models (such as N9042B & N9032B), IFBW values ≤ 40 MHz have a maximum Low Band frequency of 3.6 GHz, while $40 \text{ MHz} < \text{IFBW} \leq 1 \text{ GHz}$ have a maximum of 3.3 GHz, and $1 \text{ GHz} < \text{IFBW} \leq 1.5 \text{ GHz}$ have a maximum of 3.5 GHz. IFBW values $> 1.5 \text{ GHz}$ do not support a **Center Frequency** that can reach the Low Band maximum frequency. In these cases, **N/A** is displayed in the square brackets for Low Band.

Remote Command `[:SENSe]:POWer[:RF]:GAIN:BAND LOW | FULL`
`[:SENSe]:POWer[:RF]:GAIN:BAND?`
`[:SENSe]:POWer[:RF]:GAIN[:STaTe] OFF | ON | 0 | 1`
`[:SENSe]:POWer[:RF]:GAIN[:STaTe]?`

Example `:POW:GAIN:BAND LOW`
`:POW:GAIN:BAND?`
`:POW:GAIN OFF`
`:POW:GAIN?`

Dependencies Not available on all hardware platforms. If the preamp is not present or is unlicensed, this control is not shown
Does not appear in VXT Models M9410A/11A/15A/16A
If `:POW:GAIN:BAND FULL` is sent when a low band preamp is available, the preamp band parameter is set to `LOW` instead of `FULL`, and an "Option not installed" message is generated
Not available when the electronic/soft attenuator is enabled

Preset `LOW`

	OFF
State Saved	Saved in instrument state
Annotation	<p>When the USB Preamp is not connected to USB, the Preamp annotation in the Meas Bar says “Off” if the preamp is off and displays the frequency range of the low band or full range preamp depending on the setting. For example, if the Preamp is set to Low Band and the Low Band is 3.6 GHz the annotation says “3.6 GHz”. If it is a 13.6 GHz preamp and it is set to Full Range the annotation says “13.6 GHz”</p> <p>When the USB Preamp is connected to USB, the Preamp annotation says “Preamp: USB” if the internal preamp is off or “Preamp: USB, Int” if the internal preamp is on (only for measurements that support the USB preamp)</p>

LNA

Lets you turn the Low Noise Amplifier (**LNA**) on or off.

LNA is an additional preamplifier that provides superior DANL and frequency range compared to "**Internal Preamp**" on page 737. LNA provides lower system noise figure, especially at frequencies above 100 MHz, and can be operated up to the full range of 50 GHz instruments.

For best possible sensitivity, **LNA** can be turned on *together* with "**Internal Preamp**" on page 737, although if you operate both preamps together, note that the TOI (distortion) specifications are impacted. The sensitivity improvement of this combination is substantial when operating in high band (frequencies above 3.6 GHz).

For more details about annotation, see "**More Information**" on page 529

Remote Command	<code>[:SENSe]:POWer[:RF]:GAIN:LNA[:STATe] OFF ON 0 1</code> <code>[:SENSe]:POWer[:RF]:GAIN:LNA[:STATe]?</code>
Example	<code>:POW:GAIN:LNA ON</code>
Dependencies	<p>Requires Option LNA, except for VXT models M9415A/16A</p> <p>Does not appear in VXT models M9421A/10A/11A</p> <p>May not appear in some measurements</p> <p>LNA is not available when the electronic/soft attenuator is enabled</p>
Preset	OFF
State Saved	Saved in State

More Information

When **LNA** is installed, the preamp annotation changes to show the state of both **LNA** and **Internal Preamp**. Below is an example:

```
Atten: 8 dB  
Pre: Int on, LNA on  
μW Path: LNP, On  
Source: Off
```

Note that when operating entirely in the low band (below about 3.6 GHz), if **LNA** is on, **Internal Preamp** is switched off (even if you have its switch set to **ON**). This is because the noise performance is actually degraded in low band if both preamps are on. In this case, the annotation reflects the actual state of the two preamps, but the **Internal Preamp** annotation displays in amber, to warn you that the actual state of **Internal Preamp** does not match its switch control display:

```
Atten: 8 dB  
Pre: Int off, LNA on  
μW Path: LNP, On  
Source: Off
```

μW Path Control

Options for this control include **μW Preselector Bypass** (Option MPB), **Low Noise Path** (Option LNP) and **Full Bypass Enable** in the High Band path circuits.

When the μW Preselector is bypassed, flatness is improved, but will be subject to spurs from out of band interfering signals. When **Low Noise Path Enable** is selected, the instrument automatically bypasses certain circuitry in the high frequency bands that can contribute to noise, when it is appropriate based on other instrument settings.

For most applications, the preset state is **Standard Path**, which provides the best remote-control throughput, minimizes acoustic noise from switching and minimizes the risk of wear in the hardware switches, particularly in remote test scenarios where both low band and high band setups will follow in rapid succession. In this path, the bypass of the low band/high band switch and microwave preamp is never activated, which can cause some noise degradation but preserves the life of the bypass switch.

For applications that utilize the wideband IF paths, the preset state is **μW Preselector Bypass**, if option MPB is present. This is because, when using a wideband IF such as the 140 MHz IF, the μW Preselector's bandwidth can be narrower than the available IF bandwidth, causing degraded amplitude flatness and phase linearity, so it is desirable to bypass the preselector in the default case.

You may choose **Low Noise Path Enable** for a lower noise floor, especially in the 21–26.5 GHz region, though without improving many measures of dynamic range, and without giving the best possible noise floor. The preamp, if purchased and used, gives better noise floor than does **Low Noise Path Enable**, but the preamp's compression threshold and third-order intercept are much poorer than that of **Low Noise Path Enable**.

A fourth choice is **Full Bypass Enable**, which combines **μW Preselector Bypass** and **Low Noise Path Enable**. Because this can bypass most of the circuitry between the

3 Bluetooth Mode
3.5 EDR In-band Spur Emissions

input and the first mixer, care should be taken when using this setting to avoid damaging the mixer. **Full Bypass Enable** is only available if both options LNP and MPB are present, as well as option FBP.

Path	Example	Note
Standard Path	:POW:MW:PATH STD	Normal setting for most measurements. μ W Preselector in circuit, Low Noise Path disabled
Low Noise Path Enable	:POW:MW:PATH LNP	See " Low Noise Path Enable " on page 534
μ W Preselector Bypass	:POW:MW:PATH MPB	See " μW Preselector Bypass " on page 536
Full Bypass Enable	:POW:MW:PATH FULL	See " Full Bypass Enable " on page 537

Remote Command	<code>[:SENSE] :POWer [:RF] :MW :PATH STD LNPath MPBypass FULL</code> <code>[:SENSE] :POWer [:RF] :MW :PATH ?</code>
Example	<code>:POW:MW:PATH LNP</code> Enables the Low Noise path <code>:POW:MW:PATH ?</code>
Notes	<p>If "Presel Center" on page 734 is performed, the instrument will momentarily switch to the Standard Path, regardless of the setting of μW Path Control</p> <p>The DC Block will always be switched in when the low noise path is switched in, to protect succeeding circuitry from DC. Note that this does not mean "when the low noise path is enabled" but when, based on the Low Noise Path rules, the path is actually switched in. This can happen when the selection is Low Noise Path Enable or Full Bypass Enable. In the case where the DC Block is switched in the instrument is now AC coupled. However, if you selected DC coupling, the UI would still behave as though it were DC coupled, including all annunciation, warnings, status bits, and responses to SCPI queries. This is because, based on other settings, the instrument could switch out the low noise path at any time and hence go back to being DC coupled</p> <p>Alignment switching ignores the settings in this menu, and restores them when finished</p>
Dependencies	<p>Does not appear in CXA-m, VXT Models M9410A/11A, nor in BBIQ and External Mixing</p> <ul style="list-style-type: none"> - The Low Noise Path Enable selection does not appear unless Option LNP is present and licensed - The μW Preselector Bypass selection does not appear unless Option MPB is present and licensed - The Full Bypass Enable selection does not appear unless options LNP and MPB are both present as well as option FBP <p>In any of these cases, if the required options are not present and the SCPI command is sent, error -241, "Hardware missing; Option not installed" is generated</p> <p>Low Noise Path Enable and Full Bypass Enable are grayed-out if the current measurement does not support them</p> <p>Low Noise Path Enable and Full Bypass Enable are not supported in Avionics and MMR Modes (non-modulation measurements). In any of these cases (that is, the feature is not supported in either measurement or Mode), if the SCPI command is sent, the following error is generated: -221, "Setting Conflict; Feature not supported for this measurement"</p>

Preset	Mode	Value
	IQ Analyzer	MPB option present and licensed: MPB
	Pulse	MPB option not present and licensed: STD
	Avionics	
	All other Modes	STD
State Saved	Save in instrument state	
Range	Standard Path Low Noise Path Enable μ W Presel Bypass Full Bypass Enable	
Annotation	<p>In the Meas Bar, if the Standard path is chosen: μW Path: Standard</p> <p>If Low Noise Path is enabled but the LNP switch is not thrown: μW Path: LNP,Off</p> <p>If the Low Noise Path is enabled and the LNP switch is thrown: μW Path: LNP,On</p> <p>If the preselector is bypassed: μW Path: Bypass</p> <p>If Full Bypass Enable is selected but the LNP switch is not thrown: μW Path: FByp,Off</p> <p>If Full Bypass Enable is selected and the LNP switch is thrown: μW Path: FByp,On</p>	

μ W Path Control Auto

In VMA, WLAN, 5G NR, CQM Modes, an **Auto/Man** switch is added to μ W Path Control:



This allows the function to automatically switch based on certain Auto Rules as shown below:

VMA Mode

Measurement	When μ W Path Control is in Auto
Digital Demod	Use Standard Path unless tuned frequency > 3.6 GHz and IFBW > 15 MHz, in which case choose Preselector Bypass
Monitor Spectrum	Always Presel Bypass

3 Bluetooth Mode
3.5 EDR In-band Spur Emissions

Measurement	When μ W Path Control is in Auto
IQ Waveform	Use Standard Path unless tuned frequency > 3.6 GHz and IFBW > 15 MHz, in which case choose Preselector Bypass
Custom OFDM	Use Standard Path unless tuned frequency > 3.6 GHz and IFBW > 15 MHz, in which case choose Preselector Bypass
Channel Power	Always Presel Bypass
Occupied BW	Always Presel Bypass
CCDF	Use Standard Path unless tuned frequency > 3.6 GHz and IFBW > 15 MHz, in which case choose Preselector Bypass
ACP	Always Presel Bypass
SEM	Always Presel Bypass
Spurious Emissions	Always Standard Path

WLAN Mode

Measurement	When μ W Path Control is in Auto
Modulation Analysis	Always Presel Bypass
Spectral Flatness	Always Presel Bypass
Power vs Time	Always Presel Bypass
Monitor Spectrum	Always Presel Bypass
IQ Waveform	Always Presel Bypass
Channel Power	Always Presel Bypass
Occupied BW	Always Presel Bypass
CCDF	Always Presel Bypass
SEM	For 11be 320M, when 'Enabled Wideband IF for FFT' is OFF or 'Sweep Type Rule' is Best Dynamic Range, auto μ W path is standard For other cases, auto μ W path is presel bypass if presel bypass is enabled, auto μ W path is standard if presel bypass is not enabled
Spurious Emissions	Always Standard Path

5G NR Mode

Measurement	When μ W Path Control is in Auto
Modulation Analysis	Use Standard Path unless tuned frequency > 3.6 GHz and IFBW > 15 MHz, in which case choose Full Bypass if conditions warrant(FBP Option is available and "Allow Full Bypass in Auto" is On), otherwise choose Preselector Bypass
Monitor Spectrum	Always Standard Path
IQ Waveform	Use Standard Path unless tuned frequency > 3.6 GHz and IFBW > 15 MHz, in which case choose Full Bypass if conditions warrant(FBP Option is available and

Measurement	When μ W Path Control is in Auto
	“Allow Full Bypass in Auto” is On), otherwise choose Preselector Bypass
Channel Power	Always Standard Path
Occupied BW	Always Standard Path
CCDF	Use Standard Path unless tuned frequency > 3.6 GHz and IFBW > 15 MHz, in which case choose Preselector Bypass
ACP	Always Standard Path
SEM	Always Standard Path
Spurious Emissions	Always Standard Path
Transmit On Off Power	Use Standard Path unless tuned frequency > 3.6 GHz and Info BW > 15 MHz, in which case choose Preselector Bypass

Channel Quality Mode

Measurement	When μ W Path Control is in Auto
Group Delay	Use Standard Path unless tuned frequency > 3.6 GHz and IFBW > 15 MHz, in which case choose Full Bypass if conditions warrant(FBP Option is available and “Allow Full Bypass in Auto” is On), otherwise choose Preselector Bypass
Monitor Spectrum	Always Standard Path
IQ Waveform	Use Standard Path unless tuned frequency > 3.6 GHz and IFBW > 15 MHz, in which case choose Preselector Bypass
CCDF	Use Standard Path unless tuned frequency > 3.6 GHz and IFBW > 15 MHz, in which case choose Preselector Bypass

Remote Command	<code>[:SENSe]:POWer[:RF]:MW:PATH:AUTO ON OFF 1 0</code> <code>[:SENSe]:POWer[:RF]:MW:PATH:AUTO?</code>
Example	<code>:POW:MW:PATH:AUTO ON</code> <code>:POW:MW:PATH:AUTO?</code>
Dependencies	Only appears in VMA, WLAN, 5G NR and CQM Modes
Couplings	See the tables above
Preset	<code>ON</code>
Range	<code>ON OFF</code>

Low Noise Path Enable

Low Noise Path Enable provides a lower noise floor under some circumstances, particularly when operating in the 21–26.5 GHz region. With the Low Noise Path enabled, the low band/high band switch and microwave preamp are bypassed whenever *all* the following are true:

3 Bluetooth Mode

3.5 EDR In-band Spur Emissions

- The instrument is not in the Low Band, meaning:
- the start frequency is above 3.5 GHz and
- the stop frequency is above 3.6 GHz
- The internal preamp is not installed, or if installed, is set to **Off** or **Low Band**

Note that this means that, when any part of a sweep is done in Low Band, the Low Noise Path is not used, whether or not the **Low Noise Path Enable** is selected in the user interface. Also, if the preamp is turned on, the Low Noise Path is not used, whether or not the **Low Noise Path Enable** is selected in the user interface. The only time the Low Noise Path is used is when **Low Noise Path Enable** is selected, the sweep is completely in High Band (> 3.6 GHz) and no preamp is in use.

For measurements that use IQ acquisition, the low noise path is used when **Center Frequency** is in High Band (> 3.6 GHz) and no preamp is in use. In other words, the rules above are modified to use only the center frequency to qualify which path to switch in. This is not the case for FFTs in the Swept SA measurement; they use the same rules as swept measurements.

Note that the Low Noise Path, while giving improved DANL, has the disadvantage of decreased TOI performance and decreased gain compression performance relative to the standard path.

Note also that the bypass switch is a mechanical switch and has finite life, so if the **Low Noise Path Enable** is selected, it is possible to cause frequent cycling of this switch by frequently changing instrument settings such that the above conditions hold true only some of the time. A user making tests of this nature should consider opting for the **Standard Path**, which will never throw the bypass switch, at the expense of some degraded noise performance.

The low noise path is useful for situations where the signal level is so low that the instrument performance is dominated by noise even with 0 dB attenuation, but still high enough that the preamp option would have excessive third-order intermodulation or compression. The preamp, if purchased and used, gives better noise floor than does the “Low Noise Path.” However, its compression threshold and third-order intercept are much poorer than that of the non-preamp path.

There are some applications, typically for signals around –30 dBm, for which the third-order dynamic range of the standard path is good enough, but the noise floor is not low enough even with 0 dB input attenuation. When the third-order dynamic range of the preamp path is too little and the noise floor of the standard path is too high, the Low Noise Path can provide the best dynamic range

The graph below illustrates the concept. It shows, in red, the performance of an instrument at different attenuation settings, both with the preamp on and off, in a measurement that is affected by both instrument noise and instrument TOI. The green shows the best available dynamic range, offset by 0.5 dB for clarity. The blue

shows how the best available dynamic range improves for moderate signal levels with the low noise path switched in. In this illustration, the preamp improves the noise floor by 15 dB while degrading the third-order intercept by 30 dB, and the low noise path reduces loss by 8 dB. The attenuator step size is 2 dB.

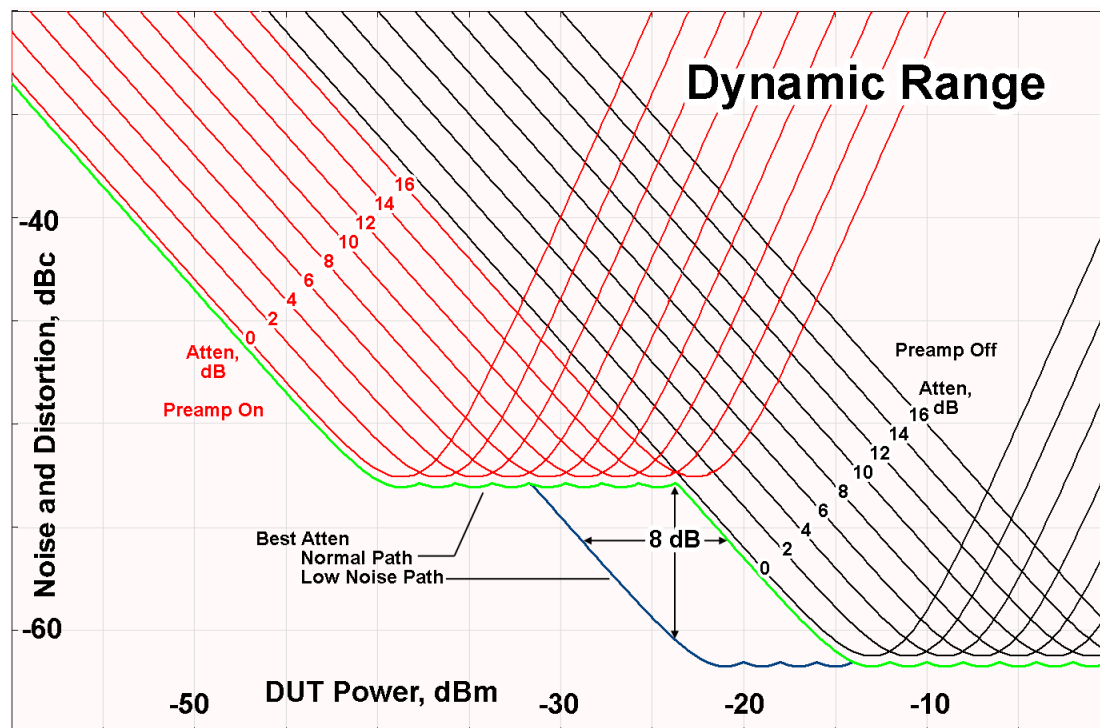

There are other times where selecting the low noise path improves performance, too. Compression-limited measurements such as finding the nulls in a pulsed-RF spectrum can profit from the low noise path in a way similar to the TOI-limited measurement illustrated. Accuracy can be improved when the low noise path allows the optimum attenuation to increase from a small amount like 0, 2 or 4 dB to a larger amount, giving better return loss at the instrument input. Harmonic measurements, such as second and third harmonic levels, are much improved using the low noise path because of the superiority of that path for harmonic (though not intermodulation) distortion performance.

µW Preselector Bypass

Toggles the preselector bypass switch for band 1 and higher. When the microwave preselector is on, the signal path is preselected. When the microwave preselector is off, the signal path is not preselected. The preselected path is the normal path for the instrument.

The preselector is a tunable bandpass filter which prevents signals away from the frequency of interest from combining in the mixer to generate in-band spurious

signals (images). The consequences of using a preselector filter are its limited bandwidth, the amplitude and phase ripple in its passband, and any amplitude and phase instability due to center frequency drift.

Option MPB or pre-selector bypass provides an unpreselected input mixer path for certain X-Series signal analyzers with frequency ranges above 3.6 GHz. This signal path allows a wider bandwidth and less amplitude variability, which is an advantage when doing modulation analysis and broadband signal analysis. The disadvantage is that, without the preselector, image signals will be displayed. Another disadvantage of bypassing the preselector is increased LO emission levels at the front panel input port.

Image responses are separated from the real signal by twice the 1st IF. For IF Paths of 10 MHz and 25 MHz, the 1st IF is 322.5 MHz, so the image response and the real signal will be separated by 645 MHz. The 1st IF will be different for other IF Path settings. When viewing a real signal and its corresponding image response in internal mixing, the image response will be to the left of the real signal.

Also, the image response and the real signal typically have the same amplitude and exhibit the same shape factor.

However, if Option FS1 (Fast Sweep Capability) is enabled, the image response in the Swept SA measurement appears lower in amplitude and has a much wider shape factor compared to the real signal.

Full Bypass Enable

With **Full Bypass Enable** selected, the microwave preselector is bypassed. In addition, the low band/high band switch and microwave preamp are bypassed whenever *all* the following are true:

- The instrument is not in the Low Band, meaning:
- the start frequency is above 3.5 GHz and
- the stop frequency is above 3.6 GHz.
- the internal preamp is not installed or if installed, is set to **Off** or **Low Band**

Note that this means that, when any part of a sweep is done in Low Band, the Low Noise Path is not used, whether or not the **Full Bypass Enable** is selected in the user interface. Also, if the preamp is turned on, the Low Noise Path is not used, whether or not the **Full Bypass Enable** is selected in the user interface. The only time the Low Noise Path is used is when **Full Bypass Enable** is selected, the sweep is completely in High Band (> 3.6 GHz) and no preamp is in use.

CAUTION

When **Full Bypass Enable** is selected, and "**Y Scale**" on page 597 is set to 0 dB, there will be a direct AC connection between the input and the first converter when the Low Noise Path switches in (when Start Freq >3.6 GHz and the Preamp is either not licensed, set to Low Band, or Off). This puts the first converter at considerable risk to be damaged by high AC power. Consequently, whenever **Full Bypass Enable** is selected, a warning message appears in the status bar:

"Full Bypass Enabled, maximum safe input power reduced"

Microwave Preselector Bypass Backwards Compatibility

Example	<code>:POW:MW:PRES OFF</code> Bypasses the microwave preselector
Notes	Included for Microwave Preselector Bypass backwards compatibility The ON parameter sets the STD path (<code>:POW:MW:PATH STD</code>) The OFF parameter sets path MPB (<code>:POW:MW:PATH MPB</code>)
Preset	ON
Backwards Compatibility SCPI	<code>[:SENSe]:POWer[:RF]:MW:PRESelector[:STATe] ON OFF 0 1</code> <code>[:SENSe]:POWer[:RF]:MW:PRESelector[:STATe]?</code>

Frequency Extender Preselection Bypass

Only applies to the high frequency path of the Frequency Extender, and only if the Frequency Extender allows it. For example, the V3050A high frequency path is 50 – 110 GHz and *does* allow control of the preselector bypass.

When the Frequency Extender's preselection is bypassed, flatness is improved, but will be subject to spurs from out-of-band interfering signals. For bandwidths greater than 2.5 [GHz], it is recommended that the signal bypass the Frequency Extender Preselector since the max bandwidth of the Preselector can be as narrow as 2.5 [GHz].

For most applications, the preset state is **OFF**, which gives the best remote-control throughput, minimizes acoustic noise from switching, minimizes out of band spurs, and minimizes the risk of wear in the hardware switches.

Preselector and Bandwidth Conflict

When the Frequency Extender Preselector is applied and the signal bandwidth is greater than 2.5 [GHz], then a settings alert message will show to warn the user that the signal may be distorted due to the limitation of the Frequency Extender Preselector bandwidth.

An example of the settings alert message is shown below.

Settings Alert message in the Status Bar at the bottom of the display.



Settings Alert message in the error queue

Type	ID	
	159	Settings Alert - DETECTED; Presel/Meas BW conflict

Software Preselection

Provided in some instruments, either to compensate for issues with provided hardware preselection or to provide the preselection function when there is no hardware preselector.

N9041B

Software Preselection compensates for the frequency range limit of the microwave preselector. Since the microwave preselector only goes up to 50 GHz, software preselection must be used to suppress and separate images above 50 GHz. The specific algorithm used for software preselection is specified by the SW Preselection Type selection – Normal or Advanced.

In N9041B, **Software Preselection** only applies for frequencies above 50 GHz, therefore it is only used for RF Input 2. Even if turned on, it is not used for other inputs, and never for frequencies below 50 GHz. This is why the label of this control contains the parenthetical note “(>~50 GHz)”.

Note that in N9041B, in Swept SA measurement, **Software Preselection** works even if the measurement is using an FFT Sweep Type. In measurements other than Swept SA, Software Preselection is not used if the measurement is using an FFT sweep type.

N9042B+V3050A

Software Preselection compensates for the frequency range limit of the microwave preselector. Since the microwave preselector only goes up to 50 GHz, software preselection must be used to suppress and separate images above 50 GHz. The specific algorithm used for software preselection is specified by the SW Preselection

Type selection – Normal or Advanced.

For N9042B+V3050A, Software Preselection only applies for frequencies above 50 GHz, therefore it is only used for External RF. Even if it is turned on, it will not be used for other inputs and never for frequencies below 50 GHz. This is why the label of this control contains the parenthetical note “(>~50 GHz)”.

Note that for N9042B+V3050A, in the Swept SA measurement, Software Preselection works even if the measurement is using an FFT Sweep Type. In measurements other than Swept SA, Software Preselection is not used if the measurement is using an FFT Sweep Type.

VXT models M9410A/11A

Software Preselection is used to provide the preselection function, as there is no hardware preselector in these models. Two background traces are taken and compared point by point, and the point with the lowest amplitude from the two traces is used. This provides a method to reduce spurs that are internally generated within the VXT, but you should note the following when using Software Preselection:

- There is some speed cost due to the need to take multiple captures
- Taking the point with the lowest amplitude in each trace will make the average noise level lower at all points that do not have a spur. This can reduce the accuracy of the measurement of noise and noise-like signals

Because of the difficulty in identifying spurs manually, you are recommended to leave Software Preselection **ON** at all times in VXT models M9410A/11A. If you turn it off in order to speed up your measurement or improve noise accuracy, be aware of unwanted onscreen spurs.

Remote Command	<code>[:SENSe]:POWer[:RF]:SWPreSel:STATe 0 1 ON OFF</code>	
	<code>[:SENSe]:POWer[:RF]:SWPreSel:STAT?</code>	
Example	<code>:POW:SWPR:STAT 1</code>	
	<code>:POW:SWPR:STAT?</code>	
Dependencies	Only appears in N9041B, N9042B+V2050A, and VXT models M9410A/11A. Does not appear in all measurements	
Couplings	Affects Sweep Time Auto Tune supports Software Preselection , so Auto Tune should be performed after setting the Software Preselection state	
Preset	N9041B	OFF
	N9042B+V3050A	ON
	M9410A/11A	ON
State Saved	Saved in instrument state	

SW Preselection Type

Specifies the algorithm used for software preselection.

Two hidden sweeps occur in succession. The second sweep is offset in LO frequency by $2 * IF / N$. For each point in each trace, the smaller amplitude from the two traces is taken and placed in that point in the selected trace. The Peak detector is auto-selected to improve the image suppression effectiveness. Responses of each trace that lie on top of one another will remain and are valid signals. Other signals are images, which are suppressed. The action of taking the smaller of the two traces will make the average noise level lower in all points that do not have an image, thus reducing the accuracy of the measurement of noise and noise-like signals.

- **NORMa1** - mathematically removes all image and multiple responses of signals present at the input
- **ADVanced** - any trace processing (such as “max hold” or trace averaging) is performed on the points of both candidate traces before the “select minimum” operation occurs. This form of processing works better for non-stationary signals, such as pulsed-RF signals

Remote Command	<code>[:SENSe]:POWer[:RF]:SWPResel NORMa1 ADVanced</code> <code>[:SENSe]:POWer[:RF]:SWPResel?</code>
Example	<code>:POW:SWPR NORM</code> <code>:POW:SWPR?</code>
Dependencies	Only appears in N9041B and N9042B+V3050A. Only appears in measurements that use the Swept method Grayed-out when " Software Preselection " on page 749 is OFF . The grayout message is “Unavailable unless SW Presel enabled”
Preset	N9041B ADVanced N9042B+V3050A NORMa1
State Saved	Saved in instrument state

SW Preselection BW

Specifies the effective bandwidth to be used for Software Preselection.

The options are:

- **NORMa1** – when making Swept measurements, a software preselection algorithm is used which takes up to 4 background acquisitions, then post-processes the result. This algorithm can remove images from signals with an occupied

bandwidth up to around 3 GHz. (Default/Preset setting). When making FFT measurements, this algorithm is not used, instead the same algorithm is used as for **NARRow** (below)

- **NARRow**– a software preselection algorithm is used which takes two background acquisitions, then post-processes the result to detect and remove images from wideband signals with occupied bandwidths up to 2 GHz. This increases the risk of images failing to be rejected, but improves the measurement speed

Remote Command	<code>[:SENSe]:POWer[:RF]:SWPResel:BW NORMa1 NARRow</code> <code>[:SENSe]:POWer[:RF]:SWPResel:BW?</code>
Example	<code>:POW:SWPR:BW NARR</code>
Dependencies	Only appears in N9041B and N9042B+V3050A. Only appears in measurements that use the Swept method Grayed-out when " Software Preselection " on page 749 is OFF . The grayout message is "Unavailable unless SW Presel enabled" For N9042B+V3050A, the parameter is SCPI-only, and always set to NARRow when Software Preselection is enabled
Preset	N9041B NORMa1 N9042B+V3050A NARRow
State Saved	Saved in instrument state

High Freq Prefilter

Lets you set the state of Prefilter for center frequencies above 1310 MHz.

In VXT Models M9410A/11A, the Receiver RF path has a bank of filters that come after the RF Attenuator in the signal path. Since this bank of filters precedes the mixer they are known as the "Prefilter" bank. Their purpose is to eliminate unwanted in-band mixing products by filtering out all but the desired frequencies before the signals get to the mixer. There are 13 prefilter bands to cover the frequencies between 9 kHz and 6000 MHz. The Prefilter provides the necessary rejection of the unwanted signal.

Remote Command	<code>[:SENSe]:<measurement>:PFILter[:STATe] ON OFF 1 0</code> <code>[:SENSe]:<measurement>:PFILter[:STATe]?</code>
Example	Enable High Freq Prefilter for the Complex Spectrum Measurement in BASIC Mode: <code>:SPEC:PFIL ON</code> Enable High Freq Prefilter for the IQ Waveform Measurement, in multiple Modes: <code>:WAV:PFIL ON</code> Enable High Freq Prefilter for the Swept SA Measurement in SA Mode:

3 Bluetooth Mode
3.5 EDR In-band Spur Emissions

	:SAN:PFIL ON
Dependencies	Only appears in VXT models M9410A/11A with center frequency above 1310 MHz
Preset	See "Prefilter Presets" on page 543 below
State Saved	Saved in instrument state

Prefilter Presets

Meas	Mode	Preset
SPEC	BASIC	OFF
WAV	BASIC, WCDMA, WLAN, LTEAFDD, LTEATDD, 5GNR, VMA	OFF
MON	WCDMA, WLAN, LTEAFDD, LTEATDD, 5GNR, VMA	OFF
RHO	WCDMA	OFF
CDP	WCDMA	OFF
PCON	WCDMA	OFF
EVMQ	WCDMA	OFF
CHP	WCDMA, WLAN, LTEAFDD, LTEATDD, 5GNR, VMA, SA	OFF
OBW	WCDMA, WLAN, LTEAFDD, LTEATDD, 5GNR, VMA, SA	OFF
ACP	WCDMA, LTEAFDD, LTEATDD, 5GNR, VMA, SA	OFF
SEM	WCDMA, WLAN, LTEAFDD, LTEATDD, 5GNR, VMA, SA	OFF
PST	WCDMA, WLAN, LTEAFDD, LTEATDD, 5GNR, VMA, SA	OFF
PVT	WLAN, LTEAFDD, LTEATDD, 5GNR	OFF
EVM	WLAN, LTEAFDD, LTEATDD, 5GNR	OFF
FLAT	WLAN	OFF
EVMM	WLAN	OFF
CEVM	LTEAFDD, LTEATDD	OFF
PAVT	5GNR, VMA	OFF
DDEM	VMA	OFF
OFDM	VMA	OFF
SAN	SA	ON
HARM	SA	ON

3.5.4 BW

The BW key opens the bandwidth menu, which contains the Res BW and Video BW controls.

3.5.4.1 Settings

The Settings tab contains the basic Bandwidth functions.

Res BW

Enables you to set the Resolution Bandwidth of the analyzer.

Remote Command	<code>[:SENSe]:IBSPurious:BANDwidth BWIDth[:RESolution] <freq></code> <code>[:SENSe]:IBSPurious:BANDwidth BWIDth[:RESolution]?</code>
Example	<code>:IBSP:BAND 100 kHz</code> <code>:IBSP:BAND?</code>
Dependencies	If meas method is FFT, This control will be grayed out
Preset	100.00 kHz
State Saved	Yes
Min/Max	1Hz/8MHz

Video BW

Enables you to set the Video Bandwidth of the analyzer.

Remote Command	<code>[:SENSe]:IBSPurious:BANDwidth BWIDth:VIDeo <freq></code> <code>[:SENSe]:IBSPurious:BANDwidth BWIDth:VIDeo?</code>
Example	<code>:IBSP:BAND:VID 200 kHz</code> <code>:IBSP:BAND:VID?</code>
Notes	Setting VBW = 100 kHz and Detector = Sample gets the same results as that of setting VBW = 300 kHz and Detector = Average
Dependencies	If meas method is FFT, This key will be grayed out
Preset	100.00 kHz
State Saved	Yes
Min/Max	1 Hz/50 MHz

3.5.5 Display

The Display key opens the Display Menu, which lets you configure display items for the current Mode, Measurement View or Window.

3.5.5.1 View

Contains controls for selecting the current **View**, and for editing User Views.

Views

This measurement has two views, the RF Spectrum View and the RF Envelope View.

These Views are multiple-window Views. When in a multiple window View, you select a window by touching it. The menu controls may sometimes change depending on which window is selected.

Whenever the View changes, the default menu is Frequency, unless otherwise specified in the View description.

View Selection Remote Commands

Allows you to select the desired measurement view.

The Enumerated ID is used with the SCPI Command `:DISP:IBSP:VIEW[:SEL]`

The Numeric ID is used with the SCPI Command `:DISP:IBSP:VIEW:NSEL`

Enumerated ID	Numeric ID	View Name & Details
<code>RFENvelope</code>	1	Provides a combination view of RF Envelope graph and the summary data as shown below
<code>RFSPpectrum</code>	2	Provides a combination view of RF Spectrum graph and the summary data as shown below

View Selection by Name

Allows you to specify the view via its enumerated ID string.

Remote Command	<code>:DISPlay: IBSPurious:VIEW[:SElect] RFENvelope RFSPpectrum</code> <code>:DISPlay:IBSPurious:VIEW[:SElect]?</code>
Example	<code>:DISP:IBSP:VIEW:SEL RFSP</code> <code>:DISP:IBSP:VIEW:SEL?</code>
Preset	<code>RFSPpectrum</code>
State Saved	Yes
Range	RF Envelope RF Spectrum

View Selection by Number (Remote Command only)

Allows you to specify the view via its numeric ID value.

Remote Command	<code>:DISPlay:IBSPurious:VIEW:NSElect <integer></code> <code>:DISPlay:IBSPurious:VIEW:NSElect?</code>
Example	<code>:DISP:IBSP:VIEW:NSEL 1</code>

	<code>:DISP:IBSP:VIEW:NSEL?</code>
Preset	1
State Saved	Yes
Min/Max	1/2

User View

Lets you choose a View from the saved User Views for the current measurement. This panel only appears if a User View exists for the current measurement.

Remote Command	<code>:DISP:VIEW:ADV:SElect <alphanumeric></code> <code>:DISP:VIEW:ADV:SElect?</code>
Example	Select Baseband as the current View <code>:DISP:VIEW:ADV:SEL "Baseband"</code>
Notes	<p>You must be in the measurement whose View you are trying to set to send the command. You can only set Views for the current measurement using this command</p> <p>For predefined views, the parameter is derived from the view name that is shown in the View list in the user interface. For example, if you are trying to select the Trace Zoom view in the Swept SA measurement, you send:</p> <pre><code>:DISP:VIEW:ADV:SEL "Trace Zoom"</code></pre> <p>because "Trace Zoom" is the name of the View as seen in the Mode/Meas dialog or in the Display, View menu</p> <p>You <i>cannot</i> use the legacy View parameter (which in this case would be <code>TZOOM</code>) with</p> <pre><code>:DISP:VIEW:ADV:SEL</code></pre> <p><code><alphanumeric></code> is case insensitive; you can specify mixed case, however the name will be evaluated on a single case. Thus, both of the following forms work:</p> <pre><code>:DISP:VIEW:ADV:SEL "Trace Zoom"</code> <code>:DISP:VIEW:ADV:SEL "TRACE ZOOM"</code></pre> <p>If the specified view is not a valid View, the query returns the error message "-224, Illegal parameter value; View with the name <alphanumeric> does not exist"</p> <p>If the display is disabled (via <code>:DISP:ENAB OFF</code>) then the error message "-221, Settings conflict; View SCPI cannot be used while Display is disabled" is generated</p>
Backwards Compatibility SCPI	The legacy node <code>:DISP:VIEW[:SElect]</code> is retained for backwards compatibility, but it only supports predefined views

Restore Layout to Default

Restores the Layout to the default for Basic.

Modified Views are very temporary; if you exit the current measurement they are discarded, and they are not saved in State. To retain this View for later use, and to be able to return easily to your original Basic View, you can save your edited View as a “User View”.

Save Layout as New View

Saves your new View as a User View. An alpha keyboard appears, which lets you name your new View; the default is the old View name plus a number.

Remote Command	<code>:DISPlay:VIEW:ADVanced:NAME <alphanumeric></code>
Example	<code>:DISP:VIEW:ADV:NAME "Baseband"</code> Creates a new View named Baseband from the current View, and selects it as the current View
Notes	<code><alphanumeric></code> is case insensitive; you can specify mixed case, however the name will be evaluated on a single case If <code><alphanumeric></code> name already exists as a View, the error message “-224, Illegal parameter value; View <alphanumeric> already exists” is generated If the display is disabled (via <code>:DISP:ENAB OFF</code>) then the error message “-221, Settings conflict; User View SCPI cannot be used while Display is disabled” is generated

Re-Save User View

You can re-edit a User View; if you make changes, then an asterisk will appear next to the User View’s name. You can then tap **Re-Save User View** to save it back to its existing name, or **Save Layout as New View** to add another, new User View.

This is a front panel function only, there is no remote command available to perform this function. To do this remotely, you must first perform **Save Layout as New View**, then delete the old User View and rename the new one with the name of the View you just deleted.

Rename User View

You can rename the current View by giving it a new unique name. Only User Views can be renamed, if the current View is a Predefined View, an error occurs.

Remote Command	<code>:DISPlay:VIEW:ADVanced:REName <alphanumeric></code>
Example	<code>:DISP:VIEW:ADV:REN "Baseband"</code>
Notes	<code><alphanumeric></code> is case insensitive; you can specify mixed case, however the name will be evaluated on a single case If the <code><alphanumeric></code> specifying the new name is already present in the list of View names, the error message “-224, Illegal parameter value; View <alphanumeric> already exists” is generated

If the current View is a Predefined View, the error message “-224, Illegal parameter value; Cannot rename a Predefined View” is generated

If the display is disabled (via `:DISP:ENAB OFF`) then the error message “-221, Settings conflict; View SCPI cannot be used while Display is disabled” is generated

Delete User View

You can delete the current View if it is a User View. The default view becomes the current view for the Measurement.

Remote Command	<code>:DISPlay:VIEW:ADVanced:DElete</code>
----------------	--

Example	<code>:DISP:VIEW:ADV:DEL</code>
---------	---------------------------------

Notes	<p><code><alphanumeric></code> is case insensitive; you can specify mixed case, however the name will be evaluated on a single case</p> <p>If the <code><alphanumeric></code> is not present in the list of View names, the error message “-224, Illegal parameter value; View <code><alphanumeric></code> does not exist” is generated</p> <p>If the current View is a Predefined View, the error message “-224, Illegal parameter value; Cannot delete a Predefined View” is generated</p> <p>If the display is disabled (via <code>:DISP:ENAB OFF</code>) then the error message “-221, Settings conflict; View SCPI cannot be used while Display is disabled” is generated</p>
-------	--

Delete All User Views

Deletes all previously saved User Views. The default view becomes the current view for the Measurement if a User View was the current view when this command was executed.

Remote Command	<code>:DISPlay:VIEW:ADVanced:DElete:ALL</code>
----------------	--

Example	<code>:DISP:VIEW:ADV:DEL:ALL</code>
---------	-------------------------------------

Notes	Disabled if there are no User Views
-------	-------------------------------------

View Editor Remote Commands

The following remote commands help you manage Views and User Views. Note that the SCPI node for User Views handles both Predefined and User Views. The legacy nodes, `:DISPlay:VIEW[:SElect]` and `:DISPlay:VIEW:NSEL`, are retained for backwards compatibility, but they only support predefined views.

View Listing Query

Returns a string containing a comma-separated list of names for *all* the Views, including User Views, available for the current Measurement.

Remote Command	<code>:DISPlay:VIEW:ADVanced:CATalog?</code>
Example	<code>:DISP:VIEW:ADV:CAT?</code>
Notes	Returns a quoted string of the available Views for the current measurement, separated by commas. The list includes names for <i>all</i> the Views, including User Views, available for the current Measurement Example: <code>"Normal,Trace Zoom,Spectrogram,Baseband,myView1,yourView1"</code> No distinction is made between Predefined and User Views If you switch measurements with the display disabled (via <code>:DISP:ENAB OFF</code>), then query the list of available Views, the result is undefined

User View Listing Query

Returns a string containing a comma-separated list of names for *only* the User Views available for the current Measurement.

Remote Command	<code>:DISPlay:VIEW:ADVanced:USER:CATalog?</code>
Example	<code>:DISP:VIEW:ADV:USER:CAT?</code>
Notes	Returns a quoted string of the available User Views for the current measurement, separated by commas. Example: <code>"Baseband,myView1,yourView1"</code> If you switch measurements with the display disabled (see "Display Enable (Remote Command Only)" on page 760), then query the list of available Views, the result is undefined

3.5.5.2 Annotation

Contains controls for setting up the annotation for the current Mode or Measurement.

Graticule

Turns the display graticule On or Off for all windows with graticules in all measurements in the current Mode. Also turns the graticule Y-Axis annotation on and off.

Remote Command	<code>:DISPlay:GRATicule[:STATe] OFF ON 0 1</code> <code>:DISPlay:GRATicule[:STATe]?</code>
Example	<code>:DISP:GRAT OFF</code>
Notes	The graticule is the set of horizontal and vertical lines that make up the grid/divisions for the X-Axis and Y-Axis
Preset	ON
State Saved	Saved in instrument state
Backwards Compatibility SCPI	<code>:DISPlay:WINDow[1]:TRACe:GRATicule:GRID[:STATe] OFF ON 0 1</code> <code>:DISPlay:WINDow[1]:TRACe:GRATicule:GRID[:STATe]?</code> This command is accepted for backwards compatibility with older instruments, but the WINDow , TRACe and GRID parameters are ignored

Screen Annotation

Controls the display of the annunciation and annotation around the graticule, including any annotation on lines (such as the display line, the threshold line, etc.) and the Y-Axis annotation, for all windows with screen annotation in all measurements in the current Mode.

This does *not* include marker annotation (or the N dB result). When **OFF**, the graticule expands to fill the entire graticule area, leaving only the 1.5% gap above the graticule, as described in the **Trace** section.

Remote Command	<code>:DISPlay:ANNotation:SCReen[:STATe] OFF ON 0 1</code> <code>:DISPlay:ANNotation:SCReen[:STATe]?</code>
Example	<code>:DISP:ANN:SCR OFF</code>
Dependencies	Grayed-out and forced to OFF when System Display Settings, Annotation is OFF
Preset	ON This remains OFF through a Preset when System Display Settings, Annotation is set to OFF
State Saved	Saved in instrument state

Trace Annotation

Turns on and off the labels on the traces, showing their detector (or their Math Mode) as described in the **Trace** section, for all windows in all measurements in the current Mode for which Trace Annotation on/off is supported.

If Trace Math is being performed on a trace, then the Trace Math annotation replaces the detector annotation.

For measurements that support limit lines, this key also turns on and off the labels on the Limit Lines. The label is the Limit number annotation and Limit Comment

3 Bluetooth Mode

3.5 EDR In-band Spur Emissions

displayed on the graph. If the length of the comment is greater than 20 characters, the first 8 characters and the last 8 characters are displayed, joined with ...

Remote Command	<code>:DISPlay:ANNotation:TRACe[:STATe] ON OFF 1 0</code> <code>:DISPlay:ANNotation:TRACe[:STATe]?</code>
Example	<code>:DISP:ANN:TRAC OFF</code>
Preset	<code>OFF</code>
State Saved	Saved in instrument state

Control Annotation

Turns on and off the display of values on the Active Function controls for all measurements in the current Mode. This is a security feature.

Remote Command	<code>:DISPlay:ACTivefunc[:STATe] ON OFF 1 0</code> <code>:DISPlay:ACTivefunc[:STATe]?</code>
Example	<code>:DISP:ACT OFF</code>
Dependencies	Grayed out and forced to <code>OFF</code> when System Display Settings, Annotation is <code>OFF</code>
Preset	<code>ON</code> This remains <code>OFF</code> through a Preset when System Display Settings, Annotation is set to <code>OFF</code>
State Saved	Saved in instrument state

Meas Bar

Turns the Measurement Bar at the top of the screen on and off for all measurements in the current Mode. When `OFF`, the graticule area expands to fill the area formerly occupied by the Measurement Bar.

Remote Command	<code>:DISPlay:ANNotation:MBAR[:STATe] OFF ON 0 1</code> <code>:DISPlay:ANNotation:MBAR[:STATe]?</code>
Example	<code>:DISP:ANN:MBAR OFF</code>
Dependencies	Grayed out and forced to <code>OFF</code> when System Display Settings, Annotation is <code>OFF</code>
Preset	<code>ON</code> This remains <code>OFF</code> through a Preset when System Display Settings, Annotation is set to <code>OFF</code>
State Saved	Saved in instrument state

Display Enable (Remote Command Only)

Turns the display on/off, including the display drive circuitry. The backlight stays lit to confirm that the instrument is on. The display enable setting is mode global.

There are three reasons for turning the display off:

1. To increase speed as much as possible by freeing the instrument from having to update the display
2. To reduce emissions from the display, drive circuitry
3. For security purposes

If you have turned off the display:

- and you are in local operation, the display can be turned back on by pressing any key or by sending `:SYSTEM:DEFAULTS MISC` or `:DISPLAY:ENABLE ON` (neither `*RST` nor `:SYSTEM:PRESET` enable the display)
- and you are in remote operation, the display can be turned back on by pressing the **Local** or **Esc** keys, or by sending `:SYSTEM:DEFAULTS MISC` or `:DISPLAY:ENABLE ON` (neither `*RST` nor `:SYSTEM:PRESET` enable the display)
- and you are using either the `:SYSTEM:KLOCK` command or GPIB local lockout, then *no* front-panel key press will turn the display back on. You must turn it back on remotely.

If the display is **OFF**, many SCPI commands related to User Views and Multiscreen functionality do not work, and return the error messages “-221, Settings conflict; Screen SCPI cannot be used when Display is disabled” or “221, Settings conflict; View SCPI cannot be used while Display is disabled”. These commands include:

Name	Command
Select User View	<code>:DISPLAY:VIEW:ADVANCED:SELECT</code>
Rename User View	<code>:DISPLAY:VIEW:ADVANCED:RENAME</code>
Delete User View	<code>:DISPLAY:VIEW:ADVANCED:DELETE</code>
Create User View	<code>:DISPLAY:VIEW:ADVANCED:NAME</code>
Select Screen	<code>:INSTRUMENT:SCREEN:SELECT</code>
Delete Screen	<code>:INSTRUMENT:SCREEN:DELETE</code>
Delete All But This Screen	<code>:INSTRUMENT:SCREEN:DELETE:ALL</code>
Add Screen	<code>:INSTRUMENT:SCREEN:CREATE</code>
Rename Screen	<code>:INSTRUMENT:SCREEN:RENAME</code>
Sequencer On/Off	<code>:SYSTEM:SEQUENCER</code>

Remote Command	<code>:DISPLAY:ENABLE OFF ON 0 1</code>
Example	<code>:DISP:ENAB OFF</code>
Couplings	<code>:DISP:ENAB OFF</code> turns Backlight OFF and <code>:DISP:ENAB ON</code> turns Backlight ON , but changing Backlight settings does <i>not</i> change the state of <code>:DISP:ENAB</code>

Preset	ON Set by :SYST:DEF MISC , but not affected by *RST or :SYSTem:PRESet
State Saved	Not saved in instrument state
Backwards Compatibility Notes	:SYST:PRES no longer turns on :DISPlay:ENABLe as it did in legacy analyzers

3.5.6 Freq

The Freq key opens the Frequency menu, which contains controls that allow you to control the Frequency and Channel parameters of the instrument.

Some features in the Frequency menu are the same for all measurements in the current Mode – they do not change as you change measurements. Settings like these are called “Meas Global” and are unaffected by Meas Preset.

3.5.6.1 Settings

The controls on the Settings tab include the Marker active function and a radio button selection of the marker control mode (Normal, Delta, or Off) for the selected marker, as well as additional functions that help you use markers.

Channel

Selects which Bluetooth channel will be measured.

Channel number is common for all the measurements. The coupling of Channel and Center Frequency apply to the following Measurements:

- Transmit Analysis
- Output Spectrum BW
- Monitor Spectrum

For other measurements, center frequency does not dependent on channel. If center frequency is changed in other measurements but channel isn’t changed, center frequency still can return to the old value only if the measurement is switched to the upward measurements.

Remote Command	[:SENSe]:CHANnel[:NUMBer] <integer> [:SENSe]:CHANnel[:NUMBer]?
Example	:CHAN 22 :CHAN?

Couplings	<p>The coupling of channel and center frequency is only applied to the following measurements:</p> <ul style="list-style-type: none"> - Transmit Analysis - Output Spectrum BW - Monitor Spectrum <p>For other measurements, center frequency does not depend on channel. Following is the coupling of channel and center frequency</p> <p>If Radio Stand is Basic or EDR: $Channel = (CF - 2.402E9) / 1.0e6$</p> <p>If the Center Frequency is set to a value between channels, the channel key should display > prior to the previous channel number if the CF is < 500 kHz above the previous channel and < prior to the next channel number if the CF is > = 500 kHz above the previous channel</p> <p>For example, if Channel = 3.4, the channel key will display >3. If Channel = 3.5, the channel key will display <4. If Channel <0, the channel key will display <0. If Channel >78(22), the channel key display will display >78(22)</p> <p>If Radio Stand is Low Energy: $Channel = (CF - 2.402E9) / 2.0e6$</p> <p>The max value of channel is 39. The range of channel is 0-39</p> <p>If the Center Frequency is set to a value between channels, the channel key should display > prior to the previous channel number if the CF is < 1 MHz above the previous channel and < prior to the next channel number if the CF is > = 1 MHz above the previous channel</p> <p>For example, if Channel = 3.4, the channel key will display >3. If Channel = 3.5, the channel key will display <4. If Channel <0, the channel key will display <0. If Channel >78(22), the channel key display will display >78(22)</p> <p>If Geography is France :</p> <ul style="list-style-type: none"> - Channel Number: 0...22 - If Center Frequency < 2.454 GHz, the channel key should display < 0 - If Center Frequency > 2.476 GHz, the channel key should display > 22 <p>If Geography is Others:</p> <ul style="list-style-type: none"> - Channel Number: 0...78 - If Center Frequency < 2.402 GHz, the channel key should display < 0 - If Center Frequency > 2.480 GHz, the channel key should display > 78
Preset	0
State Saved	Yes
Range	0 – 78
Min/Max	0 / 78

Center Frequency

Sets the frequency that corresponds to the horizontal center of the graticule. While adjusting the Center Frequency the Span is held constant.

The center frequency setting is the same for all measurements within a mode, that is, it is Meas Global. Some modes are also able to share a Mode Global center frequency value. If this is the case, the Mode will have a **Global** tab in its **Meas Setup** menu.

The **Center Freq** function sets (and queries) the Center Frequency for the currently selected input. If your instrument has multiple inputs, and you select another input, the Center Freq changes to the value for that input. SCPI commands are available to directly set the Center Freq for a specific input.

Center Freq is remembered as you go from input to input. Thus, you can set a Center Freq of 10 GHz with the RF Input selected, change to BBIQ, and set a Center Freq of 20 MHz, then switch to External Mixing and set a Center Freq of 60 GHz, and when you go back to the RF Input the Center Freq will go back to 10 GHz; back to BBIQ and it is 20 MHz; back to External Mixing and it is 60 GHz.

See:

- ["Center Frequency Presets" on page 557](#)
- ["VXT Models with Radio Heads/CIU Frequency Range" on page 559](#)
- ["RF Center Freq" on page 559](#)
- ["Ext Mix Center Freq" on page 560](#)
- ["I/Q Center Freq" on page 561](#)

Remote Command	<code>[:SENSe] :FREQuency:CENTer <freq></code> <code>[:SENSe] :FREQuency:CENTer?</code>
Example	<code>:FREQ:CENT 50 MHz</code> Sets Center Frequency to 50 MHz <code>:FREQ:CENT UP</code> Increments the Center Frequency by the value of CF Step <code>:FREQ:CENT?</code> Returns the current value of Center Frequency
Notes	Sets the RF, External Mixing or I/Q Center Frequency depending on the selected input: <ul style="list-style-type: none"> - For RF input it is equivalent to <code>:FREQ:RF:CENT</code> - For I/Q input it is equivalent to <code>:FREQ:IQ:CENT</code>

	<ul style="list-style-type: none"> - For External Mixer it is equivalent to :FREQ:EMIX:CENT <p>Preset and Max values are dependent on Hardware Options (5xx)</p> <p>If no terminator (for example, MHz) is sent, the terminator Hz is used. If a terminator with unit other than Frequency is used, an invalid suffix error message is generated</p>
Couplings	<p>In LTEAFDD/LTEATDD and 5G NR Modes:</p> <p>Center Frequency, Center Frequency Offset and Carrier Reference Frequency are coupled with the following equation:</p> <p>Center Frequency = Carrier Reference Frequency + Center Frequency Offset</p> <p>If the following conditions are satisfied at the same time:</p> <ul style="list-style-type: none"> - the Num Component Carrier equals to 1 - the Center Frequency Offset equals to 0 Hz - the mode of the Center Frequency is Auto <p>The Center Frequency is equivalent to Carrier Reference Frequency</p> <p>The major purpose of this coupling is to keep BWCC with legacy LTE, in which :SENSe:FREQuency:CENTer is used to set up the Frequency of the measurement</p> <p>Otherwise, the Center Frequency Offset is changed following the Center Frequency and the Carrier Reference Frequency keeps intact</p> <p>In MSR, Center Freq, Center Freq Offset and Carrier Ref Freq are coupled with the equation, Center Freq = Carrier Ref Freq + Center Freq Offset. When Center Freq is changed, Center Freq Offset is updated and Carrier Ref Freq is not changed</p> <p>When auto, Center Freq Offset remains the same value. Thus, Center Freq changes the same amount of Carrier Ref Freq change when Carrier Ref Freq is changed. The auto state changes to manual when either Center Freq is changed</p> <p>In Bluetooth Mode:</p> <p>Center Frequency is coupled to Channel and Geography</p> <ul style="list-style-type: none"> - If Geography is France: Center Frequency 2454 MHz + (channel number* channel space) MHz - If Geography is Others: Center Frequency 2402 MHz + (channel number* channel space) MHz - If Radio Stand is Basic or EDR, channel space is 1 MHz - If Radio Stand is Low Energy, channel space is 2 MHz <p>In other modes:</p> <p>Any value of the Center Frequency or Span that keeps start frequency and stop frequency within the frequency range of the instrument is allowed when the value is being set through the front panel numeric keypad or the SCPI command. Other frequency parameters are forced to different values if needed, to keep the start and stop frequencies within the instrument's frequency range</p>
Preset	<p>Depends on instrument maximum frequency, mode, measurement, and selected input</p> <p>See "Center Frequency Presets" on page 557, "RF Center Freq" on page 559, "Ext Mix Center Freq" on page 560, "/I/Q Center Freq" on page 561 and "VXT Models with Radio Heads/CIU Frequency Range" on page 559</p>

State Saved	Saved in instrument state
Min/Max	Depends on instrument maximum frequency, mode, measurement, and selected input See "Center Frequency Presets" on page 557, "RF Center Freq" on page 559, "Ext Mix Center Freq" on page 560, "I/Q Center Freq" on page 561 and "VXT Models with Radio Heads/CIU Frequency Range" on page 559
Annotation	Center <value> appears in the lower left corner of the display
Status Bits/OPC dependencies	Non-overlapped

Center Frequency Auto State

Remote Command	<code>[:SENSe] :FREQuency :CENTer :AUTO ON OFF 1 0</code> <code>[:SENSe] :FREQuency :CENTer :AUTO?</code>
Example	<code>:FREQ :CENT :AUTO OFF</code> <code>:FREQ :CENT :AUTO?</code>
Dependencies	This is only available in MSR, LTEAFDD/LTEATDD and 5GNR Modes
Couplings	When the Center Frequency is changed, the state is automatically changed to Manual Center Frequency , Center Frequency Offset and Carrier Reference Frequency are coupled. When Carrier Reference Frequency changes: <ul style="list-style-type: none"> - Center Frequency : Auto Center Frequency = Carrier Reference Frequency + Center Frequency Offset (fixed) - Center Frequency : Man Center Frequency (fixed) = Carrier Reference Frequency + Center Frequency Offset
Preset	ON
State Saved	Saved in instrument state
Range	Auto Man

Center Frequency Presets

The following table provides the Center Frequency Presets for the Spectrum Analyzer mode, and the Max Freq, for the various frequency options:

Freq Option	CF after Mode Preset	Stop Freq after Mode Preset	Max Freq (can't tune above)
503 (all but CXA)	1.805 GHz	3.6 GHz	3.7 GHz
503 (CXA)	1.505 GHz	3.0 GHz	3.08 GHz
507 (all but CXA)	3.505 GHz	7.0 GHz	7.1 GHz
507 (CXA)	3.755 GHz	7.5 GHz	7.58 GHz

Freq Option	CF after Mode Preset	Stop Freq after Mode Preset	Max Freq (can't tune above)
508 (all but MXE)	1.805 GHz	3.6 GHz	8.5 GHz
508 (MXE)	4.205 GHz	8.4 GHz	8.5 GHz
513	6.805 GHz	13.6 GHz	13.8 GHz
526 (except CXA and MXE)	13.255 GHz	26.5 GHz	27.0 GHz*
526 (CXA)	13.255 GHz	26.5 GHz	26.55 GHz
526 (MXE)	1.805 GHz	3.6 GHz	27.0 GHz
532	16.005 GHz	32.0 GHz	32.5 GHz
540	20.005 GHz	40.0 GHz	40.5 GHz
543	21.505 GHz	43.0 GHz	43.0 GHz
544	22.005 GHz	44.0 GHz	45.0 GHz
550	25.005 GHz	50.0 GHz	52 GHz
F03 (CXA-m)	1.505 GHz	3.0 GHz	3.08 GHz
F07 (CXA-m)	3.755 GHz	7.5 GHz	7.575 GHz
F13 (CXA-m)	6.805 GHz	13.6 GHz	13.8 GHz
F26 (CXA-m)	13.255 GHz	26.5 GHz	26.55 GHz
504 (M9421A, M8920A)	2.145 GHz	3.88GHz	3.88 GHz
506 (M9421A, M8920A)	3.245 GHz	6.08GHz	6.08 GHz
F06 (M9410A/11A)	1.0 GHz	6.08 GHz	6.08 GHz
F06 (M9415A)	1 GHz	1.08 GHz	6.6 GHz
F08 (M9415A)	1 GHz	1.08 GHz	8.6 GHz
F12 (M9415A)	1 GHz	1.08 GHz	12.9 GHz

*For option 526, the Max CF in RTSA is 26.999999995 GHz.

N9041B Center Freq Presets

Input	CF after Mode Preset	Stop Freq after Mode Preset	Max Freq (can't tune above)
Input 1, all models	25.005 GHz	50.0 GHz	52 GHz
Input 2, opt 585	42.505 GHz	85.0 GHz	86 GHz
Input 2, opt 590	45.005 GHz	90.0 GHz	92 GHz
Input 2, opt 5CX	55.005 GHz	110.0 GHz	110 GHz

Input 2, CXA and MXE

3 Bluetooth Mode
3.5 EDR In-band Spur Emissions

Model	CF after Mode Preset	Stop Freq after Mode Preset	Max Freq (can't tune above)
CXA opt C75	0.7505 GHz	1.5 GHz	1.58 GHz
MXE	505 MHz	1 GHz	1.000025 GHz

Tracking Generator Frequency Limits (CXA only)

Tracking Generator Option	Min Freq (clips to this freq when turn TG on and can't tune below while TG on)	If above this Freq, Stop Freq clipped to this Freq when TG turned on	Max Freq (can't tune above) while TG on
T03	9 kHz	3.0 GHz	3.08 GHz
T06	9 kHz	6.0 GHz	6.05 GHz

Tracking Generator Frequency Limits(CXA-m only)

Tracking Generator Option	Min Freq (clips to this freq when turn TG on and can't tune below while TG on)	If above this Freq, Stop Freq clipped to this Freq when TG turned on	Max Freq (can't tune above) while TG on
T03	2 MHz	3.08 GHz	3.08 GHz
T07	2 MHz	7.575 GHz	7.575 GHz
T13	2 MHz	13.8 GHz	13.8 GHz
T26	2 MHz	26.55 GHz	26.55 GHz

VXT Models with Radio Heads/CIU Frequency Range

The following table shows the Center Frequency Presets and Range for VXT modes with Radio Heads/CIU.

Products with Radio Heads/CIU	Preset	Start frequency	Stop frequency
M9421A + CIU	6 GHz	5.9 GHz	12 GHz
M9410A + CIU	6 GHz	5.9 GHz	12 GHz
M9410A + CIU + RRH	25 GHz	24.25 GHz	43.5 GHz

RF Center Freq

Specifies the RF Center Frequency. This command sets the Center Frequency to be used when the RF input is selected, even if the RF input is not the input that is selected at the time the command is sent. Note that **"Center Frequency" on page 555** in the **Frequency** menu on the front panel always applies to the currently selected input.

Remote Command `[:SENSe] :FREQuency:RF:CENTer <freq>`
 `[:SENSe] :FREQuency:RF:CENTer?`

Example	<code>:FREQ:RF:CENT 30 MHz</code> <code>:FREQ:RF:CENT?</code>
Notes	This command is the same in all Modes, but the parameter is Measurement Global, so the value is independent in each Mode and common across all the measurements in the Mode
Dependencies	If the electronic/soft attenuator is enabled, any attempt to set Center Frequency such that the Stop Frequency would be >3.6 GHz fails and results in an advisory message. If the equivalent SCPI command is sent, this same message is generated as part of a “-221, Settings conflict” warning
Preset	See " Center Frequency Presets " on page 557 above
State Saved	Saved in instrument state
Min	-79.999995 MHz
Max	See table above. Basically, instrument maximum frequency - 5 Hz If the knob or step keys are being used, also depends on the value of Span

Ext Mix Center Freq

Specifies the External Mixer Center Frequency. This command sets the Center Frequency to be used when the External Mixer is selected, even if the External Mixer input is not the input that is selected at the time the command is sent. Note that "[Center Frequency](#)" on page 555 in the **Frequency** menu on the front panel always applies to the currently selected input.

Remote Command	<code>[:SENSe] :FREQuency:EMIXer:CENTer <freq></code> <code>[:SENSe] :FREQuency:EMIXer:CENTer?</code>
Example	<code>:FREQ:EMIX:CENT 60 GHz</code> <code>:FREQ:EMIX:CENT?</code>
Notes	This command is the same in all Modes, but the parameter is Measurement Global, so the value is independent in each Mode and common across all the measurements in the Mode
Couplings	When returning to External Mixing after having been switched to one of the other inputs (e.g., RF), you will come back into the settings that you had when you left External Mixing. So, you will come back to the band you were in with the Center Frequency that you had. However, Span is not an input-dependent parameter, therefore you will bring the span over from the other input. Therefore, the instrument comes back with the span from the previous input, limited as necessary by the current mixer setup
Preset	When a Mode Preset is performed while in External Mixing, the Start frequency of the current Mode is set to the nominal Min Freq of the lowest harmonic range in the Harmonic Table for the current mixer setup. Similarly, the Stop frequency of the current Mode is set to the nominal Max Freq of the highest harmonic range in the Harmonic Table. The Center Freq thus presets to the point arithmetically equidistant from these two frequencies Note that, if the current measurement has a limited Span available to it, and cannot achieve the Span shown in the table (Span=Stop Freq – Start Freq), the instrument uses the maximum Span the measurement allows, and still sets the Center Freq to the midpoint of the Start and Stop Freq values in the Harmonic Table

3 Bluetooth Mode
3.5 EDR In-band Spur Emissions

When Restore Input/Output Defaults is performed, the mixer presets to the 11970A, whose Start and Stop frequencies are 26.5 and 40 GHz respectively. The center of these two frequencies is 33.25 GHz. Therefore, after a Restore Input/Output Defaults, if you go into External Mixing and do a Mode Preset while in the Spectrum Analyzer Mode, the resulting Center Freq is 33.25 GHz

State Saved	Yes
Min	The minimum frequency in the currently selected mixer band + 5 Hz If the knob or step keys are being used, also depends on Span
Max	The maximum frequency in the currently selected mixer band - 5 Hz If the knob or step keys are being used, also depends on Span

I/Q Center Freq

Specifies the I/Q Center Frequency. This command sets the Center Frequency to be used when the I/Q input is selected, even if the I/Q input is not the input that is selected at the time the command is sent. Note that **"Center Frequency" on page 555** in the **Frequency** menu on the front panel always applies to the currently selected input.

Remote Command	<code>[:SENSe]:FREQuency:IQ:CENTer <freq></code> <code>[:SENSe]:FREQuency:IQ:CENTer?</code>
Example	<code>:FREQ:IQ:CENT 30 MHz</code>
Notes	This command is the same in all Modes, but the parameter is Measurement Global, so the value is independent in each Mode and common across all the measurements in the Mode
Preset	0 Hz
State Saved	Saved in instrument state
Min	-40.049995 MHz
Max	40.049995 MHz

Span

Changes the displayed frequency range symmetrically about the center frequency.

NOTE

Entered values of Span must be odd numbers of MHz.

Remote Command	<code>[:SENSe]:IBSPurious:FREQuency:SPAN <freq></code> <code>[:SENSe]:IBSPurious:FREQuency:SPAN?</code>
Example	<code>:IBSP:FREQ:SPAN 25MHz</code> <code>:IBSP:FREQ:SPAN?</code>
Couplings	If Meas Method is FFT, the maximum value of Span couples to the MAX IFBW of the instrument

Preset	79.00 MHz
State Saved	Yes
Min/Max	1.0 MHz/ 79.000 MHz
Annotation	Bottom right of RF Spectrum graph

LMH Channel

Enables quick selection from a subset of the available channel numbers for the Low (channel 0), Middle (channel 39), or High (channel 78) channels.

Remote Command	<code>[:SENSe] :CHANne1 :LMH LOW MID HIGH</code> <code>[:SENSe] :CHANne1 :LMH?</code>
Example	<code>:FREQ:LMH MID</code> <code>:FREQ:LMH?</code>
Couplings	If Radio Stand is Basic or EDR, the soft key label is Low(0), Mid(39), High(78) If Radio Stand is Low Energy, the soft key label is Low(0), Mid(20), High(39) If geography is France, this key will be grayed-out
Preset	LOW
State Saved	Yes
Range	LOW MID HIGH
Backwards Compatibility SCPI	<code>[:SENSe] :FREQuency :LMH LOW MID HIGH</code> <code>[:SENSe] :FREQuency :LMH?</code>

Geography

Selects the desired country. The selection defines the frequency range and the available channel numbers for the transmit channel.

Remote Command	<code>[:SENSe] :FREQuency :GEOGraphy FRANce OTHeRs</code> <code>[:SENSe] :FREQuency :GEOGraphy?</code>
Example	<code>:FREQ:GEOG FRAN</code> <code>:FREQ:GEOG?</code>
Couplings	France: <ul style="list-style-type: none"> - Center Frequency 2454 MHz + (0...22) MHz - Channel Number: 0...22 Others: <ul style="list-style-type: none"> - Center Frequency 2402 MHz + (0...78) MHz

3 Bluetooth Mode
3.5 EDR In-band Spur Emissions

	- Channel Number: 0...78
Preset	OTHerS
State Saved	Yes
Range	FRANce OTHerS

CF Step

Changes the step size for the center frequency and start and stop frequency functions. Once a step size has been selected and the center frequency function is active, the step keys (and the UP|DOWN parameters for Center Frequency from remote commands) change the center frequency by the step-size value. The step size function is useful for finding harmonics and sidebands beyond the current frequency span of the instrument.

Note that the start and stop frequencies also step by the CF Step value.

Remote Command	<pre>[:SENSe]:FREQuency:CENTer:STEP[:INCRement] <freq> [:SENSe]:FREQuency:CENTer:STEP[:INCRement]? [:SENSe]:FREQuency:CENTer:STEP:AUTO OFF ON 0 1 [:SENSe]:FREQuency:CENTer:STEP:AUTO?</pre>
Example	<pre>:FREQ:CENT:STEP 500 MHz :FREQ:CENT UP</pre> <p>Increases the current center frequency value by 500 MHz</p> <pre>:FREQ:CENT:STEP? :FREQ:CENT:STEP:AUTO ON :FREQ:CENT:STEP:AUTO?</pre>
Notes	Preset and Max values are dependent on Hardware Options
Dependencies	Not available in MSR, LTEAFDD/LTEATDD, 5GNR and Channel Quality Modes If the electronic/soft attenuator is enabled, any attempt to change the value of the center frequency >3.6 GHz by pressing the Up-arrow key, fails and results in an advisory message. If the equivalent SCPI command is sent, this same message is generated as part of a "-221, Settings conflict" warning
Couplings	When auto-coupled, the center frequency step size is set to 10% of the span
Preset	Auto ON
State Saved	Saved in instrument state
Min	- (the maximum frequency of the instrument). That is, 27 GHz max freq instrument has a CF step range of +/- 27 GHz. Note that this is the maximum frequency given the current settings of the instrument, so in External Mixing, for example, it is the maximum frequency of the current mixer band
Max	The maximum frequency of the instrument. That is, 27 GHz max freq instrument has a CF step range of +/- 27 GHz. Note that this is the maximum frequency given the current settings of the instrument, so

	in External Mixing, for example, it is the maximum frequency of the current mixer band
Status Bits/OPC dependencies	non-overlapped

3.5.7 Marker

The Marker key accesses the Marker menu. A marker can be placed on a trace to allow the value of the trace at the marker point to be determined precisely. The functions in this menu include a 1-of-N selection of the control mode Normal, Delta, or Off for the selected marker. If the selected marker is Off, pressing Marker sets it to Normal and places it at the center of the screen on the trace determined by the Marker Trace rules.

Markers may also be used in pairs to read the difference (or delta) between two data points. They can be used in Marker Functions to do advanced data processing, or to specify operating points in functions like Signal Track and N dB Points.

3.5.7.1 Select Marker

Specifies the selected marker. The term “selected marker” is used throughout this document to specify which marker will be affected when you change marker settings, perform a Peak Search, etc.

The Select Marker control appears above the menu panel, indicating that it applies to all controls in the Marker menu panels. Select Marker is blanked if you select a tab whose controls do NOT depend on the selected marker (e.g., Counter).

On any menu tab for which Select Marker displays, the first control is always Marker Frequency|Time.

Notes	The selected marker is remembered even when not in the Marker menu and is used if a Search is done or a Band Function is turned on or for Signal Track or Continuous Peak
Preset	Marker 1
State Saved	The number of the selected marker is saved in instrument state
Annunciation	Appears in the marker results block label for Normal and Delta markers

3.5.7.2 Settings

This tab enables you to set measurement parameters.

Marker X-Axis Value

The command below sets and queries a marker’s X-Axis value.

3 Bluetooth Mode
3.5 EDR In-band Spur Emissions

Remote Command	<code>:CALCulate:IBSPurious:MARKer[1] 2 ... 12:X <real></code> <code>:CALCulate:IBSPurious:MARKer[1] 2 ... 12:X?</code>
Example	<code>:CALC:IBSP:MARK:X 2.402E+9</code> <code>:CALC:IBSP:MARK:X?</code>
Notes	The query is returned in the fundamental units for the current marker X-Axis scale. This command (not the query) causes the specified marker to become selected
Dependencies	The Marker X-Axis Value unit is dependent on the currently selected window For RF Envelope the units will be ns us ms s ks For RF Spectrum the units will be Hz kHz MHz GHz
Preset	After a preset, all Markers are turned OFF, so Marker X-Axis Value query will return not a number (NAN). When Marker is On, default value of Marker X-Axis Value is the center of the appropriate window
State Saved	Yes
Min	-9.91E+37
Max	9.91E+37

Marker Y-Axis Value (Remote Command Only)

The command below queries a marker's Y-Axis value only.

Remote Command	<code>:CALCulate:IBSPurious:MARKer[1] 2 ... 12:Y?</code>
Example	<code>:CALC:IBSP:MARK:Y?</code>
Preset	Since the result value is always calculated from acquisition data, the default value is arbitrary. Although the Preset/Default values are defined
Min	-9.91E+37
Max	9.91E+37

Marker Mode

Sets the marker control mode to **Normal**, **Delta**, or **Off**. All interactions and dependencies detailed under the control description are enforced when the remote command is sent. If the selected marker is Off, pressing Marker sets it to Normal and places it at the center of the screen on the trace determined by the **Marker Trace** rules. At the same time, **Marker X Axis** Value appears on the Active Function area.

The default active function is the active function for the currently selected marker control mode. If the current control mode is **Off**, there is no active function and the active function is turned off.

Remote	<code>:CALCulate:IBSPurious:MARKer[1] 2 ... 12:MODE POSition DELTa =OFF</code>
--------	--

Command	<code>:CALCulate:IBSPurious:MARKer[1] 2 ... 12:MODE?</code>
Example	<code>:CALC:IBSP:MARK:MODE POS</code> <code>:CALC:IBSP:MARK:MODE?</code>
Notes	This command (not the query) causes the specified marker to become selected
Couplings	If a marker has the mode changed to delta, the Marker Trace setting of the delta marker will be that of the reference marker If a delta marker has a reference marker in a different window, the delta marker's mode changes to normal
Preset	OFF (all markers)

Delta Marker (Reset Delta)

Pressing this button is exactly the same as pressing the “Delta” selection on the Marker Mode radio button. The selected marker becomes a Delta Marker. If the selected marker is already a Delta marker, the reference marker is moved to the current position of the selected marker, thus resetting the Delta to zero.

Marker Settings Diagram

The Marker Settings Diagram lets you configure the Marker system using a visual utility.

All Markers Off

Turns off all markers.

Remote Command	<code>:CALCulate:IBSPurious:MARKer:AOff</code>
Example	<code>:CALC:IBSPurious:MARK:AOff</code>

Couple Markers

When this function is On, moving any marker causes an equal X Axis movement of every other marker which is not Fixed or Off. By “equal X Axis movement” we mean that we preserve the difference between each marker's X Axis value (in the fundamental x-axis units of the trace that marker is on) and the X Axis value of the marker being moved (in the same fundamental x-axis units).

This may result in markers going off screen.

Remote Command	<code>:CALCulate:IBSPurious:MARKer:COUple[:STATE] ON OFF 1 0</code>
Command	<code>:CALCulate:IBSPurious:MARKer:COUple[:STATE]?</code>

Example	<code>:CALC:IBSP:MARK:COUP ON</code> <code>:CALC:IBSP:MARK:COUP?</code>
Preset	OFF, presets on Mode Preset and All Markers Off
State Saved	Saved in instrument state

3.5.7.3 Peak Search

The controls on the Peak Search tab allow you to move the marker to selected peaks of the signal, giving you enormous analysis capabilities, particularly when combined with the Delta Marker function.

NOTE Pressing the Peak Search hardkey automatically moves you to the Peak Search page of the Marker menu AND performs a Peak Search. Pressing the Peak Search tab once you are already IN the Marker menu does NOT perform a Peak Search.

Marker X-Axis Value

The Marker X-Axis Value control is the fundamental control that you use to move a marker around on the trace. This is the same as the "[Marker X-Axis Value](#)" on page 564 control on the Settings tab.

Peak Search

Pressing the Peak Search control moves the selected marker to the trace point which has the maximum y-axis value for that marker's trace.

NOTE Pressing the Peak Search hardkey automatically moves you to the Peak Search page of the Marker menu AND performs a Peak Search.

Remote Command	<code>:CALCulate:IBSPurious:MARKer[1] 2 ... 12:MAXimum</code>
Example	<code>:CALC:IBSP:MARK2:MAX</code> <code>:SYST:ERR?</code> Can be used to query the errors to determine if a peak is found. The message "No peak found" will be returned after an unsuccessful search
Notes	Sending this command selects the subopcoded marker This command does not work when the selected marker is located on the polar trace. In this case, the command is ignored

Next Peak

Pressing Next Peak moves the selected marker to the peak that is next lower in amplitude than the current marker value. Only peaks which meet all enabled peak criteria are considered. If there is no valid peak lower than the current marker position, a “No peak found” message is generated and the marker is not moved.

If the selected marker was off, then it is turned on as a normal marker and a peak search is performed.

Remote Command	<code>:CALCulate:IBSPurious:MARKer[1] 2 ... 12:MAXimum:NEXT</code>
Example	<code>:CALC:IBSP:MARK2:MAX:NEXT</code>
Notes	Sending this command selects the subopcoded marker
State Saved	Not part of saved state

Next Peak Right

Pressing Next Pk Right moves the selected marker to the nearest peak right of the current marker that meets all enabled peak criteria. If there is no valid peak to the right of the current marker position, a “No peak found” message is generated and the marker is not moved.

If the selected marker was off, then it is turned on as a normal marker and a peak search is performed.

Remote Command	<code>:CALCulate:IBSPurious:MARKer[1] 2 ... 12:MAXimum:RIGHT</code>
Example	<code>:CALC:IBSP:MARK2:MAX:RIGH</code>
Notes	Sending this command selects the subopcoded marker
State Saved	Not part of saved state

Next Peak Left

Pressing Next Pk Left moves the selected marker to the nearest peak left of the current marker that meets all enabled peak criteria. If there is no valid peak to the left of the current marker position, a “No peak found” message is generated and the marker is not moved.

If the selected marker was off, then it is turned on as a normal marker and a peak search is performed.

Pressing this control moves the selected marker to the nearest active channel left of the current marker when Marker Trace is Code Domain Power. In other cases, moves the selected marker to the highest peak left of the current marker.

Remote Command	<code>:CALCulate:IBSPurious:MARKer[1] 2 ... 12:MAXimum:LEFT</code>
Example	<code>:CALC:IBSP:MARK2:MAX:LEFT</code>
State Saved	Not part of saved state.

Minimum Peak

Moves the selected marker to the minimum y-axis value on the current trace. Minimum (negative) peak searches do not have to meet the peak search criteria. It just looks for the lowest y-axis value. If the selected marker is Off, it is turned on before the minimum search is performed.

Remote Command	<code>:CALCulate:IBSPurious:MARKer[1] 2 ... 12:MINimum</code>
Example	<code>:CALC:IBSP:MARK:MIN</code>
Notes	Sending this command selects the subopcoded marker
State Saved	Not part of saved state

Pk-Pk Search

Finds and displays the amplitude and frequency (or time, if in zero span) differences between the highest and lowest y-axis value. It places the selected marker on the minimum value on its selected trace. And it places that marker's reference marker on the peak of its selected trace.

This function turns on the reference marker and sets its mode to Normal if it is not already on. (These markers may be on two different traces.)

The rules for finding the maximum peak are exactly the same as for Peak Search , including the use of the peak criteria rules. However, the minimum trace value is not required to meet any criteria other than being the minimum y-axis value in the trace.

If the selected marker is off, a delta type marker is turned on and the peak-to-peak search is done. If the selected marker is on, but it is not a delta marker, then it is changed to delta which turns on the reference marker if needed, and then it performs the peak-to-peak function.

Remote Command	<code>:CALCulate:IBSPurious:MARKer[1] 2 ... 12:PTPeak</code>
Example	<code>:CALC:IBSP:MARK:PTP</code>
Notes	Turns on the Marker D active function Sending this command selects the subopcoded marker
Dependencies	Pk-Pk Search is not available when Coupled Markers is on
Couplings	The selected marker becomes a delta marker if not already in delta mode
State Saved	Not part of saved state

Marker Delta

Pressing this button is exactly the same as pressing the “Delta” selection on the Marker Mode radio button on the Settings tab. The selected marker becomes a Delta Marker. If the selected marker is already a Delta marker, the reference marker is moved to the current position of the selected marker, thus resetting the Delta to zero.

The control is duplicated here in the Peak Search Menu to allow you to conveniently perform a peak search and change the marker’s control mode to Delta without having to access two separate menus.

3.5.7.4 Properties

The controls on the Properties tab are used to set certain properties of the selected marker.

Marker X-Axis Value

The Marker X-Axis Value control is the fundamental control that you use to move a marker around on the trace. This is the same as the "[Marker X-Axis Value](#)" on page 564 control on the Settings tab.

Relative To

Selects the marker to which the selected marker is relative (its reference marker).

Every marker has another marker to which it is relative. This marker is referred to as the “reference marker” for that marker. This attribute is set by the Marker, Properties, Relative To control. The marker must be a Delta marker to make this attribute relevant. If it is a **Delta** marker, the reference marker determines how the marker is controlled and how its value is displayed. A marker cannot be relative to itself.

Remote Command	<code>:CALCulate:IBSPurious:MARKer[1] 2 ... 12:REference <integer></code>
Example	<code>:CALC:IBSP:MARK:REF 5</code> <code>:CALC:IBSP:MARK:REF?</code>
Notes	This command causes the marker specified with the subopcode to become selected Range (for SCPI command): 1 to 12. If the range is exceeded the value is clipped A marker cannot be relative to itself so that choice is not available, and if sent from SCPI generates error -221: “Settings conflict; marker cannot be relative to itself”

	When queried a single value is returned (the specified marker numbers relative marker)
Couplings	The act of specifying the selected marker's reference marker makes the selected marker a Delta marker If the reference marker is off it is turned on in Normal mode at the delta marker location
Preset	The preset default "Relative To" marker (reference marker) is the next higher numbered marker (current marker +1). For example, if marker 2 is selected, then it's default reference marker is marker 3. The exception is marker 12, which has a default reference of marker 1 Set to the defaults by using Restore Mode Defaults . This is not reset by Marker Off , All Markers Off , or Preset
State Saved	Saved in instrument state. Not affected by Marker Off and hence not affected by Preset or power cycle
Min	1
Max	12
Annunciation	Appears in the marker label of a Delta marker

Marker Trace

Selects the trace on which to place the marker. A marker is associated with one and only one trace. This trace is used to determine the placement, result, and X Axis Scale of the marker. All markers have an associated trace. It is from that trace that they determine their attributes and behaviors, and it is to that trace that they go when they become Normal or Delta markers.

If the marker is not **Off**, it moves the marker from the trace it was on to the new trace. If the marker changes windows, it retains its relative horizontal positions in the new window.

If the marker is **off** it stays off, but is now associated with the specified trace.

Remote Command	<code>:CALCulate:IBSPurious:MARKer[1] 2 ... 12:TRACe RFENvelope RFSPpectrum</code> <code>:CALCulate:IBSPurious:MARKer[1] 2 ... 12:TRACe?</code>
Example	<code>:CALC:IBSP:MARK2:TRAC RFEN</code> <code>:CALC:IBSP:MARK:TRACE?</code>
Couplings	Sending the remote command causes the addressed marker to become selected If ever a delta marker has a reference marker in a different window, the delta marker's mode changes to Pos(for example, it becomes a normal marker)
Preset	RF Spectrum Presets on Preset or All Markers Off
State Saved	Yes

Marker Settings Diagram

The Marker Settings Diagram lets you configure the Marker system using a visual utility. This is the same as the "[Marker Settings Diagram](#)" on page 566 control on the

Settings tab.

3.5.7.5 Marker Function

The controls on the Marker Function tab allow you to control the Marker Functions of the instrument. Marker Functions perform post-processing operations on marker data.

Marker X-Axis Value

The Marker X-Axis Value control is the fundamental control that you use to move a marker around on the trace. This is the same as the "Marker X-Axis Value" on page 564 control on the Settings tab.

Marker Function

Sets the marker control function type to, Marker Noise, Band/Interval Power, Band Interval Density, or Marker Function Off.

All interactions and dependencies detailed under the key description are enforced when the remote command is sent.

Remote Command	<code>:CALCulate:IBSPurious:MARKer[1] 2 ... 12:FUNction NOISe BPOwer BDENsity =OFF :CALCulate:IBSPurious:MARKer[1] 2 ... 12:FUNction?</code>
Example	<code>:CALC:IBSP:MARK:FUNC NOIS :CALC:IBSP:MARK:FUNC?</code>
Dependencies	Only RF Spectrum Trace has Marker Function
Preset	OFF
State Saved	Yes
Range	Marker Noise Band/Interval Power Band Interval Density Marker Function Off
Annotation	Mkr # <X value> and <Marker value> upper right on graph

Band Span

Sets the width of the frequency span for the selected marker.

Remote Command	<code>:CALCulate:IBSPurious:MARKer[1] 2 ... 12:FUNction:BAND:SPAN <freq> :CALCulate:IBSPurious:MARKer[1] 2 ... 12:FUNction:BAND:SPAN?</code>
Example	<code>:CALC:IBSP:MARK12:FUNC:BAND:SPAN 20 MHz :CALC:IBSP:MARK12:FUNC:BAND:SPAN?</code>

3 Bluetooth Mode
3.5 EDR In-band Spur Emissions

Couplings	Changing the Band Span necessarily changes the Band Left and Band/Interval Right values
Preset	0
State Saved	Yes
Min/Max	100.0 kHz/200.0 MHz

Band Left

Sets the left edge frequency for the band of the selected marker.

Remote Command	<code>:CALCulate:IBSPurious:MARKer[1] 2 ... 12:FUNCTION:BAND:LEFT <freq></code> <code>:CALCulate:IBSPurious:MARKer[1] 2 ... 12:FUNCTION:BAND:LEFT?</code>
Example	<code>:CALC:IBSP:MARK12:FUNC:BAND:LEFT 20 MHz</code> <code>:CALC:IBSP:MARK12:FUNC:BAND:LEFT?</code>
Couplings	Changing the Band Left necessarily changes the Band Span and Band Right values
Preset	Depends on X axis range of selected Trace
State Saved	Yes
Min/Max	-9.91E+37/9.91E+37

Band Right

Sets the right edge frequency for the band of the selected marker.

Remote Command	<code>:CALCulate:IBSPurious:MARKer[1] 2 ... 12:FUNCTION:BAND:RIGHT <freq></code> <code>:CALCulate:IBSPurious:MARKer[1] 2 ... 12:FUNCTION:BAND:RIGHT?</code>
Example	<code>:CALC:IBSP:MARK12:FUNC:BAND:RIGH 20 MHz</code> <code>:CALC:IBSP:MARK12:FUNC:BAND:RIGH?</code>
Couplings	Changing the Band Right necessarily changes the Band Left and Band Span values
Preset	Depends on X axis range of selected Trace
State Saved	Yes
Min/Max	-9.91E+37/9.91E+37

3.5.8 Meas Setup

The Meas Setup menu panel contains functions for setting up the measurement parameters.

3.5.8.1 Settings

The Settings Tab contains controls that pertain to the X axis parameters of the measurement. These parameters control how data on the vertical (X) axis is displayed and control instrument settings that affect the horizontal axis.

Meas Method

Selects the measurement method

Sweep means each 100 kHz bin's data capture mode is Sweep.

Remote Command	<code>[:SENSe]: IBSPurious:METhod SWEEp FFT</code> <code>[:SENSe]: IBSPurious:METhod?</code>
Example	<code>:IBSP:METh SWE</code> <code>:IBSP:METh?</code>
Preset	SWEEp
State Saved	Yes
Range	Sweep FFT

Guard Delay

Sets the guard interval relative to S0. As guard is prior to S0, so the default value of guard delay is negative.

Remote Command	<code>[:SENSe]:IBSPurious:GDELay <time></code> <code>[:SENSe]:IBSPurious:GDELay?</code>
Example	<code>:IBSP:GDEL -4.0u</code> <code>:IBSP:GDEL?</code>
Dependencies	If Meas Method is sweep, this control will be grayed out
Couplings	The Max value of Guard Delay depends on the Acquisition Time
Preset	-5.0 us
State Saved	Yes
Min/Max	-126.0 us/126.0 us

IF Gain

Enables you to control an internally switched IF amplifier with approximately 10 dB of gain. This amplifier takes full advantage of the RF dynamic range of the analyzer. When it can be turned on without an overload, the dynamic range is always better

3 Bluetooth Mode
 3.5 EDR In-band Spur Emissions

when the amplifier is set to On, than when it is set to Off. The control “IF Gain” can be used to set the IF Gain function to Auto, or to On (the extra 10 dB) or Off. These settings affect sensitivity and IF overloads.

This only applies to the RF input. It does not apply to baseband I/Q input.

IF Gain Auto

Activates the auto rules for IF Gain.

Remote Command	<code>[:SENSe]:IBSPurious:IF:GAIN:AUTO[:STATe] OFF ON 0 1</code> <code>[:SENSe]:IBSPurious:IF:GAIN:AUTO[:STATe]?</code>
Example	<code>:IBSP:IF:GAIN:AUTO OFF</code> <code>:IBSP:IF:GAIN:AUTO?</code>
Notes	This only applies to the RF input. It does not apply to baseband I/Q input
Dependencies	This control does not appear in VXT models M9421A/10A/11A, or UXM
Couplings	When either the auto attenuation works (for example, with the electrical attenuator) or optimize mechanical attenuator range is requested, the IF Gain setting is changed according to the following rule 'Auto' sets IF Gain to 'High Gain' under any of the following conditions: the input attenuator is set to 0 dB, the preamp is turned on, or the Max Mixer Level is -20 dBm or lower. For other settings, 'Auto' sets IF Gain to 'Low Gain'
Preset	OFF
State Saved	Yes
Range	Auto Man

IF Gain State

Selects the range of IF gain.

Remote Command	<code>[:SENSe]:IBSPurious:IF:GAIN[:STATe] ON OFF 1 0</code> <code>[:SENSe]:IBSPurious:IF:GAIN[:STATe]?</code>
Example	<code>:IBSP:IF:GAIN OFF</code> <code>:IBSP:IF:GAIN?</code>
Notes	Where ON = high gain OFF = low gain This only applies to the RF input. It does not apply to baseband I/Q input
Dependencies	This control does not appear in VXT models M9421A/10A/11A, or UXM
Couplings	When either the auto attenuation works (for example, with the electrical attenuator) or optimize mechanical attenuator range is requested, the IF Gain setting is changed according to the following rule

	'Auto' sets IF Gain to 'High Gain' under any of the following conditions: the input attenuator is set to 0 dB, the preamp is turned on, or the Max Mixer Level is -20 dBm or lower. For other settings, 'Auto' sets IF Gain to 'Low Gain'
Preset	OFF
State Saved	Yes
Range	Low Gain High Gain

Spur Avoidance

Because the VXT models M9410A/11A/15A are direct-conversion (zero-IF) receivers, feedthrough leakage from the local oscillator appears as a spurious signal (spur) at the center frequency. The Spur Avoidance function is provided to eliminate this spur, at the expense of some measurement speed.

When Spur Avoidance is enabled (the default), the analyzer uses a software algorithm to remove this spur from the displayed measurement data, but the algorithm only operates under certain conditions. Specifically, it only operates when the $BW \leq \max BW / 2.5$.

You can disable this function in order to speed up your measurement. When Spur Avoidance is turned Off, a warning message will appear in the status bar as "Settings Alert; Spur Avoidance Off". This is to alert you that measurement accuracy might be impacted because you have defeated the spur avoidance algorithm.

Remote Command	<code>[:SENSe]:IBSPurious:SAVoid[:STATe] ON OFF 0 1</code> <code>[:SENSe]:IBSPurious:SAVoid[:STATe]?</code>
Example	<code>:IBSP:SAV ON</code> <code>:IBSP:SAV?</code>
Dependencies	This control only appears in VXT models M9410A/11A/15A
Preset	On
State Saved	Saved in instrument state
Range	ON OFF

Preset To Standard

This is immediate. It enables the setting to comply with the standard requirement.

Remote Command	<code>[:SENSe]: IBSPurious:PRESet:STANdard</code>
Example	<code>:IBSP:PRES:STAN</code>
Couplings	Selecting Stand Setting will change Average State, Average Number, RBW, VBW, Sweep Time, Detector type, Detect Mode, Gate State, Gate Length and Gate Delay's value

Auto Couple

Immediately puts all **Auto/Man** functions into **Auto**. **Auto Couple** is confined to the current measurement only. It does not affect other measurements in the Mode.

In the **Auto** state, **Auto/Man** functions are said to be “coupled”, meaning their values change as you make changes to other values in the measurement. This helps ensure accurate measurements and optimum dynamic range. **Auto Couple** is an immediate action function, and when it is executed, all the **Auto/Man** controls for the current measurement are set to **Auto**, and all measurement settings coupled to the **Auto/Man** parameters are automatically set to their optimal values.

For further details of measurement-specific settings (if any), see "[Measurement-Specific Details](#)" on page 578 below.

Remote Command	:COUPle ALL
Example	:COUP ALL
Backwards Compatibility SCPI	:COUPLE ALL NONE
Backwards Compatibility Notes	: COUP :NONE puts all Auto/Man parameters in manual mode, decoupling all the coupled instrument parameters. It is retained for backwards compatibility and is <i>not</i> recommended for making measurements or new designs

All **Auto/Man** parameter couplings in the measurement are set to **Auto**. This includes couplings that may be unavailable or grayed-out due to the current state. For example, in the Swept SA measurement, there is no **Auto/Man** coupling for **RBW** while in Zero Span. Nonetheless, if **Auto Couple** were executed while in Zero Span, it would set **RBW** to Auto "behind the scenes" so that, on exit from Zero Span, it would be in **Auto**.

Any **Auto/Man** selection specific (local) to the other measurements in the current Mode are not affected by **Auto Couple**. Any functions that are *not* coupled with other instrument parameters, such as ranging or leveling variables, such as **AutoRange** or **AutoScale**, are not affected.

Executing **Auto Couple** generates the informational message, "All Auto/Man functions have been set to Auto".

Each parameter, upon being set to **Auto**, selects and sets the appropriate auto-coupled value based on that parameter's coupling rules. The Dependency Resolver orchestrates the couplings for parameters that depend on one or more other parameters. The coupling and dependency rules for each parameter are defined in the section describing that parameter.

Executing **Auto Couple** does not affect markers, marker functions, trace or display attributes, or any other instrument setting other than those specifically mentioned above.

Measurement-Specific Details

TOI (SA Mode only)

Parameters affected by **Auto Couple** are:

- Center Frequency Step
- Resolution Bandwidth
- Span/RBW Ratio
- Sweep Time
- Video BANDwidth VBW/RBW ratio
- Upper and Lower Tone (set to Sense)
- Zero span measurement Resolution Bandwidth
- Zero span measurement Dwell Time

Harmonics (SA Mode only)

Parameters affected by **Auto Couple** are:

- Resolution Bandwidth
- Fundamental Frequency
- Dwell Time
- Range Table Resolution Bandwidths
- Range Table Dwell Times

Meas Preset

Restores all the measurement parameters to their default values.

Remote Command `:CONFigure:IBSPurious`

Example	:CONF:IBSP
Couplings	Selecting Meas Preset restores all measurement parameters to these default values

3.5.8.2 Limits

This tab enables you to set Limit parameters.

Limit Test

Enables you to turn on or off limit checking at the specified frequency.

For each operating frequency exceptions in up to three bands of 1 MHz width centered on a frequency that is an integer multiple of 1 MHz are allowed. They must however comply with an absolute value of -20 dBm.

Remote Command	:CALCulate:IBSPurious:LIMit:STATe OFF ON 0 1 :CALCulate:IBSPurious:LIMit:STATe?
Example	:CALC:IBSP:LIM:STAT 1 :CALC:IBSP:LIM:STAT?
Preset	ON
State Saved	Yes
Range	On Off

Far Limit

Sets the far limit, in dBm for Adjacent channel power $|M-N| \geq 3$.

Remote Command	:CALCulate:IBSPurious:LIMit:FAR:UPPer[:DATA] <ampl> :CALCulate:IBSPurious:LIMit:FAR:UPPer[:DATA]?
Example	:CALC:IBSP:LIM:FAR:UPP -30.0 :CALC:IBSP:LIM:FAR:UPP?
Preset	-40.0 dBm
State Saved	Yes
Min/Max	-90 dBm/30.0 dBm

Near Limit

Sets the near limit, in dBm for Adjacent channel power $|M-N| = 2$.

Remote	:CALCulate:IBSPurious:LIMit:NEAR:UPPer[:DATA] <ampl>
--------	--

Command	:CALCulate:IBSPurious:LIMit:NEAR:UPPer[:DATA]?
Example	:CALC:IBSP:LIM:NEAR:UPP -30.0 :CALC:IBSP:LIM:NEAR:UPP?
Preset	-20.0 dBm
State Saved	Yes
Min/Max	-90.0 dBm/30.0 dBm

Relative Limit

Sets the relative limit, in dB for In-band Spurious Emissions $|M-N| = 1$.

Remote Command	:CALCulate:IBSPurious:LIMit:RELative:UPPer[:DATA] <rel_ampl> :CALCulate:IBSPurious:LIMit:RELative:UPPer[:DATA]?
Example	:CALC:IBSP:LIM:REL:UPP -30.0 :CALC:IBSP:LIM:REL:UPP?
Preset	-26.0 dB
State Saved	Yes
Min/Max	-90.0 dB/30.0 dB

3.5.8.3 Advanced

The Advanced tab contains controls for setting advanced functions of the analyzer.

This tab does not appear in EXM or VXT.

Noise Floor Extension

Allows you to turn on/configure the Noise Floor Extension (NFE) function.

When ON, the expected noise power of the analyzer (derived from a factory calibration) is subtracted from the trace data. This will usually reduce the apparent noise level by about 10 dB in low band, and 8 dB in high band (>~3.6 GHz).

NFE works with any RBW, VBW, detector, any setting of Average Type, any amount of trace averaging, and any signal type. It is ineffective when the trace is not smoothed (smoothing processes include narrow VBWs, trace averaging, and long sweep times with the detector set to Average or Peak). It works best with extreme amounts of smoothing, and with the average detector, with the Average Type set to Power.

In those cases where the cancellation is ineffective, it nonetheless has no undesirable side-effects. There is no significant speed impact to having Noise Floor Extension on.

3 Bluetooth Mode

3.5 EDR In-band Spur Emissions

The best accuracy is achieved when substantial smoothing occurs in each point before trace averaging. Thus, when using the average detector, results are better with long sweep times and fewer trace averages. When using the sample detector, the VBW filter should be set narrow with less trace averaging, instead of a wide VBW filter with more trace averaging.

Remote Command	<code>[:SENSe]:CORRection:NOISe:FLOOr ON OFF 1 0</code> <code>[:SENSe]:CORRection:NOISe:FLOOr?</code>
Example	<code>:CORR:NOIS:FLO ON</code>
Dependencies	This control only appears in instruments with the NFE or NF2 license installed. In all others, the control does not appear, however the SCPI command will be accepted without error (but will have no effect)
Couplings	When NFE is enabled in any mode manually, a prompt will be displayed reminding you to perform the Characterize Noise Floor operation if it is needed. If NFE is enabled through SCPI and a Characterize Noise Floor operation is needed, an error will be entered in the system error queue
Preset	Unaffected by Mode Preset. Turned OFF at startup and by Restore Mode Defaults in Modes that do not support Adaptive
State Saved	No

3.5.9 Sweep

The Sweep key contains controls which allow you to control the sweep and measurement functions of the analyzer, such as the sweep or measurement time and whether in Single sweep/measure or Continuous sweep/measure mode.

3.5.9.1 Sweep/Control

Accesses controls that let you operate the sweep and control functions of the instrument, such as **Sweep Time** and **Continuous/Single**.

Sweep Time

Sets the sweep time for every 100 kHz bin. It doesn't represent the whole sweep time, and it only represent the sweep time for each 100 kHz bin.

Remote Command	<code>[:SENSe]:IBSPurious:SWEep:TIME <time></code> <code>[:SENSe]:IBSPurious:SWEep:TIME?</code>
Example	<code>:IBSP:SWE:TIME 1.4ms</code> <code>:IBSP:SWE:TIME?</code>
Dependencies	If Meas Method isn't Sweep, this key will be grayed out
Preset	1.5 ms
State Saved	Yes

Min/Max 100 us/120ms

Acquisition Time

Controls the time the instrument takes to capture a single packet.

Remote Command	<code>[:SENSe]:ACQuisition:TIME <time></code> <code>[:SENSe]:ACQuisition:TIME?</code>
Example	<code>:ACQ:TIME 700uS</code> <code>:ACQ:TIME?</code>
Couplings	Acquisition Time may be clipped by the instrument if the specified acquisition time cannot be performed
Preset	3.0 ms
State Saved	Yes
Min/Max	100 us/100.0 s

Sweep Number

Accesses a menu that enables you to set the number of sweeps.

Remote Command	<code>[:SENSe]:SWEep:NUMBer <integer></code> <code>[:SENSe]:SWEep:NUMBer?</code>
Example	<code>:SWE:NUMB 10</code> <code>:SWE:NUMB?</code>
Preset	10
State Saved	Yes
Min/Max	1/10000

Sweep/Measure

Lets you toggle between **Continuous** and **Single** sweep or measurement operation. The single/continuous state is Meas Global, so the setting affects all measurements.

The front-panel key **Single/Cont** performs exactly the same function

See "[More Information](#)" on page 583

Remote Command	<code>:INITiate:CONTinuous OFF ON 0 1</code> <code>:INITiate:CONTinuous?</code>
Example	Put instrument into Single measurement operation: <code>:INIT:CONT 0</code>

	<code>:INIT:CONT OFF</code>
	Put instrument into Continuous measurement operation:
	<code>:INIT:CONT 1</code>
	<code>:INIT:CONT ON</code>
Preset	ON
	Note that <code>:SYST:PRES</code> sets <code>:INIT:CONT</code> to ON , but <code>*RST</code> sets <code>:INIT:CONT</code> to OFF
State Saved	Saved in instrument state
Annunciation	The Single/Continuous icon in the Meas Bar changes depending on the setting: <ul style="list-style-type: none"> - A line with an arrow is Single - A loop with an arrow is Continuous
Backwards Compatibility Notes	X-Series A-models had Single and Cont hardkeys in place of the SweepSingleCont softkey. In the X-Series A-models, if in single measurement, the Cont hardkey (and <code>INIT:CONT ON</code>) switched to continuous measurement, but never restarted a measurement and never reset a sweep X-Series B-models have a Cont/Single toggle control instead of Single and Cont hardkeys, but it is still true that, if in single measurement, the Cont/Single toggle control never restarts a measurement and never resets a sweep

More Information

Continuous Mode	<p>The instrument takes repetitive sweeps, averages, measurements, etc., when in continuous mode. If in average or Max/Min Hold, and the average/hold count reaches the Average/Hold Num, the count stops incrementing, but the instrument keeps sweeping</p> <p>See the Trace key description under Trace Average for the averaging formula used both before and after the Average/Hold Num is reached. The trigger condition must be met prior to each sweep</p> <p>The type of trace processing for multiple sweeps is set under the Trace key, with choices of Trace Average, Max Hold, or Min Hold</p>
Single Mode	<p>The instrument takes a single sweep when in Single mode, or if in average or Max/Min Hold, or if there is a Waterfall window displayed, it takes multiple sweeps until the average/hold count reaches the Average/Hold Num, then the count stops incrementing, and the instrument stops sweeping</p> <p>See the Trace key description under Trace Average for the averaging formula used. The trigger condition must be met prior to the sweep</p> <p>The type of trace processing for multiple sweeps is set under the Trace key, with choices of Trace Average, Max Hold, or Min Hold</p>

If the instrument is in **Single** measurement mode, pressing the **Cont/Single** toggle control does not zero the count and does not cause the sweep to be reset; the only action is to put the instrument into Continuous measurement operation.

If the instrument is already in **Continuous** sweep:

- `:INIT:CONT 1` has no effect
- `:INIT:CONT 0` places the instrument in Single Sweep but has no effect on the current sequence until $k = N$, at which point the current sequence will stop and the instrument will go to the idle state

See ["Restart" on page 806](#) for details of `:INIT:IMMEDIATE`.

If the instrument is already in **Single** sweep, `:INIT:CONT OFF` has no effect.

If the instrument is already in **Single** sweep, then pressing **Cont/Single** in the middle of a sweep does not restart the sweep or sequence. Similarly, pressing **Cont/Single** does not restart the sweep or sequence if the sweep is not in the idle state (for example, if you are taking a very slow sweep, or the instrument is waiting for a trigger). Even though pressing **Cont/Single** in the middle of a sweep does not restart the sweep, sending `:INIT:IMM` does reset it.

If the instrument is in **Single** sweep, and *not* Averaging/Holding, and you want to take one more sweep, press **Restart**.

If the instrument is in **Single** sweep, *and* Averaging/Holding, and you want to take one more sweep without resetting the Average trace or count, go to **Meas Setup** and increment the average count by 1 by pressing the **Step-Up** key while **Average/Hold Num** is the active function. You can also do this by sending `:CALC:AVER:TCON UP`.

Restart

Restarts the current sweep, or measurement, or set of averaged/held sweeps or measurements. If you are Paused, pressing **Restart** performs a Resume.

The front-panel key **Restart** performs exactly the same function.

The **Restart** function is accessed in several ways:

- Pressing the **Restart** key
- Sending `:INIT:IMM`
- Sending `:INIT:REST`

See ["More Information" on page 585](#)

Remote Command	<code>:INITiate[:IMMEDIATE]</code>
Example	<code>:INIT:IMM</code> <code>:INIT:REST</code>
Notes	<code>:INIT:REST</code> and <code>:INIT:IMM</code> perform exactly the same function

3 Bluetooth Mode
3.5 EDR In-band Spur Emissions

Couplings	Resets average/hold count k. For the first sweep overwrites all active (update = on) traces with new current data. For application modes, it resets other parameters as required by the measurement
Status Bits/OPC dependencies	This is an Overlapped command The STATUS:OPERation register bits 0 through 8 are cleared , <i>except</i> bit 6 (Waiting for Periodic Sync). Initiating a measurement and Waiting for Periodic Sync could be asynchronous The STATUS:QUESTionable register bit 9 (INTEGRity sum) is cleared The SWEEPING bit is set The MEASURING bit is set
Backwards Compatibility Notes	For Spectrum Analysis Mode in ESA and PSA, the Restart hardkey and the :INIT:REST command restarted trace averages (displayed average count reset to 1) for a trace in Clear Write , but did not restart Max Hold and Min Hold In X-Series, the Restart hardkey and the :INIT:REST command restart not only Trace Average , but MaxHold and MinHold traces as well

More Information

The **Restart** function first aborts the current sweep or measurement as quickly as possible. It then resets the sweep and trigger systems, sets up the measurement and initiates a new data measurement sequence with a new data acquisition (sweep) taken once the trigger condition is met.

If the instrument is in the process of aligning when a **Restart** is executed, the alignment finishes before the restart function is performed.

Even when set for **Single** operation, multiple sweeps may be taken when **Restart** is pressed (for example, when averaging/holding is on). Thus, when we say that **Restart** "restarts a measurement", depending on the current settings, we may mean that it:

- Restarts the current sweep
- Restarts the current measurement
- Restarts the current set of sweeps if any trace is in Trace Average, Max Hold or Min Hold
- Restarts the current set of measurements if Averaging, or Max Hold, or Min Hold is on for the measurement

If there is no Average or Max/Min Hold function (no trace in Trace Average or Hold, or **Average/Hold Num** set to 1), and no **Waterfall** window is being displayed, a single sweep is equivalent to a single measurement. A single sweep is taken after the trigger condition is met; and the instrument stops sweeping once that sweep has completed. However, with **Average/Hold Num** >1, and at least one trace set to Trace Average, Max Hold, or Min Hold, or a **Waterfall** window being displayed, multiple sweeps/data acquisitions are taken for a single measurement. The trigger condition

must be met prior to each sweep. The sweep is stopped when the average count k equals the number N set for **Average/Hold Num**.

Once the full set of sweeps has been taken, the instrument goes to the idle state. To take one more sweep without resetting the average count, increment the average count by 1, by pressing the **Step-Up** key while **Average/Hold Number** is the active function, or by sending the remote command **:CALC:AVER:TCON UP**.

Trace Update

The numeric results are not blanked at any time during the restart cycle.

For slow sweeps (see **Trace Update** section in **Trace/Detector**), the traces are updated real-time during the sweep. There may be a special circumstance in application mode measurements where an exception is made and the traces and/or results need to be blanked before displaying the new results.

To summarize, the following list shows what happens to the trace data on various events:

Event	Trace Effect
Clear/Write pressed (even if already in Clear/Write)	Set to mintracevalue
Max Hold pressed (even if already in Max Hold)	Set to mintracevalue
Min Hold pressed (even if already in Min Hold)	Set to maxtracevalue
Trace Average pressed (even if already in Trace Average)	Trace data unaffected but start new sweep/avg/hold
Restart pressed	Trace data unaffected but start new sweep/avg/hold
Parameter requiring restart changed (e.g., RBW)	Trace data unaffected but start new sweep/avg/hold

Sweep and Trigger Reset

Resetting the sweep system resets the average/hold count k to 0. It also resets the set point counter to 0. Resetting the trigger system resets the internal auto trig timer to the value set by the **Auto Trig** control.

Averaging

The weighting factor used for averaging is k . This k is also the average/hold count for how many valid sweeps (data acquisitions) have been done. This k is used for comparisons with N , as those comparisons always needs to be based on valid completed sweeps.

The displayed average/hold, **K**, shows the count for the sweep (data acquisition) in progress. $K = k + 1$, with a limit of N. The displayed value **K** changes from its previous value to 1 as soon as the trigger condition for the first data acquisition (sweep) is met.

Pause/Resume

Pauses a measurement after the current data acquisition is complete.

When paused, the label on the control changes to **Resume**. Pressing **Resume** unpauses the measurement. When paused, pressing **Restart** performs a Resume.

Remote Command	<code>:INITiate:PAUSE</code> <code>:INITiate:RESume</code>
Example	<code>:INIT:PAUS</code> <code>:INIT:RES</code>
Dependencies	Not displayed in Modes that do not support pausing
Annotation	Only on control

3.5.9.2 Sweep Config

This tab accesses controls that enable you to configure the Sweep and Control functions of the analyzer, such as Sweep Rules.

Points

Sets the number of points for each 100KHz bin from 1 to 40001. Points is couple to Sweep Time, so changing sweep time may change the sweep Points.

Remote Command	<code>[:SENSe]:IBSPurious:SWEEp:POINTs <integer></code> <code>[:SENSe]:IBSPurious:SWEEp:POINTs?</code>
Example	<code>:IBSP:SWEE:POIN 500</code> <code>:IBSP:SWEE:POIN?</code>
Couplings	Gray out if Meas Method is FFT
Preset	1001
State Saved	Yes
Min/Max	1/40001

Points Auto State

Enables the auto state for Sweep Points.

Remote Command	<code>[:SENSe]:IBSPurious:SWEep:POINts:AUTO OFF ON 0 1</code> <code>[:SENSe]:IBSPurious:SWEep:POINts:AUTO?</code>
Example	<code>:IBSP:SWE:PION:AUTO OFF</code> <code>:IBSP:SWE: PION:AUTO?</code>
Couplings	If point auto state is auto, Point value will be coupled with sweep time. Point = sweep time / 3.5us
Preset	ON

3.5.9.3 X Scale

This tab accesses controls that enable you to set the horizontal scale parameters.

Ref Value

Sets the X-axis reference level (start time) for the RF Envelope graph, allowing smaller sections of the RF Envelope trace to be viewed in greater detail.

Remote Command	<code>:DISPlay:IBSPurious:WINDow[1]:TRACe:X[:SCALE]:RLEVel <time></code> <code>:DISPlay:IBSPurious:WINDow[1]:TRACe:X[:SCALE]:RLEVel?</code>
Example	<code>:DISP:IBSP:WIND:TRAC:X:RLEV 100us</code> <code>:DISP:IBSP:WIND:TRAC:X:RLEV?</code>
Dependencies	This parameter is only available when RF Envelope View is selected
Couplings	Max value is coupled to Sweep time and X scale/division (see below)
Preset	0.000 s
State Saved	Yes
Range	0 – (Sweep time – (X scale/division * 10))
Min/Max	0 s/ (Sweep time – (X scale/division * 10))

Backwards Compatibility SCPI

Window Numbers used to be a combination of View and Window, now only Window number is sent. For backwards compatibility the old View and Window numbers are honored as below:

Window	Old SCPI Command	New SCPI Command
RF Envelope	<code>:DISP:IBSP:VIEW1:WIND1:TRAC:X:RLEV 100us</code>	<code>:DISP:IBSP:WIND1:TRAC:X:RLEV 100us</code>

Scale/Division

Sets the X-axis scale per division for the RF Envelope graph, allowing smaller sections of the RF Envelope trace to be viewed in greater detail.

Remote Command	<code>:DISPlay:IBSPurious:WINDow[1]:TRACe:X[:SCALe]:PDIVision <time></code> <code>:DISPlay:IBSPurious:WINDow[1]:TRACe:X[:SCALe]:PDIVision?</code>
Example	<code>:DISP:IBSP:WIND:TRAC:X:PDIV 5us</code> <code>:DISP:IBSP:WIND:TRAC:X:PDIV?</code>
Dependencies	This parameter is only available when RF Envelope View is selected
Couplings	Min is coupled to sample time, but maintains at least two points at any time Max value is coupled to X reference value and Sweep time
Preset	10.0 ms
State Saved	Yes
Range	Hardware Dependent
Min/Max	$(2 * \text{Sweep Time}) / (10 * \text{Number of points in RF Envelope}) / (\text{Sweep Time} - \text{Ref Level}) / 10$

Backwards Compatibility SCPI

Window Numbers used to be a combination of View and Window, now only Window number is sent. For backwards compatibility the old View and Window numbers are honored as below:

Window	Old SCPI Command	New SCPI Command
RF Envelope	<code>DISP:IBSP:VIEW1:WIND1:TRAC:X:PDIV 5us</code>	<code>DISP:IBSP:WIND1:TRAC:X:PDIV 5us</code>

Ref Position

Sets the X-axis reference position for the RF Envelope graph, allowing smaller sections of the RF Envelope trace to be viewed in greater detail.

Remote Command	<code>:DISPlay:IBSPurious:WINDow[1]:TRACe:X[:SCALe]:RPOSition LEFT CENTer RIGHT</code> <code>:DISPlay:IBSPurious:WINDow[1]:TRACe:X[:SCALe]:RPOSition?</code> Window numbers are as follows: RF Envelope: 1
Example	<code>:DISP:IBSP:WIND:TRAC:X:RPOS CENT</code> <code>:DISP:IBSP:WIND:TRAC:X:RPOS?</code>

Dependencies	This parameter is only available when RF Envelope View is selected
Preset	LEFT
State Saved	Yes
Range	Left Ctrl Right

Backwards Compatibility SCPI

Window Numbers used to be a combination of View and Window, now only Window number is sent. For backwards compatibility the old View and Window numbers are honored as below:

Window	Old SCPI Command	New SCPI Command
RF Envelope	DISP:IBSP:VIEW1:WIND1:TRAC:X:RPOSCENT	DISP:IBSP:WIND1:TRAC:X:RPOSCENT

Auto Scaling

Sets the X-axis auto scaling for the RF Envelope graph.

Remote Command	:DISPlay:IBSPurious:WINDow[1]:TRACe:X[:SCALe]:COUPle OFF ON 0 1 :DISPlay:IBSPurious:WINDow[1]:TRACe:X[:SCALe]:COUPle?
Example	:DISP:IBSP:WIND:TRAC:X:COUP ON :DISP:IBSP:WIND:TRAC:X:COUP?
Dependencies	This parameter is only available when RF Envelope View is selected
Couplings	When Auto Scaling is On, and you press the Restart front-panel key, this function automatically determines the scale per division and reference values based on the measurement results. When you manually set a value for the X Rel Value or X Scale/Div, this parameter is automatically set to Off
Preset	ON
State Saved	Yes
Range	On Off

Backwards Compatibility SCPI

Window Numbers used to be a combination of View and Window, now only Window number is sent. For backwards compatibility the old View and Window numbers are honored as below:

Window	Old SCPI Command	New SCPI Command
RF Envelope	DISP:IBSP:VIEW1:WIND1:TRAC:X:COUP ON	DISP:IBSP:WIND1:TRAC:X:COUP ON

3.5.10 Trace

The Trace key contains controls that allow you to control the traces.

3.5.10.1 Trace Control

The controls on the Trace Control tab allow you to set the type of the Trace and its update mode.

There are four trace Types: **Clear/Write**, **Trace Average**, **Max Hold** and **Min Hold**. Each type handles data in a different way.

Trace Type

Allows you to select the type of trace you want to you use for the current measurement.

There are four trace Types: **Clear/Write**, **Trace Average**, **Max Hold** and **Min Hold**.

Remote Command	<code>:TRACe:IBSPurious:TYPE WRITe AVERAge MAXHold MINHold</code> <code>:TRACe:IBSPurious:TYPE?</code>
Example	<code>:TRAC:IBSP:TYPE WRIT</code> <code>:TRAC:IBSP:TYPE?</code>
Notes	WRITe = Clear Write AVERAge = Average MAXHold = Maximum Hold MINHold = Minimum Hold
Preset	MAXHold
State Saved	Yes
Range	ClearWrite Average MaxHold MinHold

Clear and Write | Restart Averaging | Restart Max/Min Hold

A button is provided whose function is to start the trace writing as though the trace type had just been selected. Pressing this button is exactly like selecting the current trace type again – the button is provided because to many users it may not be obvious that re-selecting the current selection from a radio button menu will take an action.

This button takes on different labels depending on the Trace Type:

Clear/Write: Clear and Write

Trace Average: Restart Averaging

Max Hold: Restart Max Hold

Min Hold: Restart Min Hold

3.5.10.2 Detector

The Detector tab lets you choose and configure detectors for the selected trace.

Detector

Accesses a menu of functions that enables you to control the detectors for the current measurement. The following choices are available:

Auto - the detector selected depends on marker functions, trace functions, average type, and the trace averaging function.

Normal - the detector determines the peak of the CW-like signals, and it yields alternating maximums and minimums of noise-like signals. This is also referred to as Rosenfell detection.

Average - the detector determines the average of the signal within the sweep points. The averaging method depends upon the Average Type selection (voltage, power, or log scales).

Peak (Positive) - the detector determines the maximum of the signal within the sweep points.

Sample - the detector indicates the instantaneous level of the signal at the center of the sweep points represented by each display point.

Negative Peak - the detector determines the minimum of the signal within the sweep points.

When the detector choice is Auto, the analyzer selects the detector. The selected detector depends on marker functions, trace functions, and trace averaging functions for the current measurement.

Remote Command	<code>[:SENSe]:IBSPurious:DETEctor[:FUNction] NORMal AVERAge POSitive SAMPlE NEGative</code> <code>[:SENSe]:IBSPurious:DETEctor[:FUNction]?</code>
Example	<code>:IBSP:DET NORM</code> <code>:IBSP:DET?</code>
Notes	When you manually select a detector (instead of selecting Auto), that detector is used regardless of other analyzer settings The detector choices are: The Normal detector determines the peak of CW-like signals, and it yields alternating maximums and

3 Bluetooth Mode
 3.5 EDR In-band Spur Emissions

minimums of noise-like signals. This is also referred to as Rosenfell detection

The **Average** detector determines the average of the signal within the sweep points. The averaging method is Power Average (RMS)

The **Peak** detector determines the maximum of the signal within the sweep points

The **Sample** detector indicates the instantaneous level of the signal at the center of the sweep points represented by each display point

The **NegativePeak** detector determines the minimum of the signal within the sweep points

Preset	SAMPlE
State Saved	Yes
Range	Normal Average Peak Sample Negative Peak

Detector Select Auto/Man

This toggle sets the Detector mode to Auto or Manual. In Auto, the proper detector is chosen based on rules that take into account the measurement settings and other analyzer settings.

When any detector is selected by the user, this toggles automatically set to Man (manual).

Remote Command	<code>[:SENSe]:IBSPurious:DETECTOR:AUTO ON OFF 1 0</code>
Example	<code>:IBSP:DET:AUTO ON</code> <code>:IBSP:DET:AUTO?</code>
Couplings	When Detector setting is "Auto" Detector is set to Sample
Preset	ON
State Saved	Yes

3.6 Monitor Spectrum Measurement

The Monitor Spectrum measurement provides a quick, convenient means of looking at the entire spectrum. While the look and feel are similar to Spectrum Analyzer Mode, the functionality is greatly reduced for easy operation. The main purpose of this measurement is to show the spectrum. The default span should cover an appropriate frequency range of the application.

Measurement Commands

The following commands can be used to configure the measurement and retrieve results:

```
:CONFigure:MONitor
:CONFigure:MONitor:NDEFault
:INITiate:MONitor
:FETCh:MONitor[n]?
:READ:MONitor[n]?
:MEASure:MONitor[n]?
```

Remote Command Results

The following table describes the results returned by the queries listed above, according to the index value *n*.

n	Results Returned
1 (or not specified)	Returns trace1 data with comma separated floating numbers
2	Returns trace2 data with comma separated floating numbers
3	Returns trace3 data with comma separated floating numbers

3.6.1 Views

For modes other than MSR, LTEAFDD/LTEATDD and 5GNR, there is a single view, **Normal**.

"Normal" on page 594

This is a single window view of the spectrum

3.6.1.1 Normal

Windows: "Spectrum" on page 595

3 Bluetooth Mode
3.6 Monitor Spectrum Measurement

Single window view of the graph.

Example	<code>:DISP:MON:VIEW RTR</code>
Dependencies	This command is only available in the MSR, LTE-A FDD/TDD and 5G NR modes. In other Modes this is the only View

3.6.2 Windows

This section describes the windows used in the Monitor Spectrum measurement.

3.6.2.1 Spectrum

In all modes except **MSR, LTEAFDD/LTEATDD, and 5GNR**, this is a single trace window showing the spectrum.

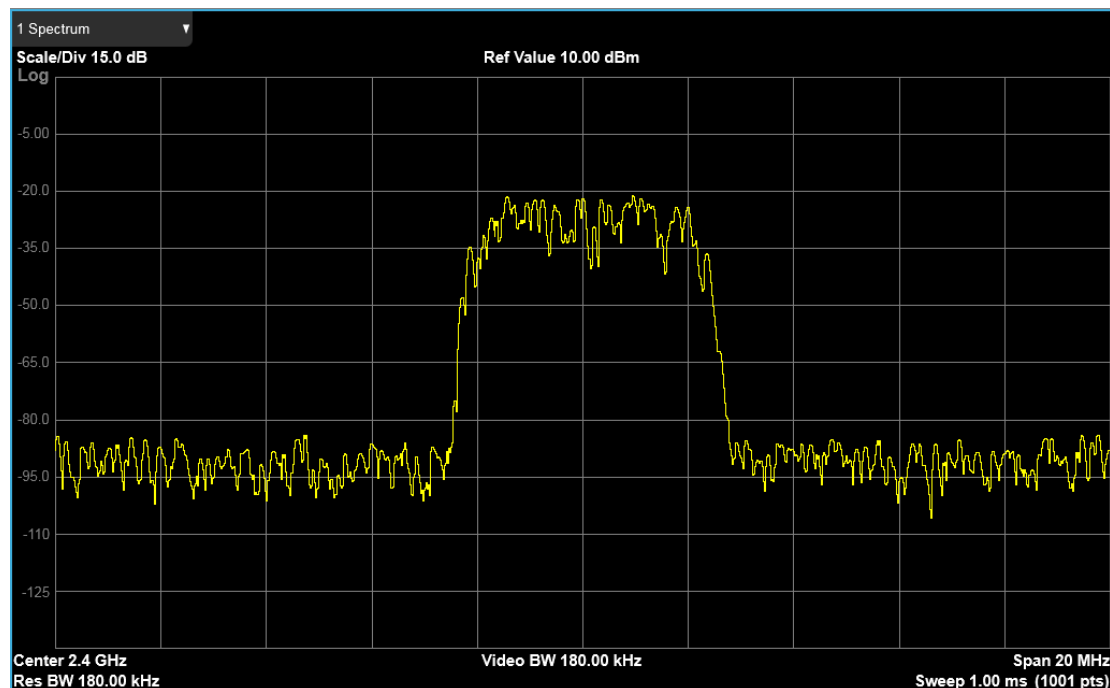

In **LTEAFDD/LTEATDD, MSR and 5GNR Modes**, multi-carriers are supported. The Carrier Attribute on/off and Sub-block Attribute on/off settings (under Display, Meas Display) are defined to allow the carrier and sub-block legends to display.

When the Carrier Attribute is on, the carrier identification and name are shown on the spectrum trace:

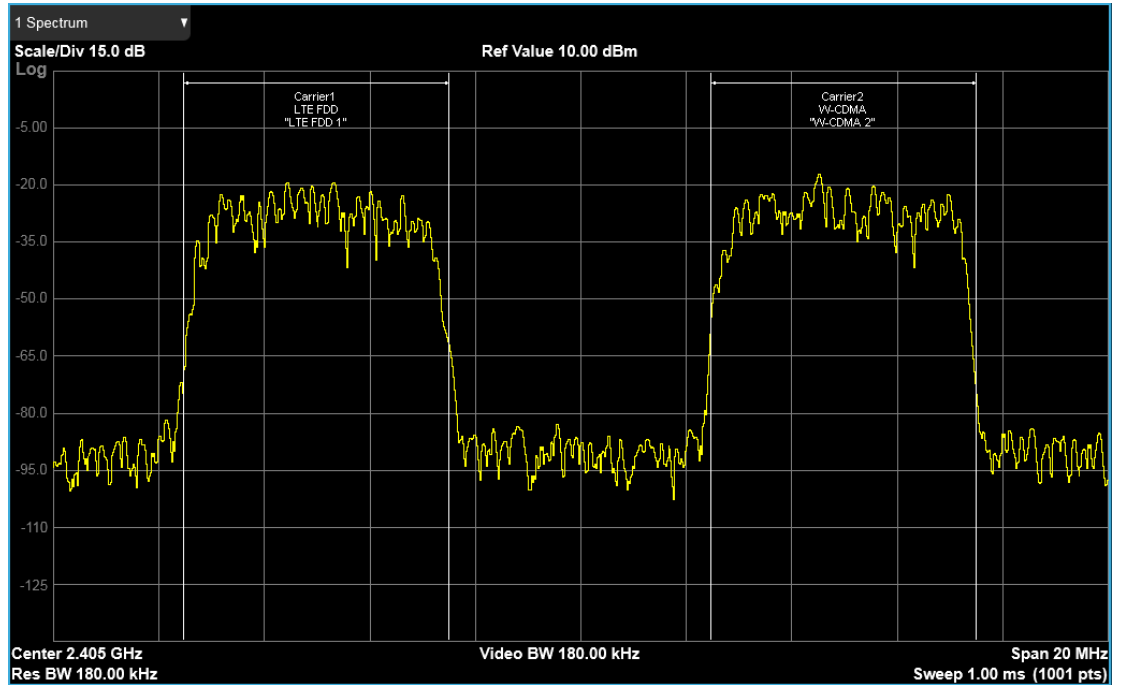

When Carrier and Sub-block attributes are both on, the sub-block scope and name are also shown on the spectrum trace:

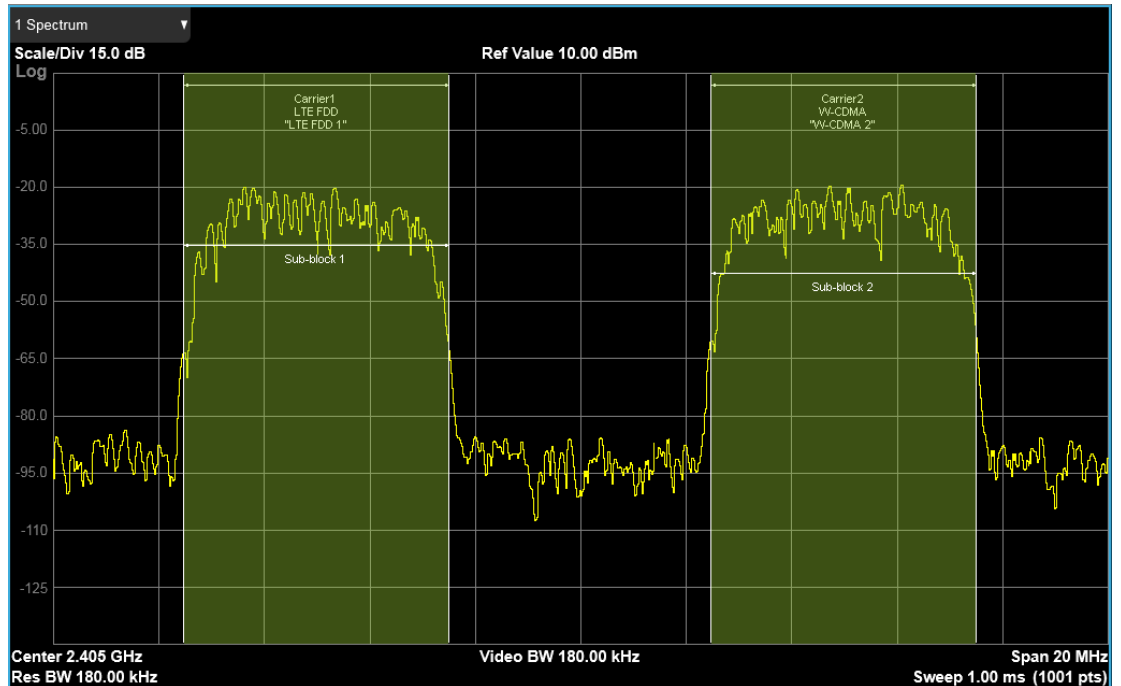

3.6.3 Amplitude

Activates the **Amplitude** menu and selects **Reference Level** or **Reference Value** as the active function, depending on the measurement.

Some features in this menu apply to multiple measurements. Some other features apply only to specific measurements and their controls are blanked or grayed-out in measurements that do not support the feature.

3.6.3.1 Y Scale

Contains controls that pertain to the Y axis parameters of the measurement. These parameters control how data on the vertical (Y) axis is displayed and control instrument settings that affect the vertical axis.

Ref Value

Sets the value for the absolute power reference. The reference line is at the top, center, or bottom of the graticule, depending on the value of "[Ref Position](#)" on page 599.

Remote Command	<code>:DISPlay:MONitor:WINDow[1]:TRACe:Y[:SCALe]:RLEVel <real></code> <code>:DISPlay:MONitor:WINDow[1]:TRACe:Y[:SCALe]:RLEVel?</code>
Example	<code>:DISP:MON:WIND:TRAC:Y:RLEV 2.0</code> <code>:DISP:MON:WIND:TRAC:Y:RLEV?</code>
Couplings	When " Auto Scaling " on page 599 is ON (default), this value is automatically determined by the measurement result. When you set a value manually, Auto Scaling changes to OFF Attenuation is not coupled to " Ref Value " on page 597
Preset	10.00 dBm
State Saved	Saved in instrument state
Min/Max	-250.00 dBm / 250.00 dBm
Annotation	Ref <value> top left of graph
Backwards Compatibility SCPI	<code>:DISPlay:MONitor:VIEW[1]:WINDow[1]:TRACe:Y[:SCALe]:RLEVel</code>

Scale/Div

For measurements that support a logarithmic Y-Axis, **Scale/Div** sets the height of one division of the graticule in the current Y-Axis unit.

Scale/Div also determines the displayed amplitude range in the log plot graph. Since there are usually 10 vertical graticule division on the display, the total amplitude range of the graph is typically 10x this amount. For example, if **Scale/Div** is 10 dB, then the total range of the graph is 100 dB.

Remote Command	<code>:DISPlay:MONitor:WINDow[1]:TRACe:Y[:SCALe]:PDIVision <rel_amp1></code> <code>:DISPlay:MONitor:WINDow[1]:TRACe:Y[:SCALe]:PDIVision?</code>
Example	<code>:DISP:MON:WIND:TRAC:Y:PDIV 5.0 dB</code> <code>:DISP:MON:WIND:TRAC:Y:PDIV?</code>
Couplings	Coupled to Scale Range as follows Scale/Div = Scale Range/10 (number of divisions) When "Auto Scaling" on page 599 is ON , this value is automatically determined by the measurement result When you change a value, Auto Scaling automatically changes to OFF
Preset	10.00 dB / Div
State Saved	Saved in instrument state
Min	0.10 dB
Max	20 dB
Annotation	<value> dB/ left upper of graph
Backwards Compatibility SCPI	<code>:DISPlay:MONitor:VIEW[1]:WINDow[1]:TRACe:Y[:SCALe]:PDIVision</code>

Scale Range

Sets the Y Axis scale range.

Remote Command	<code>:DISPlay:MONitor:WINDow[1]:TRACe:Y[:SCALe]:RANGe <rel_amp1></code> <code>:DISPlay:MONitor:WINDow[1]:TRACe:Y[:SCALe]:RANGe?</code>
Example	<code>:DISP:MON:WIND:TRAC:Y:RANG 100</code> <code>:DISP:MON:WIND:TRAC:Y:RANG?</code>
Couplings	Coupled to Scale/Div as follows Scale Range = Scale/Div * 10 (number of divisions) When you change a value, Auto Scaling automatically changes to OFF
Preset	100 dB
State Saved	Saved in instrument state
Min	1
Max	200

Ref Position

Positions the reference level at the top, center, or bottom of the Y Scale display. Changing the reference position does not change the reference level value.

Remote Command	<code>:DISPlay:MONitor:WINDow[1]:TRACe:Y[:SCALe]:RPOSition TOP CENTer BOTTom</code> <code>:DISPlay:MONitor:WINDow[1]:TRACe:Y[:SCALe]:RPOSition?</code>
Example	<code>:DISP:MON:WIND:TRAC:Y:RPOS CENT</code> <code>:DISP:MON:WIND:TRAC:Y:RPOS?</code>
Preset	TOP
State Saved	Saved in instrument state
Range	TOP CENTer BOTTom
Annotation	The greater than (>) and less than (<) symbols are displayed on both sides of the graph to indicate the Reference Position
Backwards Compatibility SCPI	<code>:DISPlay:MONitor:VIEW[1]:WINDow[1]:TRACe:Y[:SCALe]:RPOSition</code>

Auto Scaling

Toggles the **Auto Scaling** function On or Off.

Remote Command	<code>:DISPlay:MONitor:WINDow[1]:TRACe:Y[:SCALe]:COUPlE 0 1 OFF ON</code> <code>:DISPlay:MONitor:WINDow[1]:TRACe:Y[:SCALe]:COUPlE?</code>
Example	<code>:DISP:MON:WIND:TRAC:Y:COUP OFF</code> <code>:DISP:MON:WIND:TRAC:Y:COUP?</code>
Couplings	When Auto Scaling is ON , and the Restart front-panel key is pressed, this function automatically sets the scale per division to 10 dB and determines the reference values based on the measurement results When you change a value of Scale/Div , Ref Value , or Scale Range , Auto Scaling automatically changes to OFF
Preset	1
State Saved	Saved in instrument state
Range	OFF ON
Backwards Compatibility SCPI	<code>:DISPlay:MONitor:VIEW[1]:WINDow[1]:TRACe:Y[:SCALe]:COUPlE</code>

3.6.3.2 Attenuation

Controls the attenuator functions and interactions between the attenuation system components.

There are two attenuator configurations in the X-Series. One is a Dual-Attenuator configuration consisting of a mechanical attenuator and an optional electronic attenuator. The other configuration uses a single attenuator with combined mechanical and electronic sections that controls all the attenuation functions. Different models in the X-Series come with different configurations.

- See ["Dual-Attenuator Configurations"](#) on page 600
- See ["Single-Attenuator Configuration"](#) on page 601

Most attenuation settings are the same for all measurements – they do not change as you change measurements. Settings like these are called “Meas Global” and are unaffected by **Meas Preset**.

Only available when the hardware set includes an input attenuator, which is typically only the case for Keysight’s benchtop instruments. For example, this tab does *not* appear in VXT models M9421A/10A/11A, nor in UXM. In UXM, all **Attenuation** and **Range** settings are disabled, as the expected input power level is handled by the Call Processing App that drives the DUT power control.

Dependencies In measurements that support the I/Q inputs, unavailable when I/Q is the selected input. Replaced by the **Range** tab in that case

Dual-Attenuator Configurations

Configuration 1: Mechanical attenuator + optional electronic attenuator

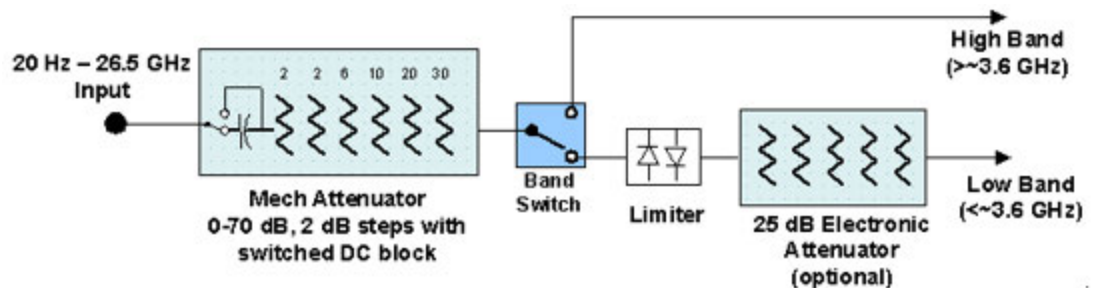

Configuration 2: Mechanical attenuator, no optional electronic attenuator

3 Bluetooth Mode
 3.6 Monitor Spectrum Measurement

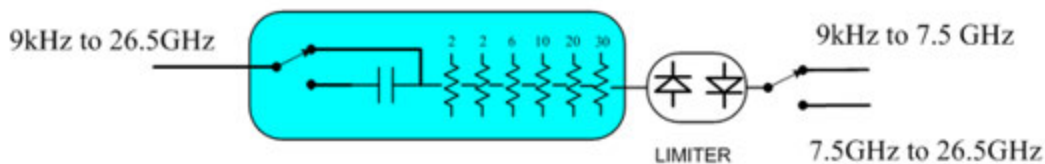

Note that Configuration 2 is not strictly speaking a dual-section attenuator, since there is no electronic section available. However, it behaves exactly like Configuration 1 without the Electronic Attenuator Option EA3, therefore for the sake of this document it is grouped into the “Dual-Attenuator” configuration.

Single-Attenuator Configuration

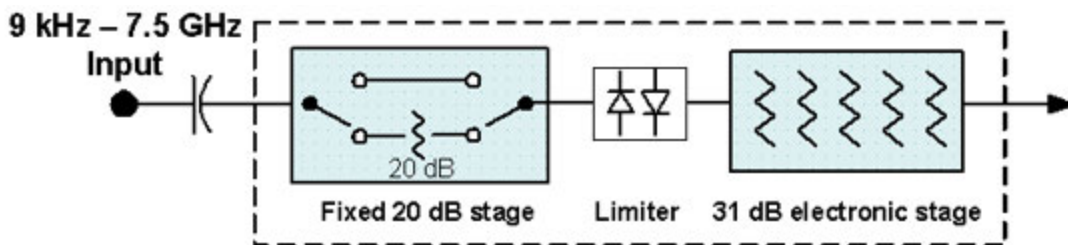

You can tell which attenuator configuration you have by pressing the Attenuation tab, which (in most Modes) opens the Attenuation menu. If the first control in the Attenuation menu says **Mech Atten** you have the Dual-Attenuator configuration. If the first control says **Atten** you have the Single-Attenuator configuration.

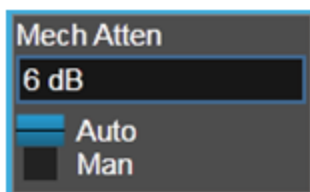

Dual Attenuator

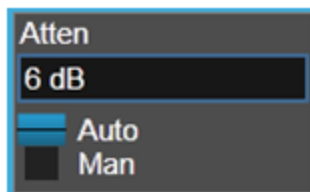

Single Attenuator

(Note that depending on the measurement, there may be no Auto/Man functionality on the Mech Atten control.)

In the Single-Attenuator configuration, you control the attenuation with a single control, as the fixed stage has only two states. In the Dual-Attenuator configuration, both stages have significant range, so you are given separate control of the mechanical and electronic attenuator stages.

When you have the Dual-Attenuator configuration, you may still have only a Single-Attenuator, because unless Option EA3 (the Electronic Attenuator option) is available, and you purchase it, you will have only the mechanical attenuator.

Full Range Atten

This control and **Attenuator Summary** only appear in N9041B, when the RF input is selected, the RF Input Port is set to RF Input 2, and the Full Range Attenuator is installed. The Full Range Attenuator adds a second input attenuator in front of RF Input 2, which enhances the protection and optimizes the performance of the extra internal mixers used by RF Input 2.

Remote Command	<code>[:SENSe]:POWer[:RF]:FRATten <rel_amp1></code> <code>[:SENSe]:POWer[:RF]:FRATten?</code>
Example	<code>:POW:FRAT 14</code> <code>:POW:FRAT?</code>
Notes	When you enter an amplitude value that falls between valid values, the value will be incremented to the next smallest valid value
Dependencies	Only appears if input RF is selected, RF Input Port 2 is selected, and the Full Range Attenuator exists
Couplings	This value is never changed by any coupling, but other couplings use this value. See Reference Level and " Mech Atten " on page 719 command descriptions
Preset	20 dB
State Saved	Saved in instrument state
Min	0 dB
Max	Only valid values are 0, 6, 14, 20 dB
Annotation	<p>When the Input is RF, and the Input Port is RF Input 2, and the Full Range Attenuator is installed: On the Meas Bar, the field "Atten" displays as follows:</p> <ul style="list-style-type: none"> - If the sweep is entirely < 50 GHz, the value shown after "Atten:" is equal to Mech Atten + Elec Atten + Full Range Atten - If the sweep is entirely > 50 GHz, the value shown after "Atten:" is equal to Full Range Atten - If the sweep straddles 50 GHz, the value shown after "Atten:" is preceded by the symbol ">=" and is equal to Full Range Atten <p>In the Amplitude, "Y Scale" on page 597 menu, and the Atten Meas Bar dropdown menu panel, a summary is displayed as follows:</p> <p>"Total Atten below 50 GHz" followed by the value of Full Range Atten + Mech Atten + Elec Atten "Total Atten above 50 GHz" followed by the value of Full Range Atten</p> <p>For example, if Mech Atten = 6 dB, Elec Atten = 4 dB, and Full Range Atten = 20 dB, the summary below is shown:</p> <ul style="list-style-type: none"> - Attenuator summary: - Total Atten below 50 GHz: 30 dB - Total Atten above 50 GHz: 20 dB

Mech Atten

Labeled **Mech Atten** in Dual-Attenuator models and **Atten** in Single-Attenuator models. In the Dual-Attenuator configuration, this control only affects the mechanical attenuator.

Lets you modify the attenuation applied to the RF input signal path. This value is normally auto-coupled to the Ref Level, the Internal Preamp Gain, any External Gain that is entered, and the Max Mixer Level, as described in the table below.

See "[Attenuator Configurations and Auto/Man](#)" on page 605

Remote Command	<pre>[:SENSe]:POWer[:RF]:ATTenuation <rel_amp1> [:SENSe]:POWer[:RF]:ATTenuation? [:SENSe]:POWer[:RF]:ATTenuation:AUTO OFF ON 0 1 [:SENSe]:POWer[:RF]:ATTenuation:AUTO?</pre>
Example	<pre>:POW:ATT 20</pre> <p>Dual-Attenuator configuration: sets the mechanical attenuator to 20 dB Single-Attenuator mode: sets the main attenuation to 20 dB (see below for definition of "main" attenuation) In either case, if the attenuator was in Auto, it is set to Manual <pre>:POW:ATT:AUTO ON</pre> Turn Auto Mech Atten ON</p>
Dependencies	<p>Some measurements do not support Auto setting of "Mech Atten" on page 603. In these measurements, the Auto/Man selection is not available, and the Auto/Man toggle function is not available</p> <p>In Dual-Attenuator configurations, when the electronic attenuator is enabled, the mechanical attenuator has no auto setting, and the Auto/Man toggle function is not available. The state of Auto/Man is remembered and restored when the electronic attenuator is once again disabled. This is described in more detail in "Elec Atten" on page 721</p> <p>See "Attenuator Configurations and Auto/Man" on page 605 for more information on the Auto/Man functionality</p> <p>:POW:ATT:AUTO is only available in measurements that support Mech Atten Auto, such as Swept SA</p>
Couplings	<p>If the RF Input Port is the RF Input:</p> <ul style="list-style-type: none"> - If the USB Preamp is connected to USB, use 0 dB for Mech Atten - Otherwise compute the auto-selected value of Mech Atten based on Reference Level, Int Preamp, External Gain, Ref Level Offset, Max Mixer Level, μW Path Control and IF Gain settings. Limit this value to be no less than 6 dB (total attenuation below 6 dB can never be chosen by Auto) - In the N9041B, if the RF Input Port is RF Input 2, use the formula above and subtract the Full Range Atten value from the result to determine the Mech Atten. Limit the value so that it is never lower than 0 dB and so that total attenuation, including Full Range Atten, is never less than 6 dB

(total attenuation, including Full Range Atten below 6 dB, can never be chosen by Auto)

In External Mixing and BBIQ, where the Attenuator is not in the signal path, the Attenuator setting changes as described above when "Mech Atten" on page 603 is in Auto, but no changes are made to the actual attenuator hardware setting until the input is changed back to the RF Input

For CXA-m with option FSA (Fine-Step Attenuator or 2 dB steps), the FSA-like behavior is only available when the frequency setting is ≤ 7.5 GHz. So, when the frequency is changed from below 7.5 GHz to above 7.5 GHz, the attenuation setting will be changed to a multiple of 10 dB which will be no smaller than the previous setting. For example, 4 dB attenuation will be changed to 10 dB

Preset	<p>The preset for Mech Attenuation is "Auto"</p> <p>The Auto value of attenuation is 10 dB</p> <p>ON</p>
State Saved	Saved in instrument state
Min	<p>0 dB</p> <p>The attenuation set by this control cannot be decreased below 6 dB with the knob or step keys. Values below 6 dB must be directly entered from the keypad or via SCPI. This protects against setting a dangerously small attenuation value, which can put the instrument at risk of damage to input circuitry. If the current mechanical attenuation is below 6 dB, it can be increased with the knob and step keys, but not decreased</p>
Max	<p>CXA Option 503 or 507: 50 dB</p> <p>EXA: 60 dB</p> <p>All other models: 70 dB</p> <p>Note that in the Single-Attenuator configuration, the total of ATT and EATT cannot exceed 50 dB. So, if the EATT is set to 24 dB first, the main attenuation cannot be greater than 26 dB and will be reduced accordingly; if the main attenuator is set to 40 dB first, EATT cannot be greater than 10 dB</p>
Annotation	<p>The current value for Total Atten is displayed in the Measurement Bar at the top of the display. A value appears for Electronic Attenuation only if the Electronic Attenuator is enabled. The annotation appears as</p> <p>Atten: <total> dB (e<elec>)</p> <p>The e letter is in amber in Single-Attenuator configurations</p> <p>For example:</p> <p>Dual-Attenuator configuration:</p> <p>Atten: 24 dB (e14)</p> <p>Indicating the total attenuation is at 24 dB and the electronic attenuation is at 14 dB</p> <p>Single-Attenuator configuration:</p> <p>A: 24 dB (e14)</p> <p>Indicating the total attenuation is at 24 dB and the "soft" attenuation is at 14 dB (see below for definition of "soft" attenuation)</p> <p>When in Manual, a # sign appears in front of Atten in the annotation</p>

Attenuator Configurations and Auto/Man

As described under "Y Scale" on page 597, there are two distinct attenuator configurations available in the X-Series, the single attenuator and Dual-Attenuator configurations. In Dual-Attenuator configurations, we have the mechanical attenuation and the electronic attenuation, and the current total attenuation is the sum of the electronic + mechanical attenuation. In Single-Attenuator configurations, we refer to the attenuation set using "Mech Atten" on page 603 (or `:POW:ATT`) as the "main" attenuation; and the attenuation that is set by `:POW:EATT` as the "soft" attenuation (`:POW:EATT` is honored even in the Single-Attenuator configuration, for compatibility purposes). Then the current total attenuation is the sum of the main + soft attenuation.

See "Elec Atten" on page 721 for more about "soft" attenuation.

NOTE

In some measurements, the **Mech Atten** control has an Auto/Man function. In these measurements, an Auto/Man switch is shown on the **Mech Atten** control:

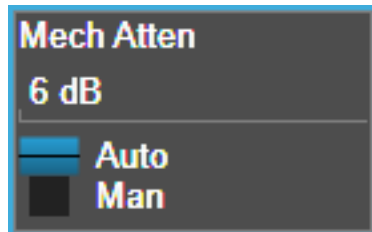

Note that in configurations that include an Electronic Attenuator, this switch is only shown when the Electronic Attenuator is disabled.

In other measurements, **Mech Atten** has no Auto/Man function. In these measurements, no switch is shown on the **Mech Atten** control:

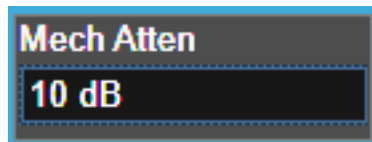

Mech Atten also appears with no switch, as above, in configurations that include an Electronic Attenuator but when the Electronic Attenuator is enabled.

Elec Atten

Controls the Electronic Attenuator in Dual-Attenuator configurations. Does not appear in Single-Attenuator configurations, because the control of both the mechanical and electronic stages of the Single-Attenuator is integrated into the single **Atten** control.

This control includes an **Enable/Disable** toggle switch; it is only possible to enter a value for the Electronic Attenuator when this switch is in the **Enable** position.

For more details about the Electronic Attenuator, see ["More Information" on page 607](#)

Remote Command	<pre>[:SENSe]:POWer[:RF]:EATTenuation <rel_amp1> [:SENSe]:POWer[:RF]:EATTenuation? [:SENSe]:POWer[:RF]:EATTenuation:STATE OFF ON 0 1 [:SENSe]:POWer[:RF]:EATTenuation:STATE?</pre>
Example	<pre>:POW:EATT 10 :POW:EATT? :POW:EATT:STAT ON :POW:EATT:STAT?</pre>
Notes	Electronic Attenuation's specification is defined only when Mechanical Attenuation is 6 dB
Dependencies	<p>Only appears in Dual-Attenuator models with an Electronic Attenuator installed and licensed. Does not appear in models with the Single-Attenuator configuration, because in the Single-Attenuator configuration there is no "electronic attenuator"; there is only a single integrated attenuator (which has both a mechanical and electronic stage). However, in the Single-Attenuator configuration, EATT SCPI commands are accepted for compatibility with other X-series instruments, and set a "soft" attenuation. The "soft" attenuation is treated as an addition to the "main" attenuation value set by the Attenuation control or :POW:ATT, and affects the total attenuation displayed on the Attenuation control and the Meas Bar</p> <p>The electronic attenuator, and the "soft" attenuation function provided in Single-Attenuator configurations, are unavailable above the low band (0-3.6 GHz, 0-3.4 GHz, 0-3 GHz, depending on the model). If the low band range is from 0-3.6 GHz, and Stop Frequency of the instrument is > 3.6 GHz, then the Enabled/Disabled section of the Elec Atten control will be OFF and grayed-out</p> <p>If "Internal Preamp" on page 737 is ON (that is, set to Low Band or Full), the electronic attenuator (and the "soft" attenuation function provided in Single-Attenuator configurations) is unavailable. In this case the Enabled/Disabled section of the Elec Atten control will be OFF and grayed-out</p> <p>If either of the above is true, and the SCPI command is sent, an error indicating that the electronic attenuator is unavailable is returned</p> <p>If both the above are true, pressing the control generates error message -221, in other words, the frequency range lockout takes precedence</p> <p>If the electronic/soft Attenuator is enabled, then the Stop Freq of the instrument is limited to 3.6 GHz and Internal Preamp is unavailable</p> <p>If "LNA" on page 738 is ON, the electronic attenuator (and the "soft" attenuation function provided in Single-Attenuator configurations) is unavailable. In this case the Enabled/Disabled section of the Elec Atten control will be OFF and grayed-out. This coupling works in the following modes/measurements:</p> <ul style="list-style-type: none"> - Channel Power, Occupied BW, ACP, SEM, Spurious Emissions, Power Stat CCDF measurements in all Modes - Transmit On Off Power measurement in 5GNR Mode - Power vs. Time and Transmit Power measurement in GSM/EDGE Mode - Burst Power measurement in Spectrum Analyzer Mode

	The SCPI-only “soft” electronic attenuation for the single-attenuator configuration is not available in all measurements; in particular, it is not available in the Swept SA measurement
Couplings	Enabling and disabling the Electronic Attenuator affects the setting of the Mechanical Attenuator (in Dual-Attenuator configurations). This is described in more detail below and in "Mechanical Attenuator Transition Rules" on page 607
Preset	0 dB OFF (Disabled) for Swept SA measurement ON (Enabled) for all other measurements that support the electronic attenuator
State Saved	Saved in instrument state
Min	0 dB
Max	Dual-Attenuator configuration: 24 dB Single-Attenuator configuration: the total of ATT and EATT cannot exceed 50 dB. So, if the EATT is set to 24 dB first, the main attenuation cannot be greater than 26 dB and will be reduced accordingly; if the main attenuator is set to 40 dB first, EATT cannot be greater than 10 dB
Annotation	See Annotation under the Mech Atten control description

More Information

The electronic attenuator offers finer steps than the mechanical attenuator, has no acoustical noise, is faster, and is less subject to wear. These advantages primarily aid in remote operation and are negligible for front panel use. See ["Using the Electronic Attenuator: Pros and Cons" on page 608](#) for a detailed discussion of the pros and cons of using the electronic attenuator.

For the Single-Attenuator configuration, for SCPI backwards compatibility, the “soft” attenuation feature replaces the Dual-Attenuator configuration’s electronic attenuator. All the same couplings and limitations apply. See ["Attenuator Configurations and Auto/Man" on page 721](#)

Mechanical Attenuator Transition Rules

When the Electronic Attenuator is enabled, the Mechanical Attenuator transitions to a state that has no Auto function. Below are the rules for transitioning the Mechanical Attenuator. Note that the information below *only* applies to the Dual-Attenuator configurations, and *only* when the Electronic Attenuator is installed:

When the Electronic Attenuation is enabled from a disabled state:

- The Mechanical Attenuator is initialized to 10 dB (this is its optimal performance setting). You can then set it as desired with SCPI, numeric keypad, step keys, or knob, and it behaves as it normally would in manual mode
- The Auto/Man state of (Mech) Atten is saved

- The Auto/Man toggle on the (Mech) Atten control disappears, and the auto rules are disabled
- The Electronic Attenuator is set to 10 dB less than the previous value of the Mechanical Attenuator, within the limitation that it must stay within the range of 0 to 24 dB of attenuation

Examples in the Dual-Attenuator configuration:

- Mech Atten at 20 dB. Elec Atten enabled, Mech Atten set to 10 dB, and Elec Atten set to 10 dB. New total attenuation equals the value before Elec Atten enabled
- Mech Atten at 0 dB. Elec Atten enabled, Mech Atten set to 10 dB, and Elec Atten set to 0 dB. New total attenuation does not equal the value before Elec Atten enabled
- Mech Atten at 40 dB. Elec Atten enabled, Mech Atten set to 10 dB, and Elec Atten set to 24 dB. New total attenuation does not equal the value before Elec Atten enabled

When the Electronic Attenuation is disabled from an enabled state:

- The Elec Atten control is grayed out
- The Auto/Man state of (Mech) Atten is restored
- If now in Auto, (Mech) Atten recouples
- If now in Man, (Mech) Atten is set to the value of total attenuation that existed before the Elec Atten was disabled. The resulting value is rounded up to the smallest value possible given the (Mech) Atten Step setting - (That is, 57 dB changes to 58 dB when (Mech) Atten Step is 2 dB)

Using the Electronic Attenuator: Pros and Cons

The electronic attenuator offers finer steps than the mechanical attenuator, has no acoustical noise, is faster, and is less subject to wear.

The “finer steps” advantage of the electronic attenuator is beneficial in optimizing the alignment of the instrument dynamic range to the signal power in the front panel as well as remote use. Thus, you can achieve improved relative signal measurement accuracy. Compared to a mechanical attenuator with 2 dB steps, the 1 dB resolution of the electronic attenuator only gives better resolution when the odd-decibel steps are used. Those odd-decibel steps are less accurately calibrated than the even-decibel steps, so one tradeoff for this superior relative accuracy is reduced absolute amplitude accuracy.

Another disadvantage of the electronic attenuator is that the spectrum analyzer loses its “Auto” setting, making operation less convenient.

Also, the relationship between the dynamic range specifications (TOI, SHI, compression, and noise) and instrument performance are less well-known with the electrical attenuator. With the mechanical attenuator, TOI, SHI, and compression threshold levels increase dB-for-dB with increasing attenuation, and the noise floor does as well. With the electronic attenuator, there is an excess attenuation of about 1 to 3 dB between 0 and 3.6 GHz, making the effective TOI, SHI, and so forth, less well known. Excess attenuation is the actual attenuation relative to stated attenuation. Excess attenuation is accounted for in the instrument calibration.

Adjust Atten for Min Clipping

Sets the combination of mechanical and electronic attenuation and gain based on the current measured signal level so that clipping will be at a minimum.

This is an immediate action function, that is, it executes once, when the control is pressed.

The algorithms that are used for the adjustment are documented under ["Pre-Adjust for Min Clipping" on page 726](#).

Remote Command	<code>[:SENSe]:POWer[:RF]:RANGe:OPTimize IMMEDIATE</code>
Example	<code>:POW:RANG:OPT IMM</code>
Notes	Executing Adjust Atten for Min Clipping initiates the measurement
Dependencies	Does not appear in the Swept SA, RTSA, Monitor Spectrum and Complex Spectrum measurements Appears in the Waveform measurement in 5G NR Mode only

Adjust Atten

Allows you to select;

- Electric attenuator only
- Combination of Electric attenuator and Mechanical attenuator

when `[:SENSe]:POWer[:RF]:RANGe:OPTimize IMMEDIATE` is executed.

Remote Command	<code>[:SENSe]:POWer[:RF]:RANGe:OPTimize:TYPE EONLY COMBined</code> <code>[:SENSe]:POWer[:RF]:RANGe:OPTimize:TYPE?</code>
Example	<code>:POW:RANG:OPT:TYPE EONL</code> <code>:POW:RANG:OPT:TYPE?</code>
Dependencies	Does not appear in the Swept SA, RTSA, Monitor Spectrum and Complex Spectrum measurements Appears in the Waveform measurement in 5G NR Mode only
Preset	<code>COMBined</code>
State Saved	Saved in instrument state

Pre-Adjust for Min Clipping

If this function is **ON**, it applies the adjustment described under "[Adjust Atten for Min Clipping](#)" on page 725 each time a measurement restarts. Therefore, in Continuous measurement mode, it only executes before the first measurement.

In Dual-Attenuator models, you can set **Elec+Mech Atten**, in which case both attenuators participate in the autoranging, or **Elec Atten Only**, in which case the mechanical attenuator does not participate in the autoranging. This latter case results in less wear on the mechanical attenuator and is usually faster.

See "[Adjustment Algorithm](#)" on page 611

Selection	SCPI	Note
Off	OFF	This is the default setting
On	ON	Available in Single-Attenuator instruments. For compatibility with models that do not have an input attenuator, the ON parameter is supported and mapped to COMBined
Elec Atten Only	ELECTrical	Selects only the electric attenuator to participate in auto ranging. This offers less wear on the mechanical attenuator and is usually faster
Elec+Mech Atten	COMBined	In Dual-Attenuator models, this selects both attenuators to participate in the autoranging

Remote Command	<code>[:SENSe]:POWer[:RF]:RANGe:OPTimize:ATTenuation OFF ON ELECTrical COMBined</code> <code>[:SENSe]:POWer[:RF]:RANGe:OPTimize:ATTenuation?</code>
Example	<code>:POW:RANG:OPT:ATT OFF</code> <code>:POW:RANG:OPT:ATT?</code>
Notes	The parameter option ELECTrical sets this function to ON in Single-Attenuator models The parameter option COMBined is mapped to ELECTrical in Single-Attenuator models. If you send COMBined , it sets the function to ON and returns ELEC to a query For SCPI compatibility with models that do not have an input attenuator, the ON parameter is honored and mapped to COMBined
Dependencies	Only appears in Dual-Attenuator models with an Electronic Attenuator installed In instruments with Dual-Attenuator model, when " Elec Atten " on page 721 is OFF or grayed-out, " Pre-Adjust for Min Clipping " on page 610 is grayed-out Does not appear in the Swept SA, RTSA, Monitor Spectrum and Complex Spectrum measurements For the Waveform measurement, available only in 5G NR Mode
Preset	OFF when Elec Atten is Disabled at preset, otherwise ELEC
State Saved	Saved in instrument state
Range	Dual-Attenuator models:

	Off Elec Atten Only Mech + Elec Atten Single-Attenuator models: Off On
--	--

Notes	ON aliases to "Elec Atten Only" (:POW:RANG:OPT:ATT ELEC) OFF aliases to "Off" (:POW:RANG:OPT:ATT OFF) :POW:RANG:AUTO? returns true if :POW:RANG:OPT:ATT is not OFF
-------	--

Backwards Compatibility SCPI	[:SENSe]:POWer[:RF]:RANGe:AUTO ON OFF 1 0 [:SENSe]:POWer[:RF]:RANGe:AUTO?
---------------------------------	--

Adjustment Algorithm

The algorithms for the adjustment are documented below:

Single-Attenuator Models

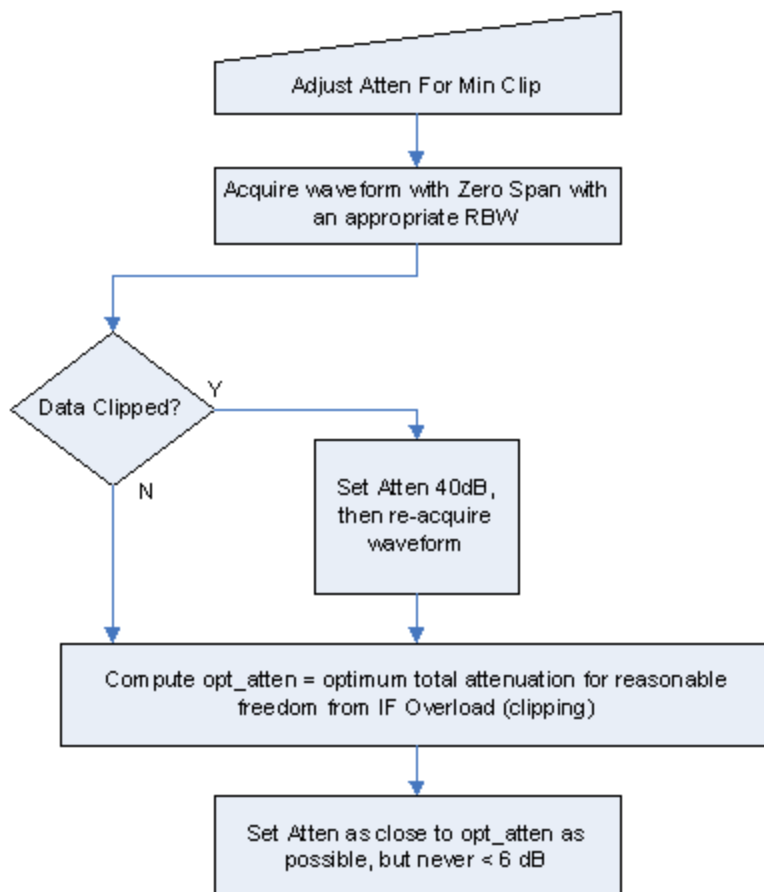

Dual-Attenuator models

"Adjust Atten for Min Clipping" on page 725 or "Pre-Adjust for Min Clipping" on page 610 selection is Mech + Elec Atten:

3 Bluetooth Mode
 3.6 Monitor Spectrum Measurement

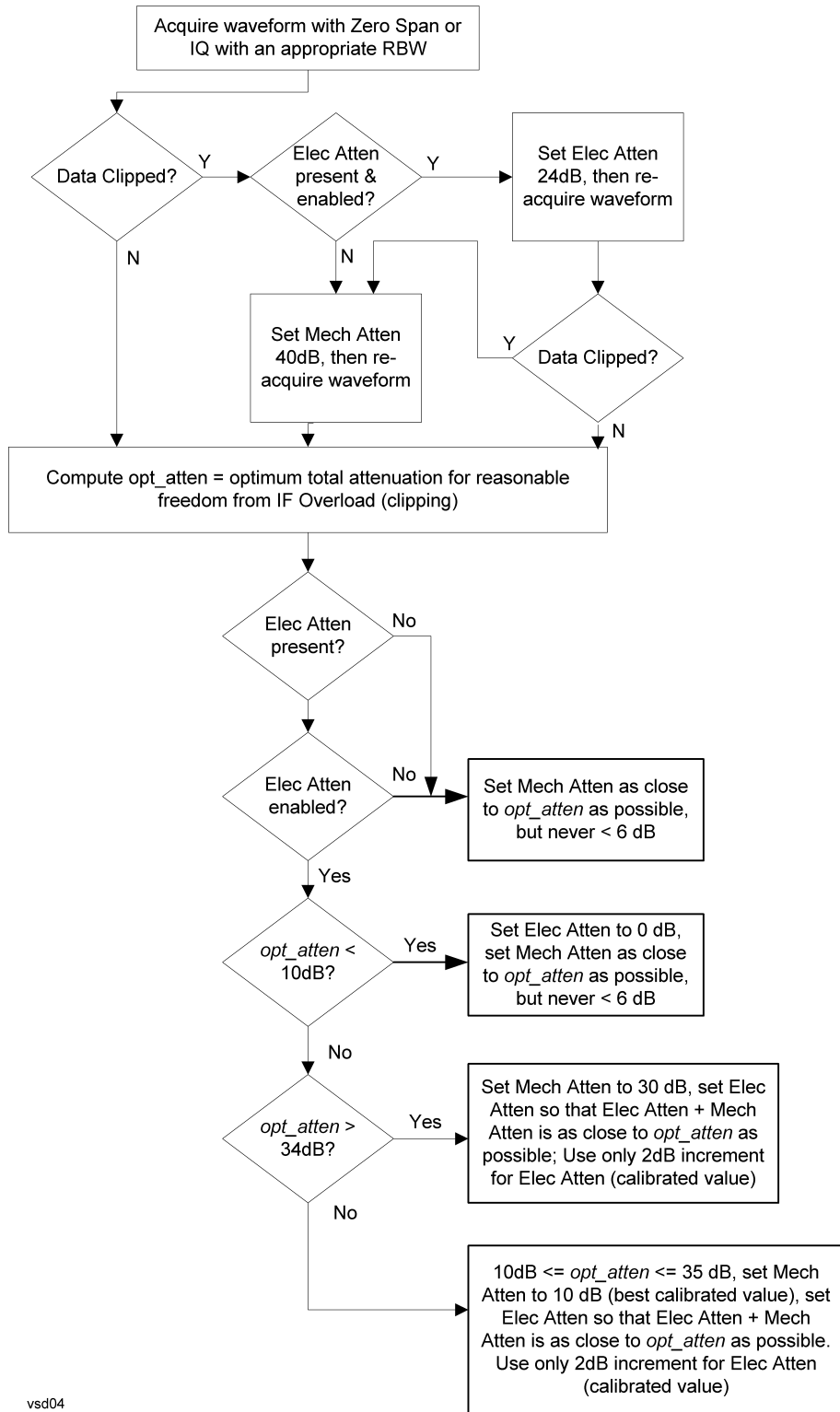

vsd04

"Pre-Adjust for Min Clipping" on page 610 selection is Elec Only.

Note that the **Mech Atten** value is not adjusted, and the value previously set is used. Therefore, there is a case that IF Overload is still observed depending on the input signal level and the Mech Atten setting.

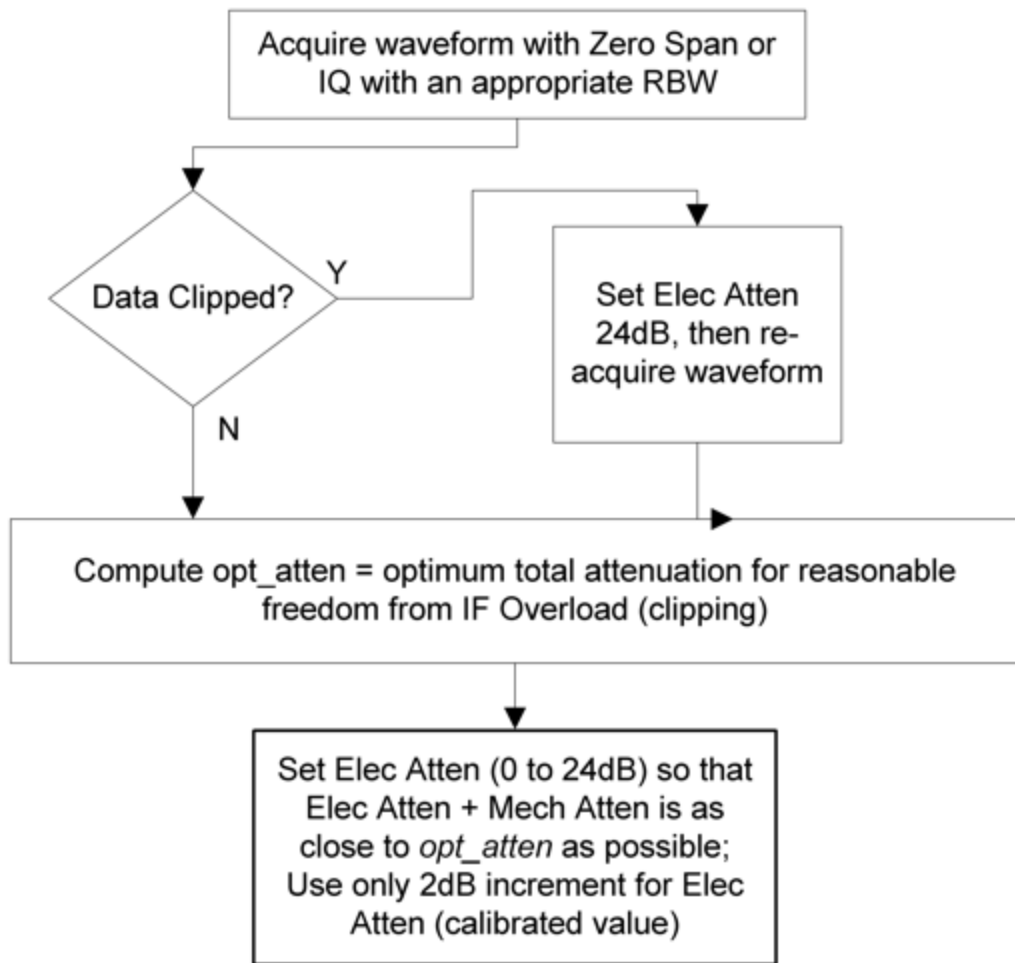

Mech Atten Step

Controls the step size used when making adjustments to the input attenuation.

Labeled **Mech Atten Step** in Dual-Attenuator models and **Atten Step** in Single-Attenuator models. In the Dual-Attenuator configuration, only affects the step size of the mechanical attenuator.

Remote Command `[:SENSe]:POWer[:RF]:ATTenuation:STEP[:INCRement] 10 dB | 2 dB`

3 Bluetooth Mode
 3.6 Monitor Spectrum Measurement

	<code>[:SENSe]:POWer[:RF]:ATTenuation:STEP[:INCRement]?</code>
Example	<code>:POW:ATT:STEP 2</code> <code>:POW:ATT:STEP?</code>
Notes	Has a toggle control on the front panel, but takes a specific value (in dB) when used remotely. The only valid values are 2 and 10
Dependencies	Blanked in EXA, CXA and CXA-m if option FSA (2 dB steps) is not present. If blanked, attempts to set it via SCPI yield an error
Couplings	When the attenuation step size changes, the current mechanical attenuation value is adjusted (if necessary) to be quantized to the new step size. That is, if step is set to 10 dB, mech atten is increased if necessary so it is a multiple of 10 dB
Preset	EXA, CXA and CXA-m: 10 dB (2 dB with option FSA) All other models: 2 dB
State Saved	Saved in instrument state

3.6.3.3 Range (Non-attenuator models)

Only available for Keysight's modular signal analyzers and certain other Keysight products, such as VXT

State Saved	No
-------------	----

Range

Represents the amplitude of the largest sinusoidal signal that could be present within the IF without being clipped by the ADC. For signals with high peak-to-average ratios, the range may need to exceed the rms signal power by a significant amount to avoid clipping.

This is a measurement global setting.

Remote Command	<code>[:SENSe]:POWer[:RF]:RANGe <real></code> <code>[:SENSe]:POWer[:RF]:RANGe?</code>
Example	<code>:POW:RANG 10 dBm</code> <code>:POW:RANG?</code>
Notes	The MIN and MAX values are affected by the External Gain parameters, and by the Center Frequency The hardware compensates for frequency response and alters the Range setting
Preset	0 dBm
State Saved	Yes
Min	-100
Max	100
Annotation	Meas Bar

Adjust Range for Min Clipping

Sets the combination of attenuation and gain based on the current measured signal level so that clipping will be at a minimum.

This is an "immediate action" function, that is, it executes once, when the key is pressed.

This key does not appear in measurements that do not support this functionality.

Remote Command	<code>[:SENSe]:POWer[:RF]:RANGe:OPTimize IMMEDIATE</code>
Notes	Executing Adjust Range for Min Clipping initiates the measurement
Dependencies	Does not appear in the Swept SA and Monitor Spectrum measurements

Pre-Adjust for Min Clipping

If this function is **ON**, it applies the adjustment described under Adjust Range For Min Clipping each time a measurement restarts. Therefore, in Continuous measurement mode, it only executes before the first measurement.

Remote Command	<code>[:SENSe]:POWer[:RF]:RANGe:OPTimize:ATTenuation OFF ON ELECTrical COMBined</code> <code>[:SENSe]:POWer[:RF]:RANGe:OPTimize:ATTenuation?</code>
Notes	Because there is no attenuator control available in these models, the control displays only ON and OFF choices. However, for SCPI compatibility with other platforms, all three parameters (ELECTrical , COMBined , and ON) are honored and all are mapped to ELECTrical , so if any of these three parameters is sent, a subsequent query will return ELEC
Dependencies	Does not appear in the Swept SA and Monitor Spectrum measurements
Preset	OFF for Swept SA measurement; ON for all other measurements that support Pre-Adjust for Min Clipping
State Saved	Saved in instrument state

Adjustment Algorithm

The algorithm for the adjustment is documented below:

3 Bluetooth Mode
3.6 Monitor Spectrum Measurement

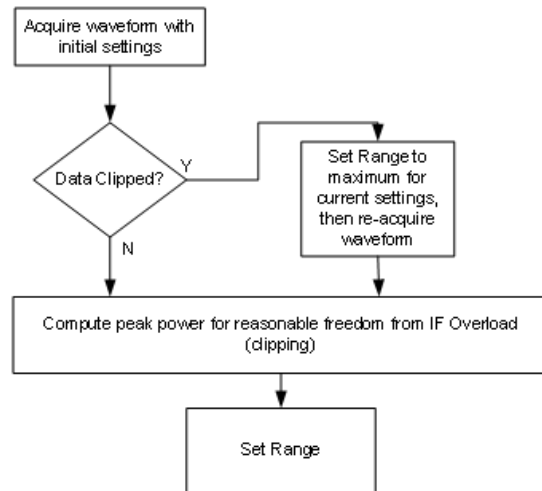

Peak-to-Average Ratio

Used with "[Range \(Non-attenuator models\)](#)" on page 731 to optimize the level control in the instrument. The value is the ratio, in dB, of the peak power to the average power of the signal to be measured. A ratio of 0 should be used for sinusoidal signals; for 802.11g OFDM signals use 9 dB.

All Modes show the current value of Peak-to-Average ratio on the control. However, some Modes do not permit changing the value. In these situations, the control is grayed-out.

Remote Command	<code>[:SENSe]:POWer[:RF]:RANGe:PARatio <real></code> <code>[:SENSe]:POWer[:RF]:RANGe:PARatio?</code>
Example	<code>:POW:RANG:PAR 12 dB</code>
Notes	In some Modes, this parameter is read-only; meaning the value will appear on the control and query via SCPI, but is not changeable. In such applications the control is grayed-out. Attempting to change the value via SCPI will be ignored but no error message will be generated
Dependencies	Does not appear in Spectrum Analyzer Mode
Preset	10 dB VXT Models M9410A/11A: 0 dB
State Saved	Saved in instrument state
Min	0 dB
Max	20 dB VXT Models M9410A/11A: 50 dB

Mixer Lvl Offset

This is an advanced setting to adjust target Range at the input mixer, which in turn affects the signal level in the instrument's IF. This setting can be used when additional optimization is needed after setting "[Peak-to-Average Ratio](#)" on page 733. Positive values of offset optimize noise performance over distortion, negative values optimize distortion performance over noise.

Remote Command	<code>[:SENSe]:POWer[:RF]:RANGe:MIXer:OFFSet <real></code> <code>[:SENSe]:POWer[:RF]:RANGe:MIXer:OFFSet?</code>
Example	<code>:POW:RANG:MIX:OFFS -5 dB</code>
Preset	0 dB
State Saved	Saved in instrument state
Min	-35 dB VXT Models M9410A/11A: -34 dB
Max	30 dB

3.6.3.4 Signal Path

Contains controls that pertain to the routing of the signal through the frontend of the instrument.

In general, only appears in instruments whose hardware supports this signal routing. For example, this tab does not appear in many of the modular instrument products, including VXT Model M9421A, or UXM.

This tab *does* appear in VXT Models M9410A/11A, because "[Software Preselection](#)" on page 749 is under this tab, and VXT Models M9410A/11A implement a version of Software Preselection.

Presel Center

Adjusts the centering of the preselector filter to optimize the amplitude accuracy at the frequency of the selected marker. If the selected marker is not on when **Presel Center** is pressed, the instrument turns on the selected marker, performs a peak search, and then performs centering on the marker's center frequency. If the selected marker is already on and between the start and stop frequencies of the instrument, the instrument performs the preselector calibration on that marker's frequency. If the selected marker is already on, but outside the frequency range between **Start Freq** and **Stop Freq**, the instrument first performs a peak search, and then performs centering on the marker's center frequency.

3 Bluetooth Mode
3.6 Monitor Spectrum Measurement

The value displayed on **"Preselector Adjust" on page 736** changes to reflect the new preselector tuning.

Certain considerations should be observed to ensure proper operation, as detailed in **"Proper Preselector Operation" on page 619**.

Remote Command	<code>[:SENSe] :POWer [:RF] :PCENter</code>
Example	<code>:POW:PCEN</code>
Notes	The rules outlined above under the control description apply for the remote command as well as the key. The result of the command depends on marker position, etc. Any message generated by the control press is also generated in response to the remote command
Dependencies	Does not appear in CXA-m, nor in VXT Models M9410A/11A Grayed-out if the microwave preselector is off <ul style="list-style-type: none"> - If the selected marker's frequency is below Band 1, an advisory message is generated "Preselector not used in this frequency range" and no action is taken - Grayed-out if entirely in Band 0, that is, if Stop Freq is below about 3.6 GHz Grayed-out if entirely above 50 GHz, that is, if Start Freq is above 50 GHz - Blanked in models that do not include a preselector, such as Option 503. If the remote command is sent in these instruments, accepted without error, and the query always returns 0 - Grayed-out in the Spectrogram View
Couplings	The active marker position determines where the centering will be attempted If the instrument is in a measurement such as averaging when centering is initiated, the act of centering the preselector restarts averaging, but the first average trace will not be taken until the centering is completed The offset applied to do the centering appears in "Preselector Adjust" on page 736
Status Bits/OPC dependencies	When centering the preselector, *OPC does not return true until the process is complete and a subsequent measurement has completed, nor are results returned in response to <code>:READ</code> or <code>:MEASure</code> queries The Measuring bit remains set (true) while this command is operating, and does not go false until the subsequent sweep/measurement has completed

Proper Preselector Operation

Certain considerations should be observed to ensure proper operation:

1. If the selected marker is **Off**, the instrument turns on a marker, performs a peak search, and adjusts the preselector using the selected marker's frequency. It uses the "highest peak" peak search method unqualified by threshold or excursion, so that there is no chance of a 'no peak found' error. It continues with that peak, even if it is the peak of just noise. Therefore, for this operation to work properly, there should be a signal on-screen in a preselected range for the peak search to find

2. If the selected marker is already **On**, the instrument attempts the centering at that marker's frequency. There is no preselector for signals below about 3.6 GHz, so if the marker is on a signal below 3.6 GHz, no centering is attempted, and an advisory message is generated
3. In some models, the preselector can be bypassed. If it is bypassed, no centering is attempted in that range and a message is generated

Preselector Adjust

Lets you manually adjust the preselector filter frequency to optimize its response to the signal of interest. Only available when "**Presel Center**" on page 734 is available.

For general purpose signal analysis, using **Presel Center** is recommended. Centering the filter minimizes the impact of long-term preselector drift. **Preselector Adjust** can be used instead to manually optimize the preselector. One application of manual optimization would be to peak the preselector response, which both optimizes the signal-to-noise ratio and minimizes amplitude variations due to small (short-term) preselector drifting.

When **Presel Center** is performed, the offset applied to do the centering becomes the new value of **Preselector Adjust**.

Remote Command	<code>[:SENSe]:POWer[:RF]:PADJust <freq></code> <code>[:SENSe]:POWer[:RF]:PADJust?</code>
Example	<code>:POW:PADJ 100KHz</code> <code>:POW:PADJ?</code>
Notes	The value on the control is displayed to 0.1 MHz resolution
Dependencies	<ul style="list-style-type: none"> - Does not appear in CXA-m - Does not appear in VXT Models M9410A/11A - Grayed-out if microwave preselector is off - Grayed-out if entirely in Band 0, that is, if Stop Freq is lower than about 3.6 GHz - Grayed-out if entirely above 50 GHz, that is, if Start Freq is higher than 50 GHz - Blank in models that do not include a preselector, such as Option 503. If the command is sent in these instruments, it is accepted without error, and the query always returns 0 - Grayed-out in the Spectrogram View
Preset	0 MHz
State Saved	The Preselector Adjust value set by " Presel Center " on page 734, or by manually adjusting Preselector Adjust Not saved in instrument state, and does not survive a Preset or power cycle

Min	-500 MHz
Max	500 MHz
Backwards Compatibility SCPI	<code>[:SENSe]:POWer[:RF]:MW:PADJust</code> <code>[:SENSe]:POWer[:RF]:MMW:PADJust</code>
Notes	The command has no effect, and the query always returns MWAVE
Backwards Compatibility SCPI	<code>[:SENSe]:POWer[:RF]:PADJust:PRESelector MWAVE MMWave EXternal</code> <code>[:SENSe]:POWer[:RF]:PADJust:PRESelector?</code>

Internal Preamp

Accesses a menu of controls for the internal preamps. Turning on the preamp gives a better noise figure, but a poorer inter-modulation distortion (TOI) to noise floor dynamic range. You can optimize this setting for your measurement.

The instrument takes the preamp gain into account as it sweeps. If you sweep outside of the range of the preamp, the instrument will also account for that. The displayed result always reflects the correct gain.

For some measurements, when the preamp is on and any part of the displayed frequency range is below the lowest frequency for which the preamp has specifications, a warning condition message appears in the status line. For example, for a preamp with a 9 kHz lowest specified frequency: "Preamp: Accy unspec'd below 9 kHz".

Selection	Example	Note
Off	<code>:POW:GAIN OFF</code>	
Low Band	<code>:POW:GAIN ON</code> <code>:POW:GAIN:BAND LOW</code>	Sets the internal preamp to use only the low band. The frequency range of the installed (optional) low-band preamp is displayed in square brackets on the Low Band selection in the dropdown
Full Range	<code>:POW:GAIN ON</code> <code>:POW:GAIN:BAND FULL</code>	Sets the internal preamp to use its full range. The low band (0-3.6 GHz, 0-3.4 GHz, 0-3 GHz, depending on the model) is supplied by the low band preamp and the frequencies above low band are supplied by the high band preamp The frequency range of the installed (optional) low-band preamp is displayed in square brackets on the Full Range selection in the dropdown. If the high band option is not installed the Full Range selection does not appear

NOTE

The maximum **Center Frequency** for Low Band, displayed in square brackets, can change based on the selected IFBW for measurements that support IFBW (for example, Waveform measurement across all Modes that support it). In certain models (such as N9042B & N9032B), IFBW values ≤ 40 MHz have a maximum Low Band frequency of 3.6 GHz, while $40 \text{ MHz} < \text{IFBW} \leq 1 \text{ GHz}$ have a maximum of 3.3 GHz, and $1 \text{ GHz} < \text{IFBW} \leq 1.5 \text{ GHz}$ have a maximum of 3.5 GHz. IFBW values $> 1.5 \text{ GHz}$ do not support a **Center Frequency** that can reach the Low Band maximum frequency. In these cases, **N/A** is displayed in the square brackets for Low Band.

Remote Command	<pre>[:SENSe]:POWer[:RF]:GAIN:BAND LOW FULL [:SENSe]:POWer[:RF]:GAIN:BAND? [:SENSe]:POWer[:RF]:GAIN[:STATE] OFF ON 0 1 [:SENSe]:POWer[:RF]:GAIN[:STATE]?</pre>
Example	<pre>:POW:GAIN:BAND LOW :POW:GAIN:BAND? :POW:GAIN OFF :POW:GAIN?</pre>
Dependencies	<p>Not available on all hardware platforms. If the preamp is not present or is unlicensed, this control is not shown</p> <p>Does not appear in VXT Models M9410A/11A/15A/16A</p> <p>If <code>:POW:GAIN:BAND FULL</code> is sent when a low band preamp is available, the preamp band parameter is set to <code>LOW</code> instead of <code>FULL</code>, and an "Option not installed" message is generated</p> <p>Not available when the electronic/soft attenuator is enabled</p>
Preset	<pre>LOW OFF</pre>
State Saved	Saved in instrument state
Annotation	<p>When the USB Preamp is not connected to USB, the Preamp annotation in the Meas Bar says "Off" if the preamp is off and displays the frequency range of the low band or full range preamp depending on the setting. For example, if the Preamp is set to Low Band and the Low Band is 3.6 GHz the annotation says "3.6 GHz". If it is a 13.6 GHz preamp and it is set to Full Range the annotation says "13.6 GHz"</p> <p>When the USB Preamp is connected to USB, the Preamp annotation says "Preamp: USB" if the internal preamp is off or "Preamp: USB, Int" if the internal preamp is on (only for measurements that support the USB preamp)</p>

LNA

Lets you turn the Low Noise Amplifier (**LNA**) on or off.

LNA is an additional preamplifier that provides superior DANL and frequency range compared to **"Internal Preamp" on page 737**. LNA provides lower system noise

figure, especially at frequencies above 100 MHz, and can be operated up to the full range of 50 GHz instruments.

For best possible sensitivity, **LNA** can be turned on *together* with "**Internal Preamp**" on page 737, although if you operate both preamps together, note that the TOI (distortion) specifications are impacted. The sensitivity improvement of this combination is substantial when operating in high band (frequencies above 3.6 GHz).

For more details about annotation, see "**More Information**" on page 623

Remote Command	<code>[:SENSe]:POWer[:RF]:GAIN:LNA[:STATe] OFF ON 0 1</code> <code>[:SENSe]:POWer[:RF]:GAIN:LNA[:STATe]?</code>
Example	<code>:POW:GAIN:LNA ON</code>
Dependencies	Requires Option LNA, except for VXT models M9415A/16A Does not appear in VXT models M9421A/10A/11A May not appear in some measurements LNA is not available when the electronic/soft attenuator is enabled
Preset	OFF
State Saved	Saved in State

More Information

When **LNA** is installed, the preamp annotation changes to show the state of both **LNA** and **Internal Preamp**. Below is an example:

```
Atten: 8 dB
Pre: Int on, LNA on
µW Path: LNP, On
Source: Off
```

Note that when operating entirely in the low band (below about 3.6 GHz), if **LNA** is on, **Internal Preamp** is switched off (even if you have its switch set to **ON**). This is because the noise performance is actually degraded in low band if both preamps are on. In this case, the annotation reflects the actual state of the two preamps, but the **Internal Preamp** annotation displays in amber, to warn you that the actual state of **Internal Preamp** does not match its switch control display:

```
Atten: 8 dB
Pre: Int off, LNA on
µW Path: LNP, On
Source: Off
```

µW Path Control

Options for this control include **µW Preselector Bypass** (Option MPB), **Low Noise Path** (Option LNP) and **Full Bypass Enable** in the High Band path circuits.

When the μ W Preselector is bypassed, flatness is improved, but will be subject to spurs from out of band interfering signals. When **Low Noise Path Enable** is selected, the instrument automatically bypasses certain circuitry in the high frequency bands that can contribute to noise, when it is appropriate based on other instrument settings.

For most applications, the preset state is **Standard Path**, which provides the best remote-control throughput, minimizes acoustic noise from switching and minimizes the risk of wear in the hardware switches, particularly in remote test scenarios where both low band and high band setups will follow in rapid succession. In this path, the bypass of the low band/high band switch and microwave preamp is never activated, which can cause some noise degradation but preserves the life of the bypass switch.

For applications that utilize the wideband IF paths, the preset state is **μ W Preselector Bypass**, if option MPB is present. This is because, when using a wideband IF such as the 140 MHz IF, the μ W Preselector's bandwidth can be narrower than the available IF bandwidth, causing degraded amplitude flatness and phase linearity, so it is desirable to bypass the preselector in the default case.

You may choose **Low Noise Path Enable** for a lower noise floor, especially in the 21–26.5 GHz region, though without improving many measures of dynamic range, and without giving the best possible noise floor. The preamp, if purchased and used, gives better noise floor than does **Low Noise Path Enable**, but the preamp's compression threshold and third-order intercept are much poorer than that of **Low Noise Path Enable**.

A fourth choice is **Full Bypass Enable**, which combines **μ W Preselector Bypass** and **Low Noise Path Enable**. Because this can bypass most of the circuitry between the input and the first mixer, care should be taken when using this setting to avoid damaging the mixer. **Full Bypass Enable** is only available if both options LNP and MPB are present, as well as option FBP.

Path	Example	Note
Standard Path	:POW:MW:PATH STD	Normal setting for most measurements. μ W Preselector in circuit, Low Noise Path disabled
Low Noise Path Enable	:POW:MW:PATH LNP	See " Low Noise Path Enable " on page 628
μ W Preselector Bypass	:POW:MW:PATH MPB	See " μW Preselector Bypass " on page 630
Full Bypass Enable	:POW:MW:PATH FULL	See " Full Bypass Enable " on page 631

Remote Command [:SENSe]:POWer[:RF]:MW:PATH STD | LNPath | MPBypass | FULL
[:SENSe]:POWer[:RF]:MW:PATH?

Example :POW:MW:PATH LNP
Enables the Low Noise path

3 Bluetooth Mode
3.6 Monitor Spectrum Measurement

: POW: MW: PATH?

Notes If "**Presel Center**" on page 734 is performed, the instrument will momentarily switch to the Standard Path, regardless of the setting of **μW Path Control**

The DC Block will always be switched in when the low noise path is switched in, to protect succeeding circuitry from DC. Note that this does not mean "when the low noise path is enabled" but when, based on the Low Noise Path rules, the path is actually switched in. This can happen when the selection is **Low Noise Path Enable** or **Full Bypass Enable**. In the case where the DC Block is switched in the instrument is now AC coupled. However, if you selected DC coupling, the UI would still behave as though it were DC coupled, including all annunciation, warnings, status bits, and responses to SCPI queries. This is because, based on other settings, the instrument could switch out the low noise path at any time and hence go back to being DC coupled

Alignment switching ignores the settings in this menu, and restores them when finished

Dependencies Does not appear in CXA-m, VXT Models M9410A/11A, nor in BBIQ and External Mixing

- The **Low Noise Path Enable** selection does not appear unless Option LNP is present and licensed
- The **μW Preselector Bypass** selection does not appear unless Option MPB is present and licensed
- The **Full Bypass Enable** selection does not appear unless options LNP and MPB are both present as well as option FBP

In any of these cases, if the required options are not present and the SCPI command is sent, error - 241, "Hardware missing; Option not installed" is generated

Low Noise Path Enable and **Full Bypass Enable** are grayed-out if the current measurement does not support them

Low Noise Path Enable and **Full Bypass Enable** are not supported in Avionics and MMR Modes (non-modulation measurements). In any of these cases (that is, the feature is not supported in either measurement or Mode), if the SCPI command is sent, the following error is generated: -221, "Setting Conflict; Feature not supported for this measurement"

Preset	Mode	Value
	IQ Analyzer	MPB option present and licensed: MPB
	Pulse	MPB option not present and licensed: STD
	Avionics	
	All other Modes	STD

State Saved Save in instrument state

Range Standard Path | Low Noise Path Enable | μW Presel Bypass | Full Bypass Enable

Annotation In the Meas Bar, if the Standard path is chosen:
μW Path: Standard

If Low Noise Path is enabled but the LNP switch is not thrown:
μW Path: LNP,Off

If the Low Noise Path is enabled and the LNP switch is thrown:
μW Path: LNP,On

If the preselector is bypassed:

μW Path: Bypass

If Full Bypass Enable is selected but the LNP switch is not thrown:

μW Path: FByp,Off

If Full Bypass Enable is selected and the LNP switch is thrown:

μW Path: FByp,On

μW Path Control Auto

In VMA, WLAN, 5G NR, CQM Modes, an **Auto/Man** switch is added to **μW Path Control**:



This allows the function to automatically switch based on certain Auto Rules as shown below:

VMA Mode

Measurement	When μW Path Control is in Auto
Digital Demod	Use Standard Path unless tuned frequency > 3.6 GHz and IFBW > 15 MHz, in which case choose Preselector Bypass
Monitor Spectrum	Always Presel Bypass
IQ Waveform	Use Standard Path unless tuned frequency > 3.6 GHz and IFBW > 15 MHz, in which case choose Preselector Bypass
Custom OFDM	Use Standard Path unless tuned frequency > 3.6 GHz and IFBW > 15 MHz, in which case choose Preselector Bypass
Channel Power	Always Presel Bypass
Occupied BW	Always Presel Bypass
CCDF	Use Standard Path unless tuned frequency > 3.6 GHz and IFBW > 15 MHz, in which case choose Preselector Bypass
ACP	Always Presel Bypass
SEM	Always Presel Bypass
Spurious Emissions	Always Standard Path

WLAN Mode

Measurement	When μW Path Control is in Auto
Modulation	Always Presel Bypass

3 Bluetooth Mode
3.6 Monitor Spectrum Measurement

Measurement	When μ W Path Control is in Auto
Analysis	
Spectral Flatness	Always Presel Bypass
Power vs Time	Always Presel Bypass
Monitor Spectrum	Always Presel Bypass
IQ Waveform	Always Presel Bypass
Channel Power	Always Presel Bypass
Occupied BW	Always Presel Bypass
CCDF	Always Presel Bypass
SEM	For 11be 320M, when 'Enabled Wideband IF for FFT' is OFF or 'Sweep Type Rule' is Best Dynamic Range, auto μ W path is standard For other cases, auto μ W path is presel bypass if presel bypass is enabled, auto μ W path is standard if presel bypass is not enabled
Spurious Emissions	Always Standard Path

5G NR Mode

Measurement	When μ W Path Control is in Auto
Modulation Analysis	Use Standard Path unless tuned frequency > 3.6 GHz and IFBW > 15 MHz, in which case choose Full Bypass if conditions warrant(FBP Option is available and "Allow Full Bypass in Auto" is On), otherwise choose Preselector Bypass
Monitor Spectrum	Always Standard Path
IQ Waveform	Use Standard Path unless tuned frequency > 3.6 GHz and IFBW > 15 MHz, in which case choose Full Bypass if conditions warrant(FBP Option is available and "Allow Full Bypass in Auto" is On), otherwise choose Preselector Bypass
Channel Power	Always Standard Path
Occupied BW	Always Standard Path
CCDF	Use Standard Path unless tuned frequency > 3.6 GHz and IFBW > 15 MHz, in which case choose Preselector Bypass
ACP	Always Standard Path
SEM	Always Standard Path
Spurious Emissions	Always Standard Path
Transmit On Off Power	Use Standard Path unless tuned frequency > 3.6 GHz and Info BW > 15 MHz, in which case choose Preselector Bypass

Channel Quality Mode

Measurement	When μ W Path Control is in Auto
Group Delay	Use Standard Path unless tuned frequency > 3.6 GHz and IFBW > 15 MHz, in which case choose Full Bypass if conditions warrant(FBP Option is available and

Measurement	When μ W Path Control is in Auto
Monitor Spectrum	“Allow Full Bypass in Auto” is On), otherwise choose Preselector Bypass
IQ Waveform	Always Standard Path
CCDF	Use Standard Path unless tuned frequency > 3.6 GHz and IFBW > 15 MHz, in which case choose Preselector Bypass
Remote Command	<code>[:SENSe] :POWer [:RF] :MW :PATH :AUTO ON OFF 1 0</code> <code>[:SENSe] :POWer [:RF] :MW :PATH :AUTO?</code>
Example	<code>:POW:MW:PATH:AUTO ON</code> <code>:POW:MW:PATH:AUTO?</code>
Dependencies	Only appears in VMA, WLAN, 5G NR and CQM Modes
Couplings	See the tables above
Preset	ON
Range	ON OFF

Low Noise Path Enable

Low Noise Path Enable provides a lower noise floor under some circumstances, particularly when operating in the 21–26.5 GHz region. With the Low Noise Path enabled, the low band/high band switch and microwave preamp are bypassed whenever *all* the following are true:

- The instrument is not in the Low Band, meaning:
- the start frequency is above 3.5 GHz and
- the stop frequency is above 3.6 GHz
- The internal preamp is not installed, or if installed, is set to **Off** or **Low Band**

Note that this means that, when any part of a sweep is done in Low Band, the Low Noise Path is not used, whether or not the **Low Noise Path Enable** is selected in the user interface. Also, if the preamp is turned on, the Low Noise Path is not used, whether or not the **Low Noise Path Enable** is selected in the user interface. The only time the Low Noise Path is used is when **Low Noise Path Enable** is selected, the sweep is completely in High Band (> 3.6 GHz) and no preamp is in use.

For measurements that use IQ acquisition, the low noise path is used when **Center Frequency** is in High Band (> 3.6 GHz) and no preamp is in use. In other words, the rules above are modified to use only the center frequency to qualify which path to switch in. This is not the case for FFTs in the Swept SA measurement; they use the same rules as swept measurements.

3 Bluetooth Mode

3.6 Monitor Spectrum Measurement

Note that the Low Noise Path, while giving improved DANL, has the disadvantage of decreased TOI performance and decreased gain compression performance relative to the standard path.

Note also that the bypass switch is a mechanical switch and has finite life, so if the **Low Noise Path Enable** is selected, it is possible to cause frequent cycling of this switch by frequently changing instrument settings such that the above conditions hold true only some of the time. A user making tests of this nature should consider opting for the **Standard Path**, which will never throw the bypass switch, at the expense of some degraded noise performance.

The low noise path is useful for situations where the signal level is so low that the instrument performance is dominated by noise even with 0 dB attenuation, but still high enough that the preamp option would have excessive third-order intermodulation or compression. The preamp, if purchased and used, gives better noise floor than does the “Low Noise Path.” However, its compression threshold and third-order intercept are much poorer than that of the non-preamp path.

There are some applications, typically for signals around -30 dBm, for which the third-order dynamic range of the standard path is good enough, but the noise floor is not low enough even with 0 dB input attenuation. When the third-order dynamic range of the preamp path is too little and the noise floor of the standard path is too high, the Low Noise Path can provide the best dynamic range

The graph below illustrates the concept. It shows, in red, the performance of an instrument at different attenuation settings, both with the preamp on and off, in a measurement that is affected by both instrument noise and instrument TOI. The green shows the best available dynamic range, offset by 0.5 dB for clarity. The blue shows how the best available dynamic range improves for moderate signal levels with the low noise path switched in. In this illustration, the preamp improves the noise floor by 15 dB while degrading the third-order intercept by 30 dB, and the low noise path reduces loss by 8 dB. The attenuator step size is 2 dB.

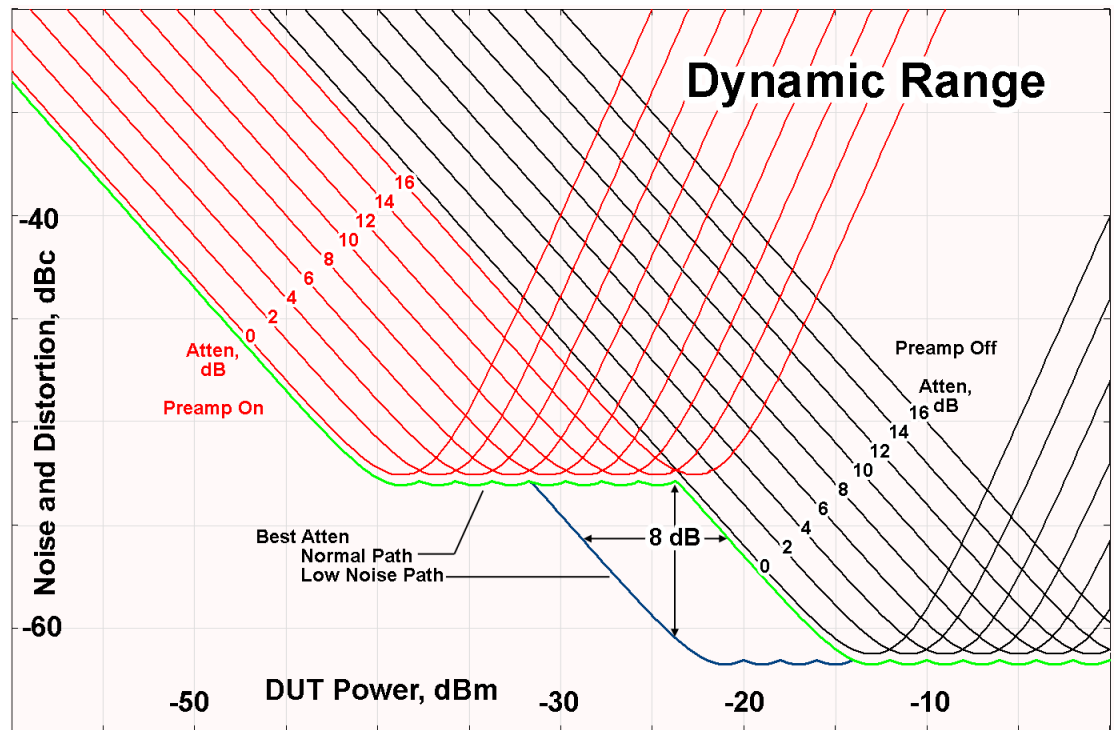

There are other times where selecting the low noise path improves performance, too. Compression-limited measurements such as finding the nulls in a pulsed-RF spectrum can profit from the low noise path in a way similar to the TOI-limited measurement illustrated. Accuracy can be improved when the low noise path allows the optimum attenuation to increase from a small amount like 0, 2 or 4 dB to a larger amount, giving better return loss at the instrument input. Harmonic measurements, such as second and third harmonic levels, are much improved using the low noise path because of the superiority of that path for harmonic (though not intermodulation) distortion performance.

µW Preselector Bypass

Toggles the preselector bypass switch for band 1 and higher. When the microwave preselector is on, the signal path is preselected. When the microwave preselector is off, the signal path is not preselected. The preselected path is the normal path for the instrument.

The preselector is a tunable bandpass filter which prevents signals away from the frequency of interest from combining in the mixer to generate in-band spurious signals (images). The consequences of using a preselector filter are its limited bandwidth, the amplitude and phase ripple in its passband, and any amplitude and phase instability due to center frequency drift.

Option MPB or pre-selector bypass provides an unpreselected input mixer path for certain X-Series signal analyzers with frequency ranges above 3.6 GHz. This signal path allows a wider bandwidth and less amplitude variability, which is an advantage when doing modulation analysis and broadband signal analysis. The disadvantage is that, without the preselector, image signals will be displayed. Another disadvantage of bypassing the preselector is increased LO emission levels at the front panel input port.

Image responses are separated from the real signal by twice the 1st IF. For IF Paths of 10 MHz and 25 MHz, the 1st IF is 322.5 MHz, so the image response and the real signal will be separated by 645 MHz. The 1st IF will be different for other IF Path settings. When viewing a real signal and its corresponding image response in internal mixing, the image response will be to the left of the real signal.

Also, the image response and the real signal typically have the same amplitude and exhibit the same shape factor.

However, if Option FS1 (Fast Sweep Capability) is enabled, the image response in the Swept SA measurement appears lower in amplitude and has a much wider shape factor compared to the real signal.

Full Bypass Enable

With **Full Bypass Enable** selected, the microwave preselector is bypassed. In addition, the low band/high band switch and microwave preamp are bypassed whenever *all* the following are true:

- The instrument is not in the Low Band, meaning:
- the start frequency is above 3.5 GHz and
- the stop frequency is above 3.6 GHz.
- the internal preamp is not installed or if installed, is set to **Off** or **Low Band**

Note that this means that, when any part of a sweep is done in Low Band, the Low Noise Path is not used, whether or not the **Full Bypass Enable** is selected in the user interface. Also, if the preamp is turned on, the Low Noise Path is not used, whether or not the **Full Bypass Enable** is selected in the user interface. The only time the Low Noise Path is used is when **Full Bypass Enable** is selected, the sweep is completely in High Band (> 3.6 GHz) and no preamp is in use.

CAUTION

When **Full Bypass Enable** is selected, and "**Y Scale**" on page 597 is set to 0 dB, there will be a direct AC connection between the input and the first converter when the Low Noise Path switches in (when Start Freq >3.6 GHz and the Preamp is either not licensed, set to Low Band, or Off). This puts the first converter at considerable risk to be damaged by high AC power. Consequently,

whenever **Full Bypass Enable** is selected, a warning message appears in the status bar:

“Full Bypass Enabled, maximum safe input power reduced”

Microwave Preselector Bypass Backwards Compatibility

Example	<code>:POW:MW:PRES OFF</code> Bypasses the microwave preselector
Notes	Included for Microwave Preselector Bypass backwards compatibility The ON parameter sets the STD path (<code>:POW:MW:PATH STD</code>) The OFF parameter sets path MPB (<code>:POW:MW:PATH MPB</code>)
Preset	ON
Backwards Compatibility SCPI	<code>[:SENSe]:POWer[:RF]:MW:PRESelector[:STATe] ON OFF 0 1</code> <code>[:SENSe]:POWer[:RF]:MW:PRESelector[:STATe]?</code>

Frequency Extender Preselection Bypass

Only applies to the high frequency path of the Frequency Extender, and only if the Frequency Extender allows it. For example, the V3050A high frequency path is 50 – 110 GHz and *does* allow control of the preselector bypass.

When the Frequency Extender’s preselection is bypassed, flatness is improved, but will be subject to spurs from out-of-band interfering signals. For bandwidths greater than 2.5 [GHz], it is recommended that the signal bypass the Frequency Extender Preselector since the max bandwidth of the Preselector can be as narrow as 2.5 [GHz].

For most applications, the preset state is **OFF**, which gives the best remote-control throughput, minimizes acoustic noise from switching, minimizes out of band spurs, and minimizes the risk of wear in the hardware switches.

Preselector and Bandwidth Conflict

When the Frequency Extender Preselector is applied and the signal bandwidth is greater than 2.5 [GHz], then a settings alert message will show to warn the user that the signal may be distorted due to the limitation of the Frequency Extender Preselector bandwidth.

An example of the settings alert message is shown below.

Settings Alert message in the Status Bar at the bottom of the display.



Settings Alert message in the error queue

Type	ID	
	159	Settings Alert - DETECTED; Presel/Meas BW conflict

Software Preselection

Provided in some instruments, either to compensate for issues with provided hardware preselection or to provide the preselection function when there is no hardware preselector.

N9041B

Software Preselection compensates for the frequency range limit of the microwave preselector. Since the microwave preselector only goes up to 50 GHz, software preselection must be used to suppress and separate images above 50 GHz. The specific algorithm used for software preselection is specified by the SW Preselection Type selection – Normal or Advanced.

In N9041B, **Software Preselection** only applies for frequencies above 50 GHz, therefore it is only used for RF Input 2. Even if turned on, it is not used for other inputs, and never for frequencies below 50 GHz. This is why the label of this control contains the parenthetical note “(>~50 GHz)”.

Note that in N9041B, in Swept SA measurement, **Software Preselection** works even if the measurement is using an FFT Sweep Type. In measurements other than Swept SA, Software Preselection is not used if the measurement is using an FFT sweep type.

N9042B+V3050A

Software Preselection compensates for the frequency range limit of the microwave preselector. Since the microwave preselector only goes up to 50 GHz, software preselection must be used to suppress and separate images above 50 GHz. The specific algorithm used for software preselection is specified by the SW Preselection Type selection – Normal or Advanced.

For N9042B+V3050A, Software Preselection only applies for frequencies above 50 GHz, therefore it is only used for External RF. Even if it is turned on, it will not be used for other inputs and never for frequencies below 50 GHz. This is why the label of this control contains the parenthetical note “(>~50 GHz)”.

Note that for N9042B+V3050A, in the Swept SA measurement, Software Preselection works even if the measurement is using an FFT Sweep Type. In measurements other than Swept SA, Software Preselection is not used if the measurement is using an FFT Sweep Type.

VXT models M9410A/11A

Software Preselection is used to provide the preselection function, as there is no hardware preselector in these models. Two background traces are taken and compared point by point, and the point with the lowest amplitude from the two traces is used. This provides a method to reduce spurs that are internally generated within the VXT, but you should note the following when using Software Preselection:

- There is some speed cost due to the need to take multiple captures
- Taking the point with the lowest amplitude in each trace will make the average noise level lower at all points that do not have a spur. This can reduce the accuracy of the measurement of noise and noise-like signals

Because of the difficulty in identifying spurs manually, you are recommended to leave Software Preselection **ON** at all times in VXT models M9410A/11A. If you turn it off in order to speed up your measurement or improve noise accuracy, be aware of unwanted onscreen spurs.

Remote Command	<code>[:SENSe]:POWer[:RF]:SWPreSel:STATe 0 1 ON OFF</code>	
	<code>[:SENSe]:POWer[:RF]:SWPreSel:STAT?</code>	
Example	<code>:POW:SWPR:STAT 1</code>	
	<code>:POW:SWPR:STAT?</code>	
Dependencies	Only appears in N9041B, N9042B+V2050A, and VXT models M9410A/11A. Does not appear in all measurements	
Couplings	Affects Sweep Time Auto Tune supports Software Preselection , so Auto Tune should be performed after setting the Software Preselection state	
Preset	N9041B	OFF
	N9042B+V3050A	ON
	M9410A/11A	ON
State Saved	Saved in instrument state	

SW Preselection Type

Specifies the algorithm used for software preselection.

Two hidden sweeps occur in succession. The second sweep is offset in LO frequency by $2 * IF / N$. For each point in each trace, the smaller amplitude from the two traces is taken and placed in that point in the selected trace. The Peak detector is auto-selected to improve the image suppression effectiveness. Responses of each trace that lie on top of one another will remain and are valid signals. Other signals are images, which are suppressed. The action of taking the smaller of the two traces will make the average noise level lower in all points that do not have an image, thus reducing the accuracy of the measurement of noise and noise-like signals.

- **NORMa1** - mathematically removes all image and multiple responses of signals present at the input
- **ADVanced** - any trace processing (such as “max hold” or trace averaging) is performed on the points of both candidate traces before the “select minimum” operation occurs. This form of processing works better for non-stationary signals, such as pulsed-RF signals

Remote Command	<code>[:SENSe]:POWer[:RF]:SWPResel NORMa1 ADVanced</code> <code>[:SENSe]:POWer[:RF]:SWPResel?</code>
Example	<code>:POW:SWPR NORM</code> <code>:POW:SWPR?</code>
Dependencies	Only appears in N9041B and N9042B+V3050A. Only appears in measurements that use the Swept method Grayed-out when "Software Preselection" on page 749 is OFF. The grayout message is “Unavailable unless SW Presel enabled”
Preset	N9041B ADVanced N9042B+V3050A NORMa1
State Saved	Saved in instrument state

SW Preselection BW

Specifies the effective bandwidth to be used for Software Preselection.

The options are:

- **NORMa1** – when making Swept measurements, a software preselection algorithm is used which takes up to 4 background acquisitions, then post-processes the result. This algorithm can remove images from signals with an occupied

bandwidth up to around 3 GHz. (Default/Preset setting). When making FFT measurements, this algorithm is not used, instead the same algorithm is used as for **NARRow** (below)

- **NARRow**– a software preselection algorithm is used which takes two background acquisitions, then post-processes the result to detect and remove images from wideband signals with occupied bandwidths up to 2 GHz. This increases the risk of images failing to be rejected, but improves the measurement speed

Remote Command	<code>[:SENSe]:POWer[:RF]:SWPResel:BW NORMal NARRow</code> <code>[:SENSe]:POWer[:RF]:SWPResel:BW?</code>
Example	<code>:POW:SWPR:BW NARR</code>
Dependencies	Only appears in N9041B and N9042B+V3050A. Only appears in measurements that use the Swept method Grayed-out when " Software Preselection " on page 749 is OFF . The grayout message is "Unavailable unless SW Presel enabled" For N9042B+V3050A, the parameter is SCPI-only, and always set to NARRow when Software Preselection is enabled
Preset	N9041B NORMal N9042B+V3050A NARRow
State Saved	Saved in instrument state

High Freq Prefilter

Lets you set the state of Prefilter for center frequencies above 1310 MHz.

In VXT Models M9410A/11A, the Receiver RF path has a bank of filters that come after the RF Attenuator in the signal path. Since this bank of filters precedes the mixer they are known as the "Prefilter" bank. Their purpose is to eliminate unwanted in-band mixing products by filtering out all but the desired frequencies before the signals get to the mixer. There are 13 prefilter bands to cover the frequencies between 9 kHz and 6000 MHz. The Prefilter provides the necessary rejection of the unwanted signal.

Remote Command	<code>[:SENSe]:<measurement>:PFILter[:STATe] ON OFF 1 0</code> <code>[:SENSe]:<measurement>:PFILter[:STATe]?</code>
Example	Enable High Freq Prefilter for the Complex Spectrum Measurement in BASIC Mode: <code>:SPEC:PFIL ON</code> Enable High Freq Prefilter for the IQ Waveform Measurement, in multiple Modes: <code>:WAV:PFIL ON</code> Enable High Freq Prefilter for the Swept SA Measurement in SA Mode:

3 Bluetooth Mode
 3.6 Monitor Spectrum Measurement

	:SAN:PFIL ON
Dependencies	Only appears in VXT models M9410A/11A with center frequency above 1310 MHz
Preset	See "Prefilter Presets" on page 637 below
State Saved	Saved in instrument state

Prefilter Presets

Meas	Mode	Preset
SPEC	BASIC	OFF
WAV	BASIC, WCDMA, WLAN, LTEAFDD, LTEATDD, 5GNR, VMA	OFF
MON	WCDMA, WLAN, LTEAFDD, LTEATDD, 5GNR, VMA	OFF
RHO	WCDMA	OFF
CDP	WCDMA	OFF
PCON	WCDMA	OFF
EVMQ	WCDMA	OFF
CHP	WCDMA, WLAN, LTEAFDD, LTEATDD, 5GNR, VMA, SA	OFF
OBW	WCDMA, WLAN, LTEAFDD, LTEATDD, 5GNR, VMA, SA	OFF
ACP	WCDMA, LTEAFDD, LTEATDD, 5GNR, VMA, SA	OFF
SEM	WCDMA, WLAN, LTEAFDD, LTEATDD, 5GNR, VMA, SA	OFF
PST	WCDMA, WLAN, LTEAFDD, LTEATDD, 5GNR, VMA, SA	OFF
PVT	WLAN, LTEAFDD, LTEATDD, 5GNR	OFF
EVM	WLAN, LTEAFDD, LTEATDD, 5GNR	OFF
FLAT	WLAN	OFF
EVMM	WLAN	OFF
CEVM	LTEAFDD, LTEATDD	OFF
PAVT	5GNR, VMA	OFF
DDEM	VMA	OFF
OFDM	VMA	OFF
SAN	SA	ON
HARM	SA	ON

3.6.4 BW

Opens the Bandwidth (**BW**) menu, which contains controls for the Resolution Bandwidth and Video Bandwidth functions of the instrument.

3.6.4.1 Settings

Contains the basic bandwidth functions. It is the only tab under **BW**.

Res BW

Activates the resolution bandwidth active function, which allows you to manually set the Resolution Bandwidth (RBW) of the instrument.

Normally, **Res BW** (Auto) selects automatic coupling of the Res BW to Span using the ratio set by the Span:3 dB RBW control (some measurements do not have a Span:3 dB RBW control, in which case the measurement chooses the optimal ratio). To decouple the resolution bandwidth, press the **Auto/Man** toggle on the **Res BW** control, or simply enter a different value for **Res BW**.

When the **Res BW** is manually selected, it may be returned to the coupled state by pressing the **Auto/Man** toggle on the **Res BW** control. This may also be done by pressing Auto Couple or by performing a **Preset**.

Only certain discrete resolution bandwidths are available. The available bandwidths are dependent on the **EMC Standard**. If an unavailable bandwidth is entered with the numeric keypad, the closest available bandwidth is selected.

See "[RBW Presets](#)" on page 639

Remote Command	<pre>[:SENSe]:MONitor:BANDwidth[:RESolution] <bandwidth> [:SENSe]:MONitor:BANDwidth[:RESolution]? [:SENSe]:MONitor:BANDwidth[:RESolution]:AUTO ON OFF 1 0 [:SENSe]:MONitor:BANDwidth[:RESolution]:AUTO?</pre>
Example	<pre>:MON:BAND 5 MHz :MON:BAND? :MON:BAND:AUTO ON :MON:BAND:AUTO?</pre>
Notes	<p>For numeric entries, all RBW Types choose the nearest (arithmetically, on a linear scale, rounding up) available RBW to the value entered</p> <p>The setting and querying of values depends on the current bandwidth type</p>
Couplings	<p>Sweep time is coupled to the RBW. As the RBW changes, the sweep time (if set to Auto) is changed to maintain amplitude calibration</p> <p>Video bandwidth (VBW) is coupled to the RBW. As the resolution bandwidth changes, the video bandwidth (if set to Auto) changes to maintain the ratio of VBW/RBW (10:1)</p> <p>When the Res BW is set to Auto, the resolution bandwidth is auto-coupled to the span. The ratio of Span/RBW is approximately 106:1 when auto coupled. When Res BW is set to Man, and the bandwidths are entered manually, these bandwidths are used regardless of other instrument settings</p>
Preset	<p>Auto (unless noted in the table below)</p> <p>See "RBW Presets" on page 639 below</p>
State Saved	<p>Saved in instrument state</p>

3 Bluetooth Mode
3.6 Monitor Spectrum Measurement

Min	1 Hz
Max	8 MHz is the max equivalent -3 dB RBW, which means that the named RBW (the one shown on the control etc.) can actually exceed 8 MHz if using a filter other than -3 dB Gaussian
Annotation	A “#” mark appears before “RBW” in the annotation when it is switched from Auto to Manual coupling
Backwards Compatibility Notes	For backwards compatibility this command obeys both the BANDwidth and BwIDth forms For ESA, the maximum Res BW was 5 MHz; on X-Series it is 8 MHz

RBW Presets

Unless noted in the table below, the Preset value of RBW is **Auto**.

Mode	Preset RBW
WLAN	100 kHz
LTE, LTETDD, LTEAFDD, LTEATDD	100 kHz
5GNR	100 kHz

Video BW

Lets you change the instrument post-detection filter (VBW or “video bandwidth”) from 1 Hz to 8 MHz in approximately 10% steps. In addition, a wide-open video filter bandwidth may be chosen by selecting 50 MHz. The VBW is annotated at the bottom of the display, in the center.

Normally, **Video BW (Auto)** selects automatic coupling of the Video BW to RBW using the ratio set by the VBW:3 dB RBW control. To decouple the resolution bandwidth, press the **Auto/Man** toggle on the **Video BW** control, or simply enter a different value for **Video BW**.

When the **Video BW** is manually selected, it may be returned to the coupled state by pressing the **Auto/Man** toggle on the **Video BW** control. This may also be done by pressing Auto Couple or by performing a **Preset**.

Remote Command	<pre>[:SENSe]:MONitor:BANDwidth:VIDeo <bandwidth> [:SENSe]:MONitor:BANDwidth:VIDeo? [:SENSe]:MONitor:BANDwidth:VIDeo:AUTO ON OFF 1 0 [:SENSe]:MONitor:BANDwidth:VIDeo:AUTO?</pre>
Example	<pre>:MON:BAND:VID 2.4 MHz :MON:BAND:VID? :MON:BAND:VID:AUTO ON :MON:BAND:VID:AUTO?</pre>

Notes	For numeric entries, the instrument chooses the nearest (arithmetically, on a linear scale, rounding up) available VBW to the value entered. The 50 MHz VBW is defined to mean “wide open” The values shown in this table reflect the conditions after a Mode Preset
Dependencies	Sometimes the displayed Video BW is not actually used to process the trace data: <ul style="list-style-type: none"> – When the Average Detector is selected and Sweep Type is set to Swept, the video bandwidth filter cannot be used, because it uses the same hardware as the Average Detector – When the Quasi-Peak, EMI Average or RMS Average detector is selected the VBW is implemented by the digital IF as part of the detector <p>When this is the case, the VBW still acts to change the Sweep Time, if Sweep Time is in Auto, and still affects the data on other traces for which this is not the case</p>
Couplings	Video bandwidth (VBW) is normally coupled to RBW. If VBW is set to Auto, then the VBW is changed as the RBW changes, to maintain the ratio set by the VBW:3 dB RBW control (usually 10:1 for measurements that do not have a VBW:3 dB RBW control)
Preset	Auto (unless noted in table below) ON
State Saved	Saved in instrument state
Min	1 Hz
Max	50 MHz
Annunciation	A “#” mark appears before “VBW” in the annotation when it is not coupled
Annotation	In the bottom center of the screen, “VBW <value> <units>” indicates the current video bandwidth value. Note that for some detectors this is not the value actually used for VBW (see above)
Backwards Compatibility Notes	For backwards compatibility this command obeys both the BANDwidth and BWIDth forms

VBW Presets

Unless noted in the table below, the Preset value of VBW is **Auto**.

Mode	Preset VBW
WLAN	1 MHz
LTE, LTETDD, LTEAFDD, LTEATDD	1 MHz
5GNR	1 MHz

VBW:3dB RBW

Selects the ratio between the video bandwidth and the equivalent 3 dB resolution bandwidth to be used for setting VBW when VBW is in Auto.

3 Bluetooth Mode
3.6 Monitor Spectrum Measurement

VBW:3dB RBW (Auto) selects automatic coupling of the VBW:3 dB RBW ratio to Detector using the rules described below in "[Coupling Auto Rules](#)" on page 641. To decouple the ratio, press the **Auto/Man** toggle on the VBW:3 dB RBW control, or simply enter a different value for VBW:3 dB RBW.

When the VBW:3dB RBW is manually selected, it may be returned to the coupled state by setting the toggle on the VBW:3 dB RBW control back to **Auto**. This may also be done by pressing Auto Couple or by performing a **Preset**.

Remote Command	<pre>[:SENSe]:MONitor:BANDwidth:VIDeo:RATio <real> [:SENSe]:MONitor:BANDwidth:VIDeo:RATio? [:SENSe]:MONitor:BANDwidth:VIDeo:RATio:AUTO OFF ON 0 1 [:SENSe]:MONitor:BANDwidth:VIDeo:RATio:AUTO?</pre>
Example	<pre>:MON:BAND:VID:RAT 2 :MON:BAND:VID:RAT? :MON:BAND:VID:RAT:AUTO 0 :MON:BAND:VID:RAT:AUTO?</pre>
Notes	The values shown in this table reflect the conditions after a Mode Preset
Couplings	See " Coupling Auto Rules " on page 641
Preset	1 ON
State Saved	Saved in instrument state
Min	0.00001
Max	3000000
Backwards Compatibility Notes	For backwards compatibility this command accepts both the BANDwidth and BWIDth forms

Coupling Auto Rules

The Auto Rules for the **VBW:3dB RBW** function are as follows.

First, if Source Mode is set to "Tracking": Use 1.0

Otherwise, we go through the following list of detector numbers and find the lowest numbered detector being used on any active traces (traces for which Update is On):

1. Peak
2. Normal
3. Average
4. Sample

5. Negative Peak
6. EMI Average
7. Quasi Peak
8. RMS Average

Use that detector to pick the ratio based on the following criteria:

1. If the measurement supports EMC Standard, and the detector is Peak and the EMC Standard is set to either CISPR or MIL, use 10.0 (we use wide VBWs to capture peak levels accurately).
2. Otherwise, if the detector is **Negative Peak**, use 1.0 (in the Negative Peak case, there are no known significant use models so we use a medium ratio).
3. Otherwise, if the detector is **Normal**, use 1.0.
4. Otherwise, if the detector is **Average**, and the span is nonzero, use 0.1. The use of a small ratio in Average detection is desirable because of its effect on the sweep time equations. The VBW filter is not actually in-circuit when the average detector is on. If the detector is Average, and the span is zero, use 10.0, which gives optimal behavior for Interval Markers in zero span. Note that only the Swept SA measurement supports Zero Span.
5. Otherwise, if the detector is EMI Average, Quasi Peak or RMS Average, use 10.0. In fact, this is a “don’t care” since no VBW is used for these detectors, as noted under “Dependencies” for the VBW control
6. Otherwise, the detector is simply **Peak** or **Sample**. These two detectors can use the same rules. In these cases, if any active trace is in max hold or min hold, use 10.0, because Max and Min Hold operations will usually be intended to capture peaks and pits without smoothing from the VBW filter; otherwise, use 1.0 as a compromise, because you have not set the instrument in a way that implies that you are measuring noise, pulsed-RF or CW signals, and for backward compatibility with earlier instruments.

Note that because the above couplings depend on which traces are active, they are re-examined whenever any trace goes active or inactive, except when this leaves no traces active. Transitioning to the state where no traces are active should not affect the couplings; in that way, the annotation will always reflect the state of the last trace which was active.

Note also that some detectors are not available in some measurements, but because of the way the above rules that does not change the logic of the rules.

Span:3dB RBW

Selects the ratio between span and resolution bandwidth.

Normally, Span:3dB RBW (Auto) selects a Span:3 dB RBW ratio of 106:1. If you manually enter the ratio, the toggle on the Span:3dB RBW control will change to **Man**. This enables you to manually select ratios more suitable for certain measurements.

When the Span:3dB RBW is manually selected, it may be returned to the coupled state by setting the toggle on the RBW:3 dB RBW control back to **Auto**. This may also be done by pressing Auto Couple or by performing a **Preset**.

Remote Command	<pre>[:SENSe]:MONitor:FREQuency:SPAN:BANDwidth[:RESolution]:RATio <integer> [:SENSe]:MONitor:FREQuency:SPAN:BANDwidth[:RESolution]:RATio? [:SENSe]:MONitor:FREQuency:SPAN:BANDwidth[:RESolution]:RATio:AUTO OFF ON 0 1 [:SENSe]:MONitor:FREQuency:SPAN:BANDwidth[:RESolution]:RATio:AUTO?</pre>
Example	<pre>:MON:FREQ:SPAN:BAND:RAT 200 :MON:FREQ:SPAN:BAND:RAT? :MON:FREQ:SPAN:BAND:RAT:AUTO ON :MON:FREQ:SPAN:BAND:RAT:AUTO?</pre>
Notes	The values shown in this table reflect the conditions after a Mode Preset
Preset	106 ON
State Saved	Saved in instrument state
Min	2
Max	10000
Backwards Compatibility SCPI	<pre>[:SENSe]:MONitor:FREQuency:SPAN:BWIDth[:RESolution]:RATio</pre>

3.6.5 Display

Opens the **Display** menu, which lets you configure display items for the current Mode, Measurement View or Window.

3.6.5.1 Meas Display

Contains controls for setting up the display for the current Measurement, View or Window.

3.6.5.2 View

Contains controls for selecting the current **View**, and for editing User Views.

View

See "Views" on page 594

User View

Lets you choose a View from the saved User Views for the current measurement. This panel only appears if a User View exists for the current measurement.

Remote Command	<code>:DISPlay:VIEW:ADVanced:SElect <alphanumeric></code> <code>:DISPlay:VIEW:ADVanced:SElect?</code>
Example	Select Baseband as the current View <code>:DISP:VIEW:ADV:SEL "Baseband"</code>
Notes	<p>You must be in the measurement whose View you are trying to set to send the command. You can only set Views for the current measurement using this command</p> <p>For predefined views, the parameter is derived from the view name that is shown in the View list in the user interface. For example, if you are trying to select the Trace Zoom view in the Swept SA measurement, you send:</p> <pre>:DISP:VIEW:ADV:SEL "Trace Zoom"</pre> <p>because "Trace Zoom" is the name of the View as seen in the Mode/Meas dialog or in the Display, View menu</p> <p>You <i>cannot</i> use the legacy View parameter (which in this case would be <code>TZOOM</code>) with</p> <pre>:DISP:VIEW:ADV:SEL</pre> <p><code><alphanumeric></code> is case insensitive; you can specify mixed case, however the name will be evaluated on a single case. Thus, both of the following forms work:</p> <pre>:DISP:VIEW:ADV:SEL "Trace Zoom"</pre> <pre>:DISP:VIEW:ADV:SEL "TRACE ZOOM"</pre> <p>If the specified view is not a valid View, the query returns the error message "-224, Illegal parameter value; View with the name <alphanumeric> does not exist"</p> <p>If the display is disabled (via <code>:DISP:ENAB OFF</code>) then the error message "-221, Settings conflict; View SCPI cannot be used while Display is disabled" is generated</p>
Backwards Compatibility SCPI	<p>The legacy node</p> <pre>:DISPlay:VIEW[:SElect]</pre> <p>is retained for backwards compatibility, but it only supports predefined views</p>

Restore Layout to Default

Restores the Layout to the default for Basic.

Modified Views are very temporary; if you exit the current measurement they are discarded, and they are not saved in State. To retain this View for later use, and to be able to return easily to your original Basic View, you can save your edited View as a “User View”.

Save Layout as New View

Saves your new View as a User View. An alpha keyboard appears, which lets you name your new View; the default is the old View name plus a number.

Remote Command	<code>:DISPlay:VIEW:ADVanced:NAME <alphanumeric></code>
Example	<code>:DISP:VIEW:ADV:NAME "Baseband"</code> Creates a new View named Baseband from the current View, and selects it as the current View
Notes	<code><alphanumeric></code> is case insensitive; you can specify mixed case, however the name will be evaluated on a single case If <code><alphanumeric></code> name already exists as a View, the error message “-224, Illegal parameter value; View <alphanumeric> already exists” is generated If the display is disabled (via <code>:DISP:ENAB OFF</code>) then the error message “-221, Settings conflict; User View SCPI cannot be used while Display is disabled” is generated

Re-Save User View

You can re-edit a User View; if you make changes, then an asterisk will appear next to the User View’s name. You can then tap **Re-Save User View** to save it back to its existing name, or **Save Layout as New View** to add another, new User View.

This is a front panel function only, there is no remote command available to perform this function. To do this remotely, you must first perform **Save Layout as New View**, then delete the old User View and rename the new one with the name of the View you just deleted.

Rename User View

You can rename the current View by giving it a new unique name. Only User Views can be renamed, if the current View is a Predefined View, an error occurs.

Remote Command	<code>:DISPlay:VIEW:ADVanced:REName <alphanumeric></code>
----------------	---

Example	<code>:DISP:VIEW:ADV:REN "Baseband"</code>
Notes	<p><code><alphanumeric></code> is case insensitive; you can specify mixed case, however the name will be evaluated on a single case</p> <p>If the <code><alphanumeric></code> specifying the new name is already present in the list of View names, the error message "-224, Illegal parameter value; View <alphanumeric> already exists" is generated</p> <p>If the current View is a Predefined View, the error message "-224, Illegal parameter value; Cannot rename a Predefined View" is generated</p> <p>If the display is disabled (via <code>:DISP:ENAB OFF</code>) then the error message "-221, Settings conflict; View SCPI cannot be used while Display is disabled" is generated</p>

Delete User View

You can delete the current View if it is a User View. The default view becomes the current view for the Measurement.

Remote Command	<code>:DISPlay:VIEW:ADVanced:DELeTe</code>
Example	<code>:DISP:VIEW:ADV:DEL</code>
Notes	<p><code><alphanumeric></code> is case insensitive; you can specify mixed case, however the name will be evaluated on a single case</p> <p>If the <code><alphanumeric></code> is not present in the list of View names, the error message "-224, Illegal parameter value; View <alphanumeric> does not exist" is generated</p> <p>If the current View is a Predefined View, the error message "-224, Illegal parameter value; Cannot delete a Predefined View" is generated</p> <p>If the display is disabled (via <code>:DISP:ENAB OFF</code>) then the error message "-221, Settings conflict; View SCPI cannot be used while Display is disabled" is generated</p>

Delete All User Views

Deletes all previously saved User Views. The default view becomes the current view for the Measurement if a User View was the current view when this command was executed.

Remote Command	<code>:DISPlay:VIEW:ADVanced:DELeTe:ALL</code>
Example	<code>:DISP:VIEW:ADV:DEL:ALL</code>
Notes	Disabled if there are no User Views

View Editor Remote Commands

The following remote commands help you manage Views and User Views. Note that the SCPI node for User Views handles both Predefined and User Views. The legacy

nodes, `:DISPlay:VIEW[:SElect]` and `:DISPlay:VIEW:NSEL`, are retained for backwards compatibility, but they only support predefined views.

View Listing Query

Returns a string containing a comma-separated list of names for *all* the Views, including User Views, available for the current Measurement.

Remote Command	<code>:DISPlay:VIEW:ADVanced:CATalog?</code>
Example	<code>:DISP:VIEW:ADV:CAT?</code>
Notes	Returns a quoted string of the available Views for the current measurement, separated by commas. The list includes names for <i>all</i> the Views, including User Views, available for the current Measurement Example: <code>"Normal,Trace Zoom,Spectrogram,Baseband,myView1,yourView1"</code> No distinction is made between Predefined and User Views If you switch measurements with the display disabled (via <code>:DISP:ENAB OFF</code>), then query the list of available Views, the result is undefined

User View Listing Query

Returns a string containing a comma-separated list of names for *only* the User Views available for the current Measurement.

Remote Command	<code>:DISPlay:VIEW:ADVanced:USER:CATalog?</code>
Example	<code>:DISP:VIEW:ADV:USER:CAT?</code>
Notes	Returns a quoted string of the available User Views for the current measurement, separated by commas. Example: <code>"Baseband,myView1,yourView1"</code> If you switch measurements with the display disabled (see "Display Enable (Remote Command Only)" on page 760), then query the list of available Views, the result is undefined

3.6.5.3 Annotation

Contains controls for setting up the annotation for the current Mode or Measurement.

Graticule

Turns the display graticule On or Off for all windows with graticules in all measurements in the current Mode. Also turns the graticule Y-Axis annotation on and off.

Remote Command	<code>:DISPlay:GRATicule[:STATe] OFF ON 0 1</code> <code>:DISPlay:GRATicule[:STATe]?</code>
Example	<code>:DISP:GRAT OFF</code>
Notes	The graticule is the set of horizontal and vertical lines that make up the grid/divisions for the X-Axis and Y-Axis
Preset	ON
State Saved	Saved in instrument state
Backwards Compatibility SCPI	<code>:DISPlay:WINDow[1]:TRACe:GRATicule:GRID[:STATe] OFF ON 0 1</code> <code>:DISPlay:WINDow[1]:TRACe:GRATicule:GRID[:STATe]?</code> This command is accepted for backwards compatibility with older instruments, but the WINDow , TRACe and GRID parameters are ignored

Screen Annotation

Controls the display of the annunciation and annotation around the graticule, including any annotation on lines (such as the display line, the threshold line, etc.) and the Y-Axis annotation, for all windows with screen annotation in all measurements in the current Mode.

This does *not* include marker annotation (or the N dB result). When **OFF**, the graticule expands to fill the entire graticule area, leaving only the 1.5% gap above the graticule, as described in the **Trace** section.

Remote Command	<code>:DISPlay:ANNotation:SCReen[:STATe] OFF ON 0 1</code> <code>:DISPlay:ANNotation:SCReen[:STATe]?</code>
Example	<code>:DISP:ANN:SCR OFF</code>
Dependencies	Grayed-out and forced to OFF when System Display Settings, Annotation is OFF
Preset	ON This remains OFF through a Preset when System Display Settings, Annotation is set to OFF
State Saved	Saved in instrument state

Trace Annotation

Turns on and off the labels on the traces, showing their detector (or their Math Mode) as described in the **Trace** section, for all windows in all measurements in the current Mode for which Trace Annotation on/off is supported.

If Trace Math is being performed on a trace, then the Trace Math annotation replaces the detector annotation.

For measurements that support limit lines, this key also turns on and off the labels on the Limit Lines. The label is the Limit number annotation and Limit Comment displayed on the graph. If the length of the comment is greater than 20 characters, the first 8 characters and the last 8 characters are displayed, joined with

Remote Command	<code>:DISPlay:ANNotation:TRACe[:STATe] ON OFF 1 0</code> <code>:DISPlay:ANNotation:TRACe[:STATe]?</code>
Example	<code>:DISP:ANN:TRAC OFF</code>
Preset	<code>OFF</code>
State Saved	Saved in instrument state

Control Annotation

Turns on and off the display of values on the Active Function controls for all measurements in the current Mode. This is a security feature.

Remote Command	<code>:DISPlay:ACTivefunc[:STATe] ON OFF 1 0</code> <code>:DISPlay:ACTivefunc[:STATe]?</code>
Example	<code>:DISP:ACT OFF</code>
Dependencies	Grayed out and forced to <code>OFF</code> when System Display Settings, Annotation is <code>OFF</code>
Preset	<code>ON</code> This remains <code>OFF</code> through a Preset when System Display Settings, Annotation is set to <code>OFF</code>
State Saved	Saved in instrument state

Meas Bar

Turns the Measurement Bar at the top of the screen on and off for all measurements in the current Mode. When `OFF`, the graticule area expands to fill the area formerly occupied by the Measurement Bar.

Remote Command	<code>:DISPlay:ANNotation:MBAR[:STATe] OFF ON 0 1</code> <code>:DISPlay:ANNotation:MBAR[:STATe]?</code>
----------------	--

Example	<code>:DISP:ANN:MBAR OFF</code>
Dependencies	Grayed out and forced to OFF when System Display Settings, Annotation is OFF
Preset	ON This remains OFF through a Preset when System Display Settings, Annotation is set to OFF
State Saved	Saved in instrument state

Display Enable (Remote Command Only)

Turns the display on/off, including the display drive circuitry. The backlight stays lit to confirm that the instrument is on. The display enable setting is mode global. There are three reasons for turning the display off:

1. To increase speed as much as possible by freeing the instrument from having to update the display
2. To reduce emissions from the display, drive circuitry
3. For security purposes

If you have turned off the display:

- and you are in local operation, the display can be turned back on by pressing any key or by sending `:SYSTEM:DEFAULTS MISC` or `:DISPLAY:ENABLE ON` (neither `*RST` nor `:SYSTEM:PRESET` enable the display)
- and you are in remote operation, the display can be turned back on by pressing the **Local** or **Esc** keys, or by sending `:SYSTEM:DEFAULTS MISC` or `:DISPLAY:ENABLE ON` (neither `*RST` nor `:SYSTEM:PRESET` enable the display)
- and you are using either the `:SYSTEM:KLOCK` command or GPIB local lockout, then *no* front-panel key press will turn the display back on. You must turn it back on remotely.

If the display is **OFF**, many SCPI commands related to User Views and Multiscreen functionality do not work, and return the error messages “-221, Settings conflict; Screen SCPI cannot be used when Display is disabled” or “221, Settings conflict; View SCPI cannot be used while Display is disabled”. These commands include:

Name	Command
Select User View	<code>:DISPLAY:VIEW:ADVANCED:SELECT</code>
Rename User View	<code>:DISPLAY:VIEW:ADVANCED:RENAME</code>
Delete User View	<code>:DISPLAY:VIEW:ADVANCED:DELETE</code>
Create User View	<code>:DISPLAY:VIEW:ADVANCED:NAME</code>
Select Screen	<code>:INSTRUMENT:SCREEN:SELECT</code>
Delete Screen	<code>:INSTRUMENT:SCREEN:DELETE</code>

3 Bluetooth Mode
3.6 Monitor Spectrum Measurement

Name	Command
Delete All But This Screen	:INSTrument:SCReen:DELeTe:ALL
Add Screen	:INSTrument:SCReen:CREate
Rename Screen	:INSTrument:SCReen:REName
Sequencer On/Off	:SYSTem:SEQuencer

Remote Command	:DISPlay:ENABle OFF ON 0 1
Example	:DISP:ENAB OFF
Couplings	:DISP:ENAB OFF turns Backlight OFF and :DISP:ENAB ON turns Backlight ON, but changing Backlight settings does <i>not</i> change the state of :DISP:ENAB
Preset	ON Set by :SYST:DEF MISC, but not affected by *RST or :SYSTem:PRESet
State Saved	Not saved in instrument state
Backwards Compatibility Notes	:SYST:PRES no longer turns on :DISPlay:ENABle as it did in legacy analyzers

3.6.6 Frequency

Opens the **Frequency** menu, which contains controls that allow you to control the Frequency and Channel parameters of the instrument.

Some features in this menu are the same for all measurements in the current Mode – they do not change as you change measurements. Settings like these are called “Meas Global” and are unaffected by Meas Preset. For example, the Center Freq setting is the same for all measurements - it does not change as you change measurements.

3.6.6.1 Settings

The Settings tab contains the basic Bandwidth functions. In most measurements it is the only tab under Bandwidth.

Channel

Selects which Bluetooth channel will be measured.

Channel number is common for all the measurements. The coupling of Channel and Center Frequency apply to the following Measurements:

- Transmit Analysis
- Output Spectrum BW
- Monitor Spectrum

For other measurements, center frequency does not depend on channel. If center frequency is changed in other measurements but channel isn't changed, center frequency still can return to the old value only if the measurement is switched to the upward measurements.

Remote Command	<code>[:SENSe]:CHANnel[:NUMBer] <integer></code> <code>[:SENSe]:CHANnel[:NUMBer]?</code>
Example	<code>:CHAN 22</code> <code>:CHAN?</code>

Couplings

The coupling of channel and center frequency is only applied to the following measurements:

- Transmit Analysis
- Output Spectrum BW
- Monitor Spectrum

For other measurements, center frequency does not depend on channel. Following is the coupling of channel and center frequency

If Radio Stand is Basic or EDR:

$$\text{Channel} = (\text{CF} - 2.402\text{E9}) / 1.0\text{e6}$$

If the Center Frequency is set to a value between channels, the channel key should display > prior to the previous channel number if the CF is < 500 kHz above the previous channel and < prior to the next channel number if the CF is > = 500 kHz above the previous channel

For example, if Channel = 3.4, the channel key will display >3. If Channel = 3.5, the channel key will display <4. If Channel < 0, the channel key will display <0. If Channel > 78(22), the channel key display will display >78(22)

If Radio Stand is Low Energy:

$$\text{Channel} = (\text{CF} - 2.402\text{E9}) / 2.0\text{e6}$$

The max value of channel is 39. The range of channel is 0-39

If the Center Frequency is set to a value between channels, the channel key should display > prior to the previous channel number if the CF is < 1 MHz above the previous channel and < prior to the next channel number if the CF is > = 1 MHz above the previous channel

For example, if Channel = 3.4, the channel key will display >3. If Channel = 3.5, the channel key will display <4. If Channel < 0, the channel key will display <0. If Channel > 78(22), the channel key display will display >78(22)

If Geography is France :

- Channel Number: 0...22
- If Center Frequency < 2.454 GHz, the channel key should display < 0

-
- If Center Frequency > 2.476 GHz, the channel key should display > 22

If Geography is Others:

- Channel Number: 0...78
- If Center Frequency < 2.402 GHz, the channel key should display < 0
- If Center Frequency > 2.480 GHz, the channel key should display > 78

Preset	0
State Saved	Yes
Range	0 – 78
Min/Max	0 / 78

Center Frequency

Sets the frequency that corresponds to the horizontal center of the graticule. While adjusting the Center Frequency the Span is held constant.

The center frequency setting is the same for all measurements within a mode, that is, it is Meas Global. Some modes are also able to share a Mode Global center frequency value. If this is the case, the Mode will have a **Global** tab in its **Meas Setup** menu.

The **Center Freq** function sets (and queries) the Center Frequency for the currently selected input. If your instrument has multiple inputs, and you select another input, the Center Freq changes to the value for that input. SCPI commands are available to directly set the Center Freq for a specific input.

Center Freq is remembered as you go from input to input. Thus, you can set a Center Freq of 10 GHz with the RF Input selected, change to BBIQ, and set a Center Freq of 20 MHz, then switch to External Mixing and set a Center Freq of 60 GHz, and when you go back to the RF Input the Center Freq will go back to 10 GHz; back to BBIQ and it is 20 MHz; back to External Mixing and it is 60 GHz.

See:

- ["Center Frequency Presets" on page 656](#)
- ["VXT Models with Radio Heads/CIU Frequency Range" on page 657](#)
- ["RF Center Freq" on page 658](#)
- ["Ext Mix Center Freq" on page 658](#)
- ["I/Q Center Freq" on page 659](#)

Remote [\[:SENSe\]:FREquency:CENTer <freq>](#)

Command	<code>[:SENSe] :FREQuency:CENTer?</code>
Example	<p><code>:FREQ:CENT 50 MHz</code></p> <p>Sets Center Frequency to 50 MHz</p> <p><code>:FREQ:CENT UP</code></p> <p>Increments the Center Frequency by the value of CF Step</p> <p><code>:FREQ:CENT?</code></p> <p>Returns the current value of Center Frequency</p>
Notes	<p>Sets the RF, External Mixing or I/Q Center Frequency depending on the selected input:</p> <ul style="list-style-type: none"> - For RF input it is equivalent to <code>:FREQ:RF:CENT</code> - For I/Q input it is equivalent to <code>:FREQ:IQ:CENT</code> - For External Mixer it is equivalent to <code>:FREQ:EMIX:CENT</code> <p>Preset and Max values are dependent on Hardware Options (5xx)</p> <p>If no terminator (for example, MHz) is sent, the terminator Hz is used. If a terminator with unit other than Frequency is used, an invalid suffix error message is generated</p>
Couplings	<p>In LTEAFDD/LTEATDD and 5GNR Modes:</p> <p>Center Frequency, Center Frequency Offset and Carrier Reference Frequency are coupled with the following equation:</p> <p>Center Frequency = Carrier Reference Frequency + Center Frequency Offset</p> <p>If the following conditions are satisfied at the same time:</p> <ul style="list-style-type: none"> - the Num Component Carrier equals to 1 - the Center Frequency Offset equals to 0 Hz - the mode of the Center Frequency is Auto <p>The Center Frequency is equivalent to Carrier Reference Frequency</p> <p>The major purpose of this coupling is to keep BWCC with legacy LTE, in which <code>:SENSe:FREQuency:CENTer</code> is used to set up the Frequency of the measurement</p> <p>Otherwise, the Center Frequency Offset is changed following the Center Frequency and the Carrier Reference Frequency keeps intact</p> <p>In MSR, Center Freq, Center Freq Offset and Carrier Ref Freq are coupled with the equation, Center Freq = Carrier Ref Freq + Center Freq Offset. When Center Freq is changed, Center Freq Offset is updated and Carrier Ref Freq is not changed</p> <p>When auto, Center Freq Offset remains the same value. Thus, Center Freq changes the same amount of Carrier Ref Freq change when Carrier Ref Freq is changed. The auto state changes to manual when either Center Freq is changed</p> <p>In Bluetooth Mode:</p> <p>Center Frequency is coupled to Channel and Geography</p> <ul style="list-style-type: none"> - If Geography is France: Center Frequency 2454 MHz + (channel number* channel space) MHz

3 Bluetooth Mode
3.6 Monitor Spectrum Measurement

- If Geography is Others: Center Frequency 2402 MHz + (channel number* channel space) MHz
- If Radio Stand is Basic or EDR, channel space is 1 MHz
- If Radio Stand is Low Energy, channel space is 2 MHz

In other modes:

Any value of the Center Frequency or Span that keeps start frequency and stop frequency within the frequency range of the instrument is allowed when the value is being set through the front panel numeric keypad or the SCPI command. Other frequency parameters are forced to different values if needed, to keep the start and stop frequencies within the instrument's frequency range

Presets	Depends on instrument maximum frequency, mode, measurement, and selected input See " Center Frequency Presets " on page 656, " RF Center Freq " on page 658, " Ext Mix Center Freq " on page 658, " I/Q Center Freq " on page 659 and " VXT Models with Radio Heads/CIU Frequency Range " on page 657
State Saved	Saved in instrument state
Min/Max	Depends on instrument maximum frequency, mode, measurement, and selected input See " Center Frequency Presets " on page 656, " RF Center Freq " on page 658, " Ext Mix Center Freq " on page 658, " I/Q Center Freq " on page 659 and " VXT Models with Radio Heads/CIU Frequency Range " on page 657
Annotation	Center <value> appears in the lower left corner of the display
Status Bits/OPC dependencies	Non-overlapped

Center Frequency Auto State

Remote Command	<code>[:SENSe] :FREQuency :CENTer :AUTO ON OFF 1 0</code> <code>[:SENSe] :FREQuency :CENTer :AUTO?</code>
Example	<code>:FREQ:CENT:AUTO OFF</code> <code>:FREQ:CENT:AUTO?</code>
Dependencies	This is only available in MSR, LTEAFDD/LTEATDD and 5GNR Modes
Couplings	When the Center Frequency is changed, the state is automatically changed to Manual Center Frequency , Center Frequency Offset and Carrier Reference Frequency are coupled. When Carrier Reference Frequency changes: <ul style="list-style-type: none"> - Center Frequency : Auto Center Frequency = Carrier Reference Frequency + Center Frequency Offset (fixed) - Center Frequency : Man Center Frequency (fixed) = Carrier Reference Frequency + Center Frequency Offset
Presets	ON
State Saved	Saved in instrument state
Range	Auto Man

Center Frequency Presets

The following table provides the Center Frequency Presets for the Spectrum Analyzer mode, and the Max Freq, for the various frequency options:

Freq Option	CF after Mode Preset	Stop Freq after Mode Preset	Max Freq (can't tune above)
503 (all but CXA)	1.805 GHz	3.6 GHz	3.7 GHz
503 (CXA)	1.505 GHz	3.0 GHz	3.08 GHz
507 (all but CXA)	3.505 GHz	7.0 GHz	7.1 GHz
507 (CXA)	3.755 GHz	7.5 GHz	7.58 GHz
508 (all but MXE)	1.805 GHz	3.6 GHz	8.5 GHz
508 (MXE)	4.205 GHz	8.4 GHz	8.5 GHz
513	6.805 GHz	13.6 GHz	13.8 GHz
526 (except CXA and MXE)	13.255 GHz	26.5 GHz	27.0 GHz*
526 (CXA)	13.255 GHz	26.5 GHz	26.55 GHz
526 (MXE)	1.805 GHz	3.6 GHz	27.0 GHz
532	16.005 GHz	32.0 GHz	32.5 GHz
540	20.005 GHz	40.0 GHz	40.5 GHz
543	21.505 GHz	43.0 GHz	43.0 GHz
544	22.005 GHz	44.0 GHz	45.0 GHz
550	25.005 GHz	50.0 GHz	52 GHz
F03 (CXA-m)	1.505 GHz	3.0 GHz	3.08 GHz
F07 (CXA-m)	3.755 GHz	7.5 GHz	7.575 GHz
F13 (CXA-m)	6.805 GHz	13.6 GHz	13.8 GHz
F26 (CXA-m)	13.255 GHz	26.5 GHz	26.55 GHz
504 (M9421A, M8920A)	2.145 GHz	3.88GHz	3.88 GHz
506 (M9421A, M8920A)	3.245 GHz	6.08GHz	6.08 GHz
F06 (M9410A/11A)	1.0 GHz	6.08 GHz	6.08 GHz
F06 (M9415A)	1 GHz	1.08 GHz	6.6 GHz
F08 (M9415A)	1 GHz	1.08 GHz	8.6 GHz
F12 (M9415A)	1 GHz	1.08 GHz	12.9 GHz

*For option 526, the Max CF in RTSA is 26.999999995 GHz.

N9041B Center Freq Presets

3 Bluetooth Mode
3.6 Monitor Spectrum Measurement

Input	CF after Mode Preset	Stop Freq after Mode Preset	Max Freq (can't tune above)
Input 1, all models	25.005 GHz	50.0 GHz	52 GHz
Input 2, opt 585	42.505 GHz	85.0 GHz	86 GHz
Input 2, opt 590	45.005 GHz	90.0 GHz	92 GHz
Input 2, opt 5CX	55.005 GHz	110.0 GHz	110 GHz

Input 2, CXA and MXE

Model	CF after Mode Preset	Stop Freq after Mode Preset	Max Freq (can't tune above)
CXA opt C75	0.7505 GHz	1.5 GHz	1.58 GHz
MXE	505 MHz	1 GHz	1.000025 GHz

Tracking Generator Frequency Limits (CXA only)

Tracking Generator Option	Min Freq (clips to this freq when turn TG on and can't tune below while TG on)	If above this Freq, Stop Freq clipped to this Freq when TG turned on	Max Freq (can't tune above) while TG on
T03	9 kHz	3.0 GHz	3.08 GHz
T06	9 kHz	6.0 GHz	6.05 GHz

Tracking Generator Frequency Limits(CXA-m only)

Tracking Generator Option	Min Freq (clips to this freq when turn TG on and can't tune below while TG on)	If above this Freq, Stop Freq clipped to this Freq when TG turned on	Max Freq (can't tune above) while TG on
T03	2 MHz	3.08 GHz	3.08 GHz
T07	2 MHz	7.575 GHz	7.575 GHz
T13	2 MHz	13.8 GHz	13.8 GHz
T26	2 MHz	26.55 GHz	26.55 GHz

VXT Models with Radio Heads/CIU Frequency Range

The following table shows the Center Frequency Presets and Range for VXT modes with Radio Heads/CIU.

Products with Radio Heads/CIU	Preset	Start frequency	Stop frequency
M9421A + CIU	6 GHz	5.9 GHz	12 GHz
M9410A + CIU	6 GHz	5.9 GHz	12 GHz
M9410A + CIU + RRH	25 GHz	24.25 GHz	43.5 GHz

RF Center Freq

Specifies the RF Center Frequency. This command sets the Center Frequency to be used when the RF input is selected, even if the RF input is not the input that is selected at the time the command is sent. Note that **"Center Frequency" on page 653** in the **Frequency** menu on the front panel always applies to the currently selected input.

Remote Command	<code>[:SENSe] :FREQuency:RF:CENTer <freq></code> <code>[:SENSe] :FREQuency:RF:CENTer?</code>
Example	<code>:FREQ:RF:CENT 30 MHz</code> <code>:FREQ:RF:CENT?</code>
Notes	This command is the same in all Modes, but the parameter is Measurement Global, so the value is independent in each Mode and common across all the measurements in the Mode
Dependencies	If the electronic/soft attenuator is enabled, any attempt to set Center Frequency such that the Stop Frequency would be >3.6 GHz fails and results in an advisory message. If the equivalent SCPI command is sent, this same message is generated as part of a "-221, Settings conflict" warning
Preset	See "Center Frequency Presets" on page 656 above
State Saved	Saved in instrument state
Min	-79.999995 MHz
Max	See table above. Basically, instrument maximum frequency - 5 Hz If the knob or step keys are being used, also depends on the value of Span

Ext Mix Center Freq

Specifies the External Mixer Center Frequency. This command sets the Center Frequency to be used when the External Mixer is selected, even if the External Mixer input is not the input that is selected at the time the command is sent. Note that **"Center Frequency" on page 653** in the **Frequency** menu on the front panel always applies to the currently selected input.

Remote Command	<code>[:SENSe] :FREQuency:EMIXer:CENTer <freq></code> <code>[:SENSe] :FREQuency:EMIXer:CENTer?</code>
Example	<code>:FREQ:EMIX:CENT 60 GHz</code> <code>:FREQ:EMIX:CENT?</code>
Notes	This command is the same in all Modes, but the parameter is Measurement Global, so the value is independent in each Mode and common across all the measurements in the Mode
Couplings	When returning to External Mixing after having been switched to one of the other inputs (e.g., RF), you will come back into the settings that you had when you left External Mixing. So, you will come back to the band you were in with the Center Frequency that you had. However, Span is not an input-dependent parameter, therefore you will bring the span over from the other input. Therefore, the instrument comes back with the span from the previous input, limited as necessary by the current mixer setup

3 Bluetooth Mode

3.6 Monitor Spectrum Measurement

Preset	<p>When a Mode Preset is performed while in External Mixing, the Start frequency of the current Mode is set to the nominal Min Freq of the lowest harmonic range in the Harmonic Table for the current mixer setup. Similarly, the Stop frequency of the current Mode is set to the nominal Max Freq of the highest harmonic range in the Harmonic Table. The Center Freq thus presets to the point arithmetically equidistant from these two frequencies</p> <p>Note that, if the current measurement has a limited Span available to it, and cannot achieve the Span shown in the table (Span=Stop Freq – Start Freq), the instrument uses the maximum Span the measurement allows, and still sets the Center Freq to the midpoint of the Start and Stop Freq values in the Harmonic Table</p> <p>When Restore Input/Output Defaults is performed, the mixer presets to the 11970A, whose Start and Stop frequencies are 26.5 and 40 GHz respectively. The center of these two frequencies is 33.25 GHz. Therefore, after a Restore Input/Output Defaults, if you go into External Mixing and do a Mode Preset while in the Spectrum Analyzer Mode, the resulting Center Freq is 33.25 GHz</p>
State Saved	Yes
Min	<p>The minimum frequency in the currently selected mixer band + 5 Hz</p> <p>If the knob or step keys are being used, also depends on Span</p>
Max	<p>The maximum frequency in the currently selected mixer band - 5 Hz</p> <p>If the knob or step keys are being used, also depends on Span</p>
<h3>I/Q Center Freq</h3> <p>Specifies the I/Q Center Frequency. This command sets the Center Frequency to be used when the I/Q input is selected, even if the I/Q input is not the input that is selected at the time the command is sent. Note that "Center Frequency" on page 653 in the Frequency menu on the front panel always applies to the currently selected input.</p>	
Remote Command	<pre>[:SENSe] :FREQuency:IQ:CENTer <freq></pre> <pre>[:SENSe] :FREQuency:IQ:CENTer?</pre>
Example	<pre>:FREQ:IQ:CENT 30 MHz</pre>
Notes	This command is the same in all Modes, but the parameter is Measurement Global, so the value is independent in each Mode and common across all the measurements in the Mode
Preset	0 Hz
State Saved	Saved in instrument state
Min	-40.049995 MHz
Max	40.049995 MHz

Span

Changes the displayed frequency range symmetrically about the center frequency. While adjusting the Span, the Center Frequency is held constant, this means that both Start Frequency and Stop Frequency will change.

If the Span is set to a value greater than the maximum allowable span of the instrument, an error message is generated indicating the data is out of range and was clipped to upper limit.

See ["Span Presets" on page 660](#)

Remote Command	<code>[:SENSe]:MONitor:FREQuency:SPAN <freq></code> <code>[:SENSe]:MONitor:FREQuency:SPAN?</code>
Example	<code>:MON:FREQ:SPAN 10 MHz</code> <code>:MON:FREQ:SPAN?</code>
Dependencies	If the electrical attenuator is enabled, any attempt to set Span such that the Stop Frequency would be >3.6 GHz results in an error In instruments with an RF Preselector, such as MXE, you cannot sweep across the band break at 3.6 GHz while the RF Preselector is in Continuous sweep, as there is a mechanical switch which bypasses the RF Preselector above 3.6 GHz
Couplings	Span affects RBW, sweptime, FFT & Sweep choice (including FFT Width, Phase Noise Optimization and ADC Dither auto couplings) <ul style="list-style-type: none"> - Any value of the Center Frequency or Span that is within the frequency range of the instrument is allowed when the value is being set through the front panel numeric keypad or the SCPI command. The other parameter is forced to a different value if needed, to keep the Start and the Stop Frequencies within the instrument's frequency range - When using the knob or the step up/down keys or the UP DOWN keywords in SCPI, the value that is being changed i.e., the Center Frequency or Span, is limited so that the other parameter is not forced to a new value
Preset	Depends on instrument maximum frequency, mode, measurement, and selected input See "Span Presets" on page 660
State Saved	Saved in instrument state
Min	10 Hz
Max	Depends on instrument maximum frequency, mode, measurement, and selected input; see "Span Presets" on page 660 If the knob or step keys are being used, depends on the value of the other three interdependent parameters Center Frequency, Start Frequency, Stop Frequency
Annunciation	Data out of range, value clipped to upper limit
Annotation	Span <value> appears on the first line of the annotation in the lower right corner of display

Span Presets

The following table provides the Max Span, for the various frequency options:

Freq Option	Max Span (can't set higher than this)
503 (all but CXA)	3.7 GHz
503, F03 (CXA, CXA-m)	3.08 GHz

3 Bluetooth Mode
 3.6 Monitor Spectrum Measurement

Freq Option	Max Span (can't set higher than this)
507 (all but CXA)	7.1 GHz
507 (CXA, CXA-m)	7.575 GHz
508 (all but MXE)	8.5 GHz
508 (MXE)	8.5 GHz
513, F13	13.8 GHz
526 (all but CXA and MXE)	27.0 GHz
526 (MXE)	27.0 GHz
526, F26 (CXA, CXA-m)	26.55 GHz
544	44.5 GHz
550	52 GHz
M9415A-F06	6.27 GHz
M9415A-F08	8.27 GHz
M9415A-F12	12.57 GHz

Input 2:

Model	Max Span (can't set higher than this)
CXA opt C75	1.58 GHz
MXE	1.000025 GHz

Note that if you are in External Mixing, the maximum Span will be equal to the Maximum Stop Frequency – Minimum Start Frequency for the currently selected mixer.

Span Presets by Mode

Mode	Radio Std	Preset Value
WCDMA		10.0 MHz
PN		1.0 MHz
GSM/EDGE		1.0 MHz
WLAN	802.11a/b/g/n/ac/ax/be (20 MHz)	25 MHz
	802.11n/ac/ax/be (40MHz)	50 MHz
	802.11ac/ax/be (80MHz)	100 MHz
	802.11ac /ax/be (160MHz)	200 MHz
	802.11be (320MHz)	400 MHz
MSR		20 MHz
LTEAFDD, LTEATDD		20 MHz

Mode	Radio Std	Preset Value
5GNR		150 MHz
RTS		40 kHz
CQM		10 MHz

LMH Channel

Enables quick selection from a subset of the available channel numbers for the Low (channel 0), Middle (channel 39), or High (channel 78) channels.

Remote Command	<code>[:SENSe] :CHANne1 :LMH LOW MID HIGH</code> <code>[:SENSe] :CHANne1 :LMH?</code>
Example	<code>:FREQ:LMH MID</code> <code>:FREQ:LMH?</code>
Couplings	If Radio Stand is Basic or EDR, the soft key label is Low(0), Mid(39), High(78) If Radio Stand is Low Energy, the soft key label is Low(0), Mid(20), High(39) If geography is France, this key will be grayed-out
Preset	LOW
State Saved	Yes
Range	LOW MID HIGH
Backwards Compatibility SCPI	<code>[:SENSe] :FREQuency :LMH LOW MID HIGH</code> <code>[:SENSe] :FREQuency :LMH?</code>

Geography

Selects the desired country. The selection defines the frequency range and the available channel numbers for the transmit channel.

Remote Command	<code>[:SENSe] :FREQuency :GEOGraphy FRANce OTHers</code> <code>[:SENSe] :FREQuency :GEOGraphy?</code>
Example	<code>:FREQ:GEOG FRAN</code> <code>:FREQ:GEOG?</code>
Couplings	France: <ul style="list-style-type: none"> - Center Frequency 2454 MHz + (0...22) MHz - Channel Number: 0...22 Others: <ul style="list-style-type: none"> - Center Frequency 2402 MHz + (0...78) MHz

3 Bluetooth Mode
3.6 Monitor Spectrum Measurement

	- Channel Number: 0...78
Preset	OTHerS
State Saved	Yes
Range	FRANce OTHerS

CF Step

Changes the step size for the center frequency and start and stop frequency functions. Once a step size has been selected and the center frequency function is active, the step keys (and the UP|DOWN parameters for Center Frequency from remote commands) change the center frequency by the step-size value. The step size function is useful for finding harmonics and sidebands beyond the current frequency span of the instrument.

Note that the start and stop frequencies also step by the CF Step value.

Remote Command	<pre>[:SENSe]:FREQuency:CENTer:STEP[:INCRement] <freq> [:SENSe]:FREQuency:CENTer:STEP[:INCRement]? [:SENSe]:FREQuency:CENTer:STEP:AUTO OFF ON 0 1 [:SENSe]:FREQuency:CENTer:STEP:AUTO?</pre>
Example	<pre>:FREQ:CENT:STEP 500 MHz :FREQ:CENT UP</pre> <p>Increases the current center frequency value by 500 MHz</p> <pre>:FREQ:CENT:STEP? :FREQ:CENT:STEP:AUTO ON :FREQ:CENT:STEP:AUTO?</pre>
Notes	Preset and Max values are dependent on Hardware Options
Dependencies	Not available in MSR, LTEAFDD/LTEATDD, 5GNR and Channel Quality Modes If the electronic/soft attenuator is enabled, any attempt to change the value of the center frequency >3.6 GHz by pressing the Up-arrow key, fails and results in an advisory message. If the equivalent SCPI command is sent, this same message is generated as part of a "-221, Settings conflict" warning
Couplings	When auto-coupled, the center frequency step size is set to 10% of the span
Preset	Auto ON
State Saved	Saved in instrument state
Min	– (the maximum frequency of the instrument). That is, 27 GHz max freq instrument has a CF step range of +/- 27 GHz. Note that this is the maximum frequency given the current settings of the instrument, so in External Mixing, for example, it is the maximum frequency of the current mixer band
Max	The maximum frequency of the instrument. That is, 27 GHz max freq instrument has a CF step range of +/- 27 GHz. Note that this is the maximum frequency given the current settings of the instrument, so

	in External Mixing, for example, it is the maximum frequency of the current mixer band
Status Bits/OPC dependencies	non-overlapped

3.6.7 Marker

Accesses a menu that enables you to select, set up and control the markers for the current measurement. If there are no active markers, **Marker** selects marker 1, sets it to Normal and places it at the center of the display. If the selected marker is Off, it is set to Normal and placed it at the center of the screen on the trace determined by the **Marker Trace** rules.

For more detailed information on the types of Markers and the interaction between Markers, see the Marker section of the Swept SA measurement.

3.6.7.1 Select Marker

Specifies the *selected marker*. The term “selected marker” is used throughout this document to specify which marker will be affected when you change marker settings, perform a Peak Search, etc.

This control appears above the menu panel, indicating that it applies to all controls in the Marker menu panels. Select Marker is blanked if you select a tab whose controls do *not* depend on the selected marker (for example, Counter).

On any menu tab for which Select Marker displays, the first control is always **Marker Frequency|Time**.

Notes	The selected marker is remembered even when not in the Marker menu and is used if a Search is done or a Band Function is turned on or for Signal Track or Continuous Peak
Preset	Marker 1
State Saved	The number of the selected marker is saved in instrument state
Annunciation	Appears in the marker results block label for Normal and Delta markers

3.6.7.2 Settings

The controls on this tab include the Marker active function and a radio button selection of the marker control mode (Normal, Delta, or Off) for the selected marker, as well as additional functions that help you use markers.

Marker Frequency

Sets the marker X Axis value in the current marker X Axis Scale unit. It has no effect if the control mode is **Off**, but is the SCPI equivalent of entering an X value if the control mode is **Normal** or **Delta**.

Remote Command	<code>:CALCulate:MONitor:MARKer[1] 2 ... 12:X <freq></code> <code>:CALCulate:MONitor:MARKer[1] 2 ... 12:X?</code>
Example	<code>:CALC:MON:MARK3:X 0</code> <code>:CALC:MON:MARK3:X?</code>
Notes	If no suffix is sent, uses the fundamental units for the current marker X Axis Scale. If a suffix is sent that does not match the current marker X Axis Scale unit, an error "Invalid suffix" is generated The query returns the marker's absolute X Axis value if the control mode is Normal , or the offset from the marker's reference marker if the control mode is Delta . The query is returned in the fundamental units for the current marker X Axis scale: Hz for Frequency and Inverse Time, seconds for Period and Time
Preset	After a preset, all markers are turned OFF, so Marker X Axis Value query returns a not a number (NAN)
State Saved	Saved in instrument state
Min	-9.9E+37
Max	9.9E+37
Annotation	Mkr # <X value> and <Marker value> upper right on graph

Marker X Axis Position (Remote Command Only)

Sets the marker X Axis Scale position in trace points. This setting has no effect if the control mode is Off, but is the SCPI equivalent of entering a value if the control mode is Normal or Delta - except in trace points rather than X Axis Scale units. The entered value is immediately translated into the current X Axis Scale units for setting the value of the marker.

Remote Command	<code>:CALCulate:MONitor:MARKer[1] 2 ... 12:X:POSition <real></code> <code>:CALCulate:MONitor:MARKer[1] 2 ... 12:X:POSition?</code>
Example	<code>:CALC:MON:MARK:X:POS 0</code> <code>:CALC:MON:MARK:X:POS?</code>
Notes	The query returns the marker's absolute X Axis value in trace points if the control mode is Normal , or the offset from the marker's reference marker in trace points if the control mode is Delta . The value is returned as a real number, not an integer, corresponding to the translation from X Axis Scale units to trace points . When a Marker is turned on, it is placed center of the screen on the trace. Therefore, the default value depends on instrument condition. If the marker is Off the response is not a number
Preset	After a preset, all markers are turned OFF , so Marker X Axis Value query returns a not a number (NAN)
State Saved	Saved in instrument state

Min	-9.9E+37
Max	9.9E+37
Marker Y Axis Value (Remote Command only)	
Returns the marker Y Axis value in the current marker Y Axis unit.	
Remote Command	<code>:CALCulate:MONitor:MARKer[1] 2 ... 12:Y?</code>
Example	<code>:CALC:MON:MARK11:Y?</code>
Notes	Returns the marker Y-axis result if the control mode is Normal or Delta . If the marker is Off , the response is Not A Number
Preset	Result dependent on Markers setup and signal source
State Saved	No
Backwards Compatibility SCPI	<code>:CALCulate:MONitor:MARKer[1] 2 ... 12:FUNCTION:RESult?</code>

Marker Mode

Sets the marker control mode to **Normal (POSITION)**, **Delta**, or **Off**. All interactions and dependencies detailed under the control description are enforced when the remote command is sent. If the selected marker is Off, pressing Marker sets it to Normal and places it at the center of the screen on the trace determined by the **Marker Trace** rules. At the same time, **Marker X Axis Value** appears on the Active Function area.

The default active function is the active function for the currently selected marker control mode. If the current control mode is **Off**, there is no active function and the active function is turned off.

Remote Command	<code>:CALCulate:MONitor:MARKer[1] 2 ... 12:MODE POSITION DELTa OFF</code> <code>:CALCulate:MONitor:MARKer[1] 2 ... 12:MODE?</code>
Example	<code>:CALC:MON:MARK:MODE POS</code> <code>:CALC:MON:MARK:MODE?</code>
Preset	OFF
State Saved	Saved in instrument state
Range	POSITION DELTA OFF
Annotation	Mkr # <X value> and <Marker value> upper right on graph

Backward Compatibility SCPI Commands

Sets or queries the state of a marker. Setting a marker that is **OFF** to **ON** (1) puts it in **Normal** mode and places it at the center of the screen.

Remote Command	<code>:CALCulate:MONitor:MARKer[1] 2 ... 12:STATe OFF ON 0 1</code> <code>:CALCulate:MONitor:MARKer[1] 2 ... 12:STATe?</code>
Example	<code>:CALC:MON:MARK3:STAT ON</code> <code>:CALC:MON:MARK3:STAT?</code>
Preset	OFF
State Saved	Saved in instrument state
Range	OFF ON

Delta Marker (Reset Delta)

Pressing this button has exactly the same effect as selecting the **Delta** selection in "**Marker Mode**" on page 666. The selected marker becomes a Delta Marker. If the selected marker is already a Delta marker, the reference marker is moved to the current position of the selected marker, thus resetting the Delta to zero.

Marker Settings Diagram

Lets you configure the Marker system using a visual utility.

All Markers Off

Turns off all markers.

Remote Command	<code>:CALCulate:MONitor:MARKer:AOFF</code>
Example	<code>:CALC:MON:MARK:AOFF</code>

Couple Markers

When this function is **ON**, moving any marker causes an equal X Axis movement of every other marker that is not Off. By "equal X Axis movement" we mean that we preserve the difference between each marker's X Axis value (in the fundamental x-axis units of the trace that marker is on) and the X Axis value of the marker being moved (in the same fundamental x-axis units).

This may result in markers going off screen.

Remote Command	:CALCulate:MONitor:MARKer:COUPle[:STATe] ON OFF 1 0
Example	:CALC:MON:MARK:COUP ON :CALC:MON:MARK:COUP?
Preset	OFF Presets on Mode Preset and All Markers Off
State Saved	Saved in instrument state

3.6.7.3 Peak Search

The controls on this tab allow you to move the marker to selected peaks of the signal, giving you enormous analysis capabilities, particularly when combined with the Delta Marker function.

NOTE

Pressing the **Peak Search** hardkey automatically moves you to the **Peak Search** page of the **Marker** menu and performs a Peak Search. Pressing the **Peak Search** tab once you are already *in* the **Marker** menu does *not* perform a Peak Search.

Marker Frequency

This is the fundamental control that you use to move a marker around on the trace. This is the same as "[Marker Frequency](#)" on [page 665](#) on the **Settings** tab.

Peak Search

Moves the selected marker to the trace point which has the maximum y-axis value for that marker's trace.

NOTE

Pressing the **Peak Search** hardkey automatically moves you to the **Peak Search** page of the **Marker** menu and performs a Peak Search. If the selected marker was off, then it is turned on as a normal marker, and a Peak Search is performed.

Remote Command	:CALCulate:MONitor:MARKer[1] 2 ... 12:MAXimum
Example	:CALC:MON:MARK2:MAX :SYST:ERR?

can be used to query the errors to determine if a peak is found. If a search is unsuccessful, then the

	message "Execution error; No peak found" (-200) will be returned
Notes	Sending this command selects the subopcoded marker

Next Peak

Moves the selected marker to the peak that is next lower in amplitude than the current marker value. If there is no valid peak lower than the current marker value, an "Execution error; No peak found" message is generated and the marker is not moved.

If the selected marker was off, then it is turned on as a normal marker and a peak search is performed.

Remote Command	<code>:CALCulate:MONitor:MARKer[1] 2 ... 12:MAXimum:NEXT</code>
Example	<code>:CALC:MON:MARK2:MAX:NEXT</code> selects marker 2 and moves it to the peak that is next lower in amplitude than the current marker value
Notes	Sending this command selects the subopcoded marker
State Saved	Not part of saved state

Marker Delta

Pressing this control has exactly the same effect as selecting the **Delta** selection in "[Marker Mode](#)" on [page 666](#) on the **Settings** tab. The selected marker becomes a Delta Marker. If the selected marker is already a Delta marker, the reference marker is moved to the current position of the selected marker, thus resetting the Delta to zero.

The control is duplicated here to allow you to conveniently perform a peak search and change the marker's control mode to Delta without having to access two separate menus.

3.6.7.4 Properties

The controls on this tab are used to set certain properties of the selected marker.

Marker Frequency

This is the fundamental control that you use to move a marker around on the trace. This is the same as "[Marker Frequency](#)" on [page 665](#) on the **Settings** tab.

Relative To

Selects the marker to which the selected marker is relative (its reference marker).

Every marker has another marker to which it is relative. This marker is referred to as the “reference marker” for that marker. This attribute is set by the **Marker, Properties, Relative To** key. The marker must be a **Delta** marker to make this attribute relevant. If it is a **Delta** marker, the reference marker determines how the marker is controlled and how its value is displayed. A marker cannot be relative to itself.

Remote Command	<code>:CALCulate:MONitor:MARKer[1] 2 ... 12:REFerence <integer></code> <code>:CALCulate:MONitor:MARKer[1] 2 ... 12:REFerence?</code>
Example	<code>:CALC:MON:MARK2:REF 1</code> <code>:CALC:MON:MARK2:REF?</code>
Notes	This command causes the marker specified with the subopcode to become selected Range (for SCPI command): 1 to 12. If the range is exceeded the value is clipped A marker cannot be relative to itself so that choice is not available, and if sent from SCPI generates error -221: “Settings conflict; marker cannot be relative to itself” When queried a single value is returned (the specified marker numbers relative marker)
Couplings	The act of specifying the selected marker’s reference marker makes the selected marker a Delta marker If the reference marker is off it is turned on in Normal mode at the delta marker location
Preset	The preset default “Relative To” marker (reference marker) is the next higher numbered marker (current marker +1). For example, if marker 2 is selected, then it’s default reference marker is marker 3. The exception is marker 12, which has a default reference of marker 1 Set to the defaults by using Restore Mode Defaults . This is not reset by Marker Off, All Markers Off, or Preset
State Saved	Saved in instrument state. Not affected by Marker Off and hence not affected by Preset or power cycle
Min	1
Max	12
Annunciation	Appears in the marker label of a Delta marker

Marker Trace

Selects the trace on which you want your marker placed. A marker is associated with one and only one trace. This trace is used to determine the placement, result, and X-Axis Scale of the marker. All markers have an associated trace; it is from that trace that they determine their attributes and behaviors, and it is to that trace that they go when they become Normal markers.

Specifying a Marker Trace manually or with this command associates the marker with the specified trace. If the marker is not **OFF**, it moves the marker from the trace it was on to the new trace. If the marker is **OFF**, it stays off but is now associated with the specified trace.

The query returns the number of the trace on which the marker is currently placed.

Remote Command	<code>:CALCulate:MONitor:MARKer[1] 2 ... 12:TRACe 1 2 3</code> <code>:CALCulate:MONitor:MARKer[1] 2 ... 12:TRACe?</code>
Example	<code>:CALC:MON:MARK:TRAC 1</code> <code>:CALC:MON:MARK:TRAC?</code>
Notes	A marker may be placed on a blanked and/or inactive trace, even though the trace is not visible and/or updating An application may register a trace name to be displayed on the control instead of a trace number
Couplings	The state of Marker Trace is not affected by the "Auto Couple" on page 787 key Sending the remote command causes the addressed marker to become selected
Preset	1
State Saved	Saved in instrument state
Min	1
Max	3

Marker Settings Diagram

Lets you configure the Marker system using a visual utility. This is the same as the **"Marker Settings Diagram" on page 667** control on the **Settings** tab.

3.6.7.5 Marker Function

The controls on this tab allow you to control the Marker Functions of the instrument. Marker Functions perform post-processing operations on marker data.

The **Marker Function** menu controls which marker functions are turned on and allows you to adjust the setup parameters for each function. These parameters include the following, but only one parameter can be assigned to a given marker:

- Marker Noise
- Band Power
- Band Density
- Off

Marker Frequency

This is the fundamental control that you use to move a marker around on the trace. This is the same as "Marker Frequency" on page 665 on the **Settings** tab.

Marker Function

Sets the marker control function type to one of the following:

NOISe	Marker Noise
BPOWer	Band Power
BDENsity	Band Density
OFF	Marker Function Off

Remote Command	<code>:CALCulate:MONitor:MARKer[1] 2 ... 12:FUNCTION NOISe BPOWer BDENsity OFF</code> <code>:CALCulate:MONitor:MARKer[1] 2 ... 12:FUNCTION?</code>
Example	<code>:CALC:MON:MARK:FUNC NOIS</code> <code>:CALC:MON:MARK:FUNC?</code>
Preset	OFF
State Saved	Yes
Range	NOISe BPOWer BDENsity OFF
Annotation	Mkr # <X value> and <Marker value> upper right on graph

Band Span

Sets the width of the frequency span for the selected marker.

Remote Command	<code>:CALCulate:MONitor:MARKer[1] 2 ... 12:FUNCTION:BAND:SPAN <freq></code> <code>:CALCulate:MONitor:MARKer[1] 2 ... 12:FUNCTION:BAND:SPAN?</code>
Example	<code>:CALC:MON:MARK12:FUNC:BAND:SPAN 20 MHz</code> <code>:CALC:MON:MARK12:FUNC:BAND:SPAN?</code>
Couplings	Changing the Band Span necessarily changes the Band Left and Band Right values
Preset	Depends on X axis range of selected Trace 10% of Span
State Saved	Yes
Min	-9.9E+37 0
Max	9.9E+37 26.5GHz

Band Left

Sets the left edge frequency or time value for the band of the selected marker.

Remote Command	<code>:CALCulate:MONitor:MARKer[1] 2 ... 12:FUNCTION:BAND:LEFT <freq></code> <code>:CALCulate:MONitor:MARKer[1] 2 ... 12:FUNCTION:BAND:LEFT?</code>
Example	<code>:CALC:MON:MARK12:FUNC:BAND:LEFT 20 GHz</code> <code>:CALC:MON:MARK12:FUNC:BAND:LEFT?</code>
Couplings	Changing the Band Left necessarily changes the Band Span value
Preset	Depends on X axis range of selected Trace
State Saved	Yes
Min	-9.9E+37
Max	9.9E+37

Band Right

Sets the right edge frequency or time value for the band of the selected marker.

Remote Command	<code>:CALCulate:MONitor:MARKer[1] 2 ... 12:FUNCTION:BAND:RIGHT <freq></code> <code>:CALCulate:MONitor:MARKer[1] 2 ... 12:FUNCTION:BAND:RIGHT?</code>
Example	<code>:CALC:MON:MARK12:FUNC:BAND:RIGH 20 GHz</code> <code>:CALC:MON:MARK12:FUNC:BAND:RIGH?</code>
Couplings	Changing the Band Right necessarily changes the Band Span value
Preset	Depends on X axis range of selected Trace
State Saved	Yes
Min	-9.9E+37
Max	9.9E+37

3.6.8 Meas Setup

This menu panel contains functions for setting up the measurement parameters and also contains functions for setting up parameters global to all measurements in the Mode.

3.6.8.1 Settings

Contains frequently used Meas Setup functions to which you will want the fastest access.

Avg|Hold Num

Specifies the number of measurement averages used when calculating the measurement result. The average is displayed at the end of each sweep.

After the specified number of average counts, the averaging mode (terminal control) setting determines the averaging action.

Remote Command	<code>[:SENSe]:MONitor:AVERage:COUNT <integer></code> <code>[:SENSe]:MONitor:AVERage:COUNT?</code>
Example	<code>:MON:AVER:COUN 25</code> <code>:MON:AVER:COUN?</code>
Preset	10
State Saved	Yes
Min/Max	1/1000
Annotation	The average count is displayed in the measurement bar on the front panel display. The annotation appears in the format n/N where n is the current average and N is the average count

Averaging On/Off

Turns averaging on or off.

Remote Command	<code>[:SENSe]:MONitor:AVERage[:STATe] OFF ON 0 1</code> <code>[:SENSe]:MONitor:AVERage[:STATe]?</code>
Example	<code>:MON:AVER ON</code> <code>:MON:AVER?</code>
Preset	OFF
State Saved	Yes
Range	OFF ON

Average Mode

Toggles the Average Mode:

- **EXPonential**- continues measurement averaging, using the specified number of averages to compute each averaged value. The average is displayed at the end of each sweep
- **REPeat**- causes the measurement to reset the average counter each time the specified number of averages is reached

Remote Command	<code>[:SENSe]:MONitor:AVERage:TCONtrol EXPonential REPeat</code>
Example	<code>:MON:AVER:TCON EXP</code> <code>:MON:AVER:TCON?</code>
Preset	<code>EXPonential</code>
State Saved	Yes
Range	<code>EXPonential REPeat</code>

Spur Avoidance

Because the VXT models M9410A/11A/15A are direct-conversion (zero-IF) receivers, feedthrough leakage from the local oscillator appears as a spurious signal (spur) at the center frequency. The **Spur Avoidance** function is provided to eliminate this spur, at the expense of some measurement speed. For Spur Avoidance, the instrument uses a software algorithm to remove this spur from the displayed measurement data.

Some measurements allow you to turn off **Spur Avoidance**, but in this measurement it is always enabled. Therefore, in this measurement the Spur Avoidance switch is unavailable (grayed out) and set to Enabled.

Furthermore, if you press the grayed-out switch, this popup message appears:

`Always enabled in this measurement. See manual for details`

Remote Command	<code>[:SENSe]:MONitor:SAVoid[:STATe]?</code>
Example	<code>:MON:SAV?</code> Always returns <code>ON</code>
Dependencies	This control only appears in VXT models M9410A/11A/15A
Preset	<code>ON</code>
State Saved	Saved in instrument state
Range	<code>ON</code>

Meas Setup Summary Table

Lets you view and access many of the parameters in the Meas Setup menus on one screen.

Auto Couple

Immediately puts all **Auto/Man** functions into **Auto**. **Auto Couple** is confined to the current measurement only. It does not affect other measurements in the Mode.

In the **Auto** state, **Auto/Man** functions are said to be “coupled”, meaning their values change as you make changes to other values in the measurement. This helps ensure accurate measurements and optimum dynamic range. **Auto Couple** is an immediate action function, and when it is executed, all the **Auto/Man** controls for the current measurement are set to **Auto**, and all measurement settings coupled to the **Auto/Man** parameters are automatically set to their optimal values.

For further details of measurement-specific settings (if any), see "[Measurement-Specific Details](#)" on page 677 below.

Remote Command	:COUPle ALL
Example	:COUP ALL
Backwards Compatibility SCPI	:COUPLE ALL NONE
Backwards Compatibility Notes	:COUP:NONE puts all Auto/Man parameters in manual mode, decoupling all the coupled instrument parameters. It is retained for backwards compatibility and is <i>not</i> recommended for making measurements or new designs

All **Auto/Man** parameter couplings in the measurement are set to **Auto**. This includes couplings that may be unavailable or grayed-out due to the current state. For example, in the Swept SA measurement, there is no **Auto/Man** coupling for **RBW** while in Zero Span. Nonetheless, if **Auto Couple** were executed while in Zero Span, it would set **RBW** to Auto "behind the scenes" so that, on exit from Zero Span, it would be in **Auto**.

Any **Auto/Man** selection specific (local) to the other measurements in the current Mode are not affected by **Auto Couple**. Any functions that are *not* coupled with other instrument parameters, such as ranging or leveling variables, such as **AutoRange** or **AutoScale**, are not affected.

Executing **Auto Couple** generates the informational message, "All Auto/Man functions have been set to Auto".

Each parameter, upon being set to **Auto**, selects and sets the appropriate auto-coupled value based on that parameter's coupling rules. The Dependency Resolver orchestrates the couplings for parameters that depend on one or more other parameters. The coupling and dependency rules for each parameter are defined in the section describing that parameter.

Executing **Auto Couple** *does not* affect markers, marker functions, trace or display attributes, or any other instrument setting other than those specifically mentioned above.

Measurement-Specific Details

TOI (SA Mode only)

Parameters affected by **Auto Couple** are:

- Center Frequency Step
- Resolution Bandwidth
- Span/RBW Ratio
- Sweep Time
- Video BANDwidth VBW/RBW ratio
- Upper and Lower Tone (set to Sense)
- Zero span measurement Resolution Bandwidth
- Zero span measurement Dwell Time

Harmonics (SA Mode only)

Parameters affected by **Auto Couple** are:

- Resolution Bandwidth
- Fundamental Frequency
- Dwell Time
- Range Table Resolution Bandwidths
- Range Table Dwell Times

Meas Preset

Restores all the measurement parameters to their default values.

Remote Command **:CONFigure:MONitor**

Example **:CONF:MON**

3.6.8.2 Radio

Contains controls to select Radio Standard and device type. It appears in the Transmit Analysis, LE In-band Emissions, Monitor Spectrum, and Output Spectrum Bandwidth measurements

Radio Standard

Allows the user to select the Radio Standard of the expected Bluetooth Signal being measured.

Remote Command	<code>[:SENSe]:RADio:STANdard BASic EDR LENergy QHS</code> <code>[:SENSe]:RADio:STANdard?</code>
Example	<code>:RAD:STAN EDR</code> <code>:RAD:STAN?</code>
Couplings	The Basic EDR Low Energy value can be available when 9081EM0E/OD license is installed The QHS value can be available when 9081SP1E license is installed
Preset	<code>BASic</code>
State Saved	Yes
Range	Basic EDR Low Energy QHS

LE PHY

Sets LE PHY type.

Remote Command	<code>[:SENSe]:RADio:LE:PHY LE1M LE2M LECoded</code> <code>[:SENSe]:RADio:LE:PHY?</code>
Example	<code>:RAD:LE:PHY LE1M</code> <code>:RAD:LE:PHY?</code>
Couplings	Grayed-out if radio standard is not LE and measurement is not LE In-band Emission
Preset	<code>LE1M</code>

Device

Allows the user to select the expected Power Class.

Remote Command	<code>[:SENSe]:RADio:DEVice PC1 PC2 PC3</code> <code>[:SENSe]:RADio:DEVice?</code>
Example	<code>:RAD:DEV PC1</code>

	:RAD:DEV?
Couplings	It determines the default limit value of Output Power Grayed-out if Radio standard is Not Basic
Preset	PC1
State Saved	Yes
Range	Power Class1 Power Class2 Power Class3

3.6.8.3 Global

The controls in this menu apply to all Modes in the instrument.

Some controls (for example, "[Global Center Freq](#)" on page 799) allow you to switch certain Meas Global parameters to a Mode Global state. These switches apply to all Modes that support global settings. For example, no matter what Mode you are in when you set **Global Center Freq** to **ON**, it applies to all Modes that support Global settings.

Other controls (for example, **Extend Low Band**) are actually set in this menu, but apply to all Modes.

Global Center Freq

The software maintains a Mode Global value called **Global Center Freq**.

When **Global Center Freq** is switched **ON**, the current Mode's center frequency is copied into the **Global Center Frequency**, and from then on all Modes that support global settings use the **Global Center Frequency**, so you can switch between any of these Modes and the **Center Frequency** remains unchanged.

Adjusting the **Center Frequency** of any Mode that supports Global Settings, while **Global Center Freq** is **ON**, modifies the **Global Center Freq**.

When **Global Center Freq** is switched **OFF**, the **Center Frequency** of the current Mode is unchanged, but now the **Center Frequency** of each Mode is once again independent.

When **Mode Preset** is pressed while **Global Center Freq** is **ON**, the **Global Center Freq** is preset to the preset **Center Frequency** of the current Mode.

This function resets to **OFF** when "[Restore Defaults](#)" on page 800 is pressed, or when **System, Restore Defaults, All Modes** is pressed.

Remote Command	:INSTrument:COUPle:FREQuency:CENTer ALL NONE
Example	:INST:COUP:FREQ:CENT ALL

	<code>:INST:COUP:FREQ:CENT?</code>
Preset	Set to OFF on Global Settings, Restore Defaults and System, Restore Defaults, All Modes
Range	ALL NONE
Preset	OFF
Backwards Compatibility SCPI	<code>:GLOBal:FREQuency:CENTer[:STATe] 1 0 ON OFF</code> <code>:GLOBal:FREQuency:CENTer[:STATe]?</code>

Global EMC Std

When this control is switched **ON**, the current Mode's EMC Std is copied into the **Global EMC Std**, and from then on all Modes that support global settings use the **Global EMC Std**, so you can switch between any of these Modes and the EMC Std remains unchanged.

Adjusting the EMC Std of any Mode that supports Global settings, while **Global EMC Std** is **ON** modifies the **Global EMC Std**.

When **Global EMC Std** is switched **OFF**, the EMC Std of the current Mode remains unchanged, but now the EMC Std of each Mode is once again independent. When **Mode Preset** is pressed while **Global EMC Std** is **ON**, **Global EMC Std** is preset to the preset EMC Std of the current Mode.

This function resets to **OFF** when "**Restore Defaults**" on page 800 is pressed, or when **System, Restore Defaults, All Modes** is pressed.

Remote Command	<code>:INSTrument:COUPle:EMC:STANdard ALL NONE</code> <code>:INSTrument:COUPle:EMC:STANdard?</code>
Example	<code>:INST:COUP:EMC:STAN ALL</code> <code>:INST:COUP:EMC:STAN?</code>
Dependencies	Only available if Option EMC is installed
Preset	Set to OFF on Global Settings, Restore Defaults and System, Restore Defaults, All Modes
Range	ALL NONE

Restore Defaults

Resets all functions in the **Global** settings menu to **OFF**. Pressing **System, Restore Defaults, All Modes** has the same effect.

Remote Command	<code>:INSTrument:COUPle:DEFault</code>
Example	<code>:INST:COUP:DEF</code>
Backwards Compatibility SCPI	<code>:GLOBal:DEFault</code>

3.6.9 Sweep

Accesses controls that enable you configure and control the acquisition of data and the X-axis parameters of the instrument. These controls might include Sweep Time, Continuous/Single, Pause/Resume, X Scale, and number of Points.

3.6.9.1 Sweep/Control

Accesses controls that let you operate the sweep and control functions of the instrument, such as **Sweep Time** and **Continuous/Single**.

Sweep Time

Controls the time the instrument takes to sweep the current frequency span in swept measurements, displays the sweep time in swept measurements, and displays the equivalent Sweep Time in FFT measurements.

When **Sweep Time** is in Auto, the instrument computes a time that will give accurate measurements based on other settings, such as RBW and VBW.

You can select a shorter sweep time to improve the measurement throughput (with some potential unspecified accuracy reduction), but the **Meas Uncal** indicator will appear if the sweep time you set is less than the calculated Auto Sweep time.

You can also select a longer sweep time, which can be useful (for example) for obtaining accurate insertion loss measurements on very narrowband filters.

NOTE

Significantly faster sweep times are available with Option FS1.

NOTE

The **Meas Uncal** (measurement uncalibrated) warning is displayed in the Status Bar at the bottom of the screen when the manual Sweep time entered is faster than the time computed by the instrument's Sweep time equations, that is, the Auto Sweep Time. The instrument's computed Sweep time will provide accurate measurements; if you sweep faster than this your measurements may be inaccurate. A **Meas Uncal** condition may be corrected by returning the Sweep Time to Auto; by entering a longer Sweep Time; or by choosing a wider RBW and/or VBW.

NOTE

On non-sweeping hardware, this control is grayed-out. The value shown on this control is an estimate. It is the measurement's turnaround time, which is the sum of signal acquisition time, FFT time, and other overhead time, to complete the entire span of the measurement. If you need to specify the same "Sweep Time"

as you would for sweeping hardware, send `[:SENSe] :<meas>:SWEep:TIME <time>`. The measurement emulates the “Sweep Time” effect, but this emulation is not straightforward, and therefore the behavior is not specified. Instead, we recommend using Minimum Acquisition Time, which provides better control.

Remote Command	<code>[:SENSe] :<meas>:SWEep:TIME <time></code> <code>[:SENSe] :<meas>:SWEep:TIME?</code>
Example	Channel Power measurement: <code>:CHP:SWE:TIME 25ms</code> <code>:CHP:SWE:TIME?</code>
Notes	In the ACP measurement in WCDMA Mode, this parameter is preset by Meas Method selection. Preset values are as follows: <ul style="list-style-type: none"> - IBW: 29 ms - IBWR: 108 ms - FAST 7.5 ms
Dependencies	On non-sweeping hardware, this control is grayed out, and the Auto/Man toggle disappears. The read-only control shows estimated sweep time In those instruments, " Minimum Acquisition Time " on page 803 is available
Couplings	Coupled to Span , RBW , VBW , and Sweep Time Rules when Sweep Time is set to Auto; Sweep Time changes when these parameters are changed When you manually set a value when in the Auto state, the state automatically changes to Man
Preset	Automatically Calculated unless noted below WCDMA Mode <ul style="list-style-type: none"> - Channel Power: 1.0 msOBW: 32.6 ms - ACP: 29 ms
State Saved	Saved in instrument state
Min	Other than non-sweeping hardware: Typically, 1 ms Non-sweeping hardware: N/A In the ACP measurement, when Meas Method is Fast Power , the minimum sweep time is span-dependent and automatically calculated
Max	Other than non-sweeping hardware: 4000 s Non-sweeping hardware: N/A
Annotation	The sweep time is displayed in the lower-right corner of the screen. The number of points is displayed parenthetically, as: Sweep 13.3 ms (1001 points) A “#” mark appears before “Sweep” in the annotation when it is switched from Auto to Manual coupling

Status Bits/OPC dependencies	Meas Uncal is Bit 0 in the register: <code>STATUS:QUESTIONABLE:INTEGRITY:UNCALIBRATED</code>
	Auto Function
Remote Command	<code>[:SENSe]:<meas>:SWEep:TIME:AUTO OFF ON 0 1</code> <code>[:SENSe]:<meas>:SWEep:TIME:AUTO?</code>
Example	Channel Power measurement: <code>:CHP:SWE:TIME:AUTO OFF</code> <code>:CHP:SWE:TIME:AUTO?</code>
Preset	WCDMA Mode <code>OFF</code> All others <code>ON</code>

Minimum Acquisition Time

Available on non-sweeping hardware.

Specifies the minimum acquisition time for each “chunk” of the measurement result. The instrument automatically divides Span into multiple chunks if needed. Therefore, the total signal acquisition time for the entire Span is:

$$\sim(\sim\text{Minimum Acquisition Time}) * (\text{The number of chunks})$$

When in Auto, this parameter’s value is determined by other parameters, such as **Span**, **RBW** and **VBW**.

You can manually increase this parameter value from this Auto value.

If increased, the instrument acquires signal for the specified time duration for each chunk. It performs additional FFTs, and averages or peak-holds the FFT results for a chunk, depending on **Detector** settings.

Note that the actual acquisition time for each chunk may exceed the **Minimum Acquisition Time** value, in order to satisfy FFT time required by other parameters, and to perform an integer number of FFTs.

Remote Command	<code>[:SENSe]:<meas>:SWEep:ACQuisition:TIME <time></code> <code>[:SENSe]:<meas>:SWEep:ACQuisition:TIME?</code> <code><meas></code> is the identifier for the current measurement; any one of CHPower - ACPower OBWidth MONitor
Example	Channel Power measurement <code>:CHP:SWE:ACQ:TIME 500 ms</code> <code>:CHP:SWE:ACQ:TIME?</code>

Dependencies	Available only on non-sweeping hardware
Couplings	Coupled to Span , RBW , and VBW when in the Auto state When you manually set a value when in the Auto state, the state automatically changes to Man
Preset	Automatically calculated
State Saved	Saved in instrument state
Min	100 ns
Max	4.00 ks
Auto Function	
Remote Command	<code>[:SENSE] : <meas> : SWEep : ACQuisition : TIME : AUTO OFF ON 0 1</code> <code>[:SENSe] : <meas> : SWEep : ACQuisition : TIME : AUTO?</code> <code><meas></code> is the identifier for the current measurement; any one of CHPower - ACPower OBWidth MONitor
Example	Channel Power measurement: <code>:CHP : SWE : ACQ : TIME : AUTO OFF</code>
Preset	ON

Sweep/Measure

Lets you toggle between **Continuous** and **Single** sweep or measurement operation. The single/continuous state is Meas Global, so the setting affects all measurements.

The front-panel key **Single/Cont** performs exactly the same function

See "[More Information](#)" on page 685

Remote Command	<code>:INITiate:CONTinuous OFF ON 0 1</code> <code>:INITiate:CONTinuous?</code>
Example	Put instrument into Single measurement operation: <code>:INIT:CONT 0</code> <code>:INIT:CONT OFF</code> Put instrument into Continuous measurement operation: <code>:INIT:CONT 1</code> <code>:INIT:CONT ON</code>
Preset	ON Note that <code>:SYST:PRES</code> sets <code>:INIT:CONT</code> to ON , but <code>*RST</code> sets <code>:INIT:CONT</code> to OFF
State Saved	Saved in instrument state
Annunciation	The Single/Continuous icon in the Meas Bar changes depending on the setting: – A line with an arrow is Single

-
- A loop with an arrow is **Continuous**
-

Backwards
Compatibility
Notes

X-Series A-models had **Single** and **Cont** hardkeys in place of the **SweepSingleCont** softkey. In the X-Series A-models, if in single measurement, the **Cont** hardkey (and **INIT:CONT ON**) switched to continuous measurement, but never restarted a measurement and never reset a sweep

X-Series B-models have a **Cont/Single** toggle control instead of **Single** and **Cont** hardkeys, but it is still true that, if in single measurement, the **Cont/Single** toggle control never restarts a measurement and never resets a sweep

More Information

Continuous Mode	<p>The instrument takes repetitive sweeps, averages, measurements, etc., when in continuous mode. If in average or Max/Min Hold, and the average/hold count reaches the Average/Hold Num, the count stops incrementing, but the instrument keeps sweeping</p> <p>See the Trace key description under Trace Average for the averaging formula used both before and after the Average/Hold Num is reached. The trigger condition must be met prior to each sweep</p> <p>The type of trace processing for multiple sweeps is set under the Trace key, with choices of Trace Average, Max Hold, or Min Hold</p>
Single Mode	<p>The instrument takes a single sweep when in Single mode, or if in average or Max/Min Hold, or if there is a Waterfall window displayed, it takes multiple sweeps until the average/hold count reaches the Average/Hold Num, then the count stops incrementing, and the instrument stops sweeping</p> <p>See the Trace key description under Trace Average for the averaging formula used. The trigger condition must be met prior to the sweep</p> <p>The type of trace processing for multiple sweeps is set under the Trace key, with choices of Trace Average, Max Hold, or Min Hold</p>

If the instrument is in **Single** measurement mode, pressing the **Cont/Single** toggle control does not zero the count and does not cause the sweep to be reset; the only action is to put the instrument into Continuous measurement operation.

If the instrument is already in **Continuous** sweep:

- **:INIT:CONT 1** has no effect
- **:INIT:CONT 0** places the instrument in Single Sweep but has no effect on the current sequence until $k = N$, at which point the current sequence will stop and the instrument will go to the idle state

See "**Restart**" on page 806 for details of **:INIT:IMMEDIATE**.

If the instrument is already in **Single** sweep, **:INIT:CONT OFF** has no effect.

If the instrument is already in **Single** sweep, then pressing **Cont/Single** in the middle of a sweep does not restart the sweep or sequence. Similarly, pressing **Cont/Single** does not restart the sweep or sequence if the sweep is not in the idle state (for example, if you are taking a very slow sweep, or the instrument is waiting for a

trigger). Even though pressing **Cont/Single** in the middle of a sweep does not restart the sweep, sending **:INIT:IMM** does reset it.

If the instrument is in **Single** sweep, and *not* Averaging/Holding, and you want to take one more sweep, press **Restart**.

If the instrument is in **Single** sweep, *and* Averaging/Holding, and you want to take one more sweep without resetting the Average trace or count, go to **Meas Setup** and increment the average count by 1 by pressing the **Step-Up** key while **Average/Hold Num** is the active function. You can also do this by sending **:CALC:AVER:TCON UP**.

Restart

Restarts the current sweep, or measurement, or set of averaged/hold sweeps or measurements. If you are Paused, pressing **Restart** performs a Resume.

The front-panel key **Restart** performs exactly the same function.

The **Restart** function is accessed in several ways:

- Pressing the **Restart** key
- Sending **:INIT:IMM**
- Sending **:INIT:REST**

See "[More Information](#)" on page 687

Remote Command	:INITiate[:IMMediate] :INITiate:REStart
Example	:INIT:IMM :INIT:REST
Notes	:INIT:REST and :INIT:IMM perform exactly the same function
Couplings	Resets average/hold count k. For the first sweep overwrites all active (update = on) traces with new current data. For application modes, it resets other parameters as required by the measurement
Status Bits/OPC dependencies	This is an Overlapped command The STATus:OPERation register bits 0 through 8 are cleared , <i>except</i> bit 6 (Waiting for Periodic Sync). Initiating a measurement and Waiting for Periodic Sync could be asynchronous The STATus:QUEStionable register bit 9 (INTEGRity sum) is cleared The SWEePING bit is set The MEASURING bit is set
Backwards Compatibility Notes	For Spectrum Analysis Mode in ESA and PSA, the Restart hardkey and the :INIT:REST command restarted trace averages (displayed average count reset to 1) for a trace in Clear Write , but did not restart Max Hold and Min Hold

In X-Series, the **Restart** hardkey and the `:INIT:REST` command restart not only **Trace Average**, but **MaxHold** and **MinHold** traces as well

More Information

The **Restart** function first aborts the current sweep or measurement as quickly as possible. It then resets the sweep and trigger systems, sets up the measurement and initiates a new data measurement sequence with a new data acquisition (sweep) taken once the trigger condition is met.

If the instrument is in the process of aligning when a **Restart** is executed, the alignment finishes before the restart function is performed.

Even when set for **Single** operation, multiple sweeps may be taken when **Restart** is pressed (for example, when averaging/holding is on). Thus, when we say that **Restart** "restarts a measurement", depending on the current settings, we may mean that it:

- Restarts the current sweep
- Restarts the current measurement
- Restarts the current set of sweeps if any trace is in Trace Average, Max Hold or Min Hold
- Restarts the current set of measurements if Averaging, or Max Hold, or Min Hold is on for the measurement

If there is no Average or Max/Min Hold function (no trace in Trace Average or Hold, or **Average/Hold Num** set to 1), and no **Waterfall** window is being displayed, a single sweep is equivalent to a single measurement. A single sweep is taken after the trigger condition is met; and the instrument stops sweeping once that sweep has completed. However, with **Average/Hold Num** >1, and at least one trace set to Trace Average, Max Hold, or Min Hold, or a **Waterfall** window being displayed, multiple sweeps/data acquisitions are taken for a single measurement. The trigger condition must be met prior to each sweep. The sweep is stopped when the average count k equals the number N set for **Average/Hold Num**.

Once the full set of sweeps has been taken, the instrument goes to the idle state. To take one more sweep without resetting the average count, increment the average count by 1, by pressing the **Step-Up** key while **Average/Hold Number** is the active function, or by sending the remote command `:CALC:AVER:TCON UP`.

Trace Update

The numeric results are not blanked at any time during the restart cycle.

For slow sweeps (see **Trace Update** section in **Trace/Detector**), the traces are updated real-time during the sweep. There may be a special circumstance in application mode measurements where an exception is made and the traces and/or results need to be blanked before displaying the new results.

To summarize, the following list shows what happens to the trace data on various events:

Event	Trace Effect
Clear/Write pressed (even if already in Clear/Write)	Set to mintracevalue
Max Hold pressed (even if already in Max Hold)	Set to mintracevalue
Min Hold pressed (even if already in Min Hold)	Set to maxtracevalue
Trace Average pressed (even if already in Trace Average)	Trace data unaffected but start new sweep/avg/hold
Restart pressed	Trace data unaffected but start new sweep/avg/hold
Parameter requiring restart changed (e.g., RBW)	Trace data unaffected but start new sweep/avg/hold

Sweep and Trigger Reset

Resetting the sweep system resets the average/hold count k to 0. It also resets the set point counter to 0. Resetting the trigger system resets the internal auto trig timer to the value set by the **Auto Trig** control.

Averaging

The weighting factor used for averaging is k . This k is also the average/hold count for how many valid sweeps (data acquisitions) have been done. This k is used for comparisons with N , as those comparisons always needs to be based on valid completed sweeps.

The displayed average/hold, K , shows the count for the sweep (data acquisition) in progress. $K = k + 1$, with a limit of N . The displayed value K changes from its previous value to 1 as soon as the trigger condition for the first data acquisition (sweep) is met.

Pause/Resume

Pauses a measurement after the current data acquisition is complete.

When paused, the label on the control changes to **Resume**. Pressing **Resume** unpauses the measurement. When paused, pressing **Restart** performs a Resume.

Remote Command	<code>:INITiate:PAUSE</code> <code>:INITiate:RESume</code>
Example	<code>:INIT:PAUS</code> <code>:INIT:RES</code>
Dependencies	Not displayed in Modes that do not support pausing
Annotation	Only on control

Abort (Remote Command Only)

Stops the current measurement. Aborts the current measurement as quickly as possible, resets the sweep and trigger systems, and puts the measurement into an "idle" state. If the instrument is in the process of aligning when `:ABORT` is sent, the alignment finishes *before* the abort function is performed, so `:ABORT` does not abort an alignment.

If the instrument is set for **Continuous** measurement, it sets up the measurement and initiates a new data measurement sequence with a new data acquisition (sweep) taken once the trigger condition is met.

If the instrument is set for **Single** measurement, it remains in the "idle" state until an `:INIT:IMM` command is received.

Remote Command	<code>:ABORT</code>
Example	<code>:ABOR</code>
Notes	If <code>:INIT:CONT</code> is ON , then a new continuous measurement will start immediately, with sweep (data acquisition) occurring once the trigger condition has been met If <code>:INIT:CONT</code> is OFF , then <code>:INIT:IMM</code> is used to start a single measurement, with sweep (data acquisition) occurring once the trigger condition has been met
Dependencies	For continuous measurement, <code>:ABORT</code> is equivalent to the Restart key Not all measurements support this command
Status Bits/OPC dependencies	The <code>STATUS:OPERation</code> register bits 0 through 8 are cleared , <i>except</i> bit 6 (Waiting for Periodic Sync). Initiating a measurement and Waiting for Periodic Sync could be asynchronous The <code>STATUS:QUEStionable</code> register bit 9 (INTEgrity sum) is cleared Since all the bits that feed into OPC are cleared by <code>:ABORT</code> , the Abort command will cause the <code>*OPC</code> query to return true

Sweep Time Annotation (Remote Query Only)

Returns the **Sweep Time Annotation** value. Available only on non-sweeping hardware.

This value is also displayed in the result trace window.

The value returned is the estimated turnaround time of each measurement cycle, in seconds. The turnaround time is the sum of the signal acquisition time, FFT time, and other overhead time, to complete the entire span of each measurement cycle.

Remote Command	<code>[:SENSe]:<meas>:SWEep:ETIME?</code> <code><meas></code> is the identifier for the current measurement; any one of <code>CHPower- ACPower OBWidth MONitor</code>
Example	Channel Power measurement <code>:CHP:SWE:ETIME?</code>
Dependencies	Available only on non-sweeping hardware
Preset	Automatically calculated

3.6.9.2 Sweep Config

Accesses controls that enable you to configure the Sweep and Control functions of the instrument, such as Sweep Rules.

Points

Sets the number of points taken per sweep, and displayed in the traces. The current value of points is displayed parenthetically, next to the sweep time in the lower-right corner of the display. Using more points provides greater resolution. Using fewer points compacts the data and decreases the time required to access a trace over the remote interface.

Increasing the number of points does not increase the sweep time. However, it can slightly impact the trace processing time and therefore the overall measurement speed. Decreasing the number of points does not decrease the sweep time, but it may speed up the measurement, depending on the other sweep settings (for example, in FFT sweeps). Fewer points will always speed up the I/O.

Due to minimum sweep rate limitations of the hardware, the minimum sweep time available to the user will increase above its normal value of 1 ms as the number of sweep points increases above 15001.

Changing the number of sweep points has several effects on the instrument. Since markers are read at the point location, the marker reading may change. The sweep time resolution will change. Trace data for all the traces will be cleared and, if Sweep is in Cont, a new trace taken. If any trace is in average or hold, the averaging starts over.

Because of sweep time quantization issues, the knob and up/down keys cannot be used to adjust the number of points.

When in a split screen display each window may have its own value for points.

3 Bluetooth Mode
 3.6 Monitor Spectrum Measurement

When sweep points is changed, an informational message "Sweep points changed, all traces cleared" is displayed and in the 5G NR mode, Auto Sweep Points is set to OFF(0).

Remote Command	<code>[:SENSe]:MONitor:SWEep:POINts <integer></code> <code>[:SENSe]:MONitor:SWEep:POINts?</code>
Example	<code>:MON:SWE:POIN 1000</code> <code>:MON:SWE:POIN?</code>
Dependencies	This function is not available when Signal ID is set to On in External Mixing Neither the knob nor the step keys can be used to change this value. If it is tried, a warning is given Not displayed in modes that do not support Swept
Couplings	Whenever the number of sweep points change: <ul style="list-style-type: none"> - All trace data is erased - Any traces with Update Off will also go to Display Off (like going from View to Blank in the older instruments) - Sweep time is re-quantized - Any limit lines that are on will be updated - If averaging/hold is on, averaging/hold starts over - Auto Sweep Points is OFF (Only 5G NR) <p>The resolution of setting the sweep time depends on the number of points selected</p>
Preset	1001 unless noted below 2001: 5G NR
State Saved	Saved in instrument state
Min	1
Max	20001
Annotation	On second line of annotations, in lower right corner in parenthesis behind the sweep annotation

3.6.10 Trace

Lets you control the acquisition, display, storage, detection, and manipulation of trace data for the available traces.

The "**Trace Control**" on [page 819](#) tab in this menu contains radio-button selections for the trace type (**Clear/Write**, **Trace Average**, **Max Hold**, **Min Hold**) and **View/Blank** setting for the selected trace.

3.6.10.1 Select Trace

Specifies the *selected trace*, which is the trace that will be affected when you change trace settings.

Select Trace appears above the menu panel, indicating that it applies to *all* controls in the menu panel. **Select Trace** is blanked if you select a tab whose controls do *not* depend on the selected trace (for example, **Trace Function**).

Notes	The selected trace is remembered even when not in the Trace menu
Dependencies	For the Swept SA measurement: <ul style="list-style-type: none"> - In Image Suppress mode, when you select a trace it becomes the active trace, and the formerly active trace goes into View - When you turn on Image Suppress, Update turns off for all traces except the selected trace For the ACP measurement, when Meas Method is RBW , FAST or FPOwer , Select Trace is disabled
Preset	Trace 1
State Saved	Yes

3.6.10.2 Trace Control

The controls on this tab allow you to set the "Trace Type" on page 820 and its update mode.

There are four Trace Types:

- **Clear/Write**
- **Trace Average**
- **Max Hold**
- **Min Hold**

Each type handles data in a different way.

Each trace also has two values that determine whether it is being written or not, and whether it is being displayed or not. These values, **Update** and **Display**, are described fully in the "View/Blank" on page 825 control description. Essentially, when **Update** is **ON**, a trace is updating, and when **Update** is **OFF** it is not. When **Display** is **ON**, it is visible and when **Display** is **OFF** it is not. These terms are used throughout the descriptions in this section.

Trace Type

There are four trace Types:

Option	Parameter	SCPI Example	Details
Clear/Write	WRITe	:TRAC2:TYPE WRIT	See: " Clear/Write " on page 696
Trace Average	AVERage	:TRAC2:TYPE AVER	See: " Trace Average " on page 696
Maximum Hold	MAXHold	:TRAC3:TYPE MAXH	See: " Max Hold " on page 697
Minimum Hold	MINHold	:TRAC5:TYPE MINH	See: " Min Hold " on page 697

Full descriptions of each type are provided below. You may select one of these types for each trace. Re-selecting the current **Trace Type** initiates the same action that selecting it the first time did, even though it is already selected. For example, selecting **Clear/Write** while **Clear/Write** is already selected will nonetheless clear the trace and begin rewriting it.

Besides the **Trace Type**, the "[View/Blank](#)" on page 825 state must be set to **Active** (**Update: ON, Display: ON**) for a trace to be updating and visible. Selecting any **Trace Type** automatically makes the trace **Active**.

See also: "[Trace Mode Backwards Compatibility Commands](#)" on page 694

Remote Command	<p>For Swept SA Measurement (in SA Mode):</p> <pre>:TRACe[1] 2 ... 6:TYPE WRITe AVERage MAXHold MINHold</pre> <pre>:TRACe[1] 2 ... 6:TYPE?</pre> <p>For all other measurements:</p> <pre>:TRACe[1] 2 3:<meas>:TYPE WRITe AVERage MAXHold MINHold</pre> <pre>:TRACe[1] 2 3:<meas>:TYPE?</pre> <p>where <meas> is the identifier for the current measurement</p>
Example	<pre>:TRAC:TYPE WRIT</pre> <pre>:TRAC:TYPE?</pre>
Couplings	<p>Selecting a Trace Type (by pressing any of the Trace Type selections or sending <code>:TRAC:TYPE</code>) sets the Trace to Active (Update: ON, Display: OFF), even if the same trace type was already selected</p> <p>When Detector setting is "Auto" (<code>[:SENSe] : <meas> : DETector : AUTO ?</code>), Detector (<code>[:SENSe] : <meas> : DETector [:FUNCTION] ?</code>) switches aligning with the switch of this parameter: "NORMal" with <code>WRITe</code> (Clear Write), "AVERage" with <code>AVERage</code>, "POSitive (peak)" with <code>MAXHold</code>, and "NEGative (peak)" with <code>MINHold</code></p>
Preset	<p>Swept SA and Monitor Spectrum: <code>WRITe</code></p> <p>All other measurements: <code>AVERage</code></p> <p>Following Preset, all traces are cleared (all trace points set to mintracevalue)</p>
State Saved	The type of each trace is saved in instrument state
Annunciation	The type for each trace is indicated in the Trace annunciator panel on the Measurement Bar

Trace Mode Backwards Compatibility Commands

In earlier instruments, the “Trace Modes” were: Clear/Write, Max Hold, Min Hold, View and Blank. Averaging was global to all traces and was controlled under the **BW/Avg** menu.

In X-Series, trace averaging can be done on a per-trace basis. The Trace Modes (now called Trace Types) are Clear/Write, Trace Average, Max Hold and Min Hold. View and Blank are set separately under "**View/Blank**" on page 825.

While this provides more flexibility, it also gives rise to potential backwards compatibility problems. To mitigate these, the old Trace Mode command has been retained and a new Trace Type command has been added. The **:TRACe:MODE** command is retained for backwards compatibility, and the **:TRACe:TYPE**, **:TRACe:UPDate** and **:TRACe:DISPlay** commands introduced for ongoing use. The old Trace Modes are selected using **:TRAC:MODE**, whose parameters are mapped into calls to **:TRACe:TYPE**, **:TRACe:UPDate** and **:TRACe:DISPlay**, and the old global Averaging command **[:SENSe]:AVERage[:STATe]** is provided for backwards compatibility. See the individual command descriptions for details.

When **Average/Hold** in the **Meas Setup, Legacy Compatibility** menu is **ON**, the following is true for traces in Max Hold and Min Hold:

- They ignore the **Average/Hold** number; **Single** for Max Hold causes one sweep only, so switching to **Single** stops after the current sweep, and switching to **Cont** starts again without clearing the accumulated result
- Max Hold is not cleared on a **Restart**, **Single** or **:INIT:IMM**, but changing a measurement parameter, like frequency or bandwidth etc., still restarts the Max Hold

Preset	WRITE
State Saved	The trace mode is an alias only
Backwards Compatibility SCPI	:TRACe[1] 2 ... 6:MODE WRITE MAXHold MINHold VIEW BLANK :TRACe[1] 2 ... 6:MODE?
Backwards Compatibility Notes	<p>The legacy :TRACe:MODE command is retained for backwards compatibility. In conjunction with the legacy :AVERage command, it works as follows:</p> <ul style="list-style-type: none"> – :AVERage ON OFF sets/clears a variable that we will call average for the sake of this discussion. This variable is maintained by the instrument solely for backwards compatibility. See the [:SENSe]:AVERage[:STATe] command description below – :TRACe:MODE WRITE sets :TRACe:TYPE WRITE (Clear/Write) unless average is true, in which case it sets it to :TRACe:TYPE AVERage. It also sets :TRACe:UPDate ON, :TRACe:DISPlay ON, for the selected trace – :TRACe:MODE MAXHold sets :TRACe:TYPE MAXHold (Max Hold). It also sets :TRACe:UPDate ON, :TRACe:DISPlay ON, for the selected trace

3 Bluetooth Mode
 3.6 Monitor Spectrum Measurement

- `:TRACe:MODE MINHold` sets `:TRACe:TYPE MINHold` (Min Hold). It also sets `:TRACe:UPDate ON`, `:TRACe:DISPlay ON`, for the selected trace
- `:TRACe:MODE VIEW` sets `:TRACe:UPDate OFF`, `:TRACe:DISPlay ON`, for the selected trace
- `:TRACe:MODE BLANK` sets `:TRACe:UPDate OFF`, `:TRACe:DISPlay OFF`, for the selected trace

The query returns the same value as `:TRACe:TYPE?`, meaning that if you set `:TRACe:MODE:VIEW` or `:TRACe:MODE:BLANK`, the query response will not be what you sent

`:TRACe[n]:MODE` was formerly used to set the type or “writing mode” of the trace. At that time, View and Blank were writing modes. The new `:TRACe:TYPE` command should be used in the future, but `:TRACe:MODE` is retained to provide backwards compatibility

In X-Series, unlike earlier instruments, Max Hold and Min Hold now obey the Average Number and counts up to a terminal value as Average always has

As the **Average/Hold Number** now affects **Min Hold** and **Max Hold**, the operations that restart Averaging (for example, the **Restart** key) now also restart **Min Hold** and **Max Hold**

As a result of these changes, legacy code that restarts averaging while retaining a running Max Hold will need to be rewritten, because the Max Hold will now restart when the Average does

Also, previous to X-Series:

- Pressing **Max Hold** while already in **Max Hold** (or doing so remotely) had no effect. Now it will clear the trace and restart the sweep and the Max Hold sequence
- Changing the vertical scale (Log/Lin or dB/div) of the display restarted **Max Hold** and **Min Hold**. This is no longer the case

Preset	<code>OFF</code>
State Saved	The state of Average is saved in Instrument State for ghosting purposes
Backwards Compatibility SCPI	<code>[:SENSe]:AVERage[:STATe] ON OFF 1 0</code> <code>[:SENSe]:AVERage[:STATe]?</code>
Backwards Compatibility Notes	<p>Previous to X-Series, Averaging (also sometimes known as trace averaging) was global to all traces, that is, it was either on or off for all active traces. The legacy command <code>[:SENSe]:AVERage[:STATe] ON OFF 1 0</code> was used to turn Averaging on or off</p> <p>In X-Series, Averaging is turned on or off on a per-trace basis, so it can be on for one trace and off for another</p> <p>For backwards compatibility, the old global Average State variable is retained solely as a legacy variable, turned on and off and queried by the legacy command <code>[:SENSe]:AVERage[:STATe] OFF ON 0 1</code>. When Average is turned on, any trace in Clear/Write will get put into Average. While Average is on, any trace put into Clear/Write by the old <code>:TRAC:MODE</code> command will instead get put into Average. When Average is turned off, any trace in Average will get put into Clear/Write</p>

Trace Type Details

Clear/Write

Each trace update replaces the old data in the trace with new data.

Pressing **Clear/Write** for the selected trace, or sending `:TRAC:TYPE WRIT` for the specified trace, sets the trace type to **Clear/Write** and clears the trace, even if you are already in **Clear/Write**. Then a new sweep is initiated. Trigger conditions must be met before the sweep actually starts, and if in **Single** the sweep won't start until **Restart** is pressed.

Pressing **Clear/Write** stops the current sweep and initiates a new one, so **Trace Average**, **Max Hold** and **Min Hold** data may be interrupted in mid-sweep when **Clear/Write** is pressed, and therefore may not accurately reflect the displayed count. Therefore, when **Clear/Write** is pressed for one trace, **Trace Average**, **Max Hold** and **Min Hold** must restart for all traces.

When in **Clear/Write**, if a measurement-related instrument setting is changed (that is, one which requires new data to be taken, like **Center Frequency** or **Attenuation**), a new sweep is initiated but the trace is not cleared.

Trace Average

The instrument maintains and displays an average trace, which represents the cumulative average on a point-by-point basis of the new trace data and previous averaged trace data.

Pressing **Trace Average** (for the selected trace), or sending `:TRAC:TYPE AVER` (for the specified trace), sets the trace type to **Trace Average**, clears the trace, initiates a new sweep, and restarts the Average sequence.

Details of the count limiting behavior and the averaging calculations may be found under **Avg|Hold Number** and **Average Type** under **Meas Setup**.

When in **Trace Average**, if a measurement-related instrument setting is changed (that is, one which requires new data to be taken, like **Center Frequency** or **Attenuation**), the average restarts and a new sweep is initiated but the trace is not cleared.

Restarting the average means:

- The average/hold count k is set to 1, so that the next time the average trace is displayed it simply represents one trace of new data
- A new sweep is initiated

- Once the new sweep starts, the trace is overwritten with current trace data as the first trace of the new average

Remember that restarting averaging also restarts **Max Hold** and **Min Hold**, as there is only one count for Trace Average and Hold.

Max Hold

The instrument maintains and displays a max hold trace, which represents the maximum data value on a point-by-point basis of the new trace data and previous trace data. Details of the count limiting behavior may be found under **Avg|Hold Number** under **Meas Setup**.

Pressing **Max Hold** for the selected trace, or sending `:TRAC:TYPE MAXH` for the specified trace, sets the Trace Type to **Max Hold**, clears the trace, initiates a new sweep, and restarts the hold sequence, even if you are already in **Max Hold**.

When in **Max Hold**, if a measurement-related instrument setting is changed (that is, one which requires new data to be taken, like **Center Frequency** or **Attenuation**), the **Max Hold** sequence restarts and a new sweep is initiated but the trace is not cleared.

Restarting the **Max Hold** sequence means:

- The average/hold count k is set to 1, so that the next time the max hold trace is displayed it simply represents one trace of new data
- A new sweep is initiated.

Remember that restarting **Max Hold** also restarts averaging and **Min Hold**, as there is only one count for Trace Average and Hold.

Min Hold

The instrument maintains and displays a min hold trace, which represents the minimum data value on a point-point basis of the new trace data and previous trace data. Details of the count limiting behavior may be found under **Avg|Hold Number** under the **Meas Setup** functions.

Pressing **Min Hold** for the selected trace, or sending `:TRAC:TYPE MINH` for the specified trace, sets the Trace Type to **Min Hold**, clears the trace, initiates a new sweep, and restarts the hold sequence, even if you are already in **Min Hold**.

When in **Min Hold**, if a measurement-related instrument setting is changed (that is, one which requires new data to be taken, like **Center Frequency** or **Attenuation**), the **Min Hold** sequence restarts and a new sweep is initiated but the trace is not cleared.

Restarting the **Min Hold** sequence means:

- The average/hold count k is set to 1, so that the next time the min hold trace is displayed it simply represents one trace of new data
- A new sweep is initiated

Remember that restarting **Min Hold** also restarts **Max Hold** and averaging, because there is only one count for Trace Average and Hold.

Clear and Write | Restart Averaging | Restart Max/Min Hold

Starts the trace writing, as though the "Trace Type" on page 820 had just been selected. The effect is exactly the same as reselecting the current **Trace Type** again – the control is provided because it may not be obvious that reselecting the same selection from a radio button menu will take any action.

This control displays different labels, depending on the selected Trace Type:

- **Clear/Write:** Clear and Write
- **Trace Average:** Restart Averaging
- **Max Hold:** Restart Max Hold
- **Min Hold:** Restart Min Hold

View/Blank

Lets you set the state of the two trace variables: **Update** and **Display**. The choices available in this dropdown menu are:

Active	Update and Display both ON
View	Update OFF ; Display ON
Blank	Update OFF ; Display OFF
Background	Update ON , Display OFF Allows a trace to be blanked <i>and</i> continue to update "in the background", which was not possible in the past

In the Swept SA measurement, a trace with **DisplayOFF** is indicated by a strikethrough of the type letter in the trace annotation panel in the Measurement Bar. A trace with **UpdateOFF** is indicated by dimming the type letter in the trace annotation panel in the Measurement Bar. In the example below, Traces 3, 4, 5 and 6 have **UpdateOFF**, and Traces 4 and 6 have **DisplayOFF**.

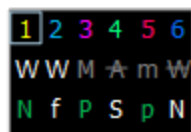

See: ["More Information" on page 700](#)

Notes	For the commands to control the two variables, Update and Display, see "Trace Update State On/Off" on page 699 and "Trace Display State On/Off" on page 699 below
Dependencies	When Signal ID is on, this key is grayed-out
Couplings	<p>Selecting a Trace Type for a trace (pressing the key or sending the equivalent command) puts the trace in Active (Update ON and Display ON), even if that trace type was already selected</p> <p>Selecting a detector for a trace (pressing the key or sending <code>[:SENS] :DET :TRAC</code>) puts the trace in Active (UpdateON and DisplayON), even if that detector was already selected</p> <p>Selecting a "Math Function" on page 828 other than OFF for a trace (pressing the key or sending the equivalent command) puts the trace in Active (UpdateON and DisplayON), even if that Math Mode was already selected</p> <p>Loading a trace from a file puts that trace in View regardless of the state it was in when it was saved; as does being the target of a Copy or a participant in an Exchange</p>

Trace Update State On/Off

Remote Command	<p>For Swept SA Measurement (in SA Mode): <code>:TRACe[1] 2 ... 6:UPDate[:STATe] ON OFF 1 0</code> <code>:TRACe[1] 2 ... 6:UPDate[:STATe]?</code></p> <p>For all other measurements: <code>:TRACe[1] 2 3:<meas>:UPDate[:STATe] ON OFF 1 0</code> <code>:TRACe[1] 2 3:<meas>:UPDate[:STATe]?</code></p> <p>where <meas> is the identifier for the current measurement</p>
Example	<p>Make trace 2 inactive (stop updating): <code>:TRAC2:UPD 0</code></p>
Couplings	Whenever you set Update to ON for any trace, the Display is set to ON for that trace
Preset	<p>For Swept SA Measurement (in SA Mode): <code>1 0 0 0 0 0</code> ON for Trace 1; OFF for 2–6</p> <p>For all other measurements: <code>1 0 0</code> ON for Trace 1; OFF for 2 & 3</p>
State Saved	Saved in instrument state

Trace Display State On/Off

Remote Command	<p>For Swept SA Measurement (in SA Mode): <code>:TRACe[1] 2 ... 6:DISPlay[:STATe] ON OFF 1 0</code> <code>:TRACe[1] 2 ... 6:DISPlay[:STATe]?</code></p> <p>For all other measurements:</p>
----------------	--

	<pre>:TRACe[1] 2 3:<meas>:DISPlay[:STATe] ON OFF 1 0</pre> <pre>:TRACe[1] 2 3:<meas>:DISPlay[:STATe]?</pre> <p>where <meas> is the identifier for the current measurement</p>
Example	<p>Make trace 1 visible:</p> <pre>:TRAC2:DISP 1</pre> <p>Blank trace 3:</p> <pre>:TRAC3:DISP 3</pre>
Couplings	Whenever you set Update to ON for any trace, the Display is set to ON for that trace
Preset	<p>For Swept SA Measurement (in SA Mode):</p> <pre>1 0 0 0 0 0</pre> <p>ON for Trace 1; OFF for 2–6</p> <p>For all other measurements:</p> <pre>1 0 0</pre> <p>ON for Trace 1; OFF for 2 & 3</p>
State Saved	Saved in instrument state

More Information

When a trace becomes inactive, any update from the **:SENSe** system (detectors) immediately stops, without waiting for the end of the sweep. The trace data remains unchanged, but stops updating. If the trace is blanked, this still does not affect the data in the trace. Traces that are blanked (**Display=OFF**) do not display nor appear on printouts, but their data stays intact, they may be queried, and markers may be placed on them

In most cases, inactive traces are static and unchanging; however, there are cases when an inactive trace will update, specifically:

- if data is written to that trace from remote
- if trace data is loaded from mass storage
- if the trace is the target of a **Copy** or participant in an **Exchange**
- if the trace is cleared using **Clear Trace**

Inactive traces that are also being displayed (traces in **View**) are displayed at half intensity. Traces in **View** display across the entire X-Axis of the instrument. Their horizontal placement does not change, even if X-Axis settings subsequently are changed, although Y-Axis settings do affect the vertical placement of data.

When a trace becomes active (**Update=ON**), the trace is cleared, the average count is reset, and a new sweep is initiated.

Note that putting a trace into **Display=OFF** and/or **Update=OFF** does *not* restart the sweep and does *not* restart Averaging or Hold functions for any traces.

Trace Settings Table

Lets you configure the Trace system using a visual utility.

Clear All Traces

Clears all traces from the display.

Remote Command	<code>:TRACe:MONitor:CLEar:ALL</code>
Example	<code>:TRAC:MON:CLE:ALL</code>
Backwards Compatibility SCPI	<code>:DISPlay:MONitor:VIEW:WINDow:TRACe:CLEar:ALL</code>

3.6.10.3 Detector

Lets you choose and configure detectors for the selected trace.

Detector

Allows you to select a specific detector for the current measurement. When the detector choice is Auto, the instrument selects the detector. The selected detector depends on marker functions, trace functions, and trace averaging functions for the current measurement.

The following options are available:

AUTO	The detector selected depends on marker functions, trace functions, average type, and the trace averaging function In the ACP measurement, when in AUTO, the detector selected is set to AVERage, unless the Radio Standard defaults state otherwise e.g., it is set to Peak for Radio Standard = PDC when Device = both MS and BTS, and when Radio Standard = NADC and Device = MS
NORMal	The detector determines the peak of the CW-like signals, and it yields alternating maximums and minimums of noise-like signals. This is also referred to as Rosenfell detection
AVERage	The detector determines the average of the signal within the sweep points, using RMS averaging
POSitive	The detector determines the maximum of the signal within the sweep points
Peak	

SAMPle The detector indicates the instantaneous level of the signal at the center of the sweep points represented by each display point

NEGative The detector determines the minimum of the signal within the sweep points

Peak

Because they may not find a spectral component's true peak, neither **AVERage** nor **SAMPle** detectors measure amplitudes of CW signals as accurately as **Peak** or **NORMal**, but they do measure noise without the biases of **Peak** detection.

Remote Command	<code>[:SENSe]:MONitor:DETEctor:TRACe[1]2 3 AVERage NEGative NORMal POSitive SAMPle RMS</code> <code>[:SENSe]:MONitor:DETEctor:TRACe?</code>												
Example	<code>:MON:DET:TRAC NORM</code> <code>:MON:DET:TRAC?</code> <code>:MON:DET RMS</code> Sets the detector to AVERage . AVERage uses RMS averaging, so this is equivalent to selecting RMS												
Notes	The query returns a string corresponding to the detector type as shown below <table border="1"> <thead> <tr> <th>String Returned</th> <th>Definition</th> </tr> </thead> <tbody> <tr> <td>NORM</td> <td>Normal</td> </tr> <tr> <td>AVER</td> <td>Average (RMS)</td> </tr> <tr> <td>POS</td> <td>Peak</td> </tr> <tr> <td>SAMP</td> <td>Sample</td> </tr> <tr> <td>NEG</td> <td>Negative Peak</td> </tr> </tbody> </table> <p>The RMS selection sets the detector type to AVERage with RMS averaging. Therefore, if RMS has been selected, the query returns "AVER"</p>	String Returned	Definition	NORM	Normal	AVER	Average (RMS)	POS	Peak	SAMP	Sample	NEG	Negative Peak
String Returned	Definition												
NORM	Normal												
AVER	Average (RMS)												
POS	Peak												
SAMP	Sample												
NEG	Negative Peak												
Couplings	When " Detector Select Auto/Man " on page 702 is ON , the detector selected depends on the Trace (Average) type												
Preset	NORMal												
State Saved	Yes												
Range	AVERage NEGative NORMal POSitive SAMPle RMS												
Annotation	The four letter mnemonic for the detector appears in the trace window next to the trace it applies to												
Backwards Compatibility SCPI	<code>[:SENSe]:MONitor:DETEctor[:FUNction]</code> Applied to Trace 1 only												

Detector Select Auto/Man

Sets the Detector mode to Auto or Manual. In Auto, the proper detector is chosen based on rules that take into account the measurement settings and other instrument settings.

3 Bluetooth Mode
 3.6 Monitor Spectrum Measurement

When any detector is selected by the user, this toggles automatically set to Man (manual).

Remote Command	<code>[:SENSe]:MONitor:DETEctor:TRACe[1] 2 3:AUTO ON OFF 1 0</code> <code>[:SENSe]:MONitor:DETEctor:TRACe[1] 2 3:AUTO?</code>
Example	<code>:MON:DET:TRAC2:AUTO ON</code> <code>:MON:DET:TRAC2:AUTO?</code>
Couplings	When this function is ON , the "Detector" on page 701 and "Trace Type" on page 820 settings automatically align as follows: <ul style="list-style-type: none"> - "NORMal" with Clear Write - "AVERage" with AVERage - "POSitive (Peak)" with MAXHold - "NEGative (Peak)" with MINHold
Preset	ON
State Saved	Yes
Backwards Compatibility SCPI	<code>[:SENSe]:MONitor:DETEctor:AUTO</code> Applied to Trace 1 only

3.7 Occupied BW Measurement

This measurement computes and displays the bandwidth occupied by a given percentage of the total mean power of a signal.

Measurement Commands

The general functionality of "CONFigure" on page 1488, "INITiate" on page 1489, "FETCh" on page 1489, "MEASure" on page 1491, and "READ" on page 1490 are described in the section **SCPI Operation and Results Query** in the topic **Programming the Instrument**.

Note that, in general, `:CONF : <Measurement>` resets the specified measurement settings to their defaults. X-Series permits the addition of the `NDEFault` node to the command, which prevents a measurement preset after a measurement switch.

The tables below list setup commands for this measurement and queries to retrieve results.

Command	Function
<code>:INITiate:OBwidth</code>	Initiates a trigger cycle for the OBW measurement, but does not return any data. You must then use <code>:FETC:OBW[n]?</code> to retrieve data
<code>:CONFigure?</code>	Does not change any measurement settings
<code>:CONFigure:OBwidth</code>	Returns the long form name of current measurement, in this case, OBwidth
<code>:CONFigure:OBwidth</code>	Selects OBW measurement with Meas Setup settings in preset state – same as Meas Preset
<code>:CONFigure:OBwidth:NDEFault</code>	Selects OBW measurement <i>without</i> affecting settings

The following queries are used to retrieve data. The type of data returned depends on the value of `n`, as detailed in "Remote Command Results" on page 705.

Command	Function
<code>:FETCh:OBwidth[n]?</code>	Retrieves the data defined by <code>n</code>
<code>:MEASure:OBwidth[n]?</code>	Switches to OBW measurement, restores default values, starts the measurement, then retrieves the data defined by <code>n</code>
<code>:READ:OBwidth[n]?</code>	Starts the measurement, then retrieves the data defined by <code>n</code>

Backwards Compatibility Queries

Command	Return Value
<code>:FETCh:OBwidth:OBwidth?</code>	Returns the Occupied Bandwidth (Hz)
<code>:MEASure:OBwidth:OBwidth?</code>	
<code>:READ:OBwidth:OBwidth?</code>	

3 Bluetooth Mode
3.7 Occupied BW Measurement

Command	Return Value
:FETCh:OBWidth:FERRor?	Returns the Transmit Frequency Error (Hz)
:MEASure:OBWidth:FERRor?	
:READ:OBWidth:FERRor?	
:FETCh:OBWidth:XDB?	Returns the xdB Bandwidth (Hz)
:MEASure:OBWidth:XDB?	
:READ:OBWidth:XDB?	

Remote Command Results

The following table describes the results returned by the **FETCh**, **MEASure**, and **READ** queries listed above, according to the index value **n**.

n	Results Returned																								
1, or not specified	Returns scalar results, in the following order: <table border="1" data-bbox="381 877 1404 1281"> <thead> <tr> <th>#</th> <th>Item</th> <th>Unit</th> </tr> </thead> <tbody> <tr> <td>1</td> <td>Occupied Bandwidth</td> <td>Hz</td> </tr> <tr> <td>2</td> <td>Total Power <i>or</i> OBW Power Power reference type can be changed with "Power Ref" on page 785 in Meas Setup</td> <td>dBm</td> </tr> <tr> <td>3</td> <td>Span</td> <td>Hz</td> </tr> <tr> <td>4</td> <td>Spectrum Trace Points</td> <td>points</td> </tr> <tr> <td>5</td> <td>Res BW</td> <td>Hz</td> </tr> <tr> <td>6</td> <td>Transmit Frequency Error</td> <td>Hz</td> </tr> <tr> <td>7</td> <td>7. x dB Bandwidth</td> <td>Hz</td> </tr> </tbody> </table>	#	Item	Unit	1	Occupied Bandwidth	Hz	2	Total Power <i>or</i> OBW Power Power reference type can be changed with "Power Ref" on page 785 in Meas Setup	dBm	3	Span	Hz	4	Spectrum Trace Points	points	5	Res BW	Hz	6	Transmit Frequency Error	Hz	7	7. x dB Bandwidth	Hz
#	Item	Unit																							
1	Occupied Bandwidth	Hz																							
2	Total Power <i>or</i> OBW Power Power reference type can be changed with "Power Ref" on page 785 in Meas Setup	dBm																							
3	Span	Hz																							
4	Spectrum Trace Points	points																							
5	Res BW	Hz																							
6	Transmit Frequency Error	Hz																							
7	7. x dB Bandwidth	Hz																							
2	Returns the frequency-domain spectrum trace (data array) for the entire frequency range being measured for Trace 1																								
3	Only available in LTEAFDD, LTEATDD, 5GNR Modes 1. Number of active carriers Returns number of active carriers within Span in Auto detected mode, otherwise the command is out of scope																								
4	Returns OBW Boundaries table results in the following order: <table border="1" data-bbox="381 1575 1404 1793"> <thead> <tr> <th>#</th> <th>Item</th> <th>Unit, if any</th> </tr> </thead> <tbody> <tr> <td>1</td> <td>Occupied bandwidth</td> <td>Hz</td> </tr> <tr> <td>2</td> <td>Total Power or OBW Power Power reference type can be changed with "Power Ref" on page 785 in Meas Setup</td> <td>dBm</td> </tr> </tbody> </table>	#	Item	Unit, if any	1	Occupied bandwidth	Hz	2	Total Power or OBW Power Power reference type can be changed with "Power Ref" on page 785 in Meas Setup	dBm															
#	Item	Unit, if any																							
1	Occupied bandwidth	Hz																							
2	Total Power or OBW Power Power reference type can be changed with "Power Ref" on page 785 in Meas Setup	dBm																							

n Results Returned			
#	Item		Unit, if any
3	x dB Reference Power		dBm
4	x dB Reference Power Frequency - offset frequency		Hz
5	x dB Reference Power Frequency - absolute frequency		Hz
6	NaN (9.91E+37)		-
7	NaN (9.91E+37)		-
8	NaN (9.91E+37)		-
9	Lower OBW boundary - offset frequency		Hz
10	Lower OBW boundary - absolute frequency		Hz
11	Lower OBW boundary - absolute power		dBm
12	Lower OBW boundary - relative power		dBc
13	Upper OBW boundary - offset frequency		Hz
14	Upper OBW boundary - absolute frequency		Hz
15	Upper OBW boundary - absolute power		dBm
16	Upper OBW boundary - relative power		dBc
17	Lower x dB BW boundary - offset frequency		Hz
18	Lower x dB BW boundary - absolute frequency		Hz
19	Lower x dB BW boundary - absolute power		dBm
20	NaN (9.91E+37)		-
21	Upper x dB BW boundary - offset frequency		Hz
22	Upper x dB BW boundary - absolute frequency		Hz
23	Upper x dB BW boundary - absolute power		dBm
24	NaN (9.91E+37)		-
	Results 6, 7, 8, 20 and 24 always return NaN (9.91E+37)		
5	Returns the frequency-domain spectrum trace (data array) for the entire frequency range being measured for Trace 2		
6	Returns the frequency-domain spectrum trace (data array) for the entire frequency range being measured for Trace 3		

3.7.1 Views

This measurement has three predefined views:

Name	SCPI Name	SCPI #
"OBW Results" on page 707	OBWResults	1
"OBW Boundaries" on page 708	BOUNDaries	2

Name	SCPI Name	SCPI #
"Gate" on page 708	See "Gate View On/Off" on page 1432	

These are multiple-window views. When in a multiple-window view, you select a window by touching it. The menu controls may sometimes change depending on which window is selected.

Whenever the **View** changes, the default menu is **Frequency**, unless otherwise specified in the **View** description.

The following SCPI commands can be used to select any view other than **Gate**.

View Selection by Name

Remote Command	<code>:DISPlay:OBWidth:VIEW[:SElect] OBWResults BOUNdaries</code> <code>:DISPlay:OBWidth:VIEW[:SElect]?</code>
Example	<code>:DISP:OBW:VIEW OBWR</code> <code>:DISP:OBW:VIEW?</code>
Preset	<code>OBWResults</code>
State Saved	Saved in instrument state
Range	<code>OBWResults BOUNdaries</code>

View Selection by Number

Remote Command	<code>:DISPlay:OBWidth:VIEW:NSElect <integer></code> <code>:DISPlay:OBWidth:VIEW:NSElect?</code>
Example	<code>:DISP:OBW:VIEW:NSEL 2</code> <code>:DISP:OBW:VIEW:NSEL?</code>
Preset	1
State Saved	Saved in instrument state
Min/Max	1/2

3.7.1.1 OBW Results

Windows: "Graph" on page 708, "Metrics - OBW Results" on page 709

The spectrum trace is displayed in the upper window. Measurement results such as Occupied Bandwidth or Power are displayed in the lower window.

Example	<code>:DISP:OBW:VIEW OBWR</code>
---------	----------------------------------

3.7.1.2 OBW Boundaries

Windows: "Graph" on page 708, "Metrics - OBW Boundaries" on page 711

The spectrum trace is displayed in the upper window. The lower window of OBW Results view is replaced by the OBW boundaries table in this view. Occupied bandwidth and X dB bandwidth for both lower and upper boundaries are displayed.

Example `:DISP:OBW:VIEW BOUN`

3.7.1.3 Gate

See "Gate View On/Off" on page 1432

3.7.2 Windows

There are four available window types. The **Gate** window is available only when "Gate View On/Off" on page 1432 is **ON** in the **Gate Settings** menu under **Trigger**.

View	#
"Graph" on page 708	1
"OBW Results" on page 707	2
"OBW Boundaries" on page 708	3
"Gate" on page 712	4

3.7.2.1 Graph

Window #1

Appears in two Views, as follows:

View	Size	Position
"OBW Results" on page 707	Three fifth, full width	Top
"OBW Boundaries" on page 708	Half, full width	Top

Spectrum View

For SA, WCDMA, WLAN mode:

3 Bluetooth Mode
 3.7 Occupied BW Measurement

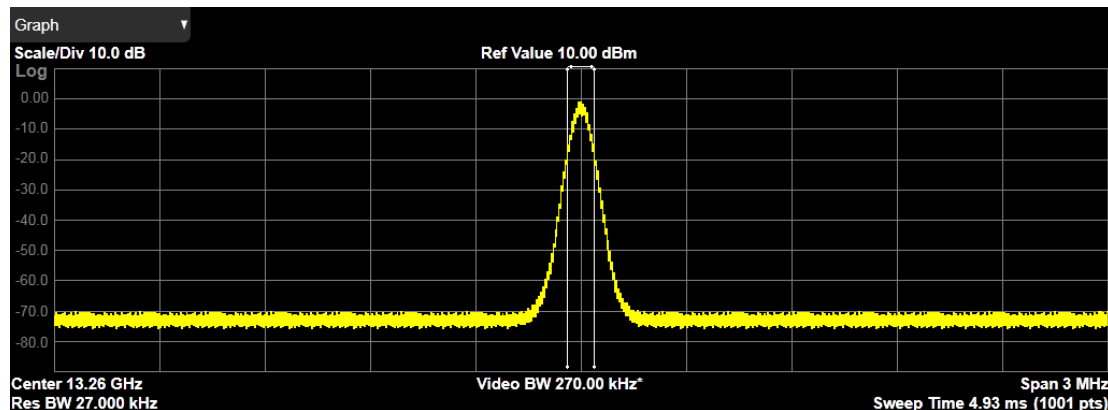

For LTE-Advanced FDD/TDD mode only

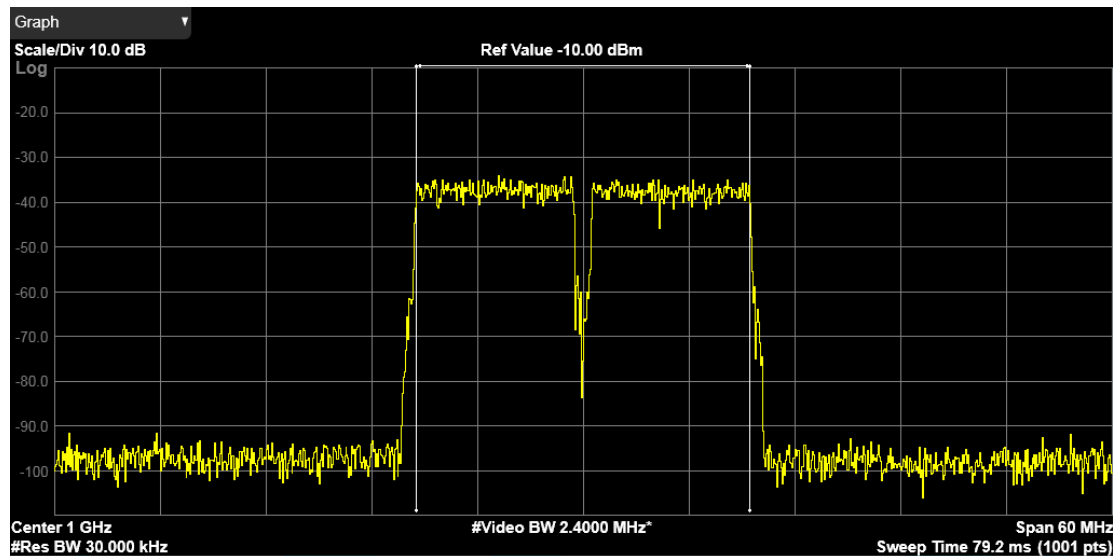

3.7.2.2 Metrics - OBW Results

Window #2

Displays the textual results of the Occupied BW measurement.

View	Size	Position
"OBW Results" on page 707	Two fifth, full width	Bottom
Gate	One third, full width	Bottom

Metrics	
Occupied Bandwidth	2.9730 MHz
Transmit Freq Error	0 Hz
x dB Bandwidth	3.000 MHz
Total Power	20.2 dBm
% of OBW Power	99.00 %
x dB	-26.00 dB

For the LTE-Advanced FDD/TDD and 5G NR modes, the metric result is shown as below:

Metrics	
Occupied Bandwidth	2.9730 MHz
Transmit Freq Error	0 Hz
x dB Bandwidth	3.000 MHz
Total Power	20.2 dBm
% of OBW Power	99.00 %
x dB	-26.00 dB

Occupied Bandwidth

The occupied bandwidth result is $f_2 - f_1$, where f_1 and f_2 are the lower and upper carrier boundary point. f_1 and f_2 are calculated with Occupied Bandwidth algorithms.

Total Power or OBW Power

The total power is the power integrated in the specified span setting. The OBW power is calculated from multiplying the total power by OBW percent power. The user can select the total power or the OBW power with the Power Ref control in Meas Setup.

Transmit Freq Error

The transmit freq error (transmit frequency error) result is calculated as the difference between $(f_2+f_1)/2$ and the tuned center frequency of the signal, where f_1 and f_2 are the lower and upper carrier boundary point.

x dB Bandwidth

The x dB result is a bandwidth measured between two points on the signal which are a certain number of dBs down from the highest signal point within the OBW Span. For example, If the 'x dB' parameter is set to -26 dB, and the 'Occupied BW Span' is set to 10 MHz, then the maximum signal power level is first determined from the 10 MHz wide trace sweep. Next, the two furthest frequencies below ($x_{db_f_1}$) and above ($x_{db_f_2}$) the frequency of the maximum level occurrence are found where the signal level is 26 dB below the peak level. This calculation also uses linear interpolation to find the lower and upper carrier boundary point within the width of a sweep point (the span divided by the number of sweep points).

The x dB bandwidth is calculated to be $x_{db_f_2} - x_{db_f_1}$.

% of OBW Power

3 Bluetooth Mode
3.7 Occupied BW Measurement

This is the setting parameter. See "[% of OBW Power](#)" on page 785

x dB

This is the setting parameter. See "[x dB](#)" on page 785.

Active Carriers

In the LTE-Advanced FDD/TDD and 5G NR modes, the number of active carriers is displayed to show how many carriers are identified as active in auto detected mode of span, otherwise “-” is displayed to indicate that it is out of scope. When there is one active carrier, Transmit Freq Error is displayed. Otherwise, “---” is displayed.

Measure Trace

See "[Measure Trace](#)" on page 840.

3.7.2.3 Metrics - OBW Boundaries

Window #3

Displays occupied bandwidth and X dB bandwidth for both lower and upper boundaries.

View	Size	Position
"OBW Boundaries" on page 708	Half, full width	Bottom
Gate	One third, full width	Bottom

Metrics		Occupied Bandwidth			x dB Reference		
		2.9730 MHz			x dB	-26.00 dB	
	Total Power	20.2 dBm			Power	0.00 dBm	
					Offset Frequency	-1.5000 MHz	
		Lower Boundary			Upper Boundary		
		Offset Freq	Abs Power	Rel Power	Offset Freq	Abs Power	Rel Power
	Occupied Bandwidth	-1.4865 MHz	0.00 dBm	-20.2 dBc	1.4865 MHz	0.00 dBm	-20.2 dBc
	x dB Bandwidth	-1.5000 MHz	-26.0 dBm		1.5000 MHz	-26.0 dBm	

Occupied Bandwidth

The occupied bandwidth result is $f_2 - f_1$, where f_1 and f_2 are the lower and upper carrier boundary point. f_1 and f_2 are calculated with Occupied Bandwidth algorithms.

Total Power or OBW Power

Total Power is the power integrated in the specified span setting. OBW Power is calculated from multiplying the total power by OBW percent power. The user can select the total power or the OBW power with the Power Ref control in Meas Setup.

x dB

This is the setting parameter. See "[x dB](#)" on page 785.

x dB Ref Pwr

The x dB reference power result shows the power of the highest signal point within the OBW Span.

x dB At Freq

The x dB reference power frequency result shows the frequency of the highest signal point within the OBW Span. The frequency display type, either Offset or Absolute, can be selected with the Boundary Frequency control under Display.

OBW Boundary Results

Name	Unit	Corresponding Results
Lower OBW boundary - offset frequency	Hz	Offset frequency of the lower OBW boundary from center frequency
Lower OBW boundary - absolute power	dB	Absolute power on the point of lower OBW boundary
Lower OBW boundary - relative power	dBc	Relative power on the point of lower OBW boundary
Upper OBW boundary - offset frequency	Hz	Offset frequency of the upper OBW boundary from center frequency
Upper OBW boundary - absolute power	dB	Absolute power on the point of upper OBW boundary
Upper OBW boundary - relative power	dBc	Relative power on the point of upper OBW boundary
Lower x dB BW boundary - offset frequency	Hz	Offset frequency of the lower x dB BW boundary from center frequency
Lower x dB BW boundary - absolute power	dB	Absolute power on the point of lower x dB BW boundary
Upper x dB BW boundary - offset frequency	Hz	Offset frequency of the lower x dB BW boundary from center frequency
Upper x dB BW boundary - absolute power	dB	Absolute power on the point of lower x dB BW boundary

3.7.2.4 Gate

Window #4

Turning on **Gate** View shows the **Gate** Window, which lets you see your Gating signal at the same time as the measured data. See the description in "[Gate View On/Off](#)" on page 1432 under **Trigger, Gate Settings**.

Views in which this window appears:

View	Size	Position
Gate	One third, full width	Top

3.7.3 Amplitude

Activates the **Amplitude** menu and selects **Reference Level** or **Reference Value** as the active function, depending on the measurement.

Some features in this menu apply to multiple measurements. Some other features apply only to specific measurements and their controls are blanked or grayed-out in measurements that do not support the feature.

3.7.3.1 Y Scale

Contains controls that pertain to the Y axis parameters of the measurement. These parameters control how data on the vertical (Y) axis is displayed and control instrument settings that affect the vertical axis.

Ref Value

Sets the value for the absolute power reference. The reference line is at the top, center, or bottom of the graticule, depending on the value of the Ref Position function.

Remote Command	<code>:DISPlay:OBWidth:WINDow[1]:TRACe:Y[:SCALe]:RLEVel <real></code> <code>:DISPlay:OBWidth:WINDow[1]:TRACe:Y[:SCALe]:RLEVel?</code>
Example	<code>:DISP:OBW:WIND:TRAC:Y:RLEV 125</code> <code>:DISP:OBW:WIND:TRAC:Y:RLEV?</code>
Couplings	When " Auto Scaling " on page 715 is ON (default), this value is automatically determined by the measurement result. When you set a value manually, Auto Scaling changes to OFF " Attenuation " on page 716 is not coupled to Ref Value
Preset	10.00 dBm
State Saved	Saved in instrument state
Min/Max	-250.00 dBm / 250.00 dBm
Annotation	Ref <value> top left of graph
Backwards Compatibility SCPI	<code>:DISPlay:OBWidth:VIEW[1]:WINDow[1]:TRACe:Y[:SCALe]:RLEVel</code>

Scale/Div

For measurements that support a logarithmic Y-Axis, **Scale/Div** sets the height of one division of the graticule in the current Y-Axis unit.

Scale/Div also determines the displayed amplitude range in the log plot graph. Since there are usually 10 vertical graticule division on the display, the total amplitude range of the graph is typically 10x this amount. For example, if Scale/Div is 10 dB, then the total range of the graph is 100 dB.

Remote Command	<code>:DISPlay:OBWidth:WINDow[1]:TRACe:Y[:SCALe]:PDIVision <rel_amp1></code>
Example	<code>:DISP:OBW:WIND:TRAC:Y:PDIV 5</code> <code>:DISP:OBW:WIND:TRAC:Y:PDIV?</code>
Couplings	Coupled to Scale Range as follows Scale/Div = Scale Range/10 (number of divisions) When the Auto Scaling is On, this value is automatically determined by the measurement result When you change a value, Auto Scaling automatically changes to Off
Preset	10.00 dB / Div
State Saved	Saved in instrument state
Min	0.10 dB
Max	20 dB
Annotation	<value> dB/ left upper of graph
Backwards Compatibility SCPI	<code>:DISPlay:OBWidth:VIEW[1]:WINDow[1]:TRACe:Y[:SCALe]:PDIVision</code>

Scale Range

Sets the Y-Axis scale range.

Remote Command	Replace <meas> with the identifier for the current measurement <code>:DISPlay:<meas>:WINDow[1]:TRACe:Y[:SCALe]:RANGe <rel_amp1></code> <code>:DISPlay:<meas>:WINDow[1]:TRACe:Y[:SCALe]:RANGe?</code>
Example	<code>:DISP:CHP:WIND:TRAC:Y:RANG 100</code> <code>:DISP:CHP:WIND:TRAC:Y:RANG?</code>
Couplings	Coupled to Scale/Div as follows Scale Range = Scale/Div * 10 (number of divisions) When you change this value, Auto Scaling automatically changes to OFF
Preset	100 dB
State Saved	Saved in instrument state
Min	1
Max	200

Ref Position

Positions the reference level at the top, center, or bottom of the Y Scale display. Changing the reference position does not change the reference level value.

Remote Command	<code>:DISPlay:OBWidth:WINDow[1]:TRACe:Y[:SCALe]:RPOSition TOP CENTer BOTTom</code> <code>:DISPlay:OBWidth:WINDow[1]:TRACe:Y[:SCALe]:RPOSition?</code>
Example	<code>:DISP:OBW:WIND:TRAC:Y:RPOS CENT</code> <code>:DISP:OBW:WIND:TRAC:Y:RPOS?</code>
Preset	TOP
State Saved	Saved in instrument state
Range	TOP CENTer BOTTom
Annotation	The greater than (>) and less than (<) symbols are displayed on both sides of the graph to indicate the Reference Position
Backwards Compatibility SCPI	<code>:DISPlay:OBWidth:VIEW[1]:WINDow[1]:TRACe:Y[:SCALe]:RPOSition</code>

Auto Scaling

Toggles **Auto Scaling** On or Off.

Remote Command	<code>:DISPlay:OBWidth:WINDow[1]:TRACe:Y[:SCALe]:COUPlE 0 1 OFF ON</code> <code>:DISPlay:OBWidth:WINDow[1]:TRACe:Y[:SCALe]:COUPlE?</code>
Example	<code>:DISP:OBW:WIND:TRAC:Y:COUP OFF</code> <code>:DISP:OBW:WIND:TRAC:Y:COUP?</code>
Couplings	When Auto Scaling is ON , and the Restart front-panel key is pressed, this function automatically sets the scale per division to 10 dB and determines the reference values based on the measurement results When you change a value of "Scale/Div" on page 713 , "Ref Value" on page 713 , or "Scale Range" on page 714 , Auto Scaling automatically changes to OFF
Preset	1
State Saved	Saved in instrument state
Range	OFF ON
Backwards Compatibility SCPI	<code>:DISPlay:OBWidth:VIEW[1]:WINDow[1]:TRACe:Y[:SCALe]:COUPlE</code>

3.7.3.2 Attenuation

Controls the attenuator functions and interactions between the attenuation system components.

There are two attenuator configurations in the X-Series. One is a Dual-Attenuator configuration consisting of a mechanical attenuator and an optional electronic attenuator. The other configuration uses a single attenuator with combined mechanical and electronic sections that controls all the attenuation functions. Different models in the X-Series come with different configurations.

- See ["Dual-Attenuator Configurations"](#) on page 716
- See ["Single-Attenuator Configuration"](#) on page 717

Most attenuation settings are the same for all measurements – they do not change as you change measurements. Settings like these are called “Meas Global” and are unaffected by **Meas Preset**.

Only available when the hardware set includes an input attenuator, which is typically only the case for Keysight’s benchtop instruments. For example, this tab does *not* appear in VXT models M9421A/10A/11A, nor in UXM. In UXM, all **Attenuation** and **Range** settings are disabled, as the expected input power level is handled by the Call Processing App that drives the DUT power control.

Dependencies In measurements that support the I/Q inputs, unavailable when I/Q is the selected input. Replaced by the **Range** tab in that case

Dual-Attenuator Configurations

Configuration 1: Mechanical attenuator + optional electronic attenuator

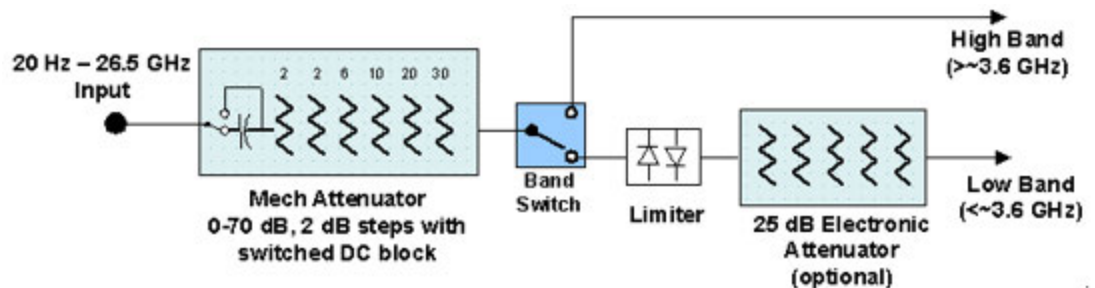

Configuration 2: Mechanical attenuator, no optional electronic attenuator

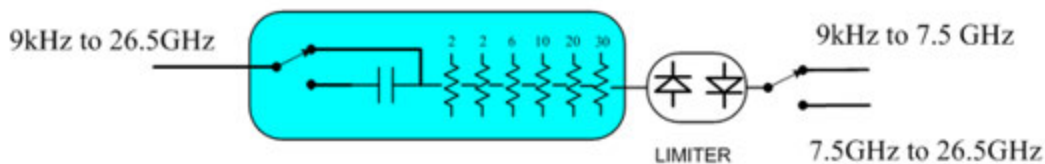

Note that Configuration 2 is not strictly speaking a dual-section attenuator, since there is no electronic section available. However, it behaves exactly like Configuration 1 without the Electronic Attenuator Option EA3, therefore for the sake of this document it is grouped into the “Dual-Attenuator” configuration.

Single-Attenuator Configuration

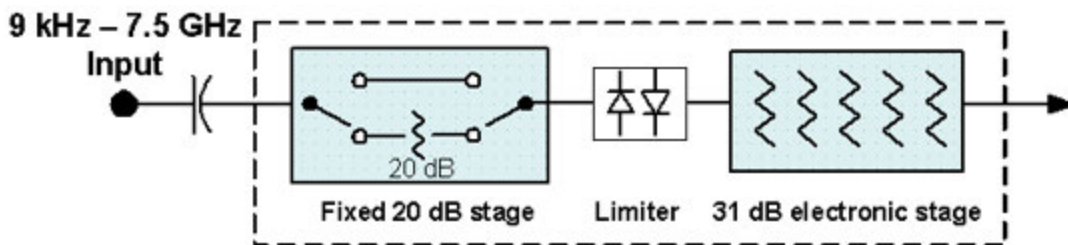

You can tell which attenuator configuration you have by pressing the Attenuation tab, which (in most Modes) opens the Attenuation menu. If the first control in the Attenuation menu says **Mech Atten** you have the Dual-Attenuator configuration. If the first control says **Atten** you have the Single-Attenuator configuration.



Dual Attenuator

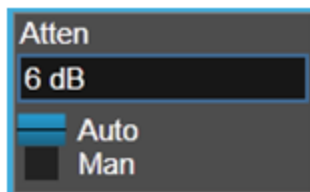

Single Attenuator

(Note that depending on the measurement, there may be no Auto/Man functionality on the Mech Atten control.)

In the Single-Attenuator configuration, you control the attenuation with a single control, as the fixed stage has only two states. In the Dual-Attenuator configuration, both stages have significant range, so you are given separate control of the mechanical and electronic attenuator stages.

When you have the Dual-Attenuator configuration, you may still have only a Single-Attenuator, because unless Option EA3 (the Electronic Attenuator option) is available, and you purchase it, you will have only the mechanical attenuator.

Full Range Atten

This control and **Attenuator Summary** only appear in N9041B, when the RF input is selected, the RF Input Port is set to RF Input 2, and the Full Range Attenuator is installed. The Full Range Attenuator adds a second input attenuator in front of RF Input 2, which enhances the protection and optimizes the performance of the extra internal mixers used by RF Input 2.

Remote Command	<code>[:SENSe]:POWer[:RF]:FRATten <rel_amp1></code> <code>[:SENSe]:POWer[:RF]:FRATten?</code>
Example	<code>:POW:FRAT 14</code> <code>:POW:FRAT?</code>
Notes	When you enter an amplitude value that falls between valid values, the value will be incremented to the next smallest valid value
Dependencies	Only appears if input RF is selected, RF Input Port 2 is selected, and the Full Range Attenuator exists
Couplings	This value is never changed by any coupling, but other couplings use this value. See Reference Level and " Mech Atten " on page 719 command descriptions
Preset	20 dB
State Saved	Saved in instrument state
Min	0 dB
Max	Only valid values are 0, 6, 14, 20 dB
Annotation	<p>When the Input is RF, and the Input Port is RF Input 2, and the Full Range Attenuator is installed: On the Meas Bar, the field "Atten" displays as follows:</p> <ul style="list-style-type: none"> - If the sweep is entirely < 50 GHz, the value shown after "Atten:" is equal to Mech Atten + Elec Atten + Full Range Atten - If the sweep is entirely > 50 GHz, the value shown after "Atten:" is equal to Full Range Atten - If the sweep straddles 50 GHz, the value shown after "Atten:" is preceded by the symbol ">=" and is equal to Full Range Atten <p>In the Amplitude, "Y Scale" on page 597 menu, and the Atten Meas Bar dropdown menu panel, a summary is displayed as follows:</p> <p>"Total Atten below 50 GHz" followed by the value of Full Range Atten + Mech Atten + Elec Atten "Total Atten above 50 GHz" followed by the value of Full Range Atten</p> <p>For example, if Mech Atten = 6 dB, Elec Atten = 4 dB, and Full Range Atten = 20 dB, the summary below is shown:</p> <ul style="list-style-type: none"> - Attenuator summary: - Total Atten below 50 GHz: 30 dB - Total Atten above 50 GHz: 20 dB

Mech Atten

Labeled **Mech Atten** in Dual-Attenuator models and **Atten** in Single-Attenuator models. In the Dual-Attenuator configuration, this control only affects the mechanical attenuator.

Lets you modify the attenuation applied to the RF input signal path. This value is normally auto-coupled to the Ref Level, the Internal Preamp Gain, any External Gain that is entered, and the Max Mixer Level, as described in the table below.

See "[Attenuator Configurations and Auto/Man](#)" on page 721

Remote Command	<pre>[:SENSe]:POWer[:RF]:ATTenuation <rel_amp1> [:SENSe]:POWer[:RF]:ATTenuation? [:SENSe]:POWer[:RF]:ATTenuation:AUTO OFF ON 0 1 [:SENSe]:POWer[:RF]:ATTenuation:AUTO?</pre>
Example	<pre>:POW:ATT 20</pre> <p>Dual-Attenuator configuration: sets the mechanical attenuator to 20 dB Single-Attenuator mode: sets the main attenuation to 20 dB (see below for definition of "main" attenuation) In either case, if the attenuator was in Auto, it is set to Manual</p> <pre>:POW:ATT:AUTO ON</pre> <p>Turn Auto Mech Atten ON</p>
Dependencies	<p>Some measurements do not support Auto setting of "Mech Atten" on page 719. In these measurements, the Auto/Man selection is not available, and the Auto/Man toggle function is not available</p> <p>In Dual-Attenuator configurations, when the electronic attenuator is enabled, the mechanical attenuator has no auto setting, and the Auto/Man toggle function is not available. The state of Auto/Man is remembered and restored when the electronic attenuator is once again disabled. This is described in more detail in "Elec Atten" on page 721</p> <p>See "Attenuator Configurations and Auto/Man" on page 721 for more information on the Auto/Man functionality</p> <p>:POW:ATT:AUTO is only available in measurements that support Mech Atten Auto, such as Swept SA</p>
Couplings	<p>If the RF Input Port is the RF Input:</p> <ul style="list-style-type: none"> - If the USB Preamp is connected to USB, use 0 dB for Mech Atten - Otherwise compute the auto-selected value of Mech Atten based on Reference Level, Int Preamp, External Gain, Ref Level Offset, Max Mixer Level, μW Path Control and IF Gain settings. Limit this value to be no less than 6 dB (total attenuation below 6 dB can never be chosen by Auto) - In the N9041B, if the RF Input Port is RF Input 2, use the formula above and subtract the Full Range Atten value from the result to determine the Mech Atten. Limit the value so that it is never lower than 0 dB and so that total attenuation, including Full Range Atten, is never less than 6 dB

(total attenuation, including Full Range Atten below 6 dB, can never be chosen by Auto)

In External Mixing and BBIQ, where the Attenuator is not in the signal path, the Attenuator setting changes as described above when "Mech Atten" on page 719 is in Auto, but no changes are made to the actual attenuator hardware setting until the input is changed back to the RF Input

For CXA-m with option FSA (Fine-Step Attenuator or 2 dB steps), the FSA-like behavior is only available when the frequency setting is ≤ 7.5 GHz. So, when the frequency is changed from below 7.5 GHz to above 7.5 GHz, the attenuation setting will be changed to a multiple of 10 dB which will be no smaller than the previous setting. For example, 4 dB attenuation will be changed to 10 dB

Preset	<p>The preset for Mech Attenuation is "Auto"</p> <p>The Auto value of attenuation is 10 dB</p> <p>ON</p>
State Saved	Saved in instrument state
Min	<p>0 dB</p> <p>The attenuation set by this control cannot be decreased below 6 dB with the knob or step keys. Values below 6 dB must be directly entered from the keypad or via SCPI. This protects against setting a dangerously small attenuation value, which can put the instrument at risk of damage to input circuitry. If the current mechanical attenuation is below 6 dB, it can be increased with the knob and step keys, but not decreased</p>
Max	<p>CXA Option 503 or 507: 50 dB</p> <p>EXA: 60 dB</p> <p>All other models: 70 dB</p> <p>Note that in the Single-Attenuator configuration, the total of ATT and EATT cannot exceed 50 dB. So, if the EATT is set to 24 dB first, the main attenuation cannot be greater than 26 dB and will be reduced accordingly; if the main attenuator is set to 40 dB first, EATT cannot be greater than 10 dB</p>
Annotation	<p>The current value for Total Atten is displayed in the Measurement Bar at the top of the display. A value appears for Electronic Attenuation only if the Electronic Attenuator is enabled. The annotation appears as</p> <p>Atten: <total> dB (e<elec>)</p> <p>The e letter is in amber in Single-Attenuator configurations</p> <p>For example:</p> <p>Dual-Attenuator configuration:</p> <p>Atten: 24 dB (e14)</p> <p>Indicating the total attenuation is at 24 dB and the electronic attenuation is at 14 dB</p> <p>Single-Attenuator configuration:</p> <p>A: 24 dB (e14)</p> <p>Indicating the total attenuation is at 24 dB and the "soft" attenuation is at 14 dB (see below for definition of "soft" attenuation)</p> <p>When in Manual, a # sign appears in front of Atten in the annotation</p>

Attenuator Configurations and Auto/Man

As described under "Y Scale" on page 597, there are two distinct attenuator configurations available in the X-Series, the single attenuator and Dual-Attenuator configurations. In Dual-Attenuator configurations, we have the mechanical attenuation and the electronic attenuation, and the current total attenuation is the sum of the electronic + mechanical attenuation. In Single-Attenuator configurations, we refer to the attenuation set using "Mech Atten" on page 719 (or `:POW:ATT`) as the "main" attenuation; and the attenuation that is set by `:POW:EATT` as the "soft" attenuation (`:POW:EATT` is honored even in the Single-Attenuator configuration, for compatibility purposes). Then the current total attenuation is the sum of the main + soft attenuation.

See "Elec Atten" on page 721 for more about "soft" attenuation.

NOTE

In some measurements, the **Mech Atten** control has an Auto/Man function. In these measurements, an Auto/Man switch is shown on the **Mech Atten** control:

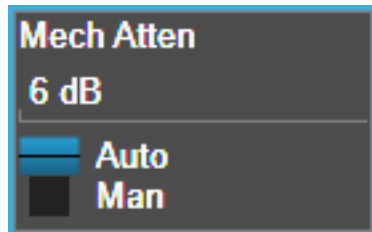

Note that in configurations that include an Electronic Attenuator, this switch is only shown when the Electronic Attenuator is disabled.

In other measurements, **Mech Atten** has no Auto/Man function. In these measurements, no switch is shown on the **Mech Atten** control:

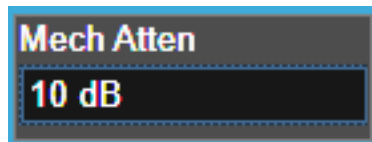

Mech Atten also appears with no switch, as above, in configurations that include an Electronic Attenuator but when the Electronic Attenuator is enabled.

Elec Atten

Controls the Electronic Attenuator in Dual-Attenuator configurations. Does not appear in Single-Attenuator configurations, because the control of both the mechanical and electronic stages of the Single-Attenuator is integrated into the single **Atten** control.

This control includes an **Enable/Disable** toggle switch; it is only possible to enter a value for the Electronic Attenuator when this switch is in the **Enable** position.

For more details about the Electronic Attenuator, see ["More Information" on page 723](#)

Remote Command	<pre>[:SENSe]:POWer[:RF]:EATTenuation <rel_amp1> [:SENSe]:POWer[:RF]:EATTenuation? [:SENSe]:POWer[:RF]:EATTenuation:STATE OFF ON 0 1 [:SENSe]:POWer[:RF]:EATTenuation:STATE?</pre>
Example	<pre>:POW:EATT 10 :POW:EATT? :POW:EATT:STAT ON :POW:EATT:STAT?</pre>
Notes	Electronic Attenuation's specification is defined only when Mechanical Attenuation is 6 dB
Dependencies	<p>Only appears in Dual-Attenuator models with an Electronic Attenuator installed and licensed. Does not appear in models with the Single-Attenuator configuration, because in the Single-Attenuator configuration there is no "electronic attenuator"; there is only a single integrated attenuator (which has both a mechanical and electronic stage). However, in the Single-Attenuator configuration, EATT SCPI commands are accepted for compatibility with other X-series instruments, and set a "soft" attenuation. The "soft" attenuation is treated as an addition to the "main" attenuation value set by the Attenuation control or :POW:ATT, and affects the total attenuation displayed on the Attenuation control and the Meas Bar</p> <p>The electronic attenuator, and the "soft" attenuation function provided in Single-Attenuator configurations, are unavailable above the low band (0-3.6 GHz, 0-3.4 GHz, 0-3 GHz, depending on the model). If the low band range is from 0-3.6 GHz, and Stop Frequency of the instrument is > 3.6 GHz, then the Enabled/Disabled section of the Elec Atten control will be OFF and grayed-out</p> <p>If "Internal Preamp" on page 737 is ON (that is, set to Low Band or Full), the electronic attenuator (and the "soft" attenuation function provided in Single-Attenuator configurations) is unavailable. In this case the Enabled/Disabled section of the Elec Atten control will be OFF and grayed-out</p> <p>If either of the above is true, and the SCPI command is sent, an error indicating that the electronic attenuator is unavailable is returned</p> <p>If both the above are true, pressing the control generates error message -221, in other words, the frequency range lockout takes precedence</p> <p>If the electronic/soft Attenuator is enabled, then the Stop Freq of the instrument is limited to 3.6 GHz and Internal Preamp is unavailable</p> <p>If "LNA" on page 738 is ON, the electronic attenuator (and the "soft" attenuation function provided in Single-Attenuator configurations) is unavailable. In this case the Enabled/Disabled section of the Elec Atten control will be OFF and grayed-out. This coupling works in the following modes/measurements:</p> <ul style="list-style-type: none"> - Channel Power, Occupied BW, ACP, SEM, Spurious Emissions, Power Stat CCDF measurements in all Modes - Transmit On Off Power measurement in 5GNR Mode - Power vs. Time and Transmit Power measurement in GSM/EDGE Mode - Burst Power measurement in Spectrum Analyzer Mode

	The SCPI-only “soft” electronic attenuation for the single-attenuator configuration is not available in all measurements; in particular, it is not available in the Swept SA measurement
Couplings	Enabling and disabling the Electronic Attenuator affects the setting of the Mechanical Attenuator (in Dual-Attenuator configurations). This is described in more detail below and in "Mechanical Attenuator Transition Rules" on page 723
Preset	0 dB OFF (Disabled) for Swept SA measurement ON (Enabled) for all other measurements that support the electronic attenuator
State Saved	Saved in instrument state
Min	0 dB
Max	Dual-Attenuator configuration: 24 dB Single-Attenuator configuration: the total of ATT and EATT cannot exceed 50 dB. So, if the EATT is set to 24 dB first, the main attenuation cannot be greater than 26 dB and will be reduced accordingly; if the main attenuator is set to 40 dB first, EATT cannot be greater than 10 dB
Annotation	See Annotation under the Mech Atten control description

More Information

The electronic attenuator offers finer steps than the mechanical attenuator, has no acoustical noise, is faster, and is less subject to wear. These advantages primarily aid in remote operation and are negligible for front panel use. See ["Using the Electronic Attenuator: Pros and Cons" on page 724](#) for a detailed discussion of the pros and cons of using the electronic attenuator.

For the Single-Attenuator configuration, for SCPI backwards compatibility, the “soft” attenuation feature replaces the Dual-Attenuator configuration’s electronic attenuator. All the same couplings and limitations apply. See ["Attenuator Configurations and Auto/Man" on page 721](#)

Mechanical Attenuator Transition Rules

When the Electronic Attenuator is enabled, the Mechanical Attenuator transitions to a state that has no Auto function. Below are the rules for transitioning the Mechanical Attenuator. Note that the information below *only* applies to the Dual-Attenuator configurations, and *only* when the Electronic Attenuator is installed:

When the Electronic Attenuation is enabled from a disabled state:

- The Mechanical Attenuator is initialized to 10 dB (this is its optimal performance setting). You can then set it as desired with SCPI, numeric keypad, step keys, or knob, and it behaves as it normally would in manual mode
- The Auto/Man state of (Mech) Atten is saved

- The Auto/Man toggle on the (Mech) Atten control disappears, and the auto rules are disabled
- The Electronic Attenuator is set to 10 dB less than the previous value of the Mechanical Attenuator, within the limitation that it must stay within the range of 0 to 24 dB of attenuation

Examples in the Dual-Attenuator configuration:

- Mech Atten at 20 dB. Elec Atten enabled, Mech Atten set to 10 dB, and Elec Atten set to 10 dB. New total attenuation equals the value before Elec Atten enabled
- Mech Atten at 0 dB. Elec Atten enabled, Mech Atten set to 10 dB, and Elec Atten set to 0 dB. New total attenuation does not equal the value before Elec Atten enabled
- Mech Atten at 40 dB. Elec Atten enabled, Mech Atten set to 10 dB, and Elec Atten set to 24 dB. New total attenuation does not equal the value before Elec Atten enabled

When the Electronic Attenuation is disabled from an enabled state:

- The Elec Atten control is grayed out
- The Auto/Man state of (Mech) Atten is restored
- If now in Auto, (Mech) Atten recouples
- If now in Man, (Mech) Atten is set to the value of total attenuation that existed before the Elec Atten was disabled. The resulting value is rounded up to the smallest value possible given the (Mech) Atten Step setting - (That is, 57 dB changes to 58 dB when (Mech) Atten Step is 2 dB)

Using the Electronic Attenuator: Pros and Cons

The electronic attenuator offers finer steps than the mechanical attenuator, has no acoustical noise, is faster, and is less subject to wear.

The “finer steps” advantage of the electronic attenuator is beneficial in optimizing the alignment of the instrument dynamic range to the signal power in the front panel as well as remote use. Thus, you can achieve improved relative signal measurement accuracy. Compared to a mechanical attenuator with 2 dB steps, the 1 dB resolution of the electronic attenuator only gives better resolution when the odd-decibel steps are used. Those odd-decibel steps are less accurately calibrated than the even-decibel steps, so one tradeoff for this superior relative accuracy is reduced absolute amplitude accuracy.

Another disadvantage of the electronic attenuator is that the spectrum analyzer loses its “Auto” setting, making operation less convenient.

Also, the relationship between the dynamic range specifications (TOI, SHI, compression, and noise) and instrument performance are less well-known with the electrical attenuator. With the mechanical attenuator, TOI, SHI, and compression threshold levels increase dB-for-dB with increasing attenuation, and the noise floor does as well. With the electronic attenuator, there is an excess attenuation of about 1 to 3 dB between 0 and 3.6 GHz, making the effective TOI, SHI, and so forth, less well known. Excess attenuation is the actual attenuation relative to stated attenuation. Excess attenuation is accounted for in the instrument calibration.

Adjust Atten for Min Clipping

Sets the combination of mechanical and electronic attenuation and gain based on the current measured signal level so that clipping will be at a minimum.

This is an immediate action function, that is, it executes once, when the control is pressed.

The algorithms that are used for the adjustment are documented under ["Pre-Adjust for Min Clipping" on page 726](#).

Remote Command	<code>[:SENSe]:POWer[:RF]:RANGe:OPTimize IMMEDIATE</code>
Example	<code>:POW:RANG:OPT IMM</code>
Notes	Executing Adjust Atten for Min Clipping initiates the measurement
Dependencies	Does not appear in the Swept SA, RTSA, Monitor Spectrum and Complex Spectrum measurements Appears in the Waveform measurement in 5G NR Mode only

Adjust Atten

Allows you to select;

- Electric attenuator only
- Combination of Electric attenuator and Mechanical attenuator

when `[:SENSe]:POWer[:RF]:RANGe:OPTimize IMMEDIATE` is executed.

Remote Command	<code>[:SENSe]:POWer[:RF]:RANGe:OPTimize:TYPE EONLY COMBined</code> <code>[:SENSe]:POWer[:RF]:RANGe:OPTimize:TYPE?</code>
Example	<code>:POW:RANG:OPT:TYPE EONL</code> <code>:POW:RANG:OPT:TYPE?</code>
Dependencies	Does not appear in the Swept SA, RTSA, Monitor Spectrum and Complex Spectrum measurements Appears in the Waveform measurement in 5G NR Mode only
Preset	<code>COMBined</code>
State Saved	Saved in instrument state

Pre-Adjust for Min Clipping

If this function is **ON**, it applies the adjustment described under "[Adjust Atten for Min Clipping](#)" on page 725 each time a measurement restarts. Therefore, in Continuous measurement mode, it only executes before the first measurement.

In Dual-Attenuator models, you can set **Elec+Mech Atten**, in which case both attenuators participate in the autoranging, or **Elec Atten Only**, in which case the mechanical attenuator does not participate in the autoranging. This latter case results in less wear on the mechanical attenuator and is usually faster.

See "[Adjustment Algorithm](#)" on page 727

Selection	SCPI	Note
Off	OFF	This is the default setting
On	ON	Available in Single-Attenuator instruments. For compatibility with models that do not have an input attenuator, the ON parameter is supported and mapped to COMBined
Elec Atten Only	ELECTrical	Selects only the electric attenuator to participate in auto ranging. This offers less wear on the mechanical attenuator and is usually faster
Elec+Mech Atten	COMBined	In Dual-Attenuator models, this selects both attenuators to participate in the autoranging

Remote Command	<code>[:SENSe]:POWer[:RF]:RANGe:OPTimize:ATTenuation OFF ON ELECTrical COMBined</code> <code>[:SENSe]:POWer[:RF]:RANGe:OPTimize:ATTenuation?</code>
Example	<code>:POW:RANG:OPT:ATT OFF</code> <code>:POW:RANG:OPT:ATT?</code>
Notes	The parameter option ELECTrical sets this function to ON in Single-Attenuator models The parameter option COMBined is mapped to ELECTrical in Single-Attenuator models. If you send COMBined , it sets the function to ON and returns ELEC to a query For SCPI compatibility with models that do not have an input attenuator, the ON parameter is honored and mapped to COMBined
Dependencies	Only appears in Dual-Attenuator models with an Electronic Attenuator installed In instruments with Dual-Attenuator model, when " Elec Atten " on page 721 is OFF or grayed-out, " Pre-Adjust for Min Clipping " on page 726 is grayed-out Does not appear in the Swept SA, RTSA, Monitor Spectrum and Complex Spectrum measurements For the Waveform measurement, available only in 5G NR Mode
Preset	OFF when Elec Atten is Disabled at preset, otherwise ELEC
State Saved	Saved in instrument state
Range	Dual-Attenuator models:

3 Bluetooth Mode
 3.7 Occupied BW Measurement

	Off Elec Atten Only Mech + Elec Atten Single-Attenuator models: Off On
Notes	ON aliases to "Elec Atten Only" (:POW:RANG:OPT:ATT ELEC) OFF aliases to "Off" (:POW:RANG:OPT:ATT OFF) :POW:RANG:AUTO? returns true if :POW:RANG:OPT:ATT is not OFF
Backwards Compatibility SCPI	[:SENSe]:POWer[:RF]:RANGe:AUTO ON OFF 1 0 [:SENSe]:POWer[:RF]:RANGe:AUTO?

Adjustment Algorithm

The algorithms for the adjustment are documented below:

Single-Attenuator Models

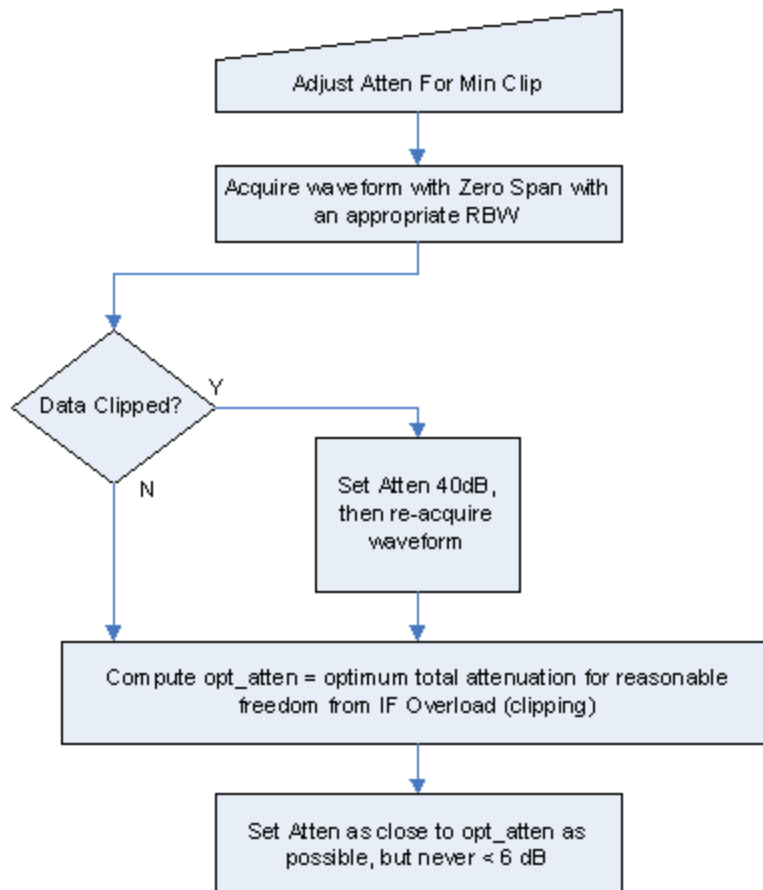

Dual-Attenuator models

"Adjust Atten for Min Clipping" on page 725 or "Pre-Adjust for Min Clipping" on page 726 selection is Mech + Elec Atten:

3 Bluetooth Mode
 3.7 Occupied BW Measurement

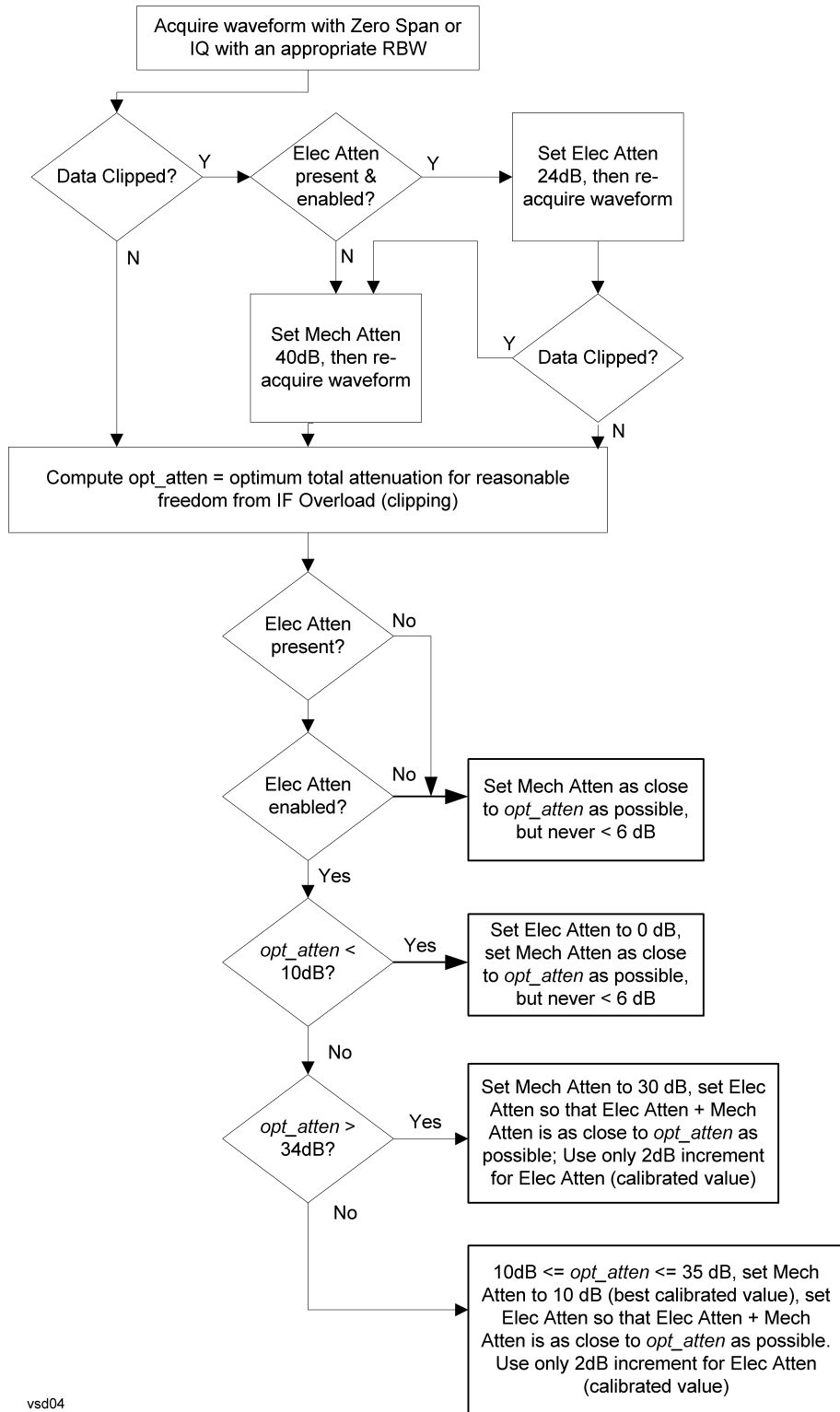

vsd04

"Pre-Adjust for Min Clipping" on page 726 selection is Elec Only.

Note that the **Mech Atten** value is not adjusted, and the value previously set is used. Therefore, there is a case that IF Overload is still observed depending on the input signal level and the Mech Atten setting.

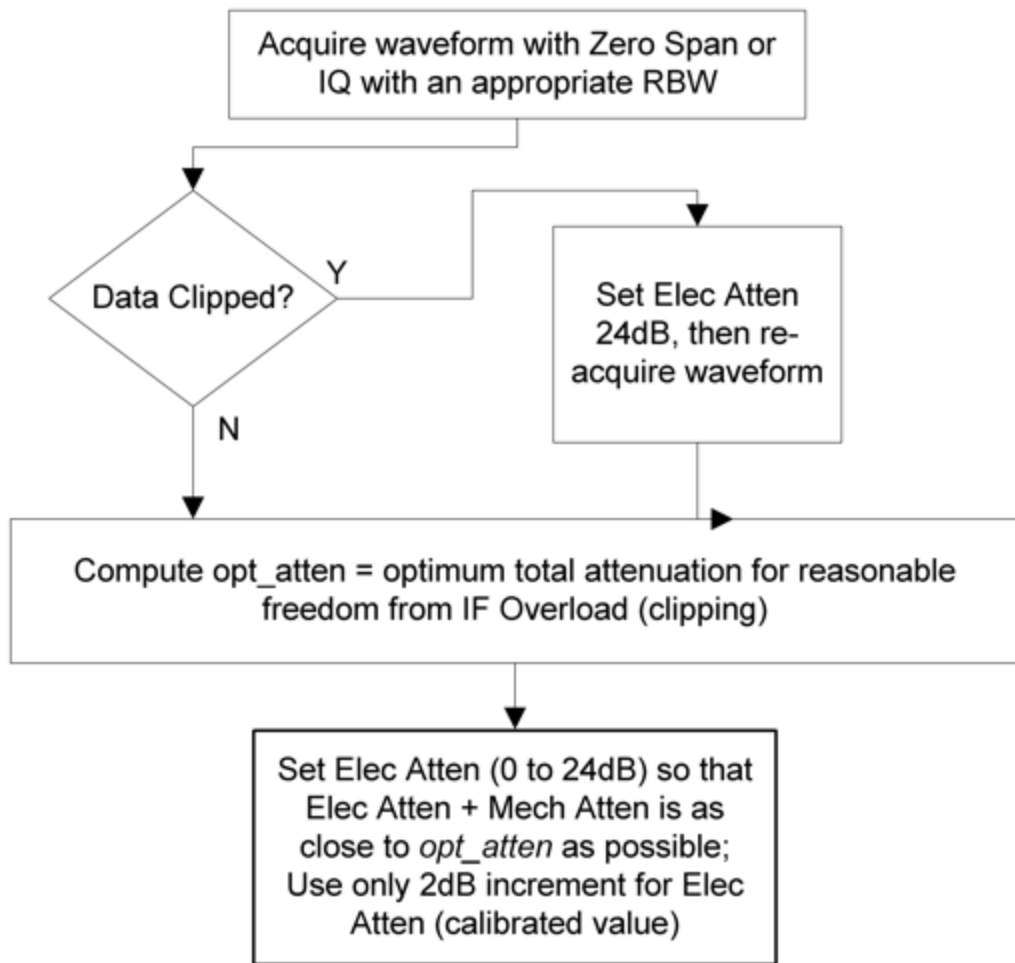

Mech Atten Step

Controls the step size used when making adjustments to the input attenuation.

Labeled **Mech Atten Step** in Dual-Attenuator models and **Atten Step** in Single-Attenuator models. In the Dual-Attenuator configuration, only affects the step size of the mechanical attenuator.

Remote Command `[:SENSe]:POWer[:RF]:ATTenuation:STEP[:INCRement] 10 dB | 2 dB`

3 Bluetooth Mode
3.7 Occupied BW Measurement

	<code>[:SENSe]:POWer[:RF]:ATTenuation:STEP[:INCRement]?</code>
Example	<code>:POW:ATT:STEP 2</code> <code>:POW:ATT:STEP?</code>
Notes	Has a toggle control on the front panel, but takes a specific value (in dB) when used remotely. The only valid values are 2 and 10
Dependencies	Blanked in EXA, CXA and CXA-m if option FSA (2 dB steps) is not present. If blanked, attempts to set it via SCPI yield an error
Couplings	When the attenuation step size changes, the current mechanical attenuation value is adjusted (if necessary) to be quantized to the new step size. That is, if step is set to 10 dB, mech atten is increased if necessary so it is a multiple of 10 dB
Preset	EXA, CXA and CXA-m: 10 dB (2 dB with option FSA) All other models: 2 dB
State Saved	Saved in instrument state

3.7.3.3 Range (Non-attenuator models)

Only available for Keysight's modular signal analyzers and certain other Keysight products, such as VXT

State Saved	No
-------------	----

Range

Represents the amplitude of the largest sinusoidal signal that could be present within the IF without being clipped by the ADC. For signals with high peak-to-average ratios, the range may need to exceed the rms signal power by a significant amount to avoid clipping.

This is a measurement global setting.

Remote Command	<code>[:SENSe]:POWer[:RF]:RANGe <real></code> <code>[:SENSe]:POWer[:RF]:RANGe?</code>
Example	<code>:POW:RANG 10 dBm</code> <code>:POW:RANG?</code>
Notes	The MIN and MAX values are affected by the External Gain parameters, and by the Center Frequency The hardware compensates for frequency response and alters the Range setting
Preset	0 dBm
State Saved	Yes
Min	-100
Max	100
Annotation	Meas Bar

Adjust Range for Min Clipping

Sets the combination of attenuation and gain based on the current measured signal level so that clipping will be at a minimum.

This is an "immediate action" function, that is, it executes once, when the key is pressed.

This key does not appear in measurements that do not support this functionality.

Remote Command	<code>[:SENSe]:POWer[:RF]:RANGe:OPTimize IMMEDIATE</code>
Notes	Executing Adjust Range for Min Clipping initiates the measurement
Dependencies	Does not appear in the Swept SA and Monitor Spectrum measurements

Pre-Adjust for Min Clipping

If this function is **ON**, it applies the adjustment described under Adjust Range For Min Clipping each time a measurement restarts. Therefore, in Continuous measurement mode, it only executes before the first measurement.

Remote Command	<code>[:SENSe]:POWer[:RF]:RANGe:OPTimize:ATTenuation OFF ON ELECTrical COMBined</code> <code>[:SENSe]:POWer[:RF]:RANGe:OPTimize:ATTenuation?</code>
Notes	Because there is no attenuator control available in these models, the control displays only ON and OFF choices. However, for SCPI compatibility with other platforms, all three parameters (ELECTrical , COMBined , and ON) are honored and all are mapped to ELECTrical , so if any of these three parameters is sent, a subsequent query will return ELEC
Dependencies	Does not appear in the Swept SA and Monitor Spectrum measurements
Preset	OFF for Swept SA measurement; ON for all other measurements that support Pre-Adjust for Min Clipping
State Saved	Saved in instrument state

Adjustment Algorithm

The algorithm for the adjustment is documented below:

3 Bluetooth Mode
3.7 Occupied BW Measurement

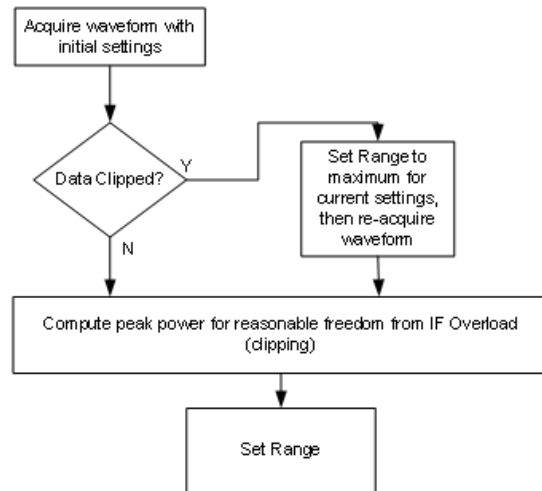

Peak-to-Average Ratio

Used with "[Range \(Non-attenuator models\)](#)" on page 731 to optimize the level control in the instrument. The value is the ratio, in dB, of the peak power to the average power of the signal to be measured. A ratio of 0 should be used for sinusoidal signals; for 802.11g OFDM signals use 9 dB.

All Modes show the current value of Peak-to-Average ratio on the control. However, some Modes do not permit changing the value. In these situations, the control is grayed-out.

Remote Command	<code>[:SENSe]:POWer[:RF]:RANGe:PARatio <real></code> <code>[:SENSe]:POWer[:RF]:RANGe:PARatio?</code>
Example	<code>:POW:RANG:PAR 12 dB</code>
Notes	In some Modes, this parameter is read-only; meaning the value will appear on the control and query via SCPI, but is not changeable. In such applications the control is grayed-out. Attempting to change the value via SCPI will be ignored but no error message will be generated
Dependencies	Does not appear in Spectrum Analyzer Mode
Preset	10 dB VXT Models M9410A/11A: 0 dB
State Saved	Saved in instrument state
Min	0 dB
Max	20 dB VXT Models M9410A/11A: 50 dB

Mixer Lvl Offset

This is an advanced setting to adjust target Range at the input mixer, which in turn affects the signal level in the instrument's IF. This setting can be used when additional optimization is needed after setting "[Peak-to-Average Ratio](#)" on page 733. Positive values of offset optimize noise performance over distortion, negative values optimize distortion performance over noise.

Remote Command	<code>[:SENSe] :POWer [:RF] :RANGe :MIXer :OFFSet <real></code> <code>[:SENSe] :POWer [:RF] :RANGe :MIXer :OFFSet?</code>
Example	<code>:POW:RANG:MIX:OFFS -5 dB</code>
Preset	0 dB
State Saved	Saved in instrument state
Min	-35 dB VXT Models M9410A/11A: -34 dB
Max	30 dB

3.7.3.4 Signal Path

Contains controls that pertain to the routing of the signal through the frontend of the instrument.

In general, only appears in instruments whose hardware supports this signal routing. For example, this tab does not appear in many of the modular instrument products, including VXT Model M9421A, or UXM.

This tab *does* appear in VXT Models M9410A/11A, because "[Software Preselection](#)" on page 749 is under this tab, and VXT Models M9410A/11A implement a version of Software Preselection.

Presel Center

Adjusts the centering of the preselector filter to optimize the amplitude accuracy at the frequency of the selected marker. If the selected marker is not on when **Presel Center** is pressed, the instrument turns on the selected marker, performs a peak search, and then performs centering on the marker's center frequency. If the selected marker is already on and between the start and stop frequencies of the instrument, the instrument performs the preselector calibration on that marker's frequency. If the selected marker is already on, but outside the frequency range between **Start Freq** and **Stop Freq**, the instrument first performs a peak search, and then performs centering on the marker's center frequency.

3 Bluetooth Mode
3.7 Occupied BW Measurement

The value displayed on "**Preselector Adjust**" on page 736 changes to reflect the new preselector tuning.

Certain considerations should be observed to ensure proper operation, as detailed in "**Proper Preselector Operation**" on page 735.

Remote Command	<code>[:SENSe] :POWer [:RF] :PCENter</code>
Example	<code>:POW:PCEN</code>
Notes	The rules outlined above under the control description apply for the remote command as well as the key. The result of the command depends on marker position, etc. Any message generated by the control press is also generated in response to the remote command
Dependencies	Does not appear in CXA-m, nor in VXT Models M9410A/11A Grayed-out if the microwave preselector is off <ul style="list-style-type: none"> - If the selected marker's frequency is below Band 1, an advisory message is generated "Preselector not used in this frequency range" and no action is taken - Grayed-out if entirely in Band 0, that is, if Stop Freq is below about 3.6 GHz Grayed-out if entirely above 50 GHz, that is, if Start Freq is above 50 GHz - Blanked in models that do not include a preselector, such as Option 503. If the remote command is sent in these instruments, accepted without error, and the query always returns 0 - Grayed-out in the Spectrogram View
Couplings	The active marker position determines where the centering will be attempted If the instrument is in a measurement such as averaging when centering is initiated, the act of centering the preselector restarts averaging, but the first average trace will not be taken until the centering is completed The offset applied to do the centering appears in " Preselector Adjust " on page 736
Status Bits/OPC dependencies	When centering the preselector, *OPC does not return true until the process is complete and a subsequent measurement has completed, nor are results returned in response to <code>:READ</code> or <code>:MEASure</code> queries The Measuring bit remains set (true) while this command is operating, and does not go false until the subsequent sweep/measurement has completed

Proper Preselector Operation

Certain considerations should be observed to ensure proper operation:

1. If the selected marker is **Off**, the instrument turns on a marker, performs a peak search, and adjusts the preselector using the selected marker's frequency. It uses the "highest peak" peak search method unqualified by threshold or excursion, so that there is no chance of a 'no peak found' error. It continues with that peak, even if it is the peak of just noise. Therefore, for this operation to work properly, there should be a signal on-screen in a preselected range for the peak search to find

2. If the selected marker is already **On**, the instrument attempts the centering at that marker's frequency. There is no preselector for signals below about 3.6 GHz, so if the marker is on a signal below 3.6 GHz, no centering is attempted, and an advisory message is generated
3. In some models, the preselector can be bypassed. If it is bypassed, no centering is attempted in that range and a message is generated

Preselector Adjust

Lets you manually adjust the preselector filter frequency to optimize its response to the signal of interest. Only available when "**Presel Center**" on page 734 is available.

For general purpose signal analysis, using **Presel Center** is recommended. Centering the filter minimizes the impact of long-term preselector drift. **Preselector Adjust** can be used instead to manually optimize the preselector. One application of manual optimization would be to peak the preselector response, which both optimizes the signal-to-noise ratio and minimizes amplitude variations due to small (short-term) preselector drifting.

When **Presel Center** is performed, the offset applied to do the centering becomes the new value of **Preselector Adjust**.

Remote Command	<code>[:SENSe]:POWer[:RF]:PADJust <freq></code> <code>[:SENSe]:POWer[:RF]:PADJust?</code>
Example	<code>:POW:PADJ 100KHz</code> <code>:POW:PADJ?</code>
Notes	The value on the control is displayed to 0.1 MHz resolution
Dependencies	<ul style="list-style-type: none"> - Does not appear in CXA-m - Does not appear in VXT Models M9410A/11A - Grayed-out if microwave preselector is off - Grayed-out if entirely in Band 0, that is, if Stop Freq is lower than about 3.6 GHz - Grayed-out if entirely above 50 GHz, that is, if Start Freq is higher than 50 GHz - Blank in models that do not include a preselector, such as Option 503. If the command is sent in these instruments, it is accepted without error, and the query always returns 0 - Grayed-out in the Spectrogram View
Preset	0 MHz
State Saved	The Preselector Adjust value set by " Presel Center " on page 734, or by manually adjusting Preselector Adjust Not saved in instrument state, and does not survive a Preset or power cycle

3 Bluetooth Mode
3.7 Occupied BW Measurement

Min	-500 MHz
Max	500 MHz
Backwards Compatibility SCPI	<code>[:SENSe]:POWer[:RF]:MW:PADJust</code> <code>[:SENSe]:POWer[:RF]:MMW:PADJust</code>
Notes	The command has no effect, and the query always returns MWAVE
Backwards Compatibility SCPI	<code>[:SENSe]:POWer[:RF]:PADJust:PRESelector MWAVE MMWave EXternal</code> <code>[:SENSe]:POWer[:RF]:PADJust:PRESelector?</code>

Internal Preamp

Accesses a menu of controls for the internal preamps. Turning on the preamp gives a better noise figure, but a poorer inter-modulation distortion (TOI) to noise floor dynamic range. You can optimize this setting for your measurement.

The instrument takes the preamp gain into account as it sweeps. If you sweep outside of the range of the preamp, the instrument will also account for that. The displayed result always reflects the correct gain.

For some measurements, when the preamp is on and any part of the displayed frequency range is below the lowest frequency for which the preamp has specifications, a warning condition message appears in the status line. For example, for a preamp with a 9 kHz lowest specified frequency: "Preamp: Accy unspec'd below 9 kHz".

Selection	Example	Note
Off	<code>:POW:GAIN OFF</code>	
Low Band	<code>:POW:GAIN ON</code> <code>:POW:GAIN:BAND LOW</code>	Sets the internal preamp to use only the low band. The frequency range of the installed (optional) low-band preamp is displayed in square brackets on the Low Band selection in the dropdown
Full Range	<code>:POW:GAIN ON</code> <code>:POW:GAIN:BAND FULL</code>	Sets the internal preamp to use its full range. The low band (0-3.6 GHz, 0-3.4 GHz, 0-3 GHz, depending on the model) is supplied by the low band preamp and the frequencies above low band are supplied by the high band preamp The frequency range of the installed (optional) low-band preamp is displayed in square brackets on the Full Range selection in the dropdown. If the high band option is not installed the Full Range selection does not appear

NOTE

The maximum **Center Frequency** for Low Band, displayed in square brackets, can change based on the selected IFBW for measurements that support IFBW (for example, Waveform measurement across all Modes that support it). In certain models (such as N9042B & N9032B), IFBW values ≤ 40 MHz have a maximum Low Band frequency of 3.6 GHz, while $40 \text{ MHz} < \text{IFBW} \leq 1 \text{ GHz}$ have a maximum of 3.3 GHz, and $1 \text{ GHz} < \text{IFBW} \leq 1.5 \text{ GHz}$ have a maximum of 3.5 GHz. IFBW values $> 1.5 \text{ GHz}$ do not support a **Center Frequency** that can reach the Low Band maximum frequency. In these cases, **N/A** is displayed in the square brackets for Low Band.

Remote Command	<pre>[:SENSe]:POWer[:RF]:GAIN:BAND LOW FULL [:SENSe]:POWer[:RF]:GAIN:BAND? [:SENSe]:POWer[:RF]:GAIN[:STATe] OFF ON 0 1 [:SENSe]:POWer[:RF]:GAIN[:STATe]?</pre>
Example	<pre>:POW:GAIN:BAND LOW :POW:GAIN:BAND? :POW:GAIN OFF :POW:GAIN?</pre>
Dependencies	<p>Not available on all hardware platforms. If the preamp is not present or is unlicensed, this control is not shown</p> <p>Does not appear in VXT Models M9410A/11A/15A/16A</p> <p>If <code>:POW:GAIN:BAND FULL</code> is sent when a low band preamp is available, the preamp band parameter is set to <code>LOW</code> instead of <code>FULL</code>, and an "Option not installed" message is generated</p> <p>Not available when the electronic/soft attenuator is enabled</p>
Preset	<pre>LOW OFF</pre>
State Saved	Saved in instrument state
Annotation	<p>When the USB Preamp is not connected to USB, the Preamp annotation in the Meas Bar says "Off" if the preamp is off and displays the frequency range of the low band or full range preamp depending on the setting. For example, if the Preamp is set to Low Band and the Low Band is 3.6 GHz the annotation says "3.6 GHz". If it is a 13.6 GHz preamp and it is set to Full Range the annotation says "13.6 GHz"</p> <p>When the USB Preamp is connected to USB, the Preamp annotation says "Preamp: USB" if the internal preamp is off or "Preamp: USB, Int" if the internal preamp is on (only for measurements that support the USB preamp)</p>

LNA

Lets you turn the Low Noise Amplifier (**LNA**) on or off.

LNA is an additional preamplifier that provides superior DANL and frequency range compared to **"Internal Preamp" on page 737**. LNA provides lower system noise

3 Bluetooth Mode
3.7 Occupied BW Measurement

figure, especially at frequencies above 100 MHz, and can be operated up to the full range of 50 GHz instruments.

For best possible sensitivity, **LNA** can be turned on *together* with "**Internal Preamp**" on page 737, although if you operate both preamps together, note that the TOI (distortion) specifications are impacted. The sensitivity improvement of this combination is substantial when operating in high band (frequencies above 3.6 GHz).

For more details about annotation, see "**More Information**" on page 739

Remote Command	<code>[:SENSe]:POWer[:RF]:GAIN:LNA[:STATe] OFF ON 0 1</code> <code>[:SENSe]:POWer[:RF]:GAIN:LNA[:STATe]?</code>
Example	<code>:POW:GAIN:LNA ON</code>
Dependencies	Requires Option LNA, except for VXT models M9415A/16A Does not appear in VXT models M9421A/10A/11A May not appear in some measurements LNA is not available when the electronic/soft attenuator is enabled
Preset	OFF
State Saved	Saved in State

More Information

When **LNA** is installed, the preamp annotation changes to show the state of both **LNA** and **Internal Preamp**. Below is an example:

```
Atten: 8 dB
Pre: Int on, LNA on
µW Path: LNP, On
Source: Off
```

Note that when operating entirely in the low band (below about 3.6 GHz), if **LNA** is on, **Internal Preamp** is switched off (even if you have its switch set to **ON**). This is because the noise performance is actually degraded in low band if both preamps are on. In this case, the annotation reflects the actual state of the two preamps, but the **Internal Preamp** annotation displays in amber, to warn you that the actual state of **Internal Preamp** does not match its switch control display:

```
Atten: 8 dB
Pre: Int off, LNA on
µW Path: LNP, On
Source: Off
```

µW Path Control

Options for this control include **µW Preselector Bypass** (Option MPB), **Low Noise Path** (Option LNP) and **Full Bypass Enable** in the High Band path circuits.

When the μ W Preselector is bypassed, flatness is improved, but will be subject to spurs from out of band interfering signals. When **Low Noise Path Enable** is selected, the instrument automatically bypasses certain circuitry in the high frequency bands that can contribute to noise, when it is appropriate based on other instrument settings.

For most applications, the preset state is **Standard Path**, which provides the best remote-control throughput, minimizes acoustic noise from switching and minimizes the risk of wear in the hardware switches, particularly in remote test scenarios where both low band and high band setups will follow in rapid succession. In this path, the bypass of the low band/high band switch and microwave preamp is never activated, which can cause some noise degradation but preserves the life of the bypass switch.

For applications that utilize the wideband IF paths, the preset state is **μ W Preselector Bypass**, if option MPB is present. This is because, when using a wideband IF such as the 140 MHz IF, the μ W Preselector's bandwidth can be narrower than the available IF bandwidth, causing degraded amplitude flatness and phase linearity, so it is desirable to bypass the preselector in the default case.

You may choose **Low Noise Path Enable** for a lower noise floor, especially in the 21–26.5 GHz region, though without improving many measures of dynamic range, and without giving the best possible noise floor. The preamp, if purchased and used, gives better noise floor than does **Low Noise Path Enable**, but the preamp's compression threshold and third-order intercept are much poorer than that of **Low Noise Path Enable**.

A fourth choice is **Full Bypass Enable**, which combines **μ W Preselector Bypass** and **Low Noise Path Enable**. Because this can bypass most of the circuitry between the input and the first mixer, care should be taken when using this setting to avoid damaging the mixer. **Full Bypass Enable** is only available if both options LNP and MPB are present, as well as option FBP.

Path	Example	Note
Standard Path	:POW:MW:PATH STD	Normal setting for most measurements. μ W Preselector in circuit, Low Noise Path disabled
Low Noise Path Enable	:POW:MW:PATH LNP	See " Low Noise Path Enable " on page 744
μ W Preselector Bypass	:POW:MW:PATH MPB	See " μW Preselector Bypass " on page 746
Full Bypass Enable	:POW:MW:PATH FULL	See " Full Bypass Enable " on page 747

Remote Command [:SENSe]:POWer[:RF]:MW:PATH STD | LNPath | MPBypass | FULL
[:SENSe]:POWer[:RF]:MW:PATH?

Example :POW:MW:PATH LNP
Enables the Low Noise path

3 Bluetooth Mode
 3.7 Occupied BW Measurement

: POW: MW: PATH?

Notes If "Presel Center" on page 734 is performed, the instrument will momentarily switch to the Standard Path, regardless of the setting of **μW Path Control**

The DC Block will always be switched in when the low noise path is switched in, to protect succeeding circuitry from DC. Note that this does not mean "when the low noise path is enabled" but when, based on the Low Noise Path rules, the path is actually switched in. This can happen when the selection is **Low Noise Path Enable** or **Full Bypass Enable**. In the case where the DC Block is switched in the instrument is now AC coupled. However, if you selected DC coupling, the UI would still behave as though it were DC coupled, including all annunciation, warnings, status bits, and responses to SCPI queries. This is because, based on other settings, the instrument could switch out the low noise path at any time and hence go back to being DC coupled

Alignment switching ignores the settings in this menu, and restores them when finished

Dependencies Does not appear in CXA-m, VXT Models M9410A/11A, nor in BBIQ and External Mixing

- The **Low Noise Path Enable** selection does not appear unless Option LNP is present and licensed
- The **μW Preselector Bypass** selection does not appear unless Option MPB is present and licensed
- The **Full Bypass Enable** selection does not appear unless options LNP and MPB are both present as well as option FBP

In any of these cases, if the required options are not present and the SCPI command is sent, error - 241, "Hardware missing; Option not installed" is generated

Low Noise Path Enable and **Full Bypass Enable** are grayed-out if the current measurement does not support them

Low Noise Path Enable and **Full Bypass Enable** are not supported in Avionics and MMR Modes (non-modulation measurements). In any of these cases (that is, the feature is not supported in either measurement or Mode), if the SCPI command is sent, the following error is generated: -221, "Setting Conflict; Feature not supported for this measurement"

Preset	Mode	Value
	IQ Analyzer	MPB option present and licensed: MPB
	Pulse	MPB option not present and licensed: STD
	Avionics	
	All other Modes	STD

State Saved Save in instrument state

Range Standard Path | Low Noise Path Enable | μW Presel Bypass | Full Bypass Enable

Annotation In the Meas Bar, if the Standard path is chosen:
 μW Path: Standard
 If Low Noise Path is enabled but the LNP switch is not thrown:
 μW Path: LNP,Off
 If the Low Noise Path is enabled and the LNP switch is thrown:
 μW Path: LNP,On
 If the preselector is bypassed:

μ W Path: Bypass

If Full Bypass Enable is selected but the LNP switch is not thrown:

μ W Path: FByp,Off

If Full Bypass Enable is selected and the LNP switch is thrown:

μ W Path: FByp,On

μ W Path Control Auto

In VMA, WLAN, 5G NR, CQM Modes, an **Auto/Man** switch is added to μ W Path Control:



This allows the function to automatically switch based on certain Auto Rules as shown below:

VMA Mode

Measurement	When μ W Path Control is in Auto
Digital Demod	Use Standard Path unless tuned frequency > 3.6 GHz and IFBW > 15 MHz, in which case choose Preselector Bypass
Monitor Spectrum	Always Presel Bypass
IQ Waveform	Use Standard Path unless tuned frequency > 3.6 GHz and IFBW > 15 MHz, in which case choose Preselector Bypass
Custom OFDM	Use Standard Path unless tuned frequency > 3.6 GHz and IFBW > 15 MHz, in which case choose Preselector Bypass
Channel Power	Always Presel Bypass
Occupied BW	Always Presel Bypass
CCDF	Use Standard Path unless tuned frequency > 3.6 GHz and IFBW > 15 MHz, in which case choose Preselector Bypass
ACP	Always Presel Bypass
SEM	Always Presel Bypass
Spurious Emissions	Always Standard Path

WLAN Mode

Measurement	When μ W Path Control is in Auto
Modulation	Always Presel Bypass

3 Bluetooth Mode
 3.7 Occupied BW Measurement

Measurement	When μ W Path Control is in Auto
Analysis	
Spectral Flatness	Always Presel Bypass
Power vs Time	Always Presel Bypass
Monitor Spectrum	Always Presel Bypass
IQ Waveform	Always Presel Bypass
Channel Power	Always Presel Bypass
Occupied BW	Always Presel Bypass
CCDF	Always Presel Bypass
SEM	For 11be 320M, when 'Enabled Wideband IF for FFT' is OFF or 'Sweep Type Rule' is Best Dynamic Range, auto μ W path is standard For other cases, auto μ W path is presel bypass if presel bypass is enabled, auto μ W path is standard if presel bypass is not enabled
Spurious Emissions	Always Standard Path

5G NR Mode

Measurement	When μ W Path Control is in Auto
Modulation Analysis	Use Standard Path unless tuned frequency > 3.6 GHz and IFBW > 15 MHz, in which case choose Full Bypass if conditions warrant(FBP Option is available and "Allow Full Bypass in Auto" is On), otherwise choose Preselector Bypass
Monitor Spectrum	Always Standard Path
IQ Waveform	Use Standard Path unless tuned frequency > 3.6 GHz and IFBW > 15 MHz, in which case choose Full Bypass if conditions warrant(FBP Option is available and "Allow Full Bypass in Auto" is On), otherwise choose Preselector Bypass
Channel Power	Always Standard Path
Occupied BW	Always Standard Path
CCDF	Use Standard Path unless tuned frequency > 3.6 GHz and IFBW > 15 MHz, in which case choose Preselector Bypass
ACP	Always Standard Path
SEM	Always Standard Path
Spurious Emissions	Always Standard Path
Transmit On Off Power	Use Standard Path unless tuned frequency > 3.6 GHz and Info BW > 15 MHz, in which case choose Preselector Bypass

Channel Quality Mode

Measurement	When μ W Path Control is in Auto
Group Delay	Use Standard Path unless tuned frequency > 3.6 GHz and IFBW > 15 MHz, in which case choose Full Bypass if conditions warrant(FBP Option is available and

Measurement	When μ W Path Control is in Auto
Monitor Spectrum	“Allow Full Bypass in Auto” is On), otherwise choose Preselector Bypass
IQ Waveform	Always Standard Path
CCDF	Use Standard Path unless tuned frequency > 3.6 GHz and IFBW > 15 MHz, in which case choose Preselector Bypass
Remote Command	<code>[:SENSe] :POWer [:RF] :MW :PATH :AUTO ON OFF 1 0</code> <code>[:SENSe] :POWer [:RF] :MW :PATH :AUTO?</code>
Example	<code>:POW:MW:PATH:AUTO ON</code> <code>:POW:MW:PATH:AUTO?</code>
Dependencies	Only appears in VMA, WLAN, 5G NR and CQM Modes
Couplings	See the tables above
Preset	ON
Range	ON OFF

Low Noise Path Enable

Low Noise Path Enable provides a lower noise floor under some circumstances, particularly when operating in the 21–26.5 GHz region. With the Low Noise Path enabled, the low band/high band switch and microwave preamp are bypassed whenever *all* the following are true:

- The instrument is not in the Low Band, meaning:
- the start frequency is above 3.5 GHz and
- the stop frequency is above 3.6 GHz
- The internal preamp is not installed, or if installed, is set to **Off** or **Low Band**

Note that this means that, when any part of a sweep is done in Low Band, the Low Noise Path is not used, whether or not the **Low Noise Path Enable** is selected in the user interface. Also, if the preamp is turned on, the Low Noise Path is not used, whether or not the **Low Noise Path Enable** is selected in the user interface. The only time the Low Noise Path is used is when **Low Noise Path Enable** is selected, the sweep is completely in High Band (> 3.6 GHz) and no preamp is in use.

For measurements that use IQ acquisition, the low noise path is used when **Center Frequency** is in High Band (> 3.6 GHz) and no preamp is in use. In other words, the rules above are modified to use only the center frequency to qualify which path to switch in. This is not the case for FFTs in the Swept SA measurement; they use the same rules as swept measurements.

3 Bluetooth Mode

3.7 Occupied BW Measurement

Note that the Low Noise Path, while giving improved DANL, has the disadvantage of decreased TOI performance and decreased gain compression performance relative to the standard path.

Note also that the bypass switch is a mechanical switch and has finite life, so if the **Low Noise Path Enable** is selected, it is possible to cause frequent cycling of this switch by frequently changing instrument settings such that the above conditions hold true only some of the time. A user making tests of this nature should consider opting for the **Standard Path**, which will never throw the bypass switch, at the expense of some degraded noise performance.

The low noise path is useful for situations where the signal level is so low that the instrument performance is dominated by noise even with 0 dB attenuation, but still high enough that the preamp option would have excessive third-order intermodulation or compression. The preamp, if purchased and used, gives better noise floor than does the “Low Noise Path.” However, its compression threshold and third-order intercept are much poorer than that of the non-preamp path.

There are some applications, typically for signals around -30 dBm, for which the third-order dynamic range of the standard path is good enough, but the noise floor is not low enough even with 0 dB input attenuation. When the third-order dynamic range of the preamp path is too little and the noise floor of the standard path is too high, the Low Noise Path can provide the best dynamic range

The graph below illustrates the concept. It shows, in red, the performance of an instrument at different attenuation settings, both with the preamp on and off, in a measurement that is affected by both instrument noise and instrument TOI. The green shows the best available dynamic range, offset by 0.5 dB for clarity. The blue shows how the best available dynamic range improves for moderate signal levels with the low noise path switched in. In this illustration, the preamp improves the noise floor by 15 dB while degrading the third-order intercept by 30 dB, and the low noise path reduces loss by 8 dB. The attenuator step size is 2 dB.

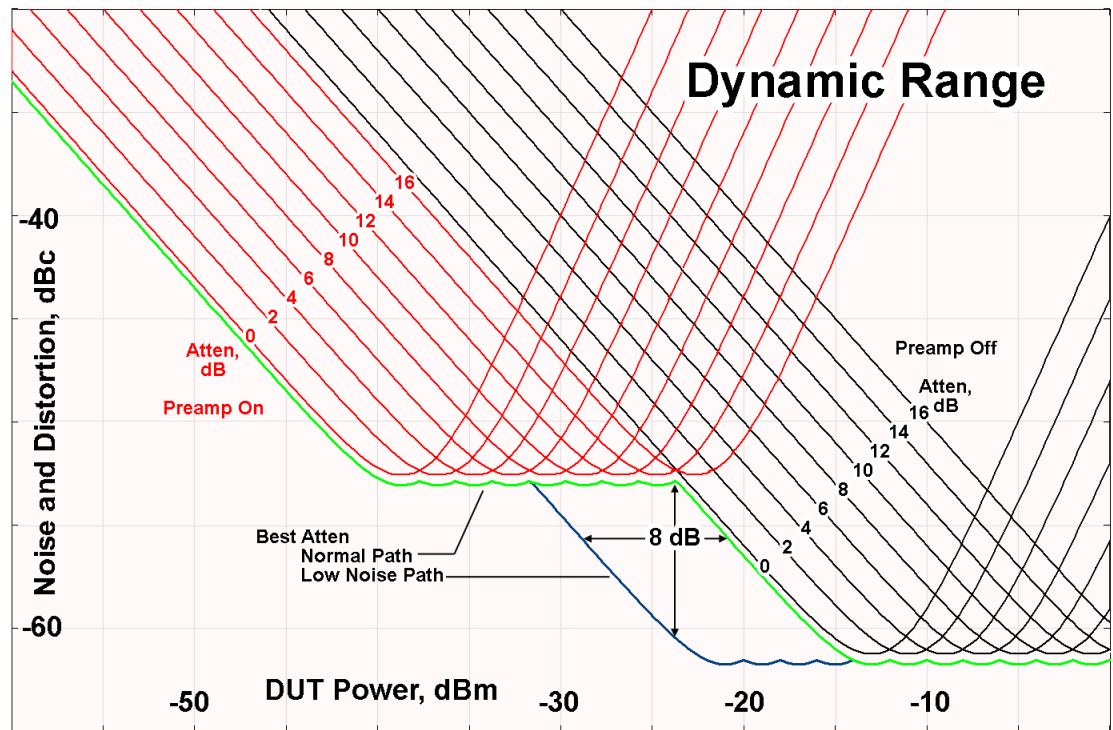

There are other times where selecting the low noise path improves performance, too. Compression-limited measurements such as finding the nulls in a pulsed-RF spectrum can profit from the low noise path in a way similar to the TOI-limited measurement illustrated. Accuracy can be improved when the low noise path allows the optimum attenuation to increase from a small amount like 0, 2 or 4 dB to a larger amount, giving better return loss at the instrument input. Harmonic measurements, such as second and third harmonic levels, are much improved using the low noise path because of the superiority of that path for harmonic (though not intermodulation) distortion performance.

μ W Preselector Bypass

Toggles the preselector bypass switch for band 1 and higher. When the microwave preselector is on, the signal path is preselected. When the microwave preselector is off, the signal path is not preselected. The preselected path is the normal path for the instrument.

The preselector is a tunable bandpass filter which prevents signals away from the frequency of interest from combining in the mixer to generate in-band spurious signals (images). The consequences of using a preselector filter are its limited bandwidth, the amplitude and phase ripple in its passband, and any amplitude and phase instability due to center frequency drift.

Option MPB or pre-selector bypass provides an unpreselected input mixer path for certain X-Series signal analyzers with frequency ranges above 3.6 GHz. This signal path allows a wider bandwidth and less amplitude variability, which is an advantage when doing modulation analysis and broadband signal analysis. The disadvantage is that, without the preselector, image signals will be displayed. Another disadvantage of bypassing the preselector is increased LO emission levels at the front panel input port.

Image responses are separated from the real signal by twice the 1st IF. For IF Paths of 10 MHz and 25 MHz, the 1st IF is 322.5 MHz, so the image response and the real signal will be separated by 645 MHz. The 1st IF will be different for other IF Path settings. When viewing a real signal and its corresponding image response in internal mixing, the image response will be to the left of the real signal.

Also, the image response and the real signal typically have the same amplitude and exhibit the same shape factor.

However, if Option FS1 (Fast Sweep Capability) is enabled, the image response in the Swept SA measurement appears lower in amplitude and has a much wider shape factor compared to the real signal.

Full Bypass Enable

With **Full Bypass Enable** selected, the microwave preselector is bypassed. In addition, the low band/high band switch and microwave preamp are bypassed whenever *all* the following are true:

- The instrument is not in the Low Band, meaning:
- the start frequency is above 3.5 GHz and
- the stop frequency is above 3.6 GHz.
- the internal preamp is not installed or if installed, is set to **Off** or **Low Band**

Note that this means that, when any part of a sweep is done in Low Band, the Low Noise Path is not used, whether or not the **Full Bypass Enable** is selected in the user interface. Also, if the preamp is turned on, the Low Noise Path is not used, whether or not the **Full Bypass Enable** is selected in the user interface. The only time the Low Noise Path is used is when **Full Bypass Enable** is selected, the sweep is completely in High Band (> 3.6 GHz) and no preamp is in use.

CAUTION

When **Full Bypass Enable** is selected, and "**Y Scale**" on page 597 is set to 0 dB, there will be a direct AC connection between the input and the first converter when the Low Noise Path switches in (when Start Freq >3.6 GHz and the Preamp is either not licensed, set to Low Band, or Off). This puts the first converter at considerable risk to be damaged by high AC power. Consequently,

whenever **Full Bypass Enable** is selected, a warning message appears in the status bar:

“Full Bypass Enabled, maximum safe input power reduced”

Microwave Preselector Bypass Backwards Compatibility

Example	<code>:POW:MW:PRES OFF</code> Bypasses the microwave preselector
Notes	Included for Microwave Preselector Bypass backwards compatibility The ON parameter sets the STD path (<code>:POW:MW:PATH STD</code>) The OFF parameter sets path MPB (<code>:POW:MW:PATH MPB</code>)
Preset	ON
Backwards Compatibility SCPI	<code>[:SENSe]:POWer[:RF]:MW:PRESelector[:STATe] ON OFF 0 1</code> <code>[:SENSe]:POWer[:RF]:MW:PRESelector[:STATe]?</code>

Frequency Extender Preselection Bypass

Only applies to the high frequency path of the Frequency Extender, and only if the Frequency Extender allows it. For example, the V3050A high frequency path is 50 – 110 GHz and *does* allow control of the preselector bypass.

When the Frequency Extender’s preselection is bypassed, flatness is improved, but will be subject to spurs from out-of-band interfering signals. For bandwidths greater than 2.5 [GHz], it is recommended that the signal bypass the Frequency Extender Preselector since the max bandwidth of the Preselector can be as narrow as 2.5 [GHz].

For most applications, the preset state is **OFF**, which gives the best remote-control throughput, minimizes acoustic noise from switching, minimizes out of band spurs, and minimizes the risk of wear in the hardware switches.

Preselector and Bandwidth Conflict

When the Frequency Extender Preselector is applied and the signal bandwidth is greater than 2.5 [GHz], then a settings alert message will show to warn the user that the signal may be distorted due to the limitation of the Frequency Extender Preselector bandwidth.

An example of the settings alert message is shown below.

Settings Alert message in the Status Bar at the bottom of the display.



Settings Alert message in the error queue

Type	ID	
	159	Settings Alert - DETECTED; Presel/Meas BW conflict

Software Preselection

Provided in some instruments, either to compensate for issues with provided hardware preselection or to provide the preselection function when there is no hardware preselector.

N9041B

Software Preselection compensates for the frequency range limit of the microwave preselector. Since the microwave preselector only goes up to 50 GHz, software preselection must be used to suppress and separate images above 50 GHz. The specific algorithm used for software preselection is specified by the SW Preselection Type selection – Normal or Advanced.

In N9041B, **Software Preselection** only applies for frequencies above 50 GHz, therefore it is only used for RF Input 2. Even if turned on, it is not used for other inputs, and never for frequencies below 50 GHz. This is why the label of this control contains the parenthetical note “(>~50 GHz)”.

Note that in N9041B, in Swept SA measurement, **Software Preselection** works even if the measurement is using an FFT Sweep Type. In measurements other than Swept SA, Software Preselection is not used if the measurement is using an FFT sweep type.

N9042B+V3050A

Software Preselection compensates for the frequency range limit of the microwave preselector. Since the microwave preselector only goes up to 50 GHz, software preselection must be used to suppress and separate images above 50 GHz. The specific algorithm used for software preselection is specified by the SW Preselection Type selection – Normal or Advanced.

For N9042B+V3050A, Software Preselection only applies for frequencies above 50 GHz, therefore it is only used for External RF. Even if it is turned on, it will not be used for other inputs and never for frequencies below 50 GHz. This is why the label of this control contains the parenthetical note “(>~50 GHz)”.

Note that for N9042B+V3050A, in the Swept SA measurement, Software Preselection works even if the measurement is using an FFT Sweep Type. In measurements other than Swept SA, Software Preselection is not used if the measurement is using an FFT Sweep Type.

VXT models M9410A/11A

Software Preselection is used to provide the preselection function, as there is no hardware preselector in these models. Two background traces are taken and compared point by point, and the point with the lowest amplitude from the two traces is used. This provides a method to reduce spurs that are internally generated within the VXT, but you should note the following when using Software Preselection:

- There is some speed cost due to the need to take multiple captures
- Taking the point with the lowest amplitude in each trace will make the average noise level lower at all points that do not have a spur. This can reduce the accuracy of the measurement of noise and noise-like signals

Because of the difficulty in identifying spurs manually, you are recommended to leave Software Preselection **ON** at all times in VXT models M9410A/11A. If you turn it off in order to speed up your measurement or improve noise accuracy, be aware of unwanted onscreen spurs.

Remote Command	<code>[:SENSe] : POWer [:RF] : SWPreSel : STATe 0 1 ON OFF</code>	
	<code>[:SENSe] : POWer [:RF] : SWPreSel : STAT?</code>	
Example	<code>: POW : SWPR : STAT 1</code>	
	<code>: POW : SWPR : STAT?</code>	
Dependencies	Only appears in N9041B, N9042B+V2050A, and VXT models M9410A/11A. Does not appear in all measurements	
Couplings	Affects Sweep Time Auto Tune supports Software Preselection , so Auto Tune should be performed after setting the Software Preselection state	
Preset	N9041B	OFF
	N9042B+V3050A	ON
	M9410A/11A	ON
State Saved	Saved in instrument state	

SW Preselection Type

Specifies the algorithm used for software preselection.

Two hidden sweeps occur in succession. The second sweep is offset in LO frequency by $2 * IF / N$. For each point in each trace, the smaller amplitude from the two traces is taken and placed in that point in the selected trace. The Peak detector is auto-selected to improve the image suppression effectiveness. Responses of each trace that lie on top of one another will remain and are valid signals. Other signals are images, which are suppressed. The action of taking the smaller of the two traces will make the average noise level lower in all points that do not have an image, thus reducing the accuracy of the measurement of noise and noise-like signals.

- **NORMa1** - mathematically removes all image and multiple responses of signals present at the input
- **ADVanced** - any trace processing (such as “max hold” or trace averaging) is performed on the points of both candidate traces before the “select minimum” operation occurs. This form of processing works better for non-stationary signals, such as pulsed-RF signals

Remote Command	<code>[:SENSe]:POWer[:RF]:SWPResel NORMa1 ADVanced</code> <code>[:SENSe]:POWer[:RF]:SWPResel?</code>
Example	<code>:POW:SWPR NORM</code> <code>:POW:SWPR?</code>
Dependencies	Only appears in N9041B and N9042B+V3050A. Only appears in measurements that use the Swept method Grayed-out when "Software Preselection" on page 749 is OFF. The grayout message is “Unavailable unless SW Presel enabled”
Preset	N9041B ADVanced N9042B+V3050A NORMa1
State Saved	Saved in instrument state

SW Preselection BW

Specifies the effective bandwidth to be used for Software Preselection.

The options are:

- **NORMa1** – when making Swept measurements, a software preselection algorithm is used which takes up to 4 background acquisitions, then post-processes the result. This algorithm can remove images from signals with an occupied

bandwidth up to around 3 GHz. (Default/Preset setting). When making FFT measurements, this algorithm is not used, instead the same algorithm is used as for **NARRow** (below)

- **NARRow**– a software preselection algorithm is used which takes two background acquisitions, then post-processes the result to detect and remove images from wideband signals with occupied bandwidths up to 2 GHz. This increases the risk of images failing to be rejected, but improves the measurement speed

Remote Command	<code>[:SENSe]:POWer[:RF]:SWPResel:BW NORMa1 NARRow</code> <code>[:SENSe]:POWer[:RF]:SWPResel:BW?</code>
Example	<code>:POW:SWPR:BW NARR</code>
Dependencies	Only appears in N9041B and N9042B+V3050A. Only appears in measurements that use the Swept method Grayed-out when " Software Preselection " on page 749 is OFF . The grayout message is "Unavailable unless SW Presel enabled" For N9042B+V3050A, the parameter is SCPI-only, and always set to NARRow when Software Preselection is enabled
Preset	N9041B NORMa1 N9042B+V3050A NARRow
State Saved	Saved in instrument state

High Freq Prefilter

Lets you set the state of Prefilter for center frequencies above 1310 MHz.

In VXT Models M9410A/11A, the Receiver RF path has a bank of filters that come after the RF Attenuator in the signal path. Since this bank of filters precedes the mixer they are known as the "Prefilter" bank. Their purpose is to eliminate unwanted in-band mixing products by filtering out all but the desired frequencies before the signals get to the mixer. There are 13 prefilter bands to cover the frequencies between 9 kHz and 6000 MHz. The Prefilter provides the necessary rejection of the unwanted signal.

Remote Command	<code>[:SENSe]:<measurement>:PFILter[:STATe] ON OFF 1 0</code> <code>[:SENSe]:<measurement>:PFILter[:STATe]?</code>
Example	Enable High Freq Prefilter for the Complex Spectrum Measurement in BASIC Mode: <code>:SPEC:PFIL ON</code> Enable High Freq Prefilter for the IQ Waveform Measurement, in multiple Modes: <code>:WAV:PFIL ON</code> Enable High Freq Prefilter for the Swept SA Measurement in SA Mode:

3 Bluetooth Mode
 3.7 Occupied BW Measurement

	:SAN:PFIL ON
Dependencies	Only appears in VXT models M9410A/11A with center frequency above 1310 MHz
Preset	See "Prefilter Presets" on page 753 below
State Saved	Saved in instrument state

Prefilter Presets

Meas	Mode	Preset
SPEC	BASIC	OFF
WAV	BASIC, WCDMA, WLAN, LTEAFDD, LTEATDD, 5GNR, VMA	OFF
MON	WCDMA, WLAN, LTEAFDD, LTEATDD, 5GNR, VMA	OFF
RHO	WCDMA	OFF
CDP	WCDMA	OFF
PCON	WCDMA	OFF
EVMQ	WCDMA	OFF
CHP	WCDMA, WLAN, LTEAFDD, LTEATDD, 5GNR, VMA, SA	OFF
OBW	WCDMA, WLAN, LTEAFDD, LTEATDD, 5GNR, VMA, SA	OFF
ACP	WCDMA, LTEAFDD, LTEATDD, 5GNR, VMA, SA	OFF
SEM	WCDMA, WLAN, LTEAFDD, LTEATDD, 5GNR, VMA, SA	OFF
PST	WCDMA, WLAN, LTEAFDD, LTEATDD, 5GNR, VMA, SA	OFF
PVT	WLAN, LTEAFDD, LTEATDD, 5GNR	OFF
EVM	WLAN, LTEAFDD, LTEATDD, 5GNR	OFF
FLAT	WLAN	OFF
EVMM	WLAN	OFF
CEVM	LTEAFDD, LTEATDD	OFF
PAVT	5GNR, VMA	OFF
DDEM	VMA	OFF
OFDM	VMA	OFF
SAN	SA	ON
HARM	SA	ON

3.7.4 BW

Opens the Bandwidth (**BW**) menu, which contains controls for ["Res BW" on page 754](#) and ["Video BW" on page 755](#).

The **Resolution BW** functions control filter bandwidth and filter type. There are two filter types, Gaussian and Flattop. The Gaussian filters have a response curve that is parabolic on a log scale. The Flattop filter shape is a close approximation of a rectangular filter.

3.7.4.1 Settings

Contains the basic bandwidth functions. In this measurement, it is the only tab under **BW**.

Res BW

Activates the resolution bandwidth active function, which allows you to manually set the resolution bandwidth (RBW) of the instrument.

Normally, **Res BW** (Auto) selects automatic coupling of the **Res BW** to "**Span**" on [page 773](#) using the ratio set by **Span:3 dB RBW** (some measurements do not have a **Span:3 dB RBW** control, in which case the measurement chooses the optimal ratio). To decouple the resolution bandwidth, press the **Auto/Man** toggle on the **Res BW** control, or simply enter a different value for **Res BW**.

When the **Res BW** is manually selected, it may be returned to the coupled state by pressing the **Auto/Man** toggle on the **Res BW** control. This may also be done by pressing "**Auto Couple**" on [page 787](#) or by performing a **Preset**.

When **Res BW** is set to **Auto**, the bandwidth selected depends on "**RBW Filter Type**" on [page 756](#).

Only certain discrete resolution bandwidths are available. The available bandwidths are dependent on **Filter Type** or **EMC Standard**. If an unavailable bandwidth is entered with the numeric keypad, the closest available bandwidth is selected.

Remote Command	<pre>[:SENSe]:OBwidth:BANDwidth[:RESolution] <bandwidth> [:SENSe]:OBwidth:BANDwidth[:RESolution]? [:SENSe]:OBwidth:BANDwidth[:RESolution]:AUTO ON OFF 1 0 [:SENSe]:OBwidth:BANDwidth[:RESolution]:AUTO?</pre>
Example	<pre>:OBW:BAND 5 MHz :OBW:BAND? :OBW:BAND:AUTO ON :OBW:BAND:AUTO?</pre>
Notes	<p>For numeric entries, all RBW Types choose the nearest (arithmetically, on a linear scale, rounding up) available RBW to the value entered</p> <p>The setting and querying of values depend on the current bandwidth type</p>
Couplings	<p>Sweep time is coupled to RBW. As RBW changes, the sweep time (if set to Auto) is changed to maintain amplitude calibration</p> <p>"Video BW" on page 755 is coupled to RBW. As the resolution bandwidth changes, the video bandwidth (if set to Auto) changes to maintain the ratio of VBW/RBW (10:1)</p> <p>When Res BW is set to Auto, the resolution bandwidth is auto-coupled to the span. The ratio of</p>

3 Bluetooth Mode

3.7 Occupied BW Measurement

	Span/RBW is approximately 106:1 when auto coupled. When Res BW is set to Man , and the bandwidths are entered manually, these bandwidths are used regardless of other instrument settings
Preset	Auto , unless noted in " RBW Presets " on page 755 below See table below
State Saved	Saved in instrument state
Min	1 Hz
Max	8 MHz is the max equivalent –3 dB RBW, which means that the named RBW (the one shown on the control etc.) can exceed 8 MHz if using a filter other than –3 dB Gaussian
Annotation	A “#” mark appears before “RBW” in the annotation when it is switched from Auto to Manual coupling
Backwards Compatibility Notes	For backwards compatibility, this command supports both BANDwidth and BWIDth forms For ESA, the maximum Res BW was 5 MHz; for X-Series it is 8 MHz

RBW Presets

Unless noted in the table below, the Preset value of RBW is **Auto**.

Mode	Preset Value
WCDMA	30 kHz
BT	10 kHz
WLAN	100 kHz
MSR	30 kHz
LTE, LTETDD, LTEAFDD, LTEATDD, 5G NR	30 kHz

Video BW

Lets you change the instrument post-detection filter (VBW or “video bandwidth”) from 1 Hz to 8 MHz, in approximately 10% steps. In addition, a wide-open video filter bandwidth may be chosen by selecting 50 MHz. The VBW is annotated at the bottom of the display, in the center.

Video BW (Auto) selects automatic coupling of **Video BW** to "[Res BW](#)" on page 754. To decouple the resolution bandwidth, press the **Auto/Man** toggle on the **Video BW** control, or simply enter a different value for **Video BW**.

When **Video BW** is manually selected, it may be returned to the coupled state by pressing the **Auto/Man** toggle on **Video BW**. This may also be done by pressing "[Auto Couple](#)" on page 787 or by performing a **Preset**.

Remote Command	<code>[:SENSe]:OBwidth:BANDwidth:VIDeo <bandwidth></code> <code>[:SENSe]:OBwidth:BANDwidth:VIDeo?</code> <code>[:SENSe]:OBwidth:BANDwidth:VIDeo:AUTO ON OFF 1 0</code> <code>[:SENSe]:OBwidth:BANDwidth:VIDeo:AUTO?</code>
----------------	---

Example	<pre>:OBW:BAND:VID 2.4 MHz :OBW:BAND:VID? :OBW:BAND:VID:AUTO ON :OBW:BAND:VID:AUTO?</pre>
Notes	<p>For numeric entries, the instrument chooses the nearest (arithmetically, on a linear scale, rounding up) available VBW to the value entered. The 50 MHz VBW is defined to mean “wide open”</p> <p>The values shown in this table reflect the conditions after a Mode Preset</p>
Dependencies	<p>Sometimes the displayed Video BW is not actually used to process the trace data:</p> <p>When the Average detector is selected, and Sweep Type is set to Swept, the video bandwidth filter cannot be used, because it uses the same hardware as the Average detector</p> <p>When the Quasi-Peak, EMI Average, or RMS Average detector is selected, Video BW is implemented by the digital IF as part of the detector</p> <p>In this case, Video BW still acts to change the Sweep Time, if Sweep Time is in Auto, and still affects the data on other traces for which this is not the case</p>
Couplings	Normally coupled to Res BW . If Video BW is set to Auto , then video bandwidth is changed as Res BW changes, to maintain the preset ratio (normally 10:1)
Preset	Auto , unless noted in "Video BW Presets" on page 756 below ON
State Saved	Saved in instrument state
Min	1 Hz
Max	50 MHz
Annunciation	A “#” mark appears before “VBW” in the annotation when it is not coupled
Annotation	In the bottom center of the screen, “VBW <value> <units>” indicates the current video bandwidth value. Note that for some detectors this is not the value used for VBW (see above)
Backwards Compatibility Notes	For backwards compatibility, this command supports both BANDwidth and BWIDTH forms

Video BW Presets

Unless noted in the table below, the Preset value is **Auto**.

Mode ID	Preset Value
WCDMA	300 kHz
BT	30 kHz

RBW Filter Type

Selects the type for the resolution bandwidth filters. Historically, the **Res BW** filters in HP/Agilent/Keysight spectrum analyzers were Gaussian filters, specified using the –3 dB bandwidth of the filter. That is, a 10 MHz **Res BW** filter was a Gaussian

3 Bluetooth Mode
3.7 Occupied BW Measurement

shape with its –3 dB points 10 MHz apart. In X-Series, you can choose between a Gaussian and Flat Top filter shape, for varying measurement conditions.

	Filter Type	SCPI
	Gaussian	GAUSSian
	Flattop	FLATtop
Remote Command	[:SENSe]:OBwidth:BAWdwidth:SHAPE GAUSSian FLATtop	
	[:SENSe]:OBwidth:BAWdwidth:SHAPE?	
Example	:OBW:BAWd:SHAP GAUS	
	:OBW:BAWd:SHAP?	
Preset	"Auto Couple" on page 787 selects the preset value	
State Saved	Saved in instrument state	
Annotation	The annotation under RBW in the bottom left of the screen shows the type of filter or bandwidth that is being used. The following examples illustrate this:	
	–3 dB (Normal) filter BW	Res BW 300 Hz
	–6 dB filter BW	Res BW (–6 dB) 422 Hz
	Noise filter BW	Res BW (Noise) 317 Hz
	Impulse filter BW	Res BW (Impulse) 444 Hz
	CISPR filter BW	Res BW (CISPR) 200 Hz
	MIL filter BW	Res BW (MIL) 1 kHz
	Flattop filter type	Res BW (Flattop) 300 Hz
Backwards Compatibility SCPI	[:SENSe]:OBwidth:BWIDth:SHAPE	

3.7.5 Display

Opens the **Display** menu, which lets you configure display items for the current Mode, Measurement View or Window.

3.7.5.1 Meas Display

Contains controls for setting the display for the current Measurement, View or Window.

x dB BW Boundaries On/Off

Turns the x dB BW Boundaries On or Off.

Remote Command	<code>:DISPlay:OBWidth:WINDow[1]:XDB 0 1 OFF ON</code> <code>:DISPlay:OBWidth:WINDow[1]:XDB?</code>
Example	<code>:DISP:OBW:WIND:XDB 1</code> <code>:DISP:OBW:WIND:XDB?</code>
Preset	0
State Saved	Saved in instrument state
Range	OFF ON
Backwards Compatibility SCPI	<code>:DISPlay:OBWidth:VIEW:WINDow[1]:XDB</code>

Boundary Frequency

Selects frequency display type:

- **OFFSet**: offsets from Center Freq to OBW boundary frequency are displayed
- **ABSolute**: absolute frequencies are displayed

Remote Command	<code>:DISPlay:OBWidth:WINDow2:BOUNDaries:FREQuency OFFSet ABSolute</code> <code>:DISPlay:OBWidth:WINDow2:BOUNDaries:FREQuency?</code>
Example	<code>:DISP:OBW:WIND2:BOUN:FREQ ABS</code> <code>:DISP:OBW:WIND2:BOUN:FREQ?</code>
Preset	OFFSet
State Saved	Saved in instrument state
Range	OFFSet ABSolute
Backwards Compatibility SCPI	<code>:DISPlay:OBWidth:VIEW2:WINDow2:BOUNDaries:FREQuency</code>

3.7.5.2 Annotation

Contains controls for setting up the annotation for the current Mode or Measurement.

Graticule

Turns the display graticule On or Off for all windows with graticules in all measurements in the current Mode. Also turns the graticule Y-Axis annotation on and off.

Remote Command	<code>:DISPlay:GRATicule[:STATe] OFF ON 0 1</code> <code>:DISPlay:GRATicule[:STATe]?</code>
Example	<code>:DISP:GRAT OFF</code>
Notes	The graticule is the set of horizontal and vertical lines that make up the grid/divisions for the X-Axis and Y-Axis
Preset	<code>ON</code>
State Saved	Saved in instrument state
Backwards Compatibility SCPI	<code>:DISPlay:WINDow[1]:TRACe:GRATicule:GRID[:STATe] OFF ON 0 1</code> <code>:DISPlay:WINDow[1]:TRACe:GRATicule:GRID[:STATe]?</code> This command is accepted for backwards compatibility with older instruments, but the <code>WINDow</code> , <code>TRACe</code> and <code>GRID</code> parameters are ignored

Screen Annotation

Controls the display of the annunciation and annotation around the graticule, including any annotation on lines (such as the display line, the threshold line, etc.) and the Y-Axis annotation, for all windows with screen annotation in all measurements in the current Mode.

This does *not* include marker annotation (or the N dB result). When `OFF`, the graticule expands to fill the entire graticule area, leaving only the 1.5% gap above the graticule, as described in the **Trace** section.

Remote Command	<code>:DISPlay:ANNotation:SCReen[:STATe] OFF ON 0 1</code> <code>:DISPlay:ANNotation:SCReen[:STATe]?</code>
Example	<code>:DISP:ANN:SCR OFF</code>
Dependencies	Grayed-out and forced to <code>OFF</code> when System Display Settings, Annotation is <code>OFF</code>
Preset	<code>ON</code> This remains <code>OFF</code> through a Preset when System Display Settings, Annotation is set to <code>OFF</code>
State Saved	Saved in instrument state

Trace Annotation

Turns on and off the labels on the traces, showing their detector (or their Math Mode) as described in the **Trace** section, for all windows in all measurements in the current Mode for which Trace Annotation on/off is supported.

If Trace Math is being performed on a trace, then the Trace Math annotation replaces the detector annotation.

For measurements that support limit lines, this key also turns on and off the labels on the Limit Lines. The label is the Limit number annotation and Limit Comment

displayed on the graph. If the length of the comment is greater than 20 characters, the first 8 characters and the last 8 characters are displayed, joined with

Remote Command	<code>:DISPlay:ANNotation:TRACe[:STATe] ON OFF 1 0</code> <code>:DISPlay:ANNotation:TRACe[:STATe]?</code>
Example	<code>:DISP:ANN:TRAC OFF</code>
Preset	<code>OFF</code>
State Saved	Saved in instrument state

Control Annotation

Turns on and off the display of values on the Active Function controls for all measurements in the current Mode. This is a security feature.

Remote Command	<code>:DISPlay:ACTivefunc[:STATe] ON OFF 1 0</code> <code>:DISPlay:ACTivefunc[:STATe]?</code>
Example	<code>:DISP:ACT OFF</code>
Dependencies	Grayed out and forced to <code>OFF</code> when System Display Settings, Annotation is <code>OFF</code>
Preset	<code>ON</code> This remains <code>OFF</code> through a Preset when System Display Settings, Annotation is set to <code>OFF</code>
State Saved	Saved in instrument state

Meas Bar

Turns the Measurement Bar at the top of the screen on and off for all measurements in the current Mode. When `OFF`, the graticule area expands to fill the area formerly occupied by the Measurement Bar.

Remote Command	<code>:DISPlay:ANNotation:MBAR[:STATe] OFF ON 0 1</code> <code>:DISPlay:ANNotation:MBAR[:STATe]?</code>
Example	<code>:DISP:ANN:MBAR OFF</code>
Dependencies	Grayed out and forced to <code>OFF</code> when System Display Settings, Annotation is <code>OFF</code>
Preset	<code>ON</code> This remains <code>OFF</code> through a Preset when System Display Settings, Annotation is set to <code>OFF</code>
State Saved	Saved in instrument state

Display Enable (Remote Command Only)

Turns the display on/off, including the display drive circuitry. The backlight stays lit to confirm that the instrument is on. The display enable setting is mode global.

3 Bluetooth Mode
 3.7 Occupied BW Measurement

There are three reasons for turning the display off:

1. To increase speed as much as possible by freeing the instrument from having to update the display
2. To reduce emissions from the display, drive circuitry
3. For security purposes

If you have turned off the display:

- and you are in local operation, the display can be turned back on by pressing any key or by sending `:SYSTEM:DEFAULTS MISC` or `:DISPLAY:ENABLE ON` (neither `*RST` nor `:SYSTEM:PRESET` enable the display)
- and you are in remote operation, the display can be turned back on by pressing the **Local** or **Esc** keys, or by sending `:SYSTEM:DEFAULTS MISC` or `:DISPLAY:ENABLE ON` (neither `*RST` nor `:SYSTEM:PRESET` enable the display)
- and you are using either the `:SYSTEM:KLOCK` command or GPIB local lockout, then *no* front-panel key press will turn the display back on. You must turn it back on remotely.

If the display is **OFF**, many SCPI commands related to User Views and Multiscreen functionality do not work, and return the error messages “-221, Settings conflict; Screen SCPI cannot be used when Display is disabled” or “221, Settings conflict; View SCPI cannot be used while Display is disabled”. These commands include:

Name	Command
Select User View	<code>:DISPLAY:VIEW:ADVANCED:SELECT</code>
Rename User View	<code>:DISPLAY:VIEW:ADVANCED:RENAME</code>
Delete User View	<code>:DISPLAY:VIEW:ADVANCED:DELETE</code>
Create User View	<code>:DISPLAY:VIEW:ADVANCED:NAME</code>
Select Screen	<code>:INSTRUMENT:SCREEN:SELECT</code>
Delete Screen	<code>:INSTRUMENT:SCREEN:DELETE</code>
Delete All But This Screen	<code>:INSTRUMENT:SCREEN:DELETE:ALL</code>
Add Screen	<code>:INSTRUMENT:SCREEN:CREATE</code>
Rename Screen	<code>:INSTRUMENT:SCREEN:RENAME</code>
Sequencer On/Off	<code>:SYSTEM:SEQUENCER</code>

Remote Command	<code>:DISPLAY:ENABLE OFF ON 0 1</code> <code>:DISPLAY:ENABLE?</code>
Example	<code>:DISP:ENAB OFF</code>
Couplings	<code>:DISP:ENAB OFF</code> turns Backlight OFF and <code>:DISP:ENAB ON</code> turns Backlight ON , but changing Backlight settings does <i>not</i> change the state of <code>:DISP:ENAB</code>

Preset	ON Set by <code>:SYST:DEF MISC</code> , but not affected by <code>*RST</code> or <code>:SYSTem:PRESet</code>
State Saved	Not saved in instrument state
Backwards Compatibility Notes	<code>:SYST:PRES</code> no longer turns on <code>:DISPlay:ENABLe</code> as it did in legacy analyzers

3.7.5.3 View

Contains controls for selecting the current **View**, and for editing User Views.

View

See "[Views](#)" on page 706

User View

Lets you choose a View from the saved User Views for the current measurement. This panel only appears if a User View exists for the current measurement.

Remote Command	<code>:DISPlay:VIEW:ADVanced:SElect <alphanumeric></code> <code>:DISPlay:VIEW:ADVanced:SElect?</code>
Example	Select Baseband as the current View <code>:DISP:VIEW:ADV:SEL "Baseband"</code>
Notes	<p>You must be in the measurement whose View you are trying to set to send the command. You can only set Views for the current measurement using this command</p> <p>For predefined views, the parameter is derived from the view name that is shown in the View list in the user interface. For example, if you are trying to select the Trace Zoom view in the Swept SA measurement, you send:</p> <pre><code>:DISP:VIEW:ADV:SEL "Trace Zoom"</code></pre> <p>because "Trace Zoom" is the name of the View as seen in the Mode/Meas dialog or in the Display, View menu</p> <p>You <i>cannot</i> use the legacy View parameter (which in this case would be <code>TZOOM</code>) with</p> <pre><code>:DISP:VIEW:ADV:SEL</code></pre> <p><code><alphanumeric></code> is case insensitive; you can specify mixed case, however the name will be evaluated on a single case. Thus, both of the following forms work:</p> <pre><code>:DISP:VIEW:ADV:SEL "Trace Zoom"</code> <code>:DISP:VIEW:ADV:SEL "TRACE ZOOM"</code></pre> <p>If the specified view is not a valid View, the query returns the error message "-224, Illegal parameter value; View with the name <alphanumeric> does not exist"</p> <p>If the display is disabled (via <code>:DISP:ENAB OFF</code>) then the error message "-221, Settings conflict;</p>

	View SCPI cannot be used while Display is disabled” is generated
Backwards Compatibility SCPI	The legacy node <code>:DISPlay:VIEW[:SElect]</code> is retained for backwards compatibility, but it only supports predefined views

Restore Layout to Default

Restores the Layout to the default for Basic.

Modified Views are very temporary; if you exit the current measurement they are discarded, and they are not saved in State. To retain this View for later use, and to be able to return easily to your original Basic View, you can save your edited View as a “User View”.

Save Layout as New View

Saves your new View as a User View. An alpha keyboard appears, which lets you name your new View; the default is the old View name plus a number.

Remote Command	<code>:DISPlay:VIEW:ADVanced:NAME <alphanumeric></code>
Example	<code>:DISP:VIEW:ADV:NAME “Baseband”</code> Creates a new View named Baseband from the current View, and selects it as the current View
Notes	<code><alphanumeric></code> is case insensitive; you can specify mixed case, however the name will be evaluated on a single case If <code><alphanumeric></code> name already exists as a View, the error message “-224, Illegal parameter value; View <alphanumeric> already exists” is generated If the display is disabled (via <code>:DISP:ENAB OFF</code>) then the error message “-221, Settings conflict; User View SCPI cannot be used while Display is disabled” is generated

Re-Save User View

You can re-edit a User View; if you make changes, then an asterisk will appear next to the User View’s name. You can then tap **Re-Save User View** to save it back to its existing name, or **Save Layout as New View** to add another, new User View.

This is a front panel function only, there is no remote command available to perform this function. To do this remotely, you must first perform **Save Layout as New View**, then delete the old User View and rename the new one with the name of the View you just deleted.

Rename User View

You can rename the current View by giving it a new unique name. Only User Views can be renamed, if the current View is a Predefined View, an error occurs.

Remote Command	<code>:DISPlay:VIEW:ADVanced:REName <alphanumeric></code>
Example	<code>:DISP:VIEW:ADV:REN "Baseband"</code>
Notes	<p><code><alphanumeric></code> is case insensitive; you can specify mixed case, however the name will be evaluated on a single case</p> <p>If the <code><alphanumeric></code> specifying the new name is already present in the list of View names, the error message "-224, Illegal parameter value; View <alphanumeric> already exists" is generated</p> <p>If the current View is a Predefined View, the error message "-224, Illegal parameter value; Cannot rename a Predefined View" is generated</p> <p>If the display is disabled (via <code>:DISP:ENAB OFF</code>) then the error message "-221, Settings conflict; View SCPI cannot be used while Display is disabled" is generated</p>

Delete User View

You can delete the current View if it is a User View. The default view becomes the current view for the Measurement.

Remote Command	<code>:DISPlay:VIEW:ADVanced:DELeTe</code>
Example	<code>:DISP:VIEW:ADV:DEL</code>
Notes	<p><code><alphanumeric></code> is case insensitive; you can specify mixed case, however the name will be evaluated on a single case</p> <p>If the <code><alphanumeric></code> is not present in the list of View names, the error message "-224, Illegal parameter value; View <alphanumeric> does not exist" is generated</p> <p>If the current View is a Predefined View, the error message "-224, Illegal parameter value; Cannot delete a Predefined View" is generated</p> <p>If the display is disabled (via <code>:DISP:ENAB OFF</code>) then the error message "-221, Settings conflict; View SCPI cannot be used while Display is disabled" is generated</p>

Delete All User Views

Deletes all previously saved User Views. The default view becomes the current view for the Measurement if a User View was the current view when this command was executed.

Remote Command	<code>:DISPlay:VIEW:ADVanced:DELeTe:ALL</code>
----------------	--

Example	<code>:DISP:VIEW:ADV:DEL:ALL</code>
Notes	Disabled if there are no User Views

View Editor Remote Commands

The following remote commands help you manage Views and User Views. Note that the SCPI node for User Views handles both Predefined and User Views. The legacy nodes, `:DISPlay:VIEW[:SElect]` and `:DISPlay:VIEW:NSEL`, are retained for backwards compatibility, but they only support predefined views.

View Listing Query

Returns a string containing a comma-separated list of names for *all* the Views, including User Views, available for the current Measurement.

Remote Command	<code>:DISPlay:VIEW:ADVanced:CATalog?</code>
Example	<code>:DISP:VIEW:ADV:CAT?</code>
Notes	Returns a quoted string of the available Views for the current measurement, separated by commas. The list includes names for <i>all</i> the Views, including User Views, available for the current Measurement Example: <code>"Normal,Trace Zoom,Spectrogram,Baseband,myView1,yourView1"</code> No distinction is made between Predefined and User Views If you switch measurements with the display disabled (via <code>:DISP:ENAB OFF</code>), then query the list of available Views, the result is undefined

User View Listing Query

Returns a string containing a comma-separated list of names for *only* the User Views available for the current Measurement.

Remote Command	<code>:DISPlay:VIEW:ADVanced:USER:CATalog?</code>
Example	<code>:DISP:VIEW:ADV:USER:CAT?</code>
Notes	Returns a quoted string of the available User Views for the current measurement, separated by commas. Example: <code>"Baseband,myView1,yourView1"</code> If you switch measurements with the display disabled (see "Display Enable (Remote Command Only)" on page 760), then query the list of available Views, the result is undefined

3.7.6 Frequency

Opens the **Frequency** menu, which contains controls that allow you to control the Frequency and Channel parameters of the instrument.

Some features in the **Frequency** menu are the same for all measurements in the current Mode – they do not change as you change measurements. Settings like these are called “Meas Global” and are unaffected by Meas Preset. For example, the Center Freq setting is the same for all measurements – it does not change as you change measurements.

3.7.6.1 Settings

Contains controls that pertain to the X-Axis parameters of the measurement. These parameters control how data on the vertical (X) axis is displayed and control instrument settings that affect the horizontal axis.

Channel

Selects the Bluetooth channel that will be measured.

Channel number is common for all measurements in the Mode.

Remote Command	<code>[:SENSe]:CHANnel[:NUMBer] <integer></code> <code>[:SENSe]:CHANnel[:NUMBer]?</code>
Example	<code>:CHAN 22</code> <code>:CHAN?</code>

Couplings The coupling of **Channel** and **Center Frequency** only applies to the following measurements:

- Transmit Analysis
- Output Spectrum BW
- Monitor Spectrum

For other measurements, **Center Frequency** does not depend on channel. The values are coupled as follows:

Radio Standard	Channel	Center Frequency Display Cutoff Frequency (See note below)
Basic or EDR	$(CF - 2.402E9) / 1.0e6$	500 kHz
Low Energy	$(CF - 2.402E9) / 2.0e6$	1 MHz

If **Center Frequency** is set to a value between channels, the **Channel** key displays > prior to the previous channel number if the CF is < the **Cutoff Frequency** above the previous channel, and <

prior to the next channel number if the CF is \geq the **Cutoff Frequency** above the previous channel

Examples:

- If Channel = 3.4, the **Channel** key displays **>3**
- If Channel = 3.5, the **Channel** key displays **<4**
- If Channel < 0 , the **Channel** key displays **<0**
- If Channel $> 78(22)$, the **Channel** key displays **>78(22)**

The **Center Frequency** display also depends on "Geography" on page 775:

Geography	Channel Number	Center Frequency Display
FRANce	0...22	If < 2.454 GHz, key displays < 0 If > 2.476 GHz, key displays > 22
OTHers	0...78	If < 2.402 GHz, key displays < 0 If > 2.480 GHz, key displays > 78

Preset 0

State Saved Yes

Range	Radio Standard	Value
	Basic or EDR	0 – 78
	Low Energy	0 – 39

Min/Max	Radio Standard	Value
	Basic or EDR	0 / 78
	Low Energy	0 / 39

Center Frequency

Sets the frequency that corresponds to the horizontal center of the graticule (when frequency Scale Type is set to linear). While adjusting **Center Frequency**, **Span** is held constant, which means that both **Start Freq** and **Stop Freq** will change.

In measurements that also have **Start Freq** and **Stop Freq** controls, pressing **Center Frequency** sets the frequency entry mode to Center/Span. In Center/Span mode, the center frequency and span values are displayed below the graticule, and the default active function in the **Frequency** menu is **Center Frequency**. In the Start/Stop annotation mode, **Start Freq** and **Stop Freq** are displayed below the graticule instead of **Center Frequency** and **Span**.

Pressing **Center Frequency** also sets the frequency entry mode to Center/Span. In Center/Span mode, the center frequency and span values are displayed below the graticule, and the default active function in the **Frequency** menu is **Center Frequency**.

When **Display Scale Type** is set to **LOG**, pressing **Center Frequency** sets the frequency that corresponds to the arithmetic mean of the start frequency and stop frequency, which is not at the horizontal center of the graticule.

The center frequency setting is the same for all measurements within a Mode, that is, it is Meas Global. Some Modes are also able to share a Mode Global center frequency value. If this is the case, the Mode has a **Global** tab in its **Meas Setup** menu.

Center Frequency sets (and queries) the center frequency for the currently selected input. If your instrument has multiple inputs, and you select another input, **Center Frequency** changes to the value for that input. SCPI commands are available to directly set **Center Frequency** for a specific input (see "**RF Center Frequency**" on page 771 and "**Ext Mix Center Freq**" on page 772).

Center Frequency is remembered as you go from input to input. Thus you can set a **Center Frequency** of 10 GHz with the RF Input selected, change to BBIQ and set a **Center Frequency** of 20 MHz, then switch to External Mixing and set a **Center Frequency** of 60 GHz. When you return to the RF Input, **Center Frequency** reverts to 10 GHz; back to BBIQ and it is 20 MHz; back to External Mixing and it is 60 GHz.

Remote Command	<code>[:SENSe] :FREQuency :CENTer <freq></code> <code>[:SENSe] :FREQuency :CENTer?</code>
Example	Set Center Frequency to 50 MHz: <code>:FREQ:CENt 50 MHz</code> Increment Center Frequency by the value of CF Step : <code>:FREQ:CENt UP</code> Return the current value of Center Frequency : <code>:FREQ:CENt?</code>
Notes	Sets the RF, External Mixing or I/Q Center Frequency depending on the selected input: <ul style="list-style-type: none"> - For RF input it is equivalent to <code>:FREQ:RF:CENt</code> - For I/Q input it is equivalent to <code>:FREQ:IQ:CENt</code> - For External Mixer it is equivalent to <code>:FREQ:EMIX:CENt</code> Preset and Max values depend on Hardware Options If no terminator (for example, MHz) is sent, the terminator Hz is used. If a terminator with unit other than frequency is used, an invalid suffix error message is generated
Dependencies	Center Frequency can be limited by Start Freq or Stop Freq limits, if Span is so large that start or stop reach their limits

3 Bluetooth Mode

3.7 Occupied BW Measurement

Couplings	<p>When operating in “swept span”, any value of Center Frequency or Span that is within the frequency range of the instrument is allowed, <i>if</i> the value is being set through the front panel numeric key pad or the SCPI command. The other parameter is forced to a different value if needed, to keep Start and Stop Frequencies within the instrument’s frequency range</p> <p>Coupling between center frequency and span: numeric (keypad) entries are treated differently than changing the value using the step keys (Up/Down Arrows) or the knob. Similarly, for remote operation, sending a numeric frequency value is treated differently than the UP DOWN keywords:</p> <ul style="list-style-type: none"> – Numeric entries (keypad or remote): Any value of Center Frequency or Span (within the frequency range of the instrument) is allowed. The other parameter is changed, as necessary, to keep the Start Freq and Stop Freq within the instrument frequency range – Knob or Step keys (up/down arrows) or UP DOWN keywords: The value of the parameter being changed (Center Frequency or Span) is limited so the other parameter is not forced to a new value. Thus, if only the step keys and knob are used, you can return to the initial Center Frequency and Span by changing only the current parameter <p>Note that, since out-of-range Start Freq and Stop Freq are never allowed, markers and trace math work correctly without requiring any special handling for out-of-range conditions</p>
Preset	<p>Depends on instrument maximum frequency, mode, measurement, and selected input</p> <p>See "Center Frequency Presets" on page 769 and "Ext Mix Center Freq" on page 772</p>
State Saved	Saved in instrument state
Min/Max	<p>Depends on instrument maximum frequency, mode, measurement, and selected input</p> <p>See "Center Frequency Presets" on page 769 and "Ext Mix Center Freq" on page 772</p>
Annotation	Center <value> appears in the lower left corner of the display
Status Bits/OPC dependencies	Non-overlapped

Center Frequency Presets

The following table provides the Center Frequency Presets for the Spectrum Analyzer mode, and the Max Freq, for the various frequency options:

Freq Option	CF after Mode Preset	Stop Freq after Mode Preset	Max Freq (can't tune above)
503 (all but CXA)	1.805 GHz	3.6 GHz	3.7 GHz
503 (CXA)	1.505 GHz	3.0 GHz	3.08 GHz
507 (all but CXA)	3.505 GHz	7.0 GHz	7.1 GHz
507 (CXA)	3.755 GHz	7.5 GHz	7.58 GHz
508 (all but MXE)	1.805 GHz	3.6 GHz	8.5 GHz
508 (MXE)	4.205 GHz	8.4 GHz	8.5 GHz
513	6.805 GHz	13.6 GHz	13.8 GHz
526 (except CXA and MXE)	13.255 GHz	26.5 GHz	27.0 GHz*

Freq Option	CF after Mode Preset	Stop Freq after Mode Preset	Max Freq (can't tune above)
526 (CXA)	13.255 GHz	26.5 GHz	26.55 GHz
526 (MXE)	1.805 GHz	3.6 GHz	27.0 GHz
532	16.005 GHz	32.0 GHz	32.5 GHz
540	20.005 GHz	40.0 GHz	40.5 GHz
543	21.505 GHz	43.0 GHz	43.0 GHz
544	22.005 GHz	44.0 GHz	45.0 GHz
550	25.005 GHz	50.0 GHz	52 GHz
F03 (CXA-m)	1.505 GHz	3.0 GHz	3.08 GHz
F07 (CXA-m)	3.755 GHz	7.5 GHz	7.575 GHz
F13 (CXA-m)	6.805 GHz	13.6 GHz	13.8 GHz
F26 (CXA-m)	13.255 GHz	26.5 GHz	26.55 GHz
504 (M9421A, M8920A)	2.145 GHz	3.88GHz	3.88 GHz
506 (M9421A, M8920A)	3.245 GHz	6.08GHz	6.08 GHz
F06 (M9410A/11A)	1.0 GHz	6.08 GHz	6.08 GHz
F06 (M9415A)	1 GHz	1.08 GHz	6.6 GHz
F08 (M9415A)	1 GHz	1.08 GHz	8.6 GHz
F12 (M9415A)	1 GHz	1.08 GHz	12.9 GHz

*For option 526, the Max CF in RTSA is 26.999999995 GHz.

N9041B Center Freq Presets

Input	CF after Mode Preset	Stop Freq after Mode Preset	Max Freq (can't tune above)
Input 1, all models	25.005 GHz	50.0 GHz	52 GHz
Input 2, opt 585	42.505 GHz	85.0 GHz	86 GHz
Input 2, opt 590	45.005 GHz	90.0 GHz	92 GHz
Input 2, opt 5CX	55.005 GHz	110.0 GHz	110 GHz

Input 2, CXA and MXE

Model	CF after Mode Preset	Stop Freq after Mode Preset	Max Freq (can't tune above)
CXA opt C75	0.7505 GHz	1.5 GHz	1.58 GHz
MXE	505 MHz	1 GHz	1.000025 GHz

Tracking Generator Frequency Limits (CXA only)

3 Bluetooth Mode
 3.7 Occupied BW Measurement

Tracking Generator Option	Min Freq (clips to this freq when turn TG on and can't tune below while TG on)	If above this Freq, Stop Freq clipped to this Freq when TG turned on	Max Freq (can't tune above) while TG on
T03	9 kHz	3.0 GHz	3.08 GHz
T06	9 kHz	6.0 GHz	6.05 GHz

Tracking Generator Frequency Limits(CXA-m only)

Tracking Generator Option	Min Freq (clips to this freq when turn TG on and can't tune below while TG on)	If above this Freq, Stop Freq clipped to this Freq when TG turned on	Max Freq (can't tune above) while TG on
T03	2 MHz	3.08 GHz	3.08 GHz
T07	2 MHz	7.575 GHz	7.575 GHz
T13	2 MHz	13.8 GHz	13.8 GHz
T26	2 MHz	26.55 GHz	26.55 GHz

RF Center Frequency

Specifies the RF Center Frequency. Sets the center frequency to use when the RF input is selected, even if the RF input is not the input that is selected at the time the command is sent. Note that **Center Frequency** in the **Frequency** menu on the front panel always applies to the currently selected input.

Remote Command	<code>[:SENSE] :FREQUENCY:RF:CENTER <freq></code> <code>[:SENSE] :FREQUENCY:RF:CENTER?</code>
Example	<code>:FREQ:RF:CENT 30 MHz</code> <code>:FREQ:RF:CENT?</code>
Notes	This command is the same in all Modes, but the parameter is Measurement Global. So, the value is independent in each Mode and common across all the measurements in the Mode
Dependencies	If the electronic/soft attenuator is enabled, any attempt to set Center Frequency such that the Stop Frequency would be >3.6 GHz fails and results in an advisory message. If the equivalent SCPI command is sent, this same message is generated as part of a "-221, Settings conflict" warning If Source Mode is set to Tracking, and the Max or Min Center Frequency is therefore limited by the limits of the source, a warning message is generated, "Data out of range; clipped to source max/min" if these limits are exceeded. Note that for an external source, these limits can be affected by the settings of Source Numerator, Source Denominator, and Power Sweep
Preset	See " Center Frequency Presets " on page 769
State Saved	Saved in instrument state

Min	Instrument Types	Value
	VXT model M9421A	55.000005 MHz
	VXT models M9410A/11A	6.505 kHz with Option LFE 330.000005 MHz without Option LFE 330.000005 MHz
	VXT model M9415A	330.000005 MHz
	M8920A	80.005 kHz
	All other instruments	-79.999995 MHz
	<i>Unless Source Mode is set to Tracking, in which case it is limited by the minimum frequency of the Source</i>	

Max See table above. Basically, instrument maximum frequency – 5 Hz. Note that, if the Source Mode is set to Tracking, the effective instrument maximum frequency may be limited by the source maximum frequency
If the knob or step keys are being used, also depends on the value of the other three interdependent parameters: **Span**, **Start Frequency** and **Stop Frequency**

Ext Mix Center Freq

Specifies the External Mixer Center Frequency. Sets the center frequency to use when the External Mixer is selected, even if the External Mixer input is not the input which is selected at the time the command is sent. Note that the **Center Frequency** function in the **Frequency** menu on the front panel always applies to the currently selected input.

Remote Command	<code>[:SENSe] :FREQuency:EMIXer:CENTer <freq></code> <code>[:SENSe] :FREQuency:EMIXer:CENTer?</code>
Example	<code>:FREQ:EMIX:CENT 60 GHz</code> <code>:FREQ:EMIX:CENT?</code>
Notes	This command is the same in all Modes, but the parameter is Measurement Global. So, the value is independent in each Mode and common across all the measurements in the Mode
Couplings	When you return to External Mixing after using one of the other inputs (for example, RF), you return to the settings that you had when you left External Mixing. So, you return to the band you were in with the Center Frequency that you had. However, Span is <i>not</i> an input-dependent parameter, so it does not change. Therefore, the instrument comes back with the Span from the previous input, limited as necessary by the current mixer setup
Preset	When Mode Preset is performed while in External Mixing, the start frequency of the current Mode is set to the nominal Min frequency of the lowest harmonic range in the Harmonic Table for the current mixer setup. Similarly, the stop frequency of the current Mode is set to the nominal Max frequency of the

highest harmonic range in the Harmonic Table. **Center Frequency** thus presets to the point arithmetically equidistant from these two frequencies

Note that, if the current measurement has a limited **Span** available to it, and cannot achieve the span shown in the table (**Span = Stop Freq – Start Freq**), the instrument uses the maximum span that the measurement allows, and still sets **Center Frequency** to the midpoint of the **Start Freq** and **Stop Freq** values in the Harmonic Table

When **Restore Input/Output Defaults** is performed, the mixer presets to the 11970A, whose Start and Stop frequencies are 26.5 and 40 GHz respectively. The center of these two frequencies is 33.25 GHz. Therefore, after **Restore Input/Output Defaults**, if you switch to External Mixing and do a **Mode Preset** while in the Spectrum Analyzer Mode, the resulting **Center Frequency** is 33.25 GHz

State Saved	Yes
Min	The minimum frequency in the currently selected mixer band + 5 Hz
Max	The maximum frequency in the currently selected mixer band - 5 Hz If the knob or step keys are being used, also depends on the value of the other three interdependent parameters Span , Start Freq and Stop Freq

Span

Set the frequency of the occupied bandwidth span for the current measurement.

Remote Command	<code>[:SENSe] :OBWidth:FREQuency:SPAN <freq></code> <code>[:SENSe] :OBWidth:FREQuency:SPAN?</code> <code>[:SENSe] :OBWidth:FREQuency:SPAN:AUTO ON OFF 0 1</code> <code>[:SENSe] :OBWidth:FREQuency:SPAN:AUTO?</code>												
Example	<code>:OBW:FREQ:SPAN 2.4 MHz</code> <code>:OBW:FREQ:SPAN?</code> <code>:OBW:FREQ:SPAN:AUTO 0</code> <code>:OBW:FREQ:SPAN:AUTO?</code>												
Notes	Span Auto Detector (<code>[:SENSe] :OBWidth:FREQuency:SPAN:AUTO</code>) is only available in the MSR, LTEAFDD/LTEATDD and 5GNR modes												
Dependencies	The Auto Detect functionality is only available in the MSR, LTEAFDD/LTEATDD and 5GNR modes												
Preset	<table border="1"> <thead> <tr> <th>Mode</th> <th>Value</th> </tr> </thead> <tbody> <tr> <td>SA</td> <td>3 MHz</td> </tr> <tr> <td>WCDMA</td> <td>10 MHz</td> </tr> <tr> <td>LTEAFDD, LTEATDD</td> <td>10 MHz</td> </tr> <tr> <td>BT</td> <td>2 MHz</td> </tr> <tr> <td>5GNR</td> <td>Automatically calculated</td> </tr> </tbody> </table>	Mode	Value	SA	3 MHz	WCDMA	10 MHz	LTEAFDD, LTEATDD	10 MHz	BT	2 MHz	5GNR	Automatically calculated
Mode	Value												
SA	3 MHz												
WCDMA	10 MHz												
LTEAFDD, LTEATDD	10 MHz												
BT	2 MHz												
5GNR	Automatically calculated												

Mode	Value														
RTS	27 kHz														
MSR	10 MHz														
WLAN	<table border="1"> <thead> <tr> <th>Radio Std</th> <th>Value</th> </tr> </thead> <tbody> <tr> <td>802.11b</td> <td>30MHz</td> </tr> <tr> <td>802.11a/g/n/ac/ax/be (20MHz)</td> <td>25 MHz</td> </tr> <tr> <td>802.11n/ac/ax/be (40MHz)</td> <td>50 MHz</td> </tr> <tr> <td>802.11n/ac/ax/be (80MHz)</td> <td>100 MHz</td> </tr> <tr> <td>802.11ac/ax/be (160MHz)</td> <td>200 MHz</td> </tr> <tr> <td>802.11be (320MHz)</td> <td>400 MHz</td> </tr> </tbody> </table>	Radio Std	Value	802.11b	30MHz	802.11a/g/n/ac/ax/be (20MHz)	25 MHz	802.11n/ac/ax/be (40MHz)	50 MHz	802.11n/ac/ax/be (80MHz)	100 MHz	802.11ac/ax/be (160MHz)	200 MHz	802.11be (320MHz)	400 MHz
Radio Std	Value														
802.11b	30MHz														
802.11a/g/n/ac/ax/be (20MHz)	25 MHz														
802.11n/ac/ax/be (40MHz)	50 MHz														
802.11n/ac/ax/be (80MHz)	100 MHz														
802.11ac/ax/be (160MHz)	200 MHz														
802.11be (320MHz)	400 MHz														

State Saved	Yes
Min	100 Hz
Max	Hardware Maximum Span
Backwards Compatibility SCPI	<code>[:SENSe] : EBWidth : FREQUENCY : SPAN</code>

LMH Channel

Enables quick selection from a subset of the available channel numbers for the Low (channel 0), Middle (channel 39), or High (channel 78) channels.

Remote Command	<code>[:SENSe] : CHANnel : LMH LOW MID HIGH</code> <code>[:SENSe] : CHANnel : LMH?</code>						
Example	<code>:FREQ:LMH MID</code> <code>:FREQ:LMH?</code>						
Couplings	<table border="1"> <thead> <tr> <th>Radio Standard</th> <th>Key Label</th> </tr> </thead> <tbody> <tr> <td>Basic or EDR</td> <td>Low(0), Mid(39), High(78)</td> </tr> <tr> <td>Low Energy</td> <td>Low(0), Mid(20), High(39)</td> </tr> </tbody> </table> <p>If "Geography" on page 775 is FRANce, this key is grayed-out</p>	Radio Standard	Key Label	Basic or EDR	Low(0), Mid(39), High(78)	Low Energy	Low(0), Mid(20), High(39)
Radio Standard	Key Label						
Basic or EDR	Low(0), Mid(39), High(78)						
Low Energy	Low(0), Mid(20), High(39)						
Preset	LOW						
State Saved	Yes						
Range	Low Mid High						
Backwards Compatibility SCPI	<code>[:SENSe] : FREQUENCY : LMH LOW MID HIGH</code> <code>[:SENSe] : FREQUENCY : LMH?</code>						

Geography

Selects the desired country. The selection defines the frequency range and the available channel numbers for the transmit channel.

Remote Command	[:SENSe]:FREQuency:GEOGraphy FRANce OTHers [:SENSe]:FREQuency:GEOGraphy?		
Example	:FREQ:GEOG FRAN :FREQ:GEOG?		
Couplings	Option	Center Frequency	Channel Number
	FRANce	2454 MHz + (0...22) MHz	0...22
	OTHers	2402 MHz + (0...78) MHz	0...78
Preset	OTHers		
State Saved	Yes		
Range	FRANce OTHers		

CF Step

Changes the step size for the center frequency and start and stop frequency functions. Once a step size has been selected, and the center frequency function is active, the step keys (and the **UP | DOWN** parameters for **Center Frequency** from remote commands) change the center frequency by the step-size value. The step size function is useful for finding harmonics and sidebands beyond the current frequency span of the instrument.

Note that Start Frequency and Stop Frequency also step by the **CF Step** value.

Remote Command	[:SENSe]:FREQuency:CENTer:STEP[:INCRement] <freq> [:SENSe]:FREQuency:CENTer:STEP[:INCRement]? [:SENSe]:FREQuency:CENTer:STEP:AUTO OFF ON 0 1 [:SENSe]:FREQuency:CENTer:STEP:AUTO?		
Example	Increase the current center frequency value by 500 MHz: :FREQ:CENT:STEP 500 MHz :FREQ:CENT UP :FREQ:CENT:STEP:AUTO ON :FREQ:CENT:STEP:AUTO?		
Notes	Preset and Max values depend on Hardware Options		
Dependencies	Span, RBW, Center frequency		

	If the electronic/soft attenuator is enabled, any attempt to change the value of the center frequency >3.6 GHz by pressing the Up Arrow key, fails and results in an advisory message. If the equivalent SCPI command is sent, this same message is generated as part of a “-221, Settings conflict” warning
Couplings	When auto-coupled in a non-zero span, the center frequency step size is set to 10% of the span When auto-coupled in zero span, the center frequency step size is set to the equivalent -3 dB RBW value
Preset	Auto ON
State Saved	Saved in instrument state
Min	- /+(the maximum frequency of the instrument). That is, 27 GHz max freq instrument has a CF step range of +/- 27 GHz. Note that this is the maximum frequency given the current settings of the instrument, so in External Mixing, for example, it is the maximum frequency of the current mixer band
Status Bits/OPC dependencies	non-overlapped

Full Span (Remote Command Only)

Changes the Occupied Bandwidth Span to show the full frequency range of the instrument. It maximizes the span within a range but does not change **Center Frequency**. When using external mixing, it changes the displayed frequency span to the frequency range specified for the selected external mixing band.

Remote Command	<code>[:SENSe] :OBWidth :FREQuency :SPAN :FULL</code>
Example	<code>:OBW :FREQ :SPAN :FULL</code>
Couplings	Selecting full span changes the measurement span value

3.7.7 Marker

Accesses a menu that enables you to select, set up and control the markers for the current measurement. If there are no active markers, **Marker** selects marker 1, sets it to **Normal** mode (see "**Marker Mode**" on page 778), and places it at the center of the display. If the selected marker is **Off**, it is set to **Normal** and placed at the center of the screen, on the trace determined by the Marker Trace rules.

3.7.7.1 Select Marker

Specifies the selected marker. The term “selected marker” is used throughout this document to specify which marker will be affected when you change marker settings, perform a **Peak Search**, etc.

This control appears above the menu panel, indicating that it applies to all controls in the **Marker** menu panels. **Select Marker** is blanked if you select a tab whose controls do *not* depend on the selected marker (for example, **Counter**).

For any menu that includes **Select Marker**, the first control is always **Marker Frequency | Time**.

Notes	The selected marker is remembered even when not in the Marker menu and is used if a search is done, or a Band Function is turned on, or for Signal Track or Continuous Peak
Preset	Marker 1
State Saved	The number of the selected marker is saved in instrument state
Annunciation	Appears in the marker results block label for Normal and Delta markers

3.7.7.2 Settings

The controls on this tab include the Marker active function and a radio button selection for the marker control mode (**Normal/POSiTion**, **Delta** or **Off**; see "**Marker Mode**" on page 778) for the selected marker, as well as additional functions that help you use markers.

Marker Frequency

Sets the marker X-Axis value in the current marker X-Axis Scale unit. It has no effect if the control mode (see "**Marker Mode**" on page 778) is **Off**, but is the SCPI equivalent of entering an X value if the control mode is **Normal** or **Delta**.

Remote Command	<code>:CALCulate:OBWidth:MARKer[1] 2 ... 12:X <freq></code> <code>:CALCulate:OBWidth:MARKer[1] 2 ... 12:X?</code>
Example	<code>:CALC:OBW:MARK3:X 0</code> <code>:CALC:OBW:MARK3:X?</code>
Notes	If no suffix is sent, uses the fundamental units for the current marker X Axis Scale. If a suffix is sent that does not match the current marker X Axis Scale unit, an error "Invalid suffix" is generated The query returns the marker's absolute X Axis value if the control mode is Normal , or the offset from the marker's reference marker if the control mode is Delta . The query is returned in the fundamental units for the current marker X Axis scale: Hz for Frequency and Inverse Time , seconds for Period and Time
Preset	After a preset, all markers are turned OFF , so Marker X Axis Value query returns Not a Number (NAN)
State Saved	Saved in instrument state
Min	-9.9E+37
Max	9.9E+37
Annotation	Mkr # <X value> and <Marker value> upper right on graph

Marker X Axis Position (Remote Command Only)

Sets the marker X-Axis Scale position in trace points. This setting has no effect if the control mode is **Off**, but is the SCPI equivalent of entering a value if the control mode is **Normal** or **Delta** – except in trace points rather than X-Axis Scale units. The entered value is immediately translated into the current X-Axis Scale units for setting the value of the marker.

Remote Command	<code>:CALCulate:OBWidth:MARKer[1] 2 ... 12:X:POSition <real></code> <code>:CALCulate:OBWidth:MARKer[1] 2 ... 12:X:POSition?</code>
Example	<code>:CALC:OBW:MARK10:X:POS 0</code> <code>:CALC:OBW:MARK10:X:POS?</code>
Notes	The query returns the marker's absolute X-Axis value in trace points if the control mode is Normal , or the offset from the marker's reference marker in trace points if the control mode is Delta . The value is returned as a real number, not an integer, corresponding to the translation from X-Axis Scale units to trace points. When a marker is turned on, it is placed center of the screen on the trace. Therefore, the default value depends on instrument condition If the marker is Off , the query response is Not A Number
Preset	After a preset, all markers are turned Off , so the query returns Not A Number (NAN)
State Saved	Saved in instrument state
Min	-9.9E+37
Max	9.9E+37

Marker Y Axis Value (Remote Query only)

Returns the marker Y-Axis value in the current marker Y-Axis unit.

Remote Command	<code>:CALCulate:OBWidth:MARKer[1] 2 ... 12:Y?</code>
Example	<code>:CALC:OBW:MARK11:Y?</code>
Notes	Returns the marker Y-Axis result, if the control mode is Normal or Delta If the marker is Off , the response is Not A Number
Preset	Result dependent on Markers setup and signal source
State Saved	No
Backwards Compatibility SCPI	<code>:CALCulate:OBWidth:MARKer[1] 2 ... 12:FUNCTION:RESult?</code>

Marker Mode

Sets the marker control mode to **Normal** (**POSition**), **Delta**, or **Off**. All interactions and dependencies detailed under the control description are enforced when the remote command is sent. If the selected marker is **OFF**, pressing **Marker** sets it to

Normal and places it at the center of the screen on the trace determined by the **Marker Trace** rules. At the same time, **Marker X Axis Value** appears on the Active Function area.

The default active function is the active function for the currently selected marker control mode. If the current control mode is **Off**, there is no active function, and the active function is turned off.

Remote Command	<code>:CALCulate:OBWidth:MARKer[1] 2 ... 12:MODE POSition DELTa OFF</code> <code>:CALCulate:OBWidth:MARKer[1] 2 ... 12:MODE?</code>
Example	<code>:CALC:OBW:MARK:MODE POS</code> <code>:CALC:OBW:MARK:MODE?</code>
Preset	OFF
State Saved	Saved in instrument state
Range	POSition DELTA OFF
Annotation	Mkr # <X value> and <Marker value> upper right on graph When Marker Trace is Polar in WCDMA mode: Mkr # <Chip Value (RHO & QPSKEVM)/Symbol Value (CDP)>, <X value> and <Y value> upper right on graph

Backwards Compatibility SCPI Command

Sets or queries the state of a marker. Setting a marker that is **OFF** to **ON** (1), puts it in **Normal** mode, and places it at the center of the screen.

Example	<code>:CALC:OBW:MARK3:STAT ON</code> <code>:CALC:OBW:MARK3:STAT?</code>
Preset	OFF
State Saved	Saved in instrument state
Range	OFF ON
Backwards Compatibility SCPI	<code>:CALCulate:OBWidth:MARKer[1] 2 ... 12:STATE OFF ON 0 1</code> <code>:CALCulate:OBWidth:MARKer[1] 2 ... 12:STATE?</code>

Delta Marker (Reset Delta)

Pressing this button has the same effect as pressing **Delta** in **Marker Mode**. The selected marker becomes a **Delta** marker. If the selected marker is already a **Delta** marker, the reference marker is moved to the current position of the selected marker, thus resetting the delta to zero.

Marker Settings Diagram

Lets you configure the **Marker** system using a visual utility.

All Markers Off

Turns off all markers.

Remote Command	:CALCulate:OBWidth:MARKer:AOff
----------------	--------------------------------

Example	:CALC:OBW:MARK:AOff
---------	---------------------

3.7.7.3 Peak Search

The controls on this tab allow you to move the marker to selected peaks of the signal, giving you enormous analysis capabilities, particularly when combined with "[Marker Delta](#)" on page 781.

NOTE

Pressing the **Peak Search** hardkey automatically moves you to the **Peak Search** page of the **Marker** menu *and* performs a peak search.

Pressing the **Peak Search** tab once you are already *in* the **Marker** menu does *not* perform a peak search.

Marker Frequency

This is the fundamental control that you use to move a marker around on the trace. It is the same as "[Marker Frequency](#)" on page 777 on the **Settings** tab.

Peak Search

Moves the selected marker to the trace point which has the maximum y-axis value for that marker's trace.

NOTE

Pressing the **Peak Search** hardkey automatically moves you to the **Peak Search** page of the **Marker** menu *and* performs a peak search.

Remote Command	:CALCulate:OBWidth:MARKer[1] 2 ... 12:MAXimum
----------------	---

Example	:CALC:OBW:MARK2:MAX :SYST:ERR?
---------	-----------------------------------

	can be used to query the errors to determine if a peak is found. The message “No peak found” (-200) will be returned after an unsuccessful search
Notes	Sending this command selects the subopcoded marker In WCDMA Mode, this command does not work when the selected marker is located on the polar trace. In this case, the command is ignored

Marker Delta

Pressing this button has the same effect as pressing **Delta** in "**Marker Mode**" on page 778 on the **Settings** tab. The selected marker becomes a **Delta** marker. If the selected marker is already a **Delta** marker, the reference marker is moved to the current position of the selected marker, thus resetting the delta to zero.

The control is duplicated here to allow you to conveniently perform a peak search and change the marker’s control mode to **Delta** without having to access two separate menus.

3.7.7.4 Properties

The controls on this tab are used to set certain properties of the selected marker.

Marker Frequency

This is the fundamental control that you use to move a marker around on the trace. It is the same as "**Marker Frequency**" on page 777 on the **Settings** tab.

Relative To

Selects the marker to which the selected marker is relative (its reference marker).

Every marker has another marker to which it is relative. This marker is referred to as the “reference marker” for that marker. This attribute is set by the **Marker, Properties, Relative To** key. The marker must be a **Delta** marker to make this attribute relevant. If it is a **Delta** marker, the reference marker determines how the marker is controlled and how its value is displayed. A marker cannot be relative to itself.

Remote Command	<code>:CALCulate:OBWidth:MARKer[1] 2 ... 12:REference <integer></code> <code>:CALCulate:OBWidth:MARKer[1] 2 ... 12:REFERENCE?</code>
Example	<code>:CALC:OBW:MARK:REF 2</code> <code>:CALC:OBW:MARK:REF?</code>
Notes	Causes the marker specified with the subopcode to become selected

	<p>Range (for SCPI command): 1 to 12. If the range is exceeded, the value is clipped</p> <p>A marker cannot be relative to itself so that choice is not available, and if sent from SCPI generates error -221: "Settings conflict; marker cannot be relative to itself"</p> <p>The query returns a single value (the specified marker number's relative marker)</p>
Couplings	<p>The act of specifying the selected marker's reference marker makes the selected marker a Delta marker</p> <p>If the reference marker is Off, it is turned on in Normal mode at the Delta marker location</p>
Preset	<p>The preset default "Relative To" marker (reference marker) is the next higher numbered marker (current marker +1). For example, if marker 2 is selected, then it's default reference marker is marker 3. The exception is marker 12, which has a default reference of marker 1</p> <p>Set to the defaults by using Restore Mode Defaults. This is not reset by Marker Off, All Markers Off, or Preset</p>
State Saved	Saved in instrument state. Not affected by Marker Off and hence not affected by Preset or power cycle
Min	1
Max	12
Annunciation	Appears in the marker label of a Delta marker

Marker Trace

Selects the trace on which you want your marker placed. A marker is associated with one and only one trace. This trace is used to determine the placement, result, and X-Axis Scale of the marker. All markers have an associated trace; it is from that trace that they determine their attributes and behaviors, and it is to that trace that they go when they become **Normal** or **Delta** markers (see "[Marker Mode](#)" on page 778).

Specifying a **Marker Trace** manually or with this command associates the marker with the specified trace. If the marker is not **Off**, it moves from the trace it was on to the new trace. If the marker is **Off**, it stays off, but is now associated with the specified trace.

The query returns the number of the trace on which the marker is currently placed.

Remote Command	<pre>:CALCulate:OBWidth:MARKer[1] 2 ... 12:TRACe 1 2 3</pre> <pre>:CALCulate:OBWidth:MARKer[1] 2 ... 12:TRACe?</pre>
Example	<pre>:CALC:OBW:MARK2:TRAC 2</pre> <pre>:CALC:OBW:MARK2:TRAC?</pre>
Notes	<p>A marker may be placed on a blanked and/or inactive trace, even though the trace is not visible and/or updating</p> <p>An application may register a trace name to be displayed on the control instead of a trace number</p>
Couplings	<p>The state of Marker Trace is not affected by "Auto Couple" on page 787</p> <p>Sending the remote command causes the addressed marker to become selected</p>

Preset	1
State Saved	Saved in instrument state

Marker Settings Diagram

Lets you configure the **Marker** system using a visual utility. It is the same as "[Marker Settings Diagram](#)" on page 780 on the **Settings** tab.

3.7.8 Meas Setup

Contains functions for setting up the measurement parameters and contains functions for setting up parameters global to all measurements in the mode.

3.7.8.1 Settings

Contains frequently used **Meas Setup** functions to which you will want the fastest access.

Avg/Hold Num

Specifies the number of measurement averages used when calculating the measurement result. The average is displayed at the end of each sweep.

Initiates an averaging routine that averages the sweep points in several successive sweeps, resulting in trace smoothing.

After the specified number of average counts, "[Average Mode](#)" on page 784 (termination control) determines the average action.

Remote Command	<code>[:SENSe] :OBWidth :AVERage :COUNT <integer></code>
Example	<code>:OBW:AVER:COUN 1500</code> <code>:OBW:AVER:COUN?</code>
Preset	10
State Saved	Yes
Min/Max	1/10000
Annotation	The average count is displayed in the measurement bar on the front panel display. The annotation appears in the format n/N where n is the current average and N is the average count
Backwards Compatibility SCPI	<code>[:SENSe] :EBWidth :AVERage :COUNT</code>

Averaging On/Off

Turns averaging on or off.

NOTE

In this measurement, **Average Type** is always preset to the [Log-Pwr Avg \(Video\)](#) method. Other averaging methods are not available.

Remote Command	<code>[:SENSe]:OBwidth:AVERage[:STATe] ON OFF 1 0</code> <code>[:SENSe]:OBwidth:AVERage[:STATe]?</code>
Example	<code>:OBW:AVER ON</code> <code>:OBW:AVER?</code>
Couplings	Averaging state is coupled to " Max Hold (Remote Command Only) " on page 790. If Max Hold is changed from OFF to ON , Averaging state is automatically set to ON
Preset	ON
State Saved	Yes
Range	ON OFF
Backwards Compatibility SCPI	<code>[:SENSe]:EBwidth:AVERage[:STATe]</code>

Average Mode

Lets you set the averaging mode.

- EXPonential** Measurement averaging continues using the specified number of averages to compute each averaged value. The average is displayed at the end of each sweep
- REPeat** The measurement resets the average counter each time the specified number of averages is reached

Remote Command	<code>[:SENSe]:OBwidth:AVERage:TCONtrol EXPonential REPeat</code> <code>[:SENSe]:OBwidth:AVERage:TCONtrol?</code>
Example	<code>:OBW:AVER:TCON REP</code> <code>:OBW:AVER:TCON?</code>
Preset	EXP
State Saved	Yes
Range	EXPonential REPeat

% of OBW Power

Assigns the percentage of the total power that is measured within the Occupied Bandwidth for the current measurement. The resulting Occupied Bandwidth limits are displayed by markers placed on the frequencies of the specified percentage.

Remote Command	<code>[:SENSe]:OBwidth:PERCent <real></code> <code>[:SENSe]:OBwidth:PERCent?</code>
Example	<code>:OBW:PERC 75</code> <code>:OBW:PERC?</code>
Preset	99.00
State Saved	Yes
Min/Max	10/99.99

Power Ref

Lets you select Power Ref type:

Total Power	<code>TPOwer</code>	Total power in the current span is displayed
OBW Power	<code>OBWPower</code>	Occupied power is displayed

When **Power Ref** type is changed, the annotation in the lower window and Remote Command SCPI Results also change.

Remote Command	<code>[:SENSe]:OBwidth:PREference OBWPower</code> <code>[:SENSe]:OBwidth:PREference?</code>
Example	<code>:OBW:PREF TPOW</code> <code>:OBW:PREF?</code>
Preset	<code>TPOwer</code>
State Saved	Saved in instrument state
Range	<code>TPOwer OBWPower</code>

x dB

Sets the x dB value used for the "x dB bandwidth" result that measures the bandwidth between two points on the signal that is x dB down from the highest signal point within the OBW Span.

Remote Command	<code>[:SENSe]:OBwidth:XDB <rel_amp></code> <code>[:SENSe]:OBwidth:XDB?</code>
----------------	---

Example	<code>:OBW:XDB -20</code> <code>:OBW:XDB?</code>
Preset	BT Mode: -20.0 dB All other Modes: -26.0 dB
State Saved	Yes
Min/Max	-100.0 dB/-0.1 dB
Backwards Compatibility SCPI	<code>[:SENSe]:EBWidth:XDB</code>

Power Integration Method

Selects the power integration method:

Normal	<code>NORMal</code>	By integrating the linear power bucket values from the lower edge of the trace, and interpolating to find the point where the integrated power equals $(1 - [\text{Occ BW \% Pwr}]) / 2$ (0.5% if, for example, the 99% occupied bandwidth is to be found) of the total power, frequency f1 is obtained. This procedure is repeated from the upper trace edge to find frequency f2. This calculation uses linear interpolation to find the lower and upper carrier boundary point within the width of a sweep point (the span divided by the number of sweep points), f1 and f2
From Center	<code>ICENter</code>	Measures the power spectrum distribution within two times or more frequency range over the requirement for Occupied Bandwidth specification centering on the current carrier frequency

Remote Command	<code>[:SENSe]:OBWidth:INTEgration[:METHod] NORMal ICENter</code> <code>[:SENSe]:OBWidth:INTEgration[:METHod]?</code>
Example	<code>:OBW:INT NORM</code> <code>:OBW:INT?</code>
Preset	For 5G NR Mode, Uplink: <code>ICENter</code> All other Modes: <code>NORMal</code>
State Saved	Yes
Range	<code>NORMal ICENter</code>

Spur Avoidance

Because VXT models M9410A/11A/15A/16A and M9410E/11E/15E/16E are direct-conversion (zero-IF) receivers, feedthrough leakage from the local oscillator appears

as a spurious signal (spur) at the center frequency. The **Spur Avoidance** function is provided to eliminate this spur, at the expense of some measurement speed.

When **Spur Avoidance** is enabled (the default), the instrument uses a software algorithm to remove this spur from the displayed measurement data, but the algorithm only operates under certain conditions. Specifically, it only operates in the multiple capture case.

You can disable this function to speed up your measurement by setting **Spur Avoidance** to “Disabled.”

Note that when **Spur Avoidance** is not in effect, either because you have disabled it or because you are not in multiple capture, the following warning message will appear in the status bar:

Settings Alert;Spur Avoidance Off

This is to alert you that measurement accuracy might be impacted by the fact that **Spur Avoidance** is not in effect.

The spur avoidance function is not available for:

- M9410A/11A with EP6 option at frequency above 6 GHz
- M9415A/16A at frequency below 380 MHz and above 12.3 GHz
- M9410E/11E/15E/16E at frequency below 380 MHz and above 25.9 GHz

Remote Command	<code>[:SENSe]:OBwidth:SAVoid[:STATe] OFF ON 0 1</code> <code>[:SENSe]:OBwidth:SAVoid[:STATe]?</code>
Example	<code>:OBW:SAV ON</code> <code>:OBW:SAV?</code>
Dependencies	Only appears in VXT models M9410A/11A/15A/16A and M9410E/11E/15E/16E
Preset	<code>OFF</code>
State Saved	Saved in instrument state
Range	<code>OFF ON</code>

Meas Setup Summary Table

Lets you view and access many of the parameters in the **Meas Setup** menus on one screen.

Auto Couple

Immediately puts all **Auto/Man** functions into **Auto**. **Auto Couple** is confined to the current measurement only. It does not affect other measurements in the Mode.

In the **Auto** state, **Auto/Man** functions are said to be “coupled”, meaning their values change as you make changes to other values in the measurement. This helps ensure accurate measurements and optimum dynamic range. **Auto Couple** is an immediate action function, and when it is executed, all the **Auto/Man** controls for the current measurement are set to **Auto**, and all measurement settings coupled to the **Auto/Man** parameters are automatically set to their optimal values.

For further details of measurement-specific settings (if any), see "[Measurement-Specific Details](#)" on page 789 below.

Remote Command	:COUPle ALL
Example	:COUP ALL
Backwards Compatibility SCPI	:COUPLE ALL NONE
Backwards Compatibility Notes	:COUP:NONE puts all Auto/Man parameters in manual mode, decoupling all the coupled instrument parameters. It is retained for backwards compatibility and is <i>not</i> recommended for making measurements or new designs

All **Auto/Man** parameter couplings in the measurement are set to **Auto**. This includes couplings that may be unavailable or grayed-out due to the current state. For example, in the Swept SA measurement, there is no **Auto/Man** coupling for **RBW** while in Zero Span. Nonetheless, if **Auto Couple** were executed while in Zero Span, it would set **RBW** to Auto "behind the scenes" so that, on exit from Zero Span, it would be in **Auto**.

Any **Auto/Man** selection specific (local) to the other measurements in the current Mode are not affected by **Auto Couple**. Any functions that are *not* coupled with other instrument parameters, such as ranging or leveling variables, such as **AutoRange** or **AutoScale**, are not affected.

Executing **Auto Couple** generates the informational message, "All Auto/Man functions have been set to Auto".

Each parameter, upon being set to **Auto**, selects and sets the appropriate auto-coupled value based on that parameter's coupling rules. The Dependency Resolver orchestrates the couplings for parameters that depend on one or more other parameters. The coupling and dependency rules for each parameter are defined in the section describing that parameter.

Executing **Auto Couple** *does not* affect markers, marker functions, trace or display attributes, or any other instrument setting other than those specifically mentioned above.

Measurement-Specific Details

TOI (SA Mode only)

Parameters affected by **Auto Couple** are:

- Center Frequency Step
- Resolution Bandwidth
- Span/RBW Ratio
- Sweep Time
- Video BANDwidth VBW/RBW ratio
- Upper and Lower Tone (set to Sense)
- Zero span measurement Resolution Bandwidth
- Zero span measurement Dwell Time

Harmonics (SA Mode only)

Parameters affected by **Auto Couple** are:

- Resolution Bandwidth
- Fundamental Frequency
- Dwell Time
- Range Table Resolution Bandwidths
- Range Table Dwell Times

Meas Preset

Restores all measurement parameters to their default values.

Remote Command **:CONFigure:OBwidth**

Example **:CONF:OBW**

Max Hold (Remote Command Only)

When **ON**, **Max Hold** displays and holds the maximum responses of the current measurement. Turn **Max Hold** **OFF** to disable the maximum hold feature.

Remote Command	<code>[:SENSe]:OBwidth:MAXHold ON OFF 1 0</code> <code>[:SENSe]:OBwidth:MAXHold?</code>
Example	<code>:OBW:MAXH ON</code> <code>:OBW:MAXH?</code>
Couplings	Max Hold is coupled to " Averaging On/Off " on page 784. Max Hold is activated only if Average state is ON . If Max Hold is changed to ON when Average state is OFF , Average state is automatically set to ON
Preset	OFF
State Saved	Yes
Range	OFF ON
Backwards Compatibility SCPI	<code>[:SENSe]:EBwidth:MAXHold</code>

3.7.8.2 Limits

Lets you set measurement limits and be alerted when they have been exceeded.

Limit

Enables you to turn on or off limit checking at the specified frequency. For results that fail the limit test, a red FAIL appears in the Meas Bar.

Remote Command	<code>:CALCulate:OBwidth:LIMit:FBLimit <freq></code> <code>:CALCulate:OBwidth:LIMit:FBLimit?</code> <code>:CALCulate:OBwidth:LIMit[:TEST] ON OFF 1 0</code> <code>:CALCulate:OBwidth:LIMit[:TEST]?</code>				
Example	<code>:CALC:OBW:LIM:FBL 50 kHz</code> <code>:CALC:OBW:LIM:FBL?</code> <code>:CALC:OBW:LIM OFF</code> <code>:CALC:OBW:LIM?</code>				
Dependencies	Appears in all Modes except MSR, LTE-A and 5G NR				
Preset	<table border="1"> <thead> <tr> <th>Mode</th> <th>Value</th> </tr> </thead> <tbody> <tr> <td>SA</td> <td>5 MHz</td> </tr> </tbody> </table>	Mode	Value	SA	5 MHz
Mode	Value				
SA	5 MHz				

3 Bluetooth Mode
3.7 Occupied BW Measurement

Mode	Value																
WCDMA																	
MSR																	
WLAN	<table border="1"> <thead> <tr> <th>Radio Std</th> <th>Value</th> </tr> </thead> <tbody> <tr> <td>802.11a/g(OFDM/DSSS-OFDM)</td> <td>20 MHz</td> </tr> <tr> <td>802.11b</td> <td>25 MHz</td> </tr> <tr> <td>802.11n/ac/ax/be (20MHz)</td> <td>20 MHz</td> </tr> <tr> <td>802.11n/ac/ax/be (40MHz)</td> <td>40 MHz</td> </tr> <tr> <td>802.11n/ac/ax/be (80MHz)</td> <td>80 MHz</td> </tr> <tr> <td>802.11ac/ax/be (160MHz)</td> <td>160 MHz</td> </tr> <tr> <td>802.11be (320MHz)</td> <td>320 MHz</td> </tr> </tbody> </table>	Radio Std	Value	802.11a/g(OFDM/DSSS-OFDM)	20 MHz	802.11b	25 MHz	802.11n/ac/ax/be (20MHz)	20 MHz	802.11n/ac/ax/be (40MHz)	40 MHz	802.11n/ac/ax/be (80MHz)	80 MHz	802.11ac/ax/be (160MHz)	160 MHz	802.11be (320MHz)	320 MHz
Radio Std	Value																
802.11a/g(OFDM/DSSS-OFDM)	20 MHz																
802.11b	25 MHz																
802.11n/ac/ax/be (20MHz)	20 MHz																
802.11n/ac/ax/be (40MHz)	40 MHz																
802.11n/ac/ax/be (80MHz)	80 MHz																
802.11ac/ax/be (160MHz)	160 MHz																
802.11be (320MHz)	320 MHz																
BT	1 MHz																
RTS	25 kHz																
Mode	Value																
SA	OFF																
All others	ON																
State Saved	Yes																
	Yes																
Range	OFF ON																
Min/Max	1 kHz/Depends on instrument maximum frequency																

3.7.8.3 Radio

Contains controls to select Radio Standard and device type. It appears in the Transmit Analysis, LE In-band Emissions, Monitor Spectrum, and Output Spectrum Bandwidth measurements

Radio Standard

Allows the user to select the Radio Standard of the expected Bluetooth Signal being measured.

Remote Command	<code>[:SENSe] :RADio:STANdard BASic EDR LENergy QHS</code>
	<code>[:SENSe] :RADio:STANdard?</code>

Example	<code>:RAD:STAN EDR</code> <code>:RAD:STAN?</code>
Couplings	The Basic EDR Low Energy value can be available when 9081EM0E/0D license is installed The QHS value can be available when 9081SP1E license is installed
Preset	<code>BASic</code>
State Saved	Yes
Range	Basic EDR Low Energy QHS

LE PHY

Sets LE PHY type.

Remote Command	<code>[:SENSe]:RADio:LE:PHY LE1M LE2M LECoded</code> <code>[:SENSe]:RADio:LE:PHY?</code>
Example	<code>:RAD:LE:PHY LE1M</code> <code>:RAD:LE:PHY?</code>
Couplings	Grayed-out if radio standard is not LE and measurement is not LE In-band Emission
Preset	LE1M

Device

Allows the user to select the expected Power Class.

Remote Command	<code>[:SENSe]:RADio:DEVIce PC1 PC2 PC3</code> <code>[:SENSe]:RADio:DEVIce?</code>
Example	<code>:RAD:DEV PC1</code> <code>:RAD:DEV?</code>
Couplings	It determines the default limit value of Output Power Grayed-out if Radio standard is Not Basic
Preset	PC1
State Saved	Yes
Range	Power Class1 Power Class2 Power Class3

3.7.8.4 Advanced

Contains controls for setting advanced functions of the instrument. This tab does not appear in EXM, nor in VXT models M9420A/10A/11A.

Noise Floor Extension

Lets you configure **Noise Floor Extension** (NFE). All Modes that support NFE let you set it on or off. Additionally, some Modes support two “on” states for NFE, **Full** and **Adaptive**, as described below.

Adaptive Option Support

At present (Release: X-Apps 2024), support for **Adaptive** NFE is as follows:

Mode	Measurements	Supports Adaptive NFE?
BT	ACP, IBEM, IBSP	No
CQM	MON	Yes
EDGE GSM	EORF, ETSP, MON	No
EMI	APD, DAN, FSC, MON, RTSC, SCH	Yes
LTEAFDD	PVT	No
LTEATDD	PVT	No
MSR	ACP, CHP, MON, OBW, SEM, SPUR	Yes
NR5G	PVT	No
PNOISE	LPL, MON, SFR	No
SA	SAN	Yes
SRCOMMS	ACP, CHP, MON, OBW, SEM, SPUR	Yes
VMA	ACP, CHP, OBW, SEM, SPUR	Yes
WCDMA	ACP, CHP, MON, OBW, SEM, SPUR	Yes
WLAN	CHP, MON, OBW, SEM, SPUR	Yes

The menus and command options are as follows:

NFE State	Modes with Adaptive NFE	Modes without Adaptive NFE	SCPI
Off	Off	Off	See "NFE On/Off Command" on page 795
On	Full	On	
Adaptive	Adaptive	n/a	See "Adaptive NFE Command" on page 795

As shown in the table above, the **On** state (in Modes that do not support **Adaptive** NFE) matches the **Full** state in Modes that *do* support **Adaptive** NFE.

To maintain SCPI backwards compatibility, the existing command to turn NFE on or off is retained, and a new command is added to set the state to turn **AdaptiveON** or **OFF**:

- `[[:SENSe]:CORRection:NOISe:FLOor ON|OFF|1|0]` is retained, with the default changed to **ON** for Modes that support **Adaptive** NFE
- `[[:SENSe]:CORRection:NOISe:FLOor:ADAPtive ON|OFF|1|0]` is added (for certain Modes), default = **ON**

When NFE is **On** or **Full**, the expected noise power of the instrument (derived from a factory calibration) is subtracted from the trace data. This will usually reduce the apparent noise level by about 10 dB in low band, and 8 dB in high band (>~3.6 GHz).

NFE works with any RBW, VBW, detector, any setting of **Average Type**, any amount of trace averaging, and any signal type. It is ineffective when the trace is not smoothed (smoothing processes include narrow VBWs, trace averaging, and long sweep times with the detector set to **Average** or **Peak**). It works best with extreme amounts of smoothing, and with the average detector, with the **Average Type** set to **Power**.

In those cases where the cancellation is ineffective, it nonetheless has no undesirable side-effects. There is no significant speed impact to having **Noise Floor Extension** on.

The best accuracy is achieved when substantial smoothing occurs in each point before trace averaging. Thus, when using the **Average** detector, results are better with long sweep times and fewer trace averages. When using the **Sample** detector, the VBW filter should be set narrow with less trace averaging, instead of a wide VBW filter with more trace averaging.

NOTE

Noise Floor Extension has no effect unless the RF Input is selected, so when **External Mixing** is selected, it does nothing.

For more details, see "[Optimal Detector & Averaging Selections](#)" on page 796 and "[Recalibration of Noise Floor](#)" on page 797.

Pros & Cons of Adaptive NFE

Adaptive NFE provides an alternative to fully-on or fully-off NFE. Fully-on NFE can, notably in cases with little or no averaging of the spectrum, result in a display that is distractingly unfamiliar in the variability in response to low level signals. Fully-off NFE fails to achieve the potential improvement in dynamic range and associated accuracy of measurement of low-level signals. **Adaptive** NFE controls the degree of potential improvement in the noise floor to give more improvement for those instrument settings that can make good use of the potential improvement—those settings with high degrees of variance reduction through some variant of averaging. When the potential improvement is small, the display acts like the fully-off case, and when it is high, it acts like the fully-on case, and in-between, application is a compromise between attractiveness and effectiveness.

In **Adaptive** NFE, there is not the same dramatic visual impact on the noise floor as there is in **Full** NFE. **Adaptive** NFE controls the amount of correction that is applied based on other instrument settings like RBW, averaging and sweep time. **Adaptive** NFE controls the degree of potential improvement in the noise floor to give more improvement for those instrument settings that can make good use of the potential improvement, such as settings that provide more averaging. The result is that when not much averaging is being performed, the signal displays more like the fully-off case; and when lots of averaging is being performed, the signal displays more like the **Full** NFE case.

Adaptive NFE is recommended for general-purpose use. For fully-ATE (automatic test equipment) applications, where possible distraction of the instrument user is not a risk, **Full** NFE is recommended.

NFE On/Off Command

Remote Command	<code>[:SENSe]:CORRection:NOISe:FLOor ON OFF 1 0</code> <code>[:SENSe]:CORRection:NOISe:FLOor?</code>
Example	<code>:CORR:NOIS:FLO ON</code>
Dependencies	Only appears in instruments with the NFE or NF2 license installed. In all others, the control does not appear. In those cases, the SCPI command is accepted without error, but has no effect
Couplings	When NFE is enabled in any Mode manually, a prompt is displayed reminding you to perform the Characterize Noise Floor operation if it is needed When NFE is enabled through SCPI, and a Characterize Noise Floor operation is needed, an error is entered in the system error queue
Preset	Unaffected by Mode Preset . Turned ON at startup and by Restore Mode Defaults in Modes that support Adaptive . Turned OFF at startup and by Restore Mode Defaults in Modes that do <i>not</i> support Adaptive In Modes that support Adaptive NFE, the default (preset) state of NFE is Adaptive . In Modes that do not support Adaptive NFE, the default state of NFE is Off
State Saved	No

Adaptive NFE Command

Only effective in instruments with the NFE or NF2 license installed, and in Modes that support **Adaptive** NFE. For coverage, see "[Adaptive Option Support](#)" on page 793 above.

For all other cases, the SCPI command below is accepted without error, but has no effect.

Remote	<code>[:SENSe]:CORRection:NOISe:FLOor:ADApTive ON OFF 1 0</code>
--------	---

Command	<code>[:SENSe] :CORRection:NOISe:FLOor:ADAPtive?</code>
Example	First turn NFE on, this is Full mode <code>:CORR:NOIS:FLO ON</code> Then set it to Adaptive <code>:CORR:NOIS:FLO:ADAP ON</code>
Couplings	To maintain backwards compatibility, sending <code>:CORR:NOIS:FLO ON</code> turns NFE AdaptiveOFF . To turn Adaptive on, you must issue the commands in the proper order, as shown in the example above
Preset	Not affected by Mode Preset , but set to ON at startup and by Restore Mode Defaults
State Saved	No

Optimal Detector & Averaging Selections

Note that some measurements do not allow you to switch the **Detector** type (which is set by default to **Average**), so the discussion of detector types here is irrelevant for those measurements. Similarly, some measurements do not allow you to set **Average Type** (set by default to **LOG**), so that discussion here is irrelevant in those cases.

The instrument is characterized in the factory (or during a field calibration) with a model of the noise, referred to the input mixer, versus frequency in each band and path combination. Bands are 0 (low band) and 1 through 4 (high band) in a 26.5 GHz instrument, for example. Paths include normal paths, preamp paths, the electronic attenuator, etc.

In most band/path combinations, the noise can be well characterized based on just two parameters and the instrument frequency response before compensation for frequency-dependent losses.

After the noise density at the input mixer is estimated, the effects of the input attenuator, RBW, detector, etc. are computed to obtain the estimated input-port-referred noise level.

In the simplest case, the measured power (signal plus analyzer noise) in each display point (bucket) is compensated by subtracting the estimated noise power, leaving just the signal power. This is the operation when **Detector** is **Average** and **Average Type** is set to **Power (RMS)**.

For best operation, **AverageDetector** (default) and **Average Type. = Power** are recommended, as already stated. In other cases, operation is often not quite as good but still highly effective. Other **Detector** options, when available, behave as follows:

Positive Peak The noise floor is estimated based on the RBW and the duration of the bucket using the same equations used in the noise marker function. The voltage of the noise is subtracted from the voltage of the observed signal-plus-noise measurement to compute the estimated signal voltage

Positive Peak is one example of processing that varies with detector to give good

3 Bluetooth Mode

3.7 Occupied BW Measurement

	estimates of the signal level without the analyzer noise
	For pulsed-RF, Positive Peak can still give excellent effectiveness
	FFT analysis does not work well, and does not perform NFE well, with pulsed-RF signals, so this combination is <i>not</i> recommended
Negative Peak	Not very useful
Sample	Works well, but never better than Average , because it does not smooth as well
Normal	A combination of peak and negative peak behaviors, and works about as well as these

For best operation, extreme smoothing is desirable, as already stated. Using narrow VBWs works well, but using very long bucket durations and the average detector works best. Reducing the number of trace points makes the buckets longer.

For best operation, **Average Type = Power (RMS)** is optimal (when this option is available). When making CW measurements in the presence of noise without NFE, averaging on the decibel scale has the advantage of reducing the effect of noise. Using NFE with **Average Type = Log-Power (LOG)** is not synergistic, though; NFE with **Average Type = Power (RMS)** works a little better than NFE with **LOG**.

The results from NFE with internal preamp can often be lower than the theoretical noise in a signal source at room temperature, a noise density of -174 dBm/Hz. This is expected and useful behavior, because NFE is designed to report the amount of input signal that exceeds the thermal noise, not the amount that includes the thermal noise. This can be a useful behavior because thermal noise often interferes with what you want to measure, instead of being part of what you want to measure. Note that NFE is not adequately accurate to always be able to read below kTB.

Recalibration of Noise Floor

In instruments with the NF2 license installed, the calibrated noise floor used by **Noise Floor Extension** should be refreshed periodically. Keysight recommends that the **Characterize Noise Floor** operation be performed after the first 500 hours of operation, *and* once every calendar year. To do this, use "**Characterize Noise Floor**" on page 945, under **System, Alignments, Advanced**. If you have not done this yourself at the recommended interval, then when you turn on **Noise Floor Extension**, the instrument will prompt you to do so with a dialog stating:

This action will take several minutes to perform. Please disconnect all cables from the RF input and press Enter to proceed. Press ESC to cancel, or Postpone to postpone for a week

If you cancel, you will be prompted again the next time you turn NFE on. If you postpone, you will be prompted again after a week passes and you then turn NFE on.

IF Gain

Sets the **IF Gain** function to one of:

Setting	SCPI	Comments
Auto	<code>AUTO = ON</code>	Auto
Low	<code>OFF</code>	Low Gain
High	<code>AUTO = OFF</code>	High Gain
	<code>ON</code>	
	<code>AUTO = OFF</code>	

This setting affects sensitivity and IF overloads. It only applies to the RF input; not to the baseband I/Q input.

Remote Command	<pre>[:SENSe]:OBWidth:IF:GAIN[:STATe] ON OFF 1 0 [:SENSe]:OBWidth:IF:GAIN[:STATe]? [:SENSe]:OBWidth:IF:GAIN:AUTO[:STATe] ON OFF 1 0 [:SENSe]:OBWidth:IF:GAIN:AUTO[:STATe]?</pre>
Example	<pre>:OBW:IF:GAIN ON :OBW:IF:GAIN? :OBW:IF:GAIN:AUTO OFF :OBW:IF:GAIN:AUTO?</pre>
Dependencies	<p>Has no effect when the U7227A USB Preamplifier is connected. This is not annotated or reflected on any control; there are no controls grayed-out nor any SCPI locked out. The instrument simply behaves as though both IF Gain is set to Low regardless of the setting on the control</p> <p>Not available in VXT models M9420A/10A/11A, EXM, or UXM</p>
Couplings	<p>Auto sets IF Gain to High (ON) under any of the following conditions:</p> <ul style="list-style-type: none"> - The input attenuator is set to 0 dB, or - The preamp is turned on and the frequency range is under 3.6 GHz <p>For other conditions, Auto sets IF Gain to Low (OFF)</p>
Preset	<pre>OFF OFF</pre>
State Saved	Saved in instrument state
Range	Low Gain High Gain

3.7.8.5 Global

The controls in this menu apply to all Modes in the instrument.

Some controls (for example, "[Global Center Freq](#)" on page 799) allow you to switch certain Meas Global parameters to a Mode Global state. These switches apply to all Modes that support global settings. For example, no matter what Mode you are in when you set **Global Center Freq** to **ON**, it applies to all Modes that support Global settings.

Other controls (for example, **Extend Low Band**) are actually set in this menu, but apply to all Modes.

Global Center Freq

The software maintains a Mode Global value called **Global Center Freq**.

When **Global Center Freq** is switched **ON**, the current Mode's center frequency is copied into the **Global Center Frequency**, and from then on all Modes that support global settings use the **Global Center Frequency**, so you can switch between any of these Modes and the **Center Frequency** remains unchanged.

Adjusting the **Center Frequency** of any Mode that supports Global Settings, while **Global Center Freq** is **ON**, modifies the **Global Center Freq**.

When **Global Center Freq** is switched **OFF**, the **Center Frequency** of the current Mode is unchanged, but now the **Center Frequency** of each Mode is once again independent.

When **Mode Preset** is pressed while **Global Center Freq** is **ON**, the **Global Center Freq** is preset to the preset **Center Frequency** of the current Mode.

This function resets to **OFF** when "[Restore Defaults](#)" on page 800 is pressed, or when **System, Restore Defaults, All Modes** is pressed.

Remote Command	<code>:INSTrument:COUPle:FREQuency:CENTer ALL NONE</code> <code>:INSTrument:COUPle:FREQuency:CENTer?</code>
Example	<code>:INST:COUP:FREQ:CENT ALL</code> <code>:INST:COUP:FREQ:CENT?</code>
Preset	Set to OFF on Global Settings, Restore Defaults and System, Restore Defaults, All Modes
Range	ALL NONE
Preset	OFF
Backwards Compatibility SCPI	<code>:GLOBal:FREQuency:CENTer[:STATe] 1 0 ON OFF</code> <code>:GLOBal:FREQuency:CENTer[:STATe]?</code>

Global EMC Std

When this control is switched **ON**, the current Mode's EMC Std is copied into the **Global EMC Std**, and from then on all Modes that support global settings use the

Global EMC Std, so you can switch between any of these Modes and the EMC Std remains unchanged.

Adjusting the EMC Std of any Mode that supports Global settings, while **Global EMC Std** is **ON** modifies the **Global EMC Std**.

When **Global EMC Std** is switched **OFF**, the EMC Std of the current Mode remains unchanged, but now the EMC Std of each Mode is once again independent. When **Mode Preset** is pressed while **Global EMC Std** is **ON**, **Global EMC Std** is preset to the preset EMC Std of the current Mode.

This function resets to **OFF** when "**Restore Defaults**" on page 800 is pressed, or when **System, Restore Defaults, All Modes** is pressed.

Remote Command	<code>:INSTRument:COUPlE:EMC:STANdard ALL NONE</code> <code>:INSTRument:COUPlE:EMC:STANdard?</code>
Example	<code>:INST:COUP:EMC:STAN ALL</code> <code>:INST:COUP:EMC:STAN?</code>
Dependencies	Only available if Option EMC is installed
Preset	Set to OFF on Global Settings, Restore Defaults and System, Restore Defaults, All Modes
Range	ALL NONE

Restore Defaults

Resets all functions in the **Global** settings menu to **OFF**. Pressing **System, Restore Defaults, All Modes** has the same effect.

Remote Command	<code>:INSTRument:COUPlE:DEFault</code>
Example	<code>:INST:COUP:DEF</code>
Backwards Compatibility SCPI	<code>:GLOBal:DEFault</code>

3.7.9 Sweep

Accesses controls to configure and control the acquisition of data, and the X-axis parameters of the instrument.

Depending on the selected mode and measurement, these controls might include: **Sweep Time, Continuous/Single, Pause/Resume, X Scale** and **Number of Points**.

3.7.9.1 Sweep/Control

Accesses controls that let you operate the sweep and control functions of the instrument, such as **Sweep Time** and **Continuous/Single**.

Sweep Time

Controls the time the instrument takes to sweep the current frequency span in swept measurements, displays the sweep time in swept measurements, and displays the equivalent Sweep Time in FFT measurements.

When **Sweep Time** is in Auto, the instrument computes a time that will give accurate measurements based on other settings, such as RBW and VBW.

You can select a shorter sweep time to improve the measurement throughput (with some potential unspecified accuracy reduction), but the **Meas Uncal** indicator will appear if the sweep time you set is less than the calculated Auto Sweep time.

You can also select a longer sweep time, which can be useful (for example) for obtaining accurate insertion loss measurements on very narrowband filters.

NOTE

Significantly faster sweep times are available with Option FS1.

NOTE

The **Meas Uncal** (measurement uncalibrated) warning is displayed in the Status Bar at the bottom of the screen when the manual Sweep time entered is faster than the time computed by the instrument's Sweep time equations, that is, the Auto Sweep Time. The instrument's computed Sweep time will provide accurate measurements; if you sweep faster than this your measurements may be inaccurate. A **Meas Uncal** condition may be corrected by returning the Sweep Time to Auto; by entering a longer Sweep Time; or by choosing a wider RBW and/or VBW.

NOTE

On non-sweeping hardware, this control is grayed-out. The value shown on this control is an estimate. It is the measurement's turnaround time, which is the sum of signal acquisition time, FFT time, and other overhead time, to complete the entire span of the measurement. If you need to specify the same "Sweep Time" as you would for sweeping hardware, send `[:SENSe] : <meas> : SWEep : TIME <time>`. The measurement emulates the "Sweep Time" effect, but this emulation is not straightforward, and therefore the behavior is not specified. Instead, we recommend using Minimum Acquisition Time, which provides better control.

Remote Command `[:SENSe] : <meas> : SWEep : TIME <time>`

`[:SENSe] : <meas> : SWEep : TIME ?`

Example Channel Power measurement:

`:CHP : SWE : TIME 25ms`

`:CHP : SWE : TIME ?`

Notes In the ACP measurement in WCDMA Mode, this parameter is preset by **Meas Method** selection. Preset

	<p>values are as follows:</p> <ul style="list-style-type: none"> - IBW: 29 ms - IBWR: 108 ms - FAST 7.5 ms 				
Dependencies	<p>On non-sweeping hardware, this control is grayed out, and the Auto/Man toggle disappears. The read-only control shows estimated sweep time</p> <p>In those instruments, "Minimum Acquisition Time" on page 803 is available</p>				
Couplings	<p>Coupled to Span, RBW, VBW, and Sweep Time Rules when Sweep Time is set to Auto; Sweep Time changes when these parameters are changed</p> <p>When you manually set a value when in the Auto state, the state automatically changes to Man</p>				
Preset	<p>Automatically Calculated unless noted below</p> <p>WCDMA Mode</p> <ul style="list-style-type: none"> - Channel Power: 1.0 msOBW: 32.6 ms - ACP: 29 ms 				
State Saved	Saved in instrument state				
Min	<p>Other than non-sweeping hardware: Typically, 1 ms</p> <p>Non-sweeping hardware: N/A</p> <p>In the ACP measurement, when Meas Method is Fast Power, the minimum sweep time is span-dependent and automatically calculated</p>				
Max	<p>Other than non-sweeping hardware: 4000 s</p> <p>Non-sweeping hardware: N/A</p>				
Annotation	<p>The sweep time is displayed in the lower-right corner of the screen. The number of points is displayed parenthetically, as:</p> <p>Sweep 13.3 ms (1001 points)</p> <p>A “#” mark appears before “Sweep” in the annotation when it is switched from Auto to Manual coupling</p>				
Status Bits/OPC dependencies	<p>Meas Uncal is Bit 0 in the register:</p> <p>STATus:QUESTionable:INTEgrity:UNCalibrated</p> <p>Auto Function</p>				
Remote Command	<p>[:SENSe]:<meas>:SWEp:TIME:AUTO OFF ON 0 1</p> <p>[:SENSe]:<meas>:SWEp:TIME:AUTO?</p>				
Example	<p>Channel Power measurement:</p> <p>:CHP:SWE:TIME:AUTO OFF</p> <p>:CHP:SWE:TIME:AUTO?</p>				
Preset	<table border="0"> <tr> <td>WCDMA Mode</td> <td>OFF</td> </tr> <tr> <td>All others</td> <td>ON</td> </tr> </table>	WCDMA Mode	OFF	All others	ON
WCDMA Mode	OFF				
All others	ON				

Minimum Acquisition Time

Available on non-sweeping hardware.

Specifies the minimum acquisition time for each “chunk” of the measurement result. The instrument automatically divides Span into multiple chunks if needed. Therefore, the total signal acquisition time for the entire Span is:

$$\sim(\sim\text{Minimum Acquisition Time}) * (\text{The number of chunks})$$

When in Auto, this parameter’s value is determined by other parameters, such as **Span**, **RBW** and **VBW**.

You can manually increase this parameter value from this Auto value.

If increased, the instrument acquires signal for the specified time duration for each chunk. It performs additional FFTs, and averages or peak-holds the FFT results for a chunk, depending on **Detector** settings.

Note that the actual acquisition time for each chunk may exceed the **Minimum Acquisition Time** value, in order to satisfy FFT time required by other parameters, and to perform an integer number of FFTs.

Remote Command	<pre>[:SENSe]:<meas>:SWEep:ACQuisition:TIME <time> [:SENSe]:<meas>:SWEep:ACQuisition:TIME? <meas> is the identifier for the current measurement; any one of CHPower- ACPower OBWidth MONitor</pre>
Example	<pre>Channel Power measurement :CHP:SWE:ACQ:TIME 500 ms :CHP:SWE:ACQ:TIME?</pre>
Dependencies	Available only on non-sweeping hardware
Couplings	Coupled to Span , RBW , and VBW when in the Auto state When you manually set a value when in the Auto state, the state automatically changes to Man
Preset	Automatically calculated
State Saved	Saved in instrument state
Min	100 ns
Max	4.00 ks
	Auto Function
Remote Command	<pre>[:SENSe]:<meas>:SWEep:ACQuisition:TIME:AUTO OFF ON 0 1 [:SENSe]:<meas>:SWEep:ACQuisition:TIME:AUTO?</pre>

	<code><meas></code> is the identifier for the current measurement; any one of <code>CHPower-</code> <code> ACPower OBWidth MONitor</code>
Example	Channel Power measurement: <code>:CHP:SWE:ACQ:TIME:AUTO OFF</code>
Preset	<code>ON</code>

Sweep/Measure

Lets you toggle between **Continuous** and **Single** sweep or measurement operation. The single/continuous state is Meas Global, so the setting affects all measurements.

The front-panel key **Single/Cont** performs exactly the same function

See "[More Information](#)" on page 804

Remote Command	<code>:INITiate:CONTinuous OFF ON 0 1</code> <code>:INITiate:CONTinuous?</code>
Example	Put instrument into Single measurement operation: <code>:INIT:CONT 0</code> <code>:INIT:CONT OFF</code> Put instrument into Continuous measurement operation: <code>:INIT:CONT 1</code> <code>:INIT:CONT ON</code>
Preset	<code>ON</code> Note that <code>:SYST:PRES</code> sets <code>:INIT:CONT</code> to <code>ON</code> , but <code>*RST</code> sets <code>:INIT:CONT</code> to <code>OFF</code>
State Saved	Saved in instrument state
Annunciation	The Single/Continuous icon in the Meas Bar changes depending on the setting: <ul style="list-style-type: none"> - A line with an arrow is Single - A loop with an arrow is Continuous
Backwards Compatibility Notes	X-Series A-models had Single and Cont hardkeys in place of the SweepSingleCont softkey. In the X-Series A-models, if in single measurement, the Cont hardkey (and <code>INIT:CONT ON</code>) switched to continuous measurement, but never restarted a measurement and never reset a sweep X-Series B-models have a Cont/Single toggle control instead of Single and Cont hardkeys, but it is still true that, if in single measurement, the Cont/Single toggle control never restarts a measurement and never resets a sweep

More Information

Continuous Mode	The instrument takes repetitive sweeps, averages, measurements, etc., when in continuous mode. If in average or Max/Min Hold, and the average/hold count reaches the Average/Hold Num , the count stops incrementing, but the instrument
-----------------	---

3 Bluetooth Mode

3.7 Occupied BW Measurement

	keeps sweeping
	See the Trace key description under Trace Average for the averaging formula used both before and after the Average/Hold Num is reached. The trigger condition must be met prior to each sweep
	The type of trace processing for multiple sweeps is set under the Trace key, with choices of Trace Average , Max Hold , or Min Hold
Single Mode	The instrument takes a single sweep when in Single mode, or if in average or Max/Min Hold, or if there is a Waterfall window displayed, it takes multiple sweeps until the average/hold count reaches the Average/Hold Num , then the count stops incrementing, and the instrument stops sweeping
	See the Trace key description under Trace Average for the averaging formula used. The trigger condition must be met prior to the sweep
	The type of trace processing for multiple sweeps is set under the Trace key, with choices of Trace Average , Max Hold , or Min Hold

If the instrument is in **Single** measurement mode, pressing the **Cont/Single** toggle control does not zero the count and does not cause the sweep to be reset; the only action is to put the instrument into Continuous measurement operation.

If the instrument is already in **Continuous** sweep:

- **:INIT:CONT 1** has no effect
- **:INIT:CONT 0** places the instrument in Single Sweep but has no effect on the current sequence until $k = N$, at which point the current sequence will stop and the instrument will go to the idle state

See "**Restart**" on page 806 for details of **:INIT:IMMEDIATE**.

If the instrument is already in **Single** sweep, **:INIT:CONT OFF** has no effect.

If the instrument is already in **Single** sweep, then pressing **Cont/Single** in the middle of a sweep does not restart the sweep or sequence. Similarly, pressing **Cont/Single** does not restart the sweep or sequence if the sweep is not in the idle state (for example, if you are taking a very slow sweep, or the instrument is waiting for a trigger). Even though pressing **Cont/Single** in the middle of a sweep does not restart the sweep, sending **:INIT:IMM** does reset it.

If the instrument is in **Single** sweep, and *not* Averaging/Holding, and you want to take one more sweep, press **Restart**.

If the instrument is in **Single** sweep, *and* Averaging/Holding, and you want to take one more sweep without resetting the Average trace or count, go to **Meas Setup** and increment the average count by 1 by pressing the **Step-Up** key while **Average/Hold Num** is the active function. You can also do this by sending **:CALC:AVER:TCON UP**.

Restart

Restarts the current sweep, or measurement, or set of averaged/held sweeps or measurements. If you are Paused, pressing **Restart** performs a Resume.

The front-panel key **Restart** performs exactly the same function.

The **Restart** function is accessed in several ways:

- Pressing the **Restart** key
- Sending `:INIT:IMM`
- Sending `:INIT:REST`

See "[More Information](#)" on page 806

Remote Command	<code>:INITiate[:IMMEDIATE]</code> <code>:INITiate:REStart</code>
Example	<code>:INIT:IMM</code> <code>:INIT:REST</code>
Notes	<code>:INIT:REST</code> and <code>:INIT:IMM</code> perform exactly the same function
Couplings	Resets average/hold count k. For the first sweep overwrites all active (update = on) traces with new current data. For application modes, it resets other parameters as required by the measurement
Status Bits/OPC dependencies	This is an Overlapped command The <code>STATUS:OPERation</code> register bits 0 through 8 are cleared , <i>except</i> bit 6 (Waiting for Periodic Sync). Initiating a measurement and Waiting for Periodic Sync could be asynchronous The <code>STATUS:QUEStionable</code> register bit 9 (<code>INTegrity</code> sum) is cleared The <code>SWEEPING</code> bit is set The <code>MEASURING</code> bit is set
Backwards Compatibility Notes	For Spectrum Analysis Mode in ESA and PSA, the Restart hardkey and the <code>:INIT:REST</code> command restarted trace averages (displayed average count reset to 1) for a trace in Clear Write , but did not restart Max Hold and Min Hold In X-Series, the Restart hardkey and the <code>:INIT:REST</code> command restart not only Trace Average , but MaxHold and MinHold traces as well

More Information

The **Restart** function first aborts the current sweep or measurement as quickly as possible. It then resets the sweep and trigger systems, sets up the measurement and initiates a new data measurement sequence with a new data acquisition (sweep) taken once the trigger condition is met.

If the instrument is in the process of aligning when a **Restart** is executed, the alignment finishes before the restart function is performed.

Even when set for **Single** operation, multiple sweeps may be taken when **Restart** is pressed (for example, when averaging/holding is on). Thus, when we say that **Restart** "restarts a measurement", depending on the current settings, we may mean that it:

- Restarts the current sweep
- Restarts the current measurement
- Restarts the current set of sweeps if any trace is in Trace Average, Max Hold or Min Hold
- Restarts the current set of measurements if Averaging, or Max Hold, or Min Hold is on for the measurement

If there is no Average or Max/Min Hold function (no trace in Trace Average or Hold, or **Average/Hold Num** set to 1), and no **Waterfall** window is being displayed, a single sweep is equivalent to a single measurement. A single sweep is taken after the trigger condition is met; and the instrument stops sweeping once that sweep has completed. However, with **Average/Hold Num** >1, and at least one trace set to Trace Average, Max Hold, or Min Hold, or a **Waterfall** window being displayed, multiple sweeps/data acquisitions are taken for a single measurement. The trigger condition must be met prior to each sweep. The sweep is stopped when the average count k equals the number N set for **Average/Hold Num**.

Once the full set of sweeps has been taken, the instrument goes to the idle state. To take one more sweep without resetting the average count, increment the average count by 1, by pressing the **Step-Up** key while **Average/Hold Number** is the active function, or by sending the remote command `:CALC:AVER:TCON UP`.

Trace Update

The numeric results are not blanked at any time during the restart cycle.

For slow sweeps (see **Trace Update** section in **Trace/Detector**), the traces are updated real-time during the sweep. There may be a special circumstance in application mode measurements where an exception is made and the traces and/or results need to be blanked before displaying the new results.

To summarize, the following list shows what happens to the trace data on various events:

Event	Trace Effect
Clear/Write pressed (even if already in Clear/Write)	Set to mintracevalue
Max Hold pressed (even if already in Max Hold)	Set to mintracevalue

Event	Trace Effect
Min Hold pressed (even if already in Min Hold)	Set to maxtracevalue
Trace Average pressed (even if already in Trace Average)	Trace data unaffected but start new sweep/avg/hold
Restart pressed	Trace data unaffected but start new sweep/avg/hold
Parameter requiring restart changed (e.g., RBW)	Trace data unaffected but start new sweep/avg/hold

Sweep and Trigger Reset

Resetting the sweep system resets the average/hold count k to 0. It also resets the set point counter to 0. Resetting the trigger system resets the internal auto trig timer to the value set by the **Auto Trig** control.

Averaging

The weighting factor used for averaging is k . This k is also the average/hold count for how many valid sweeps (data acquisitions) have been done. This k is used for comparisons with N , as those comparisons always needs to be based on valid completed sweeps.

The displayed average/hold, K , shows the count for the sweep (data acquisition) in progress. $K = k + 1$, with a limit of N . The displayed value K changes from its previous value to 1 as soon as the trigger condition for the first data acquisition (sweep) is met.

Pause/Resume

Pauses a measurement after the current data acquisition is complete.

When paused, the label on the control changes to **Resume**. Pressing **Resume** unpauses the measurement. When paused, pressing **Restart** performs a Resume.

Remote Command	<code>:INITiate:PAUSE</code> <code>:INITiate:RESume</code>
Example	<code>:INIT:PAUS</code> <code>:INIT:RES</code>
Dependencies	Not displayed in Modes that do not support pausing
Annotation	Only on control

Abort (Remote Command Only)

Stops the current measurement. Aborts the current measurement as quickly as possible, resets the sweep and trigger systems, and puts the measurement into an "idle" state. If the instrument is in the process of aligning when `:ABORT` is sent, the alignment finishes *before* the abort function is performed, so `:ABORT` does not abort an alignment.

If the instrument is set for **Continuous** measurement, it sets up the measurement and initiates a new data measurement sequence with a new data acquisition (sweep) taken once the trigger condition is met.

If the instrument is set for **Single** measurement, it remains in the "idle" state until an `:INIT:IMM` command is received.

Remote Command	<code>:ABORT</code>
Example	<code>:ABOR</code>
Notes	<p>If <code>:INIT:CONT</code> is ON, then a new continuous measurement will start immediately, with sweep (data acquisition) occurring once the trigger condition has been met</p> <p>If <code>:INIT:CONT</code> is OFF, then <code>:INIT:IMM</code> is used to start a single measurement, with sweep (data acquisition) occurring once the trigger condition has been met</p>
Dependencies	<p>For continuous measurement, <code>:ABORT</code> is equivalent to the Restart key</p> <p>Not all measurements support this command</p>
Status Bits/OPC dependencies	<p>The <code>STATUS:OPERation</code> register bits 0 through 8 are cleared, <i>except</i> bit 6 (Waiting for Periodic Sync). Initiating a measurement and Waiting for Periodic Sync could be asynchronous</p> <p>The <code>STATUS:QUEStionable</code> register bit 9 (INTEgrity sum) is cleared</p> <p>Since all the bits that feed into OPC are cleared by <code>:ABORT</code>, the Abort command will cause the <code>*OPC</code> query to return true</p>

Sweep Time Annotation (Remote Query Only)

Returns the **Sweep Time Annotation** value. Available only on non-sweeping hardware.

This value is also displayed in the result trace window.

The value returned is the estimated turnaround time of each measurement cycle, in seconds. The turnaround time is the sum of the signal acquisition time, FFT time, and other overhead time, to complete the entire span of each measurement cycle.

Remote Command	<code>[:SENSe]:<meas>:SWEep:ETIME?</code>
	<code><meas></code> is the identifier for the current measurement; any one of <code>CHPower- ACPower OBwidth MONitor</code>
Example	Channel Power measurement

	<code>:CHP:SWE:ETIME?</code>
Dependencies	Available only on non-sweeping hardware
Preset	Automatically calculated

3.7.9.2 Sweep Config

Accesses controls that let you configure the sweep and control functions of the instrument, such as "[Sweep Time Rules](#)" on page 810.

Sweep Time Rules

Switches the instrument between normal and accuracy sweep states:

Accy	<code>ACCuracy</code>
Norm	<code>NORMal</code>

Setting **Auto Sweep Time** to **Accy** results in slower sweep times, usually about three times as long, but yields better amplitude accuracy for CW signals. The instrument amplitude accuracy specifications only apply when **Auto Sweep Time** is set to **Accy**.

Additional amplitude errors which occur when **Auto Sweep Time** is set to **Norm** are usually well under 0.1 dB, though this is not guaranteed. Because of the faster sweep times and still low errors, **Norm** is the preferred setting of **Auto Sweep Time**. **Auto Sweep Time** is set to **Norm** on a **Preset**. This means that in the Preset state, instrument amplitude accuracy specifications do not apply.

Remote Command	<code>[:SENSe]:OBWidth:SWEp:TIME:AUTO:RULEs NORMal ACCuracy</code> <code>[:SENSe]:OBWidth:SWEp:TIME:AUTO:RULEs?</code>
Example	<code>:OBW:SWE:TIME:AUTO:RUL NORM</code> <code>:OBW:SWE:TIME:AUTO:RUL?</code>
Dependencies	Does not appear in Spectrum Analyzer Mode in VXT model M9420A
Preset	<code>NORMal</code>
State Saved	Saved in instrument state
Range	<code>NORMal ACCuracy</code>

Points

Sets the number of points taken per sweep, and displayed in the traces. The current value of points is displayed parenthetically, next to the sweep time in the lower-right corner of the display. Using more points provides greater resolution. Using fewer points compacts the data and decreases the time required to access a trace over the remote interface.

3 Bluetooth Mode
 3.7 Occupied BW Measurement

Increasing the number of points does not increase the sweep time. However, it can slightly impact the trace processing time and therefore the overall measurement speed. Decreasing the number of points does not decrease the sweep time, but it may speed up the measurement, depending on the other sweep settings (for example, in FFT sweeps). Fewer points will always speed up the I/O.

Due to minimum sweep rate limitations of the hardware, the minimum sweep time available to the user will increase above its normal value of 1 ms as the number of sweep points increases above 15001.

Changing the number of sweep points has several effects on the instrument. Since markers are read at the point location, the marker reading may change. The sweep time resolution will change. Trace data for all the traces will be cleared and, if **Sweep** is in **Cont**, a new trace taken. If any trace is in average or hold, the averaging starts over.

Due to sweep time quantization issues, the knob and up/down keys *cannot* be used to adjust the number of points.

When in a split-screen display, each window may have its own value for points.

When sweep **Points** is changed, an informational message "Sweep points changed, all traces cleared" is displayed, and in 5G NR Mode, **Auto Sweep Points** is set to **OFF** (0).

Remote Command	<code>[:SENSe]:OBwidth:SWEp:POINts <integer></code> <code>[:SENSe]:OBwidth:SWEp:POINts?</code>				
Example	<code>:OBW:SWE:POIN 501</code> <code>:OBW:SWE:POIN?</code>				
Dependencies	Not available when Signal ID is set to On in External Mixing Neither the knob nor the step keys can be used to change this value. If it is tried, a warning is given Not displayed in Modes that do not support Swept				
Couplings	Whenever the number of sweep points change: <ul style="list-style-type: none"> - All trace data is erased - Any traces with Update Off will also go to Display Off Sweep time is re-quantized - Any limit lines that are on will be updated - If averaging/hold is on, averaging/hold starts over - Auto Sweep Points is set to OFF (5G NR Mode only) <p>The resolution of setting the sweep time depends on the number of points selected</p>				
Preset	<table border="1"> <thead> <tr> <th>Mode</th> <th>Value</th> </tr> </thead> <tbody> <tr> <td>MSR, LTEAFDD, LTEATDD</td> <td>2001</td> </tr> </tbody> </table>	Mode	Value	MSR, LTEAFDD, LTEATDD	2001
Mode	Value				
MSR, LTEAFDD, LTEATDD	2001				

	Mode	Value
	5GNR	Automatically calculated
	All Others	1001

State Saved	Saved in instrument state
Min	101
Max	20001
Annotation	On second line of annotations, in lower right corner in parenthesis behind the sweep annotation

IF Dithering

Lets you turn IF Dithering on or off. This is a technique used in unpreselected instruments (such as Keysight's modular instruments) to enhance the rejection of images and internally-generated spurious signals.

Remote Command	<code>[:SENSe] :SWEep:IF:DITHer OFF ON 0 1</code> <code>[:SENSe] :SWEep:IF:DITHer?</code>
Dependencies	Only appears in Spectrum Analyzer Mode in VXT models
Preset	<code>OFF</code>
State Saved	Saved in instrument state

Image Protection

Lets you turn IF Protection on or off. This is a technique used in unpreselected instruments (such as Keysight's modular instruments) to detect and suppress images and spurs that may be present in non-preselected hardware.

IF Protection takes two sweeps and by correlating the data between them, provides a single, correct power-versus-frequency trace.

Remote Command	<code>[:SENSe] :SWEep:IMAGeProt OFF ON 0 1</code> <code>[:SENSe] :SWEep:IMAGeProt?</code>
Dependencies	Only appears in Spectrum Analyzer Mode in VXT models
Preset	<code>ON</code>
State Saved	Saved in instrument state

3.7.10 Trace

Lets you control the acquisition, display, storage, detection and manipulation of trace data for the available traces.

The "Trace Control" on page 819 tab of this menu contains radio-button selections for the trace type (**Clear/Write**, **Trace Average**, **Max Hold**, **Min Hold**) and **View/Blank** setting for the selected trace.

A trace is a series of data points, each having an x and a y value. The x value is frequency (or time, in zero span) and the y value is amplitude. Each data point is referred to as a *trace point*. In any given trace, trace point 0 is the first point, and trace point (*sweep_points* - 1) is the last. For example, in a 1001 point trace, the first point is 0 and the last is 1000. Another term sometimes used to describe traces is *bucket*. A bucket is the frequency span of a trace point, equal to the point spacing. For swept analysis, the y value in each bucket is measured while the instrument is sweeping across the bucket. The selected detector determines how it is measured.

When in **Single** Mode, Measurements and their Views save the trace data from the last acquisition. This is true on multiple screens. The marker and trace data will be present whenever the measurement is brought back into focus. The measurement switches for these measurements do not clear the traces, so the data will be present until the next acquisition is completed.

Invalid Data Indicator

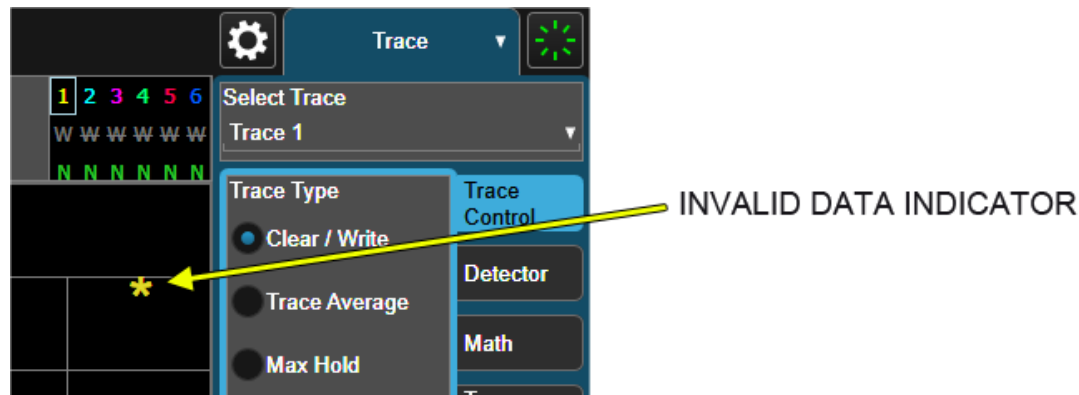

The Invalid Data Indicator is displayed whenever the data on the display does not match the settings of the instrument. The most common example of this is when instrument settings have changed in the time since the data in the traces on the display was taken. This means that the screen annotation cannot be guaranteed to match the trace data. For example, if you change **Center Frequency**, the Invalid Data Indicator will display until the trace has been retaken.

If any Trace is in View mode (displaying but not updating) and instrument settings are changed, the Invalid Data Indicator will display as long as that trace remains in View. Traces that are blanked do not turn on the Invalid Data Indicator.

Not all instrument settings require display of the invalid data indicator when they change; only changes that require a new acquisition will cause it to display. For example, changing the Y-Axis scale of the instrument does not cause the invalid data indicator to display, unless the attenuation changes.

The Invalid Data Indicator is also turned on:

- When the counter is turned on, until the completion of the first count
- When a trace is imported from mass storage and the trace's parameters do not match the current instrument settings
- When a trace is sent to the instrument from a remote interface (since there is no way to know if its settings match)

NOTE

The Invalid Data Indicator has an associated status bit that can be checked at any time to determine whether the indicator is on.

Trace right-click menu

If you right-click on a trace (or touch and hold a trace and wait for the circle to close) you will see the Trace Right-Click Menu:

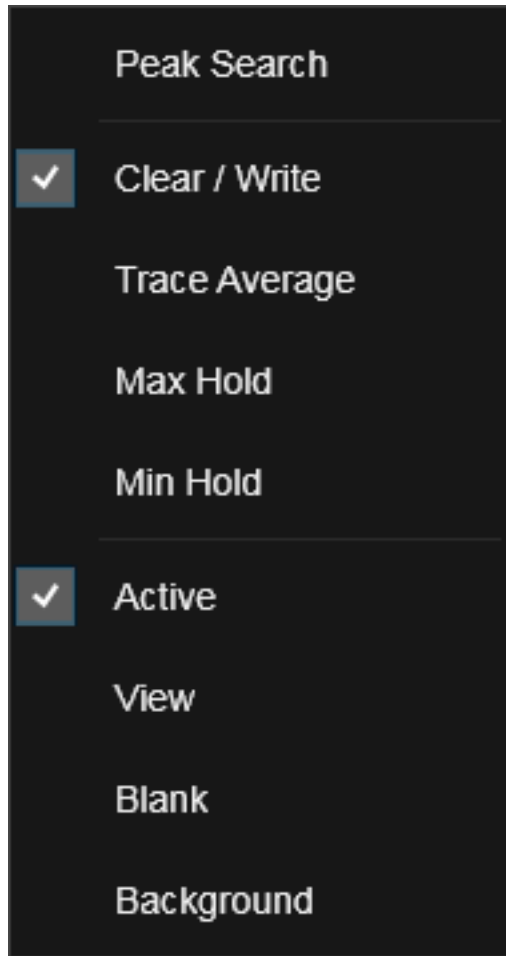

If you now tap or click on one of the items in this menu, the instrument will perform the corresponding function. **Peak Search** finds the highest peak on the selected Trace. **Clear/Write**, **Trace Average**, **Max Hold** and **Min Hold** set the "Trace Type" on [page 820](#). **Active**, **View**, **Blank**, and **Background** set the "View/Blank" on [page 825](#) type.

Waterfall Window

If you right-click on the trace (or touch and hold the trace and wait for the circle to close) in the **Waterfall** window (for example, in the Spectrogram View) you will see the Waterfall Trace Right-Click Menu:

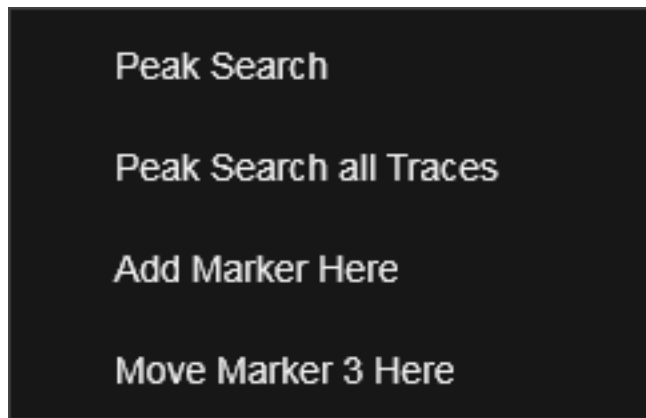

In this menu, **Peak Search** works as above. **Peak Search all Traces** finds the highest peak in the Waterfall window. **Add Marker Here** takes the lowest numbered Marker that is currently Off and turns it On as a **Normal** marker in the Waterfall window at the point where you right-clicked (or touched-and-held). **Move Marker n Here** moves the currently selected Marker to the point in the Waterfall window where you right-clicked (or touched-and-held).

Trace Update Indicator

Trace updates can take one of two forms:

1. The trace is updated in a single operation that affects all of the points in the trace at once. This happens, for example, in the case of very fast (< 200 ms) sweeps, single-chunk FFT's, and the initial math operation after a math function is set for a trace
2. The trace is updated in a series of discrete steps, with measurement data being gathered between each step. This will be the case for slow sweeps, multi-chunk FFTs, gated sweeps, etc.

In the first case, no update indicator is required. In the second case, however, a visual indicator exists on the trace where the new data is being written. The indicator is a green caret (^), which moves across the bottom of the graticule showing the current trace point.

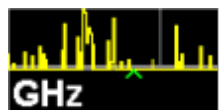

Trace Annunciator Panel

This panel appears on the right hand side of the Meas Bar. Here is an explanation of the fields in this panel, as shown below:

3 Bluetooth Mode
3.7 Occupied BW Measurement

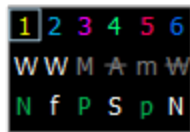

Top Line

On the top line, each trace number is shown, in the trace color. A box is drawn around the currently selected trace.

Middle Line

Below each trace number, is a letter signifying the trace type for that trace number, where

W	Clear/Write
A	Trace Average
M	Max Hold
m	Min Hold

If the letter is white, it means the trace is being updated (**Update = ON**); if the letter is dimmed, it means the trace is not being updated (**Update = OFF**). A strikethrough indicates that the trace is blanked (**Display = OFF**). Note that it is possible for a trace to be updating *and* blanked, which is useful if the trace is a trace math component.

Bottom Line

The third line shows the detector type for each trace, or, if trace math is on for that trace, it shows “f” (for “math function”). It is not always possible to have a unique detector for each trace, but the instrument hardware provides the maximum flexibility of detector selection in order to maintain the highest accuracy. The letters used for this readout are

N	Normal
A	Average
P	peak
p	negative peak
S	Sample
Q	Quasi Peak
E	EMI Average
R	RMS Average
f	math function

If the letter is green, the detector is in Auto. If white, the detector has been manually selected.

In the example above, the panel is indicating the following:

- Trace 1: Visible, being updated, in Clear/Write, with Normal detector auto selected
- Trace 2: Visible, being updated, in Clear/Write, being written to with a math function
- Trace 3: Visible, not updating, data was taken in Max Hold, with the peak detector auto selected
- Trace 4: Blanked, not updating, data was taken with Averaging turned on, Sample detector manually selected
- Trace 5: Visible, not updating, data was taken in Min Hold with Negative Peak detector auto selected
- Trace 6: Blanked, not updating, in Clear/Write, with Normal detector manually selected

Trace Annotation

When **Trace Annotation** (see **Display**) is **ON**, each non-blanked trace is labeled on the trace with the detector used to take it, unless a Trace Math function is on for that trace, in which case it is labeled with the **"Math Function"** on page 828.

The detector labels are:

NORM	Normal
PEAK	Peak
SAMP	Sample
NPEAK	Negative Peak
RMS	Average detector with Power Average (RMS)
LG AVG	Average detector with Log-Pwr Average
VAVG	Average detector with Voltage Average
QPEAK	Quasi Peak
EMI AVG	EMI Average
RMS AVG	RMS Average

The trace math labels are:

PDIF	Power Difference
PSUM	Power Sum
LOFF	Log Offset
LDIF	Log Difference

3.7.10.1 Select Trace

Specifies the *selected trace*, which is the trace that will be affected when you change trace settings.

Select Trace appears above the menu panel, indicating that it applies to *all* controls in the menu panel. **Select Trace** is blanked if you select a tab whose controls do *not* depend on the selected trace (for example, **Trace Function**).

Notes	The selected trace is remembered even when not in the Trace menu
Dependencies	For the Swept SA measurement: <ul style="list-style-type: none">- In Image Suppress mode, when you select a trace it becomes the active trace, and the formerly active trace goes into View- When you turn on Image Suppress, Update turns off for all traces except the selected trace For the ACP measurement, when Meas Method is RBW , FAST or FPOwer , Select Trace is disabled
Preset	Trace 1
State Saved	Yes

3.7.10.2 Trace Control

The controls on this tab allow you to set the "Trace Type" on page 820 and its update mode.

There are four Trace Types:

- **Clear/Write**
- **Trace Average**
- **Max Hold**
- **Min Hold**

Each type handles data in a different way.

Each trace also has two values that determine whether it is being written or not, and whether it is being displayed or not. These values, **Update** and **Display**, are described fully in the "View/Blank" on page 825 control description. Essentially, when **Update** is **ON**, a trace is updating, and when **Update** is **OFF** it is not. When **Display** is **ON**, it is visible and when **Display** is **OFF** it is not. These terms are used throughout the descriptions in this section.

Trace Type

There are four trace Types:

Option	Parameter	SCPI Example	Details
Clear/Write	WRITe	:TRAC2:TYPE WRIT	See: " Clear/Write " on page 823
Trace Average	AVERAge	:TRAC2:TYPE AVER	See: " Trace Average " on page 823
Maximum Hold	MAXHold	:TRAC3:TYPE MAXH	See: " Max Hold " on page 824
Minimum Hold	MINHold	:TRAC5:TYPE MINH	See: " Min Hold " on page 824

Full descriptions of each type are provided below. You may select one of these types for each trace. Re-selecting the current **Trace Type** initiates the same action that selecting it the first time did, even though it is already selected. For example, selecting **Clear/Write** while **Clear/Write** is already selected will nonetheless clear the trace and begin rewriting it.

Besides the **Trace Type**, the "[View/Blank](#)" on page 825 state must be set to **Active** (**Update: ON**, **Display: ON**) for a trace to be updating and visible. Selecting any **Trace Type** automatically makes the trace **Active**.

See also: "[Trace Mode Backwards Compatibility Commands](#)" on page 821

Remote Command	<p>For Swept SA Measurement (in SA Mode):</p> <pre>:TRACe[1] 2 ... 6:TYPE WRITe AVERAge MAXHold MINHold</pre> <pre>:TRACe[1] 2 ... 6:TYPE?</pre> <p>For all other measurements:</p> <pre>:TRACe[1] 2 3:<meas>:TYPE WRITe AVERAge MAXHold MINHold</pre> <pre>:TRACe[1] 2 3:<meas>:TYPE?</pre> <p>where <meas> is the identifier for the current measurement</p>
Example	<pre>:TRAC:TYPE WRIT</pre> <pre>:TRAC:TYPE?</pre>
Couplings	<p>Selecting a Trace Type (by pressing any of the Trace Type selections or sending :TRAC:TYPE) sets the Trace to Active (Update: ON, Display: OFF), even if the same trace type was already selected</p> <p>When Detector setting is "Auto" ([:SENSe]: <meas>:DETector:AUTO?), Detector ([:SENSe]: <meas>:DETector[:FUNCTion]?) switches aligning with the switch of this parameter: "NORMAL" with WRITe (Clear Write), "AVERAge" with AVERAge, "POSitive (peak)" with MAXHold, and "NEGative (peak)" with MINHold</p>
Preset	<p>Swept SA and Monitor Spectrum: WRITe</p> <p>All other measurements: AVERAge</p> <p>Following Preset, all traces are cleared (all trace points set to mintracevalue)</p>
State Saved	The type of each trace is saved in instrument state
Annunciation	The type for each trace is indicated in the Trace annunciator panel on the Measurement Bar

Trace Mode Backwards Compatibility Commands

In earlier instruments, the “Trace Modes” were: Clear/Write, Max Hold, Min Hold, View and Blank. Averaging was global to all traces and was controlled under the **BW/Avg** menu.

In X-Series, trace averaging can be done on a per-trace basis. The Trace Modes (now called Trace Types) are Clear/Write, Trace Average, Max Hold and Min Hold. View and Blank are set separately under "[View/Blank](#)" on page 825.

While this provides more flexibility, it also gives rise to potential backwards compatibility problems. To mitigate these, the old Trace Mode command has been retained and a new Trace Type command has been added. The **:TRACe:MODE** command is retained for backwards compatibility, and the **:TRACe:TYPE**, **:TRACe:UPDate** and **:TRACe:DISPlay** commands introduced for ongoing use. The old Trace Modes are selected using **:TRAC:MODE**, whose parameters are mapped into calls to **:TRACe:TYPE**, **:TRACe:UPDate** and **:TRACe:DISPlay**, and the old global Averaging command **[:SENSe]:AVERage[:STATe]** is provided for backwards compatibility. See the individual command descriptions for details.

When **Average/Hold** in the **Meas Setup, Legacy Compatibility** menu is **ON**, the following is true for traces in Max Hold and Min Hold:

- They ignore the **Average/Hold** number; **Single** for Max Hold causes one sweep only, so switching to **Single** stops after the current sweep, and switching to **Cont** starts again without clearing the accumulated result
- Max Hold is not cleared on a **Restart**, **Single** or **:INIT:IMM**, but changing a measurement parameter, like frequency or bandwidth etc., still restarts the Max Hold

Preset	WRITE
State Saved	The trace mode is an alias only
Backwards Compatibility SCPI	:TRACe[1] 2 ... 6:MODE WRITE MAXHold MINHold VIEW BLANK :TRACe[1] 2 ... 6:MODE?
Backwards Compatibility Notes	<p>The legacy :TRACe:MODE command is retained for backwards compatibility. In conjunction with the legacy :AVERage command, it works as follows:</p> <ul style="list-style-type: none"> – :AVERage ON OFF sets/clears a variable that we will call average for the sake of this discussion. This variable is maintained by the instrument solely for backwards compatibility. See the [:SENSe]:AVERage[:STATe] command description below – :TRACe:MODE WRITE sets :TRACe:TYPE WRITE (Clear/Write) unless average is true, in which case it sets it to :TRACe:TYPE AVERage. It also sets :TRACe:UPDate ON, :TRACe:DISPlay ON, for the selected trace – :TRACe:MODE MAXHold sets :TRACe:TYPE MAXHold (Max Hold). It also sets :TRACe:UPDate ON, :TRACe:DISPlay ON, for the selected trace

- `:TRACe:MODE MINHold` sets `:TRACe:TYPE MINHold` (Min Hold). It also sets `:TRACe:UPDate ON`, `:TRACe:DISPlay ON`, for the selected trace
- `:TRACe:MODE VIEW` sets `:TRACe:UPDate OFF`, `:TRACe:DISPlay ON`, for the selected trace
- `:TRACe:MODE BLANK` sets `:TRACe:UPDate OFF`, `:TRACe:DISPlay OFF`, for the selected trace

The query returns the same value as `:TRACe:TYPE?`, meaning that if you set `:TRACe:MODE:VIEW` or `:TRACe:MODE:BLANK`, the query response will not be what you sent

`:TRACe[n]:MODE` was formerly used to set the type or “writing mode” of the trace. At that time, View and Blank were writing modes. The new `:TRACe:TYPE` command should be used in the future, but `:TRACe:MODE` is retained to provide backwards compatibility

In X-Series, unlike earlier instruments, Max Hold and Min Hold now obey the Average Number and counts up to a terminal value as Average always has

As the **Average/Hold Number** now affects **Min Hold** and **Max Hold**, the operations that restart Averaging (for example, the **Restart** key) now also restart **Min Hold** and **Max Hold**

As a result of these changes, legacy code that restarts averaging while retaining a running Max Hold will need to be rewritten, because the Max Hold will now restart when the Average does

Also, previous to X-Series:

- Pressing **Max Hold** while already in **Max Hold** (or doing so remotely) had no effect. Now it will clear the trace and restart the sweep and the Max Hold sequence
- Changing the vertical scale (Log/Lin or dB/div) of the display restarted **Max Hold** and **Min Hold**. This is no longer the case

Preset	<code>OFF</code>
State Saved	The state of Average is saved in Instrument State for ghosting purposes
Backwards Compatibility SCPI	<code>[:SENSe]:AVERage[:STATe] ON OFF 1 0</code> <code>[:SENSe]:AVERage[:STATe]?</code>
Backwards Compatibility Notes	<p>Previous to X-Series, Averaging (also sometimes known as trace averaging) was global to all traces, that is, it was either on or off for all active traces. The legacy command <code>[:SENSe]:AVERage[:STATe] ON OFF 1 0</code> was used to turn Averaging on or off</p> <p>In X-Series, Averaging is turned on or off on a per-trace basis, so it can be on for one trace and off for another</p> <p>For backwards compatibility, the old global Average State variable is retained solely as a legacy variable, turned on and off and queried by the legacy command <code>[:SENSe]:AVERage[:STATe] OFF ON 0 1</code>. When Average is turned on, any trace in Clear/Write will get put into Average. While Average is on, any trace put into Clear/Write by the old <code>:TRAC:MODE</code> command will instead get put into Average. When Average is turned off, any trace in Average will get put into Clear/Write</p>

Trace Type Details

Clear/Write

Each trace update replaces the old data in the trace with new data.

Pressing **Clear/Write** for the selected trace, or sending `:TRAC:TYPE WRIT` for the specified trace, sets the trace type to **Clear/Write** and clears the trace, even if you are already in **Clear/Write**. Then a new sweep is initiated. Trigger conditions must be met before the sweep actually starts, and if in **Single** the sweep won't start until **Restart** is pressed.

Pressing **Clear/Write** stops the current sweep and initiates a new one, so **Trace Average**, **Max Hold** and **Min Hold** data may be interrupted in mid-sweep when **Clear/Write** is pressed, and therefore may not accurately reflect the displayed count. Therefore, when **Clear/Write** is pressed for one trace, **Trace Average**, **Max Hold** and **Min Hold** must restart for all traces.

When in **Clear/Write**, if a measurement-related instrument setting is changed (that is, one which requires new data to be taken, like **Center Frequency** or **Attenuation**), a new sweep is initiated but the trace is not cleared.

Trace Average

The instrument maintains and displays an average trace, which represents the cumulative average on a point-by-point basis of the new trace data and previous averaged trace data.

Pressing **Trace Average** (for the selected trace), or sending `:TRAC:TYPE AVER` (for the specified trace), sets the trace type to **Trace Average**, clears the trace, initiates a new sweep, and restarts the Average sequence.

Details of the count limiting behavior and the averaging calculations may be found under **Avg|Hold Number** and **Average Type** under **Meas Setup**.

When in **Trace Average**, if a measurement-related instrument setting is changed (that is, one which requires new data to be taken, like **Center Frequency** or **Attenuation**), the average restarts and a new sweep is initiated but the trace is not cleared.

Restarting the average means:

- The average/hold count k is set to 1, so that the next time the average trace is displayed it simply represents one trace of new data
- A new sweep is initiated

- Once the new sweep starts, the trace is overwritten with current trace data as the first trace of the new average

Remember that restarting averaging also restarts **Max Hold** and **Min Hold**, as there is only one count for Trace Average and Hold.

Max Hold

The instrument maintains and displays a max hold trace, which represents the maximum data value on a point-by-point basis of the new trace data and previous trace data. Details of the count limiting behavior may be found under **Avg|Hold Number** under **Meas Setup**.

Pressing **Max Hold** for the selected trace, or sending `:TRAC:TYPE MAXH` for the specified trace, sets the Trace Type to **Max Hold**, clears the trace, initiates a new sweep, and restarts the hold sequence, even if you are already in **Max Hold**.

When in **Max Hold**, if a measurement-related instrument setting is changed (that is, one which requires new data to be taken, like **Center Frequency** or **Attenuation**), the **Max Hold** sequence restarts and a new sweep is initiated but the trace is not cleared.

Restarting the **Max Hold** sequence means:

- The average/hold count k is set to 1, so that the next time the max hold trace is displayed it simply represents one trace of new data
- A new sweep is initiated.

Remember that restarting **Max Hold** also restarts averaging and **Min Hold**, as there is only one count for Trace Average and Hold.

Min Hold

The instrument maintains and displays a min hold trace, which represents the minimum data value on a point-by-point basis of the new trace data and previous trace data. Details of the count limiting behavior may be found under **Avg|Hold Number** under the **Meas Setup** functions.

Pressing **Min Hold** for the selected trace, or sending `:TRAC:TYPE MINH` for the specified trace, sets the Trace Type to **Min Hold**, clears the trace, initiates a new sweep, and restarts the hold sequence, even if you are already in **Min Hold**.

When in **Min Hold**, if a measurement-related instrument setting is changed (that is, one which requires new data to be taken, like **Center Frequency** or **Attenuation**), the **Min Hold** sequence restarts and a new sweep is initiated but the trace is not cleared.

Restarting the **Min Hold** sequence means:

3 Bluetooth Mode
3.7 Occupied BW Measurement

- The average/hold count k is set to 1, so that the next time the min hold trace is displayed it simply represents one trace of new data
- A new sweep is initiated

Remember that restarting **Min Hold** also restarts **Max Hold** and averaging, because there is only one count for Trace Average and Hold.

Clear and Write | Restart Averaging | Restart Max/Min Hold

Starts the trace writing, as though the "Trace Type" on page 820 had just been selected. The effect is exactly the same as reselecting the current **Trace Type** again

- the control is provided because it may not be obvious that reselecting the same selection from a radio button menu will take any action.

This control displays different labels, depending on the selected Trace Type:

- **Clear/Write**: Clear and Write
- **Trace Average**: Restart Averaging
- **Max Hold**: Restart Max Hold
- **Min Hold**: Restart Min Hold

View/Blank

Lets you set the state of the two trace variables: **Update** and **Display**. The choices available in this dropdown menu are:

Active	Update and Display both ON
View	Update OFF ; Display ON
Blank	Update OFF ; Display OFF
Background	Update ON , Display OFF Allows a trace to be blanked <i>and</i> continue to update "in the background", which was not possible in the past

In the Swept SA measurement, a trace with **DisplayOFF** is indicated by a strikethrough of the type letter in the trace annotation panel in the Measurement Bar. A trace with **UpdateOFF** is indicated by dimming the type letter in the trace annotation panel in the Measurement Bar. In the example below, Traces 3, 4, 5 and 6 have **UpdateOFF**, and Traces 4 and 6 have **DisplayOFF**.

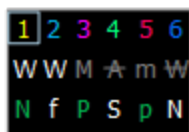

See: "[More Information](#)" on page 827

Notes	For the commands to control the two variables, Update and Display, see " Trace Update State On/Off " on page 826 and " Trace Display State On/Off " on page 826 below
Dependencies	When Signal ID is on, this key is grayed-out
Couplings	<p>Selecting a Trace Type for a trace (pressing the key or sending the equivalent command) puts the trace in Active (Update ON and Display ON), even if that trace type was already selected</p> <p>Selecting a detector for a trace (pressing the key or sending [:SENS] :DET :TRAC) puts the trace in Active (UpdateON and DisplayON), even if that detector was already selected</p> <p>Selecting a "Math Function" on page 828 other than OFF for a trace (pressing the key or sending the equivalent command) puts the trace in Active (UpdateON and DisplayON), even if that Math Mode was already selected</p> <p>Loading a trace from a file puts that trace in View regardless of the state it was in when it was saved; as does being the target of a Copy or a participant in an Exchange</p>

Trace Update State On/Off

Remote Command	<p>For Swept SA Measurement (in SA Mode):</p> <pre>:TRACe[1] 2 ... 6:UPDate[:STATe] ON OFF 1 0</pre> <pre>:TRACe[1] 2 ... 6:UPDate[:STATe]?</pre> <p>For all other measurements:</p> <pre>:TRACe[1] 2 3:<meas>:UPDate[:STATe] ON OFF 1 0</pre> <pre>:TRACe[1] 2 3:<meas>:UPDate[:STATe]?</pre> <p>where <meas> is the identifier for the current measurement</p>
Example	<p>Make trace 2 inactive (stop updating):</p> <pre>:TRAC2:UPD 0</pre>
Couplings	Whenever you set Update to ON for any trace, the Display is set to ON for that trace
Preset	<p>For Swept SA Measurement (in SA Mode):</p> <pre>1 0 0 0 0 0</pre> <p>ON for Trace 1; OFF for 2–6</p> <p>For all other measurements:</p> <pre>1 0 0</pre> <p>ON for Trace 1; OFF for 2 & 3</p>
State Saved	Saved in instrument state

Trace Display State On/Off

Remote Command	<p>For Swept SA Measurement (in SA Mode):</p> <pre>:TRACe[1] 2 ... 6:DISPly[:STATe] ON OFF 1 0</pre> <pre>:TRACe[1] 2 ... 6:DISPly[:STATe]?</pre> <p>For all other measurements:</p>
----------------	--

	<pre>:TRACe[1] 2 3:<meas>:DISPlay[:STATe] ON OFF 1 0</pre> <pre>:TRACe[1] 2 3:<meas>:DISPlay[:STATe]?</pre> <p>where <meas> is the identifier for the current measurement</p>
Example	<p>Make trace 1 visible:</p> <pre>:TRAC2:DISP 1</pre> <p>Blank trace 3:</p> <pre>:TRAC3:DISP 3</pre>
Couplings	Whenever you set Update to ON for any trace, the Display is set to ON for that trace
Preset	<p>For Swept SA Measurement (in SA Mode):</p> <pre>1 0 0 0 0 0</pre> <p>ON for Trace 1; OFF for 2–6</p> <p>For all other measurements:</p> <pre>1 0 0</pre> <p>ON for Trace 1; OFF for 2 & 3</p>
State Saved	Saved in instrument state

More Information

When a trace becomes inactive, any update from the **:SENSe** system (detectors) immediately stops, without waiting for the end of the sweep. The trace data remains unchanged, but stops updating. If the trace is blanked, this still does not affect the data in the trace. Traces that are blanked (**Display=OFF**) do not display nor appear on printouts, but their data stays intact, they may be queried, and markers may be placed on them

In most cases, inactive traces are static and unchanging; however, there are cases when an inactive trace will update, specifically:

- if data is written to that trace from remote
- if trace data is loaded from mass storage
- if the trace is the target of a **Copy** or participant in an **Exchange**
- if the trace is cleared using **Clear Trace**

Inactive traces that are also being displayed (traces in **View**) are displayed at half intensity. Traces in **View** display across the entire X-Axis of the instrument. Their horizontal placement does not change, even if X-Axis settings subsequently are changed, although Y-Axis settings do affect the vertical placement of data.

When a trace becomes active (**Update=ON**), the trace is cleared, the average count is reset, and a new sweep is initiated.

Note that putting a trace into **Display=OFF** and/or **Update=OFF** does *not* restart the sweep and does *not* restart Averaging or Hold functions for any traces.

3.7.10.3 Math

Lets you turn on and configure Trace Math functions.

Math Function

Trace Math functions perform mathematical operations between traces and, in some cases, user-specified offsets. When in a Trace Math function, the indicated function is performed during the sweep with the math function used in place of a detector. The trace operands for the math function are set using the "[Operand 1 / Operand 2](#)" on [page 834](#) controls.

- See "[How trace math is processed](#)" on [page 832](#)

Remote Command For option details, see "[Trace Math Options](#)" on [page 830](#)

For Swept SA Measurement (in SA Mode):

```
:CALCulate:MATH <trace_num>, PDIFference | PSUM | LOFFset | LDIFference | OFF, <trace_num>, <trace_num>, <real>,<real>
```

```
:CALCulate:MATH? <trace_num>
```

where <trace_num> is any one of:

```
TRACE1|...|TRACE6
```

For all other measurements:

```
:CALCulate:<meas>:MATH <trace_num>, PDIFference | PSUM | LOFFset | LDIFference | OFF, <trace_num>, <trace_num>, <real>,<real>
```

```
:CALCulate[:<meas>]:MATH? <trace_num>
```

where:

<meas> is the identifier for the current measurement, and

<trace_num> is any one of:

```
TRACe1|TRACe2|TRACe3
```

Note that the format of the **TRACe<n>** parameter differs from that for the Swept SA Measurement

Example

```
:CALC:MATH TRACE3,PDIF,TRACE1,TRACE2,0,0
```

Sets Trace 3 to Power Diff trace math function, and sets the First Trace operand (for Trace 3) to Trace 1 and the Second Trace operand (for Trace 3) to Trace 2

```
:CALC:MATH TRACE3,PSUM,TRACE1,TRACE2,0,0
```

Sets Trace 3 to Power Sum trace math function and sets the First Trace operand (for Trace 3) to Trace 1 and the Second Trace operand (for Trace 3) to Trace 2

```
:CALC:MATH TRACE3,LOFF,TRACE1,TRACE2,-6.00,0
```

3 Bluetooth Mode
 3.7 Occupied BW Measurement

	<p>Sets Trace 3 to Log Offset trace math function, sets the First Trace operand (for Trace 3) to Trace 1, leaves the Second Trace operand (for Trace 3) unchanged (it is irrelevant for this function) and sets the Log Offset (for Trace 3) to -6 dB</p> <p><code>:CALC:MATH TRACE3,LDIF,TRACE1,TRACE2,0,-6.00</code></p> <p>Sets Trace 3 to Log Diff trace math function, sets the First Trace operand (for Trace 3) to Trace 1, sets the Second Trace operand (for Trace 3) to Trace 2, and sets the Log Difference reference (for Trace 3) to -6 dBm</p> <p><code>:CALC:MATH TRACE1,OFF,TRACE2,TRACE3,0,0</code></p> <p>Turns off trace math for trace 1</p>
Notes	<p>The Trace Math Function command has 6 main set of parameters:</p> <ul style="list-style-type: none"> - Set 1 defines the “result trace”: <code>TRACE1 ... TRACE6</code> -Set 2 defines the “function”: <code>PDIFference PSUM LOFFset LDIFference OFF</code> - Set 3 is a “trace operand” (1): <code>TRACE1 ... TRACE6</code> - Set 4 is a “trace operand” (2): <code>TRACE1 ... TRACE6</code> - Set 5 defines the “Log Offset” (in dB) - Set 6 defines the “Log Difference Reference” (in dBm) <p>Note that the trace math mode is an enumeration; that is, when a math function is set for a trace, it turns off any math function that is on for that trace, then sets the new math function</p> <p>The parameters sent in the command are reflected in the values in the control menu. There is no default for any parameter; all 6 parameters must be sent to satisfy the parser. Failure to specify a parameter will result in a missing parameter message</p> <p>The query returns the math mode, the operand traces, the offset and the reference for the specified trace, all separated by commas</p>
Dependencies	<p>Trace Math is not available if Normalize is on</p> <p>Trace Math is not available if Signal ID is on</p> <p>None of the trace operands can be the destination trace. If any of the three trace math commands is sent with a destination trace number matching one of the operands, a warning is generated and the function does not turn on</p>
Couplings	<p>When a math function is changed for a trace, that trace is set to Display = ON; and Update = ON</p>
Preset	<p>For Swept SA Measurement (in SA Mode):</p> <p><code>OFF,TRACE5,TRACE6,0,0 OFF,TRACE6,TRACE1,0,0 OFF,TRACE1,TRACE2,0,0 </code> <code>OFF,TRACE2,TRACE3,0,0 OFF,TRACE3,TRACE4,0,0 OFF,TRACE4,TRACE5,0,0</code></p> <p>For all other measurements:</p> <p><code>OFF,TRACE2,TRACE3,0,0 OFF,TRACE3,TRACE1,0,0 OFF,TRACE1,TRACE2,0,0</code></p>
State Saved	<p>The trace math function for each trace is saved in instrument state</p>
Annunciation	<p>An “f” is shown on the trace annunciation panel in the Measurement Bar when a math function is on;</p>

	and the function is annotated on the trace if Trace Annotation is on
Status Bits/OPC dependencies	*OPC can be used to detect the completion of a sweep, which will also correspond to the completion of the math operation, since all math takes place during the sweep

Trace Math Options

IMPORTANT

To generate a trace math result, *you must take a sweep*. The trace math engine, described below, operates in concert with the sweep engine in the instrument. Until a sweep has been taken, even if the constituent traces are not in Update mode, no result is generated.

Note that certain events can affect the trace in ways that affects all points at once. This can happen in any number of ways, including:

- A trace clear taking place
- A trace being loaded from the file system
- Trace data being sent in from the remote interface
- A copy or exchange of trace data

You should try to avoid these occurrences during a sweep, as they will tend to invalidate the math result being accumulated.

The Trace Math functions are:

Power Diff (Op1 - Op2)

Calculates a power difference between the **First Trace** operand and the **Second Trace** operand and puts the result in the destination trace.

During the sweep, the following formula is executed for each point in the trace operands, and the corresponding point is generated for the destination trace:

$$\text{DestinationTrace} = 10 \log_{10}(10^{(1/10)(\text{FirstTrace})} - 10^{(1/10)(\text{SecondTrace})})$$

The values of the trace points are assumed to be in a decibel scale, as they are internally stored.

If a point in **FirstTrace** is equal to **maxtracevalue**, the resultant point is also **maxtracevalue**.

Otherwise, if the result of the subtraction is less than or equal to 0, the resultant point is **mintracevalue**.

Power Sum (Op1 + Op2)

Calculates a power sum between the **First Trace** operand and the **Second Trace** operand and puts the result in the destination trace.

During the sweep, the following formula is executed for each point in the trace operands, and the corresponding point is generated for the destination trace.

$$\text{DestinationTrace} = 10 \log(10(1/10)(\text{FirstTrace}) + 10(1/10)(\text{SecondTrace}))$$

The values of the trace points are assumed to be in a decibel scale, as they are internally stored.

If a point in either trace operand is equal to **maxtracevalue**, the resultant point is also **maxtracevalue**.

Log Offset (Op1 + Offset)

Calculates a log offset from the **First Trace** operand and puts the result in the destination trace. This is like the B-DL function in some older instruments. The offset is entered on the **Offset** control, which only appears when this math function is in force for the selected trace. Each destination trace has its own offset.

During the sweep, the following formula is executed for each point in the trace operand, and the corresponding point is generated for the destination trace.

$$\text{DestinationTrace} = \text{FirstTrace} + \text{Offset}$$

The values of the trace points are assumed to be in dBm (as they are internally stored) and the offset is in dB.

If a point in the trace operand is equal to **maxtracevalue**, the resultant point is also **maxtracevalue**.

If a point in the trace operand is equal to **mintracevalue**, the resultant point is also **mintracevalue**.

Example: If offset is 25 dB, then our destination trace will be higher than the operand trace by 25 dB.

Note that the **Second Trace** operand is not used for this function.

Log Diff (Op1 - Op2 + Ref)

Offsets the difference between the **First Trace** operand and the **Second Trace** operand by a reference and puts the result in the destination trace. This is like the A-B+DL function in some older instruments. The Reference is entered on the **Reference** control, which only appears when this math function is in force for the selected trace. Each destination trace has its own reference.

Offsets the difference between the **First Trace** operand and the **Second Trace** operand by a reference and puts the result in the destination trace. This is like the A-

B+DL function in some older instruments. The Reference is entered on the **Reference** control, which only appears when this math function is in force for the selected trace. Each destination trace has its own reference.

During the sweep, the following formula is executed for each point in the trace operands, and the corresponding point is generated for the destination trace.

$$\text{DestinationTrace} = (\text{FirstTrace} - \text{SecondTrace}) + \text{Reference}$$

The values of the operand trace points are assumed to be in decibel units (as they are internally stored) and the reference is in dBm so the result is in dBm.

Example: If the first operand trace 1 is at 5 dBm, the second operand trace 2 is at -5 dBm, and the reference is -25 dBm, then the destination trace will be -15 dBm.

Example: If the first operand trace 1 is at 60 dBuV, the second operand trace 2 is at 50 dBuV, and the reference is 35 dBuV, then the destination trace will be 45 dBuV.

If a point in **FirstTrace** is equal to **maxtracevalue**, the resultant point is also **maxtracevalue**.

If a point in **FirstTrace** is equal to **mintracevalue**, the resultant point is also **mintracevalue**.

If neither of the above is true for a given point, then:

- If that point in **SecondTrace** is equal to **maxtracevalue**, the resultant point is **mintracevalue**.
- If that point in **SecondTrace** is equal to **mintracevalue**, the resultant point is **maxtracevalue**.

How trace math is processed

Whenever a trace math function is turned on, or the parameters and/or operands of an existing trace math function are changed, the destination trace is cleared. After the trace is cleared, all x-axis values in the trace, and the domain of the trace, are set to match the X-Axis settings of the first trace operand. When this is complete, a new sweep is initiated.

The process of acquiring data, processing it using the math and Average/Hold functions, and presenting it as trace data, consists of several functional blocks, as shown below:

3 Bluetooth Mode
 3.7 Occupied BW Measurement

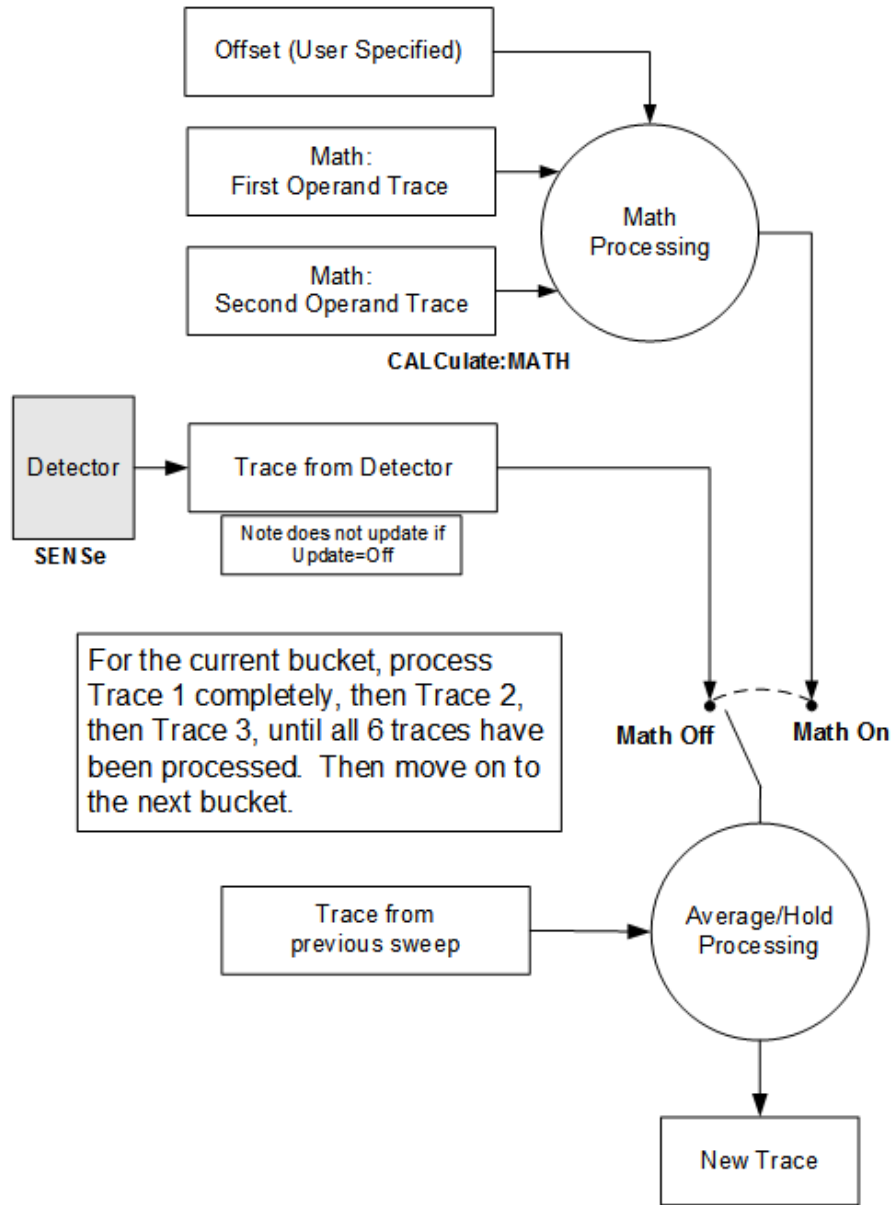

NOTE ABOUT OFFSETS: When either External Gain or Ref Level Offset is on, an offset is applied to the trace operands, and when Trace Math is on this offset is applied before any math processing is performed. Since the operands have already been offset the result trace should NOT be offset. Therefore when any Trace Math operation is performed, the sum of (External Gain - Ref Level Offset) is added to the result before it is stored in the result trace.

For each active trace, the current trace point is processed for **Trace 1**, then **Trace 2**, then **Trace 3**, etc. Trace data is taken from either the detector for that trace, or

from the mathematical result of up to two other traces and an offset, depending on whether trace math is on or not. The resultant data is then fed to the Average/Hold processing block, where (if the trace type is **Average**, **Max Hold**, or **Min Hold**) it is processed with previous trace data. The new trace data resulting from this process is then available for display, storage or remote output.

When the processing is complete for **Trace 1**, **Trace 2** is processed, and so on until all six traces have been processed. This allows a downstream trace to use as one of its math components a fully processed upstream trace. In other words, if math is **ON** for **Trace 4**, and its operand traces are **Trace 2** and **Trace 3**, then all detector, math, average and hold processing for Traces 2 and 3 is completed before the math is performed for **Trace 4**. When the current trace point is completed for all traces, the instrument moves on to the next trace point.

This allows very flexible and powerful math functions to be configured. For example, **Trace 1** can be an average trace, which can be fed with an offset to **Trace 2**, which can also be in **Max Hold**, allowing you to obtain the **Max Hold** of an Average trace.

Note that none of this processing is performed on inactive traces.

Note also that for any active trace with math **ON**, the Operand traces should have *lower* numbers than the trace (for example, using **Trace 4** as an operand for **Trace 1** will cause the data coming from **Trace 4** to be delayed by one sweep).

Operand 1 / Operand 2

These two controls select the first and second trace operands to be used for the trace math functions for the destination trace. The operands are common to all math functions for a given trace. The most recently sent **:CALCulate:MATH** command for a given trace sets the operands for that trace. Those settings are displayed on the trace operand controls for that trace.

Example	<p>The following examples are for the Swept SA measurement</p> <p>Set Trace 3 to Power Diff trace math function. Set the First Trace operand (for Trace 3) to Trace 1 and the Second Trace operand (for Trace 3) to Trace 2:</p> <pre>:CALC:MATH TRACE3,PDIF,TRACE1,TRACE2,0,0</pre> <p>Set Trace 3 to Log Offset trace math function. Set the First Trace operand (for Trace 3) to Trace 1, leave the Second Trace operand (for Trace 3) unchanged (it is irrelevant for this function) and set the Log Offset (for Trace 3) to -6 dB:</p> <pre>:CALC:MATH TRACE3,LOFF,TRACE1,TRACE2,-6.00,0</pre>
Notes	See " Math Function " on page 828 for how to specify Operands 1 and 2 using :CALCulate:MATH
Dependencies	The destination trace cannot be an operand. The destination trace number is grayed-out on the dropdown
Preset	Operand 1: Trace number minus 2 (wraps at 1). For example, for Trace 1, Operand 1 presets to Trace

	5; for Trace 6, it presets to Trace 4 Operand 2: Trace number minus 1 (wraps at 1). For example, for Trace 1, Operand 2 presets to Trace 6; for Trace 6, it presets to Trace 5
State Saved	Operands 1 and 2 for each trace are stored in instrument state

Offset

Used by the Log Offset math function.

Example	The following example is for the Swept SA measurement Set Trace 3 to Log Offset trace math function, set the First Trace operand (for Trace 3) to Trace 1, leave the Second Trace operand (for Trace 3) unchanged (it is irrelevant for this function) and set the Log Offset (for Trace 3) to -6 dB: <code>:CALC:MATH TRACE3,LOFF,TRACE1,TRACE2,-6.00,0</code>
State Saved	The Log Offset value for each trace is saved in Instrument State
Min	-100 dB
Max	100 dB

Reference

Used by the Log Diff math function.

Example	The following example is for the Swept SA measurement Set Trace 3 to Log Diff trace math function, set the First Trace operand (for Trace 3) to Trace 1, set the Second Trace operand (for Trace 3) to Trace 2, and set the Log Difference reference (for Trace 3) to -6 dBm: <code>:CALC:MATH TRACE3,LDIF,TRACE1,TRACE2,0,-6.00</code>
State Saved	The Log Difference reference value for each trace is saved in instrument state
Min/Max	Same as reference level

3.7.10.4 Detector

Lets you select and configure detectors for the specified trace.

Detector

Selects a detector to be used by the instrument for the current measurement. The following selections are available:

Option	Behavior
<code>AUTO</code>	The detector selected depends on marker functions, trace functions, average type,

Option	Behavior
	and the trace averaging function For details, see " Detector Select Auto/Man " on page 837
NORMal	The detector determines the peak of the CW-like signals, and it yields alternating maximums and minimums of noise-like signals. This is also referred to as Rosenfell detection
AVERage	The detector determines the average of the signal within the sweep points, using RMS averaging
POSitive Peak	The detector determines the maximum of the signal within the sweep points
SAMPle	The detector indicates the instantaneous level of the signal at the center of the sweep points represented by each display point
NEGative Peak	The detector determines the minimum of the signal within the sweep points
RMS	Equivalent to AVERage

Because they may not find a spectral component's true peak, neither **AVERage** nor **SAMPle** detectors measure amplitudes of CW signals as accurately as **POSitivePeak** or **NORMal**, but they do measure noise without the biases of peak detection.

Remote Command `[[:SENSe]:OBWidth:DETEctor[:FUNction] NORMal | AVERage | POSitive | SAMPle | NEGative | RMS
[:SENSe]:OBWidth:DETEctor[:FUNction]?`

Example `:OBW:DET NORM`
`:OBW:DET?`
Set the detector to **Average**. **Average** uses RMS averaging, so this is equivalent to selecting an **RMS** detector:
`:OBW:DET RMS`

Notes The query returns a name that corresponds to the detector type, as follows
The **RMS** selection sets the detector type to **AVERage**, with RMS averaging. Therefore, if **RMS** had been selected, the query returns **AVER**

String Returned	Definition
NORM	Normal
AVER	Average (RMS)
POS	Peak
SAMP	Sample
NEG	Negative Peak

Couplings When "[Detector Select Auto/Man](#)" on page 837 is **ON**, the values returned by the query depend on the setting of "[Trace Type](#)" on page 820 as follows:

	Trace Type	Query Returns:
	WRITE	NORMAL
	AVERAGE	AVERAGE
	MAXHOLD	POSITIVE
	MINHOLD	NEGATIVE
Preset	AVERAGE	
State Saved	Saved in instrument state	
Range	NORMAL AVERAGE POSITIVE SAMPLE NEGATIVE RMS	

Detector Select Auto/Man

Sets the Detector mode to **Auto (ON)** or **Man (OFF)**. In **Auto**, the proper detector is chosen based on rules that take into account the measurement settings and other instrument settings.

When you select any "Detector" on page 835 manually, this setting reverts automatically to **Man** (manual).

Remote Command	[:SENSe]:OBWidth:DETECTOR:AUTO ON OFF 1 0	
	[:SENSe]:OBWidth:DETECTOR:AUTO?	
Example	:OBW:DET:AUTO ON	
	:OBW:DET:AUTO?	
Couplings	When ON , the query "Detector" on page 835 returns values that depend on the setting of "Trace Type" on page 820 as follows:	
	Trace Type	Query Returns:
	WRITE	NORMAL
	AVERAGE	AVERAGE
	MAXHOLD	POSITIVE
	MINHOLD	NEGATIVE
Preset	ON	
State Saved	Yes	

3.7.10.5 Trace Function

Contains controls to:

- Copy and Exchange traces
- Preset or Clear all traces

From Trace

Selects the trace to be copied to or exchanged with the **"To Trace" on page 838** when a **"Copy" on page 838** or **"Exchange" on page 839** is performed

Preset 1

To Trace

Selects the trace to be copied from or exchanged with the **"From Trace" on page 838** when a **"Copy" on page 838** or **"Exchange" on page 839** is performed

Preset 2

Copy

Executes a Trace Copy based on the **"From Trace" on page 838** and **"To Trace" on page 838** parameters. The copy operation is from the **From Trace** to the **To Trace**. The action is performed once.

The X-Axis settings and domain of a trace are also copied.

Remote Command For Swept SA Measurement (in SA Mode):
`:TRACe:COPIY TRACE1 | ... | TRACE6, TRACE1 | ... | TRACE6`
 For all other measurements:
`:TRACe:<meas>:COPIY TRACe1 | TRACe2 | TRACe3, TRACe1 | TRACe2 | TRACe3`
 where `<meas>` is the identifier for the current measurement
 Note that the format of the `TRACe<n>` parameter differs from that for the Swept SA Measurement

Example Copy Trace 1 to Trace 3 and put Trace 3 in Update=Off, Display=On
`:TRAC:COPIY TRACE1, TRACE3`

Notes The command is of the form:
`:TRACe:COPIY <source_trace>, <dest_trace>`

Dependencies When Signal ID is on, this key is grayed-out

Couplings The destination trace is put in **View** (Update = Off, Display = On) after the copy

Preset For Swept SA Measurement (in SA Mode):
`TRACE1, TRACE2`
 For all other measurements:
`TRACe1, TRACe2`

Exchange

Executes a Trace Exchange based on the "From Trace" on page 838 and "To Trace" on page 838 parameters. The **From Trace** and **To Trace** values are exchanged with each other. The action is performed once.

The X-Axis settings and domain of a trace are also copied when it is exchanged with another trace.

Remote Command	<p>For Swept SA Measurement (in SA Mode): <code>:TRACe:EXCHange TRACE1 ... TRACE6, TRACE1 ... TRACE6</code></p> <p>For all other measurements: <code>:TRACe:<meas>:EXCHange TRACe1 TRACe2 TRACe3, TRACe1 TRACe2 TRACe3</code></p> <p>where <code><meas></code> is the identifier for the current measurement</p> <p>Note that the format of the <code>:TRACe<n></code> parameter differs from that for the Swept SA Measurement</p>
Example	<p>Exchange Trace 1 and Trace 2 and put both traces in Update=OFF, Display=ON: <code>:TRAC:EXCH TRACE1, TRACE2</code></p>
Notes	<p>The command is of the form: <code>:TRACe:EXCHange <trace_1>, <trace_2></code></p>
Couplings	Both traces are put in View (Update=Off, Display=On) after the exchange

Preset All Traces

Turns on Trace 1 and blanks all other traces. This is useful when you have many traces on and you want to return to having only Trace 1 on the display. Does not affect the trace type, detector or any other aspect of the trace system.

Remote Command	<code>:TRACe[:<meas>]:PRESet:ALL</code>
Example	<code>:TRAC:PRE:ALL</code>
Dependencies	When Signal ID is on, this key is grayed-out

Clear All Traces

Clears all traces. Does not affect the state of any function or variable in the instrument. Loads `mintracevalue` into all of the points for all traces, except traces in **Min Hold**, in which case it loads `maxtracevalue`, even if **Update = OFF**.

Remote Command	<code>:TRACe[:<meas>]:CLEAr:ALL</code>
Example	<code>:TRAC:CLE:ALL</code>
Dependencies	When Signal ID is on, this key is grayed-out

3.7.10.6 Advanced

Contains controls for setting advanced trace functions of the instrument.

Measure Trace

Specifies which trace's scalar results are displayed in the **Metrics** window, and retrieved by sending a **:READ** or **:FETCh** query:

- Trace 1
- Trace 2
- Trace 3

Remote Command	<pre>:CALCulate:<meas>:MTRace TRACe1 TRACe2 TRACe3 :CALCulate:<meas>:MTRace? <meas> is the identifier for the current measurement; any one of CHPower ACPower OBWidth SEMask SPURious PVTime</pre>
Example	<pre>Channel Power :CALC:CHP:MTR TRAC1 :CALC:CHP:MTR?</pre>
Dependencies	In the ACP measurement, this control is grayed-out when Meas Method is set to RBW or FAST , and only Trace 1 is enabled
Preset	TRACe1
State Saved	No
Range	Trace 1 Trace 2 Trace 3

4 System



The **System** hardkey and the “gear” icon both open the **System Settings** dialog, which allows you to access various configuration menus and dialogs. The line of tabs down the left side let you choose various pages for configuring your instrument.

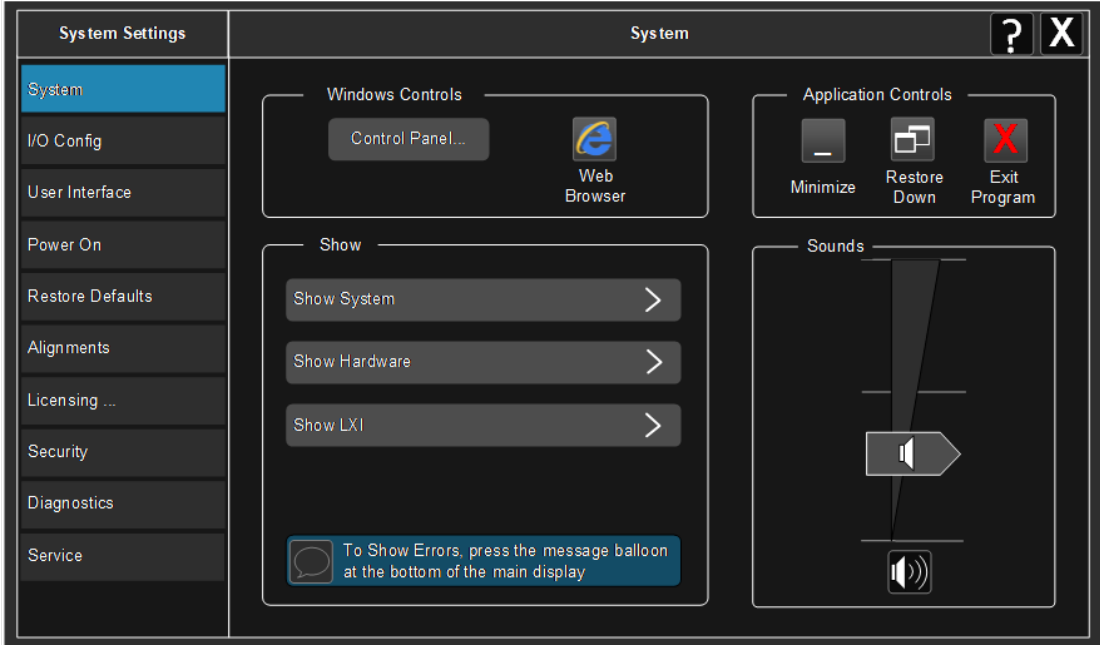

Notes No remote command for this key specifically

4.1 System

Allows access to several general system functions, including three **Show** screens for viewing system parameters. Several such **Show** screens are available on this and other **System** menu pages. They can also be accessed with the SCPI command described here.

Remote Command	:SYSTem:SHOW OFF ERRor SYSTem HARDware LXI HWSTatistics ALIGNment SOFTware CAPPligation :SYSTem:SHOW?
Example	:SYST:SHOW SYST
Notes	Displays (or exits) the System information screens
Preset	OFF
State Saved	No
Range	OFF ERRor SYSTem HARDware LXI HWSTatistics ALIGNment SOFTware CAPPligation

4.1.1 Show System

This screen is divided into three groups: product descriptive information, options tied to the hardware, and software products. Swipe up and down on this screen to scroll the display.

System Settings	< System	Show System
System	Keysight Technologies	Keysight UXA Signal Analyzer
I/O Config	Product Number	N9040B
User Interface	Serial Number	US00091133
Power On	Instrument S/W Revision	A.15.00_P0053
Restore Defaults	Revision Date	11/17/2014 11:37:12 AM
Alignments	Computer System	Windows 7 , Service Pack 1
Licensing ...	Computer Name	A-N9040B-91133
Security	IP Address	141.121.151.83
Diagnostics	IPv6 Address	2002:8d79:9753::8d79:9753
Service	Link-Local IPv6 Address	fe80::46e:1db5:7286:68ac%3
	Host ID	N9040B,US00091133
	mDNS Enabled	Yes
	mDNS Host Name	A-N9040B-91133
	mDNS Service Name	Keysight N9040B Signal Analyzer - US00091133
	Option	Name / Description
	N9040B-PC6	Intel(R) Core(TM) i7-3615QE CPU @ 2.30GHz, 16 GB
	N9040B-SSD	INTEL SSDSC2BB080G4 ATA DEVICE
	N9040B-W7X	Windows Embedded Standard 7, 64 bit OS

Example `:SYST:SHOW SYST`

4.1.1.1 Show System contents (Remote Query Only)

Returns the contents of the **Show System** screen (the entire contents, not just the currently displayed page).

Remote Command `:SYSTem:CONFigure[:SYSTem]?`

Example `:SYST:CONF?`

Notes The output is an IEEE Block format of the **Show System** contents. Each line is separated by a new-line character

4.1.1.2 Computer System description (Remote Query Only)

Returns the **Computer System** description, which consists of the operating system and patch level, as reported by operating system.

Remote Command `:SYSTem:CSYStem?`

Example `:SYST:CSYS?`

Notes Returns the Computer System name and service pack level

4.1.2 Show Hardware

Displays details of the installed hardware. This information can be used to determine versions of hardware assemblies and field-programmable devices, in the advent of future upgrades or potential repair needs.

The screen is divided into two groups: product descriptive information and hardware information. The hardware information is listed in a table format.

Example `:SYST:SHOW HARD`

4.1.3 Show LXI

Displays the product number, serial number, firmware revision, computer name, IP address, Host ID, LXI Class, LXI Version, MAC Address, and the Auto-MDIX Capability.

Example `:SYST:SHOW LXI`

4.1.4 Show Support Subscriptions

Displays the software support subscription information for the licenses available on the instrument.

Shows the software license, description, software support expiration date (format is **YYYY.MMDD**), and the software support status. The **Software Version Date** (format is **YYYY.MMDD**) shown in the header indicates the date required to access the latest software enhancements included in this version of the software. If any license has a **Software Support Expiration Date** earlier than the **Software Version Date**, then enhancements may be available that the license does *not* enable.

System Settings	System		Support Subscriptions
System	Keysight PXA	Keysight PXA Signal Analyzer	
	Product Number	N9030A	
	Instrument S/W Revision	A.20.10	
	Software Version Date	2017.1221	
I/O Config	Software License	Description	Software Support Expiration Date
User Interface	N6141EM0E-1FP	EMC Software for X-Series	2018.0430 ✓
Power On	N9030EMCA-1FP	Basic Electro-Magnetic Compatibility Functionality	2018.0430 ✓
Restore Defaults	N9030FP2A-1FP	Fast Power Measurements, up to 40 MHz bandwidth	2018.0430 ✓
Alignments	N9030FT2A-1FP	Frequency Mask Trigger >3.6 us signal duration	2018.0430 ✓
Licensing	N9030RBEA-1FP	RBW Extended, >10 MHz RBW Filter	2018.0430 ✓
Security	N9030RT2A-1FP	Real-time analysis up to maximum BW, optimum detection	2018.0430 ✓
Diagnostics	N9030TDSA-1FP	Time Domain Scan, requires N6141A/C, and DP2 or B40	2018.0430 ✓
Service	N9054EM0E-1FP	Flexible Digital Demod App, VMA	2018.0430 ✓
Debug	N9054EM1E-1FP	Custom OFDM App, VMA	2018.0430 ✓
	N9061EM0E-1FP	Remote Language Compatibility	2018.0430 ✓
	N9062EM0E-1FP	RS FSP, FSU, FSE, ESU SCPI Language Compatibility	2018.0430 ✓
	N9063EM0E-1FP	Analog Demod Measurement Application	2018.0430 ✓
	N9067EM0E-1FP	Pulse Application	2018.0430 ✓
	N9068EM0E-1FP	Phase Noise Measurement Application	2018.0430 ✓
	N9069EM0E-1FP	Noise Figure Measurement Application	2018.0430 ✓
	N9071EM0E-1FP	GSM/EDGE Measurement Application	2018.0430 ✓
	N9074EM0E-1FP	Single App Combined GSM/EDGE Measurements	2018.0430 ✓

Example `:SYST:SHOW SSINformation`

4.1.5 Show Support ID

Displays the Support ID for each license available in the instrument. Shows the **Software License**, **Description**, software support expiration date, and **Support ID** for that license.

Each license has a copy icon, which copies just the **Support ID** for that license to the Windows clipboard. This is useful to avoid typing mistakes when entering this value into another program or web site.

The **Copy all to clipboard ...** control copies all the data to the Windows clipboard, in comma-separated value (CSV) format.

System Settings	System	Support ID
System	Keysight PXA	Keysight PXA Signal Analyzer
	Product Number	N9030A
	Instrument S/W Revision	A.20.10
	Software Version Date	2017.1221
I/O Config	Software License	Description
User Interface	N6141EM0E-1FP	EMC Software for X-Series
Power On	N6141EM0E-1NP	EMC Software for X-Series (Network)
Restore Defaults	N9030EMCA-1FP	Basic Electro-Magnetic Compatibility Functi
Alignments	N9030FP2A-1FP	Fast Power Measurements, up to 40 MHz b
Licensing	N9030FT2A-1FP	Frequency Mask Trigger >3.6 us signal durc
Security	N9030RBEA-1FP	RBW Extended, >10 MHz RBW Filter
Diagnostics	N9030RT2A-1FP	Real-time analysis up to maximum BW, opti
Service	N9030TDSA-1FP	Time Domain Scan, requires N6141A/C, an
Debug	N9054EM0E-1FP	Flexible Digital Demod App, VMA
	N9054FM1F-1FP	Custom OFDM App, VMA

Copy all to clipboard ...

Example `:SYST:SHOW SID`

4.1.6 Control Panel...

Opens the Windows Control Panel. **Control Panel** is used to configure certain elements of Windows that are not configured via the Multitouch UI System menus.

NOTE This feature is *not* available if Option SF1 is installed.

Control Panel is a separate Windows application, so to return to the Instrument Application, either:

- Exit by tapping on the red **X** in the upper right-hand corner
- Use **Alt+Tab**. Press and hold the **Alt** key and press and release the **Tab** key until the Instrument logo is showing in the window in the center of the screen, then release the **Alt** key

Notes No remote command for this key

4.1.7 Web Browser

Launches the instrument's default **Web Browser**. Usually, the default is Microsoft Edge. A mouse and external keyboard are highly desirable for using the browser. To return focus to the Instrument Application, close the browser (or use **Alt-Tab**).

NOTE

This feature is *not* available if Option SF1 is installed.

4.1.8 Application Controls

Lets you Minimize or Exit the application.

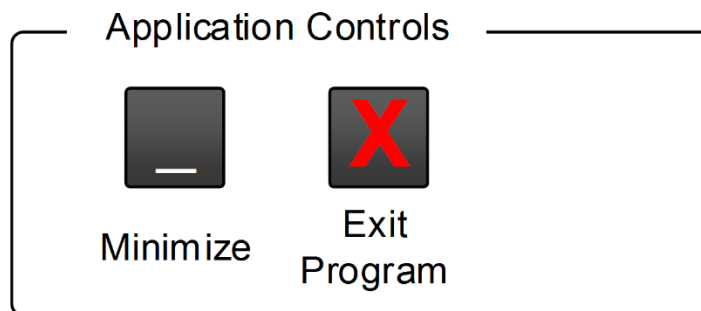

Pressing **Exit Program** displays a prompt asking if you are sure you want to close the program. If you select **OK**, the entire analyzer application will shut down, and you will lose any unsaved trace or measurement data.

Notes

No equivalent remote command for this key

4.1.9 Sounds

Lets you adjust the speaker volume using the slider, or mute/unmute the speaker, by tapping the **Speaker** icon.

Moving the slider up and down changes the speaker volume, and *also* unmutes the speaker if muted.

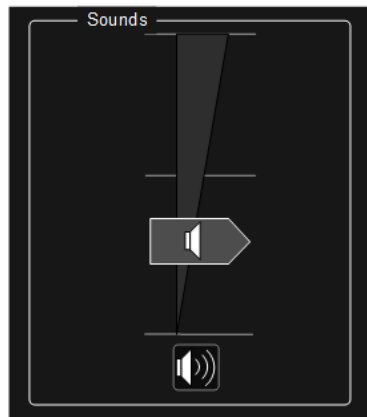

4.2 I/O Config

Allows you to specify and change the I/O configuration for remote control. Controls in this menu allow configuration of the I/O ports used for SCPI remote control over GPIB and LAN.

The SCPI LAN parameters are set using controls in this menu, but configuration of LAN settings themselves is performed using the Windows Control Panel (DHCP, Gateway, Subnet Mask, etc.).

The USB port is also available for remote control, but requires no configuration.

4.2.1 GPIB

Allows you to configure the GPIB I/O port.

Dependencies	Not available in UXM
--------------	----------------------

4.2.1.1 GPIB Address

Select the GPIB remote address.

Remote Command	<code>:SYSTem:COMMunicate:GPIB[1][:SELF]:ADDRess <integer></code>
Example	<code>:SYST:COMM:GPIB:ADDR 17</code>
Notes	If the GPIB port address is changed, all further communication must use the <i>new</i> address
Preset	Unaffected by Preset , but set to 18 by Restore Defaults > "Misc" on page 896
State Saved	No
Min	0
Max	30

4.2.1.2 GPIB Controller

Sets the GPIB port into Controller (**ON**) or Device (**OFF**) mode. In the normal state, **GPIB Controller** is disabled (**OFF**), which allows the instrument to be controlled by a remote computer. When **GPIB Controller** is enabled (**ON**), the instrument can run software applications that use the instrument's computer as a GPIB controller for devices connected to the GPIB port.

NOTE

When **GPIB Controller** is enabled, the analyzer application itself cannot be controlled over GPIB. In this case, it can be controlled via LAN or USB. The GPIB port cannot be a Controller and Device at the same time. Only one Controller can be active on the GPIB bus at any given time. If the instrument is the Controller, an external PC cannot also be a Controller.

To control the instrument from the software that is performing GPIB Controller operation, you can use an internal TCP/IP connection to the analyzer application. Use the following IP Address to send commands to the analyzer application:

```
TCPIP0:localhost:inst0:INSTR
```

Remote Command	<code>:SYSTem:COMMunicate:GPIB[1][:SELF]:CONTroller[:ENABLE] ON OFF 0 1</code> <code>:SYSTem:COMMunicate:GPIB[1][:SELF]:CONTroller[:ENABLE]?</code>
Example	Set GPIB port to Controller: <code>:SYST:COMM:GPIB:CONT ON</code> Set GPIB port to Device: <code>:SYST:COMM:GPIB:CONT OFF</code>
Notes	When the instrument becomes the Controller, Bit 0 in the Standard Event Status Register is set. When the instrument relinquishes Controller capability, bit 0 is cleared
Preset	Unaffected by Preset, but set to OFF (Disabled) by Restore Defaults > "Misc" on page 896
State Saved	No
Range	Disabled Enabled

4.2.2 SCPI LAN

Displays a menu for identifying and changing SCPI over a LAN configuration. There are several ways to send SCPI remote commands to the instrument over LAN.

Having multiple users simultaneously accessing the instrument over the LAN may lead to communication problems. These controls can help to prevent that, by disabling the telnet, socket, and/or SICL capability.

NOTE

When multiple instances of the application are running, Telnet port 5023, socket port 5025, SICL server inst0 and HiSLIP server Device 0 will be assigned to the first instance; Telnet port 5123, socket port 5125, SICL server inst1 and HiSLIP server Device 1 will be assigned to the second instance; Telnet port 5223, socket port 5225, SICL server inst2 and HiSLIP server Device 2 will be assigned to the third instance; Telnet port 5323, socket port 5325, SICL server inst3 and HiSLIP server Device 3 will be assigned to the fourth instance.

- "SCPI Telnet" on page 850
- "SCPI Socket" on page 850
- "SICL Server" on page 851
- "HiSLIP Server" on page 852
- "Verbose SCPI On/Off" on page 852
- "SCPI Socket Control Port (Remote Query Only)" on page 854

4.2.2.1 SCPI Telnet

Turns SCPI LAN telnet capability On or Off, allowing you to limit SCPI access over LAN through telnet.

Remote Command	<code>:SYSTem:COMMunicate:LAN:SCPI:TELNet:ENABle OFF ON 0 1</code> <code>:SYSTem:COMMunicate:LAN:SCPI:TELNet:ENABle?</code>
Example	<code>:SYST:COMM:LAN:SCPI:TELN:ENAB OFF</code>
Preset	Unaffected by Preset , but set to ON by Restore Defaults > "Misc" on page 896 If not set up or specified, the Secure Instrument Communications configuration setting: is ON
State Saved	No
Range	OFF ON

4.2.2.2 SCPI Socket

Turns the capability to establish Socket LAN sessions **ON** or **OFF**, to limit SCPI access over LAN through socket sessions.

Connection String & Copy Button

In "SCPI LAN" on page 849, the full SCPI connection string is displayed to the right of the **SCPI Socket ON/OFF** control. Pressing **Copy**, to the right of the string, copies the connection string to the Windows clipboard.

Remote Command	<code>:SYSTem:COMMunicate:LAN:SCPI:SOCKet:ENABle OFF ON 0 1</code> <code>:SYSTem:COMMunicate:LAN:SCPI:SOCKet:ENABle?</code>
Example	<code>:SYST:COMM:LAN:SCPI:SOCK:ENAB OFF</code>
Dependencies	If the Secure Instrument Communications configuration has disabled this connection, local changes are not allowed, and an attempt to do so results in error -221, "Disabled by Secure Instrument Communications configuration"

Preset	Unaffected by Preset , but set to ON by Restore Defaults > "Misc" on page 896 If not set up or specified, the Secure Instrument Communications configuration setting: is ON
State Saved	No
Range	OFF ON

4.2.2.3 SICL Server

Turns the **SICL Server** capability **ON** or **OFF**, to limit SCPI access over LAN through the SICL server. (SICL IEEE 488.2 protocol.)

Parameter	Description	Setting
Maximum Connections	The maximum number of connections that can be accessed simultaneously	5
Instrument Name	The name (same as the remote SICL address) of your instrument	inst0
Instrument Logical Unit	The unique integer assigned to your instrument when using SICL LAN	8
Emulated GPIB Name	The name (same as the remote SICL address) of the device used when communicating with your instrument	gpib7
Emulated GPIB Logical Unit	The unique integer assigned to your device when it is being controlled using SICL LAN	8
Emulated GPIB Address	The emulated GPIB address assigned to your transmitter tester when it is a SICL server (the same as your GPIB address)	18

Connection String & Copy Button

In "**SCPI LAN**" on page 849, the full connection string is displayed to the right of the **SICL Server ON/OFF** control. Pressing **Copy**, to the right of the string copies the connection string to the Windows clipboard.

Remote Command	:SYSTem:COMMunicate:LAN:SCPI:SICL:ENABle OFF ON 0 1 :SYSTem:COMMunicate:LAN:SCPI:SICL:ENABle?
Example	:SYST:COMM:LAN:SCPI:SICL:ENAB OFF
Dependencies	Not available in UXM If the Secure Instrument Communications configuration has disabled this connection, local changes are not allowed, and an attempt to do so results in error -221, "Disabled by Secure Instrument Communications configuration"
Preset	Unaffected by Preset , but set to ON by Restore Defaults > "Misc" on page 896 If not set up or specified, the Secure Instrument Communications configuration setting: is ON
State Saved	No
Range	OFF ON

4.2.2.4 HiSLIP Server

Turns the **HiSLIP Server** capability **ON** or **OFF**, to limit SCPI access over LAN through the HiSLIP server.

HiSLIP stands for High-Speed LAN Instrument Protocol, and is part of the IVI-6.1 specification.

Example of a VISA connection string used to connect to the HiSLIP Server on an X-Series Spectrum Analyzer:

```
TCPIP0::a-n9030a-93016::hislip0::INSTR
```

In the example above, **hislip0** is the HiSLIP device name that VISA users must include in HiSLIP VISA Address strings. Your HiSLIP device name may differ, depending on your VISA settings.

Connection String & Copy Button

In "**SCPI LAN**" on page 849, the full connection string is displayed to the right of the **HiSLIP Server ON/OFF** control. Pressing **Copy**, to the right of the string copies the connection string to the Windows clipboard.

Remote Command	<code>:SYSTem:COMMunicate:LAN:SCPI:HISLip:ENABle OFF ON 0 1</code>
Example	<code>:SYST:COMM:LAN:SCPI:HISL:ENAB OFF</code>
Preset	Unaffected by Preset , but set to ON by Restore Defaults >"Misc" on page 896 If not set up or specified, the Secure Instrument Communications configuration setting: is ON
State Saved	No
Range	OFF ON

4.2.2.5 Verbose SCPI On/Off

When you turn **Verbose SCPI ON**, additional information is returned by `:SYSTEM:ERRor?`. The additional information consists of the characters that stimulated the error. This can aid you in debugging your test programs, by indicating where in the parsing of a SCPI command the instrument encountered an invalid command or query.

Specifically, with **Verbose SCPI ON**, `:SYSTEM:ERRor?` is expanded to show the SCPI data received, with the indicator `<Err>` at the point in the stream that the error occurred.

Verbose SCPI has no effect on the **Show Errors** screen or front-panel Message Line; and only changes the response to `:SYST:ERR?`.

See the example below, where the invalid command `:SENS:BOGUS` is sent:

Normal response to `:SYST:ERR?` (using the Telnet window):

```
SCPI> SENS:BOGUS
SCPI> SYST:ERR?
-113,"Undefined header"
```

After turning on **Verbose SCPI**:

```
SCPI> SYST:BOGUS
SCPI> SYST:ERR?
-113,"Undefined header;SYST:BOGUS<Err>"
```

Remote Command	<code>:SYSTem:ERRor:VERBose OFF ON 0 1</code> <code>:SYSTem:ERRor:VERBose?</code>
Example	<code>:SYST:ERR:VERB ON</code>
Preset	Unaffected by Preset , but set to OFF by Restore Defaults > "Misc" on page 896
State Saved	No
Range	OFF ON

4.2.2.6 Device Clear on Disconnect

When using HiSLIP (High Speed LAN Instrument Protocol), Telnet, or Sockets, a communication session with the instrument is opened when you connect, and closed when you disconnect. This differs from other connections such as GPIB, USB and VXI-11 connections, which are never actually closed but stay open as long as the instrument is running.

When a session is closed, a Device Clear function is generated, which affects the entire instrument, not just the current connection. Thus, when using HiSLIP, Telnet, or Sockets, unexpected Device Clears may occur, which can disrupt measurements in ways that GPIB and VXI-11 "sessions" do not.

Device Clear on Disconnect enables these auto-generated Device Clears for Telnet, Socket, and HiSLIP sessions. For backwards compatibility, they are *not* generated unless you explicitly enable them.

There is no change in VXI-11, USB, or GPIB session behavior. These sessions do not close when you disconnect, have never generated Device Clear events, and still do not generate Device Clear events, regardless of the setting of this switch.

Remote Command	<code>:SYSTem:COMMunicate:LAN:SCPI:EOSession:DCLear:ENABLE 0 1 ON OFF</code> <code>:SYSTem:COMMunicate:LAN:SCPI:EOSession:DCLear:ENABLE?</code>
Example	<code>:SYST:COMM:LAN:SCPI:EOS:DCL:ENAB ON</code>
Preset	Unaffected by Preset , but set to OFF by Restore Defaults > "Misc" on page 896

State Saved	No
Range	OFF ON

4.2.2.7 SCPI Socket Control Port (Remote Query Only)

Returns the TCP/IP port number of the control socket associated with the SCPI socket session. This query lets you obtain the unique port number to open when a device clear is to be sent to the instrument. Every time a connection is made to the SCPI socket, the instrument creates a peer control socket. The port number for this socket is random. You must use this command to obtain the port number of the control socket. To force a device clear on this socket, open the port and send the string `DCL\n` to the instrument.

If this query is sent to a non-SCPI Socket interface, then 0 is returned.

Remote Command	<code>:SYSTem:COMMunicate:LAN:SCPI:SOCKet:CONTRol?</code>
Example	<code>:SYST:COMM:LAN:SCPI:SOCK:CONT?</code>
Preset	Unaffected by Preset or Restore Defaults > "Misc" on page 896
State Saved	No
Range	0 to 65534
Min	0
Max	65534
Backwards Compatibility SCPI	<code>:SYSTem:COMMunicate:TCPIp:CONTRol?</code>

4.2.2.8 SCPI Instrument Port (Remote Query Only)

Some MIMO applications need to be able to determine the port to use to communicate with the instrument. This query returns the port number to use for communications.

Remote Command	<code>:SYSTem:COMMunicate:LAN:INSTrument:PORT?</code>
-------------------	---

4.2.3 Web Password Reset

The embedded web server contains certain capabilities that are password-protected; modifying the LAN configuration of the instrument, and access to web pages that can change the settings of the instrument. The default password from the factory is:

`measure4u`

This control lets you set the web password as desired, or to reset the password to the factory default.

Selecting **Web Password Reset** displays a control for resetting the password as desired, or to the factory default. The built-in alpha keyboard appears. You may change the password from the factory default of “**measure4u**”.

You can cancel this entry by pressing the **Cancel (ESC)** front-panel key.

Dependencies Not available in UXM

4.2.4 System IDN Response

Allows you to specify a response to ***IDN?**, return the instrument to the **FACTory** response if you have changed it, or, if your test software is expecting the ***IDN** response to indicate Agilent Technologies, configure the instrument to respond with Agilent as the manufacturer.

The current ***IDN** response is displayed at the top of the panel, followed by the **System IDN Response** and **User IDN** controls.

4.2.4.1 System IDN Response

To select the factory-set response, select **FACTory**. To specify your own response, select **USER**. You can enter your desired response using **"User IDN" on page 856**.

If your test software expects the response to indicate Agilent Technologies as the Manufacturer, you can configure this response by selecting **AGILent**.

Remote Command	:SYSTem:IDN:CONFigure FACTory AGILent USER For option details, see "More Information" on page 855 :SYSTem:IDN:CONFigure?
Example	:SYST:IDN:CONF FACT
Notes	Affects the response returned by all Modes of the instrument, unless the current Mode has <i>also</i> specified a custom response, in which case the current Mode’s custom IDN response takes precedence over the System’s, but only while that Mode is current Survives shutdown and restart of the software and therefore survives a power cycle
Preset	The *IDN response is reset to FACTory by Restore Defaults >"Misc" on page 896 or Restore Defaults >"All" on page 897 and survives subsequent running of the software

More Information

Here are details of the options available for the System ***IDN** response:

Factory

SCPI example: `:SYST:IDN:CONF FACT`

Selects the factory default configuration of `*IDN?`, which indicates the Manufacturer as Keysight Technologies. For example,

`"Keysight Technologies,N9040B,MY00012345,A.15.00"`

where the fields are Manufacturer, Model Number, Serial Number, Firmware Revision.

NOTE

In products that run multiple instances of the X-Series Application, all instances use the *same* factory System IDN response.

Agilent

SCPI example: `:SYST:IDN:CONF AGIL`

Starting with software version x.14.50, the `*IDN?` response in the Factory configuration indicates the Manufacturer as Keysight Technologies. If your test software is expecting the response to indicate Agilent Technologies, you can configure the response with this menu selection or SCPI command.

For example:

`"Agilent Technologies,N9020A,MY00012345,A.05.01"`

NOTE

In products that run multiple instances of the X-Series Application, all instances use the *same* Agilent System IDN response.

User

SCPI example: `:SYST:IDN:CONF USER`

Selects your customized configuration of `*IDN?`

Enter your desired response using ["User IDN" on page 856](#).

4.2.4.2 User IDN

Allows you to specify your own response to `*IDN?`. You may enter your desired response with the Alpha Editor or a plugin PC keyboard. Once the value is entered, select **USER** under **System IDN Response**.

When you select this control, the active function becomes the current User string and is highlighted, so typing replaces it. If instead you wish to edit the existing string, press the left or right arrow to go to the beginning or the end.

If you enter a null string (for example, by clearing the User String while editing and then pressing **Done**), the instrument automatically reverts to the **FACTory** setting.

NOTE

In products that run multiple instances of the X-Series Application, all instances use the *same* User System IDN response.

Remote Command	<code>:SYSTem:IDN <string></code> <code>:SYSTem:IDN?</code>
Notes	<p>The <code><string></code> must consist of four fields, each separated by a comma, example: <code>:SYST:IDN "XYZ Corp,Model 12,012345,A.01.01"</code></p> <p>The four fields are <code><manufacturer></code>, <code><model number></code>, <code><serial number></code>, <code><firmware revision></code>. The fields are comma-delimited, so text within a field cannot contain a comma</p> <p>This affects the response given in all Modes of the instrument, unless the current Mode has also specified a custom response, in which case the current Mode's custom IDN response takes precedence over the System's, but only while that Mode is current</p> <p>Survives shutdown and restart of the software and therefore survives a power cycle</p> <p>Null string as parameter restores the FACTory setting, example: <code>:SYST:IDN ""</code></p>
Preset	Unaffected by Preset , but set to the original FACTory setting by Restore Defaults > "Misc" on page 896

4.2.4.3 SYSTem:PERSONa (Remote Commands Only)

The `:SYSTem:PERSONa` command set permits setting of individual fields of the `*IDN?` response.

- `"SYSTem:PERSONa:DEFault"` on page 857
- `"SYSTem:PERSONa:MANUFACTURER"` on page 858
- `"SYSTem:PERSONa:MANUFACTURER:DEFault"` on page 858
- `"SYSTem:PERSONa:MODEL"` on page 858
- `"SYSTem:PERSONa:MODEL:DEFault"` on page 859

SYSTem:PERSONa:DEFault

Resets the `*IDN` response to the instrument default.

Remote Command	<code>:SYSTem:PERSONa:DEFault</code> <code>:SYSTem:PERSONa:DEFault?</code>
Notes	<code>:SYST:PERS:DEF?</code> returns the default value of <code>*IDN?</code> even if the current setting of <code>*IDN?</code> is the non-default value. The query return type is a <code><string></code>

`:SYST:PERS:DEF`

is equivalent to:

`:SYSTem:IDN ""`

`:SYSTem:IDN:CONF DEF`

SYSTem:PERSONa:MANUFACTURER

Sets the **MANUFACTURER** field of the ***IDN?** response. This is the first field of the ***IDN?** response.

Remote Command `:SYSTem:PERSONa:MANUFACTURER <string>`

Command `:SYSTem:PERSONa:MANUFACTURER?`

Notes When setting the **MANUFACTURER** field, the current IDN response string is modified to replace the manufacturer field with the string specified by the command. If the resulting IDN response matches one of the predefined responses (`:SYST:IDN:CONF FACT | AGIL`), then the `:SYST:IDN:CONF` is set to the corresponding value. If the IDN response with the new manufacturer field is not one of the predefined values, then `:SYST:IDN:CONF` will be set to **USER** and `:SYST:IDN` will be set to the new IDN response string

The query returns the current value of the ***IDN?** Manufacturer field

SYSTem:PERSONa:MANUFACTURER:DEFAULT

Resets the **MANUFACTURER** field of the ***IDN?** response to the default value.

Remote Command `:SYSTem:PERSONa:MANUFACTURER:DEFAULT`

Command `:SYSTem:PERSONa:MANUFACTURER:DEFAULT?`

Notes The query returns the default **MANUFACTURER** field value of ***IDN?** even if the current setting of ***IDN?** is the non-default value. The return type is a `<string>`

SYSTem:PERSONa:MODEL

Sets the **MODEL** field of the ***IDN?** response. This is the second field of the ***IDN?** response.

Remote Command `:SYSTem:PERSONa:MODEL <string>`

Command `:SYSTem:PERSONa:MODEL?`

Notes When setting the **MODEL** field, the current IDN response string is modified to replace the model field with the string specified by the command. If the resulting IDN response matches one of the predefined responses (`:SYST:IDN:CONF FACT | AGIL`), then `:SYST:IDN:CONF` is set to the corresponding value. If the IDN response with the new model field is not one of the predefined values, then `:SYST:IDN:CONF` will be set to **USER** and `:SYST:IDN` will be set to the new IDN response string

The query returns the current value of the ***IDN?MODEL** field

SYSTem:PERSONa:MODEl:DEFault

Resets the **MODEl** field of the ***IDN?** response to the default value.

Remote Command	<code>:SYSTem:PERSONa:MODEl:DEFault</code> <code>:SYSTem:PERSONa:MODEl:DEFault?</code>
Notes	The query returns the default MODEl field value of *IDN? even if the current setting of *IDN? is the non-default value. The return type is a <code><string></code>

4.2.5 LXI

Accesses various **LXI** configuration properties.

Dependencies	Not available in UXM
--------------	----------------------

4.2.5.1 LAN Reset

Resets the LAN connection. This sets parameters as follows, and restarts the LAN operation:

DHCP	Enabled
Automatic IP Address	Enabled
ICMP Ping Responder	Enabled
Web Password	keysight
Dynamic DNS	Enabled
mDNS and DNS-SD	Enabled
Dynamic Link Local Addressing	Enabled
Auto Negotiation	Enabled

There is no SCPI command for this function.

4.2.5.2 Device Identification (Remote Command Only)

Enabling LXI device identification places the LXI Status Indicator in the **Identify** state. Disabling LXI device identification places the LXI Status Indicator in the **No Fault** state. The LXI Status indicator is in the upper left region of the instrument's graphical user interface.

Remote Command	<code>:LXI:IDENtify[:STATe] OFF ON 0 1</code> <code>:LXI:IDENtify[:STATe]?</code>
----------------	--

Example	<code>:LXI:IDEN ON</code>
Preset	Not part of Preset , but reset to OFF by Restore Defaults > "All" on page 897
State Saved	No
Range	OFF ON

4.2.6 Restore I/O Config Defaults

Causes the group of settings associated with the **I/O Config** menu to be reset to their default values. This also happens on **Restore Misc Defaults**, which has a SCPI command.

When **Restore I/O Config Defaults** is selected, a message appears saying:

`This will reset all of the I/O Config variables to their default state, including the GPIB address and SCPI LAN settings`

`It will not affect Alignment data or settings`

`This action cannot be undone. Do you want to proceed?`

The message provides **OK** and **Cancel** buttons so you can affirm or cancel the operation.

4.2.7 Query USB Connection (Remote Query Only)

Enables you to determine the speed of the USB connection.

Remote Command	<code>:SYSTem:COMMunicate:USB:CONNectioN?</code>	
Example	<code>:SYST:COMM:USB:CONN?</code>	
Notes	NONE	Indicates no USB connection has been made
	LSPeed	Indicates a USB low speed connection (1.5 Mbps) Note that this is reserved for future use, the T+M488 protocol is not supported on low-speed connections
	HSPeed	Indicates that a USB high speed connection (480 Mbps) has been negotiated
	FSPeed	Indicates that a USB full speed connection (12 Mbps) has been negotiated
State Saved	No	
Range	NONE LSPeed HSPeed FSPeed	

4.2.8 USB Connection Status (Remote Query Only)

Lets you determine the current status of the USB connection.

Remote Command	<code>:SYSTem:COMMunicate:USB:STATus?</code>
Example	<code>:SYST:COMM:USB:STAT?</code>
Notes	<p>SUSPended – Indicates that the USB bus is currently in its suspended state. The bus is in the suspended state when:</p> <ul style="list-style-type: none"> – The bus is not connected to any controller – The controller is currently powered off – The controller has explicitly placed the USB device into the suspended state <p>When in the suspended state, no USB activity, including start of frame packets are received</p> <p>ACTive – Indicates that the USB device is in the active state. When the device is in the active state, it receives periodic frame starts, but is not necessarily receiving or transmitting data</p>
State Saved	No
Range	<code>SUSPended ACTive</code>

4.2.9 USB Packet Count (Remote Query Only)

Lets you determine the number of packets received and transmitted on the USB bus.

Remote Command	<code>:SYSTem:COMMunicate:USB:PACKets?</code>
Example	<code>:SYST:COMM:USB:PACK?</code>
Notes	<p>Two integers are returned:</p> <ol style="list-style-type: none"> 1. The number of packets received since application invocation 2. The number of packets transmitted since application invocation <p>If no packets have been received or transmitted, the response is <code>0,0</code></p> <p>The packet count is initialized to <code>0,0</code> when the instrument application is started</p>
State Saved	No

4.2.10 Lock Remote I/O Session (Remote Command only)

An instrument can support multiple remote I/O sessions at the same time. However, you cannot *simultaneously* send remote commands from multiple sessions to the same instrument. The results in such a case are undefined.

Ensure that only *one* session actively controls the instrument at a time. Other sessions must wait until the active session finishes the instrument control.

To help achieve this cooperative instrument sharing, the following remote commands are provided:

- "Lock Remote I/O Request (Remote Query only)" on page 863
- "Unlock Remote I/O Session (Remote Command only)" on page 864
- "Remote I/O Session Lock Name (Remote Query only)" on page 864
- "Remote I/O Session Lock Owner (Remote Query only)" on page 865

Example Procedure for Lock Usage

Step	Action
1	Each session tries to obtain a lock by sending <code>:SYSTem:LOCK:REQuest?</code> This query can be sent simultaneously from multiple sessions
2	Only one session will be granted. The granted session receives <code>1</code> in response to its query
3	The granted session actively controls the instrument Meanwhile, other sessions must wait, and must periodically send <code>:SYSTem:LOCK:REQuest?</code> , requesting the lock
4	When the active session finishes its task, it releases the lock by sending <code>:SYSTem:LOCK:RELease</code>
5	Now the lock has become available, so when one of the waiting sessions sends <code>:SYSTem:LOCK:REQuest?</code> , it receives <code>1</code> in response, granting the lock to that session

By repeating steps 3, 4, and 5 above, multiple sessions can share the same instrument in a cooperative fashion.

NOTE

A session can query its own unique session name by sending `:SYSTem:LOCK:NAME?`. This session name is determined by the instrument.
A session also can query the name of the currently granted session by sending `:SYSTem:LOCK:OWNer?`.

NOTE

Remote I/O interfaces are grouped in two types: single-session interface and multi-session interface. Both types of interfaces can be used for cooperative instrument sharing.
The recommended interface is LAN HiSLIP.

Interface	Single-session	Multi-Session
GPIB	ü	
USB-488	ü	

Interface	Single-session	Multi-Session
LAN VXI-11 (SICL)	ü	
LAN Socket		ü
LAN HiSLIP		ü
LAN Telnet		ü

If using a single-session interface, care must be taken to ensure only one client uses the single-session interface.

In particular, LAN VXI-11 (SICL) interface is a single-session interface, even though multiple clients could simultaneously connect to this interface. Such multiple VXI-11 clients share the same session context; the same status registers and the same error queue. Even a SCPI query response can be received by another client. Furthermore, the lock obtained by `:SYSTem:LOCK:REQuest?` is shared among all VXI-11 clients, allowing all of them to actively control the instrument.

If a LAN VXI-11 (SICL) interface must be used by multiple clients for a cooperative instrument sharing, then VISA locking *must* be used, *in addition to* Remote I/O Session Lock.

4.2.10.1 Lock Remote I/O Request (Remote Query only)

You can lock the SCPI control of the instrument to the I/O Interface and Session by sending `:SYSTem:LOCK:REQuest?`. This permits cooperative sharing of the instrument between multiple computers, or multiple sessions from the same computer.

Remote Command	<code>:SYSTem:LOCK:REQuest?</code>
Example	<code>:SYST:LOCK:REQ?</code>
Notes	<p>Returns 1 if the lock request is granted, or 0 if the request is denied</p> <p>Lock requests on an individual interface and session can be nested and each request will increase an internal lock count by 1. For every granted request, send <code>:SYST:LOCK:REL</code> to decrement the internal lock count to fully relinquish the lock</p> <p>When the instrument is locked, Bit 0 is set in the Operation Instrument status register</p> <p>Disconnecting the individual interface and session releases the lock if the lock is granted to the interface and session</p> <p>A Device Clear over any interface and session releases the lock, regardless of the interface and session which obtained the lock</p> <p>The following queries are permitted over any interface and session, even if an interface has the instrument locked:</p> <ul style="list-style-type: none"> - <code>*IDN?</code>

-
- *OPT?
 - *STB?
 - *ESR?
 - :SYSTem:DATE?
 - :SYSTem:TIME?
 - :SYSTem:PON:TIME?
 - Queries in the :STATus subsystem
 - Queries in the :SYSTem:ERRor subsystem
 - Queries in the :SYSTem:LKEY subsystem
 - Queries in the :SYSTem:LOCK subsystem
 - Queries in the :SYSTem:METRics subsystem
 - Queries in the :SYSTem:MODuLe subsystem

All other commands and queries result in error: -203, "Command protected; Instrument locked by another I/O session"

State Saved Not part of Save/Recall

4.2.10.2 Unlock Remote I/O Session (Remote Command only)

You can unlock the SCPI control of the current I/O Interface and Session by sending **:SYSTem:LOCK:RELease**. Lock requests on an individual interface and session can be nested, and each request increases an internal lock count by 1. For every granted request, you will need to perform a release. The lock is not relinquished until the internal lock count reaches 0.

Remote Command **:SYSTem:LOCK:RELease**

Example **:SYST:LOCK:REL**

Notes When the instrument is unlocked, Bit 0 is cleared in the Operation Instrument status register

4.2.10.3 Remote I/O Session Lock Name (Remote Query only)

Use this query to obtain the name of the current I/O Interface and Session.

Remote Command **:SYSTem:LOCK:NAME?**

Example	<code>:SYST:LOCK:NAME?</code>
Notes	<p>The information returned is a string of the format: <code><I/O Interface>[/<IP address>/<Session ID>]</code></p> <p>Where IP address and Session ID are only provided for interfaces that provide multiple sessions</p> <p>Single Session interfaces (GPIB, USB-488, and LAN VXI-11) only list interface name</p> <p>Session ID is an internally generated identifier. It is not guaranteed to be consistent across instrument software versions (the identifier is subject to change when the software of the instrument is updated). The absolute value of Session ID is not significant, but the identifier will be consistent for a given software version, and can be relied upon for lock owner logic comparisons</p>

4.2.10.4 Remote I/O Session Lock Owner (Remote Query only)

Use this query to determine which I/O Interface and Session has the SCPI locked.
 If no interface and session has the SCPI locked, then the return value is **NONE**.

Remote Command	<code>:SYSTem:LOCK:OWNer?</code>
Example	<code>:SYST:LOCK:OWN?</code>
Notes	<p>The information returned is a string of the format: <code><I/O Interface>[/<IP address>/<Session ID>]</code></p> <p>Where IP address and Session ID are only provided for interfaces that provide multiple sessions</p> <p>Single Session interfaces (GPIB, USB-488, and LAN VXI-11) only list interface name</p> <p>Session ID is an internally generated identifier. It is not guaranteed to be consistent across instrument software versions (the identifier is subject to change when the software of the instrument is updated). The absolute value of Session ID is not significant, but the identifier will be consistent for a given software version, and can be relied upon for lock owner logic comparisons</p> <p>If no interface and session has the SCPI locked, then the return value is NONE</p>

4.2.11 Multiple Network Interface Card Configuration (Remote Commands Only)

Systems that have multiple Network Interface Cards (**NICs**) require additional configuration information. The following keys can be added to the XApps configuration file:

- **PrimaryNICIPv4** – IP address value is a string with the exact IP V4 format. Required field in IP v4 networks.
- **PrimaryNICIPv6** – IP address value is a string with the exact IP V6 format. Required field in IP v6 networks.

These commands do not apply to instruments that have only one NIC. The commands apply to all modular deployments that have a controller with multiple NICs.

To configure and query these configuration options, the following remote commands are provided:

- "Multiple Network Adapters Enabled (Remote Query Only)" on page 866
- "Config IPV4 Address (Remote Command Only)" on page 866
- "Config IPV6 Address (Remote Command Only)" on page 867
- "List All Physical Network Adapter IP Addresses (Remote Query Only)" on page 867

4.2.11.1 Multiple Network Adapters Enabled (Remote Query Only)

Remote Command	<code>:SYSTem:COMMunicate:LAN:MULTiple:NIC:ENABled?</code>
Example	<code>:SYSTem:COMMunicate:LAN:MULTiple:NIC:ENABled?</code>
Notes	<p>Applies to Instruments that have multiple Network Adapters. When more than one network adapter is present in the system, and they are Enabled (that is, they have a valid IP Address), this query returns:</p> <ul style="list-style-type: none"> – 1, if more than one NIC enabled – 0, if only one or No NICs are enabled
State Saved	No

4.2.11.2 Config IPV4 Address (Remote Command Only)

Remote Command	<code>:SYSTem:COMMunicate:LAN:IPV4:CONFig <ipaddress></code> <code>:SYSTem:COMMunicate:LAN:IPV4:CONFig?</code>
Example	<code>:SYSTem:COMMunicate:LAN:IPV4:CONFig "192.168.1.146"</code> <code>:SYSTem:COMMunicate:LAN:IPV4:CONFig?</code>
Notes	<p>Applies to instruments that have multiple Network Adapters. When more than one network adapter is present in the system, you must specify in the instrument config file the IP address to use to enable Remoting channel bindings. If this is not provided, Remoting connections are likely to fail on systems where multiple NICs are enabled</p> <p>Sets the valid IPV4 address, passed in as string in the config file</p> <p>The query returns IPV4 address, as a string</p> <p>If config file is missing, "" (empty string) is returned</p> <p>Changing the IPV4 value requires a restart of the instrument software, to ensure that servers use the configured IP address</p>
State Saved	No

4.2.11.3 Config IPV6 Address (Remote Command Only)

Remote Command	<code>:SYSTem:COMMunicate:LAN:IPV6:CONFig <ipaddress></code> <code>:SYSTem:COMMunicate:LAN:IPV6:CONFig?</code>
Example	<code>:SYSTem:COMMunicate:LAN:IPV6:CONFig "2001:0db8:85a3:0000:0000:8a2e:0370:7334"</code> <code>:SYSTem:COMMunicate:LAN:IPV6:CONFig?</code>
Notes	<p>Applies to instruments that have multiple Network Adapters. When more than one network adapter is present in the system, you must specify in the instrument config file the IP address to use to enable Remoting channel bindings. If this is not provided, Remoting connections are likely to fail on systems where multiple NICs are enabled</p> <p>Sets the valid IPV6 address, passed in as string in the config file</p> <p>The query returns IPV6 address, as a string</p> <p>If config file is missing, "" (empty string) is returned</p> <p>Changing the IPV6 value requires a restart of the instrument software, to ensure servers use the configured IP address</p>
State Saved	No

4.2.11.4 List All Physical Network Adapter IP Addresses (Remote Query Only)

Remote Command	<code>:SYSTem:COMMunicate:LAN:PHYSical:IPADdress:LIST?</code>
Example	<code>:SYSTem:COMMunicate:LAN:PHYSical:IPADdress:LIST?</code> <code>: "192.168.1.146,2001:0db8:85a3:0000:0000:8a2e:0370:7334"</code>
Notes	Returns the IP Addresses of the physical network adapters found in the PC/Instrument
State Saved	No

4.3 Preload / Unload Modes

The X-Series platform supports many Modes. Each Mode that is loaded uses a portion of the total available memory. At some point, this may result in insufficient free memory. This can occur during a measurement, or when loading a new Mode. A limited number of Modes can be loaded without impacting performance.

Preload / Unload Modes allows you to select and enable Modes to be preloaded at startup, and to specify the default **Power-On Mode**.

The dialog includes the following controls:

- "Power-On Mode" on page 868
- "Table of Modes" on page 869
- "Preload: Select All, Preload: Deselect All" on page 869
- "Move Up, Move Down" on page 869
- "Unload" on page 869

Modes that are not preloaded may be loaded at runtime as needed, resources permitting. However, note that loading more Modes increases memory consumption and may adversely impact performance.

When a memory-full situation occurs, the instrument notifies you with the following message:

Out of memory; Insufficient resources. Please save state if needed. You have following options:

1. Open System Settings > Configure Preload Modes to unload unused Modes
2. Reconfigure preloaded Modes on the above dialog, close and restart the analyzer SW
3. Close and restart the analyzer SW

Option 1 allows you to unload unused Modes and continue running the software, without having to restart it.

The command `:INSTrument:UNLoad <mode>` provides equivalent functionality; see "Unload" on page 869.

4.3.1 Power-On Mode

Displays a list of licensed Modes. Use this control to change the factory default Power-On Mode. The instrument will execute the selected Mode after power up. Selecting the Power-On Mode here automatically enables that Mode for preloading.

4.3.2 Table of Modes

The table of Modes becomes scrollable when the number of Modes exceeds the dialog's displayable size.

Use the check boxes in the **Preload** column to enable or disable the preloading of the Modes that you want.

Use the check boxes in the **Unload** column to select the Modes that you want to unload.

The Unload check boxes are grayed-out when the Modes are used by other Modes.

Example:

5G NR & V2X Mode cannot be loaded when either Sequence Analyzer Mode or Power Amplifier Mode are already loaded, because these Modes use 5G NR & V2X Mode. To unload 5G NR & V2X Mode, both Sequence Analyzer Mode and Power Amplifier Mode must be unloaded first.

When the active Mode is unloaded, the screen becomes blank except for the message; **"No Mode is active"**. You can then select another desired Mode.

When multiple screens are open, and a Mode is unloaded, inactive screens that have that Mode as their active Modes are closed.

The active screen is never closed.

4.3.3 Preload: Select All, Preload: Deselect All

Toggles the **Preload** checkbox state for all Applications listed, except for the Power-On Application, which is always selected.

4.3.4 Move Up, Move Down

The default order in which Applications are listed in the table is the order in which they are displayed in the **Mode/Measurement/View** Selector dialog. To change the order in this list, select the desired Application row from the table, then click **Move Up** or **Move Down** to move it to the desired position.

4.3.5 Unload

Unloads the specified Mode.

Remote `:INSTrument:UNLoad <mode>`

4 System
4.3 Preload / Unload Modes

Command	
Example	<code>:INST:UNL NR5G</code>
Notes	<p>Error message if the specified Mode is not available, -224,"Illegal parameter value;<mode> is not a valid choice"</p> <p>Error message if the specified Mode is not loaded and therefore cannot be unloaded, -221,"Settings conflict;<mode> is not loaded"</p> <p>Error message if the specified Mode is used by other Modes and therefore cannot be unloaded, -221,"Settings conflict;<mode> is used by <other modes>"</p> <p>Error message if the specified Mode does not support Unload Mode feature and therefore cannot be unloaded, -221,"Settings conflict;Feature not supported for this Mode"</p>

4.3.6 Loaded Modes (Remote Query Only)

Returns a list of loaded Modes.

Remote Command	<code>:SYSTem:APPLication:LOADed?</code>
Example	<code>:SYST:APPL:LOAD?</code>
Preset	Not affected by Preset

4.3.7 User Interface

Configures functions specific to the User Interface, such as the menu panel orientation and the display color theme.

4.3.7.1 Menu Panel Position

Allows the Menu Panel to be positioned on the **RIGHT** or **LEFT** side of the display.

Remote Command	<code>:SYSTem:DISPlay:MPPosition RIGHT LEFT</code> <code>:SYSTem:DISPlay:MPPosition?</code>
Example	<code>:SYST:DISP:MPP LEFT</code>
Preset	This is unaffected by Preset but is set to RIGHT by Restore Defaults > "User Interface" on page 895 or Restore Defaults > "All" on page 897
State Saved	Power On Persistent (survives shutdown and restart)

4.3.7.2 Menu Panel Tabs

Allows the **Menu Panel Tabs** to be positioned on the **RIGHT** or **LEFT** side of the menu panel.

Remote Command	:SYSTem:DISPlay:MPTab RIGHT LEFT :SYSTem:DISPlay:MPTab?
Example	:SYST:DISP:MPT LEFT
Preset	This is unaffected by Preset but is set to RIGHT by Restore Defaults > "User Interface" on page 895 or Restore Defaults > "All" on page 897
State Saved	Power On Persistent (survives shutdown and restart)

4.3.7.3 Annotations Local Settings/All Off

Overrides the annotation settings for all measurement in all modes and turns them all off. This provides the security based "annotation off" function of previous instruments; hence it uses the legacy SCPI command.

When this control is set to **All Off**, the **Screen Annotation**, **Meas Bar**, **Trace Annotation**, and **Control Annotation** controls under the **Display**, **Annotation** menu are grayed-out and forced to **OFF** for all measurements in all modes. When **Local Settings** is selected, you can set the local annotation settings on a measurement-by-measurement basis.

Remote Command	:DISPlay:WINDow[1]:ANNotation[:ALL] OFF ON 0 1 :DISPlay:WINDow[1]:ANNotation[:ALL]?
Example	:DISP:WIND:ANN OFF
Preset	This is unaffected by Preset but is set to ON by Restore Defaults > "User Interface" on page 895, Restore Defaults > "Misc" on page 896 or Restore Defaults > "All" on page 897
State Saved	Power On Persistent (survives shutdown and restart)
Backwards Compatibility Notes	The WINDow parameter and optional subopcode is included for backwards compatibility but ignored – all windows are equally affected

4.3.7.4 Display Theme

Allows you to change the **Display Theme**. This is similar to the Themes selection under Page Setup and Save Screen Image.

The two available themes are:

- **FILLed**: this is the normal theme using filled objects
- **OUTLine**: this theme uses color, but does not use fill for most areas on the display. It is ideal for images that need to be printed on inkjet printers. Although setting **Display Theme** to **OUTLine** does not affect screen image saves or prints, it does show you exactly how screen images will look when using the **OUTLine** theme under **Save Screen Image**, and how prints will look when using the **OUTLine** theme under **Page Setup**.

NOTE

Although the **OUTLine** theme eliminates most of the filled area, some objects remain filled. In particular, the selected marker remains filled with the green marker color, to distinguish it from the other markers. This is important, as it is the selected marker whose readout appears in the upper right corner of the display.

Remote Command	<code>:DISPlay:THEMe TDColor TDMonochrome FCOLor FMONochrome FILLed OUTLine</code>
Example	<code>:DISPlay:THEMe?</code> <code>:SYST:DISP:THEM OUTL</code> sets the display style to OUTLine
Notes	To permit code compatibility with A-model X-Series Signal Analyzer instruments, the command parameters from the A-models are mapped as follows: <ul style="list-style-type: none"> – TDColor and TDMonochrome are both mapped to FILLed (exact full color representation of what is on the screen) – FCOLor and FMONochrome are both mapped to OUTLine (uses color for traces and other items, but most filled areas are white) <p>There is no Monochrome theme in the B-model instruments, so the monochrome commands for the A-model instruments yield color themes</p> <p>The query of <code>:DISPlay:THEMe?</code> always returns FILLed or OUTLine. It never returns FCOLor, FMONochrome, TDColor, or TDMonochrome</p>
Preset	This is unaffected by Preset but is set to FILLed by Restore Defaults > "User Interface" on page 895 , Restore Defaults > "Misc" on page 896 or Restore Defaults > "All" on page 897
State Saved	Power On Persistent (survives shutdown and restart)

4.3.7.5 Backlight

Turns the display **Backlight** on and off. This setting may interact with settings under the Windows **Power** menu.

When the backlight is **OFF**, pressing ESC, TAB, SPACE, ENTER, UP, DOWN, LEFT, RIGHT, DEL, BKSP, CTRL, or ALT turns the backlight **ON** without affecting the

application. Pressing any other key turns backlight **ON**, and could potentially perform the action as well.

Remote Command	<code>:DISPlay:BACKlight ON OFF</code> <code>:DISPlay:BACKlight?</code>
Example	Turn backlight ON : <code>:DISP:BACK ON</code> Turn backlight OFF : <code>:DISP:BACK OFF</code>
Preset	Pressing any key turns the backlight back ON , as does Restore Defaults > "User Interface" on page 895, Restore Defaults > "Misc" on page 896 or Restore Defaults > "All" on page 897
State Saved	Not saved in State

4.3.7.6 Backlight Intensity

Allows the **Backlight Intensity** to be controlled from the UI settings panel.

Remote Command	<code>:SYSTem:DISPlay:BACKlight:INTensity <integer></code> <code>:SYSTem:DISPlay:BACKlight:INTensity?</code>
Example	<code>:SYST:DISP:BACK:INT 67</code>
Preset	100
State Saved	Power On Persistent (survives shutdown and restart)
Range	0-100

4.3.7.7 Hints

Hints are descriptions that provide additional information for a control. You can set **Hints** to be enabled or disabled.

Remote Command	<code>:SYSTem:DISPlay:HINTs[:STATE] OFF ON 0 1</code> <code>:SYSTem:DISPlay:HINTs?</code>
Example	<code>:SYST:DISP:HINT OFF</code>
Preset	This is unaffected by Preset but is set to ON by Restore Defaults > "User Interface" on page 895 or Restore Defaults > "All" on page 897
State Saved	Power On Persistent (survives shutdown and restart)

4.3.7.8 Numeric Entry Auto Open

Configures whether the **Numeric Entry** Panel will appear immediately when an active function control is activated (Auto Open **ON**), or be deferred until you touch it again or begin to enter a value (Auto Open **OFF**). When configured for Auto Open

4 System
4.3 Preload / Unload Modes

OFF (the default), adjusting the value with the front panel Up/Down keys or the RPG hides the **Numeric Entry Panel**.

Remote Command	:SYSTem:DISPlay:NEPimmediate ON OFF 1 0
Example	:SYST:DISP:NEP OFF
Preset	This is unaffected by Preset but is set to ON by Restore Defaults > "User Interface" on page 895 or Restore Defaults > "All" on page 897
State Saved	Power On Persistent (survives shutdown and restart)

4.3.7.9 Touch On/Off

Turns the touch functionality on and off on the display. If **OFF**, you can turn it back on using the front panel **Touch On/Off** key, or by using a mouse to toggle this control.

Preset	Always starts up ON Unaffected by Preset but is turned ON by Restore Defaults > "User Interface" on page 895 or Restore Defaults > "All" on page 897
State Saved	Not saved in state, not affected by Preset , not Power On Persistent (does not survive shutdown and restart)

4.3.7.10 Control Size

Configures the size of the controls in the user interface. This can be used to make screen dumps from a large screen instrument match those from a smaller screen instrument, to make the controls more readable on a large-screen instrument, or to display more information on a smaller screen instrument.

Remote Command	:DISPlay:UINTErface:CSIZe SMAL1 LARGe
Example	:DISP:UINT:CSIZ LARG
Preset	This is unaffected by Preset but is set to SMAL1 by Restore Defaults > "User Interface" on page 895 or Restore Defaults > "All" on page 897
State Saved	Power On Persistent (survives shutdown and restart)

4.3.7.11 Quick Save Mode

When **Quick Save Mode** is **NORMa1** (the default setting), the instrument does an immediate save of a new file of the same type and to the same directory as the previous **Save** action. When **Quick Save Mode** is in the **PROMpt** state, instead of immediately performing a **Save**, the Alpha Keyboard appears with the proposed

auto-filename in the entry area. You can then press **Enter** to accept the auto filename, or edit the name then press **Enter**. This allows you to easily save a file with a custom file name.

Remote Command	:MMEMory:STORe:QSAVe NORMa1 PROMpt :MMEMory:STORe:QSAVe?
Example	:MMEM:STOR:QSAV PROM
Preset	This is unaffected by Preset but is set to NORMa1 by Restore Defaults > "User Interface" on page 895 or Restore Defaults > "All" on page 897
State Saved	Power On Persistent (survives shutdown and restart)

4.3.7.12 Screen Tabs Left/Right

This switch, when in the **RIGHT** position, makes the screen tabs start on the right and build across to the left, thus minimizing the finger travel over to the screen tab when there is only one screen. When tabs are added from right to left, they appear as below:

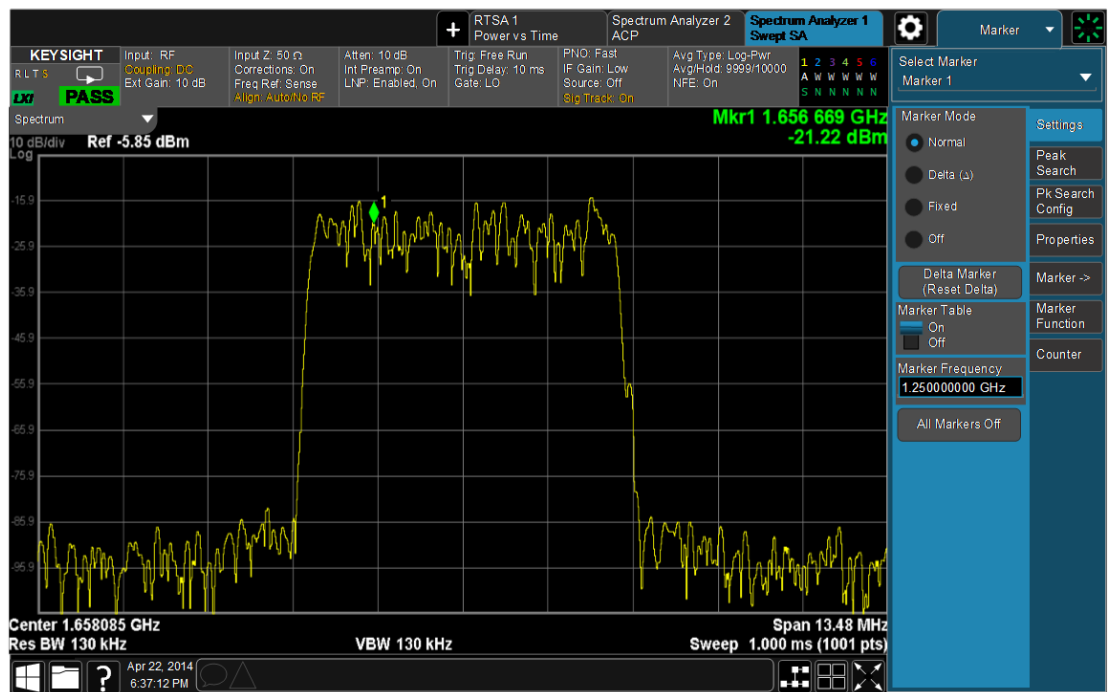

The default is **LEFT**.

Remote Command	:DISPlay:UINTErface:STAB RIGHT LEFT :INSTrument:SCReen:STAB?
Example	:DISP:UINT:STAB RIGH

4 System
4.3 Preload / Unload Modes

Preset	This is unaffected by Preset but is set to LEFT by Restore Defaults > " User Interface " on page 895 or Restore Defaults > " All " on page 897
State Saved	Power On Persistent (survives shutdown and restart)

4.3.7.13 Hide Screen Tabs in Full Screen

This switch, when in the **ON** position, causes the Screen Tabs to be hidden when in Full Screen view, thus maximizing the display area available for results. By also turning off the Meas Bar (in the **Display, Annotation** menu), you can maximize the available area for results, as shown below:

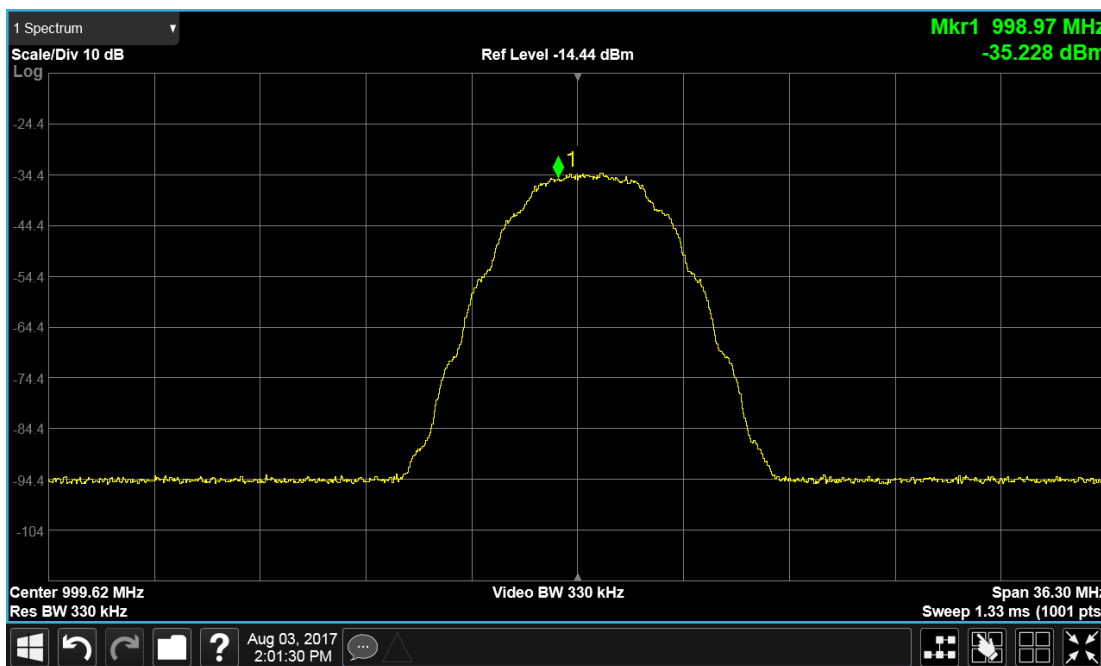

Remote Command	<pre>:DISPlay:UINterface:HTABs ON OFF 1 0</pre> <pre>:DISPlay:UINterface:HTABs?</pre> <pre>:DISPlay:UINterface:STFScreen ON OFF 1 0</pre> <p>Implemented but with wrong sense; ON turns them off and OFF turns them on; so, don't document to customer</p>
Example	<pre>:DISP:UINt:HTAB ON</pre> <p>Hide the tabs in full screen</p>
Preset	This is unaffected by Preset but is set to OFF by Restore Defaults > " User Interface " on page 895 or Restore Defaults > " All " on page 897
State Saved	Power On Persistent (survives shutdown and restart)

4.3.7.14 2-Screen Orientation

When you add a second Screen using the “+” control on the Screen Tabs bar, normally the screen is added to the right of the first screen. However, sometimes it is better to add the new screen below the first screen rather than to the right, as shown below.

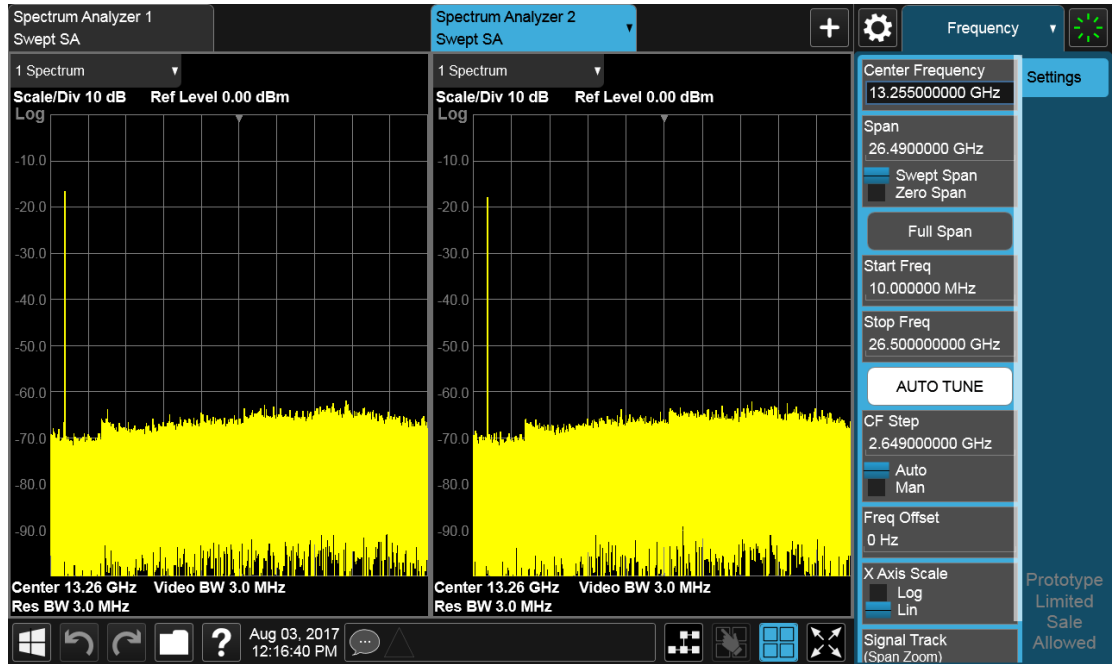

New screen added to the right (horizontal orientation)

4 System

4.3 Preload / Unload Modes

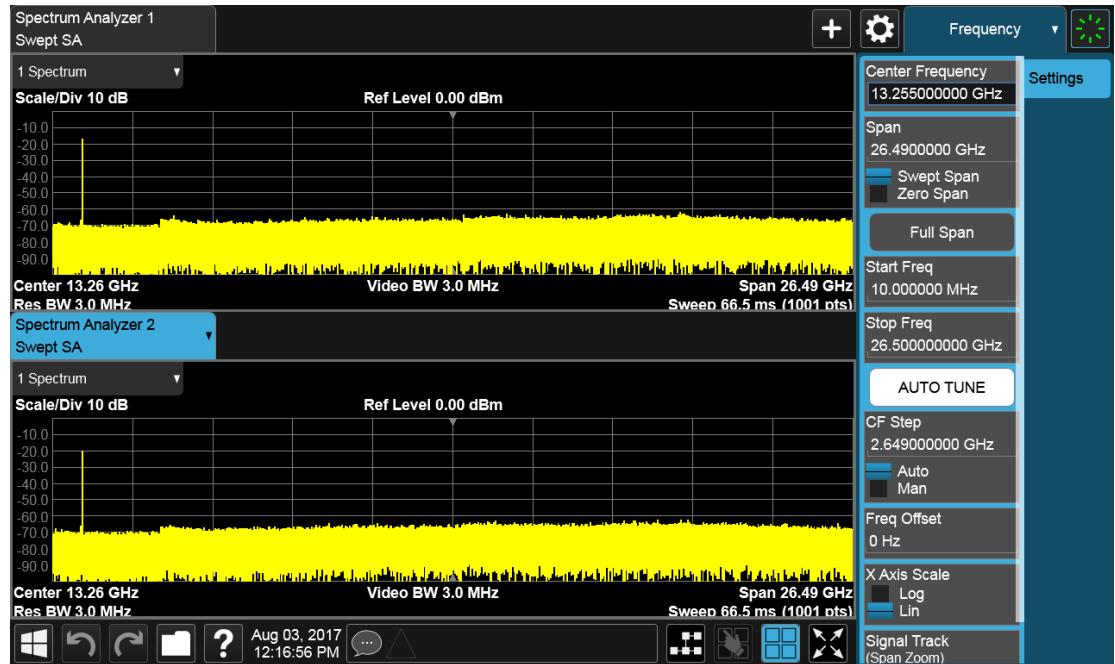

New screen added below (vertical orientation)

The **2-Screen Orientation** switch allows you to choose between these two orientations for 2-Screen configurations. The default is the **HORizontal** configuration, two Screens side-by-side.

Remote Command	<code>:INSTrument:SCReen:ORientation VERTical HORizontal</code>
Example	<code>:INST:SCR:ORI VERT</code> Set the 2 screens to be above/below each other
Preset	HOR This is unaffected by Preset but is set to HORizontal by Restore Defaults > "User Interface" on page 895 or Restore Defaults > "All" on page 897

4.3.7.15 Clock Format

Allows the **Clock Format** to be switched between 12-Hour Format (**HR12**) and 24-Hour Format (**HR24**).

Remote Command	<code>:SYSTem:DISPlay:CFORmat HR12 HR24</code> <code>:SYSTem:DISPlay:CFORmat?</code>
Example	<code>:SYST:DISP:CFOR HR12</code>
Preset	HR12
State Saved	Power On Persistent (survives shutdown and restart)
Range	12-Hour 24-Hour

4.3.7.16 Language

Accesses the selection of **Language** displayed on the menus and controls. **ENGLISH** is the default.

All Measurement Applications that share common controls will display the localized controls.

The description on the control labels is bounded by the control size. Any given language will have labels in that language that are shorter or longer than the equivalent label in English. Any localized text on the controls that does not fit the label size remains in English. Thus, for any given menu, controls may be displayed in English *and* the selected language.

- Labels that are acronyms, engineering, or technology specific terms may remain in English.
- All Application and Measurement names remain in English.
- All data in exported files remain in English.
- The Diagnostic and Service menus in the System Subsystem remain in English.
- The Windows operating system must remain in English. Changing the **Region and Language** settings in the Windows Control Panel is not supported.

External keyboards in English are supported. Localized external keyboards are not supported. When the language selected is not English, a message is displayed to explain that any external keyboard must remain in English.

Other aspects of the Graphical User Interface remain in English. The Remote User Interface (SCPI) remains in English.

Remote Command	<code>:SYSTem:DISPlay:LANGuage ENGLISH RUSSian</code> <code>:SYSTem:DISPlay:LANGuage?</code>
Example	<code>:SYST:DISP:LANG ENGL</code> <code>:SYST:DISP:LANG RUSS</code> Requires Option AKT
Preset	This is unaffected by Preset but is set to ENGLISH by Restore Defaults > " User Interface " on page 895, Restore Defaults > " Misc " on page 896 or Restore Defaults > " All " on page 897

4.3.7.17 Restore User Interface Defaults

Causes the group of settings associated with the **User Interface** menu to be reset to their default values. This also happens on **Restore Misc Defaults**.

When **User Interface** is selected, a message appears saying:

4 System
4.3 Preload / Unload Modes

This will reset all of the User Interface variables to their default state, including the menu panel location, display theme, and language.

It will not affect Alignment data or settings.

This action cannot be undone. Do you want to proceed?

The message provides **OK** and **Cancel** buttons for you to affirm or cancel the operation.

Example `:SYST:DEF UINT`

4.3.7.18 User Interface Type (Remote Query Only)

Use this query to determine if the instrument is running the Multi-Touch user interface or Softkey user interface. This is an easy way to distinguish between A-models (Softkey) instruments and Touch UI (Multi-Touch) instruments.

Remote Command `:DISP:UINterface:TYPE?`

Example `:DISP:UINT:TYPE?`

Notes The query returns **MULTITOUCH** for instruments with the Multi-Touch UI or **SOFTKEY** for instruments with the Softkey UI

4.4 Power On

Lets you select how the instrument should power on.

NOTE

In products that run multiple instances of the X-Series Application, the same Power On type is shared between all the instances.

4.4.1 Power On State

Lets you select whether the instrument powers up in a default state, or some other state. The options are:

- **MODE** and Input/Output Defaults
- **USER** Preset
- **LAST** State

Remote Command	<code>:SYSTem:PON:TYPE MODE USER LAST</code> <code>:SYSTem:PON:TYPE?</code>
Example	<code>:SYST:PON:TYPE MODE</code> <code>:SYST:PON:TYPE USER</code> <code>:SYST:PON:TYPE LAST</code>
Preset	This is unaffected by Preset but is set to MODE by Restore Defaults > "All" on page 897
State Saved	No
Backwards Compatibility SCPI	<code>:SYSTem:PON:TYPE PRESet</code> The PRESet parameter is supported for backward compatibility only, and behaves the same as MODE

Mode and Input/Output Defaults

When the instrument is powered-on in **MODE** and Input/Output Defaults, it performs "**Restore Mode Defaults**" on page 1002 for all Modes in the instrument, and performs **Restore Input/Output Defaults**.

Persistent parameters (such as Amplitude Correction tables or Limit tables) are not affected at power-on, even though they are normally cleared by **Restore Input/Output Defaults** and/or **Restore Mode Defaults**.

User Preset

Sets **Power On State** to **USER** Preset. When the instrument is powered on in User Preset, it will **User Preset** each mode and switch to the "**Power On Application**" on page 883. **Power On User Preset** does not affect any settings other than those set by a normal **User Preset**.

Backwards Compatibility Note: Power On: **User Preset** causes the instrument to power up in the "**Power On Application**" on page 883, *not* the last Mode the instrument was in prior to shutdown. Also, **Power On: User Preset** will **User Preset** all Modes. This does *not* exactly match legacy behavior.

NOTE

In products that run multiple instances of the X-Series Application, the same **User Preset** is shared between all the instances.

NOTE

An instrument can never power up for the first time in **USER** preset.

Last State

Sets **Power On State** to **LAST**. When the instrument is powered on, it will put all modes in the last state they were in prior to when the instrument was put into Power Standby, and it will start up in the mode it was last in prior to powering off the instrument. The saving of the active mode prior to shutdown happens behind the scenes when a controlled shutdown is requested, either via the front panel **Standby** key, or the remote command **:SYSTem:PDOWn**. The non-active modes are saved as they are deactivated and recalled by Power On: Last State.

Power On: Last State only works if you completed a controlled shutdown prior to powering on in **LAST**. If a controlled shutdown is not completed when in **Power On: Last State**, the instrument powers up in the last active Mode, but it may not power up in the active Mode's last state. If an invalid Mode state is detected, a **Mode Preset** occurs. To control the shutdown under remote control, use **:SYSTem:PDOWn**.

Backwards Compatibility Note: It is no longer possible to power-up the instrument in the last Mode the instrument was running with that Mode in the preset state. (ESA/PSA **SYST:PRESET:TYPE MODE** with **SYST:PON:PRESET**) You can power-on the instrument in the last Mode the instrument was running in its last state (**:SYST:PON:TYPE LAST**), or you can specify the Mode to power-up in its preset state (**:SYST:PON:MODE <mode>**).

NOTE

In products that run multiple instances of the X-Series Application, each instance has a unique **Last State**.

NOTE

An instrument can never power up for the first time in **LAST**.

If line power to the instrument is interrupted, for example by pulling the line cord plug or by switching off power to a test rack, **Power On Last State** may not work properly. For proper operation, **Power On Last State** depends on your shutting down the instrument using the **Standby** key or the `:SYSTem:PDOWn` command. This ensures the last state of each Mode is saved and can be recalled during a power-up.

4.4.2 Power On Application

Accesses a menu that lists the available Modes, and lets you select which Mode is to be the **Power On Application**. Whichever application is selected runs at power-on when the Power On Type is set to “**MODE** and Input/Output Defaults”.

NOTE

In products that run multiple instances of the X-Series Application, the same Power On Application is shared between all the instances.

Remote Command	<code>:SYSTem:PON:MODE <mode></code> where <code><mode></code> is an item from the same set that can be sent using the <code>:INSTrument[:SElect]</code> command <code>:SYSTem:PON:MODE?</code>
Example	<code>:SYST:PON:MODE SA</code>
Notes	The displayed list of possible Modes (and remote parameters) depends on which Modes are installed in the instrument
Preset	Unaffected by Preset but is set by Restore Defaults > "All" on page 897 to SA , except in the cases noted below:
	N8973B, N8974B, N8975B, N8976B NFIG
	VXT models BASIC
	M9410E/11E/15E/16E BASIC
State Saved	No

4.4.3 FPGA Configuration

Lets you choose which FPGA image you want loaded into the instrument.

Depending on your hardware configuration, your instrument may contain a Field Programmable Gate Array (FPGA) which handles much of the processing for some of the mathematically intensive features, such as Time Domain Scan (Option TDS) and Enhanced Sweep Speed (Option FS2). The FPGA is not big enough to hold the

functionality for both options, so you must decide which FPGA program you want loaded.

When licenses allow for both FPGA image versions to be available, and you have not explicitly chosen an FPGA image version, then, when the firmware is updated, the Time Domain Scan version will be loaded. In the absence of all licenses, the Enhanced Sweep Speed version will be loaded. Once you have explicitly chosen an FPGA image version, using the FPGA Configuration dialog, any future firmware updates will continue to load the chosen version as long as it is licensed.

Example: loading the Time Domain Scan FPGA image, removing the TDS license, and then updating the firmware will result in the Enhanced Sweep Speed version being loaded.

When multiple capabilities are licensed, the FPGA Configuration presents a dialog that tells you that there is insufficient space to fit all the licensed capabilities, and asks you to choose one of the FPGA programs (images).

If you remove licenses, it is possible to end up with an unlicensed capability loaded in the FPGA while a licensed capability is not loaded. In this case, the dialog does not present the **Preference** group and shows a message about unlicensed/licensed capabilities. You can dismiss the dialog if the licensed capability is not currently needed, and you do not want to take the time to load the licensed FPGA image. However, this dialog will continue to appear each time the instrument is restarted.

Behavior when the Enhanced Sweep Speed FPGA Image is Loaded

When the Enhanced Sweep Speed version of the FPGA image is loaded, sweep behavior still depends on the licenses:

- Option FS2 gives full FPGA enhanced sweep speed
- Option FS1 gives software implemented enhanced sweep speed
- Neither Option FS1 nor FS2 – no enhanced sweep speed
- Both Options FS1 and FS2 – same as Option FS2, the full FPGA enhanced sweep speed

If EMI Receiver Mode and TDS option are licensed, and the Enhanced Sweep Speed FPGA image is loaded, then you will not have the proper FPGA image loaded to fully support EMI Receiver Mode. In particular, the Frequency Scan measurement cannot use Scan Type “Time Domain Scan” (this is the normally the default Scan Type for instruments with the TDS option). Instead, EMI Receiver Mode behaves as if the TDS option is not licensed.

Behavior when the Time Domain Scan FPGA Image is loaded

When the Time Domain Scan version of the FPGA image is loaded, EMI Receiver Mode works as expected with the TDS option licensed, but the Option FS2 capability

silently reverts to FS1 behavior.

Switching Between Enhanced Sweep Speed and Time Domain Scan FPGA Images

You cannot have both full TDS and FS2 images at the same time, so to switch to the other image, you must go through the process of reloading the FPGA by choosing the desired image with the Selected FPGA control, and pressing "**Load FPGA**" on [page 887](#), or issuing the "Load FPGA" SCPI command below with the proper parameter.

Incorrect FPGA Configuration

If EMI Receiver Mode, Option TDS, or Option FS2 license is removed while the FPGA image for that license is loaded, the instrument ends up in an incorrect configuration, since the loaded FPGA image version has support for unlicensed functionality that is not accessible and does not support the currently licensed functionality. It will still function, but when the instrument recognizes this situation at startup, it automatically displays the **FPGA Configuration** dialog. The only selections available will be the licensed ones, but you can choose to dismiss the dialog and continue with the current FPGA image version if you do not want to take the time to load the correct FPGA image. The dialog will continue to be presented at each startup until the correct FPGA image is loaded.

FPGA Updates When Firmware Installs

The FPGA image and X-Series firmware are tightly coupled, so whenever the firmware is updated, the FPGA image is also checked and updated if needed. The rules for choosing between Time Domain Scan and Enhanced Sweep Speed versions of the FPGA image are:

1. Always use Time Domain Scan FPGA image for MXE
2. If neither EMC Mode nor Option TDS nor Option FS2 are licensed, the Enhanced Sweep Speed FPGA image is loaded
3. If EMC Mode and Option TDS are licensed and Option FS2 is not licensed, the Time Domain Scan FPGA image is loaded
4. If EMC Mode and Option TDS are not licensed, and Option FS2 is licensed, the Enhanced Sweep Speed FPGA image is loaded
5. If all are licensed
 - a. If "**FPGA Load Preference**" on [page 886](#) is **Time Domain Scan**, the Time Domain Scan FPGA image is loaded

- b. If **FPGA Load Preference** is **Enhanced Sweep Speed**, the Enhanced Sweep Speed FPGA image is loaded
- c. If **FPGA Load Preference** is **Prompt at Startup**:
 - a. If the last FPGA Configuration Load was Time Domain Scan, the Time Domain Scan FPGA image is loaded
 - b. If the last FPGA Configuration Load was Enhanced Sweep Speed, the Enhanced Sweep Speed FPGA image is loaded
 - c. If no FPGA has been explicitly loaded, the Time Domain Scan FPGA image is loaded

4.4.3.1 FPGA Load Preference

Select either image from the radio buttons at the top of the dialog:

Option	SCPI	Description
Time Domain Scan	TDS	Load the Time Domain Scan version of the FPGA image
Enhanced Sweep Speed	FS2	Load the Enhanced Sweep Speed version of the FPGA image
Prompt at Startup	PROMpt	Prompt at each startup, displaying the FPGA Configuration dialog. You can choose to continue with the currently loaded FPGA image version, or load a different version

If you select the image that is already loaded, you will not be prompted again. If you select a different one, the Selected FPGA control changes to that one and you must then press "**Load FPGA**" on page 887 to load the other image.

When installing new firmware, the **FPGA Load Preference** setting is used to load the preferred FPGA image version if more than one version is available. Selecting **Prompt at Startup** causes you to be prompted at each startup to select the desired version of the FPGA image.

Remote Command	<code>:SYSTem:PON:FPGA:PREference TDS FS2 PROMpt</code>
Example	<code>:SYST:PON:FPGA:PREF TDS</code> <code>:SYST:PON:FPGA:PREF?</code>
Notes	This SCPI is always available, but if the hardware does not support multiple FPGA image choices, the returned value is always: NA = Not available for this hardware Also, when not supported, any attempt to change away from NA generates error -224, "Illegal parameter value"
Dependencies	Dialogs and menus available only when EMC Mode, Option TDS and Option FS2 are all licensed

Preset	PROMpt Not affected by Mode Preset but set to PROMpt by Restore Defaults > "All" on page 897 or Power On
--------	---

4.4.3.2 Load FPGA

Depending on the "**FPGA Load Preference**" on page 886 selection, there may be a mismatch between the desired FPGA image, and the one that is currently loaded. In that case the **Load FPGA** control at the bottom of the dialog is not grayed-out, and you must press it to actually load the desired FPGA image. The image that is currently loaded is shown on the right:

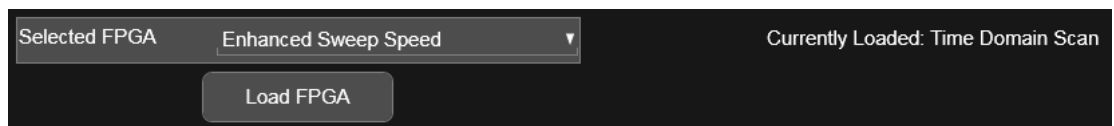

If you have a mismatch, but do not actually load the other image, the **FPGA Load Preference** is remembered, but the image you had before remains until you return to this dialog and press **Load FPGA**, or until the next time the instrument firmware is updated.

If you press **Load FPGA**, the X-series software exits, the FPGA update program runs, and the instrument reboots. After rebooting, the new image will be loaded in the FPGA.

NOTE This can take 15 minutes or more.

CAUTION If power is lost during the FPGA load process, the FPGA can become corrupted, in which case the only solution is to return it to Keysight for servicing.

Remote Command	<code>:SYSTem:PON:FPGA:LOAD TDS FS2</code>
Example	<code>:SYST:PON:FPGA:LOAD TDS</code> For options, see Dependencies row below <code>:SYST:PON:FPGA:LOAD?</code>
Notes	If the specified FPGA image version is the one already loaded, then the command does nothing. If the FPGA image needs to change, the analyzer software exits (terminating the SCPI session), and the FPGA update utility is launched. Once the FPGA has updated, the instrument will reboot This SCPI is always available, but if the hardware does not support multiple FPGA image choices, the value returned is always: NA = Not available for this hardware Also, when not supported, any attempt to change away from NA generates error -224, "Illegal parameter value"
Dependencies	Available only when there are multiple versions of the FPGA image that could be loaded

Selection limited to licensed features:

- **TDS** selection requires EMC Mode and Option TDS
- **FS2** requires Option FS2

The UI is blanked when there is only one licensed selection, and that selection is already loaded.

Sending the SCPI for an unlicensed selection results in error:

-224, "Illegal parameter value; <option> is not licensed"

Preset None. Not affected by **Mode Preset** nor any ["Restore Defaults" on page 894](#)

4.4.4 Restore Power On Defaults

This selection causes the **Power On** settings to be reset to their default values.

When this button is pressed, a message appears saying:

This will reset Power On State and Power On Application to their default state.

It will not affect Alignment data or settings.

This action cannot be undone. Do you want to proceed?

The message provides **OK** and **Cancel** buttons for you to confirm or cancel the operation.

Example `:SYST:DEF PON`

4.4.5 Configure Applications – Desktop application

The **Configure Applications** utility runs from the instrument's desktop. You must close the Instrument Application before running **Configure Applications**.

This utility can be used to:

- select applications (Modes) for preload
- determine how many Modes can fit in memory at one time
- specify the order of the Modes in the Mode menu.

The utility consists of a window with instructions, a set of **Select Application** checkboxes, a "fuel bar" style memory gauge, and keys that help you set up your configuration.

NOTE

In products that run multiple instances of the X-Series Application, the same **Configure Applications** utility is shared between all the instances.

For more details, see the following topics:

- "Preloading Applications" on page 889
- "Access to Configure Applications utility" on page 889
- "Virtual memory usage" on page 890

Example

Display the Config Applications screen:

```
:SYST:SHOW CAPP
```

Preloading Applications

During runtime, if a Mode that is not preloaded is selected using the **Mode** menu or by sending SCPI commands, there will be a pause while the Application is loaded. During this pause, a message that says "**Loading application, please wait ...**" is displayed. Once loaded, the application stays loaded, so the next time you select it during a session, there is no delay.

Preloading lets you "preload" at startup, to eliminate the runtime delay. Preloading an application causes it to be loaded into the instrument's memory when the analyzer program starts up. If you do this, the delay will increase the time it takes to start up the analyzer program, but this may be preferable to having to wait the first time you select an application. Note that, once an application is loaded into memory, it cannot be unloaded without exiting and restarting the analyzer program.

Note that there are more applications available for X-Series than can fit into Windows Virtual Memory. By allowing you to choose which licensed applications to load at startup, the **Configure Applications** utility allows you to make optimal use of the instrument memory.

Access to Configure Applications utility

A version of the utility runs the first time you power up the instrument after purchasing it from Keysight. The utility automatically configures preloads so that as many licensed applications as possible are preloaded while keeping the total estimated virtual memory usage below the limit. This auto-configuration only takes place at the very first run, and after analyzer software upgrades.

At any time, you can manually start the **Configure Applications** utility by closing the analyzer application and double-tapping the **Configure Applications** icon on the desktop.

The utility's main dialog looks like this:

4 System

4.4 Power On

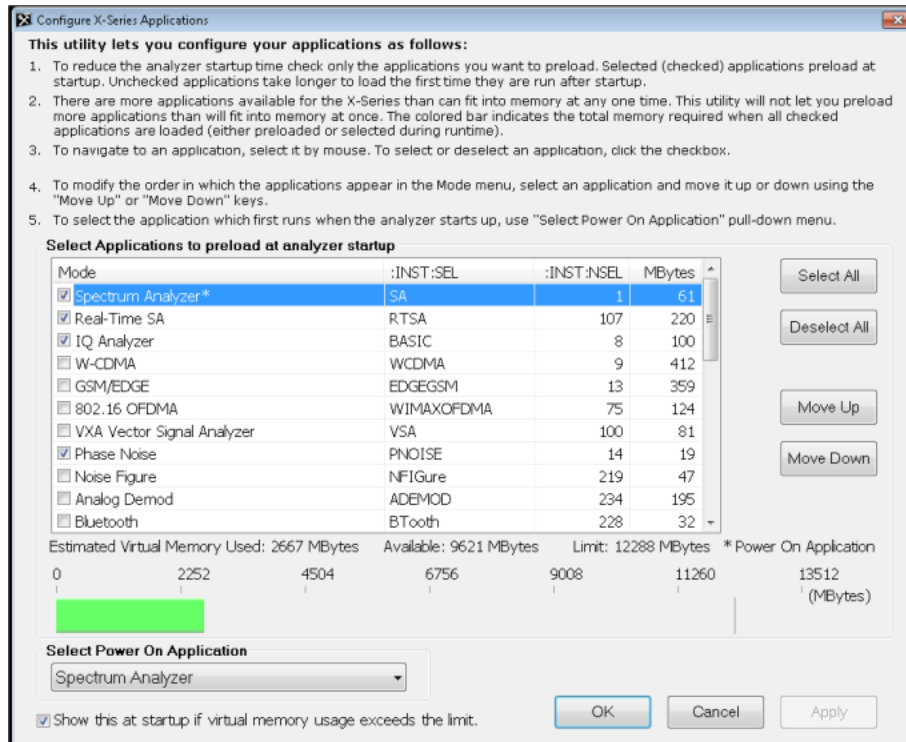

Instructions are provided below and in the utility. Use the utility to find a configuration that works best for you, and then restart the analyzer program.

- Select All** Marks all applications in the selection list. This allows you to enable all applications licensed on the instrument for pre-loading, or is a convenience for selecting all applications in one operation and then letting you deselect individual applications
- Deselect All** Clears the marks from all applications in the selection list, except the Power On application. The Power On application cannot be eliminated from the pre-load list
- Move Up** The application list is the order that applications appear in the Mode Menu. These keys let you shift the selected application up or down in the list, thus moving the selected application earlier or later in the Mode Menu
- Move Down**
- Select Power On Application** This is the same as the "Power On Application" selection on the Power On page of the System Settings dialog

Virtual memory usage

There are more applications available for X-Series than can fit into memory at any one time, so the **Configure Applications** utility includes a memory tracker that serves two purposes:

1. It will not let you preload more applications than will fit into memory at once
2. You can determine how many of your favorite applications can reside in memory at one time

The utility provides a graphical representation of the amount of memory (note that the amount of memory shown here is *virtual* memory, which is a limitation imposed by the operating system, not by the amount of physical memory you have in your instrument). You select applications to preload by checking the boxes on the left. Checked applications preload at startup. The colored fuel bar indicates the total memory required when all the checked applications are loaded (either preloaded or selected during runtime).

Here is what the fuel bar colors mean:

- RED: the applications you have selected cannot all fit into the instrument's memory. You must deselect applications until the fuel bar turns yellow
- YELLOW: the applications you have selected can all fit into the instrument's memory, but there is less than 10% of the memory left, probably not enough to load any other applications, either via preload or by selecting a Mode while the instrument is running
- GREEN: The indicator is green when <90% of the memory limit is consumed. This means the applications you have selected can all fit into the instrument's memory with room to spare. You will be able to load one or more other applications without running out of memory

If Sequence Analyzer is selected to be preloaded, all apps that are part of the Sequencer Mode (GSM/EDGE, WCDMA, CDMA2K and 1xEVDO) are preloaded (if licensed).

4.4.6 Configure Applications - Instrument boot-up

When the Instrument Application starts, a dialog box similar to the one you see when you run **Configure Applications** is displayed, allowing you to choose which licensed applications are to be loaded. This dialog is only displayed if the memory required to pre-load all the licensed applications exceeds the virtual memory available.

4.4.7 Configure Applications - Remote Commands

The following topics provide details on using remote commands to configure the list of applications you want to load into the instrument memory, or query the virtual memory utilization for your applications.

- "Configuration list (Remote Command Only)" on page 892
- "Configuration Memory Available (Remote Query Only)" on page 892
- "Configuration Memory Total (Remote Query Only)" on page 892
- "Configuration Memory Used (Remote Query Only)" on page 893
- "Configuration Application Memory (Remote Query Only)" on page 893

4.4.7.1 Configuration list (Remote Command Only)

Used to set or query the list of applications to be loaded in-memory.

Remote Command	<code>:SYSTem:PON:APPLication:LLISt <string of INSTRument:SElect names></code> <code>:SYSTem:PON:APPLication:LLISt?</code>
Example	<code>:SYST:PON:APPL:LLIS "SA,BASIC,WCDMA"</code>
Notes	<code><string of INSTRument:SElect names></code> contains items that are valid options for the <code>:INSTRument:SElect</code> command The order of the <code><INSTRument:SElect names></code> specifies the order in which the applications are loaded into memory, and the order that they appear in the Mode menu Error message -225 "Out of Memory" is reported when more applications are listed than can reside in virtual memory. When this occurs, the existing applications load list is unchanged
Preset	Not affected by Preset
State Saved	Not saved in instrument state

4.4.7.2 Configuration Memory Available (Remote Query Only)

Returns the amount of Virtual Memory remaining.

Remote Command	<code>:SYSTem:PON:APPLication:VMEMory[:AVAilable]?</code>
Example	<code>:SYST:PON:APPL:VMEM?</code>
Preset	Not affected by Preset

4.4.7.3 Configuration Memory Total (Remote Query Only)

Returns the limit of Virtual Memory allowed for applications.

Remote Command	<code>:SYSTem:PON:APPLication:VMEMory:TOTal?</code>
Example	<code>:SYST:PON:APPL:VMEM:TOT?</code>
Preset	Not affected by Preset

4.4.7.4 Configuration Memory Used (Remote Query Only)

Returns the amount of Virtual Memory used by all measurement applications.

Remote Command	<code>:SYSTem:PON:APPLication:VMEMory:USED?</code>
Example	<code>:SYST:PON:APPL:VMEM:USED?</code>
Preset	Not affected by Preset

4.4.7.5 Configuration Application Memory (Remote Query Only)

Returns the amount of Virtual Memory a particular application consumes.

Remote Command	<code>:SYSTem:PON:APPLication:VMEMory:USED:NAME? <INSTRument:SElect name></code>
Example	<code>:SYST:PON:APPL:VMEM:USED:NAME? CDMA2K</code>
Notes	<p><code><INSTRument:SElect name></code> is an item from the same set used by the <code>:INSTRument:SElect</code> command</p> <p>If the name provided is invalid, 0 (zero) is returned</p>
Preset	Not affected by Preset

4.5 Restore Defaults

Provides initialization of system setting groups, including the option to set the entire instrument back to a factory default state.

NOTE

In products that run multiple instances of the X-Series Application, all instances have the same factory default states for **Restore Defaults**.

Remote Command	<code>:SYSTem:DEFault [ALL] ALIGn INPut MISC MODes PON UINTerface SCReen</code>
Example	<code>:SYST:DEF</code>
State Saved	No

4.5.1 Input/Output

Input/Output Preset resets the group of settings and data associated with the **Input/Output** front-panel key to their default values. These settings are not affected by a **Mode Preset** because they are associated with connections to the instrument, which you will probably not want to reset every time you press **Mode Preset**.

By using **Input/Output Preset** and "[Restore Mode Defaults](#)" on page 1002, a full preset of the current mode will be performed, with the caveat that since **Input/Output Preset** is a global function, it will affect *all* modes.

This is the same as the **Input/Output Preset** button in the **Preset** dropdown and the **Input/Output** menu.

When **Input/Output** is selected, a message appears saying:

`This will reset all of the Input/Output variables to their default state, including which input is selected, all Amplitude Correction settings and data, all External Mixing settings, all Frequency Reference settings and all Output settings`

`It will not affect Alignment data or settings`

`This action cannot be undone. Do you want to proceed?`

The dialog includes **OK** and **Cancel** controls, for you to confirm or cancel the operation.

Example	<code>:SYST:DEF INP</code>
---------	----------------------------

4.5.2 I/O Config

Causes the group of settings associated with the **I/O Config** menu to be reset to their default values. This also happens on **Restore Misc Defaults**, which has a SCPI command, although **I/O Config** does not.

When **I/O Config** is selected, a message appears saying:

This will reset all of the I/O Config variables to their default state, including the GPIB address and SCPI LAN settings

It will not affect Alignment data or settings

This action cannot be undone. Do you want to proceed?

The dialog includes **OK** and **Cancel** controls, for you to affirm or cancel the operation.

4.5.3 User Interface

Causes the group of settings associated with the **User Interface** menu to be reset to their default values. This also happens on a **Restore Misc Defaults**.

When **User Interface** is selected, a message appears saying:

This will reset all of the User Interface variables to their default state, including the menu panel location, display theme, and language

It will not affect Alignment data or settings

This action cannot be undone. Do you want to proceed?

The dialog includes **OK** and **Cancel** controls, for you to affirm or cancel the operation.

Example `:SYST:DEF UINT`

4.5.4 Power On

Causes the **Power On** settings to be reset to their default values.

The Power On settings are **Power On State** and **Power On Application**.

When **Power On** is selected, a message appears saying:

This will reset Power On State and Power On Application to their default state

It will not affect Alignment data or settings

This action cannot be undone. Do you want to proceed?

The dialog includes **OK** and **Cancel** controls, for you to affirm or cancel the operation.

Example `:SYST:DEF PON`

4.5.5 Alignments

Causes the **Alignments** system settings to be reset to their default values. This does not affect any Alignment data stored in the system.

After performing this function, it may impact the auto-alignment time of the instrument until a new alignment baseline has been established.

When **Alignments** is selected, a message appears saying:

`This will reset all of the settings for the Alignment system to their default values`

`No alignment data will be erased`

`This action cannot be undone. Do you want to proceed?`

The dialog includes **OK** and **Cancel** controls, for you to affirm or cancel the operation.

Example `:SYST:DEF ALIG`

4.5.6 Misc

Causes miscellaneous system settings to be reset to their default values.

CAUTION

This function resets the GPIB address to 18.

When **Misc** is selected, a message appears saying:

`This will reset miscellaneous system settings to their default values. This includes settings for I/O Config (GPIB and SCPI LAN), the User Interface, the Save/Recall system, and the Preset type`

`It will not affect Alignment data or settings`

`This action cannot be undone. Do you want to proceed?`

The dialog includes **OK** and **Cancel** controls, for you to affirm or cancel the operation.

This Miscellaneous group contains settings that are *not* part of the other Restore Defaults groups. These include:

- All settings on the **I/O Config** page of the **System Settings** dialog
- All settings in the following table:

Miscellaneous Setting	Default Value
The SYST:PRES:TYPE	MODE
Auto File Name Number	000
Save Type	State
State Save To	Register 1
Screen Save To	SCREEN000.png
Save/Recall Shortcuts	Deleted
Display Theme	Filled
Backlight	ON
System Annotation	Local Settings
Language	English
DISP:ENABLe	ON
Full Screen	Off

Example `:SYST:DEF MISC`

4.5.7 All

Comprehensively resets **All** instrument settings to their factory default values.

Resets all **System Settings** groups, performs "[Restore Mode Defaults](#)" on page 1002 for all Modes in the instrument, and switches back to the power-on mode. Does not affect the User Preset file, or any user saved files.

When **All** is selected, a message appears:

This will reset all of the settings in the instrument to their factory default values, including the state of all Modes and Screens, the GPIB settings, the Alignment settings, and the Power On Mode

It will not affect Alignment data or settings

This action cannot be undone. We recommend canceling this operation and restoring settings individually (I/O Config, User Interface, Alignments, etc.) instead

Do you want to proceed?

The dialog includes **OK** and **Cancel** controls, for you to confirm or cancel the operation.

NOTE

If you are using a Keysight USB External Mixer, then you will need to perform **Refresh USB Mixer Connection** (SCPI command `:MIX:BAND USB`) after **Restore Defaults > All**.

4 System
4.5 Restore Defaults

Example	<code>:SYST:DEF ALL</code>
Couplings	All causes the currently running measurement to be aborted, and sets all modes to a consistent state, so it is unnecessary to couple any settings
	Backwards Compatibility SCPI
Notes	<code>:SYST:PRES:PERS</code> is the same as <code>:SYST:DEF ALL</code>
Backwards Compatibility SCPI	<code>:SYSTem:PRESet:PERSiStent</code>

4.6 Alignments

Accesses the alignment system of the instrument. You can control the automatic alignments, view alignment statistics and manually perform alignments.

The current setting of the alignment system is displayed in the Meas Bar along the top of the display. For conditions that may cause specifications to be impacted, this annotation will be in amber.

4.6.1 Auto Align

Lets you configure the automatic background alignments and the alerts from the automatic alignment system.

Dependencies	Does not appear in VXT or M9410E/11E/15E/16E
--------------	--

4.6.1.1 Auto Align

Configures the method the automatic background alignment will use when it runs.

Automatic background alignments are run periodically between measurement acquisitions. The instrument's software determines when alignments are to be performed to maintain warranted operation. The recommended setting for Auto Align is Normal.

Auto Align execution *cannot* be aborted with the **Cancel (ESC)** key. To interrupt **Auto Align** execution, select **Auto Align Off**.

Remote Command	<code>:CALibration:AUTO ON LIGHT PARTial OFF</code> For details of each option, see " Auto Align Options " on page 900 <code>:CALibration:AUTO?</code>
Example	<code>:CAL:AUTO ON</code>
Notes	While Auto Align is executing, bit 0 of Status Operation register is set
Couplings	Auto Align is set to Off if Restore Align Data is invoked
Preset	This is unaffected by Preset but is set to ON by Restore Defaults > " Alignments " on page 896
State Saved	No
Annotation	In the Meas Bar: <ul style="list-style-type: none"> - Normal with "All But RF" off: Auto (white) - Normal with "All But RF" on: Auto/No RF (amber) - Partial: Partial (amber)

	- Off: Off (amber)
Status Bits/OPC dependencies	When Auto Align is executing, Bit 0 in the Status Operational register is set An interfering signal at the RF Input may prevent automatic alignment of the RF subsystem. If this occurs, the Error Condition message “Align RF skipped” is reported, the Status Questionable Calibration bit 11 is set, and the alignment proceeds. When a subsequent alignment of the RF subsystem succeeds, either by the next cycle of automatic alignment or from an Align Now, RF, the Error Condition and Status Questionable Calibration bit 11 are cleared
Backwards Compatibility SCPI	:CALibration:AUTO ALERT Parameter ALERT is for backwards compatibility only, and is mapped to PARTial

Auto Align Options

The available settings for Auto Align are as follows:

Normal

SCPI example **:CAL:AUTO ON**

Auto Align, Normal turns on the automatic alignment of all measurement systems. This selection maintains the instrument in warranted operation across varying temperature and over time.

If the condition “Align Now All required” is set, transitioning to **Auto Align, Normal** performs the required alignments, clears the “Align Now All required” condition, then continues with further alignments as required to maintain the instrument adequately aligned for warranted operation.

When **Auto Align, Normal** is selected, the **Auto Align Off** time is set to zero.

When **Auto Align, Normal** is selected, the Meas Bar indicates Align: Auto (in white) or Align: Auto/No RF (in amber). The amber color reminds you that you are responsible for maintaining the RF alignment of the instrument.

Alignment processing because of the transition to **Normal** is executed sequentially. Thus, ***OPC?** or ***WAI** following **:CAL:AUTO ON** will return when the alignment processing is complete.

Light

SCPI example **:CAL:AUTO LIGH**

Auto Align, Light turns on the automatic alignment of all measurement systems. The **Auto Align, Light** selection allows more drift in amplitude accuracy to allow much less frequent measurement interruptions to perform alignments. The temperature changes required to trigger each alignment are increased by a factor of three. Alignments also expire from time as well as temperature. In a stable thermal

environment, the alignments occur one-ninth as often as in Normal. With these less frequent alignments, all accuracy specifications (those expressed with $\pm x$ dB tolerances) change by nominally a factor of 1.4.

If the condition “Align Now, All required” is set, transitioning to **Auto Align, Light** performs the required alignments, clears the “Align Now, All required” condition, and continues with further alignments as required to maintain the instrument adequately aligned for warranted operation.

Alignment processing because of the transition to **Light** is executed sequentially. Thus, ***OPC?** or ***WAI** following **:CAL:AUTO LIGHT** will return when the alignment processing is complete.

When **Auto Align, Light** is selected, the **Auto Align Off** time is set to zero.

When **Auto Align, Light** is selected, the Settings Panel indicates Align: Light.

Partial

SCPI example **:CAL:AUTO PART**

Auto Align, Partial disables the full automatic alignment and the maintenance of warranted operation for the benefit of improved measurement throughput. Accuracy is retained for the Resolution Bandwidth filters and the IF Passband, which is critical to FFT accuracy, demodulation, and many measurement applications. With Auto Align set to Partial, you are now responsible for maintaining warranted operation by updating the alignments when they expire. The Auto Align, Alert mechanism will notify you when alignments have expired. One solution to expired alignments is to perform the Align All, Now operation. Another is to return the Auto Align selection to Normal.

Auto Align, Partial is recommended for measurements where the throughput is so important that a few percent of improvement is more valued than an increase in the accuracy errors of a few tenths of a decibel. One good application of **Auto Align, Partial** would be an automated environment where the alignments can be called during overhead time when the device-under-test is exchanged.

When **Auto Align, Partial**, is selected the elapsed time counter begins for **Auto Align Off** time.

When **Auto Align, Partial** is selected, the Settings Panel indicates Align: Partial in an amber color. The amber color reminds you that you are responsible for maintaining the warranted operation of the instrument.

Off

SCPI example **:CAL:AUTO OFF**

Auto Align, Off disables automatic alignment and the maintenance of warranted operation, for the benefit of maximum measurement throughput. With **Auto Align**

set to **Off**, you are now responsible for maintaining warranted operation by updating the alignments when they expire. The Auto Align, Alert mechanism will notify you when alignments have expired. One solution to expired alignments is to perform the **Align All, Now** operation. Another is to return the **Auto Align** selection to **Normal**.

The **Auto Align Off** setting is rarely the best choice, because **Partial** gives almost the same improvement in throughput while maintaining the warranted performance for a much longer time. The choice is intended for unusual circumstances, such as the measurement of radar pulses where you might want the revisit time to be as consistent as possible.

When **Auto AlignOff** is selected, the **Auto Align Off** time is initialized and the elapsed time counter begins.

When **Auto AlignOff** is selected, the Settings Panel indicates Align: Off in an amber color. The amber color reminds you that you are responsible for maintaining the warranted operation of the instrument.

4.6.1.2 All but RF

Configures automatic alignment to include or exclude the RF subsystem. (Eliminating the automatic alignment of the RF subsystem prevents the input impedance from changing. The normal input impedance of 50 ohms can change to an open circuit when alignments are being used. Some devices under test do not behave acceptably under such circumstances, for example by showing instability.)

When **All but RF** is **ON**, the operator is responsible for performing an **Align Now RF** when RF-related alignments expire. The Auto Align, Alert mechanism will notify you to perform an **Align Now All** when the combination of time and temperature variation is exceeded.

When **All But RF** is **ON**, the Settings Panel indicates Align: Auto/No RF (in amber). The amber color reminds you that you are responsible for maintaining the RF alignment of the instrument.

Remote Command	<code>:CALibration:AUTO:MODE ALL NRF</code>
Example	<code>:CAL:AUTO:MODE NRF</code>
Preset	Unaffected by Preset but set to ALL by Restore Defaults > "Alignments" on page 896
State Saved	No

4.6.1.3 Alert

The instrument signals an **Alert** when conditions exist such that you will need to perform a full alignment (for example, **Align Now All**). Alert can be configured in one

of four settings:

Setting	Option
Time & Temperature	TTEmperture
Time & Temperature Light	LIGHT
7 days	WEEK
None	NONE

With **Auto Align** set to **Normal**, the configuration of **Alert** is not relevant, because the instrument's software maintains the instrument in warranted operation.

A confirmation is required when a selection other than **TTEmperture** is chosen. This prevents accidental deactivation of alerts. When setting **Alert** from the front panel to any value but **TTEmperture**, confirmation is required to transition into this setting of Alert. The confirmation dialog is:

This will suppress alerts from the Alignment system, which would notify you when an Alignment is required to maintain warranted operation. Without the alerts you will be responsible for performing an Align Now All at appropriate intervals to maintain warranted operation

Do you want to proceed?

The dialog includes **OK** and **Cancel** controls, for you to affirm or cancel the operation.

No confirmation is required when **Alert** is configured through a remote command.

For more information see "[Time & Temperature](#)" on page 903

Remote Command	:CALibration:AUTO:ALERT TTEmperture LIGHT DAY WEEK NONE :CALibration:AUTO:ALERT?
Example	:CAL:AUTO:ALER TTEM
Preset	Unaffected by Preset but set to TTEmperture by Restore Alignment Defaults
State Saved	No
Status Bits/OPC dependencies	When an alert is generated, the condition message "Align Now All required" appears in the Status Bar, and bit 14 is set in the Status Questionable Calibration register

The settings for **Alert** are detailed below.

Time & Temperature

SCPI Example CAL:AUTO:ALER TTEM

The instrument signals an alert when alignments expire due to the combination of the passage of time and changes in temperature. The alert is the Error Condition message "Align Now All required". If this choice for Alert is selected, the absence of an alert means that the instrument alignment is sufficiently up-to-date to maintain warranted accuracy.

Time & Temperature Light

SCPI Example

`CAL:AUTO:ALER LIGH`

This is a light version of Time & Temperature which means for this setting the time/temperature changes required to trigger an alert are increased by a factor of three and the time alerts will occur one-ninth as often as for Time and Temperature.

24 hours

SCPI Example

`CAL:AUTO:ALER DAY`

The instrument signals an alert after a time span of 24 hours since the last successful full alignment (for example, **Align Now All** or completion of a full **Auto Align**). You may want to select this option in an environment where the temperature is stable on a daily basis, at a small risk of accuracy errors in excess of the warranted specifications. The alert is the Error Condition message “Align Now All required”.

7 days

SCPI Example

`CAL:AUTO:ALER WEEK`

The instrument signals an alert after a time span of 168 hours since the last successful full alignment (for example, **Align Now All** or completion of a full **Auto Align**). You may want to select this option in an environment where the temperature is stable on a weekly basis, at a modest risk of accuracy degradations in excess of warranted performance. The alert is the Error Condition message “Align Now All required”.

None

SCPI Example

`CAL:AUTO:ALER NONE`

The instrument does not signal an alert. This is provided for rare occasions where you are making a long measurement that cannot tolerate **Auto Align** interruptions, and must have the ability to capture a screen image at the end of the measurement without an alert posted to the display. Keysight does not recommend using this selection in any other circumstances, because of the risk of accuracy performance drifting well beyond expected levels without the operator being informed.

4.6.2 Align Now

Accesses alignment processes that are immediate action operations. They perform complete operations and run until they are complete.

Executing immediate alignments from SCPI can be problematic due to the length of time required for the alignments to complete. Alignment commands are by their

nature sequential, meaning they must complete before any other SCPI commands can be processed. In many cases the alignment itself will take longer than the typical SCPI timeout value. Furthermore, status cannot be easily queried while a sequential command is running.

For this reason, overlapped versions of the **Align Now** commands are provided. When using these No-Operation-Pending (**NPENDING**) commands, the SCPI thread will not be blocked (will be released immediately), so that you can use `:STATus:OPERation:CONDition?` to query the alignment status bit and use `:STATus:QUESTionable:CALibration:CONDition?` to check the alignment results. As an example, `:CALibration[:ALL]:NPENDING` is the overlapped replacement for `:CALibration[:ALL]`.

While the alignment is executing, the coming NOP calibration will be ignored, and **error message “Setting Conflict, Alignment is in process”** will be posted. Also, any other operations to the instrument will be pended and postponed until the alignment is completed. The operations include: Preset, Initiate a new measurement, Device clear and so on. Accordingly, changing parameters will not take effect although the UI is updated immediately. To avoid unexpected timeouts and results, these operations are not recommended during any such alignments.

NOTE

The Alignments are not performed if the MIMO Sync is running, because the MIMO and Alignments require the same hardware resource. If the instrument is in MIMO Sync and you press a button to execute Alignments, a pop-up window appears as below. Click **OK** to stop MIMO and execute Alignments.

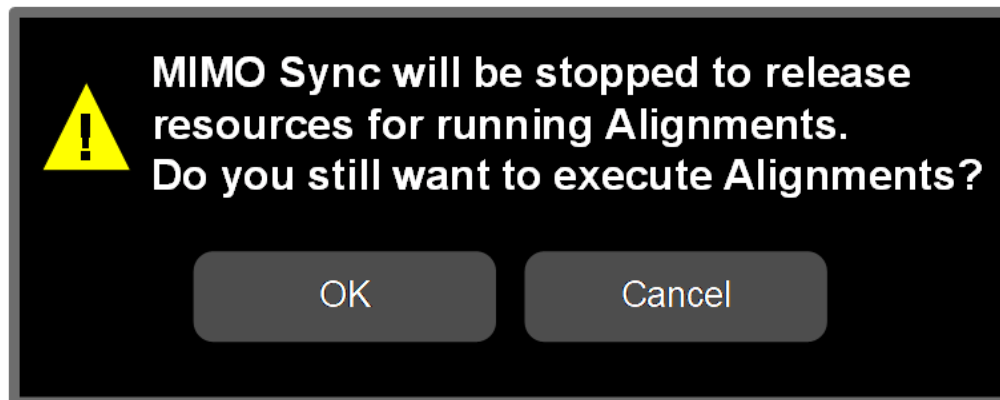

If the instrument is in MIMO sync, and you send a SCPI command to run Alignments, the align process is not executed, and a warning is generated. To execute Alignments, you must first stop MIMO via SCPI (or manually).

Controls in this Dialog

The selection and order of controls displayed in this dialog depends on the instrument type and options. Select the control of interest from the following list:

4 System

4.6 Alignments

- "Align Now All" on page 906
- "Align Now All but RF" on page 908
- "Align Now RF" on page 910
- "Align Now Expired" on page 911
- "Align Now Preselector" on page 912
- "Align Now All but RF Preselector" on page 913
- "Align Now RF Presel Only (20 Hz to 3.6 GHz)" on page 913
- "Align Now External Mixer" on page 914
- "Align Source" on page 915
- "Align Receiver" on page 916
- "Align Fast" on page 916
- "Align LO Leakage" on page 917
- "Align IF Cable" on page 917
- "Align RRH Amplitude" on page 917
- "Align LO Clock" on page 918
- "Align VXT Transceiver" on page 919
- "Align External Mixer Path" on page 923
- "Align Low Band" on page 924
- "Align High Band" on page 924

4.6.2.1 Align Now All

In PXE, the key label is **Align Now All (plus RF Presel 20 Hz – 3.6 GHz)**

Immediately executes an alignment of all subsystems. The instrument stops any measurement currently underway, performs the alignment, then restarts the measurement from the beginning (similar to pressing the **Restart** key).

If an interfering user signal is present at the RF Input, the alignment is performed on all subsystems except the RF. After completion, the Error Condition message "Align RF skipped" is generated. In addition, the Error Condition message "Align Now, RF

required” is generated, and bits 11 and 12 are set in the Status Questionable Calibration register.

The query form of the remote commands (`:CALibration[:ALL]?` or `*CAL?`) invokes the alignment of all subsystems and returns a success or failure value. An interfering user signal is not grounds for failure; if the alignment was able to succeed on all portions but unable to align the RF because of an interfering signal, the resultant will be the success value.

Successful completion of **Align Now All** will clear the “Align Now All required” Error Condition, and clear bit 14 in the Status Questionable Calibration register. It will also begin the elapsed time counter for Last Align Now All Time, and capture the Last Align Now All Temperature.

If the Align RF subsystem succeeded in aligning (no interfering signal present), the elapsed time counter begins for Last Align Now, RF Time, and the temperature is captured for the Last Align Now, RF Temperature. In addition, the Error Conditions “Align RF skipped” are cleared, the Error Condition “Align Now, RF required” is cleared, and bits 11 and 12 are cleared in the Status Questionable Calibration register

Align Now All can be interrupted, by pressing the **Cancel (ESC)** front-panel key, or remotely with Device Clear followed by the `:ABORt` SCPI command. When this occurs, the Error Condition message “Align Now All required” is generated, and bit 14 is set in the Status Questionable Condition register. This is because new alignment data may be employed for an individual subsystem, but not a cohesive set of data for all subsystems.

In many cases, you might find it more convenient to change alignments to **Normal**, instead of executing **Align Now All**. When the Auto Align process transitions to **Normal**, the instrument will immediately start to update only the alignments that have expired, thus efficiently restoring the alignment process.

Remote Command	<code>:CALibration[:ALL]</code> <code>:CALibration[:ALL]?</code>
Example	<code>:CAL</code>
Notes	<p><code>:CALibration[:ALL]?</code> returns 0 if successful, or 1 if failed</p> <p><code>:CALibration[:ALL]?</code> is the same as <code>*CAL?</code></p> <p>While Align Now All is performing the alignment, the Calibrating bit (Bit 0 in the Status Operation register) is set. Completion, or termination, will clear Bit 0 in the Status Operation register</p> <p>This command is sequential; it must complete before further SCPI commands are processed. Interrupting the alignment from remote is accomplished by invoking Device Clear followed by the <code>:ABORt</code> command</p> <p>Successful completion will clear bit 14 in the Status Questionable Calibration register</p> <p>An interfering user signal is not grounds for failure of Align Now All. However, Bits 11 and 12 are set in the Status Questionable Calibration register to indicate Align Now, RF is required</p> <p>An interfering user-supplied signal will result in the instrument requiring an Align Now, RF with the</p>

4 System
4.6 Alignments

	interfering signal removed
Couplings	<p>Initializes the time for the Last Align Now All Time</p> <p>Records the temperature for the Last Align Now All Temperature</p> <p>If Align RF component succeeded, initializes the time for the Last Align Now, RF Time</p> <p>If Align RF component succeeded, records the temperature for the Last Align Now, RF Temperature</p>
Status Bits/OPC dependencies	<p>Bits 11, 12, or 14 may be set in the Status Questionable Calibration register</p> <p>IEEE Command</p>
Remote Command	<code>*CAL</code>
Example	<code>*CAL?</code>
Notes	<p>Returns 0 if successful, or 1 if failed</p> <p><code>:CALibration[:ALL]?</code> is exactly the same as <code>*CAL?</code>, including all conditions, status register bits, and couplings</p> <p>See additional remarks described with <code>:CALibration[:ALL]?</code></p> <p>Overlapped Command</p>
Remote Command	<code>:CALibration[:ALL]:NPENding</code>
Example	<code>:CAL:NPEN</code>
Notes	<p><code>:CALibration[:ALL]:NPENding</code> is the same as <code>:CALibration[:ALL]</code>, including all conditions, status register bits, except this SCPI command <i>does not block</i> the SCPI session, so you should use status register bits to query whether the calibration is successfully completed or not</p> <p>Typical usage is:</p> <ol style="list-style-type: none"> 1. <code>:CALibration:ALL:NPENding</code> (Start a calibration) 2. <code>:STATus:OPERation:CONDition?</code> (Check if the calibration is completed or not, If bit 0 is set, then the system is doing calibration, you should repeat this SCPI query until the bit is cleared) 3. <code>:STATus:QUEStionable:CALibration:CONDition?</code> (Check if there are any errors/-failures in previous calibration procedure)

4.6.2.2 Align Now All but RF

In PXE, the key label is **Align Now All but RF (not including RF Presel)**

Immediately executes an alignment of all subsystems except the RF subsystem. The instrument will stop any measurement currently underway, perform the alignment, and then restart the measurement from the beginning (similar to pressing the **Restart** key). This can be used to align portions of the instrument that are not impacted by an interfering user input signal.

This operation might be chosen instead of **All** if you do not want the device under test to experience a large change in input impedance, such as a temporary open circuit at the instrument input.

The query form of the remote commands (`:CALibration:NRF?`) invokes the alignment and returns a success or failure value.

Successful completion of **Align Now All but RF** clears the “Align Now All required” Error Condition, and clears Bit 14 in the Status Questionable Calibration register. If “Align Now All required” was in effect prior to executing **All but RF**, the Error Condition message “Align Now RF required” is generated and Bit 12 in the Status Questionable Calibration register is set. It will also begin the elapsed time counter for Last Align Now All Time, and capture the Last Align Now All Temperature.

Align Now All but RF can be interrupted, by pressing the **Cancel (ESC)** front-panel key, or remotely with Device Clear followed by the `:ABORt` SCPI command. When this occurs, the Error Condition message “Align Now All required” is generated, and Bit 14 is set in the Status Questionable Condition register. This is because new alignment data may be used for an individual subsystem, but not a full new set of data for all subsystems.

Remote Command	<code>:CALibration:NRF</code> <code>:CALibration:NRF?</code>
Example	<code>:CAL:NRF</code>
Notes	Returns 0 if successful, or 1 if failed While Align Now All but RF is performing the alignment, Bit 0 in the Status Operation register is set. Completion, or termination, will clear Bit 0 in the Status Operation register This command is sequential; it must complete before further SCPI commands are processed. Interrupting the alignment from remote is accomplished by invoking Device Clear followed by the <code>:ABORt</code> command Successful completion clears Bit 14 in the Status Questionable Calibration register and sets Bit 12 if invoked with “Align Now All required”
Couplings	Initializes the time for the Last Align Now All Time Records the temperature for the Last Align Now All Temperature
Status Bits/OPC dependencies	Bits 12 or 14 may be set in the Status Questionable Calibration register
Overlapped Command	
Remote Command	<code>:CALibration:NRF:NPENDING</code>
Example	<code>:CAL:NRF:NPEN</code>
Notes	<code>:CALibration:NRF:NPENDING</code> is the same as <code>:CALibration:NRF</code> , including all conditions, status register bits, except that this SCPI command <i>does not block</i> the SCPI session, so you should use status register bits to query whether the calibration is successfully completed or not Typical usage is:

-
1. `:CALibration:NRF:NPEnding` (start the All but RF calibration)
 2. `:STATus:OPERation:CONDition?` (If bit 0 is set, then the system is doing calibration, you should do re-query until this bit is cleared)
 3. `:STATus:QUEStionable:CALibration:CONDition?` (to check if there are any errors/-failures in previous calibration procedure)

4.6.2.3 Align Now RF

In PXE, the key label is **Align Now RF Only**

Immediately executes an alignment of the RF subsystem. The instrument stops any measurement currently underway, performs the alignment, then restarts the measurement from the beginning (similar to pressing the **Restart** key).

This operation might be desirable if the alignments had been set to not include RF alignments, or if previous RF alignments could not complete because of interference which has since been removed.

If an interfering user signal is present at the RF Input, the alignment will terminate and generate the Error Condition message “Align RF skipped”, and Error Condition “Align Now, RF required”. In addition, bits 11 and 12 will be set in the Status Questionable Calibration register.

The query form of the remote commands (`:CALibration:RF?`) invokes the alignment of the RF subsystem and returns a success or failure value. An interfering user signal is grounds for failure.

Successful completion of **Align Now RF** begins the elapsed time counter for Last Align Now, RF Time, and capture the Last Align Now, RF Temperature.

Align Now RF can be interrupted, by pressing the **Cancel (ESC)** front-panel key, or remotely with Device Clear followed by the `:ABORt` SCPI command. When this occurs, the Error Condition message “Align Now, RF required” is generated, and Bit 12 is set in the Status Questionable Condition register. None of the new alignment data is used.

Remote Command	<code>:CALibration:RF</code> <code>:CALibration:RF?</code>
----------------	---

Example	<code>:CAL:RF</code>
---------	----------------------

Notes	<p>Returns 0 if successful, or 1 if failed (including interfering user signal)</p> <p>While Align Now RF is performing the alignment, Bit 0 in the Status Operation register is set. Completion, or termination, clears Bit 0 in the Status Operation register</p> <p>This command is sequential; it must complete before further SCPI commands are processed. Interrupting the alignment from remote is accomplished by invoking Device Clear followed by the <code>:ABORt</code> command</p>
-------	---

	<p>Successful completion clears the Error Conditions “Align RF skipped” and the Error Conditions “Align RF failed” and “Align Now, RF required”, and clears Bits 3, 11, and 12 in the Status Questionable Calibration register</p> <p>A failure encountered during alignment generates the Error Condition message “Align RF failed” and sets Bit 3 in the Status Questionable Calibration register</p> <p>An interfering user signal will result in Bits 11 and 12 being set in the Status Questionable Calibration register, to indicate Align Now, RF is required</p> <p>An interfering user supplied signal results in the instrument requiring Align Now RF with the interfering signal removed</p>
Couplings	<p>Initializes the time for the Last Align Now, RF Time</p> <p>Records the temperature for the Last Align Now, RF Temperature</p>
Status Bits/OPC dependencies	Bits 11, 12, or 14 may be set in the Status Questionable Calibration register
Overlapped Command	
Remote Command	<code>:CALibration:RF:NPEnding</code>
Example	<code>:CAL:RF:NPEN</code>
Notes	<p><code>:CALibration:RF:NPEnding</code> is the same as <code>:CALibration:RF</code>, including all conditions, status register bits, except that this SCPI command <i>does not block</i> the SCPI session, so you should use status register bits to query whether the calibration is successfully completed or not</p> <p>Typical usage is:</p> <ol style="list-style-type: none"> 1. <code>:CALibration:RF:NPEnding</code> (Start a RF calibration) 2. <code>:STATus:OPERation:CONDition?</code> (If Bit 0 is set, then the system is doing calibration, you should do re-query until this bit is cleared) 3. <code>:STATus:QUEStionable:CALibration:CONDition?</code> (to check if there are any errors/-failures in previous calibration procedure)

4.6.2.4 Align Now Expired

Alignments can be Expired when **Auto Align** is **PARTial** or **OFF**.

This control runs the alignments that have expired. This differs from performing **Align All, Now.**, which performs an alignment of all subsystems regardless of whether they are needed or not, whereas **Execute Expired Alignments** aligns only the individual subsystems that have become due.

Remote Command	<code>:CALibration:EXPIred</code>
	<code>:CALibration:EXPIred?</code>
Example	<code>:CAL:EXP?</code>
Notes	<code>:CALibration:EXPIred?</code> returns 0 if successful, or 1 if failed

While **Align Now Expired** is performing the alignment, the Calibrating bit (Bit 0 in the Status Operation register) is set. Completion, or termination, clears Bit 0 in the Status Operation register

This command is sequential; that is, it must complete before further SCPI commands are processed. Interrupting the alignment from remote is accomplished by invoking Device Clear followed by **:ABORt**

Successful completion clears bit 14 in the Status Questionable Calibration register

An interfering user signal is not grounds for failure of **Align Now Expired**. However, if RF Alignment was required, Bits 11 and 12 are set in the Status Questionable Calibration register to indicate Align Now, RF is required

Status Bits/OPC dependencies Bits 11, 12, or 14 may be set in the Status Questionable Calibration register

4.6.2.5 Align Now Preselector

Normally, Preselector Alignment runs during power up, and during the twenty minutes after power up, whenever there is a 1-degree internal temperature change.

This alignment is also run when an **"Align Now All"** on page 906 is performed. This feature is helpful during the 20-minute warm-up time to correct for preselector drift while alignments are being held off. This feature can also be used in lieu of using the Preselector Center functionality, to improve speed throughput for remote testing with minimal impact to amplitude accuracy specs. The algorithm centers the preselector at the upper and lower operating frequencies of the YTF preselector.

The **Align Now Preselector** alignment is *not* a substitute for the Characterizer Preselector Advanced Alignment, which creates the default preselector centering curves for the YTF Preselector and is typically run annually.

Remote Command **:CALibration:PRESelector?**

Example **:CAL:PRES**

Notes Returns 0 if successful, or 1 if failed (including interfering user signal)

While **Align Now Preselector** is performing the alignment, Bit 0 in the Status Operation register is set. Completion, or termination, clears Bit 0 in the Status Operation register

This command is sequential; that is, it must complete before further SCPI commands are processed. Interrupting the alignment from remote is accomplished by invoking Device Clear followed by **:ABORt**

Successful completion clears the Error Conditions "Align Preselector failed" and clears Bit 3 in the Status Questionable Calibration Failure (Extended) register

A failure encountered during alignment generates the Error Condition message "Align Preselector failed" and sets Bit 3 in the Status Questionable Calibration Failure (Extended) register

Status Bits/OPC dependencies Bit 3 may be set in the Status Questionable Calibration Failure (Extended) register

4.6.2.6 Align Now All but RF Preselector

Only available in models with the RF Preselector, such as the N9048B. It is identical to the "Align Now All" on page 906 (plus RF Presel) function, except that the RF Preselector is only partially aligned. Only the System Gain, Mechanical attenuator and Electronic attenuator alignments on the RF Preselector path are aligned. The purpose of these alignments is to improve the RF Preselector path amplitude variation compared to the bypass path.

Remote Command	<code>:CALibration:NRFPreselector</code> <code>:CALibration:NRFPreselector?</code>
Example	<code>:CAL:NRFPre</code>
Dependencies	Only appears in N9048B. Sending the SCPI command or query in other models generates an error
Status Bits/OPC dependencies	Bits 12 or 14 may be set in the Status Questionable Calibration register

4.6.2.7 Align Now RF Presel Only (20 Hz to 3.6 GHz)

Only available in models with the RF Preselector, such as the N9048B. It executes an alignment of the RF Preselector section. The receiver will stop any measurement currently underway, perform the alignment, and then restart the measurement from the beginning (similar to pressing the **Restart** key). *Only* the RF Preselector is aligned; no Align Now All function is performed first.

The query (`:CALibration:RFPreselector:ONLY?`) invokes the alignment of the RF Preselector on both Conducted and Radiated Band, and returns a success or failure value. Successful completion clears the "Align 20 Hz to 3.6 GHz required" Error Condition, and clears Bit 1 and Bit 2 in the Status Questionable Calibration Extended Needed register.

The elapsed time counter will begin for Last Align Now, Conducted Time and Last Align Now Radiated Time and the temperature is captured for Last Align Now, Conducted Temperature and Last Align Now, Radiated Temperature. The alignment can be interrupted by pressing the **Cancel (ESC)** front-panel key or remotely with Device Clear followed by the `:ABORT` SCPI command. When this occurs, the Error Condition "Align 20 Hz to 3.6 GHz required" is set because new alignment data may be employed for an individual subsystem, but not a cohesive set of data for all subsystems.

The "Align 20 Hz to 3.6 GHz required" Error Condition will appear when this alignment has expired. The user is now responsible to perform the Align Now, 20 Hz to 3.6 GHz in order to keep the receiver in warranted operation. This alignment can only be performed by the user, as it is not part of the Auto Align process.

Remote Command	<code>:CALibration:RFPreselector:ONLY</code>
----------------	--

4 System
4.6 Alignments

	:CALibration:RFPSelector:ONLY?
Example	:CAL:RFPS:ONLY
Notes	<p>Query returns 0 if successful, or 1 if failed</p> <p>When Align 20 Hz to 3.6 GHz is performing the alignment, bit 0 in the Status Operation register is set. Completion, or termination, will clear bit 0 in the Status Operation register</p> <p>This command is sequential; it must complete before further SCPI commands are processed. Interrupting the alignment from remote is accomplished by invoking Device Clear followed by the :ABORt command. Successful completion clears Bits 1 and 2 in the Status Questionable Calibration Extended Needed register and Bits 0 and 1 in Status Questionable Calibration Extended Failure register</p> <p>A failure encountered during alignment sets the Error Condition “20 Hz to 3.6 GHz Alignment Failure”, sets Bits 1 and 2 in the Status Questionable Calibration Extended Needed register, and Bit 9 in Status Questionable Calibration Extended Failure register</p>
Dependencies	<p>Only appears in N9048B. Sending the SCPI command or query in other models generates an error</p> <p>This key is grayed-out if the instrument is displaying an “Align Now All required” message. If you press the key while it is grayed-out, you will see the informational message, “Align Now All required first”</p>
Couplings	<p>Initializes the time for the Last Align Conducted Now, Conducted Time</p> <p>Initializes the time for the Last Align Radiated Now, Radiated Time</p> <p>Records the temperature for the Last Align Conducted Now, Conducted Temperature</p> <p>Records the temperature for the Last Align Radiated Now, Radiated Temperature</p>
Status Bits/OPC dependencies	<p>Bit 8 or 9 may be set in the Status Questionable Calibration register</p> <p>Bit 1 and 2 may be set in the Status Questionable Calibration Extended Needed register</p> <p>Bit 0 and 1 may be set in the Status Questionable Calibration Extended Failure register</p>

4.6.2.8 Align Now External Mixer

Immediately executes an alignment of the External Mixer that is plugged into the USB port. The instrument stops any measurement currently underway, performs the alignment, then restarts the measurement from the beginning (similar to pressing the **Restart** key). As this alignment calibrates the LO power to the mixer, this is considered an LO alignment; and failure is classified as an LO alignment failure.

The query (**:CALibration:EMIXer?**) invokes the alignment of the External Mixer and returns a success or failure value.

Remote Command	:CALibration:EMIXer :CALibration:EMIXer?
Example	:CAL:EMIX
Notes	<p>Returns 0 if successful, or 1 if failed</p> <p>While Align Now External Mixer is performing the alignment, Bit 0 in the Status Operation register is set. Completion, or termination, clears Bit 0 in the Status Operation register</p> <p>This command is sequential; it must complete before further SCPI commands are processed.</p>

	<p>Interrupting the alignment from remote is accomplished by invoking Device Clear followed by the :ABORT command</p> <p>A failure encountered during alignment generate the Error Condition message “Align LO failed” and sets Bit 5 in the Status Questionable Calibration register. Successful completion clears the “Align LO failed” message and Bit 5 in the Status Questionable Calibration register</p>
Dependencies	This control does not appear unless option EXM is present and is grayed-out, unless a USB mixer is plugged in to the USB
Status Bits/OPC dependencies	Bit3 may be set in the Status Questionable Calibration Extended Failure register

4.6.2.9 Align Source

Accesses source alignment processes that are immediate action operations. They perform complete operations and run until they are complete.

The instrument stops any sequence of the source, performs the alignment, then restarts the sequence from the beginning.

Note: This alignment corrects slow-rate drift, which does not impair specifications for time periods shorter than one week. Thus, it is required to perform this alignment on a weekly basis to maintain specifications. This alignment typically takes >2 minutes to complete.

There is no alert available for the source alignment. Operators are responsible for checking temperature shift since the last **Align Now Source** to determine whether the source alignment needs to be executed.

Remote Command	:CALibration:INTernal:SOURce[:ALL] :CALibration:INTernal:SOURce[:ALL]?
Example	:CAL:INT:SOUR
Notes	:CAL:INT:SOUR? Initiates an Alignment and returns 0 if successful, or 1 if failed
Dependencies	Only appears in VXT models M9410A/11A
Couplings	Initializes the time for the Last Align Source Now, All Time Records the temperature for the Last Align Source Now, All Temperature

Overlapped Command

Remote Command	:CALibration:INTernal:SOURce[:ALL]:NPending
Example	:CAL:INT:SOUR:NPEN
Notes	:CALibration:INTernal:SOURce[:ALL]:NPending is the same as :CALibration:INTernal:SOURce[:ALL] , including all conditions and status register bits, except that this SCPI command <i>does not block</i> the SCPI session, so you should use status register bits to query whether the calibration is successfully completed or not Typical usage is:

1. `:CALibration:INTernal:SOURce:NPENding` (start an internal source calibration)
2. `:STATus:OPERation:CONDition?` (Check if the calibration is completed or not, If Bit 0 is set, then the system is doing calibration. Repeat this query until the bit is cleared)
3. `:STATus:QUESTionable:CALibration:EXTended:FAILure:CONDition?` (Check if Bit 14 is set or not. If this bit is set, that means there are some errors in previous internal source calibration)

Dependencies Only appears in VXT models M9410A/11A

4.6.2.10 Align Receiver

Accesses receiver alignment processes that are immediate action operations. They perform complete operations and run until they are complete.

NOTE

This alignment corrects slow-rate drift, which does not impair specifications for time periods shorter than one week. Thus, it is required to perform this alignment on a weekly basis to maintain specifications. This alignment typically takes >2 minutes to complete.

There is no alert available for the receiver alignment. Operators are responsible for checking temperature shift since the last Align Now, Align Receiver, to determine whether the receiver alignment needs to be executed.

Remote Command `:CALibration:INTernal:RECeiver[:ALL]`
`:CALibration:INTernal:RECeiver[:ALL]?`

Example `:CAL:INT:REC`

Notes The query initiates an Alignment and returns 0 if successful, or 1 if failed

Dependencies Only appears in VXT models M9410A/11A

Couplings Initializes the time for the Last Align Receiver Now, All Time
Records the temperature for the Last Align Receiver Now, All Temperature

4.6.2.11 Align Fast

Accesses fast alignment processes, which are immediate action operations and perform complete operations, running until they are complete.

This aligns the subsystem that is most sensitive to temperature and time and includes:

- compensating the DC offset, gain imbalance and quadrature phase imbalance of IQ Modulator and/or Demodulator
- compensating the gain offset of RF path

It is suggested to perform Fast Alignment every 8 hours or when temperature has changed more than 5°C from the previous Fast Alignment.

Remote Command	<code>:CALibration:INTernal:FAST[:ALL]</code> <code>:CALibration:INTernal:FAST[:ALL]?</code>
Example	<code>:CAL:INT:FAST</code>
Notes	The query initiates an Alignment and returns 0 if successful, or 1 if failed
Dependencies	Only appears in VXT models M9410A/11A /15A/16A

4.6.2.12 Align LO Leakage

Accesses LO Leakage alignment processes, which are immediate action operations and perform complete operations, running until they are complete.

This alignment reduce the LO Leakage of the instrument.

Remote Command	<code>:CALibration:INTernal:LOLeakage</code> <code>:CALibration:INTernal:LOLeakage?</code>
Example	<code>:CAL:INT:LOL</code>
Notes	The query initiates an Alignment and returns 0 if successful, or 1 if failed
Dependencies	Only appears in VXT models M9410A/11A /15A/16A

4.6.2.13 Align IF Cable

Accesses IF Cable alignment processes, which are immediate action operations and perform complete operations, running until they are complete.

This alignment aligns the IF cabling to the remote heads.

Remote Command	<code>:CALibration:INTernal:RRHead:IFCable</code> <code>:CALibration:INTernal:RRHead:IFCable?</code>
Example	<code>:CAL:INT:RRH:IFC</code>
Notes	The query initiates an Alignment and returns 0 if successful, or 1 if failed
Dependencies	Only appears in VXT based solutions with M1740A/41A/42A/49A/49B RRH
Backwards Compatibility SCPI	<code>:CALibration:INTernal:IFCable</code> <code>:CALibration:INTernal:IFCable?</code>

4.6.2.14 Align RRH Amplitude

This is an immediate action operation, which runs until complete.

Aligns the Amplitude of Remote Radio Head. This operation could take quite a long time to run.

CAUTION

For M1741A/49A/49B RRH, make sure to connect 50-ohm terminations to Head Tx/Rx 1 and 2 ports.

Remote Command	<code>:CALibration:INTernal:RRHead:AMPLitude</code> <code>:CALibration:INTernal:RRHead:AMPLitude?</code>
Example	<code>:CAL:INT:RRH:AMPL?</code>
Notes	The query initiates an Alignment and returns 0 if successful, or 1 if failed
Dependencies	Only appears in VXT based solutions with M1741A/42A/49A/49B RRH
Backwards	<code>:CALibration:INTernal:RRHAmp</code>
Compatibility SCPI	<code>:CALibration:INTernal:RRHAmp?</code>

4.6.2.15 Align Fast RRH Amplitude

This is an immediate action operation, which runs until complete.

Compare to Align RRH Amplitude, it aligns the amplitude of Remote Radio Head with a wider frequency interval. This operation takes about one minute.

Remote Command	<code>:CALibration:INTernal:RRHead:AMPLitude:FAST</code> <code>:CALibration:INTernal:RRHead:AMPLitude:FAST?</code>
Example	<code>:CAL:INT:RRH:AMPL:FAST?</code>
Notes	The query initiates an alignment and returns 0 if successful, or 1 if failed
Dependencies	Only appears in VXT based solutions with M1742A RRH

4.6.2.16 Align RRH LO Power

This is an immediate action operation, which runs until complete.

Aligns the LO Power of Remote Radio Head.

Remote Command	<code>:CALibration:INTernal:RRHead:LOPower</code> <code>:CALibration:INTernal:RRHead:LOPower?</code>
Example	<code>:CAL:INT:RRH:LOP</code>
Notes	The query initiates an alignment and returns 0 if successful, or 1 if failed
Dependencies	Only appears in VXT based solutions with M1741A/49A/49B RRH

4.6.2.17 Align LO Clock

This is an immediate action operation, which runs until complete.

Synchronizes RRH LO Clocks.

Remote Command	<code>:CALibration:INTernal:RRHead:LOSync</code> <code>:CALibration:INTernal:RRHead:LOSync?</code>
Example	<code>:CAL:INT:RRH:LOS?</code>
Notes	The query initiates an Alignment and returns 0 if successful, or 1 if failed
Dependencies	Only appears in VXT based solutions with M1741A/42A/49A/49B RRH
Backwards	<code>:CALibration:INTernal:LOSync</code>
Compatibility SCPI	<code>:CALibration:INTernal:LOSync?</code>

4.6.2.18 Align VXT Transceiver

In M941xE(M941xA+M9471A) system, accesses alignment processes in VXT Transceiver(M9410A/11A/15A/16A), which are immediate action operations and perform complete operations, running until they are complete.

The instrument stops any measurement currently underway, performs the alignment, then restarts the measurement from the beginning (similar to pressing the **Restart** key).

There is no alert available for the VXT Transceiver alignment. Operators are responsible for checking temperature shift since the last **Align VXT Transceiver** to determine whether the VXT Transceiver alignment needs to be executed.

Remote Command	<code>:CALibration:INTernal:VXT:TRANsceiver</code> <code>:CALibration:INTernal:VXT:TRANsceiver?</code>
Example	<code>:CAL:INT:VXT:TRAN</code>
Notes	The query initiates an Alignment and returns 0 if successful, or 1 if failed
Dependencies	Only appears on M9410E/11E/15E/16E

4.6.2.19 Align up down converter

In M941xE(M941xA+M9471A) system, accesses alignment processes in up down converter (M9471A), which are immediate action operations and perform complete operations, running until they are complete.

The instrument stops any measurement currently underway, performs the alignment, then restarts the measurement from the beginning (similar to pressing the **Restart** key).

There is no alert available for the up down converter alignment. Operators are responsible for checking temperature shift since the last **Align up down converter** to determine whether the up down converter alignment needs to be executed.

Remote Command	<code>:CALibration:UPDown:CONVerter</code> <code>:CALibration:UPDown:CONVerter?</code>
Example	<code>:CAL:UPD:CONV</code>
Notes	The query initiates an Alignment and returns 0 if successful, or 1 if failed
Dependencies	Only appears on M9410E/11E/15E/16E

4.6.2.20 Align Selected Freq Ranges

VXT models M9410A/11A provide five alignments: **Align Now All**, **Align Source**, **Align Receiver**, **Align Fast** and **Align LO Leakage**. Every time you execute one of these alignments, the system performs a full span alignment. To save time, it is possible to limit the range of alignment frequency settings. **Align Selected Freq Ranges** allows you to set the start and stop frequency of an alignment.

The example below shows the steps for processing Align Receiver on VXT model M9410A, specifying a frequency range from 1.3 GHz to 1.8 GHz, and 2.5 GHz to 3.9 GHz.

- First row: set the Start and Stop Frequency to 1.3 GHz and 1.8 GHz. Enable the first row
- Second row: set the Start and Stop Frequency to 2.5 GHz and 3.9 GHz. Enable the second row
- Click **Align Receiver**. A message appears: “Aligning Selected Freq Ranges 1 of 7”

The equivalent SCPI command sequence is:

```
:CAL:INT:ASFR ON
:CAL:INT:ASFR:FRAN 1.3 GHz, 1.8 GHz, 2.5 GHz, 3.9 GHz
:CAL:INT:REC
```

Remote Command	<code>:CALibration:INTernal:ASFRRanges[:STATe] ON OFF 1 0</code> <code>:CALibration:INTernal:ASFRRanges?</code>
Example	<code>:CAL:INT:ASFR ON</code> <code>:CAL:INT:ASFR?</code>
Notes	When Align Selected Freq Ranges is ON , the table is displayed for setting up the frequency ranges to be aligned
Dependencies	Only available in: <ul style="list-style-type: none"> – VXT models M9410A/11A – VXT models M9410A/11A with RRH and/or CIU – M9410E/11E

Only functional for the following alignments:

- Align Now All of VXT models M9410A/11A and M9410E/11E
- Align Source
- Align Receiver
- Align Fast
- Align LO Leakage
- Align VXT Transceiver of M910E/11E
- Align Up Down Converter of M9410E/11E

Align Selected Freq Ranges only guarantees the hardware performance within the frequency range

Preset **OFF**

Enable Extended Freq Range

Allows you to set frequency ranges for VXT models M9410A/11A/15A with Remote Head and/or CIU. When Enable Extended Freq Range is not active, the frequency range is limited by VXT models only.

Remote Command `:CALibration:INTernal:ASFRanges:EXTend[:STATe] ON | OFF | 1 | 0`
`:CALibration:INTernal:ASFRanges:EXTend[:STATe]?`

Example `:CAL:INT:ASFR:EXT ON`
`:CAL:INT:ASFR:EXT?`

Dependencies Only available in VXT models M9410A/11A/15A/16A with Remote Head and/or CIU
Only available when **Align Specified Freq Ranges** is **ON**

Preset **OFF**

Frequency Range

Allows you to set the alignment frequency range.

Remote Command `:CALibration:INTernal:ASFRanges:FRANges <startFreq>,<stopFreq>[,<startFreq>,<stopFreq>][,<startFreq>,<stopFreq>][,<startFreq>,<stopFreq>][,<startFreq>,<stopFreq>]`

Example `:CAL:INT:ASFR:FRAN 1.3 GHz,1.8 GHz,2.5 GHz,3.9 GHz`
`:CAL:INT:ASFR:FRAN?`

Notes `<startFreq>`: Start frequency of an alignment
`<stopFreq>`: Stop frequency of an alignment
To process alignment for a single frequency point, set `<startFreq> = <stopFreq>`

Dependencies	<p>Only appears when "Align VXT Transceiver" on page 919 is ON</p> <p>Error message "Invalid alignment frequency range" is reported if start and stop frequencies are invalid, such as:</p> <ol style="list-style-type: none"> 1. Stop frequency - Start frequency < 0 2. the count of start and stop frequency is not even 3. the frequency is out of range. See "More Information" on page 922 4. more than 5 pairs of start and stop frequency are listed
Preset	1.0 GHz, 2.0 GHz

More Information

When **"Enable Extended Freq Range" on page 921** is not active, the frequency range depends on the VXT models. The table below lists the Start and Stop Frequency Ranges for VXT models M9410A/11A/15A:

Hardware	Options	Min Frequency	Max Frequency
M9410A/11A	F06	330 MHz	6.08 GHz
M9410A/11A	F06 & EP6	330 MHz	6.6 GHz
M9410A/11A	F06 & LFE & EP6	6.5 kHz	6.6 GHz
M9415A/16A	F06	330 MHz	6.6 GHz
M9415A/16A	F08	330 MHz	8.6 GHz
M9415A/16A	F12	330 MHz	12.9 GHz

When **Enable Extended Freq Range** is active, the frequency range depends on the extensions connected to VXT models. The table below lists the Start and Stop Frequency Range of VXT models with Radio Heads/CIU:

Connected with Radio Heads/CIU	Min frequency	Max frequency	IF Frequency range
VXT + CIU	5.9 GHz	12 GHz	1.4 GHz ~ 4.6 GHz
VXT + CIU + RRH	24.25 GHz	43.5 GHz	2.5 GHz ~ 4.5 GHz
VXT + M1742A	10 GHz	32 GHz	3.0 GHz ~ 5.5 GHz

NOTE

The Min frequency and Max frequency are also the preset frequencies. It is recommended to keep the preset frequency range for VXT models with extensions. An alignment with the full IF Frequency range will be executed ignoring the specific ranges.

The table below lists the Frequency Range of M941xE(VXT Models with M9471A)

Products with M9471A	Preset	Receiver minimum settable frequency	Source minimum settable (center)frequency	Minimum center frequency with Spec	Receiver maximum settable(center) frequency	Source maximum settable (center) frequency
M941xE without LFE option	1 GHz	330.000005 MHz	330 MHz	380MHz	26.499999995 GHz	26.5GHz
M941xE with LFE option (LFE option in M9411A or M9471A)	1 GHz	750.005 KHz	750 KHz	1MHz	26.499999995 GHz	26.5GHz

NOTE

The minimum spec frequency is 380 MHz, but the receiver minimum settable center frequency is 330.000005 MHz, the source minimum settable center frequency is 330 MHz.

With Option LFE in M9411A or in M9471A, the receiver minimum settable frequency is 750.005 kHz, the source minimum settable frequency is 750 kHz, but Spec to customer only ensure down to 1 MHz.

Enable

Enables or disables the selected frequency ranges.

Preset

Row 1: ON

Other rows: OFF

4.6.2.21 Align External Mixer Path

Immediately executes an alignment of the External Mixer Path inside the VXT models M9415A/16A. External Mixer Path is used when the RF Port is connected to an external Remote Radio Head (RRH). It provides a better performance compared to the normal path. External Mixer Path Alignment covers frequencies from 2.4 GHz to 3.4 GHz of the external mixer path.

NOTE

This alignment corrects slow-rate drift, which does not impair specifications for time periods shorter than one week. Thus, you need only perform this alignment on a weekly basis to maintain specifications. This alignment typically takes >2 minutes to complete.

There is no alert for the External Mixer Path alignment. You are responsible for checking the temperature shift since the last **Align Now, External Mixer Path**, to determine whether the external mixer path alignment needs to be executed.

Remote Command	<code>:CALibration:INTernal:EMPath</code> <code>:CALibration:INTernal:EMPath?</code>
Example	<code>:CAL:INT:EMP</code>
Notes	The query initiates an alignment and returns 0 if successful, or 1 if failed
Dependencies	Only appears in VXT models M9415A/16A when Option MXP is installed
Couplings	Initializes the time for the Last Align External Mixer Path Now, All Time Records the temperature for the Last Align External Mixer Path Now, All Temperature

4.6.2.22 Align Low Band

Accesses Low Band alignment processes that are immediate action operations. They perform complete operations and run until they are complete. Low Band Alignment covers frequencies from 380 MHz to 4.3 GHz of the non-external mixer path.

NOTE

This alignment corrects slow-rate drift, which does not impair specifications for time periods shorter than one week. Thus, you need only perform this alignment on a weekly basis to maintain specifications. This alignment typically takes >2 minutes to complete.

There is no alert for the Low Band alignment. You are responsible for checking the temperature shift since the last **Align Now, Align Low Band**, to determine whether the Low Band alignment needs to be executed.

Remote Command	<code>:CALibration:INTernal:LBAND[:ALL]</code> <code>:CALibration:INTernal:LBAND[:ALL]?</code>
Example	<code>:CAL:INT:LBAN</code>
Notes	The query initiates an Alignment, and returns 0 if successful, or 1 if failed
Dependencies	Only appears in VXT models M9415A/16A
Couplings	Initializes the time for the Last Align Low Band Now, All Time Records the temperature for the Last Align Low Band Now, All Temperature

4.6.2.23 Align High Band

Accesses High Band alignment processes that are immediate action operations. They perform complete operations and run until they are complete. High Band Alignment covers frequencies from 4.3 GHz to 12 GHz of the non-external mixer path.

NOTE

This alignment corrects slow-rate drift, which does not impair specifications for time periods shorter than one week. Thus, you need only perform this alignment on a weekly basis to maintain specifications. This alignment typically takes >2 minutes to complete.

There is no alert for the High Band alignment. You are responsible for checking the temperature shift since last **Align Now, Align High Band**, to determine whether the High Band alignment needs to be executed.

Remote Command	<code>:CALibration:INTernal:HBAND[:ALL]</code> <code>:CALibration:INTernal:HBAND[:ALL]?</code>
Example	<code>:CAL:INT:HBAN</code>
Notes	The query initiates an Alignment, and returns 0 if successful, or 1 if failed
Dependencies	Only appears in VXT models M9415A/16A
Couplings	Initializes the external time for the Last Align High Band Now, All Time Records the temperature for the Last Align High Band Now, All Temperature

4.6.3 Path Delay Calibration

Path Delay Calibration is used to remove the time delay differences between multiple power channels of a module.

Dependencies	Only available in VXT modules M9410A/11A Only for modules with matched Digital board hardware version, which means the modules are in same FPGA version The matched hardware version information is in below table
--------------	--

	Digital board Hardware version	Matched module
M9410A	2,3,4,6,10,11	Yes
M9410A	12, 13	Yes
M9411A	18	Yes
M9411A	20,21	Yes
M9411A	12,13	Yes
M9411A	0,1,2,3,4,6,10,11	Yes

4.6.3.1 Source Path Delay Calibration

Accesses the Source Path Delay Calibration processes, which are immediate-action operations and perform complete operations, running until they are complete.

NOTE

Connect the RF In of the primary module to the OUT port (COMMON, PORT 1) of the combiner.

NOTE

Before performing Path Delay Calibration of Sources, please confirm that:

NOTE

Each of the RF Out ports is connected to the RF In port of the Primary channel, using an RF combiner.

NOTE

The cables between the combiner and the Source output ports are of the same length.

NOTE

A pop-up window appears (as shown below); press OK to continue calibration.

NOTE

If the is in MIMO sync, and you send a SCPI command to run Calibration, the calibration process is not executed and instrument a warning is generated (“-221,Setting Conflict; Calibrations are not available while MIMO Sync is On”). To execute Calibration, you must first stop MIMO, manually or via SCPI.

Remote Command :CALibration:PDElay:SOURce
 :CALibration:PDElay:SOURce?

Example :CAL:PDEL:SOUR

Notes The query initiates an Alignment and returns 0 if successful, or 1 if failed
 If the calibration process detected a faulty state, an error will be generated: “Misc/System Alignment Failure”. Calibration will be aborted. Please see event log for more information:

1. Cables are not connected
2. Power control failure
3. Hardware failure
4. M9300A 10MHz reference open failure

Dependencies Only appears in VXT models M9410A/11A
 Only for modules with matched Digital board hardware version, which means the modules are in same FPGA version

4.6.3.2 Path Delay Correction On/Off(Remote Command only)

On/Off the path delay correction to enable the calibration data on the source of the module.

Remote Command	<code>:CALibration:PDElay:CORRection ON OFF</code> <code>:CALibration:PDElay:CORRection?</code>
Example	<code>:CAL:PDEL:CORR ON</code>
Notes	If the Path Delay Calibration has never been performed and there is no calibration correction data in the controller, an alert is generated
Preset	<code>OFF</code>
Range	<code>ON OFF</code>

4.6.4 Show Alignment Statistics

Shows alignment information you can use to ensure that the instrument is operating in a specific manner. The **Show Alignment Statistics** screen is where you can view time and temperature information.

Values displayed are only updated when the **Show Alignment Statistics** screen is invoked. They are not updated while the **Show Alignment Statistics** screen is being displayed. The remote commands that access this information obtain current values.

Note that some of these statistics only display if your instrument supports them; for example, Last Source Align Now All Time only shows up in instruments which contain a source which supports auto alignments.

An example of the **Show Alignment Statistics** screen would be similar to:

4 System
4.6 Alignments

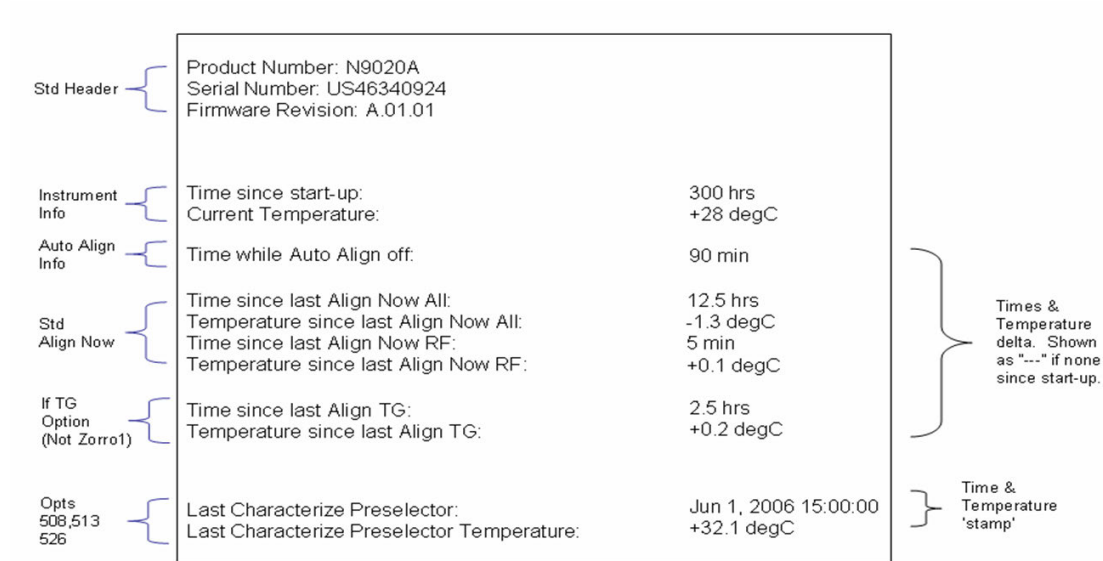

“Time while Auto Align off” is not available in VXT models M9410A/11A.

A successful **Align Now, RF** sets the Last Align RF temperature to the current temperature, and resets the Last Align RF time. A successful **Align Now All** or **Align Now All but RF** sets the Last Align Now All temperature to the current temperature, and resets the Last Align Now All time. A successful **Align Now All** also resets the Last Align RF items if the RF portion of the **Align Now** succeeded.

Example :SYST:SHOW ALIGN

Notes The values displayed on the screen are only updated upon entry to the screen, and not updated while the screen is being displayed

The following data-specific queries are available:

Query Time since Startup

Remote Command :SYSTem:PON:TIME?

Example :SYST:PON:TIME?

Notes Value is the time since the most recent start-up in seconds

State Saved No

Query Current Temperature

Remote Command :CALibration:TEMPerature:CURRent?

Example :CAL:TEMP:CURR?

Notes Value is in degrees Centigrade

State Saved No

Query Current Temperature at Remote Radio Head

Remote Command	<code>:CALibration:TEMPerature:CURRent:RRHead?</code>
Example	<code>:CAL:TEMP:CURR:RRH?</code>
Notes	Value is in degrees Centigrade
Dependencies	Only appears when Align RRH Amplitude is available
State Saved	No

Query Current Temperature at Remote Radio Head LO

Remote Command	<code>:CALibration:TEMPerature:CURRent:RRHead:LO?</code>
Example	<code>:CAL:TEMP:CURR:RRH:LO?</code>
Notes	Value is in degrees Centigrade
Dependencies	Only appears when Align RRH LO Power is available
State Saved	No

Query Time since Last Align Now All

Remote Command	<code>:CALibration:TIME:LALL?</code>
Example	<code>:CAL:TIME:LALL?</code>
Notes	Value is the elapsed time, in seconds, since the last successful Align Now All or Align Now All but RF was executed
State Saved	No

Query Temperature of Last Align Now All

Remote Command	<code>:CALibration:TEMPerature:LALL?</code>
Example	<code>:CAL:TEMP:LALL?</code>
Notes	Value is in degrees Centigrade at which the last successful Align Now All or Align Now All but RF was executed
State Saved	No

Query Time since Last Align Now Receiver

Remote Command	<code>:CALibration:TIME:INTernal:RECeiver?</code>
Example	<code>:CAL:TIME:INT:REC?</code>
Notes	Value in hours since the last successful Align Now Receiver
Dependencies	Only appears in VXT models M9410A/11A
State Saved	No

Query Temperature of Last Align Now Receiver

Remote Command	<code>:CALibration:TEMPerature:INTernal:RECeiver?</code>
Example	<code>:CAL:TEMP:INT:REC?</code>
Notes	Value in degrees Centigrade when the last successful Align Now Receiver was executed
Dependencies	Only appears in VXT models M9410A/11A
State Saved	No

Query Time since Last Align Now Source

Remote Command	<code>:CALibration:TIME:INTernal:SOURce?</code>
Example	<code>:CAL:TIME:INT:SOUR?</code>
Notes	Value in hours since the last successful Align Now Source
Dependencies	Only appears in VXT models M9410A/11A
State Saved	No

Query Temperature of Last Align Now Source

Remote Command	<code>:CALibration:TEMPerature:INTernal:SOURce?</code>
Example	<code>:CAL:TEMP:INT:SOUR?</code>
Notes	Value in degrees Centigrade when the last successful Align Now Source was executed
Dependencies	Only appears in VXT models M9410A/11A
State Saved	No

Query Time since Last Align Now Fast

Remote Command	<code>:CALibration:TIME:INTernal:FAST?</code>
Example	<code>:CAL:TIME:INT:FAST?</code>
Notes	Value in hours since the last successful Align Now Fast
Dependencies	Only appears in VXT models M9410A/11A/15A/16A
State Saved	No

Query Temperature of Last Align Now Fast

Remote Command	<code>:CALibration:TEMPerature:INTernal:FAST?</code>
Example	<code>:CAL:TEMP:INT:FAST?</code>
Notes	Value in degrees Centigrade when the last successful Align Now Fast was executed
Dependencies	Only appears in VXT models M9410A/11A/15A/16A
State Saved	No

Query Time since Last Align Now LO Leakage

Remote Command	<code>:CALibration:TIME:INTernal:LOLeakage?</code>
Example	<code>:CAL:TIME:INT:LOL?</code>
Notes	Value in hours since the last successful Align Now LO Leakage
Dependencies	Only appears in VXT models M9410A/11A/15A/16A
State Saved	No

Query Temperature of Last Align Now LO Leakage

Remote Command	<code>:CALibration:TEMPerature:INTernal:LOLeakage?</code>
Example	<code>:CAL:TEMP:INT:LOL?</code>
Notes	Value in degrees Centigrade when the last successful Align Now LO Leakage was executed
Dependencies	Only appears in VXT models M9410A/11A/15A/16A
State Saved	No

Query Time since Last Align Now IF Cable

Remote Command	<code>:CALibration:TIME:INTernal:RRHead:IFCable?</code>
Example	<code>:CAL:TIME:INT:RRH:IFC?</code>
Notes	Value in hours since the last successful Align Now IF Cable
Dependencies	Only appears in VXT based solutions with M1740A/41A/42A/49A/49B RRH
State Saved	No
Backwards Compatibility SCPI	<code>:CALibration:TIME:INTernal:IFCable?</code>

Query Temperature of Last Align Now IF Cable

Remote Command	<code>:CALibration:TEMPerature:INTernal:RRHead:IFCable?</code>
Example	<code>:CAL:TEMP:INT:RRH:IFC?</code>
Notes	Value in degrees Centigrade when the last successful Align Now IF Cable was executed
Dependencies	Only appears in VXT based solutions with M1740A/41A/42A/49A/49B RRH
State Saved	No
Backwards Compatibility SCPI	<code>:CALibration:TEMPerature:INTernal:IFCable?</code>

Query Time since Last Align LO Clock

Remote Command	<code>:CALibration:TIME:INTernal:RRHead:LOSync?</code>
----------------	--

4 System
4.6 Alignments

Example	<code>:CAL:TIME:INT:RRH:LOS?</code>
Notes	Value in hours since the last successful Align LO Clock
Dependencies	Only appears in VXT based solutions with M1741A/42A/49A/49B RRH
State Saved	No
Backwards Compatibility SCPI	<code>:CALibration:TIME:INTernal:LOSync?</code>

Query Temperature of Last Align LO Clock

Remote Command	<code>:CALibration:TEMPerature:INTernal:RRHead:LOSync?</code>
Example	<code>:CAL:TEMP:INT:RRH:LOS?</code>
Notes	Value in degrees Centigrade when the last successful Align LO Clock was executed
Dependencies	Only appears in VXT based solutions with M1741A/42A/49A/49B RRH
State Saved	No
Backwards Compatibility SCPI	<code>:CALibration:TEMPerature:INTernal:LOSync?</code>

Query Time since Last Align RRH Amplitude

Remote Command	<code>:CALibration:TIME:INTernal:RRHead:AMPLitude?</code>
Example	<code>:CAL:TIME:INT:RRH:AMPL?</code>
Notes	Value in hours since the last successful Align RRH Amplitude
Dependencies	Only appears in VXT based solutions with M1741A/42A/49A/49B RRH
State Saved	No
Backwards Compatibility SCPI	<code>:CALibration:TIME:INTernal:RRHAmp?</code>

Query Temperature of Last Align RRH Amplitude

Remote Command	<code>:CALibration:TEMPerature:INTernal:RRHead:AMPLitude?</code>
Example	<code>:CAL:TEMP:INT:RRH:AMPL?</code>
Notes	Value in degrees Centigrade when the last successful Align RRH Amplitude was executed
Dependencies	Only appears in VXT based solutions with M1741A/42A/49A/49B RRH
State Saved	No
Backwards Compatibility SCPI	<code>:CALibration:TEMPerature:INTernal:RRHAmp?</code>

Query Time since Last Align Fast RRH Amplitude

Remote Command	<code>:CALibration:TIME:INTernal:RRHead:AMPLitude:FAST?</code>
Example	<code>:CAL:TIME:INT:RRH:AMPL:FAST?</code>
Notes	Value in hours since the last successful Align Fast RRH Amplitude
Dependencies	Only appears in VXT based solutions with M1742A RRH
State Saved	No

Query Temperature of Last Align Fast RRH Amplitude

Remote Command	<code>:CALibration:TEMPerature:INTernal:RRHead:AMPLitude:FAST?</code>
Example	<code>:CAL:TEMP:INT:RRH:AMPL:FAST?</code>
Notes	Value in degrees Centigrade when the last successful Align Fast RRH Amplitude was executed
Dependencies	Only appears in VXT based solutions with M1742A RRH
State Saved	No

Query Time since Last Align RRH LO Power

Remote Command	<code>:CALibration:TIME:INTernal:RRHead:LOPower?</code>
Example	<code>:CAL:TIME:INT:RRH:LOP?</code>
Notes	Value in hours since the last successful Align RRH LO Power
Dependencies	Only appears in VXT based solutions with M1741A/49A/49B RRH
State Saved	No

Query Temperature of Last Align RRH LO Power

Remote Command	<code>:CALibration:TEMPerature:INTernal:RRHead:LOPower?</code>
Example	<code>:CAL:TEMP:INT:RRH:LOP?</code>
Notes	Value in degrees Centigrade when the last successful Align RRH LO Power was executed
Dependencies	Only appears in VXT based solutions with M1741A/49A/49B RRH
State Saved	No

Query Time since Last Align Now RF

Remote Command	<code>:CALibration:TIME:LRF?</code>
Example	<code>:CAL:TIME:LRF?</code>
Notes	Value is the elapsed time, in seconds, since the last successful Align Now, RF was executed, either individually or as a component of Align Now All
State Saved	No

Query Temperature of Last Align Now RF

Remote Command	:CALibration:TEMPerature:LRF?
Example	:CAL:TEMP:LRF?
Notes	Value is in degrees Centigrade at which the last successful Align Now RF was executed, either individually or as a component of Align Now All
State Saved	No

Query Time since Last Align IF

Remote Command	:CALibration:TIME:LIF?
Example	:CAL:TIME:LIF?
Notes	Value is the elapsed time, in seconds, since the last successful Align IF was executed
State Saved	No

Query Temperature of Last Align IF

Remote Command	:CALibration:TEMPerature:LIF?
Example	:CAL:TEMP:LIF?
Notes	Value is in degrees Centigrade at which the last successful Align IF was executed
State Saved	No

Query Time since Last Characterize Preselector

Remote Command	:CALibration:TIME:LPreselector?
Example	:CAL:TIME:LPR?
Notes	Value is the date and time the last successful Characterize Preselector was executed. The date is separated from the time by a space character Returns "" if no Characterize Preselector has ever been performed on the instrument
Dependencies	In models that do not include preselectors, this command is not enabled and any attempt to set or query yields an error
State Saved	No

Query Temperature of Last Characterize Preselector

Remote Command	:CALibration:TEMPerature:LPreselector?
Example	:CAL:TEMP:LPR?
Notes	Value is in degrees Centigrade at which the last successful Characterize Preselector was executed

Dependencies	In models that do not include preselectors, this command is not enabled and any attempt to set or query yields an error
--------------	---

State Saved	No
-------------	----

Query Time since Auto Align Off

Remote Command	<code>:CALibration:AUTO:TIME:OFF?</code>
----------------	--

Example	<code>:CAL:AUTO:TIME:OFF?</code>
---------	----------------------------------

Notes	Value is the elapsed time, in seconds, since Auto Align has been set to Off or Off with Alert . The value is 0 if Auto Align is ALL or NORF
-------	---

State Saved	No
-------------	----

Query Time since Last Align Now 20 Hz - 30 MHz

Remote Command	<code>:CALibration:TIME:RFPSector:LCONducted?</code>
----------------	--

Example	<code>:CAL:TIME:RFPS:LCON?</code>
---------	-----------------------------------

Notes	Values are the date and time the last successful Align Now, 20 Hz - 30 MHz was executed. The date is separated from the time by a semi-colon character
-------	---

State Saved	No
-------------	----

Query Temperature of Last Align Now 20 Hz - 30 MHz

Remote Command	<code>:CALibration:TEMPerature:RFPSector:LCONducted?</code>
----------------	---

Example	<code>:CAL:TEMP:RFPS:LCON?</code>
---------	-----------------------------------

Notes	Value is in degrees Centigrade at which the last successful Align Now, 20 Hz - 30 MHz was executed
-------	---

State Saved	No
-------------	----

Query Time since Last Align Now 30 MHz - 3.6 GHz

Remote Command	<code>:CALibration:TIME:RFPSector:LRADiated?</code>
----------------	---

Example	<code>:CAL:TIME:RFPS:LRAD?</code>
---------	-----------------------------------

Notes	Value is the date and time the last successful Align Now, 30 MHz - 3.6 GHz was executed. The date is separated from the time by a semi-colon character
-------	---

State Saved	No
-------------	----

Query Temperature of Last Align Now 30 MHz - 3.6 MHz

Remote Command	<code>:CALibration:TEMPerature:RFPSelector:LRADiated?</code>
Example	<code>:CAL:TEMP:RFPS:LRAD?</code>
Notes	Value is in degrees Centigrade at which the last successful Align Now, 30 MHz – 3.6 GHz was executed
State Saved	No

Query Next Scheduled Alignment Time

Remote Command	<code>:CALibration:RFPSelector:SCHeduler:TIME:NEXT?</code> Returns data using the following format: YYYY/MM/DD; HH:MM:SS
Example	<code>:CAL:RFPS:SCH:TIME:NEXT?</code>
Notes	The next run time will be updated based on the start date/time and recurrence set by the user “date” is representation of the date the task will run in the form: <code>YYYY/MM/DD</code> where: <ul style="list-style-type: none"> - <code>YYYY</code> is the four-digit representation of year. (for example, 2009) - <code>MM</code> is the two-digit representation of month. (for example, 01 to 12) - <code>DD</code> is the two-digit representation of the day. (for example, 01 to 28, 29, 30 or 31 depending on the month and year) “time” is a representation of the time of day the task will run in the form: <code>HH:MM:SS</code> where: <ul style="list-style-type: none"> - <code>HH</code> is the two-digit representation of the hour in 24-hour format - <code>MM</code> is the two-digit representation of minute - <code>SS</code> is the two-digit representation of seconds
State Saved	No

Query Time since Last Align Now External Mixer Path

Remote Command	<code>:CALibration:TIME:INTernal:EMPath?</code>
Example	<code>:CAL:TIME:INT:EMP?</code>
Notes	Value in hours since the last successful Align Now External Mixer Path
Dependencies	Only appears option MXP is installed
State Saved	No

Query Temperature of Last Align Now External Mixer Path

Remote Command	<code>:CALibration:TEMPerature:INTernal:EMPath?</code>
Example	<code>:CAL:TEMP:INT:EMP?</code>
Notes	Value in degrees Centigrade when the last successful Align Now External Mixer Path was executed
Dependencies	Only appears option MXP is installed
State Saved	No

Query Time since Last Align Now Low Band

Remote Command	<code>:CALibration:TIME:INTernal:LBANd?</code>
Example	<code>:CAL:TIME:INT:LBAN?</code>
Notes	Value in hours since the last successful Align Now Low Band
Dependencies	Only appears in VXT models M9415A/16A
State Saved	No

Query Temperature of Last Align Now Low Band

Remote Command	<code>:CALibration:TEMPerature:INTernal:LBANd?</code>
Example	<code>:CAL:TEMP:INT:LBAN?</code>
Notes	Value in degrees Centigrade when the last successful Align Now Low Band was executed
Dependencies	Only appears in VXT models M9415A/16A
State Saved	No

Query Time since Last Align Now High Band

Remote Command	<code>:CALibration:TIME:INTernal:HBAN?</code>
Example	<code>:CAL:TIME:INT:HBAN?</code>
Notes	Value in hours since the last successful Align Now High Band
Dependencies	Only appears in VXT models M9415A/16A
State Saved	No

Query Temperature of Last Align Now High Band

Remote Command	<code>:CALibration:TEMPerature:INTernal:HBANd?</code>
Example	<code>:CAL:TEMP:INT:HBAN?</code>
Notes	Value in degrees Centigrade when the last successful Align Now High Band was executed
Dependencies	Only appears in VXT models M9415A/16A
State Saved	No

Query Time since Last Align VXT Transceiver

Remote Command	:CALibration:TIME:INTernal:VXT:TRANsceiver?
Example	:CAL:TIME:INT:VXT:TRAN?
Notes	Value in hours since the last successful Align VXT Transceiver Returns NaN if Align VXT Transceiver has never been performed on the instrument
Dependencies	Only appears in M9410E/11E/15E/16E
State Saved	No

Query Temperature of Last Align VXT Transceiver

Remote Command	:CALibration:TEMPerature:INTernal:VXT:TRANsceiver?
Example	:CAL:TEMP:INT:VXT:TRAN?
Notes	Value in degrees Centigrade when the last successful Align VXT Transceiver was executed Returns 9.91E+37(NaN) if Align VXT Transceiver has never been performed on the instrument
Dependencies	Only appears in M9410E/11E/15E/16E
State Saved	No

Query Time since Last Align Up Down Converter

Remote Command	:CALibration:TIME:UPDown:CONVerter?
Example	:CAL:TIME:UPD:CONV?
Notes	Value in hours since the last successful Align Up Down Converter Returns NaN if Align Up Down Converter has never been performed on the instrument
Dependencies	Only appears in M9410E/11E/15E/16E
State Saved	No

Query Temperature of Last Align Up Down Converter

Remote Command	:CALibration:TEMPerature:UPDown:CONVerter?
Example	:CAL:TEMP:UPD:CONV?
Notes	Value in degrees Centigrade when the last successful Align Up Down Converter was executed Returns 9.91E+37(NaN) if Align Up Down Converter has never been performed on the instrument
Dependencies	Only appears in VXT models M9410A/11A and M9410E/11E
State Saved	No

Query Time since Last Path Delay Calibration

Remote Command	:CALibration:TIME:PDElay:SOURce?
----------------	----------------------------------

Example	<code>:CAL:TIME:PDEL:SOUR?</code>
Notes	The value is the elapsed time in hours since the last successful Path Delay Calibration has been performed Returns NaN if the Path Delay Calibration has never been performed
State Saved	No

Query Temperature of Last Path Delay Calibration

Remote Command	<code>:CALibration:TEMPerature:PDELay:SOURce?</code>
Example	<code>:CAL:TEMP:PDEL:SOUR?</code>
Notes	The value is in degrees Centigrade at which the last successful Path Delay Calibration has been performed Returns 9.91E+37(NaN) if the Path Delay Calibration has never been performed
State Saved	No

4.6.5 Timebase DAC

Lets you change the setting of the **Timebase DAC** from a factory calibrated setting to your own desired setting.

The display shows the current **Timebase DAC** setting at the top, and gives you a choice of **CALibrated** or **USER** setting. There is also a field for you to enter your desired setting.

Dependencies	Does not appear in VXT and M941xE
--------------	-----------------------------------

4.6.5.1 Timebase DAC

Allows control of the internal 10 MHz reference oscillator timebase. This may be used to adjust for minor frequency alignment between your signal's reference and the internal frequency reference. This adjustment has no effect if the instrument is operating with an External Frequency Reference.

If the value of the **Timebase DAC** changes (by switching to **CALibrated** from **USER** with **User Value** set to a different value, or in **USER** with a new value entered) an alignment may be necessary. The alignment system will take appropriate action; which will either invoke an alignment or cause an **Alert**.

The **CALibrated** setting sets the **Timebase DAC** to the value established during factory or field calibration. In this case the value displayed at the top of the screen is the calibrated value.

4 System
4.6 Alignments

The **USER** setting sets the **Timebase DAC** to the value set on the **User Value** control. In this case the value displayed at the top of the screen is the user value.

Remote Command	<code>:CALibration:FREQuency:REFErence:MODE CALibrated USER</code> <code>:CALibration:FREQuency:REFErence:MODE?</code>
Example	<code>:CAL:FREQ:REF:MODE CAL</code>
Notes	If the value of the timebase is changed the alignment system automatically performs an alignment or alerts that an alignment is due
Dependencies	Not available in UXM
Preset	Unaffected by Preset , but set to CALibrated by Restore Defaults > "Alignments" on page 896
State Saved	No

4.6.5.2 User Value

Lets you set the **Timebase DAC** to a value other than the value established during the factory or field calibration. The current value of the DAC is displayed at the top of the screen. This will be the Calibrated value if **Timebase DAC** is set to **CALibrated**.

Remote Command	<code>:CALibration:FREQuency:REFErence:FINE <integer></code> <code>:CALibration:FREQuency:REFErence:FINE?</code>
Example	<code>:CAL:FREQ:REF:FINE 8191</code>
Notes	If the value of the timebase is changed the alignment system automatically performs an alignment or alerts that an alignment is due
Couplings	Setting <code>:CAL:FREQ:REF:FINE</code> sets <code>:CAL:FREQ:REF:MODE USER</code>
Preset	Unaffected by Preset , but set to the factory setting by Restore Defaults > "Alignments" on page 896
State Saved	No
Min	0
Max	16383
Backwards Compatibility SCPI	<code>:CALibration:FREQuency:REFErence:COARse</code> ESA hardware contained two DAC controls for the Timebase. In X-Series the command <code>:CALibration:FREQuency:REFErence:FINE</code> is the method for adjusting the timebase. The COARse option is provided as an alias to FINE Backwards Compatibility Command
Remote Command	<code>:CALibration:FREQuency:REFErence:COARse <integer></code> <code>:CALibration:FREQuency:REFErence:COARse?</code>
Example	<code>:CAL:FREQ:REF:COAR 8191</code>
Notes	This is an alias for <code>:CAL:FREQ:REF:FINE</code> . Any change to COARse is reflected in FINE and vice-versa. See <code>:CAL:FREQ:REF:FINE</code> for description of functionality
Couplings	Setting <code>:CAL:FREQ:REF:COAR</code> sets <code>:CAL:FREQ:REF:MODE USER</code>

4.6.6 Advanced

Accesses alignment processes that are immediate action operations that perform operations that run until complete. **Advanced** alignments are performed on an irregular basis, or require additional operator interaction.

Dependencies	Not available in UXM
--------------	----------------------

4.6.6.1 Characterize Preselector

The Preselector tuning curve drifts over temperature and time. Recognize that the Amplitude, Presel Center function adjusts the preselector for accurate amplitude measurements at an individual frequency. Characterize Preselector improves the amplitude accuracy by ensuring the Preselector is approximately centered at all frequencies without the use of the Amplitude, Presel Center function. Characterize Preselector can be useful in situations where absolute amplitude accuracy is not of utmost importance, and the throughput savings or convenience of not performing a Presel Center is desired. Presel Center is required prior to any measurement for best (and warranted) amplitude accuracy.

Keysight recommends that the Characterize Preselector operation be performed yearly as part of any calibration, but performing this operation every three months can be worthwhile.

Characterize Preselector immediately executes a characterization of the Preselector, which is a YIG-tuned filter (YTF). The instrument stops any measurement currently underway, performs the characterization, then restarts the measurement from the beginning (similar to pressing the **Restart** key).

The query (**:CALibration:YTF?**) invokes the alignment of the YTF subsystem, and returns a success or failure value.

A failure encountered during alignment generates the Error Condition message “Characterize Preselector failure” and sets Bit 3 in the **STATus:QUESTIONable:CALibration:EXTended:FAILure** status register. Successful completion of **Characterize Preselector** clears this Condition. It also begins the elapsed time counter for Last Characterize Preselector Time, and captures the Last Characterize Preselector Temperature.

The last Characterize Preselector Time and Temperature survives across the power cycle, as this operation is performed infrequently.

NOTE

The **Characterize Preselector** function can be interrupted, by pressing the **Cancel (ESC)** front-panel key, or remotely with Device Clear followed by the **:ABORT SCPI** command. None of the new characterization data is then used.

However, since the old characterization data is purged at the beginning of the characterization, you now have an uncharacterized preselector. You should re-execute this function and allow it to finish before making any further preselected measurements.

Remote Command	<code>:CALibration:YTF</code> <code>:CALibration:YTF?</code>
Example	<code>:CAL:YTF</code>
Notes	<p><code>:CALibration:YTF?</code> returns 0 if successful, or 1 if failed (including interfering user signal)</p> <p>While Advanced, Characterize Preselector is performing the alignment, Bit 0 in the Status Operation register is set. Completion, or termination, clears Bit 0 in the Status Operation register</p> <p>This command is sequential; it must complete before further SCPI commands are processed. Interrupting the alignment from remote is accomplished by invoking Device Clear followed by the <code>:ABORT</code> command</p> <p>Successful completion clears Bit 9 in the Status Questionable Calibration register</p> <p>A failure encountered during alignment generates the Error Condition message “Characterize Preselector failed” and sets Bit 9 in the Status Questionable Calibration register</p> <p>For Options that support frequencies > 3.6 GHz only</p>
Dependencies	This control does not appear in models that do not contain preselectors. In these models the SCPI command is accepted without error, but no action is taken
Couplings	<p>Initializes the time for the Last Characterize Preselector Time</p> <p>Records the temperature for the Last Characterize Preselector Temperature</p> <p>Overlapped Command</p>
Remote Command	<code>:CALibration:YTF:NPENDING</code>
Example	<code>:CAL:YTF:NPEN</code>
Notes	<p><code>:CALibration:YTF:NPENDING</code> is the same as <code>:CALibration:YTF</code>, including all conditions, status register bits, except that this SCPI command <i>does not block</i> the SCPI session, so you should use status register bits to query if the calibration is successfully completed or not</p> <p>Typical usage is:</p> <ol style="list-style-type: none"> 1. <code>:CALibration:YTF:NPENDING</code> (Start a YTF calibration) 2. <code>:STATUS:OPERation:CONDition?</code> (Check if the calibration is completed or not, If Bit 0 is set, then the system is doing calibration, and you should repeat this query until the bit is cleared) 3. <code>:STATUS:QUESTionable:CALibration:EXTended:FAILure:CONDition?</code> (Check whether Bit 2 is set. If this bit is set, that means there are some errors in previous internal source calibration)

4.6.6.2 Characterize Reference Clock

Calibrates the Reference Input Phase with the External Reference Output. This feature is only available when either option DP2 or B40 is present. It requires connecting the 10 MHz OUT to the EXT REF IN port with a BNC cable before running the characterization.

See ["Front panel guided calibration sequence" on page 944](#)

Remote Command	<code>:CALibration:REference:CLOCK?</code>
Example	<code>:CAL:REF:CLOC:INIT?</code> connect cable <code>:CAL:REF:CLOC?</code> disconnect cable <code>:CAL:REF:CLOC:END?</code>
Notes	<code>:CALibration:REference:CLOCK?</code> returns 0 if successful, or 1 if failed
Dependencies	Option DP2 or B40
Couplings	Initializes the time for the Last Characterize Reference Clock Time Records the temperature for the Last Characterize Reference Clock Temperature. Expected to be run after <code>:CAL:REF:CLOC:INIT</code> , and before <code>:CAL:REF:CLOC:END</code>
Remote Command	<code>:CALibration:REference:CLOCK:INITialize?</code>
Example	<code>:CAL:REF:CLOC:INIT?</code>
Notes	Returns 0 if successful, or 1 if failed
Dependencies	Option DP2 or B40
Couplings	Expected to be run before sending <code>:CAL:REF:CLOC?</code> . This will stop the current measurement when it has completed (does not abort the current data acquisition), and prepare the instrument for the expected cabling
Remote Command	<code>:CALibration:REference:CLOCK:END?</code>
Example	<code>:CAL:REF:CLOC:END?</code>
Notes	Returns 0 if successful, or 1 if failed
Dependencies	Option DP2 or B40
Couplings	Expected to be run after sending <code>:CAL:REF:CLOC?</code> , and after removing the cable used in that Characterize Reference Clock step. This will resume any queued measurements, and concludes the reference clock characterization
Remote Command	<code>:CALibration:TIME:REference:CLOCK?</code>
Example	<code>:CAL:TIME:REference:CLOCK?</code>

4 System
4.6 Alignments

Notes	Value is the date and time the last successful Characterize Reference Clock was executed. The date is separated from the time by a space character. Returns "" if Characterize Reference Clock has never been performed on the instrument
Dependencies	Option DP2 or B40
State Saved	No

Front panel guided calibration sequence

When selecting **Characterize Reference Clock** via the front panel, the following form is displayed.

Step 1 of the guided calibration sequence:

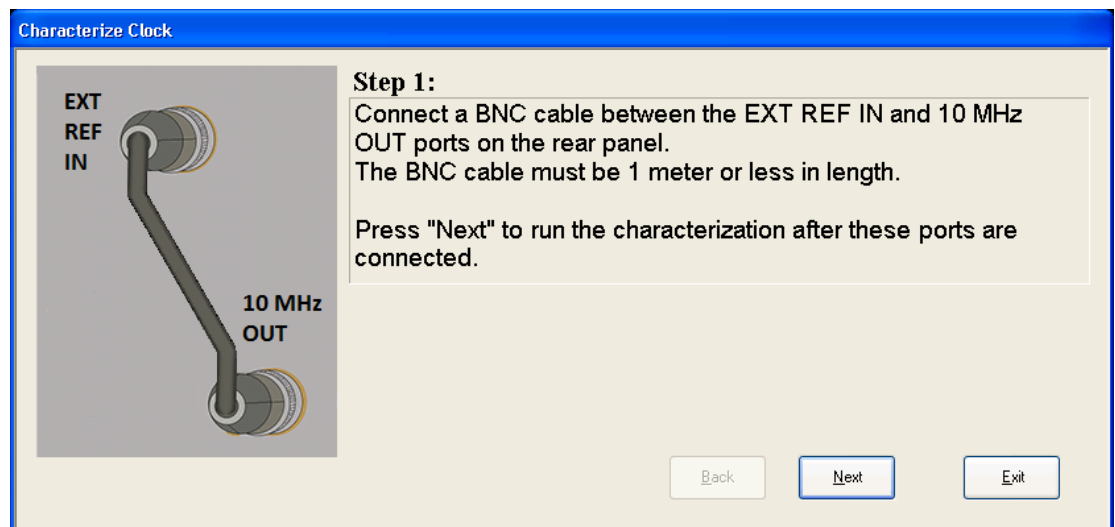

Step 2 of the guided calibration sequence:

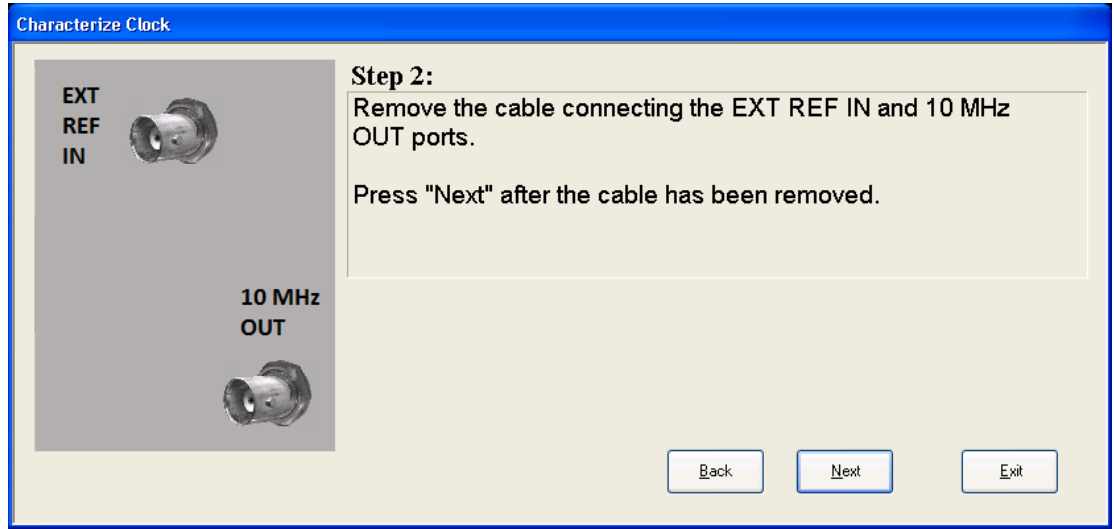

Step 3 of the guided calibration sequence:

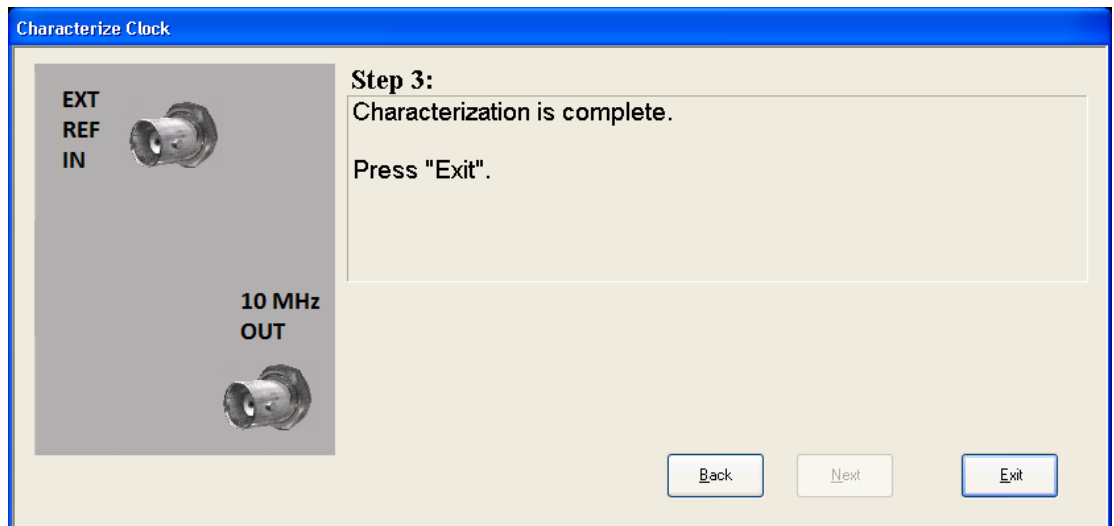

4.6.6.3 Characterize Noise Floor

On instruments with the NF2 license installed, the calibrated Noise Floor used by Noise Floor Extensions should be refreshed periodically. To do this, press **Characterize Noise Floor**. When you press this control, the instrument stops any measurement currently underway, and a dialog appears with an **OK** and **Cancel** button that says:

This action will take several minutes to perform. Please disconnect all cables from the RF input and press Enter to proceed. Press ESC to cancel

When you press **Enter** or **OK**, the characterization proceeds. After the characterization, the instrument restarts the measurement from the beginning

(similar to pressing the **Restart** key). The characterization takes many minutes to run.

The noise floor model used by Noise Floor Extensions includes an estimation of the temperature behavior of the noise floor, but this is only an estimation. The noise floor changes little with the age of the components. However, even small changes in the estimated level of the noise floor can make large changes in the effective noise floor, because the effective noise floor is the error in the estimation of the noise floor. Keysight recommends that the **Characterize Noise Floor** operation be performed when the instrument is operating at an ambient temperature that is significantly different than the ambient temperature at which this alignment was last run. In addition, Keysight recommends that the **Characterize Noise Floor** operation be performed after the first 500 hours of operation, and once every calendar year.

The noise floor model from the last operation of **Characterize Noise Floor** survives across the power cycle.

NOTE

The **Characterize Noise Floor** function can be interrupted, by pressing the **Cancel (ESC)** front-panel key, or remotely with Device Clear followed by the `:ABORT SCPI` command. None of the new characterization data is then used. However, since the old characterization data is purged at the beginning of the characterization, you now have an uncharacterized noise floor. You should re-execute this function and allow it to finish before making any further measurements with NFE. Until you do, the instrument will display a “Characterize Noise Floor required” message and set bit 12 in the Status Questionable Calibration register (`STATus:QUESTionable:CALibration:EXTended:NEEDed`).

Remote Command	<code>:CALibration:NFLoor</code> <code>:CALibration:NFLoor?</code>
Example	<code>:CAL:NFL</code>
Notes	<code>:CALibration:NFLoor?</code> returns 0 if successful, or 1 if failed (including interfering user signal) This command is sequential; it must complete before further commands are processed. Interrupting the alignment from remote is accomplished by invoking Device Clear followed by the <code>:ABORT</code> command
Dependencies	This control does not appear in models that do not contain NF2. In these models the command is accepted without error, but no action is taken
Couplings	Successful completion of Characterize Noise Floor begin the elapsed time counter or the Last Characterize Noise Floor Time
Remote Command	<code>:CALibration:TIME:NFLoor?</code>
Example	<code>:CAL:TIME:NFL?</code>
Notes	Value is the date and time the last successful Characterize Noise Floor was executed. The date is separated from the time by a space character Returns "" if no Characterize Noise Floor has ever been performed on the instrument

Dependencies	In models that do not include NF2, this command is not enabled and any attempt to set or query yields an error
State Saved	No
Remote Command	<code>:CALibration:TEMPerature:NFLoor?</code>
Example	<code>:CAL:TEMP:NFL?</code>
Notes	Value is the temperature of the last successful Characterize Noise Floor was executed Returns "" if no Characterize Noise Floor has ever been performed on the instrument
Dependencies	In models that do not include NF2, this command is not enabled and any attempt to set or query yields an error
State Saved	No
Remote Command	<code>:CALibration:TIME:ELAPsed:NFLoor?</code>
Example	<code>:CAL:TIME:ELAP:NFL?</code>
Notes	Value is the elapsed time the instrument was powered-on since the last successful Characterize Noise Floor was executed Returns "" if no Characterize Noise Floor has ever been performed on the instrument
Dependencies	In models that do not include NF2, this command is not enabled and any attempt to set or query yields an error
State Saved	No

4.6.6.4 Calibration Temperature History

The following queries let you retrieve various statistics regarding the Calibration Temperature history.

Minimum Temperature Within Last Number of Seconds

Lets you query the minimum temperature within the last number of seconds. If no data exists for the requested time, the returned value is 9.91e+37.

Remote Command	<code>:CALibration:TEMPerature:MINimum? <seconds></code>
Example	<code>:CAL:TEMP:MIN? 60</code>

Maximum Temperature Within Last Number of Seconds

Lets you query the maximum temperature within the last number of seconds. If no data exists for the requested time, the returned value is 9.91e+37.

Remote Command	<code>:CALibration:TEMPerature:MAXimum? <seconds></code>
Example	<code>:CAL:TEMP:MAX? 60</code>

Temperature Seconds Ago

Lets you query temperature X seconds ago. If no data exists for the requested time, the returned value is 9.91e+37.

Remote Command	<code>:CALibration:TEMPerature:AGO? <seconds></code>
----------------	--

Example	<code>:CAL:TEMP:AGO? 75</code>
---------	--------------------------------

Oldest Temperature Value

Lets you query the oldest recorded temperature value.

Remote Command	<code>:CALibration:TEMPerature:OLDest[:TEMPerature]?</code>
----------------	---

Example	<code>:CAL:TEMP:OLD?</code>
---------	-----------------------------

Oldest Temperature Time

Lets you query how long ago the oldest temperature value was recorded.

Remote Command	<code>:CALibration:TEMPerature:OLDest:SECONDS?</code>
----------------	---

Example	<code>:CAL:TEMP:OLD:SEC?</code>
---------	---------------------------------

4.6.6.5 TDS Alignment

Only appears in N9038B (MXE-B) when Option TDS is installed and licensed.

The TDS alignment includes [AlignNowAll](#) and [RFPresel](#) alignment. Immediately executes an alignment of the TDS subsystem. The instrument stops any measurement currently underway, performs the alignment, and then restarts the measurement from the beginning (similar to pressing the **Restart** key).

Align TDS can be interrupted by pressing the **Cancel (ESC)** front-panel key or from remote with Device Clear followed by `:ABORt`. When this occurs, no new TDS alignment data will be employed.

Remote Command	<code>:CALibration:TDS</code>
----------------	-------------------------------

Params missing? What does the query return?

`:CALibration:TDS?`

Example	<code>:CAL:TDS</code>
---------	-----------------------

Notes	This command is sequential; it must complete before further commands are processed. Interrupting the alignment from remote is accomplished by invoking Device Clear followed by the <code>:ABORt</code> command
-------	---

Dependencies	Only appears in N9038B (MXE-B) models with Option TDS installed and licensed
--------------	--

4.6.6.6 Backup or Restore Align Data...

Opens the utility for backing-up or restoring alignment data. Since this utility cannot be run while the instrument software is running, a prompt tells you to shut down the instrument first:

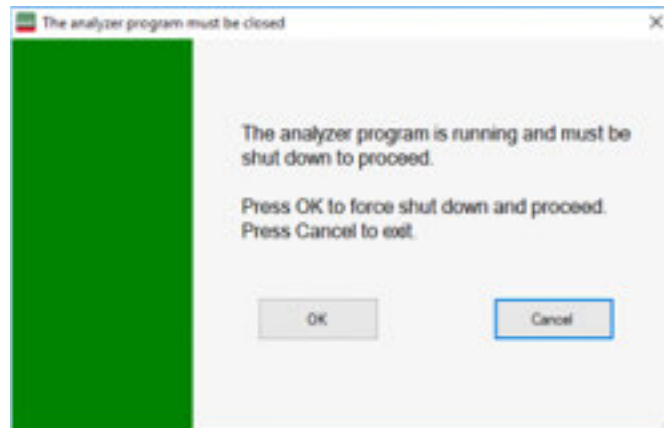

Press **OK** and the instrument will shut down and open the backup utility.

Alignment data for the instrument resides on the hard drive in a database. Keysight uses high quality hard drives; however, it is highly recommended the alignment data be backed-up to storage outside of the instrument. Additionally, for customers who use multiple CPU Assemblies or multiple disk drives, the alignment that pertains to the instrument must be transferred to the resident hard drive after a CPU or hard drive is replaced. This utility facilitates backing-up and restoring the alignment data.

NOTE

This utility allows you to navigate to any location of the Windows file system. If you are backing up alignment data to storage outside of the instrument, then it is assumed that you will use a USB memory device, or Mapped Network Drive.

Processor Assembly types PC6 and PC7 contain a removable SD memory card. When one of these CPUs is installed, the Backup and Restore Alignment Data wizard defaults to the SD card as the backup location. At every power-on, the software will check to determine if the calibration data on the SD memory card (the backup) is newer than the data in use on the disk. In such situations, before the application is loaded, you are given the opportunity to restore the data from the backup. If you respond **Yes**, the Backup and Restore Alignment Data wizard (see "[Alignment Data Wizard \(without Flash\)](#)" on page 950) will be invoked to perform the restore.

Processor Assembly types PC6S and PC7S contain an internal flash EEPROM, as well as a removable SD card. When one of these CPUs is installed, the Backup and Restore Alignment Data wizard defaults to the internal flash as the backup location. As with the PC6 and PC7, at every power-on, the software compares the timestamp

4 System
4.6 Alignments

of the backup on the flash and the timestamp of the alignment data in use on the disk. If the backup on the flash has newer data, you are given the opportunity to restore the data from the backup before the application is loaded. If you respond **Yes**, the Backup and Restore Alignment Data wizard (see "[Alignment Data Wizard \(with Flash\)](#)" on page 960) will be invoked and will prompt you to restore that backup.

For purposes of these instructions, "alignment data" and "calibration data" are used interchangeably.

Dependencies	Not available in UXM
Remote Command	<code>:CALibration:DATA:DEFault</code>
Example	<code>:CAL:DATA:DEF</code>
Notes	Restores the alignment data files to their default state
Couplings	Sets Auto Align to OFF . Sets Bit 14 in the Status Questionable Calibration register. The Error Condition message "Align Now All required" is generated

Alignment Data Wizard (without Flash)

Guides you through the operation of backing-up or restoring the alignment data.

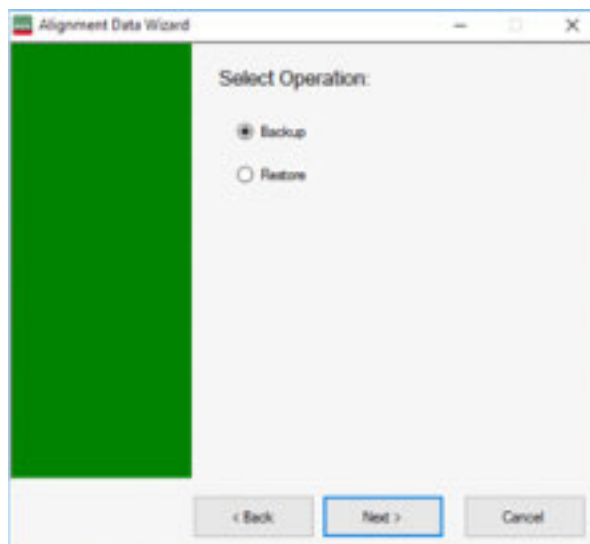
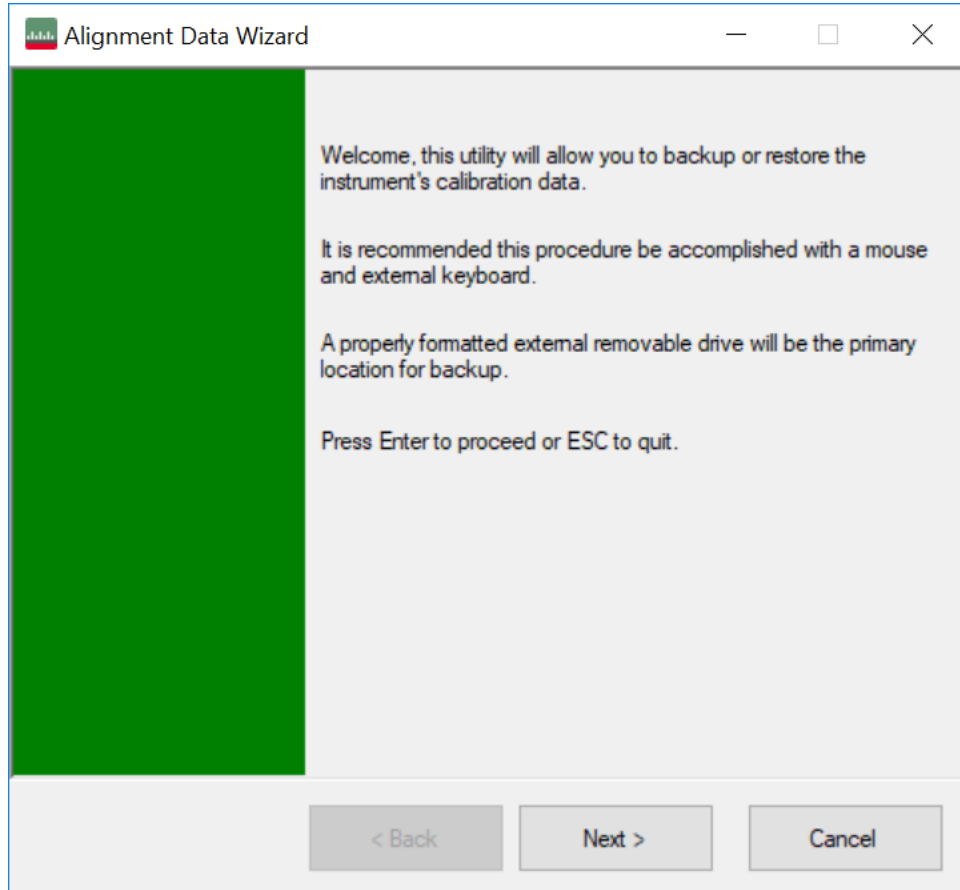

The default backup location for instruments *without* internal flash will be the first drive identified as an external drive (USB or LAN) if such is available; or, if not, the internal D: partition.

4 System
4.6 Alignments

The default file name is `<model number>_<serial number>_<date in YYYYMMDDHHMMSS>.bkz`.

The default file extension for legacy backup files was `.bak`. The Backup and Restore operations support both the `.bak` (legacy format) and `.bkz` formats.

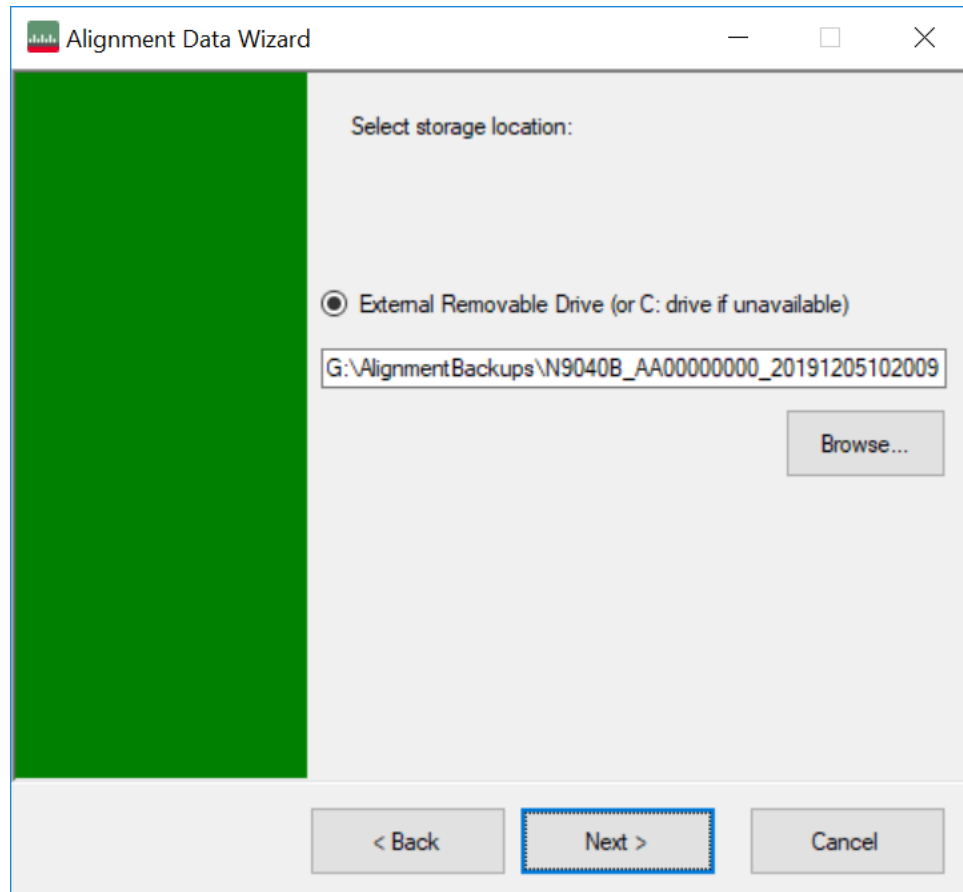

If a USB drive is present, it will be selected by default. The path defaults to the `AlignmentBackups` folder, and a filename is automatically created, in the form: `<model>_<serial number>_<date><time>.bkz`

If you wish to enter a customer filename, you can do so with an external keyboard, or by opening the onscreen Alpha keyboard, by pressing the **Keyboard** hardkey on the front panel:



When the **Next >** button is pressed, you will be prompted to create a new folder if the chosen path does not yet exist.

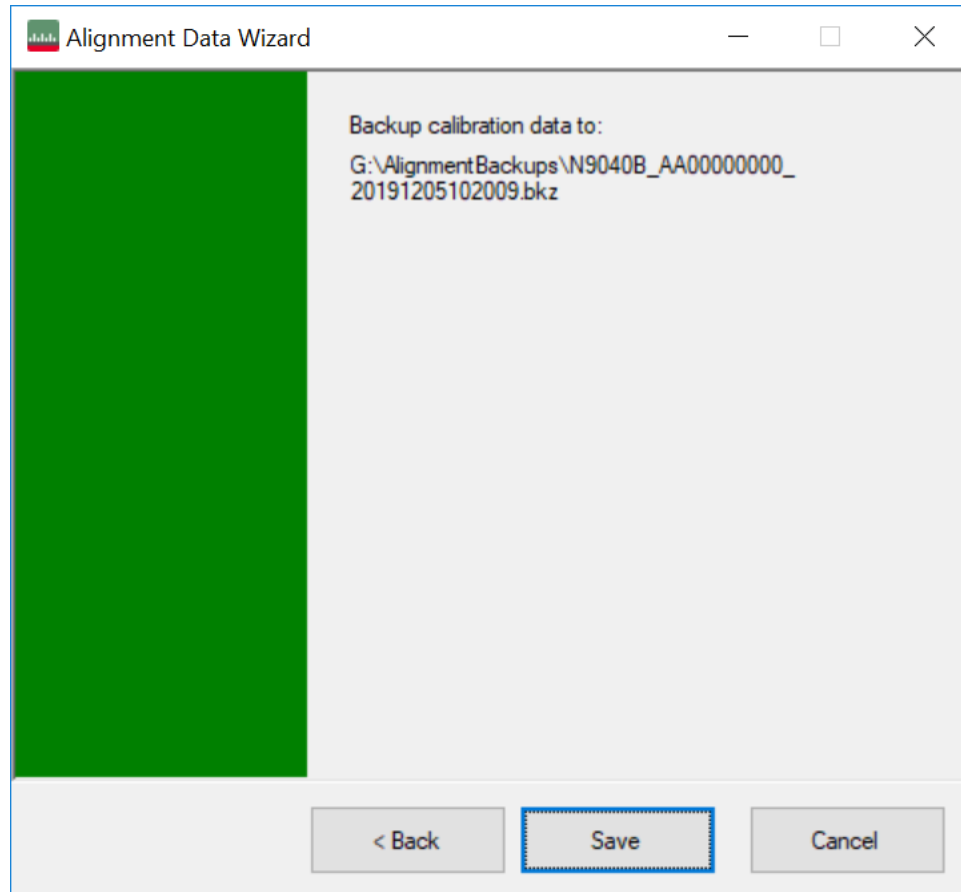

4 System
4.6 Alignments

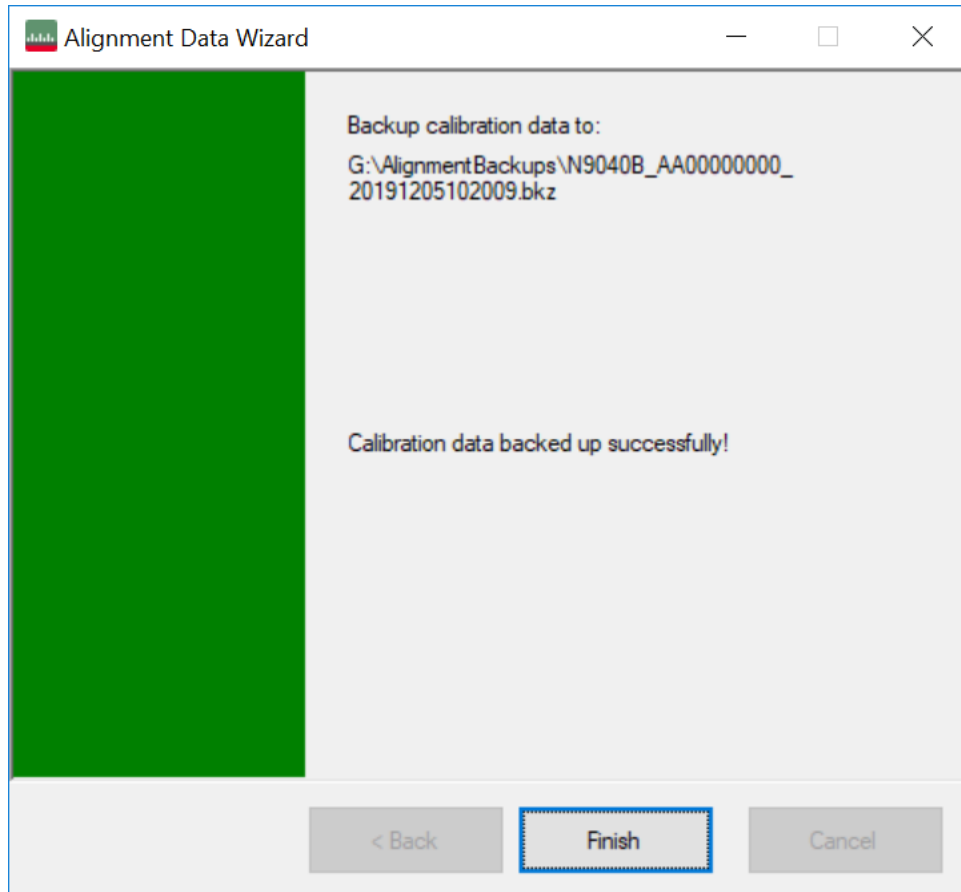

The restore operation checks the validity of the restore file using the database's built-in file validation. If the restore file is corrupt, the existing alignment data will remain in use.

If the serial number information in the backup file being restored is different from that of the instrument, the following message appears (the serial numbers shown are examples):

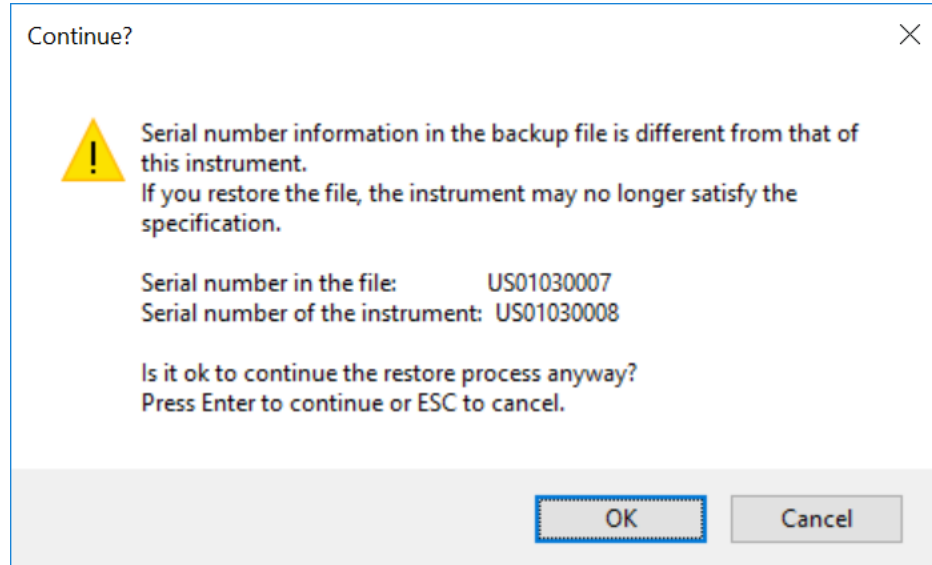

The default restore location for instruments *without* internal flash will be the first drive identified as an external drive (USB or LAN) if such is available; or, if not, the internal D: partition. The default restore file will be the most recent file that matches the default backup file name format: `<model number>_<serial number>_<date>.bkz`

4 System
4.6 Alignments

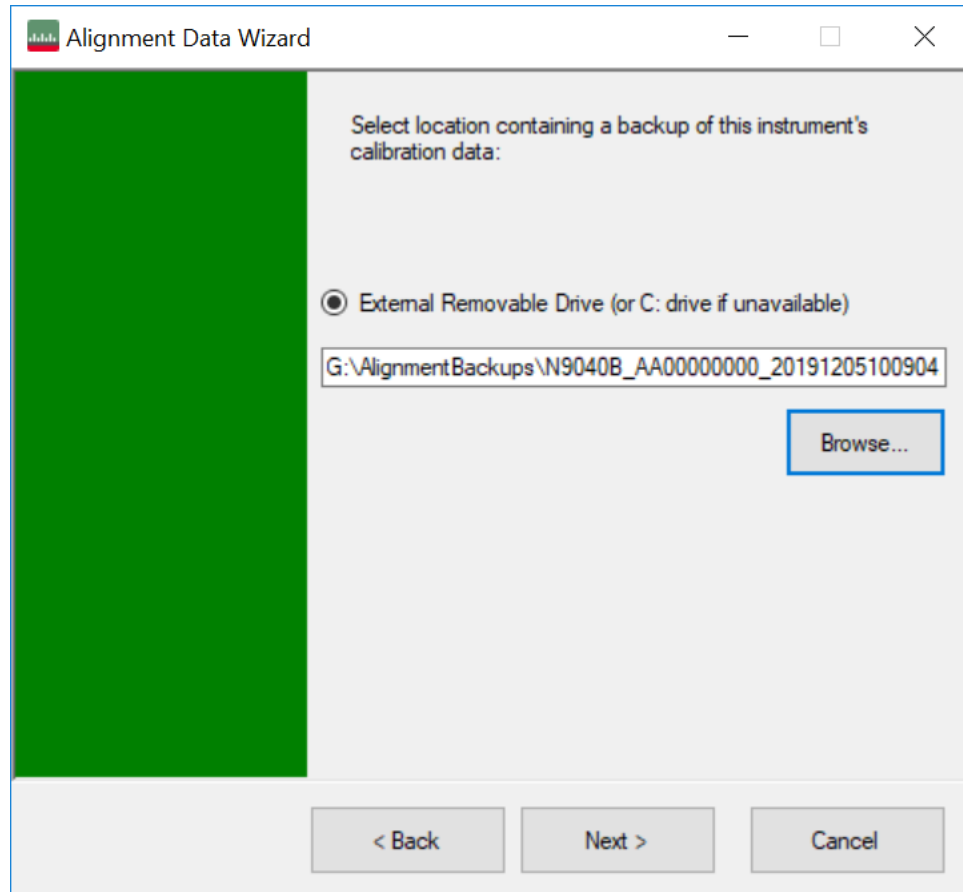

Changing the drive letter also modifies the path displayed in the box below. When this step is first loaded, the drive drop-down menu is populated with connected drives, which provide you with read access.

The path defaults to the **AlignBackups** folder. The most recent backup (*.bkz or *.bak) file in the folder will also be selected by default.

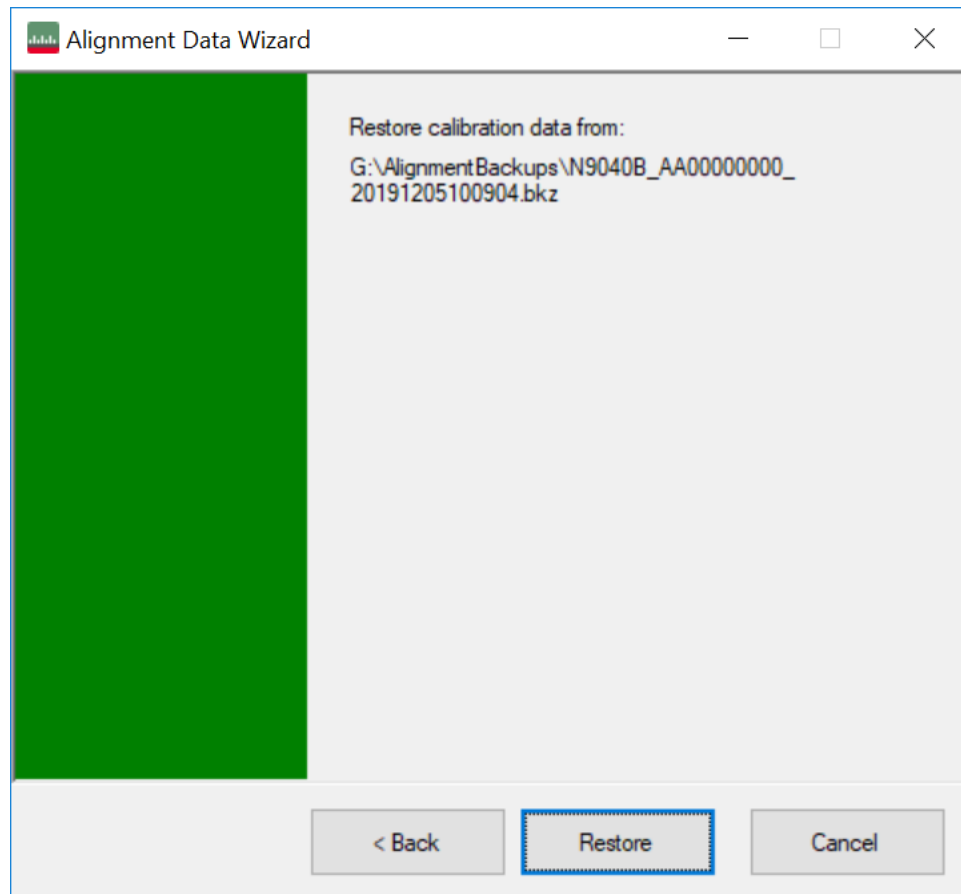

4 System
4.6 Alignments

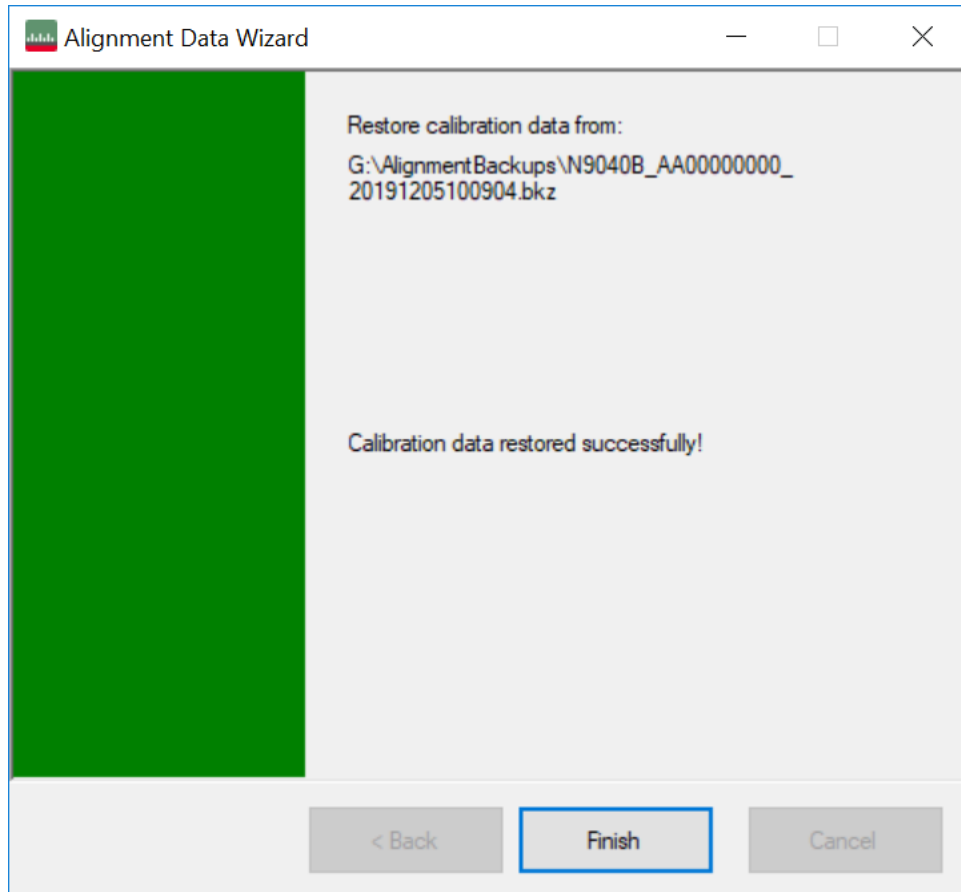

When restoring data in the legacy `.bak` format, Administrator privileges are required. You will be prompted when you attempt a restore (indicated by the UAC Shield on the **Restore** button below).

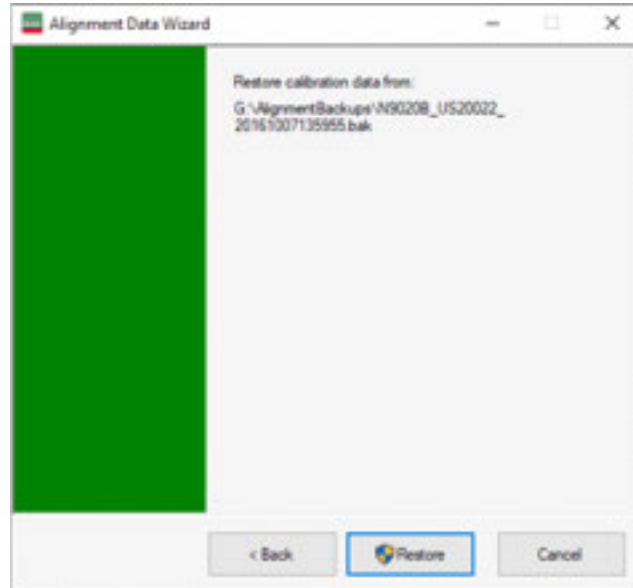

Perform Backup (without Flash) (Remote Command Only)

Invokes an alignment data backup operation to the provided location.

NOTE

Keysight recommends that the specified location should be external to the instrument (USB or Mapped Network Drive).

Remote Command :CALibration:DATA:BACKup <filename>

Example :CAL:DATA:BACK "F:\AlignDataBackup_N9020A_US00000001_2008140100.bkz"

Perform Restore (without Flash) (Remote Command Only)

Invokes an alignment data restore operation from the provided filename.

Remote Command :CALibration:DATA:RESTore <filename>

Example :CAL:DATA:REST "F:\ AlignDataBackup_N9020A_US00000001_2008140100.bkz"

Alignment Data Wizard (with Flash)

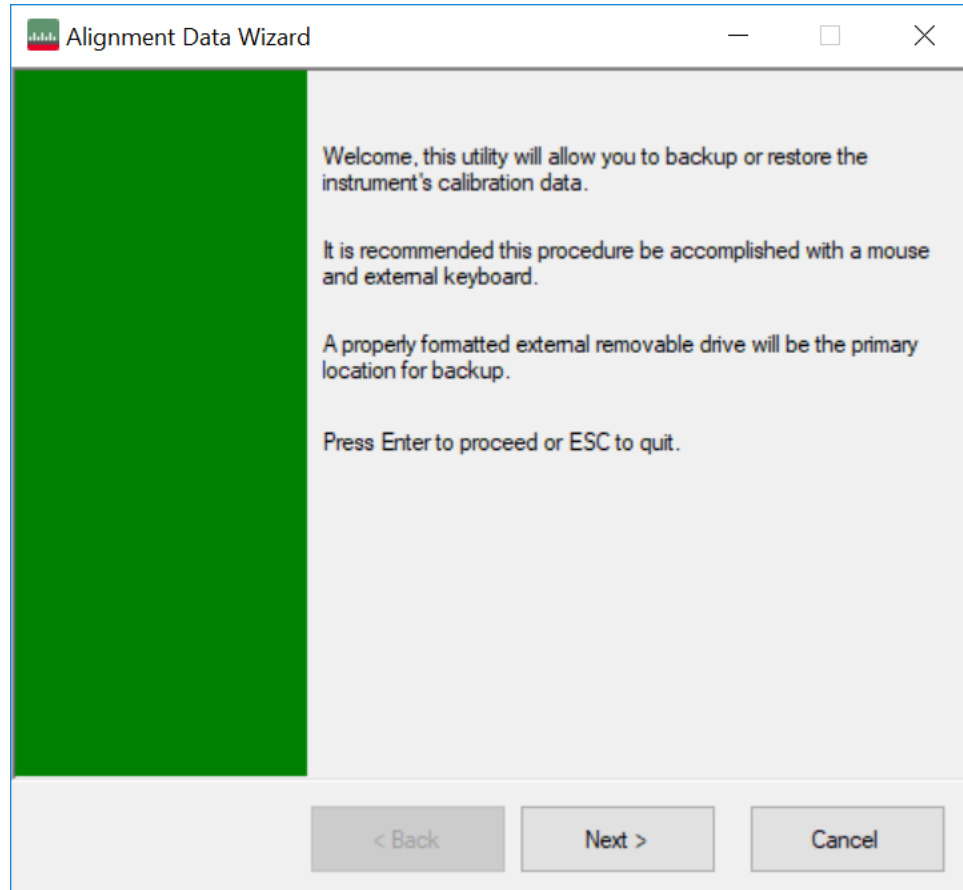

If your instrument has Processor Assembly type PC6S or PC7S (see "[Show System](#)" on page 842) the instrument has an internal flash EEPROM that can store a backup of the alignment data. In this case, the interface to the Alignment Data Wizard is enhanced to accommodate this internal storage. This section details the use of this internal flash. For details on using external storage, see the previous section ("[Alignment Data Wizard \(without Flash\)](#)" on page 950).

The Alignment Data Wizard guides you through the operations of backing up or restoring alignment data.

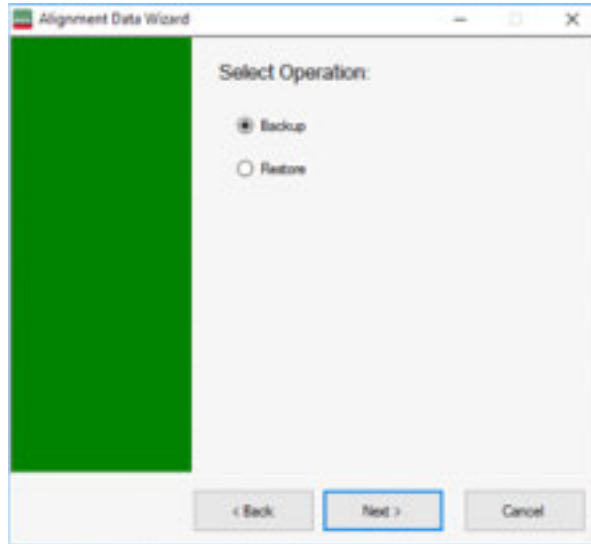

Having selected **Backup** or **Restore**, you then select the source or destination for the alignment data. As shown below, you can select either:

- Internal flash EEPROM, or,
- External Removable Drive (which includes the SD card described in "[Backup or Restore Align Data...](#)" on page 949)

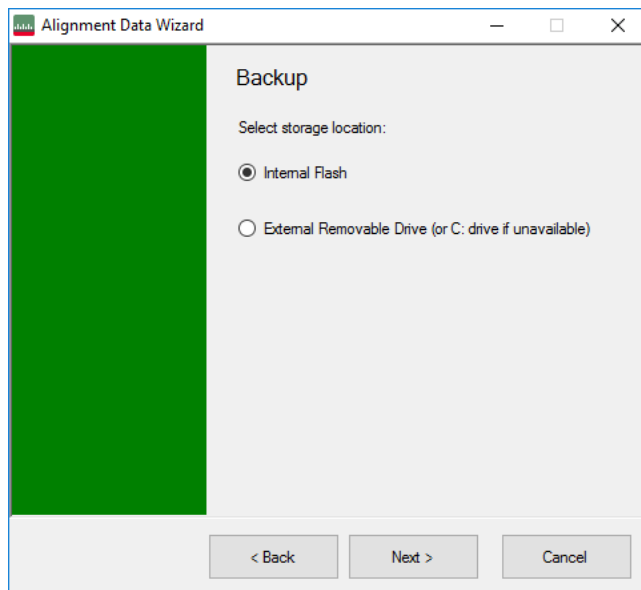

4 System
4.6 Alignments

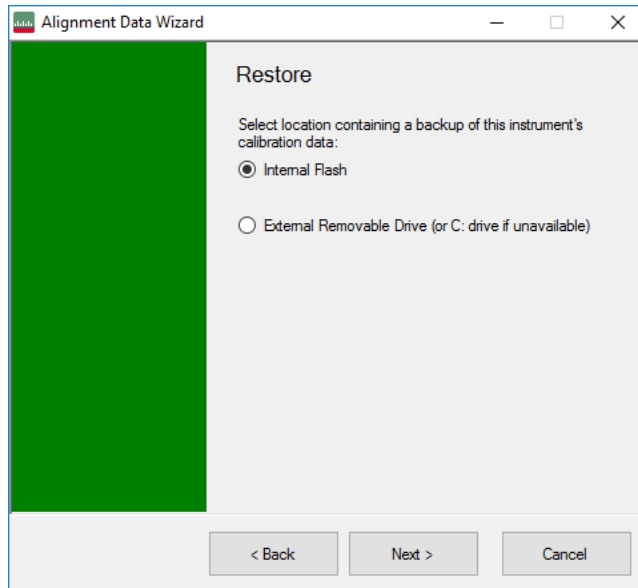

The final page of the wizard asks you to confirm the choices made in the previous pages. When the operation is complete, an indication is displayed on the same page, as below.

Backup

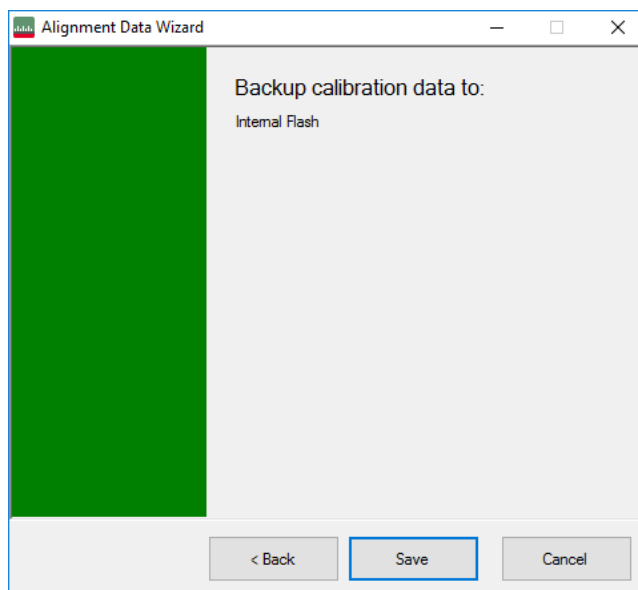

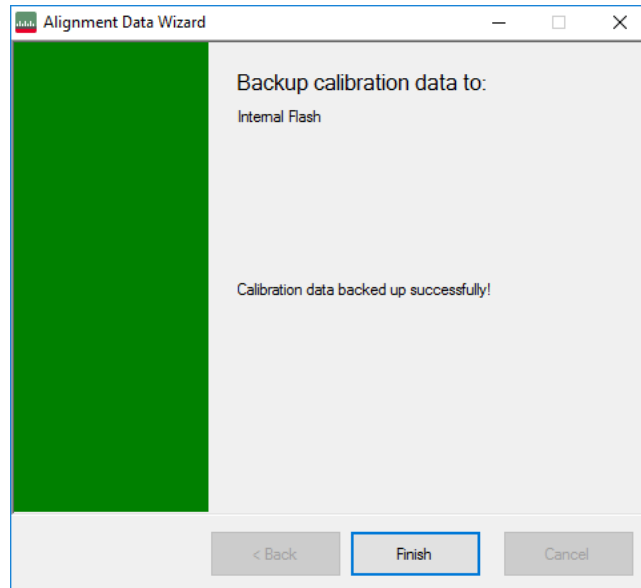

Restore

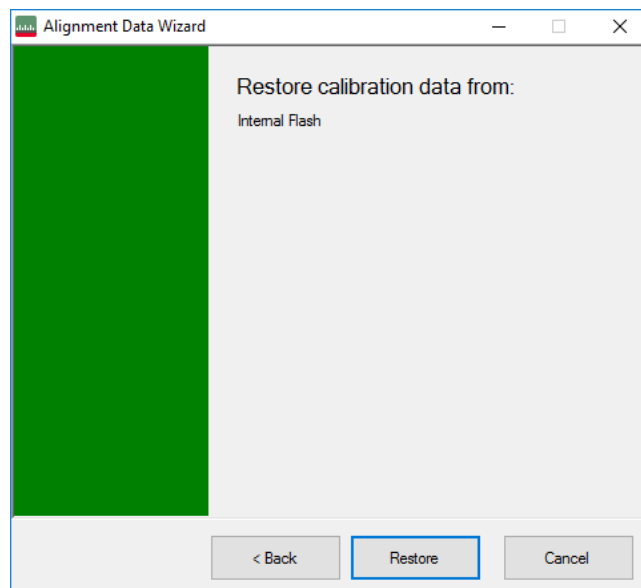

4 System

4.6 Alignments

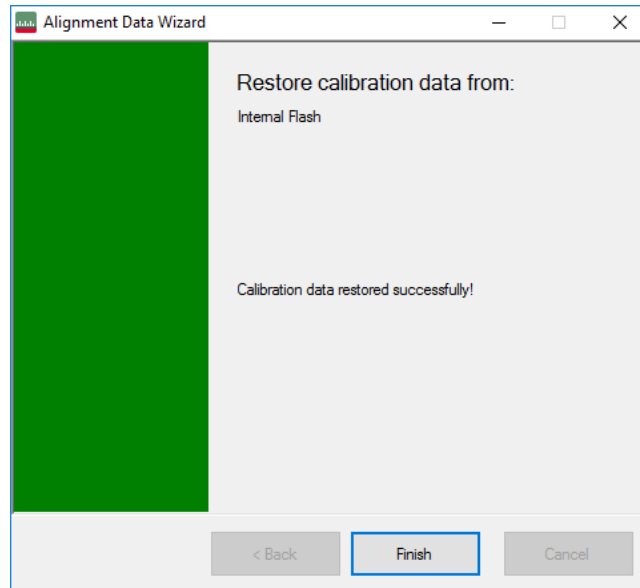

When restoring alignment data, if the serial number information in the backup file being restored is different from that of the instrument, the following message appears (the serial numbers shown are examples):

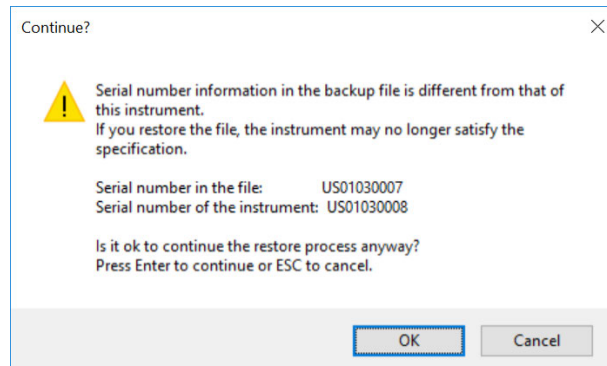

Immediately before the actual restoration, a final confirmation message is displayed detailing what is being restored and the current database that will be overwritten on the disk (the dates and versions are examples):

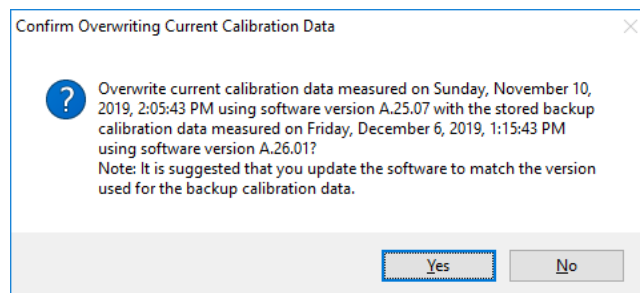

When backing up alignment data to the flash, if there is already an existing backup on the flash, a final confirmation message is displayed detailing what is being backed up and what will be overwritten on the flash (again, the dates and versions are examples):

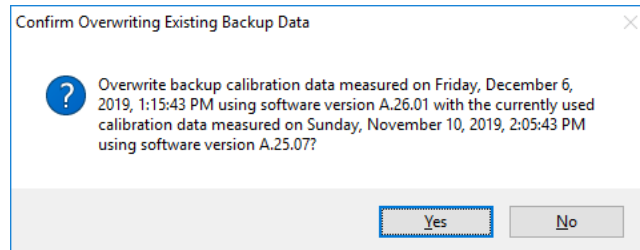

Perform Backup (with Flash) (Remote Command Only)

Invokes an alignment data backup operation to the internal flash EEPROM.

Remote Command :CALibration:DATA:INTernal:BACKup

Example :CAL:DATA:INT:BACK

Perform Restore (With Flash) (Remote Command Only)

Invokes an alignment data restore operation from the internal flash EEPROM.

Remote Command :CALibration:DATA:INTernal:RESTore

Example :CAL:DATA:INT:REST

Restore Alignment Defaults

Causes the Alignment system settings to be reset to their default values. This does not affect any Alignment data stored in the system.

After performing this function, it may impact the auto-alignment time of the instrument until a new alignment baseline has been established.

When **Alignments** is selected, a message appears saying:

This will reset all of the settings for the Alignment system to their default values

No alignment data will be erased

This action cannot be undone. Do you want to proceed?

The dialog includes **OK** and **Cancel** controls, for you to affirm or cancel the operation.

Align Now All must be executed if the value of the Timebase DAC results in a change.

Example	<code>:SYST:DEF ALIG</code>												
Notes	<p>Alignment processing that results as the transition to Auto Align Normal will be executed sequentially; thus <code>*OPC?</code> or <code>*WAI</code> will wait until the alignment processing is complete</p> <p>The parameters affected are:</p> <table border="1"> <thead> <tr> <th>Parameter</th> <th>Setting</th> </tr> </thead> <tbody> <tr> <td>Timebase DAC</td> <td>Calibrated</td> </tr> <tr> <td>Timebase DAC setting</td> <td>Calibrated value</td> </tr> <tr> <td>Auto Align State</td> <td>Normal (if the instrument is not operating with default alignment data, Off otherwise)</td> </tr> <tr> <td>Auto Align All but RF</td> <td>Off</td> </tr> <tr> <td>Auto Align Alert</td> <td>Time & Temperature</td> </tr> </tbody> </table>	Parameter	Setting	Timebase DAC	Calibrated	Timebase DAC setting	Calibrated value	Auto Align State	Normal (if the instrument is not operating with default alignment data, Off otherwise)	Auto Align All but RF	Off	Auto Align Alert	Time & Temperature
Parameter	Setting												
Timebase DAC	Calibrated												
Timebase DAC setting	Calibrated value												
Auto Align State	Normal (if the instrument is not operating with default alignment data, Off otherwise)												
Auto Align All but RF	Off												
Auto Align Alert	Time & Temperature												

4.6.6.7 oGRF Preselector

This menu and all its submenus are only available in models with the RF Preselector, such as N9038B, or N9048B.

Dependencies	Only available in RF Preselector models
--------------	---

Align Now, 20 Hz to 30 MHz

Immediately executes an alignment of the receiver subsystem. The receiver will stop any measurement currently underway, perform an Align Now All, then perform the RF Preselector alignment, and then restart the measurement from the beginning (similar to pressing the Restart key).

The query `:CALibration:RFPSelector:CONDucted?` invokes the alignment of the RF Preselector on Conducted Band and returns a success or failure value. Successful completion clears the “Align 20 Hz to 30 MHz required” Error Condition, and clears bit 1 in the Status Questionable Calibration Extended Needed register. The elapsed time counter will begin for Last Align Now, Conducted Time, and the temperature is captured for the Last Align Now, Conducted Temperature. The alignment can be interrupted by pressing the Cancel (ESC) front-panel key or remotely with Device Clear followed by the `:ABORt` SCPI command. When this occurs, the Error Condition “Align 20 Hz to 30 MHz required” is set because new alignment data may be employed for an individual subsystem, but not a cohesive set of data for all subsystems.

The “Align 20 Hz to 30 MHz required” Error Condition will appear when this alignment has expired. User is now responsible to perform the Align Now, 20 Hz to 30 MHz to keep the receiver in warranted operation. This alignment can only be performed by user as it is not part of the Auto Align process.

Remote Command	<code>:CALibration:RFPSelector:CONDUCTed</code> <code>:CALibration:RFPSelector:CONDUCTed?</code>
Example	<code>:CAL:RFPS:COND</code>
Notes	<p>The query returns 0 if successful, or 1 if failed</p> <p>When Align 20 Hz to 30 MHz is performing the alignment, bit 0 in the Status Operation register is set. Completion, or termination, will clear bit 0 in the Status Operation register</p> <p>This command is sequential; it must complete before further SCPI commands are processed. Interrupting the alignment from remote is accomplished by invoking Device Clear followed by the <code>:ABORt</code> command. Successful completion will clear bit 1 in the Status Questionable Calibration Extended Needed register and bit 0 in Status Questionable Calibration Extended Failure register</p> <p>A failure encountered during alignment will set the Error Condition “20 Hz to 30 MHz Alignment Failure” and set both bit 1 in the Status Questionable Calibration Extended Needed register and bit 9 in Status Questionable Calibration register</p>
Dependencies	Does not appear in non-RF Preselector models, setting or querying the SCPI will generate an error
Couplings	<p>Initializes the time for the Last Align Conducted Now, Conducted Time</p> <p>Records the temperature for the Last Align Conducted Now, Conducted Temperature</p>
State Saved	No
Status Bits/OPC dependencies	<p>Bit 8 or 9 may be set in the Status Questionable Calibration register</p> <p>Bit 1 may be set in the Status Questionable Calibration Extended Needed register</p> <p>Bit 0 may be set in the Status Questionable Calibration Extended Failure register</p>

Align Now, 30 MHz to 3.6 GHz

Immediately executes an alignment of the receiver subsystem. The receiver will stop any measurement currently underway, perform an Align Now All, then perform the RF Preselector alignment, and then restart the measurement from the beginning (similar to pressing the **Restart** key).

The query (`:CALibration:RFPSelector:RADiated?`) invokes the alignment of the RF Preselector on Radiated Band and returns a success or failure value. Successful completion clears the “Align 30 MHz to 3.6 GHz required” Error Condition, and clears bit 2 in the Status Questionable Calibration Extended Needed register. The elapsed time counter begins for Last Align Now, Radiated Time, and the temperature is captured for the Last Align Now, Radiated Temperature. The alignment can be interrupted by pressing the **Cancel (ESC)** front-panel key, or remotely with Device Clear followed by `:ABORt`. When this occurs, the Error Condition “Align 30 MHz to 3.6 GHz required” is set, because new alignment data may be employed for an individual subsystem, but not a cohesive set of data for all subsystems.

4 System
4.6 Alignments

The “Align 30 MHz to 3.6 GHz required” Error Condition appears when this alignment has expired. You must now perform **Align Now, 30 MHz to 3.6 GHz** to keep the receiver in warranted operation.

Remote Command	<code>:CALibration:RFPSelector:RADiated</code> <code>:CALibration:RFPSelector:RADiated?</code>
Example	<code>:CAL:RFPS:RAD</code>
Notes	<p>The query returns 0 if successful, or 1 if failed</p> <p>When Align 30 MHz to 3.6 GHz is performed, alignment, bit 0 in the Status Operation register is set. Completion, or termination, clears bit 0 in the Status Operation register</p> <p>This command is sequential; it must complete before further SCPI commands are processed. Interrupting the alignment from remote is accomplished by invoking Device Clear followed by <code>:ABORt</code>. Successful completion clears bit 2 in the Status Questionable Calibration Extended Needed register and bit 1 in Status Questionable Calibration Extended Failure register</p> <p>A failure encountered during alignment sets the Error Condition “30 MHz to 3.6 GHz Alignment Failure” and sets both bit 2 in the Status Questionable Calibration Extended Needed register and bit 9 in Status Questionable Calibration register</p>
Dependencies	Does not appear in non-RF Preselector models, setting or querying the SCPI will generate an error
Couplings	<p>Initializes the time for the Last Align Radiated Now, Radiated Time</p> <p>Records the temperature for the Last Align Radiated Now, Radiated Temperature</p>
State Saved	No
Status Bits/OPC dependencies	<p>May set Bit 8 or 9 in the Status Questionable Calibration register</p> <p>May set Bit 2 in the Status Questionable Calibration Extended Needed register</p> <p>May set Bit 1 in the Status Questionable Calibration Extended Failure register</p>

Align Now, 20 Hz to 3.6 GHz

Immediately executes an alignment of the receiver subsystem. The receiver will stop any measurement currently underway, perform an Align Now All, then perform the RF Preselector alignment, and then restart the measurement from the beginning (similar to pressing the **Restart** key).

The query (`:CALibration:RFPSelector:FULL?`) invokes the alignment of the RF Preselector on both Conducted and Radiated Band and return a success or failure value. Successful completion clears the “Align 20 Hz to 3.6 GHz required” Error Condition, and clears bit 1 and bit 2 in the Status Questionable Calibration Extended Needed register. The elapsed time counter begins for Last Align Now, Conducted Time and Last Align Now Radiated Time and the temperature is captured for Last Align Now, Conducted Temperature and Last Align Now, Radiated Temperature. The alignment can be interrupted by pressing the **Cancel (ESC)** front-panel key or remotely with Device Clear, followed by `:ABORt`. When this occurs, the Error Condition “Align 20 Hz to 3.6 GHz required” is set, because new alignment data may be employed for an individual subsystem, but not a cohesive set of data for all subsystems.

The “Align 20 Hz to 3.6 GHz required” Error Condition appears when this alignment has expired. You must now perform the Align Now, 20 Hz to 3.6 GHz to keep the receiver in warranted operation.

Remote Command	<code>:CALibration:RFPSelector:FULL</code> <code>:CALibration:RFPSelector:FULL?</code>
Example	<code>:CAL:RFPS:FULL</code>
Notes	<p>The query returns 0 if successful, or 1 if failed</p> <p>When Align 20 Hz to 3.6 GHz is performed, alignment, bit 0 in the Status Operation register is set. Completion, or termination, clears bit 0 in the Status Operation register</p> <p>This command is sequential; it must complete before further SCPI commands are processed. Interrupting the alignment from remote is accomplished by invoking Device Clear, followed by <code>:ABORT</code>. Successful completion clears bit 1, bit 2 in the Status Questionable Calibration Extended Needed register and bit 0, bit 1 in Status Questionable Calibration Extended Failure register</p> <p>A failure encountered during alignment sets the Error Condition “20 Hz to 3.6 GHz Alignment Failure” and sets bit 1, bit 2 in the Status Questionable Calibration Extended Needed register and bit 9 in Status Questionable Calibration register</p>
Dependencies	Does not appear in non-RF Preselector models, setting or querying the SCPI generates an error
Couplings	<p>Initializes the time for the Last Align Conducted Now, Conducted Time</p> <p>Initializes the time for the Last Align Radiated Now, Radiated Time</p> <p>Records the temperature for the Last Align Conducted Now, Conducted Temperature</p> <p>Records the temperature for the Last Align Radiated Now, Radiated Temperature</p>
State Saved	No
Status Bits/OPC dependencies	<p>May set Bit 8 or 9 in the Status Questionable Calibration register</p> <p>May set Bit 1 and 2 in the Status Questionable Calibration Extended Needed register</p> <p>May set Bit 0 and 1 in the Status Questionable Calibration Extended Failure register</p>

Alert

Enables or disables the display of RF Preselector alignment required message on the status line. The instrument powers up with Alert **ON**.

Remote Command	<code>:CALibration:RFPSelector:ALERT ON OFF 0 1</code> <code>:CALibration:RFPSelector:ALERT?</code>
Example	<code>:CAL:RFPS:ALER OFF</code>
Notes	Error Condition is generated when alert is ON and any of the RF Preselector alignments has expired
Preset	Unaffected by Preset, but set to ON by Restore Defaults > "Alignments" on page 896
State Saved	No
Range	OFF ON

4.6.6.8 Scheduler

Setting the Scheduler to **ON** triggers execution of the scheduled task based on the recurrence and time set in the scheduler since the last successful of the specific alignment. A warning condition of “RF Preselector alignment scheduler is ON” appears when the scheduler is set to **ON**. **OFF** prevents the Scheduler from running any scheduled task.

Remote Command	:CALibration:RFPSelector:SCHeDuler:STATe ON OFF 0 1
Example	:CAL:RFPS:SCH:STAT OFF
Preset	Unaffected by Preset, but set to ON by Restore Defaults > "Alignments" on page 896
State Saved	No
Range	OFF ON

Schedule Setup

Lets you schedule a task to run automatically at the background based on the recurrence and time set in the scheduler. Make sure that the instrument’s local time is accurate, because the Scheduler relies on this information to execute the task.

This dialog contains the following controls:

- "Task" on page 970
- "Date/Time" on page 971
- "Hour" on page 972
- "Minute" on page 972
- "Recurrence" on page 972
- "Number of Weeks" on page 972
- "Day" on page 973

Task

There are 3 tasks that can be selected for the scheduler to run.

- Task 1 is the 20 Hz to 30 MHz alignment
- Task 2 is the 30 MHz to 3.6 GHz alignment

- Task 3 is the 20 Hz to 3.6 GHz alignment

Remote Command	<code>:CALibration:RFPSelector:SCHeduler:TASK T1 T2 T3</code> <code>:CALibration:RFPSelector:SCHeduler:TASK?</code>
Example	<code>:CAL:RFPS:SCH:TASK T1</code>
Notes	Changing the task does not reset the Scheduler time, and the alignment is based on the current scheduled configuration to occur
Preset	Unaffected by Preset but set to T3 by Restore Defaults > "Alignments" on page 896
State Saved	No
Range	Task 1 Task 2 Task 3

Date/Time

Lets you configure the scheduler to run a task starting from this date and time. The date and time rely on the instrument's local time to execute a scheduled task. The date format is "YYYY/MM/DD" and the time is 24-hour clock.

Remote Command	<code>:CALibration:RFPSelector:SCHeduler:TIME:START "date", "time"</code> <code>:CALibration:RFPSelector:SCHeduler:TIME:START?</code> This query returns data using the format "YYYY/MM/DD; HH:MM:SS"
Example	<code>:CAL:RFPS:SCH:TIME:STAR "2009/8/20", "12:00:00"</code>
Notes	<p>"date" is the date the task will run, in the form YYYY/MM/DD where:</p> <ul style="list-style-type: none"> - YYYY is the four-digit representation of year (for example, 2009) - MM is the two-digit representation of month (for example, 01 to 12) - DD is the two-digit representation of the day (for example, 01 to 28, 29, 30 or 31 depending on the month and year) <p>"time" is the time of day the task will run, in the form HH:MM:SS where:</p> <ul style="list-style-type: none"> - HH is the two-digit representation of the hour in 24-hour format - MM is the two-digit representation of minute - SS is the two-digit representation of seconds
Preset	Unaffected by Preset but set to Current date and 00:00:00 by Restore Defaults > "Alignments" on page 896
State Saved	No

Hour

Lets you configure the hour for the scheduled task. The command to configure the date and time parameters of the scheduler is the same; but they each have their own front panel-control.

Notes	See "Date/Time" on page 971
Preset	Unaffected by Preset but set to Current hour and 00 by Restore Defaults > "Alignments" on page 896
State Saved	No

Minute

Lets you configure the minute for the scheduled task. The command to configure the date and time parameters of the scheduler is the same; but they each have their own front panel-control.

Notes	See "Date/Time" on page 971
Preset	Unaffected by Preset but set to Current minute and 00 by Restore Defaults > "Alignments" on page 896
State Saved	No

Recurrence

Lets you configure the scheduler to run the task recurrently on a scheduled date and time. You can schedule it to run daily, weekly, or alternate weeks.

Remote Command	<code>:CALibration:RFPSelector:SCHeduler:REcurrence DAY WEEK OFF</code>
Example	<code>:CAL:RFPS:SCH:REC DAY</code>
Preset	Unaffected by Preset but set to OFF by Restore Defaults > "Alignments" on page 896
State Saved	No
Range	<code>DAY WEEK OFF</code>

Number of Weeks

Lets you set the number of weeks that the scheduler will wait to trigger a task.

Remote Command	<code>:CALibration:RFPSelector:SCHeduler:REcurrence:WEEK <integer></code>
Example	<code>:CAL:RFPS:SCH:REC:WEEK 2</code>

Notes	New scheduled date to run the alignment task is updated when this parameter is changed
State Saved	No
Range	1-52
Min	1
Max	52

Day

Lets you set the Day of the Week the scheduler will run a scheduled task.

Remote Command	<code>:CALibration:RFPSelector:SCHeDuler:RECurrence:DAY SUN MON TUE WED THU FRI SAT</code> <code>:CALibration:RFPSelector:SCHeDuler:RECurrence:DAY?</code>
Example	<code>:CAL:RFPS:SCH:REC:DAY SUN</code>
State Saved	No
Range	Sunday Monday Tuesday Wednesday Thursday Friday Saturday

4.7 Licensing

Accesses capabilities for configuring the licenses in your instrument.

4.7.1 License Manager

Opens the License Explorer for Fixed and Transportable licenses.

NOTE

This feature is not available if Option SF1 is installed.

For help on licensing, select **Help** in the menu bar at the top of the License Explorer window.

There are also several remote commands available for licensing. See:

- ["Install License \(Remote Command Only\)" on page 982](#)
- ["Remove License \(Remote Command Only\)" on page 982](#)
- ["List Licenses \(Remote Query Only\)" on page 983](#)
- ["Validate License \(Remote Query Only\)" on page 984](#)
- ["Host ID Query \(Remote Query Only\)" on page 984](#)
- ["List Borrowed Licenses \(Remote Query Only\)" on page 979](#)
- ["Return a Borrowed License \(Remote Command Only\)" on page 980](#)

Notes

No equivalent remote command for this control

4.7.2 System Software Version Date

The date of the newest features introduced in this release of the firmware. This is *not* necessarily the same as the build date of the firmware, because the version date only changes when new features are added. For example, if A.18.06 has only defect fixes and no new features compared to A.18.05, then both A.18.05 and A.18.06 would have the same software version date.

For any feature to be enabled, the SW Support Expiration Date of the enabling license must be greater than or equal to the software version date when that feature was first introduced. See the Keysight web site for features related to a specific software application and their required support date.

The SCPI response is 3 integer values: [<year>](#), [<month>](#), [<day>](#).

Remote Command	:SYSTem:SOFTware:VERsion:DATE?
----------------	--------------------------------

Example	:SYST:SOFT:VERS:DATE?
---------	-----------------------

4.7.3 Software Support Expiration Date

This date is encoded in each software license's Version field in the **YYYY.MMDD** format. It specifies the end date of the support contract associated with this license. When a support contract is renewed, a new license is issued with an updated Version corresponding to the new contract's end date. The functionality available for a license is determined by the features available before the expiration date. For example, if feature X is introduced in a release with System Software Version Date of **2017.0831**, then a license with a Software Support Expiration Date of **2017.0831** or greater would enable feature X, but **2017.0830** or earlier would not enable feature X.

The SCPI response is 3 integer values: **<year>, <month>, <day>**.

Remote Command	:SYSTem:LKEY:SOFTware:SUPPort:EXPIration:DATE? <feature>
----------------	--

Example	:SYST:LKEY:SOFT:SUPP:EXP:DATE? "N9084EM0E-1FP"
---------	--

Dependencies	When <feature> is not a valid license, one of the following errors will be issued:
--------------	---

- -224, "IllegalParameterValue;License is not installed"
- -224, "IllegalParameterValue;Unknown license feature"
- -224, "IllegalParameterValue;Support contract not offered for this license"

4.7.4 Network Licenses

Network Licenses are available over the customer's network from a server the customer configures. The server has a count for each license and will only allow instruments to "check-out" a license up to that count. Once the count is reached for a specific license, further check-outs fail until one of the licenses is checked back in to the server. What this means is that it is possible for an instrument to have different features available to it based on what licenses are still available on the server when it tries to get licenses.

Setting up network licenses is done via the **Keysight Floating License Manager** (available on external Keysight web) and it has an Installation Guide that can be downloaded from that web page.

4.7.4.1 Application Licenses

Application Licenses (like N9077EM0E-1NP) are automatically checked out when entering the Mode that uses them, and they are automatically checked-in when leaving that Mode. Because the server may have already checked out the last license for the application to another instrument, there is now the possibility that a mode switch will fail because a required license could not be checked out from the server. If the server has a limited number of licenses compared to the number of users desiring to use that license, this may mean that switching from Mode A to Mode B then back to Mode A may fail when returning to Mode A because another instrument checked out the last available license while the user was in Mode B. Also, for Modes with multiple licenses for different features (like Multi-Standard Radio), the features available may also change when switching out of the Mode and back into it.

So, when using network licenses, it is necessary to check `:SYST:ERR?` after every Mode switch, to verify that it successfully switched. If the Mode's required licenses were not successfully checked out, the instrument posts the error:

```
-310,"System error; feature not licensed"
```

There is also a potential performance issue when using network licenses, because the instrument must communicate with the server on each license check-out and check-in. This operation is usually fast (a few milliseconds), but it depends on the network communication lag between the instrument and server. For remote servers on slow or congested networks, this could be significantly slower than that.

4.7.4.2 Instrument Software Options

Instrument software licenses are those that are reported via `*OPT?` the same as HW options. For example, N9040RT1B-1NP is an instrument software option, and is reported via `*OPT?` as `RT1`. Note that the license is composed of the model number (in this case `N9040B`) combined with the option code (`RT1`).

When instrument software options are available from a network server, the instrument automatically checks them out at start-up, and only checks them in when shutting down.

4.7.4.3 License Checked Out Query (Remote Query Only)

Shows whether the specified license is checked out from a server. Since network served licenses may not always be available when there are limited licenses available compared to the desired number of users, the features available on an instrument can vary. Use this query to see whether the feature is currently checked-out to the instrument. The return value is boolean (0 or 1), returning 1 if the feature

exists and is checked out from a server. Note that querying a license that is local to the instrument (-xFP or -xTP) also returns 0, even though the license exists and is valid, because it does not require a check-out. Also, querying a license that does not exist returns 0.

Remote Command	<code>:SYSTem:LKEY:COUT? <feature></code>
Example	<code>:SYST:LKEY:COUT? "N9080EM0E"</code> 1
Notes	<"OptionInfo"> contains the feature and the version. You must specify the feature but can omit the version. If you omit the version, the system regards it as the latest one Return Value: 0 if not checked out, 1 if checked out

4.7.4.4 List Licenses Checked Out (Remote Query Only)

Lists the licenses checked out from a server. Since network served licenses may not always be available when there are limited licenses available compared to the desired number of users, the features available on an instrument can vary. Use this query to see which features are currently checked-out to the instrument.

Remote Command	<code>:SYSTem:LKEY:COUT:LIST?</code>
Example	<code>:SYST:LKEY:COUT:LIST?</code> #284 N9073EM0E,2018.0831 N9077EM0E,2018.0831 N9080EM0E,2018.0831 N9081EM0E,2018.0831

4.7.4.5 Borrowed Network Licenses

Network licenses can be borrowed from the network license server for a time. The maximum amount of time a license can be borrowed is specified in the license installed on the server and is set at the time the license is generated by Keysight. As part of the borrow operation, you specify how long to borrow the license. This borrow period is in hours and can be any time up to the maximum allowed by the license. Once borrowed, the license appears as a local license and can be used even when not connected to the network, and the instrument software treats them the same as other time-based licenses that are installed on the instrument. This means the licenses are validated when the instrument is started and then are used without the overhead of checking them out and back in when switching Modes. At the time of the borrow, a time is specified for how long the license will be borrowed. When that time expires, the license is automatically returned to the network license server

4 System

4.7 Licensing

even if the instrument is not connected to the network. If you are done with the license before it automatically returns to the network server, the license can be explicitly returned earlier.

4.7.4.6 Borrow a License

Licenses are borrowed by using the Keysight License Manager 6 application. This can be launched from the **System Licensing** screen.

Graphic

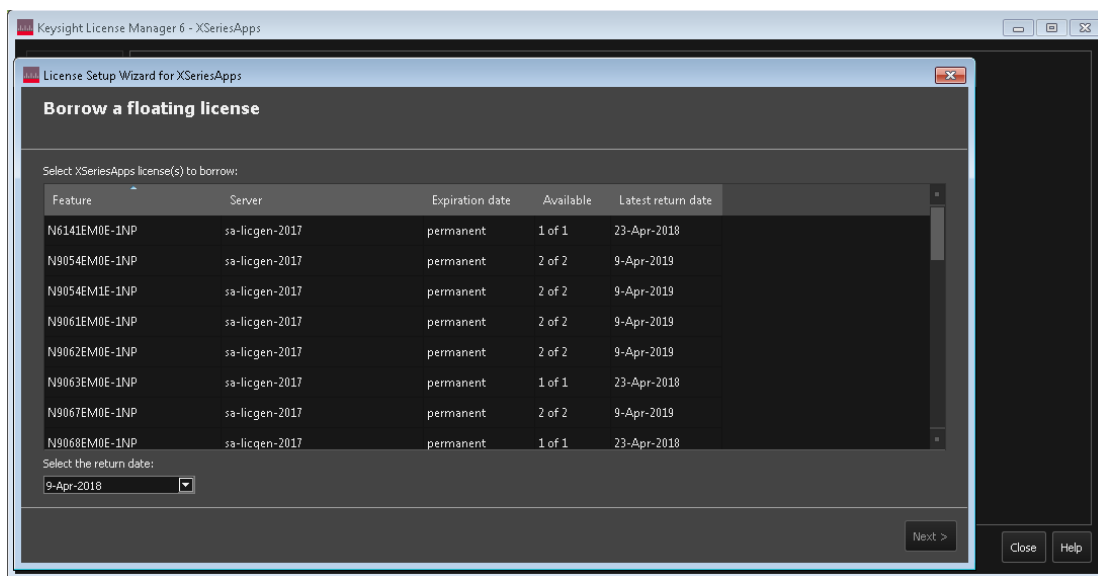

The corresponding remote command is:

Remote Command :SYSTem:LKEY:BORRow "<feature>[,<version>]",<return date>

 :SYSTem:LKEY:BORRow? "<feature>[,<version>]"

Example :SYST:LKEY:BORR "N9080EM0E", "20-Aug-2018"

 :SYST:LKEY:BORR? "N9080EM0E"

 : "20-Aug-2018"

Notes If <version> is not specified, the highest available version will be borrowed

 The <return date> is the day when the borrow will automatically be returned to the server

Dependencies For the command, when <feature> is not a valid license, or when a license is not currently available for borrowing, one of the following errors is issued:

- -224, "IllegalParameterValue;License is not installed"
- -224, "IllegalParameterValue;Unknown license feature"

- -224,"IllegalParameterValue;License not available for borrowing"

Additionally, the return date is evaluated. If it is not a valid date, the following error is issued:

- -224,"IllegalParameterValue;Invalid return date"
- -200,"Execution error; No Available Borrow Licenses For Feature: <feature>"

The return date may be clipped to the maximum borrow allowed by the license. When this happens, the following warning is issued:

- -221,"Return date clipped to maximum of <max date>"

For the query, the return is the borrow return date (as a string in `dd-mmm-yyyy` format) if the license is borrowed. In all other cases, (not borrowed, not installed, etc.) the return is an empty string

4.7.4.7 Listing Borrowed Licenses and Return a Borrowed License

The Keysight License Manager 6 can also be used to see the currently borrowed licenses or return a license before the automatic return time.

Graphic

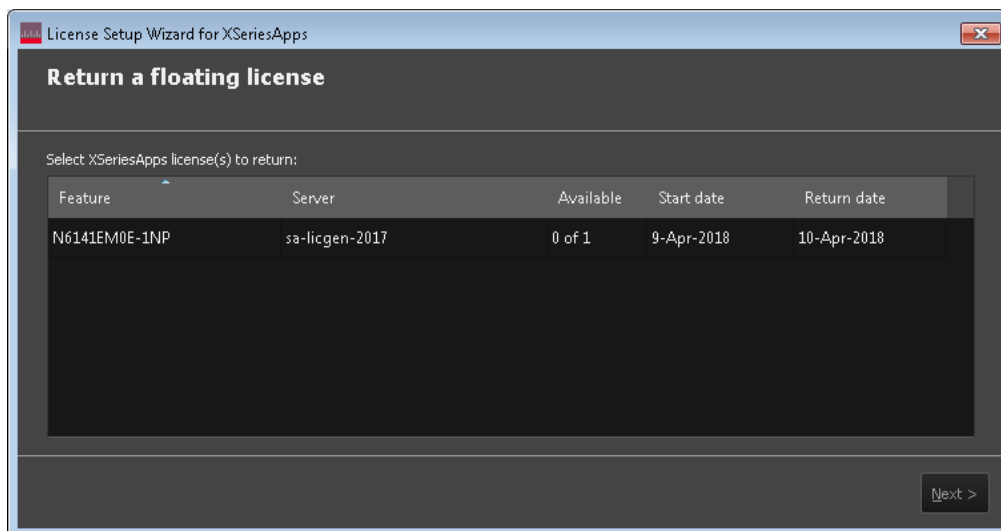

List Borrowed Licenses (Remote Query Only)

Remote Command `:SYSTem:LKEY:BORR:LIST?`

Example `:SYST:LKEY:BORR:LIST?`

`#266`

N9073EM0E, 2018.0831, 20-Aug-2018

N9077EM0E, 2018.0831, 20-Aug-2018

Return a Borrowed License (Remote Command Only)

Remote Command	<code>:SYSTem:LKEY:BORRow:RETurn "<feature>"</code>
Example	<code>:SYST:LKEY:BORR:RET "N9080EM0E"</code>
Dependencies	When <code><feature></code> is not a valid license or when a license is not borrowed, one of the following errors is issued: <ul style="list-style-type: none"> - -224, "IllegalParameterValue;License is not installed" - -224, "IllegalParameterValue;Unknown license feature" - -224, "IllegalParameterValue;License not borrowed"

4.7.4.8 Enabling Network Checkouts While Borrowed

The default for borrowed license use is that you will be explicitly borrowing all desired network licenses, and that all other available network licenses should be ignored. This allows you to intentionally limit the functionality available to the instrument to what is explicitly borrowed.

For example, the RT1/RT2 options that enable the RTSA Mode are automatically checked out when the instrument is started, because the hardware must be configured for them at startup time. If you do not intend to use RTSA, then by borrowing only the licenses you want to use and disabling other network checkouts, the RT1/RT2 licenses will not be checked out at startup. This leave more RTSA licenses available for others to use. Note that the instrument must be restarted after the borrowing has been done to ensure the release of any network licenses already acquired.

If your intent in borrowing is to ensure access to a particular feature or application, but you still want to opportunistically use other features or applications, the default behavior can be changed to enable network license checkouts even when licenses have been borrowed.

Remote Command	<code>:SYSTem:LKEY:BORRow:NETWork:COU:ENABle</code>
Example	<code>:SYST:LKEY:BORR:NETW:COU:ENAB 0</code> <code>:SYST:LKEY:BORR:NETW:COU:ENAB?</code>
Dependencies	Only visible when licensing is configured to use a network server. SCPI is always available
Preset	Unaffected by Preset but set to 0 by Restore Defaults > "Misc" on page 896 or Restore Defaults > "All" on page 897
State Saved	Power On Persistent (survives shutdown and restart)

4.7.5 USB Portable Licenses

The USB Portable license is implemented with a physical dongle that is a USB device, like a USB thumb drive. It has a Host ID fixed in the dongle HW. It does not contain any writable data and so is acceptable to high security A/D customers. Transporting licenses from one instrument to another just requires moving the dongle and license files to the desired instrument. The license files can be installed on many instruments, but they will only be valid the one instrument that has the dongle. The use of USB portable licenses requires that the Keysight Floating License Manager is installed on the instrument. The licenses can then be added to the instrument's server.

USB Portable licenses are checked out and in like Network licenses. Because the licenses are local, there will be no network latency involved in the check-out/check-in, but there can still be a slight performance degradation compared to Fixed and Transportable licenses. If the instrument allows multiple concurrent instances of the X-Series software (as is the case for modular products), there may also be availability issues if all licenses are already checked out to other X-Series instances. Plugging/un-plugging the dongle is equivalent to transporting a license to/from the instrument, however, the software must be restarted whenever the dongle is plugged in.

4.7.6 Configuring Network and USB Portable Licenses

The Keysight Floating License Manager must be used to configure the Network or USB Portable licenses before the licenses can be used. Currently, an instrument can only be configured for Network or USB Portable licenses or both.

- To set up USB Portable licenses, in the Keysight Floating License Manager select “Start a floating license server with a license file” and add files containing the USB Portable licenses desired
- To set up Network licenses, in the Keysight Floating License Manager select “Connect to a floating license server” and enter the network server's name preceded by the “@” character (example: “@myserver”)
- To set up both Network and USB Portable license, first configure the USB Portable license, then configure the Network licenses, but append “;@localhost” to the server name (example: “@myserver;@localhost”). Whenever the configuration is changed, the X-Series software must be restarted

4.7.7 Floating License Manager

Opens the License Explorer for Network and USB Portable licenses.

NOTE

This feature is not available if Option SF1 is installed.

For help on licensing, select **Help** in the menu bar at the top of the License Explorer window.

4.7.8 Install License (Remote Command Only)

Used to add a license to the instrument.

An example of such a command would be as below. The parameter is a unique 120-character code for each license.

```
SYST:LKEY "N9073A-1FP", "027253AD27F83CDA5673A9BA5F427FDA5E4F25AEB1017638211AC9F60D9C639FE539735909C551DE0A91"
```

Another example using one of the optional clauses.

```
SYST:LKEY "N9063EM0E-1FP, 2019.0330", "02220210867E187713C9AFD4C90EA0DE2B674615DD0255798EE5B237A146A0D4E411E0ABFE04D3CAFDFA", "ISSUED=30-Mar-2018"
```

NOTE

This command does not work for Transportable, Network or USB Portable licenses.

Remote Command	<code>:SYSTem:LKEY <"OptionInfo">, <"LicenseInfo">, <"Optional1">, <"Optional2">, <"Optional3">, <"Optional4">, <"Optional5"></code>
Notes	<p><code><"OptionInfo"></code> contains the feature and the version. You must specify the feature but can omit the version. If you omit the version, the system regards it as the latest one, since the system knows which version is supported for each feature</p> <p><code><"LicenseInfo"></code> contains the signature, the expiration date, and serial number for transport if transportable. You must specify the signature, but you can omit the other information. If you omit the expiration date, the system regards it as permanent. If you omit the serial number, the system regards it as non-transportable. As a result, this supports reverse compatibility</p> <p><code><"Optional#"></code> are optional parameters that may be needed to match the information in the original license</p>

4.7.9 Remove License (Remote Command Only)

Removes a particular license.

An example of such a command would be as below. The parameter is a unique 120-character code for each license.

```
SYST:LKEY:DEL "N9073A-
```

1FP”,”027253AD27F83CDA5673A9BA5F427FDA5E4F25AEB1017638211AC9F60D9C639FE53973590
9C551DE0A91”

NOTE

This command does not work for Transportable, Network or USB Portable licenses.

Remote Command	<code>:SYSTem:LKEY:DELeTe <"OptionInfo">,<"LicenseInfo"></code>
----------------	---

Notes	<p><code><"OptionInfo"></code> contains the feature and the version. You must specify the feature but can omit the version. If you omit the version, the system regards it as the latest one, if more than one version is installed</p> <p><code><"LicenseInfo"></code> contains the signature, the expiration date, and whether be transportable. You must specify the signature, but you can omit the other information. If you omit the expiration date, the system regards it as permanent. If you omit the transportability, the system regards it as non-transportable. As a result, this supports reverse compatibility</p>
-------	--

4.7.10 List Licenses (Remote Query Only)

Returns a list of installed licenses.

Remote Command	<code>:SYSTem:LKEY:LIST?</code>
----------------	---------------------------------

Notes	<p>Return Value:</p> <p>An <code><arbitrary block data></code> of all the installed instrument licenses</p> <p>The format of each license is as follows</p> <p><code><Feature>,<Version>,<Signature>,<Expiration Date>,<Serial Number for Transport>,...</code></p> <p>Return Value Example:</p> <pre>#3136 N9073A-1FP,1.000,B043920A51CA N9060A-2FP,1.000,4D1D1164BE64 N9020A-508,1.000,389BC042F920 N9073A-1F1,1.000,5D71E9BA814C,13-aug-2005</pre> <p><code><arbitrary block data></code> is:</p> <pre>#NMMM<data></pre> <p>Where:</p> <p>N is the number of digits that describes the number of MMM characters. For example, if the data was 55 bytes, N would be 2</p> <p>MMM would be the ASCII representation of the number of bytes. In the previous example, N would be 55</p> <p><code><data></code> ASCII contents of the data</p> <p>Additional fields may appear depending on the type of license (Fixed, Transportable, Network, USB Portable)</p>
-------	---

4.7.11 Validate License (Remote Query Only)

Lets you query whether a particular license is currently valid.

Remote Command	<code>:SYSTem:LKEY? <"OptionInfo"></code>
Example	<code>:SYST:LKEY? "N9073A-1FP"</code>
Notes	<p><code><"OptionInfo"></code> contains the feature and the version. You must specify the feature but can omit the version. If you omit the version, the system regards it as the latest one</p> <p>Return Value: <code><"LicenseInfo"></code> if the license is valid, null otherwise <code><"LicenseInfo"></code> contains the signature, the expiration date, and serial number if transportable</p> <p>Return Value Example: <code>"B043920A51CA"</code></p>

4.7.12 Host ID Query (Remote Query Only)

Returns the Host ID as a string.

Remote Command	<code>:SYSTem:HID?</code>
----------------	---------------------------

4.8 Security

Accesses capabilities for operating the instrument in a security-controlled environment.

The **Security** page of the **System** menu has two controls: **USB Read/Write** and **Restore Security Defaults**.

Dependencies	Not available in UXM
--------------	----------------------

4.8.1 USB Write Protect

The Windows operating system can be configured to disable write access to the USB ports for users who are in a secure environment where transferring data from the instrument is prohibited. The **USB Write Protect** control is a convenient way for you to disable write access to USB.

NOTE

This control is only available to users with Administrator privileges.

Remote Command	<code>:SYSTem:SECurity:USB:WPRotect[:ENABle] ON OFF 0 1</code> <code>:SYSTem:SECurity:USB:WPRotect[:ENABle]?</code>
Example	Set USB ports to Read-only: <code>:SYST:SEC:USB:WPR ON</code> Set USB ports to Read-Write: <code>:SYST:SEC:USB:WPR OFF</code>
Notes	When the USB ports are in Read-only mode, then no data can be stored to USB, including the internal USB memory used for a back-up location for the calibration data
Dependencies	Grayed-out unless the current user has Administrator privileges
Preset	Unaffected by Preset or any "Restore Defaults" on page 894. A Keysight Recovery sets the USB to write protect OFF
State Saved	No
Range	Read-Write Read only

4.8.2 Restore Security Defaults

Sets USB Read/Write to Enable.

NOTE

This control is only available to users with Administrator privileges.

4.9 Diagnostics

Displays a slider that allows you to view Hardware Statistics.

Dependencies	Not available in UXM
--------------	----------------------

4.9.1 Show Hardware Statistics

Provides a display of various hardware statistics. The statistics include the following:

- Mechanical relay cycles (on models with mechanical relays)
- High and Low temperature extremes
- Elapsed time that the instrument has been powered-on (odometer)

Modular instruments display only time and temperature information.

Example	<code>:SYST:SHOW HWST</code>
---------	------------------------------

Notes	The values displayed on the screen are only updated upon entry to the screen and not updated while the screen is being displayed
-------	--

4.9.2 Pathwave Calibration Advisor...

This is a separate application that helps maintain your instrument at peak performance. You can set the cal interval, configure cal due reminders, check the cal status, view cal certificates and test reports, and contact Keysight for a cal service.

The embedded help documentation can be accessed in the instrument at: <C:\Program Files\Keysight\Calibration Advisor\PCA.chm>, or via the ? button at the top right of the **PathWave Calibration Advisor** window.

4.9.3 Query the Mechanical Relay Cycle Count (Remote Query Only)

Returns the count of mechanical relay cycles.

Remote Command	<code>:SYSTem:MRELay:COUNT?</code>
----------------	------------------------------------

Example	<code>:SYST:MREL:COUN?</code>
---------	-------------------------------

Notes	Query Only
-------	------------

The return value is a comma-separated list of the individual counts for each mechanical relay
The position of the relays in the list is:

“<Cal Signal>,<AC/DC>,<2dB #1 Atten>,<2dB #2 Atten>,<6dB Atten>,<10dB Atten>,<20dB Atten>,<30dB Atten>,<Fixed Atten>,<Low Noise Path Switch>,<PreSel Bypass>”

Items in the list not pertaining to your hardware configuration return as **-999** for those items

Dependencies *Not supported by E6607C*

4.9.4 Query the Operating Temperature Extremes (Remote Query Only)

Returns the low operating temperature extreme value. The value survives a power-cycle and is the temperature extreme encountered since the value was reset by the factory or service center.

Remote Command `:SYSTem:TEMPerature:LEXTreme?`

Example `:SYST:TEMP:LEXT?`

Notes Value is in degrees Celsius at which the lowest operating temperature has been recorded since 1st power-up

State Saved No

Returns the high operating temperature extreme value. The value survives a power-cycle and is the temperature extreme encountered since the value was reset by the factory or service center.

Remote Command `:SYSTem:TEMPerature:HEXTreme?`

Example `:SYST:TEMP:HEXT?`

Notes Value is in degrees Celsius at which the highest operating temperature has been recorded since 1st power-up

State Saved No

4.9.5 Query the Elapsed Time since 1st power on (Remote Query Only)

Returns the elapsed on-time in minutes since 1st power-on.

Remote Command `:SYSTem:PON:ETIMe?`

Example `:SYST:PON:ETIM?`

Notes Query Only

4.10 Service

Accesses capabilities performed in the factory or under instructions from repair procedures. This key is only visible when the logged-in user is “**advanceduser**” or “**saservice**”. The first access to the **Service** menu after invoking the instrument application will require an authentication Service Code.

Dependencies	Not available in UXM
--------------	----------------------

4.11 System Remote Commands (Remote Commands Only)

These commands have no front-panel key equivalent.

- "List installed Options (Remote Query Only)" on page 989
- "Lock the Front-panel keys (Remote Command Only)" on page 990
- "Lock Workstation (Remote Command Only)" on page 990
- "List SCPI Commands (Remote Query Only)" on page 992
- "Front Panel activity history (Remote Query only)" on page 992
- "SCPI activity history (Remote Query only)" on page 993
- "Instrument start time (Remote Query only)" on page 993
- "SCPI Version Query (Remote Query Only)" on page 994
- "Date (Remote Command Only)" on page 994
- "Time (Remote Command Only)" on page 994
- "Input Overload Enable (Remote Command Only)" on page 995
- "Power Up (Remote Query Only)" on page 995

4.11.1 List installed Options (Remote Query Only)

Lists the installed options that pertain to the instrument (signal analyzer).

Remote Command	<code>:SYSTem:OPTions?</code>
Example	<code>:SYST:OPT?</code>
Notes	The return string is a comma-separated list of the installed options. For example: <code>"503,P03,PFR"</code> <code>:SYSTem:OPTions?</code> and <code>*OPT?</code> are the same
State Saved	No

4.11.2 Lock the Front-panel keys (Remote Command Only)

Disables the instrument keyboard to prevent local input when the instrument is controlled remotely. Annunciation showing a “K” for **KLOCK** (keyboard lock) alerts the local user that the keyboard is locked. **KLOCK** is similar to the GPIB Local Lockout function; namely that no front-panel keys are active except for the **Power Standby** key. (The instrument is allowed to be turned-off if **KLOCK** is **ON**.) The **KLOCK** command is used in remote control situations where Local Lockout cannot be used.

Although primary intent of **KLOCK** is to lock-out the front panel, it will lock-out externally connected keyboards through USB. **KLOCK** has no effect on externally connected pointing devices (mice).

The front panel ‘**Local**’ key (**Cancel/Esc**) has no effect if **KLOCK** is **ON**.

See also "[Local Button](#)" on page 109.

Remote Command	<code>:SYSTem:KLOCK OFF ON 0 1</code> <code>:SYSTem:KLOCK?</code>
Example	<code>:SYST:KLOC ON</code>
Notes	Keyboard lock remains in effect until turned-off, or until the instrument is power-cycled
Preset	Initialized to OFF at startup, unaffected by Preset
State Saved	No

4.11.3 Lock Workstation (Remote Command Only)

Performs the same functionality as the **Win+L** function or the “Lock” function on the **CTL-ALT-DEL** screen in Windows.

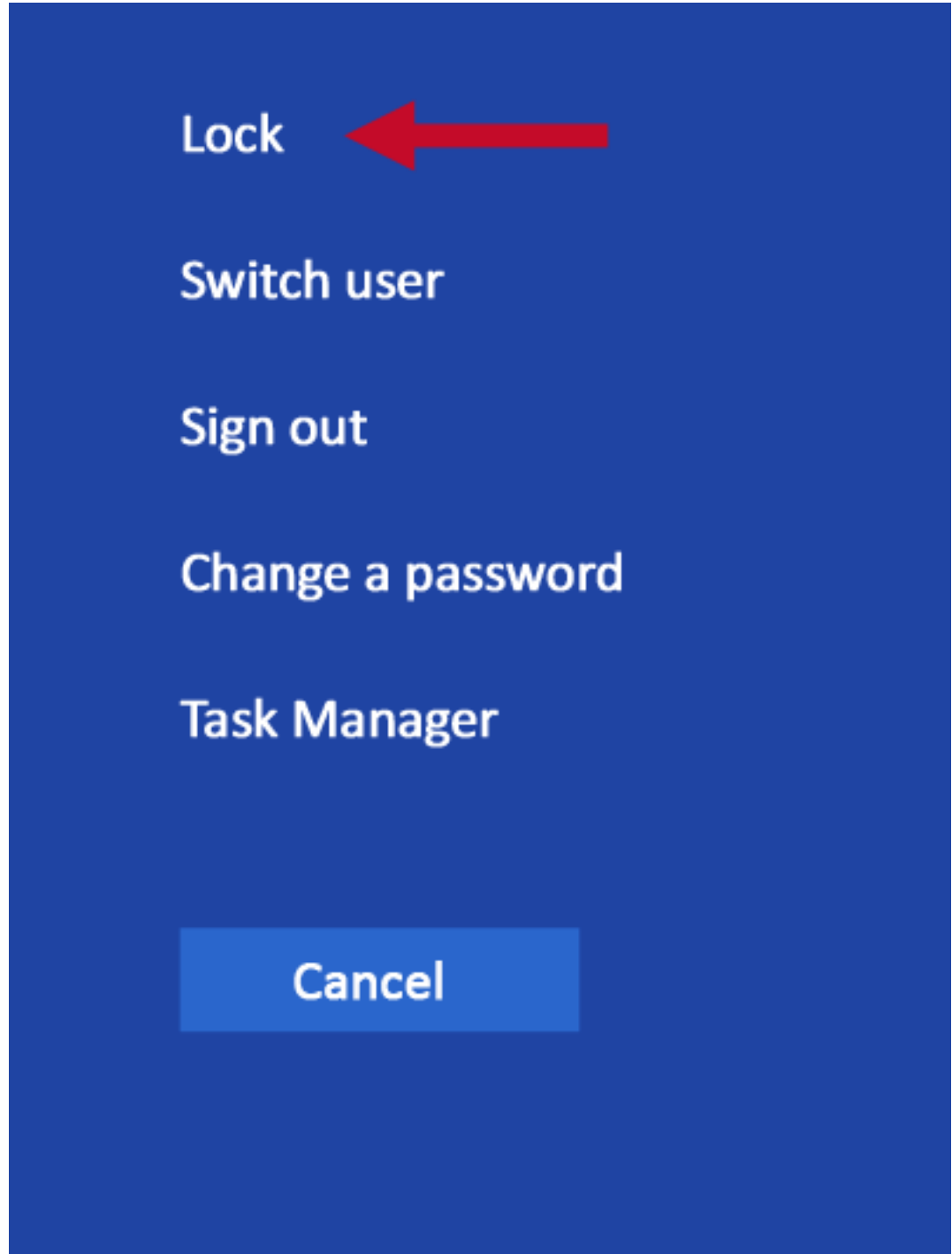

As soon as you do this, the computer is locked. The initial login screen appears; no one can access the computer at that point unless they have an account and know the account's password.

Failure to initiate adds an error to the Windows event log for SA;

4 System
 4.11 System Remote Commands (Remote Commands Only)

"LockWorkStation - Failed to initiate function"

See also "Local Button" on page 109.

Remote Command	:SYSTem:LWSTation
Example	:SYST:LWST
Notes	The lock remains in effect until a user logs in
State Saved	No

4.11.4 List SCPI Commands (Remote Query Only)

Outputs a list of the valid SCPI commands for the currently selected Mode.

Remote Command	:SYSTem:HELP:HEADers?
Example	:SYST:HELP:HEAD?
Notes	The output is an IEEE Block format, with each command separated with the New-Line character (0x0A)

4.11.5 Front Panel activity history (Remote Query only)

Instrument front panel usage can be monitored using :SYSTem:METRics:FPANel?. The monitoring occurs for front panel hardkey or softkey operation (including mouse or touch operation on instruments with Multi-Touch User Interface). The information of the usage pertains to the activity since the instrument application was started; the information does not persist after the application is terminated, or the instrument has been rebooted.

To prevent the front panel from being placed into Remote the monitoring must occur via an I/O protocol such as LAN Socket, or the remote program performing the monitoring must explicitly place the instrument into Local after the query has been performed.

Remote Command	:SYSTem:METRics:FPANel?
Example	:SYST:METR:FPAN?
Notes	The return value is a string with the format "YYYY-MM-DD<space>HH:MM:SS", in instrument local time If no front panel activity has occurred since the instrument was booted (instrument application started), the return value will be the time the instrument application started. The instrument application start time can be obtained with the query :SYSTem:METRics:STIME?

4.11.6 SCPI activity history (Remote Query only)

Instrument remote operation usage via SCPI can be monitored using `:SYSTem:METRics:SCPI?`. The monitoring occurs for SCPI control from any I/O channel (GPIB, USB, or LAN). The information of the usage pertains to the activity since the instrument application was started; the information does not persist after the application is terminated, or the instrument has been rebooted.

Remote Command	<code>:SYSTem:METRics:SCPI?</code>
Example	<code>:SYST:METR:SCPI?</code>
Notes	<p>The return value is a string with the format “YYYY-MM-DD<space>HH:MM:SS”, in instrument local time</p> <p>The following commands are excluded from the history accounting:</p> <ul style="list-style-type: none"> - <code>*IDN?</code> - <code>*OPT?</code> - <code>:SYSTem:DATE?</code> - <code>:SYSTem:TIME?</code> - <code>:SYSTem:PON:TIME?</code> - Queries in the <code>:SYSTem:ERRor</code> subsystem - Queries in the <code>:SYSTem:LKEY</code> subsystem - Queries in the <code>:SYSTem:METRics</code> subsystem - Queries in the <code>:SYSTem:MODUle</code> subsystem <p>If no SCPI activity has occurred since the instrument was booted (instrument application started), the return value will be the time the instrument application started. The instrument application start time can be obtained with <code>:SYSTem:METRics:STIME?</code></p>

4.11.7 Instrument start time (Remote Query only)

To determine if instrument activity has occurred, `:SYSTem:METRics:STIME?` can be used to determine the instrument application start time.

Remote Command	<code>:SYSTem:METRics:STIME?</code>
Example	<code>:SYST:METR:STIM?</code>
Notes	<p>The return value is a string with the format “YYYY-MM-DD<space>HH:MM:SS”, in instrument local time</p>

4.11.8 SCPI Version Query (Remote Query Only)

Returns the SCPI version number with which the instrument complies. The SCPI industry standard changes regularly. This command indicates the version used when the instrument SCPI commands were defined.

Remote Command	:SYSTem:VERSion?
Example	:SYST:VERS?

4.11.9 Date (Remote Command Only)

The recommended access to the Date, Time, and Time zone of the instrument is through the Windows native control (Control Panel, or accessing the Task Bar). You may also access this information remotely, as shown in here and in "[Time \(Remote Command Only\)](#)" on page 994.

Sets or queries the date in the instrument.

Remote Command	:SYSTem:DATE "<year>,<month>,<day>" :SYSTem:DATE?
Example	:SYST:DATE "2006,05,26"
Notes	<year> is the four-digit representation of year (for example, 2006) <month> is the two-digit representation of year (01 to 12) <day> is the two-digit representation of day (01 to 28, 29, 30, or 31, depending on the month and year) Unless the current account has Power User or Administrator privileges, sending this command generates an error, and no action is taken

4.11.10 Time (Remote Command Only)

Sets or queries the time in the instrument.

Remote Command	:SYSTem:TIME "<hour>,<minute>,<second>" :SYSTem:TIME?
Example	:SYST:TIME "13,05,26"
Notes	<hour> is the two-digit representation of the hour in 24-hour format <minute> is the two-digit representation of minute <second> is the two-digit representation of second Unless the current account has Power User or Administrator privileges, sending this command generates an error, and no action is taken

4.11.11 Input Overload Enable (Remote Command Only)

Input Overload errors are reported using the Input Overload status bit (bit 12 in the Measurement Integrity Status Register). Input Overloads (for example, ADC Overload errors) can come and go with great frequency, generating many error events (for example, for signals just on the verge of overload), and so are not put into the SCPI error queue by default. Normally the status bit is the only way for detecting these errors remotely.

Use this command to enable or disable Input Overload reporting to the SCPI queue. By default, reporting is disabled. Send `:SYSTem:ERRor:OVERload ON` to enable, or `:SYSTem:ERRor:OVERload OFF` to disable. In either case, Input Overloads *always* set the status bit.

NOTE

For versions of firmware before A.10.01, Input Overload was only a Warning and so was never available in the SCPI queue, although it did set the status bit. For A.10.01 and later, Input Overload is an error, which can be enabled to the SCPI queue using this command.

Remote Command	<code>:SYSTem:ERRor:OVERload[:STATe] 0 1 OFF ON</code>
Example	Enable overload errors: <code>:SYST:ERR:OVER 1</code>
Preset	Set to OFF by Restore Misc Defaults (no Overload errors go to SCPI)
State Saved	Saved in instrument state

4.11.12 Power Up (Remote Query Only)

Returns a list of errors encountered during the application boot-up, such as: mismatch FW-FPGA, missing Calibration data, missing hardware, and construction errors.

Remote Command	<code>:SYSTem:ERRor:PUP?</code>
Notes	If no error occurs, the return value is: "No Power Up Errors" Return Value: <code><List of error strings></code> in <code><IEEE488 Block></code> format Return Value Example: "Power up errors, see details in Windows Event Log" "Unmatched FPGA Version(s), See details in Windows Event Log"

5 Preset

The Preset functions can be accessed in two ways:

- By pressing the **Mode Preset** or **User Preset** front panel keys:



- From the menu "**Preset Dropdown**" on page 999, which appears when you press the green **Preset** icon (in the upper right corner of the display):



Types of Preset

The table below shows all possible presets, their corresponding SCPI commands and front-panel access methods.

Instrument settings are tiered in scope from those local to the current measurement to those global to all measurements and Modes. There are presets tailored to each scope. The table identifies the scope of each preset type.

NOTE

To get a Mode back to a fully predefined state, you should execute a **Restore Mode Defaults** and an **Input/Output Preset**, but since **Input/Output Preset** is a global function it will affect ALL modes.

Type Of Preset	SCPI Command	Scope of Preset	Front Panel Access
"Auto Couple" on page 787	:COUPle ALL	Local to the current measurement, only affects Auto/Man variables	Meas Setup menu
Meas Preset	:CONFigure:<meas>	Local to the current measurement Does not preset the RF Source	Meas Setup menu
"Mode Preset" on page 1000	:SYSTem:PRESet	Local to the current Mode, global to all measurements in the Mode, affects most but not all parameters in the Mode Does not affect Input/Output or System variables Presets the RF Source	Mode Preset key " Preset Dropdown " on page 999
"Restore Mode	:INSTrument:DEFau1t	Local to the current Mode, global to	"Preset

Type Of Preset	SCPI Command	Scope of Preset	Front Panel Access
Defaults" on page 1002		all measurements in the Mode, affects all parameters in the Mode, but does not affect Input/Output or System variables Does not preset the RF Source.	Dropdown" on page 999
"Restore Defaults All Modes" on page 1009	:SYSTem:DEFault MODEs	Affects all parameters in <i>all</i> Modes, but does not affect Input/Output or System variables Presets the RF Source	"Preset Dropdown" on page 999
"Restore Screen Defaults" on page 1012	:SYSTem:DEFault SCReen	Deletes all Screens but one, restores that screen to its default mode and performs Mode Preset for that mode Does not affect Input/Output or System variables Presets the RF Source	"Preset Dropdown" on page 999
"User Preset" on page 1005	:SYSTem:PRESet:USER	Local to the current Mode, global to all measurements in the Mode, affects all parameters in the Mode, as well as Input/Output variables Does not affect System variables	User Preset key "Preset Dropdown" on page 999
"User Preset All Modes" on page 1008	:SYSTem:PRESet:USER:ALL	Same as User Preset , but affects all Modes in the current Screen	"Preset Dropdown" on page 999
"User Preset All Screens" on page 1010		Affects the entire Screen Configuration; global to all Modes and Screens	"Preset Dropdown" on page 999
*RST	*RST	Same as Mode Preset . Additionally always sets Single/Cont to Single	Not available from front panel
"Input/Output Preset" on page 1003	:SYSTem:DEFault INPut	Affects all Input/Output variables Does not preset the RF Source	Input/Output menu "Preset Dropdown" on page 999 System > Restore Defaults
"Full Mode Preset" on page 1004	:SYSTem:PRESet:FULL	Same as Mode Preset + Restore Mode Defaults + Input/Output Preset . Essentially a factory preset of the current Mode Presets the RF Source	"Preset Dropdown" on page 999
"Restore User	:SYSTem:DEFault UINTErface	Affects all variables in the "User	System > Restore

Type Of Preset	SCPI Command	Scope of Preset	Front Panel Access
Interface Defaults" on page 879		Interface" group Does not preset the RF Source	Defaults User Interface tabs
"Restore Power On Defaults" on page 888	<code>:SYSTem:DEFault PON</code>	Affects all variables in the "Power On" group Presets the RF Source	System > Restore Defaults Power On tabs
"Restore Alignment Defaults" on page 965	<code>:SYSTem:DEFault ALIGn</code>	Affects all variables in the "Alignments" group Presets the RF Source	System > Restore Defaults Alignments tabs
"Restore Defaults" on page 894 (Misc)	<code>:SYSTem:DEFault MISC</code>	Affects various variables not reset by other commands Presets the RF Source	System > Restore Defaults
"Restore Defaults" on page 894 (All)	<code>:SYSTem:DEFault [ALL]</code> <code>:SYSTem:PRESet:PERsistent</code>	Affects all variables Presets the RF Source	System > Restore Defaults

5.1 Preset Dropdown

The Preset dropdown contains the following controls. In the image below, click a control for details of that control.

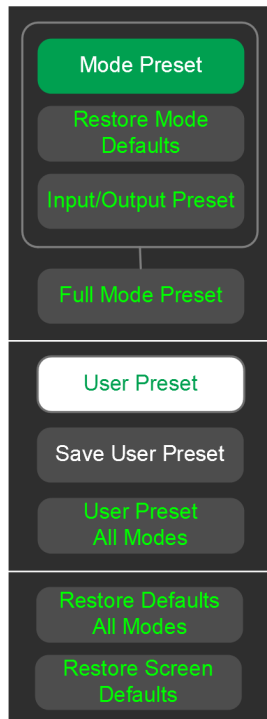

5.2 Mode Preset

Returns the current Mode to a known state. **Mode Preset** only presets the current Screen; it does not affect any other Screens.

Mode Preset also presets the RF Source. In this sense, it is equivalent to pressing **Source Preset** on the **Input/Output, RF Source** menu panel.

Mode Preset can be executed from the "**Preset Dropdown**" on page 999, or by pressing the **Mode Preset** front panel key:



It does the following for the currently active Mode:

- Aborts the currently running measurement
- Switches to the default measurement and displays the default menu for that measurement
- Sets most parameters for the Mode and all its Measurements to a preset state
- Clears the input and output buffers
- Sets Status Byte to 0

Mode Preset does *not* cause a Mode switch, nor affect any **Input/Output** or **System** settings (those set in the **System Settings** dialog).

Furthermore, some Mode settings are unaffected by **Mode Preset** (for example, Noise Floor Extensions, Limit Line data, reference marker numbers, etc.) These are only reset by "**Restore Mode Defaults**" on page 1002. In each parameter's definition table there is a note that indicates whether it is reset by **Mode Preset** or by **Restore Mode Defaults**.

See "**Preset**" on page 996 for more details.

Remote Command	:SYSTem:PRESet
Example	:SYST:PRES
Notes	*RST is preferred over :SYST:PRES for remote operation. *RST performs Mode Preset , as done by the :SYST:PRES command, and sets the measurement mode to Single measurement rather than Continuous , for optimal remote control throughput See also " *RST - Reset " on page 1483
Status Bits/OPC dependencies	Clears all pending OPC bits. The Status Byte is set to 0

5 Preset

5.2 Mode Preset

Backwards Compatibility Notes

In X-Series, the legacy “Factory Preset” has been replaced by **Mode Preset**, which only presets the currently active Mode, not the entire instrument. In X-Series, you preset the entire instrument by using **System, Restore System Defaults All**, which behaves essentially the same way as restore System Defaults did in ESA and PSA

There is also no “Preset Type” as there was in PSA. The green **Mode Preset** front-panel key does a Mode Preset, and the **User Preset** front-panel key does a User Preset. The old **PRESet:TYPE** command is ignored (without generating an error), and **SYST:PRES** without a parameter does **Mode Preset**

The settings and correction data under the **Input/Output** front-panel key (examples: Input Z Corr, Ext Amp Gain, etc.) are no longer part of any Mode, so they are not preset by **Mode Preset**. They are preset by **Restore Input/Output Defaults, Restore System Defaults All**. Note that because “**User Preset**” on [page 1005](#) performs Recall State, and all these settings are saved in State, they *are* recalled when using **User Preset**

5.3 Restore Mode Defaults

Most settings within a Mode are affected by "[Mode Preset](#)" on page 1000, but some Mode settings are unaffected (for example, Noise Floor Extensions, Limit Line data, reference marker numbers, etc.) **Restore Mode Defaults** resets all these additional settings, as well as all the **Mode Preset** settings, *except* the RF Source.

In each parameter's definition table, there is a note that indicates whether that parameter is reset by **Mode Preset** or by **Restore Mode Defaults**.

Note that a Recall State affects all a Mode's settings, both the **Mode Preset** settings and the ones additionally affected by **Restore Mode Defaults**.

Restore Mode Defaults can be executed from the "[Preset Dropdown](#)" on page 999.

When **Restore Mode Defaults** is selected, a message appears saying

*This will reset all of the current Mode's variables to their default state.
This action cannot be undone. Do you want to proceed?*

The message provides **OK** and **Cancel** buttons, to let you confirm or cancel the reset operation.

Remote Command	<code>:INSTRUMENT:DEFAULT</code>
Example	<code>:INST:DEF</code>
Notes	Clears all pending OPC bits. The Status Byte is set to 0
Couplings	Causes the currently running measurement to be aborted, and causes the default measurement to be active. Sets the Mode to a consistent state, with all default couplings set

5.4 Input/Output Preset

Resets the group of settings and data associated with the **Input/Output** front-panel key to their default values. These settings are not affected by "**Mode Preset**" on page 1000, because they are generally associated with connections to the instrument, which generally should remain unaltered.

All the variables set under the **Input/Output** front panel key are reset by **Input/Output Preset**, including Amplitude Corrections and Data (described in the **Corrections** section), with the exception of **RF Source** settings, which are unaffected.

By using **Input/Output Preset** and "**Restore Mode Defaults**" on page 1002, a full preset of the current Mode can be performed, with the caveat that, since **Input/Output Preset** is a global function, it affects *all* Modes.

Input/Output Preset can be executed from the **Input/Output** menu, from the "**Preset Dropdown**" on page 999, or from the **Restore Defaults** menu under the **System** key.

When **Input/Output Preset** is selected, a message appears saying:

"This will reset all of the Input/Output variables to their default state, including which input is selected, all Amplitude Correction settings and data, all External Mixing settings, all Frequency Reference settings and all Output settings.

It will not affect Alignment data or settings.

It will not affect RF Source settings.

This action cannot be undone. Do you want to proceed?"

The message provides **OK** and **Cancel** buttons, to let you confirm or cancel the operation.

Example

```
:SYST:DEF INP
```

Presets all **Input/Output** variables to their factory default values

5.5 Full Mode Preset

Same as performing "Mode Preset" on page 1000, "Restore Mode Defaults" on page 1002, and "Input/Output Preset" on page 1003. Essentially a factory preset of the current Mode.

When **Full Mode Preset** is selected, a message appears saying:

This will reset all of the current Mode's variables and all of the Input/Output variables to their default state, including Input and Output selection and settings, Amplitude Correction, Frequency Reference and RF Source settings.

It will not affect Alignment data or settings.

This action cannot be undone. Do you want to proceed?

The message provides **OK** and **Cancel** buttons, to let you confirm or cancel the operation.

Remote Command	:SYSTem:PRESet:FULL
Example	:SYST:PRES:FULL
Status Bits/OPC dependencies	Clears all pending OPC bits. The Status Byte is set to 0

5.6 User Preset

Recalls a state previously saved using ["Save User Preset" on page 1007](#). You can save a **User Preset** state for each Mode, allowing you to define your own favorite state for each Mode and recall it at the touch of a single button.

User Preset can be executed by pressing the **User Preset** front panel key, or from the ["Preset Dropdown" on page 999](#).



Because **User Preset** is actually a Recall State, rather than a predefined Preset, it works a little differently from ["Mode Preset" on page 1000](#), in that it affects all the variables that normally only reset on ["Restore Mode Defaults" on page 1002](#), and it affects the **Input/Output** variables, because both of these are included in State files.

A default **User Preset** file is provided for each Mode, which simply matches the current Mode's state after **Restore Mode Defaults** and ["Input/Output Preset" on page 1003](#) has been performed.

NOTE

In products that run multiple instances of the X-Series Application, all instances use the same location to save User Preset state. So, saving User Preset of one instance will overwrite the Save User Preset of another instance.

Remote Command	<code>:SYSTem:PRESet:USER</code>
Example	<p>Save the User Preset: <code>:SYST:PRES:USER:SAVE</code></p> <p>Recall the User Preset: <code>:SYST:PRES:USER</code></p>
Notes	<p><code>:SYST:PRES:USER:SAVE</code> is used to save the current state as the user preset state</p> <p>If loading a User Preset file from a different instrument, some settings may be limited and/or coupled differently, since the capabilities of the mode may have changed from when the User Preset file was saved</p>
Status Bits/OPC dependencies	Clears all pending OPC bits. The Status Byte is set to 0
Backwards Compatibility Notes	<p>In X-Series A-models, the User Preset key opened a menu that let you select from User Preset, Save User Preset, or User Preset All Modes. In B-models, the User Preset key immediately performs a User Preset, and the menu items are found under the Preset dropdown</p> <p>User Preset actually loads a state, and in legacy analyzers, it was possible to load a state without affecting the trace data, limit lines or correction data. Similarly, it was possible to do a User Preset without affecting the trace data, limit lines or correction data</p>

In X-Series, “state” always includes all of this data; so whenever state is loaded, or **User Preset** is executed, all the traces, limit lines and corrections are affected

In ESA and PSA, **User Preset** affected the entire instrument’s state. In X-Series, **User Preset** only recalls the state for the active Mode. There is a User Preset file for each Mode. **User Preset** can never cause a Mode switch as it could in legacy analyzers. If you want to recall all Modes to their user preset file state, perform User Preset *after* switching into each Mode

User Preset recalls Mode state, which can now include data, such as traces, whereas in ESA and PSA, User Preset did not affect data

5.7 Save User Preset

Saves the state of the currently active Mode in a unique location, for recall by the key "User Preset" on page 1005. Each Mode has one such location, so, for each Mode, one User Preset can be defined.

Save User Preset can be executed from the "Preset Dropdown" on page 999.

All the Mode variables are saved, including those reset by "Mode Preset" on page 1000, those only reset by "Restore Mode Defaults" on page 1002, and all **Input/Output** variables, so when you subsequently press **User Preset**, the instrument returns to the exact same setup that existed when you pressed **Save User Preset**. Thus, **User Preset** has wider scope than **Mode Preset**.

Remote Command	:SYSTem:PRESet:USER:SAVE
Example	:SYST:PRES:USER:SAVE
Notes	:SYST:PRES:SAVE creates the same file as if you requested *SAV or :MMEM:STOR:STAT, except that Save User Preset does not allow you to specify the file name or location

5.8 User Preset All Modes

Recalls all the User Preset files for each Mode, switches to the Power-on Mode, and activates the saved measurement from the Power-on Mode **User Preset** file.

User Preset All Modes can be executed from the "[Preset Dropdown](#)" on page 999

See also "[User Preset](#)" on page 1005.

Remote Command	<code>:SYSTem:PRESet:USER:ALL</code>
Example	<code>:SYST:PRES:USER:SAVE</code> <code>:SYST:PRES:USER:ALL</code>
Notes	<code>:SYST:PRES:USER:SAVE</code> is used to save the current state as the user preset state
Status Bits/OPC dependencies	Clears all pending OPC bits. The Status Byte is set to 0

5.9 Restore Defaults All Modes

Resets all Modes in the current Screen back to their default states, just as **Restore Mode Defaults** does, switches the current Screen to the Power-on Mode, and causes the default measurement for the **Power On Mode** to be active in the current Screen. Only the current Screen is affected.

Restore Defaults All Modes can be executed from the "Preset Dropdown" on page 999.

When **Restore Defaults All Modes** is selected, a message appears saying:

This will reset all of the variables for all of the Modes in the current Screen to their default state. This action cannot be undone. Do you want to proceed?

The message provides **OK** and **Cancel** buttons.

Example	<code>:SYST:DEF MOD</code>
Couplings	Causes the currently running measurement to be aborted, a switch to the Power-on Mode, and activates the default measurement for the Power-on Mode

5.10 User Preset All Screens

Recalls a screen configuration previously saved using "[Save User Preset All Screens](#)" on page 1011. The complete configuration of all Screens is loaded, including the state of each Screen.

Because **User Preset All Screens** performs a Recall State as part of its function, it affects all variables that are normally only reset by "[Restore Mode Defaults](#)" on page 1002, and affects **Input/Output** variables, because both are included in State files.

Note that recalling a screen configuration in this manner wipes out your current screen configuration, and all states of all Screens.

Notes	<p>"Save User Preset All Screens" on page 1011 is used to save the current screen configuration as the "user preset all screens" configuration</p> <p>If loading a User Preset All Screens file from a different instrument, some settings may be limited and/or coupled differently, since the capabilities of the Mode may have changed from when the User Preset All Screens file was saved</p>
Status Bits/OPC dependencies	<p>Clears all pending OPC bits</p> <p>The Status Byte is set to 0</p>

5.11 Save User Preset All Screens

Saves the current Screen Configuration in a unique location, for recall by "[User Preset All Screens](#)" on page 1010.

Save User Preset All Screens can be executed from the "[Preset Dropdown](#)" on page 999.

Besides the screen configuration, *all* Mode variables of all Screens are saved, including those reset by "[Mode Preset](#)" on page 1000, and those only reset by "[Restore Mode Defaults](#)" on page 1002, as well as all **Input/Output** variables, so when you subsequently press **User Preset All Screens**, the instrument returns to the exact Screen setup that existed when you pressed **Save User Preset All Screens**.

Notes Creates the same file as if you requested **Screen Config + State** save, except that **Save User Preset All Screens** does not allow you to specify the file name or location

5.12 Restore Screen Defaults

Resets the Screen configuration to the factory default; deleting all screens, all screen names, all screen states, and setting "Multiscreen" on page 149 to Off. A single screen will remain, set to the Power-on Mode, in a preset state with the default screen name.

Restore Screen Defaults can be executed from the "Preset Dropdown" on page 999.

When **Restore Screen Defaults** is selected, a message appears saying:

This function will delete all defined screens and their settings. This action cannot be undone.

Do you want to proceed?

The message provides **OK** and **Cancel** buttons.

Example

:SYST:DEF SCReen

5.13 Preset Type (Remote Command Only)

Remote Command	<code>:SYSTem:PRESet:TYPE FACTory MODE USER</code> <code>:SYSTem:PRESet:TYPE?</code>
Example	<code>:SYST:PRES:TYPE FACT</code>
Notes	Supported for backwards compatibility only. It is a no-op, which does not change the behavior of any preset operation
Preset	Unaffected by Preset, but set to <code>MODE</code> by <code>Restore System Defaults->All</code>
State Saved	No

5.14 Restart Instrument (Shutdown)

Shuts down the instrument, then reboots it.

Remote Command :SYSTem:PUP

Example :SYST:PUP

5.15 Restart Application (Application Shutdown)

Restarts the instrument application without rebooting the instrument. Before you send this command, make sure you have saved any trace or measurement data that you want to preserve.

Remote Command	<code>:SYSTem:PUP:PROcess</code>
Example	<code>:SYST:PUP:PROC</code> After sending this command, you must wait for the instrument software to restart
Notes	You cannot use <code>*WAI</code> or <code>*OPC?</code> to synchronize operation after a restart. This command stops and restarts the instrument application, so the SCPI operation is terminated and restarted A remote program must wait a fixed time before resuming sending commands to the instrument. The appropriate wait time depends on which applications are pre-loaded

5.16 System Log Off (Remote Command Only)

Provides a means to terminate all open Windows applications, and log off the current user. This is equivalent to performing the Windows command:

```
shutdown -l -f -t0
```

Remote Command	:SYSTem:LOFF
Example	:SYST:LOFF
Notes	Initiates an immediate log off of the current user. Exits the instrument application, so any unsaved measurement results will be lost. You cannot use *WAI or *OPC? to synchronize operation. In addition to the instrument application, all other Windows programs will be terminated, without the opportunity to save any work in progress. To perform a subsequent login, and regain instrument operation, human intervention will be required

5.17 Power Standby (Instrument Shutdown)

Pressing the power switch powers down the instrument. You are warned that shutting down will cause the application to lose unsaved data, and the instrument lets you respond to this warning before shutting down.

The command below has the same effect, except that you can specify Normal mode (**NORMa1**) or Forced mode(**FORCe**):

- In **NORMa1** mode, the system waits until you respond to the warning prompt
- In **FORCe** mode, the system shuts down after 20 seconds, and all data will be lost

If the instrument is not properly shut down prior to removal of line power, the system will validate the Journaling File System and the Power-On Last State (if the instrument is in Power-On Last State) during the following power-on. If a problem is detected, a message appears indicating that the system 'recovered' from an inappropriate shutdown. This is only an issue if **Power-On Type** is Last State. If the Last State is not valid, the instrument will power up in the last active Mode, but will perform "**Mode Preset**" on page 1000.

Remote Command	:SYSTem:PDOWn [NORMa1 FORCe]
Example	:SYST:PDOW Executes a normal shutdown
Notes	If no parameter is sent, NORMa1 is assumed

6 Input/Output

Accesses menus that let you control the Input/Output parameters of the instrument. In general, these are functions associated with external connections to the instrument, either to the inputs or the outputs.

Input/output connections tend to be based on situation-specific hardware set up. For that reason, input/output settings do *not*, in general, change when you perform a Mode Preset. You can revert to the default values in one of three ways:

- Use **Restore Input/Output Defaults**, in the **Input/Output** menu
- Use **System->Restore System Defaults->Input/Output Settings**
- Use **System -> Restore System Defaults->All**

The settings survive a Preset and a Power cycle.

A few Input/Output settings *do* respond to Mode Preset. For example, if the Calibrator is on, **Preset** turns it off, and if DC coupling is in effect, **Preset** switches it to AC. These exceptions are noted in the SCPI tables for the excepted functions.

Input/Output features are common across multiple Modes and Measurements. In general, they do not change when you change Mode or Measurement, although some controls appear only in certain measurements.

6.1 RF Source

Lets you control and configure the internal RF Source. This tab only appears in models that support a built-in independent RF Source, which include E7760B, and modular products such as EXM and VXT.

External Source Control and built-in Tracking Sources are controlled using the **Source** tab in **Meas Setup**.

Dependencies	Only appears in models that support a built-in independent RF Source, such as E7760B, EXM and VXT
--------------	---

6.1.1 RF Output

Sets the source RF power output state.

Remote Command	<code>:OUTPut[:EXTernal][:STATe] ON OFF 1 0</code> <code>:OUTPut[:EXTernal][:STATe]?</code>
Example	<code>:OUTP OFF</code> <code>:OUTP?</code>
Notes	This setting is for the independent mode and has no effect on the " List Sequencer " on page 1029. If Sequencer is ON , the List Sequencer controls the source output, and this key is grayed-out When Sequencer is OFF , makes source leave List Sequencer and this setting is blanked out, taking effect immediately
Dependencies	For E7760B, the RF Output cannot be set to ON if the RF Output port is set to NONE . If you attempt to set RF Output to ON in this situation, the error message -221, "Settings conflict; Source Output is not available while Output Port is None" is displayed <code>:OUTPut:EXTernal[:STATe]</code> is supported only when Option ESC is installed. Otherwise, only <code>:OUTPut[:STATe]</code> is supported
Preset	OFF
Range	ON OFF

6.1.2 RF Output Port

Specifies the RF Output Port used by the internal source.

Switching from the RF Output port to one of the RFIO ports changes the transmitter performance of the instrument.

The **NONE** selection is available to allow setting a half-duplex port to an Input, if it was previously assigned as an Output. Set the Output to **NONE** first, then any port can be assigned as an Input.

When using VXT M9410A/11A/15A/16A with Remote Radio Heads (such as the Keysight M1740A mmWave Transceiver for 5G), the choices in the dropdown menu appear as:

Head h RFHD p

For example, if you have two Radio Heads (numbered 1 and 2), each of which have two RF half-duplex ports, the choices for these ports will appear as below:

Head and Port	Choice in dropdown	SCPI parameter
Head 1, port RF Tx/Rx 1	Head 1 RFHD 1	RRH1RFHD1
Head 1, port RF Tx/Rx 2	Head 1 RFHD 2	RRH1RFHD2
Head 2, port RF Tx/Rx 1	Head 2 RFHD 1	RRH2RFHD1
Head 2, port RF Tx/Rx 2	Head 2 RFHD 2	RRH2RFHD2

When using the E7770A Common Interface Unit, outputs may come from the DUT IF OUT ports on the rear of the CIU or the half-duplex ports on the front of the CIU labeled DUT IF In/Out. You would select GUI parameter IF Out n or SCPI parameter IFOutn for the DUT IF OUT ports or GUI parameter IFHD n or SCPI parameter IFHDn for the DUT IF In/Out ports. See ["RF Input Port" on page 1133](#) "Parameters for VXT M9410A/11A/15A/16A and EXM when used with Radio Heads/CIU" for more details.

Remote Command `[:SENSe]:FEED:RF:PORT:OUTPut RFOut | RFIO1 | RFIO2 | RFIO3 | RFIO4 | RFHD | RFFD | A1 | A2 | A3 | B1 | B2 | B3 | IFIO1 | IFIO2 | GEN | TR | RRHhRFHDp | IFOutn | IFHDn | NONE`

For details of each option, see ["Port Options" on page 1021](#)

`[:SENSe]:FEED:RF:PORT:OUTPut?`

Example

Set output to RF Output:

`:FEED:RF:PORT:OUTP RFO`

Set output to Radio Head 1, RF Tx/Rx Port 2:

`:FEED:RF:PORT:OUTP RRH1RFHD2`

Dependencies

Only appears in models that support multiple output ports. If the SCPI command is sent with unsupported parameters in any other model, an error is generated, -221, "Settings conflict; option not installed"

RFHD and **RFFD** are only available on VXT. Option HDX is required to enable RFHD port. Option FDX is required to enable RFFD port

For E7760B: Ports IFIO1 and IFIO2 are available if Option RF2 is installed. Ports A1, A2, A3, B1, B2, B3 are available if Option RF3 is installed. Attempting to select a port for which the option is not present generates the error, -241, "Hardware missing; Output not available"

A port cannot be selected as an Output while it is occupied as an Input. If the SCPI command is sent while the port is occupied, an error is generated, -221, "Settings conflict; Output Port is not available while occupied by Input"

Additionally, the mmWave ports are divided into two banks: the A Bank and the B Bank. A port cannot be selected as an Output if any port on the *same* bank is occupied as an Input. If the SCPI command is sent for this situation, an error is generated, -221 "Settings conflict; Output Port is not available while

6 Input/Output

6.1 RF Source

	<p>port bank is occupied by Input”</p> <p>Lastly, if RF3 is present, and RF4 is absent, a mmWave port cannot be selected as an Output if the Input Port is occupied by wwWave Transceiver with a different frequency range. If the SCPI command is sent for this situation an error is generated, -221 “Settings conflict; Output Port is not available while occupied by Input of incompatible frequency”</p> <p>Ports GEN and TR are only available in modular analyzers, and only when the M9470A module is installed, such as in M8920A. Option HDX is required to enable the T/R port</p> <p>When any output is selected in a measurement that does not support it, the "No result; Meas invalid with this output" error condition occurs, and the measurement returns invalid data when queried</p>
Preset	Unaffected by Mode Preset , but set to default by Source Preset or Restore System Defaults -> All
State Saved	Saved in State
Backwards Compatibility SCPI	<p>:FEED:RF:PORT:OUTPut IFIO1</p> <p>IFIO1 is treated as IF01 and sets the IF output to be the port labeled DUT IF Out on the CIU rear panel. This is for compatibility with earlier implementations on EXM and VXT when using the E7770A Common Interface Unit</p>

Port Options

Value	Notes
RF Output RFOut	<p>On EXM with hardware M9430A, if RF Output is selected as RF Output Port, use the settings in the Half Duplex Config menu to determine which port (RFIO3 or RFIO4) will be used</p> <p>On EXM with hardware M9431A, this setting is not supported. If the SCPI command is sent with this setting, an error is generated, -221, “Settings conflict; option not installed”</p>
RFHD	<p>RFHD port is exclusive for RF Input and RF Output. If HD Port is chosen as RF Input port, pressing this key, or sending SCPI to set it, generates error message: “-221, Settings conflict; RFHD is being used as RF Input Port”</p> <p>Option HDX is required to enable RFHD port</p>
RFFD	Option FDX is required to enable RFFD port
GEN	Selects the Gen port on M8920A/20B
T/R TR	Selects the T/R port on M8920A/20B
RRHhRFHDp	<p>Used to select a port on a Radio Head (such as the Keysight M1740A mmWave Transceiver) as an output</p> <p>RRHhRFHDp corresponds to Head h, port RF Tx/Rx p. For example, RRH1RFHD2 = the port labeled RF Tx/Rx 2 on Head 1</p>

6.1.3 Half Duplex Output Port

Specifies whether **RFIO3** or **RFIO4** is the Half Duplex Output port.

Remote Command	[:SENSE]:HDUPlex:PORT:OUTPut RFIO3 RFIO4
----------------	--

Example	<code>:HDUPlex:PORT:OUTPut RFI03</code> <code>:HDUPlex:PORT:OUTPut?</code>
Dependencies	Only appears in EXM If RFI03 is selected as “Half Duplex Input Port”, then “Half Duplex Output Port” will be set to RFI04 automatically If RFI04 is selected as “Half Duplex Input Port”, then “Half Duplex Output Port” will be set to RFI03 automatically
Preset	RFI04
State Saved	Saved in State

6.1.4 RF Power

Lets you control the amplitude of the Source output. Same as "RF Power" on page 1022 in **Amplitude Setup**.

Example	<code>:SOUR:POW -100 dBm</code>
---------	---------------------------------

6.1.5 T/R Port High Power Attenuator

Controls whether additional attenuation is added at the T/R Port. The T/R port has two output paths, one that provides a 16 dB attenuator, another that bypasses this attenuator. When this control is **ON**, the path includes the 16 dB attenuator, so the maximum output level for this path is 0 dBm. When this control is **OFF**, the 16 dB attenuator is bypassed, so the maximum output level for this path is +5 dBm.

Example	<code>:FEED:RF:PORT:TR:HPOW:ATT ON</code>
---------	---

6.1.6 Amplitude Setup

Lets you access the **Amplitude Setup** panel.

Notes	This menu under this control is for independent mode, and has no effect on "List Sequencer" on page 1029. If "Sequencer" on page 1030 is ON , the List Sequencer controls the source output, and this control is grayed-out on the front panel, to indicate out-of-scope. When you set "Sequencer" on page 1030 to OFF , makes source leave List Sequencer and this control is blanked out
-------	--

6.1.6.1 RF Power

Lets you adjust the power level of the source using the numeric keypad, step keys, or RPG. Pressing any digit, 0 through 9 on the numeric keypad displays the unit terminator.

6 Input/Output
6.1 RF Source

Please refer to the "[RF Power Range](#)" on page 1023 table below for the valid ranges.

Remote Command	<code>:SOURce:POWer[:LEVel][:IMMediate][:AMPLitude] <ampl></code> <code>:SOURce:POWer[:LEVel][:IMMediate][:AMPLitude]?</code>
Example	<code>:SOUR:POW -100 dBm</code>
Notes	<p>Amplitude corrections can be specified for use with the source. In the event of amplitude corrections being applied, the valid ranges for the RF power do not change dependent on the current amplitude correction setting. If the combination of RF power + amplitude correction is higher or lower than the source output range, the Source Unleveled bit is set, and the "Source Unleveled" indicator will appear on status panel to indicate that the source cannot maintain the output power that has been requested</p> <p>When signal generator is unable to maintain the requested output level, the "Source Unleveled" indicator will appear on status panel. When the source output setting is restored to the normal range, the "Source Unleveled" is removed from status panel</p> <p>Internal source has list sequence mode, which comprises of several steps which contain separate output power, frequency and waveform etc. When the source list sequence playing is complete, the last step keeps playing, and user can use this command to change the list sequence last step's output power</p> <p>For EXT, The multiport adapter RFIO TX ports and GPS ports cannot ensure power accuracy when power setting is lower than -130dBm, this power setting value is defined by the sum of RF Power setting and related amplitude correction value. But user settable value could be lower than this limit. When application detected there exists power setting lower than -130dBm on MPA RFIO TX ports, then popup warning message . When application detected there exists power setting lower than -130dBm on MPA GPS ports, then popup warning message . This is only warning message, and check is performed when RF is ON</p>
Dependencies	The RF power is dependent on the RF output port and frequency, such that the current frequency and selected output port determine the valid range of power values
Couplings	For if AWGN State is ON and ARB State is ON , this setting is adjusted to the value to maintain the AWGN power relationship defined by Power Control Mode and other noise settings
Preset	-100 dBm
Min	The range of values depends on the current frequency and selected RF output port. See " RF Power Range " on page 1023 below for the valid ranges
Max	The range of values depends on the current frequency and selected RF output port. Refer to " RF Power Range " on page 1023 below for the valid ranges

RF Power Range

RF Output Port	Frequency Range	Min Output Power	Max Output Power
High Power RF Out	10 MHz ≤ f ≤ 6 GHz	-150 dBm	20 dBm
RFIO 1 & RFIO 2	10 MHz ≤ f ≤ 6 GHz	-150 dBm	0 dBm

Note: This is the UI power range, which is larger than the actual specification.

VXT model M9420A

RF Output Port	Frequency Range	Min Output Power	Max Output Power without Option "1EA"	Max Output Power with Option "1EA"
RF Output	60 MHz \leq f \leq 6 GHz	-150 dBm	10 dBm	25 dBm
RFHD	60 MHz \leq f \leq 6 GHz	-150 dBm	10 dBm	15 dBm
RFFD	60 MHz \leq f \leq 6 GHz	-150 dBm	0 dBm	0 dBm

Note 1: This is the UI power range, which is larger than the actual specification.

Note 2: Max output power with Option 1EA can be set to 25 dBm, but Meas Uncal (measurement uncalibrated) warning is given in the Status Bar in the lower right corner of the screen when output power set higher than 20 dBm.

VXT models M9410A/11A

Ports	Option LFE	Frequency Range	Min Output Power	Max Output Power without option "1EA"	Max Output Power with "1EA"
RF Output	With Option LFE	1 MHz \leq f \leq 60 MHz	-150 dBm	5 dBm	5 dBm
		60 MHz \leq f \leq 380MHz	-150 dBm	5 dBm	25 dBm
	Without Option LFE	380 MHz \leq f \leq 6 GHz	-150 dBm	5 dBm	25 dBm
RFHD		1 MHz \leq f \leq 6 GHz	-150 dBm	5 dBm	5 dBm

Note 1: Min Output Power is the UI power range, which is smaller than the actual specification.

Note 2: Max output power with Option 1EA can be set to 25 dBm for RF Output Port, but Meas Uncal (measurement uncalibrated) warning is given in the Status Bar in the lower right corner of the screen when the output power is set higher than 20 dBm.

Note 3: Option LFE provides Low Frequency Extension, which covers frequency from 1 MHz to 380 MHz.

VXT models M9415A/16A

RF Output Port	Frequency Range	Min Output Power	Max Output Power without Option "1EA"	Max Output Power with Option "1EA"
RF Output	$380 \text{ MHz} \leq f \leq 12.3 \text{ GHz}$	-150 dBm	5 dBm	25 dBm
RFHD	$380 \text{ MHz} \leq f \leq 12.3 \text{ GHz}$	-150 dBm	5 dBm	18 dBm

Note 1: For RF output port, the Max output power with Option 1EA can be set to 25 dBm for RF Output Port, but Meas Uncal (measurement uncalibrated) warning is given in the Status Bar in the lower right corner of the screen when the output power is set higher than 20 dBm.

Note 2: For RFHD port, the Max output power with Option 1EA can be set to 18 dBm for RF Output Port, but Meas Uncal (measurement uncalibrated) warning is given in the Status Bar in the lower right corner of the screen when the output power is set higher than 15 dBm.

M9410E/11E/15E/16E

Ports	Option LFE	Frequency Range	Min Output Power	Max Output Power
RF Output	With Option LFE	$1 \text{ MHz} \leq f \leq 380 \text{ MHz}$	-150 dBm	13 dBm
		$380 \text{ MHz} \leq f \leq 25.9 \text{ GHz}$	-150 dBm	25 dBm
	Without Option LFE	$380 \text{ MHz} \leq f \leq 25.9 \text{ GHz}$	-150 dBm	25 dBm
RFHD		$1 \text{ MHz} \leq f \leq 25.9 \text{ GHz}$	-150 dBm	5 dBm

VXT Models with Remote Radio Heads/CIU

RRH	Port	Frequency Range	Min Output Power	Max Output Power
M1742A	Head h RFHD p	$10 \text{ GHz} \leq f \leq 32 \text{ GHz}$	-150 dBm	10 dBm

M8920A/20B

RF Output Port	Frequency Range	Min Output Power	Max Output Power
Gen	100 kHz ≤ f ≤ 6 GHz	-150 dBm	without option 1EA: 3 dBm with option 1EA: 15 dBm
T/R	100 kHz ≤ f ≤ 6 GHz	-150 dBm	T/R port high power attenuator On: -15 dBm T/R port high power attenuator Off: 3 dBm

Note: This is the UI power range, which is larger than the actual specification.

6.1.6.2 Set Reference Power

Turns the power reference state to **ON**, sets the reference power value to the current RF output power, maintains this power at the RF output, and sets the displayed power to 0.00 dB. All subsequent RF power values entered under **Source**, **Amplitude**, **RF Power** are interpreted as being relative to this reference power.

When you use a power reference, the signal generator outputs an RF power that is set relative to the reference power by the value entered under **Source**, **Amplitude**, **RF Power** as follows:

Output power = reference power – entered power

Where:

- reference power equals the original RF Power entered under **Source>Amplitude>RF Power** and set as the reference power
- entered power equals a new value entered under **Source>Amplitude>Amptd Offset**

In addition, the displayed power value is the same as a new value entered under **Source**, **Amplitude**, **RF Power**.

NOTE

If Power Ref is **ON** with a reference value set, entering a value under **Source**, **Amplitude**, **RF Power** and pressing **Set Reference Power** adds that value to the existing Power Ref value.

If you wish to change the reference power value to a new value entered under **Source**, **Amplitude**, **RF Power**, first set Power Ref to **OFF**, then press **Set Reference Power**.

Dependencies Unavailable, and grayed-out, when "List Sequencer" on page 1029 is **ON**

6.1.6.3 Power Ref

Lets you toggle the state of the power reference. When you use a power reference, the signal generator outputs an RF power that is set relative to the reference power by the value entered under **Source>Amplitude>RF Power** as follows:

Output power = reference power + entered power

Where:

- reference power equals the original RF Power entered under **Source>Amplitude>RF Power** and set as the reference power
- entered power equals a new value entered under **Source>Amplitude>Amptd Offset**

For more information on Reference Frequency, see "[Set Reference Power](#)" on page 1026.

Remote Command	<code>:SOURce:POWer:REFerence <ampl></code> <code>:SOURce:POWer:REFerence?</code>
Example	<code>:SOUR:POW:REF 0.00 dBm</code>
Dependencies	Unavailable and grayed-out when " List Sequencer " on page 1029 is ON
Couplings	Coupled to " Set Reference Power " on page 1026, such that pressing Set Reference Power updates the reference power with the current output power
Preset	0.00 dBm
Min	-125.00 dBm
Max	10.00 dBm
Auto Function	

Remote Command	<code>:SOURce:POWer:REFerence:STATe OFF ON 0 1</code> <code>:SOURce:POWer:REFerence:STATe?</code>
Example	<code>:SOUR:POW:REF:STATe ON</code>
Preset	OFF

6.1.6.4 Power Unit

Modifies the units for RF Power and Power Ref. The change is immediate and does not force a restart.

Remote Command	<code>:SOURce:POWer[:LEVel][:IMMediate][:AMPLitude]:UNIT DBM W V DBUV</code> <code>:SOURce:POWer[:LEVel][:IMMediate][:AMPLitude]:UNIT?</code>
Example	Set the RF Power units to volts:

	<code>:SOUR:POW:UNIT V</code>
Couplings	RF Power and Power Ref units are modified by Power Unit
Preset	dBm
State Saved	Saved in Instrument State

6.1.6.5 Amptd Offset

Lets you specify the RF output power offset value.

When the amplitude offset is set to zero (0) and you set a new offset value (positive or negative), the displayed amplitude value changes as follows, and the RF output power does not change:

Displayed value = output power + offset value

Where:

- output power equals the original RF Power entered under **Source, Amplitude, RF Power**
- offset value equals the value entered under **Source, Amplitude, Amptd Offset**

When the amplitude offset is set to a value other than zero (0) and you enter a new RF power value under **Source, Amplitude, RF Power**, the displayed power will be the same as the value entered and the RF output power will be equal to the value entered minus the offset value as follows:

Output power = entered power – offset power

Displayed Power = output power + offset power

Displayed power = entered power

Where:

- entered power equals the amplitude entered under **Source, Amplitude, RF Power**
- offset power equals the value previously entered and set under **Source, Amplitude, Amptd Offset**

Remote Command	<code>:SOURce:POWer[:LEVel][:IMMEDIATE]:OFFSet <rel_amp1></code> <code>:SOURce:POWer[:LEVel][:IMMEDIATE]:OFFSet?</code>
Example	<code>:SOUR:POW:OFFS 0.00 dB</code>
Notes	The amplitude Offset unit follows the units set in Power Unit
Dependencies	Unavailable, and grayed-out, when List Sequencer is ON
Preset	0.00 dB

6 Input/Output

6.1 RF Source

Min	-200.00 dB
Max	200.00 dB

6.1.6.6 Amplitude Increment

Changes the step size for the RF Power function. Once an increment size has been selected and the RF Amplitude function is active, the step keys (and the **UP | DOWN** parameters for RF Power from remote commands) change the RF Power by the set value. This feature exists in EXG and MXG.

Remote Command	<code>:SOURce:POWer:STEP[:INCRement] <amp1></code> <code>:SOURce:POWer:STEP[:INCRement]?</code>
Example	<code>:SOUR:POW:STEP 1</code>
Notes	The Amplitude Increment unit follows the units set in Power Unit
Couplings	Coupled to the Step size of the RF Power function
Preset	1 dB
Min	0.1 dB
Max	10 dB

6.1.7 Frequency

Lets you control the frequency of the Source. Same as "[Frequency](#)" on page 1054 under "[Frequency Setup](#)" on page 1054.

Example	<code>:SOUR:FREQ 1.00 GHz</code>
---------	----------------------------------

6.1.8 List Sequencer

Accesses sub-menus for configuring the **List Sequencer**.

List sequences allow you to enter frequencies and amplitudes at unequal intervals in nonlinear ascending, descending or random order. Each step within the list can also include its own waveform file for playback, step duration, trigger event and trigger output.

The complexities involved in configuring the **List Sequencer** do not lend themselves to manual configuration; hence the manual configuration for this feature is limited. For easier configuration of the List Sequencer, it is recommended that you use either SCPI, or load a tab-delimited file containing the setup parameters in a tabular form. The details of the SCPI for configuring the List Sequencer can be found in "[Step Configuration \(Remote Command Only\)](#)" on page 1045.

Once the **List Sequencer** has been configured using the front panel, SCPI, or by loading a tab-delimited file, the sequence must be initiated using the front panel **Initiate Sequence** key, or the corresponding SCPI command.

Dependencies	Not available in E7760B
--------------	-------------------------

6.1.8.1 Sequencer

Sets the state of "[List Sequencer](#)" on page 1029

- When **List Sequencer** is **ON**, the source outputs the sequence defined by the sequencer
- When **List Sequencer** is **OFF**, the source outputs a single waveform segment or sequence (independent mode) at a single frequency and amplitude

Remote Command	<code>:SOURce:LIST[:STATe] ON OFF 1 0</code> <code>:SOURce:LIST[:STATe]?</code>
----------------	--

Example	<code>:SOUR:LIST OFF</code>
---------	-----------------------------

Notes	When the sequencer is ON , the List Sequencer controls the output of the source
-------	--

Dependencies	Not available in E7760B
--------------	-------------------------

Couplings	When in Sequence Analyzer Mode, and the List Sequencer state is OFF , Include Source is forced to NO , and the Include Source key is grayed-out When in Sequence Analyzer Mode, and the List Sequencer state is ON , Include Source is available to set, and an ARB memory related operation such as load or delete will be rejected
-----------	---

Preset	OFF
--------	------------

Range	ON OFF
-------	------------------------

6.1.8.2 Initiate Sequence

Arms the sequence for single execution. Once the sequence is armed, the source begins the sequence as soon as the trigger is received. If trigger is set to **Free Run**, the sequence starts immediately.

Remote Command	<code>:SOURce:LIST:TRIGger[:IMMediate]</code>
----------------	---

Example	<code>:SOUR:LIST:TRIG</code>
---------	------------------------------

Notes	When in Sequence Analyzer Mode, and Include Source is ON , the Initiate List Sequencer operation is rejected, and the key is grayed-out if the file needed by the sequencer is not already in ARB memory, the sequence cannot be initiated, and an error is generated There is a blocking SCPI query that can be used to check whether source list sequence was initiated successfully (see " Remote Software Trigger (Remote command Only) " on page 1054)
-------	--

Dependencies	In Sequence Analyzer Mode, if Meas Setup , Include Source is set to YES , Source , List Sequencer , Initiate Sequence is disabled Not available in E7760B
--------------	--

6.1.8.3 Repetition

Accesses a sub-menu to select the repetition type for the List Sequencer globally. It cannot be changed between different sequence steps.

In **Single**, the Source list plays one time after initiation. In **Continuous**, the Source list plays continuously after initiation.

This setting is available on EXM.

Remote Command	<code>:SOURce:LIST:REPetition:TYPE SINGle CONTInuous</code>
Example	<code>:SOUR:LIST:REP:TYPE SING</code> <code>:SOUR:LIST:REP:TYPE?</code>
Dependencies	Available on EXM Not available in E7760B
Preset	<code>SINGle</code>
Range	<code>SINGle CONTInuous</code>

6.1.8.4 Trig Out Type

Accesses a sub-menu to select the output trigger type for the List Sequencer globally. It cannot be changed between different sequence steps. It sets the output trigger type for the whole source sequence.

Remote Command	<code>:SOURce:LIST:TRIGger:OUTPut:TYPE STEP MARKer</code> <code>:SOURce:LIST:TRIGger:OUTPut:TYPE?</code>
Notes	<code>STEP</code> = Start of Step <code>MARKer</code> = Data Marker
Dependencies	Available on EXM Not available in E7760B
Preset	<code>STEP</code>
Backwards Compatibility SCPI	<code>:SOURce:LIST:TRIGgerout:TYPe BEGInningofstep DATAmarker</code>

6.1.8.5 Select Data Marker

When "Trig Out Type" on page 1031 is set to Data **MARKer**, specifies which marker to route.

Remote Command	<code>:SOURce:LIST:TRIGger:OUTPut:TYPE:MARKer M1 ... M4</code> <code>:SOURce:LIST:TRIGger:OUTPut:TYPE:MARKer?</code>
----------------	---

Backwards Compatibility :SOURce:LIST:TRIGgerout:TYPe:Marker
SCPI

6.1.8.6 Manual Trigger Now

Provides a software trigger event to the List Sequencer. During execution of a sequence, if the sequencer is halted on any step that has been configured with a “Manual” step trigger, then this keypress causes the sequencer to continue and execute the step.

Notes No remote command, front panel only

6.1.8.7 List Sequencer Setup

Accesses the List Sequencer setup menus.

Number of Steps

Lets you specify the number of steps within the list sequence.

Remote Command :SOURce:LIST:NUMBer:STEPs <integer>
:SOURce:LIST:NUMBer:STEPs?

Example :SOUR:LIST:NUMB:STEP 1

Notes Increasing the number of steps creates additional steps at the end of the list, with all the settings within the steps set to their default values
Decreasing the number of steps removes steps from the end of the list. The settings within the removed steps are not reset. This means that increasing the number of steps again would allow you to retrieve these steps

Dependencies The Step Count parameter is increased or decreased when you insert or delete a point from within the GUI interface to the sequencer
Not available in E7760B

Preset 1

Min 1

Max 1000

Go To Step

Lets you select the step number you wish to view or edit.

Preset 1

Min	1
Max	Step Count

Insert Step Before

Inserts a new step, with default values, before the currently selected step. Inserting a step automatically increases the Step Count parameter by 1. If a sequence has already reached the upper limit of 1000 steps, then this operation is rejected, and error -221, "Setting Conflict; Cannot insert more steps, maximum number of steps reached" is displayed.

Notes	If the list already contains the maximum limit (1000 steps), pressing this control has no effect
-------	--

Delete Step

Deletes the current step. Deleting a step automatically decreases the Step Count parameter by 1. If the sequence only has one step left, then this operation is rejected, and error -221, "Setting conflict; Cannot delete current step, minimum number of steps reached" is displayed

Notes	If the list already contains the minimum limit of 1 step, pressing this control has no effect
-------	---

Clear List

Clears the list. Clearing the list sets the number of steps to the default value (1) and sets the parameters for the only step to their default values.

Step Trigger

Lets you select the trigger input for the current step.

Remote Command	<code>:SOURce:LIST:STEP[1] 2 ... 1000:SETup:INPut:TRIGger IMMEDIATE INTERNAL EXTERNAL2 KEY BUS EXTERNAL4</code> For details of options, see " More Information " on page 1034 <code>:SOURce:LIST:STEP[1] 2 ... 1000:SETup:INPut:TRIGger?</code>
Example	<code>:SOUR:LIST:STEP2:SET:INP:TRIG BUS</code> <code>:SOUR:LIST:STEP2:SET:INP:TRIG?</code>
Notes	SCPI is supported after A.09.40
Dependencies	Not available in E7760B
Preset	<code>IMMEDIATE</code>
Range	<code>IMMEDIATE INTERNAL EXTERNAL2 KEY BUS EXTERNAL4</code>

More Information

Parameter	SCPI	Notes
Free Run	IMM	Sets the trigger input for the current step to Free Run
Internal	INT	Sets the trigger input for the current step to Internal
Manual (Trigger Key)	KEY	Sets the trigger input for the current step to Manual (Trigger Key). Any step in the sequence set to Manual will cause the sequence execution to stop until the manual trigger key is pressed. Sending the Bus Trigger SCPI command will have no effect. At any point in the sequence where the List Sequencer is paused waiting for a software trigger, a pop-up dialog is displayed until the trigger event occurs
Bus	BUS	Sets the trigger input for the current step to Bus. Any step in the sequence set to Bus will cause the sequence execution to stop until the Bus Trigger command is sent. Pressing the manual trigger key has no effect. At any point in the sequence where the List Sequencer is paused waiting for a software trigger, a pop-up dialog is displayed until the trigger event occurs
External 2	EXT2	Sets the trigger input for the current step to External 2 Note: When on EXM, trigger 2 is a bi-directional trigger port. So, when trigger 2 has been configured as OUTPUT type, choosing External 2 as the input trigger for the current step will generate error

Transition Time

Lets you specify the transition time for the current step.

The following table lists recommended values for appropriate settling times to allow for changes within the source.

Value Changed	Recommended Transition Time
Frequency	500 μ s
Amplitude	100 μ s to within 0.1 dB 20 μ s to within 1.0 dB

If the Transition Time value is shorter than the time necessary for the hardware to settle and a List Sequence is initiated, a **warning** is generated. If the Transition Time value is longer than the Step Duration, an error is generated when initiating a source list sequence. For source list sequence, transition time is included in the step duration length. If the Transition Time value is longer than the Step Duration Time, the real step duration length is extended to equal the transition time and cause a timing shift.

Remote Command	<code>:SOURce:LIST:STEP[1] 2 ... 1000:SETup:TRANsition:TIME <time></code> <code>:SOURce:LIST:STEP[1] 2 ... 1000:SETup:TRANsition:TIME?</code>
Example	<code>:SOUR:LIST:STEP2:SET:TRAN:TIME 1ms</code>

6 Input/Output
6.1 RF Source

	<code>:SOUR:LIST:STEP2:SET:TRAN:TIME?</code>
Notes	SCPI is supported after A.09.40
Dependencies	Not available in E7760B
Preset	1.0 ms
Min	0.0 ms
Max	4.0 ks

Band

Lets you select the radio band for use in the current step.

Remote Command	<code>:SOURce:LIST:STEP[1] 2 ... 1000:SETup:RADio:BAND <band></code>
	where <band> is one of: NONE PGSM EGSM RGSM DCS1800 PCS1900 GSM450 GSM480 GSM700 GSM850 TGSM810 USCELL USPCS JAPAN KOREAN NMT IMT2K UPPER SECOND PAMR400 PAMR800 IMTEXT PCS1DOT9G AWS US2DOT5G PUBLIC LOWER BANDI BANDII BANDIII BANDIV BANDV BANDVI BANDVII BANDVIII BANDIX BANDX BANDXI BANDXII BANDXIII BANDXIV BANDXIX BAND1 BAND2 BAND3 BAND4 BAND5 BAND6 BAND7 BAND8 BAND9 BAND10 BAND11 BAND12 BAND13 BAND14 BAND17 BAND18 BAND19 BAND20 BAND21 BAND24 BAND25 BAND26 BAND27 BAND28 BAND29 BAND30 BAND31 BAND65 BAND66 BAND67 BAND68 BAND71 BAND252 BAND255 BAND33 BAND34 BAND35 BAND36 BAND37 BAND38 BAND39 BAND40 BAND41 BAND42 BAND43 BAND44 BAND45 BAND46 BANDA BANDB BANDC BANDD BANDE BANDF N1 N2 N3 N5 N7 N8 N12 N20 N25 N28 N34 N38 N39 N40 N41 N50 N51 N66 N70 N71 N74 N75 N76 N77 N78 N79 N80 N81 N82 N83 N84 N86 N257 N258 N260 N261 <code>:SOURce:LIST:STEP[1] 2 ... 1000:SETup:RADio:BAND?</code>

Example	<code>:SOUR:LIST:STEP2:SET:RAD:BAND PGSM</code> <code>:SOUR:LIST:STEP2:SET:RAD:BAND?</code>
---------	--

Notes	SCPI is supported after A.09.40
Dependencies	Not available in E7760B

Here are the Radio Standards for each Band, and a SCPI example for each (Step 2 is assumed):

Band	Standard	SCPI Example
None	None	<code>:SOUR:LIST:STEP2:SET:RAD:BAND NONE</code>
P-GSM	GSM/EDGE	<code>:SOUR:LIST:STEP2:SET:RAD:BAND PGSM</code>
E-GSM	GSM/EDGE	<code>:SOUR:LIST:STEP2:SET:RAD:BAND EGSM</code>
R-GSM	GSM/EDGE	<code>:SOUR:LIST:STEP2:SET:RAD:BAND RGSM</code>
DCS 1800	GSM/EDGE	<code>:SOUR:LIST:STEP2:SET:RAD:BAND DCS1800</code>

Band	Standard	SCPI Example
PCS 1900	GSM/EDGE	:SOUR:LIST:STEP2:SET:RAD:BAND PCS1900
GSM 450	GSM/EDGE	:SOUR:LIST:STEP2:SET:RAD:BAND GSM450
GSM 480	GSM/EDGE	:SOUR:LIST:STEP2:SET:RAD:BAND GSM480
GSM 700	GSM/EDGE	:SOUR:LIST:STEP2:SET:RAD:BAND GSM700
GSM 850	GSM/EDGE	:SOUR:LIST:STEP2:SET:RAD:BAND GSM850
T-GSM 810	GSM/EDGE	:SOUR:LIST:STEP2:SET:RAD:BAND T-GSM810
US Cell	CDMA 2000	:SOUR:LIST:STEP2:SET:RAD:BAND USCELL
US PCS	CDMA 2000	:SOUR:LIST:STEP2:SET:RAD:BAND PCS
Japan Cell	CDMA 2000	:SOUR:LIST:STEP2:SET:RAD:BAND JAPAN
Korean PCS	CDMA 2000	:SOUR:LIST:STEP2:SET:RAD:BAND KOREAN
NMT 450	CDMA 2000	:SOUR:LIST:STEP2:SET:RAD:BAND NMT
IMT 2000	CDMA 2000	:SOUR:LIST:STEP2:SET:RAD:BAND IMT2K
Upper 700	CDMA 2000	:SOUR:LIST:STEP2:SET:RAD:BAND UPPER
Secondary 800	CDMA 2000	:SOUR:LIST:STEP2:SET:RAD:BAND SECOND
400 Euro PAMR	CDMA 2000	:SOUR:LIST:STEP2:SET:RAD:BAND PAMR400
800 PAMR	CDMA 2000	:SOUR:LIST:STEP2:SET:RAD:BAND PAMR800
2.5 GHz IMT EXT	CDMA 2000	:SOUR:LIST:STEP2:SET:RAD:BAND IMTEXT
US PCS 1.9 GHz	CDMA 2000	:SOUR:LIST:STEP2:SET:RAD:BAND PCS1DOT9G
AWS	CDMA 2000	:SOUR:LIST:STEP2:SET:RAD:BAND AWS
US 2.5 GHz	CDMA 2000	:SOUR:LIST:STEP2:SET:RAD:BAND US2DOT5G
700 Public Safety	CDMA 2000	:SOUR:LIST:STEP2:SET:RAD:BAND PUBLIC
C2K Lower 700	CDMA 2000	:SOUR:LIST:STEP2:SET:RAD:BAND LOWER
Band I	W-CDMA	:SOUR:LIST:STEP2:SET:RAD:BAND BANDI
Band II	W-CDMA	:SOUR:LIST:STEP2:SET:RAD:BAND BANDII
Band III	W-CDMA	:SOUR:LIST:STEP2:SET:RAD:BAND BANDIII
Band IV	W-CDMA	:SOUR:LIST:STEP2:SET:RAD:BAND BANDIV
Band V	W-CDMA	:SOUR:LIST:STEP2:SET:RAD:BAND BANDV
Band VI	W-CDMA	:SOUR:LIST:STEP2:SET:RAD:BAND BANDVI
Band VII	W-CDMA	:SOUR:LIST:STEP2:SET:RAD:BAND BANDVII
Band VIII	W-CDMA	:SOUR:LIST:STEP2:SET:RAD:BAND BANDVIII
Band IX	W-CDMA	:SOUR:LIST:STEP2:SET:RAD:BAND BANDIX
Band X	W-CDMA	:SOUR:LIST:STEP2:SET:RAD:BAND BANDX
Band XI	W-CDMA	:SOUR:LIST:STEP2:SET:RAD:BAND BANDXI
Band XII	W-CDMA	:SOUR:LIST:STEP2:SET:RAD:BAND BANDXII
Band XIII	W-CDMA	:SOUR:LIST:STEP2:SET:RAD:BAND BANDXIII
Band XIV	W-CDMA	:SOUR:LIST:STEP2:SET:RAD:BAND BANDXIV

6 Input/Output
6.1 RF Source

Band	Standard	SCPI Example
Band XIX	W-CDMA	:SOUR:LIST:STEP2:SET:RAD:BAND BANDXIX
Band 1	LTE FDD	:SOUR:LIST:STEP2:SET:RAD:BAND BAND1
Band 2	LTE FDD	:SOUR:LIST:STEP2:SET:RAD:BAND BAND2
Band 3	LTE FDD	:SOUR:LIST:STEP2:SET:RAD:BAND BAND3
Band 4	LTE FDD	:SOUR:LIST:STEP2:SET:RAD:BAND BAND4
Band 5	LTE FDD	:SOUR:LIST:STEP2:SET:RAD:BAND BAND5
Band 6	LTE FDD	:SOUR:LIST:STEP2:SET:RAD:BAND BAND6
Band 7	LTE FDD	:SOUR:LIST:STEP2:SET:RAD:BAND BAND7
Band 8	LTE FDD	:SOUR:LIST:STEP2:SET:RAD:BAND BAND8
Band 9	LTE FDD	:SOUR:LIST:STEP2:SET:RAD:BAND BAND9
Band 10	LTE FDD	:SOUR:LIST:STEP2:SET:RAD:BAND BAND10
Band 11	LTE FDD	:SOUR:LIST:STEP2:SET:RAD:BAND BAND11
Band 12	LTE FDD	:SOUR:LIST:STEP2:SET:RAD:BAND BAND12
Band 13	LTE FDD	:SOUR:LIST:STEP2:SET:RAD:BAND BAND13
Band 14	LTE FDD	:SOUR:LIST:STEP2:SET:RAD:BAND BAND14
Band 17	LTE FDD	:SOUR:LIST:STEP2:SET:RAD:BAND BAND17
Band 18	LTE FDD	:SOUR:LIST:STEP2:SET:RAD:BAND BAND18
Band 19	LTE FDD	:SOUR:LIST:STEP2:SET:RAD:BAND BAND19
Band 20	LTE FDD	:SOUR:LIST:STEP2:SET:RAD:BAND BAND20
Band 21	LTE FDD	:SOUR:LIST:STEP2:SET:RAD:BAND BAND21
Band 24	LTE FDD	:SOUR:LIST:STEP2:SET:RAD:BAND BAND24
Band 25	LTE FDD	:SOUR:LIST:STEP2:SET:RAD:BAND BAND25
Band 26	LTE FDD	:SOUR:LIST:STEP2:SET:RAD:BAND BAND26
Band 27	LTE FDD	:SOUR:LIST:STEP2:SET:RAD:BAND BAND27
Band 28	LTE FDD	:SOUR:LIST:STEP2:SET:RAD:BAND BAND28
Band 29	LTE FDD	:SOUR:LIST:STEP2:SET:RAD:BAND BAND29
Band 30	LTE FDD	:SOUR:LIST:STEP2:SET:RAD:BAND BAND30
Band 31	LTE FDD	:SOUR:LIST:STEP2:SET:RAD:BAND BAND31
Band 65	LTE FDD	:SOUR:LIST:STEP2:SET:RAD:BAND BAND65
Band 66	LTE FDD	:SOUR:LIST:STEP2:SET:RAD:BAND BAND66
Band 67	LTE FDD	:SOUR:LIST:STEP2:SET:RAD:BAND BAND67
Band 68	LTE FDD	:SOUR:LIST:STEP2:SET:RAD:BAND BAND68
Band 71	LTE FDD	:SOUR:LIST:STEP2:SET:RAD:BAND BAND71
Band 252	LTE FDD	:SOUR:LIST:STEP2:SET:RAD:BAND BAND252
Band 255	LTE FDD	:SOUR:LIST:STEP2:SET:RAD:BAND BAND255
Band 33	LTE TDD	:SOUR:LIST:STEP2:SET:RAD:BAND BAND33

Band	Standard	SCPI Example
Band 34	LTE TDD	:SOUR:LIST:STEP2:SET:RAD:BAND BAND34
Band 35	LTE TDD	:SOUR:LIST:STEP2:SET:RAD:BAND BAND35
Band 36	LTE TDD	:SOUR:LIST:STEP2:SET:RAD:BAND BAND36
Band 37	LTE TDD	:SOUR:LIST:STEP2:SET:RAD:BAND BAND37
Band 38	LTE TDD	:SOUR:LIST:STEP2:SET:RAD:BAND BAND38
Band 39	LTE TDD	:SOUR:LIST:STEP2:SET:RAD:BAND BAND39
Band 40	LTE TDD	:SOUR:LIST:STEP2:SET:RAD:BAND BAND40
Band 41	LTE TDD	:SOUR:LIST:STEP2:SET:RAD:BAND BAND41
Band 42	LTE TDD	:SOUR:LIST:STEP2:SET:RAD:BAND BAND42
Band 43	LTE TDD	:SOUR:LIST:STEP2:SET:RAD:BAND BAND43
Band 44	LTE TDD	:SOUR:LIST:STEP2:SET:RAD:BAND BAND44
Band 45	LTE TDD	:SOUR:LIST:STEP2:SET:RAD:BAND BAND45
Band 46	LTE TDD	:SOUR:LIST:STEP2:SET:RAD:BAND BAND46
Band A	TD-SCDMA	:SOUR:LIST:STEP2:SET:RAD:BAND BANDA
Band B	TD-SCDMA	:SOUR:LIST:STEP2:SET:RAD:BAND BANDB
Band C	TD-SCDMA	:SOUR:LIST:STEP2:SET:RAD:BAND BANDC
Band D	TD-SCDMA	:SOUR:LIST:STEP2:SET:RAD:BAND BANDD
Band E	TD-SCDMA	:SOUR:LIST:STEP2:SET:RAD:BAND BANDE
Band F	TD-SCDMA	:SOUR:LIST:STEP2:SET:RAD:BAND BANDF
N 1	5G NR	:SOUR:LIST:STEP2:SET:RAD:BAND N1
N 2	5G NR	:SOUR:LIST:STEP2:SET:RAD:BAND N2
N 3	5G NR	:SOUR:LIST:STEP2:SET:RAD:BAND N3
N 5	5G NR	:SOUR:LIST:STEP2:SET:RAD:BAND N5
N 7	5G NR	:SOUR:LIST:STEP2:SET:RAD:BAND N7
N 8	5G NR	:SOUR:LIST:STEP2:SET:RAD:BAND N8
N 12	5G NR	:SOUR:LIST:STEP2:SET:RAD:BAND N12
N 20	5G NR	:SOUR:LIST:STEP2:SET:RAD:BAND N20
N 25	5G NR	:SOUR:LIST:STEP2:SET:RAD:BAND N25
N 28	5G NR	:SOUR:LIST:STEP2:SET:RAD:BAND N28
N 34	5G NR	:SOUR:LIST:STEP2:SET:RAD:BAND N34
N 38	5G NR	:SOUR:LIST:STEP2:SET:RAD:BAND N38
N 39	5G NR	:SOUR:LIST:STEP2:SET:RAD:BAND N39
N 40	5G NR	:SOUR:LIST:STEP2:SET:RAD:BAND N40
N 41	5G NR	:SOUR:LIST:STEP2:SET:RAD:BAND N41
N 50	5G NR	:SOUR:LIST:STEP2:SET:RAD:BAND N50
N 51	5G NR	:SOUR:LIST:STEP2:SET:RAD:BAND N51

6 Input/Output
6.1 RF Source

Band	Standard	SCPI Example
N 66	5G NR	:SOUR:LIST:STEP2:SET:RAD:BAND N66
N 70	5G NR	:SOUR:LIST:STEP2:SET:RAD:BAND N70
N 71	5G NR	:SOUR:LIST:STEP2:SET:RAD:BAND N71
N 74	5G NR	:SOUR:LIST:STEP2:SET:RAD:BAND N74
N 75	5G NR	:SOUR:LIST:STEP2:SET:RAD:BAND N75
N 76	5G NR	:SOUR:LIST:STEP2:SET:RAD:BAND N76
N 77	5G NR	:SOUR:LIST:STEP2:SET:RAD:BAND N77
N 78	5G NR	:SOUR:LIST:STEP2:SET:RAD:BAND N78
N 79	5G NR	:SOUR:LIST:STEP2:SET:RAD:BAND N79
N 80	5G NR	:SOUR:LIST:STEP2:SET:RAD:BAND N80
N 81	5G NR	:SOUR:LIST:STEP2:SET:RAD:BAND N81
N 82	5G NR	:SOUR:LIST:STEP2:SET:RAD:BAND N82
N 83	5G NR	:SOUR:LIST:STEP2:SET:RAD:BAND N83
N 84	5G NR	:SOUR:LIST:STEP2:SET:RAD:BAND N84
N 86	5G NR	:SOUR:LIST:STEP2:SET:RAD:BAND N86
N 257	5G NR	:SOUR:LIST:STEP2:SET:RAD:BAND N257
N 258	5G NR	:SOUR:LIST:STEP2:SET:RAD:BAND N258
N 260	5G NR	:SOUR:LIST:STEP2:SET:RAD:BAND N260
N 261	5G NR	:SOUR:LIST:STEP2:SET:RAD:BAND N261

Device

Lets you specify the radio band link direction for the steps within the list sequence. The link is used in conjunction with the channel band and channel number to determine the output frequency.

Setting	Option	Description
Uplink	UP	The source calculates the uplink frequency according to an uplink formula together with selected channel band and channel number
Downlink	DOWN	The source calculates the downlink frequency according to a downlink formula together with selected channel band and channel number

Remote Command	:SOURce:LIST:STEP[1] 2 ... 1000:SETup:RADio:BAND:LINK DOWN UP :SOURce:LIST:STEP[1] 2 ... 1000:SETup:RADio:BAND:LINK?
Example	:SOUR:LIST:STEP2:SET:RAD:BAND:LINK UP :SOUR:LIST:STEP2:SET:RAD:BAND:LINK?
Notes	SCPI is supported after A.09.40

Dependencies	Not available in E7760B
Preset	DOWN
Range	DOWN UP

Freq/Chan

Lets you select the frequency or channel value for the current step. If the Band selection for the current row is **NONE**, you enter a frequency. Otherwise, enter a channel, which causes the frequency to be automatically selected, based on the Band selection.

Entering a Frequency

If the Band selection for the current row is **NONE**, enter a Frequency. This field in the table allows you to select the frequency value for the current step.

Remote Command	:SOURCE:LIST:STEP[1] 2 ... 1000:SETup:CNFRrequency <double> :SOURCE:LIST:STEP[1] 2 ... 1000:SETup:CNFRrequency?	
Example	:SOUR:LIST:STEP2:SET:CNFR 1GHz :SOUR:LIST:STEP2:SET:CNFR?	
Notes	SCPI is supported after A.09.40 Used to setup channel number or frequency setting, according to the current Radio Band setting. If Radio Band is NONE , then the value is frequency. If Radio Band is not NONE , then the value is channel number	
Dependencies	Not available in E7760B	
Couplings	The frequency value is coupled to the channel band and number for the step, such that updates to the radio band and channel number will update the frequency value to the corresponding absolute frequency. The reverse is also true, changing the frequency value causes the value of the channel number to be updated	
Preset	1.00 GHz	
Min	10.00 MHz	
Max	Hardware Dependent:	
	Option 503	3.6 GHz
	Option 504	3.9 GHz
	Option 506	6.00 GHz
	Option F06	6.08 GHz
	Option F06 & EP6	6.60 GHz

Entering a Channel

If the Band selection for the current row is not **NONE**, enter a Channel Number. This field in the table allows you to select the channel value for the current step. The frequency is selected automatically, based on the Band.

Example	<code>:SOUR:LIST:STEP2:SET:CNFR 124</code> <code>:SOUR:LIST:STEP2:SET:CNFR?</code>
Notes	SCPI is supported after A.09.40 Used to setup channel number or frequency setting, according to current Radio Band setting. If Radio Band is NONE , then the value is a frequency. If Radio Band is not NONE , then the value is a channel number
Dependencies	Not available in E7760B
Couplings	The channel number is coupled to the step frequency value. When the step frequency value is changed, the channel number increases or decreases to match the new step frequency. If the step frequency is not at an exact match for a channel number, the nearest channel number is displayed, along with a greater-than or less-than sign, to indicate the frequency is above or below the channel number
Preset	1
Min/Max	0/10838 (See " Channel " on page 1057 for valid ranges)

Power

Lets you specify the power value for the current step.

Remote Command	<code>:SOURce:LIST:STEP[1] 2 ... 1000:SETup:AMPLitude <double></code> <code>:SOURce:LIST:STEP[1] 2 ... 1000:SETup:AMPLitude?</code>
Example	<code>:SOUR:LIST:STEP2:SET:AMPL -50dBm</code> <code>:SOUR:LIST:STEP2:SET:AMPL?</code>
Dependencies	The RF power is dependent on the RF output port and frequency, such that the current frequency and selected output port determine the valid range of power values Not available in E7760B
Preset	-100 dBm
Min/Max	The range of values depends on the current frequency and selected RF output port See " RF Power " on page 1022 and the RF Power Range table for valid ranges

Waveform

Lets you select the waveform to be played back during the current step. Options are: CW, a Waveform file, Continue the previous step's waveform, or Off.

Remote Command	<code>:SOURce:LIST:STEP[1] 2 ... 1000:SETup:WAVEform <string></code>
----------------	--

	<p>where <code><string></code> is one of: <code>"CW"</code>, <code>"waveform name"</code>, <code>"Cont"</code>, <code>"Off"</code> For full details of options, see "More Information" on page 1042 <code>:SOURce:LIST:STEP[1] 2 ... 1000:SETup:WAVeform?</code></p>
Example	<code>:SOUR:LIST:STEP2:SET:WAV "CW"</code> <code>:SOUR:LIST:STEP2:SET:WAV?</code>
Notes	SCPI is supported after A.09.40
Dependencies	<p>Not available in E7760B</p> <p>For VXT models M9410A/11A/16A, if the Waveform is not Continue Previous, there is always a time gap between the current step and the previous step</p>
Preset	<code>CW</code>
Range	<code>"CW"</code> , <code>"waveform name"</code> , <code>"Cont"</code> , <code>"Off"</code>

More Information

Parameter	SCPI	Notes
CW	<code>"CW"</code>	Sets the current step to output a CW tone
Selected Waveform	<code>"waveform name"</code>	<p>Inserts a waveform from the Select Waveform dialog as the waveform for playback during the current step</p> <p>If the selected waveform contains header (which contains ARB play parameters), source list sequence will automatically apply header settings of the selected waveform in that step</p>
Continue Previous	<code>"Cont"</code>	Sets the current step to continue with playback of the waveform from the previous step. When continuing the previous waveform, the ARB playback will not pause while the source retunes to the new frequency or amplitude that may be defined for the new step
Off	<code>"Off"</code>	Disable RF output of the current step

Waveform File

Pressing the slide–aside field of this column (>) opens the ["Select Waveform" on page 1098](#) screen, which lets you select a waveform in ARB memory to playback during the current step. When you select a waveform, and press **OK**, it returns to the List Sequencer Setup screen with that file name in the table.

Step Duration

Lets you select the duration of play for the current step.

The duration can be set to be either the number of times for the ARB file associated with the sequence to play, or a specific time value, or continuous. If the step is set to play a CW tone, the step duration cannot be set to a play count.

Remote Command	<code>:SOURce:LIST:STEP[1] 2 ... 1000:SETup:DURation:TYPE TIME COUNT CONTInuous CABort</code> See "Option Details" on page 1043 <code>:SOURce:LIST:STEP[1] 2 ... 1000:SETup:DURation:TYPE?</code>
Example	<code>:SOUR:LIST:STEP2:SET:DUR:TYPE TIME</code> <code>:SOUR:LIST:STEP2:SET:DUR:TYPE?</code>
Dependencies	Not available in E7760B If in VXT models M9410A/11A/16A, Step Duration is TIME or Play COUNT , only Free Run is available for the next step. Otherwise, an error message is generated: "Parameter error; only Free Run is available as step trigger on step<n>"
Range	TIME COUNT CONTInuous CABort

Option Details

Parameter	SCPI	Notes
Time	TIME	Sets the duration of the current step to be a time value for the length of time the step will play When TIME is selected, the Time may be set using the second field under Step Duration and/or by the "Duration Time" on page 1043 command
Count	COUNT	Sets the duration of the current step to be an integer value for the number of times (play count) the ARB file is selected for playback during this step. For example, a 5 second ARB will be set to play 5 times during the step When COUNT is selected, the Count may be set using the second field under Step Duration and/or by the "Play Count" on page 1044 command
Continuous	CONTInuous	Sets the current step to be played continuously until the next step starts. The waveform will always play completely before transitioning to the next step
Continuous Abort	CABort	Sets the current step to be played continuously or until the trigger event of the next step is detected. When a trigger event is received, the waveform play will be aborted after the interval specified by the Duration Time parameter and it will then transition to the next step When Continuous Abort is selected, the Duration Time may be set using the second field under Step Duration and/or by the "Duration Time" on page 1043 command

Duration Time

Lets you specify the length of time the current step will play when ["Step Duration" on page 1042](#) is Time.

When "Step Duration" on page 1042 is Continuous Abort, this parameter specifies the maximum duration that the waveform will continue to play after a step trigger is received before the transition to the next waveform will occur. Duration is limited to a maximum of 20 seconds.

If the Transition Time value is longer than the Step Duration Time, an error is generated when initiating a source list sequence. For source list sequence, transition time is included in the step duration length (not occupy additional time). If the Transition Time value is longer than the Step Duration Time, the real step duration length is extended to equal the transition time and cause a timing shift.

Remote Command	<code>:SOURce:LIST:STEP[1] 2 ... 1000:SETup:DURation:TCOunt <double></code> <code>:SOURce:LIST:STEP[1] 2 ... 1000:SETup:DURation:TCOunt?</code>
Example	<code>:SOUR:LIST:STEP2:SET:DUR:TCO 1s</code> <code>:SOUR:LIST:STEP2:SET:DUR:TCO?</code>
Notes	When Repetition is Single , the last step continues playing after the sequence is completed. In this extended playing time, <code>:STAT:OPER:COND?</code> returns 0 for the Source Sweeping Status Bit (bit 9) SCPI is supported after A.09.40 If current Duration Type is Continuous , then error -221, "Settings conflict; Cannot accept time or count input when step duration type is Continuous on step #" is displayed
Dependencies	Not available in E7760B
Preset	VXT models M9410A/11A/16A: 2.0 ms All others: 1.00 ms
Min	For VXT models M9410A/11A/16A, the minimum duration time for first step is 1.2 ms. If the Waveform is "waveform name", the minimum duration time is 1.2 ms All others: 100 µs
Max	1800 s

Play Count

Lets you specify the number of times the current ARB waveform file will play during a step when "Step Duration" on page 1042 is Count.

"Duration Time" on page 1043

Remote Command	<code>:SOURce:LIST:STEP[1] 2 ... 1000:SETup:DURation:TCOunt <double></code> <code>:SOURce:LIST:STEP[1] 2 ... 1000:SETup:DURation:TCOunt?</code>
Example	<code>:SOUR:LIST:STEP2:SET:DUR:TCO 10</code> <code>:SOUR:LIST:STEP2:SET:DUR:TCO?</code>
Notes	SCPI is supported after A.09.40 This command is reused by Play Count and Duration Time if Duration Type is set to Play Count or Duration Time If Duration Type is Continuous , then error -221, "Settings conflict; Cannot accept time or count input

6 Input/Output
6.1 RF Source

	when step duration type is Continuous on step #" is displayed If Play Count is set for the last step, the last step of ARB keeps playing as if set to Continuous after play count setting is reached
Dependencies	Not available in E7760B
Preset	1
Min	1
Max	65536

Trig Out

Lets you specify the trigger output for the current step. The trigger output signal is sent at the start of the step.

When this is **ON**, a trigger event occurs on both Internal and External2 paths. Selecting **OFF** turns off trigger output.

Remote Command	<code>:SOURce:LIST:STEP[1] 2 ... 1000:SETup:OUTPut:TRIGger ON OFF 1 0</code> <code>:SOURce:LIST:STEP[1] 2 ... 1000:SETup:OUTPut:TRIGger?</code>
Example	<code>:SOUR:LIST:STEP2:SET:OUTP:TRIG ON</code> <code>:SOUR:LIST:STEP2:SET:OUTP:TRIG?</code>
Notes	SCPI is supported after A.09.40
Dependencies	Not available in E7760B
Preset	OFF
Range	ON OFF

Step Configuration (Remote Command Only)

Used to configure the List Sequencer, as detailed in the table below. The command is defined such that you send one command per step, with the step number being specified as a subopcode of the SCPI command. Each command includes all the parameter settings for the step. As a step is set up, the values entered are run through several levels of validation.

Remote Command	<code>:SOURce:LIST:STEP[1] 2 ... 1000:SETup <step_trigger>, <trans_time>, <band>, <link_type>, <freq_chan>, <power>, <waveform>, <duration>, <time_count>, <trig_state></code> For details of each option, see " Step Configuration Parameters " on page 1046 below <code>:SOURce:LIST:STEP[1] 2 ... 1000:SETup?</code>
Example	<code>:SOUR:LIST:STEP1:SET INT, 1ms, PGSM, DOWN, 10, -25 dBm, "GSM_Test1.bin", TIME, 10ms, OFF</code>
Dependencies	The range of subopcode values is 1 to 1000, and the value you enter is determined by the number of

steps you have configured. For details see ["Number of Steps" on page 1032](#)
If you attempt to remotely set or query a subopcode that is out of range, an error is generated

Step Configuration Parameters

There are 10 parameters for each step, which must be in the following order in the command:

- | | | |
|---|--|---|
| 1 | Step Trigger
<code><step_trigger></code> | Data Type: enum
Specifies the input trigger for the step. For further details, see "Step Trigger" on page 1033 |
| 2 | Transition Time
<code><trans_time></code> | Data Type: enum
Specifies the transition time for the step, in seconds. For further details, see "Transition Time" on page 1034 |
| 3 | Radio Band
<code><band></code> | Data Type: enum
Specifies the radio band for the step, as any one of:

NONE PGSM EGSM RGSM DCS1800 PCS1900 TGSM810 GSM450 GSM480 GSM700 GSM850 BANDI BANDII BANDIII BANDIV BANDV BANDVI BANDVII BANDVIII BANDIX BANDX BANDXI BANDXII BANDXIII BANDXIV BANDXIX USCELL USPCS JAPAN KOREAN NMT IMT2K UPPER SECOND PAMR400 PAMR800 IMTEXT PCS1DOT9G AWS US2DOT5G PUBLIC LOWER NONE BAND1 BAND2 BAND3 BAND4 BAND5 BAND6 BAND7 BAND8 BAND10 BAND11 BAND12 BAND13 BAND14 BAND17 BAND18 BAND19 BAND20 BAND21 BAND24 BAND25 BAND26 BAND33 BAND34 BAND35 BAND36 BAND37 BAND38 BAND39 BAND40 BAND41 BAND42 BAND43 BANDA BANDB BANDC BANDD BANDE BANDF N1 N2 N3 N5 N7 N8 N12 N20 N25 N28 N34 N38 N39 N40 N41 N50 N51 N66 N70 N71 N74 N75 N76 N77 N78 N79 N80 N81 N82 N83 N84 N86 N257 N258 N260 N261

For further details, see "Band" on page 1035 |
| 4 | Radio Band Link
<code><link_type></code> | Data Type: enum
Specifies the radio band link direction for the step, as either of:

DOWN UP

For further details, see "Device" on page 1039
The old Device BTS MS is obsolete, but is still supported, acting as an alias for the Link parameter |
| 5 | Frequency/Channel Number
<code><freq_chan></code> | Data Type: freq/chan num
Specifies the frequency in Hz or the channel number for the step. The channel number and frequency are combined as one parameter that represents the frequency or channel number depending on the radio band setting. If the radio band is set to NONE , this value is interpreted as a frequency value in Hz. If the radio band is set to a valid band, this value is interpreted as a channel number

For further details, see "Freq/Chan" on page 1040 |

6 Input/Output

6.1 RF Source

6	Power <power>	Data Type: ampl Specifies the output power for the step in dBm. For details of the valid ranges see "Power" on page 1041								
7	Waveform <waveform>	Data Type: string Specifies the waveform for playback during the step. The step can output either a new ARB waveform, continue playback of the previous waveform, or output a CW tone. The options for specifying these are: <table border="0" style="margin-left: 20px;"> <tr> <td style="vertical-align: top;"><filename></td> <td>Plays the specified waveform from the start. The filename value is the name of the file within ARB playback memory, it does not include the windows path to the file on the HDD. If you enter a filename for a waveform that does not reside within ARB playback memory, an error is generated</td> </tr> <tr> <td style="vertical-align: top;">CONT</td> <td>Continues playback of the ARB file from the previous step</td> </tr> <tr> <td style="vertical-align: top;">CW</td> <td>Outputs a CW tone</td> </tr> <tr> <td style="vertical-align: top;">OFF</td> <td>Disables RF output</td> </tr> </table> For further details, see "Waveform" on page 1041 and "Waveform File" on page 1042	<filename>	Plays the specified waveform from the start. The filename value is the name of the file within ARB playback memory, it does not include the windows path to the file on the HDD. If you enter a filename for a waveform that does not reside within ARB playback memory, an error is generated	CONT	Continues playback of the ARB file from the previous step	CW	Outputs a CW tone	OFF	Disables RF output
<filename>	Plays the specified waveform from the start. The filename value is the name of the file within ARB playback memory, it does not include the windows path to the file on the HDD. If you enter a filename for a waveform that does not reside within ARB playback memory, an error is generated									
CONT	Continues playback of the ARB file from the previous step									
CW	Outputs a CW tone									
OFF	Disables RF output									
8	Step Duration <duration>	Data Type: enum Specifies the duration of the step, as one of: TIME COUNT CONTinuous The duration can be specified to be either time, or play count of the ARB file associated with the step, or continuous. If Waveform is set to CW , this value cannot be set to Play Count and an error will be generated. If CONTinuous is selected, the following Time or Count value is ignored. For further details, see "Step Duration" on page 1042								
9	Time or Count <time_count>	Data Type: time/int Specifies time duration in seconds, or play count of the ARB file associated with the step For further details, see "Play Count" on page 1044								
10	Output Trigger <trig_state>	Data Type: boolean Specifies the output trigger state for the step, as one of: ON OFF 1 0 For further details, see "Trig Out" on page 1045								

Step Configuration of Step Trigger parameter list (Remote Command Only)

Configures the "Step Trigger" parameter array of the whole List Sequencer at one time. The number of arrays is the same as the step number defined in ["Number of](#)

[Steps" on page 1032](#). As a step is setup, the value entered runs through several levels of validation.

Remote Command	<code>:SOURce:LIST:SETup:INPut:TRIGger <enum>, <enum>, <enum>, ...</code> <code>:SOURce:LIST:SETup:INPut:TRIGger?</code>
Example	<code>:SOUR:LIST:SET:INP:TRIG IMM,INT,EXT2</code> <code>:SOUR:LIST:SET:INP:TRIG?</code>
Notes	The command is to setup below parameter array of whole list sequence Step Trigger <enum> - specifies the input trigger for the step. For details of the valid types of step trigger see "Step Trigger" on page 1033 If input parameter number exceeds the step number defined by "Number of Steps" on page 1032 , then error -221 "Settings conflict; The number of input parameters is too large and is truncated to current list step number" is generated, and only those parameters whose index number falls in number of steps will be updated
Dependencies	The range is 1 to 1000, which is determined by the number of steps you have configured. For details see "Number of Steps" on page 1032

Step Configuration of Transition Time parameter list (Remote Command Only)

Configures the "Transition Time" parameter array of the whole List Sequencer at once. The array size is the same as step number defined in ["Number of Steps" on page 1032](#). As a step is setup, the value entered runs through several levels of validation.

Remote Command	<code>:SOURce:LIST:SETup:TRANSition:TIME <time>, <time>, <time>, ...</code> <code>:SOURce:LIST:SETup:TRANSition:TIME?</code>
Example	<code>:SOUR:LIST:SET:TRAN:TIME 1ms,1ms,1ms</code> <code>:SOUR:LIST:SET:TRAN:TIME?</code>
Notes	The command is to setup below parameter array of whole list sequence Transition Time <time> - specifies the transition time for the step in seconds. For details of the valid ranges for the transition time see "Transition Time" on page 1034 If input parameter number exceeds the step number defined by "Number of Steps" on page 1032 , then the error -221, "Settings conflict; The number of input parameters is too large and is truncated to current list step number" is generated, and only those parameters whose index number falls in number of steps will be updated
Dependencies	The range is 1 to 1000 which is determined by the number of steps you have configured. For details see "Number of Steps" on page 1032

Step Configuration of Radio Band parameter list (Remote Command Only)

Configures the **Radio Band** parameter array of the whole List Sequencer at once. The size of the array is the same as the step number defined in ["Number of Steps"](#)

on page 1032. As a step is set up, the value entered runs through several levels of validation.

Remote Command	<code>:SOURce:LIST:SETup:RADio:BAND <enum>, <enum>, <enum>, ...</code> <code>:SOURce:LIST:SETup:RADio:BAND?</code>
Example	<code>:SOUR:LIST:SET:RAD:BAND PGSM, EGSM, RGSM</code> <code>:SOUR:LIST:SET:RAD:BAND?</code>
Notes	The command sets up the parameter array of whole list sequence Radio Band <enum> - specifies the radio band for the step. For available options, see "Band" on page 1035 If the input parameter number exceeds the step number defined by "Number of Steps" on page 1032, then error -221, "Settings conflict; The number of input parameters is too large and is truncated to current list step number" is generated, and only those parameters whose index number falls within the number of steps will be updated
Dependencies	The range is 1 to 1000, which is determined by the number of steps you have configured. For details see "Number of Steps" on page 1032

Step Configuration of Radio Band Link parameter list (Remote Command Only)

Configures the **Radio Band Link** parameter array of the whole List Sequencer at one time. The number of arrays is same as step number defined in "Number of Steps" on page 1032. As a step is set up, the value entered runs through several levels of validation.

Remote Command	<code>:SOURce:LIST:SETup:RADio:BAND:LINK <enum>, <enum>, <enum>, ...</code> <code>:SOURce:LIST:SETup:RADio:BAND:LINK?</code>
Example	<code>:SOUR:LIST:SET:RAD:BAND:LINK DOWN,UP,UP</code> <code>:SOUR:LIST:SET:RAD:BAND:LINK?</code>
Notes	The command sets up the parameter array of whole list sequence Radio Band Link <enum> - specifies the radio band link direction for the step. Options are: <code>DOWN UP</code> If input parameter number exceeds the step number defined by "Number of Steps" on page 1032, then error -221, "Settings conflict; The number of input parameters is too large and is truncated to current list step number" is generated, and only those parameters whose index number falls within the number of steps will be updated
Dependencies	The range is 1 to 1000, which is determined by the number of steps you have configured. For details see "Number of Steps" on page 1032

Step Configuration of Frequency/Channel Number parameter list (Remote Command Only)

Configures the **Frequency** or **Channel Number** parameter array of the whole List Sequencer at one time. The number of arrays is same as step number defined in ["Number of Steps" on page 1032](#). As a step is set up, the value entered runs through several levels of validation.

Remote Command	<code>:SOURce:LIST:SETup:CNFRrequency <double>, <double>, <double>, ...</code> <code>:SOURce:LIST:SETup:CNFRrequency?</code>
Example	<code>:SOUR:LIST:SET:CNFR 1GHz,100MHz,100MHz</code> <code>:SOUR:LIST:SET:CNFR?</code> <code>:SOUR:LIST:SET:CNFR 124,124,124</code> <code>:SOUR:LIST:SET:CNFR?</code>
Notes	<p>The command sets up the parameter array of whole list sequence</p> <p>Frequency/Channel Number <freq>/<chan num> - specifies the frequency in Hz or the channel number for the step. The channel number and frequency are combined as one parameter that represents the frequency or channel number depending on the radio band setting. If the radio band is set to NONE, this value is interpreted as a frequency value in Hz. If the radio band is set to a valid band, this value is interpreted as a channel number. For details of the valid ranges for frequency and channel numbers, see "Freq/Chan" on page 1040 and "Freq/Chan" on page 1040</p> <p>This command is used to setup/query channel number or frequency setting, according to current Radio Band setting of that step. If Radio Band is NONE, then it is frequency. If Radio Band is not NONE, then it is channel number</p> <p>If input parameter number exceeds the step number defined by "Number of Steps" on page 1032, then generate error -221, "Settings conflict; The number of input parameters is too large and is truncated to current list step number", and only those parameters whose index number falls in legal step number will be updated</p>
Dependencies	The range is 1 to 1000, which is determined by the number of steps you have configured. For details see "Number of Steps" on page 1032

Step Configuration of Power parameter list (Remote Command Only)

Configures the **Power** parameter array of the whole List Sequencer at one time. The number of arrays is the same as step number defined in ["Number of Steps" on page 1032](#). As a step is set up, the value entered runs through several levels of validation.

Remote Command	<code>:SOURce:LIST:SETup:AMPLitude <ampl>, <ampl>, <ampl>, ...</code> <code>:SOURce:LIST:SETup:AMPLitude?</code>
Example	<code>:SOUR:LIST:SET:AMPL -50dBm,-40dBm,-30dBm</code> <code>:SOUR:LIST:SET:AMPL?</code>
Notes	The command sets up the parameter array of whole list sequence

Power **<ampl>** - specifies the output power for the step in dBm. For details of the valid ranges, see ["Power" on page 1041](#)

If input parameter number exceeds the step number defined by ["Number of Steps" on page 1032](#), then error -221, "Settings conflict; The number of input parameters is too large and is truncated to current list step number" is generated, and only those parameters whose index number falls within legal step number will be updated

Dependencies The range is 1 to 1000, which is determined by the number of steps you have configured. For details see ["Number of Steps" on page 1032](#)

Step Configuration of Waveform parameter list (Remote Command Only)

Configures the **Waveform** parameter array of the whole List Sequencer at one time. The number of arrays is same as step number defined in ["Number of Steps" on page 1032](#). As a step is set up, the value entered runs through several levels of validation.

Remote Command `:SOURce:LIST:SETup:WAVEform <string>, <string>, <string>, ...`
`:SOURce:LIST:SETup:WAVEform?`

Example `:SOUR:LIST:SET:WAV "CW", "Off", "CONT"`
`:SOUR:LIST:SET:WAV?`

Notes Sets up or queries the parameter array of whole list sequence
Waveform **<string>** - specifies the waveform for playback during the step. The step can output either a new ARB waveform, continue playback of the previous waveform, or output a CW tone. The options for specifying these are:

<filename>	Plays the specified waveform from the start. The filename value is the name of the file within ARB playback memory, it does not include the windows path to the file on the HDD. If you enter a filename for a waveform that does not reside within ARB playback memory, an error is generated
CONT	Continues playback of the ARB file from the previous step
CW	Outputs a CW tone
OFF	Disables the RF output

If input parameter number exceeds the step number defined by ["Number of Steps" on page 1032](#), then error -221, "Settings conflict; The number of input parameters is too large and is truncated to current list step number" is generated, and only those parameters whose index number falls within number of steps will be updated

Dependencies The range is 1 to 1000 which is determined by the number of steps you have configured. For details see ["Number of Steps" on page 1032](#)

Range `"filename" | "CW" | "Off" | "CONT"`

Step Configuration of Step Duration parameter list (Remote Command Only)

Configures the **Step Duration** parameter array of the whole List Sequencer at one time. The number of arrays is same as step number defined in "[Number of Steps](#)" on [page 1032](#). As a step is set up, the value entered runs through several levels of validation.

Remote Command	<code>:SOURce:LIST:SETup:DURation:TYPE <enum>, <enum>, <enum>, ...</code> <code>:SOURce:LIST:SETup:DURation:TYPE?</code>
Example	<code>:SOUR:LIST:SET:DUR:TYPE COUN,TIME,CONT</code> <code>:SOUR:LIST:SET:DUR:TYPE?</code>
Notes	<p>Sets up or queries the parameter array of whole list sequence</p> <p>Step Duration <enum> - specifies the duration of the step. The duration can be specified to be either time, or play count of the ARB file associated with the step, or continuous. If Waveform is set to "CW", this value cannot be set to Play Count and an error will be generated. If continuous is selected, the following Time or Count value is ignored. For further details of this setting, see "Step Duration" on page 1042</p> <p>Options are: TIME COUNT CONTInuous</p> <p>If input parameter number exceeds the step number defined by "Number of Steps" on page 1032, then error -221, "Settings conflict; The number of input parameters is too large and is truncated to current list step number" is generated, and only those parameters whose index number falls within number of steps will be updated</p>
Dependencies	The range is 1 to 1000, which is determined by the number of steps you have configured. For details see " Number of Steps " on page 1032

Step Configuration of Duration Time or Play Count parameter list (Remote Command Only)

Configures the **Duration Time** or **Play Count** parameter array of the whole List Sequencer at one time. The number of arrays is same as step number defined in "[Number of Steps](#)" on [page 1032](#). As a step is set up, the value entered runs through several levels of validation.

Remote Command	<code>:SOURce:LIST:SETup:TOCount <time/int>, <time/int>, <time/int>, ...</code> <code>:SOURce:LIST:SETup:TOCount?</code>
Example	<code>:SOUR:LIST:SET:TOC 1s,2s,3s</code> <code>:SOUR:LIST:SET:TOC?</code> <code>:SOUR:LIST:SET:TOC 5,6,7</code> <code>:SOUR:LIST:SET:TOC?</code>
Notes	Sets up or queries the parameter array of whole list sequence

	<p>Time or Count <time/int> - specifies time duration in seconds or play count of the ARB file associated with the step</p> <p>If input parameter number exceeds the step number defined by "Number of Steps" on page 1032, then an error is generated, and only those parameters whose index number falls within number of steps will be updated</p> <p>If current "Step Duration" on page 1042 is "Continuous", then error -221, "Settings conflict; Cannot accept time or count input when step duration type is Continuous on step #" is generated</p>
Dependencies	The range is 1 to 1000, which is determined by the number of steps you have configured. For details see "Number of Steps" on page 1032

Step Configuration of Output Trigger parameter list (Remote Command Only)

Configures the **Output Trigger** parameter array of the whole List Sequencer at one time. The number of arrays is same as step number defined in ["Number of Steps" on page 1032](#). As a step is set up, the value entered runs through several levels of validation.

Remote Command	<pre>:SOURce:LIST:SETup:OUTPut:TRIGger <bool>, <bool>, <bool>, ... :SOURce:LIST:SETup:OUTPut:TRIGger?</pre>
Example	<pre>:SOUR:LIST:SET:OUTP:TRIG ON,OFF,ON :SOUR:LIST:SET:OUTP:TRIG?</pre>
Notes	<p>Sets up or queries the parameter array of whole list sequence</p> <p>Output Trigger <Boolean> - specifies the output trigger for the step. Options are: ON OFF 1 0</p> <p>If input parameter number exceeds the step number defined by "Number of Steps" on page 1032, then error -221, "Settings conflict; The number of input parameters is too large and is truncated to current list step number" is generated, and only those parameters whose index number falls within legal step number are updated</p>
Dependencies	The range is 1 to 1000, which is determined by the number of steps you have configured. For details see "Number of Steps" on page 1032

Clear List (Remote Command Only)

The SCPI equivalent of the Clear List UI feature described in ["Clear List" on page 1033](#).

Remote Command	<pre>:SOURce:LIST:SETup:CLEar</pre>
Example	<pre>:SOUR:LIST:SETup:CLE</pre>
Dependencies	Not available in E7760B

6.1.8.8 Remote Software Trigger (Remote command Only)

During execution of a list sequence, the sequence halts and waits at any step that has Step Trigger set to “Bus”. Sending this command triggers the step and continues the sequence.

Remote Command	<code>:SOURCE:LIST:TRIGGER:INITiate[:IMMediate]</code>
Example	<code>:SOUR:LIST:TRIG:INIT</code>
Dependencies	Not available in E7760B

6.1.8.9 Query List Sequence Initiation Armed Status (Remote Query Only)

This is a blocking SCPI query to determine whether a source list sequence has been initiated successfully.

Remote Command	<code>:SOURCE:LIST:INITiation:ARMed?</code>
Example	<code>:SOUR:LIST:INIT:ARMed?</code>
Notes	<p>Returns “1” if list sequence has been initiated successfully, or “0” if not. If the response is “0”, use <code>:SYST:ERR?</code> to query the actual error</p> <p>Like <code>*OPC?</code>, this command can be blocked until event/status “IsSourceSweeping” occurs, and then returns. Doing so can help a script query the armed status only once during the time interval of the initiation. As an ancillary to the existing <code>:SOUR:LIST:TRIGGER[:IMMediate]</code> (see "Initiate Sequence" on page 1030), send this query after <code>:SOUR:LIST:TRIG</code>. Otherwise, this query will return “1” immediately</p> <p>The return data is in the following format: Integer</p> <p>There is an alias: <code>:SOURCE:LIST:TRIGGER:INITiation:ARMed?</code></p>
Dependencies	Not available in E7760B

6.1.9 Frequency Setup

Lets you access the Frequency Setup sub-menu panel.

Notes	The menu under this control is for independent mode and has no effect on the "List Sequencer" on page 1029 . If "Sequencer" on page 1030 is ON , the List Sequencer controls the source output and this key is grayed-out, to indicate out-of-scope. When "Sequencer" on page 1030 is OFF , source leaves List Sequencer and this button is blanked out
-------	---

6.1.9.1 Frequency

Lets you set the RF Output Frequency. You can adjust the frequency of the source using the numeric keypad, step keys, or RPG. Pressing any digit (0 through 9) on the

6 Input/Output
6.1 RF Source

numeric keypad displays the unit terminator.

Remote Command	:SOURce:FREQuency[:CW] <freq> :SOURce:FREQuency[:CW]?	
Example	:SOUR:FREQ 1.00 GHz	
Notes	Internal source has list sequence mode, which comprises of several steps that contain separate output power, frequency and waveform etc. When the source list sequence playing is complete, the last step keeps playing, and you can use this command to change the list sequence last step's output frequency	
Couplings	The frequency value is coupled to the current channel band and number, such that updates to the band and number will update the frequency value to the corresponding absolute frequency	
Preset	E7760B	Depends on port selected
	EXM, with license F1A or 5WC	2.412 GHz
	VXT Models with Radio Heads/CIU	See " VXT Models with Remote Radio Heads/CIU " on page 1056
	M941xE(VXT Models with M9471A)	See " M941xE(VXT Models with M9471A) " on page 1056
	All other models	1.00 GHz
Min	E7760B	Depends on port selected
	VXT model M9420A	60 MHz
	VXT models M9410A/11A/15A/16A	380 MHz
	VXT model M9411A with Option LFE	1 MHz
	VXT Models with Radio Heads/CIU	See " VXT Models with Remote Radio Heads/CIU " on page 1056
	M941xE(VXT Models with M9471A)	See " M941xE(VXT Models with M9471A) " on page 1056
	All other models	10.00 MHz
Max	Hardware Dependent:	
	Option 503	3.6 GHz
	Option 504	3.8 GHz
	Option 506	6.00 GHz
	Option F06	6.00 GHz
	Parameters for " VXT models M9415A/16A " on page 1056	
	Parameters for " VXT Models with Remote Radio Heads/CIU " on page 1056	
	Parameters for " M941xE(VXT Models with M9471A) " on page 1056	
	For E7760B: Depends on port selected	
	For EXM, if license 5WC is present, the frequency range should be limited to: 1.1GHz-1.7GHz, 2.4GHz-2.5GHz, 4.8GHz-6.0GHz. If the user-defined frequency is outside of range, reports error message "Settings conflict; Frequency is outside available range"	

VXT models M9410A/11A

RF Output Port	Preset	Min Without Option “LFE”	Min With Option “LFE”	Max
RF Output	1 GHz	380 MHz	1 MHz	6 GHz
RFHD	1 GHz	380 MHz	1 MHz	6 GHz

VXT models M9415A/16A

Freq Option	Preset	Min	Max
F06	1 GHz	380 MHz	6.0 GHz
F08	1 GHz	380 MHz	8.0 GHz
F12	1 GHz	380 MHz	12.3 GHz

E7760B

RF Output Port	Preset	Min	Max
IFIO	16 GHz	2 GHz	18 GHz
M1650A	58.32 GHz	55 GHz	69 GHz
M1720A	28 GHz	25 GHz	29 GHz

VXT Models with Remote Radio Heads/CIU

Products with Radio Heads/CIU	Preset	Min frequency	Max frequency
VXT + CIU	6 GHz	5.9 GHz	12 GHz
VXT + CIU + RRH	28 GHz	24.25 GHz	43.5 GHz
VXT + M1742A RRH	28 GHz	10 GHz	32 GHz

M941xE(VXT Models with M9471A)

Products with M9471A	Preset	Minimum settable frequency	Minimum frequency with Spec	Maximum settable frequency
M941xE without LFE option	1 GHz	330 MHz	380MHz	26.5GHz
M941xE with LFE option (LFE option in M9411A or M9471A)	1 GHz	750 kHz	1MHz	26.5GHz

NOTE

The minimum spec frequency is 380 MHz, minimum settable center frequency is 330 MHz.

With Option LFE in M9411A or in M9471A, the minimum settable frequency is 750 kHz, but Spec to customer only ensure down to 1 MHz.

6.1.9.2 Channel

The frequency of the source can be specified by a channel number of a given frequency band. This control allows you to specify the current channel number. For the appropriate range of channel numbers for a given frequency band, see the following tables: ["GSM/EDGE Channel Number Ranges" on page 1057](#), ["W-CDMA Channel Number Ranges" on page 1058](#), ["LTE FDD Channel Number Ranges" on page 1059](#), and ["LTE TDD Channel Number Ranges" on page 1061](#).

Channel is not available on E7760B.

Remote Command	:SOURce:FREQuency:CHANnels:NUMBER <int>
Example	:SOUR:LIST:STEP2:SET:RAD:NUMB 1
Notes	Grayed-out when the "Radio Standard/Radio Band" on page 1062 is set to NONE
Couplings	The channel number is coupled to the frequency value when "Radio Standard/Radio Band" on page 1062 is not set to NONE When the frequency value is changed, the channel number increases or decreases to match the new frequency. If the frequency is not at an exact match for a channel number, the nearest channel number is displayed, with > or < indicating whether the frequency is above or below the channel number
Preset	1
Min/Max	See "GSM/EDGE Channel Number Ranges" on page 1057 , "W-CDMA Channel Number Ranges" on page 1058 , "LTE FDD Channel Number Ranges" on page 1059 , and "LTE TDD Channel Number Ranges" on page 1061

GSM/EDGE Channel Number Ranges

Band	Link (Device)	Range	Frequency (MHz)
P-GSM	Uplink (MS)	1 £ n £ 124	890.0 + 0.2*n
	Downlink (BS)	1 £ n £ 124	935.0 + 0.2*n
E-GSM	Uplink (MS)	0 £ n £ 124	890.0 + 0.2*n
		975 £ n £ 1023	890.0 + 0.2*(n-1024)
	Downlink (BS)	0 £ n £ 124	935.0 + 0.2*n
DCS 1800	Uplink (MS)	512 £ n £ 885	1710.200 + 0.20*(n-512)
		1805.200 + 0.20*(n-512)	
	Downlink (BS)	512 £ n £ 885	1805.200 + 0.20*(n-512)
PCS 1900	Uplink (MS)	512 £ n £ 810	1850.200 + 0.2*(n-512)
	Downlink (BS)	512 £ n £ 810	1930.200 + 0.2*(n-512)
R-GSM	Uplink (MS)	0 £ n £ 124	890.0 + 0.2*n
		955 £ n £ 1023	890.0 + 0.2*(n-1024)
	Downlink (BS)	0 £ n £ 124	935.0 + 0.2*n

Band	Link (Device)	Range	Frequency (MHz)
GSM 450	Uplink (MS)	955 £ n £ 1023	935.0 + 0.2*(n-1024)
	Downlink (BS)	256 £ n £ 293	450.6 + 0.2*(n-259)
GSM 480	Uplink (MS)	256 £ n £ 293	460.6 + 0.2*(n-259)
	Downlink (BS)	306 £ n £ 340	479.000 + 0.20*(n-306)
GSM 850	Uplink (MS)	306 £ n £ 340	489.000 + 0.20*(n-306)
	Downlink (BS)	128 £ n £ 251	824.200 + 0.20*(n-128)
GSM 700	Uplink (MS)	128 £ n £ 251	869.200 + 0.20*(n-128)
	Downlink (BS)	438 £ n £ 516	777.200 + 0.20*(n-438)
T-GSM810	Uplink (MS)	438 £ n £ 516	747.200 + 0.20*(n-438)
	Downlink (BS)	350 £ n £ 425	806.0 + 0.20*(n-350)
		350 £ n £ 425	851.0 + 0.20*(n-350)

W-CDMA Channel Number Ranges

Band	Link (Device)	Range	Frequency (MHz)
Band I	Downlink	10562 £ n £ 10838	n÷5
	Uplink	9612 £ n £ 9888	n÷5
Band II	Downlink	412 £ n £ 687	n÷5 + 1850.1
		9662 £ n £ 9938	n÷5
	Uplink	12 £ n £ 287	n÷5 + 1850.1
		350 £ n £ 425	n÷5
Band III	Downlink	1162 ≤ n ≤ 1513	n÷5 + 1575
	Uplink	937 ≤ n ≤ 1288	n÷5 + 1525
Band IV	Downlink	537 ≤ n ≤ 1738	n÷5 + 1805
		1887 ≤ n ≤ 2087	n÷5 + 1735.1
	Uplink	1312 ≤ n ≤ 1513	n÷5 + 1450
		1662 ≤ n ≤ 1862	n÷5 + 1380.1
Band V	Downlink	1007 ≤ n ≤ 1087	n÷5 + 670.1
		4357 ≤ n ≤ 4458	n÷5
	Uplink	782 ≤ n ≤ 862	n÷5 + 670.1
		4132 ≤ n ≤ 4233	n÷5
Band VI	Downlink	1037 ≤ n ≤ 1062	n÷5 + 670.1
		4387 ≤ n ≤ 4413	n÷5
	Uplink	812 ≤ n ≤ 837	n÷5 + 670.1
		4162 ≤ n ≤ 4188	n÷5
Band VII	Downlink	2237 ≤ n ≤ 2563	n÷5 + 2175
		2587 ≤ n ≤ 2912	n÷5 + 2105.1

6 Input/Output
6.1 RF Source

Band	Link (Device)	Range	Frequency (MHz)
	Uplink	2012 ≤ n ≤ 2338	n ÷ 5 + 2100
		2362 ≤ n ≤ 2687	n ÷ 5 + 2030.1
Band VIII	Downlink	2937 ≤ n ≤ 3088	n ÷ 5 + 340
		Uplink	2712 ≤ n ≤ 2863
Band IX	Downlink	9237 ≤ n ≤ 9387	n ÷ 5
		Uplink	8762 ≤ n ≤ 8912
Band X	Downlink	3112 ≤ n ≤ 3388	n ÷ 5 + 1490
		3412 ≤ n ≤ 3687	n ÷ 5 + 1430.1
	Uplink	2887 ≤ n ≤ 3163	n ÷ 5 + 1135
Band XI	Downlink	3187 ≤ n ≤ 3462	n ÷ 5 + 1075.1
		3712 ≤ n ≤ 3812	n ÷ 5 + 736
	Uplink	3487 ≤ n ≤ 3587	n ÷ 5 + 733
Band XII	Downlink	3837 ≤ n ≤ 3903	n ÷ 5 - 37
		3927 ≤ n ≤ 3992	n ÷ 5 - 54.9
	Uplink	3612 ≤ n ≤ 3678	n ÷ 5 - 22
		3702 ≤ n ≤ 3767	n ÷ 5 - 39.9
Band XIII	Downlink	4017 ≤ n ≤ 4043	n ÷ 5 - 55
		4067 ≤ n ≤ 4092	n ÷ 5 - 64.9
	Uplink	3792 ≤ n ≤ 3818	n ÷ 5 + 21
		3702 ≤ n ≤ 3767	n ÷ 5 - 39.9
Band XIV	Downlink	4117 ≤ n ≤ 4143	n ÷ 5 - 63
		4167 ≤ n ≤ 4192	n ÷ 5 - 72.9
	Uplink	3892 ≤ n ≤ 3918	n ÷ 5 + 12
Band XIX	Downlink	3942 ≤ n ≤ 3967	n ÷ 5 + 2.1
		712 ≤ n ≤ 763	n ÷ 5 + 735
		787 ≤ n ≤ 837	n ÷ 5 + 720.1
	Uplink	312 ≤ n ≤ 363	n ÷ 5 + 770
		387 ≤ n ≤ 437	n ÷ 5 + 755.1

LTE FDD Channel Number Ranges

The carrier frequency in the uplink and downlink is designated by the E-UTRA Absolute Radio Frequency Channel Number (EARFCN) in the range 0 - 65535. The relation between EARFCN and the carrier frequency in MHz for the downlink is given by the following equation, where F_{DL_low} and $N_{Offs-DL}$ are given in table 5.4.4-1 and N_{DL} is the downlink EARFCN.

$$F_{DL} = F_{DL_low} + 0.1(N_{DL} - N_{Offs-DL})$$

The relation between EARFCN and the carrier frequency in MHz for the uplink is given by the following equation where F_{UL_low} and $N_{Offs-UL}$ are given in table 5.4.4-1 and N_{UL} is the uplink EARFCN.

$$F_{UL} = F_{UL_low} + 0.1(N_{UL} - N_{Offs-UL})$$

Band	Downlink			Uplink		
	F_{DL_low} (MHz)	$N_{Offs-DL}$	Range of N_{DL}	F_{UL_low} (MHz)	$N_{Offs-UL}$	Range of N_{UL}
1	2110	0	0 – 599	1920	18000	18000 – 18599
2	1930	600	600 – 1199	1850	18600	18600 – 19199
3	1805	1200	1200 – 1949	1710	19200	19200 – 19949
4	2110	1950	1950 – 2399	1710	19950	19950 – 20399
5	869	2400	2400 – 2649	824	20400	20400 – 20649
6	875	2650	2650 – 2749	830	20650	20650 – 20749
7	2620	2750	2750 – 3449	2500	20750	20750 – 20449
8	925	3450	3450 – 3799	880	21450	21450 – 21799
9	1844.9	3800	3800 – 4149	1749.9	21800	21800 – 22149
10	2110	4150	4150 – 4749	1710	22150	22150 – 22749
11	1475.9	4750	4750 – 4949	1427.9	22750	22750 – 22949
12	729	5010	5010 – 5179	699	23010	23010 – 23179
13	746	5180	5180 – 5279	777	23180	23180 – 23279
14	758	5280	5280 – 5379	788	23280	23280 – 23379
...						
17	734	5730	5730 – 5849	704	23730	23730 – 23849
18	860	5850	5850 – 5999	815	23850	23850 – 23999
19	875	6000	6000 – 6149	830	24000	24000 – 24149
20	791	6150	6150 – 6449	832	24150	24150 – 24449
21	1495.9	6450	6450 – 6599	1447.9	24450	24450 – 24599
...						
24	1525	7700	7700 – 8039	1626.5	25700	25700 – 26039
25	1930	8040	8040 – 8689	1850	26040	26040 – 26689
26	859	8690	8690 – 9039	814	26690	26690 – 27039
...						

Note: The channel numbers that designate carrier frequencies so close to the operating band edges that the carrier extends beyond the operating band edge shall not be used. This implies that the first 7, 15, 25, 50, 75 and 100 channel numbers at the lower operating band edge and the last 6, 14, 24, 49, 74 and 99 channel numbers at the upper operating band edge shall not be used for channel bandwidths of 1.4, 3, 5, 10, 15 and 20 MHz respectively.

LTE TDD Channel Number Ranges

The carrier frequency in the uplink and downlink is designated by the E-UTRA Absolute Radio Frequency Channel Number (EARFCN) in the range 0 - 65535. The relation between EARFCN and the carrier frequency in MHz for the downlink is given by the following equation, where F_{DL_low} and $N_{Offs-DL}$ are given in table 5.4.4-1 and N_{DL} is the downlink EARFCN.

$$F_{DL} = F_{DL_low} + 0.1(N_{DL} - N_{Offs-DL})$$

The relation between EARFCN and the carrier frequency in MHz for the uplink is given by the following equation where F_{UL_low} and $N_{Offs-UL}$ are given in table 5.4.4-1 and N_{UL} is the uplink EARFCN.

$$F_{UL} = F_{UL_low} + 0.1(N_{UL} - N_{Offs-UL})$$

Band	Downlink			Uplink		
	F_{DL_low} (MHz)	$N_{Offs-DL}$	Range of N_{DL}	F_{UL_low} (MHz)	$N_{Offs-UL}$	Range of N_{UL}
33	1900	36000	36000 - 36199	1900	36000	36000 - 36199
34	2010	36200	36200 - 36349	2010	36200	36200 - 36349
35	1850	36350	36350 - 36949	1850	36350	36350 - 36949
36	1930	36950	36950 - 37549	1930	36950	36950 - 37549
37	1910	37550	37550 - 37749	1910	37550	37550 - 37749
38	2570	37750	37750 - 38249	2570	37750	37750 - 38249
39	1880	38250	38250 - 38649	1880	38250	38250 - 38649
40	2300	38650	38650 - 39649	2300	38650	38650 - 39649
41	2496	39650	39650 - 41589	2496	39650	39650 - 41589
42	3400	41590	41590 - 43589	3400	41590	41590 - 43589
43	3600	43590	43590 - 45589	3600	43590	43590 - 45589

Note: The channel numbers that designate carrier frequencies so close to the operating band edges that the carrier extends beyond the operating band edge shall not be used. This implies that the first 7, 15, 25, 50, 75 and 100 channel numbers at the lower operating band edge and the last 6, 14, 24, 49, 74 and 99 channel numbers at the upper operating band edge shall not be used for channel bandwidths of 1.4, 3, 5, 10, 15 and 20 MHz respectively.

6.1.9.3 Radio Setup

Lets you select the radio standard and associated radio band. You can also set the Radio Band Link to Uplink or Downlink.

Radio Standard/Radio Band

Lets you select the radio standard and associated radio band. The first column in the dialog lets you set the Radio Standard; for each standard, and the second column in the dialog changes to show you the available bands.

Once you have selected the radio standard, you can then set an active channel band. The radio standard and the active channel band allow you to use the ["Channel" on page 1057](#) control to set Channel numbers, thus setting ["Frequency" on page 1054](#) automatically.

Remote Command	<pre>:SOURce:FREQuency:CHANnels:BAND <band></pre> <p>where <band> is one of:</p> <p>NONE PGSM EGSM RGSM DCS1800 PCS1900 GSM450 GSM480 GSM700 GSM850 TGSM810 USCELL USPCS JAPAN KOREAN NMT IMT2K UPPER SECOND PAMR400 PAMR800 IMTEXT PCS1DOT9G AWS US2DOT5G PUBLIC LOWER BANDI BANDII BANDIII BANDIV BANDV BANDVI BANDVII BANDVIII BANDIX BANDX BANDXI BANDXII BANDXIII BANDXIV BANDXIX BAND1 BAND2 BAND3 BAND4 BAND5 BAND6 BAND7 BAND8 BAND9 BAND10 BAND11 BAND12 BAND13 BAND14 BAND17 BAND18 BAND19 BAND20 BAND21 BAND24 BAND25 BAND26 BAND27 BAND28 BAND29 BAND30 BAND31 BAND65 BAND66 BAND67 BAND68 BAND71 BAND252 BAND255 BAND33 BAND34 BAND35 BAND36 BAND37 BAND38 BAND39 BAND40 BAND41 BAND42 BAND43 BAND44 BAND45 BAND46 BANDA BANDB BANDC BANDD BANDE BANDF N1 N2 N3 N5 N7 N8 N12 N20 N25 N28 N34 N38 N39 N40 N41 N50 N51 N66 N70 N71 N74 N75 N76 N77 N78 N79 N80 N81 N82 N83 N84 N86 N257 N258 N260 N261</p> <pre>:SOURce:FREQuency:CHANnels:BAND?</pre>
Example	<pre>:SOUR:LIST:STEP2:SET:RAD:BAND PGSM</pre>
Notes	<p>Setting this to NONE grays-out "Channel" on page 1057 under Frequency Setup</p> <p>Here are the members of each group in Radio Standard and a SCPI example for each:</p> <p>None – no Radio Standard</p> <p>None <code>:SOUR:FREQ:CHAN:BAND NONE</code></p> <p>GSM</p> <p>Sets GSM/EDGE as the radio standard for use and accesses the GSM/EDGE specific channel band sub-menus.</p> <p>P-GSM <code>:SOUR:FREQ:CHAN:BAND PGSM</code></p> <p>E-GSM <code>:SOUR:FREQ:CHAN:BAND EGSM</code></p> <p>R-GSM <code>:SOUR:FREQ:CHAN:BAND RGSM</code></p> <p>DCS 1800 <code>:SOUR:FREQ:CHAN:BAND DCS1800</code></p>

6 Input/Output

6.1 RF Source

PCS 1900	:SOUR:FREQ:CHAN:BAND PCS1900
GSM 450	:SOUR:FREQ:CHAN:BAND GSM450
GSM 480	:SOUR:FREQ:CHAN:BAND GSM480
GSM 700	:SOUR:FREQ:CHAN:BAND GSM700
GSM 850	:SOUR:FREQ:CHAN:BAND GSM850
T-GSM 810	:SOUR:FREQ:CHAN:BAND T-GSM810

W-CDMA

Sets WCDMA as the radio standard for use and accesses the W-CDMA specific channel band sub-menus.

Band I	:SOUR:FREQ:CHAN:BAND BANDI
Band II	:SOUR:FREQ:CHAN:BAND BANDII
Band III	:SOUR:FREQ:CHAN:BAND BANDIII
Band IV	:SOUR:FREQ:CHAN:BAND BANDIV
Band V	:SOUR:FREQ:CHAN:BAND BANDV
Band VI	:SOUR:FREQ:CHAN:BAND BANDVI
Band VII	:SOUR:FREQ:CHAN:BAND BANDVII
Band VIII	:SOUR:FREQ:CHAN:BAND BANDVIII
Band IX	:SOUR:FREQ:CHAN:BAND BANDIX
Band X	:SOUR:FREQ:CHAN:BAND BANDX
Band XI	:SOUR:FREQ:CHAN:BAND BANDXI
Band XII	:SOUR:FREQ:CHAN:BAND BANDXII
Band XIII	:SOUR:FREQ:CHAN:BAND BANDXIII
Band XIV	:SOUR:FREQ:CHAN:BAND BANDXIV
Band XIX	:SOUR:FREQ:CHAN:BAND BANDXIX

LTE

Sets LTE FDD as the radio standard for use and accesses the LTE FDD specific channel band sub-menus.

Band 1	:SOUR:FREQ:CHAN:BAND BAND1
Band 2	:SOUR:FREQ:CHAN:BAND BAND2
Band 3	:SOUR:FREQ:CHAN:BAND BAND3
Band 4	:SOUR:FREQ:CHAN:BAND BAND4
Band 5	:SOUR:FREQ:CHAN:BAND BAND5
Band 6	:SOUR:FREQ:CHAN:BAND BAND6
Band 7	:SOUR:FREQ:CHAN:BAND BAND7
Band 8	:SOUR:FREQ:CHAN:BAND BAND8

Band 9	: SOUR : FREQ : CHAN : BAND BAND9
Band 10	: SOUR : FREQ : CHAN : BAND BAND10
Band 11	: SOUR : FREQ : CHAN : BAND BAND11
Band 12	: SOUR : FREQ : CHAN : BAND BAND12
Band 13	: SOUR : FREQ : CHAN : BAND BAND13
Band 14	: SOUR : FREQ : CHAN : BAND BAND14
Band 17	: SOUR : FREQ : CHAN : BAND BAND17
Band 18	: SOUR : FREQ : CHAN : BAND BAND18
Band 19	: SOUR : FREQ : CHAN : BAND BAND19
Band 20	: SOUR : FREQ : CHAN : BAND BAND20
Band 21	: SOUR : FREQ : CHAN : BAND BAND21
Band 24	: SOUR : FREQ : CHAN : BAND BAND24
Band 25	: SOUR : FREQ : CHAN : BAND BAND25
Band 26	: SOUR : FREQ : CHAN : BAND BAND26
Band 27	: SOUR : FREQ : CHAN : BAND BAND27
Band 28	: SOUR : FREQ : CHAN : BAND BAND28
Band 29	: SOUR : FREQ : CHAN : BAND BAND29
Band 30	: SOUR : FREQ : CHAN : BAND BAND30
Band 31	: SOUR : FREQ : CHAN : BAND BAND31
Band 65	: SOUR : FREQ : CHAN : BAND BAND65
Band 66	: SOUR : FREQ : CHAN : BAND BAND66
Band 67	: SOUR : FREQ : CHAN : BAND BAND67
Band 68	: SOUR : FREQ : CHAN : BAND BAND68
Band 71	: SOUR : FREQ : CHAN : BAND BAND71
Band 252	: SOUR : FREQ : CHAN : BAND BAND252
Band 255	: SOUR : FREQ : CHAN : BAND BAND255

LTE TDD

Sets LTE TDD as the radio standard for use and accesses the LTE TDD specific channel band sub-menus.

Band 33	: SOUR : FREQ : CHAN : BAND BAND33
Band 34	: SOUR : FREQ : CHAN : BAND BAND34
Band 35	: SOUR : FREQ : CHAN : BAND BAND35
Band 36	: SOUR : FREQ : CHAN : BAND BAND36
Band 37	: SOUR : FREQ : CHAN : BAND BAND37
Band 38	: SOUR : FREQ : CHAN : BAND BAND38
Band 39	: SOUR : FREQ : CHAN : BAND BAND39

6 Input/Output
6.1 RF Source

Band 40	:SOUR:FREQ:CHAN:BAND BAND40
Band 41	:SOUR:FREQ:CHAN:BAND BAND41
Band 42	:SOUR:FREQ:CHAN:BAND BAND42
Band 43	:SOUR:FREQ:CHAN:BAND BAND43
Band 44	:SOUR:FREQ:CHAN:BAND BAND44
Band 45	:SOUR:FREQ:CHAN:BAND BAND45
Band 46	:SOUR:FREQ:CHAN:BAND BAND46

5G NR

Sets 5G NR as the radio standard for use and accesses the 5G NR specific channel band sub-menus.

N 1	:SOUR:FREQ:CHAN:BAND N1
N 2	:SOUR:FREQ:CHAN:BAND N2
N 3	:SOUR:FREQ:CHAN:BAND N3
N 5	:SOUR:FREQ:CHAN:BAND N5
N 7	:SOUR:FREQ:CHAN:BAND N7
N 8	:SOUR:FREQ:CHAN:BAND N8
N 12	:SOUR:FREQ:CHAN:BAND N12
N 20	:SOUR:FREQ:CHAN:BAND N20
N 25	:SOUR:FREQ:CHAN:BAND N25
N 28	:SOUR:FREQ:CHAN:BAND N28
N 34	:SOUR:FREQ:CHAN:BAND N34
N 38	:SOUR:FREQ:CHAN:BAND N38
N 39	:SOUR:FREQ:CHAN:BAND N39
N 40	:SOUR:FREQ:CHAN:BAND N40
N 41	:SOUR:FREQ:CHAN:BAND N41
N 50	:SOUR:FREQ:CHAN:BAND N50
N 51	:SOUR:FREQ:CHAN:BAND N51
N 66	:SOUR:FREQ:CHAN:BAND N66
N 70	:SOUR:FREQ:CHAN:BAND N70
N 71	:SOUR:FREQ:CHAN:BAND N71
N 74	:SOUR:FREQ:CHAN:BAND N74
N 75	:SOUR:FREQ:CHAN:BAND N75
N 76	:SOUR:FREQ:CHAN:BAND N76
N 77	:SOUR:FREQ:CHAN:BAND N77
N 78	:SOUR:FREQ:CHAN:BAND N78
N 79	:SOUR:FREQ:CHAN:BAND N79
N 80	:SOUR:FREQ:CHAN:BAND N80

N 81	:SOUR:FREQ:CHAN:BAND N81
N 82	:SOUR:FREQ:CHAN:BAND N82
N 83	:SOUR:FREQ:CHAN:BAND N83
N 84	:SOUR:FREQ:CHAN:BAND N84
N 86	:SOUR:FREQ:CHAN:BAND N86
N 257	:SOUR:FREQ:CHAN:BAND N257
N 258	:SOUR:FREQ:CHAN:BAND N258
N 260	:SOUR:FREQ:CHAN:BAND N260
N 261	:SOUR:FREQ:CHAN:BAND N261

Radio Band Link

Lets you specify the channel band type as either uplink or downlink link direction. This value is used in conjunction with the channel band and channel number to determine the absolute frequency output by the source.

- When set to **Uplink (UP)**, the source calculates the uplink frequency using an uplink formula together with the selected channel band and channel number
- When set to **Downlink (DOWN)** the source calculates the downlink frequency using a downlink formula together with the selected channel band and channel number

Remote Command	:SOURce:RADio:BAND:LINK DOWN UP :SOURce:RADio:BAND:LINK?
Example	:SOUR:RAD:BAND:LINK UP
Preset	DOWN
Range	DOWN UP
Backwards Compatibility SCPI	:SOURce:RADio:DEVIce BTS MS :SOURce:RADio:DEVIce?
Backwards Compatibility Notes	DOWN = BTS UP = MS

6.1.9.4 Set Reference Frequency

Lets you set the frequency reference. Pressing this control turns the frequency reference state to **ON**, sets the reference frequency value to the current frequency, maintains this frequency at the RF output, and sets the displayed frequency to 0.00 Hz. All subsequent frequencies entered under Source>Frequency>Frequency are interpreted as being relative to this reference frequency.

6 Input/Output
6.1 RF Source

When you use a frequency reference, the signal generator outputs a frequency that is set relative to the reference frequency by the value entered under **Source, Frequency, Frequency** as follows:

Output frequency = reference frequency - entered frequency

Where:

- reference frequency equals the original RF frequency entered under **Source>Frequency>Frequency** and set as the reference frequency
- entered frequency equals a new value entered under **Source, Frequency, Frequency**

In addition, the displayed frequency value will be the same as the value entered under **Source>Frequency>Frequency**.

NOTE

If **Freq Reference** is **ON** with a reference value set, entering a value under **Source, Frequency, Frequency** and pressing **Set Frequency Reference** adds that value to the existing **Freq Reference** value.

If you wish to change the reference frequency value to the new value entered under **Source, Frequency, Frequency**, first set **Freq Reference** **OFF** then press **Set Frequency Reference**.

Remote Command	: SOUR ce: FREQ uency: REF erence: SET
Example	: SOUR : FREQ : REF : SET
Dependencies	Unavailable, and grayed-out, when List Sequencer is ON

6.1.9.5 Freq Reference

Lets you toggle the state of the frequency reference. When the frequency reference state is **ON**, an annunciator is displayed on the main source view to indicate this state to the user.

When you use a frequency reference, the signal generator outputs a frequency that is set relative to the reference frequency by the value entered under **Source, Frequency, Frequency** as follows:

Output frequency = reference frequency + entered frequency

Where:

- reference frequency equals the original RF frequency entered under **Source, Frequency, Frequency** and set as the reference frequency
- entered frequency equals a new value entered under **Source, Frequency, Frequency**

For more information on Reference Frequency, see ["Set Reference Frequency" on page 1066](#).

Remote Command	<code>:SOURce:FREQuency:REFerence <freq></code> <code>:SOURce:FREQuency:REFerence?</code>						
Example	<code>:SOUR:FREQ:REF 0.00 Hz</code>						
Dependencies	Unavailable, and grayed-out, when List Sequencer is ON						
Couplings	The frequency reference state is coupled to the frequency reference set immediate action. When the reference set immediate action key is pressed, or the SCPI command issued, it turns the frequency reference state ON						
Preset	0.00 Hz						
Min	0.00 Hz						
Max	Hardware Dependent: <table border="1" data-bbox="406 772 1404 903"> <tr> <td>Option 503</td> <td>3.6 GHz</td> </tr> <tr> <td>Option 504</td> <td>3.8 GHz</td> </tr> <tr> <td>Option 506</td> <td>6.00 GHz</td> </tr> </table> For E7760B: Dependent on port selected Auto Function	Option 503	3.6 GHz	Option 504	3.8 GHz	Option 506	6.00 GHz
Option 503	3.6 GHz						
Option 504	3.8 GHz						
Option 506	6.00 GHz						
Remote Command	<code>:SOURce:FREQuency:REFerence:STATe OFF ON 0 1</code> <code>:SOURce:FREQuency:REFerence:STATe?</code>						
Example	<code>:SOUR:FREQ:REF:STATe ON</code>						
Preset	OFF						

6.1.9.6 Freq Offset

Lets you specify the frequency offset value. When the frequency offset state is **ON**, an annunciator is displayed on the main source view to indicate this state.

When the frequency offset is set to zero (0) and you set a new offset value, the displayed frequency value changes as follows, and the RF output frequency does not change:

Displayed value = output frequency + offset value

Where:

- output frequency equals the original frequency entered under **Source, Frequency, Frequency**
- offset value equals the value entered under **Source, Frequency, Freq Offset**

6 Input/Output
 6.1 RF Source

When the frequency offset is set to a value other than zero (0) and you enter a new frequency value under **Source, Frequency, Frequency**, the displayed frequency will be the same as the value entered and the RF output frequency will be equal to the value entered minus the offset value as follows:

Output frequency = entered frequency – offset frequency

Displayed frequency = output frequency + offset frequency

Displayed frequency = entered frequency

Where:

- entered frequency equals the frequency entered under **Source, Frequency, Frequency**
- offset frequency equals the value previously entered and set under **Source, Frequency, Freq Offset**

Remote Command	<code>:SOURce:FREQuency:OFFSet <freq></code> <code>:SOURce:FREQuency:OFFSet?</code>
Example	<code>:SOUR:FREQ:OFFS 0 Hz</code>
Dependencies	Unavailable, and grayed-out, when List Sequencer is ON
Preset	0 Hz
Min/Max	-/+100.00 GHz

6.1.9.7 Freq Increment

Changes the step size for the RF Output Frequency function. Once an increment size has been selected and the RF Output Frequency function is active, the step keys (and the **UP | DOWN** parameters for RF Frequency from remote commands) change the RF Output Frequency by the increment set value.

This feature exists in EXG and MXG.

Remote Command	<code>:SOURce:FREQuency:STEP[:INCRement] <freq></code> <code>:SOURce:FREQuency:STEP[:INCRement]?</code>
Example	<code>:SOUR:FREQ:STEP 1.0 kHz</code>
Couplings	Coupled to the Step size of the RF Frequency function
Preset	Hardware Dependent. 10% of the span preset value
Min	1 Hz
Max	Hardware Dependent:
	Option 503 3.6 GHz
	Option 504 3.8 GHz

Option 506 6.00 GHz

For E7760B: Dependent on port selected

For EXM, if license 5WC is present, the frequency range should be limited to: 1.1GHz-1.7GHz, 2.4GHz-2.5GHz, 4.8GHz-6.0GHz. If the user-defined frequency is outside of range, reports error message "Settings conflict; Frequency is outside available range"

6.1.9.8 Rx/Tx Coupling

Allows coupling between the frequency of the Internal Source, RF Output Frequency, and the instrument Center Frequency. For all settings except **NONE**, this parameter couples the **Center Frequency** of the instrument to the RF Output Frequency of the source. Valid setting changes result in the Analyzer CF and RF Output Frequency parameters being set to the same value, plus the "Rx/Tx Offset" on page 1071.

The four states for coupling are:

SOURCE	Source follows Analyzer Coupling is in one direction only. Changes to the Center Frequency will result in the RF Output Frequency being set to the same value, with any Rx/Tx Frequency Offset applied. Changes to the RF Output Frequency will not change the Center Frequency and will change Rx/Tx Frequency Coupling to None
ANALYZER	Analyzer follows Source Coupling is in one direction only. Changes to the RF Output Frequency will result in the Center Frequency being set to the same value, with any Rx/Tx Frequency Offset applied. Changes to the Center Frequency will not change the RF Output Frequency and will change Rx/Tx Frequency Coupling to None
BOTH	Analyzer/Source Coupled Coupling is bi-directional. Changes to the Center Frequency will result in the RF Output Frequency being set to the same value, with any Rx/Tx Frequency Offset applied. Changes to the RF Output Frequency will result in the Center Frequency being set to the same value, with any Rx/Tx Frequency Offset applied
NONE	None RF Output Frequency and CF Frequency are independently controlled

Remote Command `:SOURCE:FREQUENCY:COUPLING NONE | BOTH | SOURCE | ANALYZER`
`:SOURCE:FREQUENCY:COUPLING?`

Example `:SOUR:FREQ:COUP BOTH`

Dependencies Only appears in Radio Test Mode

Preset **NONE**

Input/Output Preset

State Saved Yes

6.1.9.9 Rx/Tx Offset

Lets you offset the RF Output Frequency of the source from the **Center Frequency** of the instrument. See ["Rx/Tx Coupling" on page 1070](#) for coupling behavior.

Remote Command	<code>:SOURce:FREQuency:COUPling:OFFSet <freq></code> <code>:SOURce:FREQuency:COUPling:OFFSet?</code>						
Example	<code>:SOUR:FREQ:COUP:OFF 100 kHz</code>						
Dependencies	Grayed-out when "Rx/Tx Coupling" on page 1070 is set to NONE . If the grayed-out control is selected, the following message appears: "The parameter cannot be changed when Rx/Tx Coupling is Off" Only appears in Radio Test Mode						
Preset	0 Hz (Input/Output Preset)						
Min	-6 GHz						
Max	Hardware Dependent: <table border="1" data-bbox="406 903 1404 1039"> <tr> <td>Option 503</td> <td>3.6 GHz</td> </tr> <tr> <td>Option 504</td> <td>3.8 GHz</td> </tr> <tr> <td>Option 506</td> <td>6.00 GHz</td> </tr> </table> For E7760B: Dependent on port selected For E6640A, if license 5WC is present, the frequency range should be limited to: 1.1GHz-1.7GHz, 2.4GHz-2.5GHz, 4.8GHz-6.0GHz. If the user-defined frequency is outside of range, UI reports an error message: "Settings conflict; Frequency is outside available range"	Option 503	3.6 GHz	Option 504	3.8 GHz	Option 506	6.00 GHz
Option 503	3.6 GHz						
Option 504	3.8 GHz						
Option 506	6.00 GHz						

6.1.10 Modulation

Lets you toggle the state of modulation.

Remote Command	<code>:OUTPut:MODulation[:STATe] ON OFF 1 0</code> <code>:OUTPut:MODulation[:STATe]?</code>
Example	<code>:OUTP:MOD OFF</code>
Notes	This setting is for independent mode and has no effect on the "List Sequencer" on page 1029 . If Sequencer is ON , the List Sequencer controls the source output, and this key is grayed-out When Sequencer is OFF , source leaves List Sequencer, and this setting is blanked out, taking effect immediately When Modulation is ON , the "MOD" annunciator is displayed in the system settings panel. When Modulation is OFF , the "MOD" annunciator is cleared If Sequencer is ON , the "MOD" annunciator will be replaced by "SEQ" in the system settings panel, indicating that the output is controlled by List Sequencer

Preset	OFF
Range	ON OFF

6.1.11 Modulation Setup

Allows access to the menus for setting up the available modulation types.

Not available in E7760B.

AM/FM/PM are not available for VXT models M9415A/16A and M9415E/16E .

6.1.11.1 AM

Enables or disables amplitude modulation.

Turning **AMON** when another modulation format is already on results in the previous modulation format being turned off, and generates an error.

Remote Command	<code>:SOURce:AM:STATe ON OFF 1 0</code> <code>:SOURce:AM:STATe?</code>
Example	<code>:SOUR:AM:STAT OFF</code>
Dependencies	Not available in E7760B
Preset	OFF
Range	ON OFF

6.1.11.2 AM Mod Depth

Lets you set the amplitude modulation depth in percent.

Remote Command	<code>:SOURce:AM[:DEPTH][:LINear] <real></code> <code>:SOURce:AM[:DEPTH][:LINear]?</code>
Example	<code>:SOUR:AM 0.1</code>
Dependencies	Not available in E7760B
Preset	0.1 %
Min	0.1 %
Max	95.0 %

6.1.11.3 AM Rate

Lets you set the internal amplitude modulation rate.

6 Input/Output
6.1 RF Source

Remote Command	<code>:SOURce:AM:INTernal:FREQuency <freq></code> <code>:SOURce:AM:INTernal:FREQuency?</code>
Example	<code>:SOUR:AM:INT:FREQ 40.0 Hz</code>
Dependencies	Not available in E7760B
Preset	400.0 Hz
Min	10 Hz
Max	40 kHz

6.1.11.4 AM Rate Increment

Changes the step size for "AM Rate" on page 1072. Once an increment size has been selected and **AM Rate** is active, the step keys (and the **UP | DOWN** parameters for **AM Rate** from remote commands) change **AM Rate** by the increment value.

Remote Command	<code>:SOURce:AM:INTernal:FREQuency:STEP[:INCRement] <freq></code> <code>:SOURce:AM:INTernal:FREQuency:STEP[:INCRement]?</code>
Example	<code>:SOUR:AM:INT:FREQ:STEP 100 Hz</code> <code>:SOUR:AM:INT:FREQ:STEP?</code>
Couplings	Coupled to the increment size of AM Rate
Preset	10 Hz
State Saved	Yes
Min	1 Hz
Max	40 kHz

6.1.11.5 FM

Enables or disables frequency modulation.

Turning **FMON** when another modulation format is already on results in the previous modulation format being turned off and the generation of an error.

Remote Command	<code>:SOURce:FM:STATe ON OFF 1 0</code> <code>:SOURce:FM:STATe?</code>
Example	<code>:SOUR:FM:STAT OFF</code>
Dependencies	Not available in E7760B
Preset	OFF
Range	ON OFF

6.1.11.6 FM Deviation

Lets you set the frequency modulation deviation.

Remote Command	<code>:SOURce:FM[:DEVIation] <freq></code> <code>:SOURce:FM[:DEVIation]?</code>
Example	<code>:SOUR:FM 1.00 kHz</code>
Dependencies	Not available in E7760B
Preset	1.00 Hz
Min	1.00 Hz
Max	100.00 kHz

6.1.11.7 FM Rate

Lets you set the internal frequency modulation rate.

Remote Command	<code>:SOURce:FM:INTernal:FREQuency <freq></code> <code>:SOURce:FM:INTernal:FREQuency?</code>
Example	<code>:SOUR:FM:INT:FREQ 40.0 Hz</code>
Dependencies	Not available in E7760B
Preset	400.0 Hz
Min	10 Hz
Max	40 kHz

6.1.11.8 FM Rate Increment

Changes the step size for "FM Rate" on page 1074. Once an increment size has been selected and **FM Rate** is active, the step keys (and the **UP | DOWN** parameters for **FM Rate** from remote commands) change **FM Rate** by the increment value.

Remote Command	<code>:SOURce:FM:INTernal:FREQuency:STEP[:INCRement] <freq></code> <code>:SOURce:FM:INTernal:FREQuency:STEP[:INCRement]?</code>
Example	<code>:SOUR:FM:INT:FREQ:STEP 100 Hz</code> <code>:SOUR:FM:INT:FREQ:STEP?</code>
Couplings	Coupled to the increment size of FM Rate
Preset	10 Hz
State Saved	Yes
Min	1 Hz
Max	40 kHz

6.1.11.9 PM

Enables or disables phase modulation.

Turning **PMON** when another modulation format is already on results in the previous modulation format being turned **OFF** and the generation of an error.

Remote Command	<code>:SOURce:PM:STATe ON OFF 1 0</code> <code>:SOURce:PM:STATe?</code>
Example	<code>:SOUR:PM:STAT OFF</code>
Dependencies	Not available in E7760B
Preset	OFF
Range	ON OFF

6.1.11.10 PM Deviation

Lets you set the phase modulation deviation in radian.

Remote Command	<code>:SOURce:PM[:DEVIation] <real></code> <code>:SOURce:PM[:DEVIation]?</code>	
Example	<code>:SOUR:PM 1.00</code>	
Dependencies	Not available in E7760B	
Preset	0.1 rad	
Min	0.1 rad	
Max	Instrument Type	Value
	M9410A/11A	10.0 rad
	All Others	20.0 rad

6.1.11.11 PM Rate

Lets you set the internal phase modulation rate.

Remote Command	<code>:SOURce:PM:INTernal:FREQuency <freq></code> <code>:SOURce:PM:INTernal:FREQuency?</code>
Example	<code>:SOUR:PM:INT:FREQ 40.0 Hz</code>
Dependencies	Not available in E7760B
Preset	400.0 Hz

Min	10 Hz
Max	40 kHz

6.1.11.12 PM Rate Increment

Changes the step size for "PM Rate" on page 1075. Once an increment size has been selected and **PM Rate** is active, the step keys (and the **UP | DOWN** parameters for **PM Rate** from remote commands) change **PM Rate** by the increment value.

Remote Command	<code>:SOURce:PM:INTernal:FREQuency:STEP[:INCRement] <freq></code> <code>:SOURce:PM:INTernal:FREQuency:STEP[:INCRement]?</code>
Example	<code>:SOUR:PM:INT:FREQ:STEP 100 Hz</code> <code>:SOUR:PM:INT:FREQ:STEP?</code>
Couplings	Coupled to the increment size of PM Rate
Preset	10 Hz
State Saved	Yes
Min	1 Hz
Max	40 kHz

6.1.11.13 ARB Setup

Accesses menus for setting up the Arbitrary Waveform Generator.

Basic Control

Lets you set up the basic ARB parameters and select a waveform to play.

ARB State

Lets you toggle the state of the ARB function. When the ARB is **ON**, a "MOD" annunciator is displayed in the system settings panel. When the ARB is **OFF**, the MOD annunciator is cleared

Remote Command	<code>:SOURce:RADio:ARB[:STATe] ON OFF 1 0</code> <code>:SOURce:RADio:ARB[:STATe]?</code>
Example	<code>:SOUR:RAD:ARB OFF</code> <code>:SOUR:RAD:ARB?</code>
Notes	If ARB is ON , and you then load or delete another file to ARB memory, the playing waveform segment may not keep phase continuity during the ARB memory operation. The waveform will be replayed after the ARB operation is finished

6 Input/Output
6.1 RF Source

Dependencies	<p>This setting is for the independent mode, and has no effect on "List Sequencer" on page 1029. If Sequencer is ON, this will make the source enter List Sequencer mode, and even if ARB state is ON, the ARB file will not be played. When Sequencer is OFF, source leaves List Sequencer and this setting takes effect immediately</p> <p>The ARB can only be turned on when there is a waveform file selected for playback. On the GUI, If no waveform is selected, this key is grayed out. If you send the SCPI command to turn the ARB on with no waveform selected for playback, the ARB state remains OFF and an error is generated</p> <p>-If you try to recall a certain set of states in which the selected waveform is not in ARB memory and the ARB state is ON, errors are reported</p>
Preset	OFF
Range	ON OFF

Sample Rate

Lets you set the ARB waveform playback sample rate.

See "[More Information](#)" on page 1078

Remote Command	<pre>:SOURce:RADio:ARB:SCLock:RATE <freq></pre> <pre>:SOURce:RADio:ARB:SCLock:RATE?</pre>	
Example	<pre>:SOUR:RAD:ARB:SCL:RATE 48.00 MHz</pre>	
Notes	<p>If there is a sample rate specified in the header of the waveform file, changing that sample rate is not recommended, as it may cause problems with burst timing</p> <p>For E7760B, the Sample Rate is fixed. If this control is attempted to be set the error -221, "Settings conflict; Sample Rate is fixed" is generated</p>	
Dependencies	<p>When a new waveform is selected for playback the settings contained within the associated waveform header file are applied to the ARB. The sample rate is one of the values stored within the header file. If the newly selected waveform file has an associated header file, the sample rate is updated with the value from the header file. The sample rate will remain unchanged if the newly selected waveform does not have an associated header file</p>	
Preset		
	E7760B	2.64 GHz
	Option B40	50 MHz
	Option B85	100 MHz
	Option B1X	200 MHz
	Option B3X	375 MHz
	Option B6X	750 MHz
	Option B4X	500 MHz
	Option B8X	1.0 GHz
	Option B12	1.5 GHz

Min	E7760B: 2.64 GHz All Others: 1.00 kHz		
Max	Hardware Dependent:		
	E7760B		2.64 GHz
	VXT model M9420A	Option B40	50 MHz
		Option B85	100 MHz
		Option B1X	200 MHz
	VXT models M9410A/11A and M9410E/11E	Option B40	50 MHz
		Option B3X	375 MHz
		Option B6X	750 MHz
		Option B12	1.5 GHz
	VXT models M9415A/16A and M9415E/16E	Option B4X	500 MHz
		Option B8X	1.0 GHz
		Option B12	1.5 GHz

For VXT models M9410A/11A/15A/16A, M9410E/11E/15E/16E and E6680A/81A, the sample rate is only limited by the option, but the IF BW is limited by center frequency in addition to options. See ["More Information" on page 1078](#). Performance is guaranteed only when the bandwidth of the selected waveform is smaller than the Max IF BW

More Information

Although the range of Sample Rate only depends on the installed option, the Maximum IF BW depends on options as well as the Center Frequency.

VXT models M9410A/11A, E6680A and E6681A

Option Limitation:

Option	Maximum IF BW
B40	40 MHz
B3X	300 MHz
B6X	600 MHz
B12	1200 MHz

Center Frequency Limitation:

Center Frequency	Maximum IF BW
6.5 kHz ~ 9 kHz (Option LFE)	(CF - 6.5 kHz) * 2
9 kHz ~ 100 kHz (Option LFE)	5 kHz

6 Input/Output

6.1 RF Source

Center Frequency	Maximum IF BW
100 kHz ~ 1 MHz (Option LFE)	50 kHz
1 MHz ~ 10 MHz (Option LFE)	500 kHz
10 MHz ~ 20 MHz (Option LFE)	5 MHz
20 MHz ~ 60 MHz (Option LFE)	10 MHz
60 MHz ~ 80 MHz (Option LFE)	20 MHz
80 MHz ~ 380 MHz (Option LFE)	40 MHz
330 MHz ~ 380 MHz (without Option LFE)	(CF - 330 MHz) * 2
380 MHz ~ 550 MHz	100 MHz
550 MHz ~ 1310 MHz	200 MHz
1310 MHz ~ 2000 MHz (without Option EP6)	600 MHz
2000 MHz ~ 5480 MHz (without Option EP6)	1200 MHz
5480 MHz ~ 6080 MHz (without Option EP6)	(6080 MHz - CF) * 2
1310 MHz ~ 1900 MHz (Option EP6)	600 MHz
1900 MHz ~ 6000 MHz (Option EP6)	1200 MHz
6000 MHz ~ 6600 MHz (Option EP6)	(6600 MHz - CF) * 2

VXT models M9415A/16A

Option Limitation:

Option	Maximum IF BW
B4X	400 MHz
B8X	800 MHz
B12	1200 MHz

Center Frequency Limitation:

Center Frequency	Maximum IF BW
330 MHz ~ 380 MHz	(CF - 330 MHz) * 2
380 MHz ~ 550 MHz	100 MHz
550 MHz ~ 1310 MHz	200 MHz
1310 MHz ~ 2000 MHz	600 MHz
2000 MHz ~ 12300 MHz	1200 MHz
12300 MHz ~ 12900 MHz	(12900 MHz - CF) * 2

M9410E/11E

Option Limitation:

Option	Maximum IF BW
B40	40 MHz
B3X	300 MHz
B6X	600 MHz
B12	1200 MHz

Center Frequency Limitation:

Center Frequency	Maximum IF BW
1 MHz ~ 10 MHz (Option LFE)	500 kHz
10 MHz ~ 20 MHz (Option LFE)	5 MHz
20 MHz ~ 60 MHz (Option LFE)	10 MHz
60 MHz ~ 80 MHz (Option LFE)	20 MHz
80 MHz ~ 380 MHz (Option LFE)	40 MHz
330 MHz ~ 380 MHz (without Option LFE)	(CF - 330 MHz) * 2
380 MHz ~ 550 MHz	100 MHz
550 MHz ~ 1310 MHz	200 MHz
1310 MHz ~ 2000 MHz (without Option EP6)	600 MHz
2000 MHz ~ 25.9 GHz (without Option EP6)	1200 MHz
1310 MHz ~ 1900 MHz (Option EP6)	600 MHz
1900 MHz ~ 25.9 GHz (Option EP6)	1200 MHz
25.9 GHz ~ 26.5 GHz	Min(Max BW by option, 2*(26.5 GHz-Center Freq))

M9415E/16E

Option Limitation:

Option	Maximum IF BW
B4X	400 MHz
B8X	800 MHz
B12	1200 MHz

Center Frequency Limitation:

Center Frequency	Maximum IF BW
1 MHz ~ 10 MHz (Option LFE)	500 kHz
10 MHz ~ 20 MHz (Option LFE)	5 MHz
20 MHz ~ 60 MHz (Option LFE)	10 MHz
60 MHz ~ 80 MHz (Option LFE)	20 MHz
80 MHz ~ 380 MHz (Option LFE)	40 MHz

6 Input/Output
6.1 RF Source

Center Frequency	Maximum IF BW
330 MHz ~ 380 MHz (without Option LFE)	(CF - 330 MHz) * 2
380 MHz ~ 550 MHz	100 MHz
550 MHz ~ 1310 MHz	200 MHz
1310 MHz ~ 2000 MHz	600 MHz
2000 MHz ~ 25.9 GHz	1200 MHz
25.9 GHz ~ 26.5 GHz	Min(Max BW by option, 2*(26.5 GHz-Center Freq))

Run-Time Scaling

Lets you adjust the run-time scaling value. The run-time scaling value is applied in real-time while the waveform is playing.

Remote Command	<code>:SOURce:RADio:ARB:RSCaling <real></code> <code>:SOURce:RADio:ARB:RSCaling?</code>
Example	<code>:SOUR:RAD:ARB:RSC 100.00</code>
Notes	Cannot be set in EXM and VXT. Grayed-out in menu, and the value is fixed at 70.00%
Dependencies	When a new waveform is selected for playback the settings contained within the associated waveform header file are applied to the ARB. The run-time scaling is one of the values stored within the header file. If the newly selected waveform file has an associated header file, the run-time scaling is updated with the value from the header file. The run-time scaling will remain unchanged if the newly selected waveform does not have an associated header file
Preset	70.00 %
Min	1.00 %
Max	100.00 %

Baseband Freq Offs

Lets you adjust the value by which the baseband frequency is offset relative to the carrier.

Remote Command	<code>:SOURce:RADio:ARB:BASEband:FREQuency:OFFSet <freq></code> <code>:SOURce:RADio:ARB:BASEband:FREQuency:OFFSet?</code>
Example	<code>:SOUR:RAD:ARB:BAS:FREQ:OFFS 0.00 Hz</code>
Dependencies	When a new waveform is selected for playback the settings contained within the associated waveform header file are applied to the ARB. The baseband frequency offset is one of the values stored within the header file. If the newly selected waveform file has an associated header file, the baseband frequency offset is updated with the value from the header file. The baseband frequency offset will remain unchanged if the newly selected waveform does not have an associated header file Not available in E7760B

Preset	0.00 Hz
Min	-50.00 MHz
Max	50.00 MHz

Baseband Power

Lets you quickly control the power of the modulator prior to up-conversion to the RF carrier.

Remote Command	<code>:SOURce:RADio:ARB:BASEband:POWer <ampl></code> <code>:SOURce:RADio:ARB:BASEband:POWer?</code>
Example	<code>:SOUR:RAD:ARB:BAS:POW -10 dB</code>
Notes	The Source Power level equals RF Power plus Baseband Power. For example, if the RF Power is set to -10 dBm and the Baseband Power is set to -4 dB, the actual Source Power level is -14 dBm Can be used to change the output level very quickly compared to the RF Power
Dependencies	Only appears in VXT models M9410A/11A/15A/16A and M9410E/11E/15E/16E
Preset	0 dB
Min	-50 dB
Max	20 dB

Mkr 1-4 Polarity

Lets you set the polarity of markers 1 through 4 respectively.

Remote Command	<code>:SOURce:RADio:ARB:MPOLarity:MARKer1 ... 4 POSitive NEGative</code> <code>:SOURce:RADio:ARB:MPOLarity:MARKer1 ... 4?</code>
Example	<code>:SOUR:RAD:ARB:MPOL:MARK1 NEG</code>
Dependencies	When a new waveform is selected for playback the settings contained within the associated waveform header file are applied to the ARB. The marker polarity is one of the values stored within the header file. If the newly selected waveform file has an associated header file, the marker polarity is updated with the value from the header file. The marker polarity will remain unchanged if the newly selected waveform does not have an associated header file Not available in E7760B
Preset	<code>POSitive</code>
Range	<code>POSitive NEGative</code>

Pulse/RF Blank

Lets you select which marker is used for **Pulse/RF Blank**. This function blanks the RF when the marker signal goes low. The marker polarity determines when the

6 Input/Output

6.1 RF Source

marker signal is high. For a positive polarity, this is during the marker points. For a negative polarity, this is when there are no marker points.

Marker points should be set before using this function. Enabling this function without setting maker points may create a continuous low or high signal, dependent on the marker polarity. This causes either no RF output, or a continuous RF output.

Remote Command `:SOURce:RADio:ARB:MDEStination:PULSe NONE | M1 | M2 | M3 | M4`

For option details, see ["More Information" on page 1083](#)

`:SOURce:RADio:ARB:MDEStination:PULSe?`

Example `:SOUR:RAD:ARB:MDES:PULS NONE`

Dependencies When a new waveform is selected for playback the settings contained within the associated waveform header file are applied to the ARB. The **Pulse/RF Blank** setting is one of the values stored within the header file. If the newly selected waveform file has an associated header file, the **Pulse/RF Blank** setting is updated with the value from the header file. The **Pulse/RF Blank** setting remains unchanged if the newly selected waveform does not have an associated header file

Range `NONE | M1 | M2 | M3 | M4`

More Information

Parameter	SCPI	Notes
None	<code>NONE</code>	Sets no marker to be used for Pulse/RF Blank function, essentially turning the RF blanking function off
Marker 1	<code>M1</code>	Sets marker 1 to be used for Pulse/RF Blank
Marker 2	<code>M2</code>	Sets marker 2 to be used for Pulse/RF Blank
Marker 3	<code>M3</code>	Sets marker 3 to be used for Pulse/RF Blank
Marker 4	<code>M4</code>	Sets marker 4 to be used for Pulse/RF Blank

ALC Hold

Lets you specify which marker is routed for use within **ALC Hold**. This function holds the ALC circuitry at the average value of the sample points set by the marker.

ALC Hold operates during the low periods of the marker signal. The marker polarity determines when the marker signal is high. For positive polarity, this is during the marker points. For a negative polarity, this is when there are no maker points.

Remote Command `:SOURce:RADio:ARB:MDEStination:ALCHold NONE | M1 | M2 | M3 | M4`

For option details, see ["Option Details" on page 1084](#)

`:SOURce:RADio:ARB:MDEStination:ALCHold?`

Example `:SOUR:RAD:ARB:MDES:ALCH NONE`

Dependencies When a new waveform is selected for playback the settings contained within the associated waveform header file are applied to the ARB. The **ALC Hold** setting is one of the values stored within the header file. If the newly selected waveform file has an associated header file, the **ALC Hold** setting is updated

with the value from the header file. The **ALC Hold** setting remains unchanged if the newly selected waveform does not have an associated header file

Not available in E7760B, and VXT models M9410A/11A/15A/16A and M9410E/11E/15E/16E

Range [NONE](#) | [M1](#) | [M2](#) | [M3](#) | [M4](#)

Option Details

Parameter	SCPI	Notes
None	NONE	Use no marker for ALC Hold , essentially turning ALC Hold off
Marker 1	M1	Use marker 1 for ALC Hold
Marker 2	M2	Use marker 2 for ALC Hold
Marker 3	M3	Use marker 3 for ALC Hold
Marker 4	M4	Use marker 4 for ALC Hold

Trigger Type

Determines the behavior of the waveform when it plays.

Remote Command	:SOURce:RADio:ARB:TRIGger:TYPE CONTInuous SINGle SADVance :SOURce:RADio:ARB:TRIGger:TYPE?
Example	:SOUR:RAD:ARB:TRIG:TYPE CONT :SOUR:RAD:ARB:TRIG:TYPE?
Preset	CONTInuous
Range	Continuous Single Seg Adv

Continuous trigger

Sets the active trigger type to **Continuous**. If **Continuous** is already selected as the active trigger type, pressing this control allows access to the **Continuous trigger** type setup menu. In **Continuous** trigger mode, the waveform repeats continuously.

Remote Command	:SOURce:RADio:ARB:TRIGger:TYPE:CONTInuous[:TYPE] FREE TRIGger RESet See " Option Details " on page 1085 :SOURce:RADio:ARB:TRIGger:TYPE:CONTInuous[:TYPE]?
Example	:SOUR:RAD:ARB:TRIG:TYPE:CONT FREE
Preset	FREE
Range	Free Run Trigger + Run Reset + Run

Option Details

Parameter	SCPI	Notes
Free Run	FREE	Sets the waveform generator to play a waveform sequence or segment continuously, without waiting for a trigger. In this mode, the waveform generator does not respond to triggers
Trigger + Run	TRIGger	Sets the waveform generator to play a waveform sequence or segment continuously when the first trigger is received, and to ignore any subsequent triggers
Reset + Run	RESet	Sets the waveform generator to play a waveform sequence or segment continuously when the first trigger is received. Subsequent triggers reset the waveform sequence or segment to the start, and then play it continuously

Single trigger

Sets the active trigger type to **Single**. If **Single** is already selected as the active trigger type, pressing this control allows access to the single trigger type setup menu. In **Single** trigger mode, the waveform plays once.

Remote Command	:SOURce:RADio:ARB:RETRigger ON OFF IMMEDIATE See " Option Details " on page 1085 :SOURce:RADio:ARB:RETRigger?
Example	:SOUR:RAD:ARB:RETR OFF
Notes	ON : Buffered Trigger OFF : No Retrigger IMMEDIATE : Restart on Trigger This is defined as an enumerated SCPI command, with ON OFF being considered as enumerated types rather than Boolean. This means the query returns OFF instead of 0, and ON instead of 1
Preset	ON

Option Details

Parameter	SCPI	Notes
No Retrigger	OFF	Sets the waveform generator to play a waveform sequence or segment once when a trigger is received. Any triggers then received during playback are ignored
Buffered Trigger	ON	Sets the waveform generator to play a waveform sequence or segment once when a trigger is received. If a trigger is received during playback, the waveform generator plays the sequence or segment to the end, then plays the sequence or segment once more
Restart on Trigger	IMMEDIATE	Sets the waveform generator to play a waveform sequence or segment once when a trigger is received. If a trigger is received during playback, the waveform generator resets and plays the sequence or segment from the start

Segment Advance trigger

Sets the active trigger type to **Segment Advance**. If **Segment Advance** is already selected as the active trigger type, pressing this control allows access to the segment advance trigger type setup menu.

Segment Advance triggering allows you to control the playback of waveform segments within a waveform sequence. When a trigger is received the ARB advances to the next waveform segment within the waveform sequence. This type of triggering ignores the repetition count for the waveform segment within the waveform sequence. For example, if a waveform segment has a repetition count of 10 and you select single segment advance triggering mode, the waveform segment will only play once.

Segment Advance triggering can also be used for waveform segments only. In this situation, the same waveform segment is played again when a trigger is received.

Remote Command	<code>:SOURce:RADio:ARB:TRIGger:TYPE:SADVance[:TYPE] SINGle CONTInuous</code> See " Option Details " on page 1086 <code>:SOURce:RADio:ARB:TRIGger:TYPE:SADVance[:TYPE]?</code>
Example	<code>:SOUR:RAD:ARB:TRIG:TYPE:SADV SING</code>
Dependencies	Not available in E7760B
Preset	<code>CONTInuous</code>
Range	<code>SINGle CONTInuous</code>

Option Details

Parameter	SCPI	Notes
Single	<code>SINGle</code>	Once a trigger is received a segment is played once. If a trigger is received during playback of a segment, the segment plays to completion and the next segment is played once
Continuous	<code>CONTInuous</code>	Once a trigger is received a segment is played continuously. When subsequent triggers are received, the currently playing segment plays to completion and then the next segment is played continuously
Trigger Initiate	Front panel only	If " Trigger Source " on page 1086 is set to <code>KEY</code> , initiates an immediate trigger event

Trigger Source

Determines how the source receives the trigger that starts the waveform playing. Grayed-out if "[Trigger Type](#)" on page 1084 is free run, since free run triggers immediately with no trigger source required.

6 Input/Output

6.1 RF Source

Remote Command	<code>:SOURce:RADio:ARB:TRIGger[:SOURce] KEY BUS EXTerna11 EXTerna12 PXI</code> See "Option Details" on page 1087 <code>:SOURce:RADio:ARB:TRIGger[:SOURce]?</code>
Example	<code>:SOUR:RAD:ARB:TRIG KEY</code>
Notes	For E7760B, the available selections are KEY BUS
Dependencies	Grayed-out if Trigger Type is Continuous, Free Run
Preset	EXTerna12 For E7760B: BUS
Range	Key Bus External11 External 2 PXI

Option Details

Parameter	SCPI	Notes
Key	KEY	The waveform is triggered when you press the front panel Trigger key
Bus	BUS	Enables triggering over GPIB, LAN, or USB using: <code>:SOURce:RADio:ARB:TRIGger:INITiate</code>
External 1	EXTerna11	Enables triggering a waveform by an externally-applied signal
External 2	EXTerna12	Enables triggering a waveform by an externally-applied signal Note: in EXM, trigger 2 is a bi-directional trigger port, so when trigger 2 has been configured as OUTPUT type, selecting External 2 as the input trigger for the current step generates an error Note 2: in VXT model M9420A, triggers on an externally connected trigger source marked Trigger 1 on the front panel
PXI	PXI	Enables triggering a waveform by a PXI backplane Line applied signal

Bus Trigger Command (Remote Command Only)

Used to initiate an immediate trigger event if ["Trigger Source" on page 1086](#) is set to [BUS](#).

Remote Command	<code>:SOURce:RADio:ARB:TRIGger:INITiate</code>
Example	<code>:SOUR:RAD:ARB:TRIG:INIT</code>

Sync to Trigger Source

There is a time interval (system processing time) between the trigger event and the beginning of playing waveform. Turn on this control to compensate the system latency at the cost of cutting off the beginning of the ARB. The figure below shows the turn-on and turn-off behavior of the control.

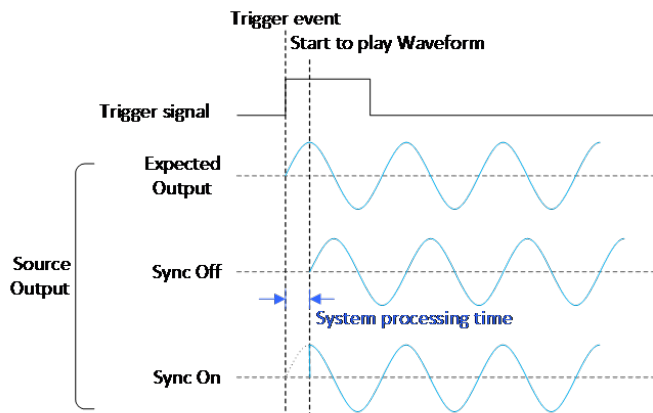

Remote Command	<code>:SOURce:RADio:ARB:TRIGger:SYNC[:STATe] ON OFF 1 0</code> <code>:SOURce:RADio:ARB:TRIGger:SYNC[:STATe]?</code>
Example	<code>:SOUR:RAD:ARB:TRIG:SYNC ON</code> <code>:SOUR:RAD:ARB:TRIG:SYNC?</code>
Notes	Compensates for the instrument internal latency. The negative trigger delay compensates the external latency (that is, heads and cables). See "External Trigger Delay" on page 1088 and "PXI Trigger Delay" on page 1091 The first PerARB trigger is cut off if Sync to Trigger Source is ON
Dependencies	Only available when "Trigger Source" on page 1086 is EXTernal1 , EXTernal2 , or PXI
Preset	OFF
Range	ON OFF

External Trigger Delay

Lets you toggle the state and value of external trigger delay. The value you enter sets a delay time between when an external trigger is received and when it is applied to the waveform. Only active if ["Trigger Source" on page 1086](#) is **EXTernal1** or **EXTernal2**.

Negative trigger delay is only supported by VXT models M9410A/11A/15A/16A and M9410E/11E/15E/16E (see ["More Information" on page 1089](#)).

Remote Command	<code>:SOURce:RADio:ARB:TRIGger[:SOURce]:EXTernal:DELay <time></code> <code>:SOURce:RADio:ARB:TRIGger[:SOURce]:EXTernal:DELay?</code>
----------------	--

6 Input/Output
6.1 RF Source

Example	:SOUR:RAD:ARB:TRIG:EXT:DEL 100ns :SOUR:RAD:ARB:TRIG:EXT:DEL?		
Notes	External trigger delay time set by users will be rounded to the nearest integer multiple of the resolution		
Dependencies	Unavailable and grayed-out when Trigger Source is not set to EXTernal11 or EXTernal12 Not available in E7760B		
Preset	1 ms		
Min	VXT models M9410A/11A/15A/16A and M9410E/11E/15E/16E: -10 s All others: 0 s		
Max	Instrument/Condition	Value	Derivation
	VXT models M9410A/11A/15A/16A	11.45324612 s	2.666667ns*(2 ³² -1)
	M9410E/11E/15E/16E	11.45324612 s	2.666667ns*(2 ³² -1)
	Continuous – Trigger + Run	11.45324612 s	2.666667ns*(2 ³² -1)
	Other trigger conditions	17.17986918 s	4 ns*(2 ³² -1)
	All others	8.589934588 s	4ns*(2 ³¹ - 1) = 8589934588 ns

Auto Function

Remote Command	:SOURce:RADio:ARB:TRIGger[:SOURce]:EXTernal:DELay:STATe OFF ON 0 1 :SOURce:RADio:ARB:TRIGger[:SOURce]:EXTernal:DELay:STATe?
Example	:SOUR:RAD:ARB:TRIG:EXT:DEL:STAT ON :SOUR:RAD:ARB:TRIG:EXT:DEL:STAT?
Preset	OFF

More Information

There is a time interval (system processing time) between the trigger event and the beginning of playing waveform. The figure below shows you the behavior. The negative trigger delay allows you to specify the beginning of a waveform.

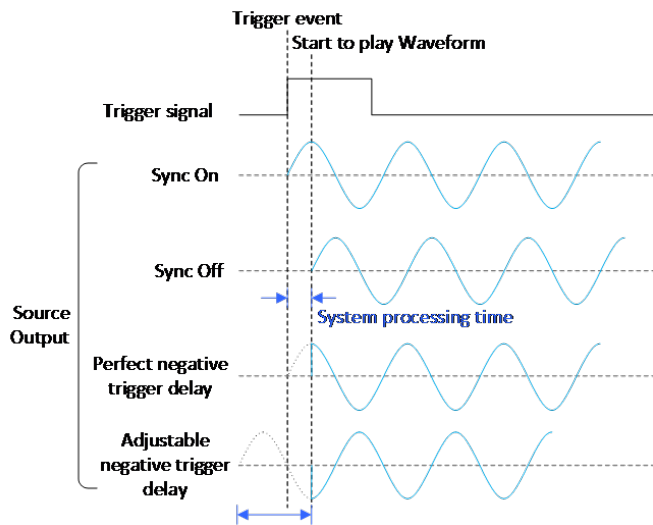

Note: the first PerArb trigger signal will be missed when the trigger delay is negative.

External Trigger Polarity

Sets the polarity of the external trigger. When **POSitive** is selected, trigger event happens on a rising edge of the external trigger in signal. When **NEGative** is selected, trigger event happens on a falling edge of the external trigger in signal.

Active only if "**Trigger Source**" on page 1086 is **EXTernal1** or **EXTernal2**.

Remote Command	<code>:SOURce:RADio:ARB:TRIGger[:SOURce]:EXTernal:SLOPe POSitive NEGative</code> <code>:SOURce:RADio:ARB:TRIGger[:SOURce]:EXTernal:SLOPe?</code>
Example	<code>:SOUR:RAD:ARB:TRIG:EXT:SLOP POS</code> <code>:SOUR:RAD:ARB:TRIG:EXT:SLOP?</code>
Dependencies	Unavailable and grayed-out when " Trigger Source " on page 1086 is not EXTernal1 or EXTernal2 Not available in E7760B
Preset	POSitive
Range	POSitive NEGative

Select PXI Line

Controls which `PXI_TRIG[0..7]` backplane line is used for the trigger source.
Only appears in modular analyzer products.

Remote Command	<code>:SOURce:RADio:ARB:TRIGger[:SOURce]:PXI:LINE <line></code> <code>:SOURce:RADio:ARB:TRIGger[:SOURce]:PXI:LINE?</code>
Example	<code>:SOUR:RAD:ARB:TRIG:PXI:LINE 2</code>
Dependencies	Unavailable and grayed-out when "Trigger Source" on page 1086 is not set to <code>PXI</code> Not available in E7760B
Preset	0
State Saved	Saved in instrument state
Range	[0,7]

PXI Trigger Delay

Lets you toggle the state and value of PXI trigger delay. The value you enter sets a delay time between when an PXI trigger is received and when it is applied to the waveform.

Only active if "Trigger Source" on page 1086 is `PXI`.

Remote Command	<code>:SOURce:RADio:ARB:TRIGger[:SOURce]:PXI:DELAy <time></code> <code>:SOURce:RADio:ARB:TRIGger[:SOURce]:PXI:DELAy?</code>		
Example	<code>:SOUR:RAD:ARB:TRIG:PXI:DEL 100ns</code> <code>:SOUR:RAD:ARB:TRIG:PXI:DEL?</code>		
Notes	PXI trigger delay time set by users will be rounded to the nearest integer multiple of the resolution		
Dependencies	Unavailable and grayed-out when "Trigger Source" on page 1086 is not <code>PXI</code> Not available in E7760B		
Preset	1 ms		
Min	VXT models M9410A/11A/15A/16A and M9410E/11E/15E/16E: -10 s		
Max	Instrument/Condition	Value	Derivation
	VXT models M9410A/11A/15A/16A	11.45324612 s	$2.666667\text{ns} * (2^{32}-1)$
	M9410E/11E/15E/16E	11.45324612 s	$2.666667\text{ns} * (2^{32}-1)$
	Continuous - Trigger + Run" trigger	11.45324612 s	$2.666667\text{ns} * (2^{32}-1)$
	Other trigger conditions	17.17986918 s	$4\text{ ns} * (2^{32}-1)$
	All Others	8.589934588 s	$4\text{ns} * (2^{31} - 1)$

Auto Function

Remote Command	<code>:SOURce:RADio:ARB:TRIGger[:SOURce]:PXI:DELay:STATe OFF ON 0 1</code> <code>:SOURce:RADio:ARB:TRIGger[:SOURce]:PXI:DELay:STATe?</code>
Example	<code>:SOUR:RAD:ARB:TRIG:PXI:DEL:STAT ON</code> <code>:SOUR:RAD:ARB:TRIG:PXI:DEL:STAT?</code>
Preset	OFF

PXI Trigger Polarity

Sets the polarity of the PXI trigger:

- When **POSitive** is selected, trigger event happens on a rising edge of the PXI trigger in signal
- When **NEGative** is selected, trigger event happens on a falling edge of the PXI trigger in signal

Active only if "[Trigger Source](#)" on page 1086 is **PXI**.

Remote Command	<code>:SOURce:RADio:ARB:TRIGger[:SOURce]:PXI:SLOPe POSitive NEGative</code> <code>:SOURce:RADio:ARB:TRIGger[:SOURce]:PXI:SLOPe?</code>
Example	<code>:SOUR:RAD:ARB:TRIG:PXI:SLOP POS</code> <code>:SOUR:RAD:ARB:TRIG:PXI:SLOP?</code>
Dependencies	Unavailable and grayed-out when " Trigger Source " on page 1086 is PXI Not available in E7760B
Preset	POSitive
Range	POSitive NEGative

I/Q Adjustments

Enables or disables the I/Q adjustments.

Remote Command	<code>:SOURce:RADio:ARB:IQADjustment:[STATe] OFF ON 0 1</code> <code>:SOURce:RADio:ARB:IQADjustment:[STATe]?</code>
Example	<code>:SOUR:RAD:ARB:IQAD ON</code> <code>:SOUR:RAD:ARB:IQAD?</code>
Dependencies	Not available in E7760B
Preset	OFF

I/Q Gain

Lets you adjust the ratio of I to Q while preserving the composite, vector magnitude. Adding Gain (+x dB) to the signal increases the I component and decreases the Q component proportionally. Reducing Gain (-x dB) decreases the I component and increases the Q component proportionally.

Remote Command	<code>:SOURce:RADio:ARB:IQADjustment:GAIN <value><unit></code> <code>:SOURce:RADio:ARB:IQADjustment:GAIN?</code>
Example	<code>:SOUR:RAD:ARB:IQAD:GAIN 0.5</code> <code>:SOUR:RAD:ARB:IQAD:GAIN?</code>
Notes	Effective only if the I/Q adjustment function is ON
Dependencies	Unavailable and grayed-out when the ARB state is OFF Not available in E7760B
Preset	+0.00000000E+000
Min	-1 dB
Max	1 dB

I/Q Delay

Lets you change the absolute phase of both I and Q with respect to triggers and markers. A positive value delays I and Q. This value affects both the external I/Q out signals and the baseband signal modulated on the RF output. This adjustment does not affect external I/Q inputs.

Remote Command	<code>:SOURce:RADio:ARB:IQADjustment:DELaY <value><unit></code> <code>:SOURce:RADio:ARB:IQADjustment:DELaY?</code>		
Example	<code>:SOUR:RAD:ARB:IQAD:DEL 10ps</code> <code>:SOUR:RAD:ARB:IQAD:DEL?</code>		
Notes	User-set IQ delay time values are rounded to the nearest integer multiple of the resolution		
Dependencies	Unavailable and grayed-out when the ARB state is off Not available in E7760B		
Preset	+0.00000000E+000		
Min/Max	Instrument Type	Min	Max
	M9410A/11A/15A/16A	-80ns	80ns
	All Others	-250ns	250ns

RMS

Lets you directly specify current RMS value used to playback currently selected waveform.

For EXM, note that an incorrect RMS value may cause inaccurate power output that is sensitive to RMS value.

This setting is also updated by RMS in waveform header or updated when invoking RMS calculation operation.

This setting can be saved to the header of currently selected waveform by ["Save Header" on page 1114](#).

Remote Command	<code>:SOURCE:RADio:ARB:RMS <float></code> <code>:SOURCE:RADio:ARB:RMS?</code>
Example	<code>:SOUR:RAD:ARB:HEAD:RMS 0.7</code> <code>:SOUR:RAD:ARB:HEAD:RMS?</code>
Notes	The valid range for this setting is 0 to 1.414 (linear). Values outside the range are clipped to the closest boundary This value does not affect Source List Sequencer, which always uses the RMS value included in each ARB header. If this setting is to take effect in List Sequencer, use "Save Header" on page 1114 to save the current RMS value to the header, then play the ARB in Source List Sequencer
Dependencies	When a new waveform is selected for playback this setting is updated by the RMS value included in the associated waveform header file. If the selected waveform has no associated header file or the header file does not include the RMS value then the instrument will try to calculate the value automatically based on the RMS Calculation Mode setting Pressing Calculate also updates this setting
Preset	0
Range	0 ~ 1.414

RMS Calculation Mode

Lets you specify the mode to calculate the current RMS.

Remote Command	<code>:SOURCE:RADio:ARB:RMS:CALCulation:MODE AUTO M1 M2 M3 M4</code> See "Option Details" on page 1095 <code>:SOURCE:RADio:ARB:RMS:CALCulation:MODE?</code>
Example	<code>:SOUR:RAD:ARB:RMS:CALC:MODE AUTO</code>
Notes	If no waveform is selected, or selected waveform is waveform sequence, the key is grayed-out
Preset	<code>AUTO</code>
Range	<code>AUTO M1 M2 M3 M4</code>

Option Details

Parameter	SCPI	Notes
Auto	AUTO	In Auto, RMS is calculated based on the whole sample range of the currently selected waveform
Marker 1	M1	Marker 1 designates the sample range for RMS calculation
Marker 2	M2	Marker 2 designates the sample range for RMS calculation
Marker 3	M3	Marker 3 designates the sample range for RMS calculation
Marker 4	M4	Marker 4 designates the sample range for RMS calculation

Calculate

Lets you calculate current RMS based on mode selected. Updates the setting in the ["RMS" on page 1094](#) control.

Remote Command	:SOURce:RADio:ARB:RMS:CALCulate
Example	:SOUR:RAD:ARB:RMS:CALC
Notes	<p>If no waveform is selected, invoking this operation generates error “-221 Setting conflict; No waveform is selected for RMS operation”</p> <p>Grayed-out if no waveform is selected, or selected waveform is waveform sequence</p> <p>If selected waveform does not contain marker data, but "RMS Calculation Mode" on page 1094 is set to marker, invoking a calculation operation generates error “-221 Setting conflict; There is no marker for currently selected waveform, auto RMS calculation mode is used instead”, and "RMS Calculation Mode" on page 1094 is coupled to Auto mode automatically</p> <p>RMS calculation is not suitable for waveform sequence. If selected waveform is waveform sequence file, invoking this operation generates error “-221 Setting conflict; RMS calculation does not apply to waveform sequence”</p> <p>You can still edit current RMS as play parameter, and save current RMS to waveform sequence header for later use</p>

Use Header RMS

Lets you quickly set RMS to value in ARB header. Updates the setting in the ["RMS" on page 1094](#) control.

Notes	<p>Grayed-out if no waveform is selected</p> <p>If no waveform is selected, invoking this operation generates error “-221 Setting conflict; No waveform is selected for RMS operation”</p>
-------	--

Real-Time 5G NR Compensation

Phase compensation is a new concept introduced into 5G NR baseband signal generation in TS38.211 as below, to address a typical 5G scenario that Tx and Rx frequencies may not be the same. In that case, without properly compensating the phase, receiver would not be able to correctly demodulate the received signal.

Modulation and up-conversion to the carrier frequency f_0 of the complex-valued OFDM baseband signal for antenna port p , subcarrier spacing configuration μ , and OFDM symbol l in a subframe assumed to start at $t = 0$ is given by the following equation for all channels and signals except PRACH:

$$Re \left\{ s_l^{(p,\mu)}(t) \cdot e^{j2\pi f_0(t - t_{start,l}^\mu - N_{CP,l}^\mu T_c)} \right\}$$

$$Re \left\{ s_l^{(p,\mu)}(t) \cdot e^{j2\pi f_0(t - t_{start,l}^\mu - N_{CP,l}^\mu T_c)} \right\}$$

From the 3GPP specification equation above, it can be observed that phase compensation is performed for a specific transmission frequency f_0 . So that means, even if a same signal configuration needs to be transmitted at multiple frequencies, we'll have to generate a different waveform for each frequency point. As a result, the number of test waveforms will increase significantly along with the frequency number. This would be a big challenge for test engineers, considering the complexity of 5G NR signal configurations - they have to maintain a large waveform library and identify each waveform carefully with its "frequency tag".

Real-Time 5G NR Phase Compensation allows you to play the same 5G NR waveform while performing phase compensation along with transmission frequency change automatically. This control allows you to turn on or off the real-time phase compensation for 5G NR waveform.

Remote Command	<code>:SOURce:RADio:ARB:NR5G:PHASe[:STATe] ON OFF 1 0</code> <code>:SOURce:RADio:ARB:NR5G:PHASe[:STATe]?</code>
Example	<code>:SOUR:RAD:ARB:NR5G:PHAS ON</code> <code>:SOUR:RAD:ARB:NR5G:PHAS?</code>
Dependencies	Only appears when Option RPC is present If the waveform is not for 5G NR, there may be error message and the output signal may be incorrect To ensure that you do <i>not</i> compensate for phase twice, once at waveform generation and again during playback, turn off this control if you had turned on phase compensation while generating the waveform
Preset	OFF
Range	ON OFF

SCS

Sets the SCS for real-time 5G NR phase compensation.

Remote Command	:SOURce:RADio:ARB:NR5G:PHASe:SCS SCS15K SCS30K SCS60K SCS60KECP SCS120K SCS240K SCS480K		
	:SOURce:RADio:ARB:NR5G:PHASe:SCS?		
Example	:SOUR:RAD:ARB:NR5G:PHAS:SCS SCS15K		
	:SOUR:RAD:ARB:NR5G:PHAS:SCS?		
Preset	SCS30K		
Range	μ	CP	Value
	0		15 kHz
	1		30 kHz
	2	Normal	60 kHz
		Extended	60 kHz
	3		120 kHz
	4		240 kHz
	5		480 kHz

Filter

Sets the state of Filter usage after real-time 5G NR phase compensation.

Remote Command	:SOURce:RADio:ARB:NR5G:PHASe:FILTer[:STATe] ON OFF 1 0		
	:SOURce:RADio:ARB:NR5G:PHASe:FILTer[:STATe]?		
Example	:SOUR:RAD:ARB:NR5G:PHAS:FILT ON		
	:SOUR:RAD:ARB:NR5G:PHAS:FILT?		
Preset	OFF		
Range	ON OFF		

Filter Bandwidth

Sets the Filter Bandwidth if Filter is used.

By searching <FilterBandwidth> node in the *.scp file, you can get the correct filter bandwidth value for phase compensation.

Remote	:SOURce:RADio:ARB:NR5G:PHASe:FILTer:BANDwidth <freq>
--------	--

Command	<code>:SOURce:RADio:ARB:NR5G:PHASe:FILTer:BANDwidth?</code>
Example	<code>:SOUR:RAD:ARB:NR5G:PHAS:FILT:BAND 99MHz</code> <code>:SOUR:RAD:ARB:NR5G:PHAS:FILT:BAND?</code>
Preset	100 MHz
Min	10 Hz
Max	1200 MHz

Select Waveform

Lets you select a waveform segment or sequence to be played by the ARB player. Presents you with a list of waveform segments files and waveform sequence files. The list of waveform segment files and waveform sequence files contains the names of all the waveform segments and waveform sequence files currently loaded into ARB playback memory.

Waveform sequences are not available in E7760B.

Waveforms formatted as `*.mat`, `*.csv` and `*.txt` are supported by models with a built-in source, such as VXT and EXM.

NOTE

To load a file from the hard drive into ARB memory, go to the **Recall, Waveform dialog**

NOTE

Selecting a waveform file does not result in automatic adjustments to burst timing; that adjustment occurs only when a waveform is loaded to ARB memory.

Remote Command	<code>:SOURce:RADio:ARB:WAVEform <string></code> <code>:SOURce:RADio:ARB:WAVEform?</code>
Example	<code>:SOUR:RAD:ARB:WAV "test_waveform.bin"</code>
Notes	<p>If the intended waveform is not in the memory yet, then issuing this command invokes ARB loading operation first, which involves a delay of unpredictable length, so this command should be followed by <code>*OPC?</code>, which holds off subsequent commands until the loading operation is complete</p> <p><code><string></code> - specifies the name of the waveform segment or waveform sequence to be played by the ARB</p> <p>Sequence Analyzer Mode only:</p> <ul style="list-style-type: none"> - If Include Source is Yes, and you attempt to play a waveform sequence but not all the required waveform segments are in the ARB playback memory, the application rejects the loading operation and an error is generated - If Include Source is No, and you attempt to play a waveform sequence but not all the required waveform segments are contained in the ARB playback memory, the application attempts to load the required segments from either the default directory or the current directory. If the ARB memory

does not have enough space for all the waveform segments to be loaded, an error is generated and none of the waveform segments is loaded

If ARB is **ON**, and you attempt to play a waveform sequence but not all the waveform segments within the sequence could be found to be loaded into ARB memory, an error is generated. The selected waveform keeps the previous value and ARB state remains On

If you specify a waveform segment via SCPI but the waveform segment is not present within ARB playback memory, and cannot be found for auto loading within the current directory or the default directory, an error is generated and the file selection remains unchanged

If you select a waveform for playback and the waveform requires a license that is not installed on the instrument, an error is generated

If ARB is **ON** and you load a file to ARB memory or delete a file from ARB memory, the playing waveform segment may not keep phase continuity during the ARB memory operation. The waveform will be replayed after the ARB operation is finished

Segments in ARB Memory

Shows you which files are loaded into the ARB memory and lets you select a file for playback.

Recall Waveform

This is the same as **Recall From File** in the **Recall, Waveform** dialog.

Delete Segment From ARB Mem

This is the same as **Delete Segment From ARB Mem** in the **Recall, Waveform** dialog.

Delete All From ARB Memory

This is the same as **Delete All From ARB Memory** in the **Recall, Waveform** dialog.

Query ARB Memory File List (Remote Query Only)

Queries the test set for the list of waveform segments in the ARB memory.

NOTE

Returns a string for waveform segment names in ARB memory. If you require a string list of waveform segments in the ARB memory, use **"Query ARB Memory Full File List (Remote Query Only)"** on page 1100

Remote Command	<code>:SOURce:RADio:ARB:CATalog?</code>						
Example	<code>:SOUR:RAD:ARB:CAT?</code>						
Notes	The return data is in the following format:						
	<table border="1"> <tr> <td><code><integer></code></td> <td>Memory used, in kB</td> </tr> <tr> <td><code><integer></code></td> <td>Memory free, in kB</td> </tr> <tr> <td><code><string> ...</code></td> <td>Comma-separated list of waveform segments within ARB memory</td> </tr> </table>	<code><integer></code>	Memory used, in kB	<code><integer></code>	Memory free, in kB	<code><string> ...</code>	Comma-separated list of waveform segments within ARB memory
<code><integer></code>	Memory used, in kB						
<code><integer></code>	Memory free, in kB						
<code><string> ...</code>	Comma-separated list of waveform segments within ARB memory						

Query ARB Memory Full File List (Remote Query Only)

Queries the test set for the string list of waveform segments in the ARB memory. Returns a string list for waveform segment names in the ARB memory.

Remote Command	<code>:SOURce:RADio:ARB:FCATalog?</code>								
Example	<code>:SOUR:RAD:ARB:FCAT?</code>								
Notes	The return data is in the following format:								
	<table border="1"> <tr> <td><code><integer></code></td> <td>Memory used, in kB</td> </tr> <tr> <td><code><integer></code></td> <td>Memory free, in kB</td> </tr> <tr> <td><code><integer></code></td> <td>File count in ARB memory</td> </tr> <tr> <td><code><string>, <string>, ... <string></code></td> <td>Comma-separated string list of waveform segments within ARB memory</td> </tr> </table>	<code><integer></code>	Memory used, in kB	<code><integer></code>	Memory free, in kB	<code><integer></code>	File count in ARB memory	<code><string>, <string>, ... <string></code>	Comma-separated string list of waveform segments within ARB memory
<code><integer></code>	Memory used, in kB								
<code><integer></code>	Memory free, in kB								
<code><integer></code>	File count in ARB memory								
<code><string>, <string>, ... <string></code>	Comma-separated string list of waveform segments within ARB memory								

EXT returns: 27499,2069653,3,"c2k.wfm", "gsm.wfm", "wcdma.wfm"

Waveform Sequences

Not available in E7760B.

Lets you build new sequences or edit existing sequences. The Sequences table displayed in this dialog shows you the sequences in the current directory. You may build a new sequence or select one of the sequences in the table and tap **Edit Selected Sequence**. The default current directory is `C:\NVARB`. Tapping any element of this path lets you select an alternate route. Tapping the **Computer** arrow lets you select a different drive. Tapping the **Back** arrow navigates to the previously selected directory.

Build New Sequence

Lets you build a new sequence of waveform segments. When you build a sequence you are building the "current sequence", and the next time you press "Build New

6 Input/Output
6.1 RF Source

Sequence” the sequence you have been building will still be there, allowing you to add or remove segments from it.

Segment

Shows the segment number assigned to this row.

Waveform

Shows the file name for the waveform inserted into this row. Use ["Insert Waveform" on page 1102](#) to insert a waveform.

Repetitions

Lets you specify the number of times the currently selected waveform is played within the sequence.

Preset	1
Min	1
Max	65535

Marker 1 – Marker 4

Lets you enable or disable Marker 1, 2, 3, or 4 for the currently selected waveform. For a waveform sequence, you can enable and disable markers on a per-segment basis, allowing you to output markers from some waveform segments within the sequence, but not for others.

Preset	Enabled
Range	Enabled Disabled

Sync Seq File

Enables or disables the saving of secondary modules' waveform sequence files based on the current primary module segment's waveform settings.

Remote Command	<code>:SOURce:RADio:ARB:SEquence:SYNC ON OFF</code> <code>:SOURce:RADio:ARB:SEquence:SYNC?</code>
Example	<code>:SOUR:RAD:ARB:SEQ:SYNC OFF</code>
Notes	Available only on primary modules If this setting is ON , when Sync Config is not NONE , the responding secondary module's waveform

	sequence file will be saved accordingly when save sequence... on the primary module, and the primary sequence file name should end with xxx0.seq , so the secondary module will be named according to the "Naming Rule" on page 1102
	Waveform names in sequence files should also follow the Naming Rule
Dependencies	Not available in E7760B
Preset	OFF
Range	ON OFF

Naming Rule

If Sync Config is not 2x2 +2x2 or 1x1+1x1, the waveform files to be used should follow this naming convention: the waveform file for the primary source should end in 0; the waveform files for the controlled sources should end in 1, 2, or 3 (reflecting the order of the TRXs). For example, for DL 11AC80 3X3 MIMO, sequence file names for TRX1, TRX2 and TRX3 should be xxx0.xx, xxx1.xx and xxx2.xx

If Sync Config is 2x2+2x2, the waveform files to be used should follow this naming convention: the waveform file for the primary source of first 2x2 should end in 0_0; the waveform files for the secondary source of first 2x2 should end in 0_1; the waveform files for the primary source of second 2x2 should end in 1_0; the waveform files for the secondary source of second 2x2 should end in 1_1. For example, for DL 11AC80 2x2 + 2x2 MIMO, waveform file names for TRX1, TRX2, TRX3 and TRX4 should be xxx0_0.xx, xxx0_1.xx, xxx1_0.xx and xxx1_1.xx

If Sync Config is 1x1+1x1, the waveform files to be used should follow this naming convention: the waveform file for the first source should end in 0_0; the waveform files for the second source should end in 1_0. For example, for DL 11AC80 1x1 + 1x1 MIMO, waveform file names for TRX1 and TRX2 should be xxx0_0.xx and xxx1_0.xx

Insert Waveform

Lets you select a waveform segment to be added to the sequence.

NOTE

To load a file from the hard drive into ARB memory, go to the **Recall, Waveform** dialog

Segments in ARB Memory

Shows you which files are loaded into the ARB memory and lets you select a file for inclusion in the sequence.

Delete Segment From ARB Mem

This is the same as **Delete Segment From ARB Mem** in the **Recall, Waveform** dialog.

Delete All From ARB Memory

This is the same as **Delete All From ARB Memory** in the **Recall, Waveform** dialog.

Delete Segment

Lets you delete the selected segment from the waveform sequence.

Save Sequence

Lets you save the newly built Waveform Sequence to the disk drive.

Sequence files have the extension `.seq`. The default filename is `WfmSequence_0000.seq`, where the 4-digit number is the lowest number that does not conflict with any filename in the current directory. Use “File Name” and “File Type” to specify your waveform sequence. The newly build sequence will be stored in the current directory.

Build New Sequence (Remote Command Only)

This is the SCPI equivalent of the waveform sequence creation features described in ["Build New Sequence" on page 1100](#).

Writes a waveform sequence file to the hard disk. You must specify the waveform sequence file path and filename which will be saved on the hard disk, and the waveform segment file path and name which will be nested into the waveform sequence file. You can utilize mass storage unit specifier (MSUS) “NVWFM” or use a real full path representation. See the example below. MSUS “NVWFM” is mapped to D:\NVARB directory on test set hard disk.

Any number of segments, up to a segment count limit of 64, can be used to create a sequence. Repeated segments are included in the count limit.

Each waveform segment name string length upper limit is 128 chars. Do not attempt to insert a waveform with a name string that exceeds 128 chars.

The internal source does not support nesting one waveform sequence file into another waveform sequence file.

Remote `:SOURce:RADio:ARB:SEquence[:MWAVeform] <filename>, <waveform1>, <reps>, NONE`

Command	<pre> M1 M2 M3 M4 M1M2 M1M3 M1M4 M2M3 M2M4 M3M4 M1M2M3 M1M2M4 M1M3M4 M2M3M4 M1M2M3M4 ALL, \{<waveform2>, <reps>, NONE M1 M2 M3 M4 M1M2 M1M3 M1M4 M2M3 M2M4 M3M4 M1M2M3 M1M2M4 M1M3M4 M2M3M4 M1M2M3M4 ALL,\}</pre>
---------	--

For additional description of each item, see ["For Setup SCPI" on page 1104](#) below

`:SOURce:RADio:ARB:SEQuence[:MWAVEform]? <filename>`

For additional description of each item, see ["For Query SCPI" on page 1105](#) below

Example	<p>For setup:</p> <pre>:SOUR:RAD:ARB:SEQ "NVWFM:testSeq1.seq", "NVWFM:wfmSegment1.wfm",10, M2M3M4, "NVWFM:wfmSegment2.wfm", 20, M1M3</pre>
---------	--

Or

```
:SOUR:RAD:ARB:SEQ "D:\NVARB\testSeq1.seq", "D:\NVARB\wfmSegment1.wfm",10,
M2M3M4, "D:\NVARB\wfmSegment2.wfm", 20, M1M3
```

For query, must specify which waveform sequence file to query

```
:SOUR:RAD:ARB:SEQ? "NVWFM:testSeq1.seq"
```

Or

```
:SOUR:RAD:ARB:SEQ? "D:\NVARB\testSeq1.seq"
```

For Setup SCPI

For the Setup SCPI command, the parameters are:

`<filename>` - String Type

This variable specifies the path and name for the waveform sequence file. The path supports MSUS (NVWFM) or a real full path representation. See example.

`<waveform1>` - String Type

This variable specifies the path and name of the first existing waveform segment. The path supports MSUS (NVWFM) or a real full path representation. See example.

The segment file must reside within ARB playback memory before it can be played by the ARB player.

`<reps>` - Integer Type

This variable specifies the number of times a segment or sequence plays before moving on to the next segment or sequence.

`<marker>` - Enum Type

NONE – This choice disables all four markers for the waveform. Disabling markers means that the waveform sequence ignores the segments or sequence marker settings.

M1, M2, M3, M4 – these choices, either individually or a combination of them, enable the markers for the waveform segment or sequence. Markers not specified are ignored for that segment or sequence.

ALL – This choice enables all four markers in the waveform segment or sequence.

<waveform2> - String type.

This variable specifies the name of a second existing waveform segment. The path supports MSUS (NVWFM) and real full path representation both. See example.

The segment file must reside within ARB playback memory before it can be played by the ARB player.

<reps> same as above, for the 2nd waveform segment.

<marker> same as above, for the 2nd waveform segment.

You can insert several waveform segments into a waveform sequence file. Just repeat inserting waveform segments as described above.

Error Checks for Setup SCPI command:

If you do not specify a filename, or you use an unsupported MSUS (that is, not NVWFM), or have an error in the waveform sequence file path, an error is generated. If the specified waveform sequence file name suffix is not “.seq”, error is generated.

If you use an unsupported MSUS (that is, not NVWFM), or have an error in the waveform segment file path, an error is generated.

If the first specified waveform file cannot be found, an error is generated.

If you nest one waveform sequence file into another waveform sequence file, an error is generated.

If the specified repetition value is larger than 65535 or smaller than 1, an error is generated.

If the specified marker type is unrecognized, an error is generated.

For Query SCPI

For the Query the parameters are:

<filename> - String type.

This variable specifies the path and name of the waveform sequence file being queried. The path supports MSUS (NVWFM) or a real full path representation. See example.

The return value is a **<string>**, which includes each waveform segment file name, repetitions, and marker type. For example:

```
>:SOUR:RAD:ARB:SEQ? "NVWFM:testSeq1.seq",  
<"wfmSegment1. wfm, 10, ALL, wfmSegment2.wfm, 20, M1M3",
```

Error Checks for Query SCPI command:

If you do not specify a filename, an error is generated.

If the waveform sequence file name is empty, an error is generated. If the specified waveform sequence file cannot be found, an error is generated.

Edit Selected Sequence

This dialog lets you edit an existing sequence of waveform segments. A table of the segments in the currently selected sequence displays, allowing you to insert waveform segments or edit the characteristics of each segment.

Segment

This field in the table shows the segment number assigned to this row.

Waveform

This field in the table shows the file name for the waveform inserted into this row. Use ["Insert Waveform" on page 1102](#) to insert a waveform.

Repetitions

Lets you specify the number of times the currently selected waveform is played within the sequence.

Preset	1
Min	1

Marker 1 – Marker 4

Lets you enable or disable Marker 1, 2, 3, or 4 for the currently selected waveform. For a waveform sequence, you can enable and disable markers on a per-segment basis, allowing you to output markers from some waveform segments within the sequence, but not for others.

Notes	No remote command, front panel only
Preset	Enabled
Range	Enabled Disabled

Sync Seq File

Change this setting to enable/disable the function of saving secondary modules' waveform sequence files based on the current primary segment's waveform settings.

Remote Command	See "Sync Seq File" on page 1101
Notes	Available only on primary modules If this setting is ON , when Sync Config is not NONE , the responding secondary module's waveform sequence file will be saved accordingly when save sequence... on the primary module, and the primary sequence file name should end with xxx0.seq , so the secondary module will be named according to the "Naming Rule" on page 1107 Waveform names in sequence files should also follow the Naming Rule
Dependencies	Not available in E7760B
Preset	OFF
Range	ON OFF

Naming Rule

If Sync Config is not 2x2 + 2x2 or 1x1 + 1x1, the waveform files to be used should follow this naming convention: the waveform file for the primary source should end in 0; the waveform files for the controlled sources should end in 1, 2, or 3 (reflecting the order of the TRXs). For example, for DL 11AC80 3X3 MIMO, sequence file names for TRX1, TRX2 and TRX3 should be xxx0.xx, xxx1.xx and xxx2.xx

If Sync Config is 2x2 + 2x2, the waveform files to be used should follow this naming convention: the waveform file for the primary source of first 2x2 should end in 0_0; the waveform files for the secondary source of first 2x2 should end in 0_1; the waveform files for the primary source of second 2x2 should end in 1_0; the waveform files for the secondary source of second 2x2 should end in 1_1. For example, for DL 11AC80 2x2 + 2x2 MIMO, waveform file names for TRX1, TRX2, TRX3 and TRX4 should be xxx0_0.xx, xxx0_1.xx, xxx1_0.xx and xxx1_1.xx

If Sync Config is 1x1 + 1x1, the waveform files to be used should follow this naming convention: the waveform file for the first source should end in 0_0; the waveform files for the second source should end in 1_0. For example, for DL 11AC80 1x1 + 1x1 MIMO, waveform file names for TRX1 and TRX2 should be xxx0_0.xx and xxx1_0.xx

Insert Waveform

This dialog p select a waveform segment to be added to the sequence.

NOTE

To load a file from the hard drive into ARB memory, go to the Recall, Waveform dialog

Segments in ARB Memory

This table shows you which files are loaded into the ARB memory and lets you select a file for inclusion in the sequence.

Delete Segment From ARB Mem

Deletes a segment from ARB memory. This is the same as **Delete Segment From ARB Mem** in the **Recall, Waveform** dialog.

Delete All From ARB Memory

Removes all segments from ARB memory. This is the same as **Delete All From ARB Memory** in the **Recall, Waveform** dialog.

Delete Segment

Lets you delete the current segment from the waveform sequence.

Notes No remote command, front panel only

Waveform Utilities

Not available in E7760B.

Only appears if there is at least one Multi-pack license installed in the instrument.

On modular instruments, such as EXM , multi-pack license operations are only allowed on the default module, that is, “TRX1” module for EXM.

For EXM, if access multi-pack license sub-menu from modules other than “TRX1”, an advisory message like “Please go to “TRX1” to operate multi-pack license” will display.

Add Waveform

Use this dialog to select and add waveforms. Pressing **OK** in this dialog adds the currently highlighted waveform to the next available slot, and returns you to the **"Waveform Utilities" on page 1108** dialog.

6 Input/Output

6.1 RF Source

Remote Command	<code>:SYSTem:LKEY:WAVeform:ADD <string></code> or <code>:SYSTem:LICense[:FPACK]:WAVeform:ADD <string></code>
Example	<code>:SYST:LKEY:WAV:ADD "mywaveform.wfm"</code> or <code>:SYST:LIC:WAV:ADD "mywaveform.wfm"</code>
Notes	<p>The second form, <code>:SYSTem:LICense[:FPACK]:WAVeform:ADD</code>, is provided for consistency with Keysight signal sources. You can use either form</p> <p>Since adding a waveform segment to a Multi-Pack license causes the license slot to enter the trial period of only 48 hours, pressing this key causes a confirmation dialog to be displayed to ensure you do want to add the waveform segment to the Multi-Pack</p> <p>If you attempt to license a waveform that is already licensed using another slot an error is generated</p> <p>For EXM, if current module is not "TRX1" module, the key is grayed-out, and error message is generated "-221 Setting conflict; Not allowed on current module. Go to "TRX1" to operate multi-pack license" when invoking SCPI</p>
Dependencies	Only available if the currently selected file is a secure waveform requiring a license, and there is at least one slot available within at least one multi-pack license. Unavailable if the waveform highlighted is a secure waveform, but is already licensed

Replace Selected Waveform

Lets you replace the waveform in the currently selected slot with the waveform currently selected in the Multi-Pack License Waveform Add view. Pressing **OK** in this dialog replaces the waveform in the currently selected slot with that currently highlighted, and returns you to the ["Waveform Utilities" on page 1108](#) dialog.

Remote Command	<code>:SYSTem:LKEY:WAVeform:REPLace <int>, <string></code> or <code>:SYSTem:LICense[:FPACK]:WAVeform:REPLace <int>, <string></code>
Example	<code>:SYST:LKEY:WAV:REPL 1, "myotherwaveform.wfm"</code> or <code>:SYST:LIC:WAV:REPL 1, "myotherwaveform.wfm"</code>
Notes	<p>The second command form, <code>:SYSTem:LICense[:FPACK]:WAVeform:REPLace</code> is provided for consistency with Keysight signal sources. You can use either form</p> <p>If you attempt to license a waveform that is already licensed using another slot an error is generated</p> <p>Waveform slot number <int> is positive. If you attempt to input a slot number less than or equals 0, an error is generated</p> <p>For EXM, if current module is not "TRX1" module, the key is grayed-out, and error message is generated "-221 Setting conflict; Not allowed on current module. Go to "TRX1" to operate multi-pack license" when invoking SCPI</p>

Clear Waveform from Slot

Lets you clear the waveform from the selected slot.

Remote Command	<code>:SYSTem:LKEY:WAVeform:CLEar <int></code> or <code>:SYSTem:LICense[:FPACK]:WAVeform:CLEar <int></code>
Example	<code>:SYST:LKEY:WAV:CLE 1</code> or <code>:SYST:LIC:WAV:CLE 1</code>
Notes	The second form: <code>:SYSTem:LICense[:FPACK]:WAVeform:CLEar</code> is provided for consistency with the style of Keysight signal sources. You can use either form Waveform slot number <code><int></code> is positive. If you attempt to input a slot number less than or equal to 0, an error is generated For EXM, if current module is not "TRX1" module, the key is grayed-out, and error message is generated "-221 Setting conflict; Not allowed on current module. Go to "TRX1" to operate multi-pack license" when invoking SCPI
Dependencies	Only available if the currently selected slot is in the trial state

Lock Waveform in Slot

If the selected slot is in the trial state or the lock required state, the waveform that occupies the slot is locked and permanently licensed.

Remote Command	<code>:SYSTem:LKEY:WAVeform:LOCK <int></code> or <code>:SYSTem:LICense[:FPACK]:WAVeform:LOCK <int></code>
Example	<code>:SYST:LKEY:WAV:LOCK 1</code> or <code>:SYST:LIC:WAV:LOCK 1</code>
Notes	The command form <code>:SYSTem:LICense[:FPACK]:WAVeform:LOCK</code> is provided for consistency with Keysight signal sources. You can use either form Waveform slot number <code><int></code> is positive. If you attempt to input a slot number less than or equal to 0, an error is generated For EXM, if current module is not "TRX1" module, the key is grayed-out, and error message is generated "-221 Setting conflict; Not allowed on current module. Go to "TRX1" to operate multi-pack license" when invoking SCPI
Dependencies	Only available if the currently selected slot is in the trial state, or the lock required state

Slot Status Query (Remote Command Only)

Returns the status of the specified slot.

Remote Command	<code>:SYSTem:LKEY:WAVeform:STATus? <int></code> or <code>:SYSTem:LICense[:FPACK]:WAVeform:STATus? <int></code>
Example	<code>:SYST:LKEY:WAV:STAT? 1</code> <"Locked" or <code>:SYST:LIC:WAV:STAT? 1</code> <"Locked"
Notes	The command form <code>:SYSTem:LICense[:FPACK]:WAVeform:STATus</code> is provided for consistency with Keysight signal sources. You can use either form Waveform slot number <code><int></code> is positive. If you attempt to input a slot number less than or equal to 0, an error is generated Result type is string. If input slot number exceeds total available slot numbers, "Nonexistent" is returned
Range	"Locked" "Available" "Trail" "LockRequired" "Nonexistent"

Slots Free Query (Remote Query Only)

Returns the number of license slots free.

Remote Command	<code>:SYSTem:LKEY:WAVeform:FREE?</code> or <code>:SYSTem:LICense[:FPACK]:WAVeform:FREE?</code>
Example	<code>:SYST:LKEY:WAV:FREE?</code> or <code>:SYST:LIC:WAV:FREE?</code>
Notes	The second form: <code>:SYSTem:LICense[:FPACK]:WAVeform:FREE</code> is provided for consistency with the style of Keysight signal sources. You can use either one

Slots Used Query (Remote Query Only)

Returns the number of license slots used.

Remote Command	<code>:SYSTem:LKEY:WAVeform:USED?</code> or <code>:SYSTem:LICense[:FPACK]:WAVeform:USED?</code>
----------------	---

Example	<code>:SYST:LKEY:WAV:USED?</code> or <code>:SYST:LIC:WAV:USED?</code>
Notes	The second form: SCPI <code>:SYSTEM:LICense[:FPACK]:WAVEform:USED</code> is provided for consistency with the style of Keysight signal sources. You can use either form

Slot Waveform Name Query (Remote Command Only)

Returns the waveform name of the specified slot.

Remote Command	<code>:SYSTEM:LKEY:WAVEform:NAME? <int></code> or <code>:SYSTEM:LICense[:FPACK]:WAVEform:NAME? <int></code>
Example	<code>:SYST:LKEY:WAV:NAME? 1</code> <code><"CDMA2K_22.wfm"</code> or <code>:SYST:LIC:WAV:NAME? 1</code> <code><"CDMA2K_22.wfm"</code>
Notes	Waveform slot number <code><int></code> is positive. If you attempt to input a slot number less than or equal to 0, an error is generated Result type is string. If input slot number exceeds total available slot numbers, "Nonexistent" is returned If no waveform stored in the specified slot, then empty string is returned

Slot Waveform Unique ID Query (Remote Command Only)

Returns the waveform unique ID of the specified slot.

Remote Command	<code>:SYSTEM:LKEY:WAVEform:UID? <int></code> or <code>:SYSTEM:LICense[:FPACK]:WAVEform:UID? <int></code>
Example	<code>:SYST:LKEY:WAV:UID? 2</code> <code><"1346752140"</code> or <code>:SYST:LIC:WAV:UID? 2</code> <code><"1346752140"</code>
Notes	Waveform slot number <code><int></code> is positive. If you attempt to input a slot number less than or equal to 0, an error is generated Result type is string. If input slot number exceeds total available slot numbers, "Nonexistent" is returned

Only Signal Studio waveform has a unique ID, which is a positive number. User-generated waveforms have no unique ID. If no waveform is stored in the specified slot, returns "0"

Locked Waveform Name List Query (Remote Query Only)

Returns the waveform name list of locked.

Remote Command	<code>:SOURCE:RADio:ARB:MPLicensed:NAME:LOCKed?</code>
Example	<code>:SOUR:RAD:ARB:MPL:NAME:LOCKed?</code> < "CDMA2K_27.wfm","GSM_MCS1.WFM","c2kWfm.wfm"

Locked Waveform Unique ID List Query (Remote Query Only)

Returns the waveform unique id list of locked.

Remote Command	<code>:SOURCE:RADio:ARB:MPLicensed:UID:LOCKed?</code>
Example	<code>:SOUR:RAD:ARB:MPL:UID:LOCKed?</code> < "2996927136","3812603511","3710986266"
Notes	Each Signal Studio waveform has a unique id recorded in header. If the unique ids are same, that means they are the same waveform. For this reason, in addition to the locked waveform name list query, there is also a locked waveform unique id list query

Multi-Pack License multi-module control state (Remote Command Only)

When **ON**, multi-pack license operations (such as adding/locking/replacinwaveform etc.) from TRXs other than TRX1 are allowed. If **OFF**, only TRX1 is allowed to operate multi-pack license, while other TRXs are only able to show the related multi-pack license information.

Remote Command	<code>:SERVICE[:PRODUCTION]:SOURCE:MCONTROL:MPLicense[:STATE] ON OFF 1 0</code> <code>:SERVICE[:PRODUCTION]:SOURCE:MCONTROL:MPLicense[:STATE]?</code>
Example	<code>:SERV:SOUR:MCON:MPL OFF</code>
Notes	Only effective in modular-based OBTs, such as EXM
Preset	OFF
Range	ON OFF

Header Utilities

If there is currently a waveform selected for playback, this table shows you the header information for the file. You can clear the header information out or edit it and save it.

Dependencies	Only available if there is currently a waveform selected for playback. Grayed-out if no waveform is selected
--------------	--

Clear Header

Lets you clear the header information from the file header associated with the currently selected waveform.

Remote Command	<code>:SOURce:RADio:ARB:HEADer:CLEar</code>
Example	<code>:SOUR:RAD:ARB:HEAD:CLE</code>
Notes	Attempting to clear the header details via SCPI when no waveform was selected for playback generates an error

Save Header

Lets you save new file header information details to the file.

Remote Command	<code>:SOURce:RADio:ARB:HEADer:SAVE</code>
Example	<code>:SOUR:RAD:ARB:HEAD:SAVE</code>
Notes	Attempting to save the header details via SCPI when no waveform was selected for playback generates an error

Query Waveform Unique ID (Remote Query Only)

Each Signal Studio waveform contains a unique waveform ID, which recorded in the header. This command allows you to query the unique waveform ID from the header.

Remote Command	<code>:MMEMory:HEADer:ID? "<file name>"</code>
Example	<p>Query the waveform already loaded into the ARB memory:</p> <pre><code>:MMEM:HEAD:ID? "test.wfm"</code></pre> <p>Query the waveform on the hard disk by absolute path:</p> <pre><code>:MMEM:HEAD:ID? "D:\NVARB\test.wfm"</code></pre>

6 Input/Output
6.1 RF Source

	Query the waveform on the hard disk by MSUS: :MMEM:HEAD:ID? "NVWFM:test.wfm"
Notes	The queried waveform file can be in ARB memory, or on hard disk. If want to query ARB in ARB memory, then give out the file name directly. If want to query ARB on the hard disk, then absolute file path or MSUS should be given along with the file name. The valid MSUS is NVWFM , which is mapped to D:\NVARB on the hard disk If the file cannot be found in ARB memory or on hard disk, an error is generated and value -1 is returned

Query Selected Waveform Header info (Remote Query Only)

Returns a listing of the current selected ARB header info. If no ARB selected, then empty string is returned.

Remote Command	:SOURCE:RADio:ARB:HEADer:INFormation?
Example	:SOUR:RAD:ARB:HEAD:INF?

Notes

After each colon of field title string, related header info string is appended

The field title string in "Range" part cannot change, for Sequence Studio needs to accurately match those string character to know which header info field it is

Below are the abbreviation descriptions:

DESC	Description
SR	Sample Rate
RTS	Run Time Scaling
RMS	Root Mean Square
M1P	Marker 1 Polarity
M2P	Marker 2 Polarity
M3P	Marker 3 Polarity
M4P	Marker 4 Polarity
ALCHR	ALC Hold Routing
RFBR	RF Blank Routing
FOFF	Frequency Offset
AWGNST	AWGN State
AWGNCN	AWGN C/N Ratio
AWGNCBW	AWGN Carrier Bandwidth
AWGNNBW	AWGN Noise Bandwidth
AWGNCRMS	AWGN Carrier RMS
ORP	DAC Over Range Protection

	UID	Unique ID
	LICSTS	License Status
Range	"DESC:", "SR:", "RTS:", "RMS:", "M1P:", "M2P:", "M3P:", "M4P:", "ALCHR:", "RFBR:", "FOFF:", "AWGNST:", "AWGNCN:", "AWGNCBW:", "AWGNNBW:", "AWGNCRMS:", "ORP:", "UID:", "LICSTS"	

6.1.12 Trigger Initiate

Initiates an immediate trigger event if the trigger source (under ARB Setup) is set to [KEY](#).

Dependencies Grayed-out unless Trigger Source is set to [KEY](#) and an ARB waveform is configured

6.1.13 Source Sync

Accesses a menu for setting up Source Synchronization for multiple models.

Only appears in modular products such as VXT, and only when the instrument is configured for MIMO analysis.

6.1.13.1 Sync Config

Lets you config MIMO type for source.

Grayed-out when Primary and Secondary modules are in Sync State.

Remote Command `:SOURce:SYNC:CONFig NONE | TWO | THRee | FOUR | SIX | EIGHt | DONE | DTWO | DTHR | DFOU`

See "[Option Details](#)" on page 1117

`:SOURce:SYNC:CONFig?`

Example `:SOUR:SYNC:CONF TWO`

Dependencies	EXM	2x2 and 1x1+1x1 MIMO are supported when license E6640A-M22 is enabled
		2x2 and 3x3 MIMO are supported when license E6640A-M33 is enabled
		2x2, 3x3, 4x4 and 2x2+2x2 MIMO are supported when license E6640A-M44 is enabled
	VXT models M9410A/11A	No-Across chassis MIMO is supported when license M941xA-MMO is enabled
		Across chassis MIMO is supported when license M941xA-MTS is enabled

6 Input/Output
6.1 RF Source

VXT models M9415A/16A	No-Across chassis MIMO is supported when license M941xA-MMO is enabled
--------------------------	--

Range [NONE](#) | [TWO](#) | [THRee](#) | [FOUR](#) | [SIX](#) | [EIGHT](#) | [DONE](#) | [DTWO](#) | [DTHR](#) | [DFOU](#)

Option Details

Parameter	SCPI	Notes
None	NONE	Sets MIMO Config type as None
2x2	TWO	Sets 2x2 as MIMO Config Type. 2 models are configured to Sync
3x3	THRee	Sets 3x3 as MIMO Config Type. 3 models are configured to Sync
4x4	FOUR	Sets 4x4 as MIMO Config Type. 4 models are configured to Sync
6x6	SIX	Sets 6x6 as MIMO Config Type. 6 models are configured to Sync
8x8	EIGHT	Sets 8x8 as MIMO Config Type. 8 models are configured to Sync
1x1+1x1	DONE	Sets 1x1+1x1 as MIMO Config Type. 2 models are configured to Sync with different center frequency. Use Segment 2 Setup to config the second model
2x2+2x2	DTWO	Sets 2x2+2x2 as MIMO Config Type. 2 groups of 2x2 MIMO. First group consists of Primary and TRX1. Second group consists of TRX2 and TRX3. Segment 2 Setup allows you to config the second group
3x3+3x3	DTHR	Sets 3x3+3x3 as MIMO Config Type. 2 groups of 3x3 MIMO. First group consists of Primary, TRX1 and TRX2. Second group consists of TRX3, TRX4 and TRX5. Segment 2 Setup allows you to config the second group
4x4+4x4	DFOU	Sets 4x4+4x4 as MIMO Config Type. 2 groups of 4x4 MIMO. First group consists of Primary, TRX1, TRX2 and TRX3. Second group consists of TRX4, TRX5, TRX6 and TRX7. Segment 2 Setup allows you to config the second group

6.1.13.2 Sync Type

Grayed-out when models are in Sync State.

Remote Command	:SOURce:SYNC:TYPE PRIMary SECondary OFF For details of parameter options, see "Options" on page 1118 :SOURce:SYNC:TYPE?
Example	:SOUR:SYNC:TYPE PRIM
Preset	OFF
Range	PRIMary SECondary OFF

Options

Parameter	Notes
OFF	This model is not listed in the Secondary module List
SECondary	Use <code>:SOURCE:SYNC:CONNECTED:NAME?</code> to obtain the Primary's name in Sync State
PRIMary	Sync Setup is only available for Primary

6.1.13.3 Sync Settings

Grayed-out when Primary and Secondary are in Sync State.

Dependencies Grayed-out when Sync Type is set to **OFF** or Secondary

Secondary Module List

Lists the parameters of Secondary modules. The Selected checkbox in each row allows you to select the Secondary module when the Sync Type is set to Primary.

- When Sync Config is set to NxN, use this control to enable N-1 Secondary modules
- When Sync Config is set to NxN+NxN, use this control to enable 2N-1 Secondary modules

See "[More Information](#)" on page 1118

Remote Command	<code>:SOURCE:SYNC:REMOte:SECOndary<integer> ON OFF 1 0</code> <code>:SOURCE:SYNC:REMOte:SEC<integer>?</code>
Example	<code>:SOUR:SYNC:REM:SEC1 ON</code> <code>:SOUR:SYNC:REM:SEC2 OFF</code>
Notes	<code><integer></code> Secondary module number in Available Models
Preset	OFF

More Information

Parameter	SCPI Example	Notes
Available Secondary modules	<code>:SOUR:SYNC:REM:SEC:List?</code>	All the available Secondary models are listed
IP Address	<code>:SOUR:SYNC:REM:SEC1:ADDR?</code>	Refer to Remote Chassis to add the IP Address for remote chassis

6 Input/Output
6.1 RF Source

Parameter	SCPI Example	Notes
Slot Number	:SOUR:SYNC:REM:SEC2:SLOT?	“Local Host” indicates that the Primary and Secondary modules share the same chassis
Socket Port	:SOUR:SYNC:REM:SEC2:SPOR?	Indicates the slot number of available models
Secondary module Order		Indicates the socket port of available models
		Shows you the models to be Secondary devices
		Use Selected to choose from available Secondary models

Sync Settings

Lets you apply the source settings of the Primary module to its Secondary modules.

Remote Command	:SOURce:SYNC:SETTings:ENABle ON OFF 1 0 :SOURce:SYNC:SETTings:ENABle?
Example	:SOUR:SYNC:SETT:ENAB ON :SOUR:SYNC:SETT:ENAB?
Notes	When Sync Settings is ON , the source settings of Primary are applied to Secondary modules. The supported settings are Amplitude, Frequency, Trigger Source, Trigger Type, RF Output and waveform related information When Sync Segment 2 is switched ON , this Toggle is set ON simultaneously
Dependencies	Waveform files naming convention: For NxN MIMO: <ul style="list-style-type: none"> - xxx0.wfm for Primary - xxx[n].wfm for TRX[n] For example, in 3x3 MIMO: <ul style="list-style-type: none"> - xxx0.wfm for Primary - xxx1.wfm for TRX1 - xxx2.wfm for TRX2 For NxN+NxN MIMO, in the first group: <ul style="list-style-type: none"> - xxx0_0.wfm for Primary - xxx0_n.wfm for TRX[n] in the second group: <ul style="list-style-type: none"> - xxx1_n.wfm for TRX[n+N] For example, in 3x3+3x3 MIMO: <ul style="list-style-type: none"> - xxx0_0 for Primary

	- xxx0_1.wfm for TRX1
	- xxx0_2.wfm for TRX2
	- xxx1_0.wfm for TRX3
	- xxx1_1.wfm for TRX4
	xxx1_2.wfm for TRX5
Preset	OFF
Range	ON OFF

Sync Segment 2

Lets you config the models in the second group of NxN+NxN MIMO.

Remote Command	:SOURCE:SYNC:SETTINGS:SEGMENT2:ENABLE ON OFF 1 0 :SOURCE:SYNC:SETTINGS:SEGMENT2:ENABLE?
Example	:SOUR:SYNC:SETT:SEGM2:ENAB ON :SOUR:SYNC:SETT:SEGM2:ENAB?
Notes	Only Frequency in settings is supported
Dependencies	When this setting is ON, Sync Settings will be turned on accordingly
Preset	OFF
Range	ON OFF

Segment 2 Frequency

When Sync Segment 2 is ON, allows you to set the frequency of models in the second group of NxN+NxN MIMO.

Remote Command	:SOURCE:SYNC:SETTINGS:SEGMENT2:FREQUENCY <freq> :SOURCE:SYNC:SETTINGS:SEGMENT2:FREQUENCY?
Example	:SOUR:SYNC:SETT:SEGM2:FREQ 1.00 GHz :SOUR:SYNC:SETT:SEGM2:FREQ?
Preset	1.00 GHz
Min	VXT models M9410A/11A/15A/16A: 380 MHz
Max	Hardware Dependent VXT models M9410A/11A/15A/16A: - Option F06 = 6.0 GHz

IP Address

Sets up the controller's IP address of Remote Secondary models.

Remote Command	<code>:SOURCE:SYNC:REMOte:ADDReSS <string></code>
Example	<code>:SOUR:SYNC:REM:ADDR "192.168.1.2"</code>
Notes	<code><string></code> - IP Address

SCPI Socket Port

Sets up the controller's SCPI socket port of Remote Secondary models.

Remote Command	<code>:SOURCE:SYNC:REMOte:IPPort <integer></code>
Example	<code>:SOUR:SYNC:REM:IPP 5025</code>
Notes	<code><integer></code> - Port

Add Secondary Module

Lets you connect the remote chassis specified by IP Address and Socket Port.

Remote Command	<code>:SOURCE:SYNC:REMOte:ADDReSS:ADD</code>
Example	<code>:SOUR:SYNC:REM:ADDR:ADD</code>
Notes	Example of how to add a remote chassis: <code>:SOUR:SYNC:REM:ADDR "192.168.1.2"</code> <code>:SOUR:SYNC:REM:IPP 5025</code> <code>:SOUR:SYNC:REM:ADDR:ADD</code> Once a remote chassis is connected, the "Secondary Module List" on page 1118 shows you the available Secondary modules

Delete Secondary Module

Lets you delete a selected remote chassis IP Address from the ["Secondary Module List" on page 1118](#).

Remote Command	<code>:SOURCE:SYNC:REMOte:ADDReSS:DELeTe</code>
Example	<code>:SOUR:SYNC:REM:ADDR:DEL</code>
Notes	Example of how to delete a remote chassis: <code>:SOUR:SYNC:REM:ADDR "192.168.1.2"</code>

`:SOUR:SYNC:REM:ADDR:DEL`

Sync Runtime Settings (Remote Command Only)

Lets you Sync runtime settings to the Secondary modules without restarting Sync.

Remote Command	<code>:SOURce:SYNC:RTSetting:STATe ON OFF 1 0</code> <code>:SOURce:SYNC:RTSetting:STATe?</code>
Example	<code>:SOUR:SYNC:RTS:STAT ON</code> <code>:SOUR:SYNC:RTS:STAT?</code>
Notes	When OFF , Sync is interrupted when changing frequency or power settings on the Primary module. After applying the new settings to the Secondary modules, Sync will restart When ON , setting changes on the Primary module are applied to the Secondary modules immediately without interrupting Sync status. This is the default behavior. The supported settings are Amplitude and Frequency
Preset	ON
Range	ON OFF

6.1.13.4 Sync Start

Lets you start synchronizing Primary and Secondary modules to play Arb synchronously.

When the Sync connection is built successfully, Primary and Secondary modules are in the Sync State.

Sync Start and Sync Config menu are grayed-out when Primary and Secondary modules are in Sync State.

Remote Command	<code>:SOURce:SYNC:START</code>
Example	<code>:SOUR:SYNC:STAR</code>
Notes	If you change the source settings during Sync State, an error message appears in the status bar: "Settings conflict; Sync connection is already established" and the change will not be applied until Sync Stop

6.1.13.5 Sync Stop

Stops the synchronization.

When Sync Stops, Sync Config menu and Sync Start will be available.

Remote Command	<code>:SOURce:SYNC:STOP</code>
Example	<code>:SOUR:SYNC:STOP</code>

6.1.13.6 Sync Connected (Remote Query Only)

Lets you query the state of synchronization.

Remote Command	<code>:SOURce:SYNC:CONNected?</code>
----------------	--------------------------------------

Example	<code>:SOUR:SYNC:CONN?</code>
---------	-------------------------------

Returns: 1 when synchronization is established, 0 when synchronization is stopped

6.1.14 Source Preset

Lets you preset the source settings to their default values.

Remote Command	<code>:SOURce:PRESet</code>
----------------	-----------------------------

Example	<code>:SOUR:PRES</code>
---------	-------------------------

6.2 Input

The controls on this tab let you select and configure the instrument's inputs.

6.2.1 Select Input

Lets you choose which signal input you want to analyze:

- "RF Input" on page 1126
- "External Mixer" on page 1126
- "I/Q" on page 1129

See also:

- "External Mixer Setup" on page 1151
- "I/Q Setup" on page 1171

Remote Command	<code>[:SENSe] :FEED RF AIQ EMIXer</code> <code>[:SENSe] :FEED?</code>
Example	Select the RF Input: <code>:FEED RF</code> Select External Mixing: <code>:FEED EMIX</code> Select BBIQ: <code>:FEED AIQ</code>
Dependencies	I/Q only appears when Option BBA present Ext Mix only appears when Option EXM present
Couplings	Connecting a U7227A USB Preamplifier to one of the instrument's USB ports causes the Input to automatically switch to the RF Input. If the RF Calibrator is on, it is turned off. Subsequently disconnecting the USB Preamp from USB does not change the Input selection, nor restore the previous selection <code>[:SENSe] :FEED RF</code> turns the calibrator OFF
Preset	Unaffected by Preset or power cycle. Survives a Mode Preset and mode changes Set to RF by Restore Input/Output Defaults or Restore System Defaults->All
State Saved	Saved in instrument state
Annotation	Displayed in the Meas Bar as "Input:." followed by: RF or Ext Mix or I/Q depending on which input is selected

6 Input/Output

6.2 Input

Backwards Compatibility SCPI	<p><code>[:SENSe] :FEED AREFERENCE</code></p> <p>In the PSA the calibrator was one of the inputs and selected using the AREF parameter to the same :FEED command that switched the inputs. In the X-Series, it is controlled in a separate menu and overrides the input selection. For code compatibility, <code>[:SENSe] :FEED AREFERENCE</code> is provided, and is aliased to <code>[SENSe] :FEED :AREF REF50</code>, which causes the input to be switched to the 50 MHz calibrator. <code>[:SENSe] :FEED RF</code> switches the input back to the RF port and turns the calibrator OFF, thus providing full compatibility with the PSA calibrator function</p> <p>Note that after sending this, <code>[:SENSe] :FEED?</code> does <i>not</i> return "AREF" but instead the currently selected input:</p> <pre>[:SENSe] :FEED IQ IONLy QONLy [:SENSe] :FEED?</pre> <p>The parameters <code>IQ IONLy QONLy</code> are supported for backwards compatibility with the E44406A</p> <pre>[:SENSe] :FEED IQ aliases to [:SENSe] :FEED : IQ :TYPE IQ [:SENSe] :FEED IONLy aliases to [:SENSe] :FEED : IQ :TYPE IONLy [:SENSe] :FEED QONLy aliases to [:SENSe] :FEED : IQ :TYPE QONLy [:SENSe] :FEED? always returns AIQ, whatever type of legacy parameter IQ IONLy QONLy has been used</pre>
Backwards Compatibility Notes	<p>Most of the settings in the X-Series Input/Output system, including External Gain, Amplitude Corrections settings and data, etc., are shared by all modes and are not changed by a mode switch. Furthermore, most variables under the Input/Output menu are not affected by Mode Preset. Both of these behaviors represent a departure from legacy behavior</p> <p>In X-Series, Input/Output settings are reset by using Restore Input/Output Defaults. They can also be reset to their default values by System->Restore System Defaults-> In/Out Config, or by System ->Restore System Defaults -> All (and corresponding SCPI)</p> <p>While this matches most use cases better, it does create some code compatibility issues. For example, Amplitude Corrections are no longer turned off by Mode Preset, but instead by Restore Input/Output Defaults</p> <p>Although Input/Output settings are not part of each Mode's State, they are saved in Save State files, so that all of the instrument settings can be recalled with Recall, State, as in legacy instruments</p>
Notes	<p>In legacy analyzers you choose between the Internal mixer or an External Mixer. In X-Series, the External Mixer is one of the choices for the Input and is selected using the <code>FEED</code> command (<code>:SENSe:FEED EXTMixer</code>)</p> <p>For compatibility, the <code>:INPut:MIXer EXTErnal INTernal</code> legacy command is mapped as follows:</p> <ol style="list-style-type: none">1. When <code>:INPut:MIXer EXTErnal</code> is received, <code>:SENSe:FEED EMIXer</code> is executed2. When <code>:INPut:MIXer INTernal</code> is received, <code>:SENSe:FEED RF</code> is executed3. When <code>:INPut:MIXer?</code> is received, the response is <code>INT</code> if any input other than the external mixer is selected, and <code>EXT</code> if the external mixer is selected
Preset	<code>INT</code>

Backwards Compatibility SCPI	<code>:INPut:MIXer EXTERNAL INTERNAL</code>
	<code>:INPut:MIXer?</code>

Backwards Compatibility Notes	PSA supports the following SCPI Command :
	<code>:INPut:MIXer:TYPE PRESelected UNPReselect</code>
	<code>:INPut:MIXer:TYPE?</code>
	PXA does not support the <code>:INPut:MIXer:TYPE</code> command

RF Input

Selects the front-panel RF input port to be the instrument signal input. If RF is already selected, pressing this key accesses the RF input setup functions.

External Mixer

Lets you select an External Mixer through which to apply signal input to the instrument. When selected, the LO/IF port becomes the input to the instrument.

External Mixing requires option EXM. The External Mixer key will not appear unless option EXM is installed. The presence of the LO/IF connector alone does not indicate that you have Option EXM licensed. To verify that option EXM is installed, press **System, Show, System**.

When External Mixer is selected, the **Center Freq** key controls the setting of the Center Freq in external mixing, which is separate from the settings of Center Freq for the RF Input or BBIQ. Each input retains its unique settings for Center Freq. A unique SCPI command is provided solely for the external mixing Center Freq (see the **Center Freq** key description), which only affects the External Mixer CF, although sending the generic Center Freq command while External Mixer is selected also controls the External Mixer CF.

Unless option EXM is present, the External Mixer key is blanked, and all SCPI commands associated with menus accessed by this key return an error. Manual FFT mode is available with external mixing, but not with Signal ID. All settings under this key, and all Frequency settings, are remembered when you go out of External Mixer, so that when **External Mixer** is chosen again, all the external mixer functions will retain their previous settings, with the exception of Signal ID which is set to OFF (Signal ID is also set to Off unless External Mixer is the selected Input). Note that this differs from ESA and PSA, in which all external mixer settings including Center Frequency are lost when you turn off External Mixing or Preset the instrument.

X-series instruments have a combined LO Out/IF In connection, whereas earlier instruments used separate ports for the LO Out and the IF in. Internal diplexers in the instrument and the mixer simplify the connection for users – only a single SMA cable is required.

6 Input/Output
6.2 Input

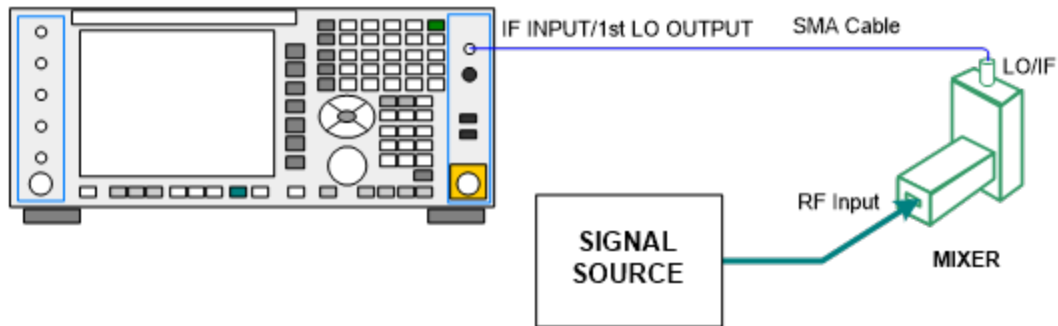

Legacy HP/Agilent and some third-party mixers have separate LO In and IF out connections. This requires you to use an external diplexer to connect these mixers. A diplexer can easily be purchased for this purpose (for example, Diplexer Model # DPL.26 or # DPL.313B from OML Inc., Morgan Hill, California, USA).

The connection diagram for such a legacy mixer is:

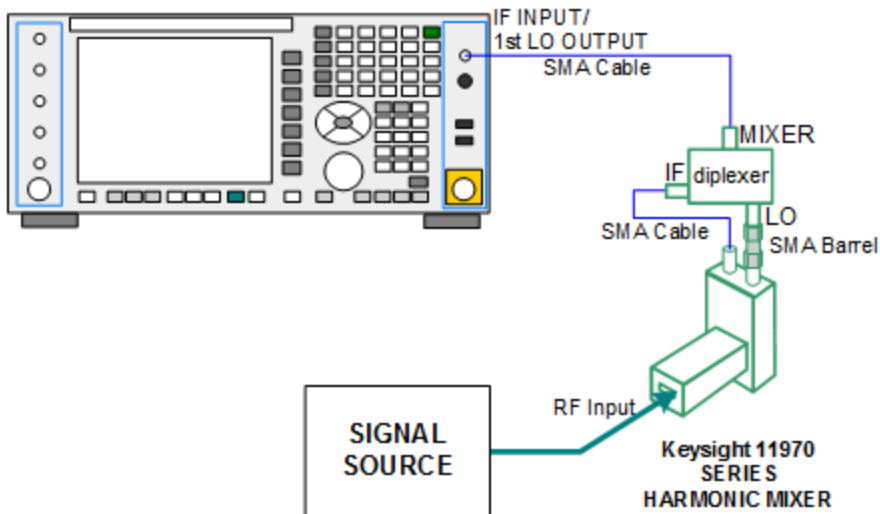

In addition, External Mixing in the X-Series supports the new Keysight M1970 series of Harmonic Mixers, which provide a USB connection for download of calibration data and additional control.

The connection diagram for one of the Keysight USB mixers is:

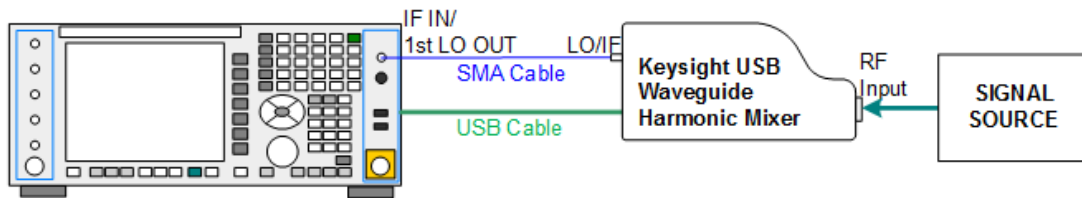

Also available in the M197x series are the M1971 series USB Mixers, which provide additional inputs and outputs for special functionality as described below. These mixers have multiple signal paths which allow them to function in three different states:

- Normal, in which the mixer functions as a classic external mixer with a single conversion:

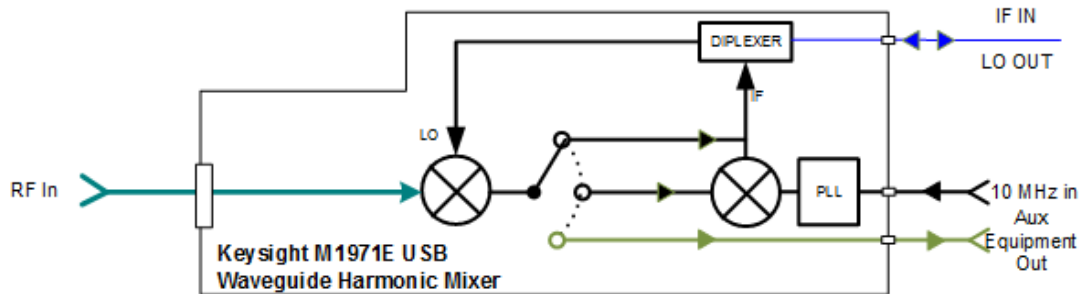

- Dual Conversion, which gives you a wider image-free range. In Dual Conversion, the first conversion is to a higher IF frequency and you provide a 10 MHz signal to which an internal PLL is locked, to effect a second downconversion:

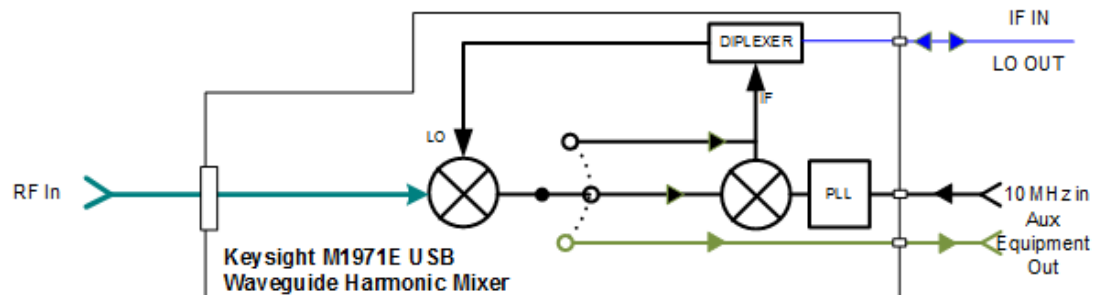

- Aux Equipment, wherein the first mixer output drives an output connector on the mixer and the instrument is out of the circuit:

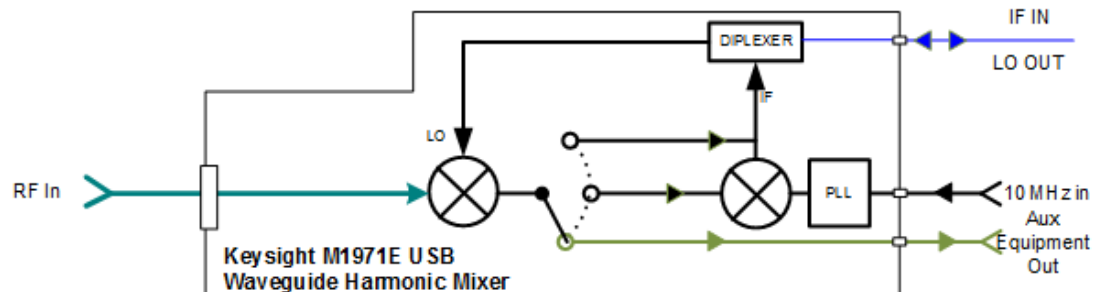

External Mixing is only supported in certain Modes and Measurements in the X-Series, as shown in the table below. When External Mixer is selected in a

6 Input/Output
6.2 Input

measurement that does not support it, the "No result; Meas invalid with Ext Mixing" error condition occurs:

Mode	Measurements	Sig ID (Image Suppress only)
Spectrum Analyzer	Swept SA	Y*
	TOI	Y
	Harmonics	N
	Spurious Emissions	Y
	Channel Power	Y
	Occupied BW	Y
	ACP	Y
	Spectrum Emissions Mask	Y
	CCDF	N
	Burst Power	N
	List Sweep	N
Phase Noise	Monitor Spectrum	Y
	Log Plot	Y
	Spot Frequency	N
	Waveform	N
I/Q Analyzer	Complex Spectrum	N
	Waveform	N
Vector Signal Analyzer	Vector Analysis	N
	Analog Demod	N
	Digital Demod	N
Analog Demod	AM	N
	FM	N
	PM	N
	FM Stereo	N

* the Swept SA measurement also supports Image Shift

I/Q

Selects the front-panel I/Q input ports to be the instrument signal input. If I/Q is already selected, pressing this key accesses the I/Q setup menu.

The Baseband I/Q functionality is a hardware option. It is option BBA. If the option is not installed, none of the I/Q functionality is enabled.

The Baseband I/Q has four input ports and one output port. The input ports are I, I-bar, Q, and Q-bar. The I and I-bar together compose the I channel, and the Q and Q-

bar together compose the Q channel. Each channel has two modes of operation, Single-Ended (also called "unbalanced") and Differential Input (also called "balanced"). When in Single-Ended operation, only the main port (I or Q) is used, and the complementary port (I-bar or Q-bar) is ignored. When in Differential Input mode, both main and complementary ports are used.

The input settings (range, attenuation, skew, impedance, external gain) apply to the channels, not the individual ports.

The system supports a variety of 1 M Ω input passive probes as well as the Keysight 113x Series active differential probes using the Infinimax probe interface.

The Keysight 113x Series active probes can be used for both single ended and differential measurements. In either case a single connection is made for each channel (on either the I or Q input). The input is automatically configured to 50 Ω single ended and the probe power is supplied through the Infinimax interface. The probe can be configured for a variety of input coupling and low frequency rejection modes. In addition, a wide range of offset voltages and probe attenuation accessories are supported at the probe interface. The active probe has the advantage that it does not significantly load the circuit under test, even with unity gain probing.

With passive 1 M Ω probes, the probe will introduce a capacitive load on the circuit, unless higher attenuation is used at the probe interface. Higher attenuation reduces the signal level and degrades the signal-to-noise-ratio of the measurement. Passive probes are available with a variety of attenuation values for a moderate cost. Most Keysight passive probes can be automatically identified by the system, setting the input impedance setting required as well as the nominal attenuation. For single ended measurements a single probe is used for each channel. Other passive probes can be used, with the attenuation and impedance settings configured manually.

For full differential measurements, the system supports probes on each of the four inputs. The attenuation of the probes should be the same for good common mode rejection and channel match.

Both active and passive probes in single ended and differential configurations can be calibrated. This calibration uses the Cal Out BNC connection and a probe connection accessory. The calibration achieves excellent absolute gain flatness in a probed measurement. It matches both the gain and frequency response of the I and Q channels as well as any delay skew, resulting in high accuracy in derived measurements such as Error Vector Magnitude (EVM).

When a probe is connected a status message will be displayed. The message will indicate if calibration data is available or not. Calibration data is saved for each type of probe (including "none") for each port and will be reapplied whenever that type of probe is re-connected to the same port. For probes with EEPROM identification, the calibration data will be stored based on the unique probe identifier and will reapply data for that particular probe if it is available. The data will not follow a probe from one port to another. For probes without EEPROM identification, the instrument

6 Input/Output

6.2 Input

cannot distinguish between different probes of the same type, and it will use the data from the last calibration for that probe type on that port.

When in differential mode, both the main and complementary probes are expected to be of the same type.

In some situations, the I and Q channels should be configured identically. In other situations, it is convenient to control them independently. Some menus have a "Q Same as I" setting that will cause the Q channel configuration to mirror the I channel configuration, avoiding the overhead of double data entry when the channels should be the same.

The output port is for calibrating the I/Q input ports, although it can also be manually controlled.

There are two types of calibrations available: cable calibration and probe calibration. The cable calibration will guide the user through connecting each input port in turn. All ports must be calibrated together. The probe calibration is done for a specific channel (I or Q). If in Single-Ended mode, only the main port is calibrated. When in Differential Input mode, the user is guided through calibrating both main and complementary ports.

The front panel I/Q port LEDs indicate the current state of that port. On (green) indicates it is active, and off (dark) indicates it is not in use. For example, the Cal Out port LED is on if and only if there is signal coming out of that port.

The input is a context, and some parameters have separate values for each context. The SCPI for these parameters has an optional "[:RF|IQ]" node. If the specific context is omitted, the command acts on the current input context's value. Here are the parameters that are input context sensitive:

- Center Frequency
- Trigger Source

It is important to distinguish between the I and Q input ports and the displayed I and Q data values. The I and Q input ports feed into a digital receiver that does digital tuning and filtering. The I and Q data seen by the user (either on the display or through SCPI) corresponds to the real ("I") and the imaginary ("Q") output from the digital receiver. When the input path is I+jQ or I Only and the center frequency is 0 Hz the I input ends up in as the real output from the receiver and appears as "I" data. Likewise, when the input path is I+jQ and the center frequency is 0 Hz, the Q input ends up as the imaginary output from the receiver and appears as "Q" data. However, when the input path is Q Only, the Q input is sent to the receiver as $Q+j0$, so the receiver output has the Q input coming out on the real output, and so in Q Only, the signal from the Q input port appears as the "I" data. Another situation where the I and Q data do not necessarily correspond directly to the I and Q inputs is when the center frequency is non-zero. The digital processing involved in the tuning

is a complex operation. This will result in I Only data appearing as both "I" and "Q" data, the same as that signal would appear if seen through the RF input port.

BBIQ is only supported in certain Modes and Measurements in the X-Series. When I/Q is selected in a measurement that does not support it, the "No Result; Meas invalid with I/Q inputs" message appears. This is error 135

Baseband I/Q Remote Language Compatibility

For the Agilent E4406A VSA Series Transmitter Tester, Option B7C provided baseband I/Q inputs. Code compatibility has been provided to allow many of the commands for Option B7C to function properly with X-Series. X-Series has hardware differences and additional capabilities (for example, E4406A does not have independent settings of I & Q, nor does it provide for probe calibrations), which make 100% compatibility impossible.

The following commands are supported:

```
:CALibration:IQ:FLATness
```

```
:INPut:IMPedance:IQ U50 | B50 | U1M | B1M
```

```
:INPut:IMPedance:REFerence <integer>
```

[:SENSe]:FEED RF | IQ | IONLY | QONLY | AREFERENCE | IFALIgn supports all parameters except IFALIgn. The FEED? query returns only RF | AIQ | AREF.

The following commands are not supported:

```
:CALibration:GIQ
```

```
:CALibration:IQ:CMR
```

```
:INPut:IQ:ALIGn OFF | ON | 0 | 1
```

The Rohde & Schwarz FSQ-B71 also provides baseband I/Q inputs. A certain amount of code compatibility is provided in X-Series, but hardware differences make this a somewhat limited set.

Supported:

The "<1|2>" is supported as "[1]".

```
INPut<1|2>:IQ:BALanced[:STATe] ON | OFF
```

```
INPut<1|2>:IQ:TYPE I | Q | IQ
```

```
INPut<1|2>:IQ:IMPedance LOW | HIGH
```

Not Supported:

```
DIAGnostic<1|2>:SERVice:IQ:CALibration:DC 0 | 0.1 | 0.178 | 0.316 | 0.562 | 1.0
```

```
DIAGnostic<1|2>:SERVice:IQ:CALibration:DESTination IHIGH | ILOW | QHIGH | QLOW
```

```
DIAGnostic<1|2>:SERVice:IQ:CALibration:PULSe: PRATe 10 kHz | ... | 4 MHz
```

```
DIAGnostic<1|2>:SERVice:IQ:INPut IQ | GND | CALDc | CALPulse
```

6 Input/Output

6.2 Input

```
INPut<1|2>:SElect AIQ | RF
TRACe<1|2>:IQ:DATA:FORMat COMPatible | IQBlock | IQPair>
TRACe<1|2>:IQ:DATA:MEMory? <offset samples>,<# of samples>
TRACe<1|2>:IQ:DATA?
TRACe<1|2>:IQ:SET <filter type>,<rbw>,<sample rate>,<trigger source>,<trigger
slope>,<pretrigger samples>,<# of samples>
TRACe<1|2>:IQ:SRATe 10.0kHz to 81.6MHz
TRACe<1|2>:IQ[:STATe] ON | OFF
```

The Rohde & Schwarz FMU has the following SCPI, which is *not* supported (these commands start/abort the probe calibration procedure, which is manually interactive from the front panel):

```
CALibration:ABORT
CALibration:PROBe[:START]
```

6.2.2 RF Input Port

Specifies the RF input port used. Only appears on units with multiple RF inputs, and lets you switch between the inputs.

Instruments that include multiple RF Input ports include:

- N9041B
- N9000B (CXA)
- N9048B (PXE)
- VXT, M941xE and EXM
- M8920A/20B
- E7760B

NOTE

Switching input ports may change the receiver performance of the instrument.

See ["Instruments with 2 Inputs" on page 1135](#)

Remote Command `[:SENSe] :FEED [:RF] :PORT [:INPut] <port>`

For instrument-specific definitions of `<port>`, see:

["Parameters for UXA/PXA/MXA/EXA/CXA/MXE/PXE/NFA" on page 1135](#)

["Parameters for EXT, EXF and EXM Wireless Test Sets" on page 1136](#)

	<p>"Parameters for VXT M9410A/11A/15A16A, M9410E/11E/15E/16E and M9420A Vector Transceivers" on page 1136</p> <p>"Parameters for VXT M9410A/11A/15A/16A and EXM when used with Radio Heads/CIU" on page 1138</p> <p>"Parameters for E7760B Wideband Transceiver" on page 1141</p> <p>"Parameters for M8920A/20B Radio Test Set" on page 1142</p> <p>"Parameters for UXM Wireless Test Set" on page 1142</p> <p><code>[:SENSe] : FEED [:RF] : PORT [:INPut] ?</code></p>
Example	<p>Use the port labeled RF Input when the selected input is RF: <code>:FEED:RF:PORT RFIN</code></p> <p>Use the port labeled RF Input 2 when the selected input is RF: <code>:FEED:RF:PORT RFIN2</code></p>
Dependencies	<p>Only appears when RF Input is selected as the Input</p> <p>Only appears in models that support multiple inputs. If the SCPI command is sent with unsupported parameters in any other model, an error is generated, -221, "Settings conflict; option not installed"</p> <p>When any input is selected in a measurement that does not support it, the "No result; Meas invalid with this input" error condition occurs, and the measurement returns invalid data when queried</p>
Couplings	<p>When switching between inputs, you may find the new input has a different frequency range than the current input. This means the frequency at the new input may be limited, depending on where you were tuned</p> <p>When you switch from an input whose maximum frequency is greater than the input to which you are switching:</p> <ol style="list-style-type: none"> 1. If the current Stop Freq is below the Max Freq for the new input, then neither Stop Freq or Start Freq needs to change 2. But if the current Stop Freq is above the Max Freq for the new input, Stop Freq must change; so, it is set to the Max Freq for the new input 3. If the Stop Freq is forced to change then, if possible, the Span is preserved with the new Stop Freq; however, the Start Freq can't go below zero <p>Example: Input 2 has a Max Freq of 110 GHz and Input 1 has a Max Freq of 52 GHz</p> <p>Case 1: Input 2 is selected and Start Freq=40 GHz, Stop Freq=60 GHz. Change to Input 1. Stop Freq changes to 52 GHz so, to preserve Span, Start Freq is set to 32 GHz</p> <p>Case 2: Input 2 is selected and Start Freq=40 GHz, Stop Freq=110 GHz. Change to Input 1. Stop Freq changes to 52 GHz. Span was 70 GHz, but new Span maximum is 52 GHz so Start Freq is set to 0 Hz</p> <p>Case 3: Input 2 is selected and Start Freq=10 GHz, Stop Freq=20 GHz. Change to Input 1. No change is necessary, Start Freq and Stop Freq don't change</p>
Preset	<p>Unaffected by Mode Preset, but set to <code>RFIN</code> on Restore Input/Output Defaults or Restore System Defaults -> All, unless noted in the platform-specific sections below</p>
State Saved	<p>Saved in instrument state</p>
Annotation	<p>Annotation in the Meas Bar reads as follows: When input is RF In: Input: RF</p>

6 Input/Output
6.2 Input

	When input is RF In 2: Input: RF2
Backwards Compatibility SCPI	<code>:INPut<1 2>:TYPE INPUT1 INPUT2</code> <code>:INPut<1 2>:TYPE?</code>
	Included for R&S ESU compatibility. In MXE, the INPUT1 parameter is aliased to RFIN and the INPUT2 parameter is aliased to RFIN2

Instruments with 2 Inputs

In models with two inputs, the second input usually has a different maximum frequency than the first input. For your convenience, the actual “Max Freq” value is allowed to go slightly higher than the nominal Max Freq for the second input, just as is the case with the first input.

Model	Nominal Input 2 Max Freq	Absolute Input 2 Max Freq	Transition rule for switching from Input 1 to Input 2
N9038A	1 GHz	1.000025 GHz	If Stop Freq is above 1.000025 GHz, it is set to 1.000025 GHz, otherwise it does not change If Start Freq is above 1.000024990 Hz, Start Freq is set to 1.000024990 Hz and Span to 10 Hz, otherwise nothing changes
N9000A with option C75	1.5 GHz	1.58 GHz	If Stop Freq is above 1.58 GHz, it is set to 1.58 GHz, otherwise it does not change If Start Freq is above 1.579999990 GHz, Start Freq is set to 1.579999990 GHz and Span to 10 Hz, otherwise nothing changes

Parameters for UXA/PXA/MXA/EXA/CXA/MXE/PXE/NFA

<port>	Input
RFIN	RF Input
RFIN2	RF Input 2
ERFIN	External RF

Example	Set the RF input to be RF Input: <code>:FEED:RF:PORT RFIN</code>
	Set the RF input to be RF Input 2 if that port exists: <code>:FEED:RF:PORT RFIN2</code>
	Set the RF input to be External RF if the V3050A unit is connected: <code>:FEED:RF:PORT ERFIN</code>

Dependencies	If the command is sent with RFIN2 or ERFIN and that port does not exist, an error is generated, -221, “Settings conflict; option not installed” ERFIN requires option “EXW”
--------------	--

Couplings	Connecting a V3050A changes the Preset to ERFIN and automatically switches the input to ERFIN . Disconnecting the V3050A changes the Preset back to RFIN and automatically switches the input to RFIN
Preset	ERFIN when V3050A is connected, otherwise RFIN
Annotation	Annotation in the Meas Bar reads as follows: <ul style="list-style-type: none"> - When input is RFIN: Input: RF - When input is RFIN2: Input: RF2 - When input is ERFIN: Input: Ext RF

Parameters for EXT, EXF and EXM Wireless Test Sets

<port>	Input
RFIO1	RFIO 1
RFIO2	RFIO 2
RFIO3	RF3 I O
RFIO4	RF4 I O

See also "[Parameters for VXT M9410A/11A/15A/16A and EXM when used with Radio Heads/CIU](#)" on page 1138

Example	Set the RF input to RFIO 1: :FEED:RF:PORT RFIO1
Dependencies	In EXF, or in EXM with hardware M9430A, if RF Input is selected as RF Input Port, you need to choose the settings in the Half Duplex Config menu to determine which port (RFIO3 or RFIO4) will be used In EXM with hardware M9431A, this setting is not supported. If the SCPI command is sent with this setting, an error is generated, -221, "Settings conflict; option not installed"
Preset	RFIO1
Annotation	Annotation in the Meas Bar reads as follows: <ul style="list-style-type: none"> - When input is RFIO1: Input: RFIO1 - When input is RFIO2: Input: RFIO2 - When input is RFIO3: Input: RFIO3 - When input is RFIO4: Input: RFIO4

Parameters for VXT M9410A/11A/15A/16A, M9410E/11E/15E/16E and M9420A Vector Transceivers

<port>	Input
RFIN	RF Input

6 Input/Output
6.2 Input

<port>	Input
RFFD	RFIO FD
RFHD	RFIO HD, Half Duplex

Example

```
:FEED:RF:PORT RFIN
:FEED:RF:PORT RFFD
:FEED:RF:PORT RFHD
:FEED:RF:PORT NONE
```

Notes

RFIN sets the RF input to be the RF Input port, labeled RF Input

RFFD sets the RF input to be the full duplex port, labeled RFIO FD. Note that Option “FDX” is required to enable this port

RFHD sets the RF input to be the half duplex port, labeled Half Duplex (M9410A/11A/15A/16A) or RFIO HD (M9420A)

M9410E/11E/15E/16E also has HD port, which is the HD port on M9471A module

NONE sets the RF In port and Half Duplex port (if HD Port is not set to RF Output) to connect to 50Ω load, as shown below:

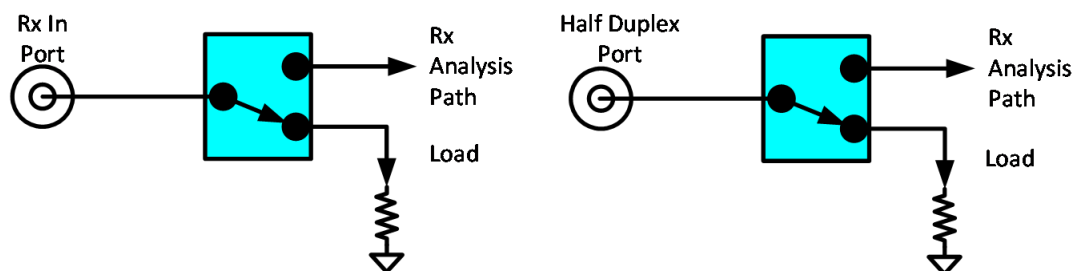

When using Source only, set RF Input to **NONE** to provide better isolation. When the input port is set to **NONE**, an error appears in the status area:

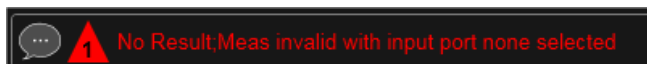

Dependencies

Option HDX is required to enable the Half Duplex (RFIO HD) port

You cannot set this port to be the input if it is already set to be the output. Attempting to do so generates error message: “-221, Settings conflict; RF Input cannot be set to RFIO HD when RF Output is RFIO HD”

NONE is not available in VXT model M9420A

Preset

RFIN

Annotation

Annotation in the Meas Bar reads as follows:

When input is RF Input: Input: RF

When input is RFIO FD: Input: RFFD

When input is RFIO HD or Half Duplex: Input: RFHD

When input is None: Input: NONE

Parameters for VXT M9410A/11A/15A/16A and EXM when used with Radio Heads/CIU

<port>	Input
RRH h RFHD p	Head h , RF Tx/Rx p , for example RRH1RFHD2 = Head 1, RF Tx/Rx 2
IFIN n	DUT IF IN for Channel n , for example IFIN1 = DUT IF IN for Channel 1
IFHD n	DUT IF In/Out for Channel n , for example IFHD1 = DUT IF In/Out for Channel 1

When using a Remote Radio Head (RRH), such as the Keysight M1740A mmWave Transceiver for 5G, with the VXT or EXM, the choices in the dropdown are dependent on which heads are installed. For example, in the case where two M1740As are present, each with two ports, the dropdown will look like this:

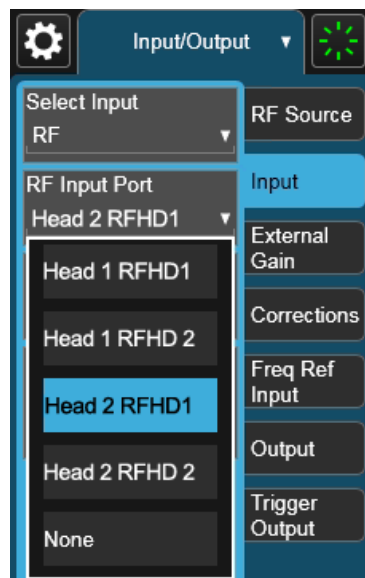

Note the inclusion of the **None** choice, which allows the input port to become unassigned, and thus allows any Output port to be assigned without concern about an Input port conflict. When the input port is unassigned, an error appears in the status area:

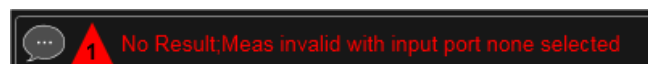

The user interface parameter RFHD p corresponds to the port labeled RF Tx/Rx p ; for example, RFHD 2 means the port labeled RF Tx/Rx 2 on the M1740A.

When using a E7770A Common Interface Unit, you may make connections to the half-duplex port on the front of the CIU labeled DUT IF In/Out, and/or to ports on the rear of the CIU labeled DUT IF IN and DUT IF OUT. For example, if your DUT has an IF Output you will usually connect it to one of the DUT IF IN ports on the rear panel of the CIU. The user interface parameter IFIN n corresponds to the DUT IF IN port for Channel n on the CIU, so you would choose IFIN 1 in the dropdown to

6 Input/Output
6.2 Input

connect to the DUT IF IN port for Channel 1, and the corresponding SCPI parameter would be IFIN1. See the figure below:

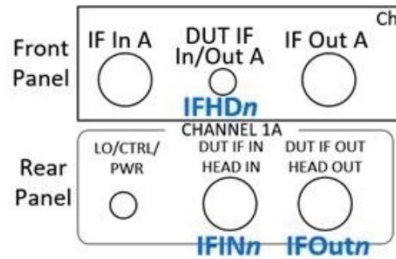

The following table lists the GUI parameter for each input or output on the CIU, and the SCPI parameter for the RF Input Port command (`[:SENSe] :FEED[:RF] :PORT [:INPut]`) and the RF Output Port command (`[:SENSe] :FEED:RF:PORT:OUTPut`):

Port	Port name on CIU	Name displayed in GUI	SCPI parameter for RF Input Port and Output Port commands
IF input port	DUT IF IN	IF In n	IFIN_n , for example IFIN1
IF output port	DUT IF OUT	IF Out n	IFOut_n , for example IFO1
IF port, half duplex	DUT IF In/Out	IFHD n	IFHD_n , for example, IFHD1

NOTE

The value of n for each port, in the multiple-port use case, may vary according to your system configuration. For the value of n for your use case, consult the Startup Guide for your particular system (for example S9100A).

An example of the GUI for the CIU ports appears below:

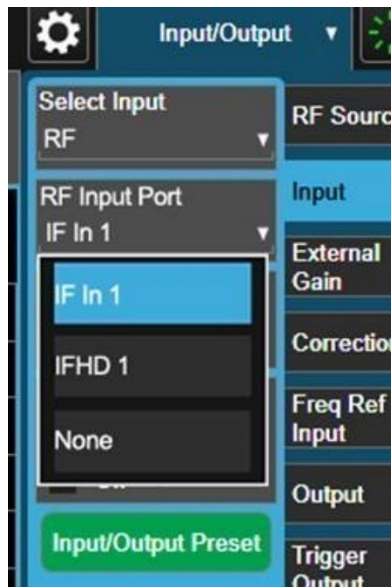

Example	<p>Set the RF input to be the port labeled RF Tx/Rx 2 on Head 1: :FEED:RF:PORT RRH1RFHD2</p> <p>Set the RF input to be the Channel 1 port labeled DUT IF IN on the CIU: :FEED:RF:PORT IFIN1</p>
Notes	<p>Parameter RRHhRFHDp corresponds to Head h, port RF Tx/Rx p; for example, RRH1RFHD2 = the port labeled RF Tx/Rx 2 on Head 1</p> <p>For the CIU, the parameter IFINc corresponds to the DUT IF IN for channel c. For example, IFIN1 would connect to the DUT IF IN port for Channel 1</p>
Dependencies	<p>The Radio Head and CIU parameters only appear when a Remote Radio Head or CIU is connected to the instrument. If these parameters are sent at any other time, an error is generated, “-221, Settings conflict; option not installed”</p>
Preset	RRH1RFHD1
Annotation	<p>Annotation in the Meas Bar reads as follows: Input:Hd <i>h</i> RFHD <i>p</i></p> <p>For example, in the case above, with RFHD 2 on Head 1 selected: Input:Hd 1 RFHD 1</p> <p>When using the CIU:</p> <ul style="list-style-type: none"> - When input is IFIN1: Input: IFIN 1 - When input is IFIN2: Input: IFIN 2 - When input is IFIN3: Input: IFIN 3 - When input is IFIN4: Input: IFIN 4
Backwards	:FEED:RF:PORT A1

6 Input/Output
6.2 Input

Compatibility SCPI A1 is treated as RRH1RFHD1 and sets the RF input to be the port labeled RF Tx/Rx 1 on Head 1
:FEED:RF:PORT B1

B1 is treated as RRH1RFHD2 and sets the RF input to be the port labeled RF Tx/Rx 2 on Head 1
:FEED:RF:PORT IFIO2

IFIO2 is treated as IFIN1, and sets the IF input to be the port labeled “DUT IF In/Out” on the CIU rear panel

Parameters for E7760B Wideband Transceiver

<port>	Input
A n	Bank A, Channel n , for example A1
B n	Bank B, Channel n , for example B1
IFIO n	IF In/Out for Channel n , for example IFIO1

Example Set the RF input to A1:
:FEED:RF:PORT A1

Set the RF input to B3:
:FEED:RF:PORT B3

Set the RF input to IFIO1:
:FEED:RF:PORT IFIO1

Dependencies Ports A1, A2, A3, B1, B2, and B3 are available if Option RF3 is installed. Ports IFIO1 and IFIO2 are available if option RF2 is installed

Note that for E7760B:

- Attempting to select a port for which the option is not present will generate the error, -241, “Hardware missing; Input not available”
- A port cannot be selected as an Input while it is occupied as an Output. Sending such a command while the port is occupied generates error: -221, “Settings conflict; Input Port is not available while occupied by Output”
- The mmWave ports are divided into two banks; the A Bank and the B Bank. A port cannot be selected as an Input if any port on the same bank is occupied as an Output. Sending a command for this situation generates error: -221 “Settings conflict; Input Port is not available while port bank is occupied by Output”

If RF3 is present and RF4 is absent, a mmWave port cannot be selected as an Input if the Output Port is occupied by mmWave Transceiver with a different frequency range. Sending a command for this situation generates error: -221 “Settings conflict; Input Port is not available while occupied by Output of incompatible frequency”

Preset E7760B with Option RF2: IFIO1
E7760B without Option RF2: the first port with mmWave Transceiver attached. If no mmWave Transceiver attached: NONE

Annotation Annotation in the Meas Bar reads as follows:

- When input is A1: Input: A1
- When input is A2: Input: A2
- When input is A3: Input: A3
- When input is B1: Input: B2
- When input is B2: Input: B2
- When input is B3: Input: B3
- When input is IFIO1: Input: IFIO1
- When input is IFIO2: Input: IFIO2

Parameters for M8920A/20B Radio Test Set

<port>	Input
ANT	Ant
TR	T/R

Example Set the RF input to be the Antenna port on M9470A, labeled **Ant**:
`:FEED:RF:PORT ANT`

Set the RF input to be the T/R port on M9470A and M8920A/20B, labeled **T/R**. Note that Option HDX is required to enable the T/R port:
`:FEED:RF:PORT TR`

Dependencies **ANT** and **TR** are only available in modular analyzers, and only when the M9470A module is installed, such as in M8920A. Option HDX is required to enable the T/R port

Preset **ANT**

Annotation Annotation in the Meas Bar reads as follows:

- When input is Ant: Input: Ant
- When input is T/R: Input: T/R

Parameters for UXM Wireless Test Set

<port>	Input
RFIN	RF Input
RFIO1	RFIO 1
RFIO2	RFIO 2

Example Set the RF input to RFIO 2:
`:FEED:RF:PORT RFIO2`

Preset **RFIN**

6.2.3 SA Frequency Extender Firmware Update (Front Panel Only)

When a Frequency Extender device (for example, V3050A) is connected and selected, if a firmware update is available for that device, this control will be visible. Because the measurement will be stopped for the duration of the firmware update, and because the update cannot be un-done, a confirmation dialog will be presented before proceeding with the firmware update. The update can take some time, so while in process, a modal dialog will be shown indicating that the update is in process and warning not to disconnect the device or turn off power. Typically, the update will take about a minute, but time can vary with the model of the Frequency Extender. When complete, the modal dialog will be dismissed, and a pop-up message will be shown for a few seconds indicating the success or failure of the update.

See ["Error Messages" on page 1143](#)

Notes	Measurement is stopped while the update is in process
Dependencies	Not available unless an External RF device is connected, External RF is the selected RF Input Port, and there is a firmware update available for the device

Error Messages

Update Already in Process Error

If a firmware update is already in process, the following message is displayed:

```
Another external device FW update is already in process. Only one update is allowed at a time
```

If received, wait until the current FW update is complete and then try again if still needed.

Unknown Assembly Error

When updating the firmware, the target hardware assembly needs to be identified. If for some reason the assembly cannot be identified, the firmware will not be able to initiate the update, and this error message will be displayed:

```
Error updating FW for external device model <model number>' serial number <serial number>
```

```
Could not find HW assembly, cannot perform FW update
```

The `<model number>` and `<serial number>` contain the actual numbers for the device.

This is a failure that warrants investigation, so you should contact Keysight Customer Support for service.

Error During Firmware Update Process

If there is an execution problem during the FW update, the specific error message(s) is written to the SA Event Log and this error message is displayed:

```
Error updating FW for external device model <model number>' serial number
<serial number>
```

Error during FW update. See windows event log for more details

The <model number> and <serial number> contain the actual numbers for the device.

6.2.4 SA Frequency Extender Cable Correction

An SA Frequency Extender, such as V3050A, is attached to the instrument with several cables. Keysight provides several cables for purchase with the frequency extender. Typically, these are 1-, 2-, or 3-meter cables for the RF and IF connections. Keysight has characterized these cables and can correct for their loss. This control allows you to specify which cable is being used.

If you are using another type of cable, the instrument *cannot* automatically correct for it, so this function must be set to **OFF**. In this case, you can use RCal to characterize the corrections.

Remote Command	<code>:INPut:FEXtender:CABLe:CORRection OFF V3050A1M V3050A2M V3050A3M</code>
Example	<code>:INP:FEXT:CABL:CORR V3050A1M</code>
Notes	The RF Input Port selections that support an SA Frequency Extender (such as V3050A) are: N9042B: External RF No other instruments support an SA Frequency Extender
Dependencies	An SA Frequency Extender must be attached, and the frequency extender's port must be the selected input for this control to be visible <ul style="list-style-type: none"> - If the instrument does not support frequency extenders, the SCPI command returns error -241, "Hardware missing; option not available" - If the instrument does support frequency extenders, but a frequency extender is not attached, the SCPI command returns error -241, "Hardware missing; Cable selection only available when supporting frequency extender attached" <p>When a frequency extender is attached, the control is not visible unless the frequency extender's port is the selected RF input, but the command will still be available. Setting the cable selection when the frequency extender's port is not active has no effect until the port is selected</p>
Preset	Unaffected by Mode Preset but set to preset value by Restore Input/Output Defaults or Restore System Defaults -> All
State Saved	Saved in instrument state

6.2.5 Half Duplex Input Port

Specify whether **RFIO3** or **RFIO4** is the Half Duplex Input port.

6 Input/Output
6.2 Input

Remote Command	<code>[:SENSe]:HDUPlex:PORT:INPut RFI03 RFI04</code>
Example	<code>:HDUPlex:PORT:INPut RFI03</code> <code>:HDUPlex:PORT:INPut?</code>
Dependencies	Only appears in EXM If RFI03 is selected as “Half Duplex Output Port”, then “Half Duplex Input Port” will be set to RFI04 automatically. If RFI04 is selected as “Half Duplex Output Port”, then “Half Duplex Input Port” will be set to RFI03 automatically
Preset	RFI03
State Saved	Saved in State

6.2.6 Port Information (Remote Command Only)

Provides information about an instrument port. The return information consists of two comma-separated fields:

- Field 1: the connection status (0 or 1)
- Field 2: a string of port information

The return information is device-dependent.

Remote Command	<code>[:SENSe]:FEED[:RF]:PORT:INformation? RFIN RFIN2 RFFD RFHD A1 A2 A3 B1 B2 B3 IFIO1 IFIO2 ANT TR</code>
Example	<code>:FEED:PORT:INF? A1</code> example = <code>1,"US56160060"</code> where <code>1</code> is the connection status and <code>"US56160060"</code> is the port information
Notes	For E7760B: The connection status (first field in the return value) indicates: 0 – the port is either not licensed for use or is not connected to a mmWave Transceiver 1 – the port is licensed; and for the case of mmWave ports, the port is connected to a mmWave Transceiver The port information (second field in the return value) contains: "" (empty string) – no applicable information Serial Number – the serial number of the connected mmWave Transceiver If you send an incompatible parameter, the return values are: <code>0,""</code>
Dependencies	Only valid for E7760B

6.2.7 RF Preselector

In models that support the RF Preselector, such as PXE (N9048B), allows you to turn the preselector on or off.

NOTE

When using the RF Preselector, if your measurement starts below 3.6 GHz and finishes above 3.6 GHz, the preselector bypass switch will have to switch in and out for every measurement. When this is the case, you will hear a clicking sound from the instrument and a warning message will be displayed: “Settings Alert: Mechanical switch cycling”. You are advised to *avoid* such setups as much as possible, to minimize switch wear. Pressing **Mode Preset** resets Stop Freq to 3.6 GHz, to exit this state, or you can manually set Stop Freq to be below 3.6 GHz.

Remote Command	<code>[:SENSe]:POWer[:RF]:RFPSelector[:STATe] 1 0 ON OFF</code> <code>[:SENSe]:POWer[:RF]:RFPSelector[:STATe]?</code>
Example	<code>:POW:RFPS 1</code> <code>:INP:PRES:STAT ON</code>
Notes	Set full compliance measurement: <code>[:SENSe]:POWer[:RF]:RFPSelector[:STATe] 1 ON</code> Set pre-compliance measurement: <code>[:SENSe]:POWer[:RF]:RFPSelector[:STATe] 0 OFF</code>
Dependencies	Only appears when RF Input is selected as the Input Only appears in MXE and PXE The RF Preselector is not available in all measurements. The key is grayed out in measurements that do not support it, unless you are in a Mode in which no measurements support it, in which case the key does not appear at all. If the preselector is unavailable, it is forced to Off. Attempting to turn it on or off in measurements that do not support it generates the error message: -221, Settings conflict; Feature not supported for this measurement The RF Preselector is not available when FFT Sweep Type is manually selected. Attempting to turn it on or off when this is the case generates an error message: -221, Settings conflict; RF Presel unavailable when Sweep Type=Manual FFT Only appears in Modes that support the RF Preselector, in other Modes, sending the SCPI command or query generates an error In Frequency Scan measurement, this key is grayed-out when final measurement is running. Warning message “Function not available while measurement is running” appears if the grayed-out key is pressed
Preset	ON
Annotation	When RF Preselector=On, “RF PRESEL” is displayed on the Settings Panel
Backwards Compatibility SCPI	<code>:INPut<1 2>:PRESelection[:STATe] ON OFF</code> <code>:INPut<1 2>:PRESelection[:STATe]?</code> Included for R&S ESU compatibility

6.2.8 Notch Filter

In some models that support the RF Preselector, such as PXE, there is also a notch filter to suppress signals in the frequency band from 2.4 GHz to 2.5 GHz. This control allows you to turn the notch filter on or off.

Remote Command	<code>[:SENSe]:POWer[:RF]:RFPSelector:NFIlter[:STATe] OFF ON 0 1</code> <code>[:SENSe]:POWer[:RF]:RFPSelector:NFIlter[:STATe]?</code>
Example	<code>:POW:RFPS:NFIL 1</code> <code>:POW:RFPS:NFIL?</code>
Dependencies	<p>Only appears when RF Input is selected as the Input</p> <p>Only appears in models that support the notch filter, such as PXE. Attempting to turn it on or off via SCPI in models that do not support it generates error message: -241 Hardware missing; Not available for this model number</p> <p>Only appears in measurements that support the Notch Filter, such as EMI Receiver measurements. Attempting to turn it on or off via SCPI in measurements that do not support it generates error message: -221, Settings conflict; Feature not supported for this measurement</p> <p>In Frequency Scan measurement, this control is grayed-out when final measurement is running, aligned with the RF Preselector key. The warning message “Function not available while measurement is running” appears if the grayed-out control is pressed</p>
Preset	<code>OFF</code>
State Saved	Saved in instrument state
Range	<code>OFF ON</code>
Annotation	<p>Due to limited space in the Measurement Bar, Notch Filter annotation is shown as part of the RF Presel state</p> <ul style="list-style-type: none"> - <code>RF Presel: On, NF</code>, when both RF Presel and Notch Filter are turned on - <code>RF Presel: On</code>, when RF Presel = on and Notch Filter= off - <code>RF Presel: Off</code>, when RF Presel = off
Backwards	<code>:INPut<1 2>:PRESelection:FILTer:NOTCh[:STATe] ON OFF</code>
Compatibility SCPI	<code>:INPut<1 2>:PRESelection:FILTer:NOTCh[:STATe]?</code>

6.2.9 RF Calibrator

Lets you choose a calibrator signal to look at or turns the calibrator off.

Remote Command	<code>[:SENSe]:FEED:AREFERENCE REF50 REF4800 OFF</code> <code>[:SENSe]:FEED:AREFERENCE?</code>
Example	Select the 50 MHz amplitude reference as the signal input: <code>:FEED:AREF REF50</code>

	Select the 4.8 GHz amplitude reference as the signal input: <code>:FEED:AREF REF4800</code>
	Turn the calibrator "off" (switches back to the selected input - RF or I/Q): <code>:FEED:AREF OFF</code>
Dependencies	Only appears when RF Input is selected as the Input Selecting an input (RF, Ext Mix or I/Q) turns the Calibrator OFF . This is true whether the input is selected using the menu panel or <code>[:SENSe] :FEED</code> The 4.8 GHz internal reference is only available in some models and frequency range options. If the 4.8 GHz reference is not present, the 4.8 GHz choice does not show, and if the REF4800 parameter is sent, the instrument generates an error
Couplings	When one of the calibrator signals is selected, the instrument routes that signal (an internal amplitude reference) to the instrument, and changes the main input selection to RF so the calibrator signal can be seen. When you turn the calibrator off it does not switch back to the previously selected input
Preset	OFF
State Saved	Saved in instrument state
Annunciation	An advisory message is sent, indicating that the input is set to internal
Backwards Compatibility SCPI	
Notes	For ESA backwards compatibility In the ESA the calibrator was a separate output which you connected to the input and switched on with this command In X-Series, the ON parameter is aliased to <code>[:SENSe] :FEED:AREF REF50</code> and the OFF parameter is aliased to <code>[:SENSe] :FEED:AREF OFF</code> When <code>:CALibration:SOURce:STATe?</code> is received, 1 is returned if any of the references is selected, or 0 if the Calibrator is OFF
Preset	OFF
Backwards Compatibility SCPI	<code>:CALibration:SOURce:STATe OFF ON 0 1</code> <code>:CALibration:SOURce:STATe?</code>

6.2.10 RF Coupling

Specifies alternating current (**AC**) or direct current (**DC**) coupling at the instrument RF input port. Selecting **AC** coupling switches in a blocking capacitor that blocks any DC voltage present at the instrument input. This decreases the input frequency range of the instrument, but prevents damage to the input circuitry of the instrument if there is a DC voltage present at the RF input.

NOTE

When operating in DC coupled mode, ensure protection of the instrument input circuitry by limiting the DC part of the input level to within 200 mV of 0 Vdc. In AC or DC coupling, limit the input RF power to +30 dBm (1 Watt).

6 Input/Output

6.2 Input

Remote Command	<code>:INPut:COUPling AC DC</code> <code>:INPut:COUPling?</code>
Example	<code>:INP:COUP DC</code>
Dependencies	Only appears when RF Input is selected as the Input Does not appear in models that are always AC coupled. When the SCPI command to set DC coupling is sent to these models, it generates the error "Illegal parameter value; This model is always AC coupled" In these models, <code>:INP:COUP?</code> always returns AC Does not appear in models that are always DC coupled. When the SCPI command to set AC coupling is sent to these models, it generates the error "Illegal parameter value; This instrument is always DC coupled" In these models, <code>:INP:COUP?</code> always returns DC
Preset	AC on models that support AC coupling On models that are always DC coupled, such as millimeter wave models (frequency ranges 30 GHz and above), the preset is DC
State Saved	Saved in instrument state

Annunciation When the RF Input is selected, and AC coupling is selected, annunciators appear in the Meas Bar to that effect:



appears in the settings panel (the row of annunciators across the top of the display) to that effect, as shown below:

When the RF Input is selected, and DC coupling is in effect, the annunciator changes as shown below:



Note the amber color, which indicates that you should exercise caution when applying a signal to any DC coupled input (see note above this table for the specific cautions)

On models that support both AC and DC coupling: when DC coupling is selected, a warning condition message appears in the status line "DC coupled" as shown below:

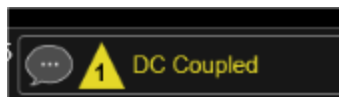

On models that support both AC and DC coupling: when AC coupling is selected, and any part of the displayed frequency range is below 10 MHz, a warning condition message appears in the status line: "AC: Accy unspec'd below 10 MHz"

In AC coupling mode, you can view signals below the corner frequency of the DC block, but below a certain frequency the amplitude accuracy is not specified.

The lowest frequency for which specifications apply is:

X-Series Model	Lowest Freq for meeting specs when AC coupled	Lowest Freq for meeting specs when DC coupled
CXA-503/507	100 kHz	n/a

X-Series Model	Lowest Freq for meeting specs when AC coupled	Lowest Freq for meeting specs when DC coupled
CXA-C75 Input 2	1 MHz	n/a
CXA-513/526	10 MHz	9 kHz
CXA-m	10 MHz	9 kHz
EXA	10 MHz	9 kHz
MXA	10 MHz	20 Hz
PXA	10 MHz	3 Hz
UXA	10 MHz	3 Hz

Some amplitude specifications apply only when coupling is set to DC. Refer to the appropriate amplitude specifications and characteristics for your instrument.

6.2.11 Input Z Correction

Sets the input impedance for unit conversions. This affects the results when the y-axis unit is voltage or current units (dBmV, dB μ V, dB μ A, V, A), but not when it is power units (dBm, W). The impedance you select is for computational purposes only, since the actual impedance is set by internal hardware to 50 ohms. Setting the computational input impedance to 75 ohms is useful when using a 75 ohm to 50-ohm adapter to measure a 75-ohm device on an instrument with a 50-ohm input impedance.

There are a variety way to make 50-to-75-ohm transitions, such as impedance transformers or minimum loss pads. The choice of the solution that is best for your measurement situation requires balancing the amount of loss that you can tolerate with the amount of measurement frequency range that you need. If you are using one of these pads/adaptors with the **Input Z Corr** function, you might also want to use the **Ext Gain** key. This function is used to set a correction value to compensate for the gain (loss) through your pad. This correction factor is applied to the displayed measurement values.

Remote Command	<code>[:SENSe]:CORRection:IMPedance[:INPut][:MAGNitude] 50 75</code> <code>[:SENSe]:CORRection:IMPedance[:INPut][:MAGNitude]?</code>
Example	Set the input impedance correction to 75 ohms: <code>:CORR:IMP 75</code>
Couplings	In CXA option C75, when RF Input 2 is selected, the Input Z Correction automatically changes to 75 ohms. You may then change it to whatever is desired. When the main RF Input is selected, the Input Z Correction automatically changes to 50 ohms. You may then change it to whatever is desired
Preset	Unaffected by Preset, but set to 50 ohms by Restore Input/Output Defaults or Restore System Defaults→All Some instruments/options may have 75 ohms available
State Saved	Saved in instrument state

6.2.12 All Screens Use Same Input

If **ON**, then all Screens share the same Input settings. This is the default state.

If **OFF**, then certain settings are allowed to be local to each Screen, meaning one Screen can have them set one way and another can have them set another way.

The Input settings that become local to each Screen when **All Screens Use Same Input** is **OFF** are:

Input Tab:

- Selected Input (RF, Ext Mix, BBIQ)
- RF Input Port (only appears in instruments with multiple RF ports, such as N9041B, MXE, and CXA)
- RF Coupling (AC/DC)
- Input Z Correction

External Gain Tab:

- External Preamp
- MS
- BTS

Corrections Tab:

- For each Correction, whether it is on or off

Note that if **All Screens Use Same Input** is **OFF** and you press the + control to create a new Screen, the new Screen contains a copy of the old Screen's state, including all its Input/Output variables.

Remote Command	:INSTrument:COUPle:SCReen:INPut ON OFF 1 0
----------------	--

Example	:INST:COUP:SCR:INP OFF
---------	------------------------

Preset	ON
--------	----

Not affected by **Input/Output Preset**, but set to **ON** by **Restore Input/Output Defaults**

6.2.13 External Mixer Setup

Lets you select the mixer type, and lets you configure your mixer (if necessary). The first page of the dialog shows you the current settings for the selected mixer. These

settings may be dependent on which IF path is currently in use, whether a + or – harmonic is currently selected, etc.

To apply any amplitude correction factors needed to correct mixer flatness, you enter values into one of the Correction tables (under **Input/Output, Corrections**). The correction conversion loss values can be extracted from data supplied with the mixer or from manual measurements you make to determine the conversion loss. Note that the correction applied by the Correction tables is global to the instrument; therefore, you should make sure to turn off the External Mixer corrections when you are not using the External Mixer input.

NOTE

Keysight USB Mixers automatically supply their flatness data to the instrument, and the correction is applied internally. No correction needs be entered, and the correction does not appear in the user-accessible Corrections tables. You are free to enter additional corrections into the Correction tables under **Input/Output, Corrections.**

Notes	The setup summary on the menu panel appears just above this control, showing the current external mixer setup
Dependencies	Only appears when External Mixer is selected as the Input
State Saved	All settings in the External Mixer Setup dialog are part of the Input/Output system, and hence are saved whenever State is saved

The **External Mixer Setup** screen looks like this:

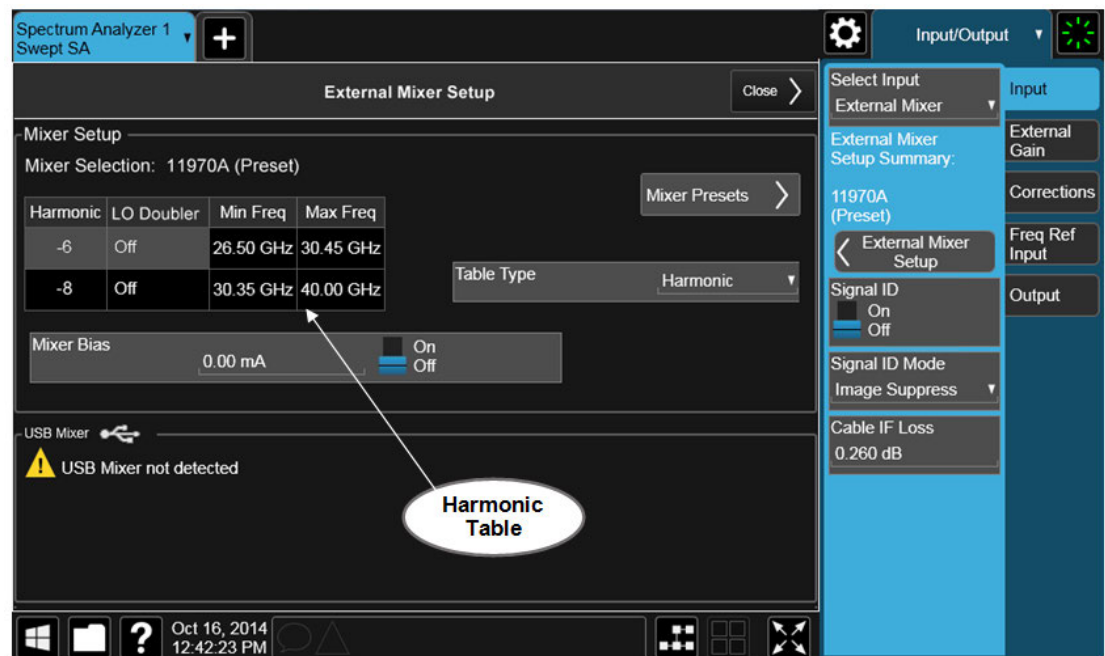

6 Input/Output

6.2 Input

The current Mixer selection (the current or most recently connected USB Mixer, or the most recent Mixer Preset, or **Custom** if you have modified the setup) reads out at the top of this screen as **Mixer Selection**

The Harmonic Table currently being used reads out below the Mixer Selection. It shows each range being used for the current mixer. Note that a band may be made up of up to 3 ranges. Each range represents a choice of mixer harmonic and doubler state. When you select a Mixer Preset, it sets the instrument Start and Stop frequency to the values shown in the Harmonic Table; Start Freq is set to the Min Freq for the bottom range, and Stop Freq is set to the Max Freq for the top range. In many cases you can exceed these nominal values; the absolute maximum and minimum frequency for each preset are shown in the tables that accompany the control descriptions for the Mixer Presets.

NOTE

If the current measurement has a limited Span available to it and cannot achieve the Span shown in the table (Span = Stop Freq - Start Freq), the instrument uses the maximum Span the measurement allows, and sets **Center Frequency to the midpoint of the Start and Stop Freq values in the Harmonic Table.**

You may edit some of the Harmonic and LO Doubler fields in the Harmonic Table, as shown by the gray backgrounds of these fields. When you edit the Harmonic Table, the Mixer Selection changes to **Custom**. To change it back you must go back into the Mixer Presets menu and select a Preset.

When you edit the Harmonic Table, the nominal Min Freq and Max Freq that are available will usually be different than the Preset you were using; and the absolute frequency limits will change as well. This may result in a change to your Start and/or Stop Freq, if the current values fall outside the new range, requiring you to retune your Center Freq to get your signal back in the center.

The instrument supports the Keysight M1970 Series Harmonic Mixers with USB connection. While in External Mixing, if one of these mixers is plugged in to a USB port, it is automatically detected and displayed in the "USB Mixer" area of the setup screen, including its model number and serial number.

The instrument assumes that if you plug a mixer into the USB you want to use that mixer, so:

1. If a USB mixer is connected to the USB port, the Mixer Presets button is grayed-out, as none of the presets make sense with a USB Mixer connected. Note that once the instrument has acquired the USB Mixer, the mixer selection will remain if it is subsequently unplugged from the USB, allowing you to plug it back in with no change to your settings. However, once you unplug it, the Mixer Presets control ceases to be grayed-out, allowing you to preset to a different mixer
2. When Restore Input/Output Defaults is performed, if a Keysight USB Mixer is plugged into the instrument's USB port, the Mixer Selection remains unchanged

- When recalling an instrument state, if a Keysight USB Mixer is plugged into the instrument's USB port, and the Mixer Selection in the recalled state is for a USB Mixer that does not match the mixer currently plugged in, you will have to unplug your mixer and then plug it back in to get the instrument to recognize your mixer

As long as the selection in Ext Mixer Setup shows one of the USB mixers, the **Mixer Bias** control is grayed-out and the Harmonic Table is no longer editable, as shown by the fact that the fields in the Harmonic Table are now black and the **Table Type** control is grayed-out.

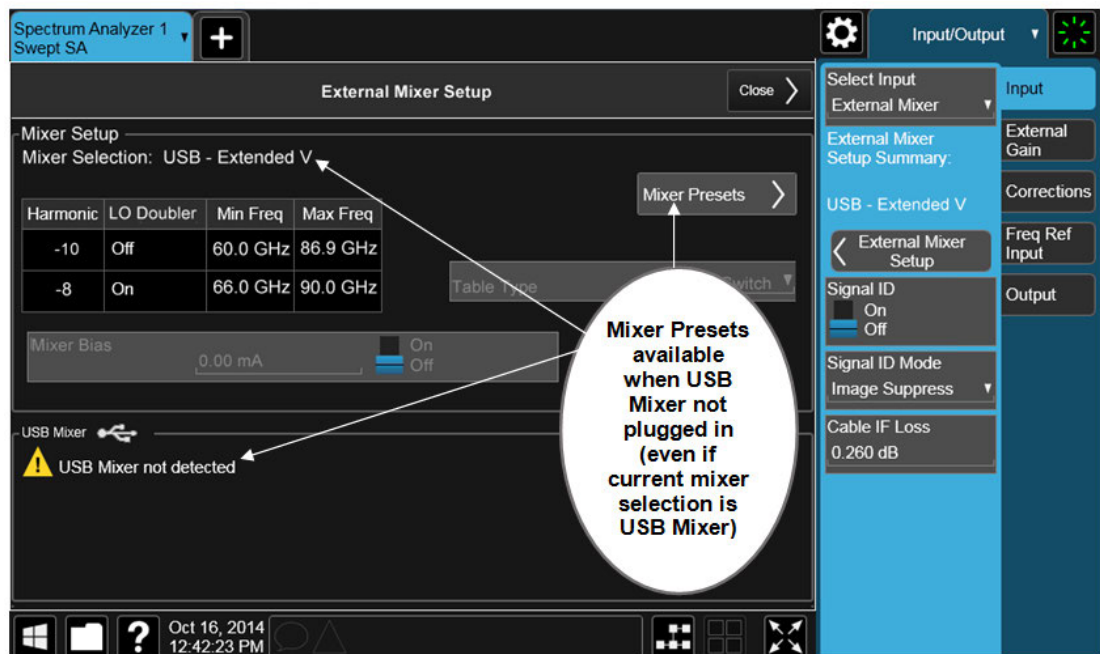

Only one USB Mixer is supported at a time. To switch to a different USB Mixer, disconnect the one that is no longer being used prior to connecting a new one.

The **Mixer Selection** displayed and menu panel readback for the Keysight M1970 series mixers is:

Mixer Model	Mixer Selection display on Setup Screen	Readback
Keysight M1970E: Option 001: 60 to 90 GHz Waveguide Harmonic Mixer	USB - M1970E-001 E-Band	USB Mixer E-Band
Keysight M1971E: Option 001: 60 to 90 GHz Waveguide Harmonic Mixer	USB - M1971E-001 E-Band	USB Mixer E-Band
Keysight M1971E: Option 003: 55 to 90 GHz	USB - M1971E-003 Extended E-Band	USB Mixer

6 Input/Output
6.2 Input

Mixer Model	Mixer Selection display on Setup Screen	Readback
GHz Waveguide Harmonic Mixer		Extended E
Keysight M1971V: Option 001: 50 to 75 GHz Waveguide Harmonic Mixer	USB - M1971E-001 V-Band	USB Mixer V-Band
Keysight M1971W: Option 001: 75 to 110 GHz Waveguide Harmonic Mixer	USB - M1971E-001 W-Band	USB Mixer W-Band
Keysight M1970V Option 001: 50 to 75 GHz Waveguide Harmonic Mixer	USB - M1970V-001 V-Band	USB Mixer V-Band
Keysight M1970V Option 002: 50 to 80 GHz Waveguide Harmonic Mixer	USB - M1970V-002 Extended V-Band	USB Mixer Extended V
Keysight M1970W Option 001: 75 to 110 GHz Waveguide Harmonic Mixer	USB - M1970W-001 W-Band	USB Mixer W-Band

The Keysight USB mixer essentially acts as a “remote front end” and is fully calibrated over the specified frequency range, without requiring any user interaction. This is particularly useful at high mm-wave frequencies, where cable loss is typically quite large, and it is desirable to bring the front end right up to the device under test, rather than bringing the mm-wave signal to the instrument using a lossy and uncalibrated cable or waveguide connection.

Connecting the mixer to the USB port on the instrument switches you to External Mixing, aborts the current measurement, and initiates an alignment of the mixer. A popup message, “USB Mixer connected” appears on the display. When a USB mixer and the LO/IF cable are connected the alignment is performed. When the alignment begins, an “Aligning” popup replaces the previous message on the display. When the alignment completes, the current measurement restarts.

6.2.13.1 Mixer Presets

Presets the mixer setup for the particular type of mixer that you are using.

These presets are divided into four groups:

- One for legacy HP/Agilent/Keysight mixers (11970)
- Three for general purpose mixers:

- presets that use a single harmonic and no doubling
- presets that use a single harmonic but double the LO
- presets that use multiple harmonics

Note that the IF/LO port provides a 3.8-14 GHz LO in two bands: 3.8-8.7 (LO fundamental), and 8.6-14 GHz (doubled LO).

In most cases, once you have executed the preset, you will not need to adjust any further settings.

Remote Command	<pre>[:SENSe]:MIXer:BAND A Q U V W NA ND NE NF NG NJ NK NQ NU NV NW NY NEXT DD DF DG DJ DK DQ DV DW DY DEXT MA ME MU MCOAX USB VDIWR6PT5M4 [:SENSe]:MIXer:BAND?</pre>								
Example	<pre>:MIX:BAND A :MIX:BAND?</pre>								
Notes	<p>A Q U V W select HP/Agilent/Keysight 11970 mixer presets NA ND NE NF NG NJ NK NQ NU NV NW NY NEXT select single harmonic, non-doubled LO presets DD DF DG DJ DK DQ DV DW DY DEXT select single harmonic, doubled LO presets MA ME MU MCOAX select multiple harmonic presets VDIWR6PT5M4 selects presets for the VDI WR6.5CCD-M4 external mixer (a Compact Down-Converter in the Keysight N9029ACST Series) VDIWR6PT5M4 requires Model N9042B with the EXW option. To use this selection, you must connect cables from the external mixer to the High LO Out and High IF In ports (not the Ext Mixer port) of the N9042B All these presets are detailed in their respective control descriptions The query returns the most recent preset, <i>unless</i> the harmonic table has been edited after the preset was executed. If the harmonic table has been edited, returns CUSTOM The command USB refreshes the USB mixer connection and automatically detects the mixer band. The query returns the following if a Keysight USB Mixer is plugged into the instrument's USB port:</p> <table border="1"> <tr> <td>USBE</td> <td>Keysight E-Band USB Mixer</td> </tr> <tr> <td>USBV</td> <td>Keysight V-Band USB Mixer</td> </tr> <tr> <td>USBVEXT</td> <td>Keysight Extended V-Band USB Mixer</td> </tr> <tr> <td>USBW</td> <td>Keysight W-Band USB Mixer</td> </tr> </table> <p>Note that the parameters CUSTOM, USBV, USBVEXT, and USBW are query responses only, and cannot be sent to the instrument The following cross-reference matches the mixer band designators used by Keysight to the EIA waveguide designations:</p>	USBE	Keysight E-Band USB Mixer	USBV	Keysight V-Band USB Mixer	USBVEXT	Keysight Extended V-Band USB Mixer	USBW	Keysight W-Band USB Mixer
USBE	Keysight E-Band USB Mixer								
USBV	Keysight V-Band USB Mixer								
USBVEXT	Keysight Extended V-Band USB Mixer								
USBW	Keysight W-Band USB Mixer								

6 Input/Output
6.2 Input

EIA	Keysight	Freq Range
WR-28	A	26.5 - 40 GHz
WR-22	Q	33 - 50 GHz
WR-19	U	40 - 60 GHz
WR-15	V	50 - 75 GHz
WR-12	E	60 - 90 GHz
WR-10	W	75 - 110 GHz
WR-8	F	90 - 140 GHz
WR-6	D	110 - 170 GHz
WR-5	G	140 - 220 GHz
WR-3	J	220 - 325 GHz

Preset

When **Restore Input/Output Defaults** is performed, an “A” mixer preset is also issued (11970A band), unless a Keysight USB Mixer is plugged into the instrument’s USB port, in which case the Mixer Selection remains unchanged

When using Keysight USB Mixers, if **Restore All Defaults (:SYSTEM:DEFault)** has been performed, either remove and reinsert the USB cable or press the **Refresh USB Mixer Connection** control

VDI CCD (N9029)

These presets select a setup that uses a single harmonic and no LO doubling.

This setup is used with an external mixer in the series VDI CCD (N9029ACST). The currently supported example is the D-band mixer VDI WR6.5CCD-M4.

Mixer	Readout on setup dialog and menu panel	Harm #	RF start	RF stop	RF center
WR6.5 M4 (D-band)	VDI WR6.5CCD-M4	-4	110	170	140

This mixer setup is enabled only for model N9042B with the EXW option. You must connect cables from this external mixer to the High LO Out and High IF In ports (not the Ext Mixer port) of the N9042B, as illustrated below:

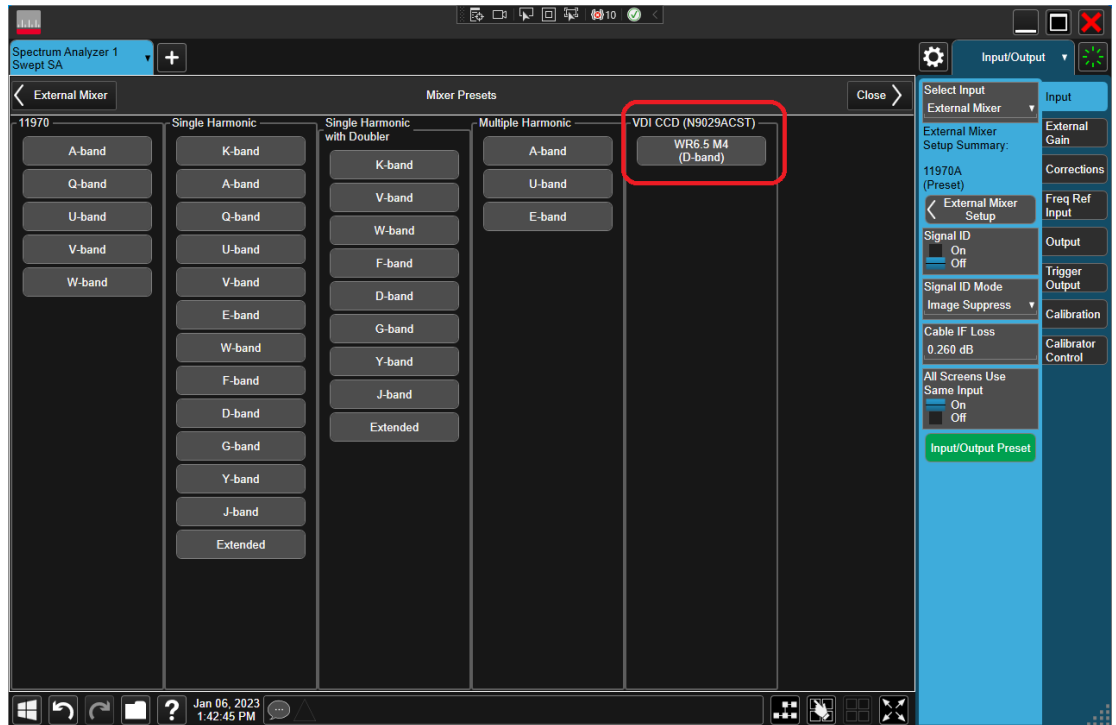

11970

Lets you preset for a model in the HP/Agilent/Keysight 11970 series.

Because the X-Series has an LO range of 3.8 - 14 GHz, and older analyzers had an LO range of 3.0 - 6.8 GHz, the harmonic numbers used in the X-Series may differ from those used on older analyzers for the same mixers. Additionally, some of the 11970 mixers cannot be operated over their full range with the X-Series without switching harmonics. Consequently, you will find that some of the bands (A-Band, for example) are broken into two ranges for use with the X-Series.

Below are the 11970A presets. The 11970U and the 11970W use a single harmonic. The other three switch harmonic mid-band. Both harmonic ranges are shown in the table. None of these mixers use LO doubling.

The 11970 K-band mixer and the 11974 preselected mixer series are not supported.

Preset	Readout on setup dialog and menu panel	Range	Harm #	RF start	RF stop	RF center
A-band	11970A	1	-6	26.5	30.45	28.475
		2	-8	30.35	40	35.175
Q-band	11970Q	1	-8	33	40.8	36.9
		2	-10	39.8	50	44.9
U-band	11970U	..	-10	40	60	50
V-band	11970V	1	-12	50	66	58
		2	-14	53	75	64
W-band	11970W	..	-18	75	110	92.5

Single Harmonic

These presets select a setup that uses a single harmonic and no doubling for the LO.

Mixer	Readout on setup dialog and menu panel	Harm #	RF start	RF stop	RF center
K-band	K-band Single Harmonic, no doubler	-4	18	26.5	22.25
A-band	A-band Single Harmonic, no doubler	-6	26.5	40	33.25
D-band	D-band Single Harmonic, no doubler	-20	110	170	140
E-band	E-band Single Harmonic, no doubler	-12	60	90	75
F-band	F-band Single Harmonic, no doubler	-18	90	140	115
Q-band	Q-band Single Harmonic, no doubler	-6	33	50	41.5
U-band	U-band Single Harmonic, no doubler	-8	40	60	50
V-band	V-band Single Harmonic, no doubler	-10	50	75	62.5
W-band	W-band Single Harmonic, no doubler	-14	75	110	92.5
G-band	G-band Single Harmonic, no doubler	-26	140	220	180
Y-band	Y-band Single Harmonic, no doubler	-30	170	260	215
J -band	J-band Single Harmonic, no doubler	-38	220	325	272.5
Extended	Extended Single Harmonic, no doubler	-40	155	345	250

Single Harmonic with doubler

These presets select a setup that uses a single harmonic and doubling for the LO.

Mixer	Readout on setup dialog and menu panel	Harm #	RF start	RF stop	RF center
D-band	D-band Single Harmonic w/doubler	-14	110	170	140
F-band	F-band Single Harmonic w/doubler	-10	90	140	115
G-band	G-band Single Harmonic w/doubler	-16	140	220	180
J-band	J-band Single Harmonic w/doubler	-24	220	325	272.5
K-band	K-band Single Harmonic w/doubler	-2	18	26.5	22.25
Q-band	Q-band Single Harmonic w/doubler	-4	33	50	41.5
V-band	V-band Single Harmonic w/doubler	-6	50	75	62.5
W-band	W-band Single Harmonic w/doubler	-8	75	110	92.5
Y-band	Y-band Single Harmonic w/doubler	-20	170	260	215
Extended	Extended Single Harmonic w/doubler	-28	245	390	317.5

Multiple Harmonics

These presets select a setup that uses multiple harmonics and may or may not use doubling for the LO.

Mixer	Readout on setup dialog and menu panel	Range	Harm #	Dblr?	RF start	RF stop	RF Center
A-band	A-band Multiple Harmonic	1	-4	N	26.5	34.1	30.3
		2	-4	Y	33.1	40	36.55
E-band	E-band Multiple Harmonic	1	-6	Y	60	83	71.5
		2	-8	Y	65	90	77.5
U-band	U-band Multiple Harmonic	1	-6	N	40	51.5	45.75
		2	-6	Y	49.5	60	54.75
Coaxial	Coaxial Multiple Harmonic	1	-4	N	26.5	34	30.25
		2	-4	Y	32.5	55	43.75
		3	-6	Y	50	70	60

6.2.13.2 Mixer Bias

Adjusts an internal bias source for use with external mixers. The bias signal is present on the center conductor of the IF input connector on the front panel. The shunt current range is from -10 mA to 10 mA, and it can be set whether Mixer Bias state is On or Off, but it will only be applied if it is On.

The bias remains as set if you switch to another input (for example, the RF Input).

Remote	<code>[:SENSe] :MIXer :BIAS <real></code>
Command	<code>[:SENSe] :MIXer :BIAS?</code>

6 Input/Output

6.2 Input

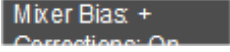
Example	<code>:MIX:BIAS 0</code> <code>:MIX:BIAS?</code>
Preset	Unaffected by Preset, but set to OFF (0) by Restore Input/Output Defaults
State Saved	Saved in instrument state
Min	-10 mA
Max	10 mA
Annunciation	When the bias is turned on this (together with the bias polarity) is indicated in the Meas Bar with a plus or minus sign:  otherwise, it reads "Off" Auto Function
Remote Command	<code>[:SENSe]:MIXer:BIAS:STATe OFF ON 0 1</code> <code>[:SENSe]:MIXer:BIAS:STATe?</code>
Example	<code>:MIX:BIAS:STAT 0</code> <code>:MIX:BIAS:STAT?</code>
Preset	OFF

6.2.13.3 Table Type

Determines the Custom Mixer configuration type. You can choose: Single Row, Harmonic Switching, or Doubler Switching. For details, see ["Available Types" on page 1161](#).

The Harmonic Table can be configured as:

- A single row (meaning only one harmonic number is used and the LO Doubler is either on or off)
- Two rows where the harmonic number switches between the first row and the second
- Two rows where the LO Doubler state switches between the first row and the second

Available Types

Table Type	Behavior
Single Row	The External Mixer always stays in the same Harmonic Number and the LO Doubler is either on or off and does not change state during a sweep. You may change the Harmonic Number and you may change the state of the Doubler
Harmonic	The External Mixer switches the Harmonic Number in the middle of the sweep. The LO Doubler may be on

Table Type	Behavior
Switching	or off, but it is the same for both Harmonic Numbers. You can set the initial Harmonic Number, and when it switches it decrements by two when the harmonic is negative and increments by two when the harmonic is positive For example, if you set the initial number to -6, when it switches it will go to -8. If you set the harmonic number to 8, when it switches it will go to 10
Doubler Switching	The External Mixer switches the doubler from Off to On in the middle of the sweep. You can set the Harmonic Number, but it stays the same for the Doubler Off state as for the Doubler On state. The LO Doubler control is grayed-out in this table type

Editable Fields

Table Type	Fields you can edit
Single Row	Harmonic and LO Doubler cells
Harmonic Switching	Harmonic and LO Doubler cells (only the first row)
Doubler Switching	Harmonics cell (only the first row)

Note that you cannot add or delete rows from the table; you can only modify the rows that are already there.

Remote Command	<code>[:SENSe]:MIXer:TTYPe SINGLE HARMonic DOUBler</code> <code>[:SENSe]:MIXer:TTYPE?</code>
Example	<code>:MIX:TTYP SING</code>
Couplings	When you change the Table Type, the Mixer Selection changes to Custom
Preset	Depends on the current Mixer Preset. Unaffected by Mode Preset , but Restore Input/Output Defaults presets the Mixer to 11970A, for which the Table Type is Harmonic Switching
State Saved	Saved in instrument state

6.2.13.4 Select VDI CCD Correction

Selects the appropriate VDI CCD Correction data by mixer Serial Number.

Remote Command	<code>[:SENSe]:VCORrection:SElect NONE <serialNumber></code> <code>[:SENSe]:VCORrection:SElect?</code>
Example	<code>:VCOR:SEL NONE</code> <code>:VCOR:SEL 123123</code>
Dependencies	Requires EXW (External Mixing Wide Bandwidth) and Ampcor (Amplitude Correction) licenses
Couplings	When the External Mixer Model or VDI CCD Corrections data changes, this field checks whether VDI CCD corrections are stored for the currently-selected External Mixer Model, and automatically selects the first serial number found, or NONE if no matching corrections are found When setting this parameter via SCPI, if no match is found for the given serial number, the parameter

is set to **NONE**. If the correction should be automatically selected, this can be done by setting the value via SCPI to **Any** (see "[External Mixer Setup](#)" on page 1151)

State Saved Saved in instrument state

6.2.13.5 Delete All VDI CCD Corrections

Erases all stored VDI CCD corrections.

Remote Command	<code>[:SENSe]:VCORrection:DELeTe</code>
Example	<code>:VCOR:DEL</code>
Dependencies	Requires EXW (External Mixing Wide Bandwidth) and Ampcor (Amplitude Correction) licenses
Couplings	When the VDI CCD corrections are deleted from memory, " Select VDI CCD Correction " on page 1162 is set to NONE

6.2.13.6 Harmonic

Lets you enter the **Harmonic** value with its associated sign (mixing mode). Only the first row of the table is editable. When you edit a value or change "[Table Type](#)" on [page 1161](#), the Mixer Selection changes to **Custom**.

In **Custom** mode, the maximum start and stop frequencies are strictly set by the LO range and the harmonic number you have chosen. The undoubled LO range is approximately 3.8 - 8.7 GHz, and (for LOs that support doubling) the doubled range is approximately 8.0 - 14.0 GHz. That range times the harmonic you have selected determines the tuning range. If your frequency is currently outside that range when you edit the Harmonic Table, the frequency will be changed to fall at the edge of the range. To change it back, go to the **Mixer Presets** menu and select a Preset.

The harmonic number is a signed integer, where the sign distinguishes between positive and negative mixing products. Desired mixing products occur at an IF frequency that equals the difference between the RF frequency (f_{RF}) and the LO frequency (Nf_{LO}). When this difference is positive, we can say $f_{IF} = f_{RF} - Nf_{LO}$. When this difference is negative, we can say $f_{IF} = Nf_{LO} - f_{RF}$. Thus, a negative harmonic means the instrument will be tuned such that the harmonic of the LO is higher than the indicated frequency by the frequency of the first IF. A positive harmonic means the instrument will be tuned such that the harmonic of the LO is lower than the indicated frequency by the frequency of the first IF.

Remote Command	<code>[:SENSe]:MIXer:HARMonic <integer></code> <code>[:SENSe]:MIXer:HARMonic?</code>
Example	<code>:MIX:HARM -28</code> <code>:MIX:HARM?</code>
Notes	The query returns the harmonic value of the first row of the harmonic table

Couplings	When you set a value for Harmonic via SCPI, the Mixer Selection changes to Custom
Preset	Unaffected by Mode Preset , but Restore Input/Output Defaults turns editing off, the Harmonic Table returns to normal, and the Mixer is preset to 11970A, which has -6 in the first row of its Harmonic Table
State Saved	Saved in instrument state
Min	-400
Max	400

6.2.13.7 LO Doubler

Lets you specify whether the Doubler is on or off. Only the first row of the table is editable, and the LO Doubler field is only editable in Single Row and Harmonic Switching table types. When you edit a value or change the Table Type, the Mixer Selection changes to **Custom**.

The LO Doubler setting controls the choice of the LO doubler state for LO's that support doubled operation. In Single Row mode it is either on or off for the one row in the table. In Harmonic Switching mode it is on for both rows or off for both rows. In Doubler switching it is off for row 1 and on for row 2, so it is not editable.

In LOs that support doubling, the fundamental band is approximately 3.8 – 8.7 GHz, and the doubled band is approximately 8.0 – 14 GHz. The higher LO frequency can result in a lower mixer harmonic and reduced mixer conversion loss.

Remote Command	<code>[:SENSe]:MIXer:LODoubler ON OFF 0 1</code> <code>[:SENSe]:MIXer:LODoubler?</code>
Example	<code>:MIX:LOD 0</code> <code>:MIX:LOD?</code>
Notes	The query returns the doubler value of the first row of the harmonic table
Dependencies	Grayed-out and set to OFF when " Table Type " on page 1161 is set to Doubler Switching Grayout message: "-221 Settings conflict; Function unavailable while Table Type=Doubler Switching"
Couplings	When you set a value via SCPI, the Mixer Selection changes to Custom
Preset	Unaffected by Mode Preset , but Restore Input/Output Defaults turns off editing, the Harmonic Table returns to normal, and the Mixer is preset to 11970A, which has the doubler Off in the first row of its Harmonic Table
State Saved	Saved in instrument state

6.2.13.8 Refresh USB Mixer Connection

Re-reads the USB devices and refreshes connection to Keysight USB mixers. This operation is the same as physically removing and reinserting the mixer's USB connection.

Example	<code>:MIX:BAND USB</code>
Notes	When using Keysight USB Mixers, if Restore All Defaults (<code>:SYSTem:DEFault</code>) has been performed, either remove and reinsert the USB cable or press Refresh USB Mixer Connection

6.2.14 Mixer Path

Determines which path you wish to use when using M1971 series USB mixers:

- **NORMa1**, in which they function as a classic external mixer with a single conversion
- **DUAL** Conversion, in which the first conversion is to a higher IF frequency (nominally 1.5 GHz) and you provide a 10 MHz signal to which an internal PLL is locked, to effect a second downconversion. The higher IF frequency used in Dual Conversion increases the image frequency offset, giving you a wider image-free conversion range. This reduces aliasing effects and improves the image suppress functionality for wideband signals
- **AUX** Equipment, wherein the first mixer output drives an output connector on the mixer and the instrument is out of the circuit. When you connect an M1971 Mixer to USB, the instrument will pull the IF and RF flatness data from the USB mixer and write this data to a user-accessible file in CSV format for your use when Aux Equipment is selected

Remote Command	<code>[:SENSe]:MIXer:MPATH NORMa1 DUAL AUX</code> <code>[:SENSe]:MIXer:MPATH?</code>
Example	<code>:MIX:MPAT NORM</code>
Dependencies	<p>Only appears when an M1971 series Mixer is connected to the USB port of the instrument</p> <p>When AUX Equipment is the selection, Sig Id is turned off to avoid shifting the LO. It is <i>not</i> turned back on when a different path is selected</p> <p>When AUX Equipment is the selection, there is no valid result, so the instrument displays a “No Result; Meas invalid with Aux Equip” error condition message (error 135)</p> <p>DUAL Conversion is grayed-out unless in the Swept SA measurement. If grayed-out and the command is sent, generates error:”-221, Settings Conflict; Dual Conversion mixer path is only available in Swept SA”</p> <p>If in DUAL Conversion and you exit Swept SA, reverts to NORMa1 setting. If you subsequently return to Swept SA, does <i>not</i> automatically return to DUAL Conversion</p> <p>When DUAL Conversion is selected, if no signal is sensed at the 10 MHz input port, an error condition is generated, “Ref missing or out of range; M1971” (error 521). This also lights the Error LED on the mixer itself</p>
Couplings	When AUX path is selected, the instrument switches to Zero Span
Preset	NORMa1
State Saved	Saved in instrument state

Annotation	In the Meas Bar, if an M1971 series Mixer is connected to the USB port of the instrument, the field Mixer Path appears and says: <ul style="list-style-type: none"> - Normal for Normal - 2xConv for Dual Conversion - Aux for Aux Equipment
------------	---

6.2.15 User IF Freq

Specifies the desired IF frequency when using the Aux Equipment path. This setting determines the LO frequency that the instrument will drive into the mixer to correspond to the specified center frequency. Note that the Aux Equipment path always uses “Negative Mixing”, that is, the LO frequency is always higher than the RF frequency.

Remote Command	<code>[:SENSe]:MIXer:UIFFreq <real></code> <code>[:SENSe]:MIXer:UIFFreq?</code>
Example	<code>:MIX:UIFF 300 MHz</code>
Dependencies	Only appears if an M1971 mixer is connected to USB and the Mixer Path is Aux Equipment
Preset	1.2 GHz
State Saved	Saved in Input/Output state
Min	0 GHz
Max	4 GHz

6.2.16 Signal ID On/Off

Toggles the Signal ID (signal identification) function On or Off. This function lets you identify multiple responses of a single input signal that are generated when using un-preselected external mixers. The use of mixers without pre-selecting filters offers the advantage of improved receiver sensitivity because of the absence of the filter insertion loss, but results in multiple responses due to images and undesired harmonic mixing products.

While in **Signal ID**, basic spectrum analyzer functions work normally (for example, you can change Span normally), but some functions are disabled (for example, some traces are unavailable).

There are two forms of **Signal ID**, Image Suppress and Image Shift. Choose the one most appropriate for your application. For Image Shift, an LO-shifted and an unshifted trace are taken in Trace 1 and Trace 2 and displayed together. Any peaks that are not the same in both traces are images. For Image Suppress, image

6 Input/Output
6.2 Input

cancellation is performed in the background using two hidden traces, and the result displayed in Trace 1, which shows only the valid signals.

When **Signal ID** is **ON**, this is indicated in the Meas Bar as Signal ID: On. The annotation is displayed in amber to alert you, because it can cause unexpected behavior if you are not aware that it is on.

Remote Command	<code>[:SENSe]:SIDentify[:STATe] OFF ON 0 1</code> <code>[:SENSe]:SIDentify[:STATe]?</code>
Example	<code>:SID 0</code> <code>:SID?</code>
Notes	Signal ID uses data from two successive sweeps. Therefore, if the instrument is in single sweep mode, two sweep triggers are used to generate the data needed for signal identification For the Log Plot measurement in the Phase Noise Mode, Signal ID works only in the segment of LO sweeping where the offsets are greater than the Rejection Offset setting. When turning it on, you may notice a discontinuity in the Phase Noise trace at the Rejection Offset setting frequency by a few dB due to the under response inherent to Signal ID
Dependencies	Only appears when External Mixer is selected as the Input Not available in some measurements. If Signal ID does not appear or is grayed-out while in your measurement, then it is not available Because Signal ID uses data from two successive sweeps, several trace and sweep functions are grayed-out in Signal ID . See the documentation for your measurement for details on which trace functions are grayed-out Not available with Signal Track, in which case Signal ID is grayed-out Turned off when External Mixer is turned off. Signal ID cannot be turned on when using internal mixing Rules for auto coupling of the Sweep and FFT controls are changed with Signal ID ON . For both the dynamic range case and the speed case, swept is chosen whenever any form of Signal ID is on. If Manual FFT is selected, Signal ID is grayed-out If Signal ID is selected in a measurement that does not support it, a warning message is generated
Couplings	The Auto Rules for detector selection select Normal for all active traces when Signal ID is turned ON
Preset	Unaffected by Preset, but set to OFF by Restore Input/Output Defaults
Annunciation	When Signal ID is on this is indicated in the Meas Bar as Signal ID: On. The annotation is displayed in amber color to alert you to the fact that Signal ID is on, as it can cause unexpected behavior if you are not aware that it is on

6.2.17 Signal ID Mode

Determines the **Signal ID** mode to use, either Image Suppress or Image Shift.

Image Suppress

Mathematically removes all image and multiple responses of signals present at the mixer input. Two hidden sweeps are taken in succession. The second sweep is offset in LO frequency by $2 * IF / N$. For each point in each trace, the smaller amplitude

from the two traces is taken and placed in that point in the selected trace. The Peak detector is auto-selected to improve the image suppression effectiveness. Responses of each trace that lie on top of one another will remain and are valid signals, others are images and are suppressed. The action of taking the smaller of the two traces will make the average noise level lower in all points that do not have an image, thus reducing the accuracy of the measurement of noise and noise-like signals.

NOTE

When changing from Image Shift to Image Suppress mode, Trace 2 is blanked, as it was used for Image Shift and contains data that you will probably not want to see in Image Suppress

Image Shift

Like the Image Suppress mode, Image Shift is a two-sweep sequence. The data from the first sweep is placed in Trace 1 and the data from the second (LO frequency shifted by $2 * IF / N$) sweep is placed in Trace 2. On alternate sweeps, the alternate trace (trace 2) is placed in front of trace 1. This way, you can see a signal at the same place on alternate sweeps, showing in yellow (trace1) and blue (trace2). Signal responses of Trace 1 and Trace 2 that have the same horizontal position are considered to be in the current band and therefore can be analyzed with the amplitude and frequency measurement systems of the SA. All other responses are invalid and should be ignored.

NOTE

This function takes control of and uses Trace 1 and Trace 2. Any data in these traces prior to activating Image Shift will be lost.

Remote Command	<code>[:SENSe]:SIDentify:MODE ISUPpress IShift</code> <code>[:SENSe]:SIDentify:MODE?</code>
Example	<code>:SID:MODE ISUP</code> <code>:SID:MODE ISH</code> <code>:SID:MODE?</code>
Dependencies	Only appears when External Mixer is selected as the Input
Preset	Unaffected by Preset, but set to ISUPpress by Restore Input/Output Defaults
State Saved	Saved in instrument state

6.2.18 Cable IF Loss

The loss at the IF in the IF/LO cable can be compensated for with this function, by entering the loss in dB for your cable.

6 Input/Output

6.2 Input

The cable loss will depend on the IF frequency. The IF frequency varies depending on which IF path your measurement is using. For best accuracy, characterize your cable's loss for the IF frequency or frequencies you will be using.

IF Frequencies

10 MHz path	322.5 MHz
25 MHz path	322.5 MHz
40 MHz path	250 MHz
140 MHz path	300 MHz

Remote Command	<code>[:SENSe]:MIXer:CIFLoss <rel_amp1></code> <code>[:SENSe]:MIXer:CIFLoss?</code>
Example	<code>:MIX:CIFL 0.23 DB</code> <code>:MIX:CIFL?</code>
Dependencies	Only appears when External Mixer is selected as the Input
Preset	0.26 dB
State Saved	Saved in instrument state
Min	-100
Max	100

6.2.19 I/Q Path

Selects which I/Q input channels are active. The LED next to each I/Q input port will be on when that port is active.

The analysis bandwidth for each channel is the same as that of the instrument. For example, the base N9020A has a bandwidth of 10 MHz. With I/Q input the I and Q channels would each have an analysis bandwidth of 10 MHz, giving 20 MHz of bandwidth when the I/Q Path is I+jQ. With option B25, the available bandwidth becomes 25 MHz, giving 25 MHz each to I and Q and 50 MHz to I+jQ.

I/Q voltage to power conversion processing is dependent on the I/Q Path selected:

- With I+jQ input, we know that the input signal may not be symmetrical about 0 Hz, because it has a complex component. Therefore, above 0 Hz only the positive frequency information is displayed, and below 0 Hz only the negative frequency information is displayed
- With all other Input Path selections, the input signal has no complex component and therefore is always symmetrical about 0 Hz. In this case, by convention, the power conversion shows the combined voltage for both the positive and negative frequencies. The information displayed below 0 Hz is the mirror of the

information displayed above 0 Hz. This results in a power reading 6.02 dB higher (for both) than would be seen with only the positive frequency voltage. Note also that, in this case the real signal may have complex modulation embedded in it, but that must be recovered by further signal processing

Remote Command	<code>[:SENSe]:FEED:IQ:TYPE IQ IONLy QONLy</code> For option details, see More Information <code>[:SENSe]:FEED:IQ:TYPE?</code>
Example	Set the input to be both the I and Q channels, combined as $I + j * Q$: <code>:FEED:IQ:TYPE IQ</code> Set the input to be only the I channel: <code>:FEED:IQ:TYPE IONL</code> Set the input to be only the Q channel: <code>:FEED:IQ:TYPE QONL</code> Turn on both I and Q channels and treat I as channel 1 and Q as channel 2: <code>:FEED:IQ:TYPE IND</code>
Dependencies	Only appears when I/Q is the selected input
Preset	<code>IQ</code>
State Saved	Yes Unaffected by Preset, but set to the default value by Restore Input/Output Defaults or Restore System Defaults->All Backwards Compatibility SCPI
Notes	For R&S FSQ-B71 compatibility
Preset	<code>IQ</code>
Backwards Compatibility SCPI	<code>:INPut[1]:IQ:TYPE IQ I Q</code> <code>:INPut[1]:IQ:TYPE?</code>

More Information

I+jQ

Sets the signal input to be both the I and Q channels. The I and Q channel data will be combined as $I + j * Q$.

I Only

Sets the signal input to be only the I channel. The Q channel will be ignored. The data collected is still complex. When the center frequency is 0 the imaginary part will always be zero, but for any other center frequency both the real and imaginary parts will be significant.

Q Only

6 Input/Output

6.2 Input

Sets the signal input to be only the Q channel. The I channel will be ignored. The Q channel will be sent to the digital receiver block as $Q+j0$. The receiver's output is still complex. When the center frequency is 0 the imaginary part will always be zero, but for any other center frequency both the real and imaginary parts will be significant. Note that since the receiver's real output is displayed as the "I" data, when the center frequency is 0, the Q Only input appears as the "I" data.

6.2.20 Reference Z

Sets the value of the impedance to be used in converting voltage to power for the I and Q channels. This does not change the hardware's path impedance (see ["Input Z" on page 1172](#)).

Remote Command	<code>:INPut:IMPedance:REference <integer></code> <code>:INPut:IMPedance:REference?</code>
Example	Set the I/Q reference impedance to 50 Ω <code>:INP:IMP:REF 50</code>
Dependencies	Only appears when I/Q is the selected input
Preset	50 Ω
State Saved	Yes Unaffected by a Preset, but set to the default value by Restore Input/Output Defaults or Restore System Defaults->All
Min/Max	1 Ω - 1 M Ω

6.2.21 I/Q Setup

Lets you set up and calibrate various parameters for the I/Q inputs.

Dependencies	Only appears when I/Q is the selected input
--------------	---

6.2.21.1 I Setup

Accesses the channel setup parameters for the I channel.

Differential

Selects differential input on or off for the I channel. For differential input (also called balanced input), the instrument uses both main and complementary ports. When differential input is off (also called single-ended or unbalanced input), the instrument uses only the main port.

Remote Command	<code>:INPut:IQ[:I]:DIFFerential OFF ON 0 1</code> <code>:INPut:IQ[:I]:DIFFerential?</code>
Example	Put the I channel in Differential mode: <code>:INP:IQ:DIFF ON</code> Put the I channel in Single Ended mode: <code>:INP:IQ:DIFF OFF</code>
Notes	When I Differential Input = On, the instrument checks for attenuation mismatches between the I and I-bar ports. If the difference in attenuation values exceeds 0.5 dB, a Settings Alert error condition, error 159 is set When I Differential Input = On, and IQ Path is I+jQ, the Q Differential input must also be On. Similarly, when I Differential Input = Off, and IQ Path is I+jQ, the Q Differential input must also be Off. If the states of the two inputs do not match, an error condition message is generated, 159, Settings Alert; I/Q mismatch: Differential
Couplings	Some active probes include built-in differential capability. When one of these probes is sensed, this key is disabled. Since the differential capability is handled in the probe, the Instrument will use only the main port and the key will show that the Instrument's Differential Input mode is Off (indicating that the complementary port is not in use) When Q Same as I is On, the value set for I will also be copied to Q
Preset	OFF (Single Ended) Unaffected by Mode Preset, but set to the default value by Restore Input/Output Defaults or Restore System Defaults->All
State Saved	Yes
Annotation	The LED on the I-bar port indicates the Differential Input setting Backwards Compatibility Command
Notes	For R&S FSQ-B71 compatibility, with no independent settings for the I and Q channels. Therefore, it is tied only to the I channel and does not provide an equivalent for the Q channel. For proper operation of the backwards compatibility command, Q Same as I should be ON
Preset	OFF
Backwards Compatibility SCPI	<code>:INPut[1]:IQ:BALanced[:STATe] OFF ON 0 1</code> <code>:INPut[1]:IQ:BALanced[:STATe]?</code>

Input Z

Selects the input impedance for the I channel. The impedance applies to both the I and I-bar ports.

The input impedance controls the hardware signal path impedance match. It is not used for converting voltage to power. The voltage to power conversion always uses the Reference Z parameter. The Reference Z parameter applies to both I and Q channels.

6 Input/Output

6.2 Input

Remote Command	<code>:INPut[1]:IQ[:I]:IMPedance LOW HIGH</code> <code>:INPut[1]:IQ[:I]:IMPedance?</code>
Example	Set the I channel input impedance to 1 M Ω : <code>:INP:IQ:IMP HIGH</code> Set the I channel input impedance to 50 Ω : <code>:INP:IQ:IMP LOW</code>
Notes	LOW = 50 Ω , HIGH = 1 M Ω When IQ Path is I+jQ, the I Input Z setting must be the same as the Q Input Z setting. If the settings of the two inputs do not match, an error condition message is generated, 159; Settings Alert; I/Q mismatch: Input Z
Couplings	Input impedance is a built-in characteristic of a probe. Therefore, whenever a probe is sensed, this key is disabled, and the value is set to match the probe When no probe is sensed on Q and Q Same as I is On, the value set for I will also be copied to Q
Preset	LOW Unaffected by Mode Preset, but set to the default value by Restore Input/Output Defaults or Restore System Defaults->All
State Saved	Yes
Annotation	"I:<I Input Z>" (examples, "I:50 Ω " or "I:1M Ω ") in the Measurement Bar. The annotation shows both the I and Q Input Z values

Skew

Sets the skew factor for the I channel. The skew will shift the channel's data in time. Use this to compensate for differences in the electrical lengths of the input paths due to cabling.

Remote Command	<code>[:SENSe]:CORRection:IQ[:I]:SKEW <seconds></code> <code>[:SENSe]:CORRection:IQ[:I]:SKEW?</code>
Example	Delay the data for the I channel by 10 ns: <code>:CORR:IQ:SKEW 10 ns</code>
Preset	0
State Saved	Yes Unaffected by Mode Preset, but set to the default value by Restore Input/Output Defaults or Restore System Defaults->All
Range	0 s to 100 ns
Min	0 s
Max	+100 ns

Combined Differential/Input Z (Remote Command Only)

For backwards compatibility only. It combines the Differential Input and Input Z selections into a single command.

Notes	<p>Provided for E4406A code compatibility</p> <p>The enum values translate as follows:</p> <table border="1"> <tr> <td>U50</td> <td>Differential Input = Off, Input Z = 50 Ω</td> </tr> <tr> <td>B50</td> <td>Differential Input = On, Input Z = 50 Ω</td> </tr> <tr> <td>U1M</td> <td>Differential Input = Off, Input Z = 1 MΩ</td> </tr> <tr> <td>B1M</td> <td>Differential Input = On, Input Z = 1 MΩ</td> </tr> </table> <p>Combines the Input Z (50 Ω or 1 M Ω) parameter with the Differential Input (Off = "Unbalanced", On = "Balanced") parameter into a single enumeration</p> <p>This backwards-compatibility command was for an instrument without independent settings for the I and Q channels. Therefore, it is tied only to the I channel and does not provide an equivalent for the Q channel. For proper operation of the backwards-compatibility command, Q Same as I should be set to ON</p> <p>Note also the subtle difference between this command and the backwards-compatibility command for Input Z. The Input Z SCPI has "IQ" before "IMP", while this command has that order reversed</p>	U50	Differential Input = Off, Input Z = 50 Ω	B50	Differential Input = On, Input Z = 50 Ω	U1M	Differential Input = Off, Input Z = 1 M Ω	B1M	Differential Input = On, Input Z = 1 M Ω
U50	Differential Input = Off, Input Z = 50 Ω								
B50	Differential Input = On, Input Z = 50 Ω								
U1M	Differential Input = Off, Input Z = 1 M Ω								
B1M	Differential Input = On, Input Z = 1 M Ω								
Couplings	Does not have an independent parameter, but instead is tied to the Differential Input and Input Z parameters. The coupling for those parameters apply to this command too								
Preset	U50								
Backwards Compatibility SCPI	:INPut:IMPedance:IQ U50 B50 U1M B1M :INPut:IMPedance:IQ?								

6.2.21.2 I Probe

Access the probe setup parameters for the I channel.

Dependencies	<p>Only appears when I/Q is the selected input</p> <p>The set of I/Q probe setup parameters will change based on the type of probe that is sensed. All probe types have the Attenuation parameter, and all probe types can be calibrated. The remaining parameters are only available for some probe types and will not be shown when not available. The probe type is determined by and reported for only for the I and Q ports, never the I-bar or Q-bar ports. The menu title will be "<ch>: <probe id>", where "<ch>" is either "I" or "Q" and "<probe id>" is the type of probe. For example, for the I Probe setup with an Keysight 1130A probe connected to the I port, the title will be "I: 1130A".</p>
--------------	--

6 Input/Output
6.2 Input

Probe calibration data is stored for each probe type for each channel. When no probe is sensed, the probe type "Unknown" is used, and this is also treated like a probe type with its own calibration data. When a probe is changed, the calibration data for that probe type for that port is restored. An advisory message will be displayed showing the new probe type and the calibration status. The calibration data is stored permanently (survives a power cycle) and is not affected by a Preset or any of the Restore commands. When the probe has EEPROM identification (most newer Keysight probes have this), the calibration data is stored by probe serial number and port, so if you have two probes of the same type, the correct calibration data will be used for each. For probes that do not have EEPROM identification, the calibration data is stored by probe type and port and the instrument cannot distinguish between different probes of the same type. In all cases (with or without EEPROM identification), the calibration data is port specific, so it will not follow a specific probe from port to port if the probe is moved.

The "Unknown" probe type is used whenever no probe is sensed. When no calibration data exists for "Unknown" the latest cable calibration data is used.

Attenuation

The attenuation is part of the calibration data stored with the probe type and is initially the value that was returned by the last calibration. You can modify this value and any changes will be stored with the calibration data and will survive power cycles and presets. When a probe calibration is performed the attenuation value will be overwritten by the calibration.

Remote Command	<code>[:SENSe]:CORRection:IQ:I:ATTenuation:RATio <real></code> <code>[:SENSe]:CORRection:IQ:I:ATTenuation:RATio?</code>
Example	Set the attenuation for the current I probe to 100.00:1: <code>:CORR:IQ:I:ATT:RAT 100</code>
Notes	Each probe type has its own attenuation setting. As probes are changed the attenuation value will reflect the new probe's setting. Changing the attenuation affects only the current probe type's setting and leaves all others unchanged When the IQ Path is I+jQ, the Q probe attenuation setting must match the I Probe attenuation setting within 1 dB. If this is not the case, an error condition message is generated, 159; Settings Alert; I/Q mismatch: Attenuation
Preset	1
State Saved	Saved with probe calibration data. Survives a power cycle and is not affected by Preset or Restore
Min/Max	0.001/10000 This is an alternate form of the SCPI command that allows input as a power instead of a ratio.
Remote Command	<code>[:SENSe]:CORRection:IQ:I:ATTenuation <rel_amp1></code> <code>[:SENSe]:CORRection:IQ:I:ATTenuation?</code>

Example	Set the attenuation for the current I probe type to 100.00:1: <code>:CORR:IQ:I:ATT 20 dB</code>
Min/Max	-60 dB /+80 dB

Offset

Some active probes have DC offset capability. When one of these probes is connected, this control will be visible. The signal is adjusted for the DC offset before entering the instrument's port. This allows for removal of a DC offset before reaching the instrument's input port voltage limits. For example, a signal that varies 1 V peak-to-peak with a DC offset equal to the instrument's max input voltage would exceed the input limits of the instrument for half its cycle. Removing the DC offset allows the instrument to correctly process the entire signal.

Remote Command	<code>:INPut:OFFSet:I <voltage></code> <code>:INPut:OFFSet:I?</code>
Example	Remove a DC offset of -0.5 V from the I channel input: <code>:INP:OFFS:I -0.5</code>
Notes	Only some probe types support Offset . For those that do, each probe type has its own Offset setting. As probes are changed, the Offset value will reflect the new probe's setting. Changing Offset affects only the current probe type's setting and leaves all others unchanged
Preset	0 V
State Saved	Saved with probe calibration data. Survives power cycle and is not affected by Preset or Restore
Min/Max	-18 V/+18 V

Coupling

Some probe types allow coupling to reject low frequencies. This filters out the DC component of a signal that is composed of a DC bias plus some AC signal. This control is visible only for probe types that have this capability.

Remote Command	<code>:INPut:COUPling:I DC LFR1 LFR2</code> <code>:INPut:COUPling:I?</code>
Example	Turn off low frequency rejection on the I channel, allowing signals down to DC: <code>:INP:COUP:I DC</code> Turn on low frequency rejection on the I channel for frequencies lower than 1.7 Hz: <code>:INP:COUP:I LFR1</code> Turn on low frequency rejection on the I channel for frequencies lower than 0.14 Hz: <code>:INP:COUP:I LFR2</code>
Notes	Only some probe types support Coupling . For those that do, each probe type has its own Coupling setting. As probes are changed, the Coupling value will reflect the new probe's setting. Changing

6 Input/Output

6.2 Input

	Coupling affects only the current probe type's setting and leaves all others unchanged
Preset	DC
State Saved	Saved with probe calibration data. Survives a power cycle and is not affected by a Preset or Restore
Range	DC AC 1.7 Hz LFR1 AC 0.14 Hz LFR2

Clear Calibration

Clears the calibration data for the current port and probe. It does not clear the data for other probe types or other ports. If the sensed probe has EEPROM identification, only the data for that specific probe is cleared. After this command has completed, the probe calibration state will be the same as if no probe calibration had ever been performed for the specified channel and probe. The probe attenuation will be the default value for that probe type and the Cable Calibration frequency response corrections will be used. This command is dependent on the Differential Input state. When Differential Input is on, both the data for the probe attached to the main port and the data for the probe attached to the complementary port are cleared. When Differential Input is off, only data for the probe attached to the main port is cleared.

Remote Command	<code>:CALibration:IQ:PROBe:I:CLEar</code>
Example	Clear the calibration data for the I channel and the current probe (with EEPROM identification) or probe type (without EEPROM identification): <code>:CAL:IQ:PROBe:I:CLE</code>

6.2.21.3 Calibrate

Invokes the guided probe calibration. The guided probe calibration is context sensitive and depends on the channel (I or Q) and the Differential Input state. The calibration is only performed on the selected channel. When the Differential control is switched to Differential, both the probe attached to the main port and the probe attached to the complementary port are calibrated. When the Differential control is switched to Single Ended, only the probe attached to the main port is calibrated.

Calibrating the Baseband I/Q ports requires several steps and manual connections. The Guided Calibration will interactively step you through the required steps, displaying diagrams to help with the connections. The steps will vary depending on the setup.

In the Guided Calibration windows, the date and time of the last calibration are displayed. If any of the items listed are displayed in yellow, this indicates that the calibration for that item is inconsistent with the latest calibration, and you should complete the entire calibration process before you exit the calibration. For passive probes with Differential On, any calibration that is more than a day older than the most recent calibration will be displayed with the color amber.

The I/Q probe calibration creates correction data for one of the front panel I/Q channels. When the probe has EEPROM identification, the data is unique to that specific probe. When the probe does not have EEPROM identification, the data will be used for all probes of the same type. The data is also unique to the channel, so calibration data for the I channel will not be used for the Q channel and vice versa.

The guided calibration (front panel only) will show connection diagrams and guide you through the I/Q Isolation Calibration and through calibrating each port. The calibration data for each port is stored separately, so as soon as a port is calibrated that data is saved and will be used. If a user presses "Exit" to exit the calibration process, the data for the port already completed will still be used. It is recommended that a calibration be completed once started, or if exited, that it be properly done before the next use of the probe. The "Next" button will perform the calibration for the current port and then proceed to the next step in the calibration procedure. The "Back" button will return to the prior port in the procedure. Both softkeys and dialog buttons are supplied for ease of use. The dialog buttons are for mouse use and the softkeys for front panel use.

The calibration can also be done via SCPI, but no connection diagrams will be shown. You will need to make the correct connections before issuing each port calibration command. Again, it is recommended that all ports be calibrated at the same time.

For Active probes or when Differential is Off, only the main port is calibrated, otherwise both the main and complementary ports are calibrated.

The instrument state remains as it was prior to entering the calibration procedure except while a port is actually being calibrated. Once a port is calibrated it returns to the prior state. A port calibration is in process only from the time the "Next" button is pressed until the next screen is shown. For SCPI, this corresponds to the time from issuing the CAL:IQ:PROB:I|B|Q|QB command until the operation is complete.

For example, if the prior instrument state is Cal Out = Off, Input = I+jQ, and Differential = Off, then up until the time the "Next" button is pressed the I Input and Q Input LEDs are on and the Cal Out, I-bar Input and Q-bar Input LEDs are off. Once the "Next" button is pressed for the I port calibration, only the Cal Out and I Input LEDs will be on, and the others will be off. When the screen progresses to the next step ("Next" button again enabled), the prior state is restored and only the I Input and Q Input LEDs are on (Cal Out is off again).

I/Q Isolation Calibration

I/Q Isolation Calibration must be run before calibrating any port with either the I/Q Cable Calibration or I/Q Probe Calibration. This calibration is performed with nothing connected to any of the front panel I/Q ports. This is the first step in both the I/Q Cable Calibration and the I/Q Probe Calibration. This dialog appears if the Calibration is being run for the first time. It can also be accessed by pressing Back

6 Input/Output
6.2 Input

from the I Input Cal, the Q Input Cal, or the I/Q Cable Cal. Pressing Next from this dialog runs the calibration

Remote Command	<code>:CALibration:IQ:ISOLation</code>
Example	<code>:CAL:IQ:ISOL</code>
Notes	All front panel I/Q ports must be unconnected
State Saved	No

I/Q Isolation Calibration Time (Remote Query Only)

Returns the last date and time that the I/Q Isolation Calibration was performed.

Remote Command	<code>:CALibration:IQ:ISOLation:TIME?</code>
Example	<code>:CAL:IQ:ISOL:TIME?</code>
Notes	Returns 6 integer values: year, month, day, hour, minute, second. When no calibration has been performed, all values are 0
Annunciation	Guided Calibration, Isolation Calibration, Last Calibration

I Port

The I port calibration is performed with the probe body attached to the front panel's I port, and the probe tip connected via an adapter to the Cal Out port. The guided calibration will show a diagram of the required connections.

Remote Command	<code>:CALibration:IQ:PROBe:I</code>
Example	<code>:CAL:IQ:PROB:I</code>
Notes	The I port must be connected to the Cal Out port before issuing the command The calibration data is saved as soon as the port is calibrated and will survive power cycles. It is not reset by any preset or restore data commands
State Saved	No

I Port Probe Calibration Time (Remote Query Only)

Return the last date and time that the I/Q Probe Calibration was performed for a specific port.

Remote Command	<code>:CALibration:IQ:PROBe:I :TIME?</code>
Example	<code>:CAL:IQ:PROB:I:TIME?</code>

Notes	This returns 6 integer values: year, month, day, hour, minute, second. When no calibration has been performed, all values are 0. The value is specific to both the port and probe, so the value will change as probes are connected or disconnected
-------	---

I-bar Port

The I-bar port calibration is performed with the probe body attached to the front panel's I-bar port and the probe tip connected via an adapter to the Cal Out port. The I-bar probe calibration is only available for passive probes with Differential On. The guided calibration will show a diagram of the required connections.

Remote Command	<code>:CALibration:IQ:PROBe:IBar</code>
----------------	---

Example	<code>:CAL:IQ:PROB:IB</code>
---------	------------------------------

Notes	The I-bar port must be connected to the Cal Out port before issuing the command The calibration data is saved as soon as the port is calibrated and will survive power cycles. It is not reset by any preset or restore data commands
-------	--

State Saved	No
-------------	----

I-bar Port Probe Calibration Time (Remote Query Only)

Return the last date and time that the I/Q Probe Calibration was performed for a specific port.

Remote Command	<code>:CALibration:IQ:PROBe:IBAR:TIME?</code>
----------------	---

Example	<code>:CAL:IQ:PROB:IBAR:TIME?</code>
---------	--------------------------------------

Notes	Returns 6 integer values: year, month, day, hour, minute, second. When no calibration has been performed, all values are 0. The value is specific to both the port and probe, so the value will change as probes are connected or disconnected
-------	--

Annunciation	Guided Calibration, Probe Calibration, Last Calibration
--------------	---

6.2.21.4 Q Setup

Access the channel setup parameters for the Q channel.

Dependencies	Only appears when I/Q is the selected input
--------------	---

Q Same as I

Many, but not all, usages require the I and Q channels have an identical setup. To simplify channel setup, the Q Same as I will cause the Q channel parameters to be

6 Input/Output

6.2 Input

mirrored from the I channel. That way you only need to set up one channel (the I channel). The I channel values are copied to the Q channel, so at the time Q Same as I is turned off the I and Q channel setups will be identical. This does not apply to Probe settings or to parameters that are determined by the probe.

Remote Command	<code>:INPut:IQ:MIRROred OFF ON 0 1</code> <code>:INPut:IQ:MIRROred?</code>
Example	Turn off the mirroring of parameters from I to Q: <code>:INP:IQ:MIRR OFF</code>
Couplings	Only displayed for the Q channel. When Yes, the I channel values for some parameters are mirrored (copied) to the Q channel. However, when a parameter is determined by the type of probe and a probe is sensed, the probe setting is always used and the I channel setting is ignored. The following parameters are mirrored: Differential Input (when not determined by probe) Input Z (when not determined by probe)
Preset	Unaffected by Preset, but set to the default value (Q Same as I set to ON) by Restore Input/Output Defaults or Restore System Defaults->All
State Saved	Saved in instrument state
Range	OFF ON

Differential

Selects differential input on or off for the Q channel. For differential input (also called balanced input), the instrument uses both the Q and Q-bar ports. When differential input is off (also called single-ended or unbalanced input), the instrument uses only the Q port.

Remote Command	<code>:INPut:IQ:Q:DIFFerential OFF ON 0 1</code> <code>:INPut:IQ:Q:DIFFerential?</code>
Example	Put the Q channel in Differential mode: <code>:INP:IQ:Q:DIFF ON</code> Put the Q channel in Single Ended mode: <code>:INP:IQ:Q:DIFF OFF</code>
Notes	When Differential Input = ON , the instrument checks for attenuation mismatches between the Q and Q-bar ports. If the difference in attenuation values exceeds 0.5 dB a Settings Alert error condition, error 159 will be set When Q Differential Input = ON , and IQ Path is I+jQ, the I Differential input must also be ON . Similarly, when Q Differential Input = OFF , and IQ Path is I+jQ, the I Differential input must also be OFF . If the states of the two inputs do not match, an error condition message is generated, 159; Settings Alert; I/Q mismatch: Differential
Couplings	Some active probes include built-in differential capability. When one of these probes is sensed, this key is disabled. Since the differential capability is handled in the probe, the Instrument will use only the main port and the key will show that the Instrument's Differential Input mode is Off (indicating that the

	complementary port not in use) When a differential probe is not sensed and Q Same as I is On, the value set for I will be copied to Q. This key is disabled when Q Same as I is On
Preset	OFF
State Saved	Yes Unaffected by a Preset, but set to the default value by Restore Input/Output Defaults or Restore System Defaults->All
Range	OFF ON
Annotation	The LED on the Q-bar port indicates the Differential Input setting

Input Z

Selects the input impedance for the Q channel. The impedance applies to both the Q and Q-bar ports.

The input impedance controls the hardware signal path impedance match. It is not used for converting voltage to power. The voltage to power conversion always uses the Reference Z parameter. The Reference Z parameter applies to both I and Q channels.

Remote Command	:INPut[1]:IQ:Q:IMPedance LOW HIGH :INPut[1]:IQ:Q:IMPedance?
Example	Set the Q channel input impedance to 1 M Ω : :INP:IQ:Q:IMP HIGH Set the Q channel input impedance to 50 Ω : :INP:IQ:Q:IMP LOW
Notes	LOW = 50 Ω, HIGH = 1 MΩ When IQ Path is I+jQ, the I Input Z setting must be the same as the Q Input Z setting. If the settings of the two inputs do not match, an error condition message is generated, 159; Settings Alert; I/Q mismatch: Input Z
Couplings	Input impedance is a built-in characteristic of a probe. Therefore, whenever a probe is sensed, this key is disabled, and the value is set to match the probe When no probe is sensed and Q Same as I is On, the value set for I will also be copied to Q. This key is disabled when Q Same as I is On
Preset	LOW
State Saved	Yes Unaffected by a Preset, but set to the default value by Restore Input/Output Defaults or Restore System Defaults->All
Range	50 Ω 1 MΩ
Annotation	"Q:<Q Input Z>" (examples, "Q:50 Ω " or "Q:1M Ω ") in the Measurement Bar. The annotation shows both the I and Q Input Z values

Skew

Sets the skew factor for the Q channel. The skew will shift the channel's data in time. Use this to compensate for differences in the electrical lengths of the input paths due to cabling and probes.

Remote Command	<code>[:SENSe]:CORRection:IQ:Q:SKEW <seconds></code> <code>[:SENSe]:CORRection:IQ:Q:SKEW?</code>
Example	Delay the data for the Q channel by 10 ns <code>:CORR:IQ:Q:SKEW 10 ns</code>
Preset	0
State Saved	Yes Unaffected by a Preset, but set to the default value by Restore Input/Output Defaults or Restore System Defaults->All
Min/Max	0 s/ 100 ns

6.2.21.5 Q Probe

Accesses the probe setup parameters for the Q channel. See "[Combined Differential/Input Z \(Remote Command Only\)](#)" on page 1174.

Dependencies	Only appears when I/Q is the selected input
--------------	---

Attenuation

The attenuation is part of the calibration data stored with the probe type and is initially the value that was returned by the last calibration. You can modify this value and any changes will be stored with the calibration data and will survive power cycles and presets. When a probe calibration is performed the attenuation value will be overwritten by the calibration.

Remote Command	<code>[:SENSe]:CORRection:IQ:Q:ATTenuation:RATio <real></code> <code>[:SENSe]:CORRection:IQ:Q:ATTenuation:RATio?</code>
Example	Set the attenuation for the current Q probe to 100.00:1: <code>:CORR:IQ:Q:ATT:RAT 100</code>
Notes	Each probe type has its own attenuation setting. As probes are changed the attenuation value will reflect the new probe's setting. Changing the attenuation affects only the current probe type's setting and leaves all others unchanged When the IQ Path is I+jQ, the Q probe attenuation setting must match the I Probe attenuation setting within 1 dB. If this is not the case, an error condition message is generated, 159; Settings Alert; I/Q mismatch: Attenuation

Preset	Each probe type has its own default. The default for the "Unknown" probe type is 1:1
State Saved	Saved with probe calibration data. Survives a power cycle and is not affected by Preset or Restore
Min/Max	0.001/10000 This is an alternate form of the SCPI command that allows input as a power instead of a ratio.
Remote Command	<code>[:SENSe]:CORRection:IQ:Q:ATTenuation <rel_ampl></code> <code>[:SENSe]:CORRection:IQ:Q:ATTenuation?</code>
Example	Set the attenuation for the current Q probe type to 100.00:1: <code>:CORR:IQ:Q:ATT 20 dB</code>
Min/Max	-60 dB /+80 dB

Offset

Some active probes have DC offset capability. When one of these probes is connected this control will be visible. The signal is adjusted for the DC offset before entering the instrument's port. This allows for removal of a DC offset before reaching the instrument's input port voltage limits. For example, a signal that varies 1 V peak-to-peak with a DC offset equal to the instrument's max input voltage would exceed the input limits of the instrument for half its cycle. Removing the DC offset allows the instrument to correctly process the entire signal.

Remote Command	<code>:INPut:OFFSet:Q <voltage></code> <code>:INPut:OFFSet:Q?</code>
Example	Remove a DC offset of -0.5 V from the Q channel input: <code>:INP:OFFS:Q -0.5</code>
Notes	Only some probe types support Offset . For those that do, each probe type has its own Offset setting. As probes are changed, the Offset value will reflect the new probe's setting. Changing Offset affects only the current probe type's setting and leaves all others unchanged
Preset	0 V
State Saved	Saved with probe calibration data. Survives power cycle and is not affected by Preset or Restore
Min/Max	-18 V/+18 V

Coupling

Some probe types allow coupling to reject low frequencies. This filters out the DC component of a signal that is composed of a DC bias plus some AC signal. This control is visible only for probe types that have this capability.

Remote Command	<code>:INPut:COUPling:Q DC LFR1 LFR2</code> <code>:INPut:COUPling:Q?</code>
----------------	--

6 Input/Output

6.2 Input

Example	<p>Turn off low frequency rejection on the Q channel, allowing signals down to DC: <code>:INP:COUP:Q DC</code></p> <p>Turn on low frequency rejection on the Q channel for frequencies lower than 1.7 Hz: <code>:INP:COUP:Q LFR1</code></p> <p>Turn on low frequency rejection on the Q channel for frequencies lower than 0.14 Hz: <code>:INP:COUP:Q LFR2</code></p>
Notes	Only some probe types support Coupling . For those that do, each probe type has its own Coupling setting. As probes are changed, the Coupling value will reflect the new probe's setting. Changing Coupling affects only the current probe type's setting and leaves all others unchanged
Preset	DC
State Saved	Saved with probe calibration data. Survives a power cycle and is not affected by a Preset or Restore
Range	DC AC 1.7 Hz LFR1 AC 0.14 Hz LFR2

Clear Calibration

Clears the calibration data for the current port and probe. It does not clear the data for other probe types or other ports. If the sensed probe has EEPROM identification, only the data for that specific probe is cleared. After this command has completed, the probe calibration state will be the same as if no probe calibration had ever been performed for the specified channel and probe. The probe attenuation will be the default value for that probe type and the Cable Calibration frequency response corrections will be used. This command is dependent on the Differential Input state. When Differential Input is on, both the data for the probe attached to the main port and the data for the probe attached to the complementary port are cleared. When Differential Input is off, only data for the probe attached to the main port is cleared.

Remote Command	<code>:CALibration:IQ:PROBe:Q:CLEar</code>
Example	<p>Clear the calibration data for the Q channel and the current probe (with EEPROM identification) or probe type (without EEPROM identification): <code>:CAL:IQ:PROBe:I:CLE</code></p>

6.2.21.6 Calibrate

Invokes the guided probe calibration. The guided probe calibration is context sensitive and depends on the channel (I or Q) and the Differential Input state. The calibration is only performed on the selected channel. When the Differential control is switched to Differential, both the probe attached to the main port and the probe attached to the complementary port are calibrated. When the Differential control is switched to Single Ended, only the probe attached to the main port is calibrated.

The I/Q Isolation Calibration must be run before calibrating any port with either the I/Q Cable Calibration or I/Q Probe Calibration. See "[I/Q Isolation Calibration](#)" on [page 1178](#)

Q Port

The Q port calibration is performed with the probe body attached to the front panel's Q port and the probe tip connected via an adapter to the Cal Out port. The guided calibration will show a diagram of the required connections.

Remote Command	<code>:CALibration:IQ:PROBe:Q</code>
Example	<code>:CAL:IQ:PROB:Q</code>
Notes	The Q port must be connected to the Cal Out port before issuing the command The calibration data is saved as soon as the port is calibrated and survives power cycles. It is not reset by any preset or restore data commands
State Saved	No

Q Port Probe Calibration Time (Remote Query Only)

Return the last date and time that the I/Q Probe Calibration was performed for a specific port.

Remote Command	<code>:CALibration:IQ:PROBe:Q:TIME?</code>
Example	<code>:CAL:IQ:PROB:Q:TIME?</code>
Notes	Returns 6 integer values: year, month, day, hour, minute, second. When no calibration has been performed, all values are 0. The value is specific to both the port and probe, so the value will change as probes are connected or disconnected
Annunciation	Guided Calibration, Probe Calibration, Last Calibration

Q-bar Port

The Q-bar port calibration is performed with the probe body attached to the front panel's Q-bar port and the probe tip connected via an adapter to the Cal Out port. The Q-bar probe calibration is only available for passive probes with Differential On. The guided calibration will show a diagram of the required connections.

Remote Command	<code>:CALibration:IQ:PROBe:QBar</code>
Example	<code>:CAL:IQ:PROB:QB</code>
Notes	The Q-bar port must be connected to the Cal Out port before issuing the command

6 Input/Output

6.2 Input

The calibration data is saved as soon as the port is calibrated and will survive power cycles. It is not reset by any preset or restore data commands

State Saved No

Q-bar Probe Calibration Time (Remote Query Only)

Return the last date and time that the I/Q Probe Calibration was performed for a specific port.

Remote Command `:CALibration:IQ:PROBe:QBAR:TIME?`

Example `:CAL:IQ:PROB:QBAR:TIME?`

Notes Returns 6 integer values: year, month, day, hour, minute, second. When no calibration has been performed, all values are 0. The value is specific to both the port and probe, so the value will change as probes are connected or disconnected

Annunciation Guided Calibration, Probe Calibration, Last Calibration

6.2.22 I/Q Cable Calibrate

The I/Q cable calibration creates correction data for each of the front panel I/Q ports. This calibration data is used whenever no probe specific calibration data is available. It is important that all ports are calibrated using the same short BNC cable so that the data is comparable from port to port.

The guided calibration (front panel only) will show connection diagrams and guide you through the isolation calibration and calibrating each port. The calibration data for each port is stored separately, so as soon as a port is calibrated that data is saved and will be used. If you press "Exit" to exit the calibration process, the data for the ports already completed will still be used. It is recommended that a calibration be completed once started, or if exited, that it be properly done before the next use of the I/Q ports. The "Next" button will perform the calibration for the current port and then proceed to the next step in the calibration procedure. The "Back" button will return to the prior port in the procedure. Both keys and dialog buttons are supplied for ease of use. The dialog buttons are for mouse use and the softkeys for front panel use.

The calibration can also be done via SCPI, but no connection diagrams will be shown. You will have to make the correct connections before issuing each port calibration command. Again, it is recommended that all ports be calibrated at the same time.

The instrument state remains as it was prior to entering the calibration procedure except while a port is actually being calibrated. Once a port is calibrated it returns to the prior state. A port calibration is in process only from the time the "Next" button is

pressed until the next screen is shown. For SCPI, this corresponds to the time from issuing the CAL:IQ:FLAT:I|B|Q|QB command until the operation is complete.

For example, if the prior instrument state is Cal Out = Off, Input = I+jQ, and Differential = Off, then up until the time the "Next" button is pressed the I Input and Q Input LEDs are on and the Cal Out, I-bar Input and Q-bar Input LEDs are off. Once the "Next" button is pressed for the I port calibration, only the Cal Out and I Input LEDs will be on and the others will be off. When the screen progresses to the next step ("Next" button again enabled), the prior state is restored and only the I Input and Q Input LEDs are on (Cal Out is off again).

The last calibration date and time for each port will be displayed. Any calibrations that are more than a day older than the most recent calibration will be displayed with the color amber.

The I/Q Isolation Calibration must be run before calibrating any port with either the I/Q Cable Calibration or I/Q Probe Calibration. See "[I/Q Isolation Calibration](#)" on [page 1178](#)

Dependencies	Only appears when I/Q is the selected input
--------------	---

6.2.22.1 I Port

The I port calibration is performed with the front panel's I port connected via a short BNC cable to the Cal Out port. The guided calibration will show a diagram of the required connections.

Remote Command	:CALibration:IQ:FLATness:I
----------------	----------------------------

Example	:CAL:IQ:FLAT:I
---------	----------------

Notes	<p>The recommended procedure is to use the same BNC cable to calibrate all I/Q ports. All I/Q ports should be calibrated sequentially during the procedure</p> <p>The calibration data is saved as soon as the port is calibrated and will survive power cycles. It is not reset by any preset or restore data commands</p> <p>The I port must be connected to the Cal Out port before issuing the command</p>
-------	--

State Saved	No
-------------	----

6.2.22.2 I-bar Port

The I-bar port calibration is performed with the front panel's I-bar port connected via a short BNC cable to the Cal Out port. The guided calibration will show a diagram of the required connections.

Remote Command	:CALibration:IQ:FLATness:IBAR
----------------	-------------------------------

6 Input/Output

6.2 Input

Example	<code>:CAL:IQ:FLAT:IBAR</code>
Notes	<p>The recommended procedure is to use the same BNC cable to calibrate all I/Q ports. All I/Q ports should be calibrated sequentially during the procedure</p> <p>The calibration data is saved as soon as the port is calibrated and will survive power cycles. It is not reset by any preset or restore data commands</p> <p>The I-bar port must be connected to the Cal Out port before issuing the command</p>
State Saved	No

6.2.22.3 Q Port

The Q port calibration is performed with the front panel's Q port connected via a short BNC cable to the Cal Out port. The guided calibration will show a diagram of the required connections.

Remote Command	<code>:CALibration:IQ:FLATness:Q</code>
Example	<code>:CAL:IQ:FLAT:Q</code>
Notes	<p>The recommended procedure is to use the same BNC cable to calibrate all I/Q ports. All I/Q ports should be calibrated sequentially during the procedure</p> <p>The calibration data is saved as soon as the port is calibrated and will survive power cycles. It is not reset by any preset or restore data commands</p> <p>The Q port must be connected to the Cal Out port before issuing the command</p>
State Saved	No

6.2.22.4 Q-bar Port

The Q-bar port calibration is performed with the front panel's Q-bar port connected via a short BNC cable to the Cal Out port. The guided calibration will show a diagram of the required connections.

Remote Command	<code>:CALibration:IQ:FLATness:QBAR</code>
Example	<code>:CAL:IQ:FLAT:QBAR</code>
Notes	<p>The recommended procedure is to use the same BNC cable to calibrate all I/Q ports. All I/Q ports should be calibrated sequentially during the procedure</p> <p>The calibration data is saved as soon as the port is calibrated and will survive power cycles. It is not reset by any preset or restore data commands</p> <p>The Q-bar port must be connected to the Cal Out port before issuing the command</p>
State Saved	No

6.2.22.5 I/Q Cable Calibration Time (Remote Query Only)

Returns the last date and time that the I/Q Cable Calibration was performed for a specific port.

Remote Command	<code>:CALibration:IQ:FLATness:I IBAR Q QBAR:TIME?</code>
Example	<code>:CAL:IQ:FLAT:I:TIME?</code>
Notes	Returns 6 integer values: year, month, day, hour, minute, second. When no calibration has been performed, all values are 0
Annunciation	Guided Calibration, Cable Calibration, Last Calibration

6.2.23 Audio Input Channel

Determines which Audio Input to be used for audio measurements.

Remote Command	<code>[:SENSe]:FEED:AFINput:PORT CH1 CH2</code> <code>[:SENSe]:FEED:AFINput:PORT?</code>
Example	<code>:FEED:AFIN CH1</code>
Dependencies	Only appears in Radio Test Mode Only appears in modular products, and only if an M9260A Audio Analyzer module is installed
Preset	Unaffected by Mode Preset, but set to Channel 1 by Input/Output Preset

6.2.24 Audio Calibrator

Lets you turn on the internal calibrator in the X-Series Audio board.

Remote Command	<code>[:SENSe]:FEED:AFALign OFF REF10</code> <code>[:SENSe]:FEED:AFALign?</code>
Example	<code>:FEED:AFAL REF10</code>
Dependencies	Only appears in Measuring Receiver Mode's Audio Measurements when Option 107 is present
Preset	<code>OFF</code>

6.2.25 Audio Coupling

Lets you set AC or DC coupling for the currently selected audio input.

Remote Command	<code>[:SENSe]:AFINput[1] 2:COUPling AC DC</code> <code>[:SENSe]:AFINput[1] 2:COUPling?</code>
----------------	---

6 Input/Output

6.2 Input

Example	<code>:AFIN:COUP AC</code>
Dependencies	Only appears in Measuring Receiver Mode and Radio Test Mode In Measuring Receiver Mode, only appear in Audio Measurements, and only if Option 107 is present In Radio Test Mode, only appears in modular products, and only if an M9260A Audio Analyzer module is installed
Preset	<code>AC</code>

6.2.26 Audio Input Ground

Lets you float or ground the low side of the currently selected audio input channel. When you choose `FLOat`, the low side of the input is disconnected from ground.

Remote Command	<code>[:SENSe]:AFINput[1] 2:LOW FLOat GROund</code> <code>[:SENSe]:AFINput[1] 2:LOW?</code>
Example	<code>:AFIN2:LOW FLO</code>
Dependencies	Only appears in Radio Test Mode Only appears in modular products, and only if an M9260A Audio Analyzer module is installed
Preset	Unaffected by Mode Preset, but set to <code>GROund</code> by Input/Output Preset

6.2.27 Audio In Impedance

Lets you set the Impedance of the currently selected audio input channel. The value you enter is rounded up to the nearest allowed value.

Remote Command	<code>[:SENSe]:AFINput[1] 2:IMPedance 50 600 1000000</code> <code>[:SENSe]:AFINput[1] 2:IMPedance?</code>
Example	<code>:AFIN:IMP 50</code>
Dependencies	Only appears in Radio Test Mode Only appears in modular products, and only if an M9260A Audio Analyzer module is installed
Preset	Unaffected by Mode Preset, but set to 600 by Input/Output Preset

6.2.28 Input/Output Preset

Resets the group of settings and data associated with the **Input/Output** front-panel key to their default values. These settings are not affected by **Mode Preset** because they are generally associated with connections to the instrument, which you generally would not want to reset every time you press **Mode Preset**.

This is the same as the control in the **Preset** dropdown, and also the same as **Input/Output** button in the **Restore Defaults** menu under **System**.

All the variables set under the **Input/Output** front panel key are reset by **Input/Output Preset**, including Amplitude Corrections and Data (described in the **Corrections** section), with the exception of RF Source settings, which are unaffected.

By using **Input/Output Preset** and **Restore Mode Defaults**, a full preset of the current mode will be performed, with the caveat that since **Input/Output Preset** is a global function it will affect *all* Modes.

When **Input/Output Preset** is selected, a message appears saying:

“This will reset all of the Input/Output variables to their default state, including which input is selected, all Amplitude Correction settings and data, all External Mixing settings, all Frequency Reference settings and all Output settings.

It will not affect Alignment data or settings.

It will not affect RF Source settings.

This action cannot be undone. Do you want to proceed?”

Use the **OK** or **Cancel** buttons to affirm or cancel the operation.

Example

:SYST:DEF INP

presets all Input/Output variables to their factory default values

6.3 External Gain

Contains controls that allow you to compensate for gain or loss in the measurement system outside the instrument. The External Gain is subtracted from the amplitude readout (or the loss is added to the amplitude readout). So, the displayed signal level represents the signal level at the output of the device-under-test, which can be the input of an external device that provides gain or loss.

Entering an External Gain value does not affect the Reference Level, therefore the trace position on screen changes, as do all of the values represented by the trace data. Thus, the values of exported trace data, queried trace data, marker amplitudes, trace data used in calculations such as N dB points, trace math, peak threshold, etc., are all affected by External Gain. Changing the External Gain, even on a trace that is not updating, immediately changes all of the above, without new data needing to be taken.

NOTE

Changing the External Gain causes the instrument to immediately stop the current sweep and prepare to begin a new sweep. The data will not change until the trace data updates because the offset is applied to the data as it is taken. If a trace is exported with a nonzero External Gain, the exported data will contain the trace data with the offset applied.

In Spectrum Analyzer Mode, a Preamp is the common external device providing gain or loss. In a measurement application mode like GSM or W-CDMA, the gain or loss could be from a BTS (Base Transceiver Station) or an MS (Mobile Station). So, in the Spectrum Analyzer mode MS and BTS would be grayed out and the only choice would be Ext Preamp. Similarly, in some of the digital communications applications, Ext Preamp will be grayed out and you would have a choice of MS or BTS.

The Ext Preamp, MS, and BS controls may be grayed-out depending on which measurement is currently selected. If any of the grayed-out controls are pressed, or the equivalent SCPI command is sent, an advisory message is generated.

6.3.1 External Preamp

This function is similar to the reference level offset function. Both affect the displayed signal level. Ref Lvl Offset is a mathematical offset only, no instrument configuration is affected. Ext Preamp gain is used when determining the auto-coupled value of the Attenuator. The External Gain value and the Maximum Mixer Level settings are both part of the automatic setting equation for the RF attenuation setting. (10 dB of Attenuation is added for every 10 dB of External Gain.)

Note that the Ref Lvl Offset and Maximum Mixer Level are described in the Amplitude section. They are reset by Mode Preset. The External Preamp Gain is reset by the "Restore Input/Output Defaults" or "Restore System Defaults->All" functions.

The Swept SA Measurement in SA Mode only supports the "Ext Preamp" function under External Gain. The other External Gain functions are grayed-out, and generate a settings conflict, if the SCPI for them is sent.

See ["More Information" on page 1194](#)

Remote Command	<code>[:SENSe]:CORRection:SA[:RF]:GAIN <rel_amp1></code> <code>[:SENSe]:CORRection:SA[:RF]:GAIN?</code>
Example	Set the Ext Gain value to 10 dB: <code>:CORR:SA:GAIN 10</code> Set the Ext Gain value to -10 dB (that is, an attenuation of 10 dB): <code>:CORR:SA:GAIN -10</code>
Notes	Does not auto return This command is new in X-Series
Dependencies	The reference level limits are determined in part by the External Gain/Atten, Max Mixer Level, and RF Atten Grayed-out in Modes that do not support External Gain
Preset	Unaffected by Preset, but set to 0 dB by Restore Input/Output Defaults or Restore System Defaults->All 0.00 dB, Gain
State Saved	Saved in instrument state
Min	-120 dB
Max	120 dB
Annotation	Displayed in the Meas Bar as "Ext Gain <value>". When the gain is zero, no annotation is shown
Backwards Compatibility SCPI	<code>[:SENSe]:CORRection:OFFSet[:MAGNitude]</code> The legacy Ext Preamp Gain key is now called Ext Gain and the sub-menu has choices of Ext Preamp MS BTS for backwards compatibility The MS and BTS choices are unavailable in Swept SA and the Ext Preamp is unavailable in the cell comms measurements

More Information

The U7227A USB Preamplifier is an accessory for the X-Series Signal Analyzer that provides gain externally, and whose gain settings are automatically loaded into the instrument over USB whenever it is connected to one of the instrument's USB ports.

While the USB Preamplifier is plugged into one of the instrument's USB ports, the instrument will consider it to be in the signal path of the RF Input and will apply the

6 Input/Output
6.3 External Gain

calibration data from the USB Preamp to measurements taken at the RF Input (on 2 input boxes, it will be considered to be in the signal path of RF Input 1; it is not supported for RF Input 2).

The USB Preamplifier contains its own cal data. This includes a noise trace suitable for use with NFE, for those models which support NFE. The act of connecting the Preamp to USB will cause the cal data to be downloaded from the preamp. When this happens, an informational message is provided saying "Cal data loaded from USB Preamp". The instrument will then automatically apply the calibration factors loaded from the Preamp in any measurement that supports the USB Preamp.

The External Preamp Gain setting may still be used, even though it is not required for the USB Preamp (since the USB Preamp supplies its own gain data to the instrument which is applied automatically). Connecting the USB Preamp does not change the External Preamp Gain setting, however unless you have another gain or attenuation element in the signal path, the appropriate setting for External Preamp Gain is 0 dB.

Overload detection and reporting will apply when the USB preamplifier is connected to USB. The USB Preamplifier has its own overload detector which reports overloads to the instrument over USB. This generates an error condition, "Input Overload; USB Preamp."

If, while the USB Preamp is connected to USB, a measurement is selected that does not support the USB preamplifier, the "No result; Meas invalid with Preamp" error condition is generated.

6.3.2 External Gain - MS

Sets an external gain/attenuation value for MS (Mobile Station) tests.

Remote Command	<code>[:SENSe]:CORRection:MS[:RF]:GAIN <rel_amp1></code> <code>[:SENSe]:CORRection:MS[:RF]:GAIN?</code>
Example	Set the Ext Gain value to 10 dB: <code>:CORR:MS:GAIN 10</code> Set the Ext Gain value to -10 dB (that is, a loss of 10 dB): <code>:CORR:MS:GAIN -10</code>
Notes	Does not auto return
Dependencies	The reference level limits are determined in part by the External Gain, Max Mixer Level, RF Atten Grayed-out in modes that do not support MS
Preset	Unaffected by Preset, but set to 0 dB by Restore Input/Output Defaults or Restore System Defaults->All 0.00 dB, Gain
State Saved	Saved in instrument state

Min	-100 dB
Max	100 dB
Backwards Compatibility SCPI	
Example	Set the Ext Gain value to -10 dB, and subsequently querying :LOSS will give 10 dB: <code>:CORR:MS:LOSS 10</code> Set the Ext Gain value to 10 dB. Subsequently querying :LOSS will return -10 dB: <code>:CORR:MS:LOSS -10</code>
Notes	A positive value of <code><rel_amp1></code> in the above command means a loss and a negative value indicates a gain If <code>:LOSS</code> is set, <code>:GAIN</code> is set to the negative value of the parameter sent If <code>:LOSS</code> is queried, it returns the negative of <code>:GAIN</code>
Preset	Unaffected by Preset, but set to 0 dB by Restore Input/Output Defaults or Restore System Defaults->All
Min/Max	-/+100 dB
Backwards Compatibility SCPI	<code>[:SENSe]:CORRection:MS[:RF]:LOSS <rel_amp1></code> <code>[:SENSe]:CORRection:MS[:RF]:LOSS?</code>

6.3.3 External Gain - BTS

Sets an external attenuation value for BTS (Base Transceiver Station) tests.

Remote Command	<code>[:SENSe]:CORRection:BTS[:RF]:GAIN <rel_amp1></code> <code>[:SENSe]:CORRection:BTS[:RF]:GAIN?</code>
Example	Set the Ext Gain value to 10 dB: <code>:CORR:BTS:GAIN 10</code> Set the Ext Gain value to -10 dB (that is, a loss of 10 dB): <code>:CORR:BTS:GAIN -10</code>
Notes	Does not auto return
Dependencies	The reference level limits are determined in part by the External Gain, Max Mixer Level, RF Atten Grayed-out in modes that do not support BTS
Preset	Unaffected by Preset, but set to 0 dB by Restore Input/Output Defaults or Restore System Defaults->All 0.00 dB, Gain
State Saved	Saved in instrument state
Min	-100 dB
Max	100 dB
Backwards Compatibility SCPI	

6 Input/Output

6.3 External Gain

Example	<p>Set the Ext Gain value to -10 dB, and subsequently querying :LOSS will give 10 dB: :CORR:BTS:LOSS 10</p> <p>Set the Ext Gain value to 10 dB. Subsequently querying :LOSS will return -10 dB: :CORR:BTS:LOSS -10</p>
Notes	<p>A positive value of <rel_amp1> in the above command means a loss and a negative value indicates a gain</p> <p>If :LOSS is set, :GAIN is set to the negative value of the parameter sent</p> <p>If :LOSS is queried, it returns the negative of :GAIN</p>
Preset	Unaffected by Preset, but set to 0 dB by Restore Input/Output Defaults or Restore System Defaults->All
Min/Max	-/+100 dB
Backwards Compatibility SCPI	<p>[:SENSe]:CORRection:BTS[:RF]:LOSS <rel_amp1></p> <p>[:SENSe]:CORRection:BTS[:RF]:LOSS?</p>

6.3.4 I Ext Gain

Affects the I channel input. However, when Q Gain in I+jQ is set to Same as I Gain, this value is applied to both I and Q channel inputs.

Remote Command	<p>[:SENSe]:CORRection:IQ:I:GAIN <rel_amp1></p> <p>[:SENSe]:CORRection:IQ:I:GAIN?</p>
Example	<p>Set the I Ext Gain to 10 dB: :CORR:IQ:I:GAIN 10</p> <p>Set the I Ext Gain to -10 dB (that is, a loss of 10 dB): :CORR:IQ:I:GAIN -10</p>
Dependencies	<p>Not available unless option BBA is installed</p> <p>Grayed-out when I/Q Path is Q Only</p>
Preset	<p>0 dB</p> <p>Unaffected by Preset, but set to 0 dB by Restore Input/Output Defaults or Restore System Defaults->All</p>
State Saved	Yes
Min/Max	-/+100 dB
Annotation	<p>Ext Gain: <I Ext Gain> dB</p> <p>No annotation is shown when Input is not I/Q. Also not shown when I Ext Gain is 0.00 dB. I Ext Gain is not shown for Input Path Q Only. When the Input Path is Independent I and Q and I Ext Gain is not the same as Q Ext Gain, both are shown. "Ext Gain: <I Ext Gain> dB, <Q Ext Gain> dB"</p>

6.3.5 Q Ext Gain

Affects the Q channel input.

Remote Command	<code>[:SENSe]:CORRection:IQ:Q:GAIN <rel_amp1></code> <code>[:SENSe]:CORRection:IQ:Q:GAIN?</code>
Example	Set the Q Ext Gain to 10 dB: <code>:CORR:IQ:Q:GAIN 10</code> Set the Q Ext Gain to -10 dB (that is, a loss of 10 dB): <code>:CORR:IQ:Q:GAIN -10</code>
Dependencies	Not available unless option BBA is installed Grayed-out when Q gain in I+jQ is set to Same as I Gain
Preset	0 dB Unaffected by Preset, but set to 0 dB by Restore Input/Output Defaults or Restore System Defaults->All
State Saved	Saved in instrument state
Min/Max	-/+100 dB
Annotation	Ext Gain: <Q Ext Gain> dB No annotation is shown when Input is not I/Q. Also not shown when Q Ext Gain is 0.00 dB. Q Ext Gain is not shown for Input Path I Only or I+jQ. When Input Path is Independent I and Q and when I and Q Ext Gain are both non-zero but are the same the annotation will be "Ext Gain: <Ext Gain> dB" and when I Ext Gain is not the same as Q Ext Gain, both are shown. "Ext Gain: <I Ext Gain> dB, <Q Ext Gain> dB"

6.3.6 Q Gain in I+jQ

When Same as I Gain (**ON**) is selected, I Ext Gain value is applied to both I and Q channel input if the Input Path is I+jQ.

When Independent (**OFF**) is selected, I and Q Ext Gain values are applied to I and Q channel input independently.

Remote Command	<code>[:SENSe]:CORRection:IQ:Q:GAIN:COUPle ON OFF 0 1</code> <code>[:SENSe]:CORRection:IQ:Q:GAIN:COUPle?</code>
Example	<code>:CORR:IQ:Q:GAIN:COUP ON</code> <code>:CORR:IQ:Q:GAIN:COUP?</code>
Preset	ON
State Saved	Yes
Range	Same as I Gain Independent

6.4 Data Source

Contains controls that let you select the source of the data being fed to the instrument analysis engine.

The ability to Save and Record files of I/Q data is an important feature of some X-Series applications, and the Data Source controls allow you to switch back and forth from actual data at the instrument input and recorded data from a File.

In addition, some measurements allow you to retain a single measurement record in a Capture Buffer, and some measurements allow you to retain a specified length data record internally in a Recorded data area.

So, for measurements that support it, the controls on this tab allow you to select data from the instrument inputs, a recalled recording File, the Capture Buffer, or the Recorded data area. For measurements that do not support these features, the **Data Source** tab does not appear, and if `:FEED:DATA SCPI` is sent, an Undefined Header error is generated.

The available choices depend on which measurement you are running. All measurements support Input; Capture Buffer and File are only available in certain measurements, as shown in the table below. The choice of the internal Recorded data area is only available in Pulse Mode.

Measurement	Capture Buffer	File
WCDMA Code Domain	x	
WCDMA Mod Accuracy	x	
VMA Digital Demod		x
VMA Custom OFDM		x
5G NR Modulation Analysis		x
FDD LTE-A Modulation Analysis		x
TDD LTE-A Modulation Analysis		x
WLAN Modulation Analysis	x	x
WLAN Spectral Flatness		x
WLAN MIMO Modulation Analysis		x
Analog Demod AM		x
Analog Demod PM		x
Analog Demod FM		x
Analog Demod FM Stereo		x
Bluetooth Transmit Analysis	x	x
IoT & SRComms LoRa CSS Demod		x

How to Record and Playback I/Q Data

In several Demod measurements (and certain other measurements), it is possible to record I/Q data to files on your hard drive or network, and then recall these files for subsequent playback. These are the measurements shown in the table above with an “x” in the **File** column.

The Recording and Playback of signal data files is a multi-step process which involves controls in several menus (listed below).

Menus involved in Record/Playback:

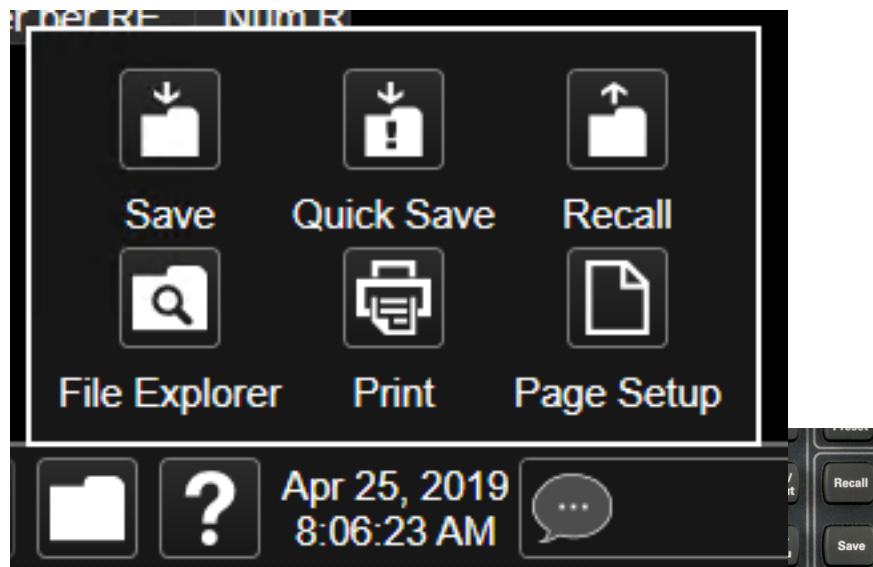

- Save, Recording (under the **Save** hardkey or the **Save** icon in the **File** panel)
- Recall, Recording (under the **Recall** hardkey or the **Recall** icon in the **File** panel)
- Sweep, Recording tab
- Sweep, Playback tab
- Input/Output, Data Source tab (this tab)

Saving a Recording

When you save a recording, a certain number of measurement records are saved to a Recording file. The amount of data that is saved varies depending on the measurement and measurement settings. The following example uses VMA Digital Demod to illustrate the process.

6 Input/Output

6.4 Data Source

If you press the **Recording** tab in the **Sweep** menu, you will see a certain number of parameters displayed on the menu panel. Before you save a Recording, these parameters are all 0, as shown below:



To save the data for the current measurement, press the **Save** hardkey (or the **Save** icon in the **File** panel) and press the **Recording** tab on the left side of the **Save** panel:

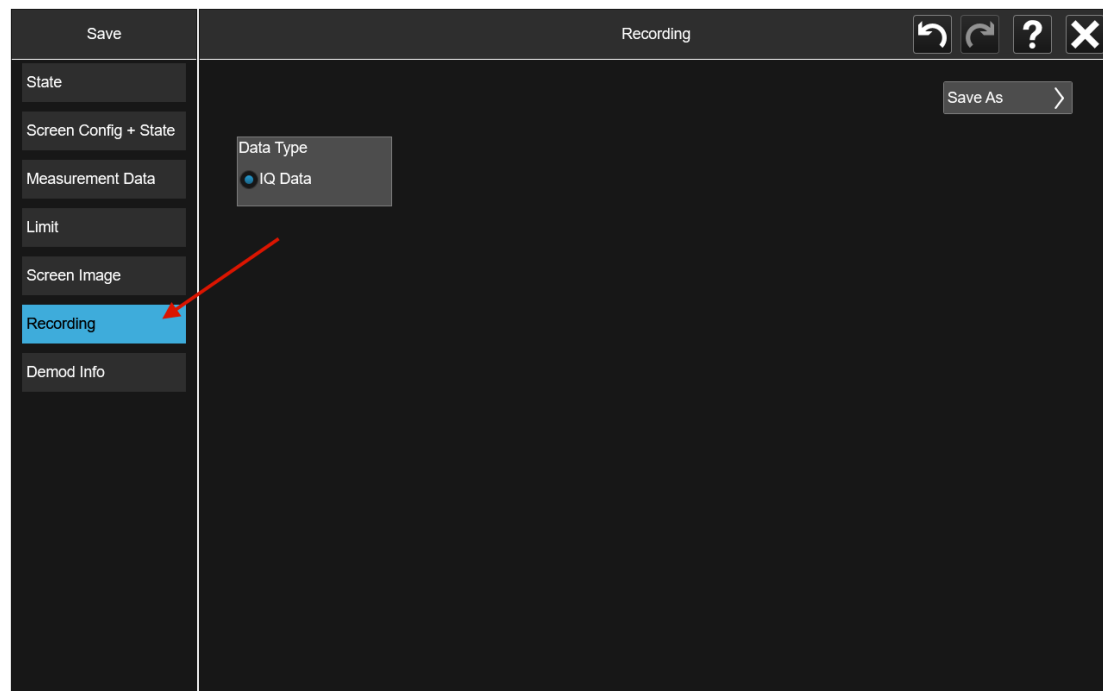

Then press **Save As** and choose the file type you would like to use for the Save (**CSV**, **SDF**, **TXT**, **BIN**, **BINX**). You can find details of the file formats in **Save > Recording**.

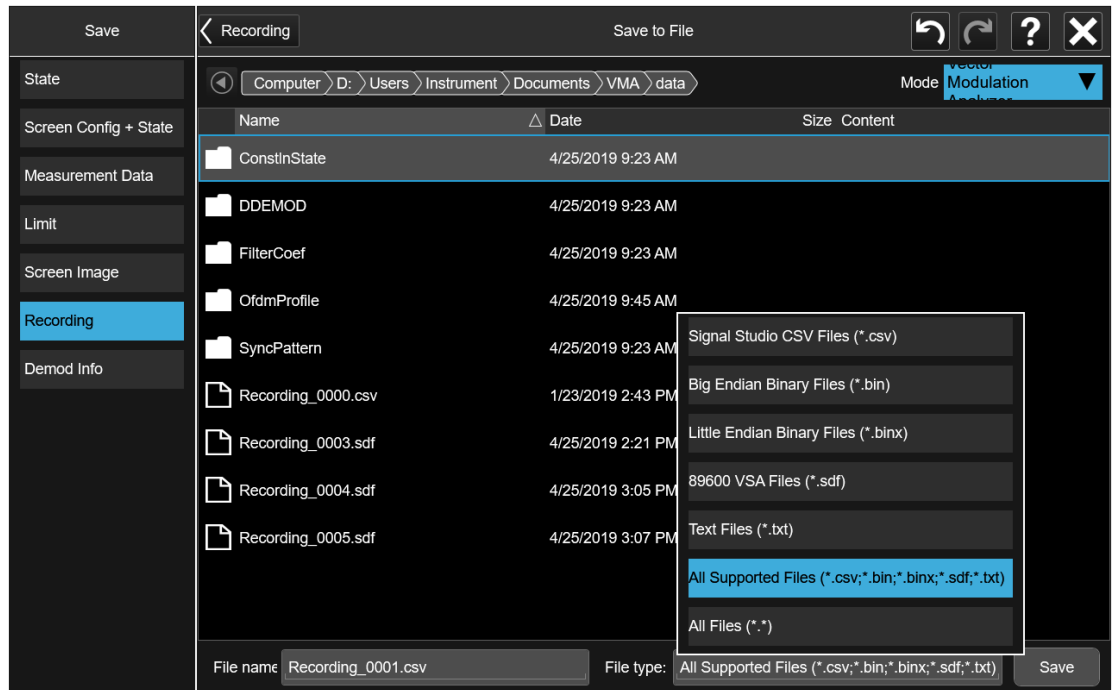

Then press **Save** to save the raw I/Q data of the current measurement.

After the Save, you will see that the data on the Recording panel has changed to describe the data in the file you just saved. You should note this data in case you need to refer to it when you recall the file, particularly as not all file formats include the Sample Rate that was used to save the data. In particular, **BIN** and **BINX** files do not include sampling rate information inside the file, so after recalling one of these file types, you will need to set the Sample Rate manually in the **Sweep, Playback** menu.

6 Input/Output

6.4 Data Source

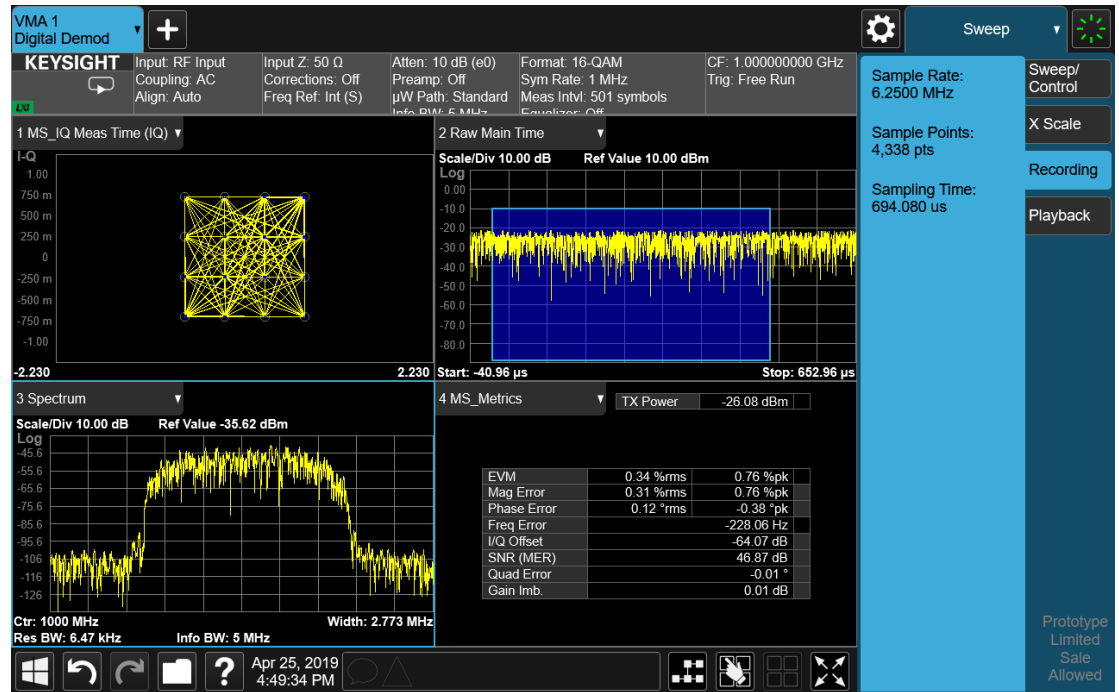

Step 2: Recalling a Recording

If you press the **Playback** tab in the **Sweep** menu, you will see a certain number of parameters displayed on the menu panel. Before you recall a Recording, these parameters are all 0, as shown below:



To recall a Recording, press the **Recall** hardkey (or the **Recall** icon in the **File** panel) and press the **Recording** tab on the left side of the **Recall** panel. Then press **Recall From** and choose the file you would like to recall. This will read the raw I/Q data from the specified file and feed it to the current measurement.

After the Recall, you will see that the data on the Recording panel has changed to describe the data in the file you just recalled:

6 Input/Output

6.4 Data Source

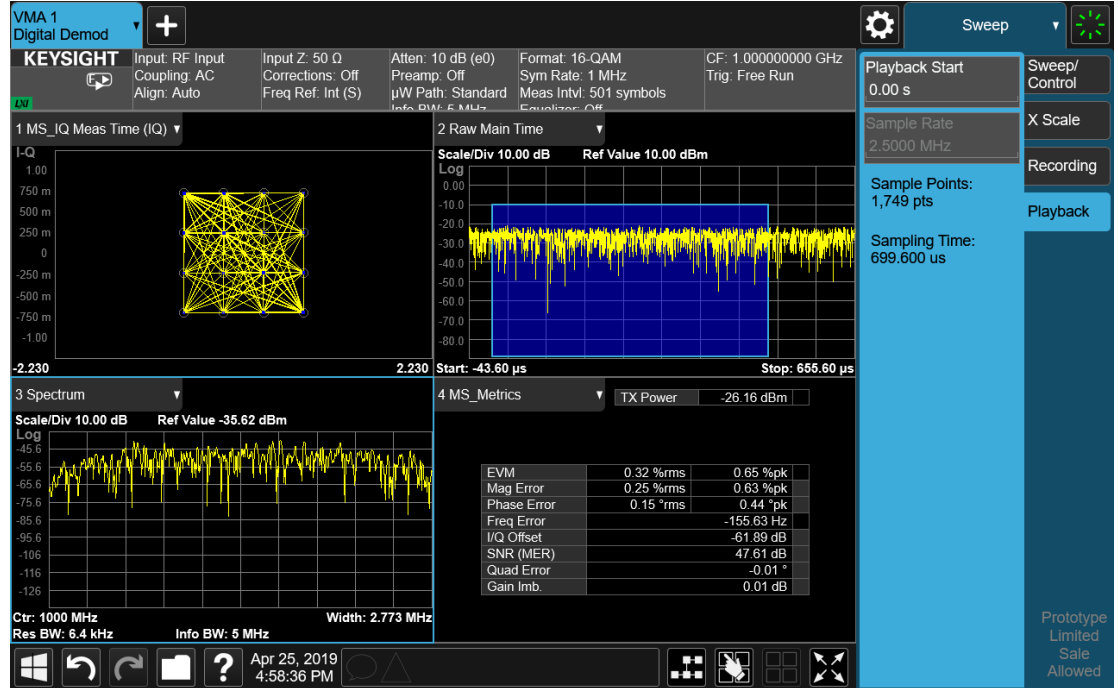

Note that the **Sample Rate** key is grayed out if the file type you loaded contains Sample Rate information. **BIN** and **BINX** files do not include sampling rate information inside the file, so after recalling one of these file types, you will need to set the Sample Rate. You should have noted the Sample Rate that was displayed on the **Sweep, Recording** menu panel after you saved the file.

After the recall is performed, you will also see that the **Data Source** control has switched to **File**. You can see this on the **Data Source** menu panel, and also on the dropdown from the Measurement Bar on the far-left side of the instrument:

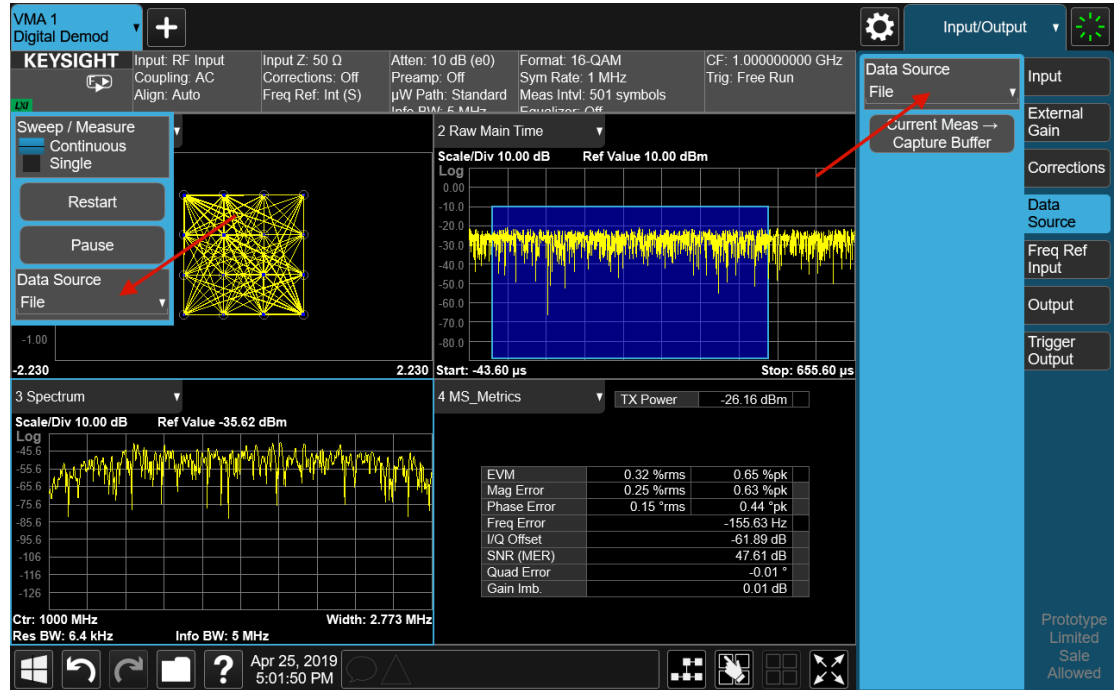

You can also see that the control indicator on the measurement bar has an “F” in it and the playback symbol (right facing triangle) displayed:



This indicates that the instrument is in **Continuous Playback** mode and is using data from a File.

If you select **Single** in the control dropdown, the indicator will change to show that it is in **Single Pause** mode as below:

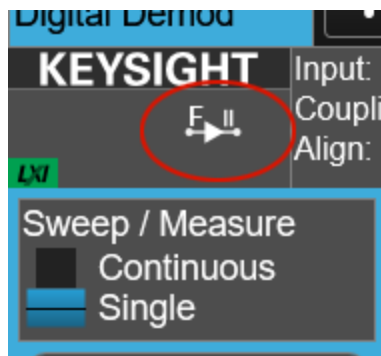

6 Input/Output

6.4 Data Source

You can now examine data in the recorded file which you loaded. How you do this depends on whether you are in **Continuous Playback** mode or **Single Pause** mode.

If you wish to return to looking at data at the instrument input, simply change the **Data Source** control from **File** back to **Input**.

Looking at your Recorded data

To examine the data you loaded, go to the **Playback** menu panel under **Sweep**. How you proceed from here depends on whether you are in **Continuous Playback** mode or **Single Pause** mode.

Continuous Playback mode

In this mode, turn the knob clockwise or use the **Up** key on the front panel to move through successive records in the recording. You will see the Playback Start control change from 0 to successively higher values as you move through the records.

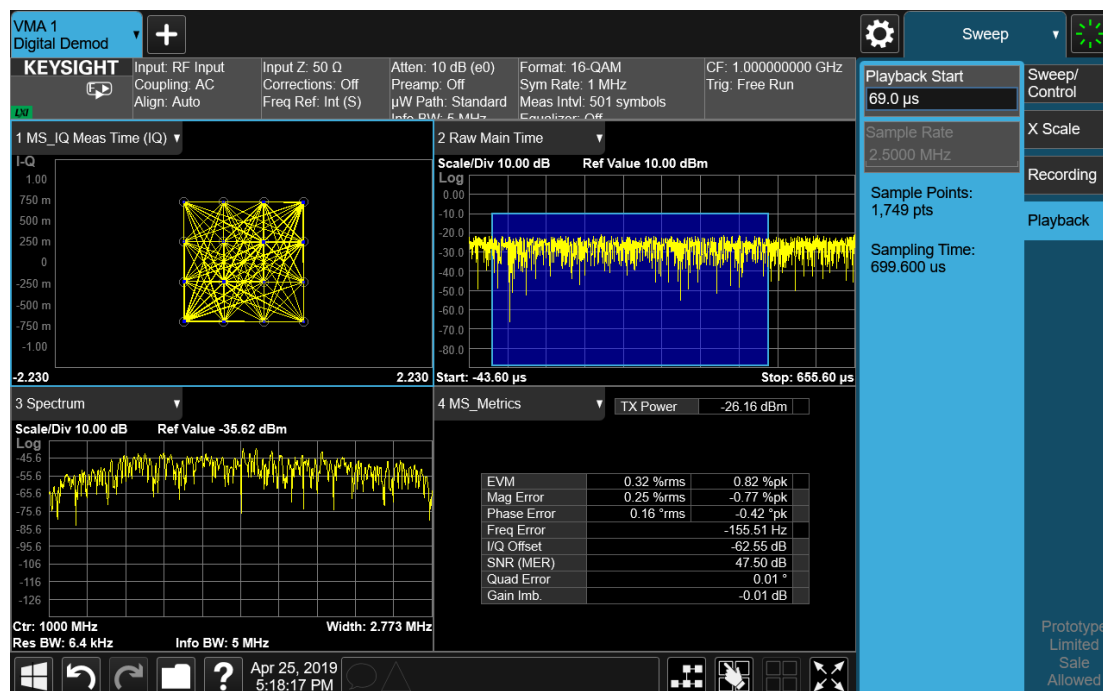

Single Pause mode

In this mode, you can only look at one record. Set the Playback Start time to the desired offset from zero and press **Restart**. A single record will be displayed.

Note that until you press **Restart**, the “invalid data” indicator (yellow asterisk) will be displayed in each window as below:

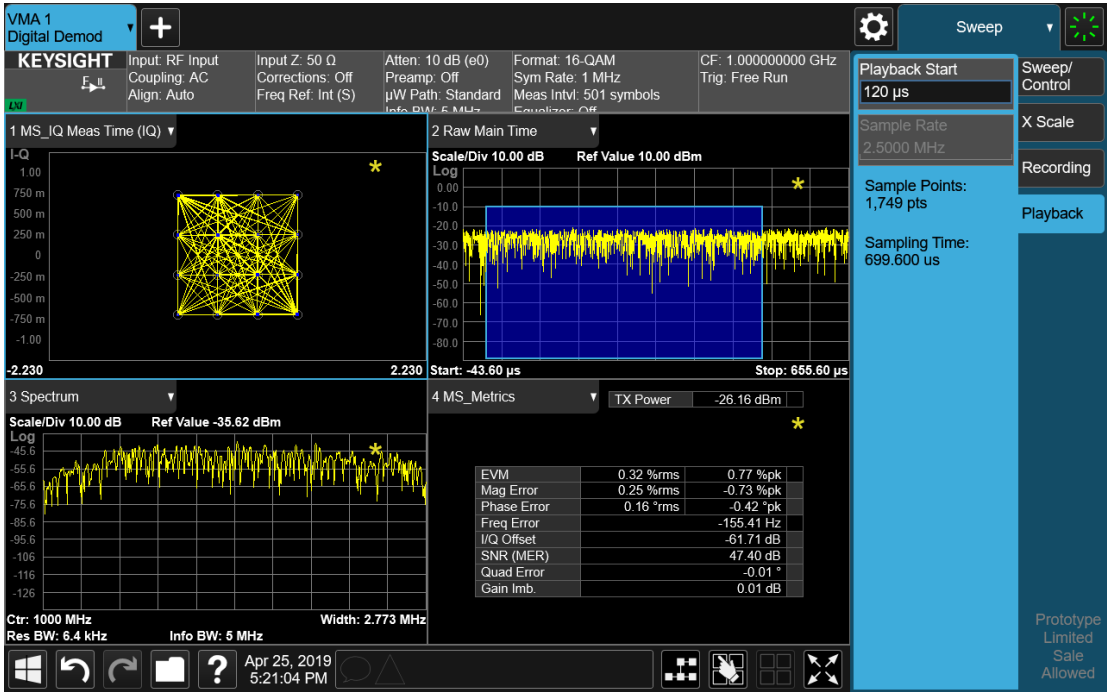

Once you press Restart, the invalid data indicator will disappear, as below:



6.4.1 Data Source

Lets you select the input to the analysis engine. The following options are available:

Input	INPut	A hardware input signal (the default). This causes the measurement to take its input data from the hardware input (for example RF, I/Q, or EXTMixer) currently selected on the Input tab under Input/Output
Capture Buffer	STORed	Data stored in a storage buffer from a single earlier acquisition. Selecting "Capture Buffer" allows you to use data that has been previously stored using the "Current Meas -> Capture Buffer" control. You can make a measurement and then, if you want to make a different measurement using the exact same data, store the raw data using the "Current Meas -> Capture Buffer" control and select "Capture Buffer" as the Data Source, then switch to the other measurement. You must have previously done a "Current Meas -> Capture Buffer" before the Capture Buffer choice is available for use
Recorded	RECORded	Data recorded to memory from a set of earlier acquisitions. Selecting "Recorded" lets you use the record buffer, previously filled by using the "Recording" tab in the Sweep menu, as the input (only available in the Pulse measurement)
File	FILE	Data recorded on a storage device from a set of earlier acquisitions. If you load a Recording using Recording under the Recall key, "File" is automatically selected, which lets you use the recorded data as though it were coming from the Input

See "[Data Source](#)" on page 1199 for a table of available choices on a per-measurement basis.

Remote Command	<code>[:SENSe]:FEED:DATA INPut STORed RECORded FILE</code> <code>[:SENSe]:FEED:DATA?</code>
Example	Cause the measurement to look at the input selection: <code>:FEED:DATA INP</code> Cause stored measurement data to be used with a different measurement that supports this: <code>:FEED:DATA STOR</code>
Dependencies	If you switch to a measurement that does not support the currently selected Data Source, the instrument switches Data Source to "Input". Attempting to select an unavailable Data Source via SCPI generates an error The Data Source setting is independent for each mode. Not all Data Sources are available in all modes
Preset	Unaffected by Preset, but set to INPut by Restore Input/Output Defaults or Restore System Defaults->All
State Saved	Saved in instrument state
Backwards Compatibility SCPI	<code>[:SENSe]:FEED:SOURce INPut STORed</code> <code>[:SENSe]:FEED:SOURce?</code>

6.4.2 Current Meas -> Capture Buffer

Stores the raw data of one measurement in the internal memory of the instrument where it can then be used by a different measurement by pressing **Stored Data**. When raw data is stored, then the data source selection switch automatically changes to **Stored Data**. Stored raw data cannot be directly accessed. There is no save/recall function to save the raw data in an external media. If you want to get the stored raw data, you must first perform a measurement using the stored raw data. Now you can access the used raw data, which is the same as stored raw data, using the **:FETCh** or **:READ** commands.

Remote Command	[:SENSe] :FEED:DATA:STORe
Example	:FEED:DATA:STOR stores recorded data
Notes	Command only; no query
Dependencies	Grayed-out in the SA measurement
Backwards Compatibility SCPI	[:SENSe] :FEED:SOURce:STORe

6.5 Corrections

Accesses the **Corrections** menu, which lets you select, turn on and off, and configure and edit Corrections. You can also select, turn on and off and configure Complex Corrections and Corrections Groups.

Corrections arrays provide Amplitude Corrections, and can be entered by the user, sent over SCPI, or loaded from a file. They allow you to correct the response of the instrument for various use cases. X-Series supports eight separate Corrections arrays, each of which can contain up to 2000 points. They can be turned on and off individually and any or all can be on at the same time. Corrections Groups let you load several (Amplitude) Corrections at a time into a Correction Group.

Complex Correction arrays provide both Amplitude and Phase Corrections, and can be loaded from a file. Currently the file type supported has the extension .s2p. Complex Corrections operate in much the same manner as Corrections - the X-series supports eight separate Complex Corrections arrays, each of which can contain up to 30000 points, and each Complex Correction can be turned on and off individually and any or all can be on at the same time. Some Modes, such as Spectrum Analyzer Mode, only support only the Amplitude (Magnitude) element of Complex Corrections. Other Modes, such as IQ Analyzer Mode and VMA, support both the Amplitude and Phase elements of Complex Corrections. If a Complex Correction is turned on in a Measurement that does not support Phase, only the Magnitude information will be used for the Correction.

Trace data is in absolute units and corrections data is in relative units. You can edit the Corrections arrays in the Corrections editor using the "Edit Correction" dialog (you cannot edit the Complex Corrections arrays; they can only be loaded from a file).

In zero span measurements (such as Zero Span in the Swept SA measurement), where the frequency is always the center frequency of the instrument, we apply the (interpolated) correction for the center frequency to all points in the trace. In the event where there are two correction amplitudes at the center frequency, we apply the first one in the table.

Note that the corrections are applied as the data is taken; therefore, a trace in **View** (Update Off) will not be affected by changes made to the corrections after the trace is put in **View**.

The **Corrections** tab only appears in Modes and Measurements that support Corrections and/or Complex Corrections. In other Modes, sending SCPI for Corrections and/or Complex Corrections will generate a Settings Conflict message

Corrections and Complex Corrections arrays are not affected by a Preset, because they are in the Input/Output system. They also survive shutdown and restarting of the instrument application, which means they will survive a power cycle. Corrections

and Complex Corrections arrays are reset (deleted) by Restore Input/Output Defaults. The following commands delete the correction registers:

- User Preset the current mode :**SYST:PRES:USER**
- User Preset all modes :**SYST:PRES:USER ALL**
- Full mode preset :**SYST:PRES:FULL**
- Restore power on default :**SYST:DEF PON**
- Restore all defaults :**SYST:DEF; :SYST:DEF ALL**
- Preset Input/Output variables :**SYST:DEF INP**
- Delete all corrections :**CORR:CSET:ALL:DEL**

The instrument Save State and Save Screen Config + State includes the data in the correction registers. If a measurement setup is saved and then recalled at a later time, the correction data will be recalled as well. This feature is useful for recreating the full instrument condition, but the user has to be careful that the recalled correction data is the desired data. For example, if the state is recalled on a different instrument different correction data might be needed. Or if the system is recalibrated, the correction data in the save state would then be stale. Applications that use measured data for corrections will generally need to reload the correction data from file whenever a state is recalled; this ensures that the correction data is current and applies to hardware in use.

In the EXM and EXF, on the RF Input/Output panel, there are two full-duplex RF ports (RFIO1 and RFIO2), RF Input and RF Output. When RF Input is selected, it will correspond to one input port from two half-duplex RF ports (RFIO3 and RFIO4), and when RF Output is selected, it will correspond to one output port from two half-duplex RF ports (RFIO3 and RFIO4). So, there are 8 sets of corrections in all that can be applied to the RF ports. Ports cannot share the same set of corrections, but a single port can have multiple corrections applied to it. The correction data is applied to incoming signals as well as transmitted signals and is in the form of a list of spot frequencies and amplitude correction levels.

Annotation	In EMI Mode, you can choose to display the correction details in the graph area by turning on Display, Annotation, Correction Annotation
------------	--

6.5.1 Select Correction

Specifies the selected correction. The term "selected correction" is used throughout this document to specify which correction will be affected by the functions.

Notes	The selected correction is remembered even when not in the correction menu
Preset	Set to Correction 1 by Restore Input/Output Defaults

6.5.2 Correction On/Off

Turning the Selected Correction from **OFF** to **ON** allows the values in it to be applied to the data. This state transition also automatically turns on "Apply Corrections" (sets it to **ON**), otherwise the correction would not take effect.

A new sweep is initiated if an amplitude correction is switched on or off. Note that changing, sending or loading corrections data does *not* directly initiate a sweep, however in general these operations will turn corrections on, which *does* initiate a sweep.

Remote Command	<code>[:SENSe]:CORRection:CSET[1] 2 ... 16[:STATe] ON OFF 1 0</code> <code>[:SENSe]:CORRection:CSET[1] 2 ... 16[:STATe]?</code>
Example	<code>:SENS:CORR:CSET1 ON</code>
Dependencies	Changing this from OFF to ON automatically turns on "Apply Corrections" Note that if any Correction is turned on that has a transducer unit set (other than "None"), the Y-Axis Unit of the instrument is forced to that Transducer Unit. All other Y-Axis Unit choices are grayed-out This command generates an "Option not available" error unless you have the proper option installed in your instrument
Preset	Not affected by Preset. Set to OFF by Restore Input/Output Defaults
State Saved	Saved in instrument state
Annotation	If <i>any</i> Correction is turned on, Corr in the Meas Bar displays in amber to indicate Corrections are in use
Backwards Compatibility Notes	Unlike legacy instruments, Preset does not turn Corrections off (Restore Input/Output Defaults does)

6.5.3 Correction Port

Maps one of the sets of corrections to a particular I/O port. This control allows any Input port (including External Mixing, BBIQ, the RF2 input, etc.) to be mapped to a specific Correction, so that the Correction is only applied when that Port is being used by the current Screen. You can also map any internal source Output port to a specific Correction.

When Current Input (CINPut) is selected for **Correction Port**, it chooses the current input port of the current Screen for the selected Correction. In other words, the Correction applies to whichever input is selected. If the input changes, the correction applies to the new input.

When using the VXT M9410A/11A with Remote Radio Heads (such as the Keysight M1740A mmWave Transceiver for 5G), the choices in the dropdown menu appear as :

Head h RFHD p

For example, if you have two Radio Heads (numbered 1 and 2), each of which have two RF half duplex ports, the choices for these ports appear as below:

Head and Port	Choice in dropdown	SCPI parameter
Head 1, port RF Tx/Rx 1	Head 1 RFHD 1	RRH1RFHD1
Head 1, port RF Tx/Rx 2	Head 1 RFHD 2	RRH1RFHD2
Head 2, port RF Tx/Rx 1	Head 2 RFHD 1	RRH2RFHD1
Head 2, port RF Tx/Rx 2	Head 2 RFHD 2	RRH2RFHD2

Remote Command `[:SENSe]:CORRection:CSET[1]|2|...|16:RF:PORT CINPut | RFIN | RFIN2 | AIQ | EMIXer | RFIO1 | RFIO2 | RFIO3 | RFIO4 | RFOut | RFHD | RFFD | ANT | GEN | TR | A1 | A2 | A3 | B1 | B2 | B3 | IFIO1 | IFIO2 | RRHnRFHDp | ERFIN`

See "Parameter Options" on page 1214

`[:SENSe]:CORRection:CSET[1]|2|...|16:RF:PORT?`

Example Set Correction Port for Correction 1 to apply to the currently selected input:
`:CORR:CSET:RF:PORT CINP`

Set Correction Port for Correction 4 to apply to Radio Head 1, RF Tx/Rx Port 2:
`:CORR:CSET4:RF:PORT RRH1RFHD2`

Notes The **RF** node in this command is retained for backwards compatibility, even though the scope of the Correction Port command goes beyond the RF ports and includes BBIQ and External Mixing

Dependencies **RFIN2** | **AIQ** | **EMIXer** are only available on C/E/M/P/UXA analyzers with the appropriate options loaded

RFOut is only available on modular products such as VXT

ANT, **GEN** and **TR** are only available in VXT and only when the M9470A module is installed, such as in the M8920A. Option "HDX" is required to enable the TR port

RFHD and **RFFD** are only available on VXT. Option HDX is required to enable RFHD port and option FDX is required to enable RFFD port

RFIO3 and **RFIO4** are only available on EXM with hardware M9431A

RFIN and **RFOut** are not available on EXM with hardware M9431A

ERFIN requires option "EXW"

Preset Unaffected by Preset. Set as below by **Restore Input/Output Defaults**:
For VXT: **RFIN**
For EXM, EXF: **RFIO1**
For all other models: **CINPut** (the currently selected input)

State Saved Saved in State

Parameter Options

Note that the presence of these ports is highly hardware dependent.

6 Input/Output
6.5 Corrections

Correction Port	SCPI	Note
Current Input	CINPut	The correction will be applied to whichever input is currently selected in the Input menu
RF Input	RFIN	Main RF Port Not available on EXM with hardware M9431A
RF Input 2	RFIN2	Second RF Port, labeled RF Input 2 Only available on certain instruments. Not available on modular instruments
BBIQ input	AIQ	Requires option BBA Not available on modular instruments
External Mixer	EMIXer	Requires option EXM Not available on modular instruments
Antenna	ANT	Antenna input port on M9470A, labeled Ant
Generator	GEN	Generator output port on M9470A, labeled Gen
T/R	TR	T/R port on M9470A, labeled T/R
RF Full Duplex	RFFD	On modular instruments, labeled RFFD . Option “FDX” is required to enable RFFD port
RF Half Duplex	RFHD	On modular instruments, labeled RFHD . Option “HDX” is required to enable RFHD port
A1	A1	On E7760B
A2	A2	On E7760B
A3	A3	On E7760B
B1	B1	On E7760B
B2	B2	On E7760B
B3	B3	On E7760B
IFIO1	IFIO1	On E7760B
IFIO2	IFIO2	On E7760B
RF Output	RFOut	Appears on some modular instruments Not available on EXM with hardware M9431A
RFIO1	RFIO1	Appears on some modular instruments
RFIO2	RFIO2	Appears on some modular instruments
RFIO3	RFIO3	Only available in EXM with hardware M9431A
RFIO4	RFIO4	Only available in EXM with hardware M9431A
GPS out	GPS	Appears on some modular instruments
GNSS out	GNSS	Appears on some modular instruments

6.5.4 Correction Direction

Selects whether corrections will be applied when the device associated with the specified correction is being used as an input, an output or in both directions. The choices are:

INPut	Correct the port only when the port is used as an Input
OUTPut	Correct the port only when the port is used as an Output
BOTH	Correct the port when the port is used as either an Input or an Output (or both)

A port that is only an Output is always corrected as an output if the Correction is On. A port that is only an Input is always corrected as an Input if the Correction is On. For a port that can be either an Input or an Output (or both), the Correction is determined by the Correction Direction setting. The default is **BOTH**, which means that by default a port that can be either an Input or an Output (or both) is corrected in both directions if the Correction is On.

Remote Command	<code>[:SENSe]:CORRection:CSET[1] 2 ... 16:DIRection INPut OUTPut BOTH</code> <code>[:SENSe]:CORRection:CSET[1] 2 ... 16:DIRection?</code>
Example	<code>:CORR:CSET2:DIR INP</code>
Dependencies	The Correction Direction control only appears when Correction Port selects a port that can either function as an input or an output (or both simultaneously), such as RFIO HD, RFFD or T/R. If the SCPI command is sent to any other port, it is accepted but ignored
Preset	Not affected by a Preset. Set to BOTH by Restore Input/Output Defaults
State Saved	Saved in State
Backwards Compatibility SCPI	The following SCPI results in the selection of BOTH (included for compatibility with early Multitouch implementations): <code>[:SENSe]:CORRection:CSET[1] 2 ... 8:DIRection BIDirectiona</code> included for compatibility with A-models modular products: <code>[:SENSe]:CORRection:CSET[1] 2 ... 8:RF:PORT:RFFD SOURce ANALyzer BOTH</code> <code>[:SENSe]:CORRection:CSET[1] 2 ... 8:RF:PORT:RFIO1 SOURce ANALyzer BOTH</code> <code>[:SENSe]:CORRection:CSET[1] 2 ... 8:RF:PORT:RFIO2 SOURce ANALyzer BOTH</code> <code>[:SENSe]:CORRection:CSET[1] 2 ... 8:RF:PORT:RFIO3 SOURce ANALyzer BOTH</code> <code>[:SENSe]:CORRection:CSET[1] 2 ... 8:RF:PORT:RFIO4 SOURce ANALyzer BOTH</code>

6.5.5 Edit Correction

Invokes the integrated editing facility for this correction set. When entering the menu, the editor window turns on, the selected correction is turned **On**, **Apply Corrections** is set to **On**, the amplitude scale is set to **Log**, and the Amplitude Correction (“Ampcor”) trace is displayed. The actual, interpolated correction trace is shown in green for the selected correction. Note that since the actual interpolated correction is shown, the correction trace may have some curvature to it. This trace represents only the correction currently being edited, rather than the total, accumulated amplitude correction for all amplitude corrections which are currently on, although the total, accumulated correction for all corrections which are turned on is still applied to the data traces.

Because corrections data is always in dB, but the Y-axis of the instrument is in absolute units, it is necessary to establish a reference line for display of the Corrections data. The reference line is halfway up the display and represents 0 dB of correction. It is labeled "0 dB CORREC". It is drawn in blue. Corrections data is always in dB. Whatever dB value appears in the correction table represents the correction to be applied to that trace at that frequency. So, if a table entry shows 30 dB that means we ADD 30 dB to each trace to correct it before displaying it. By definition all points are connected. If a gap is desired for corrections data, enter 0 dB.

Note that a well-designed Corrections array should start at 0 dB and end at 0 dB. This is because whatever the high-end point is will be extended to the top frequency of the instrument, and whatever the low-end point is will be extended down to 0 Hz. So, for a Corrections array to have no effect outside its range, you should start and end the array at 0 dB.

NOTE

The table editor only operates properly if the instrument is sweeping, because its updates are tied to the sweep system. Thus, you should not try to use the editor in single sweep, and its response will be sluggish during compute-intensive operations like narrow-span FFT sweeps.

When exiting the edit menu (by using the **Return** key or by pressing an instrument front-panel key), the editor window turns off and the Ampcor trace is no longer displayed; however, **Apply Corrections** remains **On**, any correction that was on while in the editor remains on, and the amplitude scale returns to its previous setting.

Corrections arrays are not affected by a Preset, because they are in the Input/Output system. They also survive shutdown and restarting of the instrument application, which means they will survive a power cycle.

When editing a correction, the editor remembers which correction and which element in the correction array you were editing, and returns you to that correction and that element when you return to the editor after leaving it.

6.5.5.1 Select Correction

Specifies the selected correction. The term "selected correction" is used throughout this document to specify which correction will be affected by the functions.

Notes	The selected correction is remembered even when not in the correction menu
Preset	Set to Correction 1 by Restore Input/Output Defaults

6.5.5.2 Frequency

Touching a frequency value makes the touched row the current row and lets you edit the frequency.

Min	0
Max	1 THz

6.5.5.3 Amplitude

Touching an amplitude value makes the touched row the current row and lets you edit the amplitude.

Min	-1000 dB
Max	1000 dB

6.5.5.4 Go to Row

Lets you move through the table to edit the desired point.

Min	1
Max	2000

6.5.5.5 Insert Row Below

Inserts a point below the current point. The new point is a copy of the current point and becomes the current point. The new point is not yet entered into the underlying table, and the data in the row is displayed in light gray. To enter the row into the table, press the **Enter** key, or tap either value and edit it.

6.5.5.6 Delete Row

Deletes the currently-selected point, whether or not that point is being edited, and selects the Navigate functionality. The point following the currently-selected point (or the point preceding if there is none) will be selected.

6.5.5.7 Scale X Axis

Matches the X-Axis to the selected Correction, as well as possible. Sets the Start and Stop Frequency to contain the minimum and maximum Frequency of the selected Correction. The range between Start Frequency and Stop Frequency is 12.5% above the range between the minimum and maximum Frequency, so that span exceeds this range by one graticule division on either side. If in zero-span, or there is no data in the Ampcor table, or the frequency range represented by the table is zero, no action is taken. Standard clipping rules apply if the value in the table is outside the allowable range for the X-Axis.

6 Input/Output
6.5 Corrections

Dependencies If either the first or last point in the array is outside the frequency range of the current input, an error message is generated:
“-221. Settings conflict; Start or Stop Freq out of range for current input settings”

6.5.5.8 Delete Correction

Deletes the correction values for this set. When this key is pressed, a prompt appears on the screen saying “Please press **Enter** or **OK** key to delete correction. Press **ESC** or **Cancel** to close this dialog.” The deletion is only performed if you press **OK** or **Enter**.

Remote Command `[:SENSe]:CORRection:CSET[1]|2|...|16:DELeTe`

Example `:CORR:CSET:DEL`
`:CORR:CSET1:DEL`
`:CORR:CSET4:DEL`

Notes Pressing this key when no corrections are present is accepted without error

6.5.5.9 Correction Graph

The **Correction Graph** embedded in the Edit Correction dialog lets you edit the Amplitude Correction visually. Each node in the Correction is represented by a gray circle. The current node has a blue outline in the table and a blue circle in the graph. Touch any circle and drag it where you want it to go.

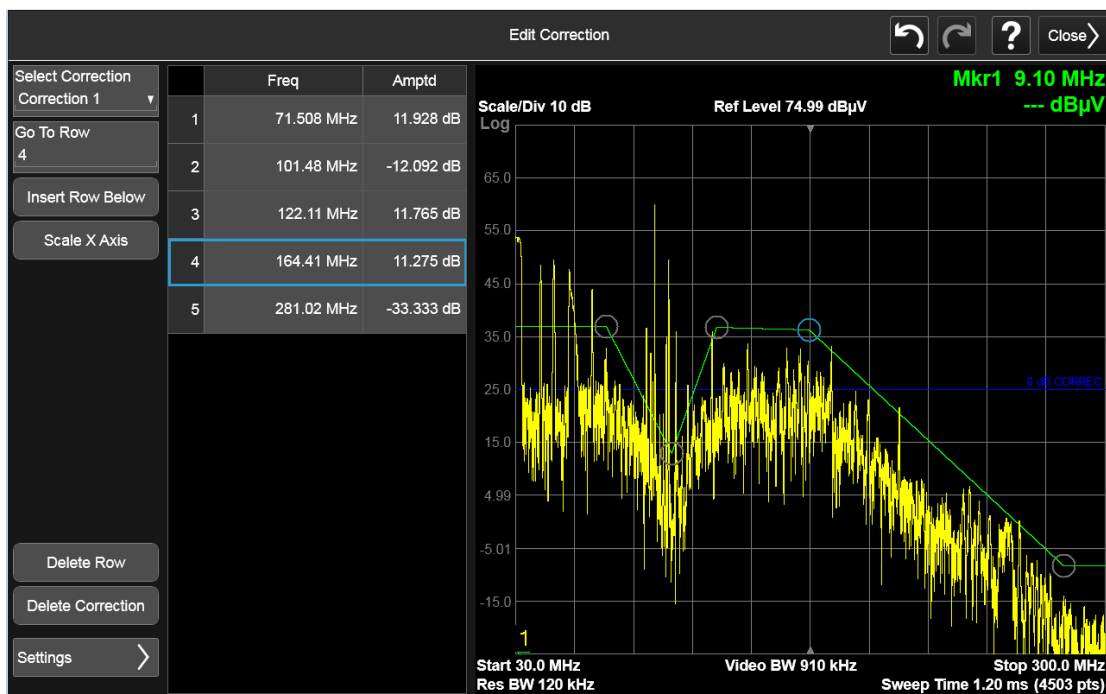

6.5.6 Edit Correction Settings

Opens another menu page that lets you set certain properties of the selected correction, such as Interpolation, Transducer Unit, Description and Comment.

6.5.6.1 Select Correction

Specifies the selected correction. The term "selected correction" is used throughout this document to specify which correction will be affected by the functions.

Notes	The selected correction is remembered even when not in the correction menu
Preset	Set to Correction 1 by Restore Input/Output Defaults

6.5.6.2 Freq Interpolation

Controls how the correction values per-bucket are calculated. We interpolate between frequencies in either the logarithmic or linear scale.

This setting is handled and stored individually per correction set.

VXT models M9410A/11A/15A/16A only support Linear Interpolation. For more details, see ["Interpolation" on page 1220](#)

Remote Command	<code>[:SENSe]:CORRection:CSET[1] 2 ... 16:X:SPACing LINear LOGarithmic</code> <code>[:SENSe]:CORRection:CSET[1] 2 ... 16:X:SPACing?</code>
Example	<code>:CORR:CSET:X:SPAC LIN</code>
Preset	Unaffected by Preset. Set to Linear by Restore Input/Output Defaults
State Saved	Saved in instrument state

Interpolation

For each bucket processed by the application, all of the correction factors at the frequency of interest (center frequency of each bucket) are summed and added to the amplitude. All trace operations and post processing treat this post-summation value as the true signal to use.

To effect this correction, the goal, for any particular start and stop frequency, is to build a correction trace, whose number of points matches the current Sweep Points setting of the instrument, which will be used to apply corrections on a bucket-by-bucket basis to the data traces.

6 Input/Output
6.5 Corrections

For amplitudes that lie between two user specified frequency points, we interpolate to determine the amplitude value. You may select either linear or logarithmic interpolation between the frequencies.

If we interpolate on a log scale, we assume that the line between the two points is a straight line on the log scale. For example, let's say the two points are (2,4) and (20,1). A straight line between them on a log scale looks like:

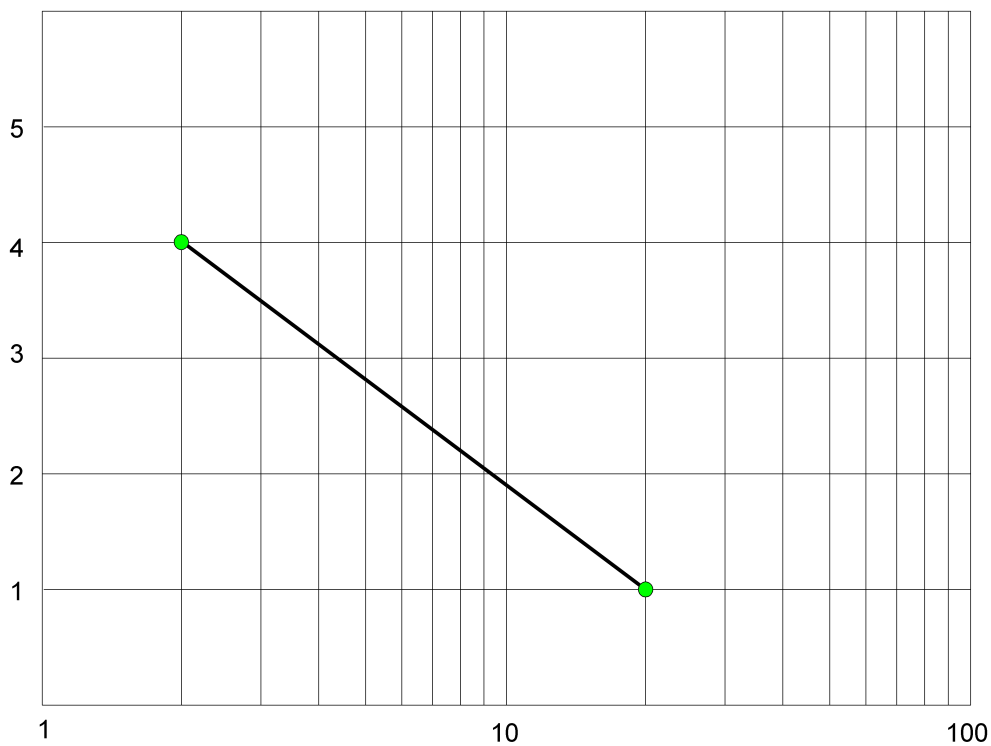

vsd17

On a linear scale (like that of the spectrum analyzer), this translates to:

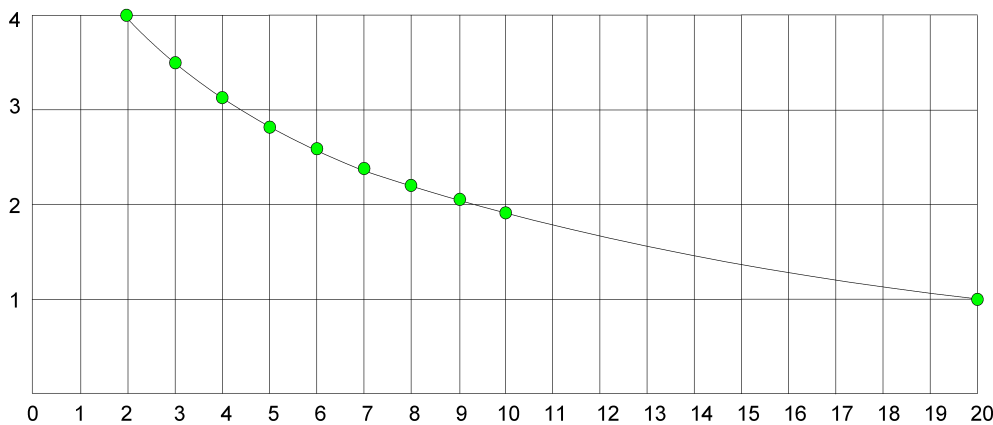

vsd19

If we interpolate on a linear scale, we assume that the two points are connected by a straight line on the linear scale, as below:

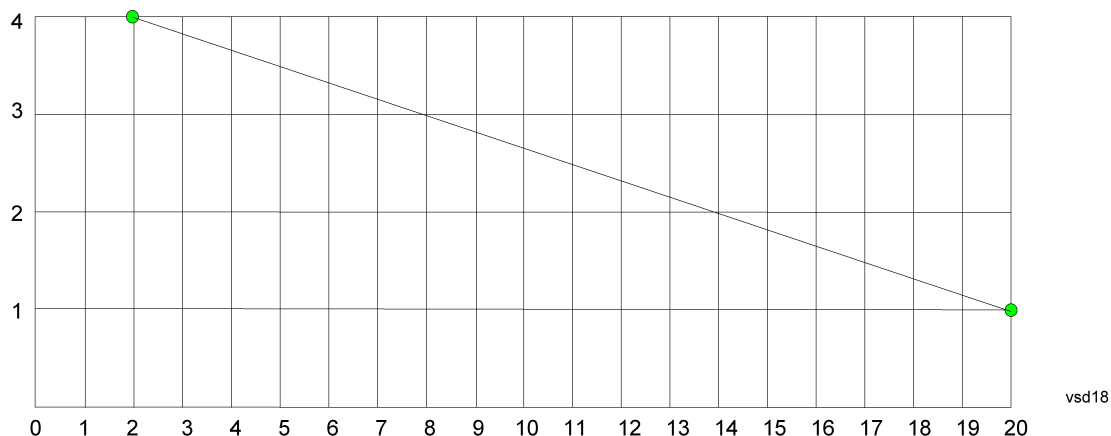

The correction to be used for each bucket is taken from the interpolated correction curve at the center of the bucket.

6.5.6.3 Transducer Unit

For devices (like antennas) that make measurements of field strength or flux density, the correction array should contain within its values the appropriate conversion factors such that, when the data on the instrument is presented in dBμV, the display is calibrated in the appropriate units. The "Transducer Unit" used for the conversion is contained within the corrections array database. It may be specified or loaded in from an external file or SCPI.

When an array with a Transducer Unit other than "None" is turned on, the Y Axis Unit of the instrument is forced to that unit. When this array is turned on, and it contains a Transducer Unit other than "None", the Y Axis Unit of the instrument is forced to that Transducer Unit., and all other Y Axis Unit choices are grayed out.

Transducer Unit only appears in certain Modes, it does not appear in all Modes that support Corrections.

See ["Examples" on page 1223](#)

Remote Command	<code>[:SENSe]:CORRection:CSET[1] 2 ... 16:ANTenna[:UNIT] GAUSS PTES1a UVM UAM UA NOConversion</code> <code>[:SENSe]:CORRection:CSET[1] 2 ... 16:ANTenna[:UNIT]?</code>
Example	<code>:CORR:CSET:ANT GAUS</code>
Dependencies	Only one Transducer units can be on at any given time. Note that this means that if a correction file with a Transducer Unit is loaded into a particular Correction, all other Corrections are set to that same Transducer unit When Normalize is On (in the Trace, Normalize menu) Transducer Unit is grayed-out and forced to None
Preset	Unaffected by Preset. Set to NOC by Restore Input/Output Defaults
State Saved	Saved in instrument state

Examples

The units that may be specified and what appears in the file and on the screen are shown below:

Transducer Unit	SCPI Example	In the Correction file	On the screen (also Y Axis Unit forced to)
dB μ V/m	:CORR:CSET:ANT UVM	Antenna Unit= μ V/m	dB μ V/m
dB μ A/m	:CORR:CSET:ANT UVA	Antenna Unit= μ A/m	dB μ A/m
dB μ A	:CORR:CSET:ANT UA	Antenna Unit= μ A	dB μ A
dBpT	:CORR:CSET:ANT PTES	Antenna Unit=pTesla	dBpT
DBG	:CORR:CSET:ANT GAUS	Antenna Unit=Gauss	DBG
None	:CORR:CSET:ANT NOC	Antenna Unit= (or no line at all)	none (not forced)

6.5.6.4 Description

Sets an ASCII description field which will be stored in an exported file. Can be displayed in the active function area by selecting as the active function, if desired to appear in a screen capture.

Remote Command	<code>[:SENSe]:CORRection:CSET[1] 2 ... 16:DESCription "text"</code> <code>[:SENSe]:CORRection:CSET[1] 2 ... 16:DESCription?</code>
Example	<code>:CORR:CSET1:DESC "11941A Antenna correction"</code>
Notes	45 chars max; may not fit on display if max chars used
Preset	Unaffected by a Preset. Set to empty by Restore Input/Output Defaults
State Saved	Saved in instrument state

6.5.6.5 Comment

Sets an ASCII comment field which will be stored in an exported file. Can be displayed in the active function area by selecting as the active function, if desired to appear in a screen capture.

Remote Command	<code>[:SENSe]:CORRection:CSET[1] 2 ... 16:COMMeNT "text"</code> <code>[:SENSe]:CORRection:CSET[1] 2 ... 16:COMMeNT?</code>
----------------	--

Example	<code>:CORR:CSET1:COMM "this is a comment"</code>
Notes	60 chars max; may not fit on display if max chars used
Preset	Unaffected by Preset. Set to empty by Restore Input/Output Defaults
State Saved	Saved in instrument state

6.5.7 Complex Corrections

This dialog is used to set up and display information about the **Complex Corrections** set. It also lets you view and edit certain information such as the Description and Comment for the selected Complex Correction.

Complex Corrections (loaded from `.s2p` files) support both magnitude and phase corrections, whereas standard corrections (loaded from standard Ampcor `.csv` files) support only magnitude corrections.

When loading an `.s2p` file, the component representing S21 is the one that is used to generate the complex correction. If no S21 component is present, a Mass Storage error is reported.

NOTE

Data types RI, MA, and DB are supported.

The phase components of the S2P file are taken to be in degrees, not in radians. You must provide the phase correction in degrees.

Unlike Correction files, S2P files describe device characteristics, rather than the correction required to compensate for those characteristics; so, when an S2P file is loaded, both the magnitude and phase are negated to turn it into a correction

Complex Corrections and standard corrections can be turned on at the same time. For example, you could turn on Correction 2, Correction 4, and Complex Correction 1 and 2, all at the same time. The magnitude part of all the corrections would add, and the phase part of the complex corrections would add.

You can have up to 64 Complex Corrections loaded simultaneously. Each Complex Correction can hold up to 30,000 points.

You can load a standard correction into Complex Corrections, but it will only provide a magnitude correction, not a phase correction.

NOTE

A standard correction (from a CSV file) can be loaded into a Complex Correction, but when it is loaded the Phase correction is set to 0 for all points.

Some measurements, like Swept SA, have no phase component to the measurement, but nonetheless support Complex Corrections. For such measurements, only the Magnitude part of the Complex Correction is applied.

6.5.7.1 Go To Row (Select Correction)

Specifies the selected complex correction. The selected correction will be identified by the blue outlined row in the dialog.

The "selected complex correction" is an important concept when sending SCPI commands to the Complex Corrections system, because in each case the SCPI command is directed to the currently selected Complex Correction and that will be the Correction which is modified by the SCPI command.

Remote Command	<code>[:SENSe]:CCORrection:CSET:SElect <integer></code> <code>[:SENSe]:CCORrection:CSET:SElect?</code>
Example	<code>:CCOR:CSET:SEL 3</code> <code>:CCOR:CSET:SEL?</code>
Notes	The selected correction is remembered even when not in the correction menu
Preset	Set to Correction 1 by Restore Input/Output Defaults
Min	1
Max	64

6.5.7.2 Delete Row

Deletes the currently-selected Complex Correction and clears all entries in that row to the default.

Remote Command	<code>[:SENSe]:CCORrection:CSET:DElete</code>
Example	Select correction 3: <code>:CCOR:CSET:SEL 3</code> Delete correction 3: <code>:CCOR:CSET:DEL</code>

6.5.7.3 Delete All

Deletes all complex corrections and clears all entries in all rows to the default.

When this key is pressed a prompt is placed on the screen that says "Please press Enter or OK key to delete all complex corrections. Press ESC or Cancel to close this dialog." The deletion is only performed if you press **OK** or **Enter**.

Remote Command	<code>[:SENSe]:CCORrection:CSET:ALL:DElete</code>
Example	<code>:CCOR:CSET:ALL:DEL</code>

6.5.7.4 Correction On

Checking or unchecking this box turns the Selected Complex Correction **ON** or **OFF**. Turning it **ON** causes the values in it to be applied to the data. This state transition also automatically turns on "Apply Corrections" (sets it to **ON**), otherwise the correction would not take effect.

A new sweep/acquisition is initiated if a complex correction is switched on or off. Note that changing, sending or loading corrections data does *not* directly initiate a sweep, however in general these operations will turn corrections on, which *does* initiate a sweep.

Remote Command	<code>[:SENSe]:CCORrection:CSET[:STATe] ON OFF 1 0</code> <code>[:SENSe]:CCORrection:CSET[:STATe]?</code>
Example	Select correction 3: <code>:CCOR:CSET:SEL 3</code> Turn correction 3 on: <code>:CCOR:CSET ON</code>
Dependencies	Changing this from OFF to ON automatically turns on "Apply Corrections" Grayed-out if Complex Corrections is not supported by the current measurement. A warning or SCPI error is generated if you try to turn it on under these circumstances: "Feature not supported for this measurement"
Preset	Not affected by Preset. Set to OFF by Restore Input/Output Defaults
State Saved	Saved in instrument state
Annotation	If <i>any</i> Complex Correction is turned on, CC in the Meas Bar will display in amber to indicate Complex Corrections are in use

6.5.7.5 Correction Port

Maps one of the sets of corrections to a particular I/O port. This control allows any Input port (including External Mixing, BBIQ, the RF2 input, etc.) to be mapped to a specific Correction, so that the Correction is only applied when that Port is being used by the current Screen. You can also map any internal source Output port to a specific Correction.

When Current Input (CINPut) is selected for **Correction Port**, it chooses the current input port of the current Screen for the selected Correction. In other words, the Correction applies to whichever input is selected. If the input changes, the correction applies to the new input.

When using the VXT M9410A/11A with Remote Radio Heads (such as the Keysight M1740A mmWave Transceiver for 5G), the choices in the dropdown menu will appear as

Head h RFHD p

6 Input/Output
6.5 Corrections

For example, if you have two Radio Heads (numbered 1 and 2), each of which have two RF half duplex ports, the choices for these ports will appear as below:

Head and Port	Choice in dropdown	SCPI parameter
Head 1, port RF Tx/Rx 1	Head 1 RFHD 1	RRH1RFHD1
Head 1, port RF Tx/Rx 2	Head 1 RFHD 2	RRH1RFHD2
Head 2, port RF Tx/Rx 1	Head 2 RFHD 1	RRH2RFHD1
Head 2, port RF Tx/Rx 2	Head 2 RFHD 2	RRH2RFHD2

See also the parameters, notes and examples table under "[Correction Port](#)" on page 1213.

Remote Command	<pre>[:SENSe]:CCORrection:CSET:PORT CINPut RFIN RFIN2 AIQ EMIXer RFOut RFIO1 RFIO2 RFIO3 RFIO4 RFHD RFFD ANT GEN TR A1 A2 A3 B1 B2 B3 IFIO1 IFIO2 RRHnRFHD ERFIN [:SENSe]:CCORrection:CSET:PORT?</pre>
Example	<p>Select correction 2: :CCOR:CSET:SEL 2</p> <p>Set correction 2 to RFIN: :CCOR:CSET:PORT RFIN</p> <p>Set Correction 2 to Radio Head 1, RF Tx/Rx Port 2: :CCOR:CSET:PORT RRH1RFHD2</p>
Dependencies	<p>RFIN2 AIQ EMIXer are only available on C/E/M/P/UXA analyzers with the appropriate options loaded</p> <p>RFOut is only available on modular products such as VXT</p> <p>ANT, GEN and TR are only available in VXT and only when the M9470A module is installed, such as in the M8920A. Option "HDX" is required to enable the TR port</p> <p>RFHD and RFFD are only available on VXT. Option HDX is required to enable RFHD port and Option FDX is required to enable RFFD port</p> <p>RFIO3 and RFIO4 are only available on EXM with hardware M9431A</p> <p>RFIN and RFOut are not available on EXM with hardware M9431A</p> <p>ERFIN requires option "EXW"</p>
Preset	Not affected by Preset. Set to CINPut by Restore Input/Output Defaults
State Saved	Saved in State

6.5.7.6 Direction

Selects whether corrections will be applied when the device associated with the specified correction is being used as an input, an output or in both directions. The choices are:

INPut Correct the port only when the port is used as an Input

	OUTPut	Correct the port only when the port is used as an Output
	BOTH	Correct the port when the port is used as either an Input or an Output (or both)
Remote Command	<code>[:SENSe]:CCORrection:CSET:DIRection INPut OUTPut BOTH</code> <code>[:SENSe]:CCORrection:CSET:DIRection?</code>	
Example	Firstly, select correction 4: <code>:CCOR:CSET:SEL 4</code> Set correction 4 to Input: <code>:CCOR:CSET:DIR INP</code>	
Dependencies	For Inputs, the only choice is INPut , so an empty table cell is displayed. For Outputs, the only choice is OUTPut , so an empty table cell is displayed. If the SCPI command is sent while one of these ports is selected, it is accepted but ignored For a port that can be either an Input or an Output (or both), such as RFHD, RFFD or T/R, all three choices are available	
Preset	Not affected by Preset. Set to BOTH by Restore Input/Output Defaults	
State Saved	Saved in State	
Backwards Compatibility SCPI	The following SCPI will result in the selection of BOTH (included for compatibility with early Multitouch implementations): <code>[:SENSe]:CCORrection:CSET:DIRection BIDirectiona</code>	

6.5.7.7 Description

Shows the Description field for the selected Complex Correction. The Description field is loaded from the second line of the `.s2p` file. (Note that, if line 2 begins with “!”, the ! is not displayed in the Description field.)

Remote Command	<code>[:SENSe]:CCORrection:CSET:DESCription "text"</code> <code>[:SENSe]:CCORrection:CSET:DESCription?</code>
Example	Firstly, select correction 4: <code>:CCOR:CSET:SEL 4</code> <code>:CCOR:CSET:DESC "PNA data import 1-1-18"</code>
Notes	45 chars max; may not fit on display if max chars used
Preset	Unaffected by Preset. Set to empty by Restore Input/Output Defaults
State Saved	Saved in instrument state

6.5.7.8 Comment

Shows the Comment field for the selected Complex Correction. The Comment field is loaded from the third line of the `.s2p` file. (Note that, if line 3 begins with “!”, the ! is not displayed in the Comment field.)

6 Input/Output
6.5 Corrections

Remote Command	<code>[:SENSe]:CCORrection:CSET:COMMeNt "text"</code> <code>[:SENSe]:CCORrection:CSET:COMMeNt?</code>
Example	Firstly, select correction 4: <code>:CCOR:CSET:SEL 4</code> <code>:CCOR:CSET:COMM "this is a comment"</code>
Notes	60 chars max; may not fit on display if max chars used
Preset	Unaffected by Preset. Set to empty by Restore Input/Output Defaults
State Saved	Saved in instrument state

6.5.7.9 File

Shows the file from which the selected correction was loaded. If correction was loaded with a SCPI command (see ["Set Data \(Remote Command Only\)" on page 1230](#)) displays "(SCPI)". If no correction is loaded, displays "(No correction loaded)"

Notes	60 chars max; may not fit on display if max chars used
State Saved	Saved in instrument state

6.5.7.10 Freq Interpolation (Remote Command Only)

Controls how the correction values per-bucket are calculated. We interpolate between frequencies in either the logarithmic or linear scale.

This setting is handled and stored individually per correction set.

VXT models M9410A/11A/15A/16A and M9410E/11E/15E/16E only support Linear Interpolation.

See ["Interpolation" on page 1220](#) under Corrections.

Remote Command	<code>[:SENSe]:CCORrection:CSET:X:SPACing LINear LOGarithmic</code> <code>[:SENSe]:CCORrection:CSET:X:SPACing?</code>
Example	Firstly, select correction 4: <code>:CCOR:CSET:SEL 4</code> Set linear interpolation: <code>:CCOR:CSET:X:SPAC LIN</code>
Preset	Unaffected by Preset. Set to LINear by Restore Input/Output Defaults
State Saved	Saved in instrument state

6.5.7.11 Set Data (Remote Command Only)

Lets you set the magnitude part of a complex correction's data via a SCPI command. This is provided for compatibility with the similar command for standard corrections, to allow you to use Complex Corrections as an extension to standard corrections.

Sending this command sets the phase part of the selected correction to 0 for all points.

The command takes an ASCII series of alternating frequency and amplitude points, each value separated by commas.

The values sent in the command will totally replace all existing correction points in the specified set.

A Complex Correction array can contain 30000 points maximum.

Remote Command	<code>[:SENSe]:CCORrection:CSET:DATA <freq>, <ampl>, ...</code> <code>[:SENSe]:CCORrection:DATA?</code>		
Example	Firstly, select correction 4: <code>:CCOR:CSET:SEL 4</code> This defines two correction points at (10 MHz, -1.0 dB) and (20 MHz, 1.0 dB) for correction set 4: <code>:CCOR:CSET:DATA 10000000,-1.0,20000000,1.0</code>		
Preset	Empty after Restore Input/Output Defaults . Survives a shutdown or restart of instrument application (including a power cycle)		
State Saved	Saved in instrument state		
Min/Max		Min	Max
	Freq	0 Hz	1 THz
	Amptd	-1000 dBm	+1000 dBm

6.5.8 Apply Corrections

When you turn on Apply Corrections, all of the Corrections that are turned On are applied to the measured data. When you turn off Apply Corrections, no Corrections are applied, even if they are turned On.

With this switch you can turn the entire Corrections system on and off without affecting the settings of any individual Corrections. Turning Apply Corrections On and Off has no effect on the On/Off switches under the individual Corrections.

6 Input/Output
6.5 Corrections

Apply Corrections affects both normal Corrections and Complex Corrections. Normal Corrections are turned On and Off using the Correction switch under Select Correction:

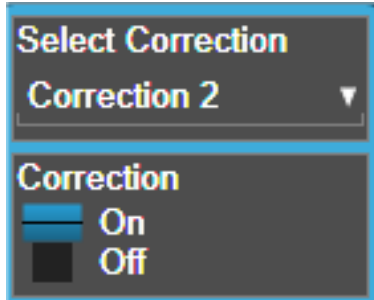

Complex Corrections are turned On and Off using the checkboxes in the Complex Corrections dialog:

Correction	On	Port	Direction	
1	<input checked="" type="checkbox"/>	Current Input	Input	D
2	<input type="checkbox"/>	Current Input	Input	

See "[Correction On/Off](#)" on page 1213) and "[Complex Corrections](#)" on page 1224.

Remote Command	<code>[:SENSe]:CORRection:CSET:ALL[:STATe] ON OFF 1 0</code> <code>[:SENSe]:CORRection:CSET:ALL[:STATe]?</code>
Example	<code>:SENS:CORR:CSET:ALL OFF</code> This command makes sure that no amplitude corrections are applied, regardless of their individual on/off settings
Couplings	Whenever you turn on any Correction or Complex Correction, Apply Corrections is automatically set to ON
Preset	Not affected by Preset. Set to OFF by Restore Input/Output Defaults
State Saved	Saved in instrument state
Annunciation	When ON , 'CORREC' appears in the Meas Bar as long as at least one of the individual corrections is enabled

6.5.9 Delete All Corrections

Erases all correction values for all Amplitude Correction sets and Complex Corrections.

When this key is pressed a prompt is placed on the screen that says “Please press Enter or OK key to delete all corrections. Press ESC or Cancel to close this dialog.” The deletion is only performed if you press **OK** or **Enter**.

Remote Command	<code>[:SENSe]:CORRection:CSET:ALL:DELeTe</code>
----------------	--

Example	<code>:CORR:CSET:ALL:DEL</code>
---------	---------------------------------

6.5.10 Correction Group On/Off

Turns the Correction Group on and off. The Correction Group allow you to preload Correction files and associate them with specific frequency ranges, so that they can be switched in and out during a sweep at the appropriate frequencies. Use the control “Edit Correction Group” below to set up your Correction Group.

The state of each Correction will be set dynamically depending on the active measurement frequency. Only the correction selected for the range that matches the active measurement frequency will be turned on, and vice versa.

Note that the Corrections in the Correction Group, although they are loaded into memory, are independent of the main Correction registers at the top of the Corrections menu, and will not display under the Select Correction, Correction On/Off or Edit Correction functions.

Remote Command	<code>[:SENSe]:CORRection:CSET:GRoup[:STATe] ON OFF 1 0</code> <code>[:SENSe]:CORRection:CSET:GRoup[:STATe]?</code>
----------------	--

Example	<code>:SENS:CORR:CSET:GRO ON</code>
---------	-------------------------------------

Dependencies	Correction group is supported in EMI Receiver Mode, and in Spectrum Analyzer Mode if option EMC or EMI Receiver Mode is present. If you switch to other measurements or modes, correction group is turned off and the Correction Group functions are not visible
--------------	--

Couplings	When on, Correction 1 through 8 is set to OFF and the correction on/off state keys are grayed out. If the grayed-out key is pressed, it generates an advisory message. If sending the SCPI to turn it on, this same message is generated as part of Settings conflict
-----------	--

Preset	Not affected by Preset. Set to OFF by Restore Input/Output Defaults
--------	---

State Saved	Saved in instrument state
-------------	---------------------------

6.5.11 Break

If break is turned on, the scan or sweep will be paused when it reaches the boundary of correction group ranges. At the same time, a window at the size of ~ 6.5cm x 3.5 cm is prompt at the upper right-hand corner of the graticule.

When running Frequency Scan measurement of Emi Receiver application, the message prompt is like below. You are given the option to resume the scan or stop the scan.

6 Input/Output
6.5 Corrections

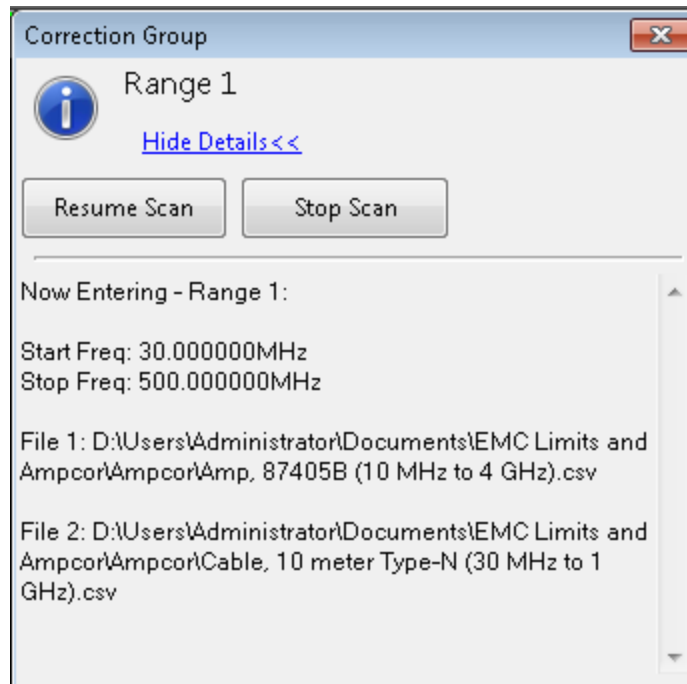
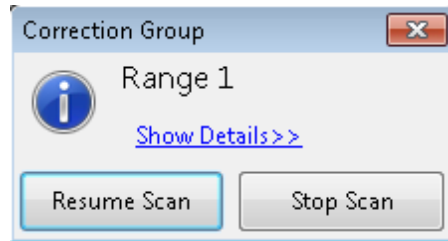

When running the Swept SA measurement in Spectrum Analyzer Mode, the message prompt is as below. You are given the option to resume the sweep or turn off the break. If in Continuous sweep, the sweep will resume after the break is turned off.



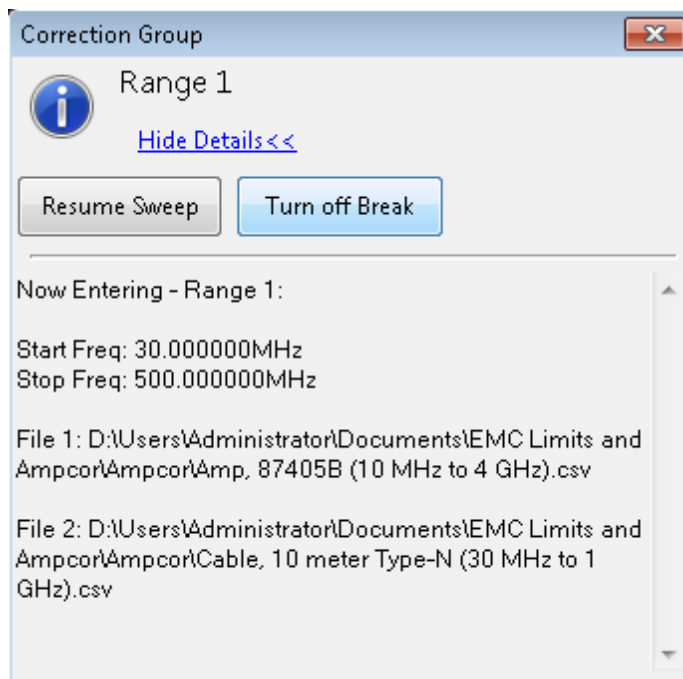

Remote Command	<code>[:SENSe]:CORRection:CSET:GROup:BRake ON OFF 1 0</code> <code>[:SENSe]:CORRection:CSET:GROup:BRake?</code>
Example	<code>:SENS:CORR:CSET:GRO:BR ON</code>
Notes	<p>When running the Frequency Scan measurement in EMI Receiver Mode, if break is turned on when a SCPI is sent to start the scan, the scan pauses when it reaches the boundary of correction group ranges. Bit 8 (Paused) of status operation register is set to true. To resume, send <code>:INITiate2:RESume</code>. To stop the scan, send <code>:ABORT</code></p> <p>When running the Swept SA measurement in Spectrum Analyzer Mode, the break state does not affect the operation of sweep when SCPI to control the sweep is sent. Instead, the SCPI commands close the message prompt if it is showing at the point the commands are sent, and the break is turned off. The SCPI includes:</p> <p><code>:INITiate:IMMEDIATE</code></p> <p><code>:INITiate:REStart</code></p> <p><code>:INITiate:CONTinuous ON OFF 1 0</code></p> <p><code>:ABORT</code></p>
Dependencies	Correction group is supported in EMI Receiver Mode, and in Spectrum Analyzer Mode if option EMC or EMI Receiver mode is present. If you switch to other measurements or modes, correction group is turned off and the Correction Group functions (like Break) are not visible
Preset	Not affected by Preset. Set to OFF by Restore Input/Output Defaults
State Saved	Saved in instrument state

6.5.12 Reload Corrections From Files

Because the Correction data for the Correction Group is loaded into memory from Correction files at the time the Group is defined, it will be necessary to reload some or all of the data if any of the files changes. This function reloads all of the correction data from all of the correction files defined in all of the ranges in the Correction Group.

Remote Command	<code>[:SENSe] :CORRection:CSET:GROup:RELoad</code>
Example	<code>:MMEM:STOR:CORR:GRO:REL</code>
Notes	If invalid data is found in the files, the correction group will be set to off, and an Execution error is generated. Error icon appears on the status column correction group table
Dependencies	Correction group is supported in EMI Receiver Mode, and in Spectrum Analyzer mode if option EMC or EMI Receiver Mode is present. If you switch to other measurements or modes, correction group is turned off and the Correction Group functions (like Reload Correction From File) are not visible
Annotation	If reload fails, error icons appear in the status column of correction group editor for the range that has the error

6.5.13 Edit Correction Group

Opens the Table Editor for the correction group. The content of correction group table including the correction data loaded from the files is not affected by Preset, and it survives power cycle. You can set it to empty with **Restore Input/Output Defaults**.

Dependencies	Correction group is supported in EMI Receiver Mode, and in Spectrum Analyzer Mode if option EMC or EMI Receiver Mode is present. If you switch to other measurements or modes, correction group is turned off and the Correction Group functions (like Edit Correction Group) are not visible
--------------	---

6.5.13.1 Go to Row

Lets you move through the table to edit the desired point.

Min	1
Max	2000

6.5.13.2 Insert Row Below

Inserts a point below the current point. The new point starts from the current range stop frequency and becomes the current point. The new point is not yet entered into the underlying table, and the data in the row is displayed in light gray.

6.5.13.3 Delete Row

Deletes the currently-selected point, whether or not that point is being edited, and selects the Navigate functionality. The point following the currently-selected point (or the point preceding if there is none) will be selected.

6.5.13.4 Select File

Indicate the correction files in which the specify file and remove file operations will take effect.

Preset	Unaffected by a Preset. Set to empty by Restore Input/Output Defaults
--------	--

6.5.13.5 Specify File

Displays the file browsing menu. When a file is selected, correction data will be loaded from the file. The correction data remains until the file is removed or the range is deleted.

Notes	<p>If the file is empty, error -250 is reported. If the file does not exist error -256 is reported. If there is a mismatch of data type, error -250 is reported</p> <p>Only one file with antenna unit can be supported per range. If you try to add another file which contains an antenna unit, a Mass Storage error is generated</p> <p>All ranges have to use a common antenna unit. If you try to add a correction file that contains a different antenna unit, a Mass Storage error is generated</p> <p>If you try to add a correction file that contains data that does not cover the range frequency, the file cannot be added, and an Execution error is generated</p>
-------	---

6.5.13.6 Remove File

Removes the selected file. When a file is removed, correction data for that file will be removed as well.

Dependencies	The key is grayed-out if there the file has not been specified. If the grayed-out key is pressed, an advisory message is generated
--------------	--

6.5.13.7 Correction Trace Display

Enables you to view the correction traces of all corrections that are added to the range currently selected. A 2-column table in the function of frequency and the accumulated amplitude correction is displayed at the left pane.

Preset	OFF
State Saved	Saved in instrument state

6.5.13.8 Description

Provides a description of up to 60 characters by which you can easily identify the correction group. The descriptions will be stored in the exported file and can be displayed in the active function area by selecting them as the active function, if desired to be in a saved screen dump.

Remote Command	<code>[:SENSe]:CORRection:CSET:GROup:DESCription "text"</code>
Example	<code>:CORR:CSET:GRO:DESC "Radiated Setup"</code>
Notes	60 chars max; may not fit on display if max chars used
Preset	Unaffected by Preset. Set to empty by Restore Input/Output Defaults
State Saved	Saved in instrument state

6.5.13.9 Comment

Provides a comment of up to 60 characters by which you can easily identify the correction group. The comments will be stored in the exported file and can be displayed in the active function area by selecting them as the active function, if desired to be in a saved screen dump.

Remote Command	<code>[:SENSe]:CORRection:CSET:GROup:COMMeNt "text"</code>
Example	<code>:CORR:CSET:GRO:COMM "For internal only"</code>
Notes	60 chars max; may not fit on display if max chars used
Preset	Unaffected by Preset. Set to empty by Restore Input/Output Defaults
State Saved	Saved in instrument state

6.5.13.10 Start Frequency

Touching a **Start Frequency** value makes the touched row the current row and lets you edit the start frequency.

Notes	You cannot set the Start Frequency to a value greater than Stop Frequency or equal to Stop Frequency. You cannot set the Start Frequency to a value that would create a span of less than 10 Hz. If you try to do any of these, the Stop Frequency will change to maintain a minimum span of 10 Hz If you change the Start Frequency of the selected range to a value smaller than the previous range's Stop Frequency, the Stop Frequency of the previous range will be changed to the same value
-------	---

	If you change the Start Frequency of the selected range to a value out of the correction data frequency range, an error icon appears on the status column and an Execution error is generated
Preset	Unaffected by Preset. Set to empty by Restore Input/Output Defaults
Min	0
Max	1 THz

6.5.13.11 Stop Frequency

Touching a **Stop Frequency** value makes the touched row the current row and lets you edit the stop frequency.

Notes	You cannot set the Stop Frequency to a value greater than Start Frequency or smaller than Start Frequency. You cannot set the Stop Frequency to a value that would create a span of less than 10 Hz. If you try to do any of these, the Start Frequency will change to maintain a minimum span of 10 Hz If you change the Stop Frequency of the selected range to a value greater the next range's Start Frequency, the Start Frequency of the next range will be changed to the same value If you change the Stop Frequency of the selected range to a value out of the correction data frequency range, an error icon appears on the status column and an Execution error is generated
Preset	Unaffected by Preset. Set to empty by Restore Input/Output Defaults
Min	0
Max	1 THz

6.5.14 Merge Correction Data (Remote Command Only)

Accepts an ASCII series of alternating frequency and amplitude points, each value separated by commas. The difference between this command and **Set Data** is that this merges new correction points into an existing set.

If any new point has the same frequency as an existing correction point, the existing point's amplitude is replaced by that of the new point.

An Ampcor array can contain 2000 total points, maximum.

Remote Command	<code>[[:SENSE]:CORRection:CSET[1] 2 ... 16:DATA:MERGe <freq>, <ampl>, ...</code>
Example	<code>:CORR:CSET1:DATA:MERGE 15000000,-5.0,25000000,5.0</code> This adds two correction points at (15 MHz, -5.0 dB) and (25 MHz, 5.0 dB) to whatever values already exist in correction set 1
Preset	Empty after Restore Input/Output Defaults . Survives shutdown/restart of instrument application (including power cycle)

Min/Max	Min	Max
Freq	0 Hz	1 THz
Amptd	-1000 dBm	+1000 dBm

6.5.15 Set (Replace) Data (Remote Command Only)

Accepts an ASCII series of alternating frequency and amplitude points, each value separated by commas.

The values sent in the command totally replace all existing correction points in the specified set.

An Ampcor array can contain 2000 points maximum.

Remote Command	<code>[:SENSe]:CORRection:CSET[1] 2 ... 16:DATA <freq>, <amp1>, ...</code> <code>[:SENSe]:CORRection:CSET[1] 2 ... 16:DATA?</code>
Example	<code>:CORR:CSET1:DATA 10000000,-1.0,20000000,1.0</code> This defines two correction points at (10 MHz, -1.0 dB) and (20 MHz, 1.0 dB) for correction set 1
Preset	Empty after Restore Input/Output Defaults . Survives a shutdown or restart of instrument application (including a power cycle)
State Saved	Saved in instrument state
Min	Freq: 0 Hz Amptd: -1000 dBm
Max	Freq: 1 THz Amptd: +1000 dBm

6.5.16 Correction Group Range Data (Remote Command Only)

Accepts an ASCII series of alternating start frequency, stop frequency and file names, each value separated by commas.

The values sent in the command replace the content of correction group.

The default path for CSV files is:

`D:\My Documents\amplitudeCorrections\`

Remote Command	<code>[:SENSe]:CORRection:CSET:GR0up[1] 2 ... 10:DATA <startFreq>,<stopFreq>,<filename1>,<filename2>,...,<filename8></code> See Notes below for explanation of the <filenameN> parameters <code>[:SENSe]:CORRection:CSET:GR0up[1] 2 ... 10:DATA?</code>
----------------	---

Example	<code>:CORR:CSET:GRO:DATA 10000000,20000000,"myAmpcor.csv"</code> <code>myAmpcor.csv</code> refers to the Amplitude Correction data from the file <code>myAmpcor.csv</code> in the default path
Notes	<code><filename></code> is the string containing the path of the correction files <code><filename2></code> , <code><filename3></code> , <code><filename4></code> , <code><filename5></code> , <code><filename6></code> , <code><filename7></code> , <code><filename8></code> are optional. You can define only <code><filename1></code> . The file name defined is added to corresponding File keys based on the sequence sent in the command. File keys with no file name set in the SCPI will be emptied Data for ranges 1 to 10 must be set in ascending order. If you try to set the data for a correction group range that is not connecting to the range currently available, a Data out of range error is generated If the file defined in data is empty, error -250 is reported. If the file does not exist, error -256 is reported. If there is a mismatch of data type, error -250 is reported Only one file with antenna unit can be supported per range. If you try to add another file that contains an antenna unit, a Mass Storage error is generated All ranges have to use a common antenna unit. If you try to add a correction file that contains a different antenna unit, a Mass Storage error is generated
Preset	Reset to Not a Number (9.91e+37) for frequencies and "" for File 1 through File 8 after Restore Input/Output Defaults . Survives a shutdown or restart of instrument application (including a power cycle)
State Saved	Saved in instrument state
Min	Start Freq and Stop Freq: 0 Hz
Max	Start Freq and Stop Freq:1 THz

6.5.17 Delete Correction Group Range (Remote Command Only)

Deletes all range values of corrections Group.

Remote Command	<code>[:SENSe] :CORRection:CSET:GROup:DELeTe</code>
Example	<code>:CORR:CSET:GRO:DEL</code>
Notes	Sending this command when no range is defined in table is accepted without error

6.6 Freq Ref Input

Lets you configure the External Frequency Reference input on the rear panel.

6.6.1 Freq Ref Input

Specifies the frequency reference as being the internal reference, an external reference at the rear panel input labeled EXT REF IN, a 1 pulse per second signal at the EXT REF IN input, or automatically sensing the appropriate reference.

See "[More Information](#)" on page 1243

Remote Command	<code>[:SENSe]:ROSCillator:SOURce:TYPE INTernal EXTernal SENSe PULSe</code> <code>[:SENSe]:ROSCillator:SOURce:TYPE?</code>
Example	<code>:ROSC:SOUR:TYPE SENS</code> <code>:ROSC:SOUR:TYPE INT</code> <code>:ROSC:SOUR:TYPE EXT</code> <code>:ROSC:SOUR:TYPE PULS</code>
Dependencies	The PULSe parameter, and support of the 1 pps signal at the EXT REF IN input, are not available in some models. If not available, the choice does not appear, and sending the PULSe parameter via SCPI generates an error For VXT models M9420A/10A/11A/15A and M9410E/11E/15E/16E the only available selection is EXTernal1 , unless M9420A/10A/11A/15A is configured in MIMO mode as Primary module. If configured in MIMO mode as Primary module, the available selection is INTernal EXTernal SENSe For EXM the only available selections are INTernal EXTernal SENSe For E7760B and M8920A/20B the only available selections are INTernal EXTernal Not available in UXM
Preset	Unaffected by Preset, but set to EXTernal in VXT models M9420A/10A/11A/15A, INTernal for E7760B, and SENSe for other models, by Restore Input/Output Defaults or Restore System Defaults->All
State Saved	Saved in instrument state
Annunciation	In the Meas Bar: If you set this to Internal and no external reference is plugged in: Freq Ref: Internal If you set this to Internal and an external reference between 1 and 50 MHz, or a 1 pps signal, IS plugged in: Freq Ref: Internal (in amber, as a warning sign) If you set this to External and an External Reference between 1 and 50 MHz is plugged in: Freq Ref: External

	<p>If you set this to External and no External Reference is sensed: Freq Ref: External (in amber, as a warning sign) When set to Pulse and a 1 pps signal is plugged in: Freq Ref: Pulse If you set this to Pulse and no Pulse Reference is sensed: Freq Ref: Pulse (in amber, as a warning sign) When set to Sense and neither a signal between 1 and 50 MHz nor a 1 pps signal is detected at the EXT REF IN input, "Sense:Int" is displayed: Freq Ref: Sense,Int When set to Sense and a signal within 5 ppm of the External Ref Freq (as set on the Ext Ref Freq control) is detected at the EXT REF IN input: Freq Ref: Sense,Ext When set to Sense and a 1 pps signal is detected at the EXT REF IN input, "Sense:Pulse" is displayed: Freq Ref: Sense,Pls</p>
Status Bits/OPC dependencies	<p>STATUS:QUESTIONABLE:FREQUENCY bit 1 set if unlocked Note: In EXM, the status bit is not set for non-controlling instances. To determine if the frequency reference is unlocked, the controlling instance must be queried</p>
Backwards Compatibility Notes	<p>Freq Ref In was not saved in state in the legacy instruments. It is part of state in the X-Series</p>
Remote Query	
Remote Command	<p>[:SENSe] :ROSCillator :SOURce?</p>
Notes	<p>Returns the current switch setting. This means:</p> <ol style="list-style-type: none"> 1. If it was set to SENSe but there is no external reference nor 1 pps signal, so the instrument is actually using the internal reference, then this query returns INTernal1, not SENSe 2. If it was set to SENSe and there is an external reference present, the query returns EXTernal1, not SENSe 3. If it was set to SENSe and there is a 1 pps signal present, the query returns PULSe, not SENSe 4. If it was set to EXTernal1, then the query returns EXTernal1 5. If it was set to INTernal1, then the query returns INTernal1 6. If it was set to PULSe, then the query returns PULSe <p>Note: In EXM, the SCPI query always returns INTernal1 for non-controlling instances</p>
Preset	<p>For VXT models M9420A/10A/11A/15A: EXTernal1 For E7760B, M8920A/20B: INTernal1 All other models: SENSe</p>
Backwards	<p>[:SENSe] :ROSCillator :SOURce? was query-only in ESA which always returned whichever</p>

6 Input/Output

6.6 Freq Ref Input

Compatibility Notes	<p>reference the instrument was using. The instrument automatically switched to the ext ref if it was present</p> <p>In PSA (which had no sensing), <code>[:SENSe]:ROSCillator:SOURce</code> set the reference (INT or EXT), so again its query returned the actual routing</p> <p>Thus, the query is 100% backwards compatible with both instruments</p> <p>Backwards Compatibility Command</p>
Notes	<p>For PSA compatibility the command form is provided and is directly mapped to <code>[:SENSe]:ROSCillator:SOURce:TYPE</code></p> <p>Note: In EXM, the command does nothing for non-controlling instances</p>
Backwards Compatibility SCPI	<code>[:SENSe]:ROSCillator:SOURce INTernal EXTernal</code>

More Information

When the frequency reference is set to internal, the internal 10 MHz reference is used even if an external reference is connected.

When the frequency reference is set to external, the instrument will use the external reference. However, if there is no external signal present, or it is not within the proper amplitude range, a condition error message is generated. When the external signal becomes valid, the error is cleared.

When the frequency reference is set to Pulse, the instrument expects a 1 pulse per second signal at the EXT REF IN input. The instrument uses this signal to adjust the frequency of the internal reference.

If Sense is selected, the instrument checks whether a signal is present at the external reference connector. If it senses a signal within 5 ppm of the External Ref Freq (as set on the **External Ref Freq** control), it will automatically switch to the external reference. If it senses a 1 pulse per second signal, it enters Pulse mode, wherein the signal is used to adjust the internal reference. When no signal is present, it automatically switches to the internal reference. No message is generated as the reference switches between pulse, external and internal. The monitoring of the external reference occurs approximately on 1 millisecond intervals, and never occurs in the middle of a measurement acquisition, only at the end of the measurement (end of the request).

If for any reason the instrument's frequency reference is not able to obtain lock, Status bit 1 in the Questionable Frequency register will be true and a condition error message is generated. When lock is regained, Status bit 1 in the Questionable Frequency register will be cleared and the condition error will be cleared.

If an external frequency reference is being used, you must enter the frequency of the external reference if it is not exactly 10 MHz. The **External Ref Freq** key is provided for this purpose.

For VXT models M9420A/10A/11A/15A, there is no internal frequency reference. To work correctly, a 100MHz external frequency reference signal is needed to connect to the front panel of the module. The default Freq Ref In setting is “External” and it cannot be set to any other types.

For VXT models M9410A/11A, External Freq Ref Input controls the “100 MHz In” port on the front panel. For VXT models M9415A/16A, External Freq Ref Input controls the “REF In” port on the front panel. For M941xE, the External Freq Ref Input is the reference in port on M941xA module.

NOTE

In EXM, a common frequency reference module serves all instrument instances, but only one instance of the software application can change the reference input type (INT or EXT or SENSE). The software application allowed to change the reference input is called the primary or controlling instance; by default, the leftmost instrument instance is the controlling instance. This can be changed in the config file “[E66XXModules.config](#)” located in the folder [E:\Keysight\Instrument](#). For the non-controlling instance(s) the reference input types (in SCPI commands, and in the Virtual Front Panel menus) are blanked and unavailable for use.

Sense

If **Sense** is selected, the instrument checks whether a signal is present at the external reference connector. If it senses a signal within 5 ppm of the External Ref Freq (as set by **External Ref Freq**), it uses this signal as an External Reference. If it senses a 1 pulse per second signal, it uses this signal to adjust the internal reference by adjusting the User setting of the Timebase DAC. When no signal is present, it automatically switches to the internal reference.

If set to **SENSe** and the instrument senses a 1 pulse per second signal, it sets the **System, Alignments, Timebase DAC** setting to **User**. This setting survives Preset and Power Cycle but is set to **Calibrated** by **System, Restore Defaults, Align** or **System, Restore Defaults, All**

Internal

The internal reference is used. A 1 pps signal at the EXT REF IN port, or a signal there between 1 and 50 MHz, causes a warning triangle to appear in the settings panel next to the word “INTERNAL”, but will otherwise be ignored.

External

The external reference is used.

Pulse

The internal reference continues to be the frequency reference for the instrument in that it determines the reference contribution to the phase noise, but its average frequency is adjusted to follow the 1 pps signal at the EXT REF IN input. Therefore, the instrument frequency accuracy will be dominated by the aging rate of the 1 pps signal instead of the aging rate of the internal reference, except during the time it takes to lock to a new 1 pps signal, approximately 10 minutes.

Sets the System, Alignments, Timebase DAC setting to “User”. This setting survives Preset and Power Cycle, but it set to “Calibrated” on a System, Restore Defaults, Align or a System, Restore Defaults, All

When a 1 pps signal is present at the EXT REF IN input, and either **Pulse** or **Sense** is selected, the internal reference frequency is affected by this signal; in effect, it “learns” a new accuracy setting. This setting can be seen by going to the **System, Alignments, Timebase Dac** menu, and looking at the **User** key in that menu. You will note that User has become automatically selected, and that the value shown on the **User** key is the updated value of the timebase DAC as “learned” from the 1 pps signal. Note that this replaces any value the user might have previously set on this key.

Once the setting is learned the user may remove the 1 pps signal; the User setting for the Timebase DAC is retained until you manually select “Calibrated” or execute a System, Restore Defaults, Align or a System, Restore Defaults, All. If you want to make the User setting permanent there is information in the Service Guide that tells you how to change the Calibrated setting of the Timebase DAC.

Note also that if the 1 pps signal is removed when Sense is selected, the instrument will simply switch to the normal state of the Internal reference and display SENSE:INT in the Settings Panel. However, if the 1 pps signal is removed when Pulse is selected, the instrument will generate an error

The J7203A Atomic Frequency Reference is an accessory for the X-Series Signal Analyzer that provides a highly accurate 1 pps timebase to use in conjunction with the Pulse setting. With the J7203A, the 1 pps signal is guaranteed to meet the input requirements of the EXT REF IN port, and the improved accuracy of the instrument’s internal frequency reference is specified. This is the only 1 pps signal that is guaranteed to function properly with the X-Series.

6.6.2 Ext Ref Freq

This key tells the instrument the frequency of the external reference. When the external reference is in use (either because the reference has been switched to External or because the Reference has been switched to Sense and there is a valid external reference present) this information is used by the instrument to determine the internal settings needed to lock to that particular external reference signal.

For the instrument to stay locked, the value entered must be within 5 ppm of the actual external reference frequency. So, it is important to get it close, or you risk an unlock condition.

Note that this value only affects the instrument's ability to lock. It does not affect any calculations or measurement results. See "Freq Offset" in the Frequency section for information on how to offset frequency values.

Remote Command	<code>[:SENSe]:ROSCillator:EXTernal:FREQuency <freq></code> <code>[:SENSe]:ROSCillator:EXTernal:FREQuency?</code>
Example	Set the external reference frequency to 20 MHz, but does not select the external reference: <code>:ROSC:EXT:FREQ 20 MHz</code> Select the external reference: <code>:ROSC:SOUR:TYPE EXT</code>
Dependencies	Still available with Internal or Pulse selected, to allow setup for when External is in use. However, the setting has no effect if the Internal Reference is in use (Freq Ref In set to Internal, Pulse, or SENSE:INT or SENSE:PULSE) Not available in UXM For VXT models M9420A/10A/11A/15A/16A and M9410E/11E/15E/16E: only 100 MHz is available
Preset	Unaffected by Mode Preset , Input/Output Preset , or Restore Defaults, Input/Output , but set to 100 MHz for VXT models and 10 MHz for other models, by Restore Defaults, Misc , or Restore Defaults, All , or Default External Ref Freq
State Saved	Power On Persistent (survives power cycle)
Min/Max	See " Minimum & Maximum Values " on page 1246

Minimum & Maximum Values

Model	Min	Max
CXA, N897xB, E7760B, M8920A/20B, CXA-m	10 MHz	10 MHz
EXA without option R13	10 MHz	10 MHz
EXA with option R13	10 MHz	20 MHz
MXA, PXA, EXM	10 MHz	50 MHz

6 Input/Output
6.6 Freq Ref Input

Model	Min	Max
VXT models	100 MHz	100 MHz
M9410E/11E/15E/16E	100 MHz	100 MHz
All other models	1 MHz	100 MHz

6.6.3 Default External Ref Freq

Restores the External Ref Freq to its default of 10 MHz.

When you set an External Ref Freq value with the **Ext Ref Freq** control, that Frequency is persistent; is not affected by Mode Preset or Input/Output Preset, and survives shutdown and power cycle. This control allows you to reset the External Ref Freq to its default value.

NOTE

The persistence of the External Ref Freq is a new behavior as of firmware version A.18.00, necessitating the addition of this control. In versions before A.18.00, the frequency reset on a power cycle/restart. Thus, you may need to use this command to retain backwards compatibility.

Remote Command	<code>[:SENSe]:ROSCillator:EXTernal:FREQuency:DEFault</code>
Example	<code>:ROSC:EXT:FREQ:DEF</code> resets the external ref frequency
Notes	Command only; no query
Dependencies	Grayed-out if the Ext Ref Freq is already set to the default Does not appear in EXM, UXM, VXT models or M8920A/20B

6.6.4 LO Ref Input

This parameter sets the LO Reference signal Input to External or Internal.

Remote Command	<code>[:SENSe]:ROSCillator:LO:INPut INTernal EXTernal</code> See " Option Details " on page 1248 <code>[:SENSe]:ROSCillator:LO:INPut?</code>
Example	<code>:ROSC:LO:INP EXT</code> <code>:ROSC:LO:INP?</code>
Dependencies	Only available in VXT models M9410A/11A/15A/16A when MIMO is on
Preset	<code>INTernal</code>
State Saved	Saved in instrument state

Option Details

Parameter	SCPI	Notes
Internal	<code>INTernal</code>	When Internal is selected, internal reference signal will be used to synchronize the LO board
External	<code>EXTernal</code>	When External is selected, external reference signal will be used to synchronize the LO board. Route the correct reference signal to the specified port before changing the LO Ref Input to External For VXT models M9410A/11A, a 4.8 GHz reference signal is required to rout to the 4.8 GHz In port

6.6.5 Ref Lock BW

Lets you adjust the Frequency Reference phase lock bandwidth. This control is available in some models of the X-Series.

It is possible to improve the phase noise of the instrument by several dB, even tens of dB, by using an external reference with excellent phase noise. When an external reference is used the instrument's close-in phase noise improves to match that of the reference.

Normally a narrow loop bandwidth is used to phase lock to the external reference. However, the Ref Lock BW control allows you to choose a wider loop bandwidth to reduce the phase noise at low offset frequencies, especially 4 to 400 Hz offset. The Wide setting represents about a 60 Hz loop bandwidth, the Narrow setting about 15 Hz.

When using an external reference with superior phase noise, Keysight recommends setting the external reference phase-locked-loop bandwidth to Wide to take advantage of that superior performance.

When using an external reference with inferior phase noise performance, Keysight recommends setting the bandwidth to Narrow.

In these relationships, inferior and superior phase noise are with respect to -134 dBc/Hz at 30 Hz offset from a 10 MHz reference. Because most reference sources have phase noise behavior that falls off at a rate of 30 dB/decade, this is usually equivalent to -120 dBc/Hz at 10 Hz offset.

In instruments with EP1 or EP2, this control only affects the external reference loop bandwidth. In instruments with EP0, this control also affects the loop bandwidth used when the Internal reference is selected (reference set manually to Internal or Pulse, or set to Sense and set by sensing to Internal or Pulse).

Remote Command `[:SENSe]:ROSCillator:BAWdth WIDE | NARRow`
 `[:SENSe]:ROSCillator:BAWdth?`

6 Input/Output
6.6 Freq Ref Input

Example	<code>:ROSC:BAND WIDE</code>
Dependencies	In instruments with EP1 or EP2: the control is available (not grayed-out) even with Internal or Pulse selected, to allow setup for when External is in use. However, the setting has no effect if the Internal Reference is in use Only appears in instruments equipped with the required hardware Does not appear in EXM, UXM, VXT models, or E7760B
Preset	Unaffected by Preset, but set to NARRow by Restore Input/Output Defaults or Restore System Defaults -> All
State Saved	Saved in Input/Output state

6.6.6 Reference Oscillator On/Off (Remote Command Only)

Provided for PSA code compatibility.

In PSA it turned the Reference Oscillator on and off, however in the X-Series the reference oscillator cannot be turned off, so no hardware is affected when it is received.

If queried it returns the state you set with the command, but note that this does not necessarily reflect the actual state of the Reference Oscillator, which is always **ON**.

Example	<code>:ROSCillator:OUTP ON</code>
Preset	Unaffected by Preset, but set to ON by Restore Input/Output Defaults or Restore System Defaults -> All
Backwards Compatibility SCPI	<code>[:SENSe]:ROSCillator:OUTPut[:STATe] ON OFF 1 0</code> <code>[:SENSe]:ROSCillator:OUTPut[:STATe]?</code>

6.6.6.1 Select Ref

Lets you select the reference model to control.

The reference status is not saved in a state file, because Reference is a standard alone module.

Remote Command	<code>[:SENSe]:ROSCillator:PXIReference:SElect NONE M9300a</code> <code>[:SENSe]:ROSCillator:PXIReference:SElect?</code>
Example	<code>:ROSC:PXIR:SEL M9300</code> <code>:ROSC:PXIR:SEL?</code>
Dependencies	Only Keysight M9300A Frequency Reference is supported
State Saved	No

6.6.6.2 Freq Ref In

Specifies the frequency reference as being the internal reference, an external reference at the front panel input labeled **Ref In**.

Remote Command	<code>[:SENSe]:ROSCillator:PXIReference:SOURce INTernal EXTernal</code> <code>[:SENSe]:ROSCillator:PXIReference:SOURce?</code>
Example	<code>:ROSC:PXIR:SOUR INT</code> <code>:ROSC:PXIR:SOUR?</code>
Dependencies	Only available when Select Ref is not NONE
Preset	INTernal
State Saved	Saved in instrument state

6.6.6.3 External Freq Ref

Tells the PXIe Ref module the frequency of the external reference. When the external reference is in use this information is used by the Ref module to determine the internal settings needed to lock to that particular external reference signal.

For the instrument to stay locked, the value entered must be within 5 ppm of the actual external reference frequency. So, it is important to get it close, or you risk an unlock condition.

Remote Command	<code>[:SENSe]:ROSCillator:PXIReference:EXTernal:FREQuency <freq></code> <code>[:SENSe]:ROSCillator:PXIReference:EXTernal:FREQuency?</code>
Example	Set the external reference frequency to 20 MHz, but does not select the external reference: <code>:ROSC:PXIR:EXT:FREQ 20 MHz</code> Select the external reference: <code>:ROSC:PXIR:SOUR EXT</code>
Dependencies	Only available when Select Ref is not NONE
Preset	10 MHz
State Saved	Yes
Min	1 MHz
Max	110 MHz

6.6.6.4 Ext Ref Locked (Remote Query Only)

Returns the External Reference locked status

Remote Command	<code>[:SENSe]:ROSCillator:PXIReference:EXTernal:LOCK?</code>
----------------	--

6 Input/Output

6.6 Freq Ref Input

Example	<code>:ROSC:PXIR:EXT:LOCK?</code>
Notes	Returns "1" if the Freq Ref Input is External and Reference is locked. Otherwise returns "0" When the Freq Ref Input is External and Reference is unlocked, the following warning message appears in the status bar: <code>Settings Alert; M9300A Ext Ref Unlocked</code>
Dependencies	Only available when Select Ref is not NONE

6.7 Output

Accesses controls that configure various output settings, like the frequency reference output, IF outputs and analog output.

Not all measurements support all output functions. For example, the Swept SA Measurement does not support the Digital Bus function or the I/Q Cal Out function under the **Output** tab; although the controls are visible, the outputs do not function in this measurement.

In addition, if the appropriate license is not present, some controls may not appear. In Modes/Measurements that do not support particular controls, the controls may appear, but no output will be generated if they are selected.

This tab does not appear in EXM or VXT model M9420A.

6.7.1 Analog Out

Lets you control which signal is fed to the “Analog Out” connector on the instrument rear panel.

In the Auto state, the Analog Output will automatically be set to the most sensible setting for the current mode or measurement.

If you make a selection manually from the **Analog Out** menu, the manually selected choice will remain in force until you change it (or re-select Auto), even if you switch to a mode or measurement for which the selected output does not apply.

Remote Command	:OUTPut:ANALog OFF SVIDeo LOGVideo LINVideo DAUDio!See Option Details :OUTPut:ANALog?
Example	:OUTP:ANAL SVIDeo causes the analog output type to be Screen Video
Preset	Unaffected by Preset, but set to DAUDio by Restore Input/Output Defaults or Restore System Defaults->All
State Saved	Saved in Input/Output State
Backwards Compatibility Notes	Prior to A.04.00, OFF was the default functionality except when in the Analog Demod application or with Tune and Listen, in which case it was DAUDio , and there was no selection menu. For backwards compatibility with earlier X-Series firmware versions, Auto (:OUTP:ANAL:AUTO ON) duplicates the prior behavior The DNWB and SANalyzer parameters, which were legal in PSA but perform no function in the X-Series, are accepted without error Auto Function

6 Input/Output
6.7 Output

Remote Command	<code>:OUTPut:ANALog:AUTO OFF ON 0 1</code> <code>:OUTPut:ANALog:AUTO?</code>
Example	<code>:OUTP:ANAL:AUTO ON</code>
Preset	ON

Option Details

Source	SCPI	Notes
Off	OFF	The Analog Output is off
Screen Video	SVIDeo	Selects the analog output to be the screen video signal. In this mode, the pre-detector data is output to the Analog Out connector. The output looks very much like the trace displayed on the instrument's screen, and depends on the Log/Lin display Scale, Reference Level, and dB per division, but is not influenced by the selected detector or any digital flatness corrections or trace post-processing (like Trace Averaging)
Log Video	LOGVidéo	Selects the analog output to be the log of the video signal. In this mode, the pre-detector data is output to the Analog Out connector with a Log scaling. The output is referenced to the current level at the mixer, does not depend on display settings like Reference Level or dB per division, and it is not influenced by the selected detector or any digital flatness corrections or trace post-processing (like Trace Averaging), but does change with input attenuation
Linear Video	LINVidéo	Selects the analog output to be the envelope signal on a linear (voltage) scale. In this mode, the pre-detector data is output to the Analog Out connector with a Linear scaling. The output is based on the current Reference Level, and is not influenced by the selected detector or any digital flatness corrections or trace post-processing (like Trace Averaging)
Demod Audio	DAUDio	Selects the analog output to be the demodulation of the video signal. When Demod Audio is selected, the demodulated audio signal appears at this output whenever the Analog Demod application is demodulating a signal or when Analog Demod Tune and Listen is operating in the Swept SA measurement When Analog Out is in the Auto state, this output is auto-selected when in the Analog Demod mode or when Analog Demod Tune and Listen is operating in the Swept SA measurement

The table below specifies the range for each output.

Analog Out	Nominal Range exc (10% overrange)	Scale Factor	Notes
Off	0 V		
Screen Video	0 – 1 V open circuit	10%/division	8566 compatible
Log Video	0 – 1 V terminated	1/(192.66 dB/V)	dB referenced to mixer level, 1V out for –10 dBm at the mixer
Linear Video	0 – 1 V terminated	100%/V	Linear referenced to Ref Level, 1 V out for RF envelope at the Ref Level

Analog Out	Nominal Range exc (10% overrange)	Scale Factor	Notes
Demod Audio	(varies with instrument setting)		

Notes about the Analog Outputs

Screen Video

This mode is similar to the Analog Output of the HP 8566 family and the Video Out (opt 124) capability of the Keysight PSA analyzer (E4444x), although there are differences in the behavior.

Screen Video output changes while in FFT Sweeps, so for measurements that use exclusively FFT Sweeps, or if the user manually chooses FFT Sweeps, the Screen Video output will look different than it does in swept mode

Because the Screen Video output uses one of the two IF processing channels, only one detector is available while Screen Video is selected. All active traces will change to use the same detector as the selected trace when Screen Video is activated.

Screen Video output is not available while any EMI Detector is selected (Quasi Peak, RMS Average or EMI Average), because these detectors use both IF processing channels. Consequently, if the user chooses an EMI Detector, there will be no Screen Video output.

The output holds at its last value during an alignment and during a marker count. After a sweep:

- If a new sweep is to follow (as in Continuous sweep mode), the output holds at its last value during the retrace before the next sweep starts. If the instrument is in zero-span, there is no retrace, as the instrument remains tuned to the Center Frequency and does not sweep. Therefore, in zero-span, the output simply remains live between display updates
- If no new sweep is to follow (as in Single sweep mode), the output remains live, and continues to show the pre-detector data

This function depends on optional capability; the selection is not available, and the command will generate an “Option not available” error unless you have Option YAV or YAS licensed in your instrument.

The Screen Video function is intended to be very similar to the 8566 Video Output and the PSA Option 124. However, unlike the PSA, it is not always on; it must be switched on by the Screen Video key. Also, unlike the PSA, there are certain dependencies (detailed above) – for example, the Quasi Peak Detector is unavailable when Screen Video is on.

6 Input/Output

6.7 Output

Furthermore, the PSA Option 124 hardware was unipolar, and its large range was padded to be exactly right for use as a Screen Video output. In the X-Series, the hardware is bipolar and has a wider range to accommodate the other output choices. Therefore, the outputs won't match up exactly and users may have to modify their setup when applying the X-Series in a PSA application.

Log Video

Log Video shows the RF Envelope with the Reference equal to the Mixer Level. The output is designed so that full scale (1 V) corresponds to -10 dBm at the mixer. The full range (0-1 V) covers 192.66 dB ; thus, 0 V corresponds to -202.66 dBm at the mixer.

Because the Log Video output uses one of the two IF processing channels, only one detector is available while Screen Video is selected. All active traces will change to use the same detector as the selected trace when Log Video is activated.

Log Video output is not available while any EMI Detector is selected (Quasi Peak, RMS Average or EMI Average), because these detectors use both IF processing channels. Consequently, if the user chooses an EMI Detector, there will be no Log Video output.

The output holds at its last value during an alignment, during a marker count, and during retrace (after a sweep and before the next sweep starts).

This function depends on optional capability. The choice will not appear, and the command will generate an "Option not available" error unless you have Option YAV licensed in your instrument.

Log Video output changes while in FFT Sweeps, so for measurements that use exclusively FFT Sweeps, or if the user manually chooses FFT Sweeps, the Log Video output will look different than it does in swept mode.

Linear Video

Linear Video shows the RF Envelope with the Reference equal to the Ref Level. The scaling is set so that 1 V output occurs with an instantaneous video level equal to the reference level, and 0 V occurs at the bottom of the graticule. This scaling gives you the ability to control the gain without having another setup control for the key. But it requires you to control the look of the display (the reference level) in order to control the analog output.

This mode is ideal for looking at Amplitude Modulated signals, as the linear envelope effectively demodulates the signal.

Because the Linear Video output uses one of the two IF processing channels, only one detector is available while Linear Video is selected. All active traces will change to use the same detector as the selected trace when Log Video is activated.

Linear Video output is not available while any EMI Detector is selected (Quasi Peak, RMS Average or EMI Average), because these detectors use both IF processing

channels. Consequently, if the user chooses an EMI Detector, there will be no Linear Video output.

The output holds at its last value during an alignment and during a marker count and during retrace (after a sweep and before the next sweep starts).

This function depends on optional capability; the choice will not appear, and the command will generate an “Option not available” error unless you have Option YAV licensed in your instrument. Linear Video output changes while in FFT Sweeps, so for measurements that use exclusively FFT Sweeps, or if the user manually chooses FFT Sweeps, the Linear Video output will look different than it does in swept mode.

Demod Audio

When Analog Out is in the Auto state, this output is auto-selected when in the Analog Demod mode or when **Analog Demod Tune and Listen** is operating in the Swept SA measurement.

If any other Analog Output is manually selected when in the Analog Demod mode or when **Analog Demod Tune and Listen** is operating in the Swept SA measurement, a condition warning message appears. This choice only appears if the Analog Demod application (N9063A), the N6141A or W6141A application, or Option EMC is installed and licensed, otherwise the choice will not appear, and the command will generate an “Option not available” error.

The output holds at its last value during an alignment and during a marker count. It is not held between sweeps, in order for Tune and Listen to work properly.

When Demod Audio is the selected Analog Output, all active traces are forced to use the same detector, and the CISPR detectors (QPD, EMI Avg, RMS Avg) are unavailable

6.7.2 Screen Video Level

Lets you control the amplitude of the Analog Output when Screen Video is selected.

- The 1V (**NORMAL**) setting provides a nominal output of 1 V peak-to-peak into an open circuit. This matches the traditional behavior of X-series instruments
- The 2V (**COMPATIBLE**) setting provides a nominal output of 2 V peak-to-peak into an open circuit. This matches the legacy behavior of PSA and earlier analyzers

Remote Command `:OUTPut:ANALog:SVIDeo NORMAL | COMPATible`
 `:OUTPut:ANALog:SVIDeo?`

Example `:OUTP:ANAL:SVID COMP`
 causes the Screen Video level to be 2 V

Dependencies	Only appears if Screen Video is the selected Analog Output
Preset	Unaffected by Preset, but set to NORM by Restore Input/Output Defaults or Restore System Defaults->All
State Saved	Saved in Input/Output State

6.7.3 Digital Bus Out

Turns on the LVDS Digital Output port for outputting digital acquisition data.

- When **ON**, all acquisitions are streamed to the output port including acquisitions for internal purposes such as Alignment. The internal processing and routing of acquisitions continues as usual and is unaffected by the state of Bus Out
- When **OFF**, no signal appears on the LVDS port

Remote Command	<code>:OUTPut:DBUS[1][:STATE] ON OFF 1 0</code> <code>:OUTPut:DBUS[1][:STATE]?</code>
Example	<code>:OUTP:DBUS ON</code>
Dependencies	Requires option RTL or control is not displayed Digital Bus Out and Wideband Digital Bus cannot both be ON at the same time, so: <ul style="list-style-type: none"> – When Wideband Digital Bus is turned ON, if Digital Bus Out is already ON, an advisory message is displayed, “Wideband Digital Bus On, Digital Bus (narrow band) forced to Off” – When Digital Bus Out is turned ON, if Wideband Digital Bus is already ON, an advisory message is displayed, “Digital Bus (narrow band) On, Wideband Digital Bus forced to Off”
Preset	OFF Set by Restore Input/Output Defaults
State Saved	Saved in Input/Output State

6.7.4 Wideband Digital Bus

Turns on the LVDS port on the Wideband IF, which causes the I/Q pairs from the current measurement to be sent to this port.

NOTE

This control is grayed-out in all Modes except RTSA, which offers the only measurement that supports wideband streaming.

- When **ON**, the internal processing and routing of acquisitions continues as usual, and the display of measurement data is unaffected
- When **OFF**, no signal appears on the LVDS port

Remote Command	<code>:OUTPut:DBUS2[:STATe] OFF ON 0 1</code> <code>:OUTPut:DBUS2[:STATe]?</code>
Example	<code>:OUTP:DBUS2 ON</code>
Notes	If this command is sent while running a measurement that does not support Wideband Digital Bus , the message “Settings conflict; Feature not supported for this measurement” is displayed
Dependencies	Requires option RTS or control is not displayed Digital Bus Out and Wideband Digital Bus cannot both be ON at the same time, so: <ul style="list-style-type: none"> – When Wideband Digital Bus is turned ON, if Digital Bus Out is already ON, an advisory message is displayed, “Wideband Digital Bus On, Digital Bus (narrow band) forced to Off” – When Digital Bus Out is turned ON, if Wideband Digital Bus is already ON, an advisory message is displayed, “Digital Bus (narrow band) On, Wideband Digital Bus forced to Off”
Preset	OFF Set by Restore Input/Output Defaults
State Saved	Saved in Input/Output State

Here is the Wideband LVDS connector as viewed from the rear panel. The pin assignments are listed below:

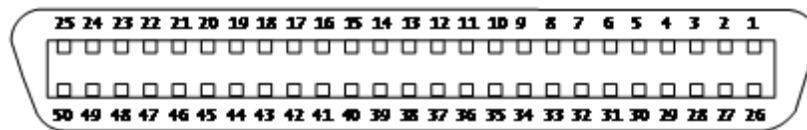

I-Cable

Connection	“-“ pin #	+“ pin #
GND	1	26
N/C	2	27
Stream_I[00]	3	28
Stream_I[01]	4	29
Stream_I[02]	5	30
Stream_I[03]	6	31
GND	7	32
Stream_I[04]	8	33
Stream_I[05]	9	34
Stream_I[06]	10	35
Stream_I[07]	11	36
GND	12	37
Stream_I[08]	13	38
Stream_I[09]	14	39

6 Input/Output
6.7 Output

Connection	“-“ pin #	“+” pin #
Stream_I[10]	15	40
Stream_I[11]	16	41
GND	17	42
Stream_I[12]	18	43
Stream_I[13]	19	44
Stream_I[14]	20	45
Stream_I[15]	21	46
GND	22	47
GND	23	48
Stream_VALID	24	49
Stream_CLK	25	50

Q-Cable

Connection	“-“ pin #	“+” pin #
GND	1	26
Stream_ALT	2	27
Stream_Q[00]	3	28
Stream_Q[01]	4	29
Stream_Q[02]	5	30
Stream_Q[03]	6	31
GND	7	32
Stream_Q[04]	8	33
Stream_Q[05]	9	34
Stream_Q[06]	10	35
Stream_Q[07]	11	36
GND	12	37
Stream_Q[08]	13	38
Stream_Q[09]	14	39
Stream_Q[10]	15	40
Stream_Q[11]	16	41
GND	17	42
Stream_Q[12]	18	43
Stream_Q[13]	19	44
Stream_Q[14]	20	45
Stream_Q[15]	21	46
GND	22	47

Connection	“-“ pin #	“+” pin #
GND	23	48
Stream_MARK_1	24	49
Stream_MARK_2	25	50
Stream_I	16 bit "I" Data	
Stream_Q[15:0]	16 bit "Q" Data	
Stream_VALID	Data valid, when '1' then I/Q data is valid	
Stream_CLK	150 MHz DDR clock	
Stream_MARK_1	Stream Mark Bit 1	
Stream_MARK_2	Stream Mark Bit 2	
Stream_ALT	currently unused	

6.7.5 Data Stream

Lets you choose data or a test pattern to output to the Wideband IF LVDS port. This can help you set up your streaming target devices.

Remote Command	<code>:OUTPut:DBUS2:DATA MEASure TEST</code> <code>:OUTPut:DBUS2:DATA?</code>
Example	<code>:OUTP:DBUS2:DATA TEST</code>
Notes	Selecting TEST routes a test pattern to the Wideband Digital Bus stream output
Preset	MEAS (set by Restore Input/Output Defaults)
State Saved	Saved in Input/Output State

6.7.6 I/Q Cal Out

The Baseband I/Q "Cal Out" port can be turned on with either a 1 kHz or a 250 kHz square wave. This can be turned on independent of the input selection. Preset resets this to **OFF**.

Remote Command	<code>:OUTPut:IQ:OUTPut IQ1 IQ250 OFF</code> <code>:OUTPut:IQ:OUTPut?</code>
Example	<code>:OUTP:IQ:OUTP IQ1</code>
Dependencies	Only available with Option BBA
Couplings	An I/Q Cable Calibration or an I/Q Probe Calibration will change the state of the Cal Out port as needed by the calibration routine. When the calibration is finished the I/Q Cal Out is restored to the pre-calibration state
Preset	OFF

6 Input/Output
6.7 Output

State Saved	Saved in instrument state
Range	1 kHz Square Wave 250 kHz Square Wave Off

6.7.7 Aux IF Out

Controls the signals that appear on the SMA output on the rear panel labeled **AUX IF OUT**

NOTE

Aux IF Out is valid for the RF Input and for the External Mixer input. In external mixing, the Aux IF output level is set by factory default to accommodate expected IF levels for the RF path. When using the External Mixing path, the **Aux IF Out** levels (for all three options CR3, CRP and ALV) will therefore be uncalibrated.

Remote Command	<code>:OUTPut:AUX SIF AIF LOGVideo OFF</code> See " Option Details " on page 1261 and " Notes on the Aux IF Outputs " on page 1262 below <code>:OUTPut:AUX?</code>
Dependencies	Does not appear in models that do not support the Aux IF Out
Preset	Unaffected by Preset, but set to OFF by Restore Input/Output Defaults or Restore System Defaults->All
State Saved	Saved in Input/Output state
Backwards Compatibility Notes	In PSA, the IF output had functionality equivalent to the SIF option in X-Series' Aux IF Out menu. In X-Series, it is necessary to switch Aux IF Out to SIF to get this functionality, whereas in PSA it is always on, since there are no other choices Hence, if you are migrating remote code from PSA, and you use the IF Output in PSA, you will need to add a command to switch this function to SIF

Option Details

The Aux IF Output options are:

Source	SCPI	Notes
Off	OFF	No signal is output from the AUX IF OUT connector on the rear panel The connector appears as an open-circuit (that is, it is not terminated in any way)
Second IF	SIF	The 2 nd IF output is routed to the rear panel connector. Annotation on the menu panel shows the current 2 nd IF frequency in use in the instrument
Arbitrary IF	AIF	The 2 nd IF output is mixed with a local oscillator and mixer to produce an arbitrary IF output between 10 MHz and 75 MHz with 500 kHz resolution. The phase noise in this mode will not be as good as in Second IF mode The IF output frequency is adjustable, through an active function which appears on the menu panel, from 10 MHz to 75 MHz with 500 kHz resolution Note that, in instruments with Options B2X or B5X, the Arbitrary IF Output is only

Source	SCPI	Notes
Fast Log Video	LOGVideo	<p>practical when the IF Bandwidth is ≤ 40 MHz, IF Path is ≤ 40 MHz, or FFT Width is ≤ 40 MHz</p> <p>The 2nd IF output is passed through a log amp and the log envelope of the IF signal is sent to the rear panel. The open circuit output level varies by about 25 mV per dB, with a top-of-screen signal producing about 1.6 Volts. The output impedance is nominally 50 ohms</p> <p>This mode is intended to meet the same requirement as Option E4440A-H7L Fast Rise Time Video Output on E4440A PSA Series, allowing you to characterize pulses with fast rise times using standard measurement suites on modern digital scopes</p>

Notes on the Aux IF Outputs

Second IF

Does not appear unless Option CR3 is installed.

The frequency of the 2nd IF depends on the current IF signal path as shown in the table below:

IF Path Selected	Frequency of "Second IF" Output
10 MHz	322.5 MHz
25 MHz	322.5 MHz
40 MHz	250 MHz
85-160 MHz	300 MHz
255 MHz	750 MHz
510 MHz	877.1484375 MHz

The signal quality, such as signal to noise ratio and phase noise, are excellent in this mode.

Arbitrary IF

Does not appear unless Option CRP is installed.

The bandwidth of this IF output varies with band and center frequency, but is about 40 MHz at the -3 dB width. When the output is centered at lower frequencies in its range, signal frequencies at the bottom of the bandwidth will "fold". For example, with a 40 MHz bandwidth (20 MHz half-bandwidth), and a 15 MHz IF center, a signal -20 MHz relative to the spectrum analyzer center frequency will have a relative response of about -3 dB with a frequency 20 MHz below the 15 MHz IF center. This -5 MHz frequency will fold to become a +5 MHz signal at the IF output. Therefore, lower IF output frequencies are only useful with known band-limited signals.

Fast Log Video

Does not appear unless Option ALV is installed.

The output is off during an alignment but not during a marker count, and is not blanked during retrace (after a sweep and before the next sweep starts).

6.7.8 Arbitrary IF Freq

Sets the frequency of the Arbitrary IF when "Aux IF Out" on page 1261 is set to AIF.

NOTE

In instruments with Options B2X or B5X, the Arbitrary IF Output is only practical when the IF Bandwidth is ≤ 40 MHz, IF Path is ≤ 40 MHz, or FFT Width is ≤ 40 MHz.

Remote Command	<code>:OUTPut:AUX:AIF <value></code> <code>:OUTPut:AUX:AIF?</code>
Example	<code>:OUTP:AUX:AIF 50 MHZ</code>
Dependencies	Only appears if "Aux IF Out" on page 1261 is AIF
Preset	Unaffected by a Preset, but set to 70 MHz by Restore Input/Output Defaults or Restore System Defaults->All
State Saved	Saved in Input/Output State
Min	10 MHz
Max	75 MHz

6.7.9 Ext/Wide IF Out

Causes the signal that is normally routed to the IF to be routed instead to the **Ext IF Out** connector on the rear panel (N9041B) or **Wide IF Out** connector on the front panel (N9042B) or rear panel (N9032B). This is available in N9041B when RF Input 2 is the selected input port and in N9032B/N9042B on RF Input and, when V3050A is attached, External RF Input.

Only one IF output (**Ext/Wide IF Out**, IF2 Out, or Aux IF Out) can be selected at a time, so switching Ext/Wide IF Out to **ON** changes IF2 Out and Aux IF Out to **OFF**, and setting Aux IF Out to something other than **OFF** or IF2 Out to **ON** forces Ext/Wide IF Out to **OFF**.

Remote Command	<code>:OUTPut:EIF ON OFF 1 0</code> <code>:OUTPut:EIF?</code>
Example	<code>:OUTP:EIF ON</code>
Dependencies	Only appears in N9041B, N9032B, and N9042B For N9041B, enabled when RF Input 2 is the selected input. When RF Input 2 is not selected, the control is grayed out and forced to Off and attempting to set it On will result in an error message

	For N9032B/N9042B, enabled on RF Input and on External RF Input when V3050A is attached When this switch is ON , no measurement is displayed, and the error “No result; meas invalid with Ext/Wide IF Out set to On” appears in the Status bar
Preset	OFF Not affected by Mode Preset , but set to OFF by Input/Output Preset
State Saved	Saved in Input/Output state
Annotation	None (but error message appears when on)
Status Bits/OPC dependencies	STATUS:QUESTIONABLE:INTEGRITY bit 1 is set when Ext/Wide IF Out is ON . This indicates an error, because no valid data is on the screen or available via SCPI. However, the signal at the Ext/Wide IF Out port is still valid given the other settings

6.7.10 IF2 Out

Causes the signal that is normally routed to the IF, when the 1 GHz IF Path is selected, to be routed instead to the **IF2 Out** connector on the rear panel.

Only one IF output (Ext IF Out, **IF2 Out**, or Aux IF Out) can be selected at a time, so switching IF2 Out to On changes Ext IF Out and Aux IF Out to Off, and setting Aux IF Out to something other than Off or Ext IF Out to On forces IF2 Out to Off.

This control only appears if Option H1G is installed. It is only available when the 1 GHz IF Path is chosen, either directly or indirectly. In all other paths it is visible but grayed out and forced to Off. Attempting to set it On when the 1GHz path is not selected generates an error.

- Direct selection of the 1 GHz path: Measurements that directly support the 1 GHz path have a 1 GHz selection in the IF Path menu in Meas Setup
- Indirect selection of the 1 GHz path: certain measurements, like CCDF, always choose the widest available path, and so will choose the 1 GHz path if it is available, even if there is no IF Path menu in the measurement. IF2 Out will be visible when this results in the 1 GHz path being selected, even if there is no control or readout indicating that the 1 GHz path is chosen

Remote Command	:OUTPut:IF2 ON OFF 1 0 :OUTPut:IF2?
Example	:OUTP:IF2 ON
Dependencies	Only appears in UXA and only when Option H1G is installed When this is ON , no measurement is displayed, and the error “No result; meas invalid with IF2 Out set to On” appears in the Status bar
Preset	OFF Not affected by Mode Preset but set to OFF by Input/Output Preset
State Saved	Saved in Input/Output state

6 Input/Output
6.7 Output

Annotation	None (but error message appears when on)
Status Bits/OPC dependencies	STATUS:QUESTIONABLE:INTEGRITY bit 1 is set when IF2 Out is ON . This indicates an error, because no valid data is on the screen or available via SCPI. However, the signal at the IF2 Out port is still valid given the other settings

6.7.11 REF Out

Lets you toggle the state of REF Out. The REF Out port is designed for MIMO, which provides the reference daisy chain for the Primary and Secondary modules.

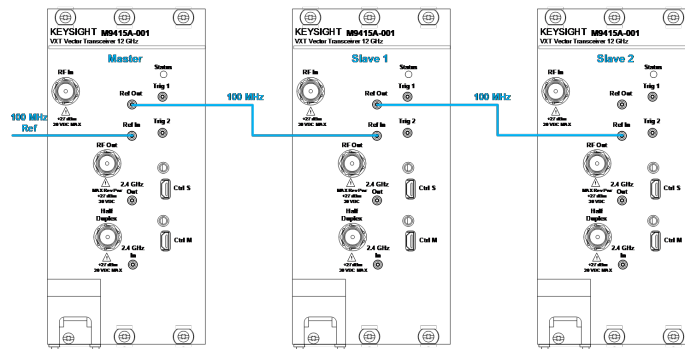

Remote Command	<code>:OUTPut:EREFerence:OUTPut ON OFF 1 0</code> <code>:OUTPut:EREFerence:OUTPut?</code>
Example	<code>:OUTP:EREF:OUTP ON</code> <code>:OUTP:EREF:OUTP?</code>
Notes	Used to route the 100 MHz reference signal on the REF In port to the REF Out port
Dependencies	Only available in VXT models M9415A/16A and M9415E/16E when Freq Ref Input is External, and Ext Ref Freq is 100 MHz
Preset	OFF
Range	ON OFF

6.7.12 LO Ref Out

Turns the LO Reference Signal Out on or off. **LO Ref Out** is used to provide reference daisy chain in MIMO or Phase Coherency.

For VXT models M9410A/11A, controls the **4.8 GHz Out** port on the front panel. Setting it **ON** outputs a 4.8 GHz reference signal.

Remote Command	<code>:OUTPut:ROSCillator:LO:OUTPut ON OFF 1 0</code> <code>:OUTPut:ROSCillator:LO:OUTPut?</code>
Example	<code>:OUTP:ROSC:LO:OUTP ON</code> <code>:OUTP:ROSC:LO:OUTP?</code>
Dependencies	Only available in VXT models M9410A/11A/15A/16A and M9410E/11E/15E/16E
Preset	<code>OFF</code>

6.8 Trigger Output

Accesses controls that configure the **Trigger Output** settings.

6.8.1 Trig 1 – 4 Out

Selects the type of output signal that will be output from the available **Trig n Out** connectors, where **n** = 1, 2, 3, or 4.

Some instruments do *not* support **Trig 2 Out** through **Trig 4 Out** outputs, nor their associated controls.

For most instruments, **Trig 1 Out** applies to the connector labeled **Trigger 1**, but for VXT model M9420A, it is labeled **Trigger 4**.

The front panel includes separate controls for each available trigger: **Trig 1 Out – Trig 4 Out**. The remote command can be used for *any* of the **Trig n Out** connectors, by specifying the appropriate parameter (for example **TRIG1**, **TRIG2**, etc.).

NOTE

Option **TARMed** is *not* available in modular instruments.

Remote Command	<pre>:TRIGger[1] 2 ... 4[:SEquence]:OUTPut HSWP MEASuring MAIN GATE GTRigger OEVen TARMed SP0int S1Marker S2Marker S3Marker S4Marker PARB FSYnc OFF</pre> <p>See "Trigger Out Options" on page 1268</p> <pre>:TRIGger[1] 2 ... 4[:SEquence]:OUTPut?</pre>
Example	<pre>:TRIG:OUTP HSWP :TRIG2:OUTP GATE</pre>
Notes	<p>Trig 2 Out is used as the source trigger out in EXM and VXT model M9420A</p> <p>The available choices in EXM and VXT model M9420A are S1Marker, S2Marker, S3Marker, S4Marker and OFF</p> <p>For Power Amplifier Mode, Trig 2 Out is set to Source Marker2 when Burst Shape & Mask is ON. In this case, Trigger 2 is used to output PA Enable Mask</p>
Dependencies	<p>Trig 2 Out through Trig 4 Out are not supported in all models. In models that do not support them, the Trig n Out control is blanked, and sending the SCPI command for this output generates an error, "Hardware missing; Not available for this model number"</p> <p>Querying Trig 2 Out through Trig 4 Out in models that do not support them returns OFF</p> <p>For VXT models M9410A/11A/15A/16A and M9410E/11E/15E/16E:</p> <ul style="list-style-type: none"> - When Trig n Out Device is ANALyzer, only MEASuring, MAIN and OFF are available - When Trig n Out Device is SOURce, only S1Marker, S2Marker, S3Marker, S4Marker, PARB, FSYnc and OFF are available

	For VXT model M9421A, Trig 2 Out is used as the Analyzer trigger output								
Preset	Unaffected by Preset, but preset to the following values by Restore Input/Output Defaults or Restore System Defaults->All :								
	<table border="1"> <tr> <td>Trigger 1</td> <td>Sweeping (HSWP)</td> </tr> <tr> <td>Trigger 2</td> <td>Gate</td> </tr> <tr> <td>Trigger 3</td> <td>Sweeping (HSWP)</td> </tr> <tr> <td>Trigger 4</td> <td>Gate</td> </tr> </table>	Trigger 1	Sweeping (HSWP)	Trigger 2	Gate	Trigger 3	Sweeping (HSWP)	Trigger 4	Gate
Trigger 1	Sweeping (HSWP)								
Trigger 2	Gate								
Trigger 3	Sweeping (HSWP)								
Trigger 4	Gate								
State Saved	Saved in instrument state								

Trigger Out Options

Source	SCPI	Notes
Off	OFF	Selects no signal to be output to the Trig n Out connector
Sweeping	HSWP	Selects the Sweeping Trigger signal to be output to the Trig n Out connector when a measurement is made This signal has historically been known as HSWP (High = Sweeping), and is 5 V TTL level with 50 Ω output impedance
Measuring	MEASuring	Selects the Measuring trigger signal to be output to the Trig n Out connector. This signal is true while the Measuring status bit is true
Main Trigger	MAIN	Selects the current instrument trigger signal to be output to the Trig n Out connector Note: For multi segment sweeps, only the first sweep segment uses the selected trigger signal. All other sweep segments trigger using Free-Run and the trigger output will reflect that
Gate Trigger	GTRigger	Selects the gate trigger signal to be output to the Trig n Out connector. This is the source of the gate timing, not the actual gate signal
Gate	GATE	Selects the gate signal to be output to the Trig n Out connector. The gate signal has been delayed and its length determined by delay and length settings. When the polarity is positive, a high on the Trig n Out connector represents the time the gate is configured to pass the signal
Odd/Even Trace Point	OEVen	Selects either the odd or even trace points as the signal to be output to the Trig n Out connector when performing swept spectrum analysis. When the polarity is positive, this output goes high during the time the instrument is sweeping past the first point (Point 0) and every other following trace point. The opposite is true if the polarity is negative
Trigger Armed	TARMed	Selects the “trigger armed” trigger signal to be output to the Trig n Out connector. This signal is true when the instrument reaches its trigger armed state <i>Not available in modular instruments</i>
Source Point Trigger	SPOint	Selects the gate signal to be output to the Trig n Out connector for use as the Point Trigger when operating an external source in Tracking mode. When Ext Trigger 1 is

Source	SCPI	Notes
		selected as the Point Trigger under Source , the Source Point Trigger under Trig 1 Out automatically gets selected. A similar pattern is used for the other Ext Trigger inputs; for example, when Ext Trigger 2 is selected as the Point Trigger under Source , the Source Point Trigger under Trig 2 Out automatically gets selected
Source Marker 1	S1Marker	Only available in VXT and M941xE. For M9420A, only for TRIG2 , for M9410A/11A/15A/16A available for both TRIG1 and TRIG2 Selects the Trigger Output at Marker 1 in the Waveform file that is currently playing
Source Marker 2	S2Marker	Only available in VXT and M941xE. For M9420A, only for TRIG2 , for M9410A/11A/15A/16A and M9410E/11E/15E/16E available for both TRIG1 and TRIG2 Selects the Trigger Output at Marker 2 in the Waveform file that is currently playing
Source Marker 3	S3Marker	Only available in VXT and M941xE. For M9420A, only for TRIG2 , for M9410A/11A/15A/16A and M9410E/11E/15E/16E available for both TRIG1 and TRIG2 Selects the Trigger Output at Marker 3 in the Waveform file that is currently playing
Source Marker 4	S4Marker	Only available in VXT and M941xE. For M9420A, only for TRIG2 , for M9410A/11A/15A/16A and M9410E/11E/15E/16E available for both TRIG1 and TRIG2 Selects the Trigger Output at Marker 4 in the Waveform file that is currently playing
PerArb	PARB	Only available in VXT Models M9410A/11A/15A/16A and M9410E/11E/15E/16E Selects the Trigger Output as PerArb. PerArb is a synchronization trigger which is generated by the ARB at the beginning of each repetition of playing the signal
FSYnc	FSYnc	Only available in VXT Models M9410A/11A/15A/16A and M9410E/11E/15E/16E Selects the Trigger Output as FSYnc , routing the Periodic Timer Sync Source signal to the specified Trigger output. That is, the signal selected by :TRIGger[:SEquence]:FRAMe:SYnc is routed to the specified trigger output The following example specifies that External 1 trigger will be used as the Periodic Timer Sync Source, and this signal will then be routed to the Trigger 2 output: TRIG:FRAM:SYnc EXT1 TRIG2:OUTP FSYnc

6.8.2 Trig 1 – 4 Out Polarity

Sets the output to the **Trig n Out** connector to trigger on either the positive or negative polarity.

Remote Command	:TRIGger[1] 2 ... 4[:SEquence]:OUTPut:POLarity POSitive NEGative :TRIGger[1] 2 ... 4[:SEquence]:OUTPut:POLarity?
Example	:TRIG1:OUTP:POL POS

Dependencies	You can only send TRIG parameters for the hardware you have; for example, you cannot send a TRIG3 parameter if your hardware does not support TRIG3 . Sending the command for an output you do not have generates an error, “Hardware missing; Not available for this model number” Querying a non-existent output returns OFF Trig 2 Out Polarity does not appear in EXM or VXT
Preset	Unaffected by Preset, but set to POSitive by Restore Input/Output Defaults or Restore System Defaults->All
State Saved	Saved in instrument state

6.8.3 Trig 1 – 4 Out Device

Sets the output to the **Trig n Out** connector to trigger on either **ANALyzer** or **SOURce**.

Remote Command	<code>:TRIGger[1] 2 ... 4[:SEquence]:OUTPut:DIRection ANALyzer SOURce</code> <code>:TRIGger[1] 2 ... 4[:SEquence]:OUTPut:DIRection?</code>						
Example	<code>:TRIG1:OUTP:DIR ANAL</code>						
Dependencies	Only available on VXT models M9410A/11A/15A/16A and M9410E/11E/15E/16E						
Preset	Unaffected by Preset Restore Input/Output Defaults and Restore System Defaults->All preset the triggers as follows:						
	<table border="1"> <thead> <tr> <th>Trig n Out Device</th> <th>Preset</th> </tr> </thead> <tbody> <tr> <td>1, 3, 4</td> <td>ANALyzer</td> </tr> <tr> <td>2</td> <td>SOURce</td> </tr> </tbody> </table>	Trig n Out Device	Preset	1, 3, 4	ANALyzer	2	SOURce
Trig n Out Device	Preset						
1, 3, 4	ANALyzer						
2	SOURce						
State Saved	Saved in instrument state						

6.8.4 Src PXI Trig Out

Selects which signal will be routed to the backplane Source PXI Trigger Output Line.

Remote Command	<code>:TRIGger:PXIE:SOURce[:SEquence]:OUTPut S1Marker S2Marker S3Marker S4Marker PARB OFF</code> See " Option details " on page 1271 <code>:TRIGger:PXIE:SOURce[:SEquence]:OUTPut?</code>
Example	<code>:TRIG:PXIE:SOUR:OUTP S1M</code> <code>:TRIG:PXIE:SOUR:OUTP?</code>
Dependencies	Only appears in EXM, VXT and M941xE
Preset	OFF
State Saved	Saved in instrument state

Option details

Here are details of all Source PXI Trigger Output options:

Source	SCPI	Notes
Off	OFF	Selects no signal to be output to the Source PXI backplane line
Source Marker 1	S1Marker	Selects the Trigger Output at Marker 1 in the Waveform file that is currently playing to be output to the Source PXI backplane line
Source Marker 2	S2Marker	Selects the Trigger Output at Marker 2 in the Waveform file that is currently playing to be output to the Source PXI backplane line
Source Marker 3	S3Marker	Selects the Trigger Output at Marker 3 in the Waveform file that is currently playing to be output to the Source PXI backplane line
Source Marker 4	S4Marker	Selects the Trigger Output at Marker 4 in the Waveform file that is currently playing to be output to the Source PXI backplane line
PerArb	PARB	A synchronization trigger that is generated by the ARB at the beginning of each repetition of playing the signal. This selection causes the PerArb Trigger Output that is currently playing to be output to the Source PXI backplane line Only available in VXT Models M9410A/11A/15A/16A and M9410E/11E/15E/16E

6.8.5 Src Trig Out Polarity

Sets the output to the Source PXI backplane trigger line to trigger on either the positive or negative polarity.

Remote Command	<code>:TRIGger:PXIE:SOURce[:SEquence]:OUTPut:POLarity POSitive NEGative</code> <code>:TRIGger:PXIE:SOURce[:SEquence]:OUTPut:POLarity?</code>
Example	<code>:TRIG:PXIE:SOUR:OUTP:POL POS</code>
Dependencies	Only appears in EXM, VXT and M941xE
Preset	Unaffected by Preset, but set to POSitive by Restore Input/Output Defaults or Restore System Defaults->All
State Saved	Saved in instrument state

6.8.6 Select Src PXI Line

Controls which backplane trigger line `TRIG[0..7]` is used for the Source Trigger Output.

Remote Command	<code>:TRIGger:PXIE:SOURce[:SEquence]:OUTPut:LINE <line></code> <code>:TRIGger:PXIE:SOURce[:SEquence]:OUTPut:LINE?</code>
----------------	--

Example	<code>:TRIGger:PXIE:SOURce:OUTPut:LINE 0</code>
Dependencies	Only appears in EXM, VXT and M941xE
Preset	4
State Saved	Saved in instrument state
Range	[0,7]

6.8.7 Analyzer PXI Trig Out

Selects the signal that will be output from Analyzer PXI Trigger Line (Backplane Trigger Line 0~3).

Remote Command	<code>:TRIGger:PXIE:ANALyzer[:SEQuence]:OUTPut HSWP MEASuring MAIN GATE GTRigger OEVen OFF</code> See "Option Details" on page 1272 <code>:TRIGger:PXIE:ANALyzer[:SEQuence]:OUTPut?</code>
Example	<code>:TRIG:PXIE:ANAL:OUTP HSWP</code>
Dependencies	Only available on certain modular analyzers, such as CXA-m, VXT models M9410A/11A/15A/16A and M9410E/11E/15E/16E For VXT models M9410A/11A/15A/16A, only OFF , MEASuring and MAIN are available
Preset	Unaffected by Preset but is preset to OFF by Restore Input/Output Defaults or Restore System Defaults->All
State Saved	Saved in instrument state

Option Details

Here are details of all Analyzer PXI Trigger Output options:

Source	SCPI	Notes
Off	OFF	Selects no signal to be output to the Analyzer PXI backplane trigger line
Sweeping (HSWP)	HSWP	Selects the Sweeping Trigger signal to be output to the Analyzer PXI backplane trigger line when a measurement is made. This signal has historically been known as "HSWP" (High = Sweeping), and is 5 V TTL level with 50-ohm output impedance
Measuring	MEAS	Selects the Measuring trigger signal to be output to the Analyzer PXI backplane trigger line. This signal is true while the Measuring status bit is true
Main Trigger	MAIN	Selects the current instrument trigger signal to be output to the Analyzer PXI backplane trigger line
Gate Trigger	GTR	Selects the gate trigger signal to be output to the Analyzer PXI backplane trigger line. This is the source of the gate timing, not the actual gate signal
Gate	GATE	Selects the gate signal to be output to the Analyzer PXI backplane trigger line. The gate signal has been delayed and its length determined by delay and length settings. When the

6 Input/Output
6.8 Trigger Output

Source	SCPI	Notes
Odd/Even Trace Point	OEV	polarity is positive, a high on the Trig Out connector represents the time the gate is configured to pass the signal Selects either the odd or even trace points as the signal to be output to the Analyzer PXI backplane trigger line when performing swept spectrum analysis. When the polarity is positive, this output goes high during the time the instrument is sweeping past the first point (Point 0) and every other following trace point. The opposite is true if the polarity is negative

6.8.8 Analyzer Trig Out Polarity

Sets the output to the Analyzer PXI backplane trigger line to trigger on either the positive or negative polarity.

Remote Command	<code>:TRIGger:PXIE:ANALyzer[:SEQuence]:OUTPut:POLarity POSitive NEGative</code> <code>:TRIGger:PXIE:ANALyzer[:SEQuence]:OUTPut:POLarity?</code>
Example	<code>:TRIG:PXIE:ANAL:OUTP:POL POS</code>
Dependencies	Only available on certain modular analyzers, such as CXA-m, VXT models M9410A/11A/15A/16A and M9410E/11E/15E/16E
Preset	Unaffected by Preset, but set to POSitive by Restore Input/Output Defaults or Restore System Defaults->All POSitive
State Saved	Saved in instrument state

6.8.9 Select Analyzer PXI Line

Controls which `PXI_TRIG[0...3]` is used for the Analyzer Trigger Output.

Remote Command	<code>:TRIGger:PXIE:ANALyzer[:SEQuence]:OUTPut:LINE <line></code> <code>:TRIGger:PXIE:ANALyzer[:SEQuence]:OUTPut:LINE?</code>
Example	<code>:TRIGger:PXIE:ANALyzer:OUTPut:LINE 0</code>
Dependencies	Only available on certain modular analyzers, such as CXA-m, VXT models M9410A/11A/15A/16A and M9410E/11E/15E/16E
Preset	0
State Saved	Saved in instrument state
Range	[0,3]

6.8.10 Source Internal Trig Out

Selects the signal which will be output from Source Internal Trigger Line.

NOTE

In some software released in 2018 and 2019, the SCPI command for this function was as below:

```
:TRIGger[:SEquence]:INTernal[:SEquence]:OUTPut
S1Marker|S2Marker|S3Marker|S4Marker|OFF
```

It was necessary to change this SCPI in release A.24.00 due to internal conflicts in the software. User code written for the A.22.xx or A.23.xx instrument software which used the old form must be rewritten to use the form below.

Remote Command	<code>:TRIGger[:SEquence]:INTernal:SOURce:OUTPut S1Marker S2Marker S3Marker S4Marker PARB OFF</code> <code>:TRIGger[:SEquence]:INTernal:SOURce:OUTPut?</code>
Example	<code>:TRIG:INT:SOUR:OUTP S1M</code>
Notes	PARB (Per ARB) -A synchronization trigger that is generated by the ARB at the beginning of each repetition of playing the signal
Dependencies	Only available on VXT models M9420A, M9410A/11A/15A/16A and M9410E/11E/15E/16E
Preset	Unaffected by Preset but preset by Restore Input/Output Defaults or Restore System Defaults->All . The value is Mode-dependent: Power Amplifier Mode: S1Marker All other Modes: OFF
State Saved	Saved in instrument state

6.8.11 Source Internal Trig Out Polarity

Sets the output to the Source Internal trigger line to trigger on either the positive or negative polarity.

NOTE

In some software released in 2018 and 2019, the SCPI command for this function was as below:

```
:TRIGger[:SEquence]:INTernal[:SEquence]:OUTPut:POLarity
POSitive|NEGative
```

It was necessary to change this SCPI in release A.24.00 due to internal conflicts in the software. User code written for the A.22.xx or A.23.xx instrument software which used the old form must be rewritten to use the form below.

Remote Command	<code>:TRIGger[:SEquence]:INTernal:SOURce:OUTPut:POLarity POSitive NEGative</code> <code>:TRIGger[:SEquence]:INTernal:SOURce:OUTPut:POLarity?</code>
Example	<code>:TRIG:INT:SOUR:OUTP:POL POS</code>
Dependencies	Only available on VXT models and M9410E/11E/15E/16E
Preset	Unaffected by Preset , but set to POSitive by Restore Input/Output Defaults or Restore System

6 Input/Output
6.8 Trigger Output

Defaults->All	
State Saved	Saved in instrument state

6.9 Calibration

Lets you configure the Comb Calibrator. This tab only appears when an RCal license is installed. Settings associated with the Calibrator are configured here.

6.9.1 Configuration

Opens the dialog shown below. This is a full screen dialog. Configuring of Cals is done using this dialog. The table consists of rows of Cals and Columns of Cal settings. You can scroll or swipe vertically or horizontally to view Cals or settings not currently shown on the screen.

Dialog with Example Table entries:

Calibration Configuration ? Close >

Cal Group
1

Cal Input
RF Input

Calibrate Checked Rows

Apply Cal Group
On
Off

Copy From Cal Group
2

Copy

Select Calibrator
RCal Module 1

Serial #: SN1234567
Version 1.20

RCal Reference
Internal

Identify RCal Module

Cal Status >

Description
Switch and Amplifier

Go to Row 2 Insert Row Below Use Current Meas Duplicate Row Delete Row Delete All

	Calibrate	Apply	Name	Last Cal	Applied	Type	Start Freq	Stop Fr
1	✓	✓	Entire Instrument	Jul 23 2019 03:32 PM	--	Magnitude	910.0 MHz	910.0 M
2	✓	✓	Switch Cal	May 14 2019 09:35 AM	--	Complex	1.000 GHz	2.000 G
3	✓	✓	Amp Cal	May 14 2019 09:35 AM	--	Magnitude	10 Hz	26.5 GH

Full Cal Group Table with Example entries:

6 Input/Output
6.9 Calibration

RCal Calibrations Table

Table will scroll vertically and horizontally

	Calibrate	Apply	Name	Last Cal	Applied	External Mixer	Cal Type
1	<input checked="" type="checkbox"/>	<input checked="" type="checkbox"/>	Entire Instrument	Aug 30 2018 03:32 PM	Yes	11970A : Normal	Vector
2	<input checked="" type="checkbox"/>	<input checked="" type="checkbox"/>	Wednesday with remote head	Sep 12 2018 02:27 PM	No	Custom : Normal	Vector
3	<input checked="" type="checkbox"/>	<input checked="" type="checkbox"/>	20190119 3:54pm	--	--	11970U : Normal	Vector
4	<input type="checkbox"/>	<input type="checkbox"/>	1 GHz – 3 GHz	--	--	11970V : Normal	Scalar
5	<input type="checkbox"/>	<input type="checkbox"/>	2 GHz – 4 GHz	--	--	K Band Single Harmonic No Doubler : Normal	Scalar
6	<input type="checkbox"/>	<input type="checkbox"/>	External Preamp	--	--	W Band Single Harmonic No Doubler : Normal	Scalar
7	<input type="checkbox"/>	<input type="checkbox"/>	(None)				
8	<input type="checkbox"/>	<input type="checkbox"/>	(None)				
9	<input type="checkbox"/>	<input type="checkbox"/>	(None)				
10	<input type="checkbox"/>	<input type="checkbox"/>	(None)				

Only shows when External Mixer is the selected Cal Input

Scalar
Vector

Start Freq	Stop Freq	Freq Step	Freq Points	Mech Atten	Mech Atten Start	Mech Atten Stop	Mech Atten Step	Elec Atten	Elec Atten Start
910.0 MHz	910.0 MHz	0 Hz	1	Step	0 dB	10 dB	2 dB	Step	0 dB
1.000 GHz	2.000 GHz	100.000 MHz	100	Reference	00 dB	00 dB	00 dB	Bypass	00 dB
10 Hz	26.5 GHz	0 Hz	3	All	00 dB	20 dB	2 dB	All	00 dB
1.000 GHz	3.000 GHz	100.00 MHz	20	Step	10 dB	50 dB	10 dB	Step	10 dB
2.000 GHz	4.000 GHz	10.000 MHz	200	Bypass	00 dB	20 dB	2 dB	All	00 dB
2.000 GHz	2.000 GHz	0 Hz	1	Reference	00 dB	00 dB	00 dB	Reference	00 dB

Step
All
Bypass

Step
All
Bypass

Elec Atten Stop	Elec Atten Step	Full Atten	Full Atten Start	Full Atten Stop	Freq Ext Atten	Freq Ext Atten Start	Freq Ext Atten Stop	IF Path
10 dB	5 dB	Step	0 dB	6 dB	Step	0 dB	6 dB	10 MHz
00 dB	00 dB	All	00 dB	00 dB	All	00 dB	00 dB	510 MHz
20 dB	10 dB	All	00 dB	200 dB	All	00 dB	200 dB	25 MHz
20 dB	2 dB	Step	6 dB	20 dB	Step	6 dB	20 dB	10 MHz
20 dB	10 dB	All	00 dB	200 dB	All	00 dB	200 dB	25 MHz
00 dB	00 dB	All	000 dB	000 dB	All	000 dB	000 dB	40 MHz

Step	Step	10 MHz
All	All	25 MHz
		40 MHz
		510 MHz
		1 GHz
		2 GHz
		4 GHz

6.9.1.1 Cal Group

This is the same as "Cal Group" on page 1311 in the Calibration tab.

6.9.1.2 Calibrate Checked Rows

Executes the Cals within the currently selected Cal Group that have the Calibrate box checked in the RCal Configuration Table.

Once selected, the following dialog box is displayed;

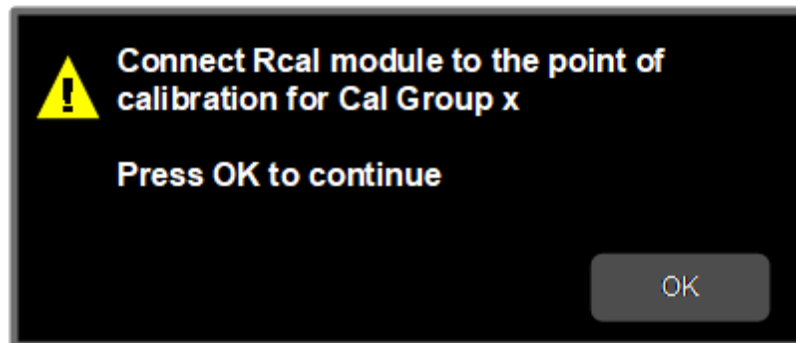

When you click OK, the following dialog is displayed;

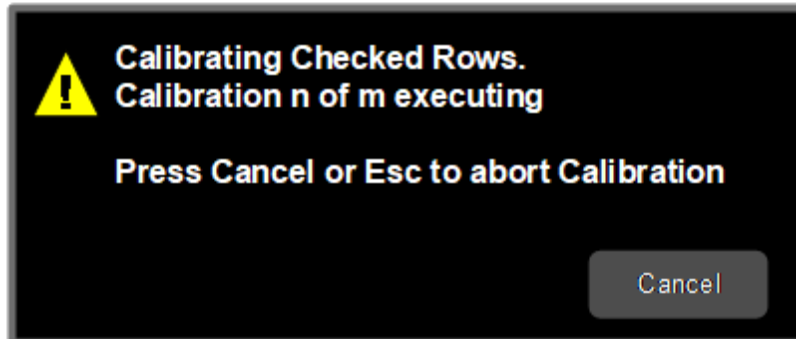

If there are multiple Cals being executed in a Cal Group, this dialog advises you when each Cal is complete. It also provides the ability to abort the Execute Cal Request. If you choose to abort, calibrations that have completed use the new Cal data and update the Last Cal field. Calibrations that have not completed retain the existing Cal data and Last Cal timestamp, or show “---” if the Cal had never been executed.

Remote Command	<code>:SYSTem:CALibration:INITiate:SElected</code>
Example	<code>:SYST:CAL:INIT:SEL</code>
Notes	Cals cannot be applied until they have been calibrated. Once a Cal has been calibrated, the Last Cal field in the table displays the date and time the Cal was last calibrated
Dependencies	Applied to the currently selected Cal Group
Couplings	Calibrate Selected is disabled if there are no Calibrate checkboxes checked. If the disabled control is selected, the advisory message “Check the Calibrate box for the Cals you want to calibrate” is displayed

6.9.1.3 Apply Cal Group

This is the same as ["Apply Cal Group" on page 1311](#) in the **Calibration** tab.

6.9.1.4 Abort Calibration

Aborts the Calibration routine of the currently selected Cal Group

Remote Command	<code>:SYSTem:CALibration:ABORt</code>
Example	<code>:SYST:CAL:ABOR</code>
Dependencies	Aborts the currently running calibration. The previously-run calibrations will still be available, but the current calibration is halted, and next calibrations selected are not executed. Once the calibration starts, the modal dialog appears, and the abort can be executed by selecting Cancel

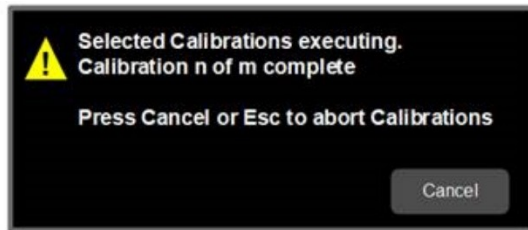

6.9.1.5 Copy From Cal Group

Determines the Cal Group from which existing rows are copied when using the "Copy" on page 1280 Group feature.

Remote Command	:SYSTem:CALibration:CGRoup:COPIY:FROM <integer>
Example	:SYST:CAL:CGR:COPIY:FROM 2 :SYST:CAL:CGR:COPIY:FROM?
Preset	1
Min	1
Max	100

6.9.1.6 Copy

Lets you copy the settings in the Cal Group specified by the **Copy From Cal Group** parameter.

All the rows in the table are copied to the selected Cal Group. The columns **Apply**, **Last Cal** and **Applied** are set to their default values.

The group level parameters are also copied, with the exception of **Apply Cal Group** and **Copy From Cal Group**.

Remote Command	:SYSTem:CALibration:CGRoup:COPIY
Example	:SYST:CAL:CGRoup:COPIY
Dependencies	Applied to the currently selected Cal Group
Couplings	Disabled if Copy From Cal Group is the same as the currently selected Cal Group. If the disabled control is selected, the advisory message "Unable to Copy from same Cal Group" is displayed, and the same message is returned remotely as a Settings Conflict If you attempt to copy from a Cal Group that is empty, the advisory message "Copy From Cal Group is empty" is displayed, and the same message is returned remotely as a Settings Conflict

6.9.1.7 Cal Input

Maps the currently selected Cal Group to a particular I/O port. This control allows any Input port (including External Mixing, the RF2 input, etc.) to be mapped to a specific Cal Group

Remote Command	<code>:SYSTem:CALibration:INPut RFIN RFIN2 EMIXer ERFIN</code> See " Option Details " on page 1281 <code>:SYSTem:CALibration:INPut?</code>
Example	<code>:SYST:CAL:INPut RFIN2</code>
Dependencies	<code>RFIN2</code> <code>EMIXer</code> are only available on C/E/M/P/UXA analyzers with the appropriate options loaded <code>ERFIN</code> is only available if a V3050A unit is connected
State Saved	Saved in State

Option Details

Note that the presence of these ports is highly hardware dependent.

Cal Input	SCPI	Notes
RF Input	<code>RFIN</code>	Main RF Port Not available on EXM with hardware M9431A
RF Input 2	<code>RFIN2</code>	Second RF Port, labeled RF Input 2 Only available on certain instruments
External Mixer	<code>EMIX</code>	Requires option EXM
External RF	<code>ERFIN</code>	Only available if a V3050A unit is connected

6.9.1.8 Freq Offset

Specifies any frequency offset that is to be applied to the currently selected Cal Group. This can be used when using an external mixer.

Remote Command	<code>:SYSTem:CALibration:FREQuency:OFFSet <freq></code> <code>:SYSTem:CALibration:FREQuency:OFFSet?</code>
Example	<code>:SYST:CAL:FREQ:OFFS 1e9</code>
Dependencies	The query applies to the currently selected Cal Group
Preset	All 0 Hz
State Saved	Saved in instrument state
Min	0 Hz
Max	100.0 GHz

6.9.1.9 Select Calibrator

Selects the calibrator for the currently selected Cal Group to use for executing the calibration when multiple modules are connected.

Remote Command	<code>:SYSTem:CALibration:MODule:SElect NONE RCM1 RCM2 RCM3 RCM4 RCM5 RCM6 RCM7 RCM8 RCM9 RCM10</code> <code>:SYSTem:CALibration:MODule:SElect?</code>
Example	<code>:SYST:CAL:MODule:SElect RCM1</code>
Notes	Details of the RCal module are displayed beneath the control. If there are no modules connected, the text states “No Modules Connected” For SCPI, if the parameter sent is for a module that is not currently connected to the instrument, the message “Selected RCal module not connected” is generated
Dependencies	The SCPI command is applied to the currently selected Cal Group
State Saved	Saved in instrument state
Range	All connected RCal modules

6.9.1.10 Identify RCal Module

Control to connect to the RCal module of the currently selected Cal Group and blink its identity light

6.9.1.11 RCal Module Serial Number (Remote Query Only)

Returns the serial number of the specified module

Remote Command	<code>:SYSTem:CALibration:MODule[1] 2 ... 10:SNUMber?</code>
Example	<code>:SYST:CAL:MOD:SNUM?</code>
Notes	If there is no module associated with the specified module number, returns an empty string

6.9.1.12 RCal Reference

Determines the reference type used by the RCal module of the currently selected Cal Group

Remote Command	<code>:SYSTem:CALibration:REFerence INTernal EXTernal</code> <code>:SYSTem:CALibration:REFerence?</code>
Example	<code>:SYST:CAL:REF EXT</code>
Dependencies	The SCPI command is applied to the currently selected Cal Group

Preset	EXternal
State Saved	Saved in instrument state
Range	Internal External

6.9.1.13 RCal Status

Opens a dialog that is used to provide the status of all active rows in all groups. Status can be one of the following: Calibrated, Applied, Calibration Failed or Apply Failed.

If a Calibration Fails, an error icon is shown in the **Calibrate** column of the row(s) that failed, with a message indicating the nature of the failure. If the failure cannot be addressed by the user, the error message “Calibration Failed. See Error Log” will be shown and details of the failure will be written to the SA Event Log.

Applying the Calibration can result in a warning if there is a mismatch between the currently executing instrument state and any of the following parameter settings;

- Cal Input
- Frequency
- IF Path
- IF Gain
- Phase Noise Optimization
- Preamp
- Coupling
- Mechanical Attenuator
- Electrical Attenuator
- Full Range Attenuator
- uW Path Control
- Mixing Mode
- External Mixer

When there is a mismatch a warning icon will be shown in the Applied column of the row(s) that had the mismatch with details in the format “<Parameter Name> does not match meas state”.

The Status dialog provides you with the group and row of a Calibration and its current state and any error details if the status is not OK.

RCal Status (Remote Query Only)

Returns a comma-separated list of the status of an individual row status in the format “Group”, “Row”, ‘Status’, “Details”

Remote Command	<code>:SYSTem:CALibration:ROW[1] 2 ... 100:STATus?</code>
Example	Return a comma-separated list for the status of an individual row, in the format “Group”, “Row”, ‘Status’, “Details”: <code>:SYST:CAL:ROW2:STAT?</code>
Dependencies	The SCPI command is applied to the currently selected Cal Group. The subopcode is used to identify the Cal row in the Cal Group If the subopcode does not reference an existing Cal row in the Cal Group, the error message “-221, Settings conflict; Subopcode does not reference an existing Cal row” is generated

All RCal Status (Remote Query Only)

Returns a comma-separated list of all entries in the Cal Status table in the format “Group”, “Row”, ‘Status’, “Details”, which is repeated for each row in the table. If there are no entries in the table, returns an empty string.

Remote Command	<code>:SYSTem:CALibration:STATus:ALL?</code>
Example	Return a comma-separated list of all entries in the Cal Status table in the format “Group”, “Row”, ‘Status’, “Details”, repeated for each row in the table: <code>:SYST:CAL:STAT:ALL?</code>

6.9.1.14 Go to Row

Sets the selected row in the Cal table for the currently selected Cal Group.

Notes	You can only go to a row that has already been added
Preset	1
State Saved	Saved in instrument state
Min	1
Max	32

6.9.1.15 Insert Row Below

Adds a new row to the currently selected Cal Group, under the currently selected row in the table or after the sub opcode used in the SCPI command. The default values for each of the settings in the row is used.

Remote Command	<code>:SYSTem:CALibration:ROW[1] 2 ... 100:INSert</code>
Example	<code>:SYST:CAL:ROW2:INSert</code>
Dependencies	The SCPI command is applied to the currently selected Cal Group. The subopcode is used to identify the Cal row in the Cal Group If the subopcode does not reference an existing Cal row in the Cal Group, the error message “-221, Settings conflict; Subopcode does not reference an existing Cal row” is generated

6.9.1.16 Description

Provides a description for the currently selected Cal Group from which the operator can easily identify the Cal Group.

Remote Command	<code>:SYSTem:CALibration:DESCription "Description"</code> <code>:SYSTem:CALibration:DESCription?</code>
Example	<code>:SYST:CAL:DESC "Description"</code>
Notes	Also shown on the Calibration menu panel, but limited to the first 18 characters
Dependencies	The SCPI command is applied to the currently selected Cal Group
State Saved	Saved in instrument state

6.9.1.17 Use Current Meas

Takes the settings from the current running measurement state to populate the Cal Row settings of the currently selected Cal Group.

Remote Command	<code>:SYSTem:CALibration:ROW[1] 2 ... 100:UCMeas</code>
Example	<code>:SYST:CAL:ROW2:UCM</code>
Dependencies	The SCPI command is applied to the currently selected Cal Group. The subopcode is used to identify the Cal row in the Cal Group If the group table is empty and subopcode is omitted or 1, a new row is created and populated using the current running measurement If the subopcode does not reference an existing Cal row in the Cal Group, the error message “-221,Settings conflict; Subopcode does not reference an existing Cal row” is generated Pressing the control or sending the SCPI command in measurements that do not support this parameter generates error -221, “Settings conflict; Feature not supported for this measurement”

6.9.1.18 Duplicate Row

Creates a new row the currently selected row, and populates the new row with the settings from the selected row of the currently selected Cal Group

Remote Command	<code>:SYSTem:CALibration:ROW[1] 2 ... 100:DUPLicate</code>
Example	<code>:SYST:CAL:ROW2:DUPL</code>
Dependencies	The SCPI command is applied to the currently selected Cal Group. The subopcode is used to identify the Cal row in the Cal Group If the subopcode does not reference an existing Cal row in the Cal Group, the error message “-221,Settings conflict; Subopcode does not reference an existing Cal row” is generated

6.9.1.19 Delete Row

Deletes the settings from the selected row of the currently selected Cal Group

Remote Command	<code>:SYSTem:CALibration:ROW[1] 2 ... 100:DELeTe</code>
Example	<code>:SYST:CAL:ROW2:DEL</code>
Notes	Disabled if the Cal Group contains no Cal rows
Dependencies	The SCPI command is applied to the currently selected Cal Group. The subopcode is used to identify the Cal row in the Cal Group If the subopcode does not reference an existing Cal row in the Cal Group, the error message “-221, Settings conflict; Subopcode does not reference an existing Cal row” is generated

6.9.1.20 Delete All

Deletes all the Cals in the currently selected Cal Group

Remote Command	<code>:SYSTem:CALibration:DELeTe:ALL</code>
Example	<code>:SYST:CAL:DEL:ALL</code>
Notes	Disabled if the Cal Group contains no Cal rows
Dependencies	The SCPI command is applied to the currently selected Cal Group

6.9.1.21 Calibrate

Determines whether the Cal row should be included when Calibrate Selected is executed.

Remote Command	<code>:SYSTem:CALibration:ROW[1] 2 ... 100:CALibrate:STATe ON OFF 1 0</code> <code>:SYSTem:CALibration:ROW[1] 2 ... 100:CALibrate:STATe?</code>
----------------	--

Example	<code>:SYST:CAL:ROW2:CAL:STAT ON</code> <code>:SYST:CAL:ROW2:CAL:STAT?</code>
Dependencies	The SCPI command is applied to the currently selected Cal Group. The subopcode is used to identify the Cal row in the Cal Group If the subopcode does not reference an existing Cal row in the Cal Group, the error message “-221, Settings conflict; Subopcode does not reference an existing Cal row” is generated
Preset	All OFF
State Saved	Saved in instrument state
Range	ON OFF

6.9.1.22 Apply

Determines the Cal that is applied.

Remote Command	<code>:SYSTem:CALibration:ROW[1] 2 ... 100:APPLY:STATe ON OFF 1 0</code> <code>:SYSTem:CALibration:ROW[1] 2 ... 100:APPLY:STATe?</code>
Example	<code>:SYST:CAL:ROW2:APPL:STAT ON</code> <code>:SYST:CAL:ROW2:APPL:STAT?</code>
Dependencies	The SCPI command is applied to the currently selected Cal Group. The subopcode is used to identify the Cal row in the Cal Group If the subopcode does not reference an existing Cal row in the Cal Group, the error message “-221, Settings conflict; Subopcode does not reference an existing Cal row” is generated You can only check the Apply checkbox for a Cal that has been executed. If you attempt to select the Apply checkbox for Cal's that have not been executed, the advisory message “Cal must be executed before it can be applied” is displayed If Apply Cal is ON , and you attempt to check the Apply checkbox for a Cal that is invalid for use with the current measurement state, the error “Cal invalid with current measurement settings is shown, and the checkbox remains unchecked
Couplings	When the Apply check box is checked, if the Apply Cal Group setting is OFF , it will be turned on. Calibrations are only applied when the Apply Cal Group is ON
Preset	All OFF
State Saved	Saved in instrument state
Range	ON OFF
Annotation	If <i>any</i> Cal check box in any group is checked and Apply Cal Group for that group is ON , RCal in the Meas Bar displays in amber to indicate Calibrations are in use

6.9.1.23 Name

Sets an ASCII text field allowing you to name the selected Cal

Remote Command	<code>:SYSTem:CALibration:ROW[1] 2 ... 100:NAME <string></code> <code>:SYSTem:CALibration:ROW[1] 2 ... 100:NAME?</code>
Example	<code>:SYST:CAL:ROW2:NAM "Monday AM Cal"</code>
Notes	45 chars max; may not fit on display if max chars used
Dependencies	The SCPI command is applied to the currently selected Cal Group. The subopcode is used to identify the Cal row in the Cal Group If the subopcode does not reference an existing Cal row in the Cal Group, the error message “-221, Settings conflict; Subopcode does not reference an existing Cal row” is generated
Preset	“Cal #”, where # is corresponding Cal number
State Saved	Saved in instrument state

6.9.1.24 Last Cal

Displays the date and time the selected Cal was last executed. Read only field.

Remote Command	<code>:SYSTem:CALibration:ROW[1] 2 ... 100:LAST?</code>
Example	Return data and time Cal 2 was last executed: <code>:SYST:CAL:ROW2:LAST?</code>
Notes	Returns a string containing the date and time the Cal was executed. If the Cal has never been executed, or any of the settings are changed, SCPI returns an empty string, and the front panel displays “---”
Dependencies	The SCPI query applies to the currently selected Cal Group If the subopcode does not reference an existing Cal row in the Cal Group, the error message “-221, Settings conflict; Subopcode does not reference an existing Cal row” is generated

6.9.1.25 Cal Applied

Displays the status of a Cal once it is applied. Is either Yes or No, depending on if the Cal was successfully applied or not. See RCalStatus for more details. If it is not being applied, the field shows “---”. Read-only field.

Remote Command	<code>:SYSTem:CALibration:ROW[1] 2 ... 100:CAPLied?</code>
Example	Return Cal Stats of Cal 2: <code>:SYST:CAL:ROW2:CAPP?</code>
Notes	Returns a string containing the date and time the Cal was executed. If the Cal has never been executed, or any of the settings are changed, SCPI returns an empty string, and the front panel displays “---”
Dependencies	The SCPI query applies to the currently selected Cal Group If the subopcode does not reference an existing Cal row in the Cal Group, the error message “-221, Settings conflict; Subopcode does not reference an existing Cal row” is generated

6.9.1.26 Cal Type

Specifies how the calibration is to be performed on the selected Cal. Options are;

- **MAGNitude**: A single CW tone is measured at the center of the screen for each frequency point
- **COMPLex**: A comb signal is measured across the full IF passband at each frequency point. Magnitude and Phase are measured

Remote Command	<code>:SYSTem:CALibration:ROW[1] 2 ... 100:TYPE MAGNitude COMPLex</code> <code>:SYSTem:CALibration:ROW[1] 2 ... 100:TYPE?</code>
Example	<code>:SYST:CAL:ROW2:TYPE COMP</code>
Dependencies	Only available if the selected RCal module has a license for complex calibrations. If it does not, this control is disabled The SCPI command applies to the currently selected Cal Group If the subopcode does not reference an existing Cal row in the Cal Group, the error message “-221, Settings conflict; Subopcode does not reference an existing Cal row” is generated
Preset	MAGNitude
State Saved	Saved in instrument state
Range	MAGNitude COMPLex

6.9.1.27 Start Freq

Specifies the start frequency of the selected Cal.

Remote Command	<code>:SYSTem:CALibration:ROW[1] 2 ... 100:FREQUENCY:START <freq></code> <code>:SYSTem:CALibration:ROW[1] 2 ... 100:FREQUENCY:START?</code>
Example	<code>:SYST:CAL:ROW2:FREQ:STAR 1e9</code>
Notes	Max values depend on Hardware Options (503, 507, 508, 513, 526)
Dependencies	The SCPI command applies to the currently selected Cal Group If the subopcode does not reference an existing Cal row in the Cal Group, the error message “-221, Settings conflict; Subopcode does not reference an existing Cal row” is generated By direct entry: You cannot set Start Frequency > Stop Frequency. You can set the Start frequency = Stop frequency. If you set Start Frequency = Stop Frequency, " Freq Step " on page 1291 is adjusted to 0, and " Freq Points " on page 1291 is adjusted to 1 With the knob or step keys: If you set Start Frequency = Stop Frequency, Freq Step is adjusted to 0, and Freq Points is adjusted to 1
Couplings	If you change the start frequency of the selected range to a value > the range's stop frequency, the

	<p>stop frequency of the previous range is changed to the same value. Freq Step is set to 0 Hz and Freq Points is set to 1</p> <p>If you change the start frequency \leq min frequency of the instrument, the start frequency of the selected range is set to the minimum frequency of the instrument</p> <p>If you change the start frequency \geq maximum frequency of the instrument, the start frequency of the selected range is set to the maximum frequency of the instrument and the stop frequency of selected range is set to the maximum frequency of the instrument. Freq Step is set to 0 Hz and Freq Points is set to 1</p>
Preset	Depends on the instrument maximum frequency
State Saved	Saved in instrument state
Min	If Scale Type is set to Lin, the min Start Frequency changes to -80 MHz
Max	Depends on the instrument maximum frequency – 10 Hz minimum span

6.9.1.28 Stop Freq

Specifies the stop frequency of the selected Cal.

Remote Command	<pre>:SYSTem:CALibration:ROW[1] 2 ... 100:FREQUENCY:STOP <freq></pre> <pre>:SYSTem:CALibration:ROW[1] 2 ... 100:FREQUENCY:STOP?</pre>
Example	<pre>:SYST:CAL:ROW2:FREQ:STOP 1e9</pre>
Notes	Max values depend on Hardware Options
Dependencies	<p>The SCPI command applies to the currently selected Cal Group</p> <p>If the subopcode does not reference an existing Cal row in the Cal Group, the error message “-221, Settings conflict; Subopcode does not reference an existing Cal row” is generated</p> <p>By direct entry:</p> <p>You cannot set Stop frequency < Start frequency. You cannot set Start frequency = Stop frequency. You can set Start frequency = Stop frequency. If you set Start Frequency = Stop Frequency, "Freq Step" on page 1291 is adjusted to 0, and "Freq Points" on page 1291 is adjusted to 1</p> <p>With the knob or step keys:</p> <p>If you set Start Frequency = Stop Frequency, Freq Step is adjusted to 0, and Freq Points is adjusted to 1</p>
Couplings	<p>If you change the stop frequency of the selected range to a value < the range's start frequency the start frequency of the range is changed to the same value. Freq Step is set to 0 Hz and Freq Points is set to 1</p> <p>If you change the stop frequency \geq the maximum frequency of the instrument, the stop frequency of the selected range is set to the maximum frequency of the instrument</p> <p>If you change stop frequency \leq the minimum frequency of the instrument, the stop frequency of the selected range is set to the minimum frequency of the instrument and the start frequency of the selected range is set to the minimum frequency of the instrument. Freq Step is set to 0 Hz and Freq Points is set to 1</p>
Preset	Depends on the instrument maximum frequency

State Saved	Saved in instrument state
Min	If Scale Type is Lin, the min Stop Frequency is changed to -79.999990 MHz
Max	Depends on the instrument maximum frequency

6.9.1.29 Freq Step

Specifies the step frequency of the selected Cal. This determines the points between the start and stop frequencies to use for Calibration.

Remote Command	<code>:SYSTem:CALibration:ROW[1] 2 ... 100:FREQUENCY:STEP <freq></code> <code>:SYSTem:CALibration:ROW[1] 2 ... 100:FREQUENCY:STEP?</code>
Example	<code>:SYST:CAL:ROW2:FREQ:STEP 1e9</code>
Notes	Max values depend on Hardware Options
Dependencies	The SCPI command applies to the currently selected Cal Group If the subopcode does not reference an existing Cal row in the Cal Group, the error message “-221, Settings conflict; Subopcode does not reference an existing Cal row” is generated You cannot set Freq Step > Stop frequency - Start frequency Attempts to set Freq Step > Stop frequency - Start frequency results in Freq Step being set to Stop frequency - Start frequency
Couplings	Coupled to " Freq Points " on page 1291. Changing Freq Step adjusts Freq Points using $((\text{Stop Freq} - \text{Start Freq}) / \text{Freq Step} + 1)$ and clips to the next integer value, which may result in Freq Step being clipped too If Freq Step is set to a value > Stop Freq - Start Freq Stop Freq is increased, and Freq Points is set to 1
Preset	All 10 kHz
State Saved	Saved in instrument state
Min	1 Hz
Max	Depends on the instrument maximum frequency

6.9.1.30 Freq Points

Specifies the frequency points of the selected Cal. This determines the points between the start and stop frequencies to use for Calibration.

Remote Command	<code>:SYSTem:CALibration:ROW[1] 2 ... 100:FREQUENCY:POINTs</code> <code>:SYSTem:CALibration:ROW[1] 2 ... 100:FREQUENCY:POINTs?</code>
Example	<code>:SYST:CAL:ROW2:FREQ:POIN 100</code>
Couplings	Coupled to " Freq Step " on page 1291. Changing Freq Points adjusts Freq Step using $(\text{Stop Freq} - \text{Start Freq}) / (\text{Freq Points} - 1)$ and clips to the next integer value, which may result in Freq Step being clipped

Preset	1
Min	1
Max	100000

6.9.1.31 Mech Atten Type

Specifies the Mech Atten type to use:

- **STEP**: Use multiple Mech Atten states determined by Mech Atten Start, Mech Atten Stop and Mech Atten Step
- **ALL**: Use all the attenuator states
- **BYPass**: Bypasses the attenuator

Remote Command	<code>:SYSTem:CALibration:ROW[1] 2 ... 100:ATTenuation:TYPE STEP ALL BYPass</code> <code>:SYSTem:CALibration:ROW[1] 2 ... 100:ATTenuation:TYPE?</code>
Example	<code>:SYST:CAL:ROW3:ATT:TYPE STEP</code>
Dependencies	The SCPI command applies to the currently selected Cal Group If the subopcode does not reference an existing Cal row in the Cal Group, the error message “-221,Settings conflict; Subopcode does not reference an existing Cal row” is generated
Preset	STEP
State Saved	Saved in instrument state
Range	STEP ALL BYPass

6.9.1.32 Mech Atten Start

Determines the first Mechanical Attenuator to be used in the Calibration

Remote Command	<code>:SYSTem:CALibration:ROW[1] 2 ... 100:ATTenuation:START <rel_amp></code> <code>:SYSTem:CALibration:ROW[1] 2 ... 100:ATTenuation:START?</code>
Example	<code>:SYST:CAL:ROW3:ATT:START 20</code>
Dependencies	Disabled unless " Mech Atten Type " on page 1292 is STEP The SCPI command applies to the currently selected Cal Group If the subopcode does not reference an existing Cal row in the Cal Group, the error message “-221,Settings conflict; Subopcode does not reference an existing Cal row” is generated
Couplings	Coupled to " Mech Atten Stop " on page 1293. Mech Atten Start must be \leq Mech Atten Stop . If Mech Atten Start $>$ Mech Atten Stop , then Mech Atten Stop = Mech Atten Start
Preset	10 dB
State Saved	Saved in instrument state
Min	0 dB

6 Input/Output
6.9 Calibration

	The attenuation set by this control cannot be decreased below 6 dB with the knob or step keys. To get to a value below 6 dB it must be directly entered from the keypad or via SCPI. This protects from adjusting the attenuation to a dangerously small value, which can put the instrument at risk of damage to input circuitry. However, if the current mechanical attenuation is below 6 dB it can be increased with the knob and step keys, but not decreased
Max	CXA Option 503 or 507: 50 dB EXA: 60 dB All other models: 70 dB Note that, in the single attenuator configuration, the total of ATT and EATT cannot exceed 50 dB, so if the EATT is set to 24 dB first, the main attenuation cannot be greater than 26 dB and is reduced accordingly; if the main attenuator is set to 40 dB first, EATT cannot be greater than 10 dB

6.9.1.33 Mech Atten Stop

Determines the last Mechanical Attenuator to be used in the Calibration

Remote Command	<code>:SYSTem:CALibration:ROW[1] 2 ... 100:ATTenuation:STOP <rel_amp1></code> <code>:SYSTem:CALibration:ROW[1] 2 ... 100:ATTenuation:STOP?</code>	
Example	<code>:SYST:CAL:ROW3:ATT:STOP 30</code>	
Dependencies	Disabled unless " Mech Atten Type " on page 1292 is STEP The SCPI command applies to the currently selected Cal Group If the subopcode does not reference an existing Cal row in the Cal Group, the error message “-221,Settings conflict; Subopcode does not reference an existing Cal row” is generated	
Couplings	Coupled to " Mech Atten Start " on page 1292. Mech Atten Start must be \leq Mech Atten Stop . If Mech Atten Start $>$ Mech Atten Stop , then Mech Atten Stop = Mech Atten Start	
Preset	10 dB	
State Saved	Saved in instrument state	
Min	0 dB The attenuation set by this control cannot be decreased below 6 dB with the knob or step keys. To get to a value below 6 dB it must be directly entered from the keypad or via SCPI. This protects from adjusting the attenuation to a dangerously small value which can put the instrument at risk of damage to input circuitry. However, if the current mechanical attenuation is below 6 dB it can be increased with the knob and step keys, but not decreased	
Max	CXA Option 503 or 507	50 dB
	EXA	60 dB
	All other models	70 dB
	Note that, in the single attenuator configuration, the total of ATT and EATT cannot exceed 50 dB, so if the EATT is set to 24 dB first, the main attenuation cannot be greater than 26 dB and is reduced accordingly; if the main attenuator is set to 40 dB first, EATT cannot be greater than 10 dB	

6.9.1.34 Mech Atten Step

Determines the Mech Attenuation Step. This determines the points between the Mechanical Attenuation min and max to use for Calibration.

Remote Command	<code>:SYSTem:CALibration:ROW[1] 2 ... 100:ATTenuation:STEP <rel_amp1></code> <code>:SYSTem:CALibration:ROW[1] 2 ... 100:ATTenuation:STEP?</code>
Example	<code>:SYST:CAL:ROW2:ATT:STEP 2dB</code>
Dependencies	Disabled unless " Mech Atten Type " on page 1292 is STEP The SCPI command applies to the currently selected Cal Group If the subopcode does not reference an existing Cal row in the Cal Group, the error message "-221, Settings conflict; Subopcode does not reference an existing Cal row" is generated
Preset	2 dB
State Saved	Saved in instrument state
Min	2 dB
Max	10 dB

6.9.1.35 Elec Atten Type

Specifies the Elec Atten type to use:

- **STEP**: Use multiple Elec Atten states determined by Elec Atten Start, Elec Atten Stop and Elec Atten Step
- **ALL**: Use all the attenuator states
- **BYPass**: Bypasses the attenuator

Remote Command	<code>:SYSTem:CALibration:ROW[1] 2 ... 100:EATTenuation:TYPE STEP ALL BYPass</code> <code>:SYSTem:CALibration:ROW[1] 2 ... 100:EATTenuation:TYPE?</code>
Example	<code>:SYST:CAL:ROW3:EATT:TYPE STEP</code>
Dependencies	The SCPI command applies to the currently selected Cal Group If the subopcode does not reference an existing Cal row in the Cal Group, the error message "-221, Settings conflict; Subopcode does not reference an existing Cal row" is generated
Preset	STEP
State Saved	Saved in instrument state
Range	STEP ALL BYPass

6.9.1.36 Elec Atten Start

Determines the first Electronic Attenuator to be used in the Calibration

6 Input/Output
6.9 Calibration

Remote Command	<code>:SYSTem:CALibration:ROW[1] 2 ... 100:EATTenuation:START <rel_amp1></code> <code>:SYSTem:CALibration:ROW[1] 2 ... 100:EATTenuation:START?</code>
Example	<code>:SYST:CAL:ROW3:EATT:START 0</code>
Dependencies	<p>Only appears in Dual Attenuator models with an Electronic Attenuator installed and licensed. It does not appear in models with the Single Attenuator configuration, as in the single attenuator configuration there is no “electronic attenuator” there is only a single integrated attenuator (which has both a mechanical and electronic stage)</p> <p>Disabled unless "Elec Atten Type" on page 1294 is STEP</p> <p>The electronic attenuator is unavailable above the low band (0-3.6 GHz, 0-3.4 GHz, or 0-3 GHz, depending on the model). If the low band ranges from 0-3.6 GHz, and Stop Frequency of the Calibration is > 3.6 GHz, then this parameter is grayed out</p> <p>If the Internal Preamp is on, meaning it is set to Low Band or Full, or the electronic attenuator is unavailable, then this parameter is grayed-out</p> <p>If either of the above is true, and if the SCPI command is sent, an error indicating that the electronic attenuator is unavailable is sent</p> <p>If both of the above are true, pressing the control generates error message -221, in other words, the frequency range lockout takes precedence</p> <p>The SCPI command applies to the currently selected Cal Group</p> <p>If the subopcode does not reference an existing Cal row in the Cal Group, the error message “-221, Settings conflict; Subopcode does not reference an existing Cal row” is generated</p>
Couplings	Coupled to Elec Atten Stop. Elec Atten Start must be <= Elec Atten Stop. If Elec Atten Start > Elec Atten Stop, Elec Atten Stop = Elec Atten Start
Preset	0 dB
State Saved	Saved in instrument state
Min	0 dB
Max	24 dB

6.9.1.37 Elec Atten Stop

Determines the last Electrical Attenuator to be used in the Calibration

Remote Command	<code>:SYSTem:CALibration:ROW[1] 2 ... 100:EATTenuation:STOP <rel_amp1></code> <code>:SYSTem:CALibration:ROW[1] 2 ... 100:EATTenuation:STOP?</code>
Example	<code>:SYST:CAL:ROW3:EATT:STOP 10</code>
Dependencies	<p>Only appears in Dual Attenuator models with an Electronic Attenuator installed and licensed. It does not appear in models with the Single Attenuator configuration, as in the single attenuator configuration there is no “electronic attenuator” there is only a single integrated attenuator (which has both a mechanical and electronic stage)</p> <p>Disabled unless "Elec Atten Type" on page 1294 is STEP</p> <p>The electronic attenuator is unavailable above the low band (0-3.6 GHz, 0-3.4 GHz or 0-3 GHz, depending on the model). If the low band ranges from 0-3.6 GHz, and Stop Frequency of the</p>

	<p>Calibration is > 3.6 GHz, then this parameter is grayed out</p> <p>If the Internal Preamp is on, meaning it is set to Low Band or Full, the electronic attenuator is unavailable, then this parameter is grayed out</p> <p>If either of the above is true, and if the SCPI command is sent, an error indicating that the electronic attenuator is unavailable is sent</p> <p>If both of the above are true, pressing the control generates error message -221, in other words, the frequency range lockout takes precedence</p> <p>For SCPI, this query applies to the currently selected Cal Group</p> <p>If the subopcode does not reference an existing Cal row in the Cal Group, the error message “-221, Settings conflict; Subopcode does not reference an existing Cal row” is generated</p>
Couplings	Coupled to Elec Atten Start. Elec Atten Stop must be >= Elec Atten Start. If Elec Atten Stop < Elec Atten Start, Elec Atten Start = Elec Atten Stop
Preset	0 dB
State Saved	Saved in instrument state
Min	0 dB
Max	24 dB

6.9.1.38 Elec Atten Step

Determines the Elec Attenuation Step. This determines the points between the Electric Attenuation min and max to use for Calibration.

Remote Command	<pre>:SYSTem:CALibration:ROW[1] 2 ... 100:EATTenuation:STEP <rel_amp></pre> <pre>:SYSTem:CALibration:ROW[1] 2 ... 100:EATTenuation:STEP?</pre>
Example	<pre>:SYST:CAL:ROW2:EATT:STEP 2dB</pre>
Dependencies	<p>Disabled unless "Elec Atten Type" on page 1294 is STEP</p> <p>The SCPI command applies to the currently selected Cal Group</p> <p>If the subopcode does not reference an existing Cal row in the Cal Group, the error message “-221, Settings conflict; Subopcode does not reference an existing Cal row” is generated</p>
Preset	1 dB
State Saved	Saved in instrument state
Min	1 dB
Max	24 dB

6.9.1.39 Full Range Atten Type

Specifies the Full Range Atten type to use. The Full Range Attenuator adds a second input attenuator at the beginning of the RF Input 2, which enhances the protection and optimizes the performance of the extra internal mixers used by RF Input 2.

- **STEP**: Use multiple Full Range Atten states determined by Full Range Atten Start and Full Range Atten Stop
- **ALL**: Use all the attenuator states

Remote Command	<code>:SYSTem:CALibration:ROW[1] 2 ... 100:FATTenuation:TYPE STEP ALL </code> <code>:SYSTem:CALibration:ROW[1] 2 ... 100:FATTenuation:TYPE?</code>
Example	<code>:SYST:CAL:ROW3:FATT:TYPE STEP</code>
Dependencies	Only appears if input RF is selected, and RF Input Port 2 is selected, and the Full Range Attenuator exists The SCPI command applies to the currently selected Cal Group If the subopcode does not reference an existing Cal row in the Cal Group, the error message “-221, Settings conflict; Subopcode does not reference an existing Cal row” is generated
Preset	STEP
State Saved	Saved in instrument state
Range	STEP ALL

6.9.1.40 Full Range Atten Start

Determines the first Full Range Attenuator to be used in the Calibration

Remote Command	<code>:SYSTem:CALibration:ROW[1] 2 ... 100:FATTenuation:START <rel_amp></code> <code>:SYSTem:CALibration:ROW[1] 2 ... 100:FATTenuation:START?</code>
Example	<code>:SYST:CAL:ROW3:FATT:START 0</code>
Dependencies	Only appears in N9041B, when the RF input is selected, and the RF Input Port is set to RF Input 2, and the Full Range Attenuator is installed Disabled unless " Full Range Atten Type " on page 1296 is STEP The SCPI command applies to the currently selected Cal Group If the subopcode does not reference an existing Cal row in the Cal Group, the error message “-221, Settings conflict; Subopcode does not reference an existing Cal row” is generated
Couplings	Coupled to Full Range Atten Stop. Full Range Atten Start must be <= Full Range Atten Stop. If Full Range Atten Start > Full Range Atten Stop, Full Range Atten Stop = Full Range Atten Start
Preset	20 dB
State Saved	Saved in instrument state
Min	0 dB
Max	Only valid values are 0, 6, 14, 20 dB

6.9.1.41 Full Range Atten Stop

Determines the last Full Range Attenuator to be used in the Calibration

Remote Command	<code>:SYSTem:CALibration:ROW[1] 2 ... 100:FATTenuation:STOP <rel_ampl></code> <code>:SYSTem:CALibration:ROW[1] 2 ... 100:FATTenuation:STOP?</code>
Example	<code>:SYST:CAL:ROW3:FAT:PT:STOP 10</code>
Dependencies	Only appears in N9041B, when the RF input is selected, and the RF Input Port is set to RF Input 2, and the Full Range Attenuator is installed Disabled unless " Full Range Atten Type " on page 1296 is <code>STEP</code> The SCPI command applies to the currently selected Cal Group If the subopcode does not reference an existing Cal row in the Cal Group, the error message “-221, Settings conflict; Subopcode does not reference an existing Cal row” is generated
Couplings	Coupled to Full Range Atten Start. Full Range Atten Stop must be \geq Full Range Atten Start. If Full Atten Stop $<$ Full Range Atten Start, Full Range Atten Start = Full Range Atten Stop
Preset	20 dB
State Saved	Saved in instrument state
Min	0 dB
Max	Only valid values are 0, 6, 14, 20 dB

6.9.1.42 Frequency Extender Attenuation Type

Specifies the Frequency Extender Attenuation type to use. **Frequency Extender Attenuation** is applied to the frequency extender’s high frequency input signal path (for example, with a V3050A frequency extender, the high frequency path is 50 GHz to 110 GHz).

- `STEP`: Use multiple Frequency Extender Attenuation states determined by Frequency Extender Attenuation Start and Frequency Extender Attenuation Stop
- `ALL`: Use all the attenuator states

Remote Command	<code>:SYSTem:CALibration:ROW[1] 2 ... 100:FEATtenuation:TYPE STEP ALL</code> <code>:SYSTem:CALibration:ROW[1] 2 ... 100:FEATtenuation:TYPE?</code>
Example	<code>:SYST:CAL:ROW3:FEAT:TYPE STEP</code>
Dependencies	Only applies, and is only visible, when the External RF (ERFIN) input is selected The SCPI command applies to the currently selected Cal Group If the subopcode does not reference an existing Cal row in the Cal Group, the error message “-221, Settings conflict; Subopcode does not reference an existing Cal row” is generated
Preset	<code>STEP</code>
State Saved	No
Range	<code>STEP ALL REFerence</code>

6.9.1.43 Frequency Extender Attenuation Start

Determines the first Frequency Extender Attenuator to be used in the Calibration.

Remote Command	<code>:SYSTem:CALibration:ROW[1] 2 ... 100:FEATtenuation:START <rel_amp1></code> <code>:SYSTem:CALibration:ROW[1] 2 ... 100:FEATtenuation:START?</code>
Example	<code>:SYST:CAL:ROW3:FEAT:START 0</code>
Dependencies	Only applies, and is only visible, when the External RF (ERFIN) input is selected Disabled unless "Frequency Extender Attenuation Type" on page 1298 is STEP The SCPI command applies to the currently selected Cal Group If the subopcode does not reference an existing Cal row in the Cal Group, the error message "-221, Settings conflict; Subopcode does not reference an existing Cal row" is generated
Couplings	Coupled to Frequency Extender Attenuation Stop. Frequency Extender Attenuation Start must be <= Frequency Extender Attenuation Stop. If Frequency Extender Attenuation Start > Frequency Extender Attenuation Stop, Frequency Extender Attenuation Stop = Frequency Extender Attenuation Start
Preset	0 dB
State Saved	Saved in instrument state
Min	0 dB
Max	V3050A: 26 dB

6.9.1.44 Frequency Extender Attenuation Stop

Determines the last Frequency Extender Attenuation to be used in the Calibration.

Remote Command	<code>:SYSTem:CALibration:ROW[1] 2 ... 100:FEATtenuation:STOP <rel_amp1></code> <code>:SYSTem:CALibration:ROW[1] 2 ... 100:FEATtenuation:STOP?</code>
Example	<code>:SYST:CAL:ROW3:FEAT:PT:STOP 26</code>
Dependencies	Only applies, and is only visible, when the External RF (ERFIN) input is selected Disabled unless "Frequency Extender Attenuation Type" on page 1298 is STEP The SCPI command applies to the currently selected Cal Group If the subopcode does not reference an existing Cal row in the Cal Group, the error message "-221, Settings conflict; Subopcode does not reference an existing Cal row" is generated
Couplings	Coupled to Frequency Extender Attenuation Start. Frequency Extender Attenuation Stop must be >= Frequency Extender Attenuation Start. If Frequency Extender Attenuation Stop < Frequency Extender Attenuation Start, Frequency Extender Attenuation Start = Frequency Extender Attenuation Stop
Preset	26 dB
State Saved	Saved in instrument state
Min	0 dB
Max	V3050A: 26 dB

6.9.1.45 Frequency Extender Atten Step

Determines the Frequency Extender Attenuation Step. This determines the points between the Frequency Extender Attenuation min and max to use for Calibration.

Remote Command	<code>:SYSTem:CALibration:ROW[1] 2 ... 100:FEATtenuation:STEP <rel_amp1></code> <code>:SYSTem:CALibration:ROW[1] 2 ... 100:FEATtenuation:STEP?</code>
Example	<code>:SYST:CAL:ROW2:FEAT:STEP 2dB</code>
Dependencies	Only applies, and is only visible, when the External RF (ERFIN) input is selected The SCPI command applies to the currently selected Cal Group If the subopcode does not reference an existing Cal row in the Cal Group, the error message “-221, Settings conflict; Subopcode does not reference an existing Cal row” is generated
Preset	1 dB
State Saved	No
Min	1 dB
Max	V3050A: 26 dB

6.9.1.46 IF Path

Determines the IF Path to be used in the Calibration.

Remote Command	<code>:SYSTem:CALibration:ROW[1] 2 ... 100:IF:PATH B10M B25M B40M B85M B125M B140M B160M B255M B510M B1G B1500M B2G B4G EXT</code> <code>:SYSTem:CALibration:ROW[1] 2 ... 100:IF:PATH?</code>	
Example	<code>:SYST:CAL:ROW2:IF:PATH B25M</code>	
Notes	B10M	10 MHz
	B25M	25 MHz
	B40M	40 MHz
	B85M	85 MHz
	B125M	125 MHz
	B140M	140 MHz
	B160M	160 MHz
	B255M	255 MHz
	B510M	510 MHz
	B1G	1 GHz
	B1500M	1.5 GHz
	B2G	2 GHz

6 Input/Output
6.9 Calibration

	B4G	4 GHz
	EXT	Depends on the hardware
	In cases where the path is not available but is selected via SCPI, generates error -241, "Hardware missing; Option not installed"	
Dependencies	Path	Availability requires Installation of:
	25 MHz	25 MHz or wider IF Bandwidth option
	40 MHz	40 MHz or wider IF Bandwidth option
	85 MHz	85 MHz or wider IF Bandwidth option
	125 MHz	125 MHz or wider IF Bandwidth option
	140 MHz	Option B1X
	160 MHz	Option B1Y. B1Y cannot be installed without B1X
	255 MHz	Option B2X or wider IF Bandwidth option
	510 MHz	Option B5Y or wider IF Bandwidth option
	1 GHz	Option H1G/B1G or wider IF Bandwidth option
	2 GHz	Option B2G(R20) or wider IF Bandwidth option
	4 GHz	Option B4G(R40) or wider IF Bandwidth option
	1.5 GHz	Option R15
	If Option B85 <i>and</i> either Option B1A or Option B1X are installed, the 85 MHz option does not appear, and B85M is disabled. Sending the command to select B85M in this case generates an error -221, "Settings Conflict; Use wider bandwidth selection"	
	If Option B1A <i>and</i> Option B1X are both installed, the 125 MHz option does not appear, and B125M is disabled. Sending the command to select B125M in this case generates an error -221, "Settings Conflict; Use wider bandwidth selection"	
	In cases where the path is not available, but is selected via SCPI, error -241, "Hardware missing; Option not installed" is generated	
	The preset value depends on the Digital IF BW setting of the default measurement	
Preset	If the 25 MHz path is not available, presets to 10 MHz	
State Saved	No	
Range	B10M B25M B40M B85M B125M B140M B160M B255M B510M B1G B1500M B2G B4G EXT	

6.9.1.47 IF Gain

Determines the IF Gain to be used in the Calibration

Remote Command	<code>:SYSTem:CALibration:ROW[1] 2 ... 100:IF:GAIN[:STATE]AUTO HIGH LOW ALL</code> <code>:SYSTem:CALibration:ROW[1] 2 ... 100:IF:GAIN[:STATE]?</code>
----------------	--

Example	<code>:SYST:CAL:ROW3:IF:GAIN ALL</code>
Dependencies	The SCPI command applies to the current selected Cal Group If the subopcode does not reference an existing Cal row in the Cal Group, the error message “-221, Settings conflict; Subopcode does not reference an existing Cal row” is generated
Preset	<code>AUTO</code>
State Saved	Saved in instrument state
Range	Auto High Gain Low Gain All

6.9.1.48 Preamp

Determines if the Preamp is to be used in the Calibration

Remote Command	<code>:SYSTem:CALibration:ROW[1] 2 ... 100:POWer[:RF]:GAIN:BAND OFF LOW FULL</code> <code>:SYSTem:CALibration:ROW[1] 2 ... 100:POWer:GAIN:BAND?</code>
Example	<code>:SYST:CAL:ROW2:POWer:GAIN:BAND OFF</code>
Dependencies	The SCPI command applies to the current selected Cal Group If the subopcode does not reference an existing Cal row in the Cal Group, the error message “-221, Settings conflict; Subopcode does not reference an existing Cal row” is generated
Preset	<code>OFF</code>
State Saved	Saved in instrument state
Range	<code>OFF LOW FULL</code>

6.9.1.49 Low Noise Amplifier (LNA)

Determines if the LNA is to be used in the Calibration.

Remote Command	<code>:SYSTem:CALibration:ROW[1] 2 ... 100:POWer[:RF]:GAIN:LNA[:STATe] ON OFF 1 0</code> <code>:SYSTem:CALibration:ROW[1] 2 ... 100:POWer[:RF]:GAIN:LNA[:STATe]?</code>
Example	<code>:SYST:CAL:ROW2:POW:GAIN:LNA ON</code> <code>:SYST:CAL:ROW2:POW:GAIN:LNA?</code>
Dependencies	The SCPI command is applied to the currently selected Cal Group. The subopcode is used to identify the Cal row in the Cal Group If the subopcode does not reference an existing Cal row in the Cal Group, the error message “-221, Settings conflict; Subopcode does not reference an existing Cal row” is generated
Preset	<code>OFF</code>
State Saved	No
Range	<code>ON OFF</code>

6.9.1.50 μ W Path Control

Determines the μ W Path Control to be used in the Calibration.

Option	SCPI
Standard Path	STD
Low Noise Path	LNPath
μ W Presel Bypass	MPBypass
Full Bypass	FULL

Remote Command	<code>:SYSTEM:CALibration:ROW[1] 2 ... 100:POWer[:RF]:MW:PATH STD LNPath MPBypass FULL</code> <code>:SYSTEM:CALibration:ROW[1] 2 ... 100:POWer[:RF]:MW:PATH?</code>
Example	<code>:SYST:CAL:ROW2:POW:MW:PATH FULL</code>
Dependencies	<p>The SCPI command applies to the current selected Cal Group</p> <p>If the subopcode does not reference an existing Cal row in the Cal Group, the error message “-221, Settings conflict; Subopcode does not reference an existing Cal row” is generated</p> <p>This column is not shown in the table unless <i>either</i> Option MPB or Option LNB is present and licensed</p> <p>The Low Noise Path selection does not appear unless Option LNP is present and licensed</p> <p>The μW Presel Bypass selection does not appear unless Option MPB is present and licensed</p> <p>The Full Bypass selection does not appear unless Options LNP, MPB and FBP are installed and licensed</p> <p>In any of these cases, if the required options are not present and the SCPI command is sent, error - 241, "Hardware missing; Option not installed" is generated</p>
Preset	STD
State Saved	Saved in instrument state
Range	STD LNPath MPBypass FULL

6.9.1.51 Coupling

Determines the Coupling to be used in the Calibration

Remote Command	<code>:SYSTEM:CALibration:ROW[1] 2 ... 100:COUPling AC DC</code> <code>:SYSTEM:CALibration:ROW[1] 2 ... 100:COUPling?</code>
Example	<code>:SYST:CAL:ROW3:COUP AC</code>
Dependencies	<p>The SCPI command applies to the current selected Cal Group</p> <p>If the subopcode does not reference an existing Cal row in the Cal Group, the error message “-221, Settings conflict; Subopcode does not reference an existing Cal row” is generated</p>
Preset	AC

State Saved	Saved in instrument state
Range	AC DC

6.9.1.52 Phase Noise Optimization

Selects the LO (local oscillator) phase noise behavior for various desired operating conditions.

For full details, see "[Parameter Options & Installed Options](#)" on page 1304 below.

Remote Command	<code>:SYSTem:CALibration:ROW[1] 2 ... 100:FREQuency:SYNTHeSis[:STATe] 1 ... 5</code> For the meaning of each numeric option value, see " Parameter Options & Installed Options " on page 1304 below <code>:SYSTem:CALibration:ROW[1] 2 ... 100:FREQuency:SYNTHeSis[:STATe]?</code>
Example	Select optimization for best wide offset phase noise: <code>:SYST:CAL:ROW1:FREQ:SYNT 2</code>
Dependencies	The SCPI command applies to the current selected Cal Group If the subopcode does not reference an existing Cal row in the Cal Group, the error message "-221, Settings conflict; Subopcode does not reference an existing Cal row" is generated
Couplings	Coupled with " Phase Noise Optimization All Option " on page 1309 When Phase Noise Optimization All is ON , selects all available LO mappings, and Phase Noise Optimization parameter will display All in the Configuration table. SCPI Query is still available to determine which parameter will be displayed when Phase Noise Optimization All is OFF
Preset	2
State Saved	Yes
Range	See " Ranges " on page 1309 below
Min	1
Max	5

Parameter Options & Installed Options

The Phase Noise Optimization control lets you optimize the setup and behavior of the Local Oscillator (LO) depending on your specific measurement conditions. You may wish to trade off noise and speed, for example, to make a measurement faster without regard to noise or with optimum noise characteristics without regard to speed.

Parameter Values Summary

Option	#	Description
"Balanced" on page 1306	1	- In instruments with EPO, balances close-in phase noise with spur avoidance

Option	#	Description
		– In instruments without EPO optimizes phase noise for small frequency offsets from the carrier
"Best Wide-offset" on page 1306	2	Optimizes phase noise for wide frequency offsets from the carrier
"Fast Tuning" on page 1306	3	Optimizes LO for tuning speed
"Best Close-in" on page 1305	4 or 1*	– In instruments with EPO, emphasizes close-in phase noise performance without regard to spur avoidance – In instruments without EPO, this setting is accepted but no action is taken
"Best Spurs" on page 1306	5	– In instruments with EPO, emphasizes spur avoidance over close-in phase noise performance – In instruments without EPO, this setting is accepted but no action taken
Auto	-	Automatically selects LO (local oscillator) phase noise behavior to optimize dynamic range and speed for various instrument operating conditions

*Dependent on Option EPO installation. See "Best Close-in" on page 1305 below.

The actual behavior varies somewhat depending on model number and option; for example, you always get Fast Tuning by choosing Option #3, but in some models, "Fast Tuning" on page 1306 is identical in effect to "Best Close-in" on page 1305.

Best Close-in

Without option EPO

`:FREQ:SYNT 1`

The LO phase noise is optimized for smaller offsets from the carrier, at the expense of phase noise farther out.

The actual frequency offset within which noise is optimized is shown with in square brackets, as this can vary depending on the hardware set in use. For example, in some instruments this annotation appears as [offset < 20 kHz]

With option EPO

`:FREQ:SYNT 4`

In instruments with Option EPO, the LO is configured for the best possible close-in phase noise (offsets up to 600 kHz from the carrier), regardless of spurious products that occur with some center frequencies. Because this is generally less desirable for close-in measurements than the "Balanced" on page 1306 setting, parameter 1 selects "Balanced" on page 1306 in EPO instruments, in the interests of optimizing

code compatibility across the family. Parameter 4 selects "Best Close-in" on page 1305, which is usually not as good a choice as "Balanced" on page 1306.

Balanced

:FREQ:SYNT 1

In instruments with EPO, the LO is configured for the best possible phase noise at offsets up to 600 kHz from the carrier whenever there are no significant spurs within the span observed with an on-screen carrier. When there will be such a spur, the LO is reconfigured in a way that allows the phase noise to increase by 7 dB mostly within ± 1 octave around 400 kHz offset. The spurs will always be below -70 dBc.

Best Spurs

:FREQ:SYNT 5

In instruments with EPO, the LO is configured for better phase noise than the "Best Wide-offset" on page 1306 case close to the carrier, but the configuration has 11 dB worse phase noise than the "Best Close-in" on page 1305 case mostly within ± 1 octave around 300 kHz offset. Spurs are even lower than in the "Balanced" on page 1306 case at better than -90 dBc, whether or not the carrier is on-screen.

This setting is never selected when Phase Noise Optimization is in Auto, you must select it manually.

Best Wide-offset

:FREQ:SYNT 2

The LO phase noise is optimized for wider offsets from the carrier. Optimization is especially improved for offsets from 70 kHz to 300 kHz. Closer offsets are compromised and the throughput of measurements (especially remote measurements where the center frequency is changing rapidly), is reduced.

The actual frequency offset beyond which noise is optimized is shown with in square brackets, as this can vary depending on the hardware set in use. For example, in some instruments this annotation appears as [offset >30 kHz]

In instruments with Option EPO, the LO is configured for the best possible phase noise at offsets up to 600 kHz from the carrier whenever there are no significant spurs within the span observed with an on-screen carrier. When there will be such a spur, the LO is reconfigured in a way that allows the phase noise to increase by 7 dB mostly within ± 1 octave around 400 kHz offset. The spurs will always be below -70 dBc.

Fast Tuning

:FREQ:SYNT 3

In this mode, the LO behavior compromises phase noise at many offsets from the carrier in order to allow rapid measurement throughput when changing the center frequency or span. The term **"Fast Tuning" on page 1306** refers to the time it takes to move the local oscillator to the start frequency and begin a sweep; this setting does not impact the actual sweep time in any way.

In instruments with EP1, the LO behavior compromises phase noise at offsets below 4 MHz in order to improve measurement throughput. The throughput is especially affected when moving the LO more than 2.5 MHz and up to 10 MHz from the stop frequency to the next start frequency.

In instruments with Option EPO, this is the same configuration as **"Best Spurs" on page 1306**. It is available with the **"Fast Tuning" on page 1306** label for convenience, and to make the user interface more consistent with other X-Series instrument family members.

(In models whose hardware does not provide for a **"Fast Tuning" on page 1306** option, the settings for **"Best Close-in" on page 1305** are used if **"Fast Tuning" on page 1306** is selected. This gives the fastest possible tuning for that hardware set.)

Auto

:FREQ:SYNT:AUTO ON

Selects the LO (local oscillator) phase noise behavior to optimize dynamic range and speed for various instrument operating conditions. The selection rules are as follows.

Auto Optimization Rules

X-Series instruments have several grades of LO, offering different configurations when in the Auto Mode. The rules for Auto selection are as follows:

Models with Option	Conditions	Selection
EPO	Center frequency is < 699.9 kHz	"Balanced" on page 1306
Models with option EPO have a two stage local oscillator, which switches to a single loop for fast tuning (available in UXA)	Span > 114.1 MHz, <i>or</i>	"Fast Tuning" on page 1306
	RBW > 800 kHz	"Fast Tuning" on page 1306
	RBW > 290 kHz, <i>or</i>	"Best Wide-offset" on page 1306
	Span > 4.2 MHz	"Best Wide-offset" on page 1306
	Other conditions	"Balanced" on page 1306
EP1	Span > 44.44 MHz, <i>or</i>	"Fast Tuning" on page 1306
Models with option EP1 have a two-	RBW > 1.9 MHz, <i>or</i>	"Fast Tuning" on page 1306

Models with Option	Conditions	Selection
loop local oscillator, which switches to a single loop for fast tuning (available in PXA)	Source Mode is set to "Tracking" Center frequency is < 195 kHz, <i>or</i> CF \geq 1 MHz <i>and</i> Span \leq 1.3 MHz <i>and</i> RBW \leq 75 kHz All other conditions	"Best Close-in" on page 1305 "Best Wide-offset" on page 1306
EP2 Models with option EP2 use a different loop bandwidth for the fast-tuning choice, which is a compromise between tuning speed and phase noise, giving good tuning speed at all offsets. Although not as good as for "Best Close-in" on page 1305; this is useful when you have to look across a wide range of spans (available, for example, in MXA for excellent phase noise)	CF < 130 kHz, <i>or</i> CF > 12 MHz <i>and</i> Span < 495 kHz <i>and</i> RBW < 40 kHz Span > 22 MHz, <i>or</i> RBW > 400 kHz, <i>or</i> CF \leq 12 MHz <i>and</i> Span < 495 kHz <i>and</i> RBW < 23 kHz All other conditions	"Best Close-in" on page 1305 "Fast Tuning" on page 1306 "Best Wide-offset" on page 1306
EP4 (available in CXA for improved phase noise)	Span > 101 MHz <i>or</i> RBW > 1.15 MHz <i>or</i> Source Mode is set to "Tracking" CF is < 109 kHz <i>or</i> CF \geq 4.95 MHz <i>and</i> Span \leq 666 kHz <i>and</i> RBW < 28 kHz All other conditions	"Fast Tuning" on page 1306 "Best Close-in" on page 1305 "Best Wide-offset" on page 1306
All Other Models Note that in these models, the hardware does not actually provide for an extra-fast tuning option, so the settings for "Fast Tuning" on page 1306 are actually the same as "Best Close-in" on page 1305, but the rules are implemented this way so that the user who doesn't care about phase noise but does care about tuning speed doesn't have to remember which of the other two settings gives faster tuning	Span > 12.34 MHz, <i>or</i> RBW > 250 kHz, <i>or</i> Source Mode is set to "Tracking" Center frequency is < 25 kHz, <i>or</i> CF \geq 1 MHz <i>and</i> Span \leq 141.4 kHz <i>and</i> RBW \leq 5 kHz All other conditions	"Fast Tuning" on page 1306 "Best Close-in" on page 1305 "Best Wide-offset" on page 1306

In all the above cases:

- The RBW to be used in the calculations is the equivalent -3 dB bandwidth of the current RBW filter
- The rules apply whether in swept spans, zero span, or FFT spans

Ranges

Option	Option #	Phase Noise Option	Range
No EPx Option	1	Best Close-in	[offset < 20 kHz]
	2	Best Wide-offset	[offset > 30 kHz]
	3	Fast Tuning	[same as Best Close-In]
EPO	4	Best Close-in	[offset < 600 kHz]
	1	Balanced	[offset < 600 kHz]
	5	Best Spurs	[offset < 600 kHz]
	2	Best Wide-offset	[offset > 800 kHz]
EP1	3	Fast Tuning	[same as Best Close-In]
	1	Best Close-in	[offset < 140 kHz]
	2	Best Wide-offset	[offset > 160 kHz]
EP2, EP3, EP5	3	Fast Tuning	[single loop]
	1	Best Close-in	[offset < 70 kHz]
	2	Best Wide-offset	[offset > 100 kHz]
EP4	3	Fast Tuning	[medium loop bw]
	1	Best Close-in	[offset < 90 kHz]
	2	Best Wide-offset	[offset > 130 kHz]
	3	Fast Tuning	[same as Best Close-In]

6.9.1.53 Phase Noise Optimization All Option

Selects all available LO settings

Remote Command	<code>:SYSTem:CALibration:ROW[1] 2 ... 100:FREQuency:SYNTHeSis:ALL[:STATe] ON OFF 1 0 :SYSTem:CALibration:ROW[1] 2 ... 100:FREQuency:SYNTHeSis:ALL[:STATe]?</code>
Example	<code>:SYST:CAL:ROW1:FREQ:SYNT:ALL ON</code>
Notes	When this parameter is ON , it overrides the Phase Noise Optimization parameter, and selects all available LO settings
Dependencies	The SCPI command applies to the current selected Cal Group If the subopcode does not reference an existing Cal row in the Cal Group, the error message “-221, Settings conflict; Subopcode does not reference an existing Cal row” is generated

Couplings	Coupled with " Phase Noise Optimization " on page 1304. When this parameter is ON , it selects all available LO mappings, and Phase Noise Optimization parameter displays All in the Configuration table. When this parameter is OFF , the Phase Noise Optimization parameter displays its previously set value in the Configuration table
Preset	OFF
State Saved	Saved in instrument state
Range	ON OFF

6.9.1.54 Mixing Mode

Determines the LO Mixing Mode to be used.

Remote Command	<code>:SYSTem:CALibration:ROW[1] 2 ... 100:LO:MMODE NORMa1 ALTErnate ALL</code> <code>:SYSTem:CALibration:ROW[1] 2 ... 100:LO:MMODE?</code>
Example	<code>:SYST:CAL:ROW3:LO:MMOD NORM</code>
Dependencies	The SCPI command applies to the current selected Cal Group If the subopcode does not reference an existing Cal row in the Cal Group, the error message “-221,Settings conflict; Subopcode does not reference an existing Cal row” is generated
Preset	NORMa1
State Saved	Saved in instrument state
Range	NORMa1 ALTErnate ALL

6.9.1.55 Match State

Determines if the Cal settings must match exactly when applying the correction. If not, the system may find the closest matching state or interpolate between states.

Remote Command	<code>:SYSTem:CALibration:ROW[1] 2 ... 100:MATCH[:STATE] ON OFF 1 0</code> <code>:SYSTem:CALibration:ROW[1] 2 ... 100:MATCH[:STATE]?</code>
Example	<code>:SYST:CAL4:MATC ON</code> <code>:SYST:CAL4:MATC?</code>
Dependencies	The SCPI command is applied to the currently selected Cal Group. The subopcode is used to identify the Cal row in the Cal Group If the subopcode does not reference an existing Cal row in the Cal Group, the error message “-221, Settings conflict; Subopcode does not reference an existing Cal row” is generated
Preset	All True
State Saved	Saved in instrument state
Range	True False

6.9.2 Cal Group

Specifies the selected Calibration Group. You can use different Cal Groups for different external hardware configurations. The Cal Group is also an important concept when sending SCPI commands to the Calibration System, because in each case the SCPI command is directed to the currently-selected Cal Group, which is the Cal Group that is modified by the SCPI command.

Remote Command	<code>:SYSTem:CALibration:CGRoup <integer></code> <code>:SYSTem:CALibration:CGRoup?</code>
Example	<code>:SYST:CAL:CGR 2</code> <code>:SYST:CAL:CGR?</code>
Preset	1
Min	1
Max	100

6.9.3 Apply Cal Group

Controls whether or not the checked **Apply** rows of the currently selected Cal Group are applied.

Remote Command	<code>:SYSTem:CALibration:CGRoup:APPLy <bool></code> <code>:SYSTem:CALibration:CGRoup:APPLy?</code>
Example	<code>:SYST:CAL:CGR:APPL ON</code> <code>:SYST:CAL:CGR:APPL?</code>
Dependencies	The SCPI command is applied to the currently selected Cal Group You can only turn on Apply Cal Group if at least one Cal for the currently selected group has been executed. If you attempt to select Apply Cal Group before any Cals have been executed, the advisory message "At least one Row must be calibrated before it can be applied" is displayed
Preset	OFF
State Saved	Saved in instrument state
Range	ON OFF
Annotation	If <i>any</i> Cal Group is ON , RCal in the Meas Bar displays in amber, to indicate that Calibrations are in use

6.9.4 All Apply Cal Group Off

Turns off **Apply Cal Group** for all groups.

Remote	<code>:SYSTem:CALibration:CGRoup:APPLy:AOff</code>
--------	--

Command

Example `:SYST:CAL:CGR:APPL:AOFF`

6.9.5 Connection

Opens the **Connection** dialog, which provides step-by-step instructions for its use.

6.10 Calibrator Control

Lets you select a calibrator and control the calibrator settings.

6.10.1 Select Cal Source

Lets you select the calibrator to control.

Remote Command	<code>:SYSTem:CALibration:TUNE[:SELEcted] NONE REF50 REF4800 TUNAb1e CALOUT RCM1 RCM2 RCM3 RCM4 RCM5 RCM6 RCM7 RCM8 RCM9 RCM10</code> <code>:SYSTem:CALibration:TUNE[:SELEcted]?</code>												
Example	<code>:SYST:CAL:TUNE:SEL TUNABLE</code> <code>:SYST:CAL:TUNE?</code>												
Notes	Options are: <table border="1"> <tr> <td><code>NONE</code></td> <td>No calibrator selected</td> </tr> <tr> <td><code>TUNAb1e</code></td> <td>Tunable internal calibrator present in N9042B</td> </tr> <tr> <td><code>CALOUT</code></td> <td>Tunable calibrator available through CALOUT front panel port in N9042B</td> </tr> <tr> <td><code>REF50</code></td> <td>50 MHz calibrator</td> </tr> <tr> <td><code>REF4800</code></td> <td>4.8 GHz calibrator</td> </tr> <tr> <td><code>RCM1 – RCM10</code></td> <td>RCal module</td> </tr> </table>	<code>NONE</code>	No calibrator selected	<code>TUNAb1e</code>	Tunable internal calibrator present in N9042B	<code>CALOUT</code>	Tunable calibrator available through CALOUT front panel port in N9042B	<code>REF50</code>	50 MHz calibrator	<code>REF4800</code>	4.8 GHz calibrator	<code>RCM1 – RCM10</code>	RCal module
<code>NONE</code>	No calibrator selected												
<code>TUNAb1e</code>	Tunable internal calibrator present in N9042B												
<code>CALOUT</code>	Tunable calibrator available through CALOUT front panel port in N9042B												
<code>REF50</code>	50 MHz calibrator												
<code>REF4800</code>	4.8 GHz calibrator												
<code>RCM1 – RCM10</code>	RCal module												
Dependencies	If the selected calibrator is not available, it does not appear in the dropdown. If you send SCPI to select a calibrator that is not available, the instrument generates an error												
Couplings	Selecting <code>REF50</code> sets the RF Calibrator to <code>REF50</code> Selecting <code>REF4800</code> sets the RF Calibrator to <code>REF4800</code> Selecting a calibrator source other than <code>REF50</code> or <code>REF4800</code> sets RF Calibrator to <code>OFF</code>												
Preset	Unaffected by Mode Preset . Set to <code>NONE</code> by Restore Input/Output Defaults or Restore System Defaults->All												

6.10.2 Cal Output

Lets you set the selected calibrator's RF power output state.

Remote Command	<code>:SYSTem:CALibration:TUNE:OUTput[:STATe] ON OFF 1 0</code> <code>:SYSTem:CALibration:TUNE:OUTput[:STATe]?</code>
Example	<code>:SYST:CAL:TUNE:OUTP ON</code> <code>:SYST:CAL:TUNE:OUTP?</code>

Preset	Unaffected by Mode Preset . Set to OFF by Restore Input/Output Defaults or Restore System Defaults->All
--------	--

6.10.3 Cal Frequency

Lets you set the selected calibrator's frequency.

Remote Command	<code>:SYSTem:CALibration:TUNE:FREQuency <freq></code> <code>:SYSTem:CALibration:TUNE:FREQuency?</code>
Example	Set source frequency to 150 MHz: <code>:SYST:CAL:TUNE:FREQ 150000000</code>
Preset	Unaffected by Mode Preset . Set to 1 GHz by Restore Input/Output Defaults or Restore System Defaults->All
Min/Max	Depend on the selected calibrator

6.10.4 Cal Signal Type

Lets you set the selected calibrator's signal type.

Remote Command	<code>:SYSTem:CALibration:TUNE:TYPE CW COMB</code> <code>:SYSTem:CALibration:TUNE:TYPE?</code>
Example	<code>:SYST:CAL:TUNE:TYPE CW</code> <code>:SYST:CAL:TUNE:TYPE?</code>
Dependencies	If the selected calibrator does not support a signal type, then that type is disabled in the dropdown Changing the signal type to a disabled option generates an error
Preset	Unaffected by Mode Preset . Set to CW by Restore Input/Output Defaults or Restore System Defaults->All

6.10.5 Cal Comb Spacing

Lets you set the calibrator's comb spacing, when the signal type is **COMB**.

Remote Command	<code>:SYSTem:CALibration:TUNE:SPACing <freq></code> <code>:SYSTem:CALibration:TUNE:SPACing?</code>
Example	Set comb spacing to 1 MHz: <code>:SYST:CAL:TUNE:SPAC 1000000</code>
Dependencies	Only appears when COMB is selected as "Cal Signal Type" on page 1314 If the selected calibrator does not support the Comb signal, attempting to set the spacing generates an error

6 Input/Output
6.10 Calibrator Control

Preset	Unaffected by Mode Preset . Set to 0 Hz by Restore Input/Output Defaults or Restore System Defaults->All
Min/Max	Dependent on the selected calibrator

6.10.6 Calibrator Reference

Determines the frequency reference type used by the RCal module of the currently selected Cal Group

Remote Command	<code>:SYSTem:CALibration:TUNE:REFerence INTERNAL EXTERNAL</code> <code>:SYSTem:CALibration:TUNE:REFerence?</code>
Example	Set the calibrator frequency reference to Internal: <code>:SYSTem:CALibration:TUNE:REFerence INTERNAL</code>
Dependencies	Only displayed when an RCal module is the selected calibrator
Preset	Unaffected by Mode Preset . Set to preset value by Restore Input/Output Defaults or Restore System Defaults->All
Range	<code>INTERNAL EXTERNAL</code>

6.11 Advanced

6.11.1 T/R Port High Power Attenuator

Controls whether additional attenuation is added at the T/R Port. The T/R port has two input paths, one that provides a 16 dB attenuator, and the other that bypasses this attenuator.

- When **ON**, the path includes the 16 dB attenuator, so the max input level for this path is +47 dBm (50 W)
- When **OFF**, the 16 dB attenuator is bypassed, so the max input level for this path is +33 dBm (2 W)

If the attenuator is turned off, the following warning message is displayed and confirmation that the attenuator is to be turned off is required;

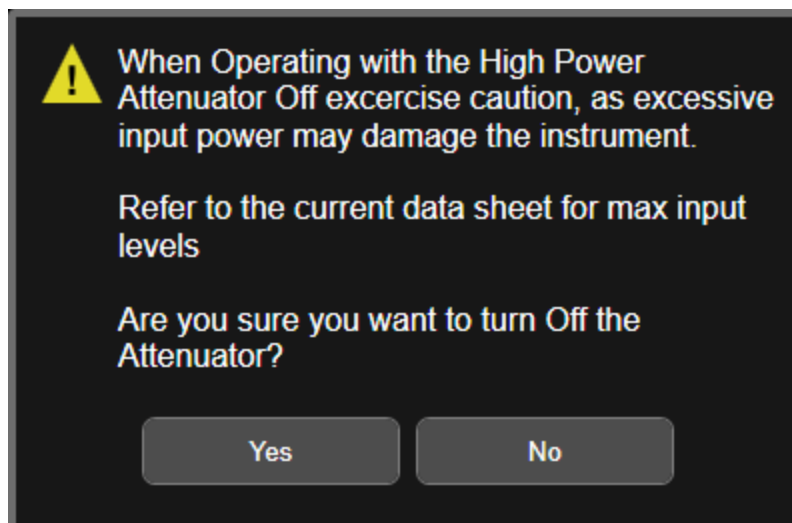

Whenever the attenuator is bypassed (**OFF**), a warning appears in the status bar: "Input caution; T/R unprotected"

In the case of an input overload at the T/R input, (>2 W with Attenuator off, or >50 W with attenuator on), or an over-temperature at the T/R input, the input is disconnected, and a dialog is displayed, stating:

"CAUTION! Excessive power has been detected at the T/R Port. The input has been disconnected. Remove the high signal power and press OK"

Or:

6 Input/Output
6.11 Advanced

“CAUTION! Over temperature has been detected at the T/R Port. The input has been disconnected. Remove the signal, allow to cool & press OK”

Until you press **OK**, the input remains disconnected, and no measurement can be made.

Remote Command	<code>[:SENSe]:FEED:RF:PORT:TR:HPOWer:ATTenuator[:STATe] ON OFF</code> <code>[:SENSe]:FEED:RF:PORT:TR:HPOWer:ATTenuator[:STATe]?</code>
Example	<code>:FEED:RF:PORT:TR:HPOW:ATT ON</code> <code>:FEED:RF:PORT:TR:HPOW:ATT?</code>
Dependencies	Only appears in modular analyzers, and only when the M9470A module is installed, such as in M8920A. Option HDX is required to enable the T/R port
Preset	<code>ON</code>
State Saved	Saved in instrument state

6.12 Aux I/O Control

This menu is only available with Option LSN, indicating that the LISN IO board is installed. It is used to control each of the eight control lines out of the rear panel connector independently. There are eight bits of control lines. The LISN Control (Mode setup) of the EMI Receiver application affects the **AUX I/O Control** settings. Whenever you change the LISN Control in Mode Setup, the corresponding AUX I/O Control data lines will also be changed. The selection at the AUX I/O Control does not affect the LISN Control (Mode Setup) setting.

6.12.1 Data 0 – Data 7

Sets the value for Data 0 through Data 7 respectively.

Remote Command	<code>:OUTPut:AUX:IO:DATA<n> OFF ON 0 1</code> where <n> in an integer 0 - 7
Example	<code>:OUTP:AUX:IO:DATA0 OFF</code>
Notes	Unaffected by Mode Preset , but Input/Output Preset presets the value to ON for all 8 data lines
Preset	ON
Range	OFF ON

6.12.2 Aux IO Control (Remote Command Only)

Sets/Queries the value for all 8 data lines.

Remote Command	<code>:OUTPut:AUX:IO <Value></code> <code>:OUTPut:AUX:IO?</code>
Example	<code>:OUTP:AUX:IO 31</code>
Notes	Unaffected by Mode Preset , but Input/Output Preset presets the value to ON for all 8 data lines
Couplings	The states of Data 0 to Data 7 under the AUX I/O Control panel (Input/Output menu) change according to the keyed-in AUX IO value
Preset	31
Min	0
Max	255
Backwards Compatibility SCPI	<code>:OUTPut:UPORt <Value></code>

7 Save/Recall/Print

This section describes the functions that can be accessed via the front panel **Save**, **Quick Save**, and **Recall** hardkeys, as well as via the controls in the front-panel folder icon, as shown below.

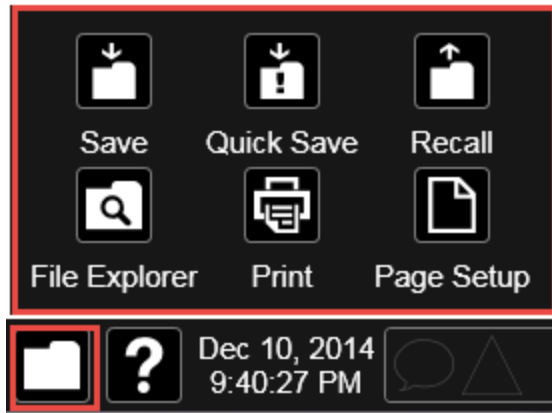

7.1 Quick Save

Quick Save repeats the previous Save at the touch of a single button. Whatever you saved before gets saved again to the same directory, and with a filename derived from the previous filename.

You access Quick Save by pressing the **Quick Save** hardkey, or by pressing the folder icon at the bottom of the display and then pressing the **Quick Save** icon. In addition, if you have a PC keyboard plugged in, the sequence **CTL-Q** will perform a Quick Save.

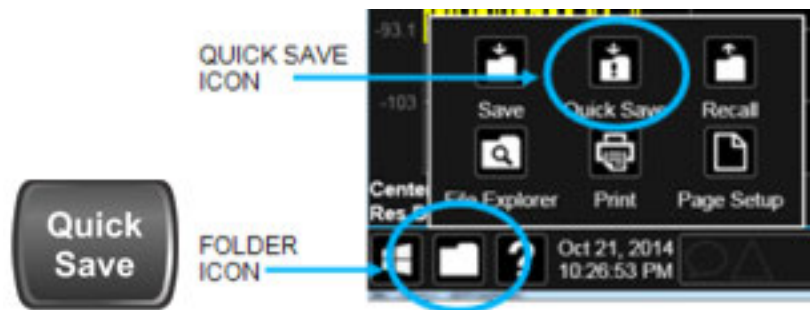

The **Quick Save** front-panel key repeats the most recent save that was performed from the **Save** menu, with the following exceptions:

- Register saves are not remembered as Saves for the purpose of the Quick Save function
- If the current measurement does not support the last non-register save that was performed, an informational message is generated, "File type not supported for this measurement"

Quick Save repeats the last type of qualified save (that is, a save qualified by the above criteria) in the last save directory by creating a unique filename using the Auto File Naming algorithm described below.

If the previous save was a Screen Image save, Quick Save saves a Screen Image when the Quick Save button is pressed. This image is *exactly* what is on the screen when the **Quick Save** button is pressed. Quick Save does *not* force a dialog exit or navigate in any way, it simply snaps the image on the screen and saves it. This lets you save images of dialogs and setup screens that would be impossible to save using the **Save** dialog.

NOTE

When **Quick Save** is pressed the display theme changes to the theme specified by the **Screen Image Theme** control in order to take the screen shot, and then changes back to the Display Theme, but no navigation is performed, and no dialogs are exited.

If **Quick Save** is pressed after startup and before any qualified Save has been performed, the Quick Save function performs a Screen Image save using the current settings for Screen Image saves (current theme, current directory), which then becomes the “last save” for the purpose of subsequent Quick Saves.

The Auto File Naming feature automatically generates a file name for use when saving a file. The filename consists of a prefix and suffix separated by a dot, as is standard for the Windows file system. A default prefix exists for each of the available file types:

Type	Default Prefix	Menu
State	State_	(Save/Recall)
Trace + State	State_	(Save/Recall)
Screen	Screen_	(Save/Recall)
Amplitude Corrections	Ampcor_	(Import/Export)
Traces	Trace_	(Import/Export)
Limit Lines	Limit_	(Import/Export)
Measurement Result	MeasR_	(Import/Export)
Capture Buffer	CapBuf_	(Import/Export)

A four-digit number is appended to the prefix to create a unique file name. The numbering sequence starts at 0000 within each Mode for each file type and updates incrementally to 9999, then wraps to 0000 again. It remembers where it was through a Mode Preset and when leaving and returning to the Mode. It is reset by Restore Misc Defaults and Restore System Defaults and subsequent running of the instrument application. So, for example, the first auto file name generated for State files is **State_0000.state**. The next is **State_0001**, and so forth.

One of the key features of Auto File Name is that we guarantee that the Auto File Name will never conflict with an existing file. The algorithm looks for the next available number. If it gets to 9999, then it looks for holes. If it find no holes, that is no more numbers are available, it gives an error.

For example, if when we get to State_0010.state there is already a State_0010.state file in the current directory, it advances the counter to State_0011.state to ensure that no conflict will exist (and then it verifies that State_0011.state also does not exist in the current directory and advances again if it does, and so forth).

If you enter a file name for a given file type, then the prefix becomes the filename you entered instead of the default prefix, followed by an underscore. The last four letters (the suffix) are the 4-digit number.

For example, if you save a measurement results file as “**fred.csv**”, then the next auto file name chosen for measurement results save will be **fred_0000.csv**.

NOTE

Although 0000 is used in the example above, the number that is used is actually the current number in the Meas Results sequence, that is, the number that would

have been used if you had not entered your own file name.

NOTE

If the filename you entered ends with `_dddd`, where `d`=any digit, making it look just like an auto file name, then the next auto file name picks up where you left off with the suffix being `dddd + 1`.

Quick Save Mode

Quick Save can be operated in the Normal mode and in a special “Prompt” mode. There is a switch on the User Interface page of the **System** menus that lets you control this.

When Quick Save Mode is in Normal (the default setting), the instrument does an immediate save of a new file of the same type and to the same directory as the previous Save action. When Quick Save Mode is in the Prompt state, instead of immediately performing a Save, the Alpha Keyboard pops up with the proposed auto-filename in the entry area. The user can then press Enter to accept the auto filename, or edit the name and press Enter. This allows you to easily save a file with a custom file name.

Notes

No remote command for this key specifically

7.2 Recall

The **Recall** dialog lets you recall previously saved states, traces and other items to the instrument from files on the instrument's internal storage, from removable devices, and from directories on the network. You access the Recall dialog by pressing the **Recall** hardkey, or by pressing the folder icon at the bottom of the display and then pressing the **Recall** icon.

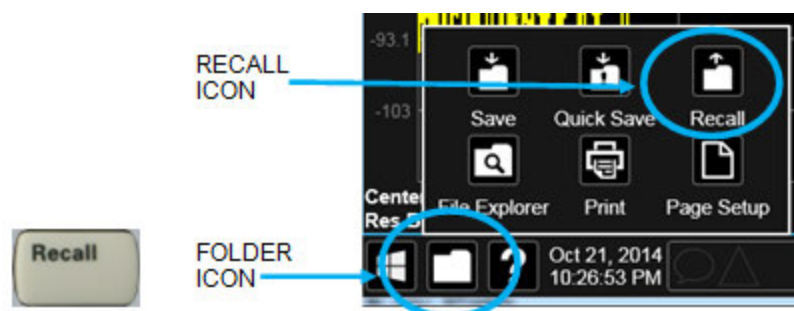

The dialog has section tabs running down the left side, which you use to specify what you want to recall, similar to the **Save** dialog. You choose the recall item and then complete the recall by choosing a register or file location from which to recall the item.

Notes No remote command for this key specifically, but `:MMEM:LOAD` is available for specific file types. For example: `:MMEM:LOAD:STATE <filename>`
If you try to recall a State file for a mode that is not licensed or not available in the instrument, an error message will occur and the state will not change

Backwards Compatibility Notes In legacy analyzers, it was possible to load a state without affecting the trace data, limit lines or correction data. Similarly (since User Preset is actually loading a state), it was possible to do a User Preset without affecting the trace data, limit lines or correction data
In the X-Series, "state" always includes all of this data; so, whenever state is loaded, all of the traces, limit lines and corrections are affected. Although this differs from previous behavior, it is desirable behavior, and should not cause adverse issues for users
Recall for the X-Series supports backward compatibility in the sense that you can recall a state file from any X-Series model number and any version of X-Series software. This is only possible if part of the recalling process goes through a limiting step after recalling the mode settings, at least for settings that may vary with version number, model number, option and license differences. If you try to recall a state file onto an instrument with less capability than what was available on the instrument during the save, the recall will ignore the state it doesn't support, and it will limit the recalled setting to what it allows
Example: if the saved state includes preamp ON, but the recalling instrument does not have a preamp; the preamp is limited to OFF. Conversely, if you save a state without a preamp, the preamp is OFF in the state file. When this saved file is recalled on an instrument with a licensed preamp, the preamp is changed to OFF. Another example is if the saved state has center frequency set to 20 GHz, but the instrument recalling the saved state is a different model and only supports 13.5 GHz. In this case, the

center frequency is limited along with any other frequency-based settings. Since the center frequency can't be preserved in this case, the recall limiting tries to at least preserve span to keep the measurement setup as intact as possible

Note that there is no state file compatibility outside of the X-Series. For example, you cannot recall a state file from ESA or PSA

7.2.1 Recall From File / Open

For every Recall type, a button appears called **Recall From File** or **Open**. “Recall From File” appears for recall types that also include registers (like State and Trace+State), and “Open” appears for all other recall types.

When you push the “Recall From File” or “Open” button, a dialog slides in from the right which allows you to see what files are saved in the current directory. See the “Save to File/Save As” section (3.1) for a depiction of this screen for the Save menu, which is similar to Recall.

The default directory is the internal directory for the current Mode and save type, on the D: drive. You may also change to another Mode's state directory by pressing the dropdown in the upper right corner labeled “Mode”. Once you have chosen a directory, the files in that directory whose extension matches the current data type (e.g., .state or .trace) are displayed in the right-hand window of the dialog. You can sort this list by name, date, file size or extension by tapping the Name, Date, Size, or Content header at the top of each column. A second tap toggles the sort order between Ascending and Descending.

Also displayed is a path depiction showing the path to the current directory. In the example shown, the path is D:\Users\Instrument\Documents\SA\screen. Tapping any element of this path lets you select an alternate route. Tapping the “Computer” arrow lets you select a different drive.



Tapping the “back” arrow navigates to the previously selected directory.

If you plug in a removable drive (e.g., a thumb drive), the browser immediately navigates to the root of that drive. Furthermore, if you had a thumb drive in and you were in a directory on the thumb, and then you exit the browser, when you come back in you are still in the same directory on that removable drive. If you remove the thumb drive, you return to the directory you had been in before the thumb drive was plugged in.

Note that for each data type there is a “current” directory, and it is the last directory used by either Save or Recall for that Mode. For example, if in SA Mode you save a Corrections file to a particular directory, then when you go to recall a Correction in SA Mode, you should be pointing at that directory. Or if in EMC Mode you recall a Limit from a particular directory then when in EMC Mode you go to save a Limit, it

should be pointing at that same directory. There is one “current” directory for each data type for each Mode (not one for Save and one for Recall).

The Filename field, just below the Path field, shows the filename that will be used. The **File Name** field is loaded with the name of the selected file. You may edit the filename by tapping it, which brings up the onscreen alpha keyboard. Press the “Done” button on this keyboard when you are done editing.

Select a file to load and press Recall. After a successful recall, a message "File <filename> recalled" or "State Register <register number> recalled" is displayed in an info box for a few seconds.

The **Files of Type** field shows the file suffix for the type of file you have selected to recall. This field only appears for files which have multiple file types that can be recalled. These file types are:

Amplitude Corrections:

- Amplitude Corrections (*.csv)
- Legacy Cable Corrections (*.cbl)
- Legacy User Corrections (*.amp)
- Legacy Other Corrections (*.oth)
- Legacy Antenna Corrections (*.ant)

Limits:

- Limit Data (*.csv)
- Legacy Limit Data (*.lim)

7.2.2 State

Lets you choose a register or file from which to recall the state.

See the Save State description for information on state files and their contents and the default paths. State files have the extension “.state”.

For rapid recall, the State menu lists 16 registers from which you can recall states. Pressing a Register button initiates the recall. You can also select a file from which to recall by pressing “Recall From File”.

Since each state file is only for one Mode, the settings for other Modes are unaffected when it is loaded. Recall State will cause a mode switch if the state being recalled is not from the current active mode.

NOTE

In products that run multiple simultaneous instances of the X-Series Application, all instances share the same registers and file directories, so make sure you know from what instance a file or register was saved before recalling it.

Remote Command	<code>:MMEMory:LOAD:STATe <filename></code>
Example	Load the state file data (on the default file directory path) into the instrument state: <code>:MMEM:LOAD:STAT "MyStateFile.state"</code>
Notes	<p>When you pick a file to recall, the instrument first verifies that the file is recallable in the current instrument by checking the software version and model number of the instrument. If there is a mismatch between the file and the instrument, the recall function tries to recall as much as possible. It may limit settings that differ based on model number, licensing or version number. In general, variables in the instrument which are not contained in the state file will be unaffected, and variables in the state file which are not contained in the instrument will be ignored</p> <p>The recall proceeds by aborting the currently running measurement, clearing any pending operations, and then loading the State from the saved state file. You can open state files from any Mode, so recalling a State file switches the instrument to the Mode that was active when the save occurred. After switching to the Mode of the saved state file, Mode settings and data (if any for the Mode) become those from the saved file. The active measurement becomes the measurement which was running when the state file was saved and the data relevant to the measurement (if there is any) is recalled</p> <p>After recalling the state, the Recall State function does the following:</p> <ul style="list-style-type: none">- Clears the input and output buffers- Status Byte is set to 0- Executes <code>*CLS</code> <p>If the file specified is empty an error is generated. If the specified file does not exist, another error is generated. If there is a mismatch between the file and the proper file type, an error is generated. If there is a mismatch between file version or model number or instrument version or model number, a warning is displayed. Then it returns to the State menu and File Open dialog goes away</p> <p>After the Recall, the instrument exits the Recall menu and returns to the previous menu</p>
Backwards Compatibility SCPI	<code>:MMEMory:LOAD:STATe 1,<filename></code> The "1" is simply ignored

7.2.2.1 Recall Type

If you have a built-in Source in your instrument, you may wish, when recalling State, to recall only the part of the State file that applies to the instrument, and leave the Source unaffected. Or you may wish to recall only the part of the State file that applies to the Source, and leave the instrument unaffected.

Lets you choose whether you wish to recall the entire Analyzer + Source state (**ALL**), just the Analyzer State **ANALyzer**), or just the Source State (**SOURce**).

Remote Command	:MMEMory:LOAD:RTYPe ALL ANALyzer SOURce
Example	:MMEM:LOAD:RTYP ALL
Dependencies	Only available in models with a built-in source, such as VXT models
Preset	ALL
Range	ALL ANALyzer SOURce

7.2.2.2 Register 1 thru Register 16

Selecting any one of these register buttons causes the State to be recalled from the specified Register. The registers are provided for rapid saving and recalling, since you do not need to specify a filename or navigate to a file. Each of the register menu keys annotates whether it is empty or at what date and time it was last modified. In addition, you can edit any of the register names to enter custom names for any register.

Although these 16 registers are the only registers available from the front panel, there are 128 state registers available in the instrument. Registers 17-128 are only available from the SCPI interface, using the ***RCL** command.

There is one set of 128 state registers in the instrument, not one set for each Mode. When a state is saved, the Mode it was saved from is saved with it; then when it is recalled, the instrument switches to that Mode.

NOTE

In products that run multiple simultaneous instances of the X-Series Application, all instances share the same registers and file directories, so make sure you know from what instance a file or register was saved before recalling it.

The date displayed follows the format specified in the **Date Format** setting in the **Control Panel**. The time shows hours and minutes.

After the recall completes, the message "Register <register number> recalled" is displayed.

If you are in the Spectrum Analyzer Mode, and you are recalling a register that was saved in the Spectrum Analyzer Mode, then after the recall, you will still be in the Recall Register menu. If the Recall causes you to switch modes, then after the Recall, you will be in the Frequency menu.

If a requested register is empty an error is generated.

Example	*RCL 1
Range	1-16 from front panel, 1-128 from SCPI

7.2.2.3 Edit Register Names

You may enter a custom name on any of the **Register** keys, to help you remember what you are using that state to recall. To do this, press the **Name** field for the register you want to rename, which brings up the onscreen alpha keyboard. Press the **Done** button on this keyboard when you are done editing.

The maximum number of characters for a register name is 30. If you delete all the characters in the custom name, it restores the default (time and date).

For more information and the SCPI command, see ["Edit Register Names" on page 1350](#) under **Save, State**.

7.2.3 Trace+State

Lets you choose a register or file for recalling the state.

See **Save, "State" on page 1349** for information on state files and their contents and the default paths. State files have the extension **".state"**.

For rapid recall, the **Trace+State** menu lists 16 registers from which you can recall trace+state files. Pressing a **Register** control initiates the recall. You can also select a file from which to recall by pressing **Recall From File**.

Since each trace+state file is only for one Mode, the settings for other Modes are unaffected when it is loaded. **Recall Trace+State** will cause a mode switch if the trace+state being recalled is not from the current active Mode.

NOTE

In products that run multiple simultaneous instances of the X-Series Application, all instances share the same registers and file directories, so make sure you know from what instance a file or register was saved before recalling it.

Trace+State files have the extension **.trace**.

The Trace+State selection only appears for measurements that support trace saves. It is blanked for modes that do not support trace saves. Saving Trace is identical to saving State, except that a **.trace** extension is used on the file instead of **.state**, and internal flags are set in the file indicating which trace was saved.

Remote Command	<code>:MMEMory:LOAD:TRACe TRACE1 ... TRACE6,<filename></code> <code>:MMEMory:LOAD:TRACe:REGister TRACE1 ... TRACE6,<integer></code>
Example	Loads the trace file data (on the default file directory path) into the specified trace; if it is a "single trace" save file, that trace is loaded to trace 2, and is set to be not updating: <code>:MMEM:LOAD:TRAC TRACE2,"MyTraceFile.trace"</code> Restore the trace data in register 2 to Trace 1:

```
:MMEM:LOAD:TRAC:REG TRACE1,2
```

Notes

When you perform the recall, the recalling Trace function must first verify the file is recallable in this instrument by checking instrument software version and model number, since it includes State. If everything matches, a full recall proceeds by aborting the currently running measurement, and loading the state from the saved state file to as close as possible to the context in which the save occurred. You can open .trace files from any mode that supports them, so recalling a Trace file switches to the mode that was active when the save occurred. After switching to the mode of the saved state file, mode settings and data (if any for the mode) are loaded with values from the saved file and the saved measurement of the mode becomes the newly active measurement, and the data relevant to the measurement (if there is any) is recalled

Once the state is loaded, the trace data must be loaded. The internal flags are consulted to see which trace to load and the "To Trace" setting to see where to load it. Trace data is always loaded with the specified trace set to View, so that the data is visible and not updating (so as not to erase the recalled data). If the file is an "all trace" file, all traces are loaded with the saved data (to the original trace the data was saved from) and set to View. Traces whose data is not loaded are restored to the update state that existed when they were saved

After recall, the instrument exits the **Recall** menu and returns to the previous menu

Some Modes and measurements do not have 6 available traces. For example, Phase Noise Mode:

```
:MMEMory:LOAD:TRACe TRACE1|TRACE2|TRACE3,<filename>
```

Some Modes and measurements have more than 6 traces. For example, Realtime SA Mode:

```
:MMEMory:STORe:TRACe TRACE1 | TRACE2 | TRACE3 | TRACE4 | TRACE5 |  
TRACE6 | TRACE7 | TRACE8 | TRACE9 | TRACE10 | TRACE11 | TRACE12 |  
ALL,<filename>
```

7.2.3.1 Recall To Trace

Lets you select which Trace to recall to. Not all Modes have the same number of available traces. The default is the currently selected trace, selected in this or any other menu with **Trace** selection. If you have selected **ALL**, then that remains selected until you specifically change it to a single trace, regardless of the trace selected in the **Trace** menu.

If the **.trace** file is an "all trace" type, **To Trace** is ignored, and the traces each go back to the trace from which they were saved.

7.2.3.2 Register 1 thru Register 16

Selecting any one of these register buttons causes the specified trace(s) and the state of the currently active mode to be recalled from the specified Register. The registers are provided for rapid saving and recalling, since you do not need to specify a filename or navigate to a file. Each of the register menu keys annotates whether it is empty or at what date and time it was last modified. In addition, you can edit any of the register names to enter custom names for any register.

7 Save/Recall/Print
7.2 Recall

There is one set of 16 trace+state registers in the instrument, not one set for each Mode. When trace+state is saved, the Mode it was saved from is saved with it; then when it is recalled, the instrument switches to that Mode.

NOTE

In products that run multiple simultaneous instances of the X-Series Application, all instances share the same registers and file directories, so make sure you know from what instance a file or register was saved before recalling it.

The date displayed follows the format specified in the **Date Format** setting under the **Control Panel**. The time shows hours and minutes.

After the recall completes, the message **Register <register number> recalled** is displayed. If a requested register is empty, an error is generated.

Recalling state from a Register is the same as recalling state from a **Trace+State File**.

Example	*RCL 1
Range	1-16

7.2.3.3 Edit Register Names

You may enter a custom name on any of the **Register** keys, to help you remember what you are using that state to recall. To do this, press the **Name** field for the register you want to rename, which brings up the onscreen alpha keyboard. Press the **Done** button on this keyboard when you are done editing

The maximum number of characters for a register name is 30. If you delete all the characters in the custom name, it restores the default (time and date).

For more information and the SCPI command, see "[Edit Register Names](#)" on page 1350 under **Save, State**.

7.2.4 Screen Config + State

Lets you load the complete configuration of all your screens from a file which you specify.

Note that recalling a screen config file wipes out your current screen configuration; you do not see a warning before it loads, but there is a note on the **Recall** page letting you know what is going to happen.

The filenames are of the form:

`State_0001.screen`

Remote	<code>:MMEMory:LOAD:SCONfig <filename></code>
--------	---

Command	
Example	Load the screen configuration from the file <code>MyScreenConfig.screen</code> in the default directory: <code>:MMEM:LOAD:SCON "myScreenConfig.screen"</code>

7.2.5 Measurement Data

Lets you specify a data type (for example, trace data) and choose a file from which to import the data.

Measurement Data files are comma-separated value (CSV) files, and contain the requested data in a form that can be imported into Excel or other spreadsheets, as well as header data that gives information on relevant instrument settings at the time the save occurred.

For more on **Measurement Data** files, see "[Measurement Data](#)" on page 1355 under **Save**.

Since the commonly exported data files are in CSV format, you can edit the data prior to importing it. This allows you to export a data file, manipulate the data in Excel (for example) and then import it.

7.2.5.1 Data Type

Lets you select the data type to recall.

Notes	There is no SCPI command for Data Type, as the type is implied in the SCPI command for each item
Dependencies	The Data Type menu for any given measurement only contains data types that are supported by that measurement. Data types that are not importable do not appear, even if they <i>do</i> appear in the corresponding Save menu

Trace

Allows you to import Trace files in the PC-readable CSV format.

Trace data files have the extension `.csv`. The trace file contains a "metadata" header which describes the state of the instrument when the file was saved. This metadata is compared to the current state of the instrument when the file is recalled; if it does not match the current state, the "invalid data indicator" (*) is displayed.

The metadata is detailed in Trace File Contents in the **Save** section.

Remote Command	<code>:MMEMory:LOAD:TRACe:DATA TRACE1 ... TRACE6,<filename></code>
Example	Import the 2nd trace from the file <code>myTrace2.csv</code> in the current path. For SA Mode, the default path is:

[My Documents\SA\data\traces](#)

[:MMEM:LOAD:TRAC DATA TRACE2,"myTrace2.csv"](#)

Dependencies	<p>For SA measurements, a trace cannot be recalled from a trace file that was exported with ALL traces selected</p> <p>A trace cannot be imported if the number of trace points in the file do not match the number of sweep points currently set for the measurement. If this happens, an error message is generated</p> <p>Errors are reported if the file is empty or missing, or if the file type does not match, or if there is a mismatch between the file type and the destination data type</p>
Couplings	When a trace is imported, Trace Update is always turned OFF for that trace and Trace Display is always turned ON
Annotation	After recall is complete, an advisory is displayed in the message bar confirming which trace file was loaded
Status Bits/OPC dependencies	Sequential - aborts the current measurement

7.2.6 Limit

Lets you select a file from which to import the **Limit** data.

Limit files are CSV files, and contain the limit data in a form that can be imported into Excel or similar spreadsheets, as well as header data that provides information on the limit.

See the **Save Limit** description ("[Limit](#)" on page 1358) for information on Limit files and their contents and the default paths. **Limit** files have the extension **.csv**.

For backwards compatibility, older limit files with the extension **.lim** can be read into the instrument, but you can only save limits as **.csv** files.

A set of preloaded **Limits** files can be found in the directory:

[My Documents/EMC Limits and Ampcor/Limits](#)

Remote Command	:MMEMory:LOAD:LIMit LLINE1 LLINE2 LLINE3 LLINE4 LLINE5 LLINE6,<-filename>
Example	<p>Import the 2nd Limit Line from the file myLimitLine2.csv in the current path:</p> <p>:MMEM:LOAD:LIM LLINE2,"myLimitLine2.csv"</p>
Dependencies	<p>Errors are reported if the file is empty or missing, or if the file type does not match, or if there is a mismatch between the file type and the destination data type</p> <p>In the Log Plot measurement in Phase Noise Mode, there are only three Limit Lines, so the valid parameters are LLINE1 LLINE2 LLINE3</p> <p>This key only appears if you have the proper option installed in your instrument</p>
Couplings	When a limit line is loaded from mass storage, it is automatically turned on. This allows the user to see it, thus confirming the load. The Margin settings will match those when the limit was saved

	The instrument cannot mix Limits domains (X Axis Unit must be Frequency or Time for both Limits). So, when a Limits file is loaded, the instrument sets the Limits domain (X Axis Unit) to match that of the file. If this changes the Limits domain from what it was before the file was loaded, all Limits data in all Limits sets is erased before the data loads. If this operation is over the remote interface, there is no warning if this occurs, so care should be taken to know the domain of the file you are loading
Annotation	After recall is complete, an advisory is displayed in the message bar confirming which limit file was loaded
Status Bits/OPC dependencies	Sequential - aborts the current measurement

7.2.6.1 Select Limit

Selects the Limit register into which the recalled **Limit** will be placed, for example, **Limit 1**.

Preset	Not part of Preset , but is reset to LLINE1 by Restore Mode Defaults Survives shutdown
--------	---

7.2.7 Correction

Allows you to import Amplitude Corrections files in the PC-readable CSV format.

Amplitude Correction files contain the correction data in a form that can be imported into Excel or similar spreadsheets, as well as header data that provides information on the correction.

For backwards compatibility, older limit files with the extensions **.amp**, **.cbl**, **.ant** and **.oth** can be read into the instrument.

A set of preloaded **Corrections** files can be found in the directory:

My Documents\EMC Limits and Ampcor\Ampcor

The default path for CSV files is:

My Documents\amplitudeCorrections

Antenna corrections are a particular kind of Amplitude Corrections – they are distinguished in the corrections file by having **Antenna Unit** set to a value other than **None**. When the Amplitude Correction is an Antenna correction and the **Antenna Unit** in the file is not **None**, the Y-Axis Unit setting changes to match the Antenna (Transducer) Unit in the file.

Remote Command	:MMEMory:LOAD:CORRection 1 ... 8, <filename>
Example	Recall the Amplitude Correction data from the file myAmpcor.csv in the current directory to the 2nd Amplitude Correction table, and turns on Correction 2: :MMEM:LOAD:CORR 2, "myAmpcor.csv"

7 Save/Recall/Print
7.2 Recall

Dependencies	<p>Only one Transducer units can be on at any given time. Note that this means that if a correction file with a Transducer Unit is loaded into a particular Correction, all other Corrections are set to that same Transducer unit</p> <p>Corrections are not supported by all Measurements. If in a Mode in which some Measurements support it, this key is grayed-out in measurements that do not. The key does not show at all if no measurements in the Mode support it</p> <p>Errors are reported if the file is empty or missing, or if the file type does not match, or if there is a mismatch between the file type and the destination data type</p> <p>This key does not appear unless you have the proper option installed in your instrument</p> <p>This command will generate an "Option not available" error unless you have the proper option installed in your instrument</p>
Couplings	When a correction file is loaded from mass storage, it is automatically turned on (CorrectionON) and Apply Corrections is set ON . This allows you to see its effect, thus confirming the load
Annotation	After recall is complete, an advisory is displayed in the message bar confirming which file was recalled
Backwards Compatibility SCPI	<code>:MMEMory:LOAD:CORRection ANTenna CABLe OTHer USER, <filename></code>
	For backwards compatibility, ANTenna maps to 1, CABLe maps to 2, OTHer maps to 3 and USER maps to 4

7.2.7.1 Select Correction

Selects the register into which the recalled **Correction** will be placed, for example, **Correction 1**.

Preset	Not part of Preset , but reset to Correction 1 by Restore Input/Output Defaults Survives a shutdown
--------	---

7.2.8 Complex Correction

Imports **Complex Corrections** files in the PC-readable **.s2p** format.

Complex Correction files contain amplitude and phase correction data in a form that can be imported into Excel or similar spreadsheets, as well as header data that gives information on the correction.

The default path for Complex Corrections files is:

`My Documents\complexCorrections\`

Remote Command	<code>:MMEMory:LOAD:CCORrection <integer>, <filename></code>
Example	Recall the Complex Correction data from the file <code>mycor.s2p</code> in the current directory to the 2nd Complex Correction table, and turns on Complex Correction 2 : <code>:MMEM:LOAD:CCOR 2, "mycor.s2p"</code>
Dependencies	Not supported by all measurements. The tab does not appear at all if no measurements in the Mode

	support it Errors are reported if the file is empty or missing, or if the file type does not match, or if there is a mismatch between the file type and the destination data type
Couplings	When a complex correction file is loaded from mass storage, it is automatically turned ON and Apply Corrections is set ON . This allows you to see its effect, thus confirming the load
Annotation	After recall is complete, an advisory is displayed in the message bar confirming which file was recalled

7.2.8.1 Select Complex Correction

Selects the register into which the recalled **Complex Correction** will be placed, for example, **Complex Correction 1**.

Preset	Not part of Preset , but is reset to Correction 1 by Restore Input/Output Defaults Survives a shutdown
--------	---

7.2.9 Recall VDI CCD Correction

Imports VDI CCD External Mixer Correction files in the PC-readable CSV (.csv) format.

The default path for VDI CCD External Mixer Correction files is the instrument's **My Documents** folder.

Remote Command	<code>:MMEMory:LOAD:VCORrection <filename></code>
Example	<code>:MMEM:LOAD:VCOR "vdi_ccd_corr.csv"</code>
Dependencies	Requires the EXW (External Mixing Wide Bandwidth) and Ampcor (Amplitude Correction) licenses VDI CCD Corrections are not supported by all measurements. The tab does not appear at all if no measurements in the Mode support it Errors are reported if the file is empty or missing, or if the file type does not match, or if there is a mismatch between the file type and the destination data type If the file is empty, message -250 is reported. If the file does not exist, message -256 is reported. If there is a mismatch between the file and the destination data type, message -250 is reported
Couplings	When a VDI CCD correction file is loaded into memory, if the correction matches the current external mixer setup and " Select VDI CCD Correction " on page 1162 is NONE , the selected VDI CCD Correction is set to the serial number of the matching correction data
Annotation	After recall is complete, an advisory is displayed in the message bar confirming which file was recalled

7.2.10 Mask

The **Mask** data type is used to import and export Mask files for measurements that use masks, such as cellular comms and real-time measurements.

7.2.11 Sequence

These need to be brought over for the EXT and/or Sequence Analyzer when they are available in the Touch UI

7.2.12 Waveform

Recalls waveforms into the ARB memory of an Internal Source.

When you select the **Waveform** tab in the **Save** dialog,, a hint appears saying “Recalls files from Mass Storage to the ARB and lets you manage the ARB memory at the same time.”

You then tap **Recall From File** to display the **Recall Waveform** dialog.

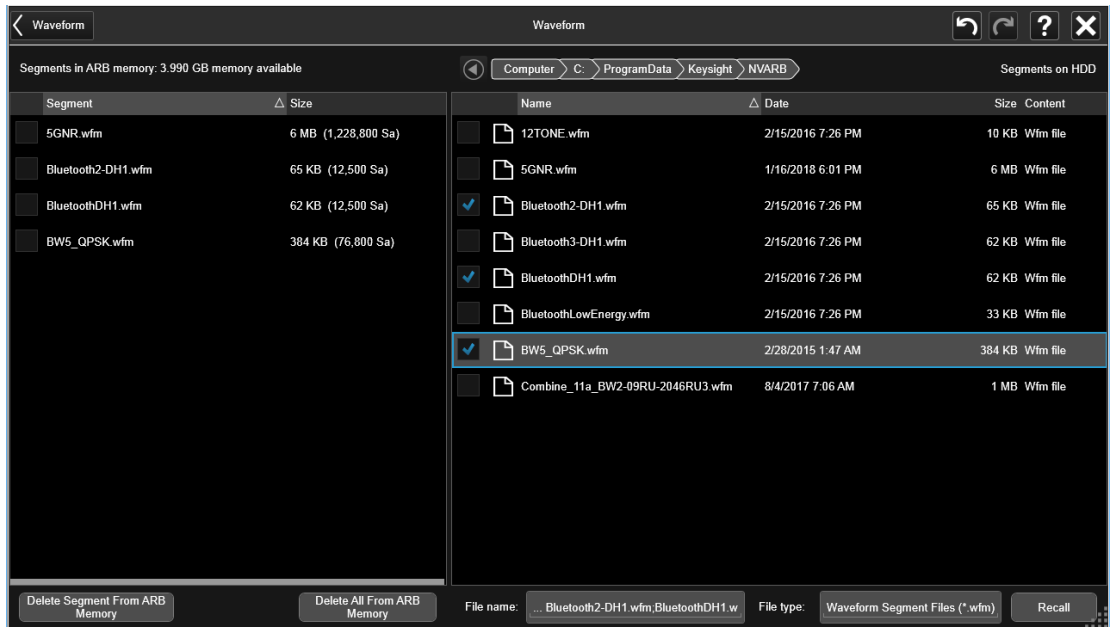

The left-hand window shows the files in ARB memory. The right-hand window shows the files on the hard drive.

You can select one or more waveform files in the right-hand window. Each file selected has a blue check box in it. To select a single file, tap that file’s row. To select additional files, tap the check box in the row of the desired additional files.

When you have selected the file or files that you wish to recall, tap Recall. The file(s) are recalled into the ARB memory, and appear in the left-hand window.

If a file of the same name already exists within ARB memory, it is overwritten. If you wish to load two segments of the same name, you must rename one of the segments

before loading it into ARB memory. To rename a segment, you can either use Windows File Explorer, or **:MMEMory:COPY**.

You can select one or more segments in the left-hand window and tap “Delete Segments from ARB memory” to delete the selected files. You can also delete all files in ARB memory by tapping “Delete All from ARB memory.”

You can change the current directory by tapping on an element of the file path at the top of the screen and selecting the desired subdirectory in the list that appears, and repeating until you have the path you want. The current directory is used for manually loading waveform segments into ARB memory for playback, and as a search location for waveform segments that are required to be loaded into ARB memory for playback of a waveform sequence or a list sequence.

File Type allows you to specify a waveform format. The available file types are listed below:

Type	Extension	Notes
Waveform Files	.wfm	Keysight Signal Studio files
Binary Files	.bin	Interleaved IQ data files. They could be single precision or double precision customer created files. One-byte marker may be added
CSV Files	.csv	Comma-separated value file. Could be generated by Excel
Text Files	.txt	
Matlab Files	.mat	Should be Level 4, Level 5 or HDF5 MAT-files (only Level 5 Matlab file is supported in X24)

Waveforms in **.csv**, **.txt** and **.mat** formats are supported by models with a built-in source, such as VXT and EXM.

.txt files are formatted according to the following rules:

1. Text files only contain the IQ information. Data in the right column represents the amplitude of real(I) points, Data in the left column represents the amplitude of imaginary(Q) points
2. The amount of data should be multiple of two (IQ pairs)
3. The data range is from $-1e10$ to $1e10$, the data type should be **int**, **float** or **double**. 16 digits or fewer for every data is acceptable
4. The values are separated by comma or tab. Extra commas or tabs are ignored
5. Use **Enter** to separate IQ pairs

Example for text file data:

0.46425922, -0.57411048

0.47184454, -0.58435995

7 Save/Recall/Print
7.2 Recall

0.48107329, -0.59014958
0.49223323, -0.58998679
0.50419607, -0.58558843
0.51679158, -0.57721768
0.53005322, -0.56481976
0.54373011, -0.54879346
0.55759183, -0.52950807
0.57141409, -0.50732489

Rules 1-3 above also apply to `.csv` data.

Dependencies Only appears if your hardware includes an Internal Source, such as in VXT

7.2.12.1 Load Segment to ARB Memory

Loads a single segment to ARB memory. Same as pressing the **Recall** button with a single waveform selected.

Remote Command `:SOURCE:RADio:ARB:LOAD <string>`
`<string>` - specifies the path name of the file to load from the HDD into ARB memory. May be a <full path + filename>, or <"NVWFM" MSUS + colon + filename>

Example `:SOUR:RAD:ARB:LOAD "D:\NVARB\testwaveform.bin"`
or
`:SOUR:RAD:ARB:LOAD "NVWFM:testwaveform.bin"`

Notes Because loading the file involves a delay of unpredictable length, this command should be followed by `*OPC?`, which holds off subsequent commands until the loading operation is complete
If you specify a file over SCPI, but the file is not at the specified location, an error is generated
If you try to load a waveform file but the file contains less than 500 IQ samples, an error is generated
VXT models M9410A/11A/15A/16A and M9410E/11E/15E/16E:
If you try to load a waveform file but the file contains less than 1024 IQ samples, an error is generated
If you try to load a Signal Studio waveform `*.wfm` that contains invalid waveform header, an error is generated
If the ARB is **ON** when you load a file to ARB memory or delete a file from ARB memory, the playing waveform segment may not keep phase continuity during the ARB memory operation. The waveform is replayed after the ARB operation is finished
ARB can be loaded into ARB memory even if required licenses are not present on the instrument. In this case, a GUI-only warning message -800, "Operation complete; Loaded <filename> successfully, but no license <required licenses> installed". You can install required licenses according to <required licenses> string to license it, or multi-pack license it
When in Sequence Analyzer Mode, and **Include Source** is **Yes**, an attempt to load a file to ARB memory is rejected with an error. When **Include Source** is **No**, and if there is insufficient free ARB memory to load the selected waveform, an error is generated

Remote Command	<code>:SOURCE:RADio:ARB:LOAD:ALL <string></code>
Example	<code>:SOUR:RAD:ARB:LOAD:ALL "D:\nvarb"</code>
Notes	<p>Loads all the segment files within the currently selected directory into ARB memory. If a file of the same name already exists within ARB memory, it is overwritten. If you wish to load two segments of the same name, you must rename one of the segments before loading it into ARB memory. To rename a segment, either use Windows File Explorer, or <code>:MEMory:COPI</code></p> <p>If you specify a directory over SCPI, but the directory does not exist, an error is generated</p> <p>If the ARB is ON, and you then load or delete a file to ARB memory, the playing waveform segment may not keep phase continuity during the ARB memory operation. The waveform is replayed after the ARB operation is finished</p> <p>When in Sequence Analyzer Mode, and Include Source is Yes, an attempt to load all files from a directory to ARB memory is rejected with an error. When Include Source is No and there is insufficient free ARB memory to load all the waveforms, when the ARB memory is full, the copy ceases, and an error is generated</p>

7.2.12.2 Delete Segment From ARB Mem

Deletes a segment from ARB memory.

Remote Command	<code>:SOURCE:RADio:ARB:DELeTe <string></code>
Example	<code>:SOUR:RAD:ARB:DEL "testwaveform.bin"</code>
Notes	<p>It is possible to delete files from within the ARB memory when the ARB is ON. However, if you attempt to delete the file that is currently playing an error is generated</p> <p>It is possible to delete a file from within the ARB memory when the sequencer state is ON, and the file is not being used by the List Sequencer. If you attempt to delete a file that is being used by the list sequencer, an error is generated</p> <p>When the Sequencer state of the List Sequencer is On, even if ARB state is On, the selected waveform will not be played. In this case, if the selected waveform is not used in List Sequence, it can be deleted, and the ARB state is turned Off</p> <p>If the ARB is ON and you load a file to ARB memory or delete a file from ARB memory, the playing waveform segment may not keep phase continuity during the ARB memory operation. The waveform is replayed after the ARB operation is finished</p> <p>When in Sequence Analyzer Mode, and Include Source is Yes, an attempt to delete a file from ARB memory is rejected with an error. When Include Source is No, and you specify a file that does not exist within ARB memory, an error is generated</p>

7.2.12.3 Delete All From ARB Memory

Removes all segments from ARB memory.

7 Save/Recall/Print
7.2 Recall

Remote Command	<code>:SOURCE:RADio:ARB:DELeTe:ALL</code>
Example	<code>:SOUR:RAD:ARB:DELeTe:ALL</code>
Notes	<p>If you attempt to delete all files from ARB memory when there are waveform files used in the Sequencer function of the List Sequencer and the Sequencer state is ON, all files except the files currently being used in list sequencer are deleted, and an error is generated</p> <p>If the ARB is ON and you load a file to ARB memory or delete a file from ARB memory, the playing waveform segment may not keep phase continuity during the ARB memory operation. The waveform is replayed after the ARB operation is finished</p> <p>When in Sequence Analyzer Mode, and Include Source is Yes, an attempt to delete all files from ARB memory is rejected with an error. When Include Source is No, and you attempt to delete all files from ARB memory when the ARB is currently playing a file, all files except the one playing are deleted and an error is generated</p>

7.2.12.4 Set Default Directory (Remote Command Only)

Sets the default directory for loading ARB files from SCPI.

Remote Command	<code>:SOURCE:RADio:ARB:DEFault:DIRectory <string></code> <code>:SOURCE:RADio:ARB:DEFault:DIRectory?</code>
Example	<code>:SOUR:RAD:ARB:DEF:DIR "D:\ArbFiles"</code> <code>:SOUR:RAD:ARB:DEF:DIR?</code>
Notes	Sets the default directory to be used as a search location for waveform segments that are required to be loaded into ARB memory for playback of a waveform sequence, and as a search location for selecting waveforms using SCPI
State Saved	Persistent, survives a power cycle and a preset but not saved in the instrument state

7.2.12.5 Query ARB Memory File List (Remote Query Only)

Queries the instrument for the list of waveform segments in the ARB memory.

NOTE

Returns a string for waveform segment names in ARB memory. If you want a string list of waveform segments in the ARB memory, use **"Query ARB Memory Full File List (Remote Query Only)"** on page 1341.

Remote Command	<code>:SOURCE:RADio:ARB:CATalog?</code>
Example	<code>:SOUR:RAD:ARB:CATalog?</code>
Notes	<p>The return data is in the following format:</p> <hr/> <p><code><integer></code> memory used</p>

<integer>	memory free
<string>...	comma separated list of waveform segments within ARB memory

7.2.12.6 Query ARB Memory Full File List (Remote Query Only)

Queries the instrument for the string list of waveform segments in the ARB memory. Returns a string list for waveform segment names in the ARB memory.

Remote Command `:SOURce:RADio:ARB:FCATalog?`

Example `:SOUR:RAD:ARB:FCATalog?`

Notes The return data is in the following format:

<integer>	Memory used
<integer>	Memory free
<integer>	File count in ARB memory
<string>,<string>, ... <string>	Comma-separated string list of waveform segments within ARB memory

Example:

`:SOUR:RAD:ARB:FCAT?`

EXT returns: 27499,2069653,3,"c2k.wfm","gsm.wfm","wcdma.wfm"

7.2.13 Power Sensor Cal Factor

Selects a file to which to export the Power Sensor Cal factor data.

Cal Factor files are XML files, and contain the cal factor data and header data that gives information on the power sensor.

The default path for **Cal Factor** Files is:

`My Documents\<mode name>\data\PSCF`

where `<mode name>` is the parameter used to select the mode with `:INST:SEL` (for example, `MRECEIVE` for Measuring Receiver Mode). Hence, a **Cal Factor** file from any measurement in the Measuring Receiver mode would be stored in:

`My Documents\MRECEIVE\data\PSCF`

Cal Factor files have the extension `.xml`. The default filename is `<Sensor Model>_<Sensor Serial Number>_0000.xml`, where the 4-digit number is the lowest number that does not conflict with any filename in the current directory. If the sensor model or serial number is blank, the default filename is `PSCF_0000.xml`.

Remote Command	<code>:MMEemory:STORe:PSCFactor <file_name></code>
Example	<code>:MMEem:STOR:PSCF "myPSCF.xml"</code>
Notes	If the save is initiated via SCPI, and the file already exists, the file will be overwritten Using the C: drive is strongly discouraged, since it runs the risk of being overwritten during an instrument software upgrade Both single and double quotes are supported for any filename parameter over SCPI
Dependencies	Only appears if you have the proper option installed in your instrument

7.2.14 Recording

Lets you specify a data type (for example, I/Q data) and select a file from which to import the data, then the data can be routed to the measurement engine as though it were being acquired from the Input.

The recording and playback of signal data files is a multi-step process that involves controls in several menus.

The menus that are involved in Record/Playback are:

- **Save**, "**Recording**" on page 1369 (under the **Save** hardkey or the **Save** icon in the **File** panel)
- **Recall**, **Recording** (this menu)
- **Sweep**, **Recording** tab
- **Sweep**, **Playback** tab
- **Input/Output**, "**Data Source**" on page 1199 tab

NOTE

A complete tutorial for the Record/Playback functionality, including how to load and save Recording files, can be found under the **Data Source tab in **Input/Output**.**

Dependencies	Only available in the following modes and measurements: <ul style="list-style-type: none">- VMA (Digital Demod and Custom OFDM)- 5G NR (Modulation Analysis)- LTE (Modulation Analysis)- WLAN (Modulation Analysis, MIMO Modulation Analysis, Spectral Flatness)- Analog Demod- Bluetooth (Transmit Analysis)
--------------	--

- IoT & SRComms (LoRa CSS Demod)

7.2.14.1 Data Type

Allows you to recall IQ data from the measurement using a specified file type (**CSV**, **SDF**, **TXT**, **BIN**, **BINX**, **BINF**, **ORB**). See "[Recording](#)" on page 1342 for details about the available file types.

Note that **BIN**, **BINX** and **BINF** files do not include sampling rate information inside the file, so after recalling one of these file types you will need to set the Sample Rate in **Sweep, Playback**, based on your note of the Sample Rate that was displayed on the **Sweep, Recording** menu panel when you saved the file.

Example `:MMEM:LOAD:RECORDing "C:\TEMP\MyIQData.csv"`

7.2.14.2 Channel

Select data channels to recall. This is only supported in the 5G NR EVM, VMA Digital Demod, VMA Custom OFDM and WLAN MIMO EVM measurements.

The `<meas>` param in the command must be replaced with the node of the active measurement:

- **EVM** for 5G NR EVM
- **EVMM** for WLAN MIMO EVM
- **DDEM** for VMA Digital Demod
- **OFDM** for VMA Custom OFDM

Remote Command `:MMEMory:LOAD:<meas>:RECORDing:CHANnel ALL | CH1 | CH2 | CH3 | CH4 | CH5 | CH6 | CH7 | CH8`

`:MMEMory:LOAD:<meas>:RECORDing:CHANnel?`

Example `:MMEM:LOAD:EVM:REC:CHAN CH1`

`:MMEM:LOAD:EVM:REC:CHAN?`

Preset `ALL`

State Saved `No`

Range `ALL | CH1 | CH2 | CH3 | CH4 | CH5 | CH6 | CH7 | CH8`

7.2.14.3 Reset

Clears all recalled data channels.

7 Save/Recall/Print
7.2 Recall

This is only supported by 5GNR EVM, VMA Digital Demod, VMA Custom OFDM and WLAN MIMO EVM measurements.

The `<meas>` param in the command must be replaced with the node of the active measurement:

- `EVM` for 5GNR EVM
- `EVMM` for WLAN MIMO EVM
- `DDEM for VMA Digital Demod`
- `OFDM for VMA Custom OFDM`

Remote Command	<code>:MMEMory:LOAD:<meas>:RECORDing:RESet</code>
Example	<code>:MMEM:LOAD:EVM:REC:RES</code>

7.2.14.4 Recalled data channel table (Display only)

Displays recalled IQ data file for each channel in a table.

7.2.15 Loss Comp

Sets the import file type to Loss Compensation Before DUT Table or to Loss Compensation After DUT Table.

Mode	NFIGURE
Parameter Name	Recall Loss Comp
Control Path	Recall
Parameter Type	ImmediateAction
SCPI Command	<code>:MMEMory:LOAD:LOSS BEFore AFTEr,<file_name></code>
SCPI Example	<code>:MMEM:LOAD:LOSS BEF,"C:\LossBefore.csv"</code> <code>:MMEM:LOAD:LOSS AFT,"C:\LossAfter.csv"</code>
Notes	Three file formats are supported: <ul style="list-style-type: none"> - Loss Compensation file (<code>.csv</code>) - Legacy Loss Compensation file (<code>.loss</code>) - S parameter file (<code>.s2p</code>)
Soft Key Label	Loss Comp
Backwards Compatibility SCPI	<code>:MMEMory:LOAD:LOSS</code>
Initial S/W Revision	A.04.00

For `.s2p` files, only the `S21` component is used for the loss compensation.

The CSV format contains the following data:

File Type

Application Name: Measurement Name

Version and Model Number

Loss Comp Data

Below is an example of a valid CSV Loss Compensation file:

```
[Filetype LossCompensation]
```

```
[NF:NFIG]
```

```
Ver. ***, Model ***
```

```
10, 1.0000
```

```
20, 2.0000
```

```
30, 3.0000
```

```
40, 4.0000
```

```
50, 5.0000
```

```
60, 6.0000
```

7.3 Save

The **Save** dialog lets you save states, traces, screen images and other items from the instrument to files on the instrument's internal storage, to removable devices, and to directories on the network. You access the dialog by pressing the **Save** hardkey, or by pressing the folder icon at the bottom of the display and then pressing the **Save** icon.

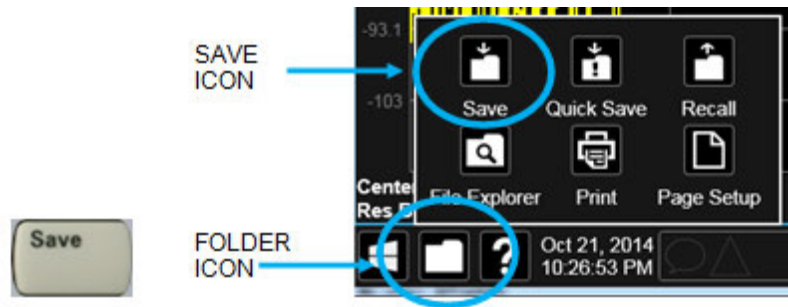

The dialog has tabs running down the left side, which you use to specify what you want to save.

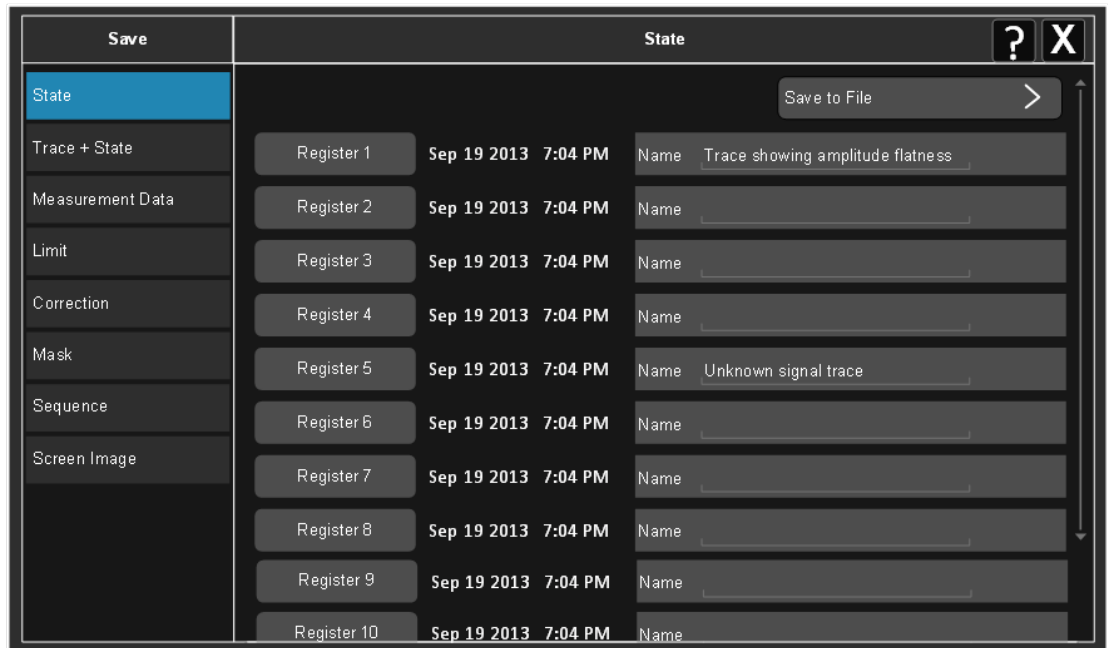

You choose the save item and then complete the save by choosing a register or file location to which to save the item.

Notes

No remote command for this key specifically, but **:MMEM:STORE** is available for specific file types
 Example: **:MMEM:STOR:STATE <filename>**

7.3.1 Save to File / Save As

For every Save type, a control appears labeled **Save to File** or **Save As**. **Save to File** appears for save types that also include registers (like State and Trace+State), and **Save As** appears for all other save types.

When you press **Save to File** or **Save As**, a dialog slides in from the right that allows you to see what files are already saved in the current directory.

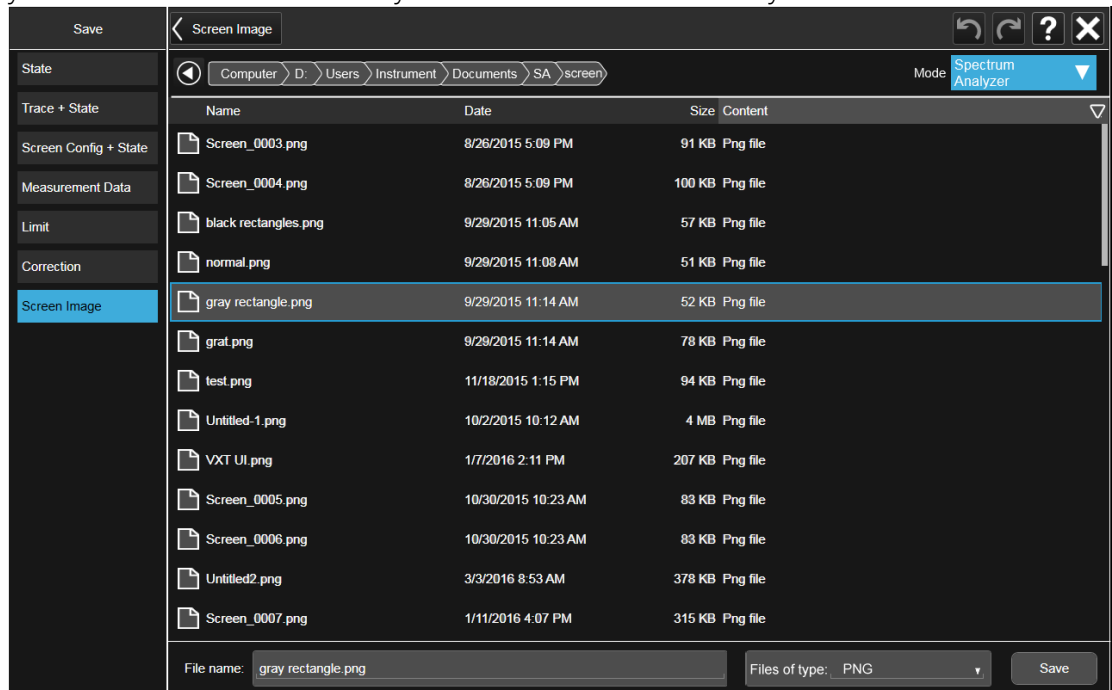

The default directory is the internal directory for the current Mode and save type, on

the **D:** drive. You may also change to another Mode's state directory by pressing the dropdown in the upper right corner labeled **Mode**. Once you have chosen a directory, the files in that directory whose extension matches the current data type (for example, **.state** or **.trace**) are displayed in the right-hand window of the dialog. You can sort this list by name, date, file size or extension by tapping the Name, Date, Size, or Content header at the top of each column. A second tap toggles the sort order between Ascending and Descending.

Also displayed is a path depiction showing the path to the current directory. In the example above, the path is **D:\Users\Instrument\Documents\SA\screen**. Tapping any element of this path lets you select an alternate route. Tapping the **Computer** arrow lets you select a different drive.



Tapping the "Back" arrow navigates to the previously selected directory.

Note: Using the C: drive is strongly discouraged, due to the risk of data being overwritten during an instrument software upgrade.

If you plug in a removable drive (for example, a thumb drive), the browser immediately navigates to the root of that drive. Furthermore, if you had a thumb drive in and you were in a directory on the thumb, and then you exit the browser, when you come back in you are still in the same directory on that removable drive. If you remove the thumb drive, you return to the directory you had been in before the thumb drive was plugged in.

Note that for each data type there is a "current" directory, and it is the last directory used by either Save or Recall for that Mode. For example, if in SA Mode you save a Corrections file to a particular directory, then when you go to recall a Correction in SA Mode, you should be pointing at that directory. Or if in EMC Mode you recall a Limit from a particular directory then when in EMC Mode you go to save a Limit, it should be pointing at that same directory. There is one "current" directory for each data type for each Mode (not one for Save and one for Recall).

The Filename field, just below the Path field, shows the filename that will be used. The **File Name** field is initially loaded with an automatically generated filename specific to the appropriate Save Type. The automatically generated filename is guaranteed not to conflict with any filename currently in the directory. You may edit the filename by tapping it, which brings up the onscreen alpha keyboard. Press the "Done" button on this keyboard when you are done editing.

Select a file to overwrite, type in a file name, or use the name suggested by the instrument (guaranteed not to conflict with any file in the current directory), and press Save. If the file specified already exists, a dialog will appear that allows you to replace the existing file by selecting **OK**, or you can Cancel the request.

After a successful save, a message "File <filename> saved" or "State Register <register number> saved" is displayed in an info box for a few seconds.

See ["Quick Save" on page 1320](#) for details of the automatic file naming algorithm.

7.3.2 State

Selects a register or file for saving the state.

State files contain essentially all the information required to return the instrument to the measurement and settings that were in effect at the time of the save. **State** files are in a proprietary binary form (for speed) and cannot be read or edited by PC software, but can be loaded back into the instrument to restore the state.

State files contain all the settings of the **Input/Output** system as well, even though **Input/Output** variables are outside of the Mode's state and unaffected by **Mode Preset**, because these are needed to restore the complete setup.

Persistent System settings (for example, GPIB address) are affected by neither **Mode Preset** nor **Restore Mode Defaults**, nor are they included in a saved **State** file.

For rapid saving, the **State** menu lists 16 registers to which you can save states. Pressing a **Register** button initiates the save. You can also select a file to which to save by pressing **Save to File**.

The default path for all **State** files is:

`My Documents\<mode name>\state`

where `<mode name>` is the parameter used to select the Mode with `:INST:SEL` (for example, `SA` for Spectrum Analyzer Mode).

State files have the extension `.state`. The default filename is `State_0000.state`, where the 4-digit number is the lowest number that does not conflict with any filename in the current directory.

NOTE

In products that run multiple simultaneous instances of the X-Series Application, all instances share the same registers and file directories, so take care not to overwrite files and/or registers from one instance that were saved by another instance.

Remote Command	<code>:MMEMory:STORe:STATe <filename></code>
Example	Store the current instrument state data in the file <code>MyStateFile.state</code> in the default directory: <code>:MMEM:STOR:STATe "MyStateFile.state"</code>
Notes	Both single and double quotes are supported for any filename parameter over remote After saving to a register, that register's menu key is updated with the date the time, unless a custom label has been entered for that key After saving to a register, you remain in the Save State menu, so that you can see the Register key update. After saving to a file, the instrument automatically returns to the previous menu and any Save As dialog goes away

Backwards	:MMEMory:STORe:STATe 1,<filename>
Compatibility SCPI	The "1" is simply ignored. The command is sequential

7.3.2.1 Register 1 thru Register 16

Selecting any one of these register buttons causes the state of the currently active Mode to be saved to the specified **Register**. The registers are provided for rapid saving and recalling, since you do not need to specify a filename or navigate to a file. Each of the register menu keys annotates whether it is empty or at what date and time it was last modified. In addition, you can edit any of the register names to enter custom names for any register.

Although these 16 registers are the only registers available from the front panel, there are 128 state registers available in the instrument. Registers 17-128 are only available from the SCPI interface, using the ***SAV** command.

There is one set of 128 state registers in the instrument, not one set for each Mode. When a state is saved, the Mode it was saved from is saved with it; then when it is recalled, the instrument switches to that Mode.

NOTE

In products that run multiple simultaneous instances of the X-Series Application, all instances share the same registers and file directories, so take care not to overwrite files and/or registers from one instance that were saved by another instance.

The date displayed follows the format specified in the **Date Format** setting under the **Control Panel**. The time shows hours and minutes.

After the save completes, the corresponding register menu key annotation is updated with the date and time and the message **Register <register number> saved** is displayed.

Example	*SAV 1
Range	1-16 from front panel, 1-128 from SCPI

7.3.2.2 Edit Register Names

You may enter a custom name for any of the **Registers**, to help you remember what you are using that state to save. To do this, press the **Name** field for the register you want to rename, which displays the onscreen alpha keyboard. Press **Done** on this keyboard when you are done editing.

The maximum number of characters for a register name is 30. If you delete all the characters in the custom name, it restores the default (time and date).

The register names are stored within the state files, but they are not part of the instrument state; that is, once you have edited a register name, loading a new state will not change that register name. Another consequence of this is that the names will be persistent through a power cycle. Also, if a named state file is transferred to another instrument, it will bring its custom name along with it.

If you try to edit the name of an empty register, the instrument first saves the state to have a file to put the name in. If you load a named state file into an instrument with older firmware, it ignores the metadata.

The ***SAV** and ***RCL** commands are not affected by the custom register names, nor are the **:MME** commands.

Remote Command	<code>:MMEemory:REGister:STATe:LABel <reg number>,"label"</code>
Example	<code>:MMEemory:REGister:STATe:LABel? <reg number></code>
Notes	<p><code><reg number></code> is an integer from 1 to 16. If the SCPI specifies an invalid register number an error message is generated, -222, "Data out of range; Invalid register label number"</p> <p><code>"label"</code> is a string from 0 to 30 characters in length. If a label exceeds 30 characters, an error message is generated, -150, "String data error; Label clipped to 30 characters"</p> <p><code>"label"</code> of zero length erases the custom label and restores the default (time and date) label. For example, <code>:MMEemory:REG:STAT:LAB 1,""</code></p>
Preset	The names are unaffected by Preset or power cycle but are set to the default label (time and date) on Restore System Defaults>Misc

7.3.3 Trace+State

Selects a register or file for saving selected traces and the state.

Trace+State files contain essentially all the information required to return the instrument to the measurement and settings that were in effect at the time of the save, as well as the data for one or all traces. **Trace+State** files are in a proprietary binary form (for speed) and cannot be read or edited by PC software, but can be loaded back into the instrument to restore the state and trace(s).

Trace+State files contain all the settings of the **Input/Output** system as well, even though **Input/Output** variables are outside of the Mode's state and unaffected by **Mode Preset**, because these are needed to restore the complete setup.

Persistent **System** settings (for example, GPIB address) are affected by neither **Mode Preset** nor **Restore Mode Defaults**, nor are they included in a saved **Trace+State** file.

For rapid saving, the **Trace+State** menu lists 16 registers to which you can save trace+state files. The **Trace+State** registers are separate registers from the **State** registers. Pressing a **Register** button initiates the save. You can also select a file to which to save by pressing **Save to File**.

The default path for all **Trace+State** files is the same as that for **State** files:

7 Save/Recall/Print
7.3 Save

My Documents\`<mode name>`\state

where `<mode name>` is the parameter used to select the mode with `:INST:SEL` (for example, `BASIC` for IQ Analyzer Mode).

NOTE

In products that run multiple simultaneous instances of the X-Series Application, all instances share the same registers and file directories, so take care not to overwrite files and/or registers from one instance that were saved by another instance.

Trace+State files have the extension `.trace`. The default filename is `State_0000.trace`, where the 4-digit number is the lowest number that does not conflict with any filename in the current directory.

The **Trace+State** selection only appears for measurements that support trace saves. It is blanked for modes that do not support trace saves. Saving **Trace** is identical to saving **State** except a `.trace` extension is used on the file instead of `.state`, and internal flags are set in the file indicating which trace was saved.

See "[More Information](#)" on page 1353.

Remote Command	<code>:MMEMory:STORe:TRACe TRACE1 TRACE2 TRACE3 TRACE4 TRACE5 TRACE6 ALL,<filename></code> <code>:MMEMory:STORe:TRACe:REGister TRACE1 TRACE2 TRACE3 TRACE4 TRACE5 TRACE6 ALL,<integer></code>
----------------	--

Example	Save the file <code>myState.trace</code> on the default path and flags it as a "single trace" file with Trace 1 as the single trace (even though all of the traces are in fact stored): <code>:MMEM:STOR:TRAC TRACE1,"myState.trace"</code> Save the file <code>myState.trace</code> on the default path and flags it as an "all traces" file: <code>:MMEM:STOR:TRAC ALL,"myState.trace"</code> Store trace 1 data in trace register 2: <code>:MMEM:STOR:TRAC:REG TRACE1,2</code>
---------	--

Notes	This command actually performs a Save State , which in the Swept SA measurement includes the trace data. However, it flags it (in the file) as a "save trace" file of the specified trace (or all traces) Some Modes and measurements do not have available all 6 traces. The Phase Noise Mode command, for example, is: <code>:MMEMory:STORe:TRACe TRACE1 TRACE2 TRACE3 ALL,<filename></code> Some modes and measurements have more than 6 traces available. The Realtime SA Mode command, for example, is: <code>:MMEMory:STORe:TRACe TRACE1 TRACE2 TRACE3 TRACE4 TRACE5 TRACE6 TRACE7 TRACE8 TRACE9 TRACE10 TRACE11 TRACE12 ALL,<filename></code> The range for the register parameter is 1-5 When you initiate a save, if the file already exists, a dialog will appear that allows you to replace the existing file by selecting OK or you can cancel the request. If you select OK , the file will be overwritten. Using the C: drive is strongly discouraged, since it runs the risk of being overwritten during an instrument software upgrade
-------	--

Both single and double quotes are supported for any filename parameter over remote

After saving to a register, that register's menu key is updated with the date and time of the save

After saving to a register, you remain in the **Save Trace** menu, so that you can see the **Register** key update. After saving to a file, the instrument automatically returns to the previous menu and any **Save As** dialog goes away

More Information

In measurements that support saving **Traces**, for example, Swept SA, the **Trace** data is saved along with the **State** in the **State** file. When recalling the **State**, the **Trace** data is recalled as well. Traces are recalled exactly as they were stored, including the writing mode and update and display modes. If a Trace was updating and visible when the **State** was saved, it returns updating and visible, and its data will be rewritten right away. When you use **State** to save and recall traces, any trace whose data must be preserved should be placed in **View** or **Blank** mode before saving.

The following table describes the **Trace Save** and **Recall** possibilities:

You want to recall state and one trace's data, leaving other traces unaffected	Save Trace+State from 1 trace. Make sure that no other traces are updating (they should all be in View or Blank mode) when the save is performed	On recall, specify the trace you want to load the one trace's data into. This trace loads in view. All other traces' data will be unaffected, although their trace mode will be as it was when the state save was performed
You want to recall all traces	Save Trace+State from ALL traces	On recall, all traces come back in View (or Blank if they were in Blank or Background when saved)
You want all traces to load exactly as they were when saved	Save State	On recall, all traces' mode and data will be exactly as they were when saved. Any traces that were updating will have their data immediately overwritten

7.3.3.1 Save From Trace

Selects the trace to be saved. The default is the currently selected trace, selected in this this or any other menu with Trace selection. If you have chosen All then it remains chosen until you specifically change it to a single trace, regardless of the trace selected in the **Trace** menu.

When you select a trace, it makes that trace the current trace, so it displays on top of all of the other traces.

7.3.3.2 Register 1 thru Register 16

Selecting any one of these register buttons causes the specified trace(s) and the state of the currently active mode to be saved to the specified register. The registers are provided for rapid saving and recalling, since you do not need to specify a filename or navigate to a file. Each of the register menu keys annotates whether it is empty or at what date and time it was last modified. In addition, you can edit any of the register names to enter custom names for any register.

There is one set of 16 trace+state registers in the instrument, not one set for each Mode. When trace+state is saved, the Mode it was saved from is saved with it; then when it is recalled, the instrument switches to that Mode.

NOTE

In products that run multiple simultaneous instances of the X-Series Application, all instances share the same registers and file directories, so take care not to overwrite files and/or registers from one instance that were saved by another instance.

The date displayed follows the format specified in the **Date Format** setting in **Control Panel**. The time shows hours and minutes.

After the save completes, the corresponding register menu key annotation is updated with the date and time and the message **Register <register number> saved** is displayed.

Example	*SAV 1
Range	1-16

7.3.3.3 Edit Register Names

You may enter a custom name for any of the registers, to help you remember what you are using that trace+state to save. To do this, press the **Name** field for the register you want to rename, which displays the onscreen alpha keyboard. Press the **Done** button on this keyboard when you are done editing.

The maximum number of characters for a register name is 30. If you delete all the characters in the custom name, it restores the default (time and date).

The register names are stored within the trace+state files, but they are not part of the instrument state; that is, once you have edited a register name, loading a new state does not change that register name. Another consequence of this is that the names are persistent through a power cycle. Also, if a named state file is transferred to another instrument, it brings its custom name along with it.

If you try to edit the name of an empty register, the instrument will first save the trace+state to have a file to put the name in. If you load a named state file into an instrument with older firmware, it ignores the metadata.

Remote Command	<code>:MMEMory:REGister:TRACe:LABel <reg number>,"label"</code>
Command	<code>:MMEMory:REGister:TRACe:LABel? <reg number></code>
Example	<code>:MMEM:REG:TRAC:LAB 1,"my label"</code>
Notes	<p><code><reg number></code> is an integer from 1 to 16. If the SCPI specifies an invalid register number an error message is generated, -222, "Data out of range; Invalid register label number"</p> <p><code>"label"</code> is a string from 0 to 30 characters in length. If a label exceeds 30 characters, an error message is generated, -150, "String data error; Label clipped to 30 characters"</p> <p><code>"label"</code> of zero length erases the custom label and restores the default (time and date) label, e.g., <code>:MMEM:REG:TRAC:LAB 1,""</code></p>
Preset	The names are unaffected by Preset or power cycle but are set to the default label (time and date) on Restore System Defaults > Misc

7.3.4 Screen Config + State

Saves the complete configuration of all your screens to a file. You choose a file to which to export the data.

Remote Command	<code>:MMEMory:STORe:SCONfig <filename></code>
Example	<p>Store the current screen configuration in the file <code>myScreenConfig.screen</code> in the default directory:</p> <p><code>:MMEM:STOR:SCON "myScreenConfig.screen"</code></p>

7.3.5 Measurement Data

Specifies a data type (for example, trace data) and choose a file to which to export the data.

Measurement Data files are comma-separated Value (CSV) files, and contain the requested data in a form that can be imported into Excel or similar spreadsheets, as well as header data that gives information on relevant instrument settings at the time the save occurred.

The main application of **Measurement Data** files is for importing data to a PC for analysis, but in some cases **Measurement Data** files can also be imported back into the instrument to recreate the data object that existed at the time of the save. For example, most **Trace** data files can be imported back into the instrument.

The default path for **Measurement Data** Files is:

`My Documents\<mode name>\data`

7 Save/Recall/Print
7.3 Save

with the subdirectory reflecting the data type and where `<mode name>` is the parameter used to select the Mode with `:INST:SEL` (for example, `SA` for Spectrum Analyzer Mode) and `<measurement name>` is the parameter used to select the measurement with `:CONF` (for example, `SAN` for Swept SA). For example, a Peak Table file from Swept SA in SA Mode would be stored in:

`My Documents\SA\data\SAN\results`

Measurement Data files have extension `.csv`. The default filename is `Prefix_0000.csv`, where the 4-digit number is the lowest number that does not conflict with any filename in the current directory, and “Prefix” is dependent on the data type:

Type	Default Prefix
Traces	Trace_
Measurement Result	MeasR_
Capture Buffer	CapBuf_

For example, the default filename for a trace data file in an empty directory would be `Trace_0000.csv`

7.3.5.1 Save From

Selects the specific item to be saved, for example, if you are exporting trace data you may specify Trace 1, Trace 2, etc.

The default for traces is the currently selected trace, selected in this this or any other menu with Trace selection. If you have chosen **All** then it remains chosen until you specifically change it to a single trace, regardless of the trace selected in the Trace menu. The **All** selection saves all six traces in one CSV file with the x-axis data in the first column and the individual trace data in succeeding columns. The header data and x-axis data in this file reflect the current settings of the measurement. Note that any traces that are in **View** or **Blank** may have different x-axis data than the current measurement settings; but this different x-axis data is *not* output to the file.

Preset	Not part of Preset , but is reset to by Restore Mode Defaults Survives shutdown
--------	--

7.3.5.2 Data Type

You choose the data type to save by using the radio button selection box. Below are the specifications for Data files for each measurement.

Notes	There is no SCPI command for Data Type , as the type is implied in the SCPI command for each item
Dependencies	The Data Type menu for any given measurement only contains data types that are supported by that measurement

Meas Results

Meas Results files contain information that describes the current state of the instrument, as detailed in Meas Result File Contents below.

This command is only available in certain measurements, such as:

- PowerSuite: Channel Power, OBW, ACP, Spectrum Emissions Mask, Spurious Emissions, Power Stat CCDF, Transmit Power, Monitor Spectrum, IQ Waveform
- IQ Analyzer: Complex Spectrum
- Phase Noise: Log Plot and Spot Frequency
- WCDMA: Code Domain, Mod Accuracy, Power Control, and QPSK EVM
- Analog Demod: AM, FM, PM and FM Stereo
- Noise Figure
- Pulse

In general, the data in the Meas Results file matches the data which is returned to a measurement data query (`:FETCh?`, `:READ?`, `:MEASure?`). These queries and the results they return are documented for each measurement, and can be found in the Help for that measurement (or in the manual for that measurement) in the section titled **Remote Command Results**.

In the **MeasResults** file, you will see a column for each value of *n*. Each column contains the value for the corresponding value of *n* in the **Remote Command Results** table.

For example, Complex Spectrum allows values of *n* up to 17, and the **MeasResults** file for Complex Spectrum has 17 columns. So, the data returned when you send `:FETCh:SPECTrum1?` matches the data in the column labeled **MeasResult1** of the Meas Results file. See the example below:

Response to FETCh:SPECTrum1?

```
2.125444221E+01,6.487077992E+07,2.050000000E+02,6.004725051E+07,3.9215
68627E+04,2.370000000E+02,0.000000000E+00,1.000000000E-
07,1.000000000E+00,2.360000000E-05,2.500000000E+01
```

MeasResult1 column from Meas Results file

```
MeasResult1
-21.25444221
64870779.92
```

7 Save/Recall/Print
7.3 Save

205
60047250.51
39215.68627
237
0
1.00E-07
1
2.36E-05
25

In addition, examples of the Meas Results files are given for each data type in the Help below.

Remote Command	<code>:MMEemory:STORe:RESults <string></code>
Example	<code>:MMEEM:STOR:RES "MeasR_0000.csv"</code>
Notes	<p>If the save is initiated via SCPI and the file already exists, the file will be overwritten</p> <p>The SCPI command exports measurement results to the file specified as the parameter in the current path. The default path is:</p> <p><code>My Documents\<current mode>\data\<measurement name>\results</code></p> <p>where <code><mode name></code> is the parameter used to select the mode with the <code>:INST:SEL</code> command (for example, <code>SA</code> for Spectrum Analyzer Mode) and <code><measurement name></code> is the parameter used to select the measurement with the <code>:CONF:</code> command (for example, <code>SAN</code> for the Swept SA measurement)</p> <p>Using the <code>C:</code> drive is strongly discouraged, since it runs the risk of being overwritten during an instrument software upgrade</p> <p>The SCPI parameter is a quoted string, which specifies the filename. Both single and double quotes are supported for any filename parameter over SCPI</p>
Annotation	After the save is complete, an advisory is displayed in the window so that the user can confirm which file was saved
Status Bits/OPC dependencies	Sequential – waits for the previous measurement to complete

7.3.6 Limit

Lets you choose a file to which to export the **Limit** data.

Limit files are CSV files, and contain the limit data in a form that can be imported into Excel or similar spreadsheets, as well as header data that gives information on the limit.

The default path for most Limits files is:

`My Documents\<mode name>\data\limits`

where `<mode name>` is the parameter used to select the mode with the `:INST:SEL` command (for example, `SA` for Spectrum Analyzer). Hence a **Limit** file from any measurement in Spectrum Analyzer Mode would be stored in:

`My Documents\SA\data\limits`

The default path for **Limit** files from the Log Plot measurement in Phase Noise Mode is:

`My Documents\PNOISE\data\LPL\limits`

The default filename is `Limit_0000.csv`, where the 4-digit number is the lowest number that does not conflict with any filename in the current directory.

For backwards compatibility, older limit files with the extension `.lim` can be read into the instrument, but you can only save limits as `.csv` files.

Remote Command	<code>:MMEMory:STORe:LIMit LLINE1 ... LLINE6,<filename></code>
Example	Save the 2nd Limit Line to the file <code>myLimitLine2.csv</code> in the current path: <code>:MMEM:STOR:LIM LLINE2,"myLimitLine2.csv"</code>
Notes	If the save is initiated via SCPI, and the file already exists, the file will be overwritten Using the C: drive is strongly discouraged, since it runs the risk of being overwritten during an instrument software upgrade Both single and double quotes are supported for any filename parameter over SCPI
Dependencies	Only appears if you have the proper option installed in your instrument In the Log Plot measurement in Phase Noise Mode, there are only three Limit Lines, so the valid parameters are <code>LLINE1 LLINE2 LLINE3</code>
Preset	1 Not part of Preset , but reset by Restore Mode Defaults Survives power cycles
State Saved	The selected Limit number is saved in instrument state
Status Bits/OPC dependencies	Sequential - waits for previous measurement to complete

Limit File Contents

Limits may be exported into a data file with a `.csv` extension. They may be imported from that data file; they may also be imported from a legacy limit file with a `.lim` extension. The `.lim` files meet the specification for limit files contained in the EMI measurement guide, HP E7415A.

.csv file format

Except for information in quotes, limit line files are not case sensitive. Information in bold is required verbatim; other text is example text, and italic text is commentary which should not be present in the file.

The first five lines are system-required header lines, and must be in the correct order:

7 Save/Recall/Print
7.3 Save

Limit	<i>Data file type name</i>
"FCC Part 15"	<i>File Description</i>
"Class B Radiated"	<i>Comment</i>
A.01.00.R0001.N9020A	<i>Instrument Version, Model Number</i>
P13 EA3 UK6 ,01	<i>Option List, File Format Version</i>

The next few lines describe the parameters; on export they will be in the order shown, on import they can be in any order. If some parameters are missing, they will revert to the default.

Type, Upper	<i>Upper Lower</i>
X Axis Unit, MHz	<i>MHz S; other units should be converted; this also specifies the domain</i>
Amplitude Unit, dBm	<i>dBm V; all other units should be converted appropriately</i>
Frequency Interpolation, Linear	<i>Logarithmic Linear</i>
Amplitude Interpolation, Logarithmic	<i>Logarithmic Linear</i>
X Control, Fixed	<i>Fixed Relative; on input we consider only the first three characters</i>
Y Control, Fixed	<i>Fixed Relative; on input we consider only the first three characters</i>
Margin, 0	<i>Always in dB. A 0 margin is equivalent to margin off</i>
X Offset, 10	<i>Expressed in the X axis units</i>
Y Offset, 5	<i>Expressed in the Amplitude units</i>

The Amplitude Unit line in the limits file may contain a transducer (formerly "antenna") factor unit, for example:

Amplitude Unit=dBuV/m

Transducer factor units are dBuV/m, dBuA/m, dBpT, and dBG. In this case, the unit is treated exactly as though it were dBuV, meaning that all of the limits are interpreted to have units of dBuV. The box does NOT change Y Axis Units when such a limit is loaded in.

The X-Axis unit also specifies the domain (time or frequency). It is not possible to have both time-domain lines and frequency-domain lines at the same time; if a time-domain line is imported while the other lines are in the frequency domain (or vice-versa), all limit lines will be deleted prior to import.

If the sign of the margin is inappropriate for the limit type (for example a positive margin for an upper limit), the sign of the margin will be changed internally so that it is appropriate.

The remaining lines describe the data. Each line in the file represents an X-Y pair. The X values should be monotonically non-decreasing, although adjacent lines in the file can have the same X value as an aid to building a stair-stepped limit line. To specify a region over which there is no limit, use +1000 dBm for upper limits or -1000 dBm for lower limits.

The data region begins with the keyword **DATA**:

DATA
200.000000,-10.00
300.000000,-10.00
300.000000,-20.00
500.000000,-20.00

.lim file format

This is a legacy format which allows files saved from older instruments to be loaded into the X-Series. *Design of files in this format is not recommended.*

Except for name and description text (which is taken verbatim), limit line files are not case sensitive.

The file may optionally start with a description block, consisting of the single line [DESCRIPTION] followed by arbitrary text. If there is no Limit Line Name header, the description text will be used as the limit line description in the GUI. If there is a Limit Line Name header, the Limit Line Name will be used instead.

Arbitrary text

The header block begins with the single line [HEADER], followed by some or all of the following fields, each with <parameter name>=<parameter value>. Excess white space around the “=” is ignored. If a field is not present or the data is invalid, the value is not changed when the limit line is loaded. Ordering of the fields is unimportant.

Limit Line Name="FCC Part 15;Class B Radiated"	
Type=Upper	Upper Lower
Frequency Unit=MHz	For time domain limits, this should say "Time Unit"
Amplitude Unit=dBm	
Frequency Interpolation=Lin	Log Lin; on input we consider only the first three characters
Amplitude Interpolation=Log	Log Lin; on input we consider only the first three characters
Mode=Fixed	Fixed Relative
Margin=0	Always in dB. A 0 margin is equivalent to margin off
Domain=Frequency	Frequency Time
Delimiter=TAB	

The data block begins with the line [DATA], and consists of any number of segments.

The Data lines represent segments – X1, Y1, X2, Y2. If the list of segments includes a gap in the middle on input, the space inside the gap will be set to ensure the limit does not fail: for upper limits maxtracevalue, for lower limits mintracevalue. If two segments overlap on input, the stricter of the two segments is used – for upper limits the lower segment, for lower limits the upper segment.

Thus, the following segments indicate into a –5 dB limit from 10 MHz to 20 MHz and 30 MHz to 40MHz:

10	-5	20	-5
30	-5	40	-5

7 Save/Recall/Print
7.3 Save

If this was an upper limit, this would be translated into the following set of limit points:

10				-5	
20				-5	
20				maxtracevalue	
30				maxtracevalue	
30				-5	
40				-5	
	30	-29.5	88	-29.5	
	88	-33	216	-33	note that we are stair-stepping the line
	230	-35.6	960	-35.6	The gap between 216 MHz and 230 MHz will never fail
	960	-43.5	5000	-43.5	

7.3.6.1 Select Limit

Selects the specific Limit to be saved, for example, Limit 1.

Preset	Not part of Preset , but reset to LLINE1 by Restore Mode Defaults Survives shutdown
--------	---

7.3.7 Correction

Exports Amplitude Corrections files in the PC-readable **.csv** format.

Amplitude Correction files contain the correction data in a form that can be imported into Excel or similar spreadsheets, as well as header data that gives information on the correction.

The default filename is **Ampcor_0000.csv**, where the 4-digit number is the lowest number that does not conflict with any filename in the current directory.

The default path for Corrections files is:

My Documents\amplitudeCorrections

For backwards compatibility, older limit files with the extensions **.amp**, **.cbl**, **.ant** and **.oth** can be read into the instrument, but you can only save corrections as **.csv** files.

See "**Correction Data File**" on page 1363

Remote Command	:MMEMory:STORe:CORRection 1 ... 8, <filename>
----------------	--

Example	Save Correction 2 to the file myAmpcor.csv on the current path:
---------	--

	<code>:MMEM:STOR:CORR 2 "myAmpcor.csv"</code>
Notes	<p>If the save is initiated via SCPI, and the file already exists, the file will be overwritten</p> <p>Using the C: drive is strongly discouraged, since it runs the risk of being overwritten during an instrument software upgrade</p> <p>Both single and double quotes are supported for any filename parameter over SCPI</p>
Dependencies	<p>Corrections are not supported by all measurements. If in a Mode in which some measurements support it, this key is grayed-out in measurements that do not. Does not appear at all if no measurements in the Mode support it</p> <p>Does not appear unless you have the proper option installed in your instrument</p>
Annotation	After save is complete, an advisory is displayed in the message bar confirming which file was saved
Backwards Compatibility SCPI	<p><code>:MMEMory:STORe:CORRection ANTenna CABLe OTHer USER, <filename></code></p> <p>For backwards compatibility, ANTenna maps to 1, CABLe maps to 2, OTHer maps to 3 and USER maps to 4</p>

Correction Data File

A Correction Data File contains a copy of one of the instrument correction tables. Corrections provide a way to adjust the trace display for predetermined gain curves (such as for cable loss).

Corrections files are text files in **.csv** (Comma-Separated Values) form, to make them importable into Excel or other spreadsheet programs. The format for Corrections files is as follows:

Line #	Type of field	Example	Notes
1	File type, must be "Amplitude Correction"	Amplitude Correction	May not be omitted
2	File Description (in quotes)	"Correction Factors for 11966E"	60 characters max; may be empty but may not be omitted. If exceeds 60 characters, error -233 Too much data reported
3	Comment (in quotes)	"Class B Radiated"	60 characters max; may be empty but may not be omitted. . If exceeds 60 characters, error -233 Too much data reported
4	Instrument Version, Model #	A.02.06,N9020A	May be empty but may not be omitted
5	Option List, File Format Version	K03 LFE EXM ,01	May be empty but may not be omitted
6	Freq Unit to be used for all frequency values in the file	Frequency Unit, MHz	assumed to be Hz if omitted

7 Save/Recall/Print
7.3 Save

Line #	Type of field	Example	Notes
7	Transducer Unit	Antenna Unit, None	If omitted leaves the Transducer unit unchanged. The amplitude unit in the Transducer Unit field is a conversion factor that is used to adjust the Y Axis Units of the current mode, if the mode supports Transducer Units. For more details on transducer correction data, refer to the Input/Output, Corrections key description. Allowable values: dBuV/m, dBuA/m, dBG, dBpT, None
8	Freq Interpolation	Frequency Interpolation, Linear	if omitted leaves the Freq Interpolation unchanged. Allowable values: Linear, Logarithmic
9	Bias value in mA	Bias,0.00	If omitted leaves the Bias value unchanged (added as of A.08.50)
10	Bias State	Bias State,On	If omitted leaves the Bias State unchanged. Allowable values: On, Off (added as of A.08.50)
11	Overlap, two values, Freq1 and Freq2, separated by commas	Overlap,33500,40000	Uses Freq Unit from line 6. Thus, in this example Freq1=33.5 GHz, Freq2= 40.0 GHz (see note below). If omitted leaves the overlap unchanged (added as of A.08.50)
12	DATA marker	DATA	Corrections data begins in the next line

Lines 2 through 5 can be empty but must appear in the file. Lines 6 through 11 are optional, the lines can be left out of the file altogether.

The Overlap row and the two Bias rows apply only to external mixing. Both are read-only, they are never written by the instrument. The only way to insert or modify these rows is to edit the file with a text editor or a spreadsheet editor. These rows are intended for use by mixer manufacturers, as they allow the manufacturer to insert data about how the mixer corrections were generated and how they should be applied. The Bias rows allow you to specify whether to turn Bias on or off when the Correction is turned on and to specify a Bias value (turning off the Correction does not change the Bias, but turning it back on again sets it to the value specified in the file). The Overlap row allows you to specify an overlap region in which two different corrections may be applied. It is expected that in the corrections data itself, there will be TWO corrections values exactly at Max Freq, otherwise Overlap is ignored. The way the overlap is processed is as follows: if at any given time the current instrument Start Freq is greater than Freq 1 and lower than Freq 2, and the current Stop Freq is greater than Freq 2, extend the first correction point at or above Freq 2 down to Freq 1, rather than using the correction data between Freq1 and Freq2.

Only one Transducer units can be on at any given time. Note that this means that if a correction file with a Transducer Unit is loaded into a particular Correction, all other Corrections are set to that same Transducer unit. Note that the legacy term "Antenna Unit" is still used in the correction file, even though the more modern term "Transducer Unit" is used in the user interface.

Similarly, the Bias rows can only be used in Correction register 1, because there can only be one setting for Bias at any given time. If a Correction file with a Bias or Bias State row is loaded into any Correction register but 1, an error is generated: Mass storage error; Can only load Bias Settings into Correction 1

The data follows the DATA row, as comma separated X, Y pairs; one pair per line.

For example, suppose you have an Antenna to correct for on an N9020A version A.02.06 and the correction data is:

- 0 dB at 200 MHz
- 17 dB at 210 MHz
- 14.8 dB at 225 MHz

Then the file will look like:

- Amplitude Correction
- "Correction Factors for 11966E"
- "Class B Radiated"
- A.02.06,N9020A
- P13 EA3 UK6,01
- Frequency Unit, MHz
- Antenna Unit, dBuV/m
- Frequency Interpolation, Linear
- DATA
- 200.000000,0.00
- 210.000000,17.00
- 225.000000,14.80

The choices for the 1 of N fields in the metadata are as follows:

7 Save/Recall/Print
7.3 Save

- Frequency Unit: Hz, kHz, MHz, GHz
- Antenna Unit: dBuV/m, dBuA/m, dBG, dBpT, None
- Frequency Interpolation: Logarithmic, Linear

7.3.7.1 Select Correction

Selects the specific Correction to be saved, for example, Correction 1.

Preset	Not part of a Preset , but reset to Correction 1 by Restore Input/Output Defaults Survives a shutdown
--------	---

7.3.8 Mask

The **Mask** data type is used to import and export Mask files for measurements that use masks, such as cellular comms and real-time measurements.

7.3.9 Waveform Sequence

Saves waveform sequences from the ARB memory of an Internal Source. When you open the Save **Waveform Sequence** dialog and press **Save**, the current waveform sequence is saved to the selected directory.

Notes	No remote command, front panel only
Dependencies	Only appears if your hardware includes an Internal Source, such as in VXT

7.3.10 Screen Image

Selects a file for saving the contents of the display.

Screen Image files are PNG (Portable Network Graphics) files with the same resolution as the data display. They contain the image that was on the screen before you opened the **Save** dialog. When the **Screen Image** key is pressed, a "thumbnail" of the captured image is displayed, with the note "This is the image that will be saved" below it.

After you have completed the save, a message "File image.png saved" (assuming **image.png** was the filename you used).

NOTE

As of firmware release A.17.50, sending ***CLS** (Clear Status) removes any message displayed on the screen. If you do not want to see the "File saved"

message after sending `:MMEM:STOR:SCR` (described below), send the following sequence (substituting your file name for `filename.png`): `:MMEM:STOR:SCR "filename.png";*CLS`

NOTE

As of firmware release A.19.50, saving a screen image removes any informational message displayed on the screen before it captures the screen. This is useful if you are sending “save image” commands in rapid sequence, as it keeps the “File saved” message from one screen capture from appearing in the next screen capture. Error messages are still captured.

If you send a succession of screen image commands *too* rapidly, the system may not have time to remove the previous message before the next screen capture. Sending screen image commands more rapidly than twice per second is not advised.

The default path for State Files is:

`My Documents\<mode name>\screen`

where `<mode name>` is the parameter used to select the mode with `:INST:SEL`, for example, `SA` for Spectrum Analyzer Mode.

Screen Image files have extension `.png`. The default filename is `Screen_0000.png`, where the 4-digit number is the lowest number that does not conflict with any filename in the current directory.

After you have completed the save, the **Quick Save** front-panel key lets you quickly repeat the last save performed, using an auto-named file, with new current screen data.

Remote Command `:MMEMory:STORe:SCReen <filename>`

Example Store the current screen image in the file `MyScreenFile.png` in the default directory:
`:MMEM:STOR:SCR "myScreen.png"`

Backwards Compatibility SCPI `:HCOPY:SDUMP:DATA?`

returns the screen image in a `<DEFINITE LENGTH ARBITRARY RESPONSE DATA>` element. The response data is IEEE Block format; the controlling computer can strip the header and store the result as a `.png` file

Blocking Screen Capture (Remote Command Only)

This command works *only* when the measurement is in **Single** mode (see ["Sweep/Measure" on page 804](#)). When the command is sent, it blocks the SCPI client, waits for the current refresh to complete, then captures the screen shot and saves it. In some instances, a single measurement is taken, and a screen shot of that measurement is captured.

7 Save/Recall/Print
7.3 Save

This command ensures that the last-measured data is refreshed on the screen before it is captured, by blocking the command and waiting for refresh to complete. The command may time out, in which case it must be re-sent.

If timeout occurs, or if the active measurement is in **Continuous** mode, an error is returned.

Remote Command	<code>:MMEMory:STORe:SCReen:BLORked <filename></code>
Example	Wait for the current screen refresh to complete before capturing the screen shot, then store the current screen image in the file <code>MyScreenFile.png</code> in the default directory: <code>:MMEM:STOR:SCR:BLOR "myScreen.png"</code>

7.3.10.1 Theme

Accesses a menu of functions that enable you to choose the theme to be used when saving the screen image. You can choose between themes to be used when saving the screen image.

See "[More Information](#)" on page 1368 for examples of the themes.

Remote Command	<code>:MMEMory:STORe:SCReen:THEME FILLed OUTLine</code> <code>:MMEMory:STORe:SCReen:THEME?</code>
Example	<code>:MMEM:STOR:SCR:THEM OUTL</code>
Preset	FILLed ; not part of Preset , but reset by Restore Misc Defaults or Restore System Defaults All
Backwards Compatibility SCPI	<code>:MMEMory:STORe:SCReen:THEMe TDCoLor TDMonochrome FCoLoR FMONochrome</code>

Backwards Compatibility Notes

To permit code compatibility with A-model X-Series Signal Analyzer instruments, the command parameters from the A-models are mapped as follows:

TDCoLor and **TDMonochrome** are both mapped to **FILLed**
(exact full color representation of what is on the screen)

FCoLoR and **FMONochrome** are both mapped to **OUTLine**
(uses color for traces and other items, but most filled areas are white)

There is no Monochrome theme in B-models, so the A-models monochrome commands yield color
`:MMEM:STOR:SCR:THEM?` always returns **FILLed** or **OUTLine**, never **FCoLoR**, **FMONochrome**, **TDCoLor**, or **TDMonochrome**

There is no monochrome theme in the X-Series Touch UI

More Information

- The **FILLed** theme is an exact representation of the information on the display
- The **OUTLine** theme eliminates most of the filled areas, in order to save ink when the image is printed. In addition, the yellow trace color is changed to be

more orange, to improve visibility against a white background. Note that some objects remain filled. In particular, the selected marker remains filled with the green marker color, in order to distinguish it from the other markers. This is important, as it is the selected marker whose readout appears in the upper right corner of the display

7.3.11 Power Sensor Cal Factor

Selects a file to which to export the Power Sensor Cal factor data.

Cal Factor files are XML files, and contain the cal factor data and header data that gives information on the power sensor.

The default path for **Cal Factor** Files is:

`My Documents\<mode name>\data\PSCF`

where `<mode name>` is the parameter used to select the mode with `:INST:SEL` (for example, `MRECEIVE` for Measuring Receiver Mode). Hence, a **Cal Factor** file from any measurement in the Measuring Receiver mode would be stored in:

`My Documents\MRECEIVE\data\PSCF`

Cal Factor files have the extension `.xml`. The default filename is `<Sensor Model>_<Sensor Serial Number>_0000.xml`, where the 4-digit number is the lowest number that does not conflict with any filename in the current directory. If the sensor model or serial number is blank, the default filename is `PSCF_0000.xml`.

Remote Command	<code>:MMEMory:STORe:PSCFactor <file_name></code>
Example	<code>:MMEM:STOR:PSCF "myPSCF.xml"</code>
Notes	<p>If the save is initiated via SCPI, and the file already exists, the file will be overwritten</p> <p>Using the C: drive is strongly discouraged, since it runs the risk of being overwritten during an instrument software upgrade</p> <p>Both single and double quotes are supported for any filename parameter over SCPI</p>
Dependencies	Only appears if you have the proper option installed in your instrument

7.3.12 Recording

Lets you save to a file data being acquired by the measurement, so that it can later be recalled and played back as though it were coming from the input.

You may specify a data type (for example, I/Q data) and choose a file to which to save the data.

The recording and playback of signal data files is a multi-step process that involves controls in several menus.

The menus that are involved in Record/Playback are:

7 Save/Recall/Print
7.3 Save

- **Save, Recording** (this menu)
- **Recall, "Recording" on page 1342** (under the **Recall** hardkey or the **Recall** icon in the **File** panel)
- **Sweep, Recording** tab
- **Sweep, Playback** tab
- **Input/Output, "Data Source" on page 1199** tab

NOTE

A complete tutorial for the Record/Playback functionality, including how to load and save Recording files, can be found under the **Data Source** tab in **Input/Output**.

Dependencies	Only available in the following Modes and measurements: <ul style="list-style-type: none">- VMA (Digital Demod and Custom OFDM)- 5G NR (Modulation Analysis)- LTE (Modulation Analysis)- WLAN (Modulation Analysis, MIMO Modulation Analysis, Spectral Flatness)- Analog Demod- Bluetooth (Transmit Analysis)- IoT & SRComms (LoRa CSS Demod)
--------------	---

7.3.12.1 Data Type

Lets you save IQ data from the measurement using a specified file type (**CSV**, **SDF**, **TXT**, **BIN**, **BINX**, **BINF**, **ORB**).

CSV	Comma-Separated Values. Excel compatible format. Plain text roughly three times the size of BINF
TXT	Text format. Plain text roughly three times the size of BINF
SDF	Format developed for Keysight 89600 VSA Software. Note that due to differences in the internal file structure, SDF files saved by X-Series are not guaranteed to work perfectly with 89600
BIN	Interleaved 16-bit Q15 signed IQ file, in Big Endian format. Q15 is a DSP format in which the most significant bit is the sign bit, followed by 15 bits of fraction. The Q15 number has a decimal range between -32768 and -32767. The data is scaled to fit within this decimal range BIN files do not include sampling rate information inside the file, there will be associated

	txt file including sampling rate and scaling information
BINX	Interleaved 16-bit Q15 signed IQ file, in Little Endian format. The data is scaled to fit within the decimal range BINX files do not include sampling rate information inside the file, there will be associated txt file including sampling rate and scaling information
BINF	32-bit IEEE 754 floating-point number in Little Endian format. The data is raw IQ data BINF files do not include sampling rate information inside the file, there will be associated txt file including sampling rate information
ORB	Format developed for Keysight ORAN Studio. This format is only supported by 5G NR, LTEAFDD and LTEATDD Modulation Analysis measurements, LTEAFDD and LTEATDD CEVM measurements

Example `:MMEM:STORe:RECORDing "C:\TEMP\MyIQData.csv"`

7.3.12.2 Channel

Select data channels to save. This is only supported by 5G NR Mode's EVM, VMA Digital Demod, VMA Custom OFDM measurements, and by WLAN Mode's MIMO EVM measurement.

The `<meas>` param in the command must be replaced with the node of the active measurement:

Parameter	Mode	Measurement
EVM	5G NR	EVM
EVMM	WLAN	MIMO EVM
DDEM	VMA	Digital Demod
OFDM	VMA	Custom OFDM

Remote Command `:MMEMory:STORe:<meas>:RECORDing:CHANnel ALL | CH1 | CH2 | CH3 | CH4 | CH5 | CH6 | CH7 | CH8`
`:MMEMory:STORe:<meas>:RECORDing:CHANnel?`

Example `:MMEM:STOR:EVM:REC:CHAN CH1`
`:MMEM:STOR:EVM:REC:CHAN?`

Preset `ALL`

State Saved `No`

Range `ALL | CH1 | CH2 | CH3 | CH4 | CH5 | CH6 | CH7 | CH8`

7.3.13 Remote Only Commands

The following commands execute file system operations such as move, copy, and transfer data from a file.

7.3.13.1 Mass Storage Catalog (Remote Command Only)

Remote Command	<code>:MMEMory:CATalog? [<directory_name>]</code> The string <code><directory_name></code> must be a valid logical path. If no string then it uses the current directory
Example	<code>:MMEM:CAT? "C:\"</code>
Notes	<p>Queries disk usage information (drive capacity, free space available) and obtains a list of files and directories in a specified directory in the following format: <code><numeric_value>,<numeric_value>,\{<file_entry>\}</code></p> <p>It returns two numeric parameters and as many strings as there are files and directories The first parameter indicates the total amount of storage currently used in bytes The second parameter indicates the total amount of storage available, also in bytes. <code><file_entry></code> is a string. Each <code><file_entry></code> indicates the name, type, and size of one file in the directory list: <code><file_name>,<file_type>,<file_size></code></p> <p>As the Windows file system has an extension that indicates file type, <code><file_type></code> is always empty. <code><file_size></code> provides the size of the file in bytes. For directories, <code><file_entry></code> is surrounded by square brackets and both <code><file_type></code> and <code><file_size></code> are empty</p>

7.3.13.2 Mass Storage Change Directory (Remote Command Only)

Remote Command	<code>:MMEMory:CDIRectory [<directory_name>]</code> <code><directory_name></code> must be a valid logical path <code>:MMEMory:CDIRectory?</code>
Example	<code>:MMEM:CDIR "C:\Program Files"</code>
Notes	<p>Changes the current directory for a mass memory file system. The <code><directory_name></code> parameter is a string. If no parameter is specified, the directory is set to the <code>*RST</code> value At <code>*RST</code>, this value is set to the default user data storage area, that is defined as <code>System.Environment.SpecialFolder.Personal</code> Query returns full path of the current directory as a quoted string</p>

7.3.13.3 Mass Storage Copy (Remote Command Only)

Remote Command	<code>:MMEMory:COPY <string>,<string>[,<string>,<string>]</code> <code><string></code> must be a valid logical path
Example	<code>:MMEM:COPY "C:\TEMP\Screen_0000.png", "C:\"</code>
Notes	<p>Copies an existing file to a new file or an existing directory to a new directory If no directory is specified, uses the current directory Two forms of parameters are allowed. The first form has two parameters. In this form, the first</p>

parameter specifies the source, and the second parameter specifies the destination

The second form has four parameters. In this form, the first and third parameters specify the source. The second and fourth parameters specify the directories. The first pair of parameters specifies the source. The second pair specifies the destination. An error is generated if the source doesn't exist or the destination file already exists

This command will generate an "access denied" error if the destination is a restricted folder (for example, `C:\Windows`) and you do not have Power User or Administrator privileges

7.3.13.4 Mass Storage Device Copy (Remote Command Only)

Transfers data to/from a file and a peripheral device.

Remote Command	<code>:MMEMory:COpy:DEvice <source_string>,<dest_string></code> <code><source_string></code> and <code><dest_string></code> must be valid logical paths
Notes	The strings must be a valid logical path or a valid device keyword. If <code>dest_string</code> is a device keyword, the data is copied from the source file to the device. If <code>source_string</code> is a device keyword, the data is copied to the source file from the device Valid device keywords are: <code>SNS</code> (smart noise source) An error is generated if the file or device is not found

7.3.13.5 Mass Storage Delete (Remote Command Only)

Remote Command	<code>:MMEMory:DELeTe <file_name>[,<directory_name>]</code> <code><file_name></code> and <code><directory_name></code> must be valid logical paths
Example	<code>:MMEM:DEL "Screen_0000.png"</code>
Notes	If no directory is specified, uses the current directory Removes a file from the specified directory. <code><file_name></code> specifies the file name to be removed. This command generates an "access denied" error if the file is in a restricted folder (for example, <code>C:\Windows</code>) and you do not have Power User or Administrator privileges

7.3.13.6 Mass Storage Data (Remote Command Only)

Creates a file containing the specified data or queries the data from an existing file.

Remote Command	<code>:MMEMory:DATA <file_name>, <data></code> <code><file_name></code> must be a valid logical path <code>:MMEMory:DATA? <file_name></code>
Example	<code>:MMEM:DATA? "MyFile.txt"</code>
Notes	If no directory is specified, uses the current directory

The command form `:MMEMory:DATA <file_name>,<data>` loads `<data>` into the file `<file_name>`. `<data>` is in 488.2 block format. `<file_name>` is string data
The response to `:MMEMory:DATA? <file_name>` is the associated `<data>` in block format

7.3.13.7 Mass Storage Make Directory (Remote Command Only)

Remote Command	<code>:MMEMory:MDIRectory <directory_name></code> <code><directory_name></code> must be a valid logical path
Example	<code>:MMEM:MDIR "C:\TEMP\NewDir"</code>
Notes	Creates a new directory. <code><directory_name></code> specifies the name to be created Generates an “access denied” error if the new directory would be in a restricted folder (for example, <code>C:\Windows</code>) and you do not have Power User or Administrator privileges

7.3.13.8 Mass Storage Move (Remote Command Only)

Remote Command	<code>:MMEMory:MOVE <string>,<string>[,<string>,<string>]</code> <code><string></code> must be valid logical paths
Example	<code>:MMEM:MOVE "C:\TEMP\Screen_0000.png", "C:\"</code>
Notes	Moves an existing file to a new file or an existing directory to a new directory Two forms of parameters are allowed. The first form has two parameters. In this form, the first parameter specifies the source, and the second parameter specifies the destination The second form has four parameters. In this form, the first and third parameters specify the source. The second and fourth parameters specify the directories. The first pair of parameters specifies the source. The second pair specifies the destination. An error is generated if the source doesn't exist or the destination file already exists This command generates an “access denied” error if the destination is a restricted folder (for example, <code>C:\Windows</code>) and you do not have Power User or Administrator privileges

7.3.13.9 Mass Storage Remove Directory (Remote Command Only)

Remote Command	<code>:MMEMory:RDIRectory <directory_name></code> <code><directory_name></code> must be a valid logical path
Example	<code>:MMEM:RDIR "C:\TEMP\NewDir"</code>
Notes	Removes a directory. The <code><directory_name></code> parameter specifies the directory name to be removed. All files and directories under the specified directory will also be removed This command generates an “access denied” error if the folder is a restricted folder (for example, <code>C:\Windows</code>) or is in a restricted folder and you do not have Power User or Administrator privileges

7.3.13.10 Mass Storage Determine Removable Media (Remote Query Only)

Used to determine whether any removable media devices are connected to the instrument. Primarily, these are USB memory devices plugged-in to the front panel or rear panel USB ports. On instruments with PC6 or PC7 CPUs, one SD card slot is available for removable media. The instrument's primary disk drive is *not* a removable media device.

Remote Command	<code>:MMEMory:RMEDia:LIST?</code>
Example	<code>:MMEM:RMED:LIST?</code>
Notes	<p>The return value is a string containing a list of partition identifiers, which are removable media devices. Each identifier will be separated by a comma. If no removable media is present, an empty string is returned</p> <p>Examples:</p> <ul style="list-style-type: none"> - One removable device present results in a return string of "F:" - Two removable devices present results in a return string of "F:,G:" <p>No removable devices present results in a return string of ""</p>

7.3.13.11 Mass Storage Determine Removable Media Label (Remote Command Only)

Used to set or query a removable media device's label.

Remote Command	<code>:MMEMory:RMEDia:LABel <partition>,<string></code>
Example	<code>:MMEM:RMED:LAB "F:","My Device"</code>
Notes	<p>If the <code><partition></code> specified does not exist or is not a removable media device, the error -252, "Missing Media" is generated</p> <p>Setting the removable media label requires Administrative privileges. If the currently logged-in user does not have appropriate privileges, error "-221, Settings conflict; Administrator privileges required" is generated</p>

7.3.13.12 Mass Storage Determine Removable Media Write-protect status (Remote Query Only)

Used to query a removable media device's write-protect status.

Remote Command	<code>:MMEMory:RMEDia:WPRotect? <partition></code>
----------------	--

Example	<code>:MMEM:RMED:WPR? "F:"</code>
Notes	The return value is 1 if the device is write-protected, and 0 if the device is write-enabled If the <code><partition></code> specified does not exist or is not a removable media device the error -252, "Missing Media" is generated
Preset	The return value depends on the SD card installed

7.3.13.13 Mass Storage Determine Removable Media size (Remote Query Only)

Queries a removable media device's total memory size (not available memory size).

Remote Command	<code>:MMEMory:RMEDia:SIZE? <partition></code>
Example	<code>:MMEM:RMED:SIZE? "F:"</code>
Notes	The return value is integer value in GBytes. Any device that is less than 1 GB returns 0 GB If the <code><partition></code> specified does not exist or is not a removable media device, the error -252, "Missing Media" is generated

7.3.13.14 :SYSTem:SET (Remote Command Only)

Obtains the state of the currently active mode in a form that can then be loaded back into the instrument quickly.

Remote Command	<code>:SYSTem:SET <instrument state in IEEE Block></code> <code>:SYSTem:SET?</code>
Notes	The query returns current instrument state of the active mode in IEEE Block data format. The state is in a machine-readable format only, as follows: <code><syst set preamble><state block data></code> Where: <code><syst set preamble></code> is the format: <code>#NMMM</code> <ul style="list-style-type: none"> - <code>N</code> = number of digits that comprise <code>MMM</code> - <code>MMM</code> = length in bytes of following data <code><state block data></code> is machine readable state data Example response: <code>#42016<state data></code> The state is recalled by sending the <code>:SYST:SET?</code> response data to the instrument. From example above: <code>:SYST:SET #42016<state data></code>

7.4 Print

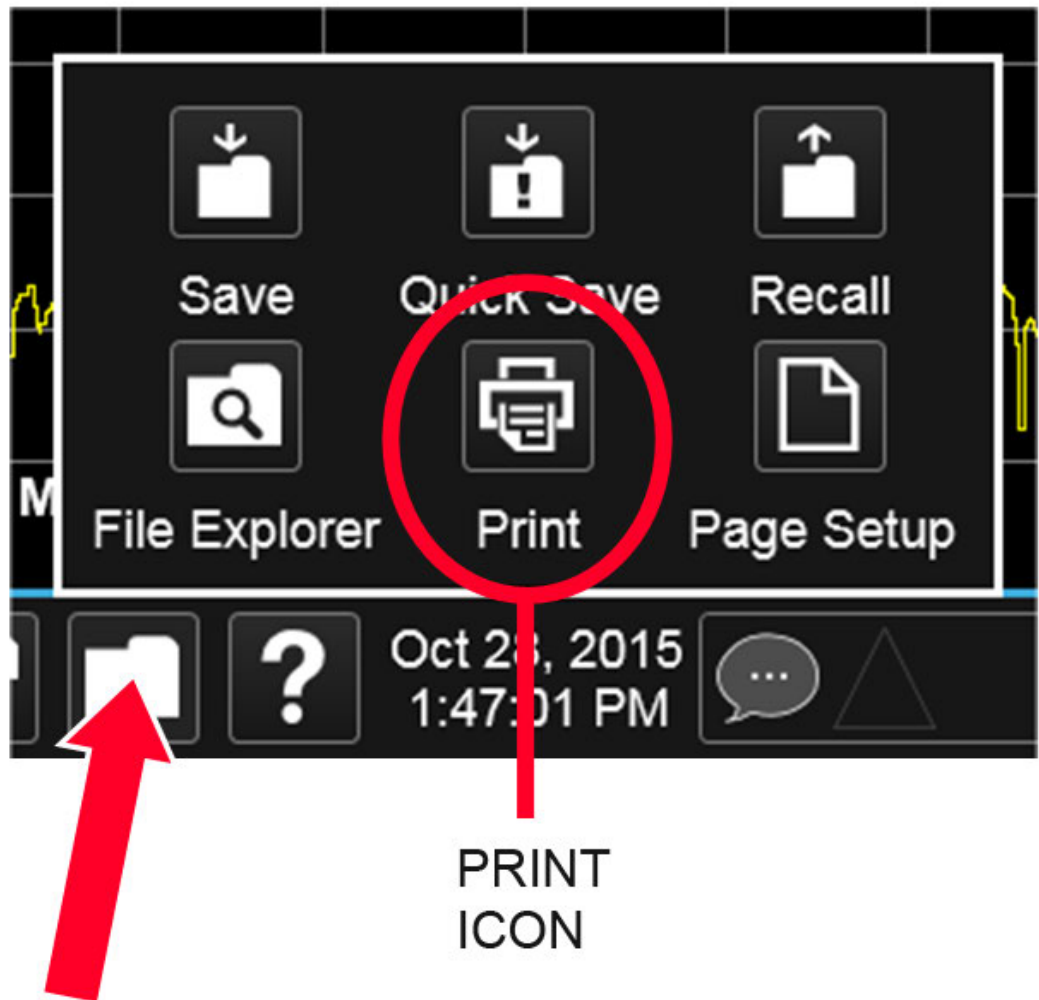

Opens a dialog for configuring printing (to the printer of your choice).

The `:HCOPY` command is equivalent to pressing the `PRINT` key.

Remote Command `:HCOPY[:IMMEDIATE]`

`:HCOPY:ABORT` can be used to abort a print that is already in progress. Sending `:HCOPY:ABORT` causes the instrument to stop sending data to the printer, although the printer may continue or even complete the print, depending on how much data was sent to the printer before you sent the `:ABORT` command.

Remote Command `:HCOPY:ABORT`

7.5 Page Setup

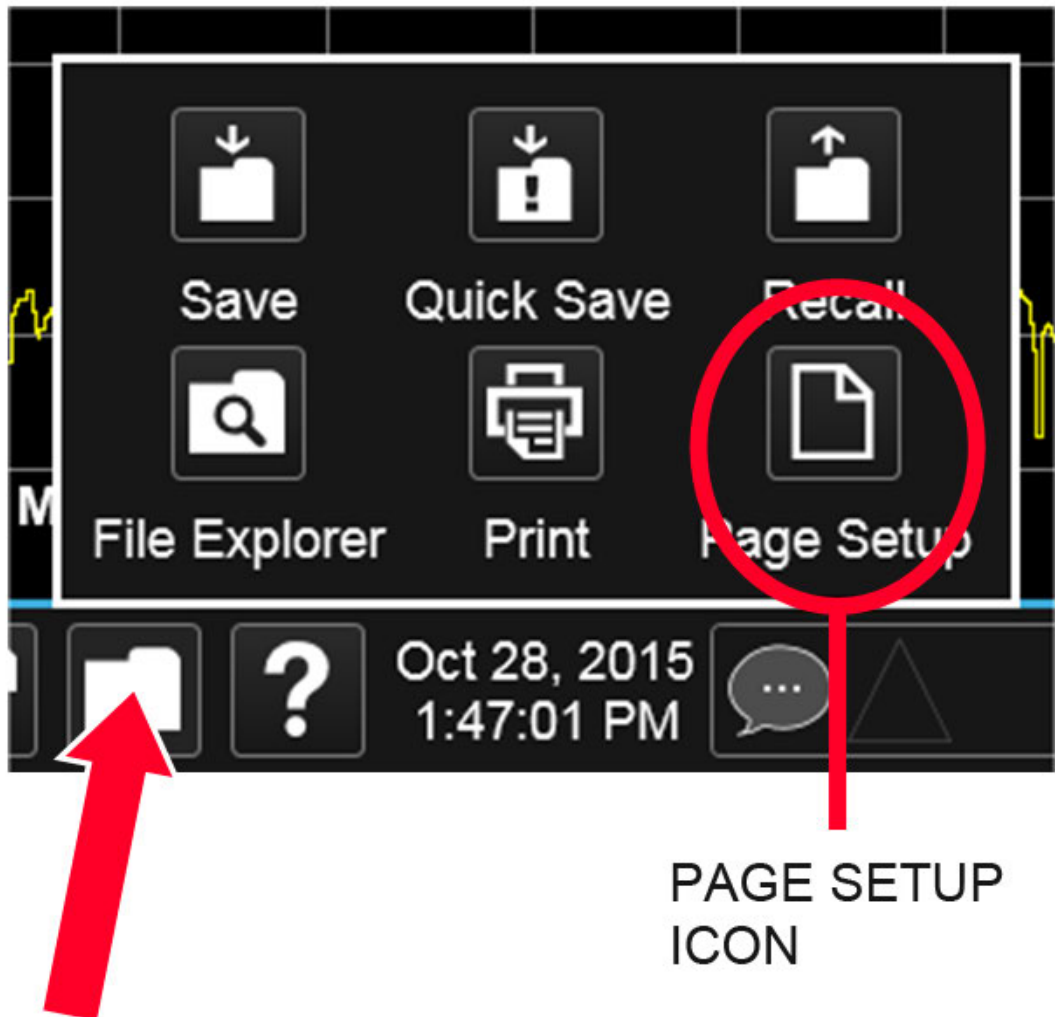

Opens a Windows Page Setup dialog that allows you to control aspects of the pages sent to the printer when the **PRINT** hardkey is pressed.

Depending on the abilities of the attached printer, paper size, paper source, page orientation and margins may all be set. There are no SCPI commands for controlling these parameters.

The dialog also has a dropdown control to let you select the Display Theme to use when printing. **Page Setup** themes are the same as those for **Screen Image** "Theme" on page 1368.

The **Theme** control has a corresponding SCPI command:

Remote Command	<code>:SYSTem:PRINt:THEMe FILLed OUTLine</code>
Command	<code>:SYSTem:PRINt:THEMe?</code>
Example	<code>:SYST:PRIN:THEM OUTL</code>
Preset	OUTL ; not part of Preset , but reset by Restore Misc Defaults or Restore System Defaults All and survives subsequent running of the modes
State Saved	No
Backwards Compatibility SCPI	<code>:SYSTem:PRINt:THEMe TDColor TDMonochrome FCOLor FMONochrome</code>
Backwards Compatibility Notes	<p>To permit code compatibility with A-model X-Series Signal Analyzer instruments, the command parameters from A-models are mapped as follows:</p> <p>TDColor and TDMonochrome are both mapped to FILLed: Exact full color representation of what is on the screen</p> <p>FCOLor and FMONochrome are both mapped to OUTLine: Uses color for traces and other items, but most filled areas are white</p> <p>There is no Monochrome theme in B-models, so the A-models' monochrome commands yield color</p> <p><code>:SYST:PRINt:THEM?</code> always returns FILLed or OUTLine; never FCOLor, FMONochrome, TDColor, or TDMonochrome</p>

8 Trigger

Controls the **Trigger** system of the instrument. In general, these are functions associated with internal triggers or trigger inputs. Trigger Output functions are configured under **Input/Output**.

Trigger functions are common across multiple Modes and Measurements, although some controls appear only in certain Modes and/or certain Measurements. Additionally, some of the tabs on the **Trigger** menu are only available in certain Modes.

Many of the Trigger functions can be set graphically using the Trigger Setting Diagram. For more information see: "[Trigger Optimization](#)" on page 1426

In general, each Measurement can have a different Trigger, and each Measurement remembers its previous-trigger setting.

8.1 Trigger

Contains controls that let you select the trigger source, and setup of each of the trigger sources. The instrument is designed to allow triggering from many sources, for example, Free Run, Video, External, RF Burst, etc.

In general, each Measurement can have a different Trigger Source, and each Measurement remembers its previous-Trigger Source.

8.1.1 Select Trig Source

Specifies the trigger source for the currently selected instrument input (RF or I/Q). If you change inputs, the new input remembers the trigger source it was last programmed to for the current measurement and uses that trigger source. When in External Mixing, the instrument uses the RF trigger source. You can directly set the trigger source for the RF Input and for the I/Q input using SCPI commands; see ["Trigger Source Presets" on page 1389](#), ["RF Trigger Source \(Remote Command Only\)" on page 1391](#), and ["I/Q Trigger Source \(Remote Command Only\)" on page 1393](#).

In general, each Measurement can have a different Trigger Source, and each Measurement remembers its previously-set Trigger Source. Not every Trigger Source is available for every Measurement, so the available choices for Select Trig Source may vary from Mode to Mode and Measurement to Measurement. The trigger sources that are available for each measurement are shown in the "List of Available Trigger sources" dropdown below.

Note that the controls available on the Trigger Tab change depending on which trigger source is selected. Tap each trigger source in the table in the "List of Available Trigger sources" dropdown to see what parameters are available for that trigger source.

Note that most measurements require the inclusion of a <measurement> parameter in the Trigger Source command. However, for the Swept SA measurement and RTSA this is not the case; for backwards compatibility, no <measurement> parameter is used when setting the Trigger Source for the Swept SA measurement or RTSA.

Waiting for Trigger

After you select a trigger source, the instrument will start its next measurement when that trigger source is satisfied. For example, if you choose External 1, the next measurement will start when the appropriate signal appears at the Trigger 1 In connector.

If the trigger source is not satisfied (for example, if no signal at the appropriate level appears at the Trigger 1 In connector), after approximately 2 seconds a popup

message will appear that says, "Waiting for trigger". The trigger annotation in the Meas Bar will also turn amber, as shown below:

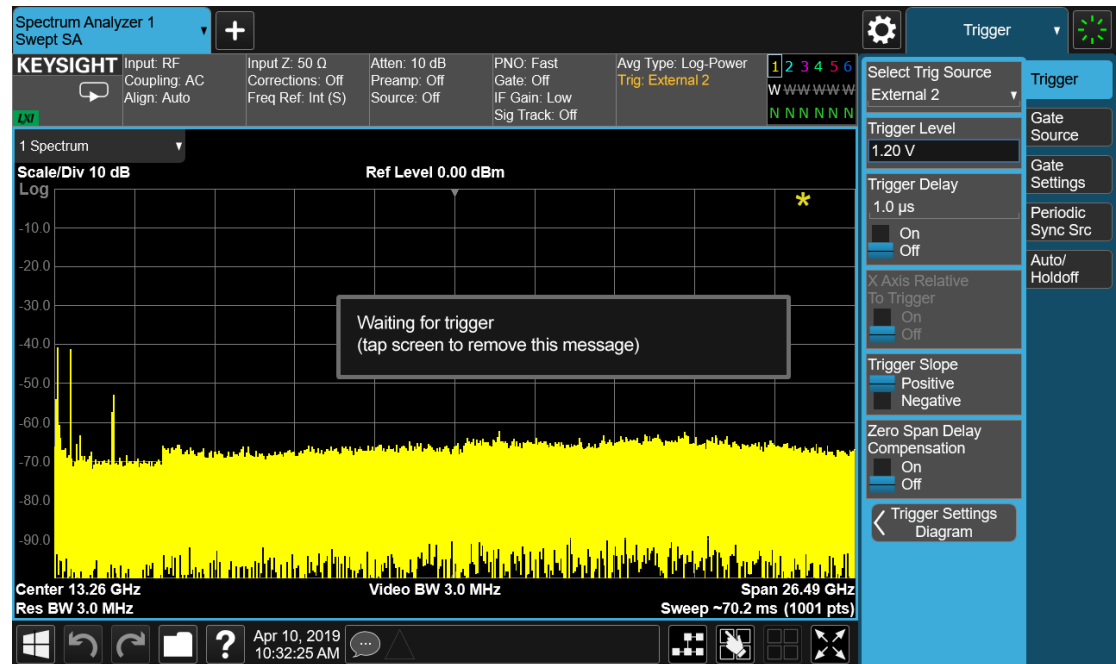

Tap anywhere on the screen (except on the message itself) to clear the popup. The annotation will remain amber until the trigger conditions are satisfied.

List of available Trigger sources

The tables show which Trigger sources are available for which Modes and Measurements, with the following exceptions:

- the Noise Figure Mode does not support Triggering at all
- the Disturbance Analyzer measurement in the EMI Mode does not support Triggering
- the Tx Band Spur measurement in the GSM/EDGE Mode does not support Triggering
- For some models (like N9042B) with ADC trigger: some IF Paths do not support Video trigger, instead they support ADC trigger

"Free Run" on page 1394

IMMediate

All Modes and measurements, except those measurements that support no triggers at all

"Video/ADC" on page 1394

VIDeo

All Modes except RTSA and Pulse

In Spectrum Analyzer Mode, all measurements except ACP and List Sweep
In WCDMA, MSR, Short Range Comms, VMA and LTE, all measurements

8 Trigger

8.1 Trigger

		except ACP
		In WLAN, all measurements
		In Phase Noise, all measurements except Log Plot and Spot Frequency
"ADC Trigger" on page 1395	ADC	All Modes and measurements supporting Video or Level, except Spectrum Analyzer mode
		Only supported in certain model's IF Paths
"Line" on page 1396	LINE	All Modes except EMI, Avionics and Analog Demod
		In Spectrum Analyzer, all measurements except List Sweep
		In WLAN and GSM/EDGE, all measurements except Power vs. Time
		In LTE and 5G NR, all measurements except Transmit On/Off Power
		In Short Range Comms, all measurements except Modulation Analysis
		In MSR, all measurements
Level [Mode: RTSA, PULSEX]	LEVe1	RTSA and Pulse Modes only
FMT [Mode: RTSA, PULSEX]	FMT	RTSA and Pulse Modes only
"External 1" on page 1396	EXTernal1	All Modes and measurements
"External 2" on page 1397	EXTernal2	All Modes and measurements
"External 3" on page 1398	EXTernal3	See "External 3 Support" on page 1384
"RF Burst" on page 1399	RFBurst	All Modes except EMI
		In Spectrum Analyzer, all measurements except List Sweep
"Periodic" on page 1400	FRAMe	All Modes except EMI
		In Spectrum Analyzer, all measurements except List Sweep
TV [Mode: SA]	TV	Spectrum Analyzer Mode only, and only in the Swept SA measurement

I/Q Triggers

"I/Q Mag" on page 1402	IQMag	All Modes except EMI, Avionics, RTSA, Analog Demod and Pulse In Spectrum Analyzer, only in Power Stat CCDF and Burst Power
"Input I" on page 1402	IINPut	In WCDMA, only in Power Stat CCDF and IQ Waveform
"Input Q" on page 1403	QINPut	In GSM/EDGE, only in EVM, GMSK Phase & Freq Error, Transmit Power and IQ Waveform In Phase Noise, only in IQ Waveform
"I (Demodulated)" on page 1403	IDEMod	In Bluetooth, only in Transmit Analysis In LTE, only in Power Stat CCDF, Modulation Analysis, Conformance EVM, and IQ Waveform
"Q (Demodulated)" on page 1404	QDEMod	In WLAN, only in Power Stat CCDF, Modulation Analysis, Spectral Flatness, and IQ Waveform In Short Range Comms, only in Power Stat CCDF and Modulation Analysis
"Aux I/Q Mag" on page 1404	AIQMag	In VMA, only in Power Stat CCDF, Digital Demod and IQ Waveform In CQM, only in Group Delay, Power Stat CCDF, and IQ Waveform
"PXI" on page 1405	PXI	All Modes and measurements (only found in modular analyzers)
"Internal" on page 1405	INTernal	All Modes and measurements (only found in modular analyzers)
"Audio External" on page 1399	AEXTernal	Via the TRIG IN connector on the M9260A Audio Analyzer module
"Prot Channel Detection" on page 1406	PRTChandet	Base Station Emulation; valid UL signal detected (PUSCH/PUCCH/PRACH/SRS)
"Prot Frame Aligned" on page 1406	PRTFrame	Base Station Emulation; periodic technology format radio frame with data frame aligned to the BSE timing
"Prot Event" on page 1407	PRTEvent	Base Station Emulation events

External 3 Support

Trigger Source **External 3** is available only in certain Modes and measurements, as follows:

5GNR	Transmit On Off, Modulation Analysis, Power Stat CCDF, and IQ Waveform measurements only
ADEMODO	Not supported
AVIONICS	Not supported
BT	Not supported
CQM	Group Delay, Power Stat CCDF, and IQ Waveform measurements only
EMI	Not supported
GSMEDGE	IQ Waveform and Transmit Power measurements only
LTEAFDD,	Power Stat CCDF, IQ Waveform, and Transmit On Off measurements only

8 Trigger

8.1 Trigger

LTEATDD	
MSR	Power Stat CCDF, and IQ Waveform measurements only
PA	Power Amplifier measurement
PNOISE	IQ Waveform measurement only
PULSEX	Pulse measurement only
SA	Power Stat CCDF and Burst Power measurements only
SRCOMMS	Modulation Analysis, Power Stat CCDF, and IQ Waveform measurements only
VMA	Digital Demod, Custom OFDM, IQ Waveform, and Power Stat CCDF measurements only
WCDMA	QPSK EVM, Power Stat CCDF, and IQ Waveform measurements only
WLAN	Spectral Flatness, Modulation Analysis, Power Vs Time, Power Stat CCDF, and IQ Waveform measurements only

Backwards Compatibility SCPI

The following SCPI commands are provided for Backwards Compatibility:

Backwards Compatibility SCPI	:TRIGger[:SEQuence]:SOURCe EXTernal For backward compatibility, the parameter EXTernal is mapped to EXTernal1 [:SENSe]:<measurement>:TRIGger:SOURce This backwards compatibility alias command is provided for ESA/PSA compatibility This backwards compatibility command does not apply to the Swept SA measurement, for that just use :TRIGger:SOURce This backwards compatibility command does not apply to the monitor spectrum, log plot and spot frequency measurements [:SENSe]:<measurement>:TRIGger:SOURce IF In earlier instruments, the parameter IF was used by apps for the video trigger, so using the IF parameter selects VIDeo triggering. Sending IF in the command causes VID to be returned to a query [:SENSe]:ACPR:TRIGger:SOURce This backwards Compatibility SCPI command is provided to support the same functionality as [:SENSe]:ACPr:TRIGger:SOURce (PSA W-CDMA, PSA cdma2000 and PSA 1xEVDO) due to the fact that the ACPr node conflicts with the ACPower node The legacy command: :TRIGger[:SEQuence]:RFBurst:FSElectivity[:STATe] OFF ON 0 1 is not supported in the X-Series, as the hardware to do Frequency Selective burst triggers does not exist in X-Series
------------------------------------	---

More Information

The **Trigger** menus let you select the trigger source and trigger settings for a sweep or measurement. In triggered operation (basically, any trigger source other than Free Run), the instrument will begin a sweep or measurement only when the

selected trigger conditions are met, generally when your trigger source signal meets the specified trigger level and polarity requirements. (In FFT measurements, the trigger controls when the data acquisition begins for FFT conversion.)

For each of the trigger sources, you may define a set of operational parameters or settings, which will be applied when that source is selected as the current trigger source. Examples of these settings are Trigger Level, Trigger Delay, and Trigger Slope. You may apply different settings for each source; so, for example, you could have a Trigger Level of 1v for External 1 trigger and -10 dBm for Video trigger.

Once you have established the settings for a given trigger source, they generally will remain unchanged for that trigger source as you go from measurement to measurement within a Mode (although the settings can change as you go from Mode to Mode). Furthermore, the trigger settings within a Mode are the same for the **Trigger** menu, the **Gate Source** menu, and the **Periodic Sync Src** menu. That is, if **Ext1** trigger level is set to 1v in the **Trigger** menu, it will appear as 1v in both the **Gate Source** and the **Periodic Sync Src** menus. For these reasons the trigger settings commands are not qualified with the measurement name, the way the trigger source commands are.

Trigger Setup Parameters:

The following examples show trigger setup parameters using an external trigger source.

Example 1 illustrates the trigger conditions with negative slope and no trigger occurs during trigger Holdoff time.

Example 2 illustrates the trigger conditions with positive slope, trigger delay, and auto trigger time.

8 Trigger
8.1 Trigger

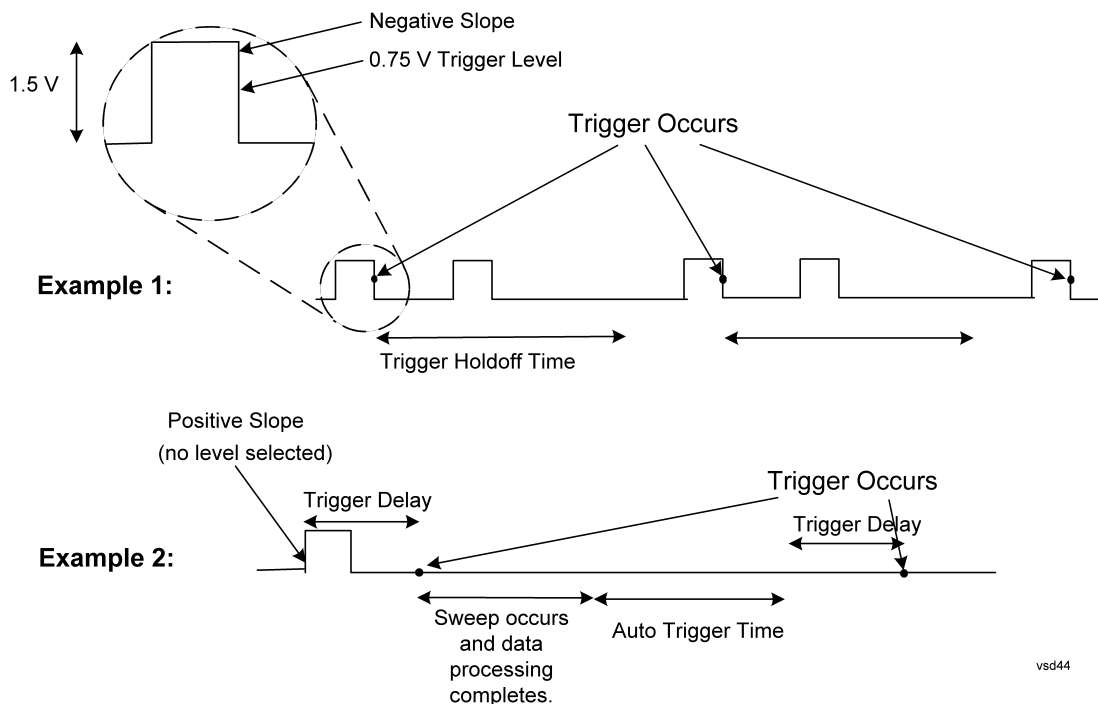

vsd44

Remote Command Swept SA and RTSA measurements:
`:TRIGger[:SEquence]:SOURce EXternal1 | EXternal2 | EXternal3 | IMMEDIATE | LINE | FRAME | RFBURST | VIDEO | TV | PXI | INTERNAL`
`:TRIGger[:SEquence]:SOURce?`

All other measurements
`:TRIGger:<measurement>[:SEquence]:SOURce EXternal1 | EXternal2 | EXternal3 | AEXternal | IMMEDIATE | LEVEL | FMT | LINE | ADC | FRAME | RFBURST | VIDEO | IQMAG | IDEMOD | QDEMOD | IINPUT | QINPUT | AIQMAG | PXI | INTERNAL | PRTCHANDET | PRTFRAME | PRTEVENT`
`:TRIGger:<measurement>[:SEquence]:SOURce?`

Example The following commands set the External 1 trigger input for various measurements

Swept SA and RTSA measurements:
`:TRIG:SOUR EXT1`

Other Spectrum Analyzer Mode measurements:
 Harmonics:
`:TRIG:HARM:SOUR EXT1`

Power Suite measurements (appear in many Modes):
 Channel Power:
`:TRIG:CHP:SOUR EXT1`

Occupied BW, Output Spectrum BW:
`:TRIG:OBW:SOUR EXT1`

Notes	<p>For some of the trigger parameters, the tie-in to the parameter is not obvious. These are:</p> <ul style="list-style-type: none">IMMEDIATE, selects Free RunFRAME, selects Periodic TriggerFMT, selects Frequency Mask TriggerAEXTERNAL, selects Audio External trigger, using the TRIG IN connector on the M9260A Audio Analyzer module <p>For most measurements, the <code><measurement></code> keyword follows TRIGGER. For Swept SA and RTSA Modes, do <i>not</i> use the <code><measurement></code> keyword. Using the wrong command form will result in an Undefined Header error</p> <p>Other trigger-related commands are found in the :INITiate and :ABORT SCPI command subsystems</p> <p>*OPC should be used after requesting data. This will hold off any subsequent changes to the selected trigger source, until after the sweep is completed and the data is returned</p> <p>Available ranges and presets can vary from mode to mode</p> <p>FMT (Pulse and RTSA apps):</p> <p>The amplitude resolution of the Frequency Mask is coupled to the Scale/Division. There are 256 vertical points therefore the amplitude resolution is computed using the algorithm: $(10 * \text{Scale/Div}) / \# \text{ Vertical Points}$</p>
Dependencies	<p>Not all trigger sources are available for each input. See the "RF Trigger Source (Remote Command Only)" on page 1391 and "I/Q Trigger Source (Remote Command Only)" on page 1393 commands for detailed information on which trigger sources are available for each input</p> <p>In some models, there is no second External input. In these models, the External 2 selection is not shown and the EXTERNAL2 parameter will generate a "Hardware missing; Not available for this model number" message</p> <p>EXTERNAL3 is available only when Option H1G is installed</p> <p>For the E7760 the only available selections are: EXTERNAL1 IMMEDIATE INTERNAL RFBURST VIDEO</p> <p>For UXM the only available selections are: EXTERNAL1 IMMEDIATE PRTCHANDET PRTFRAME PRTEVENT</p> <p>In the Pulse app, when Option B2X and H1G are installed and Digital IF BW is greater than 255.176 MHz, only three trigger sources, IMMEDIATE, LEVEL, and EXTERNAL3 are available</p> <p>Level Trigger (Pulse and RTSA apps):</p> <p>Level trigger is allowed in average detector mode</p> <p>When Level Trigger is the selected Trigger Source in the Spectrum measurement, Spectrum minimum Acquisition Time is limited to the PVT minimum Acquisition Time. If the Spectrum Acquisition Time changed as a result of going into Level Trigger, a message is posted "Min Acq Time is 200 usec when Level Trigger is ON". When Level Trigger is no longer the selected Trigger Source, Spectrum minimum Acquisition Time is restored</p> <p>FMT (Pulse and RTSA apps):</p> <p>If you were not in Free Run when you entered the FMT Setup View, you can change Trigger Source to Free Run while in the editor. This will allow you to configure the mask with a continually updating trace. When exiting FMT Setup View, the Trigger Source will be changed back to FMT</p>

8 Trigger

8.1 Trigger

For Power Stat CCDF and IQ Waveform in 5G NR and LTEATDD, switching the radio direction changes this parameter to the preset value

In Transmit On|Off Power in 5G NR and LTEATDD, the value changes as follows

- If changed to uplink: Periodic
- If changed to downlink: External 1 except for models with the H1G option. With the H1G option, it changes as follows
 - External 1, when Info BW \leq 255 MHz
 - External 3, when Info BW \geq 256 MHz

Couplings	<p>FMT (Pulse and RTSA apps):</p> <p>A remote user can enter or access FMT data via <code>:TRIGger[:SEquence]:FMT[1] 2:DATA</code></p> <p>The upper and lower masks can have different freq/ampl pairs therefore subop code 1 is for the upper mask and subop code 2 is for the lower mask</p>
Preset	See "Trigger Source Presets" below
Status Bits/OPC dependencies	The Status Operation Register bit 5 "Waiting for Trigger" is set at the same time as the Sweeping or Measuring bit is set. It is cleared when the trigger actually occurs (that is, after the trigger event occurs and all the applicable trigger criteria have been met). A corresponding pop-up message ("Waiting for trigger") is generated if no trigger signal appears after approximately 2 sec. This message goes away when a trigger signal appears

Trigger Source Presets

The following Trigger Source presets are used for these measurements after a Mode Preset or Meas Preset:

Meas	Mode	Preset for RF	Preset for IQ
Swept SA	SA	IMM	IQ not supported
CHP	SA, WCDMA, MSR, SRCOMMS, 5GNR, WLAN	IMM	IQ not supported
OBW	SA, WCDMA, LTEAFDD, LTEATDD, BT, 5GNR, WLAN	1xEVDO: EXT1 Others: IMM	IQ not supported
Transmit Analysis	BT	RFB	IQM
Adjacent Channel Power	BT	IMM	IQ not supported
LE In-band Emissions	BT	IMM	IQ not supported
EDR In-band Spurious Emissions	BT	RF Burst	IQ not supported
CCDF	SA, WCDMA, LTEAFDD, LTEATDD, MSR, SRCOMMS, 5GNR, WLAN, CQM	LTEATDD:	LTEATDD: - BTS: EXT1

Meas	Mode	Preset for RF	Preset for IQ
		- BTS: External 1 - MS: Periodic Timer Others: IMM	- MS: FRAM Others: IMM
ACP	SA, WCDMA, LTEAFDD, LTEATDD, MSR, SRCOMMS, 5GNR	IMM	IQ not supported
Tx Power	SA, GSM	RFBurst	IMM
SPUR	SA, WCDMA, MSR, LTEAFDD, LTEATDD, 5GNR, WLAN	IMM	IQ not supported
SEM	SA, WCDMA, MSR, LTEAFDD, LTEATDD, SRCOMMS, 5G NR, WLAN	IMM	IQ not supported
CDP	WCDMA	IMM	IMM
RHO	WCDMA	IMM	IMM
PCON	WCDMA	IMM	IMM
QPSK	WCDMA	EXT1	IMM
MON	All except: SA, BASIC	IMM	IQ not supported
WAV	All except: SA	LTEATDD: - BTS: External 1 - MS: Periodic Timer GSM/EDGE: RFBurst All others: IMM	LTEATDD: - BTS: EXT1 - MS: FRAM GSM/EDGE: IQM All others: IMM
EVM	LTEAFDD, LTEATDD, SRCOMMS, 5GNR, WLAN	IMM	IMM
PVT	WLAN	RFB	IQ not supported
Spectral Flatness	WLAN	IMM	IMM
SPEC	BASIC	IMM	IMM
LOG Plot	PN	IMM	IQ not supported
Spot Freq	PN	IMM	IQ not supported
GMSK PVT	EDGE/GSM	RFB	IMM
GMSK PFER	EDGE/GSM	RFB	IQM
GMSK ORFS	EDGE/GSM	RFB	IQ not supported
EDGE PVT	EDGE/GSM	RFB	IMM

8 Trigger
8.1 Trigger

Meas	Mode	Preset for RF	Preset for IQ
EDGE EVM	EDGE/GSM	RFB	IQM
EDGE ORFS	EDGE/GSM	Periodic Timer	IQ not supported
Combined WCDMA	WCDMA	IMM	IQ not supported
Combined GSM	EDGE/GSM	RFB	IQ not supported
List Power Step	WCDMA, EDGE/GSM	IMM	IQ not supported
Transmit On/Off Power	LTETDD, LTEATDD, 5GNR	BTS: External 1 (External3 when IFBW \geq 256 MHz with H1G option) MS: Periodic Timer	BTS: EXT1 MS: FRAM
Transmit Analysis	BLUETOOTH	RFB	IQ not supported
Adjacent Channel Power	BLUETOOTH	IMM	IQ not supported
LE In-band Emissions	BLUETOOTH	IMM	IQ not supported
EDR In-band Spurious Emissions	BLUETOOTH	Periodic Timer	IQ not supported
Conformance EVM Spectrum & PVT	LTEAFDD, LTEATDD, MSR RTSA	IMM IMM	IMM IQ not supported
Pulse	PULSEX	IMM	IQ not supported
AM, FM, PM, FM Stereo	ADEMOT	IMM	IQ not supported
PAvT	SA, 5GNR, VMA	IMM	IMM
Group Delay	CQM	IMM	IMM

RF Trigger Source (Remote Command Only)

Selects the trigger to be used for the specified measurement when RF is the selected input. The RF trigger source can be queried and changed even while another input is selected, but it is inactive until RF becomes the selected input.

Note the inclusion of the <measurement> parameter in the command below. Because each measurement remembers its own Trigger Source, the command must be qualified with the measurement name. Note that for the Swept SA measurement

this is not the case; for backwards compatibility, no <measurement> parameter is used when setting the Trigger Source for the Swept SA measurement.

Remote Command `:TRIGger:<measurement>[:SEQuence]:RF:SOURce EXTernal1 | EXTernal2 | IMMEDIATE | LEVel | FMT | LINE | FRAMe | RFBurst | VIDeo | IF | TV | PXI | INTernal | PRTChandet | PRTFrame | PRTEvent`
 `:TRIGger:<measurement>[:SEQuence]:RF:SOURce?`

Note that the available parameters are model number and hardware dependent

Example Select the external 1 trigger input for the ACP measurement and the RF input:
 `:TRIG:ACP:RF:SOUR EXT1`

Select video triggering for the **SANalyzer** measurement and the RF input. For **SAN**, do not use the <measurement> keyword:
 `:TRIG:RF:SOUR VID`

Notes Not all measurements have all the trigger sources available to them. Check the trigger source documentation for your specific measurement to see what sources are available

Note that not all trigger sources are available for each input, and that the available parameters are model number and hardware dependent

For the **RF Trigger Source**, the following trigger sources are available:

IMMEDIATE	free run triggering
VIDeo	triggers on the video signal level
LEVel	triggers on the video signal level with time qualified triggering
FMT	triggers on the amplitude spectrum with frequency mask triggering
LINE	triggers on the power line signal
EXTernal1 or EXTernal	triggers on an externally connected trigger source marked "Trigger 1 In" on the rear panel of standalone instruments, "Trigger 3" on the front panel of EXM and VXT model M9421A, and "Trigger 1" on the front panel of VXT models M9410A/11A/15A/16A
EXTernal2	triggers on an externally connected trigger source marked "Trigger 2 In" on the front panel of standalone instruments, and "Trigger 1" on the front panel of EXM and VXT model M9421A, and "Trigger 2" on the front panel of VXT models M9410A/11A/15A/16A. In some models, there is no second External input. In these models, the External 2 selection is not shown and the EXTernal2 parameter will generate a "Hardware missing; Not available for this model number" message
RFBurst	triggers on the bursted frame
FRAMe	triggers on the periodic timer
IF (video)	same as video, for backwards compatibility only
PRTChandet	triggers on Base Station Emulation detecting a valid UL signal (PUSCH/PUCCH/PRACH/SRS)

8 Trigger

8.1 Trigger

	<p>PRTFrame triggers on the Base Station Emulation periodic technology format radio frame with data frame aligned to the BSE timing</p> <p>PRTEvent triggers on the Base Station Emulation events</p> <p>INTernal triggers on the internal source trigger output, for models with an internal source such as VXT</p> <p>PXI trigger only supported in PXI (modular) instruments</p> <p>*OPC should be used after requesting data. This will hold off any subsequent changes to the selected trigger source, until after the sweep is completed and the data is returned</p> <p>Available ranges, and presets can vary from mode to mode</p>
Dependencies	<p>The available choices for VXT are: Free Run, Video, Internal, External 1, External 2, RF Burst, Periodic and PXI</p> <p>In VXT, Internal is only in VXT models M9410A/11A/15A/16A, not in models M9420/21A, and Internal and Periodic are not available in Spectrum Analyzer Mode</p> <p>PXI is only found in VXT</p> <p>The available choices for EXM are Free Run, Video, Internal, External 1, External 2, RF Burst, and Periodic</p> <p>The available choices for UXM are Free Run, External 1, Prot Channel Detection, Prot Frame Aligned, and Prot Event</p> <p>Prot Channel Detection, Prot Frame Aligned, and Prot Event are only available in UXM</p> <p>The available choices for E7760 are Free Run, External 1, Internal, Video and RF Burst</p> <p>In some models, there is no second External input. In these models, the External 2 selection is not shown and the EXTernal12 parameter will generate a "Hardware missing; Not available for this model number" error</p>
Status Bits/OPC dependencies	<p>The Status Operation Register bit 5 "Waiting for Trigger" is set at the same time as the Sweeping or Measuring bit is set. It is cleared when the trigger actually occurs (that is, after the trigger event occurs and all the applicable trigger criteria have been met). A corresponding pop-up message ("Waiting for trigger") is generated if no trigger signal appears after approximately 2 seconds. This message goes away when a trigger signal appears</p>
<h3>I/Q Trigger Source (Remote Command Only)</h3> <p>Selects the trigger to be used for the specified measurement when I/Q (which requires option BBA) is the selected input. The I/Q trigger source can be queried and changed even while another input is selected, but it is inactive until I/Q becomes the selected input.</p>	
Remote Command	<pre>:TRIGger:<measurement>[:SEquence]:IQ:SOURce EXTernal1 EXTernal2 IMMediate IQMag IDEMod QDEMod IINPut QINPut AIQMag :TRIGger:<measurement>[:SEquence]:IQ:SOURce?</pre>
Example	<pre>:TRIG:WAVEform:SOUR IQM</pre> <p>Selects I/Q magnitude triggering for the IQ Waveform measurement and the I/Q input</p>

Notes	<p>Not all measurements have all the trigger sources available to them. Check the trigger source documentation for your specific measurement to see what sources are available</p> <p>Note that not all trigger sources are available for each input, and that the available parameters are model number and hardware dependent</p> <p>For the I/Q Trigger Source, the following trigger sources are available:</p> <table border="1"> <tr> <td>IMMediate</td> <td>free run triggering</td> </tr> <tr> <td>EXTernal1</td> <td>triggers on an externally connected trigger source on the rear panel or EXTernal</td> </tr> <tr> <td>EXTernal2</td> <td>triggers on an externally connected trigger source on the front panel</td> </tr> <tr> <td>IQMag</td> <td>triggers on the magnitude of the I/Q signal</td> </tr> <tr> <td>IDEMod</td> <td>triggers on the I/Q signal's demodulated I voltage</td> </tr> <tr> <td>QDEMod</td> <td>triggers on the I/Q signal's demodulated Q voltage</td> </tr> <tr> <td>IINPut</td> <td>triggers on the I channel's ADC voltage</td> </tr> <tr> <td>QINPut</td> <td>triggers on the Q channel's ADC voltage</td> </tr> <tr> <td>AIQMag</td> <td>triggers on the magnitude of the auxiliary receiver channel I/Q signal</td> </tr> </table> <p>*OPC should be used after requesting data. This will hold off any subsequent changes to the selected trigger source, until after the sweep is completed and the data is returned</p> <p>Available ranges, and from mode-to-mode presets can vary</p>	IMMediate	free run triggering	EXTernal1	triggers on an externally connected trigger source on the rear panel or EXTernal	EXTernal2	triggers on an externally connected trigger source on the front panel	IQMag	triggers on the magnitude of the I/Q signal	IDEMod	triggers on the I/Q signal's demodulated I voltage	QDEMod	triggers on the I/Q signal's demodulated Q voltage	IINPut	triggers on the I channel's ADC voltage	QINPut	triggers on the Q channel's ADC voltage	AIQMag	triggers on the magnitude of the auxiliary receiver channel I/Q signal
IMMediate	free run triggering																		
EXTernal1	triggers on an externally connected trigger source on the rear panel or EXTernal																		
EXTernal2	triggers on an externally connected trigger source on the front panel																		
IQMag	triggers on the magnitude of the I/Q signal																		
IDEMod	triggers on the I/Q signal's demodulated I voltage																		
QDEMod	triggers on the I/Q signal's demodulated Q voltage																		
IINPut	triggers on the I channel's ADC voltage																		
QINPut	triggers on the Q channel's ADC voltage																		
AIQMag	triggers on the magnitude of the auxiliary receiver channel I/Q signal																		

Status Bits/OPC dependencies	<p>The Status Operation Register bit 5 "Waiting for Trigger" is set at the same time as the Sweeping or Measuring bit is set. It is cleared when the trigger actually occurs (that is, after the trigger event occurs and all the applicable trigger criteria have been met). A corresponding pop-up message ("Waiting for trigger") is generated if no trigger signal appears after approximately 2 sec. This message goes away when a trigger signal appears</p>
------------------------------	--

8.1.1.1 Free Run

Free Run triggering occurs immediately after the sweep/measurement is initiated.

Example	<p>Swept SA measurement: :TRIG:SOUR IMM</p> <p>Measurements other than Swept SA: :TRIG:<meas>:SOUR IMM</p>
Annunciation	Free Run (in the Meas Bar)

8.1.1.2 Video/ADC

The Video trigger condition is met when the video signal at the left edge of the graticule (the filtered and detected version of the input signal, including both RBW and VBW filtering) crosses the video trigger level with the chosen slope.

8 Trigger

8.1 Trigger

The Video trigger level is shown as a labeled line on the display. The line is displayed as long as Video is the selected trigger source. The Trigger Level line can be adjusted using the step keys, knob, or numeric keypad. It can also be dragged on the display with your finger or with a mouse.

When the detector selected for all active traces is the average detector, the video signal for triggering does not include any VBW filtering.

Log Plot and Spot Frequency measurements, in the Phase Noise Mode, do not support Video Trigger.

The **Trigger** tab contains the following Trigger Source dependent controls when Video Trigger is selected:

- "Prot Frame Aligned" on page 1406
- "Trigger Delay" on page 1409
- "Trigger Slope" on page 1413

Additional controls are also present, which are not dependent on the selected Trigger Source.

Note that Video Trigger is a software trigger of the acquired trace for some measurements and a hardware trigger of the IF envelope for others. Most measurements support one method or the other, although some (like ACP) don't support Video Trigger at all. For those measurements that support Video Trigger as a software trigger, the Trigger Level units will be dependent on the current Y Axis Unit for the measurement; for those that support Video Trigger as an IF Envelope trigger, the units are typically in dBm.

Example	Swept SA measurement: :TRIG:SOUR VID
	Measurements other than Swept SA: :TRIG:<meas>:SOUR VID

Annunciation Video (in the Meas Bar)

8.1.1.3 ADC Trigger

Some IF Paths in certain models (like N9042B) in IQ Measurements have an ADC trigger. ADC is like the Video trigger, but with 2 limitations due to a lack of post-processing.

First, the trigger is not limited to the current measurement's setup IF BW. The trigger sees everything in the passband, so measurements like IQA Complex Spectrum can be triggered outside of the current Digital IF BW.

The final limitation is, due to lack of post-processing, the amplitude accuracy of the ADC trigger is less than the video trigger.

If ADC trigger is available for at least one IF Path on a model, then the ADC trigger will always be seen as a trigger option in IQ Measurements. However, it will only be available (not grayed out) to select when using IF Paths that support it.

If Video Trigger is selected and measurement setup (IF Path or IF BW) is changed to a path that only supports the ADC trigger instead, then ADC trigger will be selected and *vice versa*.

Example	Measurements other than Swept SA: :TRIG:<meas>:SOUR ADC
---------	--

Annunciation	ADC (in the Meas Bar)
--------------	-----------------------

8.1.1.4 Line

When **Line** is selected, start of a new sweep/measurement will be synchronized with the next cycle of the line voltage.

Line trigger is not available when operating from a "dc power source", for example, when the instrument is powered from batteries.

Line trigger is not available when using modular instruments like the VXT.

The **Trigger** tab contains the following Trigger Source dependent controls when **Line** Trigger is selected:

- "Trigger Delay" on page 1409
- "Trigger Slope" on page 1413

Additional controls are also present that are not dependent on the selected Trigger Source.

Example	:TRIG:SOUR LINE Swept SA measurement :TRIG:<meas>:SOUR LINE Measurements other than Swept SA
---------	---

Annunciation	LINE (in the Meas Bar)
--------------	------------------------

8.1.1.5 External 1

When **External 1** is selected, a new sweep/measurement starts when the external trigger condition is met using the TRIGGER 1 IN input connector on the rear panel.

Grayed-out if Ext 1 is in use by Point Trigger in the Source Setup menu of Swept SA. Forced to "Free Run" on page 1394 if already selected and Point Trigger is set to External 1.

8 Trigger

8.1 Trigger

The **Trigger** tab contains the following Trigger Source dependent controls when External 1 Trigger is selected:

- "Prot Frame Aligned" on page 1406
- "Trigger Delay" on page 1409
- "Trigger Slope" on page 1413

Additional controls are also present that are not dependent on the selected Trigger Source.

Example	<code>:TRIG:SOUR EXT1</code> Swept SA measurement <code>:TRIG:<meas>:SOUR EXT1</code> Measurements other than Swept SA
---------	---

Annunciation	External 1 (in the Meas Bar)
--------------	------------------------------

8.1.1.6 External 2

When **External 2** is selected, a new sweep/measurement starts when the external trigger condition is met using the TRIGGER 2 IN input connector on the rear panel.

Grayed-out if Ext 2 is in use by Point Trigger in the Source Setup menu of Swept SA. Forced to "Free Run" on page 1394 if already selected and Point Trigger is set to External 2.

The **Trigger** tab contains the following Trigger Source dependent controls when External 2 Trigger is selected:

- "Prot Frame Aligned" on page 1406
- "Trigger Delay" on page 1409
- "Trigger Slope" on page 1413

Additional controls are also present that are not dependent on the selected Trigger Source.

Example	<code>:TRIG:SOUR EXT2</code> Swept SA measurement <code>:TRIG:<meas>:SOUR EXT2</code> Measurements other than Swept SA
---------	---

Annunciation	External 2 (in the Meas Bar)
--------------	------------------------------

8.1.1.7 External 3

When **External 3** is selected, a new sweep/measurement starts when the external trigger condition is met using the TRIGGER 3 IN input connector on the rear panel.

This control only appears in certain instrument and option combinations, as follows.

- For N9042B, selects the Precision External Trigger, but available only when IF Path is 255 MHz or wider. The resolution will be within one sample count of the 4.8 GHz ADC sampling rate for 255 ~ 2 GHz IF Paths, and within one sample count of the 10.2 GHz sampling rate for the 4 GHz IF Path
- For all other instruments, available only if Option H1G is installed. It is only available when the 1 GHz path is chosen, either directly or indirectly; in all other paths it is visible but grayed-out. Direct and indirect selection of the 1 GHz path occurs as follows:
 - **Direct:** Measurements that directly support the 1 GHz path have a 1 GHz selection in the **IF Path** menu in **Meas Setup**
 - **Indirect:** Certain measurements, such as Power Statistics CCDF (**PST**), always choose the widest available path, and so will choose the 1 GHz path if it is available, even if there is no **IF Path** menu for the measurement. **External 3** will be visible when this results in the 1 GHz path being selected, even if there is no control or readout indicating that the 1 GHz path has been selected

For a full list of Modes and measurements that support **External 3**, see "[External 3 Support](#)" on page 1384 in the section "[Select Trig Source](#)" on page 1381.

When **External 3** is set, and then becomes disabled because you switched away from the 1 GHz path, the Trigger Source selection reverts to the default ("[Free Run](#)" on page 1394).

When **External 3** Trigger is selected, the **Trigger** tab displays the following Trigger Source dependent controls:

- "[Prot Frame Aligned](#)" on page 1406
- "[Trigger Delay](#)" on page 1409
- "[Trigger Slope](#)" on page 1413

Additional controls are also present that are not dependent on the selected Trigger Source.

Example	<code>:TRIG:SPEC:SOUR EXT3</code> Sets External 3 as the trigger source for the Complex Spectrum measurement
Annunciation	External 3 (in the Meas Bar)

8.1.1.8 Audio External

When **Audio External** is selected, a new sweep/measurement starts when the external trigger condition is met using the TRIG IN input connector on the front panel of the M9260A Audio Analyzer module. This is a TTL level input (not analog) that supports both rising edge and falling edge triggers.

Only appears in modular instruments, and only when the M9260A Audio Analyzer module is installed, such as in M8920A.

The **Trigger** tab contains the following Trigger Source dependent controls when Audio External Trigger is selected:

- "Trigger Delay" on page 1409
- "Trigger Slope" on page 1413

Additional controls are also present that are not dependent on the selected Trigger Source.

Example

`:TRIG:RTES:SOUR AEXT`

Sets Audio External as the trigger source for the Radio Test measurement

Annunciation

Audio Ext (in the Meas Bar)

8.1.1.9 RF Burst

When **RF Burst** is selected, a new sweep/measurement starts when an RF burst envelope signal is identified from the signal at the RF Input connector.

In some models, a variety of burst trigger circuitry is available, resulting in various available burst trigger bandwidths. The instrument automatically chooses the appropriate trigger path based on the hardware configuration and other settings of the instrument.

The **Trigger** tab contains the following Trigger Source dependent controls when RF Burst is selected:

- "Trigger Level Absolute/Relative" on page 1414
- "Absolute Trigger Level" on page 1415
- "Relative Trigger Level" on page 1415
- "Trigger Delay" on page 1409
- "Trigger Slope" on page 1413

Additional controls are also present that are not dependent on the selected Trigger Source.

Example	<code>:TRIG:SOUR RFB</code> Swept SA measurement <code>:TRIG:<meas>:SOUR RFB</code> Measurements other than Swept SA
Annunciation	RF Burst (in the Meas Bar)

8.1.1.10 Periodic

When **Periodic** is selected, the instrument uses a built-in periodic timer signal as the trigger. Trigger occurrences are set by the **Periodic Timer** parameter, which is modified by the **Offset** and Periodic Sync Src.

Use this trigger when there is a periodic signal but no reliable signal on which to trigger. You can synchronize the periodic signal with outside events (using the Periodic Sync Src) to get closer to a reliable trigger signal (see ["More Information" on page 1401](#) below).

If you do not have a sync source selected (**OFF**), then the internal timer will not be synchronized with any external timing events.

The **Trigger** tab contains the following Trigger Source dependent controls when Periodic Trigger is selected:

- ["Period" on page 1417](#)
- ["Offset" on page 1418](#)
- ["Reset Offset Display" on page 1419](#)
- ["Sync Source" on page 1420](#)
- ["Trigger Delay" on page 1409](#)

Additional controls are also present that are not dependent on the selected Trigger Source.

Example	<code>:TRIG:SOUR FRAM</code> Swept SA measurement <code>:TRIG:<meas>:SOUR FRAM</code> Measurements other than Swept SA
Annunciation	Periodic (in the Meas Bar)

More Information

The graphic below shows the action of the periodic timer trigger.

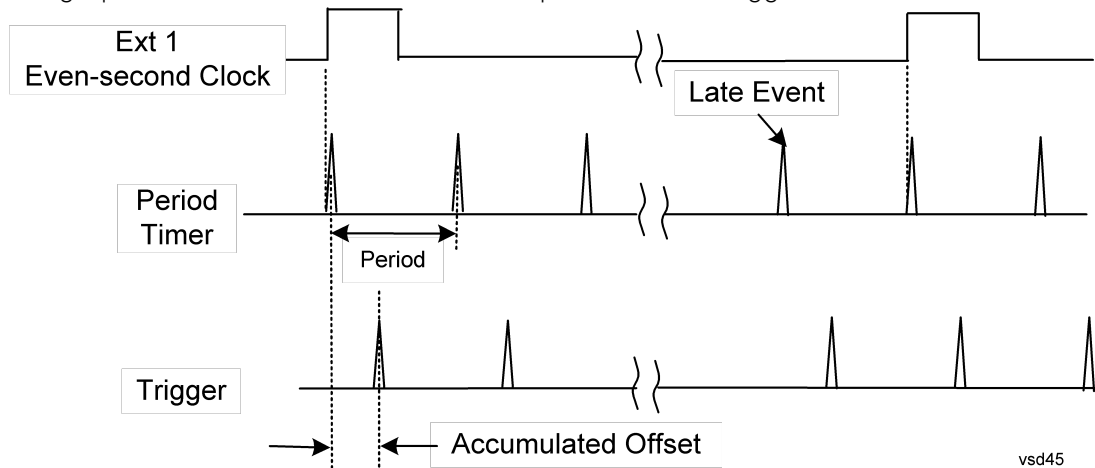

A common application is measuring periodic burst RF signals for which a trigger signal is not easily available. For example, we might be measuring a TDMA radio that bursts every 20 ms. Let's assume that the 20 ms period is very consistent. Let's also assume that we do not have an external trigger source available that is synchronized with the period, and that the signal-to-noise ratio of the signal is not high enough to provide a clean RF burst trigger at all of the analysis frequencies. For example, we might want to measure spurious transmissions at an offset from the carrier that is larger than the bandwidth of the RF burst trigger. In this application, we can set the Periodic Timer to a 20.00 ms period and adjust the offset from that timer to position our trigger just where we want it. If we find that the 20.00 ms is not exactly right, we can adjust the period slightly to minimize the drift between the period timer and the signal to be measured.

A second way to use this feature would be to use **Sync Source** temporarily, instead of **Offset**. In this case, we might tune to the signal in a narrow span and use the RF Burst trigger to synchronize the periodic timer. Then we would turn the sync source off so that it would not miss-trigger. Miss-triggering can occur when we are tuned so far away from the RF burst trigger that it is no longer reliable.

A third example would be to synchronize to a signal that has a reference time element of much longer period than the period of interest. In some CDMA applications, it is useful to look at signals with a short periodicity, by synchronizing that periodicity to the "even-second clock" edge that happens every two seconds. Thus, we could connect the even-second clock trigger to Ext1 and use then Ext1 as the sync source for the periodic timer.

The figure below illustrates this third example. The top trace represents the even-second clock. It causes the periodic timer to synchronize with the leading edge

shown. The instrument trigger occurs at a time delayed by the accumulated offset from the period trigger event. The periodic timer continues to run, and triggers continue to occur, with a periodicity determined by the instrument time base. The timer output (labeled "late event") will drift away from its ideal time due to imperfect matching between the time base of the signal being measured and the time base of the instrument, and also because of imperfect setting of the period parameter. But the synchronization is restored on the next even-second clock event. ("Accumulated offset" is described in the in the **Offset** function section.)

8.1.1.11 I/Q Mag

When **I/Q Mag** is selected, the trigger condition is met when the I/Q magnitude crosses the I/Q magnitude trigger level. The magnitude is measured at the output of the main I/Q digital receiver.

This trigger type is only valid for measurements that support the I/Q inputs.

The **Trigger** tab contains the following Trigger Source dependent controls when I/Q Mag Trigger is selected:

- ["Prot Frame Aligned" on page 1406](#)
- ["Trigger Delay" on page 1409](#)
- ["Trigger Slope" on page 1413](#)

Additional controls are also present that are not dependent on the selected Trigger Source.

Example	<code>:TRIG:<meas>:SOUR IQM</code>
Annunciation	I/Q Mag (in the Meas Bar)

8.1.1.12 Input I

When **Input I** is selected, the condition is met when the voltage at the I Input crosses the trigger level.

This trigger type is only valid for measurements that support the I/Q inputs.

The **Trigger** tab contains the following Trigger Source dependent controls when Input I Trigger is selected:

- ["Prot Frame Aligned" on page 1406](#)
- ["Trigger Delay" on page 1409](#)
- ["Trigger Slope" on page 1413](#)

8 Trigger

8.1 Trigger

Additional controls are also present that are not dependent on the selected Trigger Source.

Example	<code>:TRIG:<meas>:SOUR IINP</code>
---------	---

Annunciation	Input I (in the Meas Bar)
--------------	---------------------------

8.1.1.13 Input Q

When **Input Q** is selected, the condition is met when the voltage at the I Input crosses the trigger level.

This trigger type is only valid for measurements that support the I/Q inputs.

The **Trigger** tab contains the following Trigger Source dependent controls when Input Q Trigger is selected:

- ["Prot Frame Aligned" on page 1406](#)
- ["Trigger Delay" on page 1409](#)
- ["Trigger Slope" on page 1413](#)

Additional controls are also present that are not dependent on the selected Trigger Source.

Example	<code>:TRIG:<meas>:SOUR QINP</code>
---------	---

Annunciation	Input Q (in the Meas Bar)
--------------	---------------------------

8.1.1.14 I (Demodulated)

When **I (Demodulated)** is selected, the trigger condition is met when the I voltage crosses the I voltage trigger level.

This trigger type is only valid for measurements that support the I/Q inputs.

The **Trigger** tab contains the following Trigger Source dependent controls when I (Demodulated) Trigger is selected:

- ["Prot Frame Aligned" on page 1406](#)
- ["Trigger Delay" on page 1409](#)
- ["Trigger Slope" on page 1413](#)

Additional controls are also present that are not dependent on the selected Trigger Source.

Example	<code>:TRIG:<meas>:SOUR IDEM</code>
---------	---

Annunciation	I (Demod) (in the Meas Bar)
--------------	-----------------------------

8.1.1.15 Q (Demodulated)

When **Q (Demodulated)** is selected, the trigger condition is met when the Q voltage crosses the Q voltage trigger level.

This trigger type is only valid for measurements that support the I/Q inputs.

The **Trigger** tab contains the following Trigger Source dependent controls when Q (Demodulated) Trigger is selected:

- "Prot Frame Aligned" on page 1406
- "Trigger Delay" on page 1409
- "Trigger Slope" on page 1413

Additional controls are also present that are not dependent on the selected Trigger Source.

Example	<code>:TRIG:<meas>:SOUR QDEM</code>
---------	---

Annunciation	Q (Demod) (in the Meas Bar)
--------------	-----------------------------

8.1.1.16 Aux I/Q Mag

When **Aux I/Q Mag** is selected, the trigger condition is met when the auxiliary receiver's I/Q magnitude output crosses the Auxiliary I/Q magnitude trigger level.

This trigger type is only valid for measurements that support the I/Q inputs.

The **Trigger** tab contains the following Trigger Source dependent controls when Aux I/Q Mag Trigger is selected:

- "Prot Frame Aligned" on page 1406
- "Trigger Delay" on page 1409
- "Trigger Slope" on page 1413
- "Trigger Center Frequency" on page 1423
- "Trigger BW" on page 1423

Additional controls are also present that are not dependent on the selected Trigger Source.

Example	<code>:TRIG:<meas>:SOUR AIQM</code>
---------	---

Annunciation	Aux I/Q Mag (in the Meas Bar)
--------------	-------------------------------

8.1.1.17 PXI

When **PXI** is selected, a new sweep/measurement will start when detecting the signal from the PXI backplane trigger line.

This trigger type is only found in the modular instrument products.

The **Trigger** tab contains the following Trigger Source dependent controls when PXI Trigger is selected:

- "Select PXI Line" on page 1424
- "Trigger Delay" on page 1409
- "Trigger Slope" on page 1413

Additional controls are also present that are not dependent on the selected Trigger Source.

Example	Swept SA measurement: :TRIG:SOUR PXI Measurements other than Swept SA: :TRIG:<meas>:SOUR PXI
---------	---

Annunciation	PXI (in the Meas Bar)
--------------	-----------------------

8.1.1.18 Internal

When **Internal** is selected, the trigger condition is met when detecting the signal from the internal RF Source module.

This trigger type is only found in the modular instrument products.

The **Trigger** tab contains the following Trigger Source dependent controls when Aux I/Q Mag Trigger is selected:

- "Prot Frame Aligned" on page 1406
- "Trigger Delay" on page 1409
- "Trigger Slope" on page 1413

Additional controls are also present that are not dependent on the selected Trigger Source.

For an Internal trigger to occur, there must be a trigger output from the internal RF source. This means that you must configure the Source Trigger Output before selecting Internal as the Trigger Source. To enable the Source Trigger Output,

output trigger should not be off if internal source works as list sequence mode and Trig 2 Out should not be off if internal source works as MXG mode. Otherwise, no trigger occurs, and measurement does not start.

Example	Swept SA measurement: <code>:TRIG:SOUR INTernal</code> Measurements other than Swept SA: <code>:TRIG:<meas>:SOUR INTernal</code>
Annunciation	Internal (in the Meas Bar)

8.1.1.19 Prot Channel Detection

Selects a protocol channel detection Base Station Emulation as the trigger. When Prot Channel Detection is selected, a new sweep/measurement will start when the protocol channel detection trigger condition is met.

Protocol Channel Detection Trigger is defined as the Base Station Emulation protocol channel detection event of PUSCH, PUCCH, PRACH or SRS. With this trigger, the IQ data, and therefore the measurement, is aligned at the beginning of the LTE sub-frame where the particular event was detected. Channel transmission is aligned to the sub-frame boundary; therefore, the measurement is aligned with its transmission with the exception of SRS, which might not start at the beginning of the sub-frame containing the SRS as it might have an offset from the start of the sub-frame base on the SRS configuration, In this case, the trigger and measurement are aligned to the beginning of the sub-frame containing SRS as defined by this trigger type (which is not the beginning of the SRS itself due to the offset).

This trigger type is only available in UXM.

Example	<code>:TRIG:<meas>:SOUR PRTC</code>
Annunciation	Prot Chan Det (in the Meas Bar)

8.1.1.20 Prot Frame Aligned

Selects a protocol frame aligned Base Station Emulation as the trigger. When Prot Frame Aligned is selected, a new sweep/measurement will start when the protocol frame aligned data trigger condition is met.

Prot Frame Aligned Trigger is aligned with the Base Station Emulation Protocol uplink frame timing boundary. It depends on the technology format of the base station call processing.

This trigger type is only available in UXM.

Example	<code>:TRIG:<meas>:SOUR PRTF</code>
Annunciation	Prot Frame (in the Meas Bar)

8.1.1.21 Prot Event

Selects a protocol frame aligned Base Station Emulation as the trigger. When Prot Frame Aligned is selected, a new sweep/measurement will start when the protocol frame aligned data trigger condition is met.

Prot Event Trigger is defined as the Base Station Emulation protocol internal event such as the starting of a predefined uplink pattern for a relative power control ramp. With this trigger, the IQ data, and therefore the measurement, is aligned with the start of the desired uplink pattern.

This trigger type is only available in UXM.

Example	<code>:TRIG:<meas>:SOUR PRTF</code>
Annunciation	Prot Frame (in the Meas Bar)

8.1.2 Trigger Level

Sets the amplitude level for Trigger and Gate sources that use level triggering. When the video signal crosses this level, with the chosen slope, the trigger occurs.

For any given Trigger, Gate, or Periodic Sync Src, the same Trigger Level is used for the Trigger source in the Trigger menu, for the Gate source in the Gate Source menu, and for the Periodic Sync source in the Periodic Sync Src menu.

If **Video** is the selected trigger source, the trigger level displays as a green horizontal line with the label TRIG LVL just above it on the right:



If the value of trigger level is off screen low this line displays along the bottom of the graticule. If the value of trigger level is off screen high this line displays above the graticule but no farther above than 1.5 % of the graticule height (the same as the trace itself). Note that the TRIG LVL label cannot display above the graticule so the label itself stops at the top of the graticule.

For the I/Q Triggers, the I/Q reference impedance is used for converting between power and voltage.

Trigger Level Parameters

Source	Example	Min	Max	Prese t	Resoluti on	Step Key Incr	Knob Incr
Video	<code>TRIG:VID:LEV -40 dBm</code>	-170 dBm	+30 dBm	-25 dBm	.01 dB	Scale/Div (Log), 1 dB (Lin)	Step/10, but never < 0.1 dB
Level	<code>TRIG:LEV:LEV -40 dBm</code>	-170 dBm	+30 dBm	-25 dBm	.01 dB	Scale/Div (Log), 1 dB (Lin)	Step/10, but never < 0.1 dB
External 1 2	<code>TRIG:EXT1:LEV 0.4 V</code>	-5 V VXT models M9410A/11A/15A /16A: 0 V	5 V VXT models M9410A/11A/15A /16A: 2.5 V	1.2 V	10 mV	0.5 V	0.1 V
I/Q Mag	<code>TRIG:IQM:LEV -30 dBm</code>	-200 dBm	100 dBm	-25 dBm	.1 dB	Scale/Div (Log), 1 dB (Lin)	Step/10, but never < 0.1 dB
I (Demod)	<code>TRIG:IDEM:LEV 0.5 V</code>	-1 V	1 V	0.25 V	4 significant digits	Scale/Div	Step/100, but never < 1 μV
Q (Demod)	<code>TRIG:QDEM:LEV 0.5 V</code>	-1 V	1 V	0.25 V	4 significant digits	Scale/Div	Step/100, but never < 1 μV
Input I	<code>TRIG:IINP:LEV 0.5 V</code>	-1 V	1 V	0.25 V	4 significant digits	Scale/Div	Step/100, but never < 1 μV
Input Q	<code>TRIG:QINP:LEV 0.5 V</code>	-1 V	1 V	0.25 V	4 significant digits	Scale/Div	Step/100, but never < 1 μV
Aux Chan I/Q Mag	<code>TRIG:AIQM:LEV -30 dBm</code>	-200 dBm	100 dBm	-25 dBm	.1 dB	Scale/Div (Log), 1 dB (Lin)	Step/10, but never < 0.1 dB
Internal	<code>TRIG:INT:LEV 1.2 V</code>	-5 V VXT models M9410A/11A/15A /16A: 0 V	5 V VXT models M9410A/11A/15A /16A: 2.5 V	1.2 V	10 mV	.5 V	.1 V
ADC	<code>TRIG:ADC:L</code>	-170 dBm	30 dBm	-25	.01 dB	Scale/Div	Step/10,

8 Trigger

8.1 Trigger

Source	Example	Min	Max	Prese t	Resoluti on	Step Key Incr	Knob Incr
	EV -30 dBm			dBm		iv (Log), 1 dB (Lin)	but never < 0.1 dB

More Information

For Video Trigger Level, when sweep type = FFT, the video trigger uses the amplitude envelope in a bandwidth wider than the FFT width as a trigger source. This can be useful but does not have the same relationship between the displayed trace and the trigger level as in swept triggering.

For Video Trigger Level the settable resolution of the function is 0.01 dB, even when the Y Axis Unit is linear. In Linear Y Axis Unit (for example, Volts) this requires 4 significant digits to display on the control.

For the Level trigger source, used in RTSA and other measurements, External Gain and Ref Level Offset modify the actual trace data as it is taken and are taken into account by Trig Level.

Remote Command	<pre>:TRIGger[:SEquence]:<trig_source>:LEVel <ampl> :TRIGger[:SEquence]:<trig_source>:LEVel?</pre> <p>where <trig_source> is one of:</p> <pre>EXTernal1 EXTernal2 EXTernal3 VIDEo ADC LEVel IQMag IDEMod QDEMod IINPut QINPut AIQMag INTernal</pre>
Example	<pre>:TRIG:VID:LEV -40 dBm</pre>
Dependencies	Only appears when Video, External 1 2, or an I/Q trigger is selected as the Trigger Source
State Saved	Saved in instrument state
Backwards	<pre>:TRIGger[:SEquence]:IF:LEVel</pre>
Compatibility SCPI	<p>taken as video trigger level</p> <pre>:TRIGger[:SEquence]:IF:LEVel?</pre> <p>taken as video trigger level query</p> <pre>:TRIGger[:SEquence]:EXTernal:LEVel</pre> <p>the parameter EXTernal is mapped to EXTernal1</p> <pre>:TRIGger[:SEquence]:FRAMe:EXTernal1:LEVel</pre>

8.1.3 Trigger Delay

Controls a time delay that the instrument will wait to begin a sweep after meeting the trigger criteria, for Trigger and Gate sources that support Trigger Delay.

For any given Trigger, Gate, or Periodic Sync source, the same Trigger Delay is used for the Trigger source in the Trigger menu, for the Gate source in the Gate Source menu, and for the Periodic Sync source in the Periodic Sync Src menu.

Negative trigger delays can be used. Negative trigger delay makes intuitive sense in time domain and works well in FFT mode where the bandwidth of the filter before the video trigger is about 1.25 span. You can use negative delay to pre-trigger the instrument in the time domain or FFT, but not in swept spans. Video trigger delay may be set to negative values, in time domain, FFT and even swept, but in swept spans, negative settings of Trig Delay are treated as a zero setting within the internal hardware and the advisory message "Neg. Trig Delay unavailable in Swept Mode, zero delay used." is generated when such a delay is set.

Remote Command	<pre>:TRIGger[:SEquence]:<trig_source>:DELAy <time> :TRIGger[:SEquence]:<trig_source>:DELAy?</pre> <p>where <trig_source> is one of: LINE EXTernal1 EXTernal2 EXTernal3 AEXTernal VIDeo ADC RFBurst FRAME LEVel FMT IQMag IDEMod QDEMod IINPut QINPut AIQMag PXI INTernal</p>
Example	<pre>:TRIG:VID:DEL:STAT ON :TRIG:VID:DEL 100 ms</pre>
Dependencies	Only appears when Video, Line, External 1 2, RF Burst, Periodic Timer or an I/Q trigger is selected as the Trigger Source
Couplings	When FMT Trigger Criteria is INSIDE or OUTSIDE , FMT Trigger Delay State is forced to OFF FMT Trigger Delay MaxValue is dependent on the current AcquisitionTime. The equation is: MaxValue = 2 ¹⁶ x AcqTime, but never to exceed 70 sec. Ex: In PVT View with a min PVT Acq Time of 200 us, this Trigger Delay MaxValue is 13.26 sec. In RT Spectrum and Spectrogram with a min Acq Time of 100 us, this Trigger Delay MaxValue is 6.55 sec. When the Acq Time is increased, this MaxValue also increases
State Saved	Saved in instrument state
Annotation	Trig Delay (in the Measurement Bar)
Backwards Compatibility Notes	For backward compatibility with VSA/PSA comms apps <pre>:TRIGger[:SEquence]:IF:DELAy :TRIGger[:SEquence]:DELAy</pre> <p>The legacy <code>:TRIGger[:SEquence]:DELAy</code> command affects the delay for the VID, LINE, EXT1, EXT2, and RFB triggers</p> <p>Auto Function</p>
Remote Command	<pre>:TRIGger[:SEquence]:<trig_source>:DELAy:STATe OFF ON 0 1 :TRIGger[:SEquence]:<trig_source>:DELAy:STATe?</pre> <p>where <trig_source> is one of: LINE EXTernal1 EXTernal2 EXTernal3 AEXTernal VIDeo ADC RFBurst FRAME LEVel FMT IQMag IDEMod QDEMod IINPut QINPut AIQMag PXI INTernal</p>
Preset	OFF

Backwards Compatibility Commands

Example	<code>:TRIG:DEL 1 ms</code>
Preset	1 us
State Saved	Saved in instrument state
Backwards Compatibility	<code>:TRIGger[:SEquence]:DELay <time></code>
SCPI	<code>:TRIGger[:SEquence]:DELay?</code> <code>:TRIGger[:SEquence]:DELay:STATE OFF ON 0 1</code> <code>:TRIGger[:SEquence]:DELay:STATE?</code>

Example	<code>:TRIG:OFFS ON</code> <code>:TRIG:OFFS -100 ms</code>
---------	---

Notes
ESA commands for trigger offset, which allowed you to use a positive or negative delay when in zero span and in a Res BW ≥ 1 kHz. For ESA compatibility, X-series instruments keep track of this offset and adds it to the Trigger Delay for VIDEO, LINE, EXTERNAL1 or EXTERNAL2 whenever the value is sent to the hardware, if in Zero Span and RBW ≥ 1 kHz

Preset	Off, 0 s
State Saved	Saved in instrument state
Min	-11 s
Max	+11 s
Backwards Compatibility	<code>:TRIGger[:SEquence]:OFFSet <time></code>
SCPI	<code>:TRIGger[:SEquence]:OFFSet?</code>

Auto Function

Remote Command	<code>:TRIGger[:SEquence]:OFFSet:STATE OFF ON 0 1</code> <code>:TRIGger[:SEquence]:OFFSet:STATE?</code>
----------------	--

Preset	OFF
--------	-----

Trigger Delay Parameters

Note: in Swept SA, when transitioning from Zero Span to Swept spans, the trigger delay is clipped to -150 ms if it had been longer in Zero Span.

Source	Example	Preset	Min	Max	Resolution
Video	<code>TRIG:VID:DEL:STAT ON</code> <code>TRIG:VID:DEL 100 ms</code>	Off, 1 us	-150 ms (-10s in Swept SA Zero Span)	+500 ms	100 ns
Level	<code>TRIG:LEV:DEL:STAT ON</code>	Off, 30 ms	0 ms	70 sec (but	Multiple of Acq

Source	Example	Preset	Min	Max	Resolution
	TRIG:LEV:DEL 100 ms			dependent on Acq Time like FMT)	Time (as is FMT)
FMT	TRIG:FMT:DEL:STAT ON TRIG:FMT:DEL 100 ms	Off, 30 ms	0 ms	70 sec (but dependent on Acq Time like FMT)	Multiple of Acq Time (as is FMT)
External 1 2	TRIG:EXT1:DEL:STAT ON TRIG:EXT2:DEL 100 ms	Off, 1 us	-150 ms (-10s in Swept SA Zero Span)	+500 ms	100 ns
Line	TRIG:LINE:DEL:STAT ON TRIG:LINE:DEL 100 ms	Off, 1 us	-150 ms (-10s in Swept SA Zero Span)	+500 ms	100 ns
RF Burst	TRIG:RFB:DEL:STAT ON TRIG:RFB:DEL 100 ms	Off, 1 us	-150 ms (-10s in Swept SA Zero Span)	+500 ms	100 ns
Periodic Timer	TRIG:FRAM:DEL:STAT ON TRIG:FRAM:DEL 100 ms	Off, 1 us	-150 ms (-10s in Swept SA Zero Span)	+500 ms	100 ns
I/Q Mag	TRIG:IQM:DEL:STAT ON TRIG:IQM:DEL 10 ms	Off, 1 us	-2.5 s	+10 s	10 ns
I (Demod)	TRIG>IDEM:DEL:STAT ON TRIG>IDEM:DEL 10 ms	Off, 1 us	-2.5 s	+10 s	10 ns
Q (Demod)	TRIG:QDEM:DEL:STAT ON TRIG:QDEM:DEL 10 ms	Off, 1 us	-2.5 s	+10 s	10 ns
Input I	TRIG:IINP:DEL:STAT ON TRIG:IINP:DEL 10 ms	Off, 1 us	-2.5 s	+10 s	10 ns
Input Q	TRIG:QINP:DEL:STAT ON TRIG:QINP:DEL 10 ms	Off, 1 us	-2.5 s	+10 s	10 ns
Aux Chan I/Q Mag	TRIG:AIQM:DEL:STAT ON TRIG:AIQM:DEL 10 ms	Off, 1 us	-2.5 s	+10 s	10 ns
PXI	TRIG:PXI:DEL:STAT ON TRIG:PXI:DEL 10 ms	Off, 1 us	-150 ms	+500 ms	100 ns
Internal	TRIG:INT:DEL:STAT ON TRIG:INT:DEL 10 ms	Off, 1 us	-150 ms	+500 ms	100 ns
Prot Channel Detection	TRIG:PRTC:DEL:STAT ON TRIG:PRTC:DEL 1 ms	Off, 1 ms	-10 ms	+10 ms	100 ns

8 Trigger

8.1 Trigger

Source	Example	Preset	Min	Max	Resolution
Prot Frame Aligned	<code>TRIG:PRTF:DEL:STAT ON</code> <code>TRIG:PRTF:DEL 1 ms</code>	Off, 1 ms	-10 ms	+10 ms	100 ns
Prot Event	<code>TRIG:PRTE:DEL:STAT ON</code> <code>TRIG:PRTE:DEL 1 ms</code>	Off, 1 ms	-10 ms	+10 ms	100 ns

Note: in Bluetooth Mode, the preset value of Trigger Delay is always (On, -20us).

More Information

Here is the diagram for Frequency Mask Trigger (FMT) Trigger Delay:

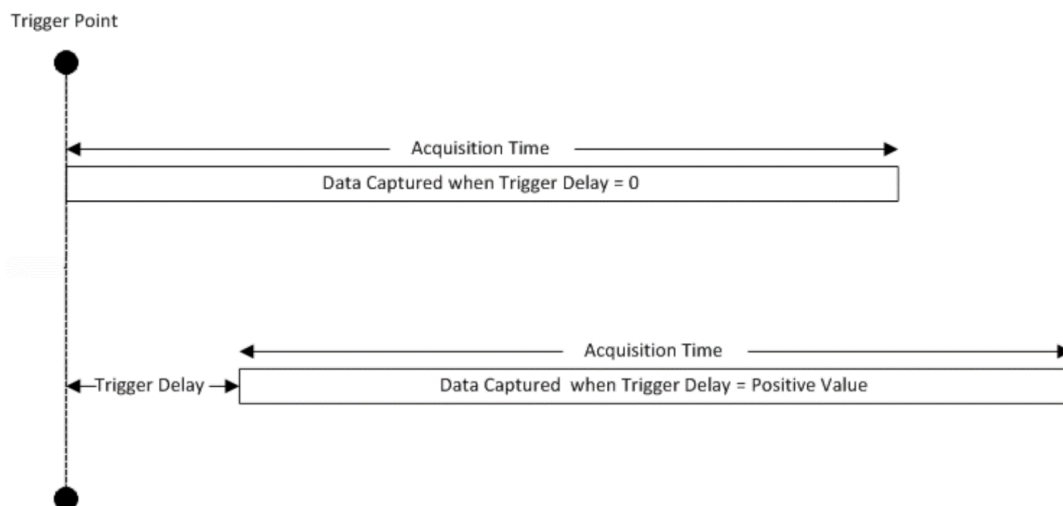

8.1.4 Trigger Slope

Sets the trigger polarity for Trigger and Gate sources that support Trigger Slope. It is set positive to trigger on a rising edge and negative to trigger on a falling edge.

For any given Trigger, Gate, or Periodic Sync source, the same Trigger Slope is used for the Trigger source in the Trigger menu, for the Gate source in the Gate Source menu, and for the Periodic Sync source in the Periodic Sync Src menu.

Remote Command `:TRIGger[:SEquence]:<trig_source>:SLOPe POSitive | NEGative`
`:TRIGger[:SEquence]:<trig_source>:SLOPe?`

where `<trig_source>` is one of:

`LINE` | `EXTernal1` | `EXTernal2` | `EXTernal3` | `AEXTernal` | `VIDeo` | `ADC RFBurst` |

	IQMag IDEMod QDEMod IINPut QINPut AIQMag PXI Internal
Example	:TRIG:VID:SLOP NEG :TRIG:VID:SLOP? :TRIG:EXT1: SLOP NEG
Dependencies	Only appears when Video, Line, External 1 2, RF Burst or an I/Q trigger is selected as the Trigger Source
Preset	POSitive
State Saved	Saved in instrument state
Backwards Compatibility SCPI	:TRIGger[:SEQuence]:IF:SLOPe NEGative POSitive :TRIGger[:SEQuence]:IF:SLOPe? For backward compatibility with VSA/PSA comms apps :TRIGger[:SEQuence]:EXTernal:SLOPe For backward compatibility, the parameter EXTernal is mapped to EXTernal1 :TRIGger[:SEQuence]:FRAMe:EXTernal1:SLOPe :TRIGger[:SEQuence]:FRAMe:EXTernal2:SLOPe

Example	:TRIG:SLOP NEG
Preset	POSitive
State Saved	Saved in instrument state
Backwards Compatibility SCPI	:TRIGger[:SEQuence]:SLOPe POSitive NEGative :TRIGger[:SEQuence]:SLOPe?

Note: when transitioning from Zero Span to Swept spans, the trigger delay is clipped to -150 ms if it had been longer in Zero Span.

8.1.5 Trigger Level Absolute/Relative

Selects either Absolute or Relative Burst Triggering.

Remote Command	:TRIGger[:SEQuence]:RFBurst:LEVel:TYPE ABSolute RELative :TRIGger[:SEQuence]:RFBurst:LEVel:TYPE?
Example	Set the trigger level type of the RF burst trigger to Relative: :TRIG:RFB:LEV:TYPE REL
Dependencies	Only appears when RF Burst is selected as the Trigger Source
Preset	ABSolute
State Saved	Saved in instrument state

8.1.6 Absolute Trigger Level

Sets the absolute trigger level for the RF burst envelope.

NOTE

When using the External Mixing path, the Absolute Trigger Level is uncalibrated because the factory default was set to accommodate the expected IF levels for the RF path.

Remote Command	<code>:TRIGger[:SEquence]:RFBurst:LEVel:ABSolute <ampl></code> <code>:TRIGger[:SEquence]:RFBurst:LEVel:ABSolute?</code>
Example	Set the trigger level of the RF burst envelope signal to the absolute level of 10 dBm: <code>:TRIG:RFB:LEV:ABS 10 dBm</code>
Notes	Sending this command does not switch the setting from relative to absolute; to switch it you need to send <code>:TRIGger[:SEquence]:RFBurst:LEVel:TYPE</code> For Bluetooth Mode, the default value is -50 dBm
Dependencies	Only appears when RF Burst is selected as the Trigger, Gate or Periodic Sync Source
Couplings	This same level is used for the RF Burst trigger source in the Trigger menu, for the RF Burst selection in the Gate Source menu, and also for the RF Burst selection in the Periodic Sync Src menu
Preset	LTEA FDD/TDD modes: -40 dBm or -50 dBm depending on the hardware 5G NR mode: -40 dBm All other modes: -20 dBm
State Saved	Saved in instrument state
Min	-200 dBm
Max	100 dBm
Backwards Compatibility SCPI	<code>:TRIGger[:SEquence]:FRAMe:RFBurst:LEVel:ABSolute</code>

8.1.7 Relative Trigger Level

Sets the relative trigger level for the RF burst envelope.

In some models, the relative burst trigger function is implemented in hardware. In other models, without the advanced triggering hardware required, the relative burst trigger function is implemented in software in some measurements, and is unavailable in other measurements.

When implemented in software, the relative RF Burst trigger function is implemented as follows:

1. The measurement starts with the absolute RF Burst trigger setting. If it cannot get a trigger with that level, auto trigger fires and the acquisition starts anyway.

After the acquisition, the measurement searches for the peak in the acquired waveform and saves it

2. In the next cycle of the measurement, the measurement determines a new absolute RF Burst level based on the peak value from the first measurement and the Relative RF Burst Trigger Level (always 0 or negative dB) set by the user. The following formula is used: absolute RF Burst level = peak level of the previous acquisition + relative RF Burst level
3. If the new absolute RF Burst level differs from the previous by more than 0.5 dB, the new level is sent to the hardware; otherwise, it is not updated (to avoid slowing down the acquisition)

Steps 2 and 3 repeat for subsequent measurements.

Remote Command	<code>:TRIGger[:SEquence]:RFBurst:LEVel:RELative <rel_ampl></code> <code>:TRIGger[:SEquence]:RFBurst:LEVel:RELative?</code>
Example	Set the trigger level of the RF burst envelope signal to the relative level of -10 dB: <code>:TRIG:RFB:LEV:REL -10 dB</code>
Notes	Sending this command does not switch the setting from absolute to relative; to switch it you need to send <code>:TRIGger[:SEquence]:RFBurst:LEVel:TYPE</code> The relative trigger level is not available in some measurements. In those measurements the <code>RELative</code> parameter, and <code>:TRIGger[:SEquence]:RFBurst:LEVel:TYPE</code> generates an error if sent
Dependencies	This control is grayed-out and Absolute Trigger Level selected if the required hardware is not present in your instrument and the current measurement does not support Relative triggering Only appears when RF Burst is selected as the Trigger Source
Preset	-6 dB GSM: -25 dB
State Saved	Saved in instrument state
Min	-45 dB
Max	0 dB
Backwards Compatibility SCPI	<code>:TRIGger[:SEquence]:RFBurst:LEVel</code> This legacy command is aliased to <code>:TRIGger[:SEquence]:RFBurst:LEVel:RELative</code> because PSA had <i>only</i> relative burst triggering In some models, a variety of burst trigger circuitry is available, resulting in various available burst trigger bandwidths. The instrument automatically chooses the appropriate trigger path based on the hardware configuration and other settings of the instrument. Here is the RF Burst Trigger Bandwidth table for Swept SA Measurement in SA mode:

8 Trigger
8.1 Trigger

Model	Option	Span	Swp Type	FFT Width	Trigger BW, -10 dB	Notes
EXA	any	All	all	all	16 MHz	
MXA	w/o B25	All	all	all	16 MHz	
MXA	B25	Zero	N/A	N/A	16 MHz	
MXA	B25	All	Swept	N/A	16 MHz	
MXA	B25	< 8 MHz	FFT	all	16 MHz	
MXA	B25	≥ 8 MHz	FFT	25 MHz	30 MHz	
PXA	any	all	all	all	> 80 MHz	Exceptions(*)

(*) Exceptions: When the RF Burst Trigger Level Type is Absolute, the start frequency is below 300 MHz, and the sweep type is either Swept or FFT with an FFT width of less than 25 MHz, then the RF Burst Trigger Bandwidth is not >80 MHz. It would be 16 MHz except in the subcase of Sweep Type = FFT and FFT Width between 8 and 25 MHz inclusive, where it would be 30 MHz.

8.1.8 Period

Sets the period of the internal periodic timer clock. For digital communications signals, this is usually set to the frame period of your current input signal. In the case that sync source is not set to OFF, and the external sync source rate is changed for some reason, the periodic timer is synchronized at every external synchronization pulse by resetting the internal state of the timer circuit.

Remote Command	<code>:TRIGger[:SEquence]:FRAMe:PERiod <time></code> <code>:TRIGger[:SEquence]:FRAMe:PERiod?</code>
Example	<code>:TRIG:FRAM:PER 100 ms</code>
Dependencies	The invalid data indicator turns on when the period is changed, until the next sweep/measurement completes Only appears when Periodic Timer is selected as the Trigger or Gate Source
Couplings	The same period is used in the Gate Source selection of the period timer
Preset	20 ms unless noted below: GSM: 4.615383 ms 5G NR: 10 ms
State Saved	Saved in instrument state
Min	100.000 ns
Max	559.0000 ms

8.1.9 Offset

Adjusts the accumulated offset between the periodic timer events and the trigger event. Adjusting the accumulated offset is different than setting an offset and requires explanation.

The periodic timer is usually not synchronized with any external events, so the timing of its output events has no absolute meaning. Since the timing relative to external events (RF signals) is important, you need to be able to adjust (offset) it. However, you have no direct way to see when the periodic timer events occur. All that you can see is the trigger timing. When you want to adjust the trigger timing, you will be changing the internal offset between the periodic timer events and the trigger event. Because the absolute value of that internal offset is unknown, we will just call that the accumulated offset. Whenever the Offset parameter is changed, you are changing that accumulated offset. You can reset the displayed offset using Reset Offset Display. Changing the display does not change the value of the accumulated offset, and you can still make additional changes to accumulated offset.

To avoid ambiguity, we define that an increase in the "offset" parameter, either from the knob or the SCPI adjust command, serves to delay the timing of the trigger event.

Remote Command	<code>:TRIGger[:SEQuence]:FRAMe:OFFSet <time></code> <code>:TRIGger[:SEQuence]:FRAMe:OFFSet?</code>
Example	<code>:TRIG:FRAM:OFFS 1.2 ms</code>
Notes	<p>The front panel interface (for example, the knob), and this command, adjust the accumulated offset, which is shown on the control</p> <p>However, the actual amount sent to the hardware each time the offset is updated is the delta value, that is, the current accumulated offset value minus the previous accumulated offset value. Note that the accumulated offset value is essentially arbitrary; it represents the accumulated offset from the last time the offset was zeroed (with the Reset Offset Display key)</p> <p>Note that this command does not change the period of the trigger waveform. Note also that Offset is used only when the sync source is set to OFF, otherwise delay is used, see "Trigger Delay" on page 1409</p> <p>An increase in the "offset" parameter, either from the knob or the SCPI adjust command, serves to delay the timing of the trigger event</p> <p>When the SCPI command is sent the value shown on the control is updated with the new value. However, the actual amount sent to the hardware is the delta value, that is, the current accumulated offset value minus the previous accumulated offset value</p> <p>The SCPI query simply returns the value currently showing on the key</p>
Dependencies	<p>The invalid data indicator turns on when the offset is changed, until the next sweep/measurement completes</p> <p>Only appears when Periodic Timer is selected as the Trigger or Gate Source</p>

8 Trigger
8.1 Trigger

Couplings	The same offset is used in the Gate Source selection of the period timer
Preset	0 s
State Saved	Saved in instrument state
Min	-10.000 s
Max	10.000 s

8.1.10 Reset Offset Display

Resets the value of the periodic trigger offset display setting to 0.0 seconds. The current displayed trigger location may include an offset value defined with the **Offset** key. Pressing this control redefines the currently displayed trigger location as the new trigger point that is 0.0 s offset. The **Offset** control can then be used to add offset relative to this new timing.

Remote Command	<code>:TRIGger[:SEquence]:FRAMe:OFFSet:DISPlay:RESet</code>
Example	<code>:TRIG:FRAM:OFFS:DISP:RES</code>
Dependencies	Only appears when Periodic Timer is selected as the Trigger or Gate Source

8.1.11 Offset Adjust (Remote Command Only)

Lets you advance the phase of the frame trigger by the amount you specify. It does *not* work in the same way as the related front panel keys.

The command does not change the period of the trigger waveform. If the command is sent multiple times, it advances the phase of the frame trigger an additional amount each time it is sent. Negative numbers are permitted.

Remote Command	<code>:TRIGger[:SEquence]:FRAMe:ADJust <time></code>
Example	<code>:TRIG:FRAM:ADJ 1.2 ms</code>
Notes	<p>Note also that Offset is used only when the sync source is set to OFF, otherwise delay is used, see section "Trigger Delay" on page 1409</p> <p>An increase in the "offset" parameter, either from the knob or the SCPI adjust command, serves to delay the timing of the trigger event</p> <p>The front panel interface (for example, the knob) and the <code>:TRIG:FRAM:OFFS</code> command adjust the accumulated offset, which is shown on the active function display. However, the actual amount sent to the hardware is the delta value, that is, the current offset value minus the previous offset value</p> <p>When the SCPI command is sent the value shown on the control (and the Active Function, if this happens to be the active function) is updated by increasing it (or decreasing it if the value sent is negative) by the amount specified in the SCPI command</p> <p>This is no query for this command</p>
Dependencies	The invalid data indicator turns on when the offset is changed, until the next sweep/measurement

	completes
Couplings	The same offset is used in the Gate Source selection of the period timer
Preset	0 s
State Saved	Saved in instrument state
Min	-10.000 s
Max	10.000 s

8.1.12 Sync Source

For convenience, you can select the Periodic Timer Sync Source using this dropdown. You can also select it from the Periodic Sync Src tab, which also contains controls that let you configure the Sync Source.

Selects a signal source for you to synchronize your periodic timer trigger to, otherwise you might be triggering at some arbitrary location in the frame. Synchronization reduces the precision requirements on the setting of the period.

Example	<pre>:TRIG:FRAM:SYNC EXT1 :TRIG:FRAM:SYNC EXT2 :TRIG:FRAM:SYNC RFB :TRIG:FRAM:SYNC OFF</pre>
Dependencies	Only appears when Periodic Timer is selected as the Trigger or Gate Source
Preset	OFF
State Saved	Saved in instrument state

8.1.13 TV Line

Selects the **TV Line** number on which to trigger. Line number range is dependent on the settings of the "[Standard](#)" on page 1422 and "[Field](#)" on page 1421 menus within the TV trigger setup functions. When the line number is incremented beyond the upper limit, the value will change to the lower limit and continue incrementing from there. When the line number is decremented below the lower limit, the value will change to the upper limit and continue decrementing from there.

Remote Command	<pre>:TRIGger[:SEquence]:TV:LINE <integer> :TRIGger[:SEquence]:TV:LINE?</pre>
Example	<pre>:TRIG:TV:LINE 20 :TRIG:TV:LINE?</pre>
Dependencies	<p>Only available in the Swept SA measurement</p> <p>Only appears when TV is selected as the Trigger Source</p>

8 Trigger

8.1 Trigger

Preset	17
State Saved	Saved in instrument state
Min	1 The minimum value is the minimum line and rolls over to the maximum value. The minimum line number depends on which Field and standard are selected
Max	The maximum value is the maximum line and rolls over to the minimum value. The maximum line number depends on which Field and standard are selected Field 1 (ODD): <ul style="list-style-type: none"> Maximum line is 263 for formats NTSC-M, NTSC-Japan, NTSC-4.43, PAL-M and PAL-60 Maximum line is 313 for formats PAL-B, D, G, H, I, PAL-N, PAL-N Combin, and SECAM-L Field 2 (EVEN): <ul style="list-style-type: none"> The maximum line 262 for formats NTSC-M, NTSC-Japan, NTSC-4.43, PAL-M and PAL-60 The maximum line is 312 for formats PAL-B, D, G, H, I, PAL-N, PAL-N Combin, and SECAM-L Field = ENTire Frame: <ul style="list-style-type: none"> 525, for formats NTSC-M, NTSC-Japan, NTSC-4.43, PAL-M and PAL-60 625, for formats PAL-B, D, G, H, I, PAL-N, PAL-N Combin, and SECAM-L

8.1.14 Field

Selects the **Field** on which to trigger:

Entire Frame	ENTire	Causes the selected line number to be viewed as an offset into the entire frame starting with line 1, the first line in Field One
Field One	ODD	Causes the selected line number to be viewed as an offset into the first field starting with Line 1, the first line in Field One
Field Two	EVEN	Causes the selected line number to be viewed as an offset into the second field. If Line 1 is selected, it is the 264th line of the frame (NTSC-M, NTSC-Japan, NTSC-4.43, PAL-M, PAL-60) or the 314th line of the frame (PAL-B,D,G,H,I, PAL-N, PAL-N-Combin, SECAM-L)

Remote Command	<code>:TRIGger[:SEquence]:TV:FMODe ENTire ODD EVEN</code> <code>:TRIGger[:SEquence]:TV:FMODe?</code>
Example	<code>:TRIG:TV:FMOD ENT</code> <code>:TRIG:TV:FMOD EVEN</code> <code>:TRIG:TV:FMOD ODD</code>
Dependencies	Only available in the Swept SA measurement Only appears when TV is selected as the Trigger Source

	This command is available only when Option B7B (TV trigger) is installed
Preset	<code>ENTire</code>
Range	<code>ENTire ODD EVEN</code>

8.1.15 Standard

Accesses the **Standard** menu keys, which select from the following TV standards:

NTSC-M	<code>MNTSc</code>
NTSC-Japan	<code>JNTSc</code>
NTSC-4.43	<code>NTSC443</code>
PAL-M	<code>MPAL</code>
PAL-B,D,G,H,I	<code>BPAL</code>
PAL-N	<code>NPAL</code>
PAL-N-Combin	<code>CPAL</code>
PAL-60	<code>PAL60</code>
SECAM-L	<code>LSEC</code>

As the TV standard is changed, the current line value is clipped as necessary to keep it valid for the chosen standard and field mode. For example, line 600 is selected in Entire Frame mode in PAL-N; if NTSC-M is selected, the line number is clipped to 525. Or, if line 313 is selected in Field 1 mode in PAL-N and NTSC-M is selected, the line number is clipped to 263. Changing back to the PAL-N standard will leave the line number at 263.

Remote Command	<code>:TRIGger[:SEquence]:TV:STANdard MNTSc JNTSc NTSC443 MPAL BPAL NPAL CPAL PAL60 LSEC</code> <code>:TRIGger[:SEquence]:TV:STANdard?</code>
Example	Sets NTSC-M <code>:TRIG:TV:STAN MNTS</code> Queries Standard <code>:TRIG:TV:STAN?</code>
Dependencies	Only available in the Swept SA measurement Only appears when TV is selected as the Trigger Source
Preset	<code>MNTS</code>
State Saved	Saved in instrument state
Range	<code>MNTSc JNTSc NTSC443 MPAL BPAL NPAL CPAL PAL60 LSEC</code>

8.1.16 Trigger Center Frequency

Sets the center frequency to be used by the auxiliary receiver for the **Auxiliary Channel I/Q Magnitude** trigger.

Remote Command	<code>:TRIGger[:SEquence]:AIQMag:CENTer <freq></code> <code>:TRIGger[:SEquence]:AIQMag:CENTer?</code>
Example	<code>:TRIG:AIQM:CENT 10 MHz</code>
Notes	Trigger CF + 1/2 Trigger BW < Max Trigger CF - 1/2 Trigger BW > Min
Dependencies	Only appears when Aux Channel I/Q Mag is selected as the Trigger Source
Preset	0 Hz
State Saved	Saved in instrument state
Range	-40 MHz to 40 MHz
Min	-40 MHz
Max	40 MHz

8.1.17 Trigger BW

Sets the information bandwidth used by the auxiliary receiver for the Auxiliary Channel I/Q Magnitude trigger.

Remote Command	<code>:TRIGger[:SEquence]:AIQMag:BANDwidth <freq></code> <code>:TRIGger[:SEquence]:AIQMag:BANDwidth?</code>
Example	<code>:TRIG:AIQM:BAND 8 MHz</code>
Notes	The combined sample rate for the main and auxiliary receivers cannot exceed 100 MSa/sec. The bandwidth available to Trigger BW is limited to what is available after the main receiver's bandwidth (Info BW, sometimes pre-FFT BW) is set. Because of this limitation, the Max is not always achievable. The combination of " Trigger Center Frequency " on page 1423 and Trigger BW is also limited: <ul style="list-style-type: none"> - Trigger CF + 1/2 Trigger BW < Max - Trigger CF - 1/2 Trigger BW > Min
Dependencies	Only appears when Aux Channel I/Q Mag is selected as the Trigger Source
Preset	Bandwidth option dependent: <ul style="list-style-type: none"> - No Opt: 10 MHz - Opt B25: 25 MHz - Opt S40: 40 MHz

State Saved	Saved in instrument state
Range	10 Hz to Maximum
Min	10 Hz
Max	Bandwidth option & I/Q input path-dependent: <ul style="list-style-type: none"> - No Opt, I or Q Only: 10 MHz, I+jQ: 20 MHz - Opt B25, I or Q Only: 25 MHz, I+jQ: 50 MHz - Opt S40, I or Q Only: 40 MHz, I+jQ: 80 MHz

8.1.18 Zero Span Delay Compensation On/Off

In **Zero Span**, there is a natural delay in the signal path, which comes from the RBW filter. This is usually desirable, as it lets you trigger on events and also see those events, because the signal is delayed from the trigger event. However, in some cases it is desirable to eliminate this delay, so that trigger events line up exactly with the zero-time point in **Zero Span**. You can use the **Zero Span Delay Comp On/Off** feature to enable or disable zero span delay compensation.

Remote Command	<code>:TRIGger[:SEquence]:EXTernal1 EXTernal2 RFBurst:DELay:COMPensation OFF ON</code> <code> 0 1</code> <code>:TRIGger[:SEquence]:EXTernal1 EXTernal2 RFBurst:DELay:COMPensation?</code>
Example	<code>:TRIG:EXT1:DEL:COMP ON</code> <code>:TRIG:EXT1:DEL:COMP?</code> <code>:TRIG:EXT2:DEL:COMP ON</code> <code>:TRIG:RFB:DEL:COMP ON</code>
Dependencies	No effect except in zero-span, but not locked out in nonzero spans Zero Span Delay Compensation only appears in the Swept SA and List Power Step measurements. Only External and RF Burst triggers support it Does not appear in VXT If the SCPI command is sent when the control is not shown, an error is returned: -221, "Settings conflict; Feature not supported for this measurement" Only appears when External 1 2 or RF Burst is selected as the Trigger, Gate or Periodic Sync Source
Preset	<code>OFF</code>
State Saved	Saved in instrument state

8.1.19 Select PXI Line

Controls which `PXI_TRIG[0..7]` backplane line is used for the trigger source.
Only found in modular analyzer products.

8 Trigger

8.1 Trigger

Remote Command	<code>:TRIGger[:SEquence]:PXI:LINE <line></code> <code>:TRIGger[:SEquence]:PXI:LINE?</code>
Example	<code>:TRIG:PXI:LIN 2</code>
Preset	0
State Saved	Saved in instrument state
Range	[0,7]

8.1.20 Reset Sync Monitor

Lets you reset the status of Synchronization for **Periodic** trigger This control works together with bit 6 “Waiting for Periodic Sync Source” in the `:STATus:OPERation:CONDition` status register.

When you first switch to periodic trigger, RF Burst is the default Sync Source. The register will be set immediately. A “Periodic Trigger, Waiting for Sync Source” message will be generated after 2 seconds (if the instrument is not synchronized). The system is waiting for a RF Burst signal. You can tap the screen to remove the message.

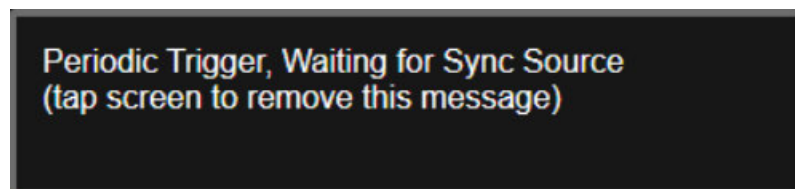

Once RF burst signal is provided and the hardware synchronized, the register will be cleared and a “Periodic Trigger Synchronized” message will be generated.

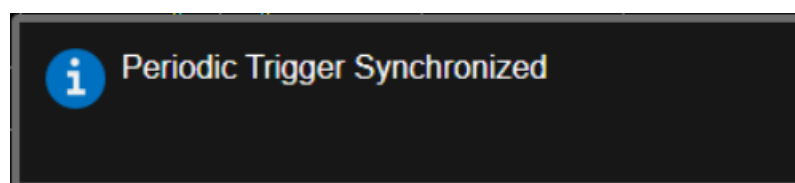

When change to a new Sync Source other than Off, take External1 as an example. You'll get the condition register set to 1 and a pop-up message again. There are the possible following conditions:

- External1 is provided: the register is cleared, message is updated.
- External1 is not provided, you set the Sync Source to Off: the register is cleared, message is cleared.
- External1 is not provided, you set the Sync Source to External2: the register and message keep the same.

- External1 is not provided, you set the Sync Source back to RF Burst: the register is cleared, message is also cleared. That’s because the instrument is synchronized to RF Burst already. If you want to make a new synchronization, you have to press “Reset Sync Monitor” you send SCPI command “:TRIG:FRAM:SMON:RES”.

Remote Command	:TRIGger[:SEquence]:FRAMe:SMONitor:RESet
Example	:TRIG:FRAM:SMON:RES
Notes	This control works together with bit 1 “Waiting for Periodic Sync Source” in the :STATus:OPERation:INSTRument:CONDition status register A “Periodic Trigger, Waiting for Sync Source” message will be generated after pressing this control, and the status bit will be set A “Periodic Trigger Synchronized” message will be generated after successfully synchronizing to Sync Source, and the status bit will be cleared
Dependencies	Only functional when Periodic Trigger is selected as the Trigger or Gate Source, and Sync Source is not Off Only available in VXT models M9410A/11A/15A/16A
Status Bits/OPC dependencies	Bit 6 of :STATus:OPERation:CONDition will be set after pressing this control

8.1.21 Trigger Optimization

Sets the trigger behavior for various desired operation conditions.

Remote Command	:TRIGger[:SEquence]:OPTimize:MODE NORMAL MJITter For option details, see " Options " on page 1426 :TRIGger[:SEquence]:OPTimize:MODE?
Example	Select trigger optimization for minimum jitter: :TRIG:OPT:MOD MJIT
Dependencies	Only appears in VXT models M9410A/11A/15A/16A Minimum jitter is functional only when digital IF BW is lower than 300 MHz. When Trigger Optimization is set to MJITter and it is not in effect, the following warning message appears in the status bar: Settings Alert; Minimum Jitter is not available
Preset	NORMAL
State Saved	Yes
Range	NORMAL MJITter

Options

Trigger optimization options are:

8 Trigger

8.1 Trigger

Trigger Optimization	SCPI	Notes
Normal	<code>NORMa1</code>	No optimization
Minimum Jitter	<code>MJITter</code>	Optimizes trigger for minimum jitter. A software resample method is provided to reduce jitter, at the expense of some measurement speed The acquisition jitter depends on the digital IF BW, the jitter will be smaller when digital IF BW gets larger. For example, when the digital IF BW is 98.3 MHz in 5GNR, the jitter varies under 15ns. When set MJITter as trigger optimization type, the jitter will be reduced to 1ns This setting applies to all the Trigger Sources

8.1.22 Trigger Settings Diagram

Lets you configure the **Trigger** system using a visual utility.

First, select what you want to configure (the Trigger, Gate or Periodic Sync Source) by tapping the box for **Trigger**, **Gate** or **Periodic Sync Source**.

Next, tap any box in the gray row to choose a Trigger Source to connect to. For **Periodic Sync Source**, you can also tap **Off**.

The **Trigger Settings Diagram** changes depending on context. The Trigger Sources that are available change depending on which input you have selected.

8.2 Gate Source

Contains controls that let you select and configure Gate control signals.

This tab appears in the **Trigger** menu panel for measurements that support gating. In measurements that do not support gating, this tab does not appear.

The menus under the **Gate Source** tab are the same as those under the **Trigger** tab, with these exceptions:

A smaller set of sources is available for gating.

The Free Run and Video selections are not provided for Gate

- The Trig Delay controls are not present
- Relative RF Burst Triggering is not available, just Absolute
- There is an additional control, Sync Holdoff, under Gate Source

Any changes to the settings in the setup menus under each Gate Source selection (for example: Trigger Level, Trigger Delay, etc.) also affect the corresponding settings under the Trigger menu keys. The gate system uses the Trigger SCPI commands for the setup functions, since each setting affects both Gate and Trigger.

Example: to set the Trigger Level for External 1 Trigger you use the command `:TRIG:EXT1:LEV`; to set the Trigger Level for External 1 Gate you use the same command, `:TRIG:EXT1:LEV`. By the same token, once you set the External 1 Trigger Level to 1v, it is 1v whether External 1 is being used as a Gate Source or a Trigger Source.

If a command is sent to the **TRIG** node to set the functions that are omitted from the **Gate Source** menus (Auto Trig, Holdoff, Trig Delay), it is accepted and the values stored, but the values are not visible from the **Gate Source** menus.

8.2.1 Select Gate Source

Selects the source of the Gate signal for doing Gated Trigger measurements.

This version of the **Select Gate Source** function is used in all measurements except the Pulse measurement application.

For the selection of the gate source the SCPI node, `:TRIGger[:SEquence]:` is replaced by `[:SENSe]:SWEep:EGATe:` as shown in the remote command below. Because you can independently set the Gate Source and the Trigger Source, there is a separate SCPI command for the Gate Source.

Remote Command `[:SENSe]:SWEep:EGATe:SOURce EXTerna11 | EXTerna12 | LINE | FRAMe | RFBurst`

8 Trigger
8.2 Gate Source

	TV VIDEo PXI INTernal [:SENSe]:SWEep:EGATe:SOURce?
Example	:SWE:EGAT:SOUR EXT1 :SWE:EGAT:SOUR?
Dependencies	Available selections differ depending on models as below
	Benchtop Line, External 1, External 2, RF Burst, Periodic, TV (Swept SA only)
	VXT Video, Internal, External 1, External 2, RF Burst, Periodic, PXI Internal and Periodic are not available in Spectrum Analyzer Mode - Internal is available only in M9410A/11A/15A/16A and unavailable in M9420/21A
	EXM Video, Internal, External 1, External 2, RF Burst, Periodic Not available in E7760 In some models, there is no second External input. In these models, the External 2 selection is not shown and the EXTernal12 parameter will generate a "Hardware missing; Not available for this model number" error
Preset	GSM/EDGE, Phase Noise: FRAM MSR: EXT1 LTEATDD, 5G NR: - Direction is Downlink: EXT1 - Direction is Uplink: FRAM All Others: EXT1

8.2.2 Sync Holdoff

Applies only to the Periodic Timer. Specifies the duration that the sync source signal for the Periodic Timer must be kept false before the transition to true to be recognized as the sync timing. The periodic timer phase is aligned when the sync source signal becomes true, after the Holdoff time is satisfied.

A holdoff of 2 ms works with most WiMAX signals, but there may be cases where the burst off duration is less than 1 ms and this value will need to be changed.

Remote Command	:TRIGger[:SEQuence]:FRAMe:SYNC:HOLDoff <time> :TRIGger[:SEQuence]:FRAMe:SYNC:HOLDoff?
Example	:TRIG:FRAM:SYNC:HOLD 5 :TRIG:FRAM:SYNC:HOLD?
Dependencies	Only appears if Periodic is the selected Gate Source Does not appear in all Measurements. For example, does not appear in Swept SA

Preset	LTEATDD: ON, 1 ms 5G NR: ON, 250.0 us 1xEVDO: OFF, 0 ms (SCPI only) Other than above: OFF, 4 msec
State Saved	Saved in instrument state
Min	0 ms
Max	+500 ms
Auto Function	
Remote Command	<code>:TRIGger[:SEquence]:FRAMe:SYNC:HOLDoff:STATe OFF ON 0 1</code> <code>:TRIGger[:SEquence]:FRAMe:SYNC:HOLDoff:STATe?</code>
Preset	LTEATDD, 5G NR: ON Others: OFF

8.3 Gate Settings

Contains controls that let you control the gating function. The Gate functionality is used to view signals best viewed by qualifying them with other events.

This tab appears in the **Trigger** menu panel for measurements that support gating. In measurements that do not support gating, this tab does not appear.

In the Swept SA measurement, the Gate controls, and all SCPI under the `[:SENSe] :SWEep:EGATe` SCPI node are unavailable when Source Mode is set to Tracking. This is because the Gate circuitry is used to sync the external source. If the Tracking Source is turned on, the Gate is turned off.

Gate setup parameters are the same for all measurements – they do not change as you change measurements. Settings like these are called “Meas Global” and are unaffected by Meas Preset.

Note that Sweep Time auto coupling rules and annotation are changed when Gate is on.

8.3.1 Gate On/Off

Turns the gate function on or off.

When the Gate Function is **ON**, the selected Gate Method is used along with the gate settings and the signal at the gate source to control the sweep and video system with the gate signal. Not all measurements allow every type of Gate Methods.

If the Gate were to be turned **ON** without a gate signal present, Marker Count operation would be unreliable, so it is locked out whenever Gate is on for measurements that support Marker Count.

Remote Command	<code>[:SENSe] :SWEep:EGATe [:STATe] OFF ON 0 1</code> <code>[:SENSe] :SWEep:EGATe [:STATe] ?</code>
Example	<code>:SWE:EGAT ON</code> <code>:SWE:EGAT ?</code>
Dependencies	The function is unavailable (grayed-out) and OFF when: <ul style="list-style-type: none"> – Gate Method is LO or Video and FFT Sweep Type is manually selected – Gate Method is FFT, and Swept Sweep Type is manually selected – Marker Count is ON <p>The following are unavailable whenever Gate is on:</p> <ul style="list-style-type: none"> – FFT under Sweep Type when Method=LO or Video or Swept under Sweep Type when Method=FFT

	<ul style="list-style-type: none"> - Marker Count <p>While Gate is on, the Auto Rules for Sweep Type are modified so that the choice agrees with the Gate Method: i.e., FFT for Method = FFT and Swept for Method = LO or Video</p> <p>When in the ACP measurement:</p> <ul style="list-style-type: none"> - When Meas Method is RBW or FAST, this function is unavailable, and the control is grayed-out - Whenever Gate is on, Meas Method, RBW, or FAST is unavailable and keys for those are grayed-out - When Gate is on, Offset Res BW and Offset Video BW are ignored (if you set these values) and the measurement works as if all Offset Res BW and all Offset Video BW are coupled with the Res BW and the Video BW under the BW menu. When Gate is on, the Offset BW control in the Offset/Limit menu is grayed-out
Preset	LTEATDD Mode: ON Other modes: OFF
State Saved	Saved in instrument state
Range	OFF ON
Annunciation	Annunciated in the Meas Bar ; if Gate is on, the word "Gate:" followed by the gate type appears, where <ul style="list-style-type: none"> - LO = Gated LO - Vid = Gated Video - FFT = Gated FFT
Backwards Compatibility SCPI	[:SENSe] :SWEep :TIME :GATE [:STATE] Available in SA and SCPI LC Modes ESA compatibility
Backwards Compatibility Notes	In ESA, Trig Delay (On) and Gate (On) could not be active at the same time. This dependency does not exist in PSA or in the X-Series

8.3.2 Gate View On/Off

Turning on Gate View puts the instrument into Gate View. When in Gate View, the regular view of the current measurement traces and results are reduced vertically to about 70% of the regular height. The Zero Span window, showing the positions of the Gate, is shown between the Measurement Bar and the reduced measurement window. By reducing the height of the measurement window, some of the annotation on the Data Display may not fit and is not shown.

Remote Command	[:SENSe] :SWEep :EGATe :VIEW ON OFF 1 0 [:SENSe] :SWEep :EGATe :VIEW?
Example	Turn on the gate view:

8 Trigger

8.3 Gate Settings

:SWE:EGAT:VIEW ON	
Dependencies	<p>In the Swept SA measurement:</p> <p>In Gate View, the regular Sweep Time (or Acquisition Time) control is grayed out, to avoid confusing the user who wants to set Gate View Sweep Time. When pressed, the grayed-out control puts up the informational message "Use Gate View Sweep Time in the Gate menu"</p> <p>In other measurements:</p> <p>When you turn Gate View on, the lower window takes on the current state of the instrument. Upon leaving Gate View, the instrument takes on the state of the lower window</p> <p>When you turn Gate View on, the upper window Sweep Time (or Acquisition Time) is set to Gate View Sweep Time (or Gate View Acquisition Time)</p>
Couplings	<p>These couplings apply to the Swept SA measurement:</p> <ul style="list-style-type: none"> - When Gate View is turned on, the instrument is set to Zero Span - Gate View automatically turns off whenever a Span other than Zero is selected - Gate View automatically turns off if you press the Swept Span toggle under Freq while in Gate View, and the instrument returns to the Span it was in before entering Gate View (even if that is Zero Span) - When Gate View is turned on, the sweep time used is the Gate View Sweep Time. This is set according to the rules in "Gate View Sweep Time" on page 1439 - When Gate View is turned off, Sweep Time is set to the normal Swept SA measurement sweep time - If Gate View is on and Gate is off, then turning on Gate turns off Gate View
Preset	OFF
State Saved	Saved in instrument state
Range	ON OFF
Annunciation	<p>For Gate View to work properly, a gate signal must be present at the selected Gate Source. Therefore, in Gate View, any time more than 2 seconds passes with no gate signal, a pop-up message "Waiting for gate input" appears. This message goes away when a gate signal appears</p>

Turning Gate View off returns the instrument to the Normal measurement view.

In Swept SA, the normal measurement view is the single-window Swept SA view. When returning to this view, the Swept SA measurement returns to the Span it was in before entering **Gate View** (even if that is Zero Span).

The **Gate View** window is triggered from the Gate Source, with zero trigger delay. Also, when updating the **Gate View** window, the Gate itself must not operate. So, it is internally shut off while the gate view window is being updated. For the Swept SA measurement, this means that the Gate is internally shut off whenever the gate view window is displayed. The measurement bar and controls continue to show the Trigger source for the main sweep window and give no indication that the Gate is shut off or that the Gate View window is triggered from the Gate Source.

When in **Gate View**, vertical lines are displayed in the Gate View window as follows:

Green lines labeled GATE START and GATE STOP are displayed at the gate edges as follows: in Edge Gate, a line is shown for Delay and one for the end of the Gate period, defined by Length. In Level Gate a line is shown only for Delay. You can adjust the position of the green lines by adjusting the gate length and the gate delay or by dragging them with your finger or the mouse.. These lines update in the Gate View window as the active function changes, even if the window is not being updated. In Gated LO and Gated Video, these lines are positioned relative to the delay reference line (not relative to 0 time). In Gated FFT, their location is relative to the left edge of the screen.

A blue line is displayed showing the delay reference, that is, the reference point for the Gate Delay within the Zero Span window. The blue line represents where (in time) the effective location of the gate start would be if the gate were programmed to zero delay.

- A second blue line is displayed at the location that represents the boundary between "compensated IF" and "compensated LO" operating modes. The second blue line is labeled "MIN FAST" because it represents the minimum Gate Delay for fast Gated LO operation. This line is only displayed in Gated LO. You cannot scroll (knob) or decrement (down key) the Gate Delay to less than that represented by the position of this line, it can only be set below this position manually, although once there it can be moved freely with the knob while below the line.

A yellow line in the Gated Video case only, is displayed at B_{length} , where B_{length} is the display point (bucket) length for the swept trace, which is given by the Sweep Time (or Acquisition Time) for that trace divided by number of Points - 1. So, it is referenced to 0 time, not to the delay reference. This line is labeled NEXT PT (it is not shown in the figure above because the figure above is for Gated LO). The yellow line represents the edge of a display point (bucket). Normally in Gated Video, the bucket length must be selected so that it exceeds the off time of the burst. There is another way to use the instrument in Gated Video measurements, and that is to set the bucket width much shorter than the off time of the burst. Then use the Max Hold trace function to fill in "missing" buckets more slowly. This allows you to see some of the patterns of the Gated Video results earlier, though seeing a completely filled-in spectrum later.

8.3.3 Gate Delay

Controls the length of time from the time the gate condition goes True until the gate is turned on.

Remote Command	<code>[:SENSe] :SWEep :EGATe :DELay <time></code>
Example	<code>:SWE :EGAT :DELay 500ms</code> <code>:SWE :EGAT :DELay ?</code>

8 Trigger
8.3 Gate Settings

Notes	Units of time are required, or no units; otherwise, an invalid suffix error message is generated
Preset	WiMAX OFDMA: 71 us GSM/EDGE: 600 us WLAN: 500 us 5G NR: 5 ms Others: 57.7 us
State Saved	Saved in instrument state
Min	0.0 us
Max	100 s
Backwards Compatibility SCPI	<code>[:SENSe]:SWEep:TIME:GATE:DELay</code> <i>This backward compatibility command is available in SA and SCPI LC Modes</i> ESA compatibility

8.3.4 Gate Length

Controls the length of time that the gate is on after it opens.

Remote Command	<code>[:SENSe]:SWEep:EGATe:LENGth <time></code> <code>[:SENSe]:SWEep:EGATe:LENGth?</code>
Example	<code>:SWE:EGAT:LENG 1</code> <code>:SWE:EGAT:LENG?</code>
Notes	Units of time are required, or no units; otherwise, an invalid suffix error message is generated
Dependencies	Grayed-out when Gate Method is set to FFT , in which case the label changes to that shown below 
	The control is also grayed-out if Gate Control = LEVe1
Preset	WiMAX OFDMA: 50 us GSM/EDGE: 200 us WLAN: 1.54 ms Others: 461.6 us
State Saved	Saved in instrument state
Min	100 ns
Max	5 s
Backwards Compatibility SCPI	<code>[:SENSe]:SWEep:TIME:GATE:LENGth</code> <i>This backward compatibility command is available in SA and SCPI LC Modes</i>

 ESA compatibility

8.3.5 Gate Method

Lets you choose one of the three different types of gating. Not all types of gating are available for all measurements.

Remote Command	<code>[:SENSe] :SWEep :EGATe :METHod LO VIdEo FFT</code> For option details, see " "LO" on page 1436 ", " "Video" on page 1436 " or " "FFT" on page 1437 " <code>[:SENSe] :SWEep :EGATe :METHod?</code>
Example	<code>:SWE :EGAT :METH FFT</code>
Dependencies	This function is only available in the Swept SA measurement in Spectrum Analyzer Mode This control is unavailable when Gate is On and FFT Sweep Type manually selected When selected, Sweep Type is forced to Swept, and the FFT selection in Sweep Type is grayed-out Only the FFT method is supported in non-SA products Only the FFT method is supported by VXT models M9410A/11A/15A/16A
Preset	LO
State Saved	Saved in instrument state
Range	Video LO FFT
Annunciation	In Meas Bar

LO

In [LO](#) gating, when Gate is [ON](#), the LO sweeps whenever the gate conditions as specified in the Gate menu are satisfied by the signal at the Gate Source.

This form of gating is more sophisticated, and results in faster measurements. With Gated LO, the instrument only sweeps while the gate conditions are satisfied. This means that a sweep could take place over several gate events. It would start when the gate signal goes true and stop when it goes false, and then continue when it goes true again. But since the LO is sweeping as long as the gate conditions are satisfied, the sweep typically finishes much more quickly than with Gated Video.

When in zero span, there is no actual sweep performed. But data is only taken while the gate conditions are satisfied. So even though there is no sweep, the gate settings will impact when data is acquired.

Video

In [Video](#) gating, when Gate is [ON](#), the video signal is allowed to pass through whenever the gate conditions as specified in the Gate menu are satisfied by the

signal at the Gate Source.

This form of gating may be thought of as a simple switch, which connects the signal to the input of the spectrum analyzer. When the gate conditions are satisfied, the switch is closed, and when the gate conditions are not satisfied, the switch is open. So we only look at the signal while the gate conditions are satisfied.

With this type of gating, you usually set the instrument to sweep very slowly. In fact, a general rule is to sweep slowly enough that the gate is guaranteed to be closed at least once per data measurement interval (bucket). Then if the peak detector is used, each bucket will represent the peak signal as it looks with the gate closed.

FFT

In **FFT** gating, when Gate is **ON**, an FFT is performed whenever the gate conditions as specified in the Gate menu are satisfied by the signal at the Gate Source. This is an FFT measurement that begins when the gate conditions are satisfied. Since the time period of an FFT is approximately $1.83/\text{RBW}$, you get a measurement that starts under predefined conditions and takes place over a predefined period. So, in essence, this is a gated measurement. You have limited control over the gate length, but it works in FFT sweeps, which the other two methods do not.

Gated FFT is not possible in zero span since the instrument is not sweeping, so in zero span the Gated LO method is used. Data is still only taken while the gate conditions are satisfied, so the gate settings do impact when data is acquired.

The Gate Length will be $1.83/\text{RBW}$.

This is a convenient way to make a triggered FFT measurement under control of an external gating signal.

8.3.6 Control Edge/Level

Sets the method of controlling the gating function from the gating signal.

- EDGE** The gate opens (after the Delay) on the selected edge (for example, positive) of the gate signal and closes on the alternate edge (for example, negative)
- LEVe1** The gate opens (after the Delay) when the gate signal has achieved a certain level and stays open as long as that level is maintained

Remote Command	<code>[:SENSe] :SWEp:EGATe:CONTRol EDGE LEVe1</code> <code>[:SENSe] :SWEp:EGATe:CONTRol?</code>
Example	<code>:SWE:EGAT:CONT EDGE</code>
Dependencies	If the Gate Method is FFT , this control is grayed-out and EDGE is selected If the Gate Source is TV, Frame, or Line, this control is grayed-out and EDGE is selected

Preset	EDGE
State Saved	Saved in instrument state
Backwards Compatibility SCPI	<p><code>[:SENSe] :SWEEp :EGATE :TYPE</code></p> <p>This backwards-compatibility command is available when the primary command is available</p> <p><code>[:SENSe] :SWEEp :TIME :GATE :TYPE</code></p> <p>This backwards-compatibility command is available in SA and SCPILC Modes ESA Compatibility</p>

8.3.7 Gate Holdoff

Lets you increase or decrease the wait time after a gate event ends before the instrument will respond to the next gate signal.

After any Gate event finishes, the instrument must wait for the sweep system to settle before it can respond to another Gate signal. The instrument calculates a "wait time," taking into account a number of factors, including RBW and Phase Noise Optimization settings. The goal is to achieve the same accuracy when gated as in ungated operation. The figure below illustrates this concept:

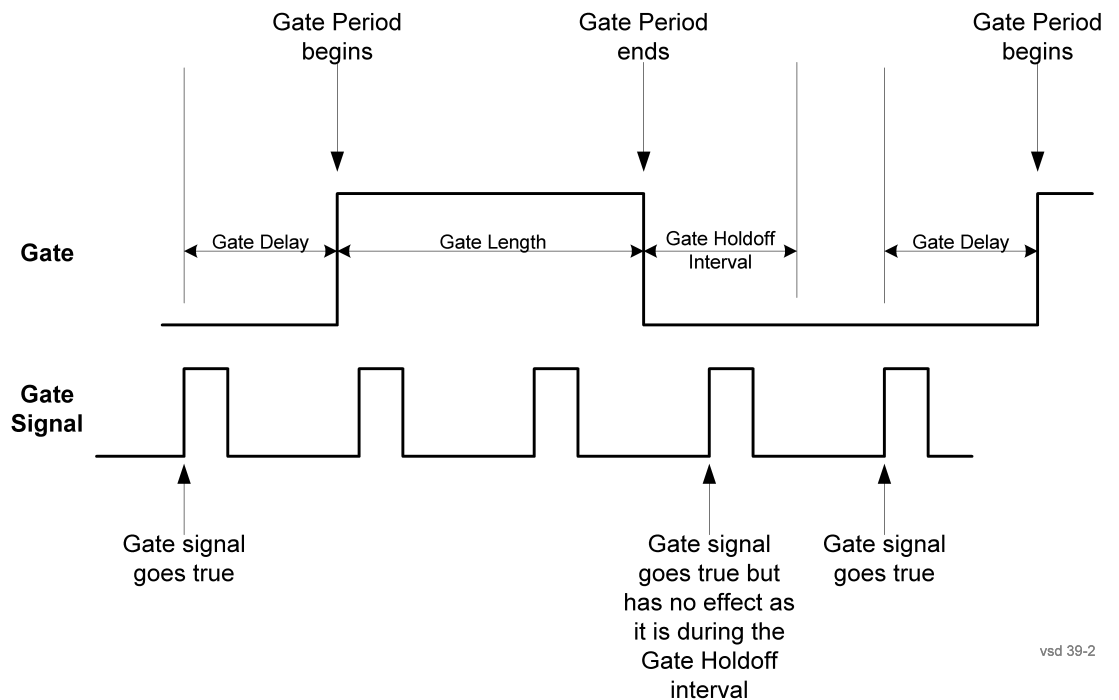

vsd 39-2

When **Gate Holdoff** is Auto, the wait time calculated by the instrument is used. When Gate Time is in Manual, the user may adjust the wait time, usually decreasing it in order to achieve greater speed, but at the risk of decreasing accuracy.

8 Trigger
8.3 Gate Settings

When the **Method** control is set to **Video** or **FFT**, the **Gate Holdoff** function has no effect.

In measurements that do not support "[Auto Function](#)" on page 1439, the value shown when Auto is selected is "---" and the manually set holdoff is returned to a query.

Remote Command	<code>[:SENSe]:SWEep:EGATe:HOLDoff <time></code> <code>[:SENSe]:SWEep:EGATe:HOLDoff?</code>
Example	<code>:SWE:EGAT:HOLD 0.0002</code> <code>:SWE:EGAT:HOLD?</code>
Couplings	<p>When Gate Holdoff is Auto, the Gate Holdoff control shows the value calculated by the instrument for the wait time</p> <p>Pressing the Gate Holdoff control while it is in Auto and not selected, causes the control to become selected and allows the user to adjust the value. If the value is adjusted, the setting changes to Man</p> <p>Pressing the Gate Holdoff key, while it is in Auto and selected, does not change the value of Gate Holdoff, but causes the setting to change to Man. Now the user can adjust the value</p> <p>Pressing the control while it is in Man and selected, cause the value to change back to Auto</p> <p>Pressing the control while it is in Man and not selected, causes the control to become selected and allows the user to adjust the value</p> <p>When Method is set to Video or FFT, the Gate Holdoff function has no effect</p>
Preset	Auto
State Saved	Saved in instrument state
Min	1 μsec
Max	1 sec

Auto Function

Remote Command	<code>[:SENSe]:SWEep:EGATe:HOLDoff:AUTO OFF ON 0 1</code> <code>[:SENSe]:SWEep:EGATe:HOLDoff:AUTO?</code>
Example	<code>:SWE:EGAT:HOLD:AUTO ON</code> <code>:SWE:EGAT:HOLD:AUTO?</code>
Preset	Auto/On
State Saved	Saved in instrument state
Range	Auto Man

8.3.8 Gate View Sweep Time

Controls the Sweep Time in the Gate View window. To provide an optimal view of the gate signal, the instrument initializes **Gate View Sweep Time** based on the current settings of Gate Delay and Gate Length.

NOTE

Since **Gate View Sweep Time** is used to calculate Gate Delay and Gate Length increments, it is maintained even when not in **Gate View**.

NOTE

In instruments without sweeping hardware such as some modular analyzers, this control may be labeled **Gate View Acquisition Time**

Remote Command	<code>[:SENSe] :SWEep:EGATe:TIME <time></code> <code>[:SENSe] :SWEep:EGATe:TIME?</code>
Example	<code>:SWE:EGAT:TIME 500 ms</code>
Dependencies	Gate View Sweep Time is initialized: <ul style="list-style-type: none"> - On Preset (after initializing delay and length) - Every time the Gate Method is set/changed <p>Additionally, in the Swept SA measurement, whenever you do a Preset, or leave Gate View, the instrument remembers the Gate Delay and Gate Length settings. Then, when returning to Gate View, if the current Gate Delay and/or Gate Length do not match the remembered values Gate View Sweep Time is re-initialized</p>
Preset	WiMAX OFDMA: 5 ms GSM/EDGE: 1 ms 5G NR: 10 ms Others: 800 μ s
State Saved	Saved in instrument state
Min	1 μ s
Max	6000 s
Annotation	The gate view Sweep Time is displayed in the lower-right corner of the gate view window

8.3.9 Gate View Start Time

Controls the time at the left edge of the Gate View.

Remote Command	<code>[:SENSe] :SWEep:EGATe:VIEW:STARt <time></code> <code>[:SENSe] :SWEep:EGATe:VIEW:STARt?</code>
Example	<code>:SWE:EGAT:VIEW:STAR 10ms</code>
Notes	Units of time are required or no units; otherwise, an invalid suffix error message is generated
Preset	0 ms
State Saved	Saved in instrument state
Min	0
Max	500 ms

8.3.10 Gate Delay Compensation

Allows you to select an RBW-dependent value by which to adjust the gate delay, to compensate for changes in the delay caused by RBW effects. You can select between uncompensated operation and two types of compensation:

Uncompensated	OFF
Delay Until RBW Settled	SETTled
Compensate for RBW Group Delay	GDElay

For full details of these options, see ["More Information" on page 1441](#)

Remote Command	<code>[:SENSe]:SWEep:EGATe:DELay:COMPensation:TYPE OFF SETTled GDElay</code> <code>[:SENSe]:SWEep:EGATe:DELay:COMPensation:TYPE?</code>
Example	<code>:SWE:EGAT:DEL:COMP:TYPE SETT</code> <code>:SWE:EGAT:DEL:COMP:TYPE?</code>
Notes	<p>Although this function is Meas Global, there are some measurements that do not support this function. In those measurements the control is not displayed, and the operation will be Uncompensated</p> <p>If some but not all measurements in a Mode support this function, then selecting a measurement that does not support it will not change the Meas Global selection; it will simply be “Uncompensated” while in that measurement. The SCPI command is still accepted while in that measurement</p> <p>If Gate Delay Compensation is not supported at all within a particular mode, the control is not displayed, and if the SCPI command is sent while in a measurement within that mode, an “Undefined Header” message is generated</p> <p>Note that, for modular products such as EXM and VXT, this function is not supported. In those products the control is not displayed and the SCPI is ignored, although it is accepted without error</p>
Preset	TD-SCDMA, LTEA FDD/TDD, 5G NR Modes: GDElay All other Modes: SETTled
State Saved	Saved in instrument state
Range	OFF SETTled GDElay

More Information

Selecting **Uncompensated** means that the actual gate delay is as you set it.

Selecting **Delay Until RBW Settled** causes the gate delay to be increased above the user setting by an amount equal to $3.06/\text{RBW}$. This compensated delay causes the GATE START and GATE STOP lines on the display to move by the compensation amount, and the actual hardware gate delay to be increased by the same amount. All the other gate lines (for example, MIN FAST) are unaffected. If the RBW subsequently changes, the compensation is readjusted for the new RBW. The value shown on the **Gate Delay** control does *not* change.

Delay Until RBW Settled allows excellent measurements of gated signals, by allowing the IF to settle following any transient that affects the burst. Excellent measurements also require that the analysis region not extend into the region affected by the falling edge of the burst. Thus, excellent measurements can only be made over a width that declines with narrowing RBWs, which is achieved by decreasing the gate length below the user setting by an amount equal to $2.53/\text{RBW}$. Therefore, for general purpose compensation, you will still want to change the gate length with changes in RBW even if the gate delay is compensated. The compensated Gate Length is limited by the instrument so that it will never go below 10% of the value shown on the Gate Length key, as otherwise the sweep times could get very long. Anytime the **Gate Length** and **RBW** values combine in such a way that this limiting takes place, a warning is displayed. For measurements that contain multiple sweeps with different RBW like SEM and SPUR, the smallest RBW is used for this limiting.

Selecting **Compensate for RBW Group Delay** causes the gate delay to be increased above the user setting by an amount equal to $1.81/\text{RBW}$. This compensated delay causes the GATE START, GATE STOP lines on the display to move by the compensation amount, and the actual hardware gate delay to be increased by the same amount. All the other gate lines (for example, MIN FAST) are unaffected. If the RBW subsequently changes, the compensation is readjusted for the new RBW. The value shown on the **Gate Delay** control does *not* change. **Compensate for RBW Group Delay** also includes gate length compensation; the gate length itself is adjusted as necessary to attempt to compensate for delay effects imposed by the RBW.

Compensate for RBW Group Delay is similar to **Delay Until RBW Settled** but compensates for the group delay of the RBW filter, rather than the filter settling time. As the RBW gets narrow, this can allow the settling tail of the RBW to affect the beginning part of the gated measurement and allow the beginning of the RBW settling transient to affect the end of the gated measurement. These two effects are symmetric because the RBW response is symmetric. Because the gate length is not automatically compensated, some users might find this compensation to be more intuitive than compensation for RBW settling.

8.3.11 Min Fast Position Query (Remote Query Only)

Queries the position of the MIN FAST line, relative to the delay reference (REF) line. See "[Gate View On/Off](#)" on page 1432. If this query is sent while not in Gate view, the MinFast calculation is performed based on the current values of the appropriate parameters and the result is returned. Reading this value lets you set an optimal gate delay value for the current measurement setup.

Example	<code>:SWE:EGAT:MIN?</code>
Backwards Compatibility SCPI	<code>[:SENSe] :SWEp:EGATe:MINFast?</code>

8.3.12 Gate Preset (Remote Command Only)

Presets the time-gated spectrum analysis capability.

This command sets gate parameter values to the ESA preset values, as follows:

- Gate trigger type = edge
- Gate polarity = positive
- Gate delay = 1 us
- Gate length = 1 us

Backwards Compatibility SCPI	<code>[:SENSe] :SWEp :TIME :GATE :PRESet</code> ESA Compatibility
---------------------------------	--

8.3.13 Gate Level (Remote Command Only)

Sets the gate input transition point level for the external **TRIGGER** inputs on the front and rear panel. This is a legacy command for PSA compatibility. It is simply an alias to the equivalent trigger level command.

Notes	This command is simply an alias to <code>:TRIGger [:SEquence] :EXTeRnal [1] 2 :LEVe1</code>
Backwards Compatibility SCPI	<code>[:SENSe] :SWEp :EGATe :EXTeRnal [1] 2 :LEVe1 <voltage></code> <code>[:SENSe] :SWEp :EGATe :EXTeRnal [1] 2 :LEVe1?</code>

8.3.14 Gate Polarity (Remote Command Only)

Sets the polarity for the gate signal. This setup is now done using the gate trigger's slope setting.

When **POSitive** is selected, a positive-going edge (Edge) or a high voltage (Level) will satisfy the gate condition, after the delay set with the Gate Delay key. When **NEGative** is selected, a negative-going edge (Edge) or a low voltage (Level) will satisfy the gate condition after the delay.

Example	<code>:SWE :EGAT :POL NEG</code> <code>:SWE :EGAT :POL ?</code>
Preset	<code>POSitive</code>
State Saved	Saved in instrument state

Backwards Compatibility SCPI	<p><code>[:SENSe]:SWEep:EGATe:POLarity NEGative POSitive</code></p> <p><code>[:SENSe]:SWEep:EGATe:POLarity?</code></p> <p>This backwards-compatibility command is available in Modes that support Gate Polarity parameter</p> <p><code>[:SENSe]:SWEep:TIME:GATE:POLarity</code></p> <p>This backwards-compatibility command is available in SA and SCPI LC Modes</p> <p>ESA compatibility</p>
------------------------------------	--

Preset	<code>HIGH</code>
--------	-------------------

Backwards Compatibility SCPI	<p><code>[:SENSe]:SWEep:TIME:GATE:LEVel HIGH LOW</code></p> <p><code>[:SENSe]:SWEep:TIME:GATE:LEVel?</code></p> <p>ESA compatibility</p>
---------------------------------	--

8.4 Enables the hardware accelerated stepped FFT gating feature (Display only)

Enables or disables the hardware-accelerated stepped FFT gating feature:

- Enabling the Hardware Acceleration feature means that the Stepped FFT algorithm will run on the FPGA for configurations where speed improvements are possible
- Disabling the hardware-accelerated stepped FFT gating means the Stepped FFT software algorithm will always run on the CPU instead of the FPGA

When enabled it is only used when applicable and determined by the current sweep configuration.

The default value is **ON** and its value is power-on persistent.

Remote Command	<code>[:SENSe] :SWEep:EGATe:HACCeLerate:ENABle OFF ON 0 1</code>
Example	<code>:SWEep:EGATe:HACCeLerate:ENABle ON</code>
Notes	Value ON means the hardware accelerated stepped FFT gating is used intelligently Value OFF means the hardware accelerated stepped FFT gating is always disabled
Dependencies	Only valid in ACP, CHP and SEM measurements
State Saved	Saved in instrument state

8.5 Periodic Sync Src

Contains controls that let you select and configure the sync signal for the **Periodic Timer** Trigger.

For convenience controls for adjusting the level and slope of the selected sync source are provided here. Note that these settings match those in the **Trigger** and **Gate Source** menus; that is, each trigger source has only one value of level and slope, regardless of which menu it is accessed from.

8.5.1 Select Periodic Timer Sync Source

Selects a signal source for you to synchronize your periodic timer trigger to, otherwise you are triggering at some arbitrary location in the frame. Synchronization reduces the precision requirements on the setting of the period.

Note that, with Sync Source **OFF**, the timing will drift unless the signal source frequency is locked to the instrument frequency reference.

Remote Command	<code>:TRIGger[:SEquence]:FRAMe:SYNC EXTErnal1 EXTErnal2 RFBurst PXI INTernal OFF</code> <code>:TRIGger[:SEquence]:FRAMe:SYNC?</code>
Example	<code>:TRIG:FRAM:SYNC EXT1</code> <code>:TRIG:FRAM:SYNC EXT2</code> <code>:TRIG:FRAM:SYNC RFB</code> <code>:TRIG:FRAM:SYNC OFF</code>
Dependencies	PXI and INTernal triggers are only found in modular analyzers such as VXT Not available in E7760 or UXM In some models, there is no second External input. In these models, the External 2 selection is not shown, and the EXTErnal2 parameter generates a “Hardware missing; Not available for this model number” message
Preset	OFF GSM/EDGE, LTE, LTETDD, 5G NR: RFBurst
State Saved	Saved in instrument state
Backwards Compatibility SCPI	<code>:TRIGger[:SEquence]:FRAMe:SYNC EXTErnal</code> For backwards-compatibility, the parameter EXTErnal is mapped to EXTErnal1

8.6 Auto/Holdoff

Contains controls that let you adjust Auto Trigger and Trigger Holdoff parameters
This tab does not appear in Spectrum Analyzer Mode in VXT model M9421A.

8.6.1 Trig Holdoff

Sets the holdoff time between triggers. When the trigger condition is satisfied, the trigger occurs, the delay begins, and the holdoff time begins. New trigger conditions will be ignored until the holdoff time expires. For a free-running trigger, the holdoff value is the minimum time between triggers.

Remote Command	<code>:TRIGger[:SEquence]:HOLDoff <time></code> <code>:TRIGger[:SEquence]:HOLDoff?</code>
Example	<code>:TRIG:HOLD:STAT ON</code> <code>:TRIG:HOLD 100 ms</code>
Dependencies	Unavailable if the selected Input is BBIQ . If this is the case, the control is grayed-out if it is pressed the informational message "Feature not supported for this Input" is displayed. If the SCPI command is sent, the error "Settings conflict; Feature not supported for this Input" is generated
Preset	All modes except GSM/EDGE, LTEAFDD/TDD and 5G NR: 100 ms GSM/EDGE, Bluetooth: 10 μ s LTEATDD: 19 ms 5G NR: 4 ms
State Saved	Saved in instrument state
Min	0 s
Max	0.5 s VXT models M9410A/11A/15A/16A: 2.86 s
Auto Function	
Remote Command	<code>:TRIGger[:SEquence]:HOLDoff:STATe OFF ON 0 1</code> <code>:TRIGger[:SEquence]:HOLDoff:STATe?</code>
Preset	All modes but GSM/EDGE: OFF GSM/EDGE mode: ON

8.6.2 Auto Trig

Sets the time that the instrument will wait for the trigger conditions to be met. If they are not met after that much time, then the instrument is triggered anyway.

Remote Command	<code>:TRIGger[:SEquence]:ATRigger <time></code> <code>:TRIGger[:SEquence]:ATRigger?</code>
Example	<code>:TRIG:ATR:STAT ON</code> <code>:TRIG:ATR 100 ms</code>
Notes	The "time that the instrument will wait" starts when the instrument is ready for a trigger, which may be hundreds of ms after the data acquisition for a sweep is done. The "time" ends when the trigger condition is satisfied, not when the delay ends
Dependencies	Not available in Real Time Spectrum Analyzer Mode
Preset	Off, 100 ms
State Saved	Saved in instrument state
Min	1 ms
Max	100 s
Auto Function	
Remote Command	<code>:TRIGger[:SEquence]:ATRigger:STATe OFF ON 0 1</code> <code>:TRIGger[:SEquence]:ATRigger:STATe?</code>
Preset	OFF

8.6.3 Holdoff Type

Enables you to set the Trigger **Holdoff Type**.

NOTE

Holdoff Type is not supported by all measurements. If the current measurement does not support it, this control does not appear, and **Holdoff Type** is Normal. If **Holdoff Type** SCPI is sent while in such a measurement, the SCPI is accepted and the setting remembered, but it has no effect until a measurement is in force that supports **Holdoff Type**.

Trigger Holdoff Type functionality

NORMa1	This is the "oscilloscope" type of trigger holdoff and is the setting when the Holdoff Type control does not appear. In this type of holdoff, no new trigger will be accepted until the holdoff interval has expired after the previous trigger
ABOVe	If the trigger slope is positive, a trigger event is generated only if the signal characteristic of interest crosses the trigger threshold (with positive slope) and then remains above the threshold for at least the holdoff time. For negative slope, the trigger event is generated if the signal characteristic crosses the threshold (with negative slope) after having been above the threshold for at least the holdoff time. In either case, the trigger event is associated with the time the level was crossed
BELow	If the trigger slope is positive, a trigger event is generated only if the signal characteristic of interest crosses the trigger threshold (with positive slope) after

8 Trigger
8.6 Auto/Holdoff

having been below the threshold for at least the holdoff time. For negative slope, the trigger event is generated if the signal characteristic crosses the threshold (with negative slope) and then remains below the threshold for at least the holdoff time. In either case, the trigger event is associated with the time the level was crossed

Remote Command	:TRIGger[:SEquence]:HOLDoff:TYPE NORMa1 ABOVe BELow :TRIGger[:SEquence]:HOLDoff:TYPE?	
Example	:TRIG:HOLD:TYPE NORM	
Preset	Modes	Setting
	GSM/EDGE	BELow
	Bluetooth	
	All others	NORMa1
State Saved	Saved in instrument state	

9 Programming the Instrument

This section provides information about the instrument's SCPI programming interface. You can also operate the instrument remotely using some legacy programming languages by running the N9061C Remote Language Compatibility measurement application and the N9062C SCPI Language Compatibility measurement application.

9.1 List of Supported SCPI Commands

The SCPI commands available while using this application are listed below.

To find a command in the list, search according to its first alphanumeric character, ignoring any leading ":" or "[" characters. The sole exception to this is the asterisk [*] prefix, identifying IEEE 488.2 Common commands and queries; all these appear at the start of the list.

Note that most commands also have query forms. In cases where a command and its query are described in the same topic, the list below includes the command and query as a *single* item, with no suffix.

Suffix	Interpretation
No suffix	Command & Query, <i>or</i> Command only For details, click the link to view the command definition
?	Query only

*

- *CAL
- *CAL
- *CLS
- *ESE
- *ESR?
- *IDN?
- *OPC
- *OPT?
- *RCL
- *RST
- *SAV
- *SRE
- *STB?
- *TRG
- *TST?
- *WAI

A

ABORt

C

CALCuLate[:<meas>]:MATH?

```

CALCulate:<meas>:MATH
CALCulate:<meas>:MTRace
CALCulate:<meas>:PLAY:SRATe
CALCulate:<meas>:PLAY:START
CALCulate:ACP:MARKer[1]|2|...|12:MODE
CALCulate:ACPower:LIMit:FAR:UPPer[:DATA]
CALCulate:ACPower:LIMit:NEAR:UPPer[:DATA]
CALCulate:ACPower:LIMit:STATe
CALCulate:ACPower:MARKer[1]|2|...|12:FUNCTION
CALCulate:ACPower:MARKer[1]|2|...|12:FUNCTION:BAND:LEFT
CALCulate:ACPower:MARKer[1]|2|...|12:FUNCTION:BAND:RIGHT
CALCulate:ACPower:MARKer[1]|2|...|12:FUNCTION:BAND:SPAN
CALCulate:ACPower:MARKer[1]|2|...|12:MAXimum
CALCulate:ACPower:MARKer[1]|2|...|12:MAXimum:LEFT
CALCulate:ACPower:MARKer[1]|2|...|12:MAXimum:NEXT
CALCulate:ACPower:MARKer[1]|2|...|12:MAXimum:RIGHT
CALCulate:ACPower:MARKer[1]|2|...|12:MINimum
CALCulate:ACPower:MARKer[1]|2|...|12:PTPeak
CALCulate:ACPower:MARKer[1]|2|...|12:REFerence
CALCulate:ACPower:MARKer[1]|2|...|12:TRACe
CALCulate:ACPower:MARKer[1]|2|...|12:X
CALCulate:ACPower:MARKer[1]|2|...|12:Y?
CALCulate:ACPower:MARKer:AOFF
CALCulate:ACPower:MARKer:COUPle[:STATe]
CALCulate:CLIMits:FAIL?
CALCulate:DATA<n>:COMPRESS?
CALCulate:DATA[1]|2|...|6:PEAKs?
CALCulate:FPOWER:POWER[1,2,...,999]?
CALCulate:FPOWER:POWER[1,2,...,999]:CONFigure
CALCulate:FPOWER:POWER[1,2,...,999]:DEFine?
CALCulate:FPOWER:POWER[1,2,...,999]:FETCh?
CALCulate:FPOWER:POWER[1,2,...,999]:INITiate
CALCulate:FPOWER:POWER[1,2,...,999]:READ?
CALCulate:FPOWER:POWER[1,2,...,999]:READ1?
CALCulate:FPOWER:POWER[1,2,...,999]:READ2?
CALCulate:FPOWER:POWER[1,2,...,999]:RESet
CALCulate:IBEMissions:LIMit:FAR:UPPer[:DATA]
CALCulate:IBEMissions:LIMit:NEAR:FO<freq>:UPPer[:DATA]
CALCulate:IBEMissions:LIMit:NEAR[:FO2M]:UPPer[:DATA]
CALCulate:IBEMissions:LIMit:STATe
CALCulate:IBEMissions:MARKer[1]|2|...|12:FUNCTION
CALCulate:IBEMissions:MARKer[1]|2|...|12:FUNCTION:BAND:LEFT
CALCulate:IBEMissions:MARKer[1]|2|...|12:FUNCTION:BAND:RIGHT
CALCulate:IBEMissions:MARKer[1]|2|...|12:FUNCTION:BAND:SPAN
CALCulate:IBEMissions:MARKer[1]|2|...|12:MAXimum
CALCulate:IBEMissions:MARKer[1]|2|...|12:MAXimum:LEFT
CALCulate:IBEMissions:MARKer[1]|2|...|12:MAXimum:NEXT
CALCulate:IBEMissions:MARKer[1]|2|...|12:MAXimum:RIGHT
CALCulate:IBEMissions:MARKer[1]|2|...|12:MINimum
CALCulate:IBEMissions:MARKer[1]|2|...|12:MODE
CALCulate:IBEMissions:MARKer[1]|2|...|12:PTPeak
  
```

9 Programming the Instrument
9.1 List of Supported SCPI Commands

CALCulate:IBEMissions:MARKer[1]|2|...|12:REFerence
CALCulate:IBEMissions:MARKer[1]|2|...|12:TRACe
CALCulate:IBEMissions:MARKer[1]|2|...|12:X
CALCulate:IBEMissions:MARKer[1]|2|...|12:Y?
CALCulate:IBEMissions:MARKer:AOFF
CALCulate:IBEMissions:MARKer:COUPle[:STATe]
CALCulate:IBSPurious:LIMit:FAR:UPPer[:DATA]
CALCulate:IBSPurious:LIMit:NEAR:UPPer[:DATA]
CALCulate:IBSPurious:LIMit:RELative:UPPer[:DATA]
CALCulate:IBSPurious:LIMit:STATe
CALCulate:IBSPurious:MARKer[1]
CALCulate:IBSPurious:MARKer[1]|2|...|12:FUNCTion
CALCulate:IBSPurious:MARKer[1]|2|...|12:FUNCTion:BAND:LEFT
CALCulate:IBSPurious:MARKer[1]|2|...|12:FUNCTion:BAND:RIGHT
CALCulate:IBSPurious:MARKer[1]|2|...|12:FUNCTion:BAND:SPAN
CALCulate:IBSPurious:MARKer[1]|2|...|12:MAXimum
CALCulate:IBSPurious:MARKer[1]|2|...|12:MAXimum:LEFT
CALCulate:IBSPurious:MARKer[1]|2|...|12:MAXimum:NEXT
CALCulate:IBSPurious:MARKer[1]|2|...|12:MAXimum:RIGHT
CALCulate:IBSPurious:MARKer[1]|2|...|12:MINimum
CALCulate:IBSPurious:MARKer[1]|2|...|12:MODE
CALCulate:IBSPurious:MARKer[1]|2|...|12:PTPeak
CALCulate:IBSPurious:MARKer[1]|2|...|12:REFerence
CALCulate:IBSPurious:MARKer[1]|2|...|12:TRACe
CALCulate:IBSPurious:MARKer[1]|2|...|12:X
CALCulate:IBSPurious:MARKer[1]|2|...|12:Y?
CALCulate:IBSPurious:MARKer:AOFF
CALCulate:IBSPurious:MARKer:COUPle[:STATe]
CALCulate:MATH
CALCulate:MONitor:MARKer[1]|2|...|12:FUNCTion
CALCulate:MONitor:MARKer[1]|2|...|12:FUNCTion:BAND:LEFT
CALCulate:MONitor:MARKer[1]|2|...|12:FUNCTion:BAND:RIGHT
CALCulate:MONitor:MARKer[1]|2|...|12:FUNCTion:BAND:SPAN
CALCulate:MONitor:MARKer[1]|2|...|12:MAXimum
CALCulate:MONitor:MARKer[1]|2|...|12:MAXimum:NEXT
CALCulate:MONitor:MARKer[1]|2|...|12:MODE
CALCulate:MONitor:MARKer[1]|2|...|12:REFerence
CALCulate:MONitor:MARKer[1]|2|...|12:STATe
CALCulate:MONitor:MARKer[1]|2|...|12:TRACe
CALCulate:MONitor:MARKer[1]|2|...|12:X
CALCulate:MONitor:MARKer[1]|2|...|12:X:POSITion
CALCulate:MONitor:MARKer[1]|2|...|12:Y?
CALCulate:MONitor:MARKer:AOFF
CALCulate:MONitor:MARKer:COUPle[:STATe]
CALCulate:OBWidth:LIMit:FBLimit
CALCulate:OBWidth:LIMit[:TEST]
CALCulate:OBWidth:MARKer[1]|2|...|12:MAXimum
CALCulate:OBWidth:MARKer[1]|2|...|12:MODE
CALCulate:OBWidth:MARKer[1]|2|...|12:REFerence
CALCulate:OBWidth:MARKer[1]|2|...|12:TRACe

CALCulate:OBWidth:MARKer[1]|2|...|12:X
CALCulate:OBWidth:MARKer[1]|2|...|12:X:POSition
CALCulate:OBWidth:MARKer[1]|2|...|12:Y?
CALCulate:OBWidth:MARKer:AOFF
CALCulate:TX:CFDRift:LIMit:DH1:DRIFt:LOWer
CALCulate:TX:CFDRift:LIMit:DH1:DRIFt:UPPer
CALCulate:TX:CFDRift:LIMit:DH1:RATE:LOWer
CALCulate:TX:CFDRift:LIMit:DH1:RATE:UPPer
CALCulate:TX:CFDRift:LIMit:DH3:DRIFt:LOWer
CALCulate:TX:CFDRift:LIMit:DH3:DRIFt:UPPer
CALCulate:TX:CFDRift:LIMit:DH3:RATE:LOWer
CALCulate:TX:CFDRift:LIMit:DH3:RATE:UPPer
CALCulate:TX:CFDRift:LIMit:DH5:DRIFt:LOWer
CALCulate:TX:CFDRift:LIMit:DH5:DRIFt:UPPer
CALCulate:TX:CFDRift:LIMit:DH5:RATE:LOWer
CALCulate:TX:CFDRift:LIMit:DH5:RATE:UPPer
CALCulate:TX:CFDRift:LIMit:DRIFt:FAIL?
CALCulate:TX:CFDRift:LIMit:FAIL?
CALCulate:TX:CFDRift:LIMit:LREFerence:DRIFt:LOWer
CALCulate:TX:CFDRift:LIMit:LREFerence:DRIFt:UPPer
CALCulate:TX:CFDRift:LIMit:LREFerence:INITial:DRIFt:LOWer
CALCulate:TX:CFDRift:LIMit:LREFerence:INITial:DRIFt:UPPer
CALCulate:TX:CFDRift:LIMit:LREFerence:RATE:LOWer
CALCulate:TX:CFDRift:LIMit:LREFerence:RATE:UPPer
CALCulate:TX:CFDRift:LIMit:RATE:FAIL?
CALCulate:TX:FSMaccuracy:LIMit:DEVM:NNPercentile:DPSK:UPPer
CALCulate:TX:FSMaccuracy:LIMit:DEVM:NNPercentile:DQPSk:UPPer
CALCulate:TX:FSMaccuracy:LIMit:DEVM:NNPercentile:FAIL?
CALCulate:TX:FSMaccuracy:LIMit:DEVM:NNPercentile:PSK:UPPer
CALCulate:TX:FSMaccuracy:LIMit:DEVM:NNPercentile:QPSK:P2:UPPer
CALCulate:TX:FSMaccuracy:LIMit:DEVM:NNPercentile:QPSK:P3:UPPer
CALCulate:TX:FSMaccuracy:LIMit:DEVM:PEAK:DPSK:UPPer
CALCulate:TX:FSMaccuracy:LIMit:DEVM:PEAK:DQPSk:UPPer
CALCulate:TX:FSMaccuracy:LIMit:DEVM:PEAK:FAIL?
CALCulate:TX:FSMaccuracy:LIMit:DEVM:PEAK:PSK:UPPer
CALCulate:TX:FSMaccuracy:LIMit:DEVM:PEAK:QPSK:P2:UPPer
CALCulate:TX:FSMaccuracy:LIMit:DEVM:PEAK:QPSK:P3:UPPer
CALCulate:TX:FSMaccuracy:LIMit:DEVM:RMS:DPSK:UPPer
CALCulate:TX:FSMaccuracy:LIMit:DEVM:RMS:DQPSk:UPPer
CALCulate:TX:FSMaccuracy:LIMit:DEVM:RMS:FAIL?
CALCulate:TX:FSMaccuracy:LIMit:DEVM:RMS:PSK:UPPer
CALCulate:TX:FSMaccuracy:LIMit:DEVM:RMS:QPSK:P2:UPPer
CALCulate:TX:FSMaccuracy:LIMit:DEVM:RMS:QPSK:P3:UPPer
CALCulate:TX:FSMaccuracy:LIMit:FAIL?
CALCulate:TX:FSMaccuracy:LIMit:FERRor:BLOCK:FAIL?
CALCulate:TX:FSMaccuracy:LIMit:FERRor:BLOCK:LOWer
CALCulate:TX:FSMaccuracy:LIMit:FERRor:BLOCK:UPPer
CALCulate:TX:FSMaccuracy:LIMit:FERRor:INITial:FAIL?
CALCulate:TX:FSMaccuracy:LIMit:FERRor:INITial:LOWer
CALCulate:TX:FSMaccuracy:LIMit:FERRor:INITial:UPPer
CALCulate:TX:FSMaccuracy:LIMit:FERRor:TOTal:FAIL?

9 Programming the Instrument
9.1 List of Supported SCPI Commands

CALCulate:TX:FSMaccuracy:LIMit:FERRor:TOTal:LOWer
CALCulate:TX:FSMaccuracy:LIMit:FERRor:TOTal:UPPer
CALCulate:TX:HRESult
CALCulate:TX:ICFT:LIMit:FAIL?
CALCulate:TX:ICFT:LIMit:LOWer
CALCulate:TX:ICFT:LIMit:UPPer
CALCulate:TX:IQOffset[:STATe]
CALCulate:TX:LIMit:STATe
CALCulate:TX:MARKer[1]|2|...|12:FUNction
CALCulate:TX:MARKer[1]|2|...|12:FUNction:BAND:LEFT
CALCulate:TX:MARKer[1]|2|...|12:FUNction:BAND:RIGHT
CALCulate:TX:MARKer[1]|2|...|12:FUNction:BAND:SPAN
CALCulate:TX:MARKer[1]|2|...|12:MAXimum
CALCulate:TX:MARKer[1]|2|...|12:MAXimum:LEFT
CALCulate:TX:MARKer[1]|2|...|12:MAXimum:NEXT
CALCulate:TX:MARKer[1]|2|...|12:MAXimum:RIGHT
CALCulate:TX:MARKer[1]|2|...|12:MINimum
CALCulate:TX:MARKer[1]|2|...|12:MODE
CALCulate:TX:MARKer[1]|2|...|12:PTPeak
CALCulate:TX:MARKer[1]|2|...|12:REFerence
CALCulate:TX:MARKer[1]|2|...|12:TRACe
CALCulate:TX:MARKer[1]|2|...|12:X
CALCulate:TX:MARKer[1]|2|...|12:Y?
CALCulate:TX:MARKer:AOff
CALCulate:TX:MARKer:COUPlE[:STATe]
CALCulate:TX:MCHar:LIMit:DF1:AVERage:FAIL?
CALCulate:TX:MCHar:LIMit:DF1:AVERage:LOWer
CALCulate:TX:MCHar:LIMit:DF1:AVERage:UPPer
CALCulate:TX:MCHar:LIMit:DF2:MAX:FAIL?
CALCulate:TX:MCHar:LIMit:DF2:MAX:LOWer
CALCulate:TX:MCHar:LIMit:FAIL?
CALCulate:TX:MCHar:LIMit:RATio:FAIL?
CALCulate:TX:MCHar:LIMit:RATio:LOWer
CALCulate:TX:OPower:LIMit:AVERage:FAIL?
CALCulate:TX:OPower:LIMit:AVERage:LOWer
CALCulate:TX:OPower:LIMit:AVERage:UPPer
CALCulate:TX:OPower:LIMit:PEAK:FAIL?
CALCulate:TX:OPower:LIMit:PEAK:RELative:PAverage
CALCulate:TX:OPower:LIMit:PEAK:UPPer
CALCulate:TX:RPower:LIMit:FAIL?
CALCulate:TX:RPower:LIMit:LOWer
CALCulate:TX:RPower:LIMit:UPPer
CALibration[:ALL]
CALibration[:ALL]:NPending
CALibration:AUTO
CALibration:AUTO:ALERT
CALibration:AUTO:MODE
CALibration:AUTO:TIME:OFF?
CALibration:DATA:BACKup
CALibration:DATA:DEFault

CALibration:DATA:INTernal:BACKup
CALibration:DATA:INTernal:REStore
CALibration:DATA:REStore
CALibration:EMIXer
CALibration:EXPIred
CALibration:FREQuency:REFeRence:COARse
CALibration:FREQuency:REFeRence:FINE
CALibration:FREQuency:REFeRence:MODE
CALibration:INTernal:ASFRanges?
CALibration:INTernal:ASFRanges:EXTend[:STATe]
CALibration:INTernal:ASFRanges:FRANges
CALibration:INTernal:ASFRanges[:STATe]
CALibration:INTernal:EMPath
CALibration:INTernal:FAST[:ALL]
CALibration:INTernal:HBAND[:ALL]
CALibration:INTernal:LBAND[:ALL]
CALibration:INTernal:LOLeakage
CALibration:INTernal:RECeiver[:ALL]
CALibration:INTernal:RRHead:AMPLitude
CALibration:INTernal:RRHead:AMPLitude:FAST
CALibration:INTernal:RRHead:IFCable
CALibration:INTernal:RRHead:LOPower
CALibration:INTernal:RRHead:LOSync
CALibration:INTernal:SOURce[:ALL]
CALibration:INTernal:SOURce[:ALL]:NPENding
CALibration:INTernal:VXT:TRANsceiver
CALibration:IQ:FLATness:I
CALibration:IQ:FLATness:I|IBAR|Q|QBAR:TIME?
CALibration:IQ:FLATness:IBAR
CALibration:IQ:FLATness:Q
CALibration:IQ:FLATness:QBAR
CALibration:IQ:ISOLation
CALibration:IQ:ISOLation:TIME?
CALibration:IQ:PROBe:I
CALibration:IQ:PROBe:I|:TIME?
CALibration:IQ:PROBe:IBar
CALibration:IQ:PROBe:IBAR:TIME?
CALibration:IQ:PROBe:I:CLEar
CALibration:IQ:PROBe:Q
CALibration:IQ:PROBe:QBar
CALibration:IQ:PROBe:QBAR:TIME?
CALibration:IQ:PROBe:Q:CLEar
CALibration:IQ:PROBe:Q:TIME?
CALibration:NFLoor
CALibration:NRF
CALibration:NRF:NPENding
CALibration:NRFpselector
CALibration:PDElay:CORRection
CALibration:PDElay:SOURce
CALibration:PRESelector
CALibration:REFeRence:CLOCK?

9 Programming the Instrument
9.1 List of Supported SCPI Commands

CALibration:REFerence:CLOCK:END?
CALibration:REFerence:CLOCK:INITialize?
CALibration:RF
CALibration:RF:NPending
CALibration:RFSelector:ALERT
CALibration:RFSelector:CONDUCTed
CALibration:RFSelector:FULL
CALibration:RFSelector:ONLY
CALibration:RFSelector:RADiated
CALibration:RFSelector:SCHeduler:RECurrence
CALibration:RFSelector:SCHeduler:RECurrence:DAY
CALibration:RFSelector:SCHeduler:RECurrence:WEEK
CALibration:RFSelector:SCHeduler:STATE
CALibration:RFSelector:SCHeduler:TASK
CALibration:RFSelector:SCHeduler:TIME:NEXT?
CALibration:RFSelector:SCHeduler:TIME:START
CALibration:TDS
CALibration:TEMPerature:AGO?
CALibration:TEMPerature:CURRent?
CALibration:TEMPerature:CURRent:RRHead?
CALibration:TEMPerature:CURRent:RRHead:LO?
CALibration:TEMPerature:INTernal:EMPath?
CALibration:TEMPerature:INTernal:FAST?
CALibration:TEMPerature:INTernal:HBAND?
CALibration:TEMPerature:INTernal:LBAND?
CALibration:TEMPerature:INTernal:LOLeakage?
CALibration:TEMPerature:INTernal:RECeiver?
CALibration:TEMPerature:INTernal:RRHead:AMPLitude?
CALibration:TEMPerature:INTernal:RRHead:AMPLitude:FAST?
CALibration:TEMPerature:INTernal:RRHead:IFCable?
CALibration:TEMPerature:INTernal:RRHead:LOPower?
CALibration:TEMPerature:INTernal:RRHead:LOSync?
CALibration:TEMPerature:INTernal:SOURce?
CALibration:TEMPerature:INTernal:VXT:TRANsceiver?
CALibration:TEMPerature:LALL?
CALibration:TEMPerature:LIF?
CALibration:TEMPerature:LPreselector?
CALibration:TEMPerature:LRF?
CALibration:TEMPerature:MAXimum?
CALibration:TEMPerature:MINimum?
CALibration:TEMPerature:NFLoor?
CALibration:TEMPerature:OLDest:SECONDS?
CALibration:TEMPerature:OLDest[:TEMPerature]?
CALibration:TEMPerature:PDElay:SOURce?
CALibration:TEMPerature:RFSelector:LCONDUCTed?
CALibration:TEMPerature:RFSelector:LRADiated?
CALibration:TEMPerature:UPDown:CONVerter?
CALibration:TIME:ELAPsed:NFLoor?
CALibration:TIME:INTernal:EMPath?
CALibration:TIME:INTernal:FAST?

CALibration:TIME:INTernal:HBAN?
CALibration:TIME:INTernal:LBANd?
CALibration:TIME:INTernal:LOLeakage?
CALibration:TIME:INTernal:RECeiver?
CALibration:TIME:INTernal:RRHead:AMPLitude?
CALibration:TIME:INTernal:RRHead:AMPLitude:FAST?
CALibration:TIME:INTernal:RRHead:IFCable?
CALibration:TIME:INTernal:RRHead:LOPower?
CALibration:TIME:INTernal:RRHead:LOSync?
CALibration:TIME:INTernal:SOURce?
CALibration:TIME:INTernal:VXT:TRANsceiver?
CALibration:TIME:LALL?
CALibration:TIME:LIF?
CALibration:TIME:LPReselector?
CALibration:TIME:LRF?
CALibration:TIME:NFLoor?
CALibration:TIME:PDElay:SOURce?
CALibration:TIME:REFeRence:CLOCK?
CALibration:TIME:RFPSelector:LCONducted?
CALibration:TIME:RFPSelector:LRADIated?
CALibration:TIME:UPDown:CONVerter?
CALibration:UPDown:CONVerter
CALibration:YTF
CALibration:YTF:NPENding
CONFigure?
CONFigure:<measurement>[:NDEFault]
CONFigure:ACPower
CONFigure:ACPower
CONFigure:ACPower:NDEFault
CONFigure:CATalog?
CONFigure:IBEMissions
CONFigure:IBEMissions
CONFigure:IBEMissions:NDEFault
CONFigure:IBSPurious
CONFigure:IBSPurious
CONFigure:IBSPurious:NDEFault
CONFigure:MONitor
CONFigure:MONitor
CONFigure:MONitor:NDEFault
CONFigure:OBWidth
CONFigure:OBWidth
CONFigure:OBWidth:NDEFault
CONFigure:TX
CONFigure:TX
CONFigure:TX:NDEFault
COUPle

D

DISPlay:<meas>:WINDow[1]:TRACe:Y[:SCALe]:RANGe
DISPlay:ACPower:VIEW:NSElect
DISPlay:ACPower:VIEW[:SElect]
DISPlay:ACPower:WINDow[1]|2:TRACe:Y[:SCALe]:COUPle
DISPlay:ACPower:WINDow[1]|2:TRACe:Y[:SCALe]:PDIVision
DISPlay:ACPower:WINDow[1]|2:TRACe:Y[:SCALe]:RLEVel
DISPlay:ACPower:WINDow[1]|2:TRACe:Y[:SCALe]:RPOStion
Display:ACPower:WINDow[1]:TRACe:X[:SCALe]:COUPle
DISPlay:ACPower:WINDow[1]:TRACe:X[:SCALe]:PDIVision
DISPlay:ACPower:WINDow[1]:TRACe:X[:SCALe]:RLEVel
DISPlay:ACPower:WINDow[1]:TRACe:X[:SCALe]:RPOStion
DISPlay:ACTivefunc[:STATe]
DISPlay:ANNotation:MBAR[:STATe]
DISPlay:ANNotation:SCReen[:STATe]
DISPlay:ANNotation:TRACe[:STATe]
DISPlay:BACKlight
DISPlay:ENABLE
DISPlay:FSCReen[:STATe]
DISPlay:GRATicule[:STATe]
DISPlay:IBEMissions:VIEW:NSElect
DISPlay:IBEMissions:VIEW[:SElect]
DISPlay:IBEMissions:WINDow[1]|2:TRACe:Y[:SCALe]:COUPle
DISPlay:IBEMissions:WINDow[1]|2:TRACe:Y[:SCALe]:PDIVision
DISPlay:IBEMissions:WINDow[1]|2:TRACe:Y[:SCALe]:RLEVel
DISPlay:IBEMissions:WINDow[1]|2:TRACe:Y[:SCALe]:RPOStion
Display:IBEMissions:WINDow[1]:TRACe:X[:SCALe]:COUPle
DISPlay:IBEMissions:WINDow[1]:TRACe:X[:SCALe]:PDIVision
DISPlay:IBEMissions:WINDow[1]:TRACe:X[:SCALe]:RLEVel
DISPlay:IBEMissions:WINDow[1]:TRACe:X[:SCALe]:RPOStion
DISPlay:IBSPurious:VIEW:NSElect
DISPlay:IBSPurious:VIEW[:SElect]
DISPlay:IBSPurious:WINDow[1]|2:TRACe:Y[:SCALe]:COUPle
DISPlay:IBSPurious:WINDow[1]|2:TRACe:Y[:SCALe]:PDIVision
DISPlay:IBSPurious:WINDow[1]|2:TRACe:Y[:SCALe]:RLEVel
DISPlay:IBSPurious:WINDow[1]|2:TRACe:Y[:SCALe]:RPOStion
DISPlay:IBSPurious:WINDow[1]:TRACe:X[:SCALe]:COUPle
DISPlay:IBSPurious:WINDow[1]:TRACe:X[:SCALe]:PDIVision
DISPlay:IBSPurious:WINDow[1]:TRACe:X[:SCALe]:RLEVel
DISPlay:IBSPurious:WINDow[1]:TRACe:X[:SCALe]:RPOStion
DISPlay:MONitor:WINDow[1]:TRACe:Y[:SCALe]:COUPle
DISPlay:MONitor:WINDow[1]:TRACe:Y[:SCALe]:PDIVision
DISPlay:MONitor:WINDow[1]:TRACe:Y[:SCALe]:RANGe
DISPlay:MONitor:WINDow[1]:TRACe:Y[:SCALe]:RLEVel
DISPlay:MONitor:WINDow[1]:TRACe:Y[:SCALe]:RPOStion
DISPlay:OBWidth:VIEW:NSElect
DISPlay:OBWidth:VIEW[:SElect]

DISPlay:OBWidth:WINDow[1]:TRACe:Y[:SCALe]:COUPlE
DISPlay:OBWidth:WINDow[1]:TRACe:Y[:SCALe]:PDIVision
DISPlay:OBWidth:WINDow[1]:TRACe:Y[:SCALe]:RLEVel
DISPlay:OBWidth:WINDow[1]:TRACe:Y[:SCALe]:RPOSition
DISPlay:OBWidth:WINDow[1]:XDB
DISPlay:OBWidth:WINDow2:BOUNdaries:FREQUency
DISPlay:THEMe
DISPlay:TX:VIEW:NSElect
DISPlay:TX:VIEW[:SElect]
DISPlay:TX:WINDow[1]|2|3:TRACe:Y[:SCALe]:COUPlE
DISPlay:TX:WINDow[1]|2|3:TRACe:Y[:SCALe]:PDIVision
DISPlay:TX:WINDow[1]|2|3:TRACe:Y[:SCALe]:RLEVel
DISPlay:TX:WINDow[1]|2|3:TRACe:Y[:SCALe]:RPOSition
DISPlay:TX:WINDow[1]|2:TRACe:X[:SCALe]:COUPlE
DISPlay:TX:WINDow[1]|2:TRACe:X[:SCALe]:PDIVision
DISPlay:TX:WINDow[1]|2:TRACe:X[:SCALe]:RLEVel
DISPlay:TX:WINDow[1]|2:TRACe:X[:SCALe]:RPOSition
DISPlay:UINTErface:CSIZE
DISPlay:UINTErface:HTABs
DISPlay:UINTErface:STAB
DISPlay:UINTErface:STFScreen
DISPlay:UINTErface:TYPE?
DISPlay:VIEW:ADVanced:CATalog?
DISPlay:VIEW:ADVanced:DElete
DISPlay:VIEW:ADVanced:DElete:ALL
DISPlay:VIEW:ADVanced:NAME
DISPlay:VIEW:ADVanced:REName
DISPlay:VIEW:ADVanced:SElect
DISPlay:VIEW:ADVanced:USER:CATalog?
DISPlay:WINDow[1]:ANNotation[:ALL]

F

FETCh:<measurement>[n]?
FETCh:ACPower[n]?
FETCh:IBEMissions[n]?
FETCh:IBSPurious[n]?
FETCh:MONitor[n]?
FETCh:OBWidth:FERRor?
FETCh:OBWidth[n]?
FETCh:OBWidth:OBWidth?
FETCh:OBWidth:XDB?
FETCh:TX?
FORMat:BORDER
FORMat[:TRACe][:DATA]

H

HCOPY:ABORt
HCOPY[:IMMediate]

I

INITiate:<measurement>
INITiate:ACPower
INITiate:CONTinuous
INITiate:IBEMissions
INITiate:IBSPurious
INITiate[:IMMediate]
INITiate:MONitor
INITiate:OBwidth
INITiate:PAUSE
INITiate:REStart
INITiate:RESume
INITiate:TX
INPut[1]:IQ[:I]:IMPedance
INPut[1]:IQ:Q:IMPedance
INPut:COUPling
INPut:COUPling:I
INPut:COUPling:Q
INPut:FEXTender:CABLE:CORRection
INPut:IMPedance:REFerence
INPut:IQ[:I]:DIFFerential
INPut:IQ:Q:DIFFerential
INPut:OFFSet:I
INPut:OFFSet:Q
INSTRument:CATalog?
INSTRument:CONFigure:<mode_id>:<meas>
INSTRument:COUPlE:DEFault
INSTRument:COUPlE:EMC:STANdard
INSTRument:COUPlE:FREQuency:CENTer
INSTRument:COUPlE:SCReen:INPut
INSTRument:DEFault
INSTRument:NSElect
INSTRument:SCReen:CATalog?
INSTRument:SCReen:CREate
INSTRument:SCReen:DELeTe
INSTRument:SCReen:DELeTe:ALL
INSTRument:SCReen:MUlTiple?
INSTRument:SCReen:MUlTiple[:STATe]
INSTRument:SCReen:ORIENTATION
INSTRument:SCReen:REName

INSTRument:SCReen:SElect
INSTRument:SCReen:STAB?
INSTRument[:SElect]
INSTRument[:SElect]
INSTRument[:SElect]
INSTRument[:SElect]
INSTRument[:SElect]
INSTRument[:SElect]
INSTRument[:SElect]
INSTRument:UNLoad

L

LXI:IDENtify[:STATe]

M

MEASure:<measurement>[n]?
MEASure:ACPower[n]?
MEASure:IBEMissions[n]?
MEASure:IBSPurious[n]?
MEASure:MONitor[n]?
MEASure:OBwidth:FERRor?
MEASure:OBwidth[n]?
MEASure:OBwidth:OBwidth?
MEASure:OBwidth:XDB?
MEASure:TX[n]?
MMEMory:CATalog?
MMEMory:CDIRectory
MMEMory:COPIY
MMEMory:COPIY:DEVIce
MMEMory:DATA
MMEMory:DELeTe
MMEMory:HEADer:ID?
MMEMory:LOAD:<meas>:RECOding:CHANnel
MMEMory:LOAD:<meas>:RECOding:RESEt
MMEMory:LOAD:CCORrection
MMEMory:LOAD:CORREction
MMEMory:LOAD:LIMit
MMEMory:LOAD:LOSS
MMEMory:LOAD:RTYPE
MMEMory:LOAD:SCONfig
MMEMory:LOAD:STATe
MMEMory:LOAD:TRACe
MMEMory:LOAD:TRACe:DATA
MMEMory:LOAD:TRACe:REGister
MMEMory:LOAD:VCORrection
MMEMory:MDIRectory

9 Programming the Instrument
9.1 List of Supported SCPI Commands

MMEMory:MOVE
MMEMory:RDIRectory
MMEMory:REGister:STATe:LABel
MMEMory:REGister:TRACe:LABel
MMEMory:RMEDia:LABel
MMEMory:RMEDia:LIST?
MMEMory:RMEDia:SIZE?
MMEMory:RMEDia:WPRotect?
MMEMory:STORe:<meas>:RECording:CHANnel
MMEMory:STORe:CORRection
MMEMory:STORe:LIMit
MMEMory:STORe:PSCFactor
MMEMory:STORe:PSCFactor
MMEMory:STORe:QSAVe
MMEMory:STORe:RESults
MMEMory:STORe:SCONfig
MMEMory:STORe:SCReen
MMEMory:STORe:SCReen:BLOCKed
MMEMory:STORe:SCReen:THEMe
MMEMory:STORe:STATe
MMEMory:STORe:TRACe
MMEMory:STORe:TRACe:REGister

O

OUTPut:ANALog
OUTPut:ANALog:AUTO
OUTPut:ANALog:SVIDeo
OUTPut:AUX
OUTPut:AUX:AIF
OUTPut:AUX:IO
OUTPut:AUX:IO:DATA<n>
OUTPut:DBUS[1][:STATe]
OUTPut:DBUS2:DATA
OUTPut:DBUS2[:STATe]
OUTPut:EIF
OUTPut:EREFerence:OUTPut
OUTPut[:EXTeRnal][:STATe]
OUTPut:IF2
OUTPut:IQ:OUTPut
OUTPut:MODulation[:STATe]
OUTPut:ROSCillator:LO:OUTPut

R

READ:<measurement>[n]?
READ:ACPower[n]?
READ:IBEMissions[n]?

READ:IBSPurious[n]?
 READ:MONitor[n]?
 READ:OBwidth:FERRor?
 READ:OBwidth[n]?
 READ:OBwidth:OBwidth?
 READ:OBwidth:XDB?
 READ:TX[n]?

S

[:SENSe] : < meas > : SWeep : ACQuisition : TIME
 [:SENSe] : < meas > : SWeep : ACQuisition : TIME : AUTO
 [:SENSe] : < meas > : SWeep : ETIme ?
 [:SENSe] : < meas > : SWeep : TIME
 [:SENSe] : < meas > : SWeep : TIME : AUTO
 [:SENSe] : < measurement > : PFILter [:STATe]
 [:SENSe] : ACP : IF : GAIN : AUTO [:STATe]
 [:SENSe] : ACP : IF : GAIN [:STATe]
 [:SENSe] : ACPower : BANDwidth | BWIDth [:RESolution]
 [:SENSe] : ACPower : BANDwidth | BWIDth : VIDEo
 [:SENSe] : ACPower : BANDwidth : SHAPE
 [:SENSe] : ACPower : DETector : AUTO
 [:SENSe] : ACPower : DETector [:FUNCTion]
 [:SENSe] : ACPower : FREQuency : SPAN
 [:SENSe] : ACPower : METHod
 [:SENSe] : ACPower : PRESet : STANdard
 [:SENSe] : ACPower : SAVoid [:STATe]
 [:SENSe] : ACPower : SWeep : POINts
 [:SENSe] : ACPower : SWeep : POINts : AUTO
 [:SENSe] : ACPower : SWeep : TIME
 [:SENSe] : ACQuisition : TIME
 [:SENSe] : AFINput [1] | 2 : COUPling
 [:SENSe] : AFINput [1] | 2 : IMPedance
 [:SENSe] : AFINput [1] | 2 : LOW
 [:SENSe] : CCORrection : CSET : COMMENT
 [:SENSe] : CCORrection : CSET : ALL : DELeTe
 [:SENSe] : CCORrection : CSET : DATA
 [:SENSe] : CCORrection : CSET : DELeTe
 [:SENSe] : CCORrection : CSET : DESCription
 [:SENSe] : CCORrection : CSET : DIRection
 [:SENSe] : CCORrection : CSET : PORT
 [:SENSe] : CCORrection : CSET : SELeCt
 [:SENSe] : CCORrection : CSET [:STATe]
 [:SENSe] : CCORrection : CSET : X : SPACing
 [:SENSe] : CCORrection : DATA ?
 [:SENSe] : CHANnel : LMH
 [:SENSe] : CHANnel : LMH
 [:SENSe] : CHANnel [:NUMBer]
 [:SENSe] : CHANnel [:NUMBer]

9 Programming the Instrument
 9.1 List of Supported SCPI Commands

```

[:SENSe]:CORRection:BTS[:RF]:GAIN
[:SENSe]:CORRection:CSET[1]|2|...|16:ANTenna[:UNIT]
[:SENSe]:CORRection:CSET[1]|2|...|16:COMMeNt
[:SENSe]:CORRection:CSET[1]|2|...|16:DATA
[:SENSe]:CORRection:CSET[1]|2|...|16:DATA:MERGe
[:SENSe]:CORRection:CSET[1]|2|...|16:DELeTe
[:SENSe]:CORRection:CSET[1]|2|...|16:DESCRiption
[:SENSe]:CORRection:CSET[1]|2|...|16:DIRection
[:SENSe]:CORRection:CSET[1]|2|...|16:RF:PORT
[:SENSe]:CORRection:CSET[1]|2|...|16[:STATe]
[:SENSe]:CORRection:CSET[1]|2|...|16:X:SPACing
[:SENSe]:CORRection:CSET:ALL:DELeTe
[:SENSe]:CORRection:CSET:ALL[:STATe]
[:SENSe]:CORRection:CSET:GRoup[1]|2|...|10:DATA
[:SENSe]:CORRection:CSET:GRoup:BReak
[:SENSe]:CORRection:CSET:GRoup:COMMeNt
[:SENSe]:CORRection:CSET:GRoup:DELeTe
[:SENSe]:CORRection:CSET:GRoup:DESCRiption
[:SENSe]:CORRection:CSET:GRoup:RELoad
[:SENSe]:CORRection:CSET:GRoup[:STATe]
[:SENSe]:CORRection:IMPedance[:INPut][:MAGNitude]
[:SENSe]:CORRection:IQ:I:ATTenuation
[:SENSe]:CORRection:IQ:I:ATTenuation:RATio
[:SENSe]:CORRection:IQ:I:GAIN
[:SENSe]:CORRection:IQ[:I]:SKEW
[:SENSe]:CORRection:IQ:Q:ATTenuation
[:SENSe]:CORRection:IQ:Q:ATTenuation:RATio
[:SENSe]:CORRection:IQ:Q:GAIN
[:SENSe]:CORRection:IQ:Q:GAIN:COUPle
[:SENSe]:CORRection:IQ:Q:SKEW
[:SENSe]:CORRection:MS[:RF]:GAIN
[:SENSe]:CORRection:NOISe:FLOor
[:SENSe]:CORRection:SA[:RF]:GAIN
[:SENSe]:FEED
[:SENSe]:FEED:AFALign
[:SENSe]:FEED:AFINput:PORT
[:SENSe]:FEED:AREFeRence
[:SENSe]:FEED:DATA
[:SENSe]:FEED:DATA:STORe
[:SENSe]:FEED:IQ:TYPE
[:SENSe]:FEED[:RF]:PORT:INFormation?
[:SENSe]:FEED[:RF]:PORT[:INPut]
[:SENSe]:FEED:RF:PORT:OUTPut
[:SENSe]:FEED:RF:PORT:TR:HPOWer:ATTenuator[:STATe]
[:SENSe]:FREQuency:CENTer
[:SENSe]:FREQuency:CENTer
[:SENSe]:FREQuency:CENTer:AUTO
[:SENSe]:FREQuency:CENTer:STEP:AUTO
[:SENSe]:FREQuency:CENTer:STEP:AUTO
[:SENSe]:FREQuency:CENTer:STEP[:INCRement]

```

```
[ :SENSe ]:FREQuency:CENTer:STEP[ :INCRement ]
[ :SENSe ]:FREQuency:EMIXer:CENTer
[ :SENSe ]:FREQuency:EMIXer:CENTer
[ :SENSe ]:FREQuency:GEOGraphy
[ :SENSe ]:FREQuency:GEOGraphy
[ :SENSe ]:FREQuency:IQ:CENTer
[ :SENSe ]:FREQuency:RF:CENTer
[ :SENSe ]:FREQuency:RF:CENTer
[ :SENSe ]:HDUPlex:PORT:INPut
[ :SENSe ]:HDUPlex:PORT:OUTPut
[ :SENSe ]:IBEMissions:BANDwidth|BWIDth[:RESolution]
[ :SENSe ]:IBEMissions:BANDwidth|BWIDth:VIDeo
[ :SENSe ]:IBEMissions:BANDwidth:SHAPE
[ :SENSe ]:IBEMissions:DETEctor:AUTO
[ :SENSe ]:IBEMissions:DETEctor[:FUNCTion]
[ :SENSe ]:IBEMissions:FREQuency:SPAN
[ :SENSe ]:IBEMissions:IF:GAIN:AUTO[:STATe]
[ :SENSe ]:IBEMissions:IF:GAIN[:STATe]
[ :SENSe ]:IBEMissions:METHod
[ :SENSe ]:IBEMissions:PRESet:STANdard
[ :SENSe ]:IBEMissions:SAVoid[:STATe]
[ :SENSe ]:IBEMissions:SWEp:POINts
[ :SENSe ]:IBEMissions:SWEp:POINts:AUTO
[ :SENSe ]:IBEMissions:SWEp:TIME
[ :SENSe ]:IBEM:RADio:FORMat
[ :SENSe ]:IBSPurious:BANDwidth|BWIDth[:RESolution]
[ :SENSe ]:IBSPurious:BANDwidth|BWIDth:VIDeo
[ :SENSe ]:IBSPurious:DETEctor:AUTO
[ :SENSe ]:IBSPurious:DETEctor[:FUNCTion]
[ :SENSe ]:IBSPurious:FREQuency:SPAN
[ :SENSe ]:IBSPurious:GDELay
[ :SENSe ]:IBSPurious:IF:GAIN:AUTO[:STATe]
[ :SENSe ]:IBSPurious:IF:GAIN[:STATe]
[ :SENSe ]:IBSPurious:METHod
[ :SENSe ]:IBSPurious:PRESet:STANdard
[ :SENSe ]:IBSPurious:SAVoid[:STATe]
[ :SENSe ]:IBSPurious:SWEp:POINts
[ :SENSe ]:IBSPurious:SWEp:POINts:AUTO
[ :SENSe ]:IBSPurious:SWEp:TIME
[ :SENSe ]:MIXer:BAND
[ :SENSe ]:MIXer:BIAS
[ :SENSe ]:MIXer:BIAS:STATe
[ :SENSe ]:MIXer:CIFLoss
[ :SENSe ]:MIXer:HARMonic
[ :SENSe ]:MIXer:LODoubler
[ :SENSe ]:MIXer:MPATH
[ :SENSe ]:MIXer:TTPe
[ :SENSe ]:MIXer:TTPe?
[ :SENSe ]:MIXer:UIFFreq
[ :SENSe ]:MONitor:AVERage:COUNT
[ :SENSe ]:MONitor:AVERage[:STATe]
```

9 Programming the Instrument
9.1 List of Supported SCPI Commands

```
[ :SENSe ]:MONitor:AVERage:TCONtrol  
[ :SENSe ]:MONitor:BANDwidth[:RESolution]  
[ :SENSe ]:MONitor:BANDwidth[:RESolution]:AUTO  
[ :SENSe ]:MONitor:BANDwidth:VIDeo  
[ :SENSe ]:MONitor:BANDwidth:VIDeo:AUTO  
[ :SENSe ]:MONitor:BANDwidth:VIDeo:RATio  
[ :SENSe ]:MONitor:BANDwidth:VIDeo:RATio:AUTO  
[ :SENSe ]:MONitor:DETEctor:TRACe?  
[ :SENSe ]:MONitor:DETEctor:TRACe[1]|2|3:AUTO  
[ :SENSe ]:MONitor:DETEctor:TRACe[1]2|3  
[ :SENSe ]:MONitor:FREQuency:SPAN  
[ :SENSe ]:MONitor:FREQuency:SPAN:BANDwidth[:RESolution]:RATio  
[ :SENSe ]:MONitor:FREQuency:SPAN:BANDwidth[:RESolution]:RATio:AUTO  
[ :SENSe ]:MONitor:SAVoid[:STATe]?  
[ :SENSe ]:MONitor:SWEp:POINTs  
[ :SENSe ]:OBwidth:AVERage:COUNT  
[ :SENSe ]:OBwidth:AVERage[:STATe]  
[ :SENSe ]:OBwidth:AVERage:TCONtrol  
[ :SENSe ]:OBwidth:BANDwidth[:RESolution]  
[ :SENSe ]:OBwidth:BANDwidth[:RESolution]:AUTO  
[ :SENSe ]:OBwidth:BANDwidth:SHApe  
[ :SENSe ]:OBwidth:BANDwidth:VIDeo  
[ :SENSe ]:OBwidth:BANDwidth:VIDeo:AUTO  
[ :SENSe ]:OBwidth:DETEctor:AUTO  
[ :SENSe ]:OBwidth:DETEctor[:FUNction]  
[ :SENSe ]:OBwidth:FREQuency:SPAN  
[ :SENSe ]:OBwidth:FREQuency:SPAN:AUTO  
[ :SENSe ]:OBwidth:FREQuency:SPAN:FULL  
[ :SENSe ]:OBwidth:IF:GAIN:AUTO[:STATe]  
[ :SENSe ]:OBwidth:IF:GAIN[:STATe]  
[ :SENSe ]:OBwidth:INTegration[:METHod]  
[ :SENSe ]:OBwidth:MAXHold  
[ :SENSe ]:OBwidth:PERCent  
[ :SENSe ]:OBwidth:PREFerence  
[ :SENSe ]:OBwidth:SAVoid[:STATe]  
[ :SENSe ]:OBwidth:SWEp:POINTs  
[ :SENSe ]:OBwidth:SWEp:TIME:AUTO:RULes  
[ :SENSe ]:OBwidth:XDB  
[ :SENSe ]:POWer:IQ[:I]:RANGe[:UPPer]  
[ :SENSe ]:POWer:IQ:Q:RANGe[:UPPer]  
[ :SENSe ]:POWer:IQ:RANGe:AUTO  
[ :SENSe ]:POWer[:RF]:ATTenuation  
[ :SENSe ]:POWer[:RF]:ATTenuation:AUTO  
[ :SENSe ]:POWer[:RF]:ATTenuation:STEP[:INCRement]  
[ :SENSe ]:POWer[:RF]:EATTenuation  
[ :SENSe ]:POWer[:RF]:EATTenuation:STATe  
[ :SENSe ]:POWer[:RF]:FRATten  
[ :SENSe ]:POWer[:RF]:GAIN:BAND  
[ :SENSe ]:POWer[:RF]:GAIN:LNA[:STATe]  
[ :SENSe ]:POWer[:RF]:GAIN[:STATe]
```

```
[ :SENSe]:POWer[:RF]:MIXer:RANGe[:UPPer]
[:SENSe]:POWer[:RF]:MIXer:RULEs
[:SENSe]:POWer[:RF]:MW:PATH
[:SENSe]:POWer[:RF]:MW:PATH:AUTO
[:SENSe]:POWer[:RF]:PADJust
[:SENSe]:POWer[:RF]:PCENter
[:SENSe]:POWer[:RF]:RANGe
[:SENSe]:POWer[:RF]:RANGe:MIXer:OFFSet
[:SENSe]:POWer[:RF]:RANGe:OPTimize
[:SENSe]:POWer[:RF]:RANGe:OPTimize
[:SENSe]:POWer[:RF]:RANGe:OPTimize:ATTenuation
[:SENSe]:POWer[:RF]:RANGe:OPTimize:ATTenuation
[:SENSe]:POWer[:RF]:RANGe:OPTimize:TYPE
[:SENSe]:POWer[:RF]:RANGe:PARatio
[:SENSe]:POWer[:RF]:RFPSelector:NFIltter[:STATe]
[:SENSe]:POWer[:RF]:RFPSelector[:STATe]
[:SENSe]:POWer[:RF]:SWPResel
[:SENSe]:POWer[:RF]:SWPResel:BW
[:SENSe]:POWer[:RF]:SWPResel:STAT?
[:SENSe]:POWer[:RF]:SWPResel:STATe
[:SENSe]:RADio:DEVIce
[:SENSe]:RADio:LE:PHY
[:SENSe]:RADio:STANdard
[:SENSe]:ROSCillator:BANdwidth
[:SENSe]:ROSCillator:EXtErnal:FREQuency
[:SENSe]:ROSCillator:EXtErnal:FREQuency:DEFault
[:SENSe]:ROSCillator:LO:INPut
[:SENSe]:ROSCillator:PXIReference:EXtErnal:FREQuency
[:SENSe]:ROSCillator:PXIReference:EXtErnal:LOCK?
[:SENSe]:ROSCillator:PXIReference:SElect
[:SENSe]:ROSCillator:PXIReference:SOURce
[:SENSe]:ROSCillator:SOURce?
[:SENSe]:ROSCillator:SOURce:TYPE
[:SENSe]:SIDentify:MODE
[:SENSe]:SIDentify[:STATe]
[:SENSe]:SWEp:EGATE:CONTRol
[:SENSe]:SWEp:EGATE:DELay
[:SENSe]:SWEp:EGATE:DELay:COMPensation:TYPE
[:SENSe]:SWEp:EGATE:HACcelerate:ENABle
[:SENSe]:SWEp:EGATE:HOLDoff
[:SENSe]:SWEp:EGATE:HOLDoff:AUTO
[:SENSe]:SWEp:EGATE:LENGth
[:SENSe]:SWEp:EGATE:METhod
[:SENSe]:SWEp:EGATE:SOURce
[:SENSe]:SWEp:EGATE[:STATe]
[:SENSe]:SWEp:EGATE:TIME
[:SENSe]:SWEp:EGATE:VIEW
[:SENSe]:SWEp:EGATE:VIEW:STARt
[:SENSe]:SWEp:IF:DITHer
[:SENSe]:SWEp:IMAGeprot
[:SENSe]:SWEp:NUMBer
```

9 Programming the Instrument
9.1 List of Supported SCPI Commands

```
[ :SENSe ]:TX:AVERAge:COUNT  
[ :SENSe ]:TX:AVERAge[ :STATe ]?  
[ :SENSe ]:TX:AVERAge[ :STATe ]OFF | ON | 0 | 1  
[ :SENSe ]:TX:AVERAge:TYPE  
[ :SENSe ]:TX:BSYNc  
[ :SENSe ]:TX:CS:SYNc:ADDReSS  
[ :SENSe ]:TX:CS:SYNc:RSData  
[ :SENSe ]:TX:CS:SYNc:RSDPattern  
[ :SENSe ]:TX:CS:SYNc:SEQuence:TYPE  
[ :SENSe ]:TX:CS:SYNc:SSMPosition:MARKer1  
[ :SENSe ]:TX:CS:SYNc:SSMPosition:MARKer2  
[ :SENSe ]:TX:CS:SYNc:SSMValue  
[ :SENSe ]:TX:CS:TONE:APNumber  
[ :SENSe ]:TX:CS:TONE:ASTime  
[ :SENSe ]:TX:CS:TONE:FAERror  
[ :SENSe ]:TX:CS:TONE:MMODE  
[ :SENSe ]:TX:CS:TONE:PMTime  
[ :SENSe ]:TX:DPSK:MARKer:START  
[ :SENSe ]:TX:DPSK:MARKer:STOP  
[ :SENSe ]:TX:FREQuency:SPAN  
[ :SENSe ]:TX:GFSK:MARKer:START  
[ :SENSe ]:TX:GFSK:MARKer:STOP  
[ :SENSe ]:TX:IF:GAIN:AUTO[ :STATe ]  
[ :SENSe ]:TX:IF:GAIN[ :STATe ]  
[ :SENSe ]:TX:OPower:MARKer:START  
[ :SENSe ]:TX:OPower:MARKer:STOP  
[ :SENSe ]:TX:PACKet:AUTO  
[ :SENSe ]:TX:PACKet:TYPE  
[ :SENSe ]:TX:POWer:IQ:REFeRence:PLANE  
[ :SENSe ]:TX:SAVoid[ :STATe ]  
[ :SENSe ]:VCORection:DELeTe  
[ :SENSe ]:VCORection:SELeCt  
[ :SENSe ]:VOLTage | Power:IQ:MIRROred  
[ :SENSe ]:VOLTage:IQ[ :I ]:RANGe[ :UPPer ]  
[ :SENSe ]:VOLTage:IQ:Q:RANGe[ :UPPer ]  
[ :SENSe ]:VOLTage:IQ:RANGe:AUTO  
SERvice[ :PRODUCTION]:SOURce:MCONtrol:MPLicense[ :STATe ]  
SOURce:AM[ :DEPTH ][ :LINear ]  
SOURce:AM:INTernal:FREQuency  
SOURce:AM:INTernal:FREQuency:STEP[ :INCRement ]  
SOURce:AM:STATe  
SOURce:FM[ :DEVIation ]  
SOURce:FM:INTernal:FREQuency  
SOURce:FM:INTernal:FREQuency:STEP[ :INCRement ]  
SOURce:FM:STATe  
SOURce:FREQuency:CHANnels:BAND  
SOURce:FREQuency:CHANnels:NUMBer  
SOURce:FREQuency:COUPLing  
SOURce:FREQuency:COUPLing:OFFSet  
SOURce:FREQuency[ :CW ]
```

SOURce:FREquency:OFFSet
 SOURce:FREquency:REFeRence
 SOURce:FREquency:REFeRence:SEt
 SOURce:FREquency:REFeRence:STATe
 SOURce:FREquency:STEP[:INCRement]
 SOURce:LIST:INITiation:ARMed?
 SOURce:LIST:NUMBer:STEPs
 SOURce:LIST:REPetition:TYPE
 SOURce:LIST:SEtUp:AMPLitude
 SOURce:LIST:SEtUp:CLear
 SOURce:LIST:SEtUp:CNFRequency
 SOURce:LIST:SEtUp:DURation:TYPE
 SOURce:LIST:SEtUp:INPut:TRIGger
 SOURce:LIST:SEtUp:OUTPut:TRIGger
 SOURce:LIST:SEtUp:RADio:BAND
 SOURce:LIST:SEtUp:RADio:BAND:LINK
 SOURce:LIST:SEtUp:TOCount
 SOURce:LIST:SEtUp:TRANSition:TIME
 SOURce:LIST:SEtUp:WAVeform
 SOURce:LIST[:STATe]
 SOURce:LIST:STEP[1]|2|...|1000:SEtUp
 SOURce:LIST:STEP[1]|2|...|1000:SEtUp:AMPLitude
 SOURce:LIST:STEP[1]|2|...|1000:SEtUp:CNFRequency
 SOURce:LIST:STEP[1]|2|...|1000:SEtUp:DURation:TOCount
 SOURce:LIST:STEP[1]|2|...|1000:SEtUp:DURation:TOCount
 SOURce:LIST:STEP[1]|2|...|1000:SEtUp:DURation:TYPE
 SOURce:LIST:STEP[1]|2|...|1000:SEtUp:INPut:TRIGger
 SOURce:LIST:STEP[1]|2|...|1000:SEtUp:OUTPut:TRIGger
 SOURce:LIST:STEP[1]|2|...|1000:SEtUp:RADio:BAND
 SOURce:LIST:STEP[1]|2|...|1000:SEtUp:RADio:BAND:LINK
 SOURce:LIST:STEP[1]|2|...|1000:SEtUp:TRANSition:TIME
 SOURce:LIST:STEP[1]|2|...|1000:SEtUp:WAVeform
 SOURce:LIST:TRIGger[:IMMediate]
 SOURce:LIST:TRIGger:INITiate[:IMMediate]
 SOURce:LIST:TRIGger:OUTPut:TYPE
 SOURce:LIST:TRIGger:OUTPut:TYPE:MARKer
 SOURce:PM[:DEViation]
 SOURce:PM:INTernal:FREquency
 SOURce:PM:INTernal:FREquency:STEP[:INCRement]
 SOURce:PM:STATe
 SOURce:POWer[:LEVeL][:IMMediate][:AMPLitude]
 SOURce:POWer[:LEVeL][:IMMediate][:AMPLitude]:UNIT
 SOURce:POWer[:LEVeL][:IMMediate]:OFFSet
 SOURce:POWer:REFeRence
 SOURce:POWer:REFeRence:STATe
 SOURce:POWer:STEP[:INCRement]
 SOURce:PRESet
 SOURce:RADio:ARB:BASEband:FREquency:OFFSet
 SOURce:RADio:ARB:BASEband:POWer
 SOURce:RADio:ARB:CATalog?
 SOURce:RADio:ARB:CATalog?

9 Programming the Instrument
9.1 List of Supported SCPI Commands

SOURce:RADio:ARB:DEFault:DIRectory
SOURce:RADio:ARB:DELeTe
SOURce:RADio:ARB:DELeTe:ALL
SOURce:RADio:ARB:FCATalog?
SOURce:RADio:ARB:FCATalog?
SOURce:RADio:ARB:HEADer:CLEAr
SOURce:RADio:ARB:HEADer:INFormation?
SOURce:RADio:ARB:HEADer:SAVE
SOURce:RADio:ARB:IQADjustment:DELay
SOURce:RADio:ARB:IQADjustment:GAIN
SOURce:RADio:ARB:IQADjustment:[STATe]
SOURce:RADio:ARB:LOAD
SOURce:RADio:ARB:LOAD:ALL
SOURce:RADio:ARB:MDEStination:ALCHold
SOURce:RADio:ARB:MDEStination:PULSe
SOURce:RADio:ARB:MPLicensed:NAME:LOCKed?
SOURce:RADio:ARB:MPLicensed:UID:LOCKed?
SOURce:RADio:ARB:MPOLarity:MARKer1|...|4
SOURce:RADio:ARB:NR5G:PHASe:FILTer:BANDwidth
SOURce:RADio:ARB:NR5G:PHASe:FILTer[:STATe]
SOURce:RADio:ARB:NR5G:PHASe:SCS
SOURce:RADio:ARB:NR5G:PHASe[:STATe]
SOURce:RADio:ARB:RETRigger
SOURce:RADio:ARB:RMS
SOURce:RADio:ARB:RMS:CALCulate
SOURce:RADio:ARB:RMS:CALCulation:MODE
SOURce:RADio:ARB:RSCaling
SOURce:RADio:ARB:SCLock:RATE
SOURce:RADio:ARB:SEQuence[:MWAVEform]
SOURce:RADio:ARB:SEQuence:SYNC
SOURce:RADio:ARB[:STATe]
SOURce:RADio:ARB:TRIGger:INITiate
SOURce:RADio:ARB:TRIGger[:SOURce]
SOURce:RADio:ARB:TRIGger[:SOURce]:EXTErnal:DELay
SOURce:RADio:ARB:TRIGger[:SOURce]:EXTErnal:DELay:STATe
SOURce:RADio:ARB:TRIGger[:SOURce]:EXTErnal:SLOPe
SOURce:RADio:ARB:TRIGger[:SOURce]:PXI:DELay
SOURce:RADio:ARB:TRIGger[:SOURce]:PXI:DELay:STATe
SOURce:RADio:ARB:TRIGger[:SOURce]:PXI:LINE
SOURce:RADio:ARB:TRIGger[:SOURce]:PXI:SLOPe
SOURce:RADio:ARB:TRIGger:SYNC[:STATe]
SOURce:RADio:ARB:TRIGger:TYPE
SOURce:RADio:ARB:TRIGger:TYPE:CONTinuous[:TYPE]
SOURce:RADio:ARB:TRIGger:TYPE:SADVance[:TYPE]
SOURce:RADio:ARB:WAVEform
SOURce:RADio:BAND:LINK
SOURce:SYNC:CONFig
SOURce:SYNC:CONNEcted?
SOURce:SYNC:REMOte:ADDReSS
SOURce:SYNC:REMOte:ADDReSS:ADD

SOURce:SYNC:REMOte:ADDReSS:DELeTe
SOURce:SYNC:REMOte:IPPort
SOURce:SYNC:REMOte:SEC<integer>?
SOURce:SYNC:REMOte:SECOndary<integer>
SOURce:SYNC:RTSetting:STATe
SOURce:SYNC:SETTings:ENABLe
SOURce:SYNC:SETTings:SEGMeNt2:ENABLe
SOURce:SYNC:SETTings:SEGMeNt2:FREQuency
SOURce:SYNC:STARt
SOURce:SYNC:STOP
SOURce:SYNC:TYPE
STATus:OPERation:CONDition?
STATus:OPERation:ENABLe
STATus:OPERation:ENABLe
STATus:OPERation[:EVENT]?
STATus:OPERation:INSTRument:CONDition?
STATus:OPERation:INSTRument:ENABLe
STATus:OPERation:INSTRument[:EVENT]?
STATus:OPERation:INSTRument:NTRansition
STATus:OPERation:INSTRument:PTRansition
STATus:OPERation:NTRansition
STATus:OPERation:PTRansition
STATus:PRESet
STATus:QUESTionable:CALibration:CONDition?
STATus:QUESTionable:CALibration:ENABLe
STATus:QUESTionable:CALibration[:EVENT]?
STATus:QUESTionable:CALibration:EXTended:FAILure:CONDition?
STATus:QUESTionable:CALibration:EXTended:FAILure:ENABLe
STATus:QUESTionable:CALibration:EXTended:FAILure[:EVENT]?
STATus:QUESTionable:CALibration:EXTended:FAILure:NTRansition
STATus:QUESTionable:CALibration:EXTended:FAILure:PTRansition
STATus:QUESTionable:CALibration:EXTended:NEEDed:CONDition?
STATus:QUESTionable:CALibration:EXTended:NEEDed:ENABLe
STATus:QUESTionable:CALibration:EXTended:NEEDed[:EVENT]?
STATus:QUESTionable:CALibration:EXTended:NEEDed:NTRansition
STATus:QUESTionable:CALibration:EXTended:NEEDed:PTRansition
STATus:QUESTionable:CALibration:NTRansition
STATus:QUESTionable:CALibration:PTRansition
STATus:QUESTionable:CALibration:SKIPPed:CONDition?
STATus:QUESTionable:CALibration:SKIPPed:ENABLe
STATus:QUESTionable:CALibration:SKIPPed[:EVENT]?
STATus:QUESTionable:CALibration:SKIPPed:NTRansition
STATus:QUESTionable:CALibration:SKIPPed:PTRansition
STATus:QUESTionable:CONDition?
STATus:QUESTionable:ENABLe
STATus:QUESTionable[:EVENT]?
STATus:QUESTionable:FREQuency:CONDition?
STATus:QUESTionable:FREQuency:ENABLe
STATus:QUESTionable:FREQuency[:EVENT]?
STATus:QUESTionable:FREQuency:NTRansition
STATus:QUESTionable:FREQuency:PTRansition

9 Programming the Instrument
9.1 List of Supported SCPI Commands

STATus:QUESTionable:INTEgrity:CONDition?
STATus:QUESTionable:INTEgrity:ENABle
STATus:QUESTionable:INTEgrity[:EVENT]?
STATus:QUESTionable:INTEgrity:NTRansition
STATus:QUESTionable:INTEgrity:OUTPut:CONDition?
STATus:QUESTionable:INTEgrity:OUTPut:ENABle
STATus:QUESTionable:INTEgrity:OUTPut[:EVENT]?
STATus:QUESTionable:INTEgrity:OUTPut:NTRansition
STATus:QUESTionable:INTEgrity:OUTPut:PTRansition
STATus:QUESTionable:INTEgrity:PTRansition
STATus:QUESTionable:INTEgrity:SIGNal:CONDition?
STATus:QUESTionable:INTEgrity:SIGNal:ENABle
STATus:QUESTionable:INTEgrity:SIGNal[:EVENT]?
STATus:QUESTionable:INTEgrity:SIGNal:NTRansition
STATus:QUESTionable:INTEgrity:SIGNal:PTRansition
STATus:QUESTionable:INTEgrity:UNCalibrated:CONDition?
STATus:QUESTionable:INTEgrity:UNCalibrated:ENABle
STATus:QUESTionable:INTEgrity:UNCalibrated[:EVENT]?
STATus:QUESTionable:INTEgrity:UNCalibrated:NTRansition
STATus:QUESTionable:INTEgrity:UNCalibrated:PTRansition
STATus:QUESTionable:NTRansition
STATus:QUESTionable:POWer:CONDition?
STATus:QUESTionable:POWer:ENABle
STATus:QUESTionable:POWer[:EVENT]?
STATus:QUESTionable:POWer:NTRansition
STATus:QUESTionable:POWer:PTRansition
STATus:QUESTionable:POWer:PTRansition?>
STATus:QUESTionable:PTRansition
STATus:QUESTionable:TEMPerature:CONDition?
STATus:QUESTionable:TEMPerature:ENABle
STATus:QUESTionable:TEMPerature[:EVENT]?
STATus:QUESTionable:TEMPerature:NTRansition
STATus:QUESTionable:TEMPerature:PTRansition
SYSTem:APPLication:CATalog[:NAME]?
SYSTem:APPLication:CATalog[:NAME]:COUNT?
SYSTem:APPLication:CATalog:OPTion?
SYSTem:APPLication:CATalog:REVision?
SYSTem:APPLication[:CURRent][:NAME]?
SYSTem:APPLication[:CURRent]:OPTion?
SYSTem:APPLication[:CURRent]:REVision?
SYSTem:APPLication:LOADed?
SYSTem:CALibration:ABORT
SYSTem:CALibration:CGRoup
SYSTem:CALibration:CGRoup:APPLY
SYSTem:CALibration:CGRoup:APPLY:AOFF
SYSTem:CALibration:CGRoup:COPY
SYSTem:CALibration:CGRoup:COPY:FROM
SYSTem:CALibration:DELeTe:ALL
SYSTem:CALibration:DESCRiption
SYSTem:CALibration:FREQUency:OFFSet

```

SYSTEM:CALibration:INITiate:SElected
SYSTEM:CALibration:INPut
SYSTEM:CALibration:MODule[1]|2|...|10:SNUMber?
SYSTEM:CALibration:MODule:SElect
SYSTEM:CALibration:REFerence
SYSTEM:CALibration:ROW[1]|2|...|100:APPLy:STATe
SYSTEM:CALibration:ROW[1]|2|...|100:ATTenuation:START
SYSTEM:CALibration:ROW[1]|2|...|100:ATTenuation:STEP
SYSTEM:CALibration:ROW[1]|2|...|100:ATTenuation:STOP
SYSTEM:CALibration:ROW[1]|2|...|100:ATTenuation:TYPE
SYSTEM:CALibration:ROW[1]|2|...|100:CALibrate:STATe
SYSTEM:CALibration:ROW[1]|2|...|100:CAPPLied?
SYSTEM:CALibration:ROW[1]|2|...|100:COUPLing
SYSTEM:CALibration:ROW[1]|2|...|100:DElete
SYSTEM:CALibration:ROW[1]|2|...|100:DUPLicate
SYSTEM:CALibration:ROW[1]|2|...|100:EATTenuation:START
SYSTEM:CALibration:ROW[1]|2|...|100:EATTenuation:STEP
SYSTEM:CALibration:ROW[1]|2|...|100:EATTenuation:STOP
SYSTEM:CALibration:ROW[1]|2|...|100:EATTenuation:TYPE
SYSTEM:CALibration:ROW[1]|2|...|100:FATTenuation:START
SYSTEM:CALibration:ROW[1]|2|...|100:FATTenuation:STOP
SYSTEM:CALibration:ROW[1]|2|...|100:FATTenuation:TYPE
SYSTEM:CALibration:ROW[1]|2|...|100:FEAttenuation:START
SYSTEM:CALibration:ROW[1]|2|...|100:FEAttenuation:STEP
SYSTEM:CALibration:ROW[1]|2|...|100:FEAttenuation:STOP
SYSTEM:CALibration:ROW[1]|2|...|100:FEAttenuation:TYPE
SYSTEM:CALibration:ROW[1]|2|...|100:FREQuency:POINts
SYSTEM:CALibration:ROW[1]|2|...|100:FREQuency:START
SYSTEM:CALibration:ROW[1]|2|...|100:FREQuency:STEP
SYSTEM:CALibration:ROW[1]|2|...|100:FREQuency:STOP
SYSTEM:CALibration:ROW[1]|2|...|100:FREQuency:SYNThesis:ALL[:STATe]
SYSTEM:CALibration:ROW[1]|2|...|100:FREQuency:SYNThesis[:STATe]
SYSTEM:CALibration:ROW[1]|2|...|100:IF:GAIN[:STATe]?
SYSTEM:CALibration:ROW[1]|2|...|100:IF:GAIN
[:STATe]AUTO|HIGH|LOW|ALL
SYSTEM:CALibration:ROW[1]|2|...|100:IF:PATH
SYSTEM:CALibration:ROW[1]|2|...|100:INSert
SYSTEM:CALibration:ROW[1]|2|...|100:LAST?
SYSTEM:CALibration:ROW[1]|2|...|100:LO:MMode
SYSTEM:CALibration:ROW[1]|2|...|100:MATCh[:STATe]
SYSTEM:CALibration:ROW[1]|2|...|100:NAME
SYSTEM:CALibration:ROW[1]|2|...|100:POWer:GAIN:BAND?
SYSTEM:CALibration:ROW[1]|2|...|100:POWer[:RF]:GAIN:BAND
SYSTEM:CALibration:ROW[1]|2|...|100:POWer[:RF]:GAIN:LNA[:STATe]
SYSTEM:CALibration:ROW[1]|2|...|100:POWer[:RF]:MW:PATH
SYSTEM:CALibration:ROW[1]|2|...|100:STATus?
SYSTEM:CALibration:ROW[1]|2|...|100:TYPE
SYSTEM:CALibration:ROW[1]|2|...|100:UCMeas
SYSTEM:CALibration:STATus:ALL?
SYSTEM:CALibration:TUNE:FREQuency
  
```

9 Programming the Instrument
9.1 List of Supported SCPI Commands

SYSTem:CALibration:TUNE:OUTput[:STATe]
SYSTem:CALibration:TUNE:REFerence
SYSTem:CALibration:TUNE[:SElected]
SYSTem:CALibration:TUNE:SPACing
SYSTem:CALibration:TUNE:TYPE
SYSTem:COMMunicate:GPIB[1][:SELF]:ADDress
SYSTem:COMMunicate:GPIB[1][:SELF]:CONTroller[:ENABle]
SYSTem:COMMunicate:LAN:INSTrument:PORT?
SYSTem:COMMunicate:LAN:IPV4:CONFig
SYSTem:COMMunicate:LAN:IPV6:CONFig
SYSTem:COMMunicate:LAN:MULTiple:NIC:ENABled?
SYSTem:COMMunicate:LAN:PHYSical:IPADdress:LIST?
SYSTem:COMMunicate:LAN:SCPI:EOSession:DCLear:ENABle
SYSTem:COMMunicate:LAN:SCPI:HISLip:ENABle
SYSTem:COMMunicate:LAN:SCPI:SICL:ENABle
SYSTem:COMMunicate:LAN:SCPI:SOCKet:CONTRol?
SYSTem:COMMunicate:LAN:SCPI:SOCKet:ENABle
SYSTem:COMMunicate:LAN:SCPI:TELNet:ENABle
SYSTem:COMMunicate:USB:CONNection?
SYSTem:COMMunicate:USB:PACKets?
SYSTem:COMMunicate:USB:STATus?
SYSTem:CONFigure[:SYSTem]?
SYSTem:CSYSTem?
SYSTem:DATE
SYSTem:DEFault
SYSTem:DISPlay:BACKlight:INTensity
SYSTem:DISPlay:CFORmat
SYSTem:DISPlay:HINTs?
SYSTem:DISPlay:HINTs[:STATe]
SYSTem:DISPlay:LANGuage
SYSTem:DISPlay:MPPosition
SYSTem:DISPlay:MPTab
SYSTem:DISPlay:NEPimmediate
SYSTem:ERRor[:NEXT]?
SYSTem:ERRor:OVERload[:STATe]
SYSTem:ERRor:PUP?
SYSTem:ERRor:VERBose
SYSTem:HELP:HEADers?
SYSTem:HID?
SYSTem:IDN
SYSTem:IDN:CONFigure
SYSTem:KLOCK
SYSTem:LICense[:FPACK]:WAVEform:ADD
SYSTem:LICense[:FPACK]:WAVEform:CLEar
SYSTem:LICense[:FPACK]:WAVEform:FREE?
SYSTem:LICense[:FPACK]:WAVEform:LOCK
SYSTem:LICense[:FPACK]:WAVEform:NAME?
SYSTem:LICense[:FPACK]:WAVEform:REPLace
SYSTem:LICense[:FPACK]:WAVEform:STATus?
SYSTem:LICense[:FPACK]:WAVEform:UID?

SYSTem:LIcense[:FPACK]:WAVEform:USED?
SYSTem:LKEY?
SYSTem:LKEY
SYSTem:LKEY:BORRow
SYSTem:LKEY:BORRow:LIST?
SYSTem:LKEY:BORRow:NETWork:COU:ENABle
SYSTem:LKEY:BORRow:RETurn
SYSTem:LKEY:COU?
SYSTem:LKEY:COU:LIST?
SYSTem:LKEY:DELeTe
SYSTem:LKEY:LIST?
SYSTem:LKEY:SOFTware:SUPPort:EXPIration:DATE?
SYSTem:LKEY:WAVEform:ADD
SYSTem:LKEY:WAVEform:CLEAr
SYSTem:LKEY:WAVEform:FREE?
SYSTem:LKEY:WAVEform:LOCK
SYSTem:LKEY:WAVEform:NAME?
SYSTem:LKEY:WAVEform:REPLace
SYSTem:LKEY:WAVEform:STATus?
SYSTem:LKEY:WAVEform:UID?
SYSTem:LKEY:WAVEform:USED?
SYSTem:LOCK:NAME?
SYSTem:LOCK:OWNer?
SYSTem:LOCK:RELease
SYSTem:LOCK:REQuest?
SYSTem:LOFF
SYSTem:LWStation
SYSTem:METRics:FPANel?
SYSTem:METRics:SCPI?
SYSTem:METRics:STIME?
SYSTem:MRELay:COUNt?
SYSTem:OPTions?
SYSTem:PDOWN
SYSTem:PERSONa:DEFault
SYSTem:PERSONa:MANufacturer
SYSTem:PERSONa:MANufacturer:DEFault
SYSTem:PERSONa:MODEl
SYSTem:PERSONa:MODEl:DEFault
SYSTem:PON:APPLication:LLISt
SYSTem:PON:APPLication:VMEMory[:AVAilable]?
SYSTem:PON:APPLication:VMEMory:TOTal?
SYSTem:PON:APPLication:VMEMory:USED?
SYSTem:PON:APPLication:VMEMory:USED:NAME?
SYSTem:PON:ETIME?
SYSTem:PON:FPGA:LOAD
SYSTem:PON:FPGA:PREFerence
SYSTem:PON:MODE
SYSTem:PON:TIME?
SYSTem:PON:TYPE
SYSTem:PRESet
SYSTem:PRESet:FULL

9 Programming the Instrument
9.1 List of Supported SCPI Commands

SYSTem:PRESet:TYPE
SYSTem:PRESet:USER
SYSTem:PRESet:USER:ALL
SYSTem:PRESet:USER:SAVE
SYSTem:PRINT:THEME
SYSTem:PUP
SYSTem:PUP:PROcEss
SYSTem:SECurity:USB:WPRotect[:ENABle]
SYSTem:SEQuencer
SYSTem:SET
SYSTem:SHOW
SYSTem:SOFTware:VERsion:DATE?
SYSTem:TEMPerature:HEXTreme?
SYSTem:TEMPerature:LEXTreme?
SYSTem:TIME
SYSTem:VERsion?

T

TRACe[:<meas>]:CLEar:ALL
TRACe:<meas>:COPY
TRACe:<meas>:EXCHange
TRACe[:<meas>]:PRESet:ALL
TRACe[1]|2|...|6:DISPLay[:STATe]
TRACe[1]|2|...|6:TYPE
TRACe[1]|2|...|6:UPDate[:STATe]
TRACe[1]|2|3:<meas>:DISPLay[:STATe]
TRACe[1]|2|3:<meas>:TYPE
TRACe[1]|2|3:<meas>:UPDate[:STATe]
TRACe:ACPower:TYPE
TRACe:CLEar
TRACe:COPY
TRACe[:DATA]
TRACe:EXCHange
TRACe:IBEMissions:TYPE
TRACe:IBSPurious:TYPE
TRACe:MONitor:CLEar:ALL
TRIGger:<measurement>[:SEQuence]:IQ:SOURce
TRIGger:<measurement>[:SEQuence]:RF:SOURce
TRIGger:<measurement>[:SEQuence]:SOURce
TRIGger[1]|2|...|4[:SEQuence]:OUTPut
TRIGger[1]|2|...|4[:SEQuence]:OUTPut:DIRectiOn
TRIGger[1]|2|...|4[:SEQuence]:OUTPut:POLarity
TRIGger:PXIE:ANALyzer[:SEQuence]:OUTPut
TRIGger:PXIE:ANALyzer[:SEQuence]:OUTPut:LINE
TRIGger:PXIE:ANALyzer[:SEQuence]:OUTPut:POLarity
TRIGger:PXIE:SOURce[:SEQuence]:OUTPut
TRIGger:PXIE:SOURce[:SEQuence]:OUTPut:LINE
TRIGger:PXIE:SOURce[:SEQuence]:OUTPut:POLarity

TRIGger[:SEquence]:<trig_source>:DElay
TRIGger[:SEquence]:<trig_source>:DElay:STATe
TRIGger[:SEquence]:<trig_source>:LEVel
TRIGger[:SEquence]:<trig_source>:SLOPe
TRIGger[:SEquence]:AIQMag:BANDwidth
TRIGger[:SEquence]:AIQMag:CENTer
TRIGger[:SEquence]:ATRigger
TRIGger[:SEquence]:ATRigger:STATe
TRIGger[:SEquence]:EXternal1|EXternal2|RFBurst:DElay:COMPensation
TRIGger[:SEquence]:FRAMe:ADJust
TRIGger[:SEquence]:FRAMe:OFFSet
TRIGger[:SEquence]:FRAMe:OFFSet:DISPlay:RESet
TRIGger[:SEquence]:FRAMe:PERiod
TRIGger[:SEquence]:FRAMe:SMONitor:RESet
TRIGger[:SEquence]:FRAMe:SYNC
TRIGger[:SEquence]:FRAMe:SYNC:HOLDoff
TRIGger[:SEquence]:FRAMe:SYNC:HOLDoff:STATe
TRIGger[:SEquence]:HOLDoff
TRIGger[:SEquence]:HOLDoff:STATe
TRIGger[:SEquence]:HOLDoff:TYPE
TRIGger[:SEquence]:INTernal:SOURce:OUTPut
TRIGger[:SEquence]:INTernal:SOURce:OUTPut:POLarity
TRIGger[:SEquence]:OFFSet:STATe
TRIGger[:SEquence]:OPTimize:MODE
TRIGger[:SEquence]:PXI:LINE
TRIGger[:SEquence]:RFBurst:LEVel:ABSolute
TRIGger[:SEquence]:RFBurst:LEVel:RELative
TRIGger[:SEquence]:RFBurst:LEVel:TYPE
TRIGger[:SEquence]:SOURce
TRIGger[:SEquence]:TV:FMODE
TRIGger[:SEquence]:TV:LINE
TRIGger[:SEquence]:TV:STANdard

9.2 IEEE 488.2 Common Commands

The instrument supports the following subset of IEEE 488.2 Common Commands, as defined in Chapter 10 of [IEEE Standard 488.2–1992](#). As indicated below, some of these commands correspond directly to instrument front-panel functionality, while others are available only as remote commands.

- ["*CAL? - Calibration Query" on page 1479](#) (Align Now All equivalent)
- ["*CLS - Clear Status" on page 1480](#)
- ["*ESE - Standard Event Status Enable" on page 1480](#)
- ["*ESR? - Standard Event Status Register Query" on page 1481](#)
- ["*IDN? - Identification Query" on page 1481](#)
- ["*OPC? - Operation Complete" on page 1482](#)
- ["*OPT? - Query Instrument Options" on page 1483](#)
- ["*RCL - Recall Instrument State" on page 1483](#) (Recall State equivalent)
- ["*RST - Reset" on page 1483](#) (Mode Preset equivalent)
- ["*SAV - Save Instrument State" on page 1484](#) (Save State equivalent)
- ["*SRE - Service Request Enable" on page 1484](#)
- ["*STB? - Status Byte Query" on page 1485](#)
- ["*TRG - Trigger" on page 1485](#)
- ["*TST? - Self Test Query" on page 1485](#)
- ["*WAI - Wait-to-Continue" on page 1486](#)

9.2.1 *CAL? - Calibration Query

[*CAL?](#) Performs a full alignment and returns a number indicating the success of the alignment. A zero is returned if the alignment is successful. A one is returned if any part of the alignment fails. The equivalent SCPI command is [:CALibrate\[:ALL\]?](#)

See ["Align Now All" on page 906](#)

Remote Command

[*CAL](#)

Example	*CAL? Runs a full alignment and returns 0 if no problems encountered
Status Bits/OPC dependencies	See "Align Now All" on page 906

9.2.2 *CLS - Clear Status

Clears the ["Status Byte Register" on page 1516](#), by emptying the error queue and clearing all bits in all of the event registers, and consequently all bits in the Status Byte Register.

The Status Byte Register summarizes the states of the other registers. It is also responsible for generating service requests.

Remote Command	*CLS
Example	*CLS Clears the error queue and the Status Byte Register
Notes	For related commands, see :SYSTEM:ERROR[:NEXT]? See also :STATUS:PRESet and all commands in the "Status Register System & STATUS Subsystem" on page 1507
Status Bits/OPC dependencies	Resets all bits in all event registers to 0, which resets all the status byte register bits to 0 also

9.2.3 *ESE - Standard Event Status Enable

Sets the desired bits in the Event Enable sub-register of the ["Standard Event Status Register" on page 1520](#), which enables the corresponding bits in the Standard Event Status Register. This register monitors I/O errors and synchronization conditions such as operation complete, request control, query error, device-dependent error, status execution error, command error, and power on. The selected bits are **ORed** to become a summary bit (bit 5) in the ["Status Byte Register" on page 1516](#), which can be queried.

The query returns the state of this register.

Numeric values for bit patterns can be entered using decimal or hexadecimal representations (0 to 32767, equivalent to **#H0** to **#H7FFF**).

Remote Command	*ESE <integer> *ESE?
Example	*ESE 36 Enables the Standard Event Status Register to monitor query and command errors (bits 2 and 5)

	*ESE?
	Returns a 36 indicating that the query and command status bits are enabled
Notes	For related commands, see the "Status Register System & STATus Subsystem" on page 1507 and :SYSTem:ERRor[:NEXT]?
Preset	255
State Saved	Not saved in state
Min	0
Max	255

9.2.4 *ESR? - Standard Event Status Register Query

Queries and clears the ["Standard Event Status Register" on page 1520](#). (This is a destructive read.) The value returned is a hexadecimal number that reflects the current state (0/1) of all the bits in the register.

Remote Command	*ESR?
Example	*ESR? Returns a 1 if there is either a query or command error, otherwise it returns a zero
Notes	For related commands, see "Status Register System & STATus Subsystem" on page 1507
Min/Max	0 / 255
Status Bits/OPC dependencies	Standard Event Status Register (bits 0 – 7)

9.2.5 *IDN? - Identification Query

Returns a string of instrument identification information. The string contains the model number, serial number, and firmware revision.

The response is organized into four fields separated by commas. The field definitions are as follows:

1. Manufacturer
2. Model
3. Serial number
4. Firmware version

Remote Command	*IDN?
----------------	--------------

Example	<p>*IDN?</p> <p>Returns instrument identification information, such as: Keysight Technologies,N9040B,US01020004,A.15.02</p> <p>Backwards Compatibility Command</p>
Example	<p>:ID?</p> <p>Returns model number, such as: N9040B</p>
Notes	<p>Provided for backwards compatibility: In Remote Language Compatibility Mode, ID? returns the model number of the emulated instrument In any other Mode, the returned model number is that of the actual instrument</p>
Backwards Compatibility SCPI	<p>:ID?</p>

9.2.6 *OPC? - Operation Complete

Sets bit 0 in the "Standard Event Status Register" on page 1520 (SESR) to "1" when pending operations have finished, that is when all overlapped commands are complete. It does not hold off subsequent operations. You can determine when the overlapped commands have completed either by polling the OPC bit in SESR, or by setting up the status system so that a service request (SRQ) is asserted when the OPC bit is set.

***OPC?** returns "1" after all the current overlapped commands are complete, so it holds off subsequent commands until the "1" is returned, then the program continues. This query can be used to synchronize events of other instruments on the external bus.

Remote Command	<p>*OPC</p> <p>*OPC?</p>
Example	<p>Select single sweeping: :INIT:CONT 0</p> <p>Initiate a sweep: :INIT:IMM</p> <p>Hold off any further commands until the sweep is complete: *OPC?</p>
Notes	<p>Not global to all remote ports or front panel. *OPC only affects operations that were initiated on the same port that the *OPC command was issued from</p> <p>*OPC is an overlapped command, but *OPC? is sequential</p> <p>*OPC? does <i>not</i> holdoff the completion of GUI update commands , such as :MMEM:LOAD:SCON "myScreenConfig.screen"</p>

9.2.7 *OPT? - Query Instrument Options

Returns a string of all installed instrument options. It is a comma-separated list, with quotes, for example:

```
"550,B25,B40,BBA,CRP,CRW,EA3,EDP,ESC,EXM,FBP,LNP,MPB,NF2,RTS,EMC,FP2"
```

Remote Command	<code>*OPT?</code>
----------------	--------------------

9.2.8 *RCL - Recall Instrument State

Recalls the instrument state from the specified instrument memory register.

- If the state being loaded has a newer firmware revision than the revision of the instrument, no state is recalled and an error is reported
- If the state being loaded has an equal firmware revision than the revision of the instrument, the state will be loaded
- If the state being loaded has an older firmware revision than the revision of the instrument, then the instrument will only load the parts of the state that apply to the older revision

Remote Command	<code>*RCL <register #></code>
Example	Recall the instrument state that is currently stored in register 7 (register 8 in the UI): <code>*RCL 7</code>
Notes	Registers 0 through 15 are accessible from the front panel in menu keys for Recall Registers. Register 0 corresponds to front panel Register 1
Min	0
Max	127
Status Bits/OPC dependencies	The command is sequential

9.2.9 *RST - Reset

`*RST` is equivalent to `:SYST:PRES;:INIT:CONT OFF`, which is a Mode Preset in the **Single** measurement state. This command is preferred over the Mode Preset command `:SYST:PRES`, because optimal remote programming occurs with the instrument in the **Single** measurement state.

`*RST` clears all pending OPC bits and sets the Status Byte to 0.

Remote Command	<code>*RST</code>
Notes	Sequential
Couplings	<code>*RST</code> causes the currently running measurement to be aborted and causes the default measurement to be active. <code>*RST</code> gets the mode to a consistent state, with all of the default couplings set
Status Bits/OPC dependencies	Clears all pending OPC bits. The " Status Byte Register " on page 1516 is set to 0

9.2.10 *SAV - Save Instrument State

Saves the current instrument state and mode to the specified instrument memory register.

Remote Command	<code>*SAV <register #></code>
Example	Save the instrument state in register 9 (register 10 in the UI): <code>*SAV 9</code>
Notes	Registers 0 through 15 are accessible from the front panel in menu keys for Save Registers. Register 0 corresponds to the front panel Register 1
Min/Max	0 / 127
Status Bits/OPC dependencies	The command is sequential

9.2.11 *SRE - Service Request Enable

Enables the desired bits of the "[Service Request Enable Register](#)" on page 1519.

The query returns the value of the register, indicating which bits are currently enabled.

Numeric values for bit patterns can be entered using decimal or hexadecimal representations (0 to 32767, equivalent to `#H0` to `#H7FFF`).

Remote Command	<code>*SRE <integer></code> <code>*SRE?</code>
Example	Enable bits 1, 2, and 4 in the service request enable register: <code>*SRE 22</code>
Notes	For related commands, see " Status Register System & STATus Subsystem " on page 1507 and <code>:SYSTem:ERRor[:NEXT]?</code>
Preset	0
Min/Max	0 / 255

Status Bits/OPC dependencies Service Request Enable Register (all bits, 0 – 7)

9.2.12 *STB? - Status Byte Query

Returns the value of the "Status Byte Register" on page 1516 without erasing its contents.

Remote Command	<code>*STB?</code>
Example	<p>Return a decimal value for the bits in the Status Byte Register:</p> <p><code>*STB?</code></p> <p>For example, if 16 is returned, it indicates that bit 5 is set and one of the conditions monitored in the standard event status register is set</p>
Notes	See related command " *CLS - Clear Status " on page 1480
Status Bits/OPC dependencies	Status Byte Register (all bits, 0 – 7)

9.2.13 *TRG - Trigger

Triggers the instrument. Use `:TRIGger[:SEquence]:SOURce` to select the trigger source.

Remote Command	<code>*TRG</code>
Example	<p>Trigger the instrument to take a sweep or start a measurement, depending on the current instrument settings:</p> <p><code>*TRG</code></p>
Notes	See related command <code>:INITiate:IMMediate</code>

9.2.14 *TST? - Self Test Query

Performs the internal self-test routines and returns a number indicating the success of the testing. The value returned is 0 if the test is successful, or 1 if it fails.

Remote Command	<code>*TST?</code>
Example	<p>Run the self-test routines:</p> <p><code>*TST?</code></p>

9.2.15 *WAI - Wait-to-Continue

Causes the instrument to wait until all overlapped commands are completed before executing any additional commands. There is no equivalent query.

Remote Command	<code>*WAI</code>
Example	Set the instrument to single sweep. Start a sweep, then wait for its completion: <code>:INIT:CONT OFF;INIT;*WAI</code>
Notes	<code>*WAI</code> does <i>not</i> wait for the completion of user-interface-related commands, such as <code>:MMEM:LOAD:SCON "myScreenConfig.screen"</code>
Status Bits/OPC dependencies	Not global to all remote ports or front panel. <code>*OPC</code> only considers operation that was initiated on the same port that the <code>*OPC</code> command was issued from

9.3 SCPI Operation and Results Query

You can use SCPI commands for remote control of measurements and querying of measurement results data. There are several alternative commands you can use to control the measurement, depending on how you wish to operate the instrument. There are also a number of queries that you can use to extract the measurement data.

In this section, “Mode” refers to a Measurement Application, for example, Spectrum Analyzer or 5G NR.

9.3.1 Mode Control

Use either `:INSTRument:SElect` or `:INSTRument:NSElect` to select the Mode. See ["Mode" on page 63](#).

`:INSTRument:CONFigure` causes a Mode *and* Measurement switch at the same time. This results in faster overall switching than sending `:INSTRument:SElect` and `:CONFigure` separately, as described in ["Mode" on page 63](#).

9.3.2 Measurement Control

This section describes the measurement control commands listed below, and their functions.

"CONFigure" on page 1488	Switches to the desired measurement. Presets all measurement settings to their defaults, <i>unless</i> <code>:NDEFault</code> is specified
"INITiate" on page 1489	Starts the measurement
"FETCh" on page 1489	Queries the data without starting the measurement. If a measurement is already in progress, waits for completion
"READ" on page 1490	Starts the measurement with the current settings and queries the data
"MEASure" on page 1491	Switches to the desired measurement, presets all measurement settings to their defaults, starts the measurement and queries the data

The relationship between the command forms is illustrated in the diagram below. `:FETCh`, `:READ` and `:MEASure` are queries that return measurement data.

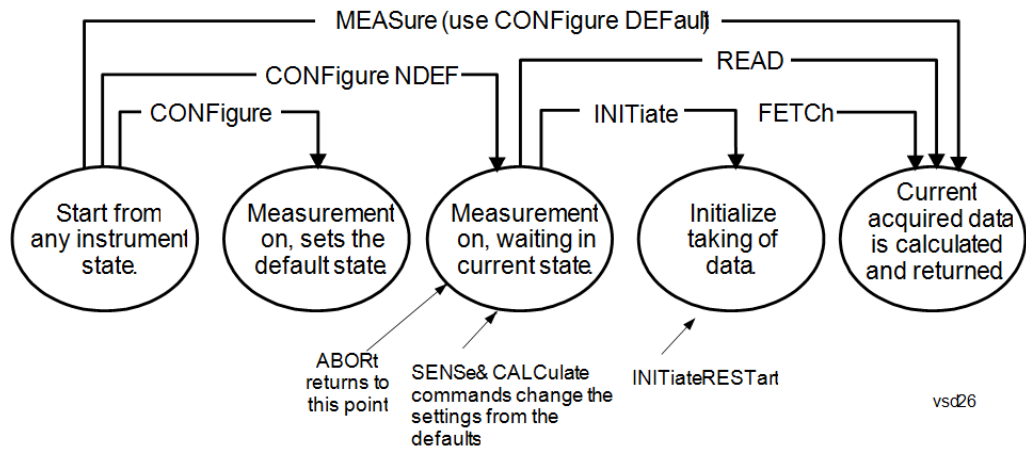

9.3.2.1 CONFigure

Stops the current measurement (if any) and sets up the instrument for the specified measurement using the measurement's default settings. Does not initiate the collection of measurement data unless `:INIT:CONT` is `ON`. If you change any measurement settings after using `:CONFigure`, `"READ"` on page 1490 can be used to initiate a measurement without changing the settings back to their defaults.

Normally `:CONFigure` presets the measurement after selecting it; but, if sent with the `NDEFault` parameter, it selects it without performing a Preset.

Remote Command `:CONFigure:<measurement>[:NDEFault]`
 `:CONFigure?`

Example Select and preset the Swept SA measurement:
 `:CONF:SAN`

 Select the Swept SA measurement *without* presetting:
 `:CONF:SAN:NDEF`

 Query the current measurement:
 `:CONF?`

Remote Command `:CONFigure:CATalog?`

Example `:CONF:CATalog?`

 returns a quoted string of all licensed measurement names in the current mode. For example, `"SAN, CHP, OBW, ACP, PST, TXP, SPUR, SEM, LIST"` for the Spectrum Analyzer mode

9.3.2.2 INITiate

Initiates a trigger cycle for the specified measurement, but does not output any data. You must then use `:FETCh<meas>` to return data. If a measurement other than the current one is specified, the instrument will switch to that measurement and then initiate it.

Remote Command `:INITiate:<measurement>`

Example Switch to the **SANalyzer** (Swept SA) measurement if not already there, then start the measurement:

`:INIT:SAN`

`:INITiate` does not change any of the measurement settings. For example, if you have already run the ACP measurement and you send `:INIT:ACP?` it initiates a new ACP measurement using the same instrument settings as the last time ACP was run.

If another measurement is running, `:INIT` switches to the specified measurement. For example, suppose you are running the channel power measurement. If you send `:INIT:ACP?` it changes from channel power to ACP and initiates an ACP measurement.

If your selected measurement is currently in the idle state, it restarts the measurement. Depending upon the measurement and the number of averages, there may be multiple data acquisitions, with multiple trigger events, for one full trigger cycle.

CAUTION

`:INIT` allows additional commands *while* the measurement is in progress.

Be aware that such additional commands may change measurement settings. They may cause the measurement in progress to be discarded, and a new measurement may start.

To wait for the completion of a measurement after sending `:INITiate`, send `"*WAI - Wait-to-Continue"` on page 1486, or `"*OPC? - Operation Complete"` on page 1482, or use `"FETCh"` on page 1489.

9.3.2.3 FETCh

Places selected data from the most recent measurement into the output buffer. Use `:FETCh` if you have already made a valid measurement and you want to retrieve data. You can issue `:FETCh` multiple times with differing `[n]` values without restarting or re-making the measurement, for example, both scalars and trace data from a single measurement.

Remote Command `:FETCh:<measurement>[n]?`

Example Fetch item 2 (Trace 2) from the **SAN** (Swept SA) measurement when the measurement completes. If not in the Swept SA measurement, returns an error:

:FETCh:SAN2?

:FETCh does not change any of the measurement settings, it simply reads the results of the current measurement. **:FETCh** may be used to return results other than those specified with the original **:READ** or **:MEASure** query that you sent.

You can only **:FETCh** results from the measurement that is currently active, it does not change to a different measurement. An error message is reported if a measurement other than the current one is specified.

If you need to get new measurement data, use **"READ"** on page 1490, which is equivalent to **"INITiate"** on page 1489 followed by **:FETCh**.

The measurement results for **n = 1** (usually the scalar result) will be returned if the optional **[n]** value is not included, or is set to 1. If the **[n]** value is set to a value other than 1, the selected data results will be returned. See each measurement for details of what types of scalar results or trace data results are available. The binary data formats should be used for handling large blocks of data since they are smaller and transfer faster than the ASCII format. See **"Format Data: Numeric Data (Remote Command Only)"** on page 1495.

Note that the data returned by **:FETCh?** uses the data setting specified by **"Format Data: Numeric Data (Remote Command Only)"** on page 1495 and **"Format Data: Byte Order (Remote Command Only)"** on page 1496 commands, and can return real or ASCII data. If the format is set to **INT, 32**, it returns **REAL, 32** data.

9.3.2.4 READ

Initiates a trigger cycle for the specified measurement and outputs the requested data. If a measurement other than the current one is specified, the instrument will switch to that measurement before it initiates the measurement and returns results.

Remote Command **:READ:<measurement>[n]?**

Example Switch to the **SANalyzer** (Swept SA) measurement if not already there, start the measurement, and return item 2 (Trace 2) from the measurement when the measurement completes:

:READ:SAN2?

:READ does not change any of the measurement settings. For example, if you have already run the ACP measurement and you send **:READ:ACP?**, it initiates a new ACP measurement using the same instrument settings as the last time ACP was run.

:READ switches to the specified measurement if the instrument is not already there. For example, suppose you have already run the ACP measurement but now you are running the Channel Power measurement. When you send **:READ:ACP?**, it changes

from Channel Power back to ACP and, using the previous ACP settings, initiates the measurement and return results.

The measurement results for $n = 1$ (usually the scalar result) will be returned if the optional `[n]` value is not included, or is set to 1. If the `[n]` value is set to a value other than 1, the selected data results will be returned. See each measurement for details of what types of scalar results or trace data results are available. The binary data formats should be used for handling large blocks of data since they are smaller and transfer faster than the ASCII format. See "[Format Data: Numeric Data \(Remote Command Only\)](#)" on page 1495.

Note that the data returned by `:READ?` uses the data setting specified by "[Format Data: Byte Order \(Remote Command Only\)](#)" on page 1496) and "[Format Data: Numeric Data \(Remote Command Only\)](#)" on page 1495, and can return real or ASCII data. If the format is set to `INT, 32` it returns `REAL, 32` data.

`:READ` blocks other SCPI communication, waiting until the measurement is complete before returning results.

For more details of how measurements proceed, see also "[INITiate](#)" on page 1489.

9.3.2.5 MEASure

Stops the current measurement (if any) and sets up the instrument for the specified measurement using the measurement's default settings, initiates a trigger cycle for the specified measurement, and outputs the requested data.

Remote Command	<code>:MEASure:<measurement>[n]?</code>
----------------	---

Example	Switch to the <code>SANalyzer</code> (Swept SA) measurement, start the measurement, and read back item 2 (Trace 2) when the measurement completes <code>:MEAS:SAN2?</code>
---------	---

This is a fast single-command way to make a measurement using the measurement's default settings. These are the settings and units that conform to the Mode Setup settings (for example, Radio Standard) that you have currently selected.

Stops the current measurement (if any) and sets up the instrument for the specified measurement using the measurement's defaults.

Initiates the data acquisition for the measurement.

Blocks other SCPI communication, waiting until the measurement is complete before returning results.

Depending on the measurement and the number of averages, there may be multiple data acquisitions, with multiple trigger events.

After the data is valid, returns the scalar results, or the trace data, for the specified measurement. The type of data returned may be defined by an `[n]` value that is sent with the command.

If the optional `[n]` value is not included, or is set to 1, scalar measurement results will be returned. If the `[n]` value is other than 1, the selected trace data results will be returned. See each command for details of which types of scalar results or trace data results are available.

The default format for data output is ASCII. (Older versions of Spectrum Analysis and Phase Noise mode measurements only use ASCII.) The binary data formats should be used for handling large blocks of data, because transfers are smaller and faster than when using the ASCII format. See ["Format Data: Numeric Data \(Remote Command Only\)" on page 1495](#) for more information.

If you need to change some of the measurement parameters from the measurement's default settings, you can set up the measurement with `:CONFigure`. Use the commands in the `:SENSe:<measurement>` and `:CALCulate:<measurement>` subsystems to change the settings, then you can use `:READ?` to initiate the measurement and query the results.

Measurement settings persist if you initiate a different measurement and then return to a previous one. Use `:READ?` if you want to use those persistent settings. If you want to go back to the default settings, use `:MEASure?`.

Note that the data returned to `:MEASure?` uses the data setting specified by ["Format Data: Byte Order \(Remote Command Only\)" on page 1496](#) and ["Format Data: Numeric Data \(Remote Command Only\)" on page 1495](#), and can return real or ASCII data. If the format is set to `INT, 32` it returns `REAL, 32` data.

9.3.3 Trace Formatting Commands

The following commands and queries are available to format and manipulate trace data.

9.3.3.1 Clear Trace (Remote Command Only)

Clears the selected trace (from the front panel) or the specified trace (from SCPI). Does not affect the state of any function or variable in the instrument. Loads `mintracevalue` into all of the points in the selected trace, unless the trace is in Min Hold in which case it loads `maxtracevalue`. This occurs even if `Update = Off`.

Remote Command	<code>:TRACe:CLEAr TRACE1 ... TRACE6</code>
Example	Clear Trace 1: <code>:TRAC:CLE TRACE1</code>

9.3.3.2 Send/Query Trace Data (Remote Command Only)

Allows trace data to be sent to the instrument or queried from the instrument. The response to the query is a list of the amplitude points which comprise the requested trace in the current Y Axis Unit of the instrument. The X Axis Unit is that of the destination trace (for send) or the source trace (for query).

See:

- "Query Trace Data" on page 1493
- "More Information" on page 1494

Remote Command	<code>:TRACe[:DATA] TRACE1 TRACE2 TRACE3 TRACE4 TRACE5 TRACE6, <data></code>
Notes	<p>The <code>TRACe[:DATA]</code> command is of the form: <code>:TRACe:DATA <trace>,<data></code></p> <p>where <code><trace></code> can be one of the following parameters: <code>TRACE1, TRACE2, TRACE3, TRACE4, TRACE5, TRACE6</code></p> <p>and where <code><data></code> can be</p> <ul style="list-style-type: none"> - ASCII data, which consists of a string of values separated by comma or - <code>REAL</code> or <code>INTEger</code> sent as a definite length block, with a header describing the data to follow
Couplings	<p>Sweep points will affect the amount of data</p> <p><code>:FORMat:DATA</code> describes the different types of data formats that can be used with trace data</p> <p>Use <code>:FORMat:BORDER</code> to set the byte order</p>

Query Trace Data

Remote Command	<code>:TRACe[:DATA]? TRACE1 TRACE2 TRACE3 TRACE4 TRACE5 TRACE6</code>
Example	<p>Send five points to Trace 1. Assuming that <code>:FORMat:DATA</code> is set to <code>ASCIi</code>, Y Axis Unit is set to dBm, and sweep points is set to 5, this will result in Trace 1 consisting of the five points -1 dBm, -2 dBm, -3 dBm, -4 dBm, and -5 dBm:</p> <p><code>:TRAC TRACE1, -1, -2, -3, -4, -5</code></p> <p>Query the instrument for the contents of trace 2:</p> <p><code>:TRAC? TRACE2</code></p>
Backwards Compatibility Notes	In X-Series, the legacy <code>RAWTRACE, LLINE1, LLINE2</code> parameters for trace data query are no longer available

More Information

The format and byte order of the sent or received data depend on ["Format Data: Numeric Data \(Remote Command Only\)" on page 1495](#) and ["Format Data: Byte Order \(Remote Command Only\)" on page 1496](#). **ASCII** data consists of a string of comma separated values. **REAL** or **INTEger** data is sent as a definite length block, with a header describing the data to follow.

For example, a four point trace might look like this if in ASCII (**FORMat:DATA ASCii**):

```
-5.87350E+01, -5.89110E+01, -5.87205E+01, -5.12345E+01<NL><END>
```

and like this if in **INTEger** with 4 bytes per point (**FORMat:DATA INT, 32**):

```
#216<16 bytes of data><NL><END>
```

where the 2 in the #216 means "2 digits of numeric data to follow", and the 16 is the 2 digits and means "16 binary bytes to follow" (this is the definite length block format).

Note that the data is terminated with **<NL><END>**. (For GPIB this is newline, or linefeed, followed by EOI set true. For LAN, this is newline only.)

The data format set by ["Format Data: Numeric Data \(Remote Command Only\)" on page 1495](#) and ["Format Data: Byte Order \(Remote Command Only\)" on page 1496](#) is used both for sending data to the instrument and receiving data from the instrument.

When sending data to the instrument, the data block must contain exactly the number of points currently specified in **Sweep, Points** or an error message will be generated and there will be no change to the target trace.

No units terminator (for example, dB or V) is used when sending data; the data is taken as being in the current Y Axis Unit of the instrument.

When a trace is sent to the instrument, it immediately overwrites all of the data in the target trace. Consequently the trace should be inactive in order to achieve predictable results. If you send trace data while a trace is active, and particularly if a sweep or an **Average** or **Max/Min Hold** sequence is already in progress, you may end up with a trace that combines the data you sent with measurement data. Similarly, when querying trace data, it is best if the instrument is not sweeping during the query.

Therefore, it is generally advisable to be in **Single** sweep, or have the trace in **View**, when sending trace data to the instrument or querying trace data from the instrument.

9.3.3.3 Format Data: Numeric Data (Remote Command Only)

Specifies the format of the trace data input and output.

Specifies the formats used for trace data during data transfer across any remote port. Affects only the data format for setting and querying trace data for `:TRACe[:DATA]`, `:TRACe[:DATA]?`, `:CALCulate:DATA[n]?` and `:FETCh:SANalyzer[n]?`.

Remote Command	<code>:FORMat[:TRACe][:DATA] ASCii INTeger,32 REAL,32 REAL,64</code> <code>:FORMat[:TRACe][:DATA]?</code>
Notes	The query response is: <code>ASCii</code> : ASC,8 <code>REAL,32</code> : REAL,32 <code>REAL,64</code> : REAL,64 <code>INTeger,32</code> : INT,32 When the numeric data format is REAL or ASCii, data is output in the current Y Axis unit. When the data format is INTeger, data is output in units of m dBm (.001 dBm) The <code>INT,32</code> format returns binary 32-bit integer values in internal units (m dBm), in a definite length block
Dependencies	Sending a data format spec with an invalid number (for example, <code>INT,48</code>) generates no error. The instrument simply uses the default (8 for <code>ASCii</code> , 32 for <code>INTeger</code> , 32 for <code>REAL</code>) Sending data to the instrument which does not conform to the current <code>FORMat</code> specified, results in an error. Sending ASCII data when a definite block is expected generates message -161 "Invalid Block Data" and sending a definite block when ASCII data is expected generates message -121 "Invalid Character in Number"
Preset	<code>ASCii</code>
Backwards Compatibility Notes	Note that the <code>INT,32</code> format is only applicable to <code>:TRACe:DATA</code> . This preserves backwards compatibility for the Swept SA measurement. For all other commands/queries that honor <code>:FORMat:DATA</code> , if <code>INT,32</code> is sent the instrument will behave as though it were set to <code>REAL,32</code>

The specifications for each output type are:

- `ASCii` Amplitude values are in ASCII, in the current Y Axis Unit, one ASCII character per digit, values separated by commas, each value in the form: `SX.YYYYYEsZZ`, where:
 S = sign (+ or -)
 X = one digit to left of decimal point
 Y = 5 digits to right of decimal point
 E = E, exponent header
 s = sign of exponent (+ or -)
 ZZ = two digit exponent
- `REAL,32` Binary 32-bit real values in the current Y Axis Unit, in a definite length block
- `REAL,64` Binary 64-bit real values in the current Y Axis Unit, in a definite length block

9.3.3.4 Format Data: Byte Order (Remote Command Only)

Selects the binary data byte order for data transfer and other queries.

Controls whether binary data is transferred in normal or swapped mode. Affects only the byte order for setting and querying trace data for `:TRACe[:DATA]`, `:TRACe[:DATA]?`, `:CALCulate:DATA[n]?` and `:FETCh:SANalyzer[n]?`.

By definition, any command that depends on this setting uses *any* format supported by `:FORMat:DATA`.

- **NORMal** order is a byte sequence that begins with the most significant byte (MSB) first, and ends with the least significant byte (LSB) last in the sequence: 1|2|3|4
- **SWAPped** order is when the byte sequence begins with the LSB first, and ends with the MSB last in the sequence: 4|3|2|1

Remote Command	<code>:FORMat:BORDER NORMal SWAPped</code> <code>:FORMat:BORDER?</code>
Preset	<code>NORMal</code>

9.3.3.5 Calculate/Compress Trace Data Query (Remote Command Only)

Returns compressed data for the currently selected measurement and sub-opcode `[n]`.

`n` = any valid sub-opcode for that measurement. See the `:MEASure:<measurement>?` query description of your specific measurement for information on the data that can be returned.

The data is returned in the current Y Axis Unit of the instrument. The command is used with a sub-opcode `<n>` (default = 1) to specify the trace. With trace queries, it is best if the instrument is not sweeping during the query. Therefore, it is generally advisable to be in **Single** sweep, or Update = Off.

This command is used to compress or decimate a long trace to extract and return only the desired data. A typical example would be to acquire N frames of GSM data and return the mean power of the first burst in each frame. The command can also be used to identify the best curve fit for the data.

Remote Command	<code>:CALCulate:DATA<n>:COMPRESS? BLOCK CFIT MAXimum MINimum MEAN DMEan RMS SAMPLE SDEVIation PPHase [,<soffset>[,<length>[,<roffset>[,<rlimit>]]]]</code>
----------------	---

Notes The command supports 5 parameters, but the last 4 (`<soffset>`, `<length>`, `<roffset>`, `<rlimit>`) are optional. The optional parameters must be entered in the specified order. For example, if you want to specify `<length>`, then you must also specify `<soffset>`. See details below for a definition

of each of these parameters

This command uses the data in the format specified by "[Format Data: Byte Order \(Remote Command Only\)](#)" on page 1496, returning either binary or ASCII data

As an example, to query the mean power of a set of GSM bursts:

- Supply a signal that is a set of GSM bursts
- Select the IQ Waveform measurement (in IQ Analyzer Mode)
- Set the sweep time to acquire at least one burst
- Set the triggers such that acquisition happens at a known position relative to a burst
- Query the mean burst levels using, `:CALC:DATA2:COMP? MEAN, 24e-6, 526e-6` (These parameter values correspond to GSM signals, where 526e-6 is the length of the burst in the slot and you just want 1 burst)

BLOCK or block data

Returns all the data points from the region of the trace data that you specify. For example, it could be used to return the data points of an input signal over several timeslots, excluding the portions of the trace data that you do not want. (This is x,y pairs for trace data and I,Q pairs for complex data.)

CFIT or curve fit

Applies curve fitting routines to the data. `<soffset>` and `<length>` are required to define the data that you want. `<roffset>` is an optional parameter for the desired order of the curve equation. The query will return the following values: the x-offset (in seconds) and the curve coefficients ((order + 1) values).

`MIN`, `MAX`, `MEAN`, `DME`, `RMS`, `SAMP`, `SDEV` and `PPH` return one data value for each specified region (or `<length>`) of trace data, for as many regions as possible until you run out of trace data (using `<roffset>` to specify regions), or they return the number of regions you specify (using `<rlimit>`) ignoring any data beyond that.

MINimum

Returns the minimum data point (y value) for the specified region(s) of trace data. For I/Q trace data, the minimum magnitude of the I/Q pairs is returned.

MAXimum

Returns the maximum data point (y value) for the specified region(s) of trace data. For I/Q trace data, the maximum magnitude of the I/Q pairs is returned.

MEAN

Returns a single value that is the arithmetic mean of the data point values (in dB/ dBm) for the specified region(s) of trace data. For I/Q trace data, the mean of the magnitudes of the I/Q pairs is returned. See the following equations.

NOTE

If the original trace data is in dB, this function returns the arithmetic mean of those log values, not log of the mean power which is a more useful value. The mean of the log is the better measurement technique when measuring CW signals in the presence of noise. The mean of the power, expressed in dB, is useful in power measurements such as Channel Power. To achieve the mean of the power, use the RMS option.

Equation 1: Mean Value of Data Points for Specified Region(s)

$$\text{MEAN} = \frac{1}{n} \sum_{X_i \in \text{region}(s)} X_i$$

where X_i is a data point value, and n is the number of data points in the specified region(s).

Equation 2: Mean Value of I/Q Data Pairs for Specified Region(s)

$$\text{MEAN} = \frac{1}{n} \sum_{X_i \in \text{region}(s)} |X_i|$$

where $|X_i|$ is the magnitude of an I/Q pair, and n is the number of I/Q pairs in the specified region(s).

DMEan

Returns a single value that is the mean power (in dB/ dBm) of the data point values for the specified region(s) of trace data. See the following equation:

Equation 3: DMEan Value of Data Points for Specified Region(s)

$$\text{DME} = 10 \times \log_{10} \left(\frac{1}{n} \sum_{X_i \in \text{region}(s)} 10^{\frac{X_i}{10}} \right)$$

RMS

Returns a single value that is the average power on a root-mean-squared voltage scale (arithmetic rms) of the data point values for the specified region(s) of trace data. See the following equation.

Equation 4: RMS Value of Data Points for Specified Region(s)

$$\text{RMS} = \sqrt{\frac{1}{n} \sum_{X_i \in \text{region}(s)} X_i^2}$$

where X_i is a data point value, and n is the number of data points in the specified region(s).

For I/Q trace data, the rms of the magnitudes of the I/Q pairs is returned. See the following equation.

NOTE

This function is very useful for I/Q trace data. However, if the original trace data is in dB, this function returns the rms of the log values which is not usually needed.

Equation 5: RMS Value of I/Q Data Pairs for Specified Region(s)

$$\text{RMS} = \sqrt{\frac{1}{n} \sum_{X_i \in \text{region}(s)} X_i X_i^*}$$

where X_i is the complex value representation of an I/Q pair, X_i^* its conjugate complex number, and n is the number of I/Q pairs in the specified region(s).

Once you have the rms value for a region of trace data (linear or I/Q), you may want to calculate the mean power. You must convert this rms value (peak volts) to power in dBm:

$$10 \times \log[10 * (\text{rms value})^2]$$

SAMPLE

Returns the first data value (x,y pair) for the specified region(s) of trace data. For I/Q trace data, the first I/Q pair is returned.

SDEViation

Returns a single value that is the arithmetic standard deviation for the data point values for the specified region(s) of trace data. See the following equation.

Equation 6: Standard Deviation of Data Point Values for Specified Region(s)

$$\text{SDEV} = \sqrt{\frac{1}{n} \sum_{X_i \in \text{region}(s)} (X_i - \bar{X})^2}$$

where X_i is a data point value, X is the arithmetic mean of the data point values for the specified region(s), and n is the number of data points in the specified region(s).

For I/Q trace data, the standard deviation of the magnitudes of the I/Q pairs is returned. See the following equation.

Equation 7: Standard Deviation of I/Q Data Pair Values for Specified Region(s)

$$SDEV = \sqrt{\frac{1}{n} \sum_{X_i \in \text{region}(s)} (|X_i| - \bar{X})^2}$$

where $|X_i|$ is the magnitude of an I/Q pair, X is the mean of the magnitudes for the specified region(s), and n is the number of data points in the specified region(s).

PPHase

Returns the x,y pairs of both rms power (dBm) and arithmetic mean phase (radian) for every specified region and frequency offset (Hz). The number of pairs is defined by the specified number of regions. This parameter can be used for I/Q vector ($n=0$) in Waveform (time domain) measurement and all parameters are specified by data point in [PPHase](#).

The rms power of the specified region may be expressed as:

$$\text{Power} = 10 \times \log [10 \times (\text{RMS I/Q value})] + 10.$$

The RMS I/Q value (peak volts) is:

$$\sqrt{\frac{1}{n} \sum_{X_i \in \text{region}} X_i X_i^*}$$

where X_i is the complex value representation of an I/Q pair, X_i^* its conjugate complex number, and n is the number of I/Q pairs in the specified region.

The arithmetic mean phase of the specified region may be expressed as:

$$\frac{1}{n} \sum_{Y_i \in \text{region}} Y_i$$

where Y_i is the unwrapped phase of I/Q pair with applying frequency correction and n is the number of I/Q pairs in the specified region.

The frequency correction is made by the frequency offset calculated by the arithmetic mean of every specified region's frequency offset. Each frequency offset is calculated by the least square method against the unwrapped phase of I/Q pair.

Sample Trace Data - Constant Envelope

(See below for explanation of variables.)

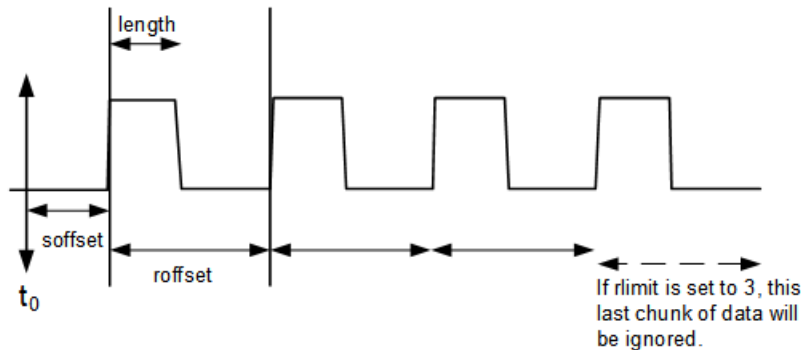

Sample Trace Data - Not Constant Envelope

(See below for explanation of variables.)

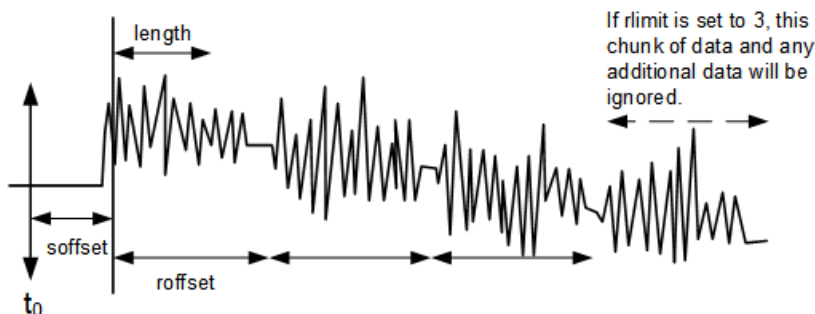

- <soffset>** Optional real number, in seconds for time-domain traces, and is a dimensionless index 0 to Npoints - 1, for frequency-domain traces
 Specifies the amount of data at the beginning of the trace that will be ignored before the decimation process starts. It is the time or frequency change from the start of the trace to the point where you want to start using the data. The default value is zero
- <length>** Optional real number, in seconds for time-domain traces, and is a dimensionless index 0 to Npoints - 1, for frequency-domain traces
 Defines how much data will be compressed into one value. This parameter has a default value equal to the current trace length
- <roffset>** Optional real number, in seconds for time-domain traces, and is a dimensionless index 0 to Npoints - 1, for frequency-domain traces
 Defines the beginning of the next field of trace elements to be compressed. This is relative to the beginning of the previous field. This parameter has a default value equal to the **<length>** variable. Note that this parameter is used for a completely different purpose when curve fitting (see "CFIT or curve fit" on page 1497 above)

`<rlimit>` Optional integer
Specifies the number of data items that you want returned. Ignores any additional items beyond that number. You can use the Start offset and the Repeat limit to pick out exactly what part of the data you want to use. The default value is all the data

9.3.3.6 Calculate Peaks of Trace Data (Remote Command Only)

Returns a list of all the peaks for the currently selected measurement and sub-opcode `[n]`. The peaks must meet the requirements of the peak threshold and excursion values.

`n` = any valid sub-opcode for the current measurement. See the `:MEASure:<measurement>` command description of your specific measurement for information on the data that can be returned.

The command can only be used with specific sub-opcodes with measurement results that are trace data. Both real and complex traces can be searched, but complex traces are converted to magnitude in dBm. In many measurements the sub-opcode `n = 0`, is the raw trace data, which cannot be searched for peaks, and sub-opcode `n = 1`, is often calculated results values which also cannot be searched for peaks.

This command uses the data setting specified by "[Format Data: Byte Order \(Remote Command Only\)](#)" on page 1496 and "[Format Data: Numeric Data \(Remote Command Only\)](#)" on page 1495, and can return real or ASCII data. If the format is set to `INT, 32`, it returns `REAL, 32` data.

The command has four types of parameters:

1. Threshold (in dBm)
2. Excursion (in dB)
3. Sorting order (amplitude, frequency, time)
4. Optional in some measurements: Display line use (all, > display line, < display line)

Remote Command	<p>For Swept SA measurement:</p> <pre>:CALCulate:DATA[1] 2 ... 6:PEAKs? <threshold>,<excursion>[,AMPLitude FREQuency TIME[,ALL GTDLine LTDLine]]</pre> <p>For most other measurements:</p> <pre>:CALCulate:DATA[1] 2 ... 6:PEAKs? <threshold>,<excursion>[,AMPLitude FREQuency TIME]</pre>
Notes	Parameters:

<n>	The trace that will be used: [1] 2 ... 6
<threshold>	The level below which trace data peaks are ignored Note that the threshold value is required and is always used as a peak criterion. To effectively disable the threshold criterion for this command, provide a substantially low threshold value such as -200 dBm Note also that the threshold value used in this command is independent of and has no effect on the threshold value stored under the Peak Criteria menu
<excursion>	The minimum amplitude variation (rise and fall) required for a signal to be identified as peak Note that the excursion value is required and is always used as a peak criterion. To effectively disable the excursion criterion for this command, provide the minimum value of 0.0 dB Note also that the excursion value used in this command is independent of and has no effect on the excursion value stored under the Peak Criteria menu

Values must be provided for threshold and excursion. The sorting and display line parameters are optional (defaults are **AMPLitude** and **ALL**)

Note that there is always a Y-axis value for the display line, regardless of whether the display line state is on or off. It is the current Y-axis value of the display line which is used by this command to determine whether a peak should be reported

Sorting order:

AMPLitude	Lists the peaks in order of descending amplitude, with the highest peak first If this optional parameter not sent, this is the default
FREQuency	Lists the peaks in order of occurrence, left to right across the x-axis
TIME	Lists the peaks in order of occurrence, left to right across the x-axis

Peaks vs. Display Line:

ALL	Lists all of the peaks found (default if optional parameter not sent)
GTDLIne	Lists all of the peaks found above the display line

Greater than display line

LTDLine	Lists all of the peaks found below the display line
----------------	---

Less than display line

For example, for Swept SA measurement in Spectrum Analyzer Mode:

:CALC:DATA4:PEAK? -40,10,FREQ,GTDL

Identifies the peaks of trace 4 that are above -40 dBm, with excursions of at least 10 dB. The peaks are returned in order of increasing frequency, starting with the lowest frequency. Only the peaks that are above the display line are returned

Query Results:

If `:FORMat:DATA REAL,32` is selected, returns a list of floating-point numbers. The first value in the list is the number of peak points that are in the following list. A peak point consists of two values: a peak amplitude followed by its corresponding frequency (or time)

If no peaks are found, the peak list consists of only the number of peaks, (0)

9.3.3.7 Smooth Trace Data (Remote Command Only)

Included for ESA compatibility. Not recommended for new designs. Use `:CALCulate:DATA:COMPRESS` instead.

Smooths the trace according to the number of points specified in `:TRACe:MATH:SMOoth:POINTs`. There is no equivalent front panel function.

The purpose of this function is to perform a spatial video averaging, as compared to the temporal version supplied by the video-average command

`[:SENSe]:AVERAge:TYPE VIDEo`. The functions of `:TRACe:MATH:SMOoth <trace>` and `[:SENSe]:AVERAge:TYPE VIDEo|POWer` are not interchangeable.

Backwards Compatibility `:TRACe:MATH:SMOoth TRACE1 | ... | TRACE6`
SCPI

Each point value is replaced with the average of the values of the selected number of points, with half of those points located on each side of any particular point (when possible). Refer to the illustration below, which shows a 401 point trace with a smoothing number of 31. Think of the trace points as “buckets” of data. To smooth (arbitrary) point 273, the instrument averages buckets 258 through 288 and applies that value to point 273.

Increasing the number of points increases smoothing at the cost of decreasing resolution.

The amount of smoothing decreases at the end points. Because `:TRACe:MATH:SMOoth <trace>` averages values that occur before and after the data point in time, display irregularities can be caused at the start and stop frequencies. To avoid possible irregularities (signal distortion) at the ends of the trace, use small values for the smooth parameter.

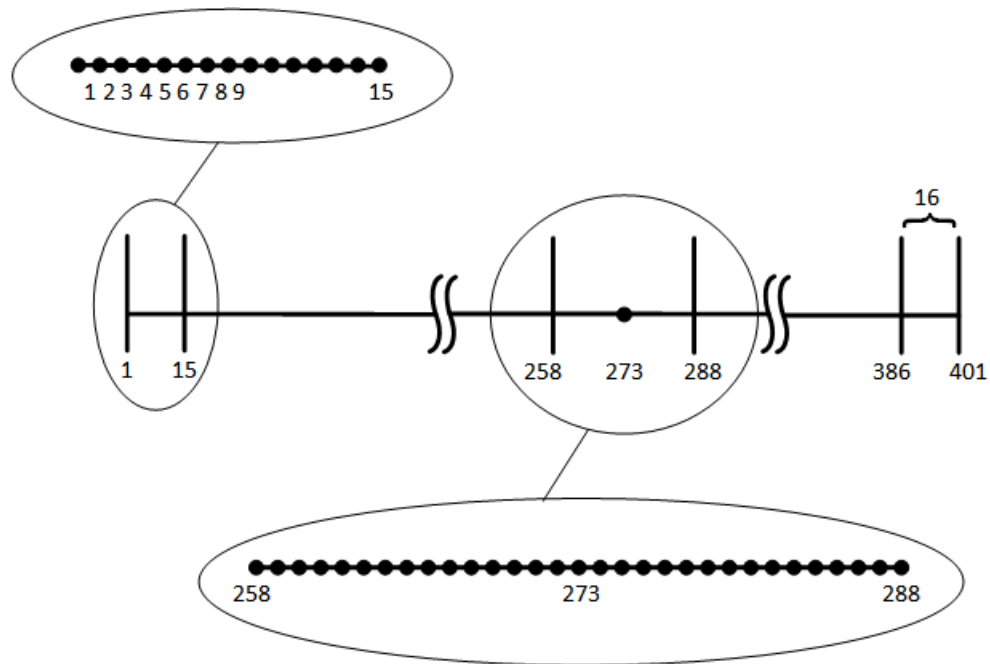

Smoothing With 401 Trace Points and 31 Smoothing Points

Refer to the illustration above for a discussion of this end-point smoothing phenomena. With 31 smoothing points and a 401 point trace, point 16 will be the first point to have full 31-bucket smoothing. Likewise, point 386 will be the last point with full 31-bucket smoothing. Under the conditions stated, points 2 through 15 will be smoothed as follows: Point 2 is derived from averaging buckets 1 through 3. Point 3 is derived from averaging buckets 1 through 5, Point 4 is derived from averaging buckets 1 through 7, and so forth until point 16 is reached. The quantity of buckets used for the smoothing running average increases at the rate of 2 buckets per point, from point 1 to point $([\text{smoothing number}+1]/2)$, at which time the full number of smoothing points is utilized. The same characteristic occurs at the completion of the trace, beginning at point 386, beyond which the number of averaging buckets begins to decrease until point 401 is reached.

By replacing the value of each point in a trace with the average of the values of a number of points centered about that point, any rapid variations in noise or signals are smoothed into more gradual variations. It thereby performs a function similar to reducing the video bandwidth without the corresponding changes in sweep time; as such, frequency resolution is decreased. Also, signal peaks are reduced with large smoothing values. This can cause the amplitude to appear to be less than its actual value.

9.3.3.8 Number of Points for Smoothing (Remote Command Only)

Included for ESA compatibility. Not recommended for new designs. Use `:CALCulate:DATA:COMPRESS` instead.

Specifies the number of points that will be smoothed. Increasing the number of points increases smoothing at the cost of decreasing resolution. If the number of points is an even number, then the number of points is increased by one. If the number of points is larger than the number of sweep points, then the number of sweep points is used, unless the number of sweep points is even, in which case the number of points will be the sweep points minus one. The number of points smoothed is always an odd number.

Example	<code>:TRAC:MATH:SMO:POIN 501</code>
Notes	Only odd values are allowed If an even value of <code><integer></code> is specified, adds 1 unless <code><integer></code> = number of sweep points, in which case subtract 1 Used with <code>TRACe:MATH:SMOoth</code>
Preset	11
Min	3
Max	Number of sweep points
Backwards Compatibility SCPI	<code>:TRACe:MATH:SMOoth:POINTs <integer></code> <code>:TRACe:MATH:SMOoth:POINTs?</code>

9.3.3.9 Mean Trace Data (Remote Command Only)

Included for ESA compatibility. Not recommended for new designs. Use `:CALCulate:DATA:COMPRESS` instead.

Returns the mean of the amplitudes of the trace amplitude elements in measurement units.

Example	<code>:TRAC:MATH:MEAN? TRACE2</code>
Backwards Compatibility SCPI	<code>:TRACe:MATH:MEAN? TRACE1 ... TRACE6</code>

9.4 Status Register System & STATus Subsystem

This section provides an overview of the X-Series SCPI status register system, and how to manage the registers. For detailed programming information on each status register, see ["Status Subsystem Registers and Commands" on page 1516](#).

The SCPI **STATus** Subsystem allows you to monitor a number of status conditions within the instrument through the use of a hierarchy of status registers containing bits which go true or false depending on various conditions.

9.4.1 Status Register System Diagram

The diagram below provides a top-level overview of all the Status Registers and their interconnections.

To navigate to detailed information about each Register, click on a register name:

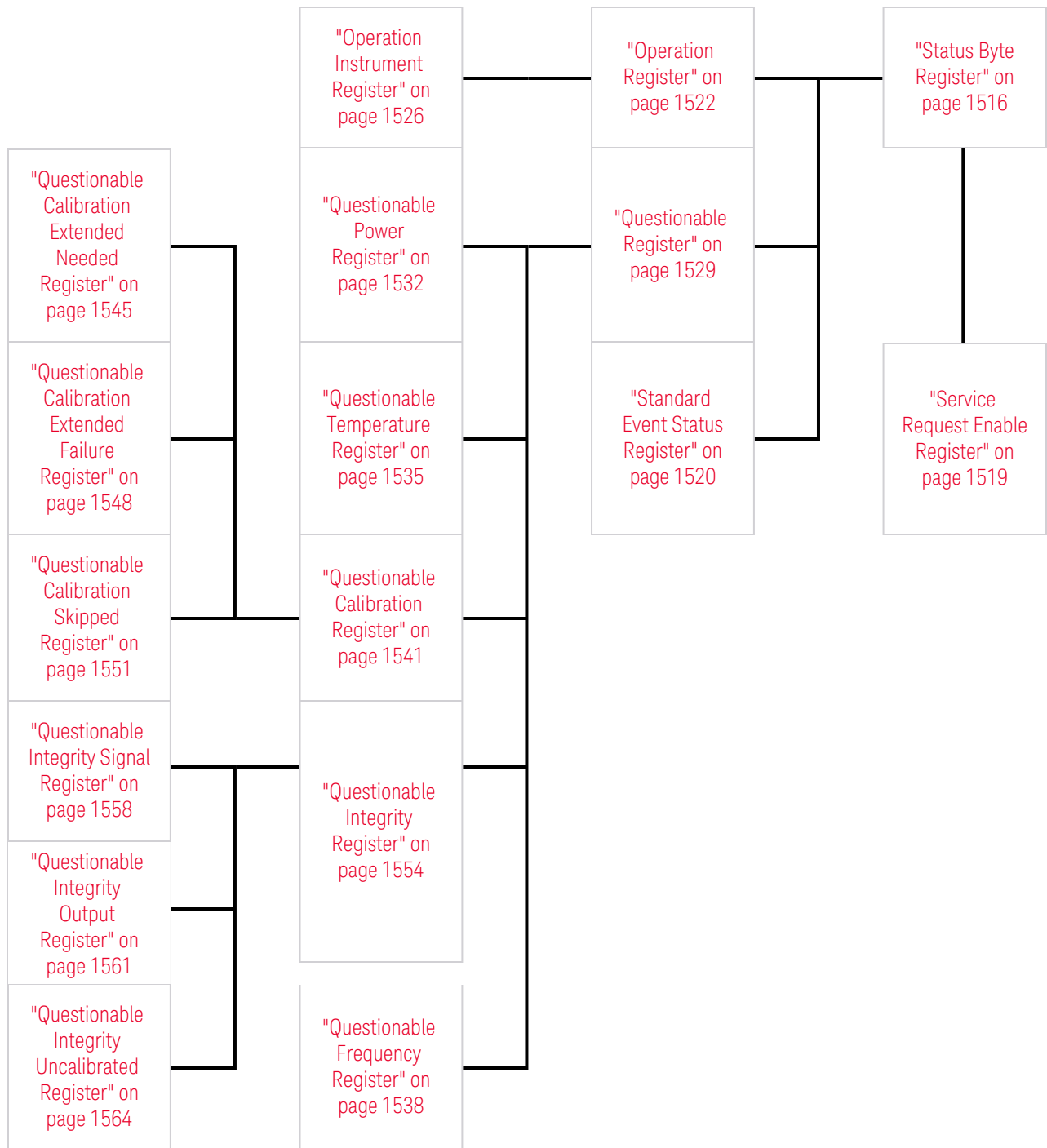

Detailed System Diagram

As from the **X-Apps 2023** update, the fully-detailed system diagram that previously appeared here is still available, but, for improved readability, it is now published as a separate high-resolution PDF. You can download the document from Keysight's web site at:

<http://literature.cdn.keysight.com/litweb/pdf/N9040-90056.pdf>

9.4.2 Status Register Hierarchy

The Status Register system contains multiple registers, arranged in a hierarchy. The lower-level registers propagate their data to the higher-level registers in the data structures by means of summary bits.

The "**Status Byte Register**" on page 1516 is at the top of the hierarchy and contains general status information for the instrument's events and conditions. All other individual registers are used to determine the specific events or conditions.

The "**Operation Register**" on page 1522 and "**Questionable Register**" on page 1529 are sets of registers that monitor the overall instrument condition. They are accessed using **:STATus:OPERation** and **:STATus:QUEStionable** commands in the **STATus** subsystem. Each composite status register set consists of five sub-registers:

1	Condition Register	Reports the real-time state of the signals monitored by this register set. There is no latching or buffering for a condition register
2	Positive Transition Register	Transition Filter Register Controls which signals will set a bit in the event register when the signal makes a low to high transition (when the condition bit changes from 0 to 1)
3	Negative Transition Register	Transition Filter Register Controls which signals will set a bit in the event register when the signal makes a high to low transition (when the condition bit changes from 1 to 0)
4	Event Register	Latches any signal state changes, in the way specified by the filter registers. Bits in the event register are never cleared by signal state changes. Event registers are cleared when read. They are also cleared by *CLS and by presetting the instrument
5	Event Enable Register	Controls which of the bits, being set in the event register, will be summarized as a single output for the register set. Summary bits are then used by the next higher register

Each status register produces a summary message bit.

The diagram below shows how the sub-registers relate to each other.

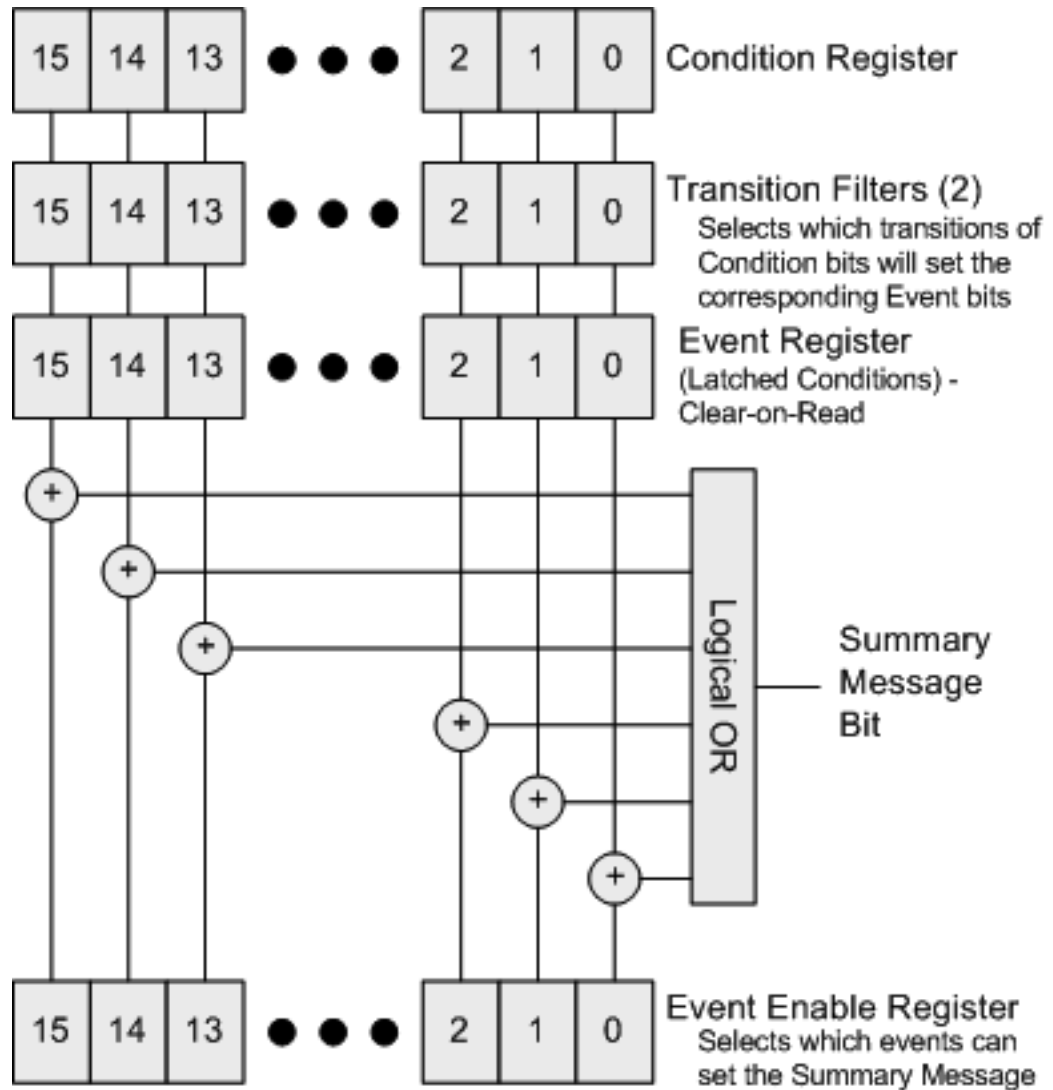

The settings of the Transition Filter registers determine whether or not a bit set in a Condition register ripples through to the Event register, as follows:

- If a bit is set in the Positive Transition register, then the corresponding bit in the Event register is set when the condition bit goes from low to high (false to true, off to on)
- Conversely, if a bit is set in the Negative Transition register then the Event register bit is set when the condition bit goes from high to low
- If *both* Transition Filter registers are set true, then the event bit for that condition is set whenever there is any change in the bit. If an event bit is set, the Event Enable register determines whether or not it will **OR** into the summary bit that is sent to the next level of register. If this bit is set, then the corresponding event bit will be included

Note that the Event register is "Clear-on-Read": when any bit is read, it is automatically cleared.

Questionable Registers

These registers report abnormal operating conditions. The status register hierarchy is:

- The summary outputs from the six [QUESTIONable:<keyword>](#) detail registers are inputs to the ["Questionable Register" on page 1529](#)
- The summary output from the ["Questionable Register" on page 1529](#) is an input to the Status Byte Register
- The summary output from the is an input to the ["Operation Register" on page 1522](#). The inputs to the ["Operation Condition Query" on page 1523](#) Register indicate the real time state of the instrument. The ["Operation Event Query" on page 1524](#) Register summary output is an input to the Status Byte Register

Note that, in E4406A only, the ["Operation Enable" on page 1524](#) Register has an additional function. It is **ANDed** with the ["Operation Condition Query" on page 1523](#) Register to determine the instrument busy state, which is checked by ["*OPC? - Operation Complete" on page 1482](#) and ["*WAI - Wait-to-Continue" on page 1486](#) . If the **ANDed** result is non-zero, the instrument is considered busy.

9.4.3 Status Register SCPI Commands

Monitoring of instrument conditions is done at the highest level using the following IEEE 488.2 common commands.

For complete command descriptions, see ["IEEE 488.2 Common Commands" on page 1479](#). Individual status registers can be set and queried using the commands described in ["Status Subsystem Registers and Commands" on page 1516](#).

*CLS	Clear Status	Clears the status byte by emptying the error queue and clearing all the event registers
*ESE	Event Status	Sets and queries the bits in the enable register part of the standard event status register
*ESE?	Enable	
*ESR?	Event Status Register	Queries and clears the event register part of the standard event status register
*OPC	Operation	Sets the standard event status register to monitor the completion of all commands. The query stops any new commands from being processed until the current processing is complete, then returns a '1'
*OPC?	Complete	
*PSC	Power-on	Sets the power-on state so that it clears the service request enable register and the event status enable register at power on
*PSC?	State Clear	

*SRE	Service Request Enable	Sets and queries the value of the service request enable register
*SRE?		
*STB?	Status Byte	Queries the value of the status byte register without erasing its contents

9.4.4 How to Use Status Registers

A program often needs to be able to detect and manage error conditions or changes in instrument status.

There are two methods you can use to programmatically access the information in status registers:

- The "[Polling Method](#)" on page 1512
- The "[Service Request \(SRQ\) Method](#)" on page 1513

The Polling Method works well if you do not need to know about changes the moment they occur. To detect a change using this method, the program must repeatedly read the registers.

The SRQ Method should be used if you must know immediately when a condition changes.

Either method allows you to monitor one or more conditions.

9.4.4.1 Polling Method

In this method, the instrument has a passive role. It only tells the controller that conditions have changed when the controller asks the right question.

Use this method when:

- your programming language/development environment does not support SRQ interrupts
- you want to write a simple, single-purpose program and don't want the added complexity of setting up an SRQ handler

To monitor a condition:

- Determine which register contains the bit that reports the condition
- Send the unique SCPI query to read that register
- Examine the bit to see if the condition has changed

Monitoring Options

You can monitor conditions in various ways:

- 1 Check the current instrument hardware and firmware status Do this by querying the condition registers, which continuously monitor status. These registers represent the current state of the instrument. Bits in a condition register are updated in real time
When the condition monitored by a particular bit becomes true, the bit is set to 1. When the condition becomes false, the bit is reset to 0
- 2 Monitor a particular condition (bit) You can enable a particular bit(s), using the ["Standard Event Status Enable Register" on page 1521](#). The instrument will then monitor that particular condition. If the bit becomes true (0 to 1 transition) in the Event Register, it will stay set until the Event Register is cleared. Querying the Event Register allows you to detect that this condition occurred, even if the condition no longer exists. The Event Register can only be cleared by querying it, or by sending `*CLS`
- 3 Monitor a particular type of change in a condition (bit) By default, the Transition Registers are set if the condition goes from 0 to 1 (false to true, or a positive transition), but you can change this behavior so the selected condition is detected if the bit goes from 1 to 0 (true to false, or a negative transition)
You can also detect *both* types of transitions, or neither
If both Transition Registers are set to 0 for a particular bit position, that bit is *not* set in the ["Standard Event Status Enable Register" on page 1521](#) for either type of change

9.4.4.2 Service Request (SRQ) Method

In this method, the instrument takes a more active role, by informing the controller when there has been a condition change, without the controller asking.

Use this method when:

- you need time-critical notification of changes
- you are monitoring more than one device which supports SRQs
- you need to have the controller do something else while waiting
- you can't afford the performance penalty inherent to polling

Using the Service Request (SRQ) Method

Your language, bus, and programming environment must be able to support SRQ interrupts, for example, BASIC used with VXI-11.3 (GPIB over LAN). When you monitor a condition with the SRQ method, you must:

- Determine which bit monitors the condition
- Determine how that bit reports to the request service (**RQS**) bit of the status byte
- Send SCPI commands to enable the bit that monitors the condition and to enable the summary bits that report the condition to the **RQS** bit
- Enable the controller to respond to service requests

When the condition changes, the instrument sets its **RQS** bit. The controller is informed of the change as soon as it occurs. As a result, the time the controller would otherwise have used to monitor the condition can be used to perform other tasks. Your program determines how the controller responds to the SRQ.

Bit 6 of the "Status Byte Register" on page 1516 is the request service (**RQS**) bit. Use ***SRE** to configure the **RQS** bit to report changes in instrument status. When such a change occurs, the **RQS** bit is set. It is cleared when the Status Byte Register is queried using ***SRE?** (with a serial poll.) It can be queried *without* erasing the contents by using ***STB?**.

When a register being set causes a summary bit in the status byte to change from 0 to 1, the instrument can initiate the service request (SRQ) process. However, the process is only initiated if *both* the following conditions are true:

The corresponding bit of the service request enable register is also set to 1

The instrument does not have a service request pending. (A service request is considered to be pending between the time the instrument's SRQ process is initiated and the time the controller reads the status byte register)

The SRQ process sets the SRQ true. It also sets the status byte's request service (**RQS**) bit to 1. Both actions are necessary to inform the controller that the instrument requires service. Setting the SRQ line *only* informs the controller that some device on the bus requires service. Setting the **RQS** bit allows the controller to determine which instrument requires service.

If your program enables the controller to detect and respond to service requests, it should instruct the controller to perform a serial poll when the SRQ is set true. Each device on the bus returns the contents of its Status Byte Register in response to this poll. The device whose **RQS** bit is set to 1 is the device that requested service.

NOTE

When you read the instrument's Status Byte Register using a serial poll, the **RQS bit is reset to 0. Other bits in the register are not affected.**

If the status register is configured to SRQ on end-of-measurement, and the measurement is in **Continuous** mode, then restarting a measurement (via **:INIT**) can cause the measuring bit to pulse low. This causes an SRQ even though you have not actually reached the "end-of-measurement" condition. To avoid this:

- Set `:INITiate:CONTinuous OFF`
- Set/enable the status registers
- Restart the measurement (send `:INIT`)

9.4.5 Status Register Bit Parameters

The diagram below shows a typical status register, in this case the "Operation Enable" on page 1524 Register. Each bit in a register is represented by a numerical value based on its location. When a command requires a bit pattern to be sent as its parameter, that can be entered as a numeric value using decimal or hexadecimal representations. (where 0 to 32767 is equivalent to `#H0` to `#H7FFF`). If you want to enable more than one bit, you send the sum of all the bits that you want to monitor.

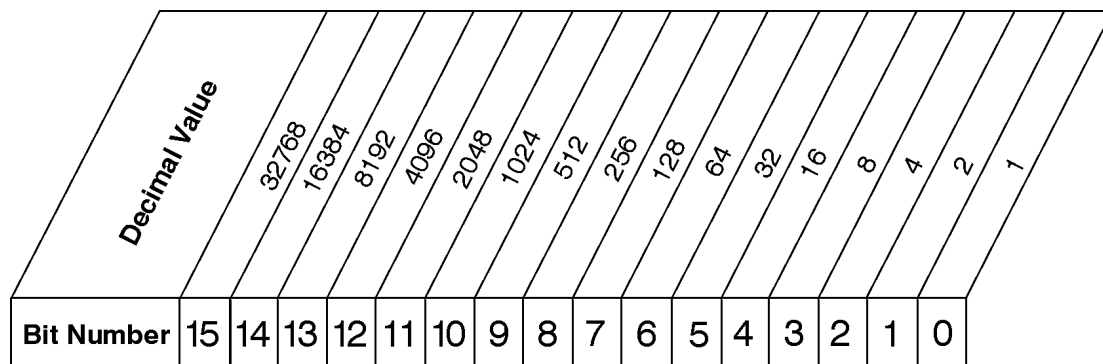

`STATus:OPERation:ENABLE <num>`
`STATus:OPERation:ENABLE?`

Standard Operation Event Enable Register

ck730a

NOTE Bit 15 is not used to report status.

Example 1

To enable bit 0 and bit 6 of standard event status register, you would send the command `*ESE 65` because $1 + 64 = 65$

The results of a query are evaluated in a similar way. If the `*STB?` command returns a decimal value of 140, ($140 = 128 + 8 + 4$) then bit 7 is true, bit 3 is true and bit 2 is true

Example 2

Suppose you want to know if an Auto-trigger Timeout occurs, but you only cared about that specific condition. So you would want to know what was happening with bit 10 in the Status Questionable Integrity register, and not about any other bits

It is usually a good idea to start by clearing all the status registers, using `*CLS`

Sending `:STAT:QUES:INT:ENAB 1024` lets you monitor only bit 10 events, instead of the default monitoring all the bits in the register. The register default is for positive transition events (0 to 1 transition), that is, when an auto-trigger timeout occurs. If instead, you want to know when the Auto-trigger timeout condition is cleared, then you set `:STAT:QUES:INT:PTR 0` and `:STAT:QUES:INT:NTR 32767`

Now, the only output from the "Questionable Integrity Register" on page 1554 will come from a bit 10 positive transition, and goes to the Integrity Sum bit 9 of the "Questionable Register" on page 1529

If you want only to monitor bit 9 of the same register, send `:STAT:QUES:ENAB 512`

The "Questionable Register" on page 1529 output goes to the "Status Questionable Summary" bit 3 of the "Status Byte Register" on page 1516. The output from this register can be enabled using `*SRE 8`.

Finally, you can use the serial polling functionality available for the particular bus/software that you are using to monitor the Status Byte Register, or you could use `*STB?` to poll the Status Byte Register.

9.4.6 Status Subsystem Registers and Commands

The Status Subsystem registers monitor various events and conditions in the instrument. Software written to control the instrument may need to monitor some of these events and conditions.

To set and query status registers, you can use the `STATus` subsystem SCPI commands and queries.

NOTE

All status register commands are sequential. You can send them in the middle of an ongoing overlapped command to get the current status. You can also send them following a sequential command. In this case, the status register command waits for the completion of the previously-sent sequential command before performing the action.

Most commands are sequential commands; only a few are overlapped.

If a command *is* overlapped, then that is explicitly stated in the command description.

See also the [Keysight X-Series Signal Analyzers Instrument Messages](#) manual for more detail on the instrument conditions that can cause these bits to be set.

9.4.6.1 Status Byte Register

Provides a one-byte overview of the entire `STATus` subsystem. All the other registers funnel into this register via summary bits, as shown in the "Status Register System

Diagram" on page 1507.

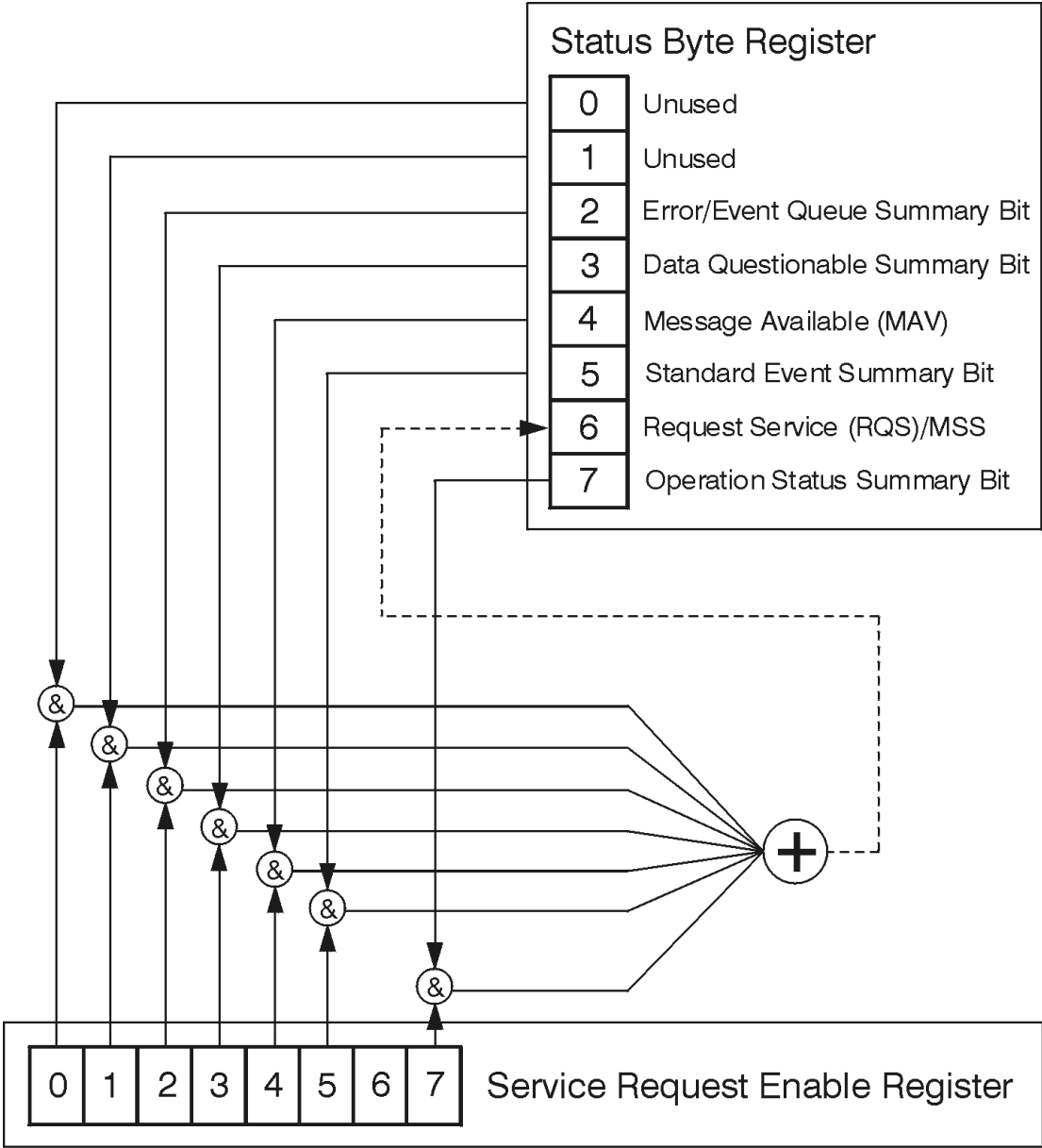

ck776a

Bit Number	7	6	5	4	3	2	1	0
Description	Standard Operation Status Summary Bit	Request Service (RQS) Summary Bit	Standard Event Status Summary Bit	Message Available (MAV)	Data Questionable Status Summary Bit	Error/Event Queue Summary Bit	Unused	Unused

*STB?

Status Byte Register

ck725a

Bit	Description
0, 1	These bits are always set to 0
2	A 1 in this bit position indicates that the SCPI error queue is not empty which means that it contains at least one error message
3	A 1 in this bit position indicates that the data questionable summary bit has been set. The data questionable event register can then be read to determine the specific condition that caused this bit to be set
4	A 1 in this bit position indicates that the instrument has data ready in the output queue. There are no lower status groups that provide input to this bit
5	A 1 in this bit position indicates that the standard event summary bit has been set. The standard event status register can then be read to determine the specific event that caused this bit to be set
6	A 1 in this bit position indicates that the instrument has at least one reason to report a status change. This bit is also called the master summary status bit (MSS)
7	A 1 in this bit position indicates that the standard operation summary bit has been set. The standard operation event register can then be read to determine the specific condition that caused this bit to be set

To query the Status Byte Register, send **"*STB? - Status Byte Query"** on page 1485. The response will be the decimal sum of the bits that are set to 1. For example, if bit number 7 and bit number 3 are set to 1, the decimal sum of the 2 bits is 128 plus 8, so the decimal value 136 is returned.

***STB** does *not* clear the status register.

The **RQS** bit is read and reset by a serial poll. The same bit position (**MSS**) is read non-destructively by ***STB?**. If you serial-poll bit 6, it is read as **RQS**, but if you send ***STB**, it reads bit 6 as **MSS**. For more information refer to Section 11 of: **IEEE Standard 488.2-1992**

In addition to the Status Byte Register, the status byte group also contains the "Service Request Enable Register" on page 1519, which lets you select which bits in the Status Byte Register will trigger a service request.

Service Request Enable Register

Enables the desired bits of the Service Request (SRQ) subsystem.

Send ***SRE <integer>**, where **<integer>** is the sum of the decimal values of the bits you want to enable plus the decimal value of bit 6. For example, assume that you want to enable bit 7 so that whenever the standard operation status register summary bit is set to 1 it will trigger a service request. Send the command ***SRE 192** (because $192 = 128 + 64$). You must always add 64 (the numeric value of RQS bit 6) to your numeric sum when you enable any bits for a service request.

***SRE?** returns the decimal value of the sum of the bits previously enabled with ***SRE <integer>**.

This register presets to zeros (0).

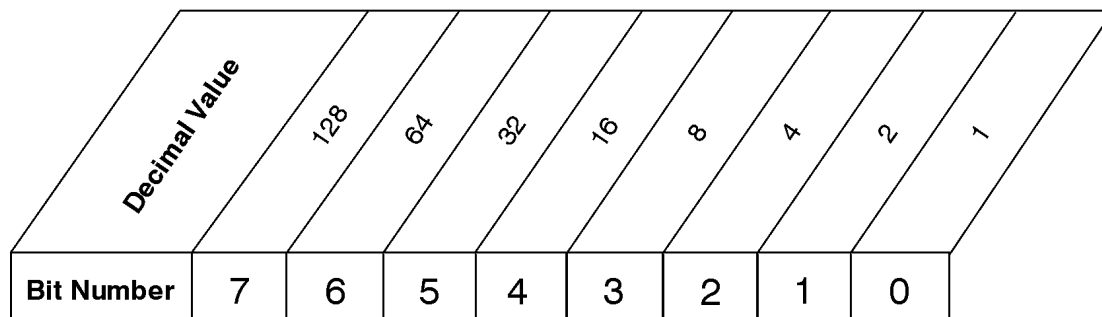

***SRE <num>**
***SRE?**

Service Request Enable Register

ck726a

See also "***SRE - Service Request Enable**" on page 1484

Preset the Status Byte

Sets bits in most of the enable and transition registers to their default state.

- Presets:
- All Transition Filters
- All Enable Registers
- Error/Event Queue Enable

Has no effect on Event Registers, Error/Event QUEue, IEEE 488.2 ESE, and SRE Registers, as described in: [IEEE Standard 488.2-1992](#)

Remote Command :STATus:PRESet

Example :STAT:PRES

9.4.6.2 Standard Event Status Register

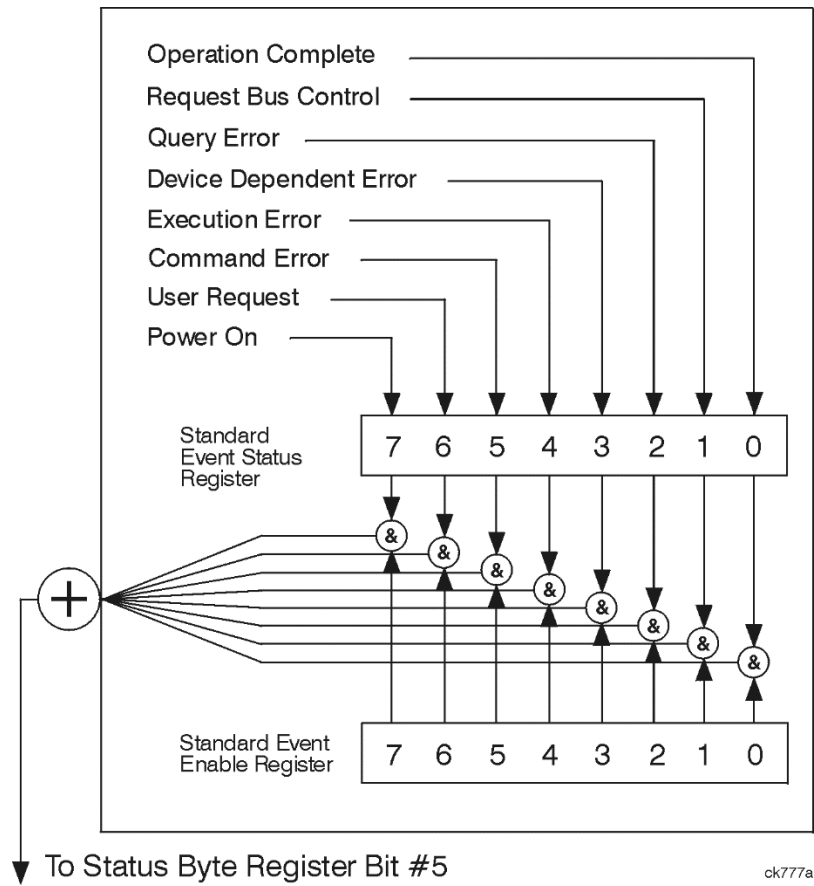

The standard event status register contains the following bits:

	Description	Power On	User Request Key (Local)	Command Error	Execution Error	Device Dependent Error	Query Error	Request Control	Operation Complete
Bit Number	7	6	5	4	3	2	1	0	

*ESR?

Standard Event Status Register

ck727a

Bit	Description
0	A 1 in this bit position indicates that all pending operations were completed following execution of the *OPC command
1	For GPIB handshaking to request control. Currently it is set to 0, because there are no implementations where the spectrum analyzer controls another instrument
2	A 1 in this bit position indicates that a query error has occurred. Query errors have SCPI error numbers from -499 to -400
3	A 1 in this bit position indicates that a device dependent error has occurred. Device dependent errors have SCPI error numbers from -399 to -300 and 1 to 32767
4	A 1 in this bit position indicates that an execution error has occurred. Execution errors have SCPI error numbers from -299 to -200
5	A 1 in this bit position indicates that a command error has occurred. Command errors have SCPI error numbers from -199 to -100
6	A 1 in this bit position indicates that the LOCAL key has been pressed. This is true even if the instrument is in local lockout mode
7	A 1 in this bit position indicates that the instrument has been turned off and then on

The Standard Event Status Register is used to determine the specific events that set bit 5 in the "Status Byte Register" on page 1516. To query this register, send *ESR?. The response will be the decimal sum of the bits that are enabled (set to 1). For example, if bit number 7 and bit number 3 are enabled, the decimal sum of the 2 bits is 128 plus 8, so the decimal value 136 is returned. See also "*ESR? - Standard Event Status Register Query" on page 1481

Standard Event Status Enable Register

In addition to the "Standard Event Status Register" on page 1520, the Standard Event status group also contains a Standard Event Status Enable Register. This

register lets you choose which bits in the standard event status register will set the summary bit (bit 5 of the status byte register) to 1. Send `*ESE <integer>`, where `<integer>` is the sum of the decimal values of the bits you want to enable. For example, to enable bit 7 and bit 6 so that whenever either of those bits is set to 1, the standard event status summary bit of the status byte register will be set to 1, send `*ESE 192` (128 + 64). `*ESE?` returns the decimal value of the sum of the bits previously enabled with `*ESE <integer>`.

The standard event status enable register presets to zeros (0).

Decimal Value									
	128	64	32	16	8	4	2	1	
Bit Number	7	6	5	4	3	2	1	0	

`*ESE <num>`
`*ESE?`

Standard Event Status Enable Register

ck728a

See also ["*ESE - Standard Event Status Enable" on page 1480](#)

9.4.6.3 Operation Register

This register and the ["Questionable Register" on page 1529](#) are sets of registers that monitor the overall instrument condition. They are accessed using `:STATus:OPERation` and `:STATus:QUESTionable`.

This register monitors the current instrument measurement state and various instrument operations for a quick summary of what is happening within the instrument. It checks to see if the instrument is calibrating, sweeping, or waiting for a trigger (see also ["*OPC? - Operation Complete" on page 1482](#)).

Description																
	Always 0	Unused	Unused	Source waiting for trigger	Instrument Summary	DC Coupled	Source sweeping	Paused	Unused	Waiting for Periodic Sync Source	Waiting for trigger	Measuring	Sweeping	Unused	Settling	Calibrating
Bit #	15	14	13	12	11	10	9	8	7	6	5	4	3	2	1	0

STATus:OPERation Register

Bit	Condition	Operation
0	Calibrating	The instrument is busy executing its Align Now process
1	Settling	The instrument circuitry is settling
3	Sweeping	The instrument is busy taking a sweep
4	Measuring	The instrument is busy making a measurement. Measurements often require multiple sweeps. They are initiated by user-interface keys or with the MEASure group of commands The bit is valid for most X-Series Modes
5	Waiting for trigger	The instrument is waiting for the trigger conditions to be met, then it will trigger a sweep or measurement
6	Waiting for Periodic Sync Source	The instrument is waiting for the Periodic trigger Sync Source conditions to be met, then the sweep or measurement period will be synchronized
8	Paused	The measurement is paused
9	Source Sweeping	The List Sequencer is running or Freq Scan results are available
10	DC Coupled	The instrument is DC coupled
11	Instrument Summary	The summary bit for the "Operation Instrument Register" on page 1526
12	Source Waiting for Trigger	The built in source is waiting for a trigger

Filter Registers

- ["Operation Condition Query" on page 1523](#)
- ["Operation Enable" on page 1524](#)
- ["Operation Event Query" on page 1524](#)
- ["Operation Negative Transition" on page 1525](#)
- ["Operation Positive Transition" on page 1525](#)

Operation Condition Query

Returns the decimal value of the sum of the bits in the Status Operation Condition register.

NOTE

The data in this register is continuously updated and reflects the current conditions.

Remote Command

`:STATus:OPERation:CONDition?`

Example	<code>:STAT:OPER:COND?</code>
Preset	0
Status Bits/OPC dependencies	Sequential command

Operation Enable

Determines which bits in the "Operation Event Query" on page 1524 register will set the Operation Status Summary bit (bit 7) in the "Status Byte Register" on page 1516.

The variable `<integer>` is the sum of the decimal values of the bits you want to enable.

NOTE

The preset condition is to have all bits in this enable register set to 0. To have any Operation Events reported to the Status Byte Register, one or more bits need to be set to 1.

Remote Command	<code>:STATus:OPERation:ENABle <integer></code> <code>:STATus:OPERation:ENABle?</code>
Example	<code>:STAT:OPER:ENAB 1</code> Sets the register so that Align Now events will be reported to the Status Byte Register
Preset	0
Min	0
Max	32767
Status Bits/OPC dependencies	Sequential command

Operation Event Query

Returns the decimal value of the sum of the bits in the Operation Event register.

NOTE

The register requires that the associated PTRansition or NTRansition filters be set before a condition register bit can set a bit in the event register. The data in this register is latched until it is queried. Once queried, the register is cleared.

Remote Command	<code>:STATus:OPERation[:EVENT]?</code>
Example	<code>:STAT:OPER?</code>
Preset	0
Status Bits/OPC depend-	Sequential command

encies

Operation Negative Transition

Determines which bits in the "Operation Condition Query" on page 1523 register will set the corresponding bit in the "Operation Event Query" on page 1524 register when the condition register bit has a negative transition (1 to 0).

The variable `<integer>` is the sum of the decimal values of the bits that you want to enable.

Remote Command	<code>:STATus:OPERation:NTRansition <integer></code> <code>:STATus:OPERation:NTRansition?</code>
Example	<code>:STAT:OPER:NTR 1</code> Align Now operation complete will be reported to the Status Byte Register
Preset	0
Min	0
Max	32767
Status Bits/OPC dependencies	Sequential command

Operation Positive Transition

Determines which bits in the "Operation Condition Query" on page 1523 register will set the corresponding bit in the "Operation Event Query" on page 1524 register when the condition register bit has a positive transition (0 to 1).

The variable `<integer>` is the sum of the decimal values of the bits that you want to enable.

Remote Command	<code>:STATus:OPERation:PTRansition <integer></code> <code>:STATus:OPERation:PTRansition?</code>
Example	<code>:STAT:OPER:PTR 1</code> Align Now operation beginning will be reported to the Status Byte Register
Preset	32767
Min	0
Max	32767
Status Bits/OPC dependencies	Sequential command

9.4.6.4 Operation Instrument Register

Monitors instrument-related operations and summarizes them in bit 11 of the "Operation Register" on page 1522.

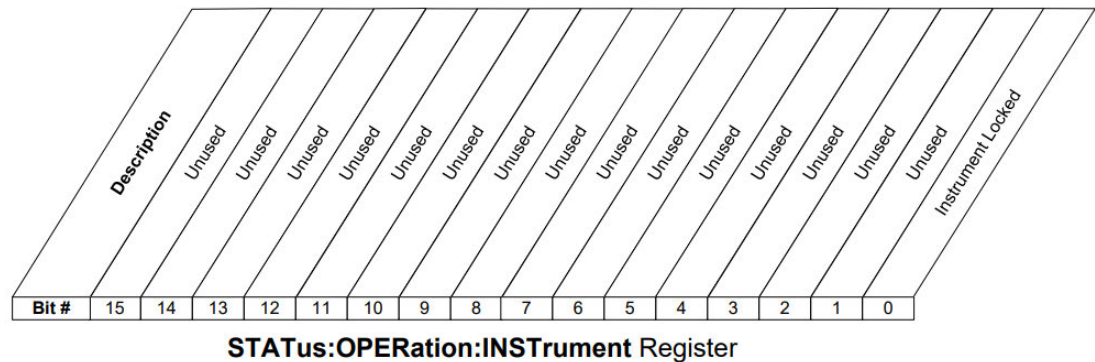

Bit	Condition	Operation
0	Instrument Locked	The instrument is locked

Filter Registers

- "Operation Instrument Condition" on page 1526
- "Operation Instrument Enable" on page 1527
- "Operation Instrument Event Query" on page 1527
- "Operation Instrument Negative Transition" on page 1528
- "Operation Instrument Positive Transition" on page 1528

Operation Instrument Condition

Returns the decimal value of the sum of the bits in the Status Operation Instrument Condition register.

NOTE The data in this register is continuously updated and reflects the current conditions.

Remote Command	:STATUS:OPERation:INSTrument:CONDition?
Example	:STAT:OPER:INST:COND?
Preset	0
Status Bits/OPC dependencies	Sequential command

Operation Instrument Enable

Determines which bits in the "Operation Instrument Condition" on page 1526 Register will set bits in the "Operation Instrument Event Query" on page 1527 register, which also sets the Instrument Summary bit (bit 11) in the "Operation Instrument Register" on page 1526.

The variable `<integer>` is the sum of the decimal values of the bits you want to enable.

NOTE

The preset condition is to have all bits in this enable register set to 0. To have any Instrument Events reported to the Status Byte Register, one or more bits need to be set to 1.

Remote Command	<code>:STATus:OPERation:INSTrument:ENABle <integer></code>
	<code>:STATus:OPERation:INSTrument:ENABle?</code>
Example	<code>:STAT:OPER:INST:ENAB 1</code>
	Sets the register so that Instrument Locked will be reported to the Status Byte Register
Preset	32767
Min	0
Max	32767
Status Bits/OPC dependencies	Sequential command

Operation Instrument Event Query

Returns the decimal value of the sum of the bits in the Operation Instrument Event register.

NOTE

The register requires that the associated PTRansition or NTRansition filters be set before a condition register bit can set a bit in the event register. The data in this register is latched until it is queried. Once queried, the register is cleared.

Remote Command	<code>:STATus:OPERation:INSTrument[:EVENT]?</code>
Example	<code>:STAT:OPER:INST?</code>
Preset	0
Status Bits/OPC dependencies	Sequential command

Operation Instrument Negative Transition

Determines which bits in the "Operation Condition Query" on page 1523 Register will set the corresponding bit in the "Operation Event Query" on page 1524 register when the condition register bit has a negative transition (1 to 0).

The variable `<integer>` is the sum of the decimal values of the bits that you want to enable.

Remote Command	<code>:STATus:OPERation:INSTrument:NTRansition <integer></code> <code>:STATus:OPERation:INSTrument:NTRansition?</code>
Example	<code>:STAT:OPER:INST:NTR 1</code> Instrument Locked being cleared will be reported to the Instrument Summary of the Status Operation register
Preset	0
Min	0
Max	32767
Status Bits/OPC dependencies	Sequential command

Operation Instrument Positive Transition

Determines which bits in the "Operation Condition Query" on page 1523 Register will set the corresponding bit in the "Operation Event Query" on page 1524 register when the condition register bit has a positive transition (0 to 1).

The variable `<integer>` is the sum of the decimal values of the bits that you want to enable.

Remote Command	<code>:STATus:OPERation:INSTrument:PTRansition <integer></code> <code>:STATus:OPERation:INSTrument:PTRansition?</code>
Example	<code>:STAT:OPER:INST:PTR 1</code> Instrument Locked being set will be reported to the Instrument Summary of the Status Operation register
Preset	32767
Min	0
Max	32767
Status Bits/OPC dependencies	Sequential command

9.4.6.5 Questionable Register

This register and the "Operation Register" on page 1522 monitor the overall instrument condition. They are accessed using :STATus:OPERation and :STATus:QUEStionable.

This register monitors the instrument's condition to see if anything questionable has happened. It detects anything that might cause an error or a bad measurement, such as a hardware problem, an out-of-calibration situation, or a unusual signal. All the bits are summary bits from lower-level event registers.

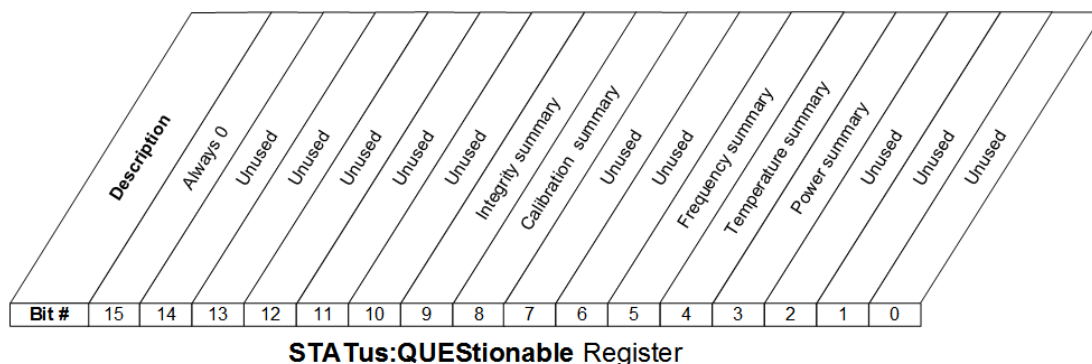

Bit	Condition	Operation
3	Power summary	Summary bit for "Questionable Power Register" on page 1532
4	Temperature summary	Summary bit for "Questionable Temperature Register" on page 1535
5	Frequency summary	Summary bit for "Questionable Frequency Register" on page 1538
8	Calibration summary	Summary bit for "Questionable Calibration Register" on page 1541
9	Integrity summary	Summary bit for "Questionable Integrity Register" on page 1554

Filter Registers

- "Questionable Condition" on page 1530
- "Questionable Enable" on page 1530
- "Questionable Event Query" on page 1531
- "Questionable Negative Transition" on page 1531
- "Questionable Positive Transition" on page 1531

Questionable Condition

Returns the decimal value of the sum of the bits in the Questionable Condition register.

NOTE The data in this register is continuously updated and reflects current conditions.

Remote Command	<code>:STATus:QUEStionable:CONDition?</code>
Example	<code>:STAT:QUES:COND?</code>
Preset	0
Status Bits/OPC dependencies	Sequential command

Questionable Enable

Determines which bits in the "Questionable Event Query" on page 1531 Register will set the Questionable Status Summary bit (bit3) in the "Status Byte Register" on page 1516.

The variable `<integer>` is the sum of the decimal values of the bits you want to enable.

NOTE The preset condition is all bits in this enable register set to 0. To report any Questionable Events to the Status Byte Register, one or more bits need to be set to 1. The "Standard Event Status Register" on page 1520 should be queried after each measurement to check the Questionable Status Summary (bit 3). If it is equal to 1, a condition during the test may have made the test results invalid. If it is equal to 0, this indicates that no hardware problem or measurement problem was detected by the analyzer.

Remote Command	<code>:STATus:QUEStionable:ENABle <integer></code> <code>:STATus:QUEStionable:ENABle?</code> <code>:STATus:OPERation:ENABle <integer></code> <code>:STATus:OPERation:ENABle?</code>
Example	<code>:STAT:QUES:ENAB 16</code> Sets the register so that questionable temperature events will be reported to the Status Byte Register
Preset	0
Min	0
Max	32767
Status Bits/OPC	Sequential command

dependencies

Questionable Event Query

Returns the decimal value of the sum of the bits in the Questionable Event register.

NOTE

The register requires that the associated PTRansition or NTRansition filters be set before a condition register bit can set a bit in the event register. The data in this register is latched until it is queried. Once queried, the register is cleared.

Remote Command	:STATus:QUEStionable[:EVENT]?
Example	:STAT:QUES?
Preset	0
Status Bits/OPC dependencies	Sequential command

Questionable Negative Transition

Determines which bits in the "Questionable Condition" on page 1530 Register will set the corresponding bit in the "Questionable Event Query" on page 1531 Register when the condition register bit has a negative transition (1 to 0).

The variable <integer> is the sum of the decimal values of the bits that you want to enable.

Remote Command	:STATus:QUEStionable:NTRansition <integer> :STATus:QUEStionable:NTRansition?
Example	:STAT:QUES:NTR 16 Temperature summary 'questionable cleared' will be reported to the Status Byte Register
Preset	0
Min	0
Max	32767
Status Bits/OPC dependencies	Sequential command

Questionable Positive Transition

Determines which bits in the "Questionable Condition" on page 1530 Register will set the corresponding bit in the "Questionable Event Query" on page 1531 Register when the condition register bit has a positive transition (0 to 1).

The variable `<integer>` is the sum of the decimal values of the bits that you want to enable.

Remote Command	<code>:STATus:QUESTIONable:PTRansition <integer></code> <code>:STATus:QUESTIONable:PTRansition?</code>
Example	<code>:STAT:QUES:PTR 16</code> Temperature summary 'questionable asserted' will be reported to the Status Byte Register
Preset	32767
Min	0
Max	32767
Status Bits/OPC dependencies	Sequential command

9.4.6.6 Questionable Power Register

Monitors power-related conditions within the instrument and summarizes them in bit 3 of the "Questionable Register" on page 1529.

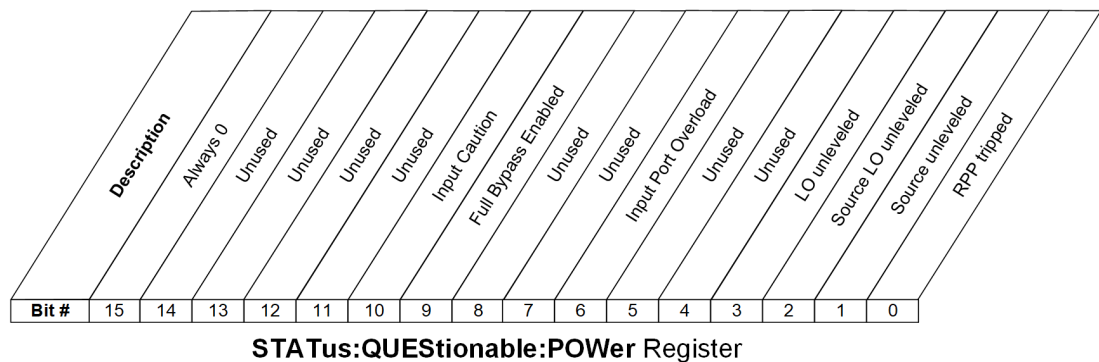

Bit	Condition	Operation
0	RPP tripped	(not currently in use)
1	Source Unleveled	The built-in source is not properly leveled
2	Source LO Unleveled	(not currently in use)
3	LO Unleveled	(not currently in use)
6	Input Port Overload	A power overload condition exists at an input port
9	Full Bypass Enabled	Frontend circuitry is bypassed, use caution to protect the mixer
10	Input Caution	Input circuitry is configured such that care is required to prevent damage

Filter Registers

- "Questionable Power Condition" on page 1533
- "Questionable Power Enable" on page 1533
- "Questionable Power Event Query" on page 1534
- "Questionable Power Negative Transition" on page 1534
- "Questionable Power Positive Transition" on page 1534

Questionable Power Condition

Returns the decimal value of the sum of the bits in the Questionable Power Condition register.

NOTE The data in this register is continuously updated and reflects the current conditions.

Remote Command	:STATus:QUESTionable:POWer:CONDition?
Example	:STAT:QUES:POW:COND?
Preset	0
Status Bits/OPC dependencies	Sequential command

Questionable Power Enable

Determines which bits in the "Questionable Power Condition" on page 1533 Register will set bits in the Questionable Power Event register, which also sets the Power Summary bit (bit 3) in the "Questionable Register" on page 1529.

The variable `<integer>` is the sum of the decimal values of the bits you want to enable.

Remote Command	:STATus:QUESTionable:POWer:ENABle <integer>
Example	:STAT:QUES:POW:ENAB 2
	Source Unlevelled will be reported to the Power Summary of the Status Questionable register
Preset	32767
Min	0
Max	32767
Status Bits/OPC dependencies	Sequential command

Questionable Power Event Query

Returns the decimal value of the sum of the bits in the Questionable Power Event Query register.

NOTE

The register requires that the associated PTRansition or NTRansition filters be set before a condition register bit can set a bit in the event register. The data in this register is latched until it is queried. Once queried, the register is cleared.

Remote Command	:STATus:QUESTionable:POWer[:EVENT]?
Example	:STAT:QUES:POW?
Preset	0
Status Bits/OPC dependencies	Sequential command

Questionable Power Negative Transition

Determines which bits in the "Questionable Power Condition" on page 1533 register will set the corresponding bit in the "Questionable Power Event Query" on page 1534 register when the condition register bit has a negative transition (1 to 0).

The variable <integer> is the sum of the decimal values of the bits that you want to enable.

Remote Command	:STATus:QUESTionable:POWer:NTRansition <integer> :STATus:QUESTionable:POWer:NTRansition?
Example	:STAT:QUES:POW:NTR 2 Source Unlevelled being cleared will be reported to the Power Summary of the Status Questionable register
Preset	0
Min	0
Max	32767
Status Bits/OPC dependencies	Sequential command

Questionable Power Positive Transition

Determines which bits in the "Questionable Power Condition" on page 1533 register will set the corresponding bit in the "Questionable Power Event Query" on page 1534 register when the condition register bit has a positive transition (0 to 1).

The variable `<integer>` is the sum of the decimal values of the bits that you want to enable.

Remote Command	<code>:STATus:QUEStionable:POWer:PTRansition <integer></code>
	<code>:STATus:QUEStionable:POWer:PTRansition?></code>
Example	<code>:STAT:QUES:POW:PTR 32</code> Source Unlevelled being set will be reported to the Power Summary of the Status Questionable register
Preset	32767
Min	0
Max	32767
Status Bits/OPC dependencies	Sequential command

9.4.6.7 Questionable Temperature Register

Monitors temperature-related conditions within the instrument and summarizes them in bit 4 of the "Questionable Register" on page 1529.

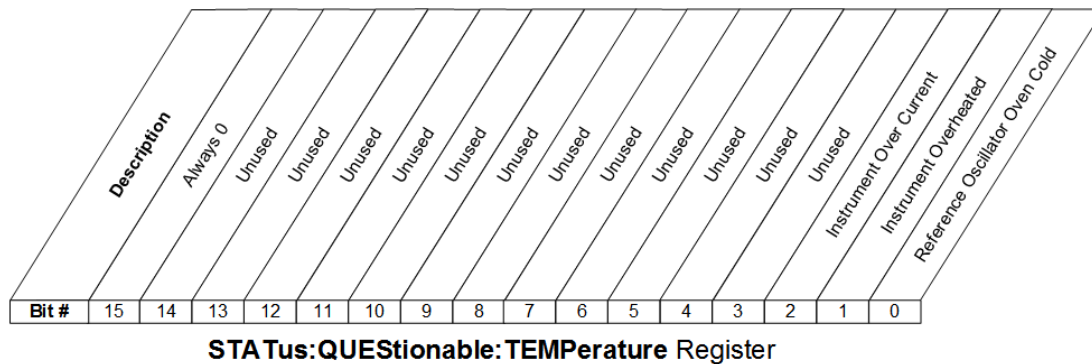

Bit	Condition	Operation
0	Reference Oscillator Oven Cold	(not currently in use)
1	Instrument overheated (over temperature)	Excessive heat has been detected in some part of the instrument
2	Instrument over current	Excessive heat has been detected in some part of the instrument, the instrument should be restarted

Filter Registers

- "Questionable Temperature Condition" on page 1536
- "Questionable Temperature Enable" on page 1536

- "Questionable Temperature Event Query" on page 1537
- "Questionable Temperature Negative Transition" on page 1537
- "Questionable Temperature Positive Transition" on page 1537

Questionable Temperature Condition

Returns the decimal value of the sum of the bits in the Questionable Temperature Condition register.

NOTE

The data in this register is continuously updated and reflects the current conditions.

Remote Command	:STATus:QUEStionable:TEMPerature:CONDition?
Example	:STAT:QUES:TEMP:COND?
Preset	0
Status Bits/OPC dependencies	Sequential command

Questionable Temperature Enable

Determines which bits in the "Questionable Temperature Condition" on page 1536 Register will set bits in the "Questionable Temperature Event Query" on page 1537 register, which also sets the Temperature Summary bit (bit 4) in the "Questionable Register" on page 1529.

The variable `<integer>` is the sum of the decimal values of the bits you want to enable.

Remote Command	:STATus:QUEStionable:TEMPerature:ENABle <integer> :STATus:QUEStionable:TEMPerature:ENABle?
Example	:STAT:QUES:TEMP:ENAB 2 Instrument Overheated will be reported to the Temperature Summary of the Questionable Register
Preset	32767
Min	0
Max	32767
Status Bits/OPC dependencies	Sequential command

Questionable Temperature Event Query

Returns the decimal value of the sum of the bits in the Questionable Temperature Event register.

NOTE The register requires that the associated PTRansition or NTRansition filters be set before a condition register bit can set a bit in the event register. The data in this register is latched until it is queried. Once queried, the register is cleared.

Remote Command	:STATus:QUESTionable:TEMPerature[:EVENT]?
Example	:STAT:QUES:TEMP?
Preset	0
Status Bits/OPC dependencies	Sequential command

Questionable Temperature Negative Transition

Determines which bits in the "Questionable Temperature Condition" on page 1536 Register will set bits in the "Questionable Temperature Event Query" on page 1537 register, when the condition register bit has a negative transition (1 to 0).

The variable <integer> is the sum of the decimal values of the bits that you want to enable.

Remote Command	:STATus:QUESTionable:TEMPerature:NTRansition <integer> :STATus:QUESTionable:TEMPerature:NTRansition?
Example	:STAT:QUES:TEMP:NTR 2 Instrument Overheated being cleared will be reported to the Temperature Summary of the Status Questionable register
Preset	0
Min	0
Max	32767
Status Bits/OPC dependencies	Sequential command

Questionable Temperature Positive Transition

Determines which bits in the "Questionable Temperature Condition" on page 1536 Register will set bits in the "Questionable Temperature Event Query" on page 1537 register, when the condition register bit has a positive transition (0 to 1).

The variable `<integer>` is the sum of the decimal values of the bits that you want to enable.

Remote Command	<code>:STATus:QUESTionable:TEMPerature:PTRansition <integer></code> <code>:STATus:QUESTionable:TEMPerature:PTRansition?</code>
Example	<code>:STAT:QUES:TEMP:PTR 2</code> Instrument Overheated being set will be reported to the Temperature Summary of the Questionable register
Preset	32767
Min	0
Max	32767
Status Bits/OPC dependencies	Sequential command

9.4.6.8 Questionable Frequency Register

Monitors frequency-related conditions within the instrument and summarizes them in bit 5 of the "Questionable Register" on page 1529.

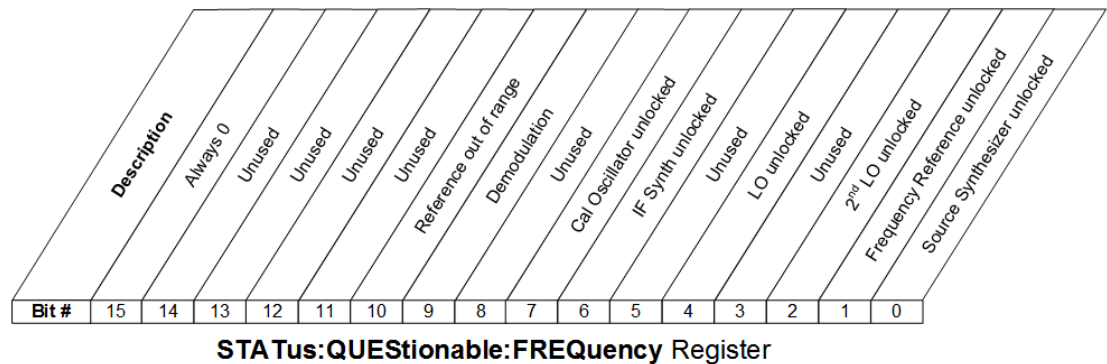

Bit	Condition	Operation
0	Source Synth Unlocked	The synthesizer in the built-in source is not locked
1	Frequency Reference Unlocked	The instrument's frequency reference is unlocked
2	2 nd LO Unlocked	The instrument's second LO (local oscillator) is unlocked
4	LO Unlocked	The instrument's main LO (local oscillator) is unlocked
6	IF Synth Unlocked	The synthesizer in the IF is not locked
7	Cal Osc Unlocked	The oscillator used for internal calibrations is not locked
9	Demodulation	Demodulation cannot be performed due to an out of range frequency

Bit	Condition	Operation
10	Reference missing or out of range	The signal being fed to a reference input is missing or too high or low in frequency for the reference to lock

Filter Registers

- "Questionable Frequency Condition" on page 1539
- "Questionable Frequency Enable" on page 1539
- "Questionable Frequency Event Query" on page 1540
- "Questionable Frequency Negative Transition" on page 1540
- "Questionable Frequency Positive Transition" on page 1541

Questionable Frequency Condition

Returns the decimal value of the sum of the bits in the Questionable Frequency Condition register.

NOTE The data in this register is continuously updated and reflects the current conditions.

Remote Command	:STATus:QUEStionable:FREQuency:CONDition?
Example	:STAT:QUES:FREQ:COND?
Preset	0
Status Bits/OPC dependencies	Sequential command

Questionable Frequency Enable

Determines which bits in the "Questionable Frequency Condition" on page 1539 Register will set bits in the "Questionable Temperature Event Query" on page 1537 register, which also sets the Frequency Summary bit (bit 5) in the "Questionable Register" on page 1529.

The variable `<integer>` is the sum of the decimal values of the bits you want to enable.

Remote Command	:STATus:QUEStionable:FREQuency:ENABle <integer>
Example	:STAT:QUES:FREQ:ENAB 2
	Frequency Reference Unlocked will be reported to the Frequency Summary of the Status Questionable

	register
Preset	32767
Min	0
Max	32767
Status Bits/OPC dependencies	Sequential command

Questionable Frequency Event Query

Returns the decimal value of the sum of the bits in the Questionable Frequency Event register.

NOTE

The register requires that the associated PTRansition or NTRansition filters be set before a condition register bit can set a bit in the event register. The data in this register is latched until it is queried. Once queried, the register is cleared.

Remote Command	<code>:STATus:QUESTionable:FREQuency[:EVENT]?</code>
Example	<code>:STAT:QUES:FREQ?</code>
Preset	0
Status Bits/OPC dependencies	Sequential command

Questionable Frequency Negative Transition

Determines which bits in the "Questionable Frequency Condition" on page 1539 register will set the corresponding bit in the "Questionable Frequency Event Query" on page 1540 register when the condition register bit has a negative transition (1 to 0).

The variable `<integer>` is the sum of the decimal values of the bits that you want to enable.

Remote Command	<code>:STATus:QUESTionable:FREQuency:NTRansition <integer></code> <code>:STATus:QUESTionable:FREQuency:NTRansition?</code>
Example	<code>:STAT:QUES:FREQ:NTR 2</code> Frequency Reference 'regained lock' will be reported to the Frequency Summary of the Status Questionable register
Preset	0
Min	0
Max	32767

Status Bits/OPC dependencies Sequential command

Questionable Frequency Positive Transition

Determines which bits in the "Questionable Frequency Condition" on page 1539 register will set the corresponding bit in the "Questionable Frequency Event Query" on page 1540 register when the condition register bit has a positive transition (0 to 1).

The variable `<integer>` is the sum of the decimal values of the bits that you want to enable.

Remote Command	<code>:STATus:QUESTionable:FREQuency:PTRansition <integer></code>
Example	<code>:STAT:QUES:FREQ:PTR 2</code> Frequency Reference 'became unlocked' will be reported to the Frequency Summary of the Status Questionable register
Preset	32767
Min	0
Max	32767
Status Bits/OPC dependencies	Sequential command

9.4.6.9 Questionable Calibration Register

Monitors calibration-related conditions within the instrument and summarizes them in bit 8 of the "Questionable Register" on page 1529. Three of the bits are summary bits from lower-level event registers.

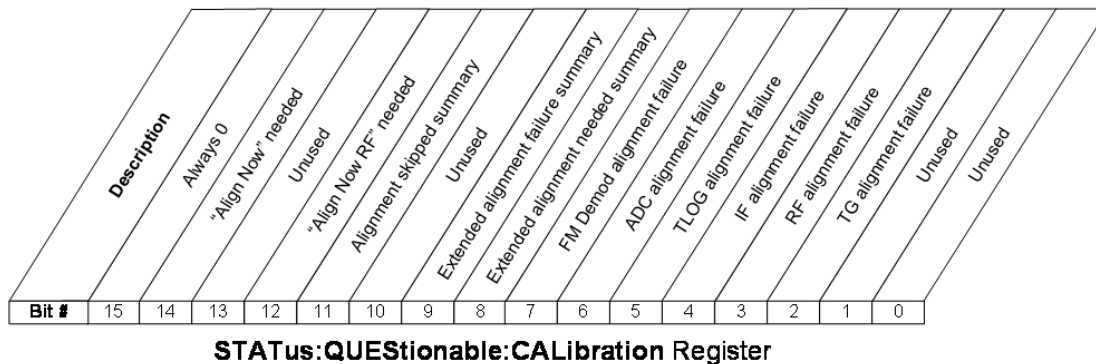

Bit	Condition	Operation
2	TG Alignment Failure	The Tracking Generator failed to align properly
3	RF Alignment Failure	The RF section (frontend) failed to align properly
4	IF Alignment Failure	The IF section failed to align properly
5	LO Alignment Failure	The LO (local oscillator) failed to align properly
6	ADC Alignment Failure	The ADC section failed to align properly
7	FM Demod Alignment Failure	The FM Demod section failed to align properly
8	Extended Align Needed Summary	Summary bit for "Questionable Calibration Extended Needed Register" on page 1545
9	Extended Align Failure Summary	Summary bit for "Questionable Calibration Extended Failure Register" on page 1548
11	Align Skipped Summary	Summary bit for "Questionable Calibration Skipped Register" on page 1551
12	"Align Now RF" required	Go to the System, Alignments, Align Now menu and perform an "Align Now RF"
14	"Align Now" required	Go to the System, Alignments, Align Now menu and perform an "Align Now All" or an "Align Now Expired"

Filter Registers

- "Questionable Calibration Condition" on page 1542
- "Questionable Calibration Enable" on page 1543
- "Questionable Calibration Event Query" on page 1543
- "Questionable Calibration Negative Transition" on page 1544
- "Questionable Calibration Positive Transition" on page 1544

Questionable Calibration Condition

Returns the decimal value of the sum of the bits in the Questionable Calibration Condition register.

NOTE

The data in this register is continuously updated and reflects the current conditions.

Remote Command	<code>:STATus:QUEStionable:CALibration:CONDition?</code>
Example	<code>:STAT:QUES:CAL:COND?</code>
Preset	0
Status Bits/OPC dependencies	Sequential command

Questionable Calibration Enable

Determines which bits in the "Questionable Calibration Condition" on page 1542 Register will set bits in the "Questionable Calibration Event Query" on page 1543 register, which also sets the Calibration Summary bit (bit 8) in the "Questionable Register" on page 1529.

The variable `<integer>` is the sum of the decimal values of the bits you want to enable.

Remote Command	<code>:STATus:QUEStionable:CALibration:ENABle <integer></code> <code>:STATus:QUEStionable:CALibration:ENABle?</code>
Example	<code>:STAT:QUES:CAL:ENAB 16384</code> Can be used to query if an alignment is needed, if you have turned off the automatic alignment process
Min	0
Max	32767
Status Bits/OPC dependencies	Sequential command

Questionable Calibration Event Query

Returns the decimal value of the sum of the bits in the Questionable Calibration Event register.

NOTE The register requires that the associated PTRansition or NTRansition filters be set before a condition register bit can set a bit in the event register. The data in this register is latched until it is queried. Once queried, the register is cleared.

Remote Command	<code>:STATus:QUEStionable:CALibration[:EVENT]?</code>
Example	<code>:STAT:QUES:CAL?</code>
Preset	0
Status Bits/OPC dependencies	Sequential command

Questionable Calibration Negative Transition

Determines which bits in the "Questionable Calibration Condition" on page 1542 register will set the corresponding bit in the "Questionable Calibration Event Query" on page 1543 register when the condition register bit has a negative transition (1 to 0).

The variable `<integer>` is the sum of the decimal values of the bits that you want to enable.

Remote Command	<code>:STATus:QUESTionable:CALibration:NTRansition <integer></code> <code>:STATus:QUESTionable:CALibration:NTRansition?</code>
Example	<code>:STAT:QUES:CAL:NTR 16384</code> "Align All Now Needed" being cleared will be reported to the Calibration Summary of the Status Questionable register
Preset	0
Min	0
Max	32767
Status Bits/OPC dependencies	Sequential command

Questionable Calibration Positive Transition

Determines which bits in the "Questionable Calibration Condition" on page 1542 register will set the corresponding bit in the "Questionable Calibration Event Query" on page 1543 register when the condition register bit has a positive transition (0 to 1).

The variable `<integer>` is the sum of the decimal values of the bits that you want to enable.

Remote Command	<code>:STATus:QUESTionable:CALibration:PTRansition <integer></code> <code>:STATus:QUESTionable:CALibration:PTRansition?</code>
Example	<code>:STAT:QUES:CAL:PTR 16384</code> "Align All Now Needed" being set will be reported to the Calibration Summary of the Status Questionable register
Preset	32767
Min	0
Max	32767
Status Bits/OPC dependencies	Sequential command

9.4.6.10 Questionable Calibration Extended Needed Register

Monitors conditions that occur because a calibration or alignment is required to guarantee accurate measurements. It summarizes them in bit 8 of the "Questionable Calibration Register" on page 1541.

Bit #	Description
15	Always 0
14	Unused
13	Unused
12	Characterize Noise Floor required
11	Characterize Preselector required
10	Unused
9	Unused
8	MPA Align required
7	Unused
6	Unused
5	Align current frequency range required
4	Input attenuation not calibrated
3	Unused
2	Align 30 MHz-1 GHz required
1	Align 9 kHz-30 MHz required
0	Unused

STATus:QUESTIONable:CALibration:EXTended:NEEdeD Register

Bit	Condition	Operation
1	Align 9kHz-30MHz required	EMI receiver alignment required, 9kHz-30 MHz (conducted band)
2	Align 30MHz-1GHz required	EMI receiver alignment required, 30 MHz-1 GHz (radiated band)
4	Input Attenuation not calibrated	The input attenuator is uncalibrated
5	Align current frequency range required	Alignment for current set frequency range is needed. It is suggested to process Align Selected Freq Range for the frequency range in use
8	MPA Align required	The Multiport Adaptor must be calibrated (EXT only)
11	Characterize Preselector required	Go to the System, Alignments, Advanced menu and perform a "Characterize Preselector"
12	Characterize Noise Floor required	Go to the System, Alignments, Advanced menu and perform a "Characterize Noise Floor"

Filter Registers

- "Questionable Calibration Extended Needed Condition" on page 1546
- "Questionable Calibration Extended Needed Enable" on page 1546
- "Questionable Calibration Extended Needed Event Query" on page 1547

- "Questionable Calibration Extended Needed Negative Transition" on page 1547
- "Questionable Calibration Extended Needed Positive Transition" on page 1547

Questionable Calibration Extended Needed Condition

Returns the decimal value of the sum of the bits in the Questionable Calibration Extended Needed Condition register.

NOTE

The data in this register is continuously updated and reflects the current conditions.

Remote Command	:STATus:QUESTionable:CALibration:EXTended:NEEDed:CONDition?
Example	:STAT:QUES:CAL:EXT:NEED:COND?
Preset	0
Status Bits/OPC dependencies	Sequential command

Questionable Calibration Extended Needed Enable

Determines which bits in the "Questionable Calibration Extended Needed Condition" on page 1546 will set bits in the "Questionable Calibration Extended Needed Event Query" on page 1547 register, which also sets bit 14 of the "Questionable Calibration Register" on page 1541.

The variable `<integer>` is the sum of the decimal values of the bits that you want to enable.

Remote Command	:STATus:QUESTionable:CALibration:EXTended:NEEDed:ENABle <integer> :STATus:QUESTionable:CALibration:EXTended:NEEDed:ENABle?
Example	:STAT:QUES:CAL:EXT:NEED:ENAB 2 Can be used to query if an EMI conducted alignment is needed
Preset	32767
Min	0
Max	32767
Status Bits/OPC dependencies	Sequential command

Questionable Calibration Extended Needed Event Query

Returns the decimal value of the sum of the bits in the Questionable Calibration Extended Needed Event register.

NOTE The register requires that the associated PTRansition or NTRansition filters be set before a condition register bit can set a bit in the event register. The data in this register is latched until it is queried. Once queried, the register is cleared.

Remote Command	:STATus:QUESTionable:CALibration:EXTended:NEEDed[:EVENT]?
Example	:STAT:QUES:CAL:EXT:NEED?
Preset	0
Status Bits/OPC dependencies	Sequential command

Questionable Calibration Extended Needed Negative Transition

Determines which bits in the "Questionable Calibration Extended Needed Condition" on page 1546 register will set the corresponding bit in the "Questionable Calibration Extended Needed Event Query" on page 1547 register when the condition register bit has a negative transition (1 to 0).

The variable <integer> is the sum of the decimal values of the bits that you want to enable.

Remote Command	:STATus:QUESTionable:CALibration:EXTended:NEEDed:NTRansition <integer> :STATus:QUESTionable:CALibration:EXTended:NEEDed:NTRansition?
Example	:STAT:QUES:CAL:EXT:NEED:NTR 2 Conducted alignment required bit being cleared will be reported
Preset	0
Min	0
Max	32767
Status Bits/OPC dependencies	Sequential command

Questionable Calibration Extended Needed Positive Transition

Determines which bits in the "Questionable Calibration Extended Needed Condition" on page 1546 register will set the corresponding bit in the "Questionable Calibration

Extended Needed Event Query" on page 1547 register when the condition register bit has a positive transition (0 to 1).

The variable `<integer>` is the sum of the decimal values of the bits that you want to enable.

Remote Command	<code>:STATus:QUESTIONable:CALibration:EXTended:NEEDED:PTRansition <integer></code> <code>:STATus:QUESTIONable:CALibration:EXTended:NEEDED:PTRansition?</code>
Example	<code>:STAT:QUES:CAL:EXT:NEED:PTR 2</code> Conducted alignment required bit being set will be reported
Preset	32767
Min	0
Max	32767
Status Bits/OPC dependencies	Sequential command

9.4.6.11 Questionable Calibration Extended Failure Register

Monitors conditions that occur because a calibration or alignment has failed to complete properly. It summarizes them in bit 9 of the "Questionable Calibration Register" on page 1541.

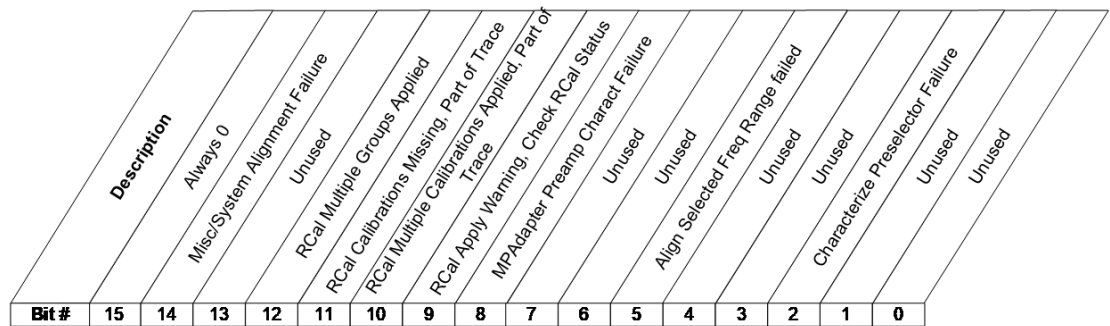

STATus:QUESTIONable:CALibration:EXTended:FAILURE Register

Bit	Condition	Operation
2	Characterize Preselector Failure	The preselector characterization failed
5	Align Selected Freq Range failed	The alignment for selected frequency range failed
8	MPAdapter Preamp Charact Failure	The Multiport Adaptor must be calibrated (EXT only)
9	RCal Apply Warning, Check RCal Status	The calibration request sent to the RCal module failed

Bit	Condition	Operation
10	RCal Multiple Calibrations Applied, Part of Trace	More than one calibration is being applied to part of the trace for current measurement
11	RCal Calibrations Missing, Part of Trace	The calibration being applied is not being applied to all of the trace for the current measurement
12	RCal Multiple Groups Applied	More than one calibrated rows are being applied to the current measurement
14	Misc/System Alignment Failure	Miscellaneous/System alignments have failed

Filter Registers

- ["Questionable Calibration Extended Failure Condition" on page 1549](#)
- ["Questionable Calibration Extended Failure Enable" on page 1549](#)
- ["Questionable Calibration Extended Failure Event Query" on page 1550](#)
- ["Questionable Calibration Extended Failure Negative Transition" on page 1550](#)
- ["Questionable Calibration Extended Failure Positive Transition" on page 1551](#)

Questionable Calibration Extended Failure Condition

Returns the decimal value of the sum of the bits in the Questionable Calibration Extended Failure Condition register.

NOTE

The data in this register is continuously updated and reflects the current conditions.

Remote Command	<code>:STATus:QUEStionable:CALibration:EXTended:FAILure:CONDition?</code>
Example	<code>:STAT:QUES:CAL:EXT:FAIL:COND?</code>
Preset	0
Status Bits/OPC dependencies	Sequential command

Questionable Calibration Extended Failure Enable

Determines which bits in the ["Questionable Calibration Extended Failure Condition" on page 1549](#) Register will set bits in the ["Questionable Calibration Extended Failure Event Query" on page 1550](#) register, which also sets bit 9 of the ["Questionable Calibration Register" on page 1541](#).

The variable `<integer>` is the sum of the decimal values of the bits that you want to enable.

Remote Command	<code>:STATus:QUESTionable:CALibration:EXTended:FAILure:ENABle <integer></code> <code>:STATus:QUESTionable:CALibration:EXTended:FAILure:ENABle?</code>
Example	<code>:STAT:QUES:CAL:EXT:FAIL:ENAB 1</code> Can be used to query if an EMI conducted alignment failed
Preset	32767
Min	0
Max	32767
Status Bits/OPC dependencies	Sequential command

Questionable Calibration Extended Failure Event Query

Returns the decimal value of the sum of the bits in the Questionable Calibration Extended Failure Event register.

NOTE

The register requires that the associated PTRansition or NTRansition filters be set before a condition register bit can set a bit in the event register. The data in this register is latched until it is queried. Once queried, the register is cleared.

Remote Command	<code>:STATus:QUESTionable:CALibration:EXTended:FAILure[:EVENT]?</code>
Example	<code>:STAT:QUES:CAL:EXT:FAIL?</code>
Preset	0
Status Bits/OPC dependencies	Sequential command

Questionable Calibration Extended Failure Negative Transition

Determines which bits in the "Questionable Calibration Extended Failure Condition" on page 1549 register will set the corresponding bit in the "Questionable Calibration Extended Failure Event Query" on page 1550 register when the condition register bit has a negative transition (1 to 0).

The variable `<integer>` is the sum of the decimal values of the bits that you want to enable.

Remote Command	<code>:STATus:QUESTionable:CALibration:EXTended:FAILure:NTRansition <integer></code> <code>:STATus:QUESTionable:CALibration:EXTended:FAILure:NTRansition?</code>
Example	<code>:STAT:QUES:CAL:EXT:FAIL:NTR 1</code>

	Conducted alignment failed bit being cleared will be reported
Preset	0
Min	0
Max	32767
Status Bits/OPC dependencies	Sequential command

Questionable Calibration Extended Failure Positive Transition

Determines which bits in the "Questionable Calibration Extended Failure Condition" on page 1549 register will set the corresponding bit in the "Questionable Calibration Extended Failure Event Query" on page 1550 register when the condition register bit has a positive transition (0 to 1).

The variable `<integer>` is the sum of the decimal values of the bits that you want to enable.

Remote Command	<code>:STATus:QUESTionable:CALibration:EXTended:FAILure:PTRansition <integer></code> <code>:STATus:QUESTionable:CALibration:EXTended:FAILure:PTRansition?</code>
Example	<code>:STAT:QUES:CAL:EXT:FAIL:PTR 1</code> Conducted alignment failed bit being set will be reported
Preset	32767
Min	0
Max	32767
Status Bits/OPC dependencies	Sequential command

9.4.6.12 Questionable Calibration Skipped Register

Monitors conditions that occur because a calibration or alignment has been skipped due to various settings or conditions. It summarizes them in bit 11 of the "Questionable Calibration Register" on page 1541.

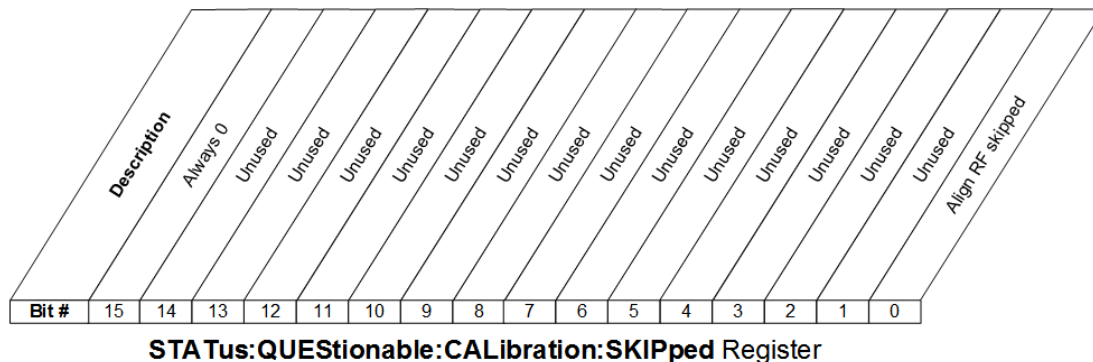

Bit	Condition	Operation
0	Align RF skipped	During an alignment, the calibration of the RF section (frontend) of the instrument was not performed. This can be caused by an interfering user signal present at the RF Input See "Align Now" on page 904, "Align Now All" on page 906

Filter Registers

- "Questionable Calibration Skipped Condition" on page 1552
- "Questionable Calibration Skipped Enable" on page 1553
- "Questionable Calibration Skipped Event Query" on page 1553
- "Questionable Calibration Skipped Negative Transition" on page 1553
- "Questionable Calibration Skipped Positive Transition" on page 1554

Questionable Calibration Skipped Condition

Returns the decimal value of the sum of the bits in the Questionable Calibration Skipped Condition register.

NOTE The data in this register is continuously updated and reflects the current conditions.

Remote Command: `:STATUS:QUESTIONable:CALibration:SKIPPed:CONDition?`

Example: `:STAT:QUES:CAL:SKIP:COND?`

Preset: 0

Status Bits/OPC dependencies: Sequential command

Questionable Calibration Skipped Enable

Determines which bits in the "Questionable Calibration Skipped Condition" on page 1552 Register will set bits in the "Questionable Calibration Skipped Event Query" on page 1553 register, which also sets bit 11 of the "Questionable Calibration Register" on page 1541.

The variable `<integer>` is the sum of the decimal values of the bits that you want to enable.

Remote Command	<code>:STATus:QUESTIONable:CALibration:SKIPped:ENABle <integer></code>
Example	<code>:STAT:QUES:CAL:SKIP:ENAB 1</code> Can be used to query if an RF alignment skipped condition is detected
Preset	32767
Min	0
Max	32767
Status Bits/OPC dependencies	Sequential command

Questionable Calibration Skipped Event Query

Returns the decimal value of the sum of the bits in the Questionable Calibration Event register.

NOTE

The register requires that the associated PTRansition or NTRansition filters be set before a condition register bit can set a bit in the event register. The data in this register is latched until it is queried. Once queried, the register is cleared.

Remote Command	<code>:STATus:QUESTIONable:CALibration:SKIPped[:EVENT]?</code>
Example	<code>:STAT:QUES:CAL:SKIP?</code>
Preset	0
Status Bits/OPC dependencies	Sequential command

Questionable Calibration Skipped Negative Transition

Determines which bits in the "Questionable Calibration Skipped Condition" on page 1552 register will set the corresponding bit in the "Questionable Calibration Skipped

[Event Query" on page 1553](#) register when the condition register bit has a negative transition (1 to 0).

The variable `<integer>` is the sum of the decimal values of the bits that you want to enable.

Remote Command	<code>:STATus:QUESTionable:CALibration:SKIPped:NTRansition <integer></code> <code>:STATus:QUESTionable:CALibration:SKIPped:NTRansition?</code>
Example	<code>:STAT:QUES:CAL:SKIP:NTR 1</code> RF Align Skipped bit being cleared will be reported
Preset	0
Min	0
Max	32767
Status Bits/OPC dependencies	Sequential command

Questionable Calibration Skipped Positive Transition

Determines which bits in the ["Questionable Calibration Skipped Condition" on page 1552](#) register will set the corresponding bit in the ["Questionable Calibration Skipped Event Query" on page 1553](#) register when the condition register bit has a positive transition (0 to 1).

The variable `<integer>` is the sum of the decimal values of the bits that you want to enable.

Remote Command	<code>:STATus:QUESTionable:CALibration:SKIPped:PTRansition <integer></code> <code>:STATus:QUESTionable:CALibration:SKIPped:PTRansition?</code>
Example	<code>:STAT:QUES:CAL:SKIP:PTR 1</code> RF Align Skipped bit being set will be reported
Preset	32767
Min	0
Max	32767
Status Bits/OPC dependencies	Sequential command

9.4.6.13 Questionable Integrity Register

Monitors measurement integrity-related conditions within the instrument and summarizes them in bit 9 of the ["Questionable Register" on page 1529](#). Two of the bits are summary bits from lower-level event registers.

9 Programming the Instrument
 9.4 Status Register System & STATus Subsystem

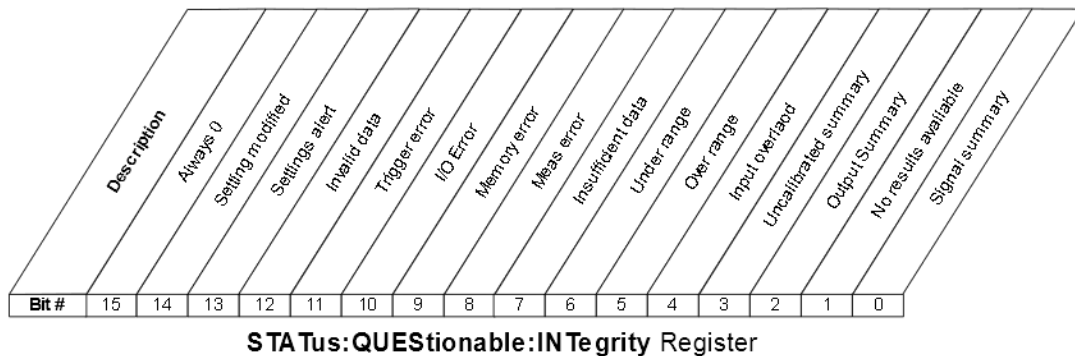

Bit	Condition	Operation
0	Signal Summary	The summary bit for the "Questionable Integrity Signal Register" on page 1558
1	No Result	The current measurement is incompatible with a setting or combination of settings, such as the selected Input, Radio Standard, etc.
2	Output Summary	The summary bit for the "Questionable Integrity Output Register" on page 1561
3	Uncalibrated Summary	The summary bit for the "Questionable Integrity Uncalibrated Register" on page 1564
4	Input Overload	A signal overload condition exists
5	Over Range	The signal at the input for this measurement is too high. You should increase the attenuation or decrease the signal level
6	Under Range	The signal at the input for this measurement is too low. You should decrease the attenuation or increase the signal level
7	Insufficient Data	Signal or settings conditions did not allow enough data to be taken during an acquisition for a valid measurement
8	Meas Error	(not currently in use)
9	Memory Error	There is not enough memory to perform the desired operation
10	I/O Error	I/O settings are preventing communication with an instrument or peripheral
11	Trigger Error	Signal or settings conditions did not allow enough data to be taken during an acquisition for a valid measurement
12	Invalid data	The Invalid Data indicator (* in upper right of display) is on, indicating that onscreen data may be stale and not match the current settings
13	Settings Alert	Settings are not right for a valid measurement, but the instrument is nonetheless allowing a measurement to be taken
14	Setting Modified	Settings are not right for a valid measurement, and the instrument is using different settings than the ones you entered in order to take a measurement

Filter Registers

- "Questionable Integrity Condition" on page 1556
- "Questionable Integrity Enable" on page 1556
- "Questionable Integrity Event Query" on page 1557
- "Questionable Integrity Negative Transition" on page 1557
- "Questionable Integrity Positive Transition" on page 1557

Questionable Integrity Condition

Returns the decimal value of the sum of the bits in the Questionable Integrity Condition register.

NOTE

The data in this register is continuously updated and reflects the current conditions.

Remote Command	:STATus:QUESTionable:INTEgrity:CONDition?
Example	:STAT:QUES:INT:COND?
Preset	0
Status Bits/OPC dependencies	Sequential command

Questionable Integrity Enable

Determines which bits in the "Questionable Integrity Condition" on page 1556 Register will set bits in the "Questionable Integrity Event Query" on page 1557 register, which also sets the Integrity Summary bit (bit 9) in the "Questionable Register" on page 1529.

The variable `<integer>` is the sum of the decimal values of the bits that you want to enable.

Remote Command	:STATus:QUESTionable:INTEgrity:ENABle <integer> :STATus:QUESTionable:INTEgrity:ENABle?
Example	:STAT:QUES:INT:ENAB 8 Uncalibrated Summary will be reported to the Integrity Summary of the Status Questionable register
Preset	32767
Min	0
Max	32767
Status Bits/OPC dependencies	Sequential command

Questionable Integrity Event Query

Returns the decimal value of the sum of the bits in the Questionable Integrity Event register.

NOTE

The register requires that the associated PTRansition or NTRansition filters be set before a condition register bit can set a bit in the event register. The data in this register is latched until it is queried. Once queried, the register is cleared.

Remote Command	:STATus:QuesTionable:INTEgrity[:EVENT]?
Example	:STAT:QUES:INT?
Preset	0
Status Bits/OPC dependencies	Sequential command

Questionable Integrity Negative Transition

Determines which bits in the "Questionable Integrity Condition" on page 1556 register will set the corresponding bit in the "Questionable Integrity Event Query" on page 1557 register when the condition register bit has a negative transition (1 to 0).

The variable <integer> is the sum of the decimal values of the bits that you want to enable.

Remote Command	:STATus:QuesTionable:INTEgrity:NTRansition <integer> :STATus:QuesTionable:INTEgrity:NTRansition?
Example	:STAT:QUES:INT:NTR 8 Uncalibrated Summary being cleared will be reported to the Integrity Summary of the Status Questionable register
Preset	0
Min	0
Max	32767
Status Bits/OPC dependencies	Sequential command

Questionable Integrity Positive Transition

Determines which bits in the "Questionable Integrity Condition" on page 1556 register will set the corresponding bit in the "Questionable Integrity Event Query" on page 1557 register when the condition register bit has a positive transition (0 to 1).

The variable `<integer>` is the sum of the decimal values of the bits that you want to enable.

Remote Command	<code>:STATus:QUEStionable:INTEgrity:PTRansition <integer></code> <code>:STATus:QUEStionable:INTEgrity:PTRansition?</code>
Example	<code>:STAT:QUES:INT:PTR 8</code> Uncalibrated Summary being set will be reported to the Integrity Summary of the Status Questionable register
Preset	32767
Min	0
Max	32767
Status Bits/OPC dependencies	Sequential command

9.4.6.14 Questionable Integrity Signal Register

Monitors conditions that occur because a measurement may not be able to return an accurate or valid result due to signal conditions. It summarizes them in bit 0 of the "Questionable Integrity Register" on page 1554.

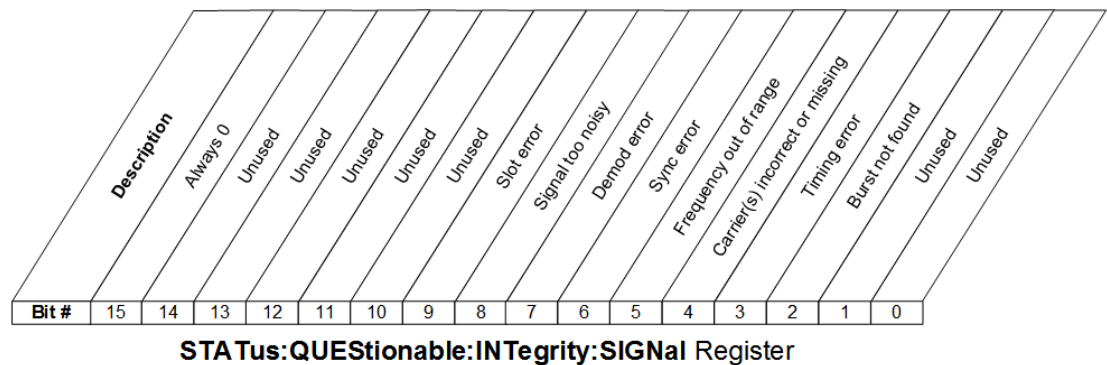

Bit	Condition	Operation
2	Burst not found	The instrument is expecting a bursted signal but such a signal cannot be detected because of inappropriate parameter settings or incorrect signal content
3	Timing Error	The instrument cannot establish appropriate timing from the signal
4	Carrier(s) incorrect or missing	The instrument cannot find the expected carrier(s) within the frequency ranges in which it is looking
5	Frequency out of range	One or more system or signal input frequencies are out of range
6	Sync error	The instrument cannot establish sync with the measured signal
7	Demod error	The instrument cannot demodulate the signal due to inappropriate

Bit	Condition	Operation
		signal or settings conditions
8	Signal Too Noisy	The instrument cannot measure the desired signal because it is too noisy
9	Slot Error	No valid signal slot found in captured data

Filter Registers

- ["Questionable Integrity Signal Condition" on page 1559](#)
- ["Questionable Integrity Signal Enable" on page 1559](#)
- ["Questionable Integrity Signal Event Query" on page 1560](#)
- ["Questionable Integrity Signal Negative Transition" on page 1560](#)
- ["Questionable Integrity Signal Positive Transition" on page 1561](#)

Questionable Integrity Signal Condition

Returns the decimal value of the sum of the bits in the Questionable Integrity Signal Condition register.

NOTE

The data in this register is continuously updated and reflects the current conditions.

Remote Command	<code>:STATus:QUESTionable:INTEgrity:SIGNal:CONDition?</code>
Example	<code>:STAT:QUES:INT:SIGN:COND?</code>
Preset	0
Status Bits/OPC dependencies	Sequential command

Questionable Integrity Signal Enable

Determines which bits in the ["Questionable Integrity Signal Condition" on page 1559](#) Register will set bits in the ["Questionable Integrity Signal Event Query" on page 1560](#) register, which also sets the Integrity Summary bit (bit 9) in the ["Questionable Register" on page 1529](#).

The variable `<integer>` is the sum of the decimal values of the bits that you want to enable.

Remote	<code>:STATus:QUESTionable:INTEgrity:SIGNal:ENABLE <integer></code>
--------	---

Command	<code>:STATus:QUESTionable:INTEgrity:SIGNal:ENABle?</code>
Example	<code>:STAT:QUES:INT:SIGN:ENAB 4</code> Burst Not Found will be reported to the Integrity Summary of the Status Questionable register
Preset	32767
Min	0
Max	32767
Status Bits/OPC dependencies	Sequential command

Questionable Integrity Signal Event Query

Returns the decimal value of the sum of the bits in the Questionable Integrity Signal Event register.

NOTE

The register requires that the associated PTRansition or NTRansition filters be set before a condition register bit can set a bit in the event register. The data in this register is latched until it is queried. Once queried, the register is cleared.

Remote Command	<code>:STATus:QUESTionable:INTEgrity:SIGNal[:EVENT]?</code>
Example	<code>:STAT:QUES:INT:SIGN?</code>
Preset	0
Status Bits/OPC dependencies	Sequential command

Questionable Integrity Signal Negative Transition

Determines which bits in the "Questionable Integrity Signal Condition" on page 1559 register will set the corresponding bit in the "Questionable Integrity Signal Event Query" on page 1560 register when the condition register bit has a negative transition (1 to 0).

The variable `<integer>` is the sum of the decimal values of the bits that you want to enable.

Remote Command	<code>:STATus:QUESTionable:INTEgrity:SIGNal:NTRansition <integer></code> <code>:STATus:QUESTionable:INTEgrity:SIGNal:NTRansition?</code>
Example	<code>:STAT:QUES:INT:SIGN:NTR 4</code> Burst not found being cleared will be reported to the Integrity Summary of the Status Questionable register
Preset	0

Min	0
Max	32767
Status Bits/OPC dependencies	Sequential command

Questionable Integrity Signal Positive Transition

Determines which bits in the "Questionable Integrity Signal Condition" on page 1559 register will set the corresponding bit in the "Questionable Integrity Signal Event Query" on page 1560 register when the condition register bit has a positive transition (0 to 1).

The variable `<integer>` is the sum of the decimal values of the bits that you want to enable.

Remote Command	<code>:STATus:QUEStionable:INTEgrity:SIGNal:PTRansition <integer></code> <code>:STATus:QUEStionable:INTEgrity:SIGNal:PTRansition?</code>
Example	<code>:STAT:QUES:INT:SIGN:PTR 4</code> Burst not found being set will be reported to the Integrity Summary of the Status Questionable register
Preset	32767
Min	0
Max	32767
Status Bits/OPC dependencies	Sequential command

9.4.6.15 Questionable Integrity Output Register

Monitors conditions that occur in connection status currently limited to ODI streaming . It summarizes them in bit 2 of the "Questionable Integrity Register" on page 1554.

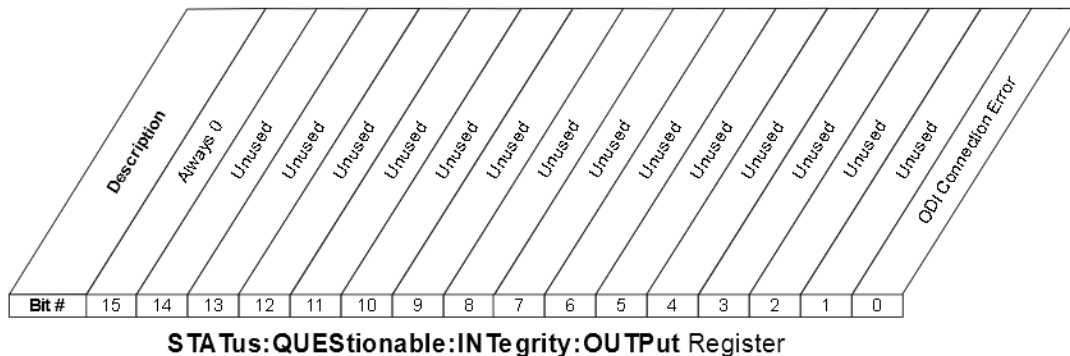

Bit	Condition	Operation
0	ODI Connection Error	ODI Connection Error This bit is never triggered, only its aliases are

Filter Registers

- "Questionable Integrity Output Condition" on page 1562
- "Questionable Integrity Output Enable" on page 1562
- "Questionable Integrity Output Event Query" on page 1563
- "Questionable Integrity Output Negative Transition" on page 1563
- "Questionable Integrity Output Positive Transition" on page 1564

Questionable Integrity Output Condition

Returns the decimal value of the sum of the bits in the Questionable Integrity Output Condition register.

NOTE

The data in this register is continuously updated and reflects the current conditions.

Remote Command	<code>:STATus:QUESTionable:INTEgrity:OUTPut:CONDition?</code>
Example	<code>:STAT:QUES:INT:OUTP:COND?</code>
Preset	0
Status Bits/OPC dependencies	Sequential command

Questionable Integrity Output Enable

Determines which bits in the "Questionable Integrity Output Condition" on page 1562 register will set the corresponding bit in the "Questionable Integrity Output Event Query" on page 1563 register, which also sets the Data Output Summary bit (bit 2) in the "Questionable Integrity Register" on page 1554.

The variable `<integer>` is the sum of the decimal values of the bits that you want to enable.

Remote Command	<code>:STATus:QUESTionable:INTEgrity:OUTPut:ENABLE</code> <code>:STATus:QUESTionable:INTEgrity:OUTPut:ENABLE?</code>
Example	<code>:STAT:QUES:INT:OUTP:ENAB 1</code>

	Oversweep (Meas Uncal) is reported to the Integrity Summary of the Status Questionable register
Preset	32767
Min	0
Max	32767
Status Bits/OPC dependencies	Sequential command

Questionable Integrity Output Event Query

Returns the decimal value of the sum of the bits in the "Questionable Integrity Output Condition" on page 1562 register.

NOTE The register requires that the associated PTRansition or NTRansition filters be set before a condition register bit can set a bit in the event register. The data in this register is latched until it is queried. Once queried, the register is cleared.

Remote Command	:STATus:QUESTionable:INTEgrity:OUTPut[:EVENT]?
Example	:STAT:QUES:INT:OUTP?
Preset	0
Status Bits/OPC dependencies	Sequential command

Questionable Integrity Output Negative Transition

Determines which bits in the "Questionable Integrity Output Condition" on page 1562 register will set the corresponding bit in the "Questionable Integrity Output Event Query" on page 1563 register when the condition register bit has a negative transition (1 to 0).

The variable <integer> is the sum of the decimal values of the bits that you want to enable.

Remote Command	:STATus:QUESTionable:INTEgrity:OUTPut:NTRansition <integer> :STATus:QUESTionable:INTEgrity:OUTPut:NTRansition?
Example	:STAT:QUES:INT:OUTP:NTR 1
	Oversweep cleared is reported to the Integrity Summary of the Status Questionable register
Preset	0
Min	0
Max	32767
Status Bits/OPC dependencies	Sequential command

Questionable Integrity Output Positive Transition

Determines which bits in the "Questionable Integrity Output Condition" on page 1562 register will set the corresponding bit in the "Questionable Integrity Output Event Query" on page 1563 register when the condition register bit has a positive transition (0 to 1).

The variable `<integer>` is the sum of the decimal values of the bits that you want to enable.

Remote Command	<code>:STATus:QUESTionable:INTEgrity:OUTPut:PTRansition <integer></code> <code>:STATus:QUESTionable:INTEgrity:OUTPut:PTRansition?</code>
Example	<code>:STAT:QUES:INT:OUTP:PTR 1</code> Oversweep set is reported to the Integrity Summary of the Status Questionable register
Preset	32767
Min	0
Max	32767
Status Bits/OPC dependencies	Sequential command

9.4.6.16 Questionable Integrity Uncalibrated Register

Monitors conditions that occur because a measurement may not be able to return an accurate or valid result due to a mismatch between instrument settings and the signal, placing the instrument in an uncalibrated state for that signal. It summarizes them in bit 3 of the "Questionable Integrity Register" on page 1554.

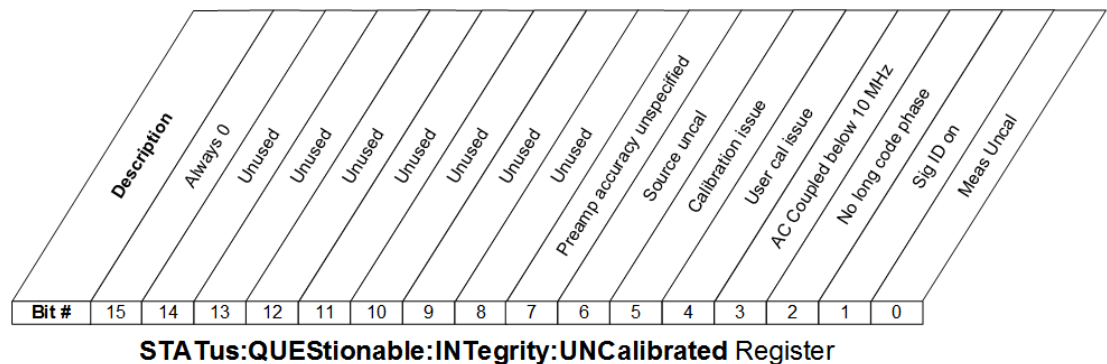

Bit	Condition	Operation
0	Meas Uncal	A Meas Uncal warning is being displayed; generally this means the sweep time must be reduced or the RBW increased
1	Signal ID on	In external mixing, the Sig ID function is on, which will impact the

Bit	Condition	Operation
		trace results
2	No Long Code Phase	The long code phase that identifies an access channel cannot be found (WCDMA)
3	AC coupled: Accy unspec'd <10 MHz	The instrument is AC coupled but is operating below 10 MHz, where the blocking capacitor will impact measurement accuracy
4	User cal issue	In noise figure measurements, the User Cal has not been performed or has been invalidated
5	Calibration issue	In noise figure measurements, one or more calibration or measurement frequency point exceeds the currently loaded Cal or Meas ENR Table frequency ranges
6	Source uncal	While using a Tracking Source, settings are putting it into an uncalibrated operational state
7	Preamp accuracy unspecified below XX MHz	The preamp is being used but is operating below frequencies for which its accuracy is specified

Filter Registers

- ["Questionable Integrity Uncalibrated Condition" on page 1565](#)
- ["Questionable Integrity Uncalibrated Enable" on page 1566](#)
- ["Questionable Integrity Uncalibrated Event Query" on page 1566](#)
- ["Questionable Integrity Uncalibrated Negative Transition" on page 1566](#)
- ["Questionable Integrity Uncalibrated Positive Transition" on page 1567](#)

Questionable Integrity Uncalibrated Condition

Returns the decimal value of the sum of the bits in the Questionable Integrity Uncalibrated Condition register.

NOTE

The data in this register is continuously updated and reflects the current conditions.

Remote Command	<code>:STATus:QUESTionable:INTegrity:UNCalibrated:CONDition?</code>
Example	<code>:STAT:QUES:INT:UNC:COND?</code>
Preset	0
Status Bits/OPC dependencies	Sequential command

Questionable Integrity Uncalibrated Enable

Determines which bits in the "Questionable Integrity Uncalibrated Condition" on page 1565 Register will set bits in the "Questionable Integrity Uncalibrated Event Query" on page 1566 register, which also sets the Data Uncalibrated Summary bit (bit 3) in the "Questionable Integrity Register" on page 1554.

The variable `<integer>` is the sum of the decimal values of the bits that you want to enable.

Remote Command	<code>:STATus:QUESTionable:INTEgrity:UNCalibrated:ENABle</code>
Example	<code>:STAT:QUES:INT:UNC:ENAB 1</code> Oversweep (Meas Uncal) is reported to the Integrity Summary of the Status Questionable register
Preset	32767
Min	0
Max	32767
Status Bits/OPC dependencies	Sequential command

Questionable Integrity Uncalibrated Event Query

Returns the decimal value of the sum of the bits in the "Questionable Integrity Uncalibrated Condition" on page 1565 register.

NOTE

The register requires that the associated PTRansition or NTRansition filters be set before a condition register bit can set a bit in the event register. The data in this register is latched until it is queried. Once queried, the register is cleared.

Remote Command	<code>:STATus:QUESTionable:INTEgrity:UNCalibrated[:EVENT]?</code>
Example	<code>:STAT:QUES:INT:UNC?</code>
Preset	0
Status Bits/OPC dependencies	Sequential command

Questionable Integrity Uncalibrated Negative Transition

Determines which bits in the "Questionable Integrity Uncalibrated Condition" on page 1565 register will set the corresponding bit in the "Questionable Integrity

"Uncalibrated Event Query" on page 1566 register when the condition register bit has a negative transition (1 to 0).

The variable `<integer>` is the sum of the decimal values of the bits that you want to enable.

Remote Command	<code>:STATus:QUESTionable:INTEgrity:UNCalibrated:NTRansition <integer></code> <code>:STATus:QUESTionable:INTEgrity:UNCalibrated:NTRansition?</code>
Example	<code>:STAT:QUES:INT:UNC:NTR 1</code> Oversweep cleared is reported to the Integrity Summary of the Status Questionable register
Preset	0
Min	0
Max	32767
Status Bits/OPC dependencies	Sequential command

Questionable Integrity Uncalibrated Positive Transition

Determines which bits in the "Questionable Integrity Uncalibrated Condition" on page 1565 register will set the corresponding bit in the "Questionable Integrity Uncalibrated Event Query" on page 1566 register when the condition register bit has a positive transition (0 to 1).

The variable `<integer>` is the sum of the decimal values of the bits that you want to enable.

Remote Command	<code>:STATus:QUESTionable:INTEgrity:UNCalibrated:PTRansition <integer></code> <code>:STATus:QUESTionable:INTEgrity:UNCalibrated:PTRansition?</code>
Example	<code>:STAT:QUES:INT:UNC:PTR 1</code> Oversweep set is reported to the Integrity Summary of the Status Questionable register
Preset	32767
Min	0
Max	32767
Status Bits/OPC dependencies	Sequential command

10 Hardware-Accelerated Fast Power Measurement (Remote Command Only)

The **Fast Power** option (FP2) enables very fast channel power measurements for instruments with the prerequisite hardware (DP2 and/or B40). It accomplishes this by performing real-time overlapped FFTs at the hardware layer, using software for basic post-processing before returning the result to the user. The upshot of this approach is improved throughput for user applications that require many sequential power measurements.

The analysis bandwidth of FP2 may be limited by the licenses in the instrument.

NOTE

FP2 is remote-only, which means the instrument does not switch to any particular mode or measurement. FP2 commands can be sent while another application is in use on the front panel.

Each Fast Power measurement can be predefined using an array index, and up to 1,000 measurements can be stored. In the following documentation, instances of [1,2,...,999] can be substituted with a particular measurement index, for example, `:CALC:FPOW:POW1?`, `:CALC:FPOW:POW2?`, `:CALC:FPOW:POW134?`. In this way, power measurements can be defined one time in a batch, and then executed multiple times without having to redefine them, similar to “list mode” on other measurements.

In addition to basic channel power measurements, there are a number of other measurement “functions” for each channel, including peak power, peak frequency, and power spectral density.

10.1 Reset Fast Power Measurement (Remote Command Only)

Resets the measurement configuration to the defaults.

Remote Command	<code>:CALCulate:FPOWer:POWer[1,2,...,999]:RESet</code>
----------------	---

Example	<code>:CALC:FPOW:POW1:RES</code>
---------	----------------------------------

Notes	Option FP2 is required
-------	------------------------

10.2 Reset Fast Power Measurement (Remote Command Only)

Resets the measurement configuration to the defaults.

Remote Command	<code>:CALCulate:FPOWer:POWer[1,2,...,999]:RESet</code>
Example	<code>:CALC:FPOW:POW1:RES</code>
Notes	Option FP2 is required

10.2.1 Acquisition Time

Example	<code>:CALC:FPOW:POW1:DEF "AcquisitionTime=0.002"</code>
Notes	Sets the time in which the entire spectrum is measured. An increase in the acquisition time yields an improvement in measurement repeatability
Preset	0.001 s
Range	0 s to 1 s

10.2.2 Center Frequency

Example	<code>:CALC:FPOW:POW1:DEF "CenterFrequency=2e9"</code>
Notes	Sets the frequency in which the measurement is centered around. "Channel Offset Frequency Array" on page 1577 is calculated relative to the center frequency
Preset	1 GHz
Range	0 Hz to maximum instrument frequency

10.2.3 DC Coupled

Example	<code>:CALC:FPOW:POW1:DEF "DCCoupled=True"</code>
Notes	Allows you to specify whether the DC blocking capacitor is utilized. Set to True when measuring frequencies below 10 MHz
Preset	False
Range	True (DC Coupled) or False (AC Coupled)

10.2.4 Detector Type

Example	<code>:CALC:FPOW:POW1:DEF "DetectorType=Peak"</code>
---------	--

10 Hardware-Accelerated Fast Power Measurement (Remote Command Only)
 10.2 Reset Fast Power Measurement (Remote Command Only)

Notes	Option FP2 is required Allows you to choose whether a RMS average or peak value is used during the measurement
Preset	RmsAverage
Range	RmsAverage, Peak

10.2.5 Do Noise Correction

Example	<code>:CALC:FPOW:POW1:DEF "DoNoiseCorrection=True"</code>
Notes	When noise correction is enabled, the linear noise power contributed by the instrument is subtracted from all measurements. This effectively lowers the noise floor of the instrument When noise correction is enabled, the first measurement for a given set of input parameters will take extra time. This is because the instrument takes an extra acquisition with the RF input disconnected from the instrument's front end to measure the noise of just the instrument. The measured noise floor is stored in a cache so the noise acquisition will occur only once for the same state settings. In other words, if noise correction was turned on and the instrument made an acquisition at frequency A, then frequency B, and back again to frequency A, the hidden initial noise floor acquisition would only occur for the first acquisition at frequency A and the cached noise floor would be used the second time frequency A was measured
Preset	False
Range	True (enable noise correction) or False (disable noise correction)

10.2.6 Do Spur Suppression

Example	<code>:CALC:FPOW:POW1:DEF "DoSpurSuppression=True"</code>
Notes	When measuring very low level signals, or when large out-of-band inputs are input into the instrument, sometimes unwanted spurs and residuals can appear in the measured spectrum. Spur suppression is a method to help minimize the levels of these internally generated spurs and residuals When spur suppression is enabled, the instrument will automatically take two acquisitions using two different internal analog LO frequencies. The FFT spectrums from both acquisitions are combined by taking the minimum power between both traces on a per FFT bin basis. External signals will have the same amplitude for both traces and therefore will return the expected amplitudes. However, low level spurs and residuals generated internally to the instrument tend to move to different FFT bins depending on the internal analog LO frequency used, and therefore tend to be suppressed using this spur suppression method Because two acquisitions, rather than a single acquisition, are made when spur suppression is enabled, the measurement time will always be slower when spur suppression is enabled
Preset	False
Range	True (enable spur suppression) or False (disable spur suppression)

10.2.7 Electronic Attenuator Bypass

Example	<code>:CALC:FPOW:POW1:DEF "ElecAttBypass =False"</code>
Notes	Allows you to either utilize or bypass the electronic attenuator. The electronic attenuator is only available for frequencies up to 3.6 GHz. Set parameter to true when using frequencies above 3.6 GHz and set the parameter to false when using the preamp
Preset	True
Range	True (bypass electronic attenuator) or False (use electronic attenuator)

10.2.8 Electronic Attenuation

Example	<code>:CALC:FPOW:POW1:DEF "ElecAttenuation=10"</code>
Notes	Option EA3 is required The electronic attenuation value parameter sets the amount of electrical attenuation from 0 to 24 dB (1 dB steps) Set "ElecAttBypass=False" to make sure the electronic attenuator path is enabled
Preset	0 dB
Range	0 – 24 dB (1 dB steps)

10.2.9 External Reference Frequency

Example	<code>:CALC:FPOW:POW1:DEF "ExternalReferenceFrequency=10"</code>
Notes	This is the user-specified frequency of the external reference: <ul style="list-style-type: none">– Used when "Frequency Reference Source" on page 1572 is set to external or auto when the external source is present– Unused if FrequencyReferenceSource is set to internal
Preset	10 MHz

10.2.10 Frequency Reference Source

Example	<code>:CALC:FPOW:POW1:DEF "FrequencyReferenceSource= InternalFrequencyReference"</code>
Notes	Specifies which frequency reference source should be used for this request: <ul style="list-style-type: none">– If ExternalFrequencyReference is selected and no external reference is present, the frequency reference unlocks but the data acquisition will continue– If AutoExternalFrequencyReference is selected, the hardware senses whether an

10 Hardware-Accelerated Fast Power Measurement (Remote Command Only)
10.2 Reset Fast Power Measurement (Remote Command Only)

external source is present before starting the data acquisition. If no external source is present then the internal source is selected and the data acquisition will continue

Preset	InternalFrequencyReference
Range	InternalFrequencyReference , ExternalFrequencyReference , AutoExternalFrequencyReference

10.2.11 IF Gain

Example	<code>:CALC:FPOW:POW1:DEF "IFGain=10"</code>
Notes	Allows you to specify the gain at the IF stage anywhere from -6 to 16 dB (1 dB steps). This is an advanced feature; for most cases this should remain at its default value of 0 dB
Preset	0 dB
Range	-6 – 16 dB (1 dB steps)

10.2.12 IF Type

Example	<code>:CALC:FPOW:POW1:DEF "IFType=B25M"</code>
Notes	Allows you to select between different IF paths. For example, if the signal is less than 25 MHz wide, then you can select the B25M path to take advantage of additional filtering on this analog IF path
Preset	B40M
Range	B10M, B25M, B40M

10.2.13 Include Power Spectrum

Example	<code>:CALC:FPOW:POW1:DEF "IncludePowerSpectrum=True"</code>
Notes	Allows you to read data on the entire spectrum for diagnostic purposes. It is not recommended for production use. See <code>:CALC:FPOW:POW[n]:READ2?</code> for details on the binary format of the response
Preset	False
Range	True (return both channel power and full power spectrum) False (returns only channel power)

10.2.14 Mechanical Attenuation

Example	<code>:CALC:FPOW:POW1:DEF "MechAttenuation=10"</code>
Notes	Sets the amount of mechanical attenuation anywhere from 0 to 70 dB (2 dB steps)
Preset	0 dB
Range	0 – 70 dB (2 dB steps)

10.2.15 Preamp Mode

Example	<code>:CALC:FPOW:POW1:DEF "PreAmpMode=Low"</code>
Notes	The license for the appropriate preamp is required Specifies whether the preamps are being utilized. Low allows any preamps up to 3.6 GHz, and Full allows all licensed preamps. Set "ElecAttBypass=True" in order to utilize any preamps
Preset	Off
Range	Off, Low, Full

10.2.16 Resolution Bandwidth Mode

Example	<code>:CALC:FPOW:POW1:DEF "PreAmpMode=Low"</code>
Notes	Allows you to choose whether the RBW filter is automatically or manually set. The BestSpeed value minimizes measurement time, while the Narrowest value minimizes RBW size (minimum of two FFT bins per RBW) To manually specify an RBW, set this parameter to Explicit, and set the ResolutionBW parameter to the desired value
Preset	BestSpeed
Range	BestSpeed, Narrowest, Explicit

10.2.17 Resolution Bandwidth

Example	<code>:CALC:FPOW:POW1:DEF "ResolutionBW=25e3"</code>
Notes	Sets the 3-dB bandwidth of the RBW filter. The ResolutionBWMode parameter must be set to Explicit in order to manually set the RBW
Preset	0 Hz

10.2.18 Trigger Delay

Example	<code>:CALC:FPOW:POW1:DEF "TriggerDelay=0.025"</code>
Notes	Sets the time after an external trigger is detected until the measurement is performed
Preset	0 s
Range	0 – 1 s

10.2.19 Trigger Level

Example	<code>:CALC:FPOW:POW1:DEF "TriggerLevel=2"</code>
Notes	Sets the voltage value at which an external trigger is detected
Preset	1.2 V
Range	-5 to 5 V

10.2.20 Trigger Slope

Example	<code>:CALC:FPOW:POW1:DEF "TriggerSlope=Negative"</code>
Notes	Specifies the direction of the edge trigger voltage for detection
Preset	Positive
Range	Positive, Negative

10.2.21 Trigger Source

Example	<code>:CALC:FPOW:POW1:DEF "TriggerSource=Ext1"</code>
Notes	Allows you to choose between measurement's triggering freely or controlled by an external input. Ext1 and Ext2 correspond to Trigger 1 In and Trigger 2 In, respectively
Preset	Free
Range	Free, Ext1, Ext2

10.2.22 Trigger Timeout

Example	<code>:CALC:FPOW:POW1:DEF "TriggerTimeout=0.1"</code>
Notes	Sets the time in which the instrument will wait for a trigger before automatically performing the measurement
Preset	1 s
Range	0 – 1 s

10.2.23 Signal Input

Example	<code>:CALC:FPOW:POW1:DEF "SignalInput=Fp50MHzCW"</code>
Notes	Allows you to select between using the main RF input or the internal instrument reference CW signal of 50 MHz

Preset	FpMainRf
Range	FpMainRf, Fp50MHzCW

10.2.24 Use Preselector

Example	<code>:CALC:FPOW:POW1:DEF "UsePreSelector=True"</code>
Notes	Allows you to either utilize or bypass the front end tunable filter at frequencies above 3.6 GHz. For frequencies below 3.6 GHz, the preselector is automatically bypassed, so you do not need to set this parameter to False in those cases
Preset	False
Range	True (use preselector above 3.6 GHz) False (preselector bypassed)

10.2.25 Channel Bandwidth Array

Example	<code>:CALC:FPOW:POW1:DEF "Bandwidth=[3.84e6, 5e6, 3.84e6]"</code>
Notes	Defines the bandwidth of each channel that will be measured All array parameters should have the same number of elements. Alternatively, if all the elements are the same value, a single number with no square brackets can be used to define the parameter
Preset	[1e6]
Range	0 to 40 MHz

10.2.26 Channel Filter Type Array

Example	<code>:CALC:FPOW:POW1:DEF "FilterType=[RRC, IBW, RRC]"</code>
Notes	The filter type parameter allows you to choose between an integration bandwidth (IBW) filter or a root-raised-cosine (RRC) filter. The integration bandwidth filter weighs all frequencies within the bandwidth equally. The root-raised-cosine filter has an associated shape parameter, defined by the FilterAlpha parameter All array parameters should have the same number of elements. Alternatively, if all the elements are the same value, a single value with no square brackets can be used to define the parameter
Preset	[IBW]
Range	IBW, RRC

10.2.27 Channel Filter Alpha Array

Example	<code>:CALC:FPOW:POW1:DEF "FilterAlpha=[0.5, 0.0, 0.5]"</code>
---------	--

10 Hardware-Accelerated Fast Power Measurement (Remote Command Only)
 10.2 Reset Fast Power Measurement (Remote Command Only)

Notes	The filter alpha parameter allows you to adjust the alpha value associated with the root-raised-cosine (RRC) filter type. Set FilterType to RRC in order to utilize this parameter All array parameters should have the same number of elements. Alternatively, if all the elements are the same value, a single number with no square brackets can be used to define the parameter
Preset	[0.22]
Range	0.0 – 1.0

10.2.28 Channel Measurement Function Array

Example	<code>:CALC:FPOW:POW1:DEF "Function=[BandPower, PeakPower, BandPower]"</code>												
Notes	This parameter array defines what measurement is being made for each individually-specified channel: <table border="1"> <tr> <td>BandPower</td> <td>Total power within the specified bandwidth of the channel (dBm)</td> </tr> <tr> <td>BandDensity</td> <td>Total power density within the specified bandwidth of the channel (dBm/Hz)</td> </tr> <tr> <td>PeakPower</td> <td>The peak power value within the specified bandwidth of the channel (dBm)</td> </tr> <tr> <td>PeakFrequency</td> <td>The frequency which corresponds to the peak power value within the specified bandwidth of the channel. This frequency is relative to the center frequency (Hz)</td> </tr> <tr> <td>XdBBandwidth</td> <td>The half power (-3.01 dB) bandwidth of the highest amplitude signal that resides within the channel (Hz), dB is configurable using XdBBandwidth parameter</td> </tr> <tr> <td>OccupiedBandwidth</td> <td>The bandwidth at which 99% of the total power resides within the channel (Hz), percentage configurable using OccupiedBandwidthPercent parameter</td> </tr> </table> All array parameters should have the same number of elements Alternatively, if all the elements are the same value, a single value with no square brackets can be used to define the parameter	BandPower	Total power within the specified bandwidth of the channel (dBm)	BandDensity	Total power density within the specified bandwidth of the channel (dBm/Hz)	PeakPower	The peak power value within the specified bandwidth of the channel (dBm)	PeakFrequency	The frequency which corresponds to the peak power value within the specified bandwidth of the channel. This frequency is relative to the center frequency (Hz)	XdBBandwidth	The half power (-3.01 dB) bandwidth of the highest amplitude signal that resides within the channel (Hz), dB is configurable using XdBBandwidth parameter	OccupiedBandwidth	The bandwidth at which 99% of the total power resides within the channel (Hz), percentage configurable using OccupiedBandwidthPercent parameter
BandPower	Total power within the specified bandwidth of the channel (dBm)												
BandDensity	Total power density within the specified bandwidth of the channel (dBm/Hz)												
PeakPower	The peak power value within the specified bandwidth of the channel (dBm)												
PeakFrequency	The frequency which corresponds to the peak power value within the specified bandwidth of the channel. This frequency is relative to the center frequency (Hz)												
XdBBandwidth	The half power (-3.01 dB) bandwidth of the highest amplitude signal that resides within the channel (Hz), dB is configurable using XdBBandwidth parameter												
OccupiedBandwidth	The bandwidth at which 99% of the total power resides within the channel (Hz), percentage configurable using OccupiedBandwidthPercent parameter												
Preset	BandPower												
Range	BandPower, BandDensity, PeakPower, PeakFrequency, XdBBandwidth, OccupiedBandwidth												

10.2.29 Channel Offset Frequency Array

Example	<code>:CALC:FPOW:POW1:DEF "OffsetFrequency=[-5e6, 0, 5e6]"</code>
Notes	The offset frequency parameter array defines the difference between the center frequency to the center frequency of each channel All array parameters should have the same number of elements
Preset	[0]
Range	0 to 20 MHz

10.2.30 Channel Occupied Bandwidth Percent Array

Example	<code>:CALC:FPOW:POW1:DEF "OccupiedBandwidthPercent =[0.95, 0.95, 0.95]"</code>
Notes	This parameter only applies for channels whose Function is set to OccupiedBandwidth. The occupied bandwidth percent parameter specifies the percent of total power in these channels. The valid range for this parameter is 0.0 to 1.0, where 1.0 represents 100%. The default for this parameter is 0.99, which will return the bandwidth that contains 99% of the total channel power
Preset	[0.99]
Range	0 – 1.0

10.2.31 Channel x-dB Bandwidth Array

Example	<code>:CALC:FPOW:POW1:DEF " XdbBandwidth =[-6.02, -3.01, -1.0]"</code>
Notes	This parameter only applies for channels whose Function is set to XdbBandwidth. The X dB bandwidth parameter is used to specify the power relative to the peak channel power over which the bandwidth is calculated. The parameter value must be a negative number
Preset	[-3.01]
Range	-200 to 0 dB

10.3 Define Fast Power Measurement Query (Remote Command Only)

Retrieves a list of all defined parameters in an ASCII string format

The following is an example of returned results:

```
"DCCoupled=False,ElecAttBypass=True,ElecAttenuation=0,IFGain=0,MechAttenuation=0,PreAmpMode=Off,PreSelectorOffset=0,UsePreSelector=False,ExternalReferenceFrequency=10000000,FrequencyReferenceSource=AutoExternalFrequencyReference,IFType=B40M,LOMode=SLW,SignalInput=FpMainRf,AcquisitionTime=0.001,CenterFrequency=100000000,ResolutionBW=0,ResolutionBWMode=BestSpeed,DetectorType=RmsAverage,Bandwidth=[1000000],OffsetFrequency=[0],Function=[BandPower],FilterType=[IBW],FilterAlpha=[0.22],OccupiedBandwidthPercent=[0.99],XdBBandwidth=[3.01],DoNoiseCorrection=False,DoSpurSuppression=False,MeasurementMethod=HardwareFFT,IncludePowerSpectrum=False,TriggerDelay=0,TriggerLevel=1.2,TriggerSlope=Positive,TriggerSource=Free,TriggerTimeout=1"
```

Remote Command	:CALCulate:FPOWER:POWER[1,2,...,999]:DEFine?
Example	:CALC:FPOW:POW1:DEF?
Notes	Retrieves a list of all defined parameters in an ASCII format

10.4 Configure Fast Power Measurement (Remote Command Only)

Begins hardware setup and returns immediately, with no acquisition made. This can be used in parallel with other hardware operations to effectively hide the hardware setup time.

Remote Command	<code>:CALCulate:FPOwer:POwer[1,2,...,999]:CONFigure</code>
Example	<code>:CALC:FPOW:POW1:CONF</code>
Notes	Option FP2 is required

10.5 Initiate Fast Power Measurement (Remote Command Only)

Begins an acquisition and returns immediately. The results of the measurement can be retrieved using `:FETCh`.

Remote Command	<code>:CALCulate:FPOWer:POWer[1,2,...,999]:INITiate</code>
Example	<code>:CALC:FPOW:POW1:INIT</code>
Notes	Option FP2 is required

10.6 Fetch Fast Power Measurement (Remote Command Only)

Used to retrieve the results of an acquisition initiated by `:INIT`. The returned results are in *ASCII string* format. The string begins and ends with quotation marks.

Remote Command	<code>:CALCulate:FPOWer:POWer[1,2,...,999]:FETCh?</code>
Example	<code>:CALC:FPOW:POW1:FETC?</code>
Notes	<p>Option FP2 is required</p> <p>Returns m comma-separated ASCII values, where m corresponds to the number of bandwidths defined</p> <ol style="list-style-type: none">1. Declared function return in the 1st specified channel2. Declared function return in the 2nd specified channel...m. Declared function return in the last specified channel <p>The INIT and FETC? command sequence performs the same functionality of a single CALC:FPOW:POW[n]? query. Units of the returned values are dependent on the Function parameter for each channel</p>

10.7 Execute Fast Power Measurement (Remote Command Only)

This query is shorthand for `:INIT` immediately followed by `:FETC?`. The returned results are in *ASCII string* format. The string begins and ends with quotation marks.

Remote Command	<code>:CALCuLate:FPOWer:POWer[1,2,...,999]?</code>
Example	<code>:CALC:FPOW:POW1?</code>
Notes	Option FP2 is required See notes for Fast Power Fetch for return format

10.8 Binary Read Fast Power Measurement (Remote Command Only)

This query is shorthand for `:INIT` immediately followed by `:FETC?`. The returned results are in *binary format*.

Remote Command	<code>:CALCulate:FPOWer:POWer[1,2,...,999]:READ?</code> <code>:CALCulate:FPOWer:POWer[1,2,...,999]:READ1?</code>
Example	<code>:CALC:FPOW:POW1:READ?</code> <code>:CALC:FPOW:POW1:READ1?</code>
Notes	Option FP2 is required Returns m 4 byte floating point binary values (Little-Endian), where m corresponds to the number of bandwidths defined

10.9 Diagnostic Binary Read Fast Power Measurement (Remote Command Only)

This query is shorthand for `:INIT` immediately followed by `:FETC?`. The returned results are in *binary format*. This command is used primarily for diagnostic purposes, to test for ADC overloads and to visibly inspect the spectrum.

Remote Command	<code>:CALCulate:FPOWer:POWer[1,2,...,999]:READ2?</code>
Example	<code>:CALC:FPOW:POW1:READ2?</code>
Notes	<p>Option FP2 is required</p> <p>Note: Spectrum data is only returned if the IncludePowerSpectrum parameter is set to True. If IncludePowerSpectrum is False, the number of spectrum points will be zero (0)</p> <p>Units of the returned values are dependent on the Function parameter per channel (e.g. dBm for BandPower, Hz for PeakFrequency)</p> <p>Returns binary data (Little-Endian) that contains information on m amount of channels, along with ADC over range and full spectrum data</p> <p>The following is the binary format of the response</p> <p>Bandwidth Return Value</p> <ol style="list-style-type: none"> 1. Number of channels specified, m [4 byte int] 2. Declared function result for the 1st specified channel [4 byte float] 3. Declared function result for the 2nd specified channel [4 byte float] <p>...</p> <ol style="list-style-type: none"> (m + 1). Declared function result for the last (mth) specified channel [4 byte float] <p>ADC Over Range</p> <ol style="list-style-type: none"> 1. ADC over-range occurred (1: true, 0: false) [2 byte short] <p>Spectrum Data</p> <ol style="list-style-type: none"> 1. Number of points in the spectrum data, k [4 byte int] 2. Start frequency of spectrum data (Hz) [8 byte double] 3. Step frequency of spectrum data (Hz) [8 byte double] 4. FFT bin at 1st point (dBm) [4 byte float] 5. FFT bin at 2nd point (dBm) [4 byte float] <p>...</p> <ol style="list-style-type: none"> (k + 3). FFT bin at last (kth) point (dBm) [4 byte float]

