

SEM5000A 系列

电子校准件

SME5000A Series
Electronic Calibration
(Ecal) Modules



快速指南
QuickStart
01A



深圳市鼎阳科技股份有限公司
SIGLENT TECHNOLOGIES CO.,LTD

版权和声明

版权

深圳市鼎阳科技股份有限公司版权所有

商标信息

SIGLENT 是深圳市鼎阳科技股份有限公司的注册商标

声明

- 本公司产品受已获准及尚在审批的中华人民共和国专利的保护。
- 本公司保留改变规格及价格的权利。
- 本手册提供的信息取代以往出版的所有资料。
- 未经本公司同意，不得以任何形式或手段复制、摘抄、翻译本手册的内容。

产品认证

SIGLENT 认证本产品符合中国国家产品标准和行业产品标准，并进一步认证本产品符合其他国际标准组织成员的相关标准。

联系我们

深圳市鼎阳科技股份有限公司

地址：广东省深圳市宝安区 68 区安通达工业园四栋&五栋

服务热线：400-878-0807

E-mail: support@siglent.com

网址: <http://www.siglent.com>

目录/Category

版权和声明	1
一般安全概要	3
安全术语和标记.....	3
保养和清洁	4
一般性检查	4
使用前准备	5
前面板	6
后面板	7
连接和断开电子校准件	8
更多产品信息	9
COPYRIGHT AND STATEMENT	11
GENERAL SAFETY SUMMARY	12
SAFETY TERMS AND SYMBOLS.....	12
MAINTENANCE AND CLEANING.....	13
GENERAL INSPECTION.....	13
PREPARING FOR USE.....	14
FRONT PANEL	15
REAR PANEL	16
CONNECTING AND DISCONNECTING ECAL MODULE.....	17
FOR MORE PRODUCT INFORMATION.....	18

一般安全概要

了解下列安全性预防措施，以避免人身伤害，并防止本产品或与其相连接的任何其它产品受到损坏。为了避免可能发生的危险，请务必按照规定使用本产品。

- 只有合格的技术人员才可执行维修程序
- 防止火灾或人身伤害
- 使用适当的 **USB** 线 只可使用所在国家认可的本产品专用 **USB** 线。
- 查看所有终端的额定值 为了防止火灾或电击危险，请查看本产品的所有额定值和标记说明。在连接产品前，请阅读本产品手册，以便进一步了解有关额定值的信息。
- 怀疑产品出现故障时，请勿操作 如怀疑本产品有损坏，请让合格的维修人员进行检查。
- 避免电路外露 **USB** 线接通后请勿接触外露的接头和元件。
- 勿在潮湿环境下操作
- 勿在易燃易爆环境中操作
- 保持产品表面清洁和干燥

安全术语和标记

本产品上使用的术语

CAUTION 表示对本产品及其他财产有潜在的危险存在。

本产品上使用的标记



小心

保养和清洁

保养：

存放或放置仪器时，请勿使电子校准件长时间受阳光直射。

清洁：

请根据使用情况经常对仪器进行清洁。

方法如下：

1. 使用质地柔软的抹布擦拭仪器和接头外部的浮尘。
2. 使用一块用水浸湿的软布清洁仪器，请注意断开电源。如要更彻底地清洁，可使用 75% 异丙醇的水溶剂。

注意：为避免损坏仪器，请勿使用任何腐蚀性试剂或清洁试剂，请勿将其置于雾气、液体或溶剂中。在重新通电使用前，请确认仪器已干燥，避免因水分造成电气短路甚至人身伤害。

一般性检查

当您得到一台新的仪器时，建议您按以下方式逐步进行检查。

- 查看是否存在因运输问题而造成的损坏

如发现包装箱或泡沫塑料保护垫严重破坏，请先保留，直到整机和附件通过电性和机械性测试。

- 检查整机

如果发现仪器外部损坏，请与负责此业务的 SIGLENT 经销商或当地办事处联系，SIGLENT 会安排维修或更换新机。

- 检查附件

关于提供的附件明细，在“装箱单”中已有详细的说明，您可以参照此检查附件是否齐全。如发现附件有缺少或损坏，请与负责此业务的 SIGLENT 经销商或当地办事处联系。

使用前准备

外观尺寸

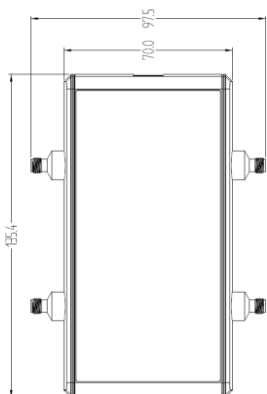

正视图



侧视图

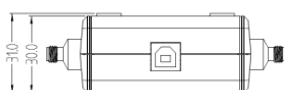

俯视图

连接电源

使用 USB 电缆直连矢量网络分析仪，矢量网络分析仪通过 USB 电缆提供控制和供电。将电子校准件连接到矢量网络分析仪时，矢量网络分析仪会自动识别校准件类型、频率范围和连接器类型。

前面板



1. 射频连接器
2. 商标
3. 系列型号
4. 指示灯
5. 注意事项
6. 官网地址

功能说明

编号	说明	概要
1	射频连接器	主要包括： SMA阴头，SMA阳头，Type-N阴头，Type-N阳头，3.5mm阴头，3.5mm阳头 注：正确连接机器，对准螺纹，不要物理损坏连接器。
2	系列型号	具体系列和工作频段
3	WAIT指示灯	WAIT指示灯（红色），表示等待，仪器还未到达正常工作温度
4	READY指示灯	READY指示灯（绿色），表示仪器已到达正常工作温度，可以校准
5	注意事项	最大功率电平：±20dBm；最大保护直流电压：±35V

供电

指示灯亮，代表电源连接成功；指示灯不亮，代表电源未打开，连接不成功。

后面板

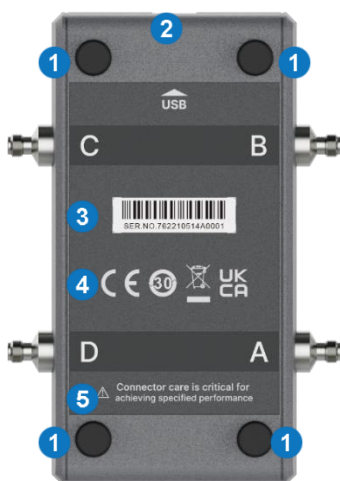

1. 脚垫
2. USB 接口
3. 系列条形码
4. 安全术语和标记
5. 注意事项

功能说明

编号	说明	概要
1	脚垫	用于支撑电子校准件
2	USB接口	可以通过USB线缆连接矢量网络分析仪，用于供电和控制
3	系列条形码	机器编号
4	标志	安全术语和标记
5	注意事项	说明需要被关注的信息

连接和断开电子校准件

连接电子校准件

首先电子校准件会通过USB电缆（随套件提供）连接到矢量网络分析仪，然后由分析仪通过USB电缆提供控制和供电。将电子校准件连接到分析仪时，分析仪会自动识别校准件类型、频率范围和连接器类型。如图1所示，USB电缆与电子校准件连接，此时USB电缆的另外一端连接矢量网络分析仪的USB接口。连接完成后，指示灯亮起。



图 1

然后根据电子校准件的射频连接器选择不同的射频电缆，在使用射频电缆连接电子校准件与矢量网络分析仪的过程中，必须要使用扭矩扳手来保护射频连接器。在使用扭矩扳手的过程中，需要注意扭矩扳手力矩的大小，通过设置适当的力矩来连接射频连接器。具体使用方法如图2所示。



图 2

本次参考案例使用的是4端口电子校准件，与2端口电子校准件使用方法一致。具体连接方式如下图3和图4所示：



图 3



图 4

连接完成后，观察指示灯，Wait指示灯（红色），Ready指示灯（绿色）。当指示灯为绿色时，代表可以进行校准；如果指示灯为红色，则需要等到其变为绿色再开始校准。

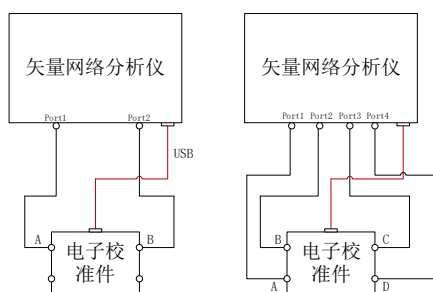
断开电子校准件

只需要断开USB电缆，使电子校准件停止工作。然后在A、B、C、D端口处断开射频连接器即可。

更多产品信息

您可以在 Utility 菜单栏中获取您的设备信息和查看所有选件的安装状态，欲了解本产品更多信息，请查阅如下手册（您可登录 SIGLENT 官网下载 <http://www.siglent.com>）。

《SEM5000A 电子校准件数据手册》：提供本产品的主要特色和技术指标。

Copyright and statement

- SIGLENT TECHNOLOGIES CO., LTD All Rights Reserved.
- SIGLENT is the registered trademark of SIGLENT TECHNOLOGIES CO., LTD.
- SIGLENT products are protected by patent law worldwide.
- Information in this publication replaces all previously corresponding material.
- SIGLENT reserves the right to modify or change parts of or all the specifications or pricing policies at the company's sole decision.
- Any method of copying, extracting or translating the contents of this manual is not allowed without the permission of SIGLENT.

General safety summary

Carefully read the following safety precautions to avoid any personal injury or damage to the instrument and any products connected to it. To avoid potential hazards, please use the instrument as specified:

- Only qualified technicians can carry out maintenance of the product.
- Only the USB cable designed for the instrument and authorized by the local country could be used.
- To avoid fire or electric shock, please look over all ratings and safety labels on the instrument. Before connecting the instrument, please read the manual carefully to gain more information about the ratings.
- Do not touch exposed contacts or components when the power is on.
- To avoid short-circuiting to the interior of the device or electric shock, please do not operate the instrument in a humid environment.
- To avoid damage to the device or personal injury, it is important to operate the device away from an explosive atmosphere.
- To avoid the influence of dust and moisture in the air, please keep the surface of the device clean and dry.

Safety terms and symbols

Terms on the product, these terms may appear on the product.

DANGER: Indicates direct injuries or hazards that may happen.

Symbols on the product, these symbols may appear on the product:



Warning

Maintenance and cleaning

Maintenance:

When storing or placing the instrument, do not expose the electronic calibrator to direct sunlight for long periods of time.

Cleaning:

Please clean the instrument as often as you use it. The method is as follows:

1. Use a soft cloth to wipe the instrument and the outside of the connector of any floating dust.
2. Clean the instrument with a soft cloth moistened with water, taking care to disconnect the power supply.

For a more thorough cleaning, use an aqueous solvent of 75% isopropyl alcohol.

Note: To avoid damage to the instrument, do not use any corrosive or cleaning reagents, do not expose it to mist, liquids or solvents. Before re-energising the instrument for use, make sure it is dry to avoid electrical short circuits or even personal injury caused by moisture.

General inspection

Inspect the shipping container:

Keep the shipping container or cushioning material until the contents of the shipment have been completely checked and the instrument has passed both electrical and mechanical tests. The consigner or carrier will be responsible for damages to the instrument resulting from shipment. **SIGLENT** will not provide free maintenance or replacement.

Inspect the instrument:

If the instrument is found to be damaged, defective, or fails in electrical or mechanical tests, please contact **SIGLENT**.

Check the accessories:

Please check the accessories according to the packing list. If the accessories are incomplete or damaged, please contact your **SIGLENT** sales representative.

Preparing for use

Mechanical dimensions:

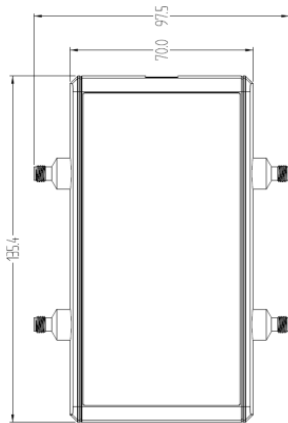

Elevation View



Side View

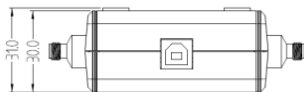

Top View

Power Supply

Use the USB cable to connect directly to the vector network analyser which provides control and power via the USB cable. The analyser will automatically recognize the calibrator type, frequency range and connector type when the electronic calibrator is connected to it.

Front panel



1. RF connectors
2. Brand
3. Series & Model
4. Indicators
5. Notes
6. Official website

Figure 1 Front panel

Table 1 Front panel area description:

No.	Items	Description
1	RF connectors	Inclusion: SMA female, SMA male, Type-N female, Type-N male, 3.5mm female, 3.5mm male. Notes: Connect the machine correctly, align the threads and do not physically damage the connector.
2	Brand	Brand information of SIGLENT.
3	Series & Model	Specific series and operating frequency bandwidth.
4	Indicators	WAIT light (red) indicates that the instrument has not reached normal operating temperature and needs to wait. READY light (green) indicates that the instrument has reached its normal operating temperature and is ready for operation.
5	Notes	Maximum input power level: $\pm 20\text{dBm}$. Maximum protection DC voltage: $\pm 35\text{V}$.
6	Official website	The official website of SIGLENT.

Power Supply

The indicator lights on indicates that the power connection is successful. A failure of lights indicates that the power connection is unsuccessful and does not work properly.

Rear panel

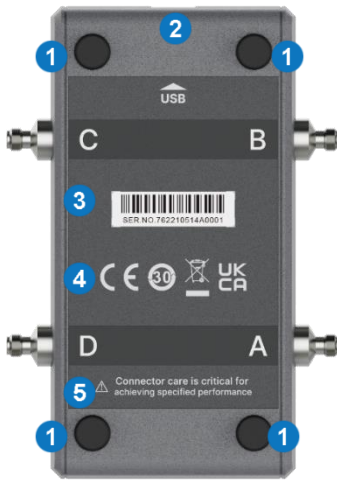

1. Pad
2. USB port
3. Barcode
4. Symbol
5. Notes

Figure 2 Rear panel

Table 2 Rear panel area description:

No.	Items	Description
1	Pad	Used to sustain ECal modules.
2	USB port	Connect a vector network analyzer with a USB cable to act as a power and control cable.
3	Barcode	Recording machine codes.
4	Symbol	Safety terms and symbols.
5	Cautions	Explain some important notes.

Connecting and disconnecting ECal module

Connecting ECal module:

Firstly, ECal module is connected to the vector network analyzer through a USB cable (provided with the kit), and then the analyzer provides control and power through the cable. The analyzer will automatically identify the calibration piece type, frequency range, and connector type when the connection is completed. As shown in Figure 3, the USB cable is connected to ECal module, and the other end of the USB cable is connected to the USB interface of the vector network analyzer. After the connection is completed, the indicator lights on.



Figure 3 Connection diagram 1

Secondly, selecting different RF cables based on the RF connector of ECal module. During the process of connecting ECal module with the vector network analyzer using RF cables, it is necessary to use a torque wrench in order to protect the RF connector. It is also necessary to pay attention to the torque of the torque wrench and connect the RF connector by setting an appropriate torque when using the torque wrench. The specific usage method is shown in Figure 4 below.



Figure 4 Connection diagram 2

This reference case uses a 4-port ECal module which is used in the same way as the 2-port ECal module. The specific connections are shown in Figure 5 and Figure 6 below.

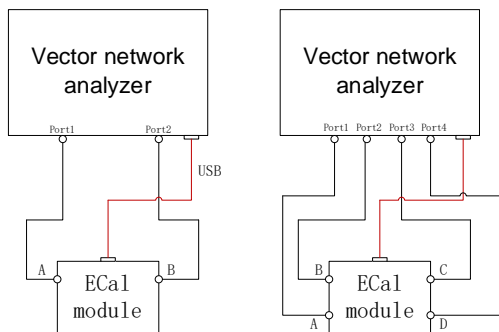

Figure 5 Connection diagram 3



Figure 6 Connection diagram 4

When the connection is completed, observe the indicators: **Wait** indicator (red) and **Ready** indicator (green). When the indicator is green, it means that calibration is ready; if the indicator is red, you need to wait until it turns green before starting calibration.

Disconnecting ECal module:

Simply disconnect the USB cable to stop ECal module from working. Then disconnect the RF connectors at ports A, B, C, and D.

For more product information

You can obtain the instrument information and installation status of all options through Utility menu, for more information of this product, please refer to the following manuals (you can also download them from the **SIGLENT** web site):

SEM5000A Electronic Calibration (ECal) Modules Data Sheet:

Provides the main characteristics and specifications of this instrument.

保修卡



请用户务必填写后沿虚线剪下寄回

客户信息反馈登记表

感谢您购买鼎阳科技的产品,请妥善保管此产品保修卡及销售专用发票

产品合格证明
Quality Certificate

制造商名称: 深圳市鼎阳科技股份有限公司

检验合格
Certified

QA
PASS

产品型号
Model

序列号
Serial No.

售后服务中心:

服务中心地址: 广东省深圳市宝安区 68 区留仙三路安通达工业园五栋一楼

服务与支持热线: 400-878-0807

邮箱: Service@sialent.com

维修登记卡

维修记录一	故障现象	
	接收日期	
	故障处理情况	
	维修工程师	
	返回日期	
维修记录二	故障现象	
	接收日期	
	故障处理情况	
	维修工程师	
	返回日期	

公司名称: _____

联系人名称: _____

联系电话: _____

电子邮箱: _____

通讯地址: _____

购买日期: _____

产品型号: _____

产品序列号: _____

硬件版本: _____

软件版本: _____

故障现象描述: _____

保修概要

深圳市鼎阳科技股份有限公司 (SIGLENT TECHNOLOGIES CO., LTD) 承诺其产品在保修期内正常使用发生故障, SIGLENT 将为用户免费维修或更换部件。

本保修适用于中国大陆地区用户从大陆正规渠道所购买的 SIGLENT 产品。SIGLENT 厂家直销渠道, 授权代理销售渠道及授权网络销售渠道, 用户在购买 SIGLENT 产品时有权要求商家提供 SIGLENT 授权证明文件以保证自身利益。

标准保修承诺

SIGLENT 承诺本产品主机保修期三年, 模块类、探头类、电池类产品保修一年。SIGLENT 产品保修起始日期默认为客户有效购机凭证 (税务发票) 上的日期。无法提供有效购机凭证的, 则将产品的出厂日期延后 7 天 (默认货运时间) 作为保修起始日期。

维修承诺

对于免费维修的产品, SIGLENT 承诺在收到故障产品后 10 个工作日内维修完毕。对于有偿维修的产品, SIGLENT 将在用户付费后 10 个工作日内将故障产品维修完毕。若用户确认不维修, SIGLENT 将故障产品返回客户。

以下情况不包含在 SIGLENT 免费维修范围内:

- 因错误安装或在非产品规定的工作环境下使用造成的仪器故障或损坏;
- 产品外观损坏 (如烧伤、挤压变形等);
- 产品保修封条被撕毁或有揭开痕迹;
- 使用未经 SIGLENT 认可的电源或电源适配器造成的意外损坏;
- 因不可抗拒因素 (如地震、雷击等) 造成的故障或损坏;

本保修卡代替先前发布的保修卡版本, 其他任何形式的保修条款应以上述的保修说明为准, SIGLENT 拥有对维修事宜的最终解释权。

深圳市鼎阳科技股份有限公司

Headquarters:

SIGLENT Technologies Co., Ltd
Add: Bldg No.4 & No.5, Antongda
Industrial Zone, 3rd Liuxian Road, Bao'an
District, Shenzhen, 518101, China
Tel: + 86 755 3688 7876
Fax: + 86 755 3359 1582
Email: sales@siglent.com
Website: int.siglent.com

North America:

SIGLENT Technologies America, Inc
6557 Cochran Rd Solon, Ohio 44139
Tel: 440-398-5800
Toll Free: 877-515-5551
Fax: 440-399-1211
Email: info@siglentna.com
Website: www.siglentna.com

Europe:

SIGLENT Technologies Germany GmbH
Add: Staetzlinger Str. 70
86165 Augsburg, Germany
Tel: +49(0)-821-666 0 111 0
Fax: +49(0)-821-666 0 111 22
Email: info-eu@siglent.com
Website: www.siglenteu.com

联系我们

深圳市鼎阳科技股份有限公司
全国免费服务热线: 400-878-0807
网址: www.siglent.com

声明

 **SIGLENT** 鼎阳 是深圳市鼎阳科技股份有限公司的注册商标，事先未经过允许，不得以任何形式或通过任何方式复制本手册中的任何内容。

本资料中的信息代替原先的此前所有版本。
技术数据如有变更，恕不另行通告。

技术许可

对于本文档中描述的硬件和软件，仅在得到许可的情况下才会提供，并且只能根据许可进行使用或复制。

Follow us on
Facebook: SiglentTech



2 7 7 4 0 1 0 4 7 4