

The world's most trusted OSAs

AQ6370 Series
Optical Spectrum Analyzer

Precision Making

Bulletin AQ6370SR-20EN



No longer confined to telecommunications, the emergence of photonics in industrial manufacturing, biological studies, healthcare, lighting, imaging and sensing for safety, security and environmental pollution control is today driving the demand for wider ranging wavelengths and higher precision measurement.

Our long experience working with customers in the optical Test & Measurement Industry has enabled us to design the world's most reliable and versatile Optical Spectrum Analyzers. In fact they feature specific technical characteristics that make them the most efficient and effective instruments for measuring devices and systems used in the various applications of photonics.

Yokogawa's AQ6370 OSA Series can satisfy the specific test and measurement needs of R&D and manufacturing centers belonging to any Industry.

The AQ6370 OSA Series delivers:

Reliability – The most trusted OSAs in the world thanks to their unmatched measurement accuracy, robustness and proven quality.

Performance – Best in class, state of the art and high-precision instruments that keep pace with the ever changing and fast evolving optical technology.

Expertise – For more than 30 years our R&D and Product Specialist teams have been listening to the needs of OSA users to continuously provide them with innovative and effective solutions for their measuring challenges.



30+ years of experience

In 2002 Yokogawa became a leading supplier of optical spectrum analyzers following the acquisition of Ando Electric. Today, with more than 30 years of experience in optical testing, Yokogawa can offer a full range of OSAs, each one specifically designed to accurately and quickly measure the performance of photonic devices and systems used in diverse applications.

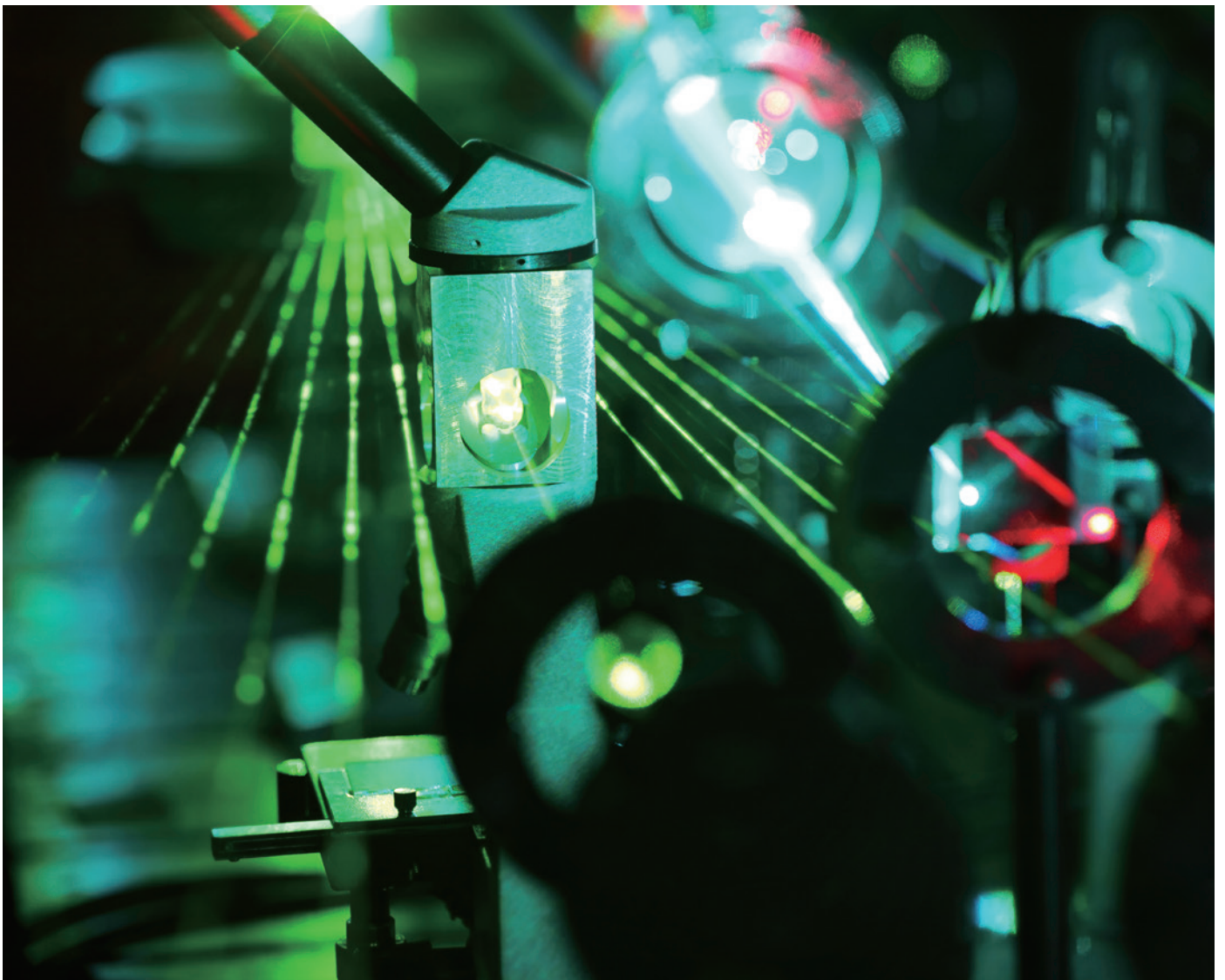

Selection guide

The AQ6370 series are high-speed and high-performance Optical Spectrum Analyzers based on the diffraction grating technology. They satisfy measurement needs of a wide range of R&D and industrial manufacturing applications with a product lineup of five models covering the broad wavelength range from visible light to mid-infrared (350 to 3400 nm).

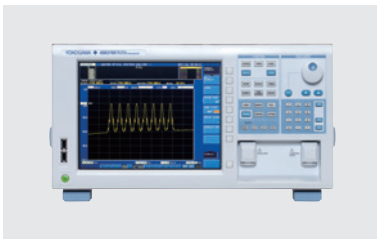

AQ6370D Dedicated for telecom applications

Optical communications

- Wavelength range: 600 to 1700 nm
 - Wavelength accuracy: ± 0.01 nm (high-performance model)
 - Wavelength resolution setting: 0.02 to 2 nm
 - Level range: +20 to -90 dBm
 - Close-in dynamic range: 78 dB typ. (peak ± 1.0 nm, high-performance model)
- <Applications>
- Emission spectrum evaluation of optical transceivers and LD modules
 - OSNR measurement of WDM transmission signals
 - Optical amplifier (EDFA) measurement

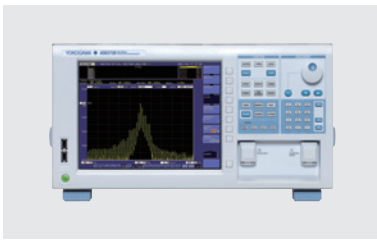

AQ6373B Optimized for visible light measurements

VIS

- Wavelength range: 350 to 1200 nm
 - Wavelength accuracy: ± 0.05 nm
 - Wavelength resolution setting: 0.01 to 10 nm
 - Level range: +20 to -80 dBm
 - Close-in dynamic range: 60 dB (peak ± 0.5 nm)
- <Applications>
- Characterization of light sources used in biomedical and consumer products
 - Color analysis of visible LED

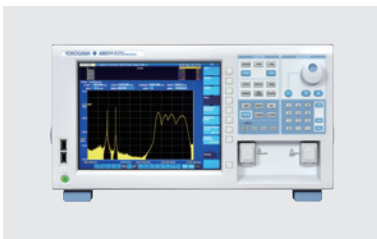

AQ6374 Wide range model covering the spectrum from visible to communication wavelengths

VIS & optical communications

- Wavelength range: 350 to 1750 nm
 - Wavelength accuracy: ± 0.05 nm
 - Wavelength resolution setting: 0.05 to 10 nm
 - Level range: +20 to -80 dBm
 - Close-in dynamic range: 60 dB (peak ± 1.0 nm)
- <Applications>
- Wavelength loss characteristics of optical fibers
 - Characterization of broadband light sources
 - Characterization of lasers from visible light to optical communications wavelengths

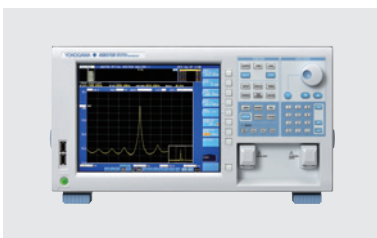

AQ6375B Long wavelength model covering the exNIR region over 2 μ m

exNIR

- Wavelength range: 1200 to 2400 nm
 - Wavelength accuracy: ± 0.05 nm
 - Wavelength resolution setting: 0.05 to 2 nm
 - Level range: +20 to -70 dBm
 - Close-in dynamic range: 55 dB (peak ± 0.8 nm)
- <Applications>
- Characterization of sources used in Laser Absorption Spectroscopy
 - Characterization of broadband light sources such as Supercontinuum light sources
 - Measurement of gas absorption spectra

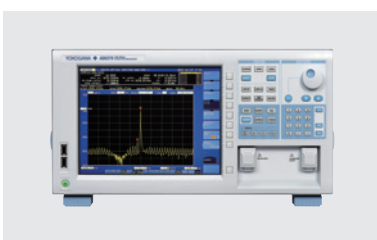

AQ6376 Long wavelength model covering the MWIR region over 3 μ m

MWIR

- Wavelength range: 1500 to 3400 nm
 - Wavelength accuracy: ± 0.50 nm
 - Wavelength resolution setting: 0.1 to 2 nm
 - Level range: +13 to -65 dBm
 - Close-in dynamic range: 55 dB (peak ± 2.0 nm)
- <Applications>
- Characterization of sources used in Laser Absorption Spectroscopy
 - Characterization of broadband light sources such as Supercontinuum light sources
 - Measurement of gas absorption spectra

Specifications and features

Model		AQ6370D	AQ6373B	AQ6374	AQ6375B	AQ6376
Band		Optical communications	VIS	VIS & optical communications	exNIR	MWIR
Wavelength range (nm)	Min.	600	350	350	1200	1500
	Max.	1700	1200	1750	2400	3400
Wavelength accuracy (nm)		±0.1 (Full range) ±0.04 (1450 to 1520 nm) ±0.01 (1520 to 1580 nm)* ±0.02 (1580 to 1620 nm)	±0.2 (Full range) ±0.05 (633 nm)	±0.2 (Full range) ±0.05 (633 nm) ±0.05 (1523 nm)	±0.5 (Full range) ±0.05 (1520 to 1580 nm) ±0.1 (1580 to 1620 nm)	±0.5 (Full range)
Wavelength linearity (nm)		±0.01 to 0.02	—	—	—	—
Wavelength resolution setting (nm)	Min.	0.02	0.01	0.05	0.05	0.1
	Max.	2	10	10	2	2
Maximum number of sampling		50001	50001	100001	50001	50001
Measurement level range (dBm)	Max.	+20	+10 (400 to 550 nm) +20 (550 to 1100 nm)	+10 (400 to 550 nm) +20 (550 to 1700 nm)	+20	+13
	Min.	-60 (600 to 1000 nm) -80 (1000 to 1300 nm) -90 (1300 to 1620 nm)	-60 (400 to 500 nm) -80 (500 to 1000 nm) -60 (1000 to 1100 nm)	-70 (400 to 900 nm) -80 (900 to 1600 nm)	-62 (1300 to 1500 nm) -67 (1500 to 1800 nm) -70 (1800 to 2200 nm) -67 (2200 to 2400 nm)	-65 (1500 to 2200 nm) -55 (2200 to 3200 nm)
Level accuracy (dB)		±0.4	±1.0	±1.0	±1.0	±1.0
Level linearity (dB)		±0.05	±0.2	±0.2	±0.05	±0.2
Level flatness (dB)		±0.1 to ±0.2	—	—	—	—
Polarization dependence (dB)		±0.05 to ±0.08	—	±0.15	±0.1	—
Dynamic range (dB)		50 (±0.1 nm, RES: 0.02 nm, typ.)* 78 (±1.0 nm, RES: 0.05 nm, typ.)*	60 (±0.5 nm, RES: 0.02 nm)	60 (±1.0 nm, RES: 0.05 nm)	45 (±0.4 nm, RES: 0.05 nm) 55 (±0.8 nm, RES: 0.05 nm)	40 (±1.0 nm, RES: 0.1 nm) 55 (±2.0 nm, RES: 0.1 nm)
Applicable fiber	SMF	Yes	Yes	Yes	Yes	Yes
	GI	Yes	Yes	Yes	Yes	Yes
	Large core	—	Yes	Yes	—	—
Purge feature		—	—	Yes	Yes	Yes
Built-in cut filter for high order diffracted light		—	Yes	Yes	Yes	Yes
Light source for optical alignment		Yes	Yes	Yes	Yes	Yes
Light source for wavelength calibration		Yes	—	Yes	Yes	Yes

*High-performance model

Wavelengths covered by each model

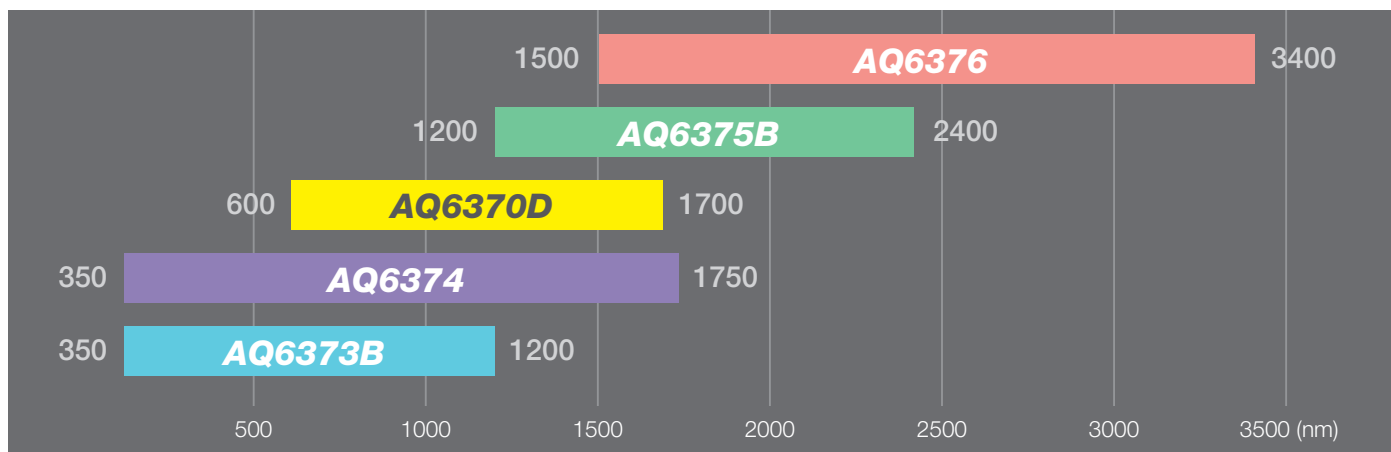

World class optical performance and unique characteristics

The highest resolution (up to 20 pm*) & highest close-in dynamic range (up to 78 dB**)

The advanced monochromator enables the detection of spectral signals which are in close proximity to be distinguished and accurately measured.

The highest sensitivity (down to -90 dBm*)

Low-power optical signals can be measured accurately and quickly, without any need to use averaging over many measurements. Moreover, with the *High Dynamic Mode* enabled, the instrument will maximize its dynamic range performance by eliminating the influence of stray-light, a disturbing factor for the photodetector caused by strong input signal which increases the noise floor.

The widest measurement power range (up to 110 dB*)

The high quality photodetector and the smart design of the gain circuitry enable the AQ6370 Series to have an incredibly wide measurement power range. The OSA can analyze very strong signals without being damaged and very weak signals as well, with a great accuracy.

* AQ6370D model

** AQ6370D model, typical value

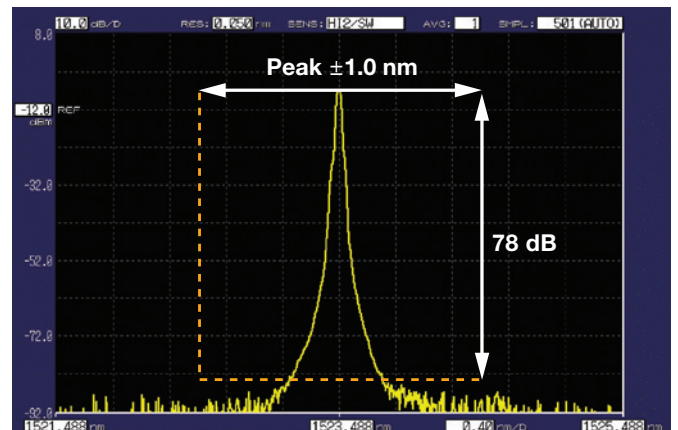

AQ6370D, Peak ± 1.0 nm, resolution setting 0.05 nm, High dynamic mode: ON, High performance model, typical

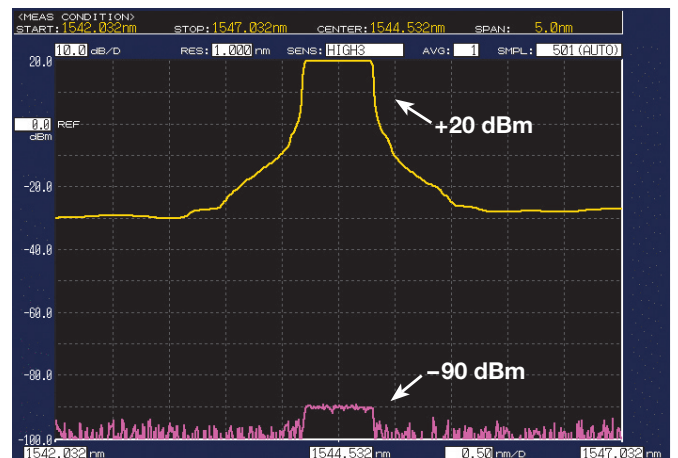

AQ6370D, Sensitivity setting: HIGH3 High dynamic mode: OFF, typical

The free space optical input

The optical input structure designed for the AQ6370 Series is the most effective to guarantee high coupling efficiency, measurements repeatability and no maintenance.

The free space optical input is, in fact:

- Dual purpose:* accepts both SM and MM (up to 800 μm core diameter) fibers without the high insertion loss due to the mismatch between MM and SM fibers
- Versatile:* accepts both /PC and /APC connectors
- Worry-free:* no internal fiber can be scratched by inaccurate coupling of fibers
- Maintenance-free:* no internal fiber can get dirty

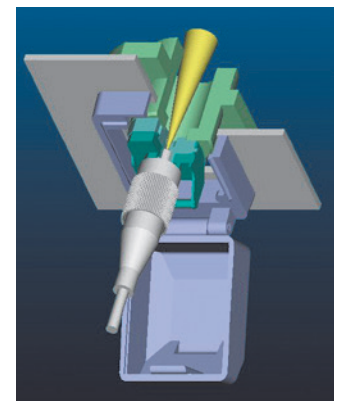

Optical input structure (note. AQ6373B uses a fixed connector)

Gas purging feature

Due to their high resolution and sensitivity, the AQ6370 Series can actually detect the presence of water molecules in the air. The water vapor detected in the upper Near-IR wavelength region could overlay or mask the spectral characteristics of the actual device under test.

The monochromator of AQ6374, AQ6375B and AQ6376 models is equipped with a closed-loop circuit for air purging and, by continuously supplying a pure purge gas such as nitrogen (or even just dry air) through the ports on the back panel, the OSA can measure a spectrum which is no more affected by the water vapor absorptions.



Purge gas IN/OUT

Built-in cut filter for high order diffracted light

Due to the diffractive technology used, the monochromator in some circumstances could generate high order diffracted light which appears at wavelengths equal to the integral multiple of input wavelengths.

AQ6370 Series OSAs are equipped with a cut-off filter to eliminate such artifacts which affect measurement results.



The built-in calibration source

Ambient temperature change, vibrations and shock affect the measurement accuracy of high precision products like optical spectrum analyzers. We want our OSAs to be able to deliver always the precise measurements they were designed for, therefore our instruments are equipped with a light source for calibration.

Calibration process is fully automatic and takes only 2 minutes to complete. It includes:

- The Optical Alignment function, which automatically aligns the optical path in the monochromator to assure the level accuracy;
- The Wavelength Calibration function, which automatically calibrates the spectrum analyzer with the reference source to ensure the wavelength accuracy.

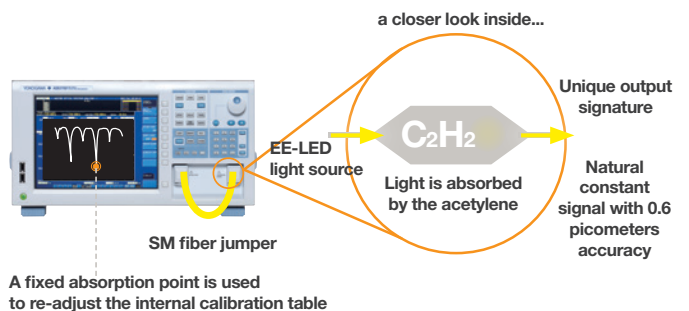

The built-in reference source for wavelength calibration, available for AQ6370D, AQ6374, AQ6375B and AQ6376.

The greatest flexibility to set parameters

The AQ6370 Series has been designed to guarantee testing flexibility: plenty of parameters' settings help the user to configure the instrument to obtain the maximum measurement performance according to the specific requirement of each test session.

OSA performance are derived by the following 4 main parameters: Power Sensitivity, Spectral Resolution, Measurement Speed and Close-In Dynamic Range.

AQ6370 Series users can tune their instrument in order to make it the best performer for the specific application they are about to test. By choosing the right combination of values of the mentioned parameters, the user can have an OSA extremely fast or extremely sensitive or with extremely high resolution.

The user of any AQ6370 Series OSA can set the measurement conditions by choosing among:

- 7 level sensitivity values
- Up to 10^{-1} wavelength resolution values
- ANY wavelength span², including 0 nm span
- ANY number of averaging times from 1 to 999
- ANY number of sampling points from 101 to 100001^{3, 4}

*1: 5 res. values selectable in AQ6376, 6 res. values selectable in AQ6375B, 7 res. values selectable in AQ6370D, 8 res. values selectable in AQ6374, 10 res. values selectable in AQ6373B

*2: within the wavelength range covered by each model

*3: AQ6374 except from 101 to 50001

*4: minimum sampling interval = 1 pm for AQ6370D and AQ6373B, 2 pm for AQ6374 and AQ6375B, 3 pm for AQ6376



Highly efficient functions to increase productivity

Reducing the design and manufacturing costs is a key target for vendors of optical devices.

Test & Measurement instruments for optical devices' evaluation are therefore expected to lower the finished product cost by shortening its inspection time after manufacturing and by increasing productivity of R&D and Production personnel.

Fast measurement at any sensitivity value

With a state-of-the-art monochromator, fast gain circuits and advanced noise reduction techniques, the AQ6370 series achieves an incredibly fast scanning speed even when measuring low power signals. Double speed mode increases the sweep speed up to 2 times compared to the standard sweep mode, with only a 2 dB penalty on the standard sensitivity value.

Up to 16* specific data analysis functions

The AQ6370 series OSAs have built-in analysis functions to characterize WDM systems, optical fiber amplifiers, different types of light sources and filters. The automatic calculation of the major parameters of the device under test will contribute to its fast characterisation.

- WDM (OSNR) analysis
- Optical Fiber Amplifier analysis
- DFB-LD analysis
- FP-LD (VCSEL) analysis
- LED analysis
- Spectral Width analysis
- Notch Width analysis
- SMSR analysis
- PMD analysis
- Optical Power analysis
- Color analysis
- Filter Peak analysis
- Filter Bottom analysis
- WDM Filter Peak analysis
- WDM Filter Bottom analysis
- Go/No-Go Judgment

*Each model of the AQ6370 Series has a different list of built-in analysis functions. Discover them into the product-specific sections further on this brochure.

Data logging function

Records analysis results such as WDM analysis (OSNR, optical signal/noise ratio), distributed feedback laser diode (DFB-LD) analysis, and multi-peak measurements at up to 10000 points per channel with time stamps. Recorded data can be displayed in table and graphical forms. This function is useful for the longterm stability testing and temperature cycle testing of systems and devices. The optical spectrum of each measurement can also be stored for reviewing and troubleshooting.

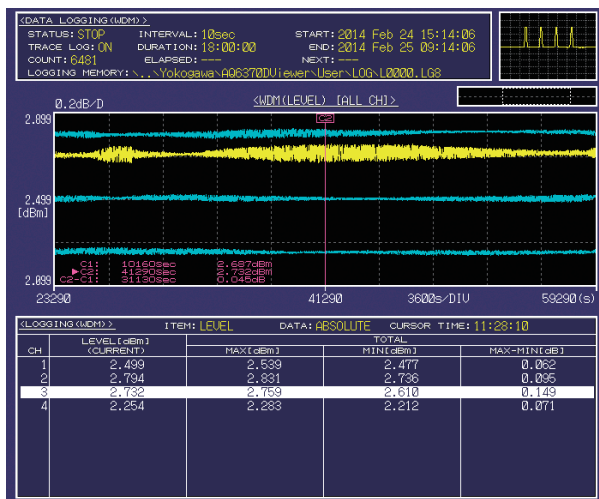

Advanced marker function

Adds markers to obtain the power spectral density and the integrated power of a designated spectrum. This new feature makes it easy to get an OSNR value of the signal, whether modulated or not, directly from its spectrum.

Building automated test systems

Thanks to the built-in Macro Programming Function, all AQ6370 Series models can perform automatic measurements and control external equipment through their remote interfaces.

GP-IB, RS-232 and Ethernet ports enable the instrument to be remotely controlled by a PC using standard SCPI-compatible or proprietary AQ6317-compatible commands. Also LabVIEW® drivers are available.

The AQ6370 Viewer

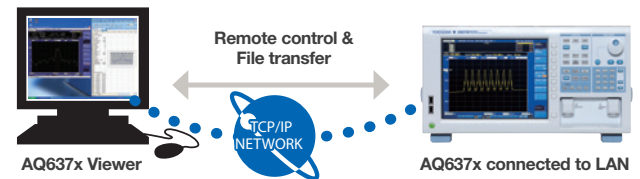

Real-time remote control

With the AQ6370 Viewer, a software package which replicates on your PC the instrument's screen, you can:

- remotely control and operate with the instrument;
- display, analyze and transfer the data acquired by the instrument on your remote PC.

The AQ6370 Viewer is appreciated especially by:

- Production Managers, who can command the instrument and collect its measurement results from their office without physically going to the actual production line.
- Service Engineers, who can help their customers or colleagues by setting the instrument in the proper way, tuning it on the device/system they want to test.

Various features for a comfortable test environment

Mouse and keyboard operation

More than 30 years of feedback from users has enabled intuitive and easy-to-use front panel operation. Mouse functionality provides ease of use for navigation and the keyboard helps to enter numbers and file names.



Point the item to modify



Modify settings using the keys on the screen.

Trace zooming

- Change display conditions, such as center wavelength and span, by clicking and dragging the mouse.
- Enlarge your area of interest instantly and move it at will.
- No need for another measurement to modify the display conditions.

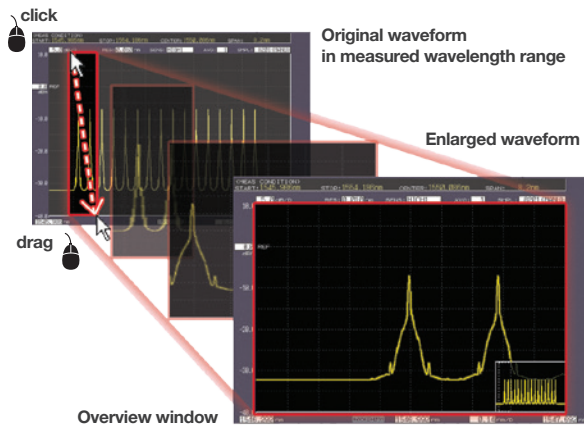

Trace calculation and analysis

Seven individual traces

- Simultaneous multi-trace display;
- Calculation between traces (subtraction between traces);
- Max/Min Hold function.

USB ports

Four USB ports in total available on front and back facilitate the use of external devices such as a mouse, keyboard, external hard drives and memory sticks.

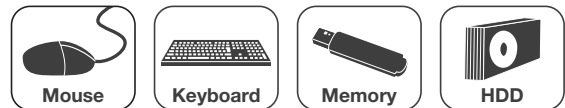

Thumbnail file preview

The thumbnail allows an easy and fast route to find a particular file out of many files in internal and external storage.

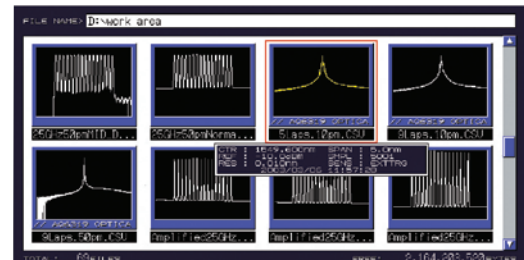

All-at once trace filing

A time-saving feature which allows to save all seven traces in one file at once. Files are saved in CSV format and can be easily manipulated with a PC application software.

A wealth of functions and connection interfaces

AQ6370 Series

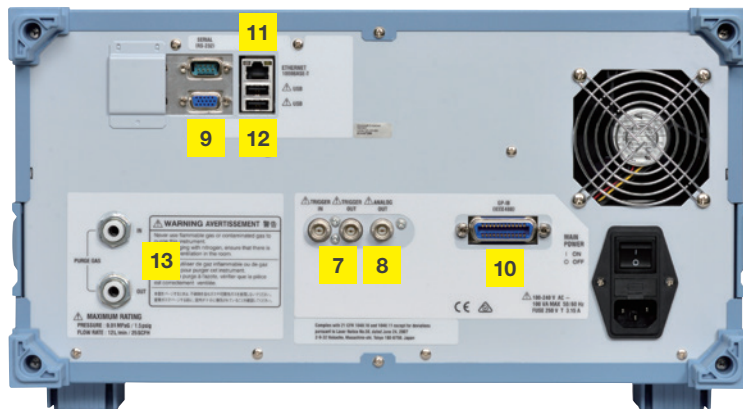
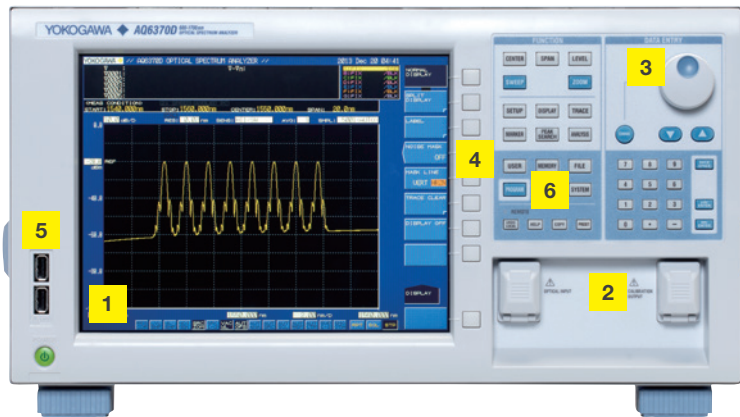

AQ6375B/AQ6376

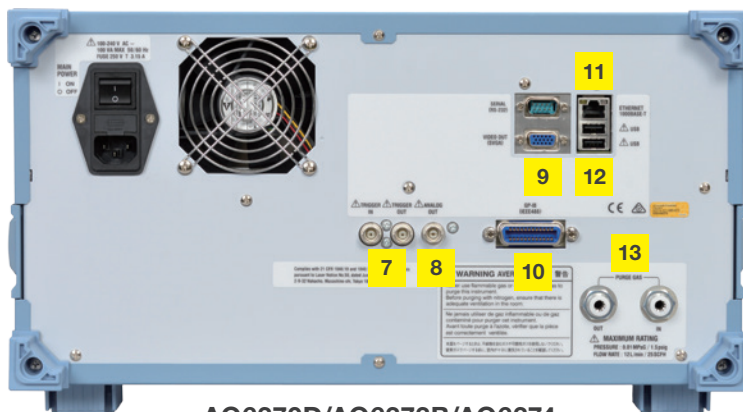

AQ6370D/AQ6373B/AQ6374

1 High Resolution Display

A large 10.4-inch SVGA LCD clearly displays detailed waveforms and numerical results. On-screen buttons facilitate the instrument setting by using the mouse.

2 Optical interfaces

The AQ6370D, AQ6374, AQ6375B and AQ6376 offer a universal type optical connector system for optical input and calibration output enabling direct coupling to popular styles of optical connectors. The connectors can be replaced by users.

3 Rotary knob

This multifunctional knob allows easy and quick adjustment of parameters and settings.

4 USER button

Registering frequently used soft keys in the USER button allows execution of frequently used functions in a just a few steps.

5 USB

USB ports to easily operate on the instrument using a mouse and a keyboard.

6 Macro programming button

User can compile up to 64 programs (200 steps per program) to build-up automatic measurement systems.

- No external PC is required.
- Easy to create test program by recording the user's actual key strokes and parameter selections.
- Can control external equipment through the remote interfaces.

7 Trigger IN/Trigger OUT

Pulsed light measurement, Gate sampling

8 Analog OUT

Voltage output for a stability test w/oscilloscope

9 Serial (RS-232), Video OUT (SVGA)

Auxiliary interfaces

10 GP-IB (IEEE 488.1/488.2)

11 Ethernet

12 USB (2X)

13 Purge gas IN/OUT (AQ6374, AQ6375B and AQ6376)

Typical applications

System test

WDM OSNR test

AQ6370D

AQ6370D's wide close-in dynamic range allows accurate OSNR measurement of DWDM transmission systems. The built-in WDM analysis function analyzes the measured waveform and shows peak wavelength, peak level and OSNR of WDM signals up to 1024 channels simultaneously. The Curve Fit function is used to accurately measure noise levels.

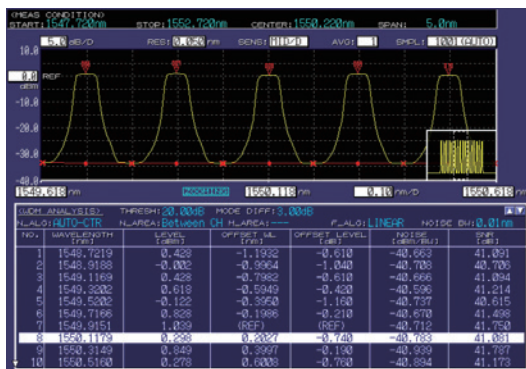
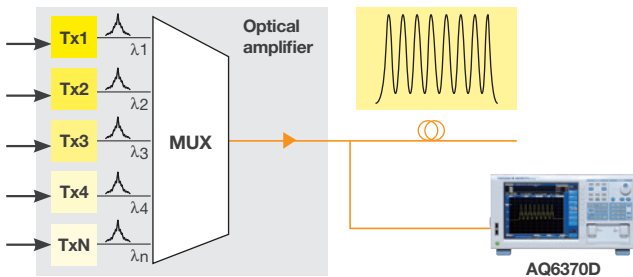

Example of WDM OSNR analysis

Optical amplifier test

AQ6370D

The AQ6370D has an automated function for amplifier analysis under the name "EDFA-NF". Despite the name, it is in fact suitable for characterizing many types of optical amplifiers.

A typical measurement setup for amplifier testing is shown in figure 1. It consists of a set of multiplexed lasers, an attenuator for tuning the laser power level, an optical spectrum analyzer and of course the optical fiber amplifier.

The OSA takes two high-resolution recordings of the wavelength range that is covered by the lasers. One trace is taken before amplification and one after amplification. The obtained result will be close to the results shown in figure 2. Immediately it will be noticed that the recorded peaks after amplification will be higher than before amplification. The same holds for the noise levels.

The EDFA-NF Analysis Function automatically detects the laser peaks, extracts the required measurement values, performs the calculations and displays in a table (figure 3) the values of ASE, GAIN and NF of the DUT.

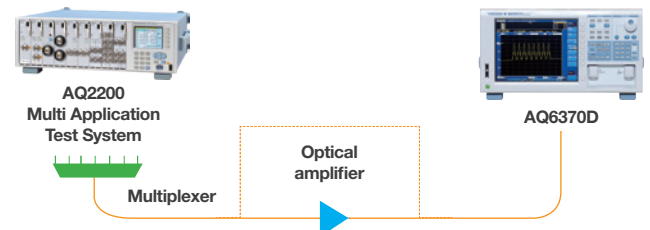

Figure 1 – The typical experimental setup for optical amplifier testing.

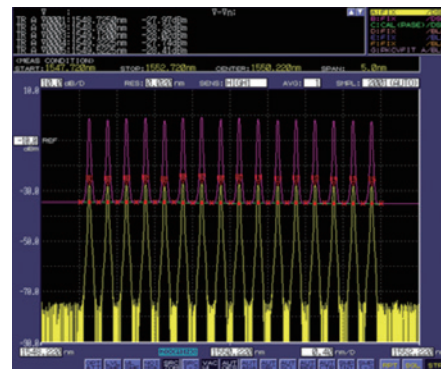

Figure 2 – Typical measurement result showing two traces; one before amplification (yellow) and one after amplification (purple).



Figure 3 – The automated routine for the analysis of optical amplifiers provides a table with their relevant parameters

Active component test

Characterization of laser sources

AQ6370D	AQ6373B	AQ6374
AQ6375B	AQ6376	

Today various light sources such as DFB-LD, FP-LD and VCSEL emitting in the visible light to mid-infrared wavelength region are mounted into many different devices/systems used in different areas of application, such as:

- **Telecommunication:** with glass fiber or plastic fiber.
- **Industrial:** Barcode scanners, LiDAR surface scanners;
- **Consumer electronics:** audio output of Hi-Fi audio systems, laser printers, computer mice;



Example of DFB-LD analysis (AQ6370D)

stable oscillation in the absorption region in order to achieve sensitive detection of the gas of interest. Most of the greenhouse gases, for example CO₂, SO₂, NO_x and CH₄, have strong absorption lines in the 2-3 μm wavelength region.

The lasers used in Absorption Spectroscopy are DFB-LD and VCSEL. Important parameters for evaluating the performance of these lasers are the Side Mode Suppression Ratio (which is the amplitude difference between the main mode and the side mode), and the Spontaneous Emission level (which is the magnitude of background noise light). Both parameters can be accurately and quickly measured by the AQ6375B and AQ6376.

Characterization of Supercontinuum light sources

AQ6374	AQ6375B
AQ6376	

Supercontinuum light is generated by promoting highly nonlinear optical processes in special materials, e.g. photonic crystal fiber, by pumping them with a mode-locked pulsed laser (typically a femtosecond Ti: Sapphire laser). Supercontinuum light can be best described as ‘broad as a lamp, bright as a laser’, in fact it matches the characteristics of incandescent and fluorescent lamps—i.e. very broad spectrum—with the characteristics of lasers—i.e. high spatial coherence and very high brightness, which enables optimum coupling to a fiber and outstanding single-mode beam quality.

The Supercontinuum light sources are nowadays finding applications in a diverse range of fields, including optical coherence tomography, frequency metrology, fluorescence lifetime imaging, optical communications, gas sensing and many others.

The AQ6370 series, thanks to its premium performance, are the ideal instruments to test and characterize Supercontinuum light sources during their pre and post production quality checks.

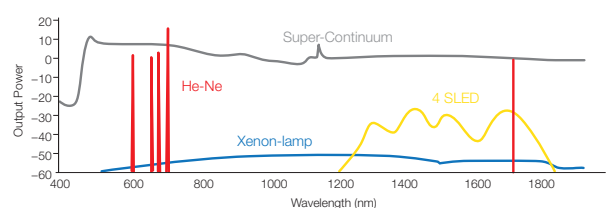

source: <http://www.nktp Photonics.com/supercontinuum>

Optical transceiver test

AQ6370D

In conjunction with bit error rate test (BERT) equipment, the AQ6370D can measure the center wavelength and spectral width of transceivers and LD modules. Various built-in analysis functions, such as DFB-LD, FP-LD (VCSEL), and LED facilitate the test process.



Characterization of sources used in laser Absorption Spectroscopy

AQ6375B
AQ6376

Laser Absorption Spectroscopy is a measurement technique used to detect and measure the concentration of gases in the air, and in open or closed environment. The lasers used in Absorption Spectroscopy require excellent single-mode operation performance, which directly determines the limits of detection. Furthermore such lasers should produce a

Visible LED test

AQ6373B AQ6374

The optical spectrum of visible LEDs used in lighting, signage, sensing and other applications can be measured and analyzed. By supporting the large core fiber input, AQ6373B and AQ6374 can efficiently get the LED light and measure its spectrum. The built-in Color Analysis function automatically evaluates the dominant wavelength, the chromatic coordinates and the color temperature of the source.

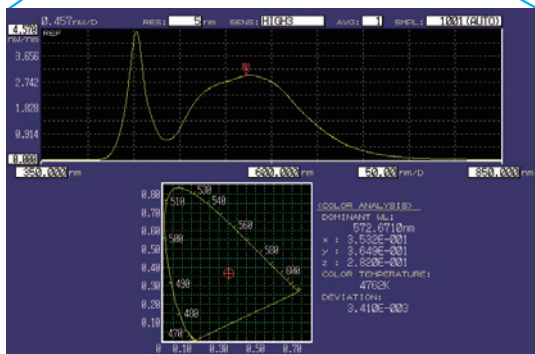
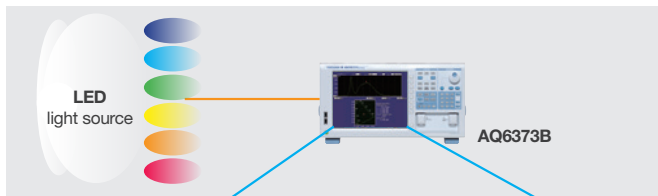

Example of color analysis with AQ6373B

Passive component test

In conjunction with a broadband light source such as ASE, SLD, SC light source, the OSA can simply perform evaluation of passive devices such as WDM filters and FBG. Superb optical characteristics of the AQ6370 series enable higher resolution and wider dynamic range measurements. The built-in optical filter analysis function simultaneously reports peak/bottom wavelength, level, crosstalk, and ripple width.

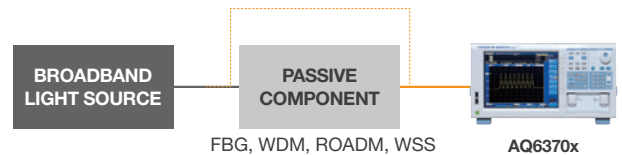

Loss wavelength characterization of optical fibers

AQ6374

The amount of the signal loss in a fiber is dependent on the propagation wavelength. Such dependency is caused by the typical absorption of optical fibers and by the effect of Rayleigh scattering. The material and type of fiber influence the loss values: in the case of a quartz single mode fiber, the loss around 1.55 μm is approx. 0.2 dB/km, which is the smallest reachable, while around 1.4 μm a bigger loss occurs due to water ions (OH). The loss wavelength characterization of this type of optical fiber requires measurements over a wide range of wavelengths.

In combination with a white light source, the AQ6374 efficiently measures the losses over a wide range of wavelengths. The loss value is displayed in terms of the loss per unit length of the optical fiber.

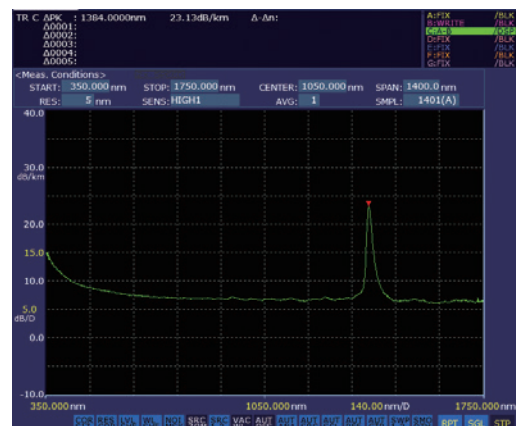

Measurement example of wavelength loss characterization with AQ6374

Characterization of Fiber Bragg Gratings

AQ6370D	AQ6373B	AQ6374
AQ6375B	AQ6376	

A Fiber Bragg Grating (FBG) is a type of distributed Bragg reflector constructed in a short segment of optical fiber that reflects particular wavelengths of light and transmits all the others. This is achieved by creating a periodic variation in the refractive index of the fiber core, which generates a wavelength specific dielectric mirror. A Fiber Bragg Grating can therefore be used as an inline optical filter to block certain wavelengths, or as a wavelength-specific reflector. The primary application of Fiber Bragg Gratings is in optical communications systems: they are specifically used as notch filters and they are also used in optical multiplexers and demultiplexers with an optical circulator, or optical add-drop multiplexer (OADM). Fiber Bragg Gratings tuned on 2-3 μm region are also used as direct sensing elements for strain and temperature in instrumentation applications such as seismology and in pressure sensors for extremely harsh environments. To characterize FBGs, the high wavelength resolution and high dynamic range of the AQ6370 series are indispensable.

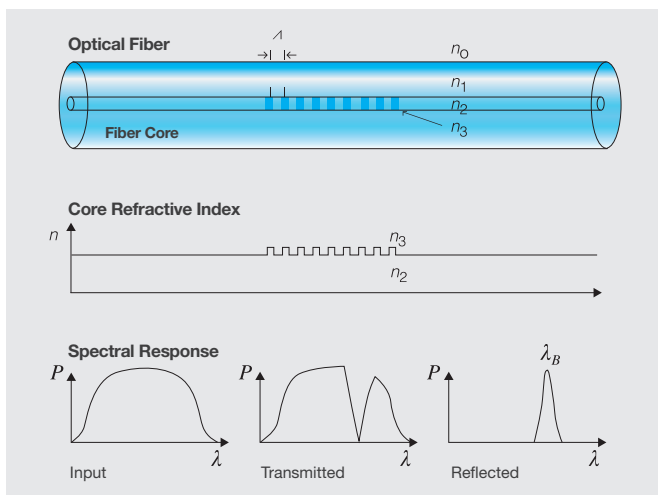

Gas detection and concentration measurements

AQ6370D	AQ6374
AQ6375B	AQ6376

Used together with a broadband light source like Super Continuum (SC) or Super Luminescent Diode (SLD), the AQ6370 series can show the absorption spectrum of the gas mixture under test.

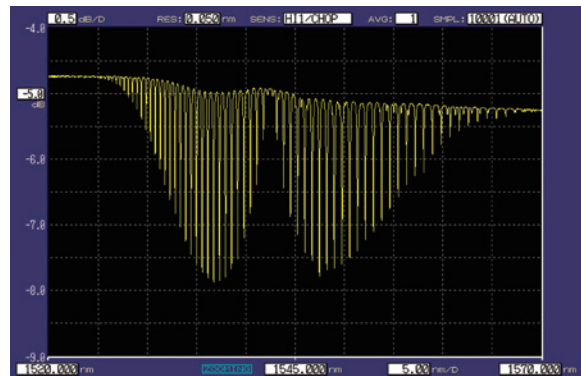

Hydrogen Cyanide H₁₃C₁₄N absorption spectrum measurement with AQ6375B

AQ6370D

The OSA market leader in the telecom Industry

Its flexibility in parameters' setting and its unmatched performance make the AQ6370D model the best choice for R&D and Production of optical communication devices.

Features

Wavelength range: 600 to 1700 nm

With its broad wavelength range coverage, AQ6370D is suitable to test devices designed for single-mode as well as multimode transmissions.

Standard- and high-performance models

There are two models available, with the high performance model providing even higher wavelength accuracy and dynamic range.

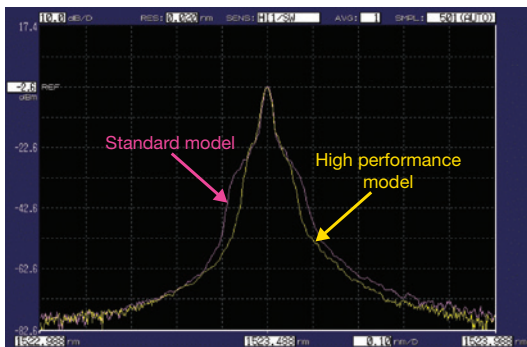

Example of the spectral shape

7 wavelength resolution settings: 20 pm to 2 nm

To enable the user to choose the best value according to the characteristics of the DUT.

7 level sensitivity settings: down to -90 dBm

To enable the user to choose the best value according to test applications and measurement speed requirements.

High close-in dynamic range: 78 dB typ.

With sharp spectral characteristics of the AQ6370D monochromator, signals in close proximity can be clearly separated and accurately measured.

Fast measurement: only 0.2 s for 100 nm span

With sensitivity set to NORM_AUTO (-70 dBm). Double speed mode increases the sweep speed up to 2 times compared to the standard sweep mode, with only a 2 dB penalty on the standard sensitivity value.

High wavelength accuracy: ± 0.01 nm

Easily maintained thanks to the built-in Calibration function and wavelength reference source (optional).

Wavelength range	Standard (-12)	High performance (-22)
1520 to 1580 nm	± 0.02 nm	± 0.01 nm
1580 to 1620 nm	± 0.02 nm	± 0.02 nm
1450 to 1520 nm	± 0.04 nm	± 0.04 nm
Full wavelength range	± 0.1 nm	± 0.1 nm

NOTE: AQ6370D model guarantees the high wavelength accuracy of ± 0.1 nm over the whole wavelength range from 600 nm to 1700 nm. In this manner Yokogawa supports customers with applications outside the C and L bands with highly reliable measurements.

High straylight suppression ratio: 80 dB typ.

The AQ6370D monochromator is specifically designed to offer excellent stray-light suppression capability without using the High Dynamic Mode setting which could increase the measurement time substantially when activated. Moreover, the AQ6370D is the first and only OSA in the world to guarantee the straylight suppression ratio specification.

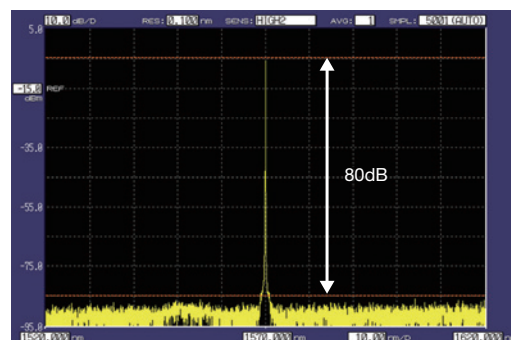

Straylight suppression ratio
(high dynamic mode: = off, high performance model)

Littrow light cancellation

The Littrow light is an artifact caused by a strong signal peak and appears at a wavelength about 200 nm below the actual signal peak. The advanced monochromator used in AQ6370D reduces the Littrow light appearance.

APC connector level correction function

Corrects the level offset caused by the higher insertion loss of Angled PC connectors.

15 built-in analysis functions for popular applications

AQ6373B

The high-performance model optimized for visible light measurement

Gate sampling function

Facilitates the recirculating loop testing of optical transmission systems. Using an external gate signal, the AQ6370D obtains the optical spectrum of the signal which is passing through a certain loop.

Resolution calibration function

Calibrates the resolution bandwidth with an external light source. With this new feature, the measurements of power spectral density of a broad spectrum light source will be more accurate.

With the ability to provide high speed, accurate analysis of the wavelength range between 350 nm and 1200 nm, The AQ6373B is well suited for a broad range of applications.

Features

Wavelength Range: 350 to 1200 nm

10 wavelength resolution settings: 10 pm to 10 nm

To enable the user to choose the best value according to the device/system under test.



405 nm FP-LD measurement
(resolution setting: 0.01 nm)

Wide measurable level range: -80 dBm to +20 dBm

To be suitable to measure high power as well as low power sources used in different fields of application.

Wavelength accuracy: ± 0.05 nm

The wavelength accuracy can be maintained by the calibration using an external light source including HeNe laser and Argon light source.

Close-in dynamic range: 60 dB

Special optical free space input

suitable also for LARGE-CORE fibers, up to 800 μm .

Smoothing function

Reduces the noise on the measured spectrum

Color analysis function

Enables the AQ6373B to show the chromatic coordinates of the light source under test.

AQ6374

The wide range model covering from visible light to communications wavelength

The AQ6374 covers a wide range of wavelengths from 350 to 1750 nm including the visible (from 380 to 780 nm) and the communications regions.

Features

Wavelength range: 350 to 1750 nm

8 wavelength resolution settings: 0.05 to 10 nm

To enable the user to choose the best value according to the device/system under test.

Wide measurable level range: -80 to +20 dBm

To be suitable to measure high power as well as low power sources used in different fields of application.

Wavelength accuracy: ± 0.05 nm

The wavelength accuracy can be maintained by the calibration using the built-in reference light source or an external light source including HeNe laser and Argon light source.

Close-in dynamic range: 60 dB

Fast measurement

The instrument takes only 0.5 s for 100 nm span (with sensitivity set to NORM_AUTO).

Number of sampling: 100001

The number of wavelength samples has been doubled. One sweep can measure a wider wavelength range at high resolution.

16 data analysis functions

DFB-LD analysis, Optical filter analysis, color analysis etc.

Purge feature

Built-in cut filter for high order diffracted light

The AQ 6374 automatically sets an internal optical filter according to the measurement wavelength range. The filter drastically reduces the influence of high order diffracted light on the measurement.

Other's functions

Data logging, smoothing and horizontal scale also in wave number (cm^{-1})

AQ6375B (2 μm)

The long wavelength model covering exNIR region

The AQ6375B covers not only telecommunication wavelengths, but also the exNIR region which is often used for environmental sensing and medical applications.

Features

Wavelength range: 1200 to 2400 nm

6 wavelength resolution settings: 50 pm to 2 nm

To enable the user to choose the best value according to the device/system under test.

Wide measurable level range: -70 to +20 dBm

To be suitable to measure high power as well as low power sources used in different fields of application. Sensitivity: HIGH1-3 are only high dynamic mode.

Wavelength accuracy: ± 0.05 nm

Easily maintained thanks to the built-in Calibration Function and wavelength reference source.

Close-in dynamic range: 55 dB

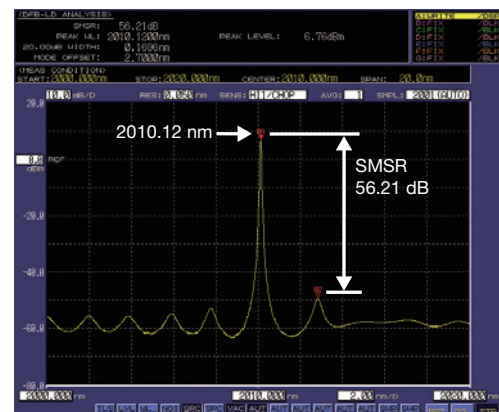

Measurement example of 2010 nm DFB-LD
(Res: 0.05 nm, Span: 20 nm)

Horizontal scale also in Wave Number (cm^{-1})

In addition to the commonly-used scales in wavelength (nm) and frequency (THz).

Purge feature

Built-in cut filter for high order diffracted light

The AQ6375B cuts incoming light below 1150 nm with the built-in filter. The filter drastically reduces the influence of high order diffracted light on the measurement.

AQ6376 (3 μm)

The long wavelength model covering MWIR region

The AQ6376 covers the MWIR region which is often used for environmental sensing and medical applications.

Features

Wavelength range: 1500 to 3400 nm

5 wavelength resolution settings: 0.1 to 2 nm

To enable the user to choose the best value according to the device/system under test.

Wide measurable level range: -65 to +13 dBm

To be suitable to measure high power as well as low power sources used in different fields of application. Sensitivity: HIGH1-3 are only high dynamic mode.

Wavelength accuracy: ± 0.5 nm

Easily maintained thanks to the built-in Calibration Function and wavelength reference source.

Close-in dynamic range: 55 dB

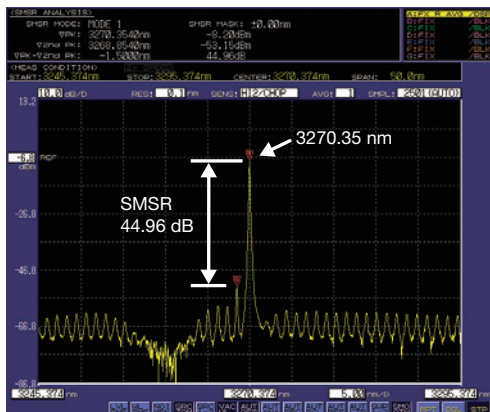

Measurement example of 3270 nm DFB-LD
(Res: 0.1 nm, Span: 50 nm)

Horizontal scale also in Wave Number (cm^{-1})

In addition to the commonly-used scales in wavelength (nm) and frequency (THz).

Purge feature

Built-in cut filter for high order diffracted light

The AQ 6376 automatically sets an internal optical filter according to the measurement wavelength range. The filter drastically reduces the influence of high order diffracted light on the measurement.

Accessories and related products

AQ6370 Series accessories and related products are available to fully support your testing needs.

NA Conversion Adapter

The Numerical Aperture (NA) Conversion Adapter is a unique adapter that reduces to half the NA of a connected fiber and is only applicable to the AQ6370 series in which free space optical input structure is used. With this adapter, the AQ6370 series improves the dynamic range (signal to noise ratio) in the passive component measurement and the level stability in the active device measurement.



Adapter Code	Applicable fiber	Wavelength range
735383-A001	Multimode fiber GI 50/125 μm	350 to 1700 nm
735383-A002	Multimode fiber GI 62.5/125 μm	350 to 1700 nm

AQ2200 Series

Multi-Application Test System (MATS)

The AQ2200 MATS is the ideal system for measuring and evaluating a wide range of optical devices and optical transmission systems.

A variety of measurement modules are available, including: high-stability light sources, high-speed optical sensors, high-resolution variable optical attenuators, low insertion loss optical switches and optical transceiver interfaces. These modules can be installed in any combination on a single platform, providing an ideal measurement system for a variety of applications.



AQ6150 Series Optical Wavelength Meters

The AQ6150 and AQ6151 Optical Wavelength Meters are fast, accurate and cost-effective instruments for carrying out measurements in the telecommunications wavelength range from 1270 to 1650 nm.



Specifications

AQ6370D

Items	Specifications	
Spec-code	Standard (-12)	High performance (-22)
Wavelength range ^{*1}	600 to 1700 nm	
Span ^{*1}	0.1 nm to 1100 nm (Full span), and 0 nm	
Wavelength accuracy ^{*1, *2, *5}	±0.02 nm (1520 to 1580 nm) ±0.02 nm (1580 to 1620 nm) ±0.04 nm (1450 to 1520 nm) ±0.10 nm (Full range)	±0.01 nm (1520 to 1580 nm) ±0.02 nm (1580 to 1620 nm) ±0.04 nm (1450 to 1520 nm) ±0.10 nm (Full range)
Wavelength linearity ^{*1, *2, *5}	±0.01 nm (1520 to 1580 nm), ±0.02 nm (1450 to 1520 nm, 1580 to 1620 nm)	
Wavelength repeatability ^{*1, *2}	±0.005 nm (1 min.)	
Wavelength resolution setting ^{*1, *2}	0.02, 0.05, 0.1, 0.2, 0.5, 1 and 2 nm	
Wavelength resolution bandwidth accuracy ^{*1, *2}	±5% (1450 to 1620 nm, Resolution setting: ≥ 0.1 nm, after performing the Resolution Calibration function, at the wavelength of resolution calibration)	
Min. sampling resolution ^{*1}	0.001 nm	
Number of sampling	101 to 50001, AUTO	
Level sensitivity setting	NORM_HOLD, NORM_AUTO, NORMAL, MID, HIGH1, HIGH2 and HIGH3	
High dynamic mode	SWITCH (Sensitivity: MID, HIGH1-3)	
Level sensitivity ^{*2, *3, *4, *7}	-90 dBm (1300 to 1620 nm), -85 dBm (1000 to 1300 nm), -60 dBm (600 to 1000 nm) (Sensitivity: HIGH3)	
Maximum input power ^{*2, *3}	+20 dBm (Per channel, full range)	
Maximum safe input power ^{*2, *3}	+25 dBm (Total input power)	
Level accuracy ^{*2, *3, *4, *6}	±0.4 dB (1310/1550 nm, Input level: -20 dBm, Sensitivity: MID, HIGH1-3)	
Level linearity ^{*2, *3}	±0.05 dB (Input level: -50 to +10 dBm, Sensitivity: HIGH1-3)	
Level flatness ^{*2, *3, *6}	±0.1 dB (1520 to 1580 nm), ±0.2 dB (1450 to 1520 nm, 1580 to 1620 nm)	
Polarization dependence ^{*2, *3, *6}	±0.05 dB (1550/1600 nm), ±0.08 dB (1310 nm)	
Dynamic range ^{*1, *2, *8}	Resolution: 0.02 nm	55 dB (Peak ±0.2 nm) 37 dB (Peak ±0.1 nm)
	Resolution: 0.05 nm	73 dB (Peak ±1.0 nm) 62 dB (Peak ±0.4 nm) 45 dB (Peak ±0.2 nm)
	Resolution: 0.1 nm	57 dB (Peak ±0.4 nm) 40 dB (Peak ±0.2 nm)
Stray-light suppression ratio ^{*7, *10}	73 dB	76 dB (Typ. 80 dB)
Optical return loss ^{*11}	Typ. 35 dB (with angled-PC connector)	
Applicable fiber	SM (9.5/125 μm), GI (50/125 μm, 62.5/125 μm), Large core fiber (up to 200 μm)	
Optical connector	Optical input: AQ9447 (□□) Connector adapter (option) required. Calibration output: AQ9441 (□□) Connector adapter (option) required. (□□) Connector type FC or SC	
Built-in calibration light source ^{*12}	Wavelength reference source (For optical alignment and wavelength calibration)	
Sweep time ^{*1, *7, *9}	NORM_AUTO: 0.2 s, NORMAL: 1 s, MID: 2 s, HIGH1: 5 s, HIGH2: 20 s, HIGH3: 75 s	
Warm-up time	Minimum 1 hour (After warming up, optical alignment adjustments required.)	

*1: Horizontal scale: Wavelength display mode.

*2: With 9.5/125 μm single mode fiber with a PC type connector, after 1 hour of warm-up, after optical alignment with built-in reference light source or a single longitudinal mode laser (wavelength 1520 to 1560 nm, peak level ≥ -20 dBm, level stability ≤ 0.1 dBpp, and wavelength stability ≤ ±0.01 nm).

*3: Vertical scale: Absolute power display mode, resolution setting: ≥ 0.05 nm, resolution correction: OFF.

*4: With 9.5/125 μm single mode fiber (B1.1 type defined on IEC60793-2, PC polished, mode field diameter: 9.5 μm, NA: 0.104 to 0.107).

*5: After wavelength calibration with built-in reference light source or a single longitudinal mode laser (wavelength 1520 to 1560 nm, peak level ≥ -20 dBm and absolute wavelength accuracy ±0.003 nm).

*6: Temperature condition changes to 23 ±3°C at 0.05 nm resolution setting.

*7: High dynamic mode: OFF, pulse light measurement mode: OFF, resolution correction: OFF.

*8: 1523 nm, high dynamic mode: SWITCH, resolution correction: OFF

*9: Span: ≤ 100 nm, number of sampling: 1001, average number: 1.

*10: With He-Ne laser (1523 nm), 0.1 nm resolution setting, 1520 nm to 1620 nm except for peak wavelength ±2 nm.

*11: With Yokogawa's master single mode fiber with an angled-PC connector. Typ. 15 dB with PC connector.

*12: Option.

"Typical" or "typ." in this document means "Typical value", which is for reference, not guaranteed specification.

AQ6373B

Items	Specifications
Wavelength range ^{*1}	350 to 1200 nm
Span ^{*1}	0.5 nm to 850 nm (Full span), and 0 nm
Wavelength accuracy ^{*1}	±0.05 nm (633 nm), ±0.20 nm (400 to 1100 nm) (After wavelength calibration with 633 nm He-Ne laser.)
Wavelength resolution setting ^{*1, *2}	0.02, 0.05, 0.1, 0.2, 0.5, 1, 2, 5, 10 nm (Full range), and 0.01 nm (400 to 470 nm)
Minimum sampling resolution ^{*1}	0.001 nm
Number of sampling	101 to 50001, AUTO
Level sensitivity setting	NORM_HOLD, NORM_AUTO, NORMAL, MID, HIGH1, HIGH2 and HIGH3
High dynamic mode	SWITCH (Sensitivity: MID, HIGH1-3)
Level sensitivity ^{*3}	-80 dBm (500 to 1000 nm), -60 dBm (400 to 500 nm, 1000 to 1100 nm) (Typical, Resolution setting: ≥ 0.2 nm, Averaging: 10 times, Sensitivity: HIGH3)
Maximum safe input power ^{*3}	+20 dBm (550 to 1100 nm), +10 dBm (400 to 550 nm) (Total input power)
Level accuracy ^{*2}	±1.0 dB (850 nm, Input level: -20 dBm, Resolution setting: ≥ 0.2 nm, Sensitivity: MID, HIGH1-3, SMF [MFD 5 μm@850 nm, NA0.14])
Level linearity ^{*3}	±0.2 dB (Input level: -40 to 0 dBm, Sensitivity: HIGH1-3)
Dynamic range ^{*1}	60 dB (Peak ±0.5 nm, Resolution: 0.02 nm, 633 nm)
Applicable fiber	SM, GI (50/125 μm, 62.5/125 μm), Large core fiber (up to 800 μm)
Optical connector	FC type (Optical input and Calibration output)
Built-in calibration light source	Optical alignment source (For optical alignment. Wavelength reference is not equipped.)
Sweep time ^{*1, *4}	NORM_AUTO: 0.5 s, NORMAL: 1 s, MID: 2 s, HIGH1: 5 s, HIGH2: 20 s, HIGH3: 75 s
Warm-up time	Minimum 1 hour (After warming up, optical alignment adjustment with built-in light source required.)

Performance and functions can be limited by type of used fiber. The specifications are only guaranteed when a single mode fiber in which light travels in single mode at measured wavelength is used. In case that measured wavelength is less than the cut-off wavelength of the used fiber, or a multimode fiber is used, a measured spectrum may be inaccurate due to a speckle noise. Please be cautious especially when measuring high coherency sources like gas laser and Laser diode.

*1: Horizontal scale: Wavelength display mode.

*2: Actual wavelength resolution varies according to a measured wavelength. Actual resolution at 10 nm resolution setting is about 8 nm at most.

*3: Vertical scale: Absolute power display mode.

*4: High dynamic mode: OFF, number of sampling: 1001, average number: 1,
span: ≤ 100 nm excluding 450 to 470 nm and 690 to 700 nm.

AQ6374

Items	Specifications
Wavelength range ^{*1}	350 to 1750 nm
Span ^{*1}	0.5 nm to 1400 nm (Full span), and 0 nm
Wavelength accuracy ^{*1, *2, *5}	±0.05 nm (633 nm) (After wavelength calibration with 633 nm He-Ne laser.), ±0.05 nm (1523 nm), ±0.20 nm (Full range)
Wavelength repeatability ^{*1, *2, *5}	±0.015 nm (1 min.)
Wavelength resolution setting ^{*1, *2}	0.05, 0.1, 0.2, 0.5, 1, 2, 5, 10 nm
Minimum sampling resolution ^{*1}	0.002 nm
Number of sampling	101 to 100001, AUTO
Level sensitivity setting	NORM_HOLD, NORM_AUTO, NORMAL, MID, HIGH1, HIGH2 and HIGH3
High dynamic mode	SWITCH (Sensitivity: MID, HIGH1-3)
Level sensitivity ^{*2, *3, *6}	-80 dBm (900 to 1600 nm), -70 dBm (400 to 900 nm) (Sensitivity: HIGH3)
Maximum safe input power ^{*2, *3}	+20 dBm (550 to 1750 nm), +10 dBm (400 to 550 nm) (Total input power)
Level accuracy ^{*2, *3, *4}	±1.0 dB (1550 nm, Input level: -20 dBm, Sensitivity: HIGH1-3)
Level linearity ^{*2, *3}	±0.2 dB (Input level: -40 to 0 dBm, Sensitivity: HIGH1-3)
Polarization dependence ^{*2, *3, *4}	±0.15 dB (1550 nm)
Dynamic range ^{*1, *2}	60 dB (Peak ±1.0 nm, Resolution: 0.05 nm, 633 nm/1523 nm)
Applicable fiber	SM (9.5/125 μm), GI (50/125 μm, 62.5/125 μm), Large core fiber (up to 800 μm)
Optical connector	Optical input: AQ9447 (□□) Connector adapter (option) required. Calibration output: AQ9441 (□□) Connector adapter (option) required. (□□) Connector type FC or SC
Built-in calibration light source	Wavelength reference source (For optical alignment and wavelength calibration)
Sweep time ^{*1, *6, *7}	NORM_AUTO: 0.5 s, NORMAL: 1 s, MID: 2 s, HIGH1: 5 s
Warm-up time	Minimum 1 hour (After warming up, optical alignment adjustment with built-in light source required.)

*1: Horizontal scale: Wavelength display mode.

*2: With 9.5/125 μm single mode fiber, after optical alignment with built-in reference light source, when the purge gas is not used.

*3: Vertical scale: Absolute power display mode, resolution setting: ≥ 0.2 nm

*4: With 9.5/125 μm single mode fiber (B1.1 type defined on IEC60793-2, PC polished,
mode field diameter: 9.5 μm, NA: 0.104 to 0.107).

*5: Resolution setting: 0.05 nm

*6: Pulse light measurement mode: OFF.

*7: Span: ≤ 100 nm (excluding 570 to 580 nm and 900 to 1080 nm), number of
sampling: 1001, average number: 1.

AQ6375B/AQ6376

Items	Specifications	
Model	AQ6375B	AQ6376
Wavelength range ^{*1}	1200 to 2400 nm	1500 to 3400 nm
Span ^{*1}	0.5 nm to 1200 nm (Full span), 0 nm	0.5 nm to 1900 nm (Full span), 0 nm
Wavelength accuracy ^{*1, *2, *5}	±0.05 nm (1520 to 1580 nm), ±0.10 nm (1580 to 1620 nm), ±0.50 nm (Full range)	±0.50 nm (Full range)
Wavelength repeatability ^{*1, *2}	±0.015 nm (1 min.)	
Wavelength resolution setting ^{*1, *2}	0.05, 0.1, 0.2, 0.5, 1 and 2 nm	0.1, 0.2, 0.5, 1 and 2 nm
Minimum sampling resolution ^{*1}	0.002 nm	0.003 nm
Number of sampling	101 to 50001, AUTO	
Level sensitivity setting	NORM_HOLD, NORM_AUTO, NORMAL, MID, HIGH1, HIGH2 and HIGH3 (Only High dynamic mode (/CHOP) in HIGH1-3)	
Level sensitivity ^{*2, *3, *4, *6}	-70 dBm (1800 to 2200 nm), -67 dBm (1500 to 1800 nm, 2200 to 2400 nm), -62 dBm (1300 to 1500 nm) (Sensitivity: HIGH3)	-65 dBm (1500 to 2200 nm), -55 dBm (2200 to 3200 nm), -50 dBm (3200 to 3400 nm) (Sensitivity: HIGH3)
Maximum input power ^{*2, *3}	+20 dBm (Per channel, full wavelength range)	+13 dBm (Per channel, full wavelength range)
Maximum safe input power ^{*2, *3}	+25 dBm (Total input power)	+20 dBm (Total input power)
Level accuracy ^{*2, *3, *4, *8}	±1.0 dB (1550 nm, input level: -20 dBm, Sensitivity: MID, HIGH1-3)	±1.0 dB (1550 nm, input level: -20 dBm, Sensitivity: HIGH1-3)
Level linearity ^{*2, *3}	±0.05 dB (Input level: -30 to +10 dBm, Sensitivity: HIGH1-3)	±0.2 dB (Input level: -30 to +10 dBm, Sensitivity: HIGH1-3)
Polarization dependence ^{*2, *3, *8}	±0.1 dB (1550 nm)	—
Dynamic range ^{*1, *2}	45 dB (Peak ±0.4 nm, Resolution: 0.05 nm), 55 dB (Peak ±0.8 nm, Resolution: 0.05 nm) (1523 nm, Sensitivity: HIGH1-3)	40 dB (Peak ±1 nm, Resolution: 0.1 nm), 55 dB (Peak ±2 nm, Resolution: 0.1 nm) (1523 nm, Sensitivity: HIGH1-3)
Applicable fiber	SM (9.5/125 μm), GI (50/125 μm, 62.5/125 μm)	
Optical connector	Optical input: AQ9447 (□□) Connector adapter (option) required. Calibration output: AQ9441 (□□) Connector adapter (option) required. (□□) Connector type FC or SC	
Built-in calibration light source	Wavelength reference source (For optical alignment and wavelength calibration)	
Sweep time ^{*1, *6, *7}	NORM_AUTO: 0.5 s, NORMAL: 1 s, MID: 2 s, HIGH1: 20 s	
Warm-up time	Minimum 1 hour (After warming up, optical alignment adjustment with built-in light source required.)	

*1: Horizontal scale: Wavelength display mode.

*2: With 9.5/125 μm single mode fiber, after 2 hours of warm-up, after optical alignment with built-in reference light source, when the purge gas is not used.

*3: Vertical scale: Absolute power display mode, resolution setting: ≥ 0.1 nm (AQ6375B)/ ≥ 0.2 nm (AQ6376).

*4: With 9.5/125 μm single mode fiber (B1.1 type defined on IEC60793-2, PC polished, mode field diameter: 9.5 μm, NA: 0.104 to 0.107).

*5: After wavelength calibration with built-in reference light source, sampling resolution: ≤ 0.003 nm (AQ6375B)/AUTO (AQ6376), sensitivity: MID, HIGH1-3

*6: Pulse light measurement mode: OFF.

*7: Span: ≤ 100 nm (The AQ6376 excluding 2200 to 2220 nm), number of sampling: 1001, average number: 1.

*8: Temperature condition changes to 23 ±3°C at 0.1 nm resolution setting (AQ6375B only).

General Functions

Items	Functions	
Measurement	Measurement mode	CW light, Pulsed light, External trigger, Gate sampling, Air/vacuum wavelength
	Sweep mode	Repeat, Single, AUTO (Self-configuration), Sweep between line markers, Zero span sweep (0 nm span), Data logging
	Condition settings	Center wavelength, Span, Number of sampling, Wavelength resolution, Sensitivity, High dynamic mode, Number of averaging (1 to 999 times), Double speed mode, Smoothing, APC level correction ^{*1} , Large core size fiber mode (A6373B/AQ6374 only)
	Others	Sweep status output, Analog output
Display	Vertical scale	Level scale (0.1 to 10 dB/div. and linear), Level subscale (0.1 to 10 dB/div. and linear), Reference level, Divisions (8, 10 or 12), power spectral density (dB/nm), dB/km, %, Noise mask
	Horizontal scale	Wavelength (nm), Frequency (THz), Wave number (cm ⁻¹) (AQ6374, AQ6375B and AQ6376), Trace zoom in/out
	Display mode & items	Normal display, Split display, Data table, Label, Template, Measurement conditions
Trace	Trace functions	7 independent traces, Maximum/Minimum hold, Calculation between traces, Normalizing, Curve fit, Peak curve fit, Marker curve fit, Roll averaging (2 to 100 times)
	Others	Trace copy/clear, Write/Fix setting, Display/Blank setting
Marker & Search	Marker	Delta markers (Max. 1024), Vertical/horizontal line markers, Advanced markers
	Search	Peak, Bottom, Next peak, Next bottom, Multi peak, Multi bottom, Auto-search (ON/OFF), Search between horizontal line markers, Search zoomed area
Data analysis	Analysis functions	Spectral width (threshold, envelope, RMS, peak-RMS, notch), WDM (OSNR) analysis, EDFA-NF analysis (excl. AQ6373B), Filter peak/bottom analysis, WDM filter peak/bottom analysis (excl. AQ6373B), DFB-LD/ FP-LD/ LED analysis, SMSR analysis, Power analysis, PMD analysis, Color analysis (AQ6373B/AQ6374 only), Pass/Fail analysis with template
	Others	Auto-analysis (ON/OFF), Analysis between horizontal line markers, Analysis in zoomed area
Automated measurement	Program function	64 programs, 200 steps per program
Other functions	Optical alignment	Auto-optical alignment with built-in light source or an external reference source.
	Wavelength calibration	Auto-wavelength calibration with built-in wavelength reference source (excl. AQ6373B) or an external wavelength reference source. Note. AQ6373B requires an external reference source for wavelength calibration.
	Resolution calibration ^{*1}	Resolution calibration with an external reference source.

*1: AQ6370D only

General Specifications

Items	Specifications	
Electrical interface	GP-IB, RS-232, Ethernet, USB, SVGA output, Analog output port, Trigger input port, Trigger output port	
Remote control ^{*1}	GP-IB, RS-232, Ethernet (TCP/IP), AQ6317 series compatible commands (IEEE488.1) and IEEE488.2	
Purge gas input/output terminals ^{*2}	Outer diameter 1/4 nylon tube (inch size)	
Data storage	Internal storage: 512 MBytes, Internal memory: 64 Traces, 64 programs, 3 template lines External storage: USB storage (memory/HDD), FAT32 format File types: CSV (text), Binary, BMP, TIFF	
Display ^{*3}	10.4-inch color LCD (Resolution: 800 × 600)	
Dimensions	426 (W) × 221 (H) × 459 (D) mm (Excluding protector and handle)	
Mass	AQ6370D/AQ6373B/AQ6374: 19 kg, AQ6375B/AQ6376: 23 kg	
Power requirements	100 to 240 V AC, 50/60 Hz, approx. 100 VA	
Environmental conditions	Performance guarantee temperature: +18 to +28°C, Operating temperature: +5 to +35°C Storage temperature: -10 to +50°C, Humidity: 20 to 80%RH (no condensation)	
Safety standards	EN 61010-1	
EMC	Laser ^{*4}	EN 60825-1:2014, IEC 60825-1:2007, GB 7247.1-2012 Class 1
	Immunity	EN 61326-1 Table 2
RoHS	EN 50581	
Recommended calibration period	1 year	

*1: Some AQ6317 series commands may not be compatible due to changes in specifications or functions.

*2: AQ6374, AQ6375B and AQ6376

*3: Liquid crystal display may include a few defective pixels (within 0.002% with respect to the total number of pixels including RGB). There may be a few pixels on the liquid crystal display that do not emit all the time or remains ON all the time. These are not malfunctions.

*4: With built-in calibration light source

Dimensions

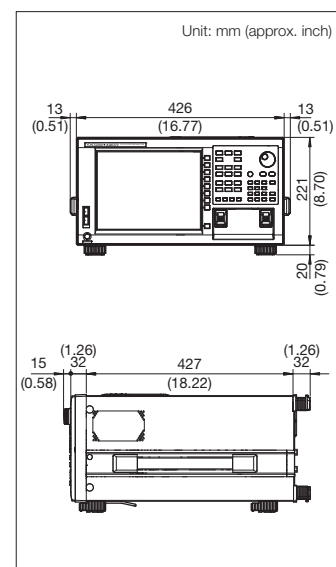

Model and Suffix code

AQ6370D

Model	Suffix	Descriptions	
AQ6370D		AQ6370D Optical Spectrum Analyzer	
Spec code	-12	Standard model	
	-22	High performance model	
Built-in light source	-L0	Without light source	
	-L1	Wavelength reference source	
Power cord	-D	UL/CSA standard and PSE compliant, 125 V	
	-F	VDE/Korean standard, 250 V	
	-R	Australian standard, 250 V	
	-H	Chinese standard, 250 V	
	-Q	British standard, 250 V	
	-N	Brazilian standard, 250 V	
	-T	Taiwanese standard, 125 V	
	-B	Indian standard, 250 V	
	-U	IEC Plug Type B, 250 V	
Factory installed options	/FC	AQ9447 (FC) Connector Adapter	For Optical Input
	/SC	AQ9447 (SC) Connector Adapter	
	/RFC	AQ9441 (FC) Connector Adapter	For Calibration Output
	/RSC	AQ9441 (SC) Connector Adapter	

AQ6373B

Model	Suffix	Descriptions
AQ6373B		AQ6373B Optical Spectrum Analyzer
Spec code	-12	Standard model
Built-in light source	-L1	Optical alignment source
Power cord	-D	UL/CSA standard and PSE compliant, 125 V
	-F	VDE/Korean standard, 250 V
	-R	Australian standard, 250 V
	-H	Chinese standard, 250 V
	-Q	British standard, 250 V
	-N	Brazilian standard, 250 V
	-T	Taiwanese standard, 125 V
	-B	Indian standard, 250 V
	-U	IEC Plug Type B, 250 V

AQ6374/AQ6375B/AQ6376

Model	Suffix	Descriptions	
AQ6374		AQ6374 Optical Spectrum Analyzer	
AQ6375B		AQ6375B Optical Spectrum Analyzer	
AQ6376		AQ6376 Optical Spectrum Analyzer	
Spec code	-10	Standard model	
Built-in light source	-L1	Wavelength reference source	
Power cord	-D	UL/CSA standard and PSE compliant, 125 V	
	-F	VDE/Korean standard, 250 V	
	-R	Australian standard, 250 V	
	-H	Chinese standard, 250 V	
	-Q	British standard, 250 V	
	-N	Brazilian standard, 250 V	
	-T	Taiwanese standard, 125 V	
	-B	Indian standard, 250 V	
	-U	IEC Plug Type B, 250 V	
Factory installed options	/FC	AQ9447 (FC) Connector Adapter	For Optical Input
	/SC	AQ9447 (SC) Connector Adapter	
	/RFC	AQ9441 (FC) Connector Adapter	For Calibration Output
	/RSC	AQ9441 (SC) Connector Adapter	

Factory Installed Options

Optical Connector Adapters

(AQ6370D, AQ6374, AQ6375B and AQ6376)



For optical input port
AQ9447 Connector Adapter
/SC, /FC

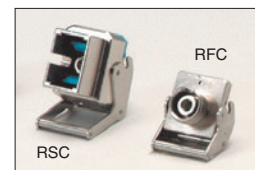

For calibration output port
AQ9441 Connector Adapter
/RSC, /RFC

Accessories (optional)

Model	Suffix	Descriptions
735371		AQ6370 Viewer (For the AQ6360 and all the AQ6370 series models)
AQ9447		AQ9447 Connector Adapter
	Connector type	-FCC FC type -SCC SC type
AQ9441		AQ9441 Connector Adapter
	Connector type	-FCC FC type -SCC SC type
735383		NA Conversion Adapter (for GI50/125 μm) -A001 -A002 NA Conversion Adapter (for GI62.5/125 μm)
751535	-E5	Rack mount kit (inch type)

■ Microsoft, MS, and Windows are registered trademarks or trademarks of Microsoft Corporation in the US and other countries. LabVIEW is a U.S. registered trademark of National Instruments. Other company names and product names appearing in this document are the registered trademarks of their respective companies.

NOTICE

- Before operating the product, read the user's manual thoroughly for proper and safe operation.

■ Any company's names and product names mentioned in this document are trade names, trademarks or registered trademarks of their respective companies.

Yokogawa's Approach to Preserving the Global Environment

- Yokogawa's electrical products are developed and produced in facilities that have received ISO14001 approval.
- In order to protect the global environment, Yokogawa's electrical products are designed in accordance with Yokogawa's Environmentally Friendly Product Design Guidelines and Product Design Assessment Criteria.

This is a Class A instrument based on Emission standards EN61326-1 and EN55011, and is designed for an industrial environment. Operation of this equipment in a residential area may cause radio interference, in which case users will be responsible for any interference which they cause.

YOKOGAWA

<https://tmi.yokogawa.com/>

YMI-KS-MI-SE07

YOKOGAWA TEST & MEASUREMENT CORPORATION

Global Sales Dept. /Phone: +81-422-52-6237 E-mail: tm@cs.jp.yokogawa.com
Facsimile: +81-422-52-6462

The contents in this catalog is as of April 2019. Subject to change without notice.

Copyright © 2014, Yokogawa Test & Measurement Corporation

[Ed: 09/b]

Printed in Japan, 903(KP)

YOKOGAWA CORPORATION OF AMERICA

Phone: +1-800-888-6400 E-mail: tmi@us.yokogawa.com

YOKOGAWA EUROPE B.V.

Phone: +31-88-4641429 E-mail: tmi@nl.yokogawa.com

YOKOGAWA TEST & MEASUREMENT (SHANGHAI) CO., LTD.

Phone: +86-21-6239-6363 E-mail: tmi@cs.cn.yokogawa.com

YOKOGAWA ELECTRIC KOREA CO., LTD.

Phone: +82-2-2628-3810 E-mail: TMI@kr.yokogawa.com

YOKOGAWA ENGINEERING ASIA PTE. LTD.

Phone: +65-6241-9933 E-mail: TMI@sg.yokogawa.com

YOKOGAWA INDIA LTD.

Phone: +91-80-4158-6396 E-mail: tmi@in.yokogawa.com

YOKOGAWA ELECTRIC CIS LTD.

Phone: +7-495-737-78-68 E-mail: info@ru.yokogawa.com

YOKOGAWA AMERICA DO SUL LTDA.

Phone: +55-11-3513-1300 E-mail: tm@br.yokogawa.com

YOKOGAWA MIDDLE EAST & AFRICA B.S.C(c)

Phone: +973-17-358100 E-mail: help.ymatmi@bh.yokogawa.com Facsimile: +973-17-336100

Facsimile: +86-21-6880-4987

Facsimile: +82-2-2628-3899

Facsimile: +65-6241-9919

Facsimile: +91-80-2852-1442

Facsimile: +7-495-737-78-69

Facsimile: +973-17-336100